

28 November 2014

T. Scott Dixon
Department of Philosophy
University of California, Davis

What Is the Well-Foundedness of Grounding?^{1,2}

(Forthcoming in *Mind*)

1. Introduction

A number of philosophers think that grounding is, in some sense, well-founded.³ This thesis, however, is not always articulated precisely, nor is there a consensus in the literature as to how it should be characterized.⁴ In what follows, I consider several principles that one might have in mind when asserting that grounding is well-founded, and I argue that one of these principles, which I call ‘full foundations’, best captures the relevant claim. My argument is by the process of elimination. For each of the inadequate principles, I illustrate its inadequacy by showing either that it excludes cases that should not be ruled out by a well-foundedness axiom for grounding, or that it admits cases that should be ruled out.

For simplicity, I call those who think that grounding is well-founded ‘(metaphysical) foundationalists’, and the view they espouse ‘(metaphysical) foundationalism’.⁵ Before introducing any of the principles, it will be helpful to consider some examples of foundationalists, and to discuss the role that foundationalism plays in their philosophical views. This will provide an idea of what is at stake when it comes to the question of whether or not grounding is well-founded. Before this, however, I’ll characterize grounding itself, and introduce some other useful notions.

Following Gideon Rosen (2010: 115), I take the fundamental notion of grounding to be that of

¹Thanks to Michael Bench-Capon, Cody Gilmore, Tim Houk, Matt Leonard, Stephan Leuenberger, Ulrich Meyer, Daniel Nolan, Jonathan Schaffer, Adam Sennet, Scott Shalkowski, Ted Shear, audiences at the 2013 Center for Metaphysics and Mind Graduate Conference at University of Leeds and the 2014 APA Pacific Division Meeting, and several anonymous referees for extremely helpful comments and discussion.

²After I wrote this paper, I learned that many of the central arguments and conclusions are arrived at independently by Brian Rabern and Gabriel Rabin (manuscript).

³For endorsements of this thesis, see Brzozowski 2008: 199-201, Schaffer 2010: 37 and 61-65, and Bennett 2011: 30-31. These endorsements will be discussed in more detail below. Lowe (1998: 158) endorses the thesis that a similar notion, existential dependence, is well-founded.

⁴For some characterizations of the thesis, see Cameron 2008: 2-3 and 4, Orilia 2009: 333-34, Fine 2010: 100, Rosen 2010: 116, Schaffer 2010: 37, Bennett 2011: 30, Bliss 2013: 416 and 2014: 247, Trogdon 2013b: 108, Morganti 2014: 232-33, and Tahko 2014: 259-61.

⁵These terms are inspired by, but characterized a bit differently from, the terminology found in Schaffer 2010: 37, Bliss 2013: 416 and 2014: 245, Morganti 2014: 232-33, and Tahko 2014: 259.

full grounding, which I assume to be an asymmetric (and hence irreflexive) and transitive relation that holds exclusively among facts. I express full grounding claims as instances of the following schema.

x is fully grounded by Γ ,

where ‘ x ’ is a singular variable and ‘ Γ ’ is a plural one. I allow a single object to be assigned to any plural term, and assume that, for any Γ , there is an x such that x is among Γ . That is, I assume that there are no empty pluralities. Roughly, for x to be fully grounded by some facts is for these facts to be metaphysically prior to x and to provide a complete non-causal explanation of x . It is typically understood to require, among other things, that the facts metaphysically necessitate x (although metaphysical necessitation is not *sufficient* for grounding).⁶ Consider an example. The fact that grass is green and snow is white is fully grounded by the fact that grass is green together with the fact that snow is white.⁷

I will also make heavy use of the notion of *partial grounding*, which is standardly defined in terms of full grounding as follows.

Partial Grounding. x is partially grounded by $\Gamma =_{df}$ there are Δ such that (i) x is fully grounded by Δ and (ii) Γ are among Δ .⁸

If x is fully grounded by Γ , then x is partially grounded by Γ , since, for all Γ , Γ are among Γ . So the fact that grass is green and snow is white is partially, as well as fully, grounded by the fact that grass is green together with the fact that snow is white. But it’s not true, in general, that if x is partially grounded by Γ , then x is fully grounded by Γ . If x is partially, but not fully, grounded by some facts Γ , then Γ provide a partial, but not full, non-causal explanation of x . For example, the fact that grass is green and snow is white is partially, but not fully, grounded by the fact that grass is green.⁹

⁶See, for example, Witmer et al. 2005: 332, Trogon 2009: 128 and 2013a, deRosset 2010: 91, Rosen 2010: 118, Bennett 2011: 36, Correia 2011: 3, Audi 2012b: 697, Fine 2012b: 1, Raven 2012: 690-91, and Bliss 2014: 147.

⁷While I take the fundamental notion of grounding to be expressed by a predicate rather than an operator, what is said below will be of interest to those who work in an operator framework as well. See Correia 2010: 253-54 for a discussion of the difference between operationalist and predicationalist conceptions of grounding. It will also be of interest to those who work in a predicationalist framework but think that grounding may hold between things other than facts. See, for example, Schaffer 2009: 375-76.

⁸See Rosen 2010: 115, Audi 2012b: 698, Fine 2012a: 50, and Raven 2013: 194 for endorsements of this definition.

⁹See Audi 2012b: 698 and Fine 2012a: 50 and 2012b: 3-5 for more discussion on the difference between full and partial grounding. I have Fine’s notion of a strict ground in mind, rather than weak ground. See Fine 2012a: 51-53 and 2012b: 3-7.

In what follows, I allow singular as well as plural terms to fill the second argument places of both the full and partial grounding predicates. Similarly, I allow singular as well as plural terms to flank the ‘is/are among’ predicate. I also allow the construction of complex plural terms from simpler singular or plural terms via lists. So, for example, ‘ x, y ’, ‘ x, Γ ’, and ‘ Γ, Δ ’ are all plural terms.

I capture the transitivity of grounding with the following axiom governing full grounding.

Full Transitivity. For any x, y, Γ , and Δ , if x is fully grounded by y, Γ and y is fully grounded by Δ , then x is fully grounded by Γ, Δ .¹⁰

The transitivity of partial grounding follows from full transitivity.¹¹ I capture the asymmetry of grounding with the following axiom governing partial grounding.

Partial Asymmetry. For any x and y , if x is partially grounded by y , then y is not partially grounded by x .

The irreflexivity of partial grounding follows from partial asymmetry, as does the asymmetry and irreflexivity of full grounding.¹²

In addition to these two axioms and the notion of partial grounding, it will be helpful to have several other concepts on hand. First, I distinguish between *fundamental* and *non-fundamental* facts. Let ‘ \mathbf{F} ’ plurally denote the domain of facts.

Fundamentality. x is fundamental $=_{df}$ (i) x is among \mathbf{F} and (ii) there are no Γ such that x is partially grounded by Γ .¹³

A non-fundamental fact is just a fact which is not fundamental. The notion of a *grounding structure* will also be useful.

Grounding Structures. Γ are a grounding structure $=_{df}$ (i) Γ are among \mathbf{F} and (ii) there are x and y among Γ such that x is partially grounded by y .

¹⁰I take (FT) from Rosen 2010: 116. See Correia 2010: 262 and 2011: 3 for operationalist versions of this principle. The operationalist version is derivable in Fine’s system PLG as well. See Fine 2012b: 6.

¹¹It is worth noting that there are philosophers who reject the claim that even partial grounding is transitive. In particular, see Schaffer 2012.

¹²There are also philosophers who reject the irreflexivity of grounding and similar dependence relations. See Jenkins 2011. Barnes (manuscript) argues against the claim that a similar notion, ontological dependence, is asymmetric.

¹³Adapted from Schaffer 2009: 373.

Hasse diagrams will be useful for representing grounding structures. In such diagrams, each node represents an individual fact, and a dashed line running in a downward direction from a node x to another node y (which may run through multiple other nodes) indicates that x is partially grounded by y . As a matter of convention, I assume that, in any given diagram, the only grounding claims that hold are those that are either depicted or implied by those depicted along with the definition of partial grounding and full transitivity. *Fig. 1* and *Fig. 2* depict grounding structures. *Fig. 3* does not.

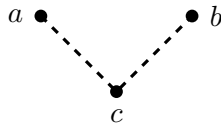

Fig. 1

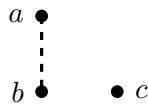

Fig. 2

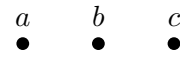

Fig. 3

Grounding structures will be important in what follows. Each of the candidate well-foundedness axioms will be assessed on the basis of which grounding structures it admits, and which it excludes.

Another notion that will be useful in what follows is that of a *grounding chain*.

Grounding Chains. Γ are a grounding chain =_{df} (i) Γ are a grounding structure and (ii) grounding is connected over Γ ,

where

Connectedness. A binary relation R is connected over Γ =_{df} for any x and y among Γ , either Rxy , Ryx , or $x = y$.¹⁴

Grounding chains are depicted in *Fig. 4* and *Fig. 5*.



Fig. 4

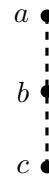

Fig. 5

Note that *Fig. 5* depicts four grounding chains: a, b ; b, c ; a, c ; and a, b, c . The grounding structures depicted in *Fig. 1* and *Fig. 2* are not grounding chains, since grounding is not connected over

¹⁴See Paseau (2010: 172) for a notion that is similar to a grounding chain, which he calls a ‘path’.

either of them. (It should be noted, however, that they *include* some.) Nor is the structure depicted in *Fig. 3* a grounding chain, since it fails to qualify even as a grounding structure.

The grounding chains depicted in *Fig. 4* and *Fig. 5* are examples of chains that *terminate*.

(Downwardly) Terminating Grounding Chains. Γ are a (downwardly) terminating grounding chain =_{df} (i) Γ are a grounding chain and (ii) some y among Γ partially grounds every other x among Γ .¹⁵

Fig. 6 depicts a non-terminating grounding chain.

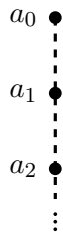

Fig. 6

A characteristic feature of chains that do *not* terminate is that, no matter which fact one chooses in such a chain, there will be another fact in that chain that partially grounds the chosen fact.

2. Foundationalism and Its Application

I am now in a position to introduce some examples of foundationalists, and to discuss the role that foundationalism plays in their philosophical views. As mentioned, this will provide an idea of what is at stake when it comes to the question of whether or not grounding is well-founded. I begin with Jonathan Schaffer, who writes,

If one thing exists only *in virtue of* another, then there must be something from which the reality of the derivative entities ultimately derives. (Schaffer 2010: 37, italics in the original)

Otherwise, he says,

Being would be infinitely deferred, never achieved. (Schaffer 2010: 62)

¹⁵Grounding chains may terminate *upwardly* or *downwardly*. I define only the notion of downward termination, since only it is relevant to the issue of the well-foundedness of grounding.

Schaffer (2010: 61-65) employs foundationalism as a premise in an argument for priority monism, the view that the universe fully grounds each of its proper parts.¹⁶ This view is to be contrasted with pluralism, according to which the universe is fully grounded by any proper parts which together compose it. Monism can easily handle the possibility of gunky objects without abandoning the well-foundedness of grounding, where

Gunk. x is gunky =_{df} every part of x has a proper part.¹⁷

Granted, the universe would have infinitely many proper parts if it contained gunky objects. But each such part would be fully grounded by the universe. The pluralist, on the other hand, faces problems. Schaffer discusses several strategies the pluralist might employ in an attempt to accommodate the possibility of gunky objects. Each of these strategies, Schaffer points out, puts the pluralist in an awkward position. Of relevance to the issue at hand is the strategy in which the pluralist admits the possibility of non-terminating grounding chains. But this, Schaffer notes, contradicts the claim that grounding is well-founded. As Schaffer doesn't think any of the other strategies are successful either, he finds reason to prefer monism to pluralism.

Jacek Brzozowski (2008) also endorses foundationalism. He considers the question of whether, in general, the fact that a composite object has the location it does is fully grounded by the fact that the parts which compose that object have the locations they do. He thinks that either way one answers this question, one faces a problem. The problem associated with the affirmative answer is of particular relevance to the issue at hand. In effect, Brzozowski argues that if the locations of composite objects are derived from the locations of their parts, then the possibility of gunky objects implies that grounding is not well-founded. And since grounding *is* well-founded, gunky objects with locations can't exist. Brzozowski provides support for this last premise in the following passage.

Imagine someone who holds that whenever a is F , a 's being F is derived from a 's standing in an instantiation relation R to F . And then they add that a and F standing in the instantiation relation R is derived from a , F , and R standing in the instantiation relation R^* ; and that a , F , R , standing in R^* is derived from all those standing in R^{**} , and so on ad infinitum. This regress would certainly be vicious, as the entire series of instantiations would be grounded in nothing at all. In effect, this story leaves open the explanatory task of telling us how the instantiation of F by a even gets off the ground. (Brzozowski 2008: 199-200)

¹⁶I must shelve the assumption that grounding holds only between facts when describing Schaffer's view.

¹⁷From Lewis 1991: 20.

Brzozowski and Schaffer, then, employ foundationalism for similar ends.

Karen Bennett (2011) also appears to endorse foundationalism. Bennett seeks to assuage concerns about the intelligibility of grounding. These concerns are based on the thought that grounding can be neither fundamental nor grounded by something. One reason Bennett mentions for thinking that grounding cannot be fundamental is that grounding connects the fundamental to the non-fundamental. This is at odd's with Ted Sider's *purity principle*: "fundamental truths involve only fundamental notions" (2011: 106). According to this principle, grounding cannot be fundamental, since truths involving that notion by necessity involve non-fundamental notions.

There is also reason, however, to think that grounding can't be non-fundamental. Bennett discusses two allegedly vicious regresses that would result if it were. The bulk of Bennett's paper is devoted to arguing that neither of these regresses is in fact vicious, concluding that it is possible for grounding to be non-fundamental, and thus saving grounding from the threat of unintelligibility. One of these regresses, which Bennett calls the 'fact regress', would allegedly arise if, in general, the fact that x is grounded by y must itself be grounded by something distinct from either x or y . Bennett alleges that if this were true, and at least one thing grounded another, an infinite series of facts would arise, each grounded by another in the series.¹⁸ Bennett concludes that the existence of such a series would constitute a violation of the well-foundedness of grounding.

The central problem [with the fact regress] is that requiring a ground for every grounding fact violates the well-foundedness of the grounding relation. If every grounding fact is grounded, there are priority chains that are not only infinitely long, but which also fail to terminate or 'ground out' in something ungrounded. (Bennett 2011: 30)

So it appears that Bennett too would assent to the claim that grounding is well-founded. I now turn to considering the several principles that the foundationalist might have in mind when she says that grounding is well-founded.

3. Full Foundations: An Adequate Well-Foundedness Axiom for Grounding

The principle that best captures the claim that grounding is well-founded has not, to my knowledge, been discussed in the literature.¹⁹

(FS) Every non-fundamental fact x is fully grounded by some fundamental facts Γ .

¹⁸See Dixon manuscript a and Rabern and Rabin manuscript for reasons to think that this allegation is false.

¹⁹An equivalent principle is considered by Rabern and Rabin (manuscript). They and I arrived at it independently.

The adequacy of (FS) as a well-foundedness axiom for grounding may be related to its capturing an informal principle one might endorse about the behavior of grounding: that the derivative must have its source in, or acquire its being from, the non-derivative. But the best way to see that (FS) is the correct well-foundedness axiom for grounding is to consider the most plausible alternatives to it, and to see why each is inadequate.

4. Terminating Chains

The first alternative principle the foundationalist might adopt as a well-foundedness axiom for grounding is suggested by some language used by Lowe (1998: 158), Schaffer (2010: 37), and Bennett (2011: 30).²⁰

(S) Every grounding chain terminates.

Neither Lowe, Schaffer, nor Bennett provide definitions for the term ‘grounding chain’ or ‘terminates’, so they may have something different in mind. But, given the above definitions of those terms, which seem to be the most natural ones available, (S) cannot function as an adequate well-foundedness axiom for grounding. It excludes the following type of grounding structure, which shouldn’t be ruled out by such an axiom. I call such structures *fully pedestalled grounding chains*. (FS), in contrast, admits these structures.

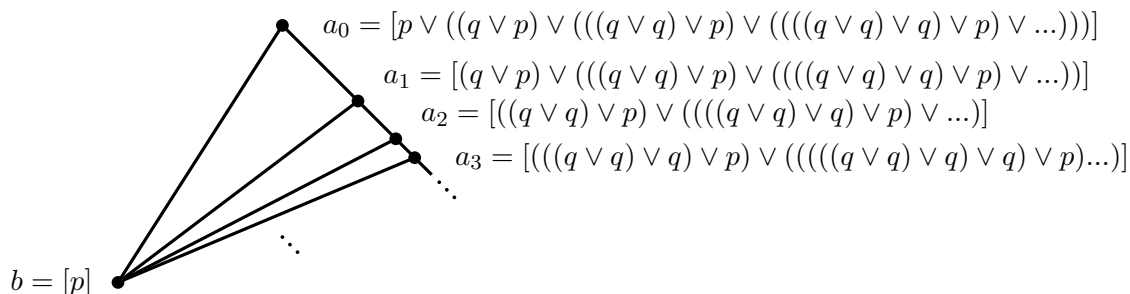

Fig. 7 A Fully Pedestalled Chain

In this diagram and those to follow, I distinguish full grounding from partial grounding by representing the former with solid lines. $\lceil \varphi \rceil$ abbreviates ‘the fact that φ ’.

Each fully pedestalled chain contains a non-terminating grounding chain, and is such that each non-fundamental fact it includes is fully grounded by the same fundamental facts. In the fully

²⁰As mentioned in fn. 3, Lowe’s discussion is framed in terms of existential dependence, rather than grounding.

pedestalled chain depicted in *Fig. 7*, each a_i is fully grounded by each a_{i+1} , and is also fully grounded by b . b is fundamental. Because each fully pedestalled chain contains a non-terminating grounding chain (such as $a_i, a_{i+1}, a_{i+2}, \dots$ for each $i \in \mathbb{N}$ in *Fig. 7*), each such structure is excluded by (S). Yet one might think that examples of such grounding structures are metaphysically possible.²¹

Before considering examples of fully pedestalled chains, it is worth noting that, because every non-fundamental fact in each fully pedestalled chain is fully grounded by some fundamental facts, (FS) admits such structures. In the fully pedestalled chain depicted in *Fig. 7*, the only non-fundamental facts are the a_i 's for all $i \in \mathbb{N}$. And each is fully grounded by b , which is fundamental. So (FS) admits grounding structures excluded by (S). As it turns out, (S) implies (FS).²² As a result, (FS) is strictly weaker than that (S).

I now consider two potential examples of fully pedestalled chains. As shown in *Fig. 7*, a fully pedestalled chain results if one admits infinite disjunctions, conceived as the result of an infinite number of applications of a binary operation, given a true proposition and the standard principles governing the interaction of grounding and disjunction.

- (**VI-L**) If φ (and $[\varphi] \neq [\varphi \vee \psi]$), then $[\varphi \vee \psi]$ is fully grounded by $[\varphi]$.
- (**VI-R**) If ψ (and $[\psi] \neq [\varphi \vee \psi]$), then $[\varphi \vee \psi]$ is fully grounded by $[\psi]$.²³

Consider the sentences ‘grass is green’ and ‘snow is red’. By (VI-L), [grass is green or ((snow is red or grass is green) or ((snow is red or snow is red) or grass is green) or ...)] is fully grounded by [grass is green]. Also by (VI-L), [(snow is red or grass is green) or ((snow is red or snow is red) or grass is green) or ...] is fully grounded by [snow is red or grass is green]. And by (VI-R), [snow is red or grass is green] is fully grounded by [grass is green]. With these claims in place, full transitivity (see section 1) guarantees that [(snow is red or grass is green) or ((snow is red or snow is red) or grass is green) or ...] is fully grounded by [grass is green]. Things will go similarly for the rest of the infinite disjunctions. As a result, this grounding structure, if it exists, qualifies as a

²¹Cameron (2008: 4), Orilia (2009: 334, fn. 2), Bliss (2013: 416) and (2014: fn. 9), and Trogdon (2013b: 108) appear to recognize the possibility of grounding structures of this sort.

²²I omit a proof of this claim. It requires the principle of dependent choices. See Jech 2006: 50.

²³Adapted from Correia 2010: 267 and 2011: 5, Rosen 2010: 117, Schnieder 2011: 449, and Fine 2012a: 58. The parenthetical restriction is necessary, since, if, for example, $[p] = [p \vee q]$, then (VI-L) would yield the result that $[p \vee q]$ is partially grounded by $[p \vee q]$, or, equivalently, $[p]$ is partially grounded by $[p]$. This would violate the irreflexivity of grounding. For an endorsement of an operationalist version of this restriction, see Correia 2010: 268.

fully pedestalled chain.^{24,25}

For those who are uncomfortable with infinite disjunctions conceived in this way, consider the following example. The international prototype kilogram (IPK) is a solid platinum-iridium cylinder located near Paris, which acts as the standard for the kilogram. As such, it is exactly 1 kg in mass.²⁶ Thus the fact that the IPK is exactly 1 kg in mass exists. Suppose that things have their maximally determinate masses fundamentally. Now, there is an infinite number of closed intervals within the interval [0 kg, 2 kg], each of which includes 1 kg. This means that there is an infinite number of facts of the form \lceil the fact that the IPK is between x kg and y kg in mass \rceil , where the interval $[x$ kg, y kg] includes 1 kg and is within the interval [0 kg, 2 kg]. Consider the (countably) infinite subset of those facts that is suggested by the following elliptical list.

- $a_0 =$ [the IPK is between 0 kg and 2 kg in mass]
- $a_1 =$ [the IPK is between 0.5 kg and 1.5 kg in mass]
- $a_2 =$ [the IPK is between 0.75 kg and 1.25 kg in mass]
- $a_3 =$ [the IPK is between 0.875 kg and 1.125 kg in mass]
- \vdots

One might think that the following two principles hold.

(M1) For any positive real numbers x , y , z , and w , if the closed interval $[z$ kg, w kg] is within the closed interval $[x$ kg, y kg], then the fact [the IPK is between x kg and y kg in mass] is fully grounded by the fact [the IPK is between z kg and w kg in mass].

²⁴Thanks to Cody Gilmore for this example. One might wonder why the disjuncts must be so complex. Why wouldn't one simply want to choose $[p \vee (p \vee (p \vee \dots))]$ for a_0 ? By (VI-L), this fact will be fully grounded by $[p]$. Note, however, that by (VI-R), this fact will also be fully grounded by $[p \vee (p \vee \dots)]$. While this might seem at first glance to be a different fact than the first disjunction, it is not. Each expression begins with an occurrence of ' $p \vee$ ' followed by a countably infinite number of occurrences of ' $(p \vee$ ', followed by a countably infinite number of occurrences of ')', and ended by an occurrence of ']'. As a result, this example would result in a violation of irreflexivity. Fine (2012a) both endorses (VI-L) and (VI-R) (58) and admits infinite disjunctions (60-62). A person in Fine's position, and who further conceives of infinite disjunctions as the result of an infinite number of applications of a binary operation, must restrict admissible infinite disjunctions to those which do not result in violations of irreflexivity. Fortunately, there is independent reason to think that such infinite disjunctions do not exist, as they would have themselves as proper parts. (More thanks to Cody Gilmore for this point.) The same goes for infinite conjunctions, of course.

²⁵Some have expressed concerns about conceiving of infinite disjunctions (and conjunctions) as the result of an infinite number of applications of a binary operation. I admit, this is not the standard in infinitary logic. They are usually conceived as the result of a single application of an operation that takes an infinite number of arguments. (See, for example, Scott and Tarski 1958: 166, Karp 1964: 1, Barwise 1968: 2, and Green 1975: 77.) Given (VI-L) and (VI-L), infinite disjunctions and conjunctions still give rise to non-terminating grounding chains on this conception. Traditionally, the disjunction of a countably infinite number of propositions, like p_0, p_1, p_2, \dots , is denoted $[\bigvee\{p_0, p_1, p_2, \dots\}]$. According to this conception, $[p_0 \vee (p_1 \vee (p_2 \vee \dots))]$ = $[\bigvee\{p_0, p_1, p_2, \dots\}]$. By (VI-L), then, $[\bigvee\{p_0, p_1, p_2, \dots\}]$ is fully grounded by $[p_0]$, and by (VI-L), it is fully grounded by $[p_1 \vee (p_2 \vee (p_3 \vee \dots))]$. And since $[p_1 \vee (p_2 \vee (p_3 \vee \dots))]$ = $[\bigvee\{p_1, p_2, p_3, \dots\}]$, $[\bigvee\{p_0, p_1, p_2, \dots\}]$ is fully grounded by $[\bigvee\{p_1, p_2, p_3, \dots\}]$. Continuing this process will obviously result in a non-terminating grounding chain.

²⁶Apologies to Wittgenstein (1953: §50).

(M2) For any positive real numbers x and y , if 1 kg is within the closed interval [x kg, y kg] and $x \neq y$, then the fact [the IPK is between x kg and y kg in mass] is fully grounded by the fact [the IPK is exactly 1 kg in mass].

(M1) delivers special cases of an object's instantiating less determinate properties being grounded by its instantiating more determinate ones. (M2) delivers special cases of an object's instantiating a determinate property being fully grounded by its instantiating a maximally determinate one. If one adopts these principles, and countenances the facts in the above list, the resulting grounding structure qualifies as a fully pedestalled chain. Each fact in the list is fully grounded by each of those below it, as well as by [the IPK is exactly 1 kg in mass] (= b).²⁷

Before moving on to a discussion of the next alternative principle the foundationalist might adopt as a well-foundedness axiom for grounding, it is worth addressing some concerns one might have about these examples. First, each of them involves overdetermination of grounds. But this is not cause for great concern. If disjunctive and general existential facts exist, cases of overdetermination abound. Second, it is worth noting that each of the examples is consistent with the definition of partial grounding. In each example, each non-fundamental fact in the structure is fully grounded by every fact by which it is partially grounded. As a result, whenever x is partially grounded by y , there are Δ such that x is fully grounded by Δ and y is among Δ . In particular, x is fully grounded by y (and y is among y).

Finally, the reader may have noticed that these examples rely on a rather abundant and fine-grained conception of facts. The same is true of those to come. While these examples, and those to come, probably do not require the precise conception of facts I have in mind, it may nevertheless be helpful to set out this conception explicitly. I understand facts to be structural complexes, having constituents that are arranged in a certain way. In particular, according to this conception, facts have particulars, properties, relations, connectives (or their semantic values), quantifiers (or their semantic values), etc., as constituents. Facts can differ because their constituents differ, or because, while they have the same constituents, these constituents are arranged in different ways in the relevant facts. Indeed, I even take facts to differ if they have different numbers of *occurrences*

²⁷It may be that [the IPK is between x kg and y kg in mass] is fully grounded by [the IPK is between z kg and w kg in mass] *only together with* [the closed interval [z kg, w kg] is within the closed interval [x kg, y kg]], and that it is fully grounded by [the IPK is exactly 1 kg in mass] *only together with* [1 kg is between x kg and y kg]. However, the grounding structure that results from these additions still qualifies as a fully pedestalled chain.

of a given constituent. So, for example, $[p \vee p] \neq [p \vee (p \vee p)]$.²⁸ (Such cases are just special cases of differences in arrangement.) I also work with a rather abundant and fine-grained view of properties and relations, according to which a great many predicates express a property. It should be clear by this point that I take facts to be individuated almost as finely as sentences. See Rosen 2010: 114-15 for a statement of a very similar conception of facts.

I recognize that many people will be uncomfortable with a conception of facts that is as abundant and fine-grained as the view just described. Given a sufficiently sparse or coarse-grained view of facts, it may appear less important to distinguish between different potential well-foundedness axioms for grounding. For example, if someone does not countenance disjunctive facts, she may not be convinced by the first example that (S) is inadequate.²⁹ And if she doesn't countenance facts involving determinable properties, she may not be convinced by the second example. For such a person, (S) might appear to suffice as a well-foundedness axiom for grounding. But there are at least some adherents to the abundant, fine-grained view of facts as well, such as Rosen (2010: 114-15), and it is a more difficult question which axiom one should choose on such a view.

Furthermore, even if one does adhere to a sparse or coarse-grained view of facts, the impossibility of certain grounding structures, like the examples of fully pedestalled chains presented above, is best understood to be the result of the particular conception of facts with which one works, and not the result of a violation of the well-foundedness of grounding. Whether a certain principle correctly captures the well-foundedness of grounding should not depend upon how one conceives of facts. Instead, if possible, there should be a single well-foundedness axiom for everyone. Those with a sparse or coarse-grained conception of facts can still rule out the grounding structures they find objectionable. But for these philosophers, it will be their conception of facts, rather than a well-foundedness axiom for grounding, that rules out the relevant structures. In light of these considerations, when undertaking an investigation into the nature of the well-foundedness of grounding, it is better to work with the abundant, fine-grained view of facts, rather than a sparse or coarse-grained one, at least if a complete investigation is to be assured. For this reason, the examples above suffice to show that (S) cannot function as an adequate well-foundedness axiom for

²⁸Thanks to Cody Gilmore and an anonymous referee for this example.

²⁹Armstrong (1997: 1 and 19) and Audi (2012a: 114-15) are among those who express skepticism about disjunctive facts. Audi (2013) argues that there are no disjunctive properties, and thinks that *ipso facto* there are no disjunctive facts either (see Audi 2012a: 115).

grounding.

5. The Definition of Well-Foundedness

The second alternative principle the foundationalist might adopt is considered by Trogdon (2013b: 108) and Tahko (2014: 260).

(WF) Every non-empty set of facts has a minimal ground,

where

Minimal Grounds. S has a minimal ground $=_{df}$ there is a $y \in S$ such that, for every $x \in S$, y is not partially grounded by x .

This principle is attractive because it is a straightforward application of the standard mathematical definition of a well-founded relation to grounding.³⁰

A binary relation R is well-founded on a set $S =_{df}$ every non-empty subset of S has a minimal element with respect to R , i.e., for every non-empty $T \subseteq S$, there is an $x \in T$ such that for every $y \in T$, it is not the case that Ryx .

The problem with (WF) is that, given how I have defined grounding chains and termination, it is equivalent to (S).³¹ While it isn't easy to see that these two principles are equivalent, it is relatively easy to see that (WF), like (S), excludes fully pedestalled chains. Consider the one depicted in *Fig. 7*. Any subset $\{a_i, a_{i+1}, a_{i+2}, \dots\}$, for any $i \in \mathbb{N}$, fails to have a minimal ground. This is because, for any fact a_i one picks in any such set, there will be a fact that partially grounds it, namely, a_j for any $j > i$. (WF), then, fares no better than (S).

6. Maximal Chains

The third alternative principle the foundationalist might adopt is considered by Cameron (2008: 4) and Trogdon (2013b: 108), though they state it differently.

(M) Every maximal grounding chain terminates,

³⁰Strictly speaking, then, grounding is well-founded just in case it satisfies (WF) or an equivalent principle. The sense in which I use the term throughout this paper, of course, is less strict, and refers to the several characterizations of the notion the foundationalist might have in mind.

³¹I omit a proof of this claim. It requires the principle of dependent choices. See Jech 2006: 50.

where

(Downwardly) Maximal Grounding Chains. Γ are a (downwardly) maximal grounding chain $=_{df}$ (i) Γ are a grounding chain and (ii) there is no y that partially grounds every x among Γ .^{32,33}

Like (FS), (M) has an advantage over (S) and (WF), since it admits fully pedestalled chains. While these grounding structures contain an infinite number of non-terminating grounding chains, none of them is maximal. Consider the fully pedestalled chain depicted in *Fig. 7*. Each non-terminating grounding chain $a_i, a_{i+1}, a_{i+2}, \dots$ for any $i \in \mathbb{N}$ in that structure is non-maximal, since something, b , fully, and so partially, grounds every fact in each of those chains. The only maximal grounding chains in that structure, on the other hand, like a_0, a_1, a_2, \dots, b and a_1, a_2, a_3, \dots, b , terminate at b .

The ability of (M) to accommodate such structures may be related to its capturing another informal principle, different from the one captured by (FS), that one might endorse about the behavior of grounding: that all dependence must trace to an ultimate source. Grounding would certainly trace to an ultimate source if every maximal grounding chain were downwardly finite (like the chains depicted in *Figs. 4* and *5*). Grounding would also trace to an ultimate source if some maximal chains were infinite, but each of them terminated (as is the case with pedestalled chains). The only way grounding would not always trace to an ultimate source is if there existed a maximal non-terminating grounding chain (like the chain depicted in *Fig. 6*). And (M), unlike (S) or (WF), excludes only those grounding structures that contain such chains. In fact, because every maximal chain is a chain, each of (S) and (WF) implies (M). And because (M) admits grounding structures excluded by (S) and (WF) (fully pedestalled chains), (M) is strictly weaker than each of those principles.

³²Grounding chains may be *upwardly* or *downwardly* maximal. I define only the notion of downward maximality, since only it is relevant to the issue of the well-foundedness of grounding. Roughly, the (downwardly) maximal grounding chains are just the chains that “reach down the farthest” among all the facts partially ordered by grounding. Thanks to Stephan Leuenberger (personal communication) for bringing my attention to this sense of a maximal grounding chain, and to this intuitive formulation of the principle. Note that a maximal chain is defined differently in Bliss 2013: 416.

³³(M) is equivalent to the following principle.

(L) Every grounding chain Γ has a lower bound,

where

Lower Bounds. x is a lower bound of $\Gamma =_{df}$ every y among Γ is identical to or partially grounded by x .

Trogon (2013b: 108) formulates the principle in this way. Rabern and Rabin (manuscript) formulate it in a similar way. I omit a proof that (M) and (L) are equivalent. It requires the axiom of choice, and is a bit more straightforward if one uses the equivalent Hausdorff maximal principle. See Hausdorff 1962: 197-98 and Frink 1952.

Despite these considerations, the foundationalist should not be satisfied with (M), since it admits grounding structures that should be ruled out by a well-foundedness axiom for grounding. I call these structures (*properly*) *partially pedestalled chains*. (FS) excludes them.

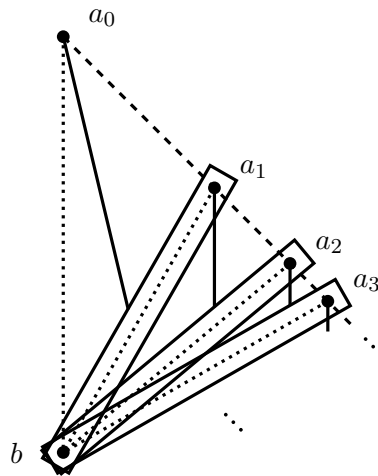

Fig. 8 A (Properly) Partially Pedestalled Chain

In this diagram and those to follow, I distinguish *proper* partial grounding claims (partial grounding claims that are not also full grounding claims) from partial grounding claims (partial grounding claims that may be either properly partial or full) by representing the former with dotted (rather than dashed) lines. When there is more than one fact among Γ , I indicate that x is fully grounded by Γ by connecting x via a solid line to a solid box that encloses the facts among Γ .

Each partially pedestalled chain contains a non-terminating grounding chain, and is such that each non-fundamental fact included in any non-terminating chain in each such structure is partially *but not fully* grounded by the same fundamental facts, and is fully grounded by those fundamental facts together with a non-fundamental fact lower than it in any non-terminating chain in the structure which includes it. This last feature ensures that any such structure will satisfy the definition of partial grounding.³⁴ Further, at least one non-fundamental fact in each partially pedestalled chain fails to be fully grounded by any fundamental facts. For this reason, (FS) excludes such grounding structures. In the partially pedestalled chain depicted in *Fig. 8*, each a_i is partially

³⁴Full transitivity guarantees that each fact a_i in any non-terminating grounding chain $a_j, a_{j+1}, a_{i+2}, \dots$ of any partially pedestalled chain is fully grounded by a_k, b for each $k > i$, and not just by a_{i+1}, b . Since it is guaranteed by full transitivity, I do not include this requirement in the general characterization of partially pedestalled chains. It is enough, to satisfy the definition of partial grounding, that each non-fundamental fact is fully grounded by *some* facts, whichever facts they may be.

(perhaps fully) grounded by each a_{i+1} , is partially, but not fully, grounded by b , and is fully grounded by a_{i+1}, b . b is fundamental. *None* of the a_i 's are fully grounded by any fundamental facts.

(M), in contrast, admits partially pedestalled chains. Since some facts, which happen to be fundamental, partially ground every fact in each non-terminating chain in any partially pedestalled chain, none of those chains is maximal. Every maximal chain in any partially pedestalled chain terminates (at each of those fundamental facts). In the grounding structure depicted in *Fig. 8*, the non-terminating grounding chains, $a_i, a_{i+1}, a_{i+2}, \dots$ for each $i \in \mathbb{N}$, aren't maximal, since b partially grounds every fact in every such chain. The only maximal chains in that structure, on the other hand, like a_0, a_1, a_2, \dots, b and a_1, a_2, a_3, \dots, b , terminate at b . There is reason, however, to think that an adequate well-foundedness axiom for grounding should exclude partially pedestalled chains. In what follows, I will show this by way of a specific example of such a grounding structure.

I will show that a version of the *ground-theoretic instantiation regress*, if it existed, would be an example of a partially pedestalled chain. A version of this regress unfolds when one assumes that $F(a)$, and endorses every instance of the following schema.

(IR) For any x_0, x_1, \dots, x_n , if $R(x_0, x_1, \dots, x_n)$, then $[R(x_0, x_1, \dots, x_n)]$ is fully grounded by $[x_0, x_1, \dots, x_n$ instantiate R -ness (in that order)].

These two assumptions result in an infinite number of grounding claims, which are suggested by the following elliptical list.

1. $[Fa]$ is fully grounded by $[a$ instantiates F ness].
2. $[a$ instantiates F ness] is fully grounded by $[a$ and F -ness instantiate instantiation].
3. $[a$ and F -ness instantiate instantiation] is fully grounded by $[a, F$ -ness, and instantiation instantiate instantiation].
- ⋮

Often, during presentations of the instantiation regress, a different instantiation predicate is posited at each step in the regress, which has an adicity of one more than the adicity of the predicate at the previous step. This is done to remain neutral about the identity of the instantiation relations that appear predicatively at each step in the regress.³⁵ For simplicity, I assume that there is just

³⁵For examples, see Brzozowski 2008: 199-200 and Cameron 2008: 2. Nolan 2008: 178 and Schnieder 2004: 227 also do this in their initial presentations of a non-ground-theoretic version of the instantiation regress.

one instantiation relation, and that it is variably polyadic.

So far, the instantiation regress looks only like a non-terminating grounding chain, not a partially pedestalled chain. I call this the *naïve version*, and I take it for granted that the foundationalist will want her well-foundedness axiom to rule out such a structure. But now consider another version of the regress, according to which the instantiation regress qualifies as a partially pedestalled chain. I'll call this the *sophisticated version*. The foundationalist will not be happy with structures like it either.

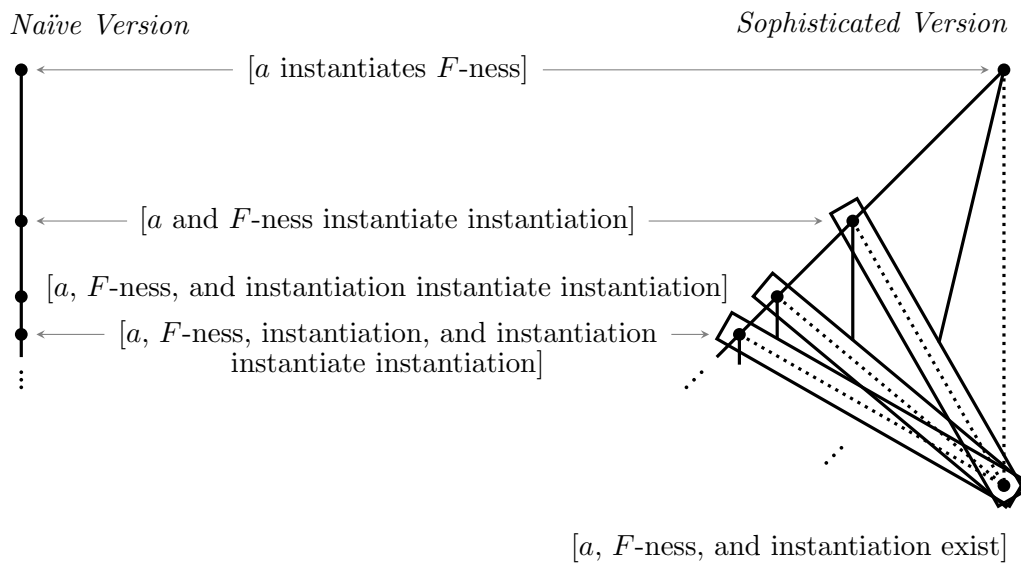

Fig. 9 Two Versions of the Ground-Theoretic Instantiation Regress

In addition to the facts that appear in the naïve version, the sophisticated version includes the facts $[a \text{ exists}]$, $[F\text{-ness exists}]$, and $[\text{instantiation exists}]$. Each of these facts is fundamental, and partially, but not fully, grounds each fact in the non-terminating chain. I leave $[Fa]$ out of consideration for simplicity. I do not mean to imply that it too is partially grounded by $[\text{instantiation exists}]$. To simplify the diagram, I merge these three facts into one in Fig. 9, $[a, F\text{-ness, and instantiation exist}]$, and suppose that it is fundamental.

In both versions of the instantiation regress, some non-fundamental fact fails to be fully grounded by any fundamental facts. Indeed, in both versions, *every* such fact fails in this respect. In the naïve version, no such fact is even partially grounded by any fundamental fact. In the sophisticated version, each fact in the chain is partially, *but not fully*, grounded by some fundamental facts, namely, $[a \text{ exists}]$, $[F\text{-ness exists}]$, and $[\text{instantiation exists}]$. The only facts which fully ground

any fact in the chain are either non-fundamental, or include at least one non-fundamental fact. [a instantiates F -ness], for example, is fully grounded by [a and F -ness instantiate instantiation]. But the latter is not fundamental. [a instantiates F -ness] is also fully grounded by [a and F -ness instantiate instantiation] together with [a exists], [F -ness exists], and [instantiation exists]. But again, one of the facts in that list is not fundamental. Thus, the sophisticated version of the instantiation regress, if it existed, would be an example of a partially pedestalled chain.³⁶

The foundationalist’s attitude toward the naïve version of the regress is that it is metaphysically impossible, and violates the intended well-foundedness axiom for grounding, whatever that axiom turns out to be.³⁷ The foundationalist ought to make the same diagnosis of the sophisticated version. After all, why should the addition of the given fundamental facts make any difference to the foundationalist? None of these fundamental facts, independently or jointly, manage to fully ground any of the non-fundamental facts in the regress. The non-fundamental facts that failed to “fully ground out in the fundamental” in the naïve version still fail to do so in the sophisticated version. Assuming, then, that the foundationalist’s well-foundedness axiom needs to rule out the sophisticated version of the instantiation regress, and partially pedestalled chains more generally, one may conclude that (M) is not the intended axiom. (FS), however, does better in this respect.

7. Weakly Maximal Chains.

Before the fourth alternative principle can be introduced, a couple of definitions are required.

Final Segments. Δ are a final segment of $\Gamma =_{df}$ (i) Γ are a grounding chain, (ii) Δ are among Γ , and (iii) every x among Γ , but not among Δ , is partially grounded by every y among Δ .

³⁶One might be concerned that, for example, [a instantiates F -ness] is fully grounded by [a and F -ness instantiate instantiation], together with b , while it is also fully grounded by [a and F -ness instantiate instantiation] alone. Audi (2012b: 699), for example, adopts a principle, which he calls “minimality”, which rules out situations like this.

Minimality. For any x and Γ , if x is fully grounded by Γ , then there are no Δ such that x is fully grounded by Δ and Γ are properly among Δ ,

where

Proper Inclusion. Γ are properly among $\Delta =_{df}$ (i) Γ are among Δ and (ii) there is an x such that x is among Δ and x is not among Γ .

There is reason, however, to think that minimality is false. Consider [grass is green & grass is colored]. Plausibly, it is fully grounded by [grass is green], [grass is colored], as well as by [grass is green] alone. See Dixon manuscript b for a more detailed discussion.

³⁷For some endorsements of the claim that a version of the instantiation regress is vicious, see Armstrong: 1978: 70, Brzozowski 2008: 200-201 and Cameron 2008. While Audi (2012a: 112-13) does not explicitly state that it is vicious, it is implicit in his discussion.

Weakly (Downwardly) Maximal Grounding Chains. Γ are a weakly (downwardly) maximal grounding chain $=_{df}$ (i) Γ are a grounding chain and (ii) there are no Δ that fully ground every x among any final segment of Γ .

To avoid confusion, the notion of maximality introduced in the last section can officially be known as ‘strong maximality’. Note that any grounding chain that is strongly maximal is weakly maximal. But a chain can be weakly maximal without being strongly maximal.

The fourth alternative principle the foundationalist might adopt as a well-foundedness axiom for grounding may now be introduced. It is not, to my knowledge, considered anywhere in the literature. It was suggested to me, in a different guise, by Stephan Leuenberger (personal communication), as an alternative to (M) that excludes partially pedestalled chains.³⁸

(WM) Every weakly maximal grounding chain terminates.

Like (FS) and (M), (WM) has an advantage over (S) and (WF), since it admits fully pedestalled chains. Every weakly maximal chain in such structures terminate. Consider the fully pedestalled chain depicted in *Fig. 7*. The only weakly maximal grounding chains, $a_i, a_{i+1}, a_{i+2}, \dots, b$ for each $i \in \mathbb{N}$, terminate at b . So (WM) admits structures excluded by (S) and (WF). Moreover, since every weakly maximal grounding chain is a grounding chain, each of (S) and (WF) implies (WM). As a result, (WM) is strictly weaker than each of those principles.

Like (FS), (WM) has an advantage over (M) as well, since it excludes partially pedestalled chains, and thus does what a well-foundedness axiom ought to do about such structures. Partially pedestalled chains contain weakly maximal non-terminating grounding chains. Consider the one depicted in *Fig. 8*. No Δ fully ground each a_i for $i \in \mathbb{N}$ (b partially, but not fully, grounds each of them). As a result, the chains $a_j, a_{j+1}, a_{j+2}, \dots$ for each $j \in \mathbb{N}$ are weakly maximal. Those chains, however, fail to terminate. So (WM) excludes structures admitted by (M). And since every (strongly) maximal grounding chain is weakly maximal, (WM) implies (M). As a result, (M) is strictly weaker than (WM). So (WM) implies the informal principle about grounding captured by (M): that all dependence must trace to an ultimate source. But it guarantees more: not only must chains that are (strongly) maximal terminate; ones that are merely weakly maximal must terminate as well. For this reason, (WM) might be attractive to those who are inclined towards that informal

³⁸A weakly maximal grounding chain, as defined above, is nothing other than a *maximal w-sequence* in Leuenberger’s (2014, pp. 170–71) terminology.

principle about grounding, but who also think that partially pedestalled chains are metaphysically impossible.

Despite these considerations, (WM) also fails to capture the well-foundedness of grounding, since it excludes the following type of grounding structure, which shouldn't be ruled out by a well-foundedness axiom. I call such structures *fully crutched chains*. (FS), in contrast, admits these structures.

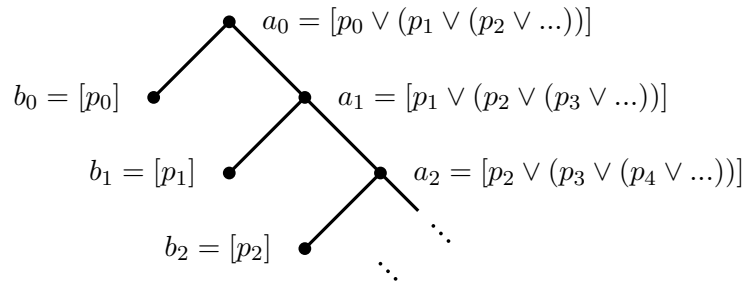

Fig. 10 A Fully Crutched Chain

Any fully crutched chain contains a non-terminating grounding chain, and is such that each non-fundamental fact included in any non-terminating chain in each such structure is fully grounded by some fundamental facts. The non-fundamental facts in a given non-terminating chain in such a structure are fully grounded by different fundamental facts. Specifically, for each non-fundamental fact x in each fully crutched chain, there are fundamental facts Γ that fully ground x , none of which partially grounds any non-fundamental fact that partially grounds x . In the fully crutched chain depicted in Fig. 10, each a_i is fully grounded by a_{i+1} , and is also fully grounded by b_i . Each b_i is fundamental, and no a_j is fully, or even partially, grounded by b_i where $j > i$. Because each fully crutched chain contains (strongly) maximal non-terminating grounding chains ($a_i, a_{i+1}, a_{i+2}, \dots$ for each $i \in \mathbb{N}$ in Fig. 10), and because each (strongly) maximal chain is weakly maximal, each such structure is excluded by (WM). Yet one might think that examples of such grounding structures are metaphysically possible.

Before considering examples of fully crutched chains, it is worth noting that, because every non-fundamental fact in each fully crutched chain is fully grounded by some fundamental facts, (FS) admits such structures. In the fully crutched chain depicted in Fig. 10, the only non-fundamental facts are the a_i 's for all $i \in \mathbb{N}$. And each a_i is fully grounded by each b_j for all $j \geq i$, each of which is fundamental. So (FS) admits grounding structures excluded by (WM). As it turns out, (WM)

implies (FS).³⁹ As a result, (FS) is strictly weaker than (WM). It is worth noting that (M) too excludes fully crutched chains, since they contain (strongly) maximal non-terminating grounding chains. So (FS) admits grounding structures excluded by (M). But, as I showed in the last section, (M) admits structures excluded by (FS) (partially pedestalled chains). (M) and (FS), then, are logically independent.

I now consider two potential examples of fully crutched chains. As shown in *Fig. 10*, a fully crutched chain results if one admits infinite disjunctions, conceived as the result of an infinite number of applications of a binary operation, given the principles (VI-L) and (VI-R) and a countably infinite number of true propositions, where each of these propositions corresponds to a unique fundamental fact. Consider a specific example. Suppose there are at least a countably infinite number of spacetime points, s_0, s_1, s_2, \dots , and consider the facts suggested by the following elliptical list.

$$\begin{aligned} b_0 &= [s_0 \text{ exists}] \\ b_1 &= [s_1 \text{ exists}] \\ b_2 &= [s_2 \text{ exists}] \\ &\vdots \end{aligned}$$

Suppose further that each of these facts is fundamental. By (VI-L), $[s_0 \text{ exists or } (s_1 \text{ exists or } (s_2 \text{ exists or } \dots))]$ is fully grounded by $[s_0 \text{ exists}]$. $[s_1 \text{ exists or } (s_2 \text{ exists or } (s_3 \text{ exists or } \dots))]$ is fully grounded by $[s_1 \text{ exists}]$. $[s_2 \text{ exists or } (s_3 \text{ exists or } (s_4 \text{ exists or } \dots))]$ is fully grounded by $[s_2 \text{ exists}]$. And so on. By (VI-R), $[s_0 \text{ exists or } (s_1 \text{ exists or } (s_2 \text{ exists or } \dots))]$ is fully (and so partially) grounded by $[s_1 \text{ exists or } (s_2 \text{ exists or } (s_3 \text{ exists or } \dots))]$. $[s_1 \text{ exists or } (s_2 \text{ exists or } (s_3 \text{ exists or } \dots))]$ is fully (and so partially) grounded by $[s_2 \text{ exists or } (s_3 \text{ exists or } (s_4 \text{ exists or } \dots))]$. And so on. As a result, this structure, if it exists, qualifies as a fully crutched chain.⁴⁰

Here's a more concrete example. Consider a world with countably infinitely many mereologically simple objects, o_0, o_1, o_2, \dots . Suppose that o_0 has a mass of exactly 1 kg, and, for each o_i , o_i is twice the mass of o_{i+1} , and that these things have their maximally determinate masses fundamentally.

Then consider the facts suggested by the following elliptical lists.

³⁹I omit a proof of this claim. It requires the axiom of choice, and is more straightforward if one uses the equivalent Hausdorff maximality principle.

⁴⁰Audi (2012a: 103 and 115 and 2012b: 700-01) is skeptical of existential facts as well as disjunctive ones. While the facts in this example, and some of those to come, are existential, there are ways to adapt the examples to avoid this. For instance, 'exists' might be replaced with 'is a spacetime point' in the example above.

$a_0 =$ [something with a non-zero mass of at most 1 kg exists]
 $a_1 =$ [something with a non-zero mass of at most 0.5 kg exists]
 $a_2 =$ [something with a non-zero mass of at most 0.25 kg exists]
 \vdots
 $b_0 =$ [o_0 is exactly 1 kg in mass]
 $b_1 =$ [o_1 is exactly 0.5 kg in mass]
 $b_2 =$ [o_2 is exactly 0.25 kg in mass]
 \vdots

One might think that the following two principles hold.

(M3) For any positive real numbers x and y , if (i) something with a non-zero mass of at most y kg exists and (ii) $y = 0.5x$, then [something with a non-zero mass of at most x kg exists] is fully (and so partially) grounded by [something with a non-zero mass of at most y kg exists].

(M4) For any positive real number x , if something with a mass of exactly x kg exists, then [something with a non-zero mass of at most x kg exists] is fully grounded by [something with a mass of exactly x kg exists].

If so, the resulting grounding structure qualifies as a fully crutched chain. Each fact in the first list is fully grounded by each of those below it, as well as by at least one fact in the second list.⁴¹ These examples provide reason to think that (WM) cannot function as an adequate well-foundedness axiom for grounding. They also provide an extra reason to think that (M) can't either.

8. Partial Foundation

The fifth alternative principle the foundationalist might adopt, and the last I consider, is attractive because it is equivalent to the partial ground-theoretic analog of the set-theoretic axiom of foundation of *ZF*. A contrastive version of it is considered by Schaffer (2012: 133).

(PF) Every non-fundamental fact x is partially grounded by some fundamental fact y .⁴²

⁴¹It may be that [something with a non-zero mass of at most x kg exists] is fully grounded by [something with a mass of at most $0.5x$ kg exists] *only together with* [$0.5x$ kg is less than or equal to x kg]. However, the grounding structure that results from these additions still qualifies as a fully crutched chain.

⁴²The set-theoretic axiom of foundation states that every non-empty set has a member with which it has no members in common. For a more formal statement of this axiom, see Jech 2006: 63. One may obtain the partial ground-theoretic version by replacing every occurrence of 'is a member of' with 'partially grounds', arriving at the following.

(R) For any x , if x is not fundamental then, for some y , x is partially grounded by y and there is no z such that both y is partially grounded by z and x is partially grounded by z .

In plain English, (R) says that every non-fundamental fact is partially grounded by a fundamental fact with which it does not share a partial ground. (PF) is equivalent to (R). I omit a proof of this claim.

Like (FS), (M), and (WM), (PF) has an advantage over (S) and (WF), since it admits fully pedestalled chains. Every non-fundamental fact in each such structure is partially grounded by a fundamental fact. Consider the fully pedestalled chain depicted in *Fig. 7*. The only non-fundamental facts in that structure are the a_i 's for all $i \in \mathbb{N}$, and each is fully, and so partially grounded by b , a fundamental fact.

Like (FS), (PF) has an advantage over (M) and (WM) as well, since it admits fully crutched chains. Every non-fundamental fact in each such structure is partially grounded by a fundamental fact. Consider the fully crutched chain depicted in *Fig. 10*. The only non-fundamental facts in that structure are the a_i 's for all $i \in \mathbb{N}$, and each is fully, and so partially, grounded by each b_j for $j \geq i$. So (PF) admits grounding structures excluded (M). As it turns out, (M) implies (PF).⁴³ As a result, (PF) is strictly weaker than (M).

Despite these considerations, the foundationalist should not be satisfied with (PF). It fares no better than (M) with respect to partially pedestalled chains, since each non-fundamental fact in each such grounding structure is partially grounded by some fundamental fact. Consider the one depicted in *Fig. 8*. The a_i 's for all $i \in \mathbb{N}$ are the only non-fundamental facts in this structure. And each is partially grounded by a fundamental fact: b . As a result, (PF) fails to do one of the things that an adequate well-foundedness axiom ought to do: exclude such structures. Before concluding, it is worth noting that this means that (PF) admits grounding structures excluded by (FS). Given the definition of partial grounding, (FS) implies (PF). (This definition guarantees that any non-fundamental fact that is fully grounded by some fundamental facts Γ is partially grounded by some fundamental fact among Γ .) As a result, (PF) is strictly weaker than (FS).

9. Conclusion

It is now clear how the foundationalist should capture the claim that grounding is well-founded. It is not that (S) every grounding chain terminates, which is equivalent to the claim that (WF) grounding is a well-founded relation, according to the standard mathematical definition. Nor is it that (WM) every weakly maximal grounding chain terminates, which is a bit weaker of a requirement. Nor is it that (M) every (strongly) maximal grounding chain terminates, which is weaker still. It isn't even that (PF) every non-fundamental fact is partially grounded by some fundamental

⁴³I omit a proof of this claim. It requires the axiom of choice, and is more straightforward if one uses the equivalent Hausdorff maximality principle.

fact, which is even weaker. Instead, the claim grounding is well-founded is best understood as the claim that (FS) every non-fundamental fact is fully grounded by some fundamental facts, which is stronger than (PF), weaker than (WM), and logically independent of (M). The relative strengths of the candidate principles can be represented more perspicuously as follows.

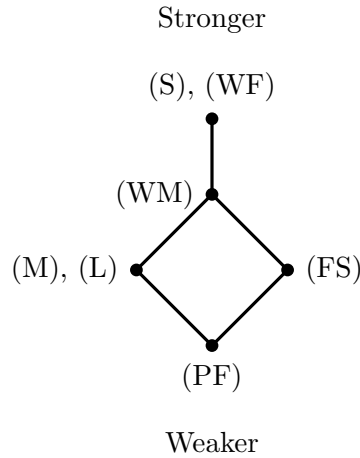

Fig. 11 Relative Strengths of the Candidates

In this diagram, each node represents an equivalence class of axioms, and a line running in a downward direction from a node x to another node y (which may pass through multiple other nodes) indicates that y is strictly weaker than x .

(FS) has an advantage over the other principles because, among them all, only it both admits fully pedestalled and fully crutched chains, and excludes partially pedestalled chains. A summary of the structures admitted (yes) and excluded (no) by each principle are shown in the following table.

Grounding Structure/Axiom	(S), (WF)	(WM)	(M), (L)	(FS)	(PF)
fully pedestalled chains	no	yes	yes	yes	yes
partially pedestalled chains	no	no	yes	no	yes
fully crutched chains	no	no	no	yes	yes

The basic idea behind foundationalism, then, is that the derivative must have its source in, or acquire its being from, the non-derivative.

References

- Audi, P. 2012a. A clarification and defense of the notion of grounding. In *Metaphysical Grounding*, eds. F. Correia and B. Schnieder, 101-21. Cambridge: Cambridge University Press.
- Audi, P. 2012b. Grounding: Toward a theory of the in-virtue-of relation. *The Journal of Philosophy* 109 (12), 685-711.
- Audi, P. 2013. How to rule out disjunctive properties. *Noûs* 47 (4), 748-766.
- Armstrong, D. M. 1978. *Universals and Scientific Realism, Volume I: Nominalism and Realism*. Cambridge: Cambridge University Press.
- Armstrong, D. M. 1997. *A World of States of Affairs*. Cambridge: Cambridge University Press.
- Barnes, E. manuscript. Symmetric dependence.
- Barwise, J. 1968. Implicit definability and compactness in infinitary languages. In *The Syntax and Semantics of Infinitary Languages*. Berlin: Springer-Verlag.
- Bennett, K. 2011. By our bootstraps. *Philosophical Perspectives* 25: 27-41.
- Bliss, R. L. 2013. Viciousness and the structure of reality. *Philosophical Studies* 166 (2), 399-418.
- Bliss, R. L. 2014. Viciousness and circles of ground. *Metaphilosophy* 45 (2), 245-56.
- Brzozowski, J. 2008. On locating composite objects. In *Oxford Studies in Metaphysics, Volume 4*, ed. D. Zimmerman, 193-222. Oxford: Oxford University Press.
- Cameron, R. P. 2008. Turtles all the way down: Regress, priority, and fundamentality in metaphysics. *The Philosophical Quarterly* 58 (230): 1-14.
- Correia, F. 2010. Grounding and truth-functions. *Logique et Analyse* 53 (211), 251-79.
- Correia, F. 2011. From grounding to truth-making: Some thoughts. *Philosophical Papers Dedicated to Kevin Mulligan*, <http://www.philosophie.ch/kevin/festschrift/Correia-paper.pdf>.
- deRosset, L. 2010. Getting priority straight. *Philosophical Studies* 149 (1), 73-97.
- Dixon, T. S. manuscript a. Bennett's fact regress revisited (again).
- Dixon, T. S. manuscript b. Grounding, determinables, and supplementation.
- Fine, K. 2010. Some puzzles of ground. *Notre Dame Journal of Formal Logic* 51 (1), 97-118.
- Fine, K. 2012a. Guide to ground. In *Metaphysical Grounding*, eds. F. Correia and B. Schnieder, 37-80. Cambridge: Cambridge University Press.
- Fine, K. 2012b. The pure logic of ground. *The Review of Symbolic Logic* 5 (1), 1-25.
- Frink, O. 1952. A proof of the maximal chain theorem. *American Journal of Mathematics* 74 (3), 676-78.
- Green, J. 1975. Consistency properties for finite quantifier languages. In *Infinitary Logic: In Memoriam Carol Karp*, eds. A. Dold and B. Eckermann, 73-123. Berlin: Springer-Verlag, 73-123.
- Hausdorff, F. 1962. *Set Theory*. New York: Chelsea Publishing Company.
- Jech, T. 2006. *Set Theory: 3rd Millenium Edition*. Berlin: Springer.
- Jenkins, C. S. I. 2011. Is metaphysical dependence irreflexive? *The Monist* 94 (2), 267-76.
- Karp, C. C. 1964. *Languages with Expressions of Infinite Length*. Amsterdam: North-Holland.

- Leuenberger, S. 2014. Grounding and necessity. *Inquiry*, 57 (2) , pp. 151–74.
- Lewis, D. 1991. *Parts of Classes*. Oxford: Basil Blackwell.
- Lowe, E. J. 1998. *The Possibility of Metaphysics: Substance, Identity, and Time*. Oxford: Oxford University Press.
- Morganti, M. 2014. Metaphysical infinitism and the regress of being. *Metaphilosophy* 45 (2), 232-44.
- Nolan, D. 2008. Truthmakers and predication. In *Oxford Studies in Metaphysics, Volume 4*, ed. D. Zimmerman, 171-92. Oxford: Oxford University Press.
- Orilia, F. 2009. Bradley’s regress and ungrounded dependence chains: A reply to Cameron. *Dialectica* 63 (3), 333-41.
- Paseau, A. 2010. The definitions of ultimate ontological basis and the fundamental layer. *The Philosophical Quarterly* 60 (238), 169-75.
- Rabern, B. and G. Rabin manuscript. Well-founding grounding grounding.
- Raven, M. J. 2012. In defense of ground. *Australasian Journal of Philosophy* 90 (4), 687-701.
- Raven, M. J. 2013. Is ground a strict partial order? *American Philosophical Quarterly* 50 (2), 193-201.
- Rosen, G. 2010. Metaphysical dependence: Grounding and reduction. In *Modality: Metaphysics, Logic, and Epistemology*, eds. B. Hale and A. Hoffman, 109-136. Oxford: Oxford University Press, 109-35.
- Schaffer, J. 2009. On what grounds what. In *Metametaphysics: New Essays on the Foundations of Ontology*, eds. D. Manley, D. Chalmers, and R. Wasserman, 347-83. Oxford: Oxford University Press.
- Schaffer, J. 2010. Monism: The priority of the whole. *Philosophical Review* 119 (1), 31-76.
- Schaffer, J. 2012. Grounding, transitivity and contrastivity. In *Metaphysical Grounding: Understanding the Structure of Reality*, eds. F. Correia and B. Schnieder, 122-38. Cambridge: Cambridge University Press.
- Schnieder, B. 2004. Once more: Bradleyan regresses. In *On Relations and Predicates.*, eds. H. Hochberg and K. Mulligan, 219-56.
- Schnieder, B. 2011. A logic for ‘because’. *The Review of Symbolic Logic* 4 (3), 445-65.
- Scott, D. and Tarski, A. 1958. The sentential calculus with infinitely long expressions. *Colloquium Mathematicum* 16, 166-70.
- Sider, T. 2011. *Writing the Book of the World*. Oxford: Oxford University Press.
- Tahko, T. 2014. Boring Infinite Descent. *Metaphilosophy* 45 (2), 257-69.
- Trogon, K. 2009. Monism and intrinsicity. *Australasian Journal of Philosophy* 87 (1), 127-48.
- Trogon, K. 2013a. Grounding: Necessary or contingent? *Pacific Philosophical Quarterly* 94 (4), 465-485.
- Trogon, K. 2013b. An introduction to grounding. In *Varieties of Dependence: Ontological Dependence, Grounding, Supervenience, Response-Dependence*, eds. M. Hoeltje, B. Schnieder, and A. Steinberg. Philosophia Verlag.

Witmer, D. G., B. Butchard, and K. Trogdon 2005. Intrinsicity without naturalness. *Philosophy and Phenomenological Research*. 70 (2), 326-50.

Wittgenstein, L. 1953. *Philosophical Investigations*. Oxford: Basil Blackwell.