

Florentin Smarandache

(author and editor)

Collected Papers

(on Neutrosophics
and other topics)

Volume XIV

Global
Knowledge

2022

Florentin Smarandache

(author and editor)

Collected Papers

(on Neutrosophics and other topics)

Volume XIV

Peer-Reviewers:

Victor Christianto

Malang Institute of Agriculture (IPM), Malang, INDONESIA
victorchristianto@gmail.com

Mumtaz Ali

Department of Mathematics, Quaid-i-Azam University, Islamabad, PAKISTAN
mumtazali770@yahoo.com

Bui Cong Cuong

Vietnam Academy of Science and Technology, 18 Hoang Quoc Viet, Hanoi, SR VIETNAM
bccuong@gmail.com

Daniela Gîfu

Institute of Computer Science, Romanian Academy, Iași Branch, Iași, ROMANIA
daniela.gifu@iit.academiaromana-is.ro

Surapati Pramanik

Department of Mathematics, Nandalal Ghosh B.T. College, Panpur, Bhatpara, West Bengal, INDIA
sura_pati@yahoo.co.in

Dragiša Stanujkić

Faculty of Management in Zajecar, John Naisbitt University, Belgrade, SERBIA
dragisa.stanujkic@fmz.edu.rs

Edmundas Kazimieras Zavadskas

Civil Engineering Faculty, Vilnius Gediminas Technical University, Vilnius, LITHUANIA
edmundas.zavadskas@vgtu.lt

Florentin Smarandache

(author and editor)

Collected Papers

(on Neutrosophics and other topics)

Volume XIV

GLOBAL KNOWLEDGE

Publishing House

Miami, United States of America

2022

Editors:

GLOBAL KNOWLEDGE - Publishing House

848 Brickell Ave Ste 950 Miami
Florida 33131, United States
<https://egk.ccgecon.us>
info@egk.ccgecon.us

ADSUMUS – Scientific and Cultural Society

13, Dimitrie Cantemir St.
410473 Oradea City, Romania
<https://adsumus.wordpress.com/>
ad.sumus@protonmail.com

NSIA Publishing House

Neutrosphic Science International Association

<https://www.publishing-nsia.com/>
University of New Mexico, Gallup, United States Universidad
Regional Autónoma de los Andes (UNIANDES), Babahoyo,
Los Rios, Ecuador

Publishing:

Prof. Dan Florin Lazar

lazar.danflorin@yahoo.com

Prof. Dr. Maykel Yelandi Leyva Vazquez

ub.c.investigacion@uniandes.edu.ec

ISBN 978-1-59973-744-7

Introductory Note

This fourteenth volume of Collected Papers is an eclectic tome of 87 papers in Neutrosophics and other fields, such as mathematics, fuzzy sets, intuitionistic fuzzy sets, picture fuzzy sets, information fusion, robotics, statistics, or extenics, comprising 930 pages, published between 2008-2022 in different scientific journals or currently *in press*, by the author alone or in collaboration with the following 99 co-authors (alphabetically ordered) from 26 countries: Ahmed B. Al-Nafee, Adesina Abdul Akeem Agboola, Akbar Rezaei, Shariful Alam, Marina Alonso, Fran Andujar, Toshinori Asai, Assia Bakali, Azmat Hussain, Daniela Baran, Bijan Davvaz, Bilal Hadjadji, Carlos Díaz Bohorquez, Robert N. Boyd, M. Caldas, Cenap Özel, Pankaj Chauhan, Victor Christianto, Salvador Coll, Shyamal Dalapati, Irfan Deli, Balasubramanian Elavarasan, Fahad Alsharari, Yonfei Feng, Daniela Gifu, Rafael Rojas Gualdrón, Haipeng Wang, Hemant Kumar Gianey, Noel Batista Hernández, Abdel-Nasser Hussein, Ibrahim M. Hezam, Ilanthenral Kandasamy, W.B. Vasantha Kandasamy, Muthusamy Karthika, Nour Eldeen M. Khalifa, Madad Khan, Kifayat Ullah, Valeri Kroumov, Tapan Kumar Roy, Deepesh Kunwar, Le Thi Nhung, Pedro López, Mai Mohamed, Manh Van Vu, Miguel A. Quiroz-Martínez, Marcel Migdalovici, Kritika Mishra, Mohamed Abdel-Basset, Mohamed Talea, Mohammad Hamidi, Mohammed Alshumrani, Mohamed Loey, Muhammad Akram, Muhammad Shabir, Mumtaz Ali, Nassim Abbas, Munazza Naz, Ngan Thi Roan, Nguyen Xuan Thao, Rishwanth Mani Parimala, Ion Pătrașcu, Surapati Pramanik, Quek Shio Gai, Qiang Guo, Rajab Ali Borzooei, Nimitha Rajesh, Jesús Estupiñán Ricardo, Juan Miguel Martínez Rubio, Saeed Mirvakili, Arsham Borumand Saeid, Saeid Jafari, Said Broumi, Ahmed A. Salama, Nirmala Sawan, Gheorghe Săvoiu, Ganeshsree Selvachandran, Seok-Zun Song, Shahzaib Ashraf, Jayant Singh, Rajesh Singh, Son Hoang Le, Tahir Mahmood, Kenta Takaya, Mirela Teodorescu, Ramalingam Udhayakumar, Maikel Y. Leyva Vázquez, V. Venkateswara Rao, Luige Vlădăreanu, Victor Vlădăreanu, Gabriela Vlădeanu, Michael Voskoglou, Yaser Saber, Yong Deng, You He, Youcef Chibani, Young Bae Jun, Wadei F. Al-Omeri, Hongbo Wang, Zayen Azzouz Omar.

Keywords

Neutrosophy; Neutrosophic Logic; Neutrosophic Sets; Neutrosophic Probability; Decision Making; Extenics; Plithogeny; Plithogenic Set; Plithogenic Logic; Plithogenic Probability; Plithogenic Statistics; COVID-19; Dezert-Smarandache Theory; Single Valued Neutrosophic Set; Interval Neutrosophic Sets; Set-Theoretic Operator; Neutrosophic-Tendential Fuzzy Logic; Neutrosophic Index; Index Statistical Method; Price Index; Interpreter Index; Neutrosophic Interpreter Index; Neutrosophic Soft Expert Set; Neutrosophic Soft Expert Images; Neutrosophic Soft Expert Inverse Images; Mapping On Neutrosophic Soft Expert Set; Single Valued Neutrosophic Graph; Strong Single Valued Neutrosophic Graph; Constant Single Valued Neutrosophic Graph; Complete Single Valued Neutrosophic Graph; Dijkstra Algorithm; Interval Valued Neutrosophic Number; Shortest Path Problem; Network; Triangular Fuzzy Neutrosophic Sets; Score Function; Bipolar Neutrosophic Graph; Generalized Bipolar Neutrosophic Graphs; Matrix Representation; Adjacency Matrix; Neutrosophic Optimization; Goal Programming Problem; Project Management; Score And Accuracy Functions; Generalized Neutrosophic Set; Generalized Neutrosophic Subalgebra; Generalized Neutrosophic Ideal; Spanning Tree Problem; Entropy Measure; Intuitionistic Fuzzy Set; Inconsistent Intuitionistic Fuzzy Set; Picture Fuzzy Set; Ternary Fuzzy Set; Pythagorean Fuzzy Set; Atanassov's Intuitionistic Fuzzy Set of second type; Spherical Fuzzy Set; n-HyperSpherical Neutrosophic Set; q-Rung Orthopair Fuzzy Set; truth-membership; indeterminacy-membership; falsehood-nonmembership; Regret Theory; Grey System Theory; Three-Ways Decision; n-Ways Decision; Neutrosophication; Refined Neutrosophy; Refined Neutrosophication; Sentiment Analysis; Speech Analysis; Clustering Algorithm; K-means; Hierarchical Agglomerative Clustering; Neutrosophic Minimal Structure.

Florentin Smarandache is an emeritus prof. dr. of mathematics at the University of New Mexico, United States. He got his MSc in Mathematics and Computer Science from the University of Craiova, Romania, PhD in Mathematics from the State University of Kishinev, and Postdoctoral in Applied Mathematics from Okayama University of Sciences, Japan, and The Guangdong University of Technology, Guangzhou, China. He is the founder of neutrosophy (generalization of dialectics), neutrosophic set, logic, probability and statistics since 1995 and has published hundreds of papers and books on neutrosophic physics, superluminal and instantaneous physics, unmatter, quantum paradoxes, absolute theory of relativity, redshift and blueshift due to the medium gradient and refraction index besides the Doppler effect, paradoxism, outerart, neutrosophy as a new branch of philosophy, Law of Included Multiple-Middle, multispace and multistructure, hypersoft set, IndetermSoft Set and IndetermHyperSoft Set, SuperHyperGraph, SuperHyperTopology, SuperHyperAlgebra, Neutrosophic SuperHyperAlgebra, degree of dependence and independence between neutrosophic components, refined neutrosophic set, neutrosophic over-under-off-set, plithogenic set / logic / probability / statistics, neutrosophic triplet and duplet structures, quadruple neutrosophic structures, extension of algebraic structures to NeutroAlgebra and AntiAlgebra, NeutroGeometry & AntiGeometry, Dezert-Smarandache Theory and so on to many peer-reviewed international journals and many books and he presented papers and plenary lectures to many international conferences around the world.

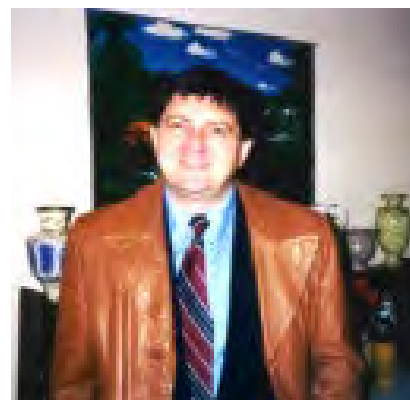

outerart, neutrosophy as a new branch of philosophy, Law of Included Multiple-Middle, multispace and multistructure, hypersoft set, IndetermSoft Set and IndetermHyperSoft Set, SuperHyperGraph, SuperHyperTopology, SuperHyperAlgebra, Neutrosophic SuperHyperAlgebra, degree of dependence and independence between neutrosophic components, refined neutrosophic set, neutrosophic over-under-off-set, plithogenic set / logic / probability / statistics, neutrosophic triplet and duplet structures, quadruple neutrosophic structures, extension of algebraic structures to NeutroAlgebra and AntiAlgebra, NeutroGeometry & AntiGeometry, Dezert-Smarandache Theory and so on to many peer-reviewed international journals and many books and he presented papers and plenary lectures to many international conferences around the world.

In addition, he published many books of poetry, dramas, children' stories, translations, essays, a novel, folklore collections, traveling memories, and art albums [<http://fs.unm.edu/FlorentinSmarandache.htm>].

Contents

NEUTROSOPHICS

Haibin Wang, Florentin Smarandache, Yanqing Zhang, Rajshekhar Sunderraman

Single Valued Neutrosophic Sets / 32

Florentin Smarandache

Neutrosophic Transdisciplinarity - Multi-Space & Multi-Structure / 37

Florentin Smarandache, Daniela Gifu, Mirela Teodorescu

Neutrosophic elements in discourse / 40

Said Broumi, Irfan Deli, Florentin Smarandache

N-Valued Interval Neutrosophic Sets and Their Application in Medical Diagnosis / 48

Florentin Smarandache, Gheorghe Săvoiu

Neutrosophic Index Numbers: Neutrosophic Logic Applied in The Statistical Indicators Theory / 73

Said Broumi, Ali Mumtaz, Florentin Smarandache

Mappings on Neutrosophic Soft Expert Sets / 107

Said Broumi, Mohamed Talea, Assia Bakali, Florentin Smarandache

Single Valued Neutrosophic Graphs / 124

Said Broumi, Mohamed Talea, Assia Bakali, Florentin Smarandache

Application of Dijkstra Algorithm for Solving Interval Valued Neutrosophic Shortest Path Problem / 140

Said Broumi, Mohamed Talea, Assia Bakali, Florentin Smarandache, Luige Vladareanu

Shortest Path Problem Under Triangular Fuzzy Neutrosophic Information / 146

Said Broumi, Mohamed Talea, Assia Bakali, Florentin Smarandache

Generalized Bipolar Neutrosophic Graphs of Type 1 / 152

Florentin Smarandache

Introducing a Theory of Neutrosophic Evolution: Degrees of Evolution, Indeterminacy, and Involution / 159

Ibrahim M. Hezam, Mohamed Abdel-Baset, Florentin Smarandache

Neutrosophic Goal Programming / 165

Mai Mohamed, Mohamed Abdel-Baset, Florentin Smarandache, Yongquan Zhou

A Critical Path Problem in Neutrosophic Environment / 179

Wadei Al-Omeri, Florentin Smarandache

New Neutrosophic Sets via Neutrosophic Topological Spaces / 187

- Mai Mohamed, Mohamed Abdel-Baset, Abdel-Nasser Hussein, Florentin Smarandache
Neutrosophic linear fractional programming problem / 208
- Said Broumi, Florentin Smarandache, Mumtaz Ali, Assia Bakali, Mohamed Talea, Ganeshsree Selvachandran
Complex Neutrosophic Soft Set / 227
- Seok-Zun Song, Madad Khan, Florentin Smarandache, Young Bae Jun
Interval neutrosophic sets applied to ideals in BCK/BCI-algebras / 233
- Said Broumi, Assia Bakali, Mohamed Talea, Florentin Smarandache, V. Venkateswara Rao
Bipolar Complex Neutrosophic Graphs of Type 1 / 244
- Seok-Zun Song, Madad Khan, Florentin Smarandache, Young Bae Jun
A Novel Extension of Neutrosophic Sets and Its Application in BCK/BCI-Algebras / 264
- Said Broumi, Mohamed Talea, Assia Bakali, Florentin Smarandache, Kifayat Ullah
Bipolar Neutrosophic Minimum Spanning Tree / 283
- Said Broumi, Assia Bakali, Mohamed Talea, Florentin Smarandache, V. Venkateswara Rao
Interval Complex Neutrosophic Graph of Type 1 / 289
- Surapati Pramanik, Shyamal Dalapati, Shariful Alam, Florentin Smarandache, Tapan Kumar Roy
NC-Cross Entropy Based MADM Strategy in Neutrosophic Cubic Set Environment / 309
- M. Caldas, Saeid Jafari, Nimitha Rajesh, Florentin Smarandache
On I-open sets and I-continuous functions in ideal Bitopological spaces / 338
- Balasubramanian Elavarasan, Florentin Smarandache, Young Bae Jun
Neutrosophic \aleph -ideals in semigroups / 350
- M. Karthika, M. Parimala, Saeid Jafari, Florentin Smarandache, Mohammed Alshumrani, Cenap Ozel, R. Udhayakumar
Neutrosophic complex $\alpha\psi$ connectedness in neutrosophic complex topological spaces / 358
- Said Broumi, Mohamed Talea, Assia Bakali, Florentin Smarandache, Quek Shio Gai, Ganeshsree Selvachandran
Introduction of some new results on interval-valued neutrosophic graphs / 365
- Florentin Smarandache
Neutrosophic Set is a Generalization of Intuitionistic Fuzzy Set, Inconsistent Intuitionistic Fuzzy Set (Picture Fuzzy Set, Ternary Fuzzy Set), Pythagorean Fuzzy Set (Atanassov's Intuitionistic Fuzzy Set of second type), q-Rung Orthopair Fuzzy Set, Spherical Fuzzy Set, and n-HyperSpherical Fuzzy Set, while Neutrosophication is a Generalization of Regret Theory, Grey System Theory, and Three-Ways Decision (revisited) / 388
- Rafael Rojas-Gualdrón, Florentin Smarandache, Carlos Díaz-Bohorquez
Aplicación de la teoría neutrosófica para el tratamiento de la incertidumbre en la gestión del riesgo en la cadena de suministro. Application of the Neutrosophical Theory to Deal with Uncertainty in Supply Chain Risk Management / 438

- Mohammad Hamidi, Arsham Borumand Saeid, Florentin Smarandache
On Neutrosophic Refined EQ-Filters / 457
- Mohammad Hamidi, Florentin Smarandache
Single-valued neutrosophic directed (Hyper)graphs and applications in networks / 473
- Kritika Mishra, Ilanthenral Kandasamy, W. B. Vasantha Kandasamy, Florentin Smarandache
A Novel Framework Using Neutrosophy for Integrated Speech and Text Sentiment Analysis / 490
- Wadei F. Al-Omeri, Saeid Jafari, Florentin Smarandache
 (Φ, Ψ) -Weak Contractions in Neutrosophic Cone Metric Spaces via Fixed Point Theorems / 511
- Muthusamy Karthika, Rishwanth M. Parimala, Florentin Smarandache
An Introduction to Neutrosophic Minimal Structure Spaces / 519
- Rishwanth Mani Parimala, Cenap Özel, Florentin Smarandache, Muthusamy Karthika
A New Type of Quasi Open Functions in Neutrosophic Topological Environment / 530
- Florentin Smarandache, Miguel A. Quiroz-Martínez, Jesús Estupiñán Ricardo, Noel Batista Hernández, Maikel Y. Leyva Vázquez
Application of Neutrosophic Offsets for Digital Image Processing / 540
- Florentin Smarandache, Akbar Rezaei, Adesina Abdul Akeem Agboola, Young Bae Jun, Rajab Ali Borzooei, Bijan Davvaz, Arsham Borumand Saeid, Mohammad Akram, Mohammad Hamidi, Saeed Mirvakili
On Neutro Quadruple Groups / 549
- Ahmed B. Al-Nafee, Florentin Smarandache, A. A. Salama
New Types of Neutrosophic Crisp Closed Sets / 557
- Yaser Saber, Fahad Alsharari, Florentin Smarandache
An introduction to single-valued neutrosophic soft topological structure / 566
- Michael Voskoglou, Said Broumi, Florentin Smarandache
A Combined Use of Soft and Neutrosophic Sets for Student Assessment with Qualitative Grades / 582
- Florentin Smarandache
Improved Definition of NonStandard Neutrosophic Logic and Introduction to Neutrosophic Hyperreals (Fifth version) / 588
- Florentin Smarandache
Neutrosafia, generalizare a Dialecticii. Noțiuni fundamentale / 608
- Florentin Smarandache
Circuite și fluxuri neutrosofice / 623
- Florentin Smarandache
Există o neutralitate în fiecare neutralitate / 629
- Florentin Smarandache
Filosofia este neutrosopică sau nu este deloc / 635

Florentin Smarandache

Modus neutrosophicus / 642

Florentin Smarandache

Neutrosofie maieutică / 648

Florentin Smarandache

Neutrosafia, o teorie a teoriilor / 654

Florentin Smarandache

Neutrosafia ca matrice universală / 661

Florentin Smarandache

Spirit și materie în neutrosografie / 667

Florentin Smarandache

Transdisciplinaritate neutrosografică / 675

FUZZY SETS, INTUITIONISTIC FUZZY SETS, PICTURE FUZZY SETS

Said Broumi, Florentin Smarandache

New Operations over Interval Valued Intuitionistic Hesitant Fuzzy Set / 683

Nguyen Xuan Thao, Mumtaz Ali, Le Thi Nhung, Hemant Kumar Gianey, Florentin Smarandache

A new multi-criteria decision making algorithm for medical diagnosis and classification problems using divergence measure of picture fuzzy sets / 692

Ngan Thi Roan, Salvador Coll, Marina Alonso, Juan Miguel Martínez Rubio, Pedro López, Fran Andujar, Son Hoang Le, Manh Van Vu, Florentin Smarandache

The picture fuzzy distance measure in controlling network power consumption / 704

Azmat Hussain, Tahir Mahmood, Florentin Smarandache, Shahzaib Ashraf

TOPSIS Approach for MCGDM based on Intuitionistic Fuzzy Rough Dombi Aggregation Operations / 724

MATHEMATICS

Florentin Smarandache

A Group-Permutation Algorithm to Solve the Generalized SUDOKU / 748

Ion Pătrașcu, Florentin Smarandache

Two Triangles With The Same Orthocenter and A Vectorial Proof Of Stevanovic's Theorem / 751

Rajesh Singh, Jayant Singh, Florentin Smarandache

A Note on Testing of Hypothesis / 755

Ion Pătrașcu, Florentin Smarandache

Cercurile Apollonius de rangul -1 / 759

Ion Pătrașcu, Florentin Smarandache

Două probleme de minimum geometric / 761

Ion Pătrașcu, Florentin Smarandache

Câteva probleme privind calculul unor măsuri de unghiuri într-un triunghi isoscel / 764

Victor Christianto, Florentin Smarandache

Continuum Hypothesis Revisited: From Cantor, to Godel, then to Discrete Cellular Space model / 767

INFORMATION FUSION

Said Broumi, Florentin Smarandache

New Distance and Similarity Measures of Interval Neutrosophic Sets / 782

Florentin Smarandache

Reliability and Importance Discounting of Neutrosophic Masses / 789

Nassim Abbas, Youcef Chibani, Bilal Hadjadji, Zayen Azzouz Omar, Florentin Smarandache

A DSMT Based System for Writer-Independent Handwritten Signature Verification / 800

Qiang Guo, Haipeng Wang, You He, Yong Deng, Florentin Smarandache

An Evidence Fusion Method with Importance Discounting Factors based on Neutrosophic Probability Analysis in DSMT Framework / 808

ROBOTICS

Marcel Migdalovici, Luige Vlădăreanu, Gabriela Vlădeanu, Daniela Baran, Said Broumi, Florentin Smarandache, Hongbo Wang, Yonfei Feng

Some mathematical aspects on walking robots stable evolution / 819

Kenta Talaba, Toshinori Asai, Valeri Kroumov, Florentin Smarandache

Simulation Environment for Mobile Robots Testing Using ROS and Gazebo / 825

Luige Vlădăreanu, Victor Vlădăreanu, Hongnian Yu, Hongbo Wang, Florentin Smarandache

Robot Advanced Intellectual Control developed through Flexible Intelligent Portable Platform / 831

STATISTICS and NEUTROSOPHIC STATISTICS

Rajesh Singh, Pankaj Chauhan, Nirmala Sawan, Florentin Smarandache

Ratio estimators in simple random sampling using information on auxiliary attribute / 839

Rajesh Singh, Jayant Singh, Florentin Smarandache

Optimum Statistical Test Procedure / 846

Rajesh Singh, Pankaj Chauhan, Nirmala Sawan, Florentin Smarandache

Improved Exponential Estimator for Population Variance Using Two Auxiliary Variables / 856

Rajesh Singh, Pankaj Chauhan, Nirmala Sawan, Florentin Smarandache

Improvement in Estimating Population Mean Using Two Auxiliary Variables in Two-Phase Sampling / 864

Deepesh Kunwar, Jayant Singh, Florentin Smarandache

Neutrosophic statistical evaluation of migration with particular reference to Jaipur / 872

Deepesh Kunwar, Jayant Singh, Florentin Smarandache

Neutrosophic statistical techniques to find migration pattern in Jaipur / 881

Florentin Smarandache

Neutrosophic Statistics is an extension of Interval Statistics, while Plithogenic Statistics is the most general form of statistics (third version) / 891

MISCELLANEA

Florentin Smarandache, Victor Vlădăreanu

Applications of Extenics to 2D-Space and 3D-Space / 922

Victor Christianto, Florentin Smarandache

On Global corporate control and Federal Reserve between 2007-2010 / 927

Florentin Smarandache

A Quarter of Century for Octagon Mathematical Magazine. Dedicated to the 25 years of Octagon Mathematical Magazine / 933

Victor Christianto, Florentin Smarandache

On the Efficacy of High-dose Ascorbic Acid as Anticancer Treatment: A Literature Survey / 934

Mohamed Abdel-Basset, Florentin Smarandache

Preface. Revista Investigacion Operacional / 938

Florentin Smarandache

Marinela Preoteasa (1952 – 2020) / 939

Mohamed Loey, Florentin Smarandache, Nour Eldeen M. Khalifa

A Deep Transfer Learning Model with Classical Data Augmentation and CGAN to Detect COVID-19 from Chest CT Radiography Digital Images / 941

Victor Christianto, Robert N. Boyd, Florentin Smarandache

Remark on Recent Experimental Findings Supporting Smarandache's Hypothesis and Quantum Sorites Paradoxes and Sub Quantum Kinetic Model of Electron / 958

Florentin Smarandache

Octogon magazine celebrates 30 years of existence / 959

Victor Christianto, Florentin Smarandache

Notes on the other side of creativity in mathematical physics development: schizotypy and the need for a new approach in exploring new physics / 961

List of Countries

ALGERIA (4)

UNITED STATES OF AMERICA (2)

SAUDI ARABIA (3)

BRASIL (1)

PR CHINA (6)

COLOMBIA (2)

DENMARK (1)

ECUADOR (4)

EGYPT (7)

GREECE (1)

INDIA (20)

INDONESIA (1)

IRAN (6)

IRAQ (1)

JAPAN (3)

JORDAN (1)

MALAYSIA (2)

MOROCCO (3)

NIGERIA (1)

PAKISTAN (9)

ROMÂNIA (7)

SOUTH KOREA (2)

SPAIN (5)

TURKEY (1)

SR VIETNAM (5)

YEMEN (1)

List of Papers

NEUTROSOPHICS

1. Haibin Wang, Florentin Smarandache, Yanqing Zhang, Rajshekhar Sunderraman (2012). Single Valued Neutrosophic Sets. *Technical Sciences and Applied Mathematics*, 10-14
2. Florentin Smarandache (2013). Neutrosophic Transdisciplinarity - Multi-Space & Multi-Structure. Proceedings of Conference on Multispace & Multistructure, Beijing, 22-24
3. Florentin Smarandache, Daniela Gîfu, Mirela Teodorescu (2015). Neutrosophic elements in discourse. *Social Sciences and Education Research Review* (2), 1, 25-32
4. Said Broumi, Irfan Deli, Florentin Smarandache (2015). N-Valued Interval Neutrosophic Sets and Their Application in Medical Diagnosis. *Critical Review X*, 45-69
5. Florentin Smarandache, Gheorghe Săvoiu (2015). Neutrosophic Index Numbers: Neutrosophic Logic Applied in The Statistical Indicators Theory. *Critical Review X*, 67-100
6. Said Broumi, Ali Mumtaz, Florentin Smarandache (2015). Mappings on Neutrosophic Soft Expert Sets. *Journal of New Theory* 5, 26-42
7. Said Broumi, Mohamed Talea, Assia Bakali, Florentin Smarandache (2016). Single Valued Neutrosophic Graphs. *Journal of New Theory* 10, 86-101
8. Said Broumi, Mohamed Talea, Assia Bakali, Florentin Smarandache (2016). Application of Dijkstra Algorithm for Solving Interval Valued Neutrosophic Shortest Path Problem. IEEE Symposium Series on Computational Intelligence (SSCI), 6; DOI: 10.1109/SSCI.2016.7850151
9. Said Broumi, Mohamed Talea, Assia Bakali, Florentin Smarandache, Luige Vladareanu (2016). Shortest Path Problem Under Triangular Fuzzy Neutrosophic Information. 10th International Conference on Software, Knowledge, Information Management & Applications (SKIMA), 6
10. Said Broumi, Mohamed Talea, Assia Bakali, Florentin Smarandache (2017). Generalized Bipolar Neutrosophic Graphs of Type 1. 20th International Conference on Information Fusion Xi'an, China, 1714-1720
11. Florentin Smarandache (2017). Introducing a Theory of Neutrosophic Evolution: Degrees of Evolution, Indeterminacy, and Involution. *Progress in Physics* 13(2), 130-135
12. Ibrahim M. Hezam, Mohamed Abdel-Baset, Florentin Smarandache (2017). Neutrosophic Goal Programming. In *Neutrosophic Operational Research*, vol. I, eds.: Prof. Florentin Smarandache, Dr. Mohamed Abdel-Basset, Dr. Yongquan Zhou, 63-76
13. Mai Mohamed, Mohamed Abdel-Baset, Florentin Smarandache, Yongquan Zhou (2017). A Critical Path Problem in Neutrosophic Environment. In *Neutrosophic Operational Research*, vol. I, eds.: Prof. Florentin Smarandache, Dr. Mohamed Abdel-Basset, Dr. Yongquan Zhou, 167-174
14. Wadei Al-Omeri, Florentin Smarandache (2017). New Neutrosophic Sets via Neutrosophic Topological Spaces. In *Neutrosophic Operational Research*, vol. I, eds.: Prof. Florentin Smarandache, Dr. Mohamed Abdel-Basset, Dr. Yongquan Zhou, 189-209
15. Mai Mohamed, Mohamed Abdel-Baset, Abdel-Nasser Hussein, Florentin Smarandache (2017). Neutrosophic linear fractional programming problem. *Octagon Mathematical Magazine* 25(1), 202-220

16. Said Broumi, Florentin Smarandache, Mumtaz Ali, Assia Bakali, Mohamed Talea, Ganeshsree Selvachandran (2017). Complex Neutrosophic Soft Set. FUZZ-IEEE Conference on Fuzzy Systems, Naples, Italy, 9-12 July 2017, 6
17. Seok-Zun Song, Madad Khan, Florentin Smarandache, Young Bae Jun (2017). Interval neutrosophic sets applied to ideals in BCK/BCI-algebras. *Neutrosophic Sets and Systems*, 18, 16-26
18. Said Broumi, Assia Bakali, Mohamed Talea, Florentin Smarandache, V. Venkateswara Rao (2018). Bipolar Complex Neutrosophic Graphs of Type 1. In *New Trends in Neutrosophic Theory and Applications*, vol. II, eds.: Florentin Smarandache, Surapati Pramanik, 189-209
19. Seok-Zun Song, Madad Khan, Florentin Smarandache, Young Bae Jun (2018). A Novel Extension of Neutrosophic Sets and Its Application in BCK/BCI-Algebras. In *New Trends in Neutrosophic Theory and Applications*, vol. II, eds.: Florentin Smarandache, Surapati Pramanik, 308-326
20. Said Broumi, Mohamed Talea, Assia Bakali, Florentin Smarandache, Kifayat Ullah (2018). Bipolar Neutrosophic Minimum Spanning Tree. *Smart Application and Data Analysis for Smart Cities (SADASC'18)*; DOI: 10.2139/ssrn.3127519
21. Said Broumi, Assia Bakali, Mohamed Talea, Florentin Smarandache, V. Venkateswara Rao (2018). Interval Complex Neutrosophic Graph of Type 1. In *Neutrosophic Operational Research*, vol. III, eds.: Prof. Florentin Smarandache, Dr. Mohamed Abdel-Basset, Dr. Victor Chang, 87-106
22. Surapati Pramanik, Shyamal Dalapati, Shariful Alam, Florentin Smarandache, Tapan Kumar Roy (2018). NC-Cross Entropy Based MADM Strategy in Neutrosophic Cubic Set Environment. *Mathematics* 6, 67; DOI: 10.3390/math6050067
23. M. Caldas, Saeid Jafari, Nimitha Rajesh, Florentin Smarandache (2018). On I-open sets and I-continuous functions in ideal Bitopological spaces. International Conference on Topology and its Applications, Nafpaktos, Greece, 44-56
24. Balasubramanian Elavarasan, Florentin Smarandache, Young Bae Jun (2019). Neutrosophic \mathfrak{N} -ideals in semigroups. *Neutrosophic Sets and Systems* 28, 273-280
25. M. Karthika, M. Parimala, Saeid Jafari, Florentin Smarandache, Mohammed Alshumrani, Cenap Ozel, R. Udhayakumar (2019). Neutrosophic complex $\alpha\psi$ connectedness in neutrosophic complex topological spaces. *Neutrosophic Sets and Systems* 29, 158-164
26. Said Broumi, Mohamed Talea, Assia Bakali, Florentin Smarandache, Quek Shio Gai, Ganeshsree Selvachandran (2019). Introduction of some new results on interval-valued neutrosophic graphs. *Journal of Information and Optimization Sciences*, 24; DOI: 10.1080/02522667.2018.1541782
27. Florentin Smarandache (2019). Neutrosophic Set is a Generalization of Intuitionistic Fuzzy Set, Inconsistent Intuitionistic Fuzzy Set (Picture Fuzzy Set, Ternary Fuzzy Set), Pythagorean Fuzzy Set (Atanassov's Intuitionistic Fuzzy Set of second type), q-Rung Orthopair Fuzzy Set, Spherical Fuzzy Set, and n-HyperSpherical Fuzzy Set, while Neutrosophication is a Generalization of Regret Theory, Grey System Theory, and Three-Ways Decision (revisited). *Journal of New Theory* 29, 1-35
28. Rafael Rojas-Gualdrón, Florentín Smarandache, Carlos Díaz-Bohorquez (2019). Aplicación de la teoría neutrosófica para el tratamiento de la incertidumbre en la gestión del riesgo en la cadena de suministro. Application of the Neutrosophical Theory to Deal with Uncertainty in Supply Chain Risk Management. *Aglala* 10(2), 19

29. Mohammad Hamidi, Arsham Borumand Saeid, Florentin Smarandache (2019). On Neutrosophic Refined EQ-Filters. *Journal of Intelligent & Fuzzy Systems* 37, 1181-1196; DOI:10.3233/JIFS-182618
30. Mohammad Hamidi, Florentin Smarandache (2019). Single-valued neutrosophic directed (Hyper)graphs and applications in networks. *Journal of Intelligent & Fuzzy Systems* 37, 2869-2885; DOI: 10.3233/JIFS-190036
31. Kritika Mishra, Ilanthenral Kandasamy, W. B. Vasantha Kandasamy, Florentin Smarandache (2020). A Novel Framework Using Neutrosophy for Integrated Speech and Text Sentiment Analysis. *Symmetry* 12, 1715; DOI: 10.3390/sym12101715
32. Wadei F. Al-Omeri, Saeid Jafari, Florentin Smarandache (2020). (Φ, Ψ) -Weak Contractions in Neutrosophic Cone Metric Spaces via Fixed Point Theorems. *Mathematical Problems in Engineering*, Article ID 9216805, 8; DOI: 10.1155/2020/9216805
33. Muthusamy Karthika, Rishwanth M. Parimala, Florentin Smarandache (2020). An Introduction to Neutrosophic Minimal Structure Spaces. *Neutrosophic Sets and Systems* 36, 378-388
34. Rishwanth Mani Parimala, Cenap Özel, Florentin Smarandache, Muthusamy Karthika (2020). A New Type of Quasi Open Functions in Neutrosophic Topological Environment, 10
35. Florentin Smarandache, Miguel A. Quiroz-Martínez, Jesús Estupiñán Ricardo, Noel Batista Hernández, Maikel Y. Leyva Vázquez (2020). Application of Neutrosophic Offsets for Digital Image Processing. *Revista Investigacion Operacional* 41(5), 603-611
36. Florentin Smarandache, Akbar Rezaei, Adesina Abdul Akeem Agboola, Young Bae Jun, Rajab Ali Borzooei, Bijan Davvaz, Arsham Borumand Saeid, Mohammad Akram, Mohammad Hamidi, Saeed Mirvakili (2021). On Neutro Quadruple Groups. The 51st Annual Iranian Mathematics Conference, University of Kashan, 15-20 February 2021, 1227-1234
37. Ahmed B. Al-Nafee, Florentin Smarandache, A. A. Salama (2022). New Types of Neutrosophic Crisp Closed Sets. *Neutrosophic Sets and Systems* 36, 175-183
38. Yaser Saber, Fahad Alsharari, Florentin Smarandache (2022). An introduction to single-valued neutrosophic soft topological structure. *Soft Computing*, 16; DOI: 10.1007/s00500-022-07150-4
39. Michael Voskoglou, Said Broumi, Florentin Smarandache (2022). A Combined Use of Soft and Neutrosophic Sets for Student Assessment with Qualitative Grades. *Journal of Neutrosophic and Fuzzy Systems* 4(1), 15-20; DOI: 10.54216/JNFS.040102
40. Florentin Smarandache (2022). Improved Definition of NonStandard Neutrosophic Logic and Introduction to Neutrosophic Hyperreals (Fifth version). *Neutrosophic Sets and Systems* 51, 26-46.
41. Florentin Smarandache (2022). Neutrosafia, generalizare a Dialecticii. Noțiuni fundamentale. *In press*, 15
42. Florentin Smarandache (2022). Circuite și fluxuri neutrosifice. *In press*, 6
43. Florentin Smarandache (2022). Există o neutralitate în fiecare neutralitate. *In press*, 7
44. Florentin Smarandache (2022). Filosofia este neutrosifică sau nu este deloc. *In press*, 7
45. Florentin Smarandache (2022). Modus neutrosophicus. *In press*, 6
46. Florentin Smarandache (2022). Neutrosografie maieutică. *In press*, 6
47. Florentin Smarandache (2022). Neutrosafia, o teorie a teoriilor. *In press*, 7
48. Florentin Smarandache (2022). Neutrosafia ca matrice universală. *In press*, 6
49. Florentin Smarandache (2022). Spirit și materie în neutrosografie. *In press*, 8
50. Florentin Smarandache (2022). Transdisciplinaritate neutrosifică. *In press*, 7

FUZZY SETS, INTUITIONISTIC FUZZY SETS, PICTURE FUZZY SETS

1. Said Broumi, Florentin Smarandache (2014). New Operations over Interval Valued Intuitionistic Hesitant Fuzzy Set. *Mathematics and Statistics* 2(2), 62-71; DOI: 10.13189/ms.2014.020202
2. Nguyen Xuan Thao, Mumtaz Ali, Le Thi Nhung, Hemant Kumar Gianey, Florentin Smarandache (2019). A new multi-criteria decision making algorithm for medical diagnosis and classification problems using divergence measure of picture fuzzy sets. *Journal of Intelligent & Fuzzy Systems* 37(6), 7785-7796; DOI: 10.3233/JIFS-182697
3. Ngan Thi Roan, Salvador Coll, Marina Alonso, Juan Miguel Martínez Rubio, Pedro López, Fran Andujar, Son Hoang Le, Manh Van Vu, Florentin Smarandache (2020). The picture fuzzy distance measure in controlling network power consumption. *Journal of Fuzzy Extension and Applications* 1(3), 139-158; DOI: 10.22105/jfea.2020.249183.1009
4. Azmat Hussain, Tahir Mahmood, Florentin Smarandache, Shahzaib Ashraf (2022). TOPSIS Approach for MCGDM based on Intuitionistic Fuzzy Rough Dombi Aggregation Operations. *SSRN Electronic Journal*, 23; DOI: 10.2139/ssrn.4203412

MATHEMATICS

1. Florentin Smarandache (2011). A Group-Permutation Algorithm to Solve the Generalized SUDOKU. *Recreații matematice*, Anul XIII, Nr. 1, 20-22
2. Ion Pătrașcu, Florentin Smarandache (2011). Two Triangles With The Same Orthocenter and A Vectorial Proof Of Stevanovic's Theorem. In: Marcelina Mocanu, Cornel Berceanu, Catalin Barbu (coordinators), Simpozionul National de Geometrie "Gheorghe Titeica": editia II, Bacau, Romania, 24-27 martie 2011
3. Rajesh Singh, Jayant Singh, Florentin Smarandache (2011). A Note on Testing of Hypothesis. *Italian Journal of Pure and Applied Mathematics* 28, 161-164
4. Ion Pătrașcu, Florentin Smarandache (2017). Cercurile Apollonius de rangul -1. *Recreații matematice*, Anul XIX, Nr. 2, 114-115
5. Ion Pătrașcu, Florentin Smarandache (2018). Două probleme de minimum geometric. *Recreații matematice*, Anul XX, nr. 1, 16-18
6. Ion Pătrașcu, Florentin Smarandache (2018). Câteva probleme privind calculul unor măsuri de unghiuri într-un triunghi isoscel. *Revista de Matematică din Timișoara*, Anul XXIII (Seria a IV-a), Nr. 4, 3-5
7. Victor Christianto, Florentin Smarandache (2021). Continuum Hypothesis Revisited: From Cantor, to Godel, then to Discrete Cellular Space model. *Asia Mathematica* 5(2), 11 – 12

INFORMATION FUSION

1. Said Broumi, Florentin Smarandache (2014). New Distance and Similarity Measures of Interval Neutrosophic Sets. 17th International Conference on Information Fusion, 13-19
2. Florentin Smarandache (2014). Reliability and Importance Discounting of Neutrosophic Masses. *Critical Review* IX, 33-43
3. Nassim Abbas, Youcef Chibani, Bilal Hadjadji, Zayen Azzouz Omar, Florentin Smarandache (2016). A DSMT Based System for Writer-Independent Handwritten Signature Verification, 8

4. Qiang Guo, Haipeng Wang, You He, Yong Deng, Florentin Smarandache (2017). An Evidence Fusion Method with Importance Discounting Factors based on Neutrosophic Probability Analysis in DS_mT Framework. *Neutrosophic Sets and Systems* 17, 64-73

ROBOTICS

1. Marcel Migdalovici, Luige Vlădăreanu, Gabriela Vlădeanu, Daniela Baran, Said Broumi, Florentin Smarandache, Hongbo Wang, Yonfei Feng (2016). Some mathematical aspects on walking robots stable evolution. 10th International Conference on Software, Knowledge, Information Management & Applications (SKIMA), 199-204
2. Kenta Takaya, Toshinori Asai, Valeri Kroumov, Florentin Smarandache (2016). Simulation Environment for Mobile Robots Testing Using ROS and Gazebo. 20th International Conference on System Theory, Control and Computing (ICSTCC), Sinaia, Romania, 6
3. Luige Vlădăreanu, Victor Vlădăreanu, Hongnian Yu, Hongbo Wang, Florentin Smarandache (2019). Robot Advanced Intellectual Control developed through Flexible Intelligent Portable Platform. *International Journal of Advanced Trends in Computer Science and Engineering* 8(1.1), 202-208; DOI: 10.30534/ijatcse/2019/3881.12019

STATISTICS and NEUTROSOPHIC STATISTICS

1. Rajesh Singh, Pankaj Chauhan, Nirmala Sawan, Florentin Smarandache (2008). Ratio estimators in simple random sampling using information on auxiliary attribute. *Pakistan Journal of Statistics and Operation Research* 4(1),47-53
2. Rajesh Singh, Jayant Singh, Florentin Smarandache (2009). Optimum Statistical Test Procedure. *Italian Journal of Pure and Applied Mathematics* 26, 219-228
3. Rajesh Singh, Pankaj Chauhan, Nirmala Sawan, Florentin Smarandache (2011). Improved Exponential Estimator for Population Variance Using Two Auxiliary Variables. *Italian Journal of Pure and Applied Mathematics* 28, 101-108
4. Rajesh Singh, Pankaj Chauhan, Nirmala Sawan, Florentin Smarandache (2011). Improvement in Estimating Population Mean Using Two Auxiliary Variables in Two-Phase Sampling. *Italian Journal of Pure and Applied Mathematics* 28, 135-142
5. Deepesh Kunwar, Jayant Singh, Florentin Smarandache (2018). Neutrosophic statistical evaluation of migration with particular reference to Jaipur. *Octagon Mathematical Magazine* 26(2), 560-568
6. Deepesh Kunwar, Jayant Singh, Florentin Smarandache (2018). Neutrosophic statistical techniques to find migration pattern in Jaipur. *Octagon Mathematical Magazine* 26(2), 583-592
7. Florentin Smarandache (2022). Neutrosophic Statistics is an extension of Interval Statistics, while Plithogenic Statistics is the most general form of statistics (third version). *In press*, 30

MISCELLANEA

1. Florentin Smarandache, Victor Vlădăreanu (2012). Applications of Extenics to 2D-Space and 3D-Space. SKIMA, Chengdu, China, Track 7: Intelligent & Informed, 4

2. Victor Christianto, Florentin Smarandache (2015). Federal Reserve. *Journal of Research in Economics and International Finance* 4(2), 6; DOI: 10.14303/jrief.2015.109
3. Florentin Smarandache (2017). A Quarter of Century for Octagon Mathematical Magazine. Dedicated to the 25 years of Octagon Mathematical Magazine. *Octagon Mathematical Magazine* 25(2), 6
4. Victor Christianto, Florentin Smarandache (2018). On the Efficacy of High-dose Ascorbic Acid as Anticancer Treatment: A Literature Survey. *BAOJ Cancer Research & Therapy* 4:2, 4
5. Mohamed Abdel-Basset, Florentin Smarandache (2020). Preface. *Revista Investigacion Operacional* 41(5), 1
6. Florentin Smarandache (2020). Marinela Preoteasa (1952 – 2020), 2
7. Mohamed Loey, Florentin Smarandache, Nour Eldeen M. Khalifa (2020). A Deep Transfer Learning Model with Classical Data Augmentation and CGAN to Detect COVID-19 from Chest CT Radiography Digital Images. *In press*, 17. DOI: 10.20944/preprints202004.0252.v1
8. Victor Christianto, Robert N. Boyd, Florentin Smarandache (2021). Remark on Recent Experimental Findings Supporting Smarandache's Hypothesis and Quantum Sorites Paradoxes and Sub Quantum Kinetic Model of Electron. 4th International Conference on Materials Science and Materials Chemistry, *Advanced Materials Science Research* 1(4), 1
9. Florentin Smarandache (2022). Octagon magazine celebrates 30 years of existence. *Octagon Mathematical Magazine* 30(1), 25-26
10. Victor Christianto, Florentin Smarandache (2022). Notes on the other side of creativity in mathematical physics development: schizotypy and the need for a new approach in exploring new physics. *Octagon Mathematical Magazine* 30(1), 302-308

List of Authors

A

Ahmed B. Al-Nafee

Open Educational College, Math Dept., Babylon, IRAQ
ahm_math_88@yahoo.com

Adesina Abdul Akeem Agboola

Department of Mathematics, College of Physical Sciences, Federal University of Agriculture, Abeokuta, Ogun State, NIGERIA
agboolaaaa@funaab.edu.ng

Akbar Rezaei

Department of Mathematics, Payame Noor University, Tehran, IRAN
rezaei@pnu.ac.ir

Shariful Alam

Department of Mathematics, Indian Institute of Engineering Science and Technology, Shibpur, Howrah, West Bengal, INDIA
salam@math.iiests.ac.in

Marina Alonso

UPV Universitat Politècnica de València, SPAIN

Fran Andujar

Universidad de Valladolid, SPAIN

Toshinori Asai

FBR Technology Engineering Services Co., Tsuruga City, JAPAN
asronx@gmail.com

Assia Bakali

Ecole Royale Navale, Boulevard Sour Jdid, Casablanca, MOROCCO
assiabakali@yahoo.fr

Azmat Hussain

Department of Mathematics and Statistics, Faculty of Basic and Applied Sciences, International Islamic University Islamabad, PAKISTAN
azmat.phdma66@gmail.com

B

Daniela Baran

Dynamical Systems, National Institute of Aircraft Research “Elie Carafoli”, Bucharest, ROMÂNIA
dbaran@incas.ro

Bijan Davvaz

Department of Mathematics, Yazd University, Yazd, IRAN
davvaz@yazd.ac.ir

Bilal Hadjadji

Faculty of Electronics and Computer Science, University of Science and Technology, Algiers, ALGERIA
bhadjadji@usthb.dz

Carlos Díaz Bohorquez

Universidad Industrial de Santander, Bucaramanga, Santander, COLOMBIA

Robert N. Boyd

Princeton Biotechnology Corporation, Department Information Physics Research, UNITED STATES OF AMERICA

C**M. Caldas**

Departamento de Matematica Aplicada, Universidade Federal Fluminense, Niteroi, BRASIL
gmamccs@vm.uff.br

Cenap Özel

Department of Mathematics, King Abdulaziz University, Makkah, SAUDI ARABIA
cenap.ozel@gmail.com

Pankaj Chauhan

School of Statistics, DAVV, Indore, INDIA

Victor Christianto

Malang Institute of Agriculture (IPM), Malang, INDONESIA
victorchristianto@gmail.com

Salvador Coll

UPV Universitat Politècnica de València, SPAIN

D**Shyamal Dalapati**

Department of Mathematics, Indian Institute of Engineering Science and Technology, Shibpur, Howrah, West Bengal, INDIA
shyamal.rs2015@math.iiests.ac.in

Irfan Deli

Muallim Rifat Faculty of Education, Aralik University, Kilis, TURKEY
irfandeli@kilis.edu.tr

E**Balasubramanian Elavarasan**

Department of Mathematics, Karunya Institute of Technology and Sciences, Coimbatore, Tamilnadu, INDIA
elavarasan@karunya.edu

F**Fahad Alsharari**

Department of Mathematics, Faculty of Science Al-Azhar University, Assiut, EGYPT
f.alsharari@mu.edu.sa

Yonfei Feng

Laboratory of Advanced Forging & Stamping Technology and Science, Yanshan University, Qinhuangdao, PR CHINA

G**Daniela Gifu**

Institute of Computer Science, Romanian Academy, Iași Branch, Iași, ROMANIA
daniela.gifu@iit.academiaromana-is.ro

Rafael Rojas Gualdrón

Universidad Industrial de Santander, Bucaramanga, Santander, COLOMBIA

H**Haipeng Wang**

Institute of Information Fusion Technology Department Naval Aeronautical and Astronautical University Yantai, PR CHINA

Hemant Kumar Gianey

Thapar Institute of Engineering and Technology, Patiala Punjab, INDIA

Noel Batista Hernández

Universidad de Guayaquil, Guayas, ECUADOR

Abdel-Nasser Hussein

Department of Information System, Faculty of Computers and Informatics, Zagazig University, Sharqiyah, EGYPT
nasserhr@gmail.com

I**Ibrahim M. Hezam**

Department of Computer, Faculty of Education, Ibb University, Ibb city, YEMEN
ibrahizam.math@gmail.com

K**Ilanthenral Kandasamy**

School of Computer Science and Engineering, VIT, Vellore, Tamil Nadu, INDIA
ilanthenral.k@vit.ac.in

W.B. Vasantha Kandasamy

School of Computer Science and Engineering, VIT, Vellore, Tamil Nadu, INDIA
vasantha.wb@vit.ac.in

Muthusamy Karthika

Department of Mathematics, Bannari Amman Institute of Technology, Sathyamangalam, Tamil Nadu, INDIA
karthikamuthusamy1991@gmail.com

Nour Eldeen M. Khalifa

Department of Information Technology, Faculty of Computers & Artificial Intelligence, Cairo University, Cairo, EGYPT
nourmahmoud@cu.edu.eg

Madad Khan

Department of Mathematics, COMSATS University Islamabad, Abbottabad Campus, PAKISTAN
madadkhan@cuiatd.edu

Kifayat Ullah

Department of Mathematics & Statistics, International Islamic University, Islamabad, PAKISTAN
kifayat.phdma72@iiu.edu.pk

Valeri Kroumov

Dept. of Electrical & Electronic Engineering, Okayama University of Science, Okayama City, JAPAN
val@ee.ous.ac.jp

Tapan Kumar Roy

Department of Mathematics, Indian Institute of Engineering Science and Technology, Shibpur, Howrah, West Bengal, INDIA
tkroy@math.iiests.ac.in

Deepesh Kunwar

Department of Statistics, University of Rajasthan, Jaipur, INDIA

L**Le Thi Nhung**

Vietnam National University of Agriculture, Hanoi, SR VIETNAM

Pedro López

UPV Universitat Politècnica de València, SPAIN

M**Mai Mohamed**

Department of Operations Research, Faculty of Computers and Informatics, Zagazig University, Sharqiyah, EGYPT
mmgaafar@zu.edu.eg

Manh Van Vu

VNU University of Science, Vietnam National University, Hanoi, SR VIETNAM

Miguel A. Quiroz-Martínez

Universidad Politécnica Salesiana, Guayaquil, Guayas, ECUADOR

Marcel Migdalovici

Robotics and Mechatronics Dept., Institute of Solid Mechanics of the Romanian Academy, Bucharest, ROMÂNIA
migdal@imsar.bu.edu.ro

Kritika Mishra

Shell India Markets, RMZ Ecoworld Campus, Marathahalli, Bengaluru, Karnataka, INDIA
kritika.mishra@shell.com

Mohamed Abdel-Basset

Department of Operations Research, Faculty of Computers and Informatics, Zagazig University, Sharqiyah, EGYPT
analyst_mohamed@yahoo.com

Mohamed Talea

Laboratory of Information processing, Faculty of Science Ben M'Sik, University Hassan II, Casablanca, MOROCCO
taleamohamed@yahoo.fr

Mohammad Hamidi

Department of Mathematics, University of Payame Noor, Tehran, IRAN
m.hamidi@pnu.ac.ir

Mohammed Alshumrani

Department of Mathematics, King Abdulaziz University (KAU), Jeddah, SAUDI ARABIA
maalshmrani1@kau.edu.sa

Mohamed Loey

Department of Computer Science, Faculty of Computers and Artificial Intelligence, Benha University, Benha, EGYPT
mloey@fci.bu.edu.eg

Muhammad Akram

Department of Mathematics, University of the Punjab, New Campus, Lahore, PAKISTAN
m.akram@pucit.edu.pk

Muhammad Shabir

Department of Mathematics, Quaid-i-Azam University, Islamabad, PAKISTAN
mshabirbhatti@yahoo.co.uk

Mumtaz Ali

Department of Mathematics, Quaid-i-Azam University, Islamabad, PAKISTAN
mumtazali770@yahoo.com

N**Nassim Abbas**

Faculty of Electronics and Computer Science, University of Science and Technology, Algiers, ALGERIA
nabbas@usthb.dz

Munazza Naz

Department of Mathematical Sciences, Fatima Jinnah Women University, Rawalpindi, PAKISTAN
munazzanaz@yahoo.com

Ngan Thi Roan

VNU University of Science, Vietnam National University, Hanoi, SR VIETNAM
roanngan@gmail.com

Nguyen Xuan Thao

Faculty of Information Technology, Vietnam National University of Agriculture, SR VIETNAM
nxthao2000@gmail.com

P**Rishwanth Mani Parimala**

Department of Mathematics, Bannari Amman Institute of Technology, Sathyamangalam, Tamil Nadu, INDIA
rishwanthpari@gmail.com

Ion Pătrașcu

“Fratii Buzesti” National College, Craiova, ROMÂNIA

Surapati Pramanik

Department of Mathematics, Nandalal Ghosh B.T. College, Panpur, Bhatpara, West Bengal, INDIA
surapati@yahoo.co.in

Q**Quek Shio Gai**

UCSI College KL Campus, Jalan Choo Lip Kung, Cheras, Kuala Lumpur, MALAYSIA
quekshg@yahoo.com

Qiang Guo

Institute of Information Fusion Technology Department Naval Aeronautical and Astronautical University Yantai, PR CHINA
gq19860209@163.com

R**Rajab Ali Borzooei**

Department of Mathematics, Shahid Beheshti University, Tehran, IRAN
borzooei@sbu.ac.ir

Nimitha Rajesh

Department of Mathematics, Rajah Serfoji Govt. College, Thanjavur, Tamilnadu, INDIA
nrajesh_topology@yahoo.co.in

Jesús Estupiñan Ricardo

Universidad Regional Autónoma de los Andes. (UNIANDES), Sede Babahoyo, Los Ríos, ECUADOR

Juan Miguel Martínez Rubio

UPV Universitat Politècnica de València, SPAIN

S**Saeed Mirvakili**

Department of Mathematics, Payame Noor University, Tehran, IRAN
saeed_mirvakili@pnu.ac.ir

Arsham Borumand Saeid

Department of Pure Mathematics, Faculty of Mathematics and Computer, Shahid Bahonar University of Kerman, Kerman, IRAN
arsham@uk.ac.ir

Saeid Jafari

College of Vestsjaelland South, Slagelse, DENMARK
jafaripersia@gmail.com

Said Broumi

Laboratory of Information Processing, Faculty of Science Ben M'Sik, University Hassan II, Casablanca, MOROCCO
broumisaid78@gmail.com

Ahmed A. Salama

Department of Mathematics and Computer Science, Faculty of Science, Port Said University, EGYPT
drsalama44@gmail.com

Nirmala Sawan

School of Statistics, DAVV, Indore (M.P.), India

Gheorghe Săvoiu

University of Pitești, Pitești, ROMÂNIA
gheorghe.savoiu@upit.ro

Ganeshsree Selvachandran

Faculty of Business & Information Science, UCSI University, Jalan Menara Gading, Kuala Lumpur, MALAYSIA
Ganeshsree@ucsiuniversity.edu.my

Seok-Zun Song

Department of Mathematics, Jeju National University, Jeju, SOUTH KOREA
szsong@jejunu.ac.kr

Shahzaib Ashraf

Department of Mathematics and Statistics, Bacha Khan University, Charsadda, Khyber Pakhtunkhwa, PAKISTAN
shahzaibashraf@awkum.edu.pk

Jayant Singh

Department of Statistics, University of Rajasthan, Jaipur, INDIA
jayantsingh47@rediffmail.com

Rajesh Singh

Department of Statistics, BHU, Varanasi, INDIA
rsinghstat@yahoo.com

Son Hoang Le

VNU Information Technology Institute, Vietnam National University, Hanoi, SR VIETNAM

Florentin Smarandache

University of New Mexico, 705 Gurley Ave., Gallup, NM 87301, UNITED STATES OF AMERICA
smarand@unm.edu

T**Tahir Mahmood**

Department of Mathematics and Statistics, Faculty of Basic and Applied Sciences, International Islamic University Islamabad, PAKISTAN
tahirbakhat@iiu.edu.pk

Kenta Takaya

Graduate School, Okayama University of Science, Okayama City, JAPAN
kenta@kids.ee.ous.ac.jp

Mirela Teodorescu

Neutrosophic Science International Association, Romanian Branch, ROMANIA
mirela.teodorescu@yahoo.co.uk

U**Ramalingam Udhayakumar**

Department of Mathematics, School of Advanced Sciences, Vellore Institute of Technology, Vellore, INDIA
udhayaram_v@yahoo.co.in

V**Maikel Y. Leyva Vázquez**

Universidad Politécnica Salesiana, Guayaquil, Guayas, ECUADOR
mleyva@ups.edu.ec

V. Venkateswara Rao

Mathematics Division, Department of S&H, Chirala Engineering College, Chirala, INDIA
vunnamvenky@gmail.com

Luige Vlădăreanu

Dept. of Mechatronics and Robotics, Institute of Solid Mechanics, Romanian Academy, Bucharest, ROMÂNIA
luigiv@arexim.ro

Victor Vlădăreanu

“Politehnica” University of Bucharest, Faculty of Electronics II, Bucharest, ROMÂNIA

Gabriela Vlădeanu

Dept. of Mechatronics and Robotics, Institute of Solid Mechanics, Romanian Academy, Bucharest, ROMÂNIA

Michael Voskoglou

Department of Mathematical Sciences, University of Peloponnese, GREECE
voskoglou@teiwest.gr

Y**Yaser Saber**

Department of Mathematics, College of Science and Human Studies, Majmaah University, Majmaah, SAUDI ARABIA
y.sber@mu.edu.sa

Yong Deng

School of Computer and Information Science Southwest University, Chongqing, PR CHINA

You He

Institute of Information Fusion Technology Department Naval Aeronautical and Astronautical University Yantai, PR CHINA

Youcef Chibani

Faculty of Electronics and Computer Science, University of Science and Technology, Algiers, ALGERIA
ychibani@usthb.dz

Young Bae Jun

Department of Mathematics Education, Gyeongsang National University, Jinju, SOUTH KOREA
skywine@gmail.com

W**Wadei F. Al-Omeri**

Department of Mathematics, Al-Balqa Applied University, Salt, JORDAN
wadeimoon1@hotmail.com

Hongbo Wang

Parallel Robot & Mechatronic System, Laboratory of Hebei Province, Yanshan University, Qinhuangdao, PR CHINA
hongbo_w@ysu.edu.cn

Z

Zayen Azzouz Omar

Faculty of Electronics and Computer Science, University of Science and Technology, Algiers, ALGERIA
azzouz-omar.zayen.1@ens.etsmtl.ca

NEUTROSOPHICS

Single Valued Neutrosophic Sets

Haibin Wang, Florentin Smarandache, Yanqing Zhang, Rajshekhar Sunderraman

Haibin Wang, Florentin Smarandache, Yanqing Zhang, Rajshekhar Sunderraman (2012). Single Valued Neutrosophic Sets. *Technical Sciences and Applied Mathematics*, 10-14

Abstract: *Neutrosophic set is a part of neutrosophy which studies the origin, nature, and scope of neutralities, as well as their interactions with different ideational spectra. Neutrosophic set is a powerful general formal framework that has been recently proposed. However, neutrosophic set needs to be specified from a technical point of view. To this effect, we define the set-theoretic operators on an instance of neutrosophic set, we call it single valued neutrosophic set (SVNS). We provide various properties of SVNS, which are connected to the operations and relations over SVNS.*

Keywords: *neutrosophic set, single valued neutrosophic set, set-theoretic operator.*

1. INTRODUCTION

The concept of fuzzy sets was introduced by Zadeh in 1965 [1]. Since then fuzzy sets and fuzzy logic have been applied in many real applications to handle uncertainty. The traditional fuzzy set uses one real value $\mu_A(x) \in [0,1]$ to represent the grade of membership of fuzzy set A defined on universe X. Sometimes $\mu_A(x)$ itself is uncertain and hard to be defined by a crisp value. So the concept of interval valued fuzzy sets was proposed [2] to capture the uncertainty of grade of membership. Interval valued fuzzy set uses an interval value $[\mu_A^L(x), \mu_A^U(x)]$ with $0 \leq \mu_A^L(x) \leq \mu_A^U(x) \leq 1$ to represent the grade of membership of fuzzy set A. In some applications such as expert system, belief system and information fusion, we should consider not only the truth-membership supported by the evident but also the falsity-membership against by the evident. That is beyond the scope of fuzzy sets and interval valued fuzzy sets. In 1986, Atanassov introduced the intuitionistic fuzzy sets [3] which is a generalization of fuzzy sets and provably equivalent to interval valued fuzzy sets. The intuitionistic fuzzy sets consider both truth-membership $t_A(x)$ and falsity-

membership $f_A(x)$, with $t_A(x), f_A(x) \in [0,1]$ and $0 \leq t_A(x) + f_A(x) \leq 1$. Intuitionistic fuzzy sets can only handle incomplete information not the indeterminate information and inconsistent information which exists commonly in belief system. In intuitionistic fuzzy sets, indeterminacy is $1 - t_A(x) - f_A(x)$ by default. For example, when we ask the opinion of an expert about certain statement, he or she may that the possibility that the statement is true is 0.5 and the statement is false is 0.6 and the degree that he or she is not sure is 0.2.

In neutrosophic set, indeterminacy is quantified explicitly and truth-membership, indeterminacy-membership and falsity-membership are independent. This assumption is very important in a lot of situations such as information fusion when we try to combine the data from different sensors. Neutrosophy was introduced by Smarandache in 1995. "It is a branch of philosophy which studies the origin, nature and scope of neutralities, as well as their interactions with different ideational spectra" [4]. Neutrosophic set is a power general formal framework which generalizes the concept of the classic set, fuzzy set [1], interval valued fuzzy set [2], intuitionistic fuzzy set [3] etc. A neutrosophic set A defined on universe U. $x = x(T, I, F) \in A$ with T, I and

F being the real standard or non-standard subsets of $]0^-, 1^+[$. T is the degree of truth-membership function in the set A, I is the indeterminacy-membership function in the set A and F is the falsity-membership function in the set A.

The neutrosophic set generalizes the above mentioned sets from philosophical point of view. From scientific or engineering point of view, the neutrosophic set and set-theoretic operators need to be specified. Otherwise, it will be difficult to apply in the real applications. In this paper, we define the settheoretic operators on an instance of neutrosophic set called single valued neutrosophic set (svns).

2. NEUTROSOPHIC SET

This section gives a brief overview of concepts of neutrosophic set defined in [2]. Here, we use different notations to express the same meaning. Let S_1 and S_2 be two real standard or non-standard subsets, then $S_1 + S_2 = \{x|x = s_1 + s_2, s_1 \in S_1 \text{ and } s_2 \in S_2\}$, $\{1^+\} + S_2 = \{x|x = 1^+ + s_2, s_2 \in S_2\}$. $S_1 - S_2 = \{x|x = s_1 - s_2, s_1 \in S_1 \text{ and } s_2 \in S_2\}$, $\{1^+\} - S_2 = \{x|x = 1^+ - s_2, s_2 \in S_2\}$. $S_1 \times S_2 = \{x|x = s_1 \times s_2, s_1 \in S_1 \text{ and } s_2 \in S_2\}$.

Definition 1 (Neutrosophic Set). Let X be a space of points (objects), with a generic element in X denoted by x. A neutrosophic set A in X is characterized by a truth-membership function T_A , an indeterminacy-membership function I_A and a falsity-membership function F_A . $T_A(x)$, $I_A(x)$ and $F_A(x)$ are real standard or non-standard subsets of $]0^-, 1^+[$. That is

$$T_A : X \rightarrow]0^-, 1^+[\tag{1}$$

$$I_A : X \rightarrow]0^-, 1^+[\tag{2}$$

$$F_A : X \rightarrow]0^-, 1^+[\tag{3}$$

There is no restriction on the sum of $T_A(x)$, $I_A(x)$ and $F_A(x)$, so $0^- \leq \sup T_A(x) + \sup I_A(x) + \sup F_A(x) \leq 3^+$.

Definition 2. The complement of a neutrosophic set A is denoted by $c(A)$ and is defined by

$$T_{c(A)}(x) = \{1^+\} - T_A(x) \tag{4}$$

$$I_{c(A)}(x) = \{1^+\} - I_A(x) \tag{5}$$

$$F_{c(A)}(x) = \{1^+\} - F_A(x) \tag{6}$$

for all x in X.

Definition 3 (Containment). A neutrosophic set A is contained in the other neutrosophic set B, $A \subseteq B$, if and only if

$$\inf T_A(x) \leq \inf T_B(x), \sup T_A(x) \leq \sup T_B(x) \tag{7}$$

$$\inf F_A(x) \geq \inf F_B(x), \sup F_A(x) \geq \sup F_B(x) \tag{8}$$

Definition 4 (Union). The union of two neutrosophic sets A and B is a neutrosophic set C, written as $C = A \cup B$, whose truth-membership, indeterminacy-membership and falsity-membership functions are related to those of A and B by

$$T_C(x) = T_A(x) + T_B(x) - T_A(x) \times T_B(x) \tag{9}$$

$$I_C(x) = I_A(x) + I_B(x) - I_A(x) \times I_B(x) \tag{10}$$

$$F_C(x) = F_A(x) + F_B(x) - F_A(x) \times F_B(x) \tag{11}$$

for all x in X.

Definition 5 (Intersection). The intersection of two neutrosophic sets A and B is a neutrosophic set C, written as $C = A \cap B$, whose truth-membership, indeterminacy-membership and falsity-membership functions are related to those of A and B by

$$T_C(x) = T_A(x) \times T_B(x) \tag{12}$$

$$I_C(x) = I_A(x) \times I_B(x) \tag{13}$$

$$F_C(x) = F_A(x) \times F_B(x) \tag{14}$$

for all x in X.

3. SINGLE VALUED NEUTROSOPHIC SET

In this section, we present the notion of single valued neutrosophic set (SVNS). SVNS is an instance of neutrosophic set which can be used in real scientific and engineering applications.

Definition 6 (Single Valued Neutrosophic Set). Let X be a space of points (objects), with a generic element in X denoted by x. A single valued neutrosophic set (SVNS) A in X is characterized by truth-membership function T_A , indeterminacy-membership function I_A and falsity-membership function F_A . For each point x in X, $T_A(x)$, $I_A(x)$, $F_A(x) \in [0, 1]$.

When X is continuous, a SVNS A can be written as

$$A = \int_X \langle T(x), I(x), F(x) \rangle / x, x \in X \quad (15)$$

When X is discrete, a SVNS A can be written as

$$A = \sum_{i=1}^n \langle T(x_i), I(x_i), F(x_i) \rangle / x_i, x_i \in X \quad (16)$$

Consider parameters such as capability, trustworthiness and price of semantic Web services. These parameters are commonly used to define quality of service of semantic Web services. In this section, we will use the evaluation of quality of service of semantic Web services [8] as running example to illustrate every set-theoretic operation on single valued neutrosophic sets.

Example 1. Assume that $X = [x_1, x_2, x_3]$. x_1 is capability, x_2 is trustworthiness and x_3 is price. The values of x_1, x_2 and x_3 are in $[0,1]$. They are obtained from the questionnaire of some domain experts, their option could be a degree of “good service”, a degree of indeterminacy and a degree of “poor service”. A is a single valued neutrosophic set of X defined by

$$A = \langle 0.3, 0.4, 0.5 \rangle / x_1 + \langle 0.5, 0.2, 0.3 \rangle / x_2 + \langle 0.7, 0.2, 0.2 \rangle / x_3$$

B is a single valued neutrosophic set of X defined by

$$B = \langle 0.6, 0.1, 0.2 \rangle / x_1 + \langle 0.3, 0.2, 0.6 \rangle / x_2 + \langle 0.4, 0.1, 0.5 \rangle / x_3$$

Definition 7 (Complement). The complement of a single valued neutrosophic set A is denoted by $c(A)$ and is defined by

$$T_{c(A)}(x) = F_A(x) \quad (17)$$

$$I_{c(A)}(x) = 1 - I_A(x) \quad (18)$$

$$F_A(x) = T_A(x) \quad (19)$$

for all x in X .

Example 2. Let A be the single valued neutrosophic set defined in Example 1. Then,

$$c(A) = \langle 0.5, 0.6, 0.3 \rangle / x_1 + \langle 0.3, 0.8, 0.5 \rangle / x_2 + \langle 0.2, 0.8, 0.7 \rangle / x_3$$

Definition 8 (Containment). A single valued neutrosophic set A is contained in

the other single valued neutrosophic set B , $A \subseteq B$, if and only if

$$T_A(x) \leq T_B(x) \quad (20)$$

$$I_A(x) \leq I_B(x) \quad (21)$$

$$F_A(x) \geq F_B(x) \quad (22)$$

for all x in X .

Note that by the definition of containment, X is partial order not linear order. For example, let A and B be the single valued neutrosophic sets defined in Example 1. Then, A is not contained in B and B is not contained in A .

Definition 9. Two single valued neutrosophic sets A and B are equal, written as $A = B$, if and only if $A \subseteq B$ and $B \subseteq A$.

Theorem 3. $A \subseteq B \Leftrightarrow c(B) \subseteq c(A)$

Proof: $A \subseteq B \Leftrightarrow T_A \leq T_B, I_A \leq I_B, F_B \leq F_A$
 $1 - I_B \leq 1 - I_A, T_B \geq T_A \Leftrightarrow c(B) \subseteq c(A)$

Definition 10 (Union). The union of two single valued neutrosophic sets A and B is a single valued neutrosophic set C , written as $C = A \cup B$, whose truthmembership, indeterminacy-membership and falsity-membership functions are related to those of A and B by

$$T_C(x) = \max(T_A(x), T_B(x)) \quad (23)$$

$$I_C(x) = \max(I_A(x), I_B(x)) \quad (24)$$

$$F_C(x) = \max(F_A(x), F_B(x)) \quad (25)$$

for all x in X .

Example 3. Let A and B be the single valued neutrosophic sets defined in Example 1. Then,

$$A \cup B = \langle 0.6, 0.4, 0.2 \rangle / x_1 + \langle 0.5, 0.2, 0.3 \rangle / x_2 + \langle 0.7, 0.2, 0.2 \rangle / x_3$$

Theorem 2. $A \cup B$ is the smallest single valued neutrosophic set containing both A and B .

Proof: It is straightforward from the definition of the union operator.

Definition 11 (Intersection). The intersection of two single valued neutrosophic sets A and B is a single valued neutrosophic set C , written as $C = A \cap B$, whose truthmembership, indeterminacy-membership and

falsity-membership functions are related to those of A and B by

$$T_C(x) = \min(T_A(x), T_B(x)) \quad (26)$$

$$I_C(x) = \min(I_A(x), I_B(x)) \quad (27)$$

$$F_C(x) = \min(F_A(x), F_B(x)) \quad (28)$$

for all x in X.

Example 4. Let A and B be the single valued neutrosophic sets defined in Example 1. Then,

$$A \cap B = \langle 0.3, 0.4, 0.5 \rangle / x_1 + \langle 0.3, 0.2, 0.6 \rangle / x_2 + \langle 0.4, 0.1, 0.5 \rangle / x_3$$

Theorem 3. $A \cap B$ is the largest single valued neutrosophic set contained in both A and B.

Proof: It is direct from the definition of intersection operator.

Definition 12 (Difference). The difference of two single valued neutrosophic set C, written as $C = A \setminus B$, whose truth-membership, indeterminacy-membership and falsity-membership functions are related to those of A and B by

$$T_C(x) = \min(T_A(x), F_B(x)) \quad (29)$$

$$I_C(x) = \min(I_A(x), 1 - I_B(x)) \quad (30)$$

$$F_C(x) = \min(F_A(x), T_B(x)) \quad (31)$$

for all x in X.

Example 5. Let A and B be the single valued neutrosophic sets defined in Example 1. Then,

$$A/B = \langle 0.2, 0.4, 0.6 \rangle / x_1 + \langle 0.5, 0.2, 0.3 \rangle / x_2 + \langle 0.5, 0.2, 0.4 \rangle / x_3$$

Now we will define two operators: truth-favorite (Δ) and falsity-favorite (∇) to remove the indeterminacy in the single valued neutrosophic sets and transform it into intuitionistic fuzzy sets or paraconsistent sets. These two operators are unique on single valued neutrosophic sets.

Definition 13 (Truth-favorite). The truth-favorite of a single valued neutrosophic set A is a single valued neutrosophic set B, written as $B = \Delta A$, whose truthmembership and falsity-membership functions are related to those of A by

$$T_B(x) = \min(T_A(x) + I_A(x), 1) \quad (32)$$

$$I_B(x) = 0 \quad (33)$$

$$F_B(x) = F_A(x) \quad (34)$$

for all x in X.

Example 6. Let A be the single valued neutrosophic set defined in Example 1. Then,

$$\Delta A = \langle 0.7, 0, 0.5 \rangle / x_1 + \langle 0.7, 0, 0.3 \rangle / x_2 + \langle 0.9, 0, 0.2 \rangle / x_3$$

Definition 14 (Falsity-favorite). The falsity-favorite of a single valued neutrosophic set B, written as $B = \nabla A$, whose truth-membership and falsity-membership functions are related to those of A by

$$T_B(x) = T_A(x) \quad (35)$$

$$I_B(x) = 0 \quad (36)$$

$$F_B(x) = \min(F_A(x) + I_A(x), 1) \quad (37)$$

for all x in X.

Example 8. Let A be the single valued neutrosophic set defined in Example 1. Then

$$\nabla A = \langle 0.3, 0, 0.9 \rangle / x_1 + \langle 0.5, 0, 0.5 \rangle / x_2 + \langle 0.7, 0, 0.4 \rangle / x_3$$

4. PROPERTIES OF SET- THEORETIC OPERATORS

In this section, we will give some properties of set-theoretic operators defined on single valued neutrosophic sets as in Section 3.

Property 1 (Commutativity). $A \cup B = B \cup A$, $A \cap B = B \cap A$, $A \times B = B \times A$.

Property 2 (Associativity). $A \cup (B \cup C) = (A \cup B) \cup C$, $A \cap (B \cap C) = (A \cap B) \cap C$, $A \times (B \times C) = (A \times B) \times C$.

Property 3 (Distributivity). $A \cup (B \cap C) = (A \cup B) \cap (A \cup C)$, $A \cap (B \cup C) = (A \cap B) \cup (A \cap C)$.

Property 4 (Idempotency). $A \cup A = A$, $A \cap A = A$, $\Delta \Delta A = \Delta A$, $\nabla \nabla A = \nabla A$.

Property 5. $A \cap \phi = \phi$, $A \cup X = X$, where $T\phi = I\phi = 0$, $F\phi = 1$ and $T_X = I_X = 1$, $F_X = 0$.

Property 6. $A \cup \phi = A$, $A \cap X = A$, where $T\phi = I\phi = 0$, $F\phi = 1$ and $T_X = I_X = 1$, $F_X = 0$.

Property 7 (Absorption). $A \cup (A \cap B) = A$, $A \cap (A \cup B) = A$.

Property 8 (De Morgan’s Laws). $c(A \cap B) = c(A) \cap c(B)$, $c(A \cup B) = c(A) \cup c(B)$.

Property 9 (Involution). $c(c(A)) = A$.

Here, we notice that by the definition of complement, union and intersection of single valued neutrosophic sets, single valued neutrosophic sets satisfy the most properties of classic set, fuzzy set and intuitionistic fuzzy set. Same as fuzzy set and intuitionistic fuzzy set, it does not satisfy the principle of middle exclude.

5. CONCLUSIONS

In this paper, we have presented an instance of neutrosophic set called single valued neutrosophic set (SVNS). The single valued neutrosophic set is a generalization of classic set, fuzzy set, interval valued fuzzy set, intuitionistic fuzzy set and paraconsistent set. The notion of inclusion, complement, union, intersection, have been defined on single valued neutrosophic sets. Various properties of set-theoretic operators have been provided. In the future, we will create the logic inference system based on single valued neutrosophic

sets and apply the theory to solve practical applications in areas such as expert system, information fusion system, question-answering system, bioinformatics and medical informatics, etc.

REFERENCES

1. Zadeh, L., *Fuzzy sets*, Inform and Control, 8, 1965, pp.338-353;
2. Turksen, I., *Interval valued fuzzy sets based on normal forms*, Fuzzy Sets and Systems, 20, 1986, pp.191-210;
3. Atanassov, K., *Intuitionistic fuzzy sets*, Fuzzy Sets and Systems, 20, 1986, pp.87-96;
4. Smarandache, F., *A Unifying Field in Logics, Neutrosophy: Neutrosophic Probability, Set and Logic*, Rehoboth: American Research Press, 1999;
5. Wang, H., Zhang, Y., Sunderraman, R., *Soft semantic web services agent*, The Proceedings of NAFIPS, 2004, pp.126-129.

Neutrosophic Transdisciplinarity — Multi-Space & Multi-Structure

Florentin Smarandache

Florentin Smarandache (2013). Neutrosophic Transdisciplinarity - Multi-Space & Multi-Structure. Proceedings of Conference on Multispace & Multistructure, Beijing, 22-24

§1. Definitions

Neutrosophic Transdisciplinarity means to find common features to uncommon entities, i.e., for vague, imprecise, not-clear-boundary entity $\langle A \rangle$ one has:

$\langle A \rangle \cap \langle nonA \rangle \neq \emptyset$, or even more $\langle A \rangle \cap \langle antiA \rangle \neq \emptyset$. Similarly, $\langle A \rangle \cap \langle neutA \rangle = \emptyset$ and $\langle antiA \rangle \cap \langle neutA \rangle = \emptyset$, up to $\langle A \rangle \cap \langle neutA \rangle \cap \langle antiA \rangle = \emptyset$, where $\langle nonA \rangle$ means what is not A , and $\langle antiA \rangle$ means the opposite of $\langle A \rangle$.

There exists a *principle of attraction* not only between the opposites $\langle A \rangle$ and $\langle antiA \rangle$ (as in dialectics), but also between them and their neutralities $\langle neutA \rangle$ related to them, since $\langle neutA \rangle$ contributes to the Completeness of knowledge. $\langle neutA \rangle$ means neither $\langle A \rangle$ nor $\langle antiA \rangle$, but in between; $\langle neutA \rangle$ is included in $\langle nonA \rangle$.

As part of Neutrosophic Transdisciplinarity we have the following important conceptions.

§2. Multi-Structure and Multi-Space

2.1 Multi-Concentric-Structure

Let S_1 and S_2 be two distinct structures, induced by the ensemble of laws L , which verify the ensembles of axioms A_1 and A_2 respectively, such that A_1 is strictly included in A_2 . One says that the set M , endowed with the properties:

- a) M has an S_1 -structure;
- b) there is a proper subset P (different from the empty set \emptyset , from the unitary element, from the idempotent element if any with respect to S_2 , and from the whole set M) of the initial set M , which has an S_2 -structure;
- c) M doesn't have an S_2 -structure,

is called a 2-concentric-structure. We can generalize it to an n -concentric-structure, for $n \geq 2$ (even infinite-concentric-structure).

(By default, 1-concentric structure on a set M means only one structure on M and on its proper subsets.)

An n -concentric-structure on a set S means a weak structure $\{w(0)\}$ on S such that there exists a chain of proper subsets

$$P(n - 1) < P(n - 2) < \dots < P(2) < P(1) < S,$$

where $<$ means *included in*, whose corresponding structures verify the inverse chain

$$\{w(n - 1)\} > \{w(n - 2)\} > \dots > \{w(2)\} > \{w(1)\} > \{w(0)\},$$

where $>$ signifies *strictly stronger* (i.e., structure satisfying more axioms).

For example, say a groupoid D , which contains a proper subset S which is a semigroup, which in its turn contains a proper subset M which is a monoid, which contains a proper subset NG which is a non-commutative group, which contains a proper subset CG which is a commutative group, where D includes S , which includes M , which includes NG , which includes CG . In fact, this is a 5-concentric-structure.

2.2 Multi-Space

Let S_1, S_2, \dots, S_n be n structures on respectively the sets M_1, M_2, \dots, M_n , where $n \geq 2$ (n may even be infinite). The structures S_i , $i = 1, 2, \dots, n$, may not necessarily be distinct two by two; each structure S_i may be or not n_i -concentric, for $n_i \geq 1$. And the sets M_i , $i = 1, 2, \dots, n$, may not necessarily be disjoint, also some sets M_i may be equal to or included in other sets M_j , $j = 1, 2, \dots, n$. We define the *multi-space* M as a union of the previous sets:

$$M = M_1 \cup M_2 \cup \dots \cup M_n,$$

hence we have n (different or not, overlapping or not) structures on M . A multi-space is a space with many structures that may overlap, or some structures may include others or may be equal, or the structures may interact and influence each other as in our everyday life.

Therefore, a region (in particular a point) which belong to the intersection of $1 \leq k \leq n$ sets M_i may have k different structures in the same time. And here it is the difficulty and beauty of the a multi-space and its overlapping multi-structures.

(We thus may have $\langle R \rangle \neq \langle R \rangle$, i.e. a region R different from itself, since R could be endowed with different structures simultaneously.)

For example, we can construct a geometric multi-space formed by the union of three distinct subspaces: an Euclidean subspace, a hyperbolic subspace and an elliptic subspace.

As particular cases when all M_i sets have the same type of structure, we can define the Multi-Group (or n -group; for example; bigroup, tri-group, etc., when all sets M_i are groups), Multi- Ring (or n -ring, for example biring, tri-ring, etc. when all sets M_i are rings), Multi-Field (n -field), Multi-Lattice (n -lattice), Multi-Algebra (n -algebra), Multi-Module (n -module), and so on - which may be generalized to infinite-structure-space (when all sets have the same type of structure), etc.

§3. Conclusion

The multi-space comes from reality, it is not artificial, because our reality is not homogeneous, but has many spaces with different structures. A multi-space means a combination of any

spaces (may be all of the same dimensions, or of different dimensions - it doesn't matter). For example, a Smarandache geometry (SG) is a combination of geometrical (manifold or pseudo-manifold, etc.) spaces, while the multi-space is a combination of any (algebraic, geometric, analytical, physics, chemistry, etc.) space. So, the multi-space can be interdisciplinary, i.e. math and physics spaces, or math and biology and chemistry spaces, etc. Therefore, an SG is a particular case of a multi-space. Similarly, a Smarandache algebraic structure is also a particular case of a multi-space.

This multi-space is a combination of spaces on the horizontal way, but also on the vertical way (if needed for certain applications). On the horizontal way means a simple union of spaces (that may overlap or not, may have the same dimension or not, may have metrics or not, the metrics if any may be the same or different, etc.). On the vertical way means more spaces overlapping in the same time, every one different or not. The multi-space is really very general because it tries to model our reality. The parallel universes are particular cases of the multi-space too. So, they are multi-dimensional (they can have some dimensions on the horizontal way, and other dimensions on the vertical way, etc.).

The multi-space with its multi-structure is a *Theory of Everything*. It can be used, for example, in the *Unified Field Theory* that tries to unite the gravitational, electromagnetic, weak, and strong interactions (in physics).

Reference

- [1] F.Smarandache, *Mixed Non-Euclidean geometries*, Arhivele Statului, Filiala Valcea, Rm. Valcea, 1969.

Neutrosophic elements in discourse

Florentin Smarandache, Daniela Gîfu, Mirela Teodorescu

Florentin Smarandache, Daniela Gîfu, Mirela Teodorescu (2015). Neutrosophic elements in discourse. *Social Sciences and Education Research Review* (2), 1, 25-32

Abstract

Discourse analysis is a synergy of social science disciplines, including linguistics, education, sociology, anthropology, social work, cognitive psychology, social psychology, area studies, cultural studies, international relations, human geography, communication studies, and translation studies, subject to its own assumptions, dimensions of analysis, and methodologies. The aim of this paper is to present the applicability of (t, i, f)-Neutrosophic Social Structures, introduced for the first time as new type of structures, called (t, i, f)-Neutrosophic Structures, and presented from a neutrosophic logic.

Neutrosophy theory can be assimilated to interpret and evaluate the individual opinion of social structures. This type of analyse already tested and applied in mathematics, artificial intelligence as well can be applied in social sciences by reseachers in social sciences, communication, sociology, psychology.

Keywords: discourse, neutrosophy, truth, false, uncertainty

1 Introduction

The specifics of indeterminacy, of the hesitation between truth and false in social space is given by the fact that the uncertainty is not just a status of variables, but a status of the epistemic subject. Related to subject the status can be accordingly, equivalent of truth, disagreement, equivalent of false, or neutral. Any uncertainty is an uncertainty of creativity. In this context, neutrosophy considers a proposition, theory, event, concept, or entity, “A” in relation to its opposite, “Anti-A” and that which is not A, “Non-A”, and that which is neither “A” nor “Anti-A”, denoted by “Neut-A”. Neutrosophy is the basis of neutrosophic logic, neutrosophic set, neutrosophic probability and neutrosophic statistic.

When we are talking about neutrosophic social structures, we have to take into account that the social structure is not a homogeneous and uniform construction. Its uni-plan appearance is the result of a correct conjecture on horizontal dimension. On the other hand, on the vertical dimension of social structure are identified three levels of the social mechanism of interaction-communication presented as network. The first level is the individual one, of the actor and the relationships he has with other actors individually. The second level is that of structure / structures of which the actor belongs (family, group, clique, clan etc.) and the third level is the social network as an integer, as whole. The social structure is configured as a whole it comprises and crosses the individuals relational (Smarandache, 2005; Teodorescu, Opran, Voinea, 2014).

In his writes, Immanuel Kant postulated intelligence as the ability to bear the uncertainty: the more ability to bear the uncertainty is greater, the higher the intelligence is. The superior minds have uncertainties, the mediocre one have indecision. Uncertainty is inextricably bound by a decision: there is not uncertainty without a thinking direction of estimation, prediction, forecasting, alternative future type (Vladutescu et al, 2010; Voinea, 2014). The novelty of this neutrosophic structure is that the uncertainty is the object of discussing, how can it to modify the structure, to which of truth or false status is going.

2 Previous work . The discourse between true and false

Neutrosophy Theory is a new science, it is applied in algebraic structures, geometry, physics, artificial intelligence, robotics, philosophy, aesthetics, communication, arts, literature. For example in communication, professor Smarandache together professor Vladutescu asserts: “Some communicational relationships are contradictory, others are neutral, since within the manifestations

of life there are found conflicting meanings and/or neutral meanings. In case of arts, M. Teodorescu and M. G. Paun shows: "what is beautiful coincides with what is good, and indeed in different historical epochs were set very close connections between beautiful and good. But if we judge by our daily experience, we tend to define as good not only what we like, but what we would like to have for us" (Teodorescu & Păun, 2014). In hermeneutics, also we have neutrosophical interpretation. Hermeneutists agree that there is an irrepressible tendency to project modern meanings of words on the texts that represent a neutrosophic approach. The hermeneutist cannot entirely escape from the condition of present time being. The interpreter's limit is the author quality. Once written, the work refuses whoever produced it, and it isolates and wrongs him. The author will never provide the best interpretation of his own work, if such an interpretation is there somehow. The author does not have a right of interpretation derived from the right he has previously had to write (de Figueiredo, 2014). In the same context, looking in arts, we can assert that an evaluation of Ugliness has some traits in common with an assessment of Beauty. First, we can only assume that the ordinary people's taste would correspond to some extent with the artistic taste of their times. "If a visitor came from outer space would enter into a contemporary art gallery, and would see female faces painted by Picasso and would hear that visitors consider them beautiful, would make the mistaken belief that the everyday reality men of our times considere beautiful and enticing that female creatures whose face resembles to that represented by the painter" (Eco, 2007). The same visitor from space could change opinions if they attend a fashion show or a Miss Universe contest, which will see that are agreed other Beauty models.

We should like to investigate the neutrosophy structures on discourse. Every discourse is the work of formatting techniques, enunciating of a message. The discourse is the original way in which the message is sent. The engaged authors in discourse study started from the finding that "the success in communication depends not only on interlocutor's linguistic competence, but the general competence of communication comprehending: a referential dimension (of the field); a situational dimension (interpersonal norms and types of discourse), a textual dimension, micro and macro-structural" (Roventă-Frumușani, 2000).

Finally, "producing discourse is both controlled, selected, organized and redistributed through a number of procedures that were meant to conjure powers and dangers, to dominate the random event, to avoid overwhelming, her redoubtable materiality" (Foucault, 1998).

Truth and false are a seemingly indestructible syncretism. Cogitations effort must focus on veridic processing of the "credible" material. For this, as for any other substantial undertake, and not thorough ceremonial, is required an impulse, a triggering internal necessity, a set of tools, a set of rules and principles work (Stan, 2008; Voinea, 2011; Vlăduțescu, 2013). The veridic procedure works as the result of procedural engagement of relationships and veridic forces. The most used tools for opinion influence, all of time, are conviction and persuasion. Conviction corresponds to a communicational act aiming to alter the mental state of an individual in a context where he retains or believes that retains a certain freedom. Conviction is an effective method to influence, in that it allows to achieve the objective, but it is not always effective, i.e. it is limited in time and is uneconomical. Persuasion is more subtle, seemingly more mobile, it is directly insidious. Its objectives are the same: to change finally an opinion, an attitude or behavior, but with the agreement and through pseudo-convictive internalization from the target. Persuasion, a verbal method par excellence, it has become definitive in the current acceptance in our century, reaching the postmodern era to be theorized and widely used in complex strategies such as political techniques (Negrea, 2014). In this vast space of individual opinions, group or entire network, they can be classified in three states (truth, uncertainty, false), in part or entirely. Persuasion is a method of influencing the mind to truth or false depending on the aim of the discourse.

3 Work methodology. Arguments for Neutrosophical Social Structures

In any field of knowledge, each structure is composed of two parts: a **space**, and a **set of axioms** (or **laws**) acting (governing) on it. If the space, or at least one of its axioms (laws), has some indeterminacy of the form $(t, i, f) \neq (1, 0, 0)$, that structure is a (t, i, f) - Neutrosophic Structure. If the structure is applied to social area, we have (t, i, f) - *Neutrosophic Social Structures*. The (t, i, f) - *Neutrosophic Social Structures* [based on the components $t = \text{truth}$, $i = \text{numerical indeterminacy}$, $f = \text{falsehood}$] are exponential remodeled in social space from the perspective of social actor (Smarandache, 2005).

3.1. *Numerical Indeterminacy* (or *Degree of Indeterminacy*), which has the form $(t, i, f) \neq (1, 0, 0)$, where t, i, f are numbers, intervals, or subsets included in the unit interval $[0, 1]$, and it is the base for the (t, i, f) -Neutrosophic Social Structures.

3.2 Indeterminate Space (due to Partially Known Element).

Given the set $M = \{3, 4, 9(0.7, 0.1, 0.3)\}$, we have two elements 3 and 4 which surely belong to M , and one writes them neutrosophically as $3(1, 0, 0)$ and $4(1, 0, 0)$, while the third element 9 belongs only partially (70%) to M , its appurtenance to M is indeterminate (10%), and does not belong to M (in a percentage of 30%).

Example

Let suppose we have 2 candidates in final confronting of election, each one having own voting pool. After voting, we evaluate data from point of view neutrosophic.

Neutrosophic analysis looks like:

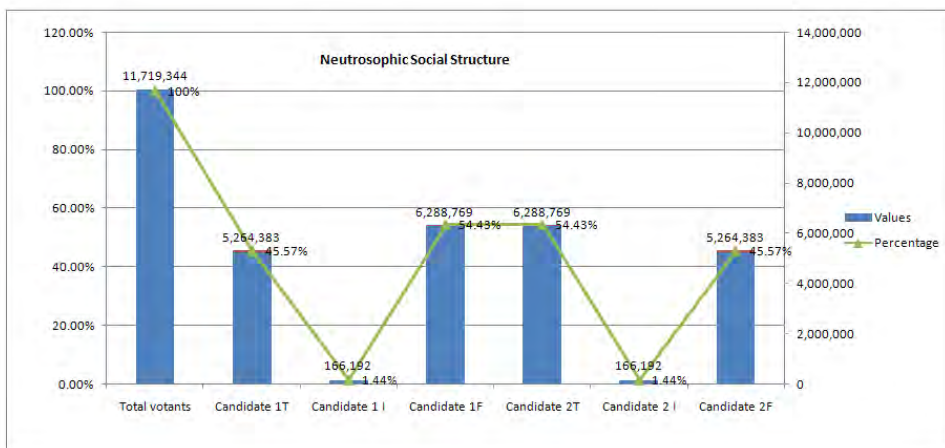

Figure 1. Analysis of votings

The neutrosophic space $M = \{c1(t1, i1, f1), c2(t2, i2, f2)\}$ where the law of neutrosophic social structure is: winning the election.

Data obtained of two candidates are:

In values, representing the votes:

Candidate	T	I	F
C1	t1 5.264.384	i1 166.111	f1 6.288.769
C2	t2 6.288.769	i2 166.111	f2 5.264.384
Percentage			
C1	t1 45,57%	i1 1,44%	f1 54,43%
C2	t2 54,43%	i2 1,44%	f2 45,57%

This analysis is for the votings.
 We have also the analysis of whole situation of all possible votants.

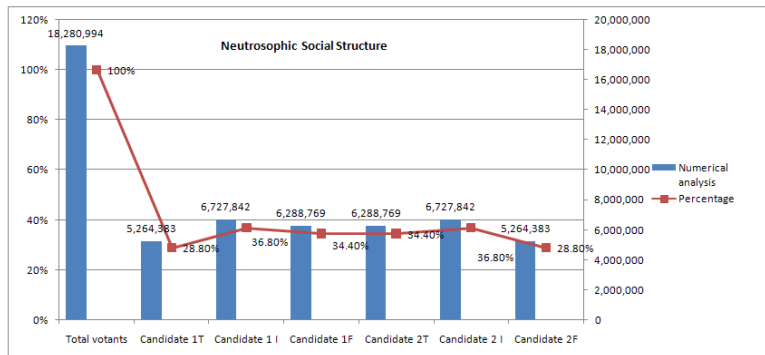

Figure 2 Analysis of possible votants

In values, representing the votes:

Candidate	T	I	F
C1	t1 5.264.384	i1 6.727.842	f1 6.288.769
C2	t2 6.288.769	i2 6.727.842	f2 5.264.384
Percentage			
C1	t1 28,8%	i1 36,8%	f1 34,4%
C2	t2 34,4%	i2 36,8%	f2 28,8%

The result is relevant, indeterminacy has a very high rate, 36,8%, this evaluation can be interesting for sociologist, how to decrease indeterminacy and increase both truth and false. Important decision is how to decrease this iincertainty percentage in favor of candidates. Anyway this is interpretation from Neutrosophic Social Structures point of view (Waiyaki & Brits, 2015).

4 Conclusion

As a whole, the social structure appears as the panel of nodes and connections that represent abstract actors and relevant relations between them. The main elements of a social structure are the actor and his relationships. The actors’s opinions of a structure are of infinite variety in relation to a relationship / law, with total or partial agreement, total rejection. Through this new theory of

neutrosophy can make a qualitative and quantitative assessment and analysis of opinions, evaluation that can be used for analyze of the evaluated actors's space taken as part and then evaluated as part analysis in whole.

References

- Bunăiașu, C. M., Vlăduțescu, Ș., & Strungă, A. C. (2014). Managerial competences in the field of university curriculum for virtual learning communities. *Revista romaneasca pentru educatie multidimensionala-Journal for Multidimensional Education*, 6(2), 17-27.
- Călin, R. A., & Evelyne, A. (2014). L'impact de la negligence manifestee au cours de leur formation professionnelle par les etudiants futurs professeurs sur filesysteme educatif: etude comparative Cameroun-Roumanie. *Creativity, Imaginary, Language*.
- de Figueiredo, C. M. M. (2014). *Emotions and Recommender Systems: A Social Network Approach* (Doctoral dissertation, Universidade do Porto).
- Eco, U. (2005). *Istoria Frumosului*. București: Editura RAO.
- Eco, U. (2007). *Istoria Urâtului*. București: Editura RAO.
- Florea, Cristina Andreea, & Strungă, Alexandru Constantin (2015). Innovative Training Strategies in Teaching Financial and Monetary Models in the Context of Socio-Economical Cohesion. In C. M. Bunăiașu, E. R. Opran, & D. V. Voinea, *Creativity in social sciences*. Craiova : Editura Sitech.
- Foucault, M. (1998). *Ordinea discursului*. București: Ed. Eurosong & Book.
- Gîfu, D. (2013). *Temeliile Turnului Babel*. București: Editura Academiei Române.
- Iorgulescu, A. (2009). *Introducere în relații publice*. Universitaria.
- Kot, S., & Brzezinski, S. (2015). Market Orientation Factors in Sustainable Development and Corporate Social Responsibility. *Asian Journal of Applied Sciences*, 8(2), 101-112.
- Lorenc, A. K., Michnej, M., & Szkoda, M. (2014). LoadFix is an information system which enhances security of the loading processes in railway transport. *Logistyka*, (5), 919-925.
- Marcu, M. (2009). *Comunicare și structuri organizaționale*. Universitaria.
- Monteiro, T. A., Giuliani, A. C., Cavazos-Arroyo, J., & Pizzinatto, N. K., Mezcla del Marketing verde: una perspectiva teorica.
- Niesyto, J., & Lovasova, R. (2015). The EU Funds are a Chance of the Regional Development in Reference to the Sport Infrastructure in Years 2007-2013. *Polish Journal of Management Studies*, 11(1), 100-112.
- Pop, Tiberiu Viorel (2014). Concepte și metode noi de abordare a gândirii specifice în design. De la proiectarea de produs la designul de anticipare.
- Rovența-Frumușani, D. (2000). *Argumentarea. Modele și strategii*. București: Editura ALL.
- Smarandache, F. (2015). (T, I, F) - Neutrosophic and I-Neutrosophic Structures. *Neutrosophic Sets and Systems*, (8), 3-10.
- Smarandache, F. (2015). Thesis-Antithesis-Neutrothesis, and Neutrosynthesis. *Neutrosophic Sets and Systems*, (8), 64-67.
- Smarandache, F. Neutrosophic Interpretation of Tao Te Ching (English-Chinese bilingual), Translation by Fu Yuhua.

Smarandache, F., & Christianito, V. (2005). *Multi-Valued Logic, Neutrosophy, and Schrodinger Equation*. Infinite Study.

Smarandache, Florentin, & Osman, Salah (2007). *Neutrosophy in Arabic Philosophy*. Renaissance High Press, Ann Arbor.

Stan, N. R. (2008). The relation between human dignity and human rights in the Orthodox perspective. Institut oecuménique.

Vlăduțescu, Ș. (2013). A battle with uncertainty 1 of the communication as an Academic discipline: title uncertainty. *Studies on Literature, Discourse and Multicultural Dialogue*, 493-504.

Vladutescu, Stefan; Cucui, Ion; Popescu, Delia Mioara; et al. (2010). Communication in Negative Journalism. Edited by: Mastorakis, N; Mladenov, V; Zaharim, A; et al. Conference: 8th International Conference on Management, Marketing and Finances Location: Penang, Malaysia Date: Mar 23-25, 2010 Recent Advances in Management, Marketing, Finances: Proceedings of the 8th WSEAS International Conference (MMF 10) Book Series: Recent Advances in Electrical Engineering Pages: 161-165 Published: 2010.

Voinea, D. V., Bușu, O. V., Opran, E. R., & Vlăduțescu, Ș. (2015). Embarrassments in Managerial Communication. *Polish Journal of Management Studies*, 11(2), 171-180.

Voinea, D. V., Negrea, X., & Vlăduțescu, Ș. (2014). Interpersonal communicational manipulations. *Postmodern Openings*, (04), 43-56.

Waiyaki, E. C., & Brits, A. (2015). Leveraging Telematics for Optimal Fleet Performance. *International Journal of Business*, 1(1).

N-Valued Interval Neutrosophic Sets and Their Application in Medical Diagnosis

Said Broumi, Irfan Deli, Florentin Smarandache

Said Broumi, Irfan Deli, Florentin Smarandache (2015). N-Valued Interval Neutrosophic Sets and Their Application in Medical Diagnosis. *Critical Review X*, 45-69

Abstract

In this paper a new concept is called n-valued interval neutrosophic sets is given. The basic operations are introduced on n-valued interval neutrosophic sets such as; union, intersection, addition, multiplication, scalar multiplication, scalar division, truth-favorite and false-favorite. Then, some distances between n-valued interval neutrosophic sets (NVINS) are proposed. Also, we propose an efficient approach for group multi-criteria decision making based on n-valued interval neutrosophic sets. An application of n-valued interval neutrosophic sets in medical diagnosis problem is given.

Keywords

Neutrosophic sets, n-valued neutrosophic set, interval neutrosophic sets, n-valued interval neutrosophic sets.

1 Introduction

In 1999, Smarandache [37] proposed the concept of neutrosophic set (NS for short) by adding an independent indeterminacy-membership function which

is a generalization of classic set, fuzzy set [45], intuitionistic fuzzy set [3] and so on. In NS, the indeterminacy is quantified explicitly and truth-membership (T), indeterminacy (I) membership, and false-membership (F) are completely independent and from scientific or engineering point of view, the NS operators need to be specified. Therefore, Wang et al [39] defined a single valued neutrosophic set (SVNS) and then provided the set theoretic operations and various properties of single valued neutrosophic sets and Wang et al. [40] proposed the set theoretic operations on an instance of neutrosophic set is called interval valued neutrosophic set (IVNS) which is more flexible and practical than NS. The works on single valued neutrosophic set (SVNS) and interval valued neutrosophic sets (IVNS) and their hybrid structure in theories and application have been progressing rapidly (e.g., [1,2,4-19,21,22,24-26,28-30,36,41,43]). Also, neutrosophic sets extended neutrosophic models in [13,16] both theory and application by using [27,31].

The concept of intuitionistic fuzzy multiset and some propositions with applications is originally presented by Rajarajeswari and Uma [32-35]. After Rajarajeswari and Uma, Smarandache [38] presented n-Valued neutrosophic sets with applications. Recently, Chatterjee et al. [20], Deli et al. [18, 23], Ye et al. [42] and Ye and Ye [44] initiated definition of neutrosophic multisets with some operations. Also, the authors gave some distance and similarity measures on neutrosophic multisets. In this paper, our objective is to generalize the concept of n-valued neutrosophic sets (or neutrosophic multi sets; or neutrosophic refined sets) to the case of n-valued interval neutrosophic sets.

The paper is structured as follows; in Section 2, we first recall the necessary background on neutrosophic sets, single valued neutrosophic sets, interval valued neutrosophic sets and n-valued neutrosophic sets (or neutrosophic multi sets). Section 3 presents the concept of n-valued interval neutrosophic sets and derive their respective properties with examples. Section 4 presents the distance between two n-valued interval neutrosophic sets. Section 5 presents an application of this concept in solving a decision making problem. Section 6 concludes the paper.

2 Preliminaries

This section gives a brief overview of concepts of neutrosophic set theory [37], n-valued neutrosophic set theory [42,44] and interval valued neutrosophic set theory [40]. More detailed explanations related to this subsection may be found in [18,20,23,37,40,42,44].

Definition 2.1. [37,39] Let X be an universe of discourse, with a generic element in X denoted by x , then a neutrosophic (NS) set A is an object having the form

$$A = \{ \langle x: T_A(x), I_A(x), F_A(x) \rangle, x \in X \}$$

where the functions $T, I, F : X \rightarrow]-0, 1+[$ define respectively the degree of membership (or Truth), the degree of indeterminacy, and the degree of non-membership (or Falsehood) of the element $x \in X$ to the set A with the condition.

$$-0 \leq T_A(x) + I_A(x) + F_A(x) \leq 3+$$

From philosophical point of view, the neutrosophic set takes the value from real standard or non-standard subsets of $]-0, 1+[$. So instead of $]-0, 1+[$ we need to take the interval $[0, 1]$ for technical applications, because $]-0, 1+[$ will be difficult to apply in the real applications such as in scientific and engineering problems.

For two NS, $A_{NS} = \{ \langle x, T_A(x), I_A(x), F_A(x) \rangle \mid x \in X \}$

and $B_{NS} = \{ \langle x, T_B(x), I_B(x), F_B(x) \rangle \mid x \in X \}$ the two relations are defined as follows:

$$(1) A_{NS} \subseteq B_{NS} \text{ if and only if } T_A(x) \leq T_B(x), I_A(x) \geq I_B(x), F_A(x) \geq F_B(x)$$

$$(2) A_{NS} = B_{NS} \text{ if and only if } T_A(x) = T_B(x), I_A(x) = I_B(x), F_A(x) = F_B(x)$$

Definition 2.2. [40] Let X be a space of points (objects) with generic elements in X denoted by x . An interval valued neutrosophic set (for short IVNS) A in X is characterized by truth-membership function $T_A(x)$, indeterminacy-membership function $I_A(x)$ and falsity-membership function $F_A(x)$. For each point x in X , we have that $T_A(x), I_A(x), F_A(x) \subseteq [0, 1]$.

For two IVNS

$$A_{IVNS} = \{ \langle x, [\inf T_A^1(x), \sup T_A^1(x)], [\inf I_A^1(x), \sup I_A^1(x)], [\inf F_A^1(x), \sup F_A^1(x)] \rangle : x \in X \}$$

and

$$B_{IVNS} = \{ \langle x, [\inf T_B^1(x), \sup T_B^1(x)], [\inf I_B^1(x), \sup I_B^1(x)], [\inf F_B^1(x), \sup F_B^1(x)] \rangle : x \in X \}$$

Then,

1. $A_{IVNS} \subseteq B_{IVNS}$ if and only if

$$\begin{aligned} \inf T_A^1(x) &\leq \inf T_B^1(x), \sup T_A^1(x) \leq \sup T_B^1(x), \\ \inf I_A^1(x) &\geq \inf I_B^1(x), \sup I_A^1(x) \geq \sup I_B^1(x), \\ \inf F_A^1(x) &\geq \inf F_B^1(x), \sup F_A^1(x) \geq \sup F_B^1(x), \end{aligned}$$

for all $x \in X$.

$$\begin{aligned} 2. \quad A_{IVNS} &= B_{IVNS} \text{ if and only if,} \\ \inf T_A^1(x) &= \inf T_B^1(x), \sup T_A^1(x) = \sup T_B^1(x), \\ \inf I_A^1(x) &= \inf I_B^1(x), \sup I_A^1(x) = \sup I_B^1(x), \\ \inf F_A^1(x) &= \inf F_B^1(x), \sup F_A^1(x) = \sup F_B^1(x), \end{aligned}$$

for any $x \in X$.

3. $A_{IVNS}^c = \{x, [\inf F_A^1(x), \sup F_A^1(x)], [1 - \sup I_A^1(x), 1 - \inf I_A^1(x)], [\inf T_A^1(x), \sup T_A^1(x)]: x \in X\}$
4. $A_{IVNS} \cap B_{IVNS} = \{<x, [\inf T_A^1(x) \wedge \inf T_B^1(x), \sup T_A^1(x) \wedge \sup T_B^1(x)], [\inf I_A^1(x) \vee \inf I_B^1(x), \sup I_A^1(x) \vee \sup I_B^1(x)], [\inf F_A^1(x) \vee \inf F_B^1(x), \sup F_A^1(x) \vee \sup F_B^1(x)]: x \in X\}$
5. $A_{IVNS} \cup B_{IVNS} = \{<x, [\inf T_A^1(x) \vee \inf T_B^1(x), \sup T_A^1(x) \vee \sup T_B^1(x)], [\inf I_A^1(x) \wedge \inf I_B^1(x), \sup I_A^1(x) \wedge \sup I_B^1(x)], [\inf F_A^1(x) \wedge \inf F_B^1(x), \sup F_A^1(x) \wedge \sup F_B^1(x)]: x \in X\}$
6. $A_{IVNS} \setminus B_{IVNS} = \{<x, [\min\{\inf T_A^1(x), \inf F_B^1(x)\}, \min\{\sup T_A^1(x), \sup F_B^1(x)\}], [\max(\inf I_A^1(x), 1 - \sup I_B^1(x)), \max(\sup I_A^1(x), 1 - \inf I_B^1(x))], [\max(\inf F_A^1(x), \inf T_B^1(x)), \max(\sup F_A^1(x), \sup T_B^1(x))]: x \in X\}$
7. $A_{IVNS} + B_{IVNS} = \{<x, [\min(\inf T_A^1(x) + \inf T_B^1(x), 1), \min(\sup T_A^1(x) + \sup T_B^1(x), 1)], [\min(\inf I_A^1(x) + \inf I_B^1(x), 1), \min(\sup I_A^1(x) + \sup I_B^1(x), 1)], [\min(\inf F_A^1(x) + \inf F_B^1(x), 1), \min(\sup F_A^1(x) + \sup F_B^1(x), 1)] > : x \in X\}$
8. $A_{IVNS} \cdot a = \{<x, [\min(\inf T_A^1(x) \cdot a, 1), \min(\sup T_A^1(x) \cdot a, 1)], [\min(\inf I_A^1(x) \cdot a, 1), \min(\sup I_A^1(x) \cdot a, 1)], [\min(\inf F_A^1(x) \cdot a, 1), \min(\sup F_A^1(x) \cdot a, 1)], [\min(\inf I_A^1(x) \cdot a, 1), \min(\sup I_A^1(x) \cdot a, 1)] > : x \in X\}$
9. $A_{IVNS} / a = \{<x, [\min(\inf T_A^1(x) / a, 1), \min(\sup T_A^1(x) / a, 1)], [\min(\inf I_A^1(x) / a, 1), \min(\sup I_A^1(x) / a, 1)], [\min(\inf F_A^1(x) / a, 1), \min(\sup F_A^1(x) \cdot a, 1)] > : x \in X\}$
10. $\Delta A_{IVNS} = \{<x, [\min(\inf T_A^1(x) + \inf I_A^1(x), 1), \min(\sup T_A^1(x) + \sup I_B^1(x), 1)], [0, 0], [\inf F_A^1(x), \sup F_A^1(x)] > : x \in X\}$
11. $\nabla A_{IVNS} = \{<x, [\inf T_A^1(x), \sup T_A^1(x)], [0, 0],$

$$[\min(\inf F_A^1(x) + \inf I_A^1(x), 1), \min(\sup F_A^1(x) + \sup I_A^1(x), 1)] > : x \in X\}$$

Definition 2.3. [20,42] Let E be a universe. A n-valued neutrosophic sets on E can be defined as follows:

$$A = \{<x, (T_A^1(x), T_A^2(x), \dots, T_A^p(x)), (I_A^1(x), I_A^2(x), \dots, I_A^p(x)), (F_A^1(x), F_A^2(x), \dots, F_A^p(x))>: x \in X\}$$

where

$$T_A^1(x), T_A^2(x), \dots, T_A^p(x), I_A^1(x), I_A^2(x), \dots, I_A^p(x), F_A^1(x), F_A^2(x), \dots, F_A^p(x): E \rightarrow [0, 1] \text{ such that}$$

$$0 \leq T_A^i(x) + I_A^i(x) + F_A^i(x) \leq 3 \text{ for } i=1, 2, \dots, p \text{ for any } x \in X,$$

Here, $(T_A^1(x), T_A^2(x), \dots, T_A^p(x)), (I_A^1(x), I_A^2(x), \dots, I_A^p(x))$ and $(F_A^1(x), F_A^2(x), \dots, F_A^p(x))$

is the truth-membership sequence, indeterminacy-membership sequence and falsity-membership sequence of the element x, respectively. Also, P is called the dimension of n-valued neutrosophic sets (NVNS) A.

3 N-Valued Interval Neutrosophic Sets

Following the n-valued neutrosophic sets (multiset or refined set) and interval neutrosophic sets defined in [20,38,42,44] and Wang et al. in [40], respectively. In this section, we extend these sets to n-valued interval valued neutrosophic sets.

Definition 3.1. Let X be a universe, a n-valued interval neutrosophic sets (NVINS) on X can be defined as follows:

$$A = \{x, \left(\begin{array}{l} [\inf T_A^1(x), \sup T_A^1(x)], [\inf T_A^2(x), \sup T_A^2(x)], \dots, \\ [\inf T_A^p(x), \sup T_A^p(x)] \end{array} \right), \left(\begin{array}{l} [\inf I_A^1(x), \sup I_A^1(x)], [\inf I_A^2(x), \sup I_A^2(x)], \dots, \\ [\inf I_A^p(x), \sup I_A^p(x)] \end{array} \right), [\inf F_A^1(x), \sup F_A^1(x)], ([\inf F_A^2(x), \sup F_A^2(x)], \dots, ([\inf F_A^p(x), \sup F_A^p(x)]): x \in X\}$$

where

$$\inf T_A^1(x), \inf T_A^2(x), \dots, \inf T_A^p(x), \inf I_A^1(x), \inf I_A^2(x), \dots, \inf I_A^p(x), \inf F_A^1(x), \inf F_A^2(x), \dots, \inf F_A^p(x), \sup T_A^1(x), \sup T_A^2(x), \dots, \sup T_A^p(x),$$

$$\sup I_A^1(x), \sup I_A^2(x), \dots, \sup I_A^q(x),$$

$$\sup F_A^1(x), \sup F_A^2(x), \dots, \sup F_A^r(x) \in [0, 1]$$

such that $0 \leq \sup T_A^i(x) + \sup I_A^i(x) + \sup F_A^i(x) \leq 3, \forall i=1, 2, \dots, p$.

In our study, we focus only on the case where $p=q=r$ is the interval truth-membership sequence, interval indeterminacy-membership sequence and interval falsity-membership sequence of the element x , respectively. Also, p is called the dimension of n -valued interval (NVINS) A . Obviously, when the upper and lower ends of the interval values of $T_A^i(x), I_A^i(x), F_A^i(x)$ in a NVINS are equal, the NVINS reduces to n -valued neutrosophic set (or neutrosophic multiset proposed in [17,20]).

The set of all n -valued interval neutrosophic set on X is denoted by $NVINS(X)$.

Example 3.2. Let $X=\{x_1, x_2\}$ be the universe and A is an n -valued interval neutrosophic sets

$$A = \{ \langle x_1, \{[.1, .2], [.2, .3]\}, \{[.3, .4], [.1, .5]\}, \{[.3, .4], [.2, .5]\} \rangle,$$

$$\langle x_2, \{[.3, .4], [.2, .4]\}, \{[.3, .5], [.2, .4]\}, \{[.1, .2], [.3, .4]\} \rangle \}$$

Definition 3.3. The complement of A is denoted by A^c and is defined by

$$A^c = \{x, ([\inf F_A^1(x), \sup F_A^1(x)], [\inf F_A^2(x), \sup F_A^2(x)], \dots,$$

$$([\inf F_A^p(x), \sup F_A^p(x)]),$$

$$\left([1 - \sup I_A^1(x), 1 - \inf I_A^1(x)], [1 - \sup I_A^2(x), 1 - \inf I_A^2(x)], \dots, \right),$$

$$[1 - \sup I_A^p(x), 1 - \inf I_A^p(x)]$$

$$([\inf T_A^1(x), \sup T_A^1(x)], [\inf T_A^2(x), \sup T_A^2(x)], \dots,$$

$$[\inf T_A^p(x), \sup T_A^p(x)]): x \in X \}.$$

Example 3.4. Let us consider the Example 3.5. Then we have,

$$A^c = \{ \langle x_1, \{[.3, .4], [.2, .5]\}, \{[.6, .7], [.5, .9]\}, \{[.1, .2], [.2, .3]\} \rangle,$$

$$\langle x_2, \{[.1, .2], [.3, .4]\}, \{[.5, .7], [.6, .8]\}, \{[.3, .4], [.2, .4]\} \rangle \}$$

Definition 3.5. For $\forall i=1, 2, \dots, p$ if $\inf T_A^i(x) = \sup T_A^i(x) = 0$ and $\inf I_A^i(x) = \sup I_A^i(x) = \inf F_A^i(x) = \sup F_A^i(x) = 1$, then A is called null n -valued interval neutrosophic set denoted by Φ , for all $x \in X$.

Example 3.6. Let $X=\{x_1, x_2\}$ be the universe and A is an n -valued interval neutrosophic sets

$$\Phi = \{ \langle x_1, \{[0, 0], [0, 0]\}, \{[1, 1], [1, 1]\}, \{[1, 1], [1, 1]\} \rangle,$$

$$\langle x_2, \{[0, 0], [0, 0]\}, \{[1, 1], [1, 1]\}, \{[1, 1], [1, 1]\} \rangle \}.$$

Definition 3.7. For $\forall i=1,2,\dots,p$ if $\inf T_A^i(x) = \sup T_A^i(x) = 1$ and $\inf I_A^i(x) = \sup I_A^i(x) = \inf F_A^i(x) = \sup F_A^i(x) = 0$, then A is called universal n-valued interval neutrosophic set denoted by E, for all $x \in X$.

Example 3.8. Let $X = \{x_1, x_2\}$ be the universe and A is an n-valued interval neutrosophic sets

$$E = \{ \langle x_1, \{ [1, 1], [1, 1] \}, \{ [0, 0], [0, 0] \}, \{ [0, 0], [0, 0] \} \rangle, \langle x_2, \{ [1, 1], [1, 1] \}, \{ [0, 0], [0, 0] \}, \{ [0, 0], [0, 0] \} \rangle \}.$$

Definition 3.9. A n-valued interval neutrosophic set A is contained in the other n-valued interval neutrosophic set B, denoted by $A \subseteq B$, if and only if

$$\begin{aligned} &\inf T_A^1(x) \leq \inf T_B^1(x), \inf T_A^2(x) \leq \inf T_B^2(x), \dots, \inf T_A^p(x) \leq \inf T_B^p(x), \\ &\sup T_A^1(x) \leq \sup T_B^1(x), \sup T_A^2(x) \leq \sup T_B^2(x), \dots, \sup T_A^p(x) \leq \sup T_B^p(x), \\ &\inf I_A^1(x) \geq \inf I_B^1(x), \inf I_A^2(x) \geq \inf I_B^2(x), \dots, \inf I_A^p(x) \geq \inf I_B^p(x), \\ &\sup I_A^1(x) \geq \sup I_B^1(x), \sup I_A^2(x) \geq \sup I_B^2(x), \dots, \sup I_A^p(x) \geq \sup I_B^p(x), \\ &\inf F_A^1(x) \geq \inf F_B^1(x), \inf F_A^2(x) \geq \inf F_B^2(x), \dots, \inf F_A^p(x) \geq \inf F_B^p(x), \\ &\sup F_A^1(x) \geq \sup F_B^1(x), \sup F_A^2(x) \geq \sup F_B^2(x), \dots, \sup F_A^p(x) \geq \sup F_B^p(x) \end{aligned}$$

for all $x \in X$.

Example 3.10. Let $X = \{x_1, x_2\}$ be the universe and A and B are two n-valued interval neutrosophic sets

$$A = \{ \langle x_1, \{ [1, .2], [2, .3] \}, \{ [4, .5], [6, .7] \}, \{ [5, .6], [7, .8] \} \rangle, \langle x_2, \{ [1, .4], [1, .3] \}, \{ [6, .8], [4, .6] \}, \{ [5, .6], [6, .7] \} \rangle \}$$

and

$$B = \{ \langle x_1, \{ [5, .7], [4, .5] \}, \{ [3, 4], [1, .5] \}, \{ [3, 4], [2, .5] \} \rangle, \langle x_2, \{ [2, .5], [3, .6] \}, \{ [3, .5], [2, 4] \}, \{ [1, .2], [3, 4] \} \rangle \}$$

Then, we have $A \subseteq B$.

Definition 3.11. Let A and B be two n-valued interval neutrosophic sets. Then, A and B are equal, denoted by $A = B$ if and only if $A \subseteq B$ and $B \subseteq A$.

Proposition 3.12. Let $A, B, C \in NVINS(X)$. Then,

1. $\emptyset \subseteq A$
2. $A \subseteq A$

3. $A \subseteq E$
4. $A \subseteq B$ and $B \subseteq C \rightarrow A \subseteq C$
5. $K=L$ and $L=M \leftrightarrow K = M$
6. $K \subseteq L$ and $L \subseteq K \leftrightarrow K = L$.

Definition 3.13. Let A and B be two n-valued interval neutrosophic sets. Then, intersection of A and B, denoted by $A \cap B$, is defined by

$$A \cap B = \{ \langle x, ([\inf T_A^1(x) \wedge \inf T_B^1(x), \sup T_A^1(x) \wedge \sup T_B^1(x)], [\inf T_A^2(x) \wedge \inf T_B^2(x), \sup T_A^2(x) \wedge \sup T_B^2(x)], \dots, [\inf T_A^p(x) \wedge \inf T_B^p(x), \sup T_A^p(x) \wedge \sup T_B^p(x)]), ([\inf I_A^1(x) \vee \inf I_B^1(x), \sup I_A^1(x) \vee \sup I_B^1(x)], [\inf I_A^2(x) \vee \inf I_B^2(x), \sup I_A^2(x) \vee \sup I_B^2(x)], \dots, [\inf I_A^p(x) \vee \inf I_B^p(x), \sup I_A^p(x) \vee \sup I_B^p(x)]), ([\inf F_A^1(x) \vee \inf F_B^1(x), \sup F_A^1(x) \vee \sup F_B^1(x)], [\inf F_A^2(x) \vee \inf F_B^2(x), \sup F_A^2(x) \vee \sup F_B^2(x)], \dots, [\inf F_A^p(x) \vee \inf F_B^p(x), \sup F_A^p(x) \vee \sup F_B^p(x)]) \rangle : x \in X \}$$

Example 3.14. Let $U = \{x_1, x_2\}$ be the universe and A and B are two n-valued interval neutrosophic sets

$$A = \{ \langle x_1, \{[.1, .2], [.2, .3]\}, \{[.4, .5], [.6, .7]\}, \{[.5, .6], [.7, .8]\} \rangle, \langle x_2, \{[.1, .4], [.1, .3]\}, \{[.6, .8], [.4, .6]\}, \{[.3, .4], [.2, .7]\} \rangle \}$$

and

$$B = \{ \langle x_1, \{[.3, .7], [.3, .5]\}, \{[.2, .4], [.3, .5]\}, \{[.3, .6], [.2, .7]\} \rangle, \langle x_2, \{[.3, .5], [.4, .6]\}, \{[.3, .5], [.4, .5]\}, \{[.3, .4], [.1, .2]\} \rangle \}$$

Then,

$$A \cap B = \{ \langle x_1, \{[.1, .2], [.2, .3]\}, \{[.4, .5], [.6, .7]\}, \{[.5, .6], [.7, .8]\} \rangle, \langle x_2, \{[.1, .4], [.1, .3]\}, \{[.6, .8], [.4, .6]\}, \{[.3, .4], [.2, .7]\} \rangle \}$$

Proposition 3.15. Let A, B, C ∈ NVINS(X). Then,

1. $A \cap A = A$
2. $A \cap \emptyset = \emptyset$.
3. $A \cap E = A$
4. $A \cap B = B \cap A$
5. $(A \cap B) \cap C = A \cap (B \cap C)$.

Proof: The proof is straightforward.

Definition 3.16. Let A and B be two n-valued interval neutrosophic sets. Then, union of A and B, denoted by $A \cup B$, is defined by

$$\begin{aligned}
 A \cup B = \{ & x, < ([\inf T_A^1(x) \vee \inf T_B^1(x), \sup T_A^1(x) \vee \sup T_B^1(x)], [\inf T_A^2(x) \vee \inf T_B^2(x), \sup T_A^2(x) \vee \sup T_B^2(x)], \dots, [\inf T_A^p(x) \vee \inf T_B^p(x), \sup T_A^p(x) \vee \sup T_B^p(x)]), ([\inf I_A^1(x) \wedge \inf I_B^1(x), \sup I_A^1(x) \wedge \sup I_B^1(x)], [\inf I_A^2(x) \wedge \inf I_B^2(x), \sup I_A^2(x) \wedge \sup I_B^2(x)], \dots, [\inf I_A^p(x) \wedge \inf I_B^p(x), \sup I_A^p(x) \wedge \sup I_B^p(x)]), ([\inf F_A^1(x) \wedge \inf F_B^1(x), \sup F_A^1(x) \wedge \sup F_B^1(x)], [\inf F_A^2(x) \wedge \inf F_B^2(x), \sup F_A^2(x) \wedge \sup F_B^2(x)], \dots, [\inf F_A^p(x) \wedge \inf F_B^p(x), \sup F_A^p(x) \wedge \sup F_B^p(x)]) > : x \in X \}
 \end{aligned}$$

Proposition 3.17. Let $A, B, C \in NVINS(X)$. Then,

1. $A \cup A = A$.
2. $A \cup \emptyset = A$.
3. $A \cup E = E$.
4. $A \cup B = B \cup A$.
5. $(A \cup B) \cup C = A \cup (B \cup C)$.

Proof: The proof is straightforward.

Definition 3.18. Let A and B be two n -valued interval neutrosophic sets. Then, difference of A and B , denoted by $A \setminus B$, is defined by

$$\begin{aligned}
 A \setminus B = \{ & x, ([\min\{\inf T_A^1(x), \inf F_B^1(x)\}, \min\{\sup T_A^1(x), \sup F_B^1(x)\}], [\min\{\inf T_A^2(x), \inf F_B^2(x)\}, \min\{\sup T_A^2(x), \sup F_B^2(x)\}], \dots, [\min\{\inf T_A^p(x), \inf F_B^p(x)\}, \min\{\sup T_A^p(x), \sup F_B^p(x)\}]), ([\max(\inf I_A^1(x), 1 - \sup I_B^1(x)), \max(\sup I_A^1(x), 1 - \inf I_B^1(x))], [\max(\inf I_A^2(x), 1 - \sup I_B^2(x)), \max(\sup I_A^2(x), 1 - \inf I_B^2(x))], \dots, [\max(\inf I_A^p(x), 1 - \sup I_B^p(x)), \max(\sup I_A^p(x), 1 - \inf I_B^p(x))]), ([\max(\inf F_A^1(x), \inf T_B^1(x)), \max(\sup F_A^1(x), \sup T_B^1(x))], [\max(\inf F_A^2(x), \inf T_B^2(x)), \max(\sup F_A^2(x), \sup T_B^2(x))], \dots, [\max(\inf F_A^p(x), \inf T_B^p(x)), \max(\sup F_A^p(x), \sup T_B^p(x))]) : x \in X \}
 \end{aligned}$$

Example 3.19. Let $X = \{x_1, x_2\}$ be the universe and A and B are two n -valued interval neutrosophic sets

$$\begin{aligned}
 A = \{ & \langle x_1, \{ [.1, .2], [.2, .3] \}, \{ [.4, .5], [.6, .7] \}, \{ [.5, .6], [.7, .8] \} \rangle, \\
 & \langle x_2, \{ [.1, .4], [.1, .3] \}, \{ [.6, .8], [.4, .6] \}, \{ [.3, .4], [.2, .7] \} \rangle \}
 \end{aligned}$$

and

$$\begin{aligned}
 B = \{ & \langle x_1, \{ [.3, .7], [.3, .5] \}, \{ [.2, .4], [.3, .5] \}, \{ [.3, .6], [.2, .7] \} \rangle, \\
 & \langle x_2, \{ [.3, .5], [.4, .6] \}, \{ [.3, .5], [.4, .5] \}, \{ [.3, .4], [.1, .2] \} \rangle \}
 \end{aligned}$$

Then,

$$A \setminus B = \{ \langle x_1, \{[.1, .2], [2, .3]\}, \{[.6, .8], [6, .7]\}, \{[.5, .7], [7, .8]\} \rangle, \langle x_2, \{[.1, .4], [1, .2]\}, \{[.6, .8], [5, .6]\}, \{[.3, .5], [4, 7]\} \rangle \}$$

Definition 3.20. Let A and B be two n-valued interval neutrosophic sets. Then, addition of A and B, denoted by $A \tilde{+} B$, is defined by

$$\begin{aligned} A \tilde{+} = \{ \langle x, & ([\min(\inf T_A^1(x) + \inf T_B^1(x), 1), \min(\sup T_A^1(x) + \sup T_B^1(x), 1)], \\ & [\min(\inf T_A^2(x) + \inf T_B^2(x), 1), \min(\sup T_A^2(x) + \sup T_B^2(x), 1)], \dots, \\ & [\min(\inf T_A^p(x) + \inf T_B^p(x), 1), \min(\sup T_A^p(x) + \sup T_B^p(x), 1)] \rangle \\ & ([\min(\inf I_A^1(x) + \inf I_B^1(x), 1), \min(\sup I_A^1(x) + \sup I_B^1(x), 1)], \\ & [\min(\inf I_A^2(x) + \inf I_B^2(x), 1), \min(\sup I_A^2(x) + \sup I_B^2(x), 1)], \dots, \\ & [\min(\inf T_A^p(x) + \inf T_B^p(x), 1), \min(\sup T_A^p(x) + \sup T_B^p(x), 1)] \rangle, \\ & ([\min(\inf F_A^1(x) + \inf F_B^1(x), 1), \min(\sup F_A^1(x) + \sup F_B^1(x), 1)], \\ & [\min(\inf F_A^2(x) + \inf F_B^2(x), 1), \min(\sup F_A^2(x) + \sup F_B^2(x), 1)], \dots, \\ & [\min(\inf F_A^p(x) + \inf F_B^p(x), 1), \min(\sup F_A^p(x) + \sup F_B^p(x), 1)] \rangle : x \in X \}. \end{aligned}$$

Example 3.21. Let $X = \{x_1, x_2\}$ be the universe and A and B are two n-valued interval neutrosophic sets

$$A = \{ \langle x_1, \{[.1, .2], [2, .3]\}, \{[.4, .5], [6, .7]\}, \{[.5, .6], [7, .8]\} \rangle, \langle x_2, \{[.1, .4], [1, .3]\}, \{[.6, .8], [4, .6]\}, \{[.3, .4], [2, .7]\} \rangle \}$$

and

$$B = \{ \langle x_1, \{[.3, .7], [3, .5]\}, \{[2, .4], [3, .5]\}, \{[.3, .6], [2, .7]\} \rangle, \langle x_2, \{[.3, .5], [4, .6]\}, \{[3, .5], [4, .5]\}, \{[.3, .4], [1, .2]\} \rangle \}$$

then,

$$A \tilde{+} B = \{ \langle x_1, \{[.4, .9], [5, .8]\}, \{[.6, .9], [9, 1]\}, \{[.8, 1], [9, 1]\} \rangle, \langle x_2, \{[.4, .9], [5, .9]\}, \{[.9, 1], [8, 1]\}, \{[.6, .8], [3, 9]\} \rangle \}.$$

Proposition 3.22. Let A, B, C \in NVINS(X). Then,

1. $A \tilde{+} B = B \tilde{+} A$.
2. $(A \tilde{+} B) \tilde{+} C = A \tilde{+} (B \tilde{+} C)$.

Proof: The proof is straightforward.

Definition 3.23. Let A and B be two n-valued interval neutrosophic sets. Then, scalar multiplication of A, denoted by $A \tilde{\cdot} a$, is defined by

$$A \tilde{\cdot} a = \{ x, ([\min(\inf T_A^1(x) \cdot a, 1), \min(\sup T_A^1(x) \cdot a, 1)], [\min(\inf T_A^2(x) \cdot a, 1), \min(\sup T_A^2(x) \cdot a, 1)] \}$$

$$\begin{aligned} & \dots, [\min(\inf T_A^p(x) \cdot a, 1), \min(\sup T_A^p(x) \cdot a, 1)], \\ & ([\min(\inf I_A^1(x) \cdot a, 1), \min(\sup I_A^1(x) \cdot a, 1)], \\ & [\min(\inf I_A^2(x) \cdot a, 1), \min(\sup I_A^2(x) \cdot a, 1)], \dots, \\ & [\min(\inf I_A^p(x) \cdot a, 1), \min(\sup I_A^p(x) \cdot a, 1)]), \\ & ([\min(\inf F_A^1(x) \cdot a, 1), \min(\sup F_A^1(x) \cdot a, 1)], \\ & [\min(\inf I_A^1(x) \cdot a, 1), \min(\sup I_A^1(x) \cdot a, 1)], \dots, \\ & [\min(\inf I_A^p(x) \cdot a, 1), \min(\sup I_A^p(x) \cdot a, 1)]): x \in X \}. \end{aligned}$$

Example 3.24. Let $X = \{x_1, x_2\}$ be the universe and A and B are two n-valued interval neutrosophic sets

$$A = \{ \langle x_1, \{[.1, .2], [2, .3]\}, \{[.4, .5], [6, .7]\}, \{[.5, .6], [7, .8]\} \rangle, \langle x_2, \{[.1, .4], [1, .3]\}, \{[6, 8], [4, .6]\}, \{[3, 4], [2, .7]\} \rangle \}$$

and

$$B = \{ \langle x_1, \{[.3, .7], [3, .5]\}, \{[.2, .4], [3, .5]\}, \{[.3, .6], [2, .7]\} \rangle, \langle x_2, \{[.3, .5], [4, .6]\}, \{[3, 5], [4, .5]\}, \{[3, 4], [1, .2]\} \rangle \}$$

then,

$$A \sim 2 = \{ \langle x_1, \{[.2, .4], [4, .6]\}, \{[.8, 1], [1, 1]\}, \{[1, 1], [1, 1]\} \rangle, \langle x_2, \{[.2, 8], [2, .6]\}, \{[1, 1], [8, 1]\}, \{[6, 8], [4, 1]\} \rangle \}$$

Proposition 3.25. Let $A, B, C \in NVINS(X)$. Then,

1. $A \sim B = B \sim A$
2. $(A \sim B) \sim C = A \sim (B \sim C)$

Proof: The proof is straightforward.

Definition 3.26. Let A and B be two n-valued interval neutrosophic sets. Then, scalar division of A, denoted by $A \tilde{/} a$, is defined by

$$\begin{aligned} A \tilde{/} a = \{ & x, [\min(\inf T_A^1(x)/a, 1), \min(\sup T_A^1(x)/a, 1)], \\ & [\min(\inf T_A^2(x)/a, 1), \min(\sup T_A^2(x)/a, 1)] \\ & \dots, [\min(\inf T_A^p(x)/a, 1), \min(\sup T_A^p(x)/a, 1)], ([\min(\inf I_A^1(x)/ \\ & a, 1), \min(\sup I_A^1(x)/a, 1)], [\min(\inf I_A^2(x)/a, 1), \min(\sup I_A^2(x)/ \\ & a, 1)], \dots, [\min(\inf I_A^p(x)/a, 1), \min(\sup I_A^p(x)/a, 1)]), \\ & [[\min(\inf F_A^1(x)/a, 1), \min(\sup F_A^1(x)/a, 1)], [\min(\inf F_A^2(x)/ \\ & a, 1), \min(\sup F_A^2(x)/a, 1)], \dots, [\min(\inf I_A^p(x)/ \\ & a, 1), \min(\sup I_A^p(x)/a, 1)]]: x \in X \}. \end{aligned}$$

Example 3.27. Let $X = \{x_1, x_2\}$ be the universe and A and B are two n-valued interval neutrosophic sets

$$A = \{ \langle x_1, \{[.1, .2], [2, .3]\}, \{[.4, .5], [6, .7]\}, \{[.5, .6], [7, .8]\} \rangle, \langle x_2, \{[.1, .4], [1, .3]\}, \{[.6, .8], [4, .6]\}, \{[.3, .4], [2, .7]\} \rangle \}$$

and

$$B = \{ \langle x_1, \{[.3, .7], [3, .5]\}, \{[.2, .4], [3, .5]\}, \{[.3, .6], [2, .7]\} \rangle, \langle x_2, \{[.3, .5], [4, .6]\}, \{[.3, .5], [4, .5]\}, \{[.3, .4], [1, .2]\} \rangle \}$$

then,

$$A \tilde{=} \{ \langle x_1, \{[.05, .1], [1, .15]\}, \{[.2, .25], [3, .35]\}, \{[.25, .3], [35, .4]\} \rangle, \langle x_2, \{[.05, .2], [05, .15]\}, \{[.3, .4], [2, .3]\}, \{[.15, .2], [1, .35]\} \rangle \}$$

Definition 3.28. Let A and B be two n-valued interval neutrosophic sets. Then, truth-Favorite of A, denoted by $\tilde{\Delta}A$, is defined by

$$\begin{aligned} \tilde{\Delta}A = \{ & x, ([\min(\inf T_A^1(x) + \inf I_A^1(x), 1), \min(\sup T_A^1(x) + \sup I_B^1(x), 1)], [\min(\inf T_A^2(x) + \inf I_A^2(x), 1), \min(\sup T_A^2(x) + \sup I_A^2(x), 1)], \dots, \\ & [\min(\inf T_A^p(x) + \inf I_A^p(x), 1), \min(\sup T_A^p(x) + \sup I_A^p(x), 1)]) , ([0,0], [0,0], \dots, [0,0]), \\ & ([\inf F_A^1(x), \sup F_A^1(x)], [\inf F_A^2(x), \sup F_A^2(x)], \dots, \\ & [\inf F_A^p(x), \sup F_A^p(x)]): x \in X \} \end{aligned}$$

Example 3.29. Let $X = \{x_1, x_2\}$ be the universe and A and B are two n-valued interval neutrosophic sets

$$A = \{ \langle x_1, \{[.1, .2], [2, .3]\}, \{[.4, .5], [6, .7]\}, \{[.5, .6], [7, .8]\} \rangle, \langle x_2, \{[.1, .4], [1, .3]\}, \{[.6, .8], [4, .6]\}, \{[.3, .4], [2, .7]\} \rangle \}$$

and

$$B = \{ \langle x_1, \{[.3, .7], [3, .5]\}, \{[.2, .4], [3, .5]\}, \{[.3, .6], [2, .7]\} \rangle, \langle x_2, \{[.3, .5], [4, .6]\}, \{[.3, .5], [4, .5]\}, \{[.3, .4], [1, .2]\} \rangle \}$$

Then,

$$\tilde{\Delta}A = \{ \langle x_1, \{[.5, .7], [.8, 1]\}, \{[0, 0], [0, 0]\}, \{[.5, .6], [7, .8]\} \rangle, \langle x_2, \{[.7, 1], [.5, .9]\}, \{[0, 0], [0, 0]\}, \{[.3, .4], [2, .7]\} \rangle \}$$

Proposition 3.30. Let $A, B, C \in NVINS(X)$. Then,

1. $\tilde{\Delta} \tilde{\Delta}A = \tilde{\nabla}A$.
2. $\tilde{\Delta} (A \cup B) \subseteq \tilde{\Delta} A \cup \tilde{\Delta} B$.
3. $\tilde{\Delta} (A \cap B) \subseteq \tilde{\Delta} A \cap \tilde{\Delta} B$
4. $\tilde{\Delta} (A \tilde{+} B) \subseteq \tilde{\Delta} A \tilde{+} \tilde{\Delta} B$.

Proof: The proof is straightforward.

Definition 3.31. Let A and B be two n-valued interval neutrosophic sets. Then, false-Favorite of A, denoted by $\tilde{\nabla}A$, is defined by

$$\begin{aligned} \tilde{\nabla}A = & \{x([\inf T_A^1(x), \sup T_A^1(x)], [\inf T_A^2(x), \sup T_A^2(x)], \dots, \\ & [\inf T_A^p(x), \sup T_A^p(x)]), [0,0], [0,0], \dots, [0,0], [\min(\inf F_A^1(x) + \\ & \inf I_A^1(x), 1), \min(\sup F_A^1(x) + \sup I_B^1(x), 1)], [\min(\inf F_A^2(x) + \\ & \inf I_A^2(x), 1), \min(\sup F_A^2(x) + \sup I_A^2(x), 1)], \dots, [\min(\inf F_A^p(x) + \\ & \inf I_A^p(x), 1), \min(\sup F_A^p(x) + \sup I_A^p(x), 1)]: x \in X \} \end{aligned}$$

Example 3.32. Let $X = \{x_1, x_2\}$ be the universe and A and B are two n-valued interval neutrosophic sets

$$\begin{aligned} A = \{ \langle x_1, \{[.1, .2], [2, .3]\}, \{[.4, .5], [6, .7]\}, \{[.5, .6], [7, .8]\} \rangle, \\ \langle x_2, \{[.1, .4], [1, .3]\}, \{[6, .8], [4, .6]\}, \{[3, .4], [2, .7]\} \rangle \} \end{aligned}$$

and

$$\begin{aligned} B = \{ \langle x_1, \{[.3, .7], [3, .5]\}, \{[2, .4], [3, .5]\}, \{[3, .6], [2, .7]\} \rangle, \\ \langle x_2, \{[.3, .5], [4, .6]\}, \{[3, .5], [4, .5]\}, \{[3, .4], [1, .2]\} \rangle \} \end{aligned}$$

Then,

$$\begin{aligned} \tilde{\nabla}A = \{ \langle x_1, \{[.1, .2], [2, .3]\}, \{[0, 0], [0, 0]\}, \{[.9, 1], [1, 1]\} \rangle, \\ \langle x_2, \{[.1, .4], [1, .3]\}, \{[0, 0], [0, 0]\}, \{[.9, 1], [6, 1]\} \rangle \} \end{aligned}$$

Proposition 3.33. Let $A, B, C \in NVINS(X)$. Then,

1. $\tilde{\nabla}\tilde{\nabla}A = \tilde{\nabla}A$.
2. $\tilde{\nabla}(A \cup B) \subseteq \tilde{\nabla}A \cup \tilde{\nabla}B$.
3. $\tilde{\nabla}(A \cap B) \subseteq \tilde{\nabla}A \cap \tilde{\nabla}B$.
4. $\tilde{\nabla}(A \tilde{+} B) \subseteq \tilde{\nabla}A \tilde{+} \tilde{\nabla}B$.

Proof: The proof is straightforward.

Here $\vee, \wedge, +, \cdot, /, \sim, \tilde{}$ denotes maximum, minimum, addition, multiplication, scalar multiplication, scalar division of real numbers respectively.

Definition 3.34. Let E is a real Euclidean space E^n . Then, a NVINS A is convex if and only if

$$\begin{aligned} \inf T_A^i(x)(\lambda x_1 + (1-\lambda) x_2) &\geq \min(\inf T_A^i(x_1), \inf T_A^i(x_2)), \\ \sup T_A^i(x)(\lambda x_1 + (1-\lambda) x_2) &\geq \min(\sup T_A^i(x_1), \sup T_A^i(x_2)), \\ \inf I_A^i(x)(\lambda x_1 + (1-\lambda) x_2) &\leq \min(\inf I_A^i(x_1), \inf I_A^i(x_2)), \\ \sup I_A^i(x)(\lambda x_1 + (1-\lambda) x_2) &\leq \min(\sup I_A^i(x_1), \sup I_A^i(x_2)), \\ \inf F_A^i(x)(\lambda x_1 + (1-\lambda) x_2) &\leq \min(\inf F_A^i(x_1), \inf F_A^i(x_2)), \\ \sup F_A^i(x)(\lambda x_1 + (1-\lambda) x_2) &\leq \min(\sup F_A^i(x_1), \sup F_A^i(x_2)), \end{aligned}$$

for all $x_1, x_2 \in E$ and all $\lambda \in [0, 1]$ and $i = 1, 2, \dots, p$.

Theorem 3.35. If A and B are convex, so is their intersection.

Proof: Let $C = A \cap B$

$$\begin{aligned} \inf T_C^j(\lambda x_1 + (1-\lambda)x_2) &\geq \min(\inf T_A^j(\lambda x_1 + (1-\lambda)x_2), \inf T_B^j(\lambda x_1 \\ &+ (1-\lambda)x_2)), \sup T_C^j(\lambda x_1 + (1-\lambda)x_2) \geq \min(\sup T_A^j(\lambda x_1 + (1-\lambda)x_2), \\ &\sup T_B^j(\lambda x_1 + (1-\lambda)x_2)), \inf I_C^j(\lambda x_1 + (1-\lambda)x_2) \leq \max(\inf I_A^j(\lambda x_1 \\ &+ (1-\lambda)x_2), \inf I_B^j(\lambda x_1 + (1-\lambda)x_2)), \sup I_C^j(\lambda x_1 + (1-\lambda)x_2) \leq \max \\ &(\sup I_A^j(\lambda x_1 + (1-\lambda)x_2), \sup I_B^j(\lambda x_1 + (1-\lambda)x_2)), \inf F_C^j(\lambda x_1 + (1- \\ &\lambda)x_2) \leq \max(\inf F_A^j(\lambda x_1 + (1-\lambda)x_2), \inf F_B^j(\lambda x_1 + (1-\lambda)x_2)), \\ &\sup F_C^j(\lambda x_1 + (1-\lambda)x_2) \leq \max(\sup F_A^j(\lambda x_1 + (1-\lambda)x_2), \sup F_B^j(\lambda x_1 \\ &+ (1-\lambda)x_2)) \text{ since } A \text{ and } B \text{ are convex: } \inf T_A^j(\lambda x_1 + (1-\lambda)x_2) \geq \min \\ &(\inf T_A^j(x_1) + \inf T_A^j(x_2)), \sup T_A^j(\lambda x_1 + (1-\lambda)x_2) \geq \min(\sup T_A^j \\ &(x_1) + \sup T_A^j(x_2)), \inf I_A^j(\lambda x_1 + (1-\lambda)x_2) \leq \max(\inf I_A^j(x_1) + \inf \\ &I_A^j(x_2)), \sup I_A^j(\lambda x_1 + (1-\lambda)x_2) \leq \max(\sup I_A^j(x_1) + \sup I_A^j \\ &(x_2)), \inf F_A^j(\lambda x_1 + (1-\lambda)x_2) \leq \max(\inf F_A^j(x_1) + \inf F_A^j(x_2)), \\ &\sup F_A^j(\lambda x_1 + (1-\lambda)x_2) \leq \max(\sup F_A^j(x_1) + \sup F_A^j(x_2)), \\ &\inf T_B^j(\lambda x_1 + (1-\lambda)x_2) \geq \max(\inf T_B^j(x_1) + \inf T_B^j(x_2)), \sup T_B^j \\ &(\lambda x_1 + (1-\lambda)x_2) \geq \min(\sup T_B^j(x_1) + \sup T_B^j(x_2)), \inf I_B^j(\lambda x_1 + (1- \\ &\lambda)x_2) \leq \max(\inf I_B^j(x_1) + \inf I_B^j(x_2)), \sup I_B^j(\lambda x_1 + (1-\lambda)x_2) \leq \max \\ &(\sup I_B^j(x_1) + \sup I_B^j(x_2)), \inf F_B^j(\lambda x_1 + (1-\lambda)x_2) \leq \max(\inf F_B^j \\ &(x_1) + \inf F_B^j(x_2)), \sup F_B^j(\lambda x_1 + (1-\lambda)x_2) \leq \max(\sup F_B^j(x_1) + \\ &\sup F_B^j(x_2)). \end{aligned}$$

Hence,

$$\begin{aligned} \inf T_C^j(\lambda x_1 + (1-\lambda)x_2) &\geq \min(\min(\inf T_A^j(x_1) + \inf T_A^j(x_2)), \min \\ &(\inf T_B^j(x_1) + \inf T_B^j(x_2))) = \min(\inf T_A^j(x_1) + \inf T_B^j(x_1)), \min \\ &(\inf T_A^j(x_2) + \inf T_B^j(x_2)) = \min(\inf T_C^j(x_1) + \inf T_C^j(x_2)), \\ \sup T_C^j(\lambda x_1 + (1-\lambda)x_2) &\geq \min(\min(\sup T_A^j(x_1) + \sup T_A^j(x_2)), \min \\ &(\sup T_B^j(x_1) + \sup T_B^j(x_2))) = \min(\sup T_A^j(x_1) + \sup T_B^j(x_1)), \\ &\min(\sup T_A^j(x_2) + \sup T_B^j(x_2)) = \min(\sup T_C^j(x_1) + \sup T_C^j \\ &(x_2)), \\ \inf I_C^j(\lambda x_1 + (1-\lambda)x_2) &\leq \max(\max(\inf I_A^j(x_1) + \inf I_A^j(x_2)), \max(\inf \\ &I_B^j(x_1) + \inf I_B^j(x_2))) = \max(\inf I_A^j(x_1) + \inf I_B^j(x_1)), \max(\inf I_A^j \\ &(x_2) + \inf I_B^j(x_2)) = \max(\inf I_C^j(x_1) + \inf I_C^j(x_2)). \end{aligned}$$

Definition 3.36. An n-valued interval neutrosophic set is strongly convex if for any two points x_1 and x_2 and any λ in the open interval (0,1).

$$\inf T_A^i(x)(\lambda x_1 + (1-\lambda)x_2) > \min(\inf T_A^i(x_1), \inf T_A^i(x_2)),$$

$$\begin{aligned} \sup T_A^i(x)(\lambda x_1 + (1-\lambda) x_2) &> \min(\sup T_A^i(x_1), \sup T_A^i(x_2)), \\ \inf I_A^i(x)(\lambda x_1 + (1-\lambda) x_2) &< \min(\inf I_A^i(x_1), \inf I_A^i(x_2)), \\ \sup I_A^i(x)(\lambda x_1 + (1-\lambda) x_2) &< \min(\sup I_A^i(x_1), \sup I_A^i(x_2)), \\ \inf F_A^i(x)(\lambda x_1 + (1-\lambda) x_2) &< \min(\inf F_A^i(x_1), \inf F_A^i(x_2)), \\ \sup F_A^i(x)(\lambda x_1 + (1-\lambda) x_2) &< \min(\sup F_A^i(x_1), \sup F_A^i(x_2)), \end{aligned}$$

for all x_1, x_2 in X and all λ in $[0, 1]$ and $i = 1, 2, \dots, p$.

Theorem 3.37. If A and B are strongly convex, so is their intersection.

Proof: The proof is similar to Theorem 3.25

4 Distances between n-valued interval neutrosophic sets

In this section, we present the definitions of the Hamming, Euclidean distances between n-valued interval neutrosophic sets, generalized weighted distance and the similarity measures between n-valued interval neutrosophic sets based on the distances, which can be used in real scientific and engineering applications.

On the basis of the Hamming distance and Euclidean distance between two interval neutrosophic set defined by Ye in [43], we give the following Hamming distance and Euclidean distance between NVINSs as follows:

Definition 4.1 Let A and B two n-valued interval neutrosophic sets, Then, the Hamming distance is defined by:

$$\begin{aligned} 1- d_{HD} = & \frac{1}{p} \sum_{j=1}^p \frac{1}{6} \sum_{i=1}^n [| \inf T_A^j(x_i) - \inf T_B^j(x_i) | + | \sup T_A^j(x_i) - \\ & \sup T_B^j(x_i) | + | \inf I_A^j(x_i) - \inf I_B^j(x_i) | + | \sup I_A^j(x_i) - \\ & \sup I_B^j(x_i) | + | \inf F_A^j(x_i) - \inf F_B^j(x) | + | \sup F_A^j(x_i) - \\ & \sup F_B^j(x) |] \end{aligned}$$

The normalized Hamming distance is defined by:

$$\begin{aligned} 2- d_{NHD} = & \frac{1}{p} \sum_{j=1}^p \frac{1}{6n} \sum_{i=1}^n [| \inf T_A^j(x_i) - \inf T_B^j(x_i) | + | \sup T_A^j(x_i) - \\ & \sup T_B^j(x_i) | + | \inf I_A^j(x_i) - \inf I_B^j(x_i) | + | \sup I_A^j(x_i) - \\ & \sup I_B^j(x_i) | + | \inf F_A^j(x_i) - \inf F_B^j(x) | + | \sup F_A^j(x_i) - \\ & \sup F_B^j(x) |] \end{aligned}$$

However, the difference of importance is considered in the elements in the universe. Therefore, we need to consider the weights of the elements x_i ($i=1, 2, \dots, n$) into account. In the following, we defined the weighted Hamming distance with $w = \{w_1, w_2, \dots, w_n\}$

3- eighted normalized Hamming distance is defined by:

$$d_{wHD} = \frac{1}{p} \sum_{j=1}^p \frac{1}{6n} \sum_{i=1}^n w_i [| \inf T_A^j(x_i) - \inf T_B^j(x_i) | + | \sup T_A^j(x_i) - \sup T_B^j(x_i) | + | \inf I_A^j(x_i) - \inf I_B^j(x_i) | + | \sup I_A^j(x_i) - \sup I_B^j(x_i) | + | \inf F_A^j(x_i) - \inf F_B^j(x_i) | + | \sup F_A^j(x_i) - \sup F_B^j(x_i) |]$$

If $w_i = (\frac{1}{n}, \frac{1}{n}, \dots, \frac{1}{n})$, then (3) reduces to the Normalized Hamming distance.

Example 4.2. Let $X = \{x_1, x_2\}$ be the universe and A and B are two n -valued interval neutrosophic sets

$$A = \{ \langle x_1, \{[.1, .2], [.2, .3]\}, \{[.4, .5], [.6, .7]\}, \{[.5, .6], [.7, .8]\} \rangle, \langle x_2, \{[.1, .4], [.1, .3]\}, \{[.6, .8], [.4, .6]\}, \{[.3, .4], [.2, .7]\} \rangle \}$$

and

$$B = \{ \langle x_1, \{[.3, .7], [.3, .5]\}, \{[.2, .4], [.3, .5]\}, \{[.3, .6], [.2, .7]\} \rangle, \langle x_2, \{[.3, .5], [.4, .6]\}, \{[.3, .5], [.4, .5]\}, \{[.3, .4], [.1, .2]\} \rangle \}$$

Then, we have $d_{HD} = 0.4$.

Definition 4.3. Let A, B two n -valued interval neutrosophic sets. Thus,

1. The Euclidean distance d_{ED} is defined by:

$$d_{ED} = \left\{ \frac{1}{p} \sum_{j=1}^p \frac{1}{6} \sum_{i=1}^n \left[\left(\inf T_A^j(x_i) - \inf T_B^j(x_i) \right)^2 + \left(\sup T_A^j(x_i) - \sup T_B^j(x_i) \right)^2 + \left(\inf I_A^j(x_i) - \inf I_B^j(x_i) \right)^2 + \left(\sup I_A^j(x_i) - \sup I_B^j(x_i) \right)^2 + \left(\inf F_A^j(x_i) - \inf F_B^j(x_i) \right)^2 + \left(\sup F_A^j(x_i) - \sup F_B^j(x_i) \right)^2 \right] \right\}^{\frac{1}{2}}$$

2. The normalized Euclidean distance d_{NED} is defined by:

$$d_{NED} = \left\{ \frac{1}{p} \sum_{j=1}^p \frac{1}{6n} \sum_{i=1}^n \left[\left(\inf T_A^j(x_i) - \inf T_B^j(x_i) \right)^2 + \left(\sup T_A^j(x_i) - \sup T_B^j(x_i) \right)^2 + \left(\inf I_A^j(x_i) - \inf I_B^j(x_i) \right)^2 + \left(\sup I_A^j(x_i) - \sup I_B^j(x_i) \right)^2 + \left(\inf F_A^j(x_i) - \inf F_B^j(x_i) \right)^2 + \left(\sup F_A^j(x_i) - \sup F_B^j(x_i) \right)^2 \right] \right\}^{\frac{1}{2}}$$

However, the difference of importance is considered in the elements in the universe. Therefore, we need to consider the weights of the elements x_i ($i=1, 2, \dots, n$) into account. In the following, we defined the weighted Euclidean distance with $w = \{w_1, w_2, \dots, w_n\}$

3. The weighted Euclidean distance d_{WED} is defined by:

$$d_{WED} = \left\{ \frac{1}{p} \sum_{j=1}^p \frac{1}{6n} \sum_{i=1}^n w_i \left[\left(\inf T_A^j(x_i) - \inf T_B^j(x_i) \right)^2 + \left(\sup T_A^j(x_i) - \sup T_B^j(x_i) \right)^2 + \left(\inf I_A^j(x_i) - \inf I_B^j(x_i) \right)^2 + \left(\sup I_A^j(x_i) - \sup I_B^j(x_i) \right)^2 + \left(\inf F_A^j(x_i) - \inf F_B^j(x_i) \right)^2 + \left(\sup F_A^j(x_i) - \sup F_B^j(x_i) \right)^2 \right] \right\}^{\frac{1}{2}}$$

If $w_i = (\frac{1}{n}, \frac{1}{n}, \dots, \frac{1}{n})$, then (3) reduces to the Normalized Euclidean distance.

Example 4.4. Let $X = \{x_1, x_2\}$ be the universe and A and B are two n -valued interval neutrosophic sets

$$A = \{ \langle x_1, \{[.1, .2], [2, .3]\}, \{[.4, .5], [.6, .7]\}, \{[.5, .6], [.7, .8]\} \rangle, \langle x_2, \{[.1, .4], [1, .3]\}, \{[.6, .8], [4, .6]\}, \{[.3, .4], [2, .7]\} \rangle \}$$

and

$$B = \{ \langle x_1, \{[.3, .7], [3, .5]\}, \{[.2, .4], [3, .5]\}, \{[.3, .6], [2, .7]\} \rangle, \langle x_2, \{[.3, .5], [4, .6]\}, \{[.3, .5], [4, .5]\}, \{[.3, .4], [1, .2]\} \rangle \}$$

then, we have $d_{ED} = 0.125$.

Definition 4.5. Let A, B two n -valued interval neutrosophic sets. Then based on Broumi et al.[11] we proposed a generalized interval valued neutrosophic weighted distance measure between A and B as follows:

$$d_\lambda(A, B) = \left\{ \frac{1}{p} \sum_{j=1}^p \frac{1}{6n} \sum_{i=1}^n w_i \left[\left| \inf T_A^j(x_i) - \inf T_B^j(x_i) \right|^\lambda + \left| \sup T_A^j(x_i) - \sup T_B^j(x_i) \right|^\lambda + \left| \inf I_A^j(x_i) - \inf I_B^j(x_i) \right|^\lambda + \left| \sup I_A^j(x_i) - \sup I_B^j(x_i) \right|^\lambda + \left| \inf F_A^j(x_i) - \inf F_B^j(x_i) \right|^\lambda + \left| \sup F_A^j(x_i) - \sup F_B^j(x_i) \right|^\lambda \right] \right\}^{\frac{1}{\lambda}}$$

If $\lambda=1$ and $w_i = (\frac{1}{n}, \frac{1}{n}, \dots, \frac{1}{n})$, then the above equation reduces to the normalized Hamming distance.

If $\lambda=2$ and $w_i = (\frac{1}{n}, \frac{1}{n}, \dots, \frac{1}{n})$, then the above equation reduces to the normalized Euclidean distance.

Theorem 4.6. The defined distance $d_k(A, B)$ between NVINSs A and B satisfies the following properties (1-4), for $(k=HD, NHD, ED, NED)$;

1. $d_k(A, B) \geq 0$,
2. $d_k(A, B) = 0$ if and only if $A = B$; for all $A, B \in NVINSs$,

3. $d_k(A, B) = d_k(B, A)$,
4. If $A \subseteq B \subseteq C$, for $A, B, C \in NVINSS$, then $d_k(A, C) \geq d_k(A, B)$ and $d_k(A, C) \geq d_k(B, C)$.

Proof: it is easy to see that $d_k(A, B)$ satisfies the properties (D1)-(D3). Therefore, we only prove (D4). Let $A \subseteq B \subseteq C$, then,

$$\begin{aligned} \inf T_A^j(x_i) \leq \inf T_B^j(x_i) \leq \inf T_C^j(x_i), \sup T_A^j(x_i) \leq \sup T_B^j(x_i) \leq \\ \sup T_C^j(x_i), \inf I_A^j(x_i) \geq \inf I_B^j(x_i) \geq \inf I_C^j(x_i), \sup I_A^j(x_i) \geq \\ \sup I_B^j(x_i) \geq \sup I_C^j(x_i), \end{aligned}$$

and

$$\begin{aligned} \inf F_A^j(x_i) \geq \inf F_B^j(x_i) \geq \inf F_C^j(x_i), \sup F_A^j(x_i) \geq \sup F_B^j(x_i) \geq \\ \sup F_C^j(x_i), \end{aligned}$$

for $k = (HD, NHD, ED, NED)$, we have

$$\begin{aligned} |\inf T_A^j(x_i) - \inf T_B^j(x_i)|^k &\leq |\inf T_A^j(x_i) - \inf T_C^j(x_i)|^k, |\sup T_A^j(x_i) - \\ \sup T_B^j(x_i)|^k &\leq |\sup T_A^j(x_i) - \sup T_C^j(x_i)|^k, \\ |\inf T_B^j(x_i) - \inf T_C^j(x_i)|^k &\leq |\inf T_A^j(x_i) - \inf T_C^j(x_i)|^k, |\sup T_B^j(x_i) - \\ \sup T_C^j(x_i)|^k &\leq |\sup T_A^j(x_i) - \sup T_C^j(x_i)|^k, \\ |\inf I_A^j(x_i) - \inf I_B^j(x_i)|^k &\leq |\inf I_A^j(x_i) - \inf I_C^j(x_i)|^k, |\sup I_A^j(x_i) - \\ \sup I_B^j(x_i)|^k &\leq |\sup I_A^j(x_i) - \sup I_C^j(x_i)|^k, \\ |\inf I_B^j(x_i) - \inf I_C^j(x_i)|^k &\leq |\inf I_A^j(x_i) - \inf I_C^j(x_i)|^k, |\sup I_B^j(x_i) - \\ \sup I_C^j(x_i)|^k &\leq |\sup I_A^j(x_i) - \sup I_C^j(x_i)|^k \\ |\inf I_A^j(x_i) - \inf I_B^j(x_i)|^k &\leq |\inf I_A^j(x_i) - \inf I_C^j(x_i)|^k, |\sup I_A^j(x_i) - \\ \sup I_B^j(x_i)|^k &\leq |\sup I_A^j(x_i) - \sup I_C^j(x_i)|^k, \\ |\inf I_B^j(x_i) - \inf I_C^j(x_i)|^k &\leq |\inf I_A^j(x_i) - \inf I_C^j(x_i)|^k, |\sup I_B^j(x_i) - \\ \sup I_C^j(x_i)|^k &\leq |\sup I_A^j(x_i) - \sup I_C^j(x_i)|^k, \\ |\inf F_A^j(x_i) - \inf F_B^j(x_i)|^k &\leq |\inf F_A^j(x_i) - \inf F_C^j(x_i)|^k, |\sup F_A^j(x_i) - \\ \sup F_B^j(x_i)|^k &\leq |\sup F_A^j(x_i) - \sup F_C^j(x_i)|^k, \\ |\inf F_B^j(x_i) - \inf F_C^j(x_i)|^k &\leq |\inf F_A^j(x_i) - \inf F_C^j(x_i)|^k, \\ |\sup F_B^j(x_i) - \sup F_C^j(x_i)|^k &\leq |\sup F_A^j(x_i) - \sup F_C^j(x_i)|^k \end{aligned}$$

Hence

$$\begin{aligned}
 & |\inf T_A^j(x_i) - \inf T_B^j(x_i)|^k + |\sup T_A^j(x_i) - \sup T_B^j(x_i)|^k + |\inf I_A^j(x_i) - \\
 & \inf I_B^j(x_i)|^k + |\sup I_A^j(x_i) - \sup I_B^j(x_i)|^k + |\inf F_A^j(x_i) - \\
 & \inf F_B^j(x_i)|^k + |\sup F_A^j(x_i) - \sup F_B^j(x_i)|^k \leq |\inf T_A^j(x_i) - \\
 & \inf T_C^j(x_i)|^k + |\sup T_A^j(x_i) - \sup T_C^j(x_i)|^k + |\inf I_A^j(x_i) - \\
 & \inf I_C^j(x_i)|^k + |\sup I_A^j(x_i) - \sup I_C^j(x_i)|^k + |\inf F_A^j(x_i) - \\
 & \inf F_C^j(x_i)|^k + |\sup F_A^j(x_i) - \sup F_C^j(x_i)|^k \\
 & \frac{1}{p} \sum_{j=1}^p \frac{1}{6} \sum_{i=1}^n |\inf T_A^j(x_i) - \inf T_B^j(x_i)|^k + |\sup T_A^j(x_i) - \sup T_B^j(x_i)|^k \\
 & \quad + |\inf I_A^j(x_i) - \inf I_B^j(x_i)|^k \\
 & \quad + |\sup I_A^j(x_i) - \sup I_B^j(x_i)|^k \\
 & \quad + |\inf F_A^j(x_i) - \inf F_B^j(x_i)|^k \\
 & \quad + |\sup F_A^j(x_i) - \sup F_B^j(x_i)|^k \\
 & \leq \frac{1}{p} \sum_{j=1}^p \frac{1}{6} \sum_{i=1}^n |\inf T_A^j(x_i) - \inf T_C^j(x_i)|^k \\
 & \quad + |\sup T_A^j(x_i) - \sup T_C^j(x_i)|^k \\
 & \quad + |\inf I_A^j(x_i) - \inf I_C^j(x_i)|^k \\
 & \quad + |\sup I_A^j(x_i) - \sup I_C^j(x_i)|^k \\
 & \quad + |\inf F_A^j(x_i) - \inf F_C^j(x_i)|^k \\
 & \quad + |\sup F_A^j(x_i) - \sup F_C^j(x_i)|^k
 \end{aligned}$$

Then $d_k(A, B) \leq d_k(A, C)$

$$\begin{aligned}
 & |\inf T_B^j(x_i) - \inf T_C^j(x_i)|^k + |\sup T_B^j(x_i) - \sup T_C^j(x_i)|^k + |\inf I_B^j(x_i) - \\
 & \inf I_C^j(x_i)|^k + |\sup I_B^j(x_i) - \sup I_C^j(x_i)|^k + |\inf F_B^j(x_i) - \\
 & \inf F_C^j(x_i)|^k + |\sup F_B^j(x_i) - \sup F_C^j(x_i)|^k \leq |\inf T_A^j(x_i) - \\
 & \inf T_C^j(x_i)|^k + |\sup T_A^j(x_i) - \sup T_C^j(x_i)|^k + |\inf I_A^j(x_i) - \\
 & \inf I_C^j(x_i)|^k + |\sup I_A^j(x_i) - \sup I_C^j(x_i)|^k + |\inf F_A^j(x_i) - \\
 & \inf F_C^j(x_i)|^k + |\sup F_A^j(x_i) - \sup F_C^j(x_i)|^k
 \end{aligned}$$

$$\begin{aligned}
 & \frac{1}{p} \sum_{j=1}^p \frac{1}{6} \sum_{i=1}^n \left| \inf T_B^j(x_i) - \inf T_C^j(x_i) \right|^k + \left| \sup T_B^j(x_i) - \sup T_C^j(x_i) \right|^k \\
 & \quad + \left| \inf I_B^j(x_i) - \inf I_C^j(x_i) \right|^k + \left| \sup I_B^j(x_i) - \sup I_C^j(x_i) \right|^k \\
 & \quad + \left| \inf F_B^j(x_i) - \inf F_C^j(x_i) \right|^k + \left| \sup F_B^j(x_i) - \sup F_C^j(x_i) \right|^k \\
 & \leq \frac{1}{p} \sum_{j=1}^p \frac{1}{6} \sum_{i=1}^n \left| \inf T_A^j(x_i) - \inf T_C^j(x_i) \right|^k \\
 & \quad + \left| \sup T_A^j(x_i) - \sup T_C^j(x_i) \right|^k + \left| \inf I_A^j(x_i) - \inf I_C^j(x_i) \right|^k \\
 & \quad + \left| \sup I_A^j(x_i) - \sup I_C^j(x_i) \right|^k + \left| \inf F_A^j(x_i) - \inf F_C^j(x_i) \right|^k \\
 & \quad + \left| \sup F_A^j(x_i) - \sup F_C^j(x_i) \right|^k
 \end{aligned}$$

Then $d_k(B, C) \leq d_k(A, C)$.

Combining the above inequalities with the above defined distance formulas (1)-(4), we can obtain that $d_k(A, B) \leq d_k(A, C)$ and $d_k(B, C) \leq d_k(A, C)$ for $k=$ (HD, NHD, ED, NED).

Thus the property (D4) is obtained.

It is well known that similarity measure can be generated from distance measure. Therefore we may use the proposed distance measure to define similarity measures.

Based on the relationship of similarity measure and distance we can define some similarity measures between NVINSs A and B as follows:

Definition 4.7. The similarity measure based on $s_{NVINS}(A, B) = 1 - d_k(A, B)$, $s_{NVINS}(A, B)$ is said to be the similarity measure between A and B, where $A, B \in NVINS$.

Theorem 4.8. The defined similarity measure $s_{NVINS}(A, B)$ between NVINSs A and B satisfies the following properties (1-4),

1. $s_{NVINS}(A, B) = s_{NVINS}(B, A)$.
2. $s_{NVINS}(A, B) = (1, 0, 0) = \underline{1}$.if $A=B$ for all $A, B \in NVINSs$.
3. $s_{NVINS}(A, B) \in [0, 1]$
4. If $A \subseteq B \subseteq C$ for all $A, B, C \in NVINSs$ then $s_{NVINS}(A, B) \geq s_{NVINS}(A, C)$ and $s_{NVINS}(B, C) \geq s_{NVINS}(A, C)$.

From now on, we use

$$A = \left\{ x, \left(\begin{array}{l} [\inf T_A^1(x), \sup T_A^1(x)], [\inf I_A^1(x), \sup I_A^1(x)], \\ [\inf F_A^1(x), \sup F_A^1(x)] \end{array} \right), \dots \right\}$$

$$\left(\begin{array}{c} [\inf T_A^p(x), \sup T_A^p(x)], [\inf I_A^p(x), \sup I_A^p(x)], \\ [\inf F_A^p(x), \sup F_A^p(x)] \end{array} \right): x \in E$$

instead of

$$A = \{x, \left(\begin{array}{c} [\inf T_A^1(x), \sup T_A^1(x)], [\inf T_A^2(x), \sup T_A^2(x)], \dots, \\ [\inf T_A^p(x), \sup T_A^p(x)] \end{array} \right), \right. \\ \left. \left(\begin{array}{c} [\inf I_A^1(x), \sup I_A^1(x)], [\inf I_A^2(x), \sup I_A^2(x)], \dots, \\ [\inf I_A^p(x), \sup I_A^p(x)] \end{array} \right), \right. \\ \left. \left([\inf F_A^1(x), \sup F_A^1(x)], ([\inf F_A^2(x), \sup F_A^2(x)], \dots, \right. \right. \\ \left. \left. ([\inf F_A^p(x), \sup F_A^p(x)]) \right) : x \in E \}.$$

5 Medical Diagnosis using NVINS

In what follows, let us consider an illustrative example adopted from Rajarajeswari and Uma [32] with minor changes and typically considered in [17,20,37]. Obviously, the application is an extension of intuitionistic fuzzy multi sets [17,20,32,33,34].

"As Medical diagnosis contains lots of uncertainties and increased volume of information available to physicians from new medical technologies, the process of classifying different set of symptoms under a single name of disease becomes difficult. In some practical situations, there is the possibility of each element having different truth membership, indeterminate and false membership functions. The proposed similarity measure among the patients Vs symptoms and symptoms Vs diseases gives the proper medical diagnosis. The unique feature of this proposed method is that it considers multi truth membership, indeterminate and false membership. By taking one time inspection, there may be error in diagnosis. Hence, this multi time inspection, by taking the samples of the same patient at different times gives best diagnosis" [32].

Now, an example of a medical diagnosis will be presented.

Example 5.1. Let $P = \{P_1, P_2, P_3\}$ be a set of patients, $D = \{\text{Viral Fever, Tuberculosis, Typhoid, Throat disease}\}$ be a set of diseases and $S = \{\text{Temperature, cough, throat pain, headache, body pain}\}$ be a set of symptoms. Our solution is to examine the patient at different time intervals (three times a day), which in turn give arise to different truth membership, indeterminate and false membership function for each patient.

Table I: Q (the relation Between Patient and Symptoms)

Q	Temperature	Cough	Throat pain	Headache	Body Pain
P ₁	[.3..4],[.4..5],[.3..7] [0..3],[.1..3],[0..5] [0..6],[.4..5],[.3..4]	[.1..2],[.3..6],[.6..8] [0..5],[.4..7],[.4..5] [.2..3],[0..5],[.4..6]	[0..5],[.2..6],[0..4] [.3..4],[.2..3],[.3..4] [0..7],[.3..7],[.3..5]	[.2..3],[.3..5],[0..7] [.4..5],[.4..7],[.3..6] [.2..6],[0..6],[.3..4]	[0..4],[.6..7],[.2..5] [.2..4],[.4..5],[.1..2] [.1..3],[.1..3],[.2..3]
P ₂	[.2..3],[.4..5],[.1..2] [.4..5],[.2..5],[0..3] [.6..7],[.4..5],[.4..5]	[.5..7],[0..4],[.7..8] [.6..7],[0..5],[.4..5] [.4..6],[.2..7],[0..3]	[.5..6],[0..6],[.2..3] [.4..7],[.4..6],[.3..4] [.1..3],[.2..3],[.5..7]	[.2..5],[.5..6],[.1..5] [.2..3],[.2..5],[.5..6] [.1..3],[.3..4],[.4..5]	[.2..4],[.4..6],[.1..4] [0..5],[.2..4],[.5..6] [.5..7],[0..7],[.2..4]
P ₃	[.1..3],[0..5],[.4..6] [.1..2],[.3..4],[.2..5] [.2..4],[.4..5],[.3..7]	[.2..3],[0..7],[.1..4] [.5..6],[0..3],[.3..5] [.3..5],[.2..5],[.4..6]	[.2..4],[.3..6],[0..6] [.4..5],[0..3],[.3..4] [.5..7],[.4..6],[.3..7]	[.2..3],[.5..6],[.4..5] [.2..4],[0..4],[.2..7] [.4..5],[.2..3],[.3..5]	[0..6],[.4..7],[.2..3] [.2..3],[.2..3],[.1..2] [0..6],[.2..4],[.4..6]

Let the samples be taken at three different timings in a day (in 08:00,16:00,24:00).

Table II: R (the relation among Symptoms and Diseases)

R	Viral Fever	Tuberculosis	Typhoid	Throat diseases
Temperature	[.2..4],[.3..5],[.3..7]	[.1..4],[.2..6],[.6..7]	[0..3],[.4..6],[0..2]	[.3..4],[.2..5],[0..6]
Cough	[.2..4],[.2..3],[0..5]	[.3..4],[.2..5],[.7..8]	[.3..4],[.2..3],[.1..2]	[.4..5],[.1..3],[0..5]
Throat Pain	[0..4],[.2..4],[.2..4]	[0..2],[.3..6],[.6..7]	[.1..2],[.4..5],[.3..4]	[.2..4],[.2..5],[.3..7]
Headache	[.4..7],[0..3],[.3..5]	[.1..2],[0..5],[0..6]	[.3..4],[.2..3],[.2..5]	[0..3],[.3..6],[.2..5]
Body Pain	[.1..4],[.2..5],[.3..4]	[.5..7],[.4..5],[.2..5]	[.2..3],[.2..4],[.2..3]	[0..4],[.1..2],[.1..3]

Table III: The Hamming distance between NVINS Q and R

Hamming Distance	Viral Fever	Tuberculosis	Typhoid	Throat diseases
P ₁	0.1511	0.1911	0.1678	0.1689
P ₂	0.1911	0.2089	0.1789	0.1644
P ₃	0.1433	0.1967	0.1533	0.1456

Table IV: The similarity Measure between NVINS Q and R

Similarity measure	Viral Fever	Tuberculosis	Typhoid	Throat diseases
P ₁	0.8489	0.8089	0.8322	0.8311
P ₂	0.8089	0.7911	0.8211	0.8356
P ₃	0.8567	0.8033	0.8467	0.8544

The highest similarity measure from the Table IV gives the proper medical diagnosis. Therefore, patient P₁ suffers from Viral Fever, P₂ suffers from Throat disease and P₃ suffers from Viral Fever.

6 Conclusion

In this paper, we give n-valued interval neutrosophic sets and desired operations such as; union, intersection, addition, multiplication, scalar multiplication, scalar division, truth-favorite and false-favorite. The concept of n-valued interval neutrosophic set is a generalization of interval valued neutrosophic set, single valued neutrosophic sets and single valued neutrosophic multi sets. Then, we introduce some distances between n-valued

interval neutrosophic sets (NVINS) and propose an efficient approach for group multi-criteria decision making based on n-valued interval neutrosophic sets. The distances have natural applications in the field of pattern recognition, feature extraction, region extraction, image processing, coding theory etc.

7 References

- [1] A. A. Salama, O. M. Khaled and K. M. Mahfouz, *Neutrosophic Correlation and Simple Linear Regression*, Neutrosophic Sets and Systems, 5 (2014) 3-8.
- [2] M. Arora, R. Biswas, U. S. Pandey, *Neutrosophic Relational Database Decomposition*, International Journal of Advanced Computer Science and Applications, 2/ 8 (2011) 121-125.
- [3] K. T. Atanassov, *Intuitionistic Fuzzy Set*, Fuzzy Sets and Systems, 20(1) (1986) 87-86.
- [4] M. Bhowmik and M. Pal, *Intuitionistic Neutrosophic Set*, Journal of Information and Computing Science, 4/2 (2009) 142-152.
- [5] M. Bhowmik and M. Pal, *Intuitionistic Neutrosophic Set Relations and Some of Its Properties*, Journal of Information and Computing Science, 5/3 (2010) 183-192.
- [6] S. Broumi and F. Smarandache, *Cosine Similarity Measure of Interval Valued Neutrosophic Sets*, Neutrosophic Sets and Systems, 5 (2014) 15-20.
- [7] M. Bhowmik and M. Pal, *Intuitionistic Neutrosophic Set Relations and Some of Its Properties*, Journal of Information and Computing Science, 5/ 3 (2010) 183-192.
- [8] S. Broumi and I. Deli, *Correlation measure for neutrosophic Refined sets and its application in medical Diagnosis*, Palestine journal of mathematics, 5(1) (2015), accepted.
- [9] S. Broumi, R. Sahin, F. Smarandache, *Generalized Interval Neutrosophic Soft Set and its Decision Making Problem*, Journal of New Results in Science, 7 (2014) 29-47.
- [10] S. Broumi, I. Deli, and F. Smarandache, *Relations on Interval Valued Neutrosophic Soft Sets*, Journal of New Results in Science, 5 (2014) 1-20.
- [11] S. Broumi, I. Deli and F. Smarandache, *Distance and Similarity Measures of Interval Neutrosophic Soft Sets*, Critical Review, Center for Mathematics of Uncertainty, Creighton University, USA, 8, (2014) 14-31.
- [12] S. Broumi, F. Smarandache, *Single valued neutrosophic trapezoid linguistic aggregation operators based multi-attribute decision making*,

- Bulletin of Pure & Applied Sciences- Mathematics and Statistics, 33/2 (2014) 135-155.
- [13] S. Broumi, F. Smarandache, *Interval Valued Neutrosophic Soft Rough Set*, International Journal of Computational Mathematics. (2015), <http://dx.doi.org/10.1155/2015/232919>.
- [14] S. Broumi, F. Smarandache, *Neutrosophic refined similarity measure based on cosine function*, Neutrosophic Sets and Systems, 6 (2014) 41-47.
- [15] S. Broumi, F. Smarandache, *Single valued neutrosophic soft expert soft set and its application*, Journal of New Theory 3, (2015) 67-88.
- [16] S. Broumi, F. Smarandache, *Interval neutrosophic rough sets*, Neutrosophic Sets and Systems, 7 (2015) 23-31.
- [17] S. Broumi, I. Deli and F. Smarandache, *Distance and Similarity Measures of Interval Neutrosophic Soft Sets*, Critical Review, Center for Mathematics of Uncertainty, Creighton University, USA 8 (2014) 14–31.
- [18] S. Broumi, I. Deli, *Correlation Measure for Neutrosophic Refined Sets and its application in Medical Diagnosis*, Palestine Journal of Mathematics, (2015) in press.
- [19] S. Broumi, F. Smarandache, *Soft Interval Valued Neutrosophic Rough Sets*, Neutrosophic Sets and Systems, 7 (2015) 69- 80.
- [20] R. Chatterjee, R. Majumdar, S. K. Samanta, *Single valued neutrosophic multisets*, Annals fuzzy mathematic and information science, (2015).
- [21] H. D. Cheng, Y Guo. *A new neutrosophic approach to image thresholding*, New Mathematics and Natural Computation 4(3) (2008) 291–308.
- [22] I. Deli and S. Broumi, *Neutrosophic Soft Relations and Some Properties*, Annals of fuzzy mathematics and informatics, 9/1 (2015)169-182.
- [23] I. Deli, S. Broumi and F. Smarandache, *On neutrosophic multisets and its application in medical diagnosis* (2015) (submitted).
- [24] I. Deli and S. Broumi, *Neutrosophic Soft Matrices and NSM-Decision Making*, Journal of Intelligent & Fuzzy Systems, DOI:10.3233/IFS-141505.
- [25] I. Deli, *Interval-valued neutrosophic soft sets and its decision making* <http://arxiv.org/abs/1402.3130>.
- [26] M. Dhar, S. Broumi and F. Smarandache. *A Note on Square Neutrosophic Fuzzy Matrices*, Neutrosophic sets and systems, 3 (2014) 37-41.
- [27] D. Dubios and H. Prade, *Rough fuzzy sets and fuzzy rough sets*, Int. J. Gen. Syst., 17 (1990) 191-208.
- [28] P. K. Maji, *Neutrosophic soft set*, Annals of Fuzzy Mathematics and Informatics, 5(1) (2013) 157-168.
- [29] P. Majumdar, S. K. Samanta, *On similarity and entropy of neutrosophic sets*, Journal of Intelligent and Fuzzy Systems, DOI:10.3233/IFS-130810.

- [30] F. G. Lupiáñez, *On neutrosophic topology*, *Kybernetes*, 37/6 (2008) 797-800.
- [31] Z. Pawlak, *Rough sets*, *International Journal of Computer and Information Sciences* 11/4 (1982) 341–356.
- [32] P. Rajarajeswari and N. Uma, *On Distance and Similarity Measures of Intuitionistic Fuzzy Multi Set*, *IOSR Journal of Mathematics*, 5(4) (2013) 19--23.
- [33] P. Rajarajeswari and N. Uma, *A Study of Normalized Geometric and Normalized Hamming Distance Measures in Intuitionistic Fuzzy Multi Sets*, *International Journal of Science and Research, Engineering and Technology*, 2(11) (2013) 76--80.
- [34] P. Rajarajeswari, N. Uma, *Intuitionistic Fuzzy Multi Relations*, *International Journal of Mathematical Archives*, 4(10) (2013) 244-249.
- [35] P. Rajarajeswari, N. Uma, *Correlation Measure For Intuitionistic Fuzzy Multi Sets*, *International Journal of Research in Engineering and Technology*, 3(1) (2014) 611-617.
- [36] A. A. Salama, O. M. Khaled and K. M. Mahfouz, *Neutrosophic Correlation and Simple Linear Regression*, *Neutrosophic Sets and Systems*, Vol. 5, (2014) 3-8.
- [37] F. Smarandache, *A Unifying Field in Logics. Neutrosophy: Neutrosophic Probability, Set and Logic*, Rehoboth: American Research Press,(1998).
- [38] F. Smarandache, *n-Valued Refined Neutrosophic Logic and Its Applications in Physics*, *Progress in Physics*, 4 (2013) 143-146.
- [39] H. Wang, F. Smarandache, Y. Q. Zhang, R. Sunderraman, *Single valued neutrosophic sets*, *Multispace and Multistructure*, 4 (2010) 410–413.
- [40] H. Wang, F. Smarandache, Y. Q. Zhang, R. Sunderraman, *Interval Neutrosophic Sets and Logic: Theory and Applications in Computing*, Hexis, Phoenix, AZ, (2005).
- [41] J. Ye, *Similarity measures between interval neutrosophic sets and their multicriteria decision-making method*, *Journal of Intelligent & Fuzzy Systems*, DOI: 10.3233/IFS-120724.
- [42] S. Ye, J. Fu, and J. Ye, *Medical Diagnosis Using Distance- Based Similarity Measures of Single Valued Neutrosophic Multisets*, *Neutrosophic Sets and Systems* 7 (2015) 47-52.
- [43] J. Ye, *Similarity measures between interval neutrosophic sets and their multicriteria decision-making method*, *Journal of Intelligent & Fuzzy Systems*, DOI: 10.3233/IFS-120724.
- [44] S. Ye, J. Ye, *Dice similarity measure between single valued neutrosophic multisets and its application in medical diagnosis*, *Neutrosophic Sets and Systems* 6 (2014) 48-52.
- [45] L. A. Zadeh, *Fuzzy Sets*, *Inform. and Control*, 8 (1965) 338-353.

Neutrosophic Index Numbers: Neutrosophic Logic Applied in The Statistical Indicators Theory

Florentin Smarandache, Gheorghe Săvoiu

Florentin Smarandache, Gheorghe Săvoiu (2015). Neutrosophic Index Numbers: Neutrosophic Logic Applied in The Statistical Indicators Theory. *Critical Review X*, 67-100

Abstract

Neutrosophic numbers easily allow modeling uncertainties of prices universe, thus justifying the growing interest for theoretical and practical aspects of arithmetic generated by some special numbers in our work. At the beginning of this paper, we reconsider the importance in applied research of instrumental discernment, viewed as the main support of the final measurement validity. Theoretically, the need for discernment is revealed by decision logic, and more recently by the new neutrosophic logic and by constructing neutrosophic-type index numbers, exemplified in the context and applied to the world of prices, and, from a practical standpoint, by the possibility to use index numbers in characterization of some cyclical phenomena and economic processes, e.g. inflation rate. The neutrosophic index numbers or neutrosophic indexes are the key topic of this article. The next step is an interrogative and applicative one, drawing the coordinates of an optimized discernment centered on neutrosophic-type index numbers. The inevitable conclusions are optimistic in relation to the common future of the index method and neutrosophic logic, with statistical and economic meaning and utility.

Keyword

neutrosophic-tendential fuzzy logic, neutrosophic logic, neutrosophic index, index statistical method, price index, interpreter index, neutrosophic interpreter index.

1 Introduction

Any decision, including the statistical evaluation in the economy, requires three major aspects, distinct but interdependent to a large extent, starting with *providing the needed knowledge to a certain level of credibility* (reducing

uncertainty, available knowledge being incomplete and unreliable in different proportions, and the condition of certainty rarely being encountered in practice, the determinism essentially characterizing only the theory), then by the *discernment of choosing the decision option*, and, finally, by *obtaining the instrumental and quantified consensus*. In the hierarchy of measurement results qualities, the discernment of instrumental choice – by selection of the tool, of the technics, or of the method from the alternative options that characterizes all available solutions – should be declared the fundamental property of applied research. Moreover, the discernment can be placed on a scale intensity, from experimental discernment or decision discernment, selected according to the experience acquired in time, then ascending a “ladder” revealed by perpetual change of the continuous informational discernment or by the discernment obtained through knowledge from new results of research in specific activity, until the final stage of intuitional discernment (apparently rational, but mostly based on intuition), in fact the expression of a researcher's personal reasoning.

In summary, the process of making a measurement decision, based on a spontaneous and intuitive personal judgment, contains a referential system that experiences, more or less by chance, different quantifying actions satisfying to varying degrees the needs of which the system is aware in a fairly nuanced manner. The actions, the tools, the techniques and the measurement methods that are experienced as satisfactory will be accepted, resumed, fixed and amplified as accurate, and those that are experienced as unsatisfactory will be removed from the beginning. A modern discernment involves completing all the steps of the described “ladder”, continuously exploiting the solutions or the alternatives enabling the best interpretation, ensuring the highest degree of differentiation, offering the best diagnostic, leading to the best treatment, with the most effective impact in real time. However, some modern measurement theories argue that human social systems, in conditions of uncertainty, resort to a simplified decision-making strategy, respectively the adoption of the first satisfactory solution, coherently formulated, accepted by relative consensus (the Dow Jones index example is a perennial proof in this respect).

Neutrosophic logic facilitates the discernment in relation to natural language, and especially with some of its terms, often having arbitrary values. An example in this regard is the formulation of common market economies: “inflation is low and a slight increase in prices is reported,” a mathematical imprecise formulation since it is not exactly known which is the percentage of price increase; still, if it comes about a short period of time and a well defined market of a product, one can make the assumption that a change to the current price is between 0% and 100% compared to the last (basic) price.

A statement like – “if one identifies a general increase in prices close to zero” (or an overall increase situated between three and five percent, or a general increase around up to five percent), “then the relevant market enjoys a low inflation” – has a corresponding degree of truth according to its interpretation in the context it was issued. However, the information must be interpreted accordingly to a certain linguistic value, because it can have different contextual meanings (for Romania, an amount of 5% may be a low value, but for the EU even an amount of five percent is certainly a very high one).

Neutrosophic logic, by employing neutrosophic-type sets and corresponding membership functions, could allow detailing the arrangement of values covering the area of representation of a neutrosophic set, as well as the correspondence between these values and their degree of belonging to the related neutrosophic set, or by employing neutrosophic numbers, especially the neutrosophic indexes explained in this paper; and could open new applied horizons, e.g. price indexes that are, in fact, nothing else than interpreters, but more special – on the strength of their special relationship with the reality of price universe.

2 Neutrosophic Logic

First of all, we should define what the Logic is in general, and then the Neutrosophic Logic in particular.

Although considered elliptical by Nae Ionescu, the most succinct and expressive metaphorical definition of the Logic remains that – Logic is “the thinking that thinks itself.”

The Logic has indisputable historical primacy as science. The science of Logic seeks a finite number of consequences, operating with sets of sentences and the relationship between them. The consequence’s or relationship’s substance is exclusively predicative, modal, or propositional, such generating Predicative Logic, Modal Logic, or Propositional Logic.

A logic calculation can be syntactic (based on evidence) and semantic (based on facts). The Classical Logic, or the Aristotelian excluded middle logic, operates only with the notions of truth and false, which makes it inappropriate to the vast majority of real situations, which are unclear or imprecise. According to the same traditional approach, an object could either belong or not belong to a set.

The essence of the new Neutrosophic Logic is based on the notion of vagueness: a neutrosophic sentence may be only true to a certain extent; the notion of belonging benefits from a more flexible interpretation, as more items may

belong to a set in varying degrees. The first imprecision based logic (early neutrosophic) has existed since 1920, as proposed by the Polish mathematician and logician Jan Łukasiewicz, which expanded the truth of a proposition to all real numbers in the range [0; 1], thus generating the possibility theory, as reasoning method in conditions of inaccuracy and incompleteness [1].

In early fuzzy logic, a neutrosophic-tendential logic of Łukasiewicz type, this paradox disappears, since if φ has the value of 0.5, its own negation will have the same value, equivalent to φ . This is already a first step of a potentially approachable gradation, by denying the true statement (1) by the false statement (φ) and by the new arithmetic result of this logic, namely the new value $1 - \varphi$.

In 1965, Lotfi A. Zadeh extended the possibility theory in a formal system of fuzzy mathematical logic, focused on methods of working using nuanced terms of natural language. Zadeh introduced the degree of membership/truth (t) in 1965 and defined the *fuzzy set*.

Atanassov introduced the degree of nonmembership/falsehood (f) in 1986 and defined the *intuitionistic fuzzy set*.

Smarandache introduced the degree of indeterminacy/neutrality (i) as independent component in 1995 (published in 1998), and defined the neutrosophic set. In 2013, he refined the neutrosophic set to n components:

$$t_1, t_2, \dots, t_j; i_1, i_2, \dots, i_k; f_1, f_2, \dots, f_l,$$

where $j + k + l = n > 3$.

The words “neutrosophy” and “neutrosophic” were coined/invented by F. Smarandache in his 1998 book. Etymologically, “neutro-sophy” (noun) [French *neutre* <Latin *neuter, neutral*, and Greek *sophia*, skill/wisdom] means “knowledge of neutral thought”, while “neutrosophic” (adjective), means “having the nature of, or having the characteristic of Neutrosophy”.

Going over, in fuzzy set, there is only a degree (percentage) of belonging of an element to a set (Zadeh, 1965). Atanassov introduced in 1986 the degree (percentage) of non-belonging of an element to a set, and developed the intuitionistic fuzzy set. Smarandache introduced in 1995 the degree (percentage) of indeterminacy of belonging, that is: we do not know if an element belongs, or does not belong to a set), defining the neutrosophic set.

The neutrosophy, in general, is based on the neutral part, neither membership nor non-membership, and in neutrosophic logic, in particular: neither true, nor false, but in between them. Therefore, an element $x(t, i, f)$ belongs to a

neutrosophic set M in the following way: x is $t\%$ in M , $i\%$ indeterminate belonging, and $f\%$ does not belong. Or we can look at this issue in probabilistic terms as such: the chance for the element x to belong to the set M is $t\%$, the indeterminate chance to belong is $i\%$, and the chance not to belong is $f\%$.

In normalized cases, $t + i + f = 1$ (100%), but in general, if the information about the possibility of membership of the element x in the set M is independently sourced (not communicating with one another, so not influencing each other), then it may be that $0 \leq t + i + f \leq 3$.

In more general or approximated cases, t, i, f can be included intervals in $[0, 1]$, or even certain subsets included in $[0, 1]$, i.e. when working with inaccurate, wrong, contradictory, vague data.

In 1972, S.S.L. Chang and L. A. Zadeh sketched the use of fuzzy logic (also of tendential-neutrosophic logic) in conducting technological processes by introducing the concept of linguistic variables defined not by numbers, but as a variable in linguistic terms, clearly structured by letters or words. The linguistic variables can be decomposed into a multitude of terms, covering the full range of the considered parameter.

On the other hand, unlike the classical logic (Aristotelian, mathematic and boolean), which work exclusively with two exact numerical values (0 for false and 1 for true), the fuzzy early-neutrosophic logic was able to use a wide continuous spectrum of logical values in the range $[0, 1]$, where 0 indicates complete falsity, and 1 indicates complete truth. However, if an object, in classical logic, could belong to a set (1) or not belong to a set (0), the neutrosophic logic redefines the object's degree of membership to the set, taking any value between 0 and 1. The linguistic refinement could be fuzzy tendential-neutrosophically redefined, both logically and mathematically, by inaccuracy, by indistinctness, by vagueness. The mathematical clarification of imprecision and vagueness, the more elastic formal interpretation of membership, the representation and the manipulation of nuanced terms of natural language, all these characterize today, after almost half a century, the neutrosophic logic.

The first major application of the neutrosophic logical system has been carried out by L.P. Holmblad and J.J. Ostergaard on a cement kiln automation [2], in 1982, followed by more practical various uses, as in high traffic intersections or water treatment plants. The first chip capable of performing the inference in a decision based on neutrosophic logic was conducted in 1986 by Masaki Togai and Hiroyuki Watanabe at AT&T Bell Laboratories, using the digital implementation of *min-max* type logics, expressing elementary union and intersection operations [3].

A neutrosophic-tendential fuzzy set, e.g. denoted by F , defined in a field of existence U , is characterized by a membership function $\mu^F(x)$ which has values in the range $[0, 1]$ and is a generalization of the concise set [4], where the belonging function takes only one of two values, zero and one. The membership function provides a measure of the degree of similarity of an element U of neutrosophic-tendential fuzzy subset F . Unlike the concise sets and subsets, characterized by net frontiers, the frontiers of the neutrosophic-tendential fuzzy sets and subsets are made from regions where membership function values gradually fade out until they disappear, and the areas of frontiers of these nuanced subsets may overlap, meaning that the elements from these areas may belong to two neighboring subsets at the same time.

As a result of the neutrosophic-tendential fuzzy subset being characterized by frontiers, which are not net, the classic inference reasoning, expressed by a *Modus Ponens* in the traditional logic, of form:

$$(p \rightarrow (p \rightarrow q)) \rightarrow q, \text{ i.e.: } \begin{array}{l} \text{premise: if } p, \text{ then } q \\ \text{fact: } p \\ \text{consequence: } q, \end{array}$$

becomes a *generalized Modus Ponens*, according to the neutrosophic-tendential fuzzy logic and under the new rules of inference suggested from the very beginning by Lotfi A. Zadeh [5], respectively in the following expression:

$$\begin{array}{l} \text{premise: if } x \text{ is } A, \text{ then } y \text{ is } B \\ \text{fact: } x \text{ is } A' \\ \text{consequence: } y \text{ is } B', \text{ where } B' = A' \circ (A \rightarrow B). \end{array}$$

(*Modus ponens* from classical logic could have the rule *max-min* as correspondent in neutrosophic-tendential fuzzy logic).

This inference reasoning, which is essentially the basis of the neutrosophic-tendential fuzzy logic, generated the use of expression “approximate reasoning”, with a nuanced meaning. Neutrosophic-tendential fuzzy logic can be considered a first extension of meanings of the incompleteness theory to date, offering the possibility of representing and reasoning with common knowledge, ordinary formulated, therefore having found applicability in many areas.

The advantage of the neutrosophic-tendential fuzzy logic was the existence of a huge number of possibilities that must be validated at first. It could use linguistic modifiers of the language to appropriate the degree of imprecision represented by a neutrosophic-tendential fuzzy set, just having the natural language as example, where people alter the degree of ambiguity of a sentence using adverbs as *incredibly, extremely, very*, etc. An adverb can modify a verb, an adjective, another adverb, or the entire sentence.

After designing and analyzing a logic system with neutrosophic-tendential fuzzy sets [6], one develops its algorithm and, finally, its program incorporating specific applications, denoted as neutrosophic-tendential fuzzy controller. Any neutrosophic-tendential fuzzy logic consists of four blocks: the fuzzyfication (transcribing by the membership functions in neutrosophic input sets), the basic rules block (which contains rules, mostly described in a conditional manner, drawn from concise numerical data in a single collection of specific judgments, expressed in linguistic terms, having neutrosophic sets associated in the process of inference or decision), the inference block (transposing by neutrosophic inferential procedures nuanced input sets into nuanced output sets), and the defuzzyfication (transposing nuanced output sets in the form of concise numbers).

The last few decades are increasingly dominated by artificial intelligence, especially by the computerized intelligence of experts and the expert-systems; alongside, the tendential-neutrosophic fuzzy logic has gradually imposed itself, being more and more commonly used in tendential-neutrosophic fuzzy control of subways and elevators systems, in tendential-neutrosophic fuzzy-controlled household appliances (washing machines, microwave ovens, air conditioning, so on), in voice commands of tendential-neutrosophic fuzzy types, like *up*, *land*, *hover*, used to drive helicopters without men onboard, in tendential-neutrosophic fuzzy cameras that maps imaging data in medical lens settings etc.

In that respect, a bibliography of theoretical and applied works related to the tendential-neutrosophic fuzzy logic, certainly counting thousands of articles and books, and increasing at a fast pace, proves the importance of the discipline.

3 Construction of Sets and Numbers of Neutrosophic Type in the Universe of Prices heading

As it can be seen from almost all fields of science and human communication, natural language is structured and prioritized through logical nuances of terms. Valorisation of linguistic nuances through neutrosophic-tendential fuzzy logic, contrary to traditional logic, after which an object may belong to a set or may not belong to a set, allow the use with a wide flexibility of the concept of belonging [7].

Neutrosophic-tendential fuzzy numbers are used in practice to represent more precisely defined approximate values. For example, creating a budget of a business focused on selling a new technology, characterized by uncertainty in relation to the number of firms that have the opportunity to purchase it for a

prices ensuring a certain profit of the producer, a price situated between 50 and 100 million lei, with the highest possible range in the interval situated somewhere between 70 and 75, provides, among other things, a variant to define concretely a neutrosophic-tendential fuzzy number Z , using the set of pairs (offered contractual price, possibility, or real degree of membership), that may lead to a steady price: $Z = [(50, 0), (60, 0.5), (70, 1), (75, 1), (85; 0.5) (100, 0)]$.

Given that X represents a universe of discourse, with a linguistic variable referring to the typical inflation or to a slight *normal-upward* shift of the price of a product, in a short period of time and in a well-defined market, specified by the elements x , it can be noted Δp , where $\Delta p = (p_1 - p_0) / p_0$. In the following exemplification, the values of Δp are simultaneously considered positive for the beginning and also below 1 (it is not hypothetically allowed, in a short period of time, a price increase more than double the original price, respectively the values of Δp are situated in the interval between 0 and 1). A neutrosophic-tendential fuzzy set A of a universe of discourse X is defined or it is characterized by a function of belonging $\mu_A(x)$ or $\mu_A(\Delta p)$, associating to each item x or Δp a degree of membership in the set A , as described by the equation:

$$\mu_A(x): X \rightarrow [0,1] \text{ or } \mu_A(\Delta p): X \rightarrow [0,1]. \tag{1}$$

To graphically represent a neutrosophic-tendential fuzzy set, we must first define the function of belonging, and thus the solution of spacial unambiguous definition is conferred by the coordinates x and $\mu_A(x)$ or Δp and $\mu_A(\Delta p)$:

$$A = \{[x, \mu_A(x)] \mid x \in [0,1]\}$$

or
$$A = \{[\Delta p, \mu_A(\Delta p)] \mid \Delta p \in [0,1]\} \tag{2}$$

A finite universe of discourse $X = \{x_1, x_2, \dots, x_n\}$ or $X = \{\Delta p_1, \Delta p_2, \dots, \Delta p_n\}$ can redeem, for simplicity, a notation of type:

$$A = \{\mu_1/x_1 + \mu_2/x_2 + \dots + \mu_n/x_n\},$$

respectively
$$A = \{\mu_1/\Delta p_1 + \mu_2/\Delta p_2 + \dots + \mu_n/\Delta p_n\}.$$

For example, in the situation of linguistic variable “a slight increase in price,” one can detail multiple universes of discourse, be it a summary one $X = \{0, 10, 20, 100\}$, be it an excessive one $X = \{0, 10, 20, 30, 40, 50, 60, 70, 80, 90, 100\}$, the breakdowns being completed by membership functions for percentage values of variable Δp , resorting either to a reduced notation:

$$A = [0/1 + 10 / 0,9 + 20 / 0,8 + 100 / 0],$$

or to an extended one:

$$A = [0/1 + 10/0,9 + 20/0,8 + 30/0,7 + 40/0,6 + 50/0,5 + 60/0,4 + 70/0,3 + 80/0,2 + 90/0,1 + 100/0].$$

The meaning of this notations starts with inclusion in the slight increase of a both unchanged price, where the difference between the old price of 20 lei and the new price of a certain product is nil, thus the unchanged price belonging 100% to the set of “slight increase of price”, and of a changed price of 22 lei, where $\Delta p = (p_1 - p_0) / p_0 = 0,1$ or 10%, therefore belonging 90% to the set of “slight increase of price”, ... , and, finally, even the price of 40 lei, in proportion of 0% (its degree of belonging to the analyzed set being 0).

Let us represent graphically, in a situation of a summary inflationary discourse:

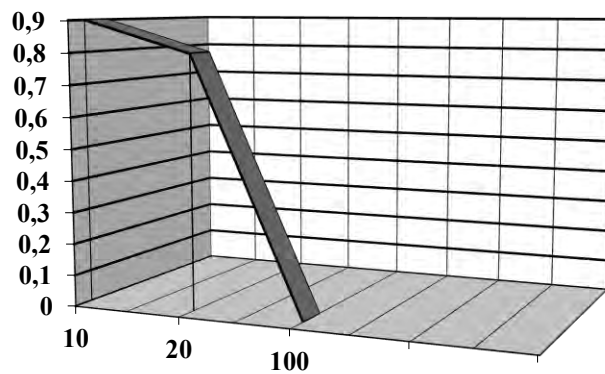

Graphic 2. Neutrosophic-tendential excessively described fuzzy set.

To define a neutrosophic number, some other important concepts are required from the theory of neutrosophic set:

- the *support* of A or the strict subset of X , whose elements have nonzero degrees of belonging in A :

$$\text{supp}(A) = \{x \in X \mid \mu_A(x) > 0\}$$
or
$$\text{supp}(A) = \{\Delta p \in X \mid \mu_A(\Delta p) > 0\}, \tag{3}$$
- the *height* of A or the highest value of membership function [8]:

$$h(A) = \sup \mu_A(x), \text{ where } x \in X$$
or
$$h(A) = \sup \mu_A(\Delta p), \text{ where } \Delta p \in X, \tag{4}$$
- the *nucleus* of A or the *strict subset* of X , whose elements have unitary degrees of belonging in A :

$$n(A) = \{x \in X \mid \mu_A(x) = 1\}$$

$$\text{or } n(A) = \{\Delta p \in X \mid \mu A(\Delta p) = 1\}, \tag{5}$$

- the *subset A of subset B* of neutrosophic-tendential fuzzy type: for A and B neutrosophic subsets of X, A becomes a *subset of B* if $\mu A(X) \leq \mu B(X)$, in the general case of any $x \in X$, $\mu A(x) \leq \mu B(x)$, $\tag{6}$

- *neutrosophic-tendential fuzzy subsets equal to X* or $A = B \Leftrightarrow \mu A(X) = \mu B(X)$, if $A \subset B$ și $B \subset A$. $\tag{7}$

The first three operations with neutrosophic-tendential fuzzy set according to their importance are broadly the same as those of classical logic (reunion, intersection, complementarity etc.), being defined in the neutrosophic-tendential fuzzy logic by characteristic membership functions. If A and B are two fuzzy or nuanced neutrosophic-tendential subsets, described by their membership functions $\mu A(x)$ or $\mu B(x)$, one gets the following results:

- a. The neutrosophic-tendential fuzzy *reunion* is defined by the membership function: $\mu A \cup B(x) = \max[\mu A(x), \mu B(x)]$;
- b. The neutrosophic-tendential fuzzy *intersection* is rendered by the expression: $\mu A \cap B(x) = \min[\mu A(x), \mu B(x)]$;
- c. The neutrosophic-tendential fuzzy *complementarity* is theor-etically identic with the belonging function: $\mu B(x) = 1 - \mu A(x)$.

The neutrosophic-tendential fuzzy logic does not respect the classical principles of excluded middle and noncontradiction. For the topic of this article, a greater importance presents the arithmetic of neutrosophic-tendential fuzzy numbers useful in building the neutrosophic indexes and mostly the interpret indexes.

The neutrosophic-tendential fuzzy numbers, by their nuanced logic, allow a more rigorous approach of indexes in general and, especially, of interpreter indexes and price indexes, mathematically solving a relatively arbitrary linguistic approach of inflation level.

The arguments leading to the neutrosophic-type indexes solution are:

1. The inflation can be corectly defined as the rate of price growth (Δp), in relation to either the past price, when $\Delta p = (p_1 - p_0) / p_0$, or an average price, and then $\Delta p = (p_1 - p_m) / p_m$ (the index from which this rate will be extracted, just as inflation is extracted from IPCG as soon as it was quantified, will be a neutrosophic-type index number purely expressing a mathematical coefficient).

2. The denominator or the *reference base* of statistical index, from which the rate defining the inflation is extracted, is the most important value; the optimal choice acquires a special significance, while the numerator *reported level* of statistical index is the signal of variation or stationarity of the studied phenomenon. Similarly, in the nuanced logic of neutrosophic-tendential fuzzy numbers, the denominator value of Δp (either p_0 , or p_m) still remains essential, keeping the validity of the index paradox, as a sign of evolution or variation, to be fundamentally dependent on denominator, although apparently it seems to be signified by the nominator.
3. The prices of any economy can be represented as a universe of discourse X , with a linguistic variable related to typical inflation or to a slight *normal-upward* shift of a product price, in a short period of time and in a well-defined market, specified by the elements x , the variable being denoted by Δp , where $\Delta p = (p_1 - p_0) / p_0$ or $\Delta p = (p_1 - p_m) / p_m$.
4. The values of Δp can be initially considered both positive and negative, but still smaller than 1. This is normal and in fact a price increase more than double the original price can not even be admitted in a short interval of time (usually a decade or a month), respectively the values of Δp are initially placed in the interval between -1 and 1, so that in the end $\Sigma \Delta p / n$, where n represents the number of registered prices, the overwhelming majority of real cases to belong to the interval [0;1].
5. All operations generated by the specific arithmetic of constructing a neutrosophic number or a neutrosophic-type index are possible in the nuanced logic of neutrosophic numbers, finally being accepted even negative values or deflation processes (examples 1 and 2).
6. The *equations* with neutrosophic-tendential fuzzy numbers and the *functions* specified by neutrosophic-tendential fuzzy numbers offer a much better use in constructing the hedonic functions – that were the relative computing solution of price dynamics of new products replacing in the market the technologically obsolete products, a solution often challenged in contemporary statistics of inflation. Example 3 resolves more clearly the problem of products substitution due to new technologies, but placing the divergences in the plane of correctness of the functions specified by neutrosophic numbers,

regarding the measurement of price increases or of inflationary developments.

7. Some current calculation procedures capitalize the simplified notation

$$A = \{\mu_1/x_1 + \mu_2/x_2 + \dots + \mu_n/x_n\},$$

respectively $A = \{\mu_1/\Delta p_1 + \mu_2/\Delta p_2 + \dots + \mu_n/\Delta p_n\}.$

Even the calculation formula of IPCG of Laspeyres type constitutes a way to build an anticipation method of constructing neutrosophic-tendential fuzzy numbers. Thus $IPCG = \frac{\sum I^p(p_0q_0)}{\sum (p_0q_0)}$, where

$$\frac{(p_0q_0)}{\sum (p_0q_0)} = C_p \text{ where } I^p = \text{the index of month } t \text{ compared to the}$$

average price and $C_p =$ weighting coefficient, finally becomes $IPCG = \sum I^p \times C_p$, for each item or group of expenditures being required the values Δp and C_p .

4 Index Numbers or Statistical Indexes

In Greek, *deixis* means “to indicate”, which makes the indicator to be that *which indicates* (etymologically). An indicator linguistically defines the situation, the time and the subject of an assertion. The concept of linguistic indicator becomes indicial exclusively in practical terms, respectively the pragmatism turns an indicator into an index as soon as the addressee and the recipient are clarified. The indicial character is conferred by specifying the addressee, but especially the recipient, and by determining the goals that created the indicator. The indicial is somehow similar to the symptom or to the syndrome in an illness metaphor of a process, phenomenon or system, be it political, economic or social.

The symptom or the factor analysis of illness coincides with its explanatory fundamental factor, and a preventive approach of the health of a process, a phenomenon or a system obliges to the preliminary construction of indexes. The index is also a specific and graphic sign which reveals its character as iconic or reflected sign. The iconicity degree or the coverage depth in specific signs increases in figures, tables, or charts, and reaches a statistical peak with indexes. The statistical index reflects more promptly the information needed for a correct diagnosis, in relation to the flow chart and the table. The systemic

approach becomes salutary. The indexes, gathered in systems, generates the systematic indicial significance, characterized by:

- in-depth approach of complex phenomena,
- temporal and spatial ongoing investigation,
- diversification of recipients,
- extending intension (of sense) and increasing the extension coverage (of described reality),
- gradual appreciation of development,
- motivating the liasons with described reality,
- ensuring practical conditions that are necessary for clustering of temporal primary indexes or globalization of regional indexes,
- diversification of addressees (sources) and recipients (beneficiaries),
- limiting restrictions of processing,
- continued expansion of the range of phenomena and processes etc.

The complexity and the promptness of the indicial overpass any other type of complexity and even promptness.

After three centuries of existing, the index method is still the method providing the best statistical information, and the advanced importance of indexes is becoming more evident in the expediency of statistical information. The assessments made by means of indexes offer qualitatively the pattern elements defining national economies, regional or community and, ultimately, international aggregates. Thinking and practice of the statistical work emphasize the relevance of factorial analysis by the method of index, embodied in the interpreter (price) indexes of inflation, in the efficient use of labor indexes etc. Because the favorite field of indexes is the economic field, they gradually became key economic indicators. The indexes are used in most comparisons, confrontations, territorial and temporal analysis – as measuring instruments. [9]

Originating etymologically in Greek *deixis*, which became in latin *index*, the index concept has multiple meanings, e.g. *index, indicator, title, list, inscription*. These meanings have maintained and even have enriched with new one, like *hint, indication, sign*. The statistical index is accepted as method, system, report or reference, size or relative indicator, average value of relative sizes or relative average change, instrument or measurement of relative change, pure number or adimensional numerical expression, simplified representation by substituting raw data, mathematical function or distinctive value of the axiomatic index theory etc.

Defined as *pure number* or adimensional numerical expression, the index is a particular form of “numerical purity”, namely of independence in relation to the measurement unit of comparable size. The term “index” was first applied to dynamic data series and is expressed as a relative number. Even today, it is considered statistically an adimensional number, achieved in relation either to two values of the same simple variable corresponding to two different periods of time or space, or to two sizes of a complex indicator, whose simple sizes are heterogeneous and can not be directly added together. The first category is that of individual (particular or elementary) indexes, and the second, known as synthetic or group indexes category, which is indeed the most important. Considered as a variation scheme of a single or of multiple sizes or phenomena, the index is a simplified representation by substituting raw data by their report, aimed at rebuilding the evolution of temporal and spatial observed quantities. Whenever a variable changes its level in time or space, a statistical index is born (Henri Guitton). Approached as statistical and mathematical function, the index generated a whole axiomatic theory which defines it as an economic measure, a function $F: D \rightarrow \mathbb{R}$, which projects a set or a set D of economic interest goals (information and data) into a set or a set of real numbers \mathbb{R} , which satisfies a system of relevant economic conditions – for example, the properties of monotony, homogeneity or homothety or relative identity (Wolfgang Eichhorn).

Thus, the concept of “index” is shown by a general method of decomposition and factorial analysis; it is used in practice mainly as system. The index is defined either as a report or a reference which provides a characteristic number, or as synthetic relative size, either as relative indicator (numerical adimensional indicator), or as pure number, either in the condensed version as the weighted average of relative sizes or the measure of the average relative change of variables at their different time moments, different spaces or different categories, and, last but not least, as a simplified mathematical representation, by substituting the raw data by their report through a function with the same name – index function - respectively $F: D \rightarrow \mathbb{R}$, where $F(z_1, z_2, \dots, z_k) = z_1 / z_2$, with z representing a specific variable and D the set of goals, information and data of (economic) interest, and \mathbb{R} is the set of real numbers. [10; 11; 12; 13; 14]

The above mentioned properties means the following:

→ MONOTONY (A)

An index is greater than the index of whose variables resultative vector is less than the initial index vector, all other conditions being constant:

$$z_1 / z_2 > x_1 / x_2 \Rightarrow F(\underline{z}) > F(\underline{x})$$

or:

$$z_1 \nearrow \rightarrow F(\underline{z}) \text{ is strictly increasing}$$

$$z_2 \searrow \rightarrow F(\underline{z}) \text{ is strictly decreasing}$$

$$z_i = ct \rightarrow F(\underline{z}) \text{ is constant, where } i = \overline{3k}$$

(where z is the vector of objective economic phenomenon, and \underline{z} a correspondent real number).

→ HOMOGENEITY (A)

If all variables “ z ” have a common factor λ , the resulting index $F(\lambda \underline{z})$ is equal to the product of the common factor λ and the calculated index, if a multiplication factor λ is absent.

- of 1st degree (cu referire la z_1)

$$F(\lambda z_1, z_2, \dots, z_k) = \lambda F(\underline{z}) \text{ for any } z > 0 \text{ and } \lambda > 0$$

- of “zero” degree

$$F(\lambda \underline{z}) = F(\underline{z}) \text{ for any } \lambda > 0.$$

→ IDENTITY (A) (“STATIONARY”)

If there is no change of variables ($z_1 = z_2$), the index is uniform or stationary regardless of other conditions.

$F(1, 1, z_3, \dots, z_k) = 1$ for any z_3, \dots, z_k (for description simplification of F , we considered $z_1 = z_2 = 1$).

→ ADDITIVITY (T)

If the variable z is expressed in terms of its original value through an algebraic sum ($z_1 = z_2 + \bar{z}$), the new index $F(z_2 + \bar{z})$ is equal to the algebraic sum of generated indexes $F(z_2) + F(\bar{z})$

$$F(z_2 + \bar{z}) = F(z_2) + F(\bar{z}).$$

→ MULTIPLICATION (T)

If the variable z is multiplied by the values $(\lambda_1, \dots, \lambda_k) \in \mathbb{R}_+$, than the resulting index $F(\lambda_1 z_1, \lambda_2 z_2, \dots, \lambda_k z_k)$ is equal to the product between the differentially multiplied variable $z(\lambda_1, \dots, \lambda_k)$ and the initial index $F(\underline{z})$

$$F(\lambda_1 z_1, \dots, \lambda_k z_k) = z(\lambda_1, \dots, \lambda_k) F(\underline{z}),$$

where $\lambda_i \in \mathbb{R}_+$ and $i = \overline{1, k}$.

→ QUASILINEARITY (T)

If a_1, a_2, \dots, a_k and b are real constant, and $a_1, a_2, \dots, a_k \neq 0$, and given the continuous and strictly monotone function $f: \mathbb{R}_+ \rightarrow \mathbb{R}$, having the inverse function f^{-1} , it verifies the relation:

$$F(\underline{z}) = f^{-1}[a_1 f(z_1) + a_2 f(z_2) + \dots + a_k f(z_k) + b].$$

→ DIMENSIONALITY (A)

If all variables z_1 and z_2 are multiplied by a certain factor λ , the resulting index is equal to the initial index, as the case of the multiplying by λ would not have been existed.

$$F(\lambda z_1, \lambda z_2, \dots, \lambda z_k) = \frac{\lambda}{\lambda} F(\underline{z}) = F(\underline{z}), \text{ for any } z > 0 \text{ and } \lambda > 0.$$

→ INTERIORITY (T) (“AVERAGE VALUE”)

The index $F(\underline{z})$ should behave as an average value of individual indices, being inside the interval of minimum and maximum value

$$\min \left\{ \frac{z_{1i}}{z_{2i}} \right\} \leq F(\underline{z}) \leq \max \left\{ \frac{z_{1i}}{z_{2i}} \right\}.$$

→ MEASURABILITY (A)

The index $F(\underline{z})$ is independent, respectively it is unaffected by the measurement units in which the variables are denominated

$$F\left(\frac{z_1}{\lambda_1}, \dots, \frac{z_k}{\lambda_k}; \lambda_1 z_1, \dots, \lambda_k z_k\right) = F(z_1, z_2, \dots, z_k) = F(\underline{z}).$$

→ PROPORTIONALITY (T)

(Homogeneity of 1st degree of a stationary initial index)

If an index is in the state of identity, respectively $F(1, 1, z_3, \dots, z_k) = 1$ for any z_3, \dots, z_k , the proportional increase of variable z_1 by turning it from to λ lead to a similar value of the obtained index $F(\lambda, 1, z_3, \dots, z_k) = \lambda$ (where $\lambda \in \mathbb{R}_+$)

→ REVERSIBILITY (T) (ANTISYMMETRY AND SYMMETRY)

Considered as an axiom, the reversibility implies a double interpretation:

- the reversibility temporal or territorial approach generates an antisymmetry of Fisher type, respectively the index calculated as a report between the current period level or the compared space and the period level or reference space must be an inverse amount of the calculated index as report between the period level or reference space and the current period level or the compared space:

$$F(z_1, z_2, \dots, z_k) \cdot \frac{1}{F(z_2, z_1, \dots, z_k)} = 1$$

- the factorial approach generates a symmetry of Fisher type, respectively, if the phenomenon was split into qualitative and quantitative factors ($z_1 = \sum n_1\theta_1$ and $z_2 = \sum n_0\theta_0$), changing index factors does not modify the product of new indexes (symmetry of “crossed” indexes)

$$\left(\frac{\sum n_1\theta_1}{\sum n_1\theta_0} \cdot \frac{\sum n_1\theta_0}{\sum n_0\theta_0} = \frac{\sum n_1\theta_1}{\sum n_0\theta_0} \right)$$

→ CIRCULARITY (T) (TRANZITIVITY OR CONCATENATION)

The product of successive indexes represents a closed circle, respectively an index of the first level reported to the top level of the variable.

$$F(z_1, z_2, \dots, z_k) \cdot F(z_2, z_3, \dots, z_k) \cdot F(z_{i-1}, z_i, \dots, z_k) = F(z_1, z_i, \dots, z_k)$$

→ DETERMINATION (T) (CONTINUITY)

If any scalar argument in $F(z_1, z_2, \dots, z_k)$ tends to zero, then $F(\underline{z})$ tends as well to a unique positive value of a real number (all other variable-dependent values).

→ AGGREGATION (A) (INDEX OF INDEXES)

The index of a set of variables is equal to an aggregated index when it is derived from indexes of each group sizes. Let all sizes: $z_n = F(z_1, z_2, \dots, z_n)$ be partial indexes; the index F is aggregative if $F_n(\underline{z}) = F[F(z_1, z_2, \dots, z_n)]$.

→ EXPANSIBILITY (A) (- specific to aggregate indexes)

$$F_n(\underline{z}) < F_{n+1}(\underline{z}, 0)$$

→ PRESERVING THE VALUE INDEX (*Theorem*)

The aggregated index, written in the form of average index, which corresponds to a value index equal to the real value index, preserves the value index.

→ UNICITY (*Theorem*)

An index F is not accepted as unique index if there exists two indices $F_1 \neq F_2$ such that:

$$F(z_1, z_2, \dots, z_k) = \begin{cases} F_1 & \text{for } k \in K_1, \text{ where } K_1, K_2 \in N \text{ \textit{ } } \forall k = \overline{1, K} \\ F_2 & \text{for } k \in K_2 \end{cases}$$

where z is the variable, k the variables set, K_1 and K_2 are two subsets of the set N , such that $K_1 \cup K_2 = N$ and $K_1 \cap K_2 = \emptyset$. This property requires the index calculation algorithm to be the same for all analyzed variables.

→ The USE OF INDEXES

This is a property resulting from data promptitude and data availability, easiness and rapidity of calculation, from simplicity of formula and of weighting system, from truthfulness of base and practical construction of indexes.

As shown, the axiomatic theory of economy is in fact a sum of properties-conditions mostly expressed by *axioms (A)* defining indexes, and by *theorems* and corollaries thereof derived from axioms and from tests (**T**) whose role is also important in the construction of indexes. Depending on the system of indexes they belong to, and on the specific use, the required properties are layered by Helmut Diehl in:

- *basic requirements* – imposed by specific circumstances of the project;
- *required properties* – ensuring fundamental qualities and operational consistency;
- *desirable properties* – providing some technical facilities and even some theoretical elegance;
- *special properties* – generated by construction and method.

Gathering specific characteristics in a definition as general as possible, the index is considered an indicator, *a statistical category*, expressed through a synthetic size that renders the relative variation between two states – one “actual” (or territoriality of interest), another “baseline” – of a phenomenon,

or a relative number resulted by the comparison of a statistical indicator values, a measure of the relative change of variables at different time points and in different spaces, or in different categories, set in relation to a certain characteristic feature.

The evolution in time of indexes required for over three centuries solving all sort of theoretical and methodological problems regarding the method calculation, including formula, the base choice, the weighting system and, especially, the practical construction. [10; 11; 12; 13; 14]

Process optimization of this issue is not definitively over even though its history is quite eventful, as summarized in Box No. 1, below. Moreover, even this paper is only trying to propose a new type of neutrosophic index or a neutrosophic-type index number.

Box No. 1

The index – appeared, as the modern statistics, in the school of political arithmetics – has as father an Anglican Bishop, named William Fleetwood. The birth year of the first interpreter index is 1707; it was recorded by studying the evolution of prices in England between 1440 and 1707, a work known under the title “Chicon Preciosum”. The value of this first index was 30/5, respectively 600,0%, and it was built on the simple arithmetical mean of eight products: wheat, oats, beans, clothing, beer, beef, sheepmeat and ham. Moreover, the world prices – a world hardly approachable because of specific amplitude, sui generis heterogeneity and apparently infinite trend – was transformed into a homogeneous population through interpreter indexes. In 1738, Dutot C. examines the declining purchasing power of the French currency between 1515 and 1735, through a broader interpreter index, using the following formula:

$$(1.1) \quad \text{Dutot Index: } \frac{p_1 + p_2 + \dots + p_n}{P_1 + P_2 + \dots + P_n} = \frac{\sum_{i=1}^n p_i}{\sum_{i=1}^n P_i}, \text{ where: } p_i \text{ and } P_i$$

= prices of current period vs. basic period.

If you multiply the numerator and denominator index by (1/n), the calculation formula of Dutot index becomes a mean report, respectively:

$$\left(\sum_{i=1}^n p_i / n \right) : \left(\sum_{i=1}^n P_i / n \right).$$

To quantify the effect of the flow of precious metals in Europe after the discovery of the Americas, the Italian historian, astronomer and economist Gian Rinaldo Carli, in 1764, used the simple arithmetic mean for three products, i.e. wheat, wine and oil, in constructing the interpreter index determined for 1500 and 1750:

$$(1.2) \quad \text{Carli Index: } \frac{1}{n} \left(\frac{p_1}{P_1} + \frac{p_2}{P_2} + \dots + \frac{p_n}{P_n} \right) = \frac{1}{n} \sum_{i=1}^n \frac{p_i}{P_i}$$

As William Fleetwood has the merit of being the first to homogenize the heterogeneous variables through their ratio, using the results to ensure the

necessary comparisons, the same way Dutot and Carli are praiseworthy for generating the “adimensionality” issue, namely the transformation of absolute values into relative values, generally incomparable or not reducible to a central (essential or typical) value (a value possessing an admissible coefficient of variation in statistical terms). But the most important improvement in index construction, streamlining its processing, belongs to Englishman Arthur Young, by introducing the *weight* (ponderation), i.e. coefficients meant to point the *relative importance* of the various items that are part of the index.

Young employed two weighting formulas, having as a starting point either *Dutot*:

(1.3) *Young Index* (1):

$$\frac{p_1k_1 + p_2k_2 + \dots + p_nk_n}{P_1K_1 + P_2K_2 + \dots + P_nK_n} = \frac{\sum_{i=1}^n p_i k_i}{\sum_{i=1}^n P_i K_i},$$

where k_i = coefficient of importance of product i ,

or *Carli*:

(1.4) *Young Index* (2):

$$\frac{1}{\sum_{i=1}^n C_i} \left(\frac{p_1}{P_1} C_1 + \frac{p_2}{P_2} C_2 + \dots + \frac{p_n}{P_n} C_n \right) = \frac{1}{\sum_{i=1}^n C_i} \times \sum_{i=1}^n \frac{p_i}{P_i} \times C_i = \sum_{i=1}^n \frac{p_i}{P_i} \times \frac{C_i}{\sum_{i=1}^n C_i},$$

where $\frac{C_i}{\sum_{i=1}^n C_i}$ = weighting coefficient and $\sum_{i=1}^n (c.p.)_i = 1$.

After *Young solution* from 1812, the new problem of designing indexes has become the effect of weight variations. Sir George Shuckburgh Evelyn introduced, in 1798, the concept of “basic year”, thus anticipating *the dilemma of base selection and of construction of the weighting system*. In 1863, by the index calculated as geometric mean of individual indexes, Stanley Jevons extended the issue to the formula:

(1.5) *Jevons Index*:

$$\sqrt[n]{\prod_{i=1}^n \frac{P_i}{P_i}}$$

Jevons does not distinguish between individual indexes, giving them the same importance.

Two indexes imposed by the German school of statistics remain today, like the two terrestrial poles, structural limits of *weighting systems*. The first is the index of Etienne Laspeyres, produced in 1864, using basic period weighting, and the second is the index of Hermann Paasche, drafted in 1874, using the current period as weighting criterion:

(1.6) *Laspeyres Index*: $\frac{\sum p_{i1} q_{i0}}{\sum p_{i0} q_{i0}}$ or $\frac{\sum p_{i0} q_{i1}}{\sum p_{i0} q_{i0}}$ and

(1.7) *Paasche Index*: $\frac{\sum p_{i1} q_{i1}}{\sum p_{i0} q_{i1}}$ or $\frac{\sum p_{i1} q_{i1}}{\sum p_{i1} q_{i0}}$, where:

p_{i0}, p_{i1} = basic period prices (0) and current period prices (1)

q_{i0}, q_{i1} = basic period quantities (0) and current period quantities (1).

Although the provided indexes only checks the identity condition ($I_{1/1}^X = X_1/X_1 = 1$) from Fischer's tests for elementary indexes, however they are the most commonly used in practice due to the economic content of each construction. Several "theoretical" indexes were placed close to the Laspeyres and Paasche indexes, but with the loss of specific business content, and different of Ladislaus von Bortkiewicz relationship. They can be called unreservedly indexes of "mesonic"-type, based on authors' wishes to situate the values within the difference (P - L), to provide a solution of equilibrium between the two limit values in terms of choosing of base. Along with the two weighting systems, other issues are born, like weighting constancy and inconsistency, or connecting the bases on the extent of aging or disuse. Of the most popular "mesonic"-type index formulas [5], there are the constructions using common, ordinary statistics. The simple arithmetic mean of Laspeyres and Paasche indexes is known as *Sidgwick - Drobisch* index.

$$(1.8) \text{ Sidgwick - Drobisch Index: } \frac{L+P}{2}$$

The arithmetic mean of the quantities of the two periods (thus becoming weight) generates the *Marshall - Edgeworth* index or *Bowley - Edgeworth* index (1885 - 1887).

$$(1.9) \text{ Marshall - Edgeworth Index: } \frac{\sum p_{i1}(q_{i0} + q_{i1})}{\sum p_{i0}(q_{i0} + q_{i1})}$$

The geometric mean of quantities in the two periods converted in weights fully describes the *Walsh* index (1901).

$$(1.10) \text{ Walsh Index: } \frac{\sum p_{i1}\sqrt{(q_{i1} \times q_{i0})}}{\sum p_{i0}\sqrt{(q_{i1} \times q_{i0})}}$$

The simple geometric mean of Laspeyres and Paasche indexes is none other than the well-known *Fisher* index (1922).

$$(1.11) \text{ Fisher Index: } \sqrt{(L \times P)}$$

The index checks three of the four tests of its author, Irving Fisher: the identity test, the symmetry test, or the reversibility-in-time test and the completeness test, or the factors reversibility test. The only test that is not entirely satisfied is the chaining (circularity) test. The advantage obtained by the reversibility of Fisher index:

$$(1.12) \quad F_{0/1} = \sqrt{(L_{1/0} \times P_{1/0})} = \frac{1}{\sqrt{(L_{1/0} \times P_{1/0})}} = \frac{1}{F_{1/0}},$$

is unfortunately offset by the disadvantage caused by the lack of real economic content. A construction with real practical valences is that of *R.H.I. Palgrave* (1886), which proposed a calculation formula of an arithmetic average index weighted by the total value of goods for the current period ($v_{1i} = p_{1i} \cdot q_{1i}$):

$$(1.13) \text{ Palgrave Index: } \frac{\sum i_{1/0} \times (p_{1i} q_{1i})}{\sum p_{1i} q_{1i}} = \frac{\sum i_{1/0} \times (v_{1i})}{\sum v_{1i}}.$$

The series of purely theoretical or generalized indexes is unpredictable and full of originality.

Cobb - Douglas solution (1928) is a generalization of Jevons index, using unequal weights and fulfilling three of Fisher's tests (less the completeness or the reversibility of factors):

$$(1.14) \text{ Cobb - Douglas Index: } \prod_{i=1}^n \left(\frac{P_i}{P_i} \right)^{\alpha_i}, \text{ where } \alpha_i > 0 \text{ and } \sum_{i=1}^n \alpha_i = 1.$$

Stuvel version, an index combining the Laspeyres index „of price factor” (L^P) and the Laspeyres index „of quantity factor” (L^Q), proposed in 1957, exclusively satisfies the condition of identity as its source:

$$(1.15) \text{ Stuvel Index: } \frac{L^P - P^Q}{2} + \sqrt{\frac{(L^P - P^Q)^2}{4} + I^{(P \times Q)}}$$

(where I^(P×Q) = total variation index)

Another construction, inspired this time from the „experimental” design method, based on the factorial conception, but economically ineffective, lacking such a meaning, is R.S. Banerjee index (1961), a combination of indexes as well, but of Laspeyres type and Paasche type:

$$(1.16) \text{ Banerjee Index: } \frac{L+1}{\frac{1}{P}+1} = \frac{P(L+1)}{(P+1)}$$

A true turning point of classical theorizing in index theory is the *autoregressive* index.

$$(1.17) \text{ Autoregressive Index: } \frac{\sum (p_i P_i a_i^2)}{\sum (P_i)^2 \times a_i^2},$$

Therefore, *a_i* means the quantities of products or weights (importance) coefficients. This only verifies the provided identity, although conditionally constructed, respectively:

$$\sum [p_i - P_i \times I_{\text{AUTOREGRESSIVE}}]^2 = \text{minimum.}$$

Torngvist (1936) and *Divisia* (1925) indexes are results of generalizations of mathematical type, defining the following relationships:

$$(1.18) \ln(\text{Torngvist Index}) = \sum \frac{1}{2} \left[\frac{p_i q_i}{\sum p_i q_i} + \frac{P_i Q_i}{\sum P_i Q_i} \right] \times \ln \frac{p_i}{P_i},$$

where: $\frac{p_i q_i}{\sum p_i q_i}$ and $\frac{P_i Q_i}{\sum P_i Q_i}$ are weights of specific transactions values *p_iq_i* and *P_iQ_i*.

The usual shape under which one meets the *Divisia* index is:

$$(1.19) P_{0t} Q_{0t} = \frac{\sum P_{it} Q_{it}}{\sum P_{i0} Q_{i0}}$$

by individual prices indexes, respectively:

$$P(i_{p1} + i_{p2} + \dots + i_{pn}) = i_{pi}.$$

Contemporary multiplication processes of indexes calculation formulas have two trends, *one already visible of extrem axiomatization and mathematization*, based on *Torngvist* and *Divisia* indexes models, which culminated with the school

of axiomatic indexes, and another, of resumption of the logic stream of economic significance of index construction, specific for the latest international constructions at the end of the twentieth century, respectively the integration variants of additive construction patterns or additive-multiplicative mixed models, close to the significance of real phenomena. In this regard, one could summary present the comparative advantage index or David Neven index (1895).

(1.20) *David Neven Index*:

$$\left(\frac{x_k}{\sum x_k} - \frac{m_k}{\sum m_k} \right) \times 100$$

where x and m are values of exports and imports in

the industry k . The index belongs to the range of values (-100%; 100%), but rarely achieves in practice higher values than 10% or lower than - 10%. etc.

In the theory and practice of index numbers construction, to quantify and interpret the degree and the direction of the weights influence, use is made of Bortkiewicz relationship [15]. This specific relationship is based on factorial indexes and yields to the following equality:

$$I_{1/0}^{x(f_1)} : I_{1/0}^{x(f_0)} = 1 + r_{x_i f_i} \cdot C_{v_{x_i}} \cdot C_{v_{f_i}} \tag{1.21}$$

where:

$r_{x_i f_i}$ is a simple linear correlation coefficient between individual indexes of the qualitative factor x_i and individual indexes of the weights (respectively, individual indexes of the qualitative factor f_i),

$C_{v_{x_i}}$ is the coefficient of variation of individual indexes of variable x to their environmental index,

$C_{v_{f_i}}$ is the coefficient of variation of individual indexes of weights towards their environment index,

while $I_{1/0}^{x(f_1)} = \frac{\sum x_1 f_1}{\sum x_0 f_1}$ and $I_{1/0}^{x(f_0)} = \frac{\sum x_1 f_0}{\sum x_0 f_0}$.

The interpretation of that relationship shows that *the weighting system does not influence the index of a numerically expressed group variable, if the product of the three factors is null*, respectively $r_{x_i f_i} \times C_{v_{x_i}} \times C_{v_{f_i}} = 0$.

This is possible in three distinct situations:

a) $r_{x_i f_i} = 0 \Rightarrow x_i$ and f_i are independent to each other (there is no connection between individual indexes i^x and i^f),

b) $C_{v_{x_i}} = 0 \Rightarrow$ the absence of any variation on the part of x or f

c) $C_{v_{f_i}} = 0$ (individual indexes are equal to the average index).

Product sign of factors $r_{x_i f_i} \times C_{v_{x_i}} \times C_{v_{f_i}}$ is positive or negative depending on $r_{x_i f_i}$, the sign of the latter being decisive.

The interpretation of the influence of the weighting systems on the value of a synthetic index is based on the following three cases:

- The synthetic index calculated using current period weights is equal with the same index calculated with the weights of the basic period when at least one of the factors is equal to „0”.
- The synthetic index calculated using current period weights is bigger in value than the index calculated with the weights of the basic period when the three factors are different from „0” and the simple linear correlation coefficient is positive.
- The synthetic index calculated using current period weights is lower in value than the index calculated with the weights of the basic period when the three factors are different from „0” and the simple linear correlation coefficient is negative.

Applying Bortkiewicz's relationship to the interpretation of statistical indexes offers the opportunity to check the extent and direction to which the weighting system that is employed influence the value of the indexes.

The conclusive instauration of a sign in language, be it gradually, is a lengthy process, where the sign (the representative or the signifier) replaces at a certain moment the representative (the signifier). The sign substitutes an object and can express either a quality (*qualisign*), or a current existence (*synsign*), or a general law (*legisign*). Thus, the index appears as sign together with an icon (e.g.: a chart, a graphic), a symbol (e.g.: currency), a rhema (e.g.: the mere possibility), a dicent (e.g.: a fact), an argument (e.g.: a syllogism) etc. The semiotic *index* can be defined as a sign that loses its sign once the object disappears or it is destroyed, but it does not lose this status if there is no interpreter. The index can therefore easily become its own interpreter sign. Currency as sign takes nearly all detailed semiotic forms, e.g. *qualisign* or hard currency, symbol of a broad range of sciences, or *legisign* specific to monetary and banking world. As the world's history is marked by inflation, and currency implicitly, as briefly described in Box nr. 2 below, likewise the favorite index of the inflationary phenomenon remains the interpreter index.

Box No. 2

The inflation – an evolution perceived as diminishing the value or purchasing power of the domestic currency, defined either as an imbalance between a stronger domestic price growth and an international price growth, or as a major macroeconomic imbalance of material-monetary kind and practically grasped as a general and steady increase in prices – appeared long before economics. Inflationary peak periods or “critical moments” occurred in the third century, at the beginning of sixteenth century, during the entire eighteenth and the twentieth centuries. The end of the third century is marked by inflation through currency, namely excessive uncovered currency issuance in the Roman Empire, unduely and in vain approached by the Emperor Diocletian in 301 by a “famous” edict of maximum prices which sanctioned the “crime” of price increase by death penalty. The Western Roman Empire collapsed and the reformer of the Eastern Roman Empire, Constantine the Great, imposed an imperial currency, called “solidus” or

“nomisma”, after 306, for almost 1000 years. The beginning of the sixteenth century, due to the great geographical discoveries, brings, together with gold and silver from the “new world”, over four times price increases, creating problems throughout Europe by precious metal excess of Spain and Portugal, reducing the purchasing power of their currencies and, finally, of all European money. If the seventeenth century is a century of inflationary “princes”, which were maintaining wars by issuing calp fluctuating currency, the twentieth century distinguishes itself by waves of inflation, e.g. the inflation named “Great Depression began in Black Thursday”, or the economic crisis in 1930, the inflation hidden in controlled and artificial imposed prices of “The Great Planning”, the inflation caused by price evolutions of oil barrel, or sometimes galloping inflation of Eastern European countries' transition to market economy. Neither the “edicts” or the “assignats” of Catherine II, as financial guarantees of currency, nor the imposed or controlled prices were perennial solutions against inflation.

Inflation is driven, par excellence, by the term “excess”: excessive monetary emission or inflation through currency, excessive solvable demand or inflation by demand, excessive nominal demand, respectively by loan or loan inflation, excessive cost or cost-push inflation; but rarely by the term “insufficiency”, e.g. insufficient production, or supply inflation. Measurement of overall and sustained price growth – operation initiated by Bishop William Fleetwood in 1707 by estimating at about 500% the inflation present in the English economy between 1440 and 1707 – lies on the statistical science and it materializes into multiple specific assessment tools, all bearing the name of price indexes, which originated in interpreter indexes. Modern issues impose new techniques, e.g. econophysics modeling, or modeling based on neutrosophic numbers resulted from nuanced logic.

5 Neutrosophic Index Numbers

or Neutrosophic-Type Interpreter Indexes

Created in the full-of-diversity world of prices, the first index was one of *interpreter* type. The term “interpreter” must be understood here by the originary meaning of its Latin component, respectively *inter* = between (middle, implicit mediation) and *pretium* = price. [16]

The distinct national or communautaire definitions, assigned to various types of price indexes, validate, by synthesizing, the statement that the interpreter index has, as constant identical components, the following features:

- measuring tool that provides an *estimate* of price trends (consumer goods in PCI, industrial goods in IPPI or import/export, rent prices, building cost etc.);
- *alienation* of goods and services (respectively, actual charged prices and tariffs);
- *price change between a fixed period* (called basic period or reference period) and *a variable period* (called current period).

The most used interpreter indexes are the following:

- PCI – Prices of Consumer (goods and services) Index measures the overall evolution of prices for bought goods and tariffs of services, considered the main tool for assessing inflation;
- IPPI – Industrial Producers’ Price Index of summarizes developments and changes in average prices of products manufactured and supplied by domestic producers, actually charged in the first stage of commercialization, used both for deflating industrial production valued at current prices, and for determining inflation within “producer prices”. This index is one of the few indexes endowed with power of “premonition”, a true Cassandra of instruments in the so-populated world of instruments measuring inflation. Thus, IIPP anticipates the developments of IPCG. The analysis of the last 17 years shows a parallel dynamics of evolution of the two statistical tools for assessing inflation, revealing the predictive ability of IPCG dynamics, starting from the development of IIPP;
- UVI – Unit Value Index of export / import contracts characterizes the price dynamics of export / import, expanding representative goods price changes ultimately providing for products a coverage rate of maximum 92%, allowing deflation through indicators characterizing the foreign trade, and even calculating the exchange ratio;
- CLI – Cost of Living Index shows which is the cost at market prices in the current period, in order to maintain the standard of living achieved in the basic period, being calculated as a ratio between this hypothetical cost and the actual cost (consumption) of the basic period; the need for this type of interpreter index is obvious above all in the determination of real wages and real income;
- IRP – Index of Retail Price sets the price change for all goods sold through the retail network, its importance as a tool to measure inflation within “retail prices” being easily noticed;
- BCI – Building Cost Index assesses price changes in housing construction, serving for numerous rental indexation, being used independently or within IPCG, regardless of the chosen calculation method;
- FPPI-F – food products price index measures changes in prices of food products on the *farm market* (individual or associated

farmers market), providing important information about inflation on this special market;

- GDP deflator index or *the implicit deflator of GDP* – GDP price index that is not calculated directly by measuring price changes, but as a result of the ratio between nominal GDP or in current prices and GDP expressed in comparable prices (after separately deflating the individual components of this macroeconomic indicator); GDP deflator has a larger coverage as all other price indexes.

The main elements of the construction of an interpreter index refer to official name, construction aims, official computing base, weighting coefficients, sources, structure, their coverage and limits, choosing of the weighting system, of the calculation formula, method of collection, price type and description of varieties, product quality, seasonality and specific adjustments, processing and analysis of comparable sources, presentation, representation and publication. The instrumental and applied description of consumer goods price index has as guidelines: definition, the use advantages and the use disadvantages, the scope, data sources, samples used in construction, the weighting system, the actual calculation, the inflation calculated as the rate of IPCG, specific indicators of inflation, uses of IPCG and index of purchasing power of the national currency.

As there seems natural, there is a statistical correlation and a gap between two typical constructions of price index and interpreter index, IPPI and PCI. Any chart, a chronogram or a historiogram, shows the evolution of both the prices of goods purchased, and of paid services that benefited common people (according to the consumer goods price index), and of the industrial goods prices that went out of the enterprises' gate (according to the producers' price index) and are temporarily at intermediaries, following to reach the consumers in a time period from two weeks to six months, depending on the length of "commercial channel".

The interpreter indexes are statistical tools – absolutely necessary in market economies – allowing substitution of adjectival-type characterizations of inflation within an ordinal scale. As the variable measured on an ordinal scale is equipped with a relationship of order, the following ordering becomes possible:

- the level of subnormal inflation (between 0 and 3%);
- the level of (infra)normal inflation (Friedman model with yearly inflation between 3 and 5%);
- the level of moderate inflation (between 5 and 10% yearly);
- the level of maintained inflation (between 10 and 20% yearly);

- the level of persistent inflation (between 20 and 100% yearly);
- the level of enforced inflation (between 100 and 200% yearly);
- the level of accelerated inflation (between 200 and 300% yearly);
- the level of excessive inflation (over 300% yearly).

Knowing the correct level of inflation, the dynamics and the estimates of short-term price increase allow development appreciation of value indicators in real terms. The consumer goods price index, an interpreter index that can inflate or deflate all nominal value indicators, remains a prompt measurement tool of inflation at the micro and macroeconomic level.

Any of the formulas or of the classical and modern weighting systems used in price indexes' construction can be achieved by neutrosophic-tendential fuzzy numbers following operations that can be performed in neutrosophic arithmetics. A random example [17, 18, 19] relative to historical formulas and classical computing systems (maintaining the traditional name of "Index Number") is detailed for the main indexes used to measure inflation, according to the data summarized in Table 1.

The statistical data about the price trends and the quantities of milk and cheese group are presented below for two separate periods:

Table 1.

Product	Basic price p_0	Current price p_t	Total expenses in the basic period (p_0q_0)	Total expenses in the basic period with current prices (p_tq_0)	Total expenses in current period with basic prices (p_0q_t)	Total expenses in the current period (p_tq_t)	Weighting coefficients (Cp_0) $p_0q_0/\sum p_0q_0$	Quantities of products bought in the basic period (q_0)	Quantities of products bought in the current period (q_t)
Milk	1,20	1,70	12,0	17,0	10,8	15,3	15,6	10	9
Butter	1,90	1,70	15,2	13,6	13,3	11,9	19,8	8	7
Yogurt	0,85	0,90	3,4	3,6	5,1	5,4	4,4	4	6
Sour cream	1,25	3,00	1,25	3,0	1,25	3,0	1,6	1	1
Cheese	7,50	8,00	45,0	48,0	52,5	56,0	58,6	6	7
Total group	12,70	15,30	76,85	85,2	82,95	91,6	100,0	-	-

A. Historical solutions (unorthodox) focused on calculating formula for the simple aggregate and unweighted index (quantities are not taken into account, although there have been changes as a result of price developments)

$$I. \text{ Index Number} = \frac{\sum p_t}{\sum p_0} = \frac{15,30}{12,70} = 1,205.$$

The inflation rate extracted from index = 0,205 or 20,5%.

B. Contemporary solutions focused on formula for calculating the aggregate weighted index in classical system

I. Index Number by classical Laspeyres formula =

$$\frac{\sum(ptq_0)}{\sum(poq_0)} = \frac{85,2}{76,85} = 1,109.$$

The inflation rate extracted from index = 0,109 or 10,9%.

II. Index Number expressed by relative prices or individual prices indexes by Laspeyres formula =

$$\frac{\sum \frac{p_t}{p_o}(p_o q_o)}{\sum(p_o q_o)} = \frac{85,2}{76,85} = 1,109 \text{ or } \sum \frac{p_t}{p_o} \times C p_o = 1,109.$$

The inflation rate extracted from index = 0,109 or 10,9%.

III. Index Number by Paasche formula =

$$\frac{\sum(ptq_t)}{\sum(poq_t)} = \frac{91,6}{82,95} = 1,104.$$

The inflation rate extracted from index = 0,104 or 10,4%.

IV. Index Number by Fisher formula =

$$\sqrt{\text{Laspeyres Index Number} \times \text{Paasche Index Number}} = \\ = \sqrt{1,109 \times 1,104} = 1,106.$$

The inflation rate extracted from index = 0,106 or 10,6%.

V. Index Number by Marshall-Edgeworth formula =

$$\frac{\sum[pt(q_0 + q_t)]}{\sum[po(q_0 + q_t)]} = \frac{176,8}{159,8} = 1,106.$$

The inflation rate extracted from index = 0,106 or 10,6%.

VI. Index Number by Tornqvist formula =

$$\Pi \left(\frac{p_t}{p_o} \right)^w \text{ where } w = \frac{p_o q_o}{2 \sum p_o q_o} + \frac{p_t q_t}{2 \sum p_t q_t} = \\ = \left(\frac{1,7}{1,2} \right)^{0,1616} \times \left(\frac{1,7}{1,9} \right)^{0,1639} \times \left(\frac{0,9}{0,85} \right)^{0,0516} \times \left(\frac{3,0}{1,25} \right)^{0,0245} \times \left(\frac{8,0}{7,5} \right)^{0,5985} = 1,106.$$

The inflation rate extracted from index = 0,106 or 10,6%.

As one can see, three Index Numbers or price indexes in Fisher, Marshall-Edgeworth and Tornqvist formulas lead to the same result of inflation of 10.6%, which is placed in median position in relation to the Laspeyres and Paasche indexes.

However, the practice imposed Laspeyres index because of obtaining a high costs and a relatively greater difficulty of weighting coefficients in the current period (t). [17]

C. Neutrosophic index-based computing solutions

Starting from the definition of “a slight increase in price” variable, denoted by Δp , where $\Delta p = (p_1 - p_0) / p_0$, data from Table 1 are recalculated in Table 2, below and defines the same *unorthodox* but classic solutions (especially in the last two columns).

Table 2.

Product	Basic price p_0	Current price p_t	Quantities of products bought in the basic period (q_0)	Quantities of products bought in the current period (q_t)	Total expenses in the basic period ($p_0 q_0$)	Total expenses in the current period ($p_t q_t$)	Classic Index Number (p_t / p_0)	$\Delta p = (p_t - p_0) / p_0$	$\Delta pq = (p_t q_t - p_0 q_0) / p_0 q_0$
Milk	1.20	1.70	10	9	12.0	15.3	1.4167	0.4167	0.2750
Butter	1.90	1.70	8	7	15.2	11.9	0.8947	-0.1053	-0.2171
Yogurt	0.85	0.90	4	6	3.4	5.4	1.0588	0.0588	0.5882
Sour cream	1.25	3.00	1	1	1.25	3.0	2.4000	1.4000	1.4000
Cheese	7.50	8.00	6	7	45.0	56.0	1.0667	0.0667	0.2444
Total group	12.70	15.30	-	-	76.85	91.6	1.2047	0.2047	0.1919

The identical values of Fisher, Marshall-Edgeworth and Tornqvist indices offer a hypothesis similar with the neutrosophic statistics and especially with neutrosophic frequencies. The highest similarity with the idea of neutrosophic statistics consists of the Tornqvist formula’s solution. The calculus of the absolute and relative values for necessary neutrosophic frequencies is described in the Table 3.

Table 3.

Product	Total expenses in the basic period ($p_0 q_0$)	Weighting coefficients (C_{p_0}) = $p_0 q_0 / \sum p_0 q_0$	Total expenses in the basic period with current prices ($p_t q_0$)	Weighting coefficients (C_{p_0}) = $p_t q_0 / \sum p_t q_0$	Total expenses in current period with basic prices ($p_0 q_t$)	Weighting coefficients (C_{p_0}) = $p_0 q_t / \sum p_0 q_t$	Total expenses in the current period ($p_t q_t$)	Weighting coefficients (C_{p_t}) = $p_t q_t / \sum p_t q_t$
Milk	12.0	15.62	17.0	20.0	10.8	13.0	15.3	16.70
Butter	15.2	19.78	13.6	16.0	13.3	16.0	11.9	12.99
Yogurt	3.4	4.42	3.6	4.2	5.1	6.2	5.4	5.90
Sour cream	1.25	1.63	3.0	3.5	1.25	1.5	3.0	3.28
Cheese	45.0	58.55	48.0	56.3	52.5	63.3	56.0	61.13
Total group	76.85	100.00	85.2	100.0	82.95	100.0	91.6	100.00

In this situation, the construction of major modern indexes is the same as the practical application of statistical frequencies of neutrosophic type generating neutrosophic indexes in the seemingly infinite universe of prices specific to inflation phenomena, as a necessary combination between classical indexes and thinking and logic of frequencial neutrosophic statistics [20; 21; 22; 2. 3].

Table 4.

Product	Classic Index Number (p _t / p ₀) (unorthodox)	Relative Neutrosophic Frequency RNF(0) Weighting coefficients (C _{p0}) = p ₀ q ₀ / Σp ₀ q ₀	Relative Neutrosophic Frequency RNF(t,0) Weighting coefficients (C _{p0}) = p _t q ₀ / Σp _t q ₀	Relative Neutrosophic Frequency RNF(0,t) Weighting coefficients (C _{p0}) = p ₀ q _t / Σp ₀ q _t	Relative Neutrosophic Frequency RNF(t) Weighting coefficients (C _p) = p _t q _t / Σp _t q _t	w = [RNF ₍₀₎ + RNF _(t)] : 2
Milk	1.4167	15.62	20.0	13.0	16.70	16.16 % or 0.1616
Butter	0.8947	19.78	16.0	16.0	12.99	16.39 % or 0.1639
Yogurt	1.0588	4.42	4.2	6.2	5.90	5.16 % or 0.0516
Sour cream	2.4000	1.63	3.5	1.5	3.28	2.45 % or 0.0245
Cheese	1.0667	58.55	56.3	63.3	61.13	59.84 % or 0.5984
Total group	1.2047	100.0	100.0	100.0	100.00	100.00 or 1.0000

In this case, index of Tornqvist type is determined exploiting the relative statistical frequencies of neutrosophic type consisting of column values (C_{p0}) and (C_{p_t}) according to the new relations:

$$\Pi \left(\frac{p_t}{p_0} \right)^w \text{ where } w = \frac{p_0 q_0}{2 \sum p_0 q_0} + \frac{p_t q_t}{2 \sum p_t q_t} = [RNF_{(0)} + RNF_{(t)}] : 2$$

Finally, applying the values in Table 4 shows that the result $\Pi \left(\frac{p_t}{p_0} \right)^w$ is identical.

$$\Pi \left(\frac{p_t}{p_0} \right)^w = 1.4167^{0.1616} \times 0.8947^{0.1639} \times 1.0588^{0.0516} \times 2.4^{0.0245} \times 1.0667^{0.5985} = 1.106$$

5 Conclusion

Over time, the index became potentially-neutrosophic, through the weighting systems of the classical indexes, especially after Laspeyres and Paasche. This journey into the world of indexes method merely proves that, with Tornqvist, we are witnessing the birth of neutrosophic index, resulting from applying predictive statistical neutrosophic frequencies, still theoretically not exposed by the author of this kind of thinking, actually the first author of the present article.

Future intention of the authors is to exceed, by neutrosophic indexes, the level of convergence or even emergence of unorthodox classical indexes, delineating excessive prices (high or low) by transforming into probabilities the classical interval $[0 ; 1]$, either by the limiting values of Paasche and Laspeyres indexes, redefined as reporting base, or by detailed application of the neutrosophic thinking into statistical space of effective prices, covered by the standard interpreter index calculation (the example of PCI index is eloquent through its dual reference to time and space as determination of ten-years average index type, by arithmetic mean, and as determination of local average index type, by geometric mean of a large number of territories according to EU methodology, EUROSTAT).

6 Notes and Bibliography

- [1] An information can be considered incomplete in relation to two scaled qualitative variables. The first variable is trust given to the information by the source. by the measuring instrument or by the degree of professionalism of the expert who analyze it. the final scale of uncertainty having as lower bound the completely uncertain information and as upper bound the completely definite information. The second variable is accuracy of the information content. the information benefiting of a sure content on the scale of imprecision only when the set of specified values is single-tone. i.e. holding a unique value.
- [2] Holmblad L.P., Ostergaard J.J., *Control of a cement kiln by neutrosophic logic techniques*. Proc. Conf. on Eighth IFAC. Kyoto. Japan (1981). pp. 809-814.
- [3] Togai M., Watanabe H., *A VLSI implementation of a neutrosophic-inference engine: toward an expert system on a chip*. In „Information Sciences: An International Journal archive”. Volume 38. Issue 2 (1986). pp. 147-163.
- [4] A concise set A in existence domain U (providing the set of values allowed for a variable) can be objectively defined by:
- a. listing all the items contained;
 - b. finding a definition conditions such specified: $A = \{x | x \text{ knowing certain conditions}\}$;
 - c. introduction of a zero-one membership function for A . denoted by $\mu_A(x)$ or characteristic (community. discriminatory or indicative) function {where: $A \geq \mu_A(x) = 1$. if... and $\mu_A(x) = 0$ if...}, the subset A being thus equivalent to the function of belonging.

meaning that, mathematically, knowing $\mu_A(x)$ becomes equivalent to know A itself.

- [5] When $A' = A$ and $B' = B$. the rule identifies or becomes the particular case of a classical Modus Ponens. (Zadeh. L. A.. 1994. *Foreword*. in II. Marks J.F. ed., *The Neutrosophic Logic Technology and its Applications*. IEEE Publications).
- [6] The logic system with tendential-neutrosophic fuzzy sets essentially transposes highly nuanced words in concise numbers; it was introduced in the vocabulary of contemporary logic by E. H. Mamdani in 1983. at San Francisco IEEE conference about tendential-neutrosophic fuzzy systems.
- [7] Gâlea Dan. Leon Florin. *Teoria mulțimilor neutrosofice* [Neutrosophic Set Theory]. Biblioteca virtuală de Inteligență artificială. Universitatea Tehnică "Gh. Asachi" Iași. Facultatea de Automatică și Calculatoare. <http://eureka.cs.tuiasi/>. pag. 1-9
- [8] The height value mathematically described by the relationship (4) classifies the neutrosophic-tendential fuzzy subsets in *normal* or *normalized*. when $h(A) = 1$. i.e. $\exists x \in X$ such that $\mu_A(x) = 1$ or $\exists(\Delta p) \in X$. such that $\mu_A(\Delta p) = 1$; and in *subnormal* or *subnormalized* when it appears impossible the existence of a height equal to 1. (Gâlea Dan. Leon Florin. *Teoria mulțimilor fuzzy / Fuzzy Set Theory*).
- [9] Gheorghe Săvoiu. (2007). *Statistica. Un mod științific de gândire* [Statistics. A scientific way of thinking]. Bucharest (Romania): Universitară. pp. 244-258.
- [10] Gheorghe Săvoiu. (2001). *Universul prețurilor și indicii interpret* [The Universe of Prices and the Interpreter Indexes]. Pitești (Romania): Independența Economică. p. 71.
- [11] Ioan Moldovan. (1999). *Metoda de calcul și estimare a indicilor costului vieții* [Method of calculation and estimation of cost of living indices]. Cluj (Romania): Focus.
- [12] Gheorghe Săvoiu. (2009). *Two important traditional prices' indices for the measurement of inflation and cost-of-living in Romania, during the last century*. Scientific Bulletin – Economic Sciences. Vol. 8 (14). pp. 1-8.
- [13] Gheorghe Săvoiu. Ion Iorga-Siman. (2011). *The concept of time in the physical way of thinking, and its impact on knowledge and the evaluation of inflation as an economic phenomenon*. In "Econophysics. Sociophysics & Other Multidisciplinary Sciences Journal" (ESMSJ). Vol. 1 (2). pp. 25-35.
- [14] Gheorghe Săvoiu. (2013). *A Statistical Applied Method. Drawing on the Consumer Price Index and its Investigative Qualities*. Romanian

- Statistical Review Supplement. Romanian Statistical Review. vol. 61(2)/ 2013. pp. 116-122.
- [15] Ladislauss von Bortkiewicz (1868-1931), statistician, mathematician, economist and demographer of German origin, professor at Petersburg and Berlin, with an essential contribution to the index theory by the rapport built to assess the influence share in an aggregate index.
- [16] Săvoiu G.. (2003). Statistică generală. Argumente în favoarea formării gândirii statistice [General Statistics. Arguments in favor of the Statistical Thinking Training]. Pitești (Romania): Independența Economică.
- [17] Statistics New Zealand (1995). Consumers Price Index Revision 1993. New Zealand.
- [18] OECD (1994). Sources and Methods Consumer Price Indexes. France.
- [19] International Labour Office (1987). Sources and Methods Labour Statistics. Vol. 1: Consumer Price Indexes. Geneva.
- [20] L. A. Zadeh. Fuzzy Sets. In „Inform. and Control”. 8 (1965). pp. 338-353.
- [21] K. T. Atanassov. Intuitionistic Fuzzy Set. In „Fuzzy Sets and Systems”. 20(1) (1986). pp. 87-96.
- [22] Florentin Smarandache (1998). *Neutrosophy. Neutrosophic Probability, Set, and Logic*. Amer. Res. Press. Rehoboth. USA. 105 pages.
- [23] Florentin Smarandache. *n-Valued Refined Neutrosophic Logic and Its Applications in Physics*. In „Progress in Physics”. Vol. 4 (2013). pp. 143-146.

Mappings on Neutrosophic Soft Expert Sets

Said Broumi, Ali Mumtaz, Florentin Smarandache

Said Broumi, Ali Mumtaz, Florentin Smarandache (2015). Mappings on Neutrosophic Soft Expert Sets. *Journal of New Theory* 5, 26-42

Abstract - In this paper we introduced mapping on neutrosophic soft expert sets through which we can study the images and inverse images of neutrosophic soft expert sets. Further, we investigated the basic operations and other related properties of mapping on neutrosophic soft expert sets in this paper.

Keywords - Neutrosophic soft expert set, neutrosophic soft expert images, neutrosophic soft expert inverse images, mapping on neutrosophic soft expert set.

1. Introduction

Neutrosophy has been introduced by Smarandache [14, 15, 16] as a new branch of philosophy. Smarandache using this philosophy of neutrosophy to initiate neutrosophic sets and logics which is the generalization of fuzzy logic, intuitionistic fuzzy logic, paraconsistent logic etc. Fuzzy sets [42] and intuitionistic fuzzy sets [36] are characterized by membership functions, membership and non-membership functions, respectively. In some real life problems for proper description of an object in uncertain and ambiguous environment, we need to handle the indeterminate and incomplete information. Fuzzy sets and intuitionistic fuzzy sets are not able to handle the indeterminate and inconsistent information. Thus neutrosophic set (NS in short) is defined by Smarandache [15], as a new mathematical tool for dealing with problems involving incomplete, indeterminacy, inconsistent knowledge. In NS, the indeterminacy is quantified explicitly and truth-membership, indeterminacy membership, and false-membership are completely independent. From scientific or engineering point of view, the neutrosophic set and set-theoretic view, operators need to be defined. Otherwise, it will be difficult to apply in the

real applications. Therefore, H. Wang et al [19] defined a single valued neutrosophic set (SVNS) and then provided the set theoretic operations and various properties of single valued neutrosophic sets. Recent research works on neutrosophic set theory and its applications in various fields are progressing rapidly. A lot of literature can be found in this regard in [3, 6, 7, 8, 9, 10, 11, 12, 13, 25, 26, 27, 28, 29, 30, 31, 32, 33, 34, 35, 61, 62, 70, 73, 76, 80, 83, 84, 85, 86].

In other hand, Molodtsov [12] initiated the theory of soft set as a general mathematical tool for dealing with uncertainty and vagueness and how soft set theory is free from the parameterization inadequacy syndrome of fuzzy set theory, rough set theory, probability theory. A soft set is a collection of approximate descriptions of an object. Later Maji et al.[58] defined several operations on soft set. Many authors [37, 41, 44, 47, 49, 50, 51, 52, 53, 54, 55, 56, 57, 60] have combined soft sets with other sets to generate hybrid structures like fuzzy soft sets, generalized fuzzy soft sets, rough soft sets, intuitionistic fuzzy soft sets, possibility fuzzy soft sets, generalized intuitionistic fuzzy softs, possibility vague soft sets and so on. All these research aim to solve most of our real life problems in medical sciences, engineering, management, environment and social sciences which involve data that are not crisp and precise. But most of these models deal with only one opinion (or) with only one expert. This causes a problem with the user when questionnaires are used for the data collection. Alkhazaleh and Salleh in 2011 [65] defined the concept of soft expert set and created a model in which the user can know the opinion of the experts in the model without any operations and give an application of this concept in decision making problem. Also, they introduced the concept of the fuzzy soft expert set [64] as a combination between the soft expert set and the fuzzy set. Based on [15], Maji [53] introduced the concept of neutrosophic soft set a more generalized concept, which is a combination of neutrosophic set and soft set and studied its properties. Various kinds of extended neutrosophic soft sets such as intuitionistic neutrosophic soft set [68, 70, 79], generalized neutrosophic soft set [61, 62], interval valued neutrosophic soft set [23], neutrosophic parameterized fuzzy soft set [72], Generalized interval valued neutrosophic soft sets [75], neutrosophic soft relation [20, 21], neutrosophic soft multiset theory [24] and cyclic fuzzy neutrosophic soft group [61] were studied. The combination of neutrosophic soft sets and rough sets [77, 81, 82] is another interesting topic.

Recently, Broumi and Smarandache [88] introduced, a more generalized concept, the concept of the intuitionistic fuzzy soft expert set as a combination between the soft expert set and the intuitionistic fuzzy set. The same authors defined the concept of single valued neutrosophic soft expert set [87] and gave the application in decision making problem. The concept of single valued neutrosophic soft expert set deals with indeterminate and inconsistent data. Also, Sahin et al. [91] presented the concept of neutrosophic soft expert sets. The soft expert models are richer than soft set models since the soft set models are created with the help of one expert where as the soft expert models are made with the opinions of all experts. Later on, many researchers have worked with the concept of soft expert sets and their hybrid structures [1, 2, 17, 18, 24, 38, 39, 46, 48, 87, 91, 92].

The notion of mapping on soft classes are introduced by Kharal and Ahmad [4]. The same authors presented the concept of a mapping on classes of fuzzy soft sets [5] and studied the properties of fuzzy soft images and fuzzy soft inverse images of fuzzy soft sets, and supported them with examples and counter inconsistency in examples. In neutrosophic environment, Alkhazaleh et al [67] studied the notion of mapping on neutrosophic soft classes.

Until now, there is no study on mapping on the classes of neutrosophic soft expert sets, so there is a need to develop a new mathematical tool called “Mapping on neutrosophic soft expert set”.

In this paper, we introduce the notion of mapping on neutrosophic soft expert classes and study the properties of neutrosophic soft expert images and neutrosophic soft expert inverse images of neutrosophic soft expert sets. Finally, we give some illustrative examples of mapping on neutrosophic soft expert for intuition.

2. Preliminaries

In this section, we will briefly recall the basic concepts of neutrosophic sets, soft sets, neutrosophic soft sets, soft expert sets, fuzzy soft expert sets, intuitionistic fuzzy soft expert sets and neutrosophic soft expert sets.

Let U be an initial universe set of objects and E is the set of parameters in relation to objects in U . Parameters are often attributes, characteristics or properties of objects. Let $P(U)$ denote the power set of U and $A \subseteq E$.

2.1. Neutrosophic Set

Definition 2.1 [15] Let U be an universe of discourse, Then the neutrosophic set A is an object having the form $A = \{ \langle x: T_A(x), I_A(x), F_A(x) \rangle, x \in U \}$, where the functions $T_A(x), I_A(x), F_A(x) : U \rightarrow]0,1^+[$ define respectively the degree of membership, the degree of indeterminacy, and the degree of non-membership of the element $x \in X$ to the set A with the condition.

$$0 \leq \sup T_A(x) + \sup I_A(x) + \sup F_A(x) \leq 3^+.$$

From philosophical point of view, the neutrosophic set takes the value from real standard or non-standard subsets of $]0,1^+[$. So instead of $]0,1^+[$ we need to take the interval $[0,1]$ for technical applications, because $]0,1^+[$ will be difficult to apply in the real applications such as in scientific and engineering problems.

For two NS,

$$A_{NS} = \{ \langle x, T_A(x), I_A(x), F_A(x) \rangle \mid x \in X \}$$

And

$$B_{NS} = \{ \langle x, T_B(x), I_B(x), F_B(x) \rangle \mid x \in X \}$$

We have,

1. $A_{NS} \subseteq B_{NS}$ if and only if

$$T_A(x) \leq T_B(x), I_A(x) \geq I_B(x), F_A(x) \geq F_B(x).$$

2. $A_{NS} = B_{NS}$ if and only if,

$$T_A(x) = T_B(x), I_A(x) = I_B(x), F_A(x) = F_B(x) \text{ for all } x \in X.$$

3. The complement of A_{NS} is denoted by A_{NS}^o and is defined by

$$A_{NS}^o = \{ \langle x, F_A(x), 1 - T_A(x), T_A(x) \mid x \in X \rangle \}$$

$$4. A \cap B = \{ \langle x, \min\{T_A(x), T_B(x)\}, \max\{I_A(x), I_B(x)\}, \max\{F_A(x), F_B(x)\} \rangle : x \in X \}$$

$$5. A \cup B = \{ \langle x, \max\{T_A(x), T_B(x)\}, \min\{I_A(x), I_B(x)\}, \min\{F_A(x), F_B(x)\} \rangle : x \in X \}$$

As an illustration, let us consider the following example.

Example 2.2. Assume that the universe of discourse $U = \{x_1, x_2, x_3, x_4\}$. It may be further assumed that the values of x_1, x_2, x_3 and x_4 are in $[0, 1]$, then A is a neutrosophic set (NS) of U such that,

$$A = \{ \langle x_1, 0.4, 0.6, 0.5 \rangle, \langle x_2, 0.3, 0.4, 0.7 \rangle, \langle x_3, 0.4, 0.4, 0.6 \rangle, \langle x_4, 0.5, 0.4, 0.8 \rangle \}$$

2.2. Soft Set

Definition 2.3 [12] Let U be an initial universe set and E be a set of parameters. Let $P(U)$ denote the power set of U . Consider a nonempty set $A, A \subset E$. A pair (K, A) is called a soft set over U , where K is a mapping given by $K : A \rightarrow P(U)$.

As an illustration, let us consider the following example.

Example 2.4 Suppose that U is the set of houses under consideration, say $U = \{h_1, h_2, \dots, h_5\}$. Let E be the set of some attributes of such houses, say $E = \{e_1, e_2, \dots, e_5\}$, where e_1, e_2, \dots, e_5 stand for the attributes “beautiful”, “costly”, “in the green surroundings”, “moderate”, respectively.

In this case, to define a soft set means to point out expensive houses, beautiful houses, and so on. For example, the soft set (K, A) that describes the “attractiveness of the houses” in the opinion of a buyer, say Thomas, may be defined like this:

$$A = \{e_1, e_2, e_3, e_4, e_5\};$$

$$K(e_1) = \{h_2, h_3, h_5\}, K(e_2) = \{h_2, h_4\}, K(e_3) = \{h_1\}, K(e_4) = U, K(e_5) = \{h_3, h_5\}.$$

2.3 Neutrosophic Soft Sets

Definition 2.5 [59] Let U be an initial universe set and $A \subset E$ be a set of parameters. Let $NS(U)$ denotes the set of all neutrosophic subsets of U . The collection (F, A) is termed to be the neutrosophic soft set over U , where F is a mapping given by $F : A \rightarrow NS(U)$.

Example 2.6 Let U be the set of houses under consideration and E is the set of parameters.

Each parameter is a neutrosophic word or sentence involving neutrosophic words. Consider $E = \{\text{beautiful, wooden, costly, very costly, moderate, green surroundings, in good repair, in bad repair, cheap, expensive}\}$. In this case, to define a neutrosophic soft set means to point out beautiful houses, wooden houses, houses in the green surroundings and so on. Suppose that, there are five houses in the universe U given by $U = \{h_1, h_2, \dots, h_5\}$ and the set of parameters

$A = \{e_1, e_2, e_3, e_4\}$, where e_1 stands for the parameter 'beautiful', e_2 stands for the parameter 'wooden', e_3 stands for the parameter 'costly' and the parameter e_4 stands for 'moderate'. Then the neutrosophic set (F, A) is defined as follows:

$$(F, A) = \left\{ \begin{array}{l} \left(e_1 \left\{ \frac{h_1}{(0.5, 0.6, 0.3)'} \frac{h_2}{(0.4, 0.7, 0.6)'} \frac{h_3}{(0.6, 0.2, 0.3)'} \frac{h_4}{(0.7, 0.3, 0.2)'} \frac{h_5}{(0.8, 0.2, 0.3)'} \right\} \right) \\ \left(e_2 \left\{ \frac{h_1}{(0.6, 0.3, 0.5)'} \frac{h_2}{(0.7, 0.4, 0.3)'} \frac{h_3}{(0.8, 0.1, 0.2)'} \frac{h_4}{(0.7, 0.1, 0.3)'} \frac{h_5}{(0.8, 0.3, 0.6)'} \right\} \right) \\ \left(e_3 \left\{ \frac{h_1}{(0.7, 0.4, 0.3)'} \frac{h_2}{(0.6, 0.7, 0.2)'} \frac{h_3}{(0.7, 0.2, 0.5)'} \frac{h_4}{(0.5, 0.2, 0.6)'} \frac{h_5}{(0.7, 0.3, 0.4)'} \right\} \right) \\ \left(e_4 \left\{ \frac{h_1}{(0.8, 0.6, 0.4)'} \frac{h_2}{(0.7, 0.9, 0.6)'} \frac{h_3}{(0.7, 0.6, 0.4)'} \frac{h_4}{(0.7, 0.8, 0.6)'} \frac{h_5}{(0.9, 0.5, 0.7)'} \right\} \right) \end{array} \right\}$$

Definition 2.7 [59] Let (H, A) and (G, B) be two NSs over the common universe U . Then the union of (H, A) and (G, B) , is denoted by " $(H, A) \tilde{\cup} (G, B)$ " and is defined by $(H, A) \tilde{\cup} (G, B) = (K, C)$, where $C = A \cup B$ and the truth-membership, indeterminacy-membership and falsity-membership of (K, C) are as follows:

$$T_{K(e)}(m) = \begin{cases} T_{H(e)}(m) & \text{if } e \in A - B \\ T_{G(e)}(m) & \text{if } e \in B - A \\ \max(T_{H(e)}, T_{G(e)}(m)) & \text{if } e \in A \cap B \end{cases}$$

$$I_{K(e)}(m) = \begin{cases} I_{H(e)}(m) & \text{if } e \in A - B \\ I_{G(e)}(m) & \text{if } e \in B - A \\ \frac{(I_{H(e)}(m) + I_{G(e)}(m))}{2} & \text{if } e \in A \cap B \end{cases}$$

$$F_{K(e)}(m) = \begin{cases} F_{H(e)}(m) & \text{if } e \in A - B \\ F_{G(e)}(m) & \text{if } e \in B - A \\ \min(F_{H(e)}, F_{G(e)}(m)) & \text{if } e \in A \cap B \end{cases}$$

Definition 2.8 [59] Let (H, A) and (G, B) be two NSs over the common universe U . Then the intersection of (H, A) and (G, B) , is denoted by " $(H, A) \tilde{\cap} (G, B)$ " and is defined by $(H, A) \tilde{\cap} (G, B) = (K, C)$, where $C = A \cap B$ and the truth-membership, indeterminacy-membership and falsity-membership of (K, C) are as follows:

$$T_{K(e)}(m) = \begin{cases} T_{H(e)}(m) & \text{if } e \in A - B \\ T_{G(e)}(m) & \text{if } e \in B - A \\ \min(T_{H(e)}, T_{G(e)}(m)) & \text{if } e \in A \cap B \end{cases}$$

$$I_{K(e)}(m) = \begin{cases} I_{H(e)}(m) & \text{if } e \in A - B \\ I_{G(e)}(m) & \text{if } e \in B - A \\ \frac{(I_{H(e)}(m) + I_{G(e)}(m))}{2} & \text{if } e \in A \cap B \end{cases}$$

$$F_{K(e)}(m) = \begin{cases} F_{H(e)}(m) & \text{if } e \in A - B \\ F_{G(e)}(m) & \text{if } e \in B - A \\ \max(F_{H(e)}, F_{G(e)}(m)) & \text{if } e \in A \cap B \end{cases}$$

2.4. Soft expert sets

Definition 2.9 [65] Let U be a universe set, E be a set of parameters and X be a set of experts (agents). Let $O = \{1 = \text{agree}, 0 = \text{disagree}\}$ be a set of opinions. Let $Z = E \times X \times O$ and $A \subseteq Z$.

A pair (F, E) is called a soft expert set over U , where F is a mapping given by $F: A \rightarrow P(U)$ and $P(U)$ denote the power set of U .

Definition 2.10 [65] An agree-soft expert set $(F, A)_1$ over U , is a soft expert subset of (F, A) defined as :

$$(F, A)_1 = \{F(\alpha) : \alpha \in E \times X \times \{1\}\}.$$

Definition 2.11 [65] A disagree- soft expert set $(F, A)_0$ over U , is a soft expert subset of (F, A) defined as :

$$(F, A)_0 = \{F(\alpha) : \alpha \in E \times X \times \{0\}\}.$$

2.5. Fuzzy Soft expert sets

Definition 2.12 [64] A pair (F, A) is called a fuzzy soft expert set over U , where F is a mapping given by

$F : A \rightarrow I^U$, and I^U denote the set of all fuzzy subsets of U .

2.6. Intuitionistic Fuzzy Soft Expert sets

Definition 2.13 [88] Let $U = \{u_1, u_2, u_3, \dots, u_n\}$ be a universal set of elements, $E = \{e_1, e_2, e_3, \dots, e_m\}$ be a universal set of parameters, $X = \{x_1, x_2, x_3, \dots, x_i\}$ be a set of experts (agents) and $O = \{1 = \text{agree}, 0 = \text{disagree}\}$ be a set of opinions. Let $Z = \{E \times$

$X \times Q \}$ and $A \subseteq Z$. Then the pair (U, Z) is called a soft universe. Let $F: Z \rightarrow (I \times I)^U$ where $(I \times I)^U$ denotes the collection of all intuitionistic fuzzy subsets of U . Suppose $F: Z \rightarrow (I \times I)^U$ be a function defined as:

$$F(z) = F(z)(u_i), \text{ for all } u_i \in U.$$

Then $F(z)$ is called an intuitionistic fuzzy soft expert set (IFSES in short) over the soft universe (U, Z)

For each $z_i \in Z$. $F(z) = F(z_i)(u_i)$ where $F(z_i)$ represents the degree of belongingness and non-belongingness of the elements of U in $F(z_i)$. Hence $F(z_i)$ can be written as:

$$F(z_i) = \{(\frac{u_1}{F(z_i)(u_1)}), \dots, (\frac{u_i}{F(z_i)(u_i)})\}, \text{ for } i=1,2,3,\dots,n$$

where $F(z_i)(u_i) = \langle \mu_{F(z_i)}(u_i), \omega_{F(z_i)}(u_i) \rangle$ with $\mu_{F(z_i)}(u_i)$ and $\omega_{F(z_i)}(u_i)$ representing the membership function and non-membership function of each of the elements $u_i \in U$ respectively.

Sometimes we write F as (F, Z) . If $A \subseteq Z$. we can also have IFSES (F, A) .

2.7 Neutrosophic Soft Expert Sets

Definition 2.14 [89] A pair (F, A) is called a neutrosophic soft expert set over U , where F is a mapping given by

$$F : A \rightarrow P(U)$$

where $P(U)$ denotes the power neutrosophic set of U .

3. Mapping on Neutrosophic Soft Expert Set

In this paper, we introduce the mapping on neutrosophic soft expert classes. Neutrosophic soft expert classes are collections of neutrosophic soft expert sets. We also define and study the properties of neutrosophic soft expert images and neutrosophic soft expert inverse images of neutrosophic soft expert sets, and support them with examples and theorems.

Definition 3.1 Let $(\widetilde{U}, \widetilde{Z})$ and $(\widetilde{Y}, \widetilde{Z}')$ be neutrosophic soft expert classes. Let $r: U \rightarrow Y$ and $s: Z \rightarrow Z'$ be mappings.

Then a mapping $f: (\widetilde{U}, \widetilde{Z}) \rightarrow (\widetilde{Y}, \widetilde{Z}')$ is defined as follows :

For a neutrosophic soft expert set (F, A) in $(\overline{U}, \overline{Z})$, $f(F, A)$ is a neutrosophic soft expert set in $(\overline{Y}, \overline{Z}')$, where

$$f(F, A) (\beta) (y) = \begin{cases} \bigvee_{x \in r^{-1}(y)} (\bigvee_{\alpha} F(\alpha)) & \text{if } r^{-1}(y) \text{ and } s^{-1}(\beta) \cap A \neq \emptyset, \\ 0 & \text{otherwise} \end{cases}$$

for $\beta \in s(Z) \subseteq Z'$, $y \in Y$ and $\forall \alpha \in s^{-1}(\beta) \cap A$, $f(F, A)$ is called a neutrosophic soft expert image of the neutrosophic soft expert set (F, A) .

Definition 3.2 Let $(\overline{U}, \overline{Z})$ and $(\overline{Y}, \overline{Z}')$ be the neutrosophic soft expert classes. Let $r: U \rightarrow Y$ and $s: Z \rightarrow Z'$ be mappings. Then a mapping $f^{-1}: (\overline{Y}, \overline{Z}') \rightarrow (\overline{U}, \overline{Z})$ is defined as follows : For a neutrosophic soft expert set (G, B) in $(\overline{Y}, \overline{Z}')$, $f^{-1}(G, B)$ is a neutrosophic soft expert set in $(\overline{U}, \overline{Z})$,

$$f^{-1}(G, B) (\alpha) (u) = \begin{cases} G(s(\alpha))(r(u)) & , \text{if } s(\alpha) \in B \\ 0 & \text{otherwise} \end{cases}$$

For $\alpha \in s^{-1}(\beta) \subseteq Z$ and $u \in U$, $f^{-1}(G, B)$ is called a neutrosophic soft expert inverse image of the neutrosophic soft expert set (F, A) .

Example 3.3. Let $U = \{u_1, u_2, u_3\}$, $Y = \{y_1, y_2, y_3\}$ and let $A \subseteq Z = \{(e_1, p, 1), (e_2, p, 0), (e_3, p, 1)\}$, and $A' \subseteq Z' = \{(e'_1, p', 1), (e'_2, p', 0), (e'_1, q', 1)\}$.

Suppose that $(\overline{U}, \overline{A})$ and $(\overline{Y}, \overline{A}')$ are neutrosophic soft expert classes. Define $r: U \rightarrow Y$ and $s: A \rightarrow A'$ as follows :

$$r(u_1) = y_1, r(u_2) = y_3, r(u_3) = y_2,$$

$$s(e_1, p, 1) = (e'_2, p', 0), s(e_2, p, 0) = (e'_1, p', 1), s(e_3, p, 1) = (e'_1, q', 1),$$

Let (F, A) and (G, A') be two neutrosophic soft experts over U and Y respectively such that.

$$(F, A) = \left\{ \left((e_1, p, 1), \left\{ \frac{u_1}{(0.4, 0.3, 0.6)}, \frac{u_2}{(0.3, 0.6, 0.4)}, \frac{u_3}{(0.3, 0.5, 0.5)} \right\} \right), \left((e_3, p, 1), \left\{ \frac{u_1}{(0.3, 0.3, 0.2)}, \frac{u_2}{(0.5, 0.4, 0.4)}, \frac{u_3}{(0.6, 0.4, 0.3)} \right\} \right), \left((e_2, p, 0), \left\{ \frac{u_1}{(0.5, 0.6, 0.3)}, \frac{u_2}{(0.5, 0.3, 0.6)}, \frac{u_3}{(0.6, 0.4, 0.7)} \right\} \right) \right\}$$

$$(G, A') = \left\{ \left((e'_1, p', 1), \left\{ \frac{y_1}{(0.3, 0.2, 0.1)}, \frac{y_2}{(0.5, 0.6, 0.4)}, \frac{y_3}{(0.3, 0.5, 0.1)} \right\} \right), \left((e'_1, q', 1), \left\{ \frac{y_1}{(0.5, 0.7, 0.4)}, \frac{y_2}{(0.5, 0.2, 0.3)}, \frac{y_3}{(0.6, 0.5, 0.1)} \right\} \right), \left((e'_2, p', 0), \left\{ \frac{y_1}{(0.3, 0.2, 0.4)}, \frac{y_2}{(0.1, 0.7, 0.5)}, \frac{y_3}{(0.1, 0.4, 0.2)} \right\} \right) \right\}$$

Then we define the mapping from $f: (\widetilde{U}, \widetilde{Z}) \rightarrow (\widetilde{Y}, \widetilde{Z}')$ as follows :

For a neutrosophic soft expert set (F, A) in (U, Z) , $(f(F, A), K)$ is neutrosophic soft expert set in (Y, Z') where

$K = s(A) = \{(e'_1, p', 1), (e'_2, p', 0), (e'_1, q', 1)\}$ and is obtained as follows:

$$\begin{aligned} f(F, A) (e'_1, p', 1) (y_1) &= V_{x \in r^{-1}(y_1)} (V_\alpha F(\alpha)) = V_{x \in \{u_1\}} (V_{\alpha \in \{(e_2, p, 0), (e_3, p, 1)\}} F(\alpha)) \\ &= (0.5, 0.6, 0.3) \cup (0.3, 0.3, 0.2) \\ &= (0.5, 0.45, 0.2) \end{aligned}$$

$$\begin{aligned} f(F, A) (e'_1, p', 1) (y_2) &= V_{x \in r^{-1}(y_2)} (V_\alpha F(\alpha)) = V_{x \in \{u_3\}} (V_{\alpha \in \{(e_2, p, 0), (e_3, p, 1)\}} F(\alpha)) \\ &= (0.6, 0.4, 0.7) \cup (0.6, 0.4, 0.3) \\ &= (0.6, 0.4, 0.3) \end{aligned}$$

$$\begin{aligned} f(F, A) (e'_1, p', 1) (y_3) &= V_{x \in r^{-1}(y_3)} (V_\alpha F(\alpha)) = V_{x \in \{u_2\}} (V_{\alpha \in \{(e_2, p, 0), (e_3, p, 1)\}} F(\alpha)) \\ &= (0.5, 0.3, 0.6) \cup (0.5, 0.4, 0.4) \\ &= (0.5, 0.35, 0.4) \end{aligned}$$

Then,

$$f(F, A) (e'_1, p', 1) = \left\{ \frac{y_1}{(0.5, 0.45, 0.2)}, \frac{y_2}{(0.6, 0.4, 0.3)}, \frac{y_3}{(0.5, 0.35, 0.4)} \right\}$$

$$\begin{aligned} f(F, A) (e'_2, p', 0) (y_1) &= V_{x \in r^{-1}(y_1)} (V_\alpha F(\alpha)) = V_{x \in \{u_1\}} (V_{\alpha \in \{(e_1, p, 1)\}} F(\alpha)) \\ &= (0.4, 0.3, 0.6) \end{aligned}$$

$$\begin{aligned} f(F, A) (e'_2, p', 0) (y_2) &= V_{x \in r^{-1}(y_2)} (V_\alpha F(\alpha)) = V_{x \in \{u_3\}} (V_{\alpha \in \{(e_1, p, 1)\}} F(\alpha)) \\ &= (0.3, 0.5, 0.5) \end{aligned}$$

$$\begin{aligned} f(F, A) (e'_2, p', 0) (y_3) &= V_{x \in r^{-1}(y_3)} (V_\alpha F(\alpha)) = V_{x \in \{u_2\}} (V_{\alpha \in \{(e_1, p, 1)\}} F(\alpha)) \\ &= (0.3, 0.6, 0.4) \end{aligned}$$

Next,

$$f(F, A) ((e'_2, p', 0)) = \left\{ \frac{y_1}{(0.4, 0.3, 0.6)}, \frac{y_2}{(0.3, 0.5, 0.5)}, \frac{y_3}{(0.3, 0.6, 0.4)} \right\}$$

$$\begin{aligned} f(F, A) (e'_1, q', 1) (y_1) &= V_{x \in r^{-1}(y_1)} (V_\alpha F(\alpha)) = V_{x \in \{u_1\}} (V_{\alpha \in \{(e_3, p, 1)\}} F(\alpha)) \\ &= (0.3, 0.3, 0.2) \end{aligned}$$

$$\begin{aligned} f(F, A) (e'_1, q', 1) (y_2) &= V_{x \in r^{-1}(y_2)} (V_\alpha F(\alpha)) = V_{x \in \{u_3\}} (V_{\alpha \in \{(e_3, p, 1)\}} F(\alpha)) \\ &= (0.6, 0.4, 0.3) \end{aligned}$$

$$\begin{aligned} f(F, A) (e'_1, q', 1) (y_3) &= V_{x \in r^{-1}(y_3)} (V_\alpha F(\alpha)) = V_{x \in \{u_2\}} (V_{\alpha \in \{(e_3, p, 1)\}} F(\alpha)) \\ &= (0.5, 0.4, 0.4) \end{aligned}$$

Also.

$$f(F, A) ((e'_1, q', 1)) = \left\{ \frac{y_1}{(0.3, 0.3, 0.2)}, \frac{y_2}{(0.6, 0.4, 0.3)}, \frac{y_3}{(0.5, 0.4, 0.4)} \right\}$$

Hence,

$$(f(F, A), K) = \left\{ \left((e'_1, p', 1), \left\{ \frac{y_1}{(0.5, 0.45, 0.2)}, \frac{y_2}{(0.6, 0.4, 0.3)}, \frac{y_3}{(0.5, 0.35, 0.4)} \right\} \right), \right. \\ \left. \left((e'_2, p', 0), \left\{ \frac{y_1}{(0.4, 0.3, 0.6)}, \frac{y_2}{(0.3, 0.5, 0.5)}, \frac{y_3}{(0.3, 0.6, 0.4)} \right\} \right), \right. \\ \left. \left((e'_1, q', 1), \left\{ \frac{y_1}{(0.3, 0.3, 0.2)}, \frac{y_2}{(0.6, 0.4, 0.3)}, \frac{y_3}{(0.5, 0.4, 0.4)} \right\} \right) \right\}$$

Next, for the neutrosophic soft expert set inverse images, we have the following:

For a neutrosophic soft expert set (G, A') in (Y, Z') , $(f^{-1}(G, A'), D)$ is a neutrosophic soft expert set in (U, Z) , where

$D = s^{-1}(A') = \{(e_1, p, 1), (e_2, p, 0), (e_3, p, 1)\}$, and is obtained as follows:

$$f^{-1}(G, B)(e_1, p, 1)(u_1) = G(s(e_1, p, 1))(r(u_1)) = G((e'_2, p', 0))(y_1) = (0.3, 0.2, 0.4)$$

$$f^{-1}(G, B)(e_1, p, 1)(u_2) = G(s(e_1, p, 1))(r(u_2)) = G((e'_2, p', 0))(y_3) = (0.1, 0.4, 0.2)$$

$$f^{-1}(G, B)(e_1, p, 1)(u_3) = G(s(e_1, p, 1))(r(u_3)) = G((e'_2, p', 0))(y_2) = (0.1, 0.7, 0.5)$$

Then

$$f^{-1}(G, B)(e_1, p, 1) = \left\{ \frac{u_1}{(0.3, 0.2, 0.4)}, \frac{u_2}{(0.1, 0.4, 0.2)}, \frac{u_3}{(0.1, 0.7, 0.5)} \right\}$$

$$f^{-1}(G, B)(e_2, p, 0)(u_1) = G(s(e_2, p, 0))(r(u_1)) = G((e'_1, p', 1))(y_1) = (0.3, 0.2, 0.1)$$

$$f^{-1}(G, B)(e_2, p, 0)(u_2) = G(s(e_2, p, 0))(r(u_2)) = G((e'_1, p', 1))(y_3) = (0.3, 0.5, 0.1)$$

$$f^{-1}(G, B)(e_2, p, 0)(u_3) = G(s(e_2, p, 0))(r(u_3)) = G((e'_1, p', 1))(y_2) = (0.5, 0.6, 0.4)$$

Then,

$$f^{-1}(G, B)(e_2, p, 0) = \left\{ \frac{u_1}{(0.3, 0.2, 0.1)}, \frac{u_2}{(0.3, 0.5, 0.1)}, \frac{u_3}{(0.5, 0.6, 0.4)} \right\}$$

$$f^{-1}(G, B)(e_3, p, 1)(u_1) = G(s(e_3, p, 1))(r(u_1)) = G((e'_1, q', 1))(y_1) = (0.5, 0.7, 0.4)$$

$$f^{-1}(G, B)(e_3, p, 1)(u_2) = G(s(e_3, p, 1))(r(u_2)) = G((e'_1, q', 1))(y_3) = (0.6, 0.5, 0.1)$$

$$f^{-1}(G, B)(e_3, p, 1)(u_3) = G(s(e_3, p, 1))(r(u_3)) = G((e'_1, q', 1))(y_2) = (0.5, 0.2, 0.3)$$

Then

$$f^{-1}(G, B)(e_3, p, 1) = \left\{ \frac{u_1}{(0.5, 0.7, 0.4)}, \frac{u_2}{(0.6, 0.5, 0.1)}, \frac{u_3}{(0.5, 0.2, 0.4)} \right\}$$

Hence

$$(f^{-1}(G, A'), D) = \left\{ \left((e_1, p, 1), \left\{ \frac{u_1}{(0.3, 0.2, 0.4)}, \frac{u_2}{(0.1, 0.4, 0.2)}, \frac{u_3}{(0.1, 0.7, 0.5)} \right\} \right), \right.$$

$$\left((e_2, p, 0), \left\{ \frac{u_1}{(0.3,0.2,0.1)}, \frac{u_2}{(0.3,0.5,0.1)}, \frac{u_3}{(0.5,0.6,0.4)} \right\} \right), \\ \left((e_3, p, 1), \left\{ \frac{u_1}{(0.5,0.7,0.4)}, \frac{u_2}{(0.6,0.5,0.1)}, \frac{u_3}{(0.5,0.2,0.4)} \right\} \right) \Big\}$$

Definition 3.4 Let $f: (\widetilde{U}, \widetilde{Z}) \rightarrow (\widetilde{Y}, \widetilde{Z}')$ be a mapping and (F, A) and (G, B) a neutrosophic soft expert sets in $(\widetilde{U}, \widetilde{E})$. Then for $\beta \in Z', y \in Y$ the union and intersection of neutrosophic soft expert images (F, A) and (G, B) are defined as follows :

$$\left(f(F, A) \widetilde{V} f(G, B) \right) (\beta)(y) = f(F, A)(\beta)(y) \widetilde{V} f(G, B)(\beta)(y). \\ \left(f(F, A) \widetilde{\wedge} f(G, B) \right) (\beta)(y) = f(F, A)(\beta)(y) \widetilde{\wedge} f(G, B)(\beta)(y).$$

Definition 3.5 Let $f: (\widetilde{U}, \widetilde{Z}) \rightarrow (\widetilde{Y}, \widetilde{Z}')$ be a mapping and (F, A) and (G, B) a neutrosophic soft expert sets in $(\widetilde{U}, \widetilde{E})$. Then for $\alpha \in Z, u \in U$, the union and intersection of neutrosophic soft expert inverse images (F, A) and (G, B) are defined as follows :

$$\left(f^{-1}(F, A) \widetilde{V} f^{-1}(G, B) \right) (\alpha)(u) = f^{-1}(F, A)(\alpha)(u) \widetilde{V} f^{-1}(G, B)(\alpha)(u). \\ \left(f^{-1}(F, A) \widetilde{\wedge} f^{-1}(G, B) \right) (\alpha)(u) = f^{-1}(F, A)(\alpha)(u) \widetilde{\wedge} f^{-1}(G, B)(\alpha)(u).$$

Theorem 3.6 Let $f: (\widetilde{U}, \widetilde{Z}) \rightarrow (\widetilde{Y}, \widetilde{Z}')$ be a mapping. Then for neutrosophic soft expert sets (F, A) and (G, B) in the neutrosophic soft expert class $(\widetilde{U}, \widetilde{Z})$.

1. $f(\emptyset) = \emptyset$
2. $f(Z) \subseteq Y$.
3. $f\left((F, A) \widetilde{V} (G, B) \right) = f(F, A) \widetilde{V} f(G, B)$
4. $f\left((F, A) \widetilde{\wedge} (G, B) \right) = f(F, A) \widetilde{\wedge} f(G, B)$
5. If $(F, A) \subseteq (G, B)$, then $f(F, A) \subseteq f(G, B)$.

Proof: For (1), (2) and (5) the proof is trivial, so we just give the proof of (3) and (4).
 (3). For $\beta \in Z'$ and $y \in Y$, we want to prove that

$$\left(f(F, A) \widetilde{V} f(G, B) \right) (\beta)(y) = f(F, A)(\beta)(y) \widetilde{V} f(G, B)(\beta)(y)$$

For left hand side, consider $f\left((F, A) \widetilde{V} (G, B) \right) (\beta)(y) = f(H, A \cup B)(\beta)(y)$. Then

$$f(H, A \cup B)(\beta)(y) = \begin{cases} \bigvee_{x \in r^{-1}(y)} (V_{\alpha} H(\alpha)) & \text{if } r^{-1}(y) \text{ and } s^{-1}(\beta) \cap (A \cup B) \neq \emptyset, \\ 0 & \text{otherwise} \end{cases} \tag{1.1}$$

such that $H(\alpha) = F(\alpha) \widetilde{\cup} G(\alpha)$ where $\widetilde{\cup}$ denotes neutrosophic union. Considering only the non-trivial case, Then equation 1.1 becomes:

$$f(H, A \cup B)(\beta)(y) = \bigvee_{x \in r^{-1}(y)} (V(F(\alpha) \widetilde{\cup} G(\alpha))) \tag{1.2}$$

For right hand side and by using definition 3.4, we have

$$\begin{aligned}
 (f(F, A) \tilde{\vee} f(G, B))(\beta)(y) &= f(F, A)(\beta)(y) \vee f(G, B)(\beta)(y) \\
 &= \left(\bigvee_{x \in r^{-1}(y)} \left(\bigvee_{\alpha \in S^{-1}(\beta) \cap A} F(\alpha) \right) (x) \right) \vee \left(\bigvee_{x \in r^{-1}(y)} \left(\bigvee_{\alpha \in S^{-1}(\beta) \cap B} F(\alpha) \right) (x) \right) \\
 &= \bigvee_{x \in r^{-1}(y)} \bigvee_{\alpha \in S^{-1}(\beta) \cap (A \cup B)} (F(\alpha) \vee G(\alpha)) \\
 &= \bigvee_{x \in r^{-1}(y)} (V(F(\alpha) \tilde{\cup} G(\alpha))) \tag{1.3}
 \end{aligned}$$

From equation (1.1) and (1.3) we get (3)

(4). For $\beta \in Z'$ and $y \in Y$, and using definition 3.4, we have

$$\begin{aligned}
 f((F, A) \tilde{\wedge} (G, B))(\beta)(y) &= f(H, A \cup B)(\beta)(y) \\
 &= \bigvee_{x \in r^{-1}(y)} \left(\bigvee_{\alpha \in S^{-1}(\beta) \cap (A \cup B)} H(\alpha) \right) (x) \\
 &= \bigvee_{x \in r^{-1}(y)} \left(\bigvee_{\alpha \in S^{-1}(\beta) \cap (A \cup B)} F(\alpha) \tilde{\wedge} G(\alpha) \right) (x) \\
 &= \bigvee_{x \in r^{-1}(y)} \left(\bigvee_{\alpha \in S^{-1}(\beta) \cap (A \cup B)} F(\alpha)(x) \tilde{\wedge} G(\alpha)(x) \right) \\
 &\subseteq \left(\bigvee_{x \in r^{-1}(y)} \left(\bigvee_{\alpha \in S^{-1}(\beta) \cap A} F(\alpha) \right) \right) \wedge \bigvee_{x \in r^{-1}(y)} \left(\bigvee_{\alpha \in S^{-1}(\beta) \cap B} G(\alpha) \right) \\
 &= f((F, A)(\beta)(y) \wedge (G, B)(\beta)(y)) \\
 &= (f(F, A) \tilde{\wedge} f(G, B))(\beta)(y)
 \end{aligned}$$

This gives (4).

Theorem 3.7 Let $f^{-1}: (\overline{U}, \overline{Z}) \rightarrow (\overline{Y}, \overline{Z}')$ be a an inverse mapping. Then for neutrosophic soft expert sets (F, A) and (G, B) in the neutrosophic soft expert class $(\overline{U}, \overline{Z})$.

1. $f^{-1}(\emptyset) = \emptyset$
2. $f^{-1}(X) \subseteq X$.
3. $f^{-1}((F, A) \tilde{\vee} (G, B)) = f^{-1}(F, A) \tilde{\vee} f^{-1}(G, B)$
4. $f^{-1}((F, A) \tilde{\wedge} (G, B)) = f^{-1}(F, A) \tilde{\wedge} f^{-1}(G, B)$
5. If $(F, A) \subseteq (G, B)$, Then $f^{-1}(F, A) \subseteq f^{-1}(G, B)$.

Proof. The proof is straightforward.

4. Conclusion

In this paper, we studied mappings on neutrosophic soft expert classes and their basic properties. We also give some illustrative examples of mapping on neutrosophic soft expert set. We hope these fundamental results will help the researchers to enhance and promote the research on neutrosophic soft set theory.

References

[1] A. ArokiaLancy, C. Tamilarasi and I. Arockiarani, Fuzzy Parameterization for decision making in riskmanagement system via soft expert set, International Journal of Innovative Research and studies, vol. 2 issue 10, (2013) 339-344, from www.ijirs.com.

- [2] A. ArokiaLancy, I. Arockiarani, A Fusion of soft expert set and matrix models, International Journal of Research in Engineering and technology, Vol. 02, issue 12, (2013) 531-535, from <http://www.ijret.org>
- [3] A. Kharal, A Neutrosophic Multicriteria Decision Making Method, New Mathematics and Natural Computation, Creighton University, USA, 2013.
- [4] A. Kharal and B. Ahmad, Mappings on soft classes, New Mathematics and Natural Computation, 07 (3) (2011), 471-481.
- [5] A. Kharal and B. Ahmad, Mappings on Fuzzy soft classes, Advances in Fuzzy Systems Volume 2009 (2009), Article ID 407890, 6 pages
- [6] A.Q. Ansaria, R. Biswas and S. Aggarwal, Neutrosophic classifier: An extension of fuzzy classifier, Applied Soft Computing 13 (2013) 563-573.
- [7] A. A. Salama and S. A. Alblowi, Neutrosophic Set and Neutrosophic Topological Spaces, ISOR J. Mathematics, Vol.(3), Issue(3), (2012) 31-35.
- [8] A. A. Salama, "Neutrosophic crisp point & neutrosophic crisp ideals", Neutrosophic Sets and Systems, Vol.1, No. 1, (2013) 50-54.
- [9] A. A. Salama and F. Smarandache, "Filters via neutrosophic crisp sets", Neutrosophic Sets and Systems, Vol.1, No. 1, (2013) 34-38.
- [10] A. Salama, S. Broumi and F. Smarandache, Neutrosophic crisp open set and neutrosophic crisp continuity via neutrosophic crisp ideals, IJ. Information Engineering and Electronic Business, Vol.6, No.3, (2014), 1-8 , DOI: 10.5815/ijieeb.2014.03.01
- [11] D. Rabounski, F. Smarandache and L. Borissova, Neutrosophic methods in general relativity, Hexis, (2005).
- [12] D. Molodtsov, Soft set theory-first result, Computers and Mathematics with Applications, 37(1999) 19-31.
- [13] F. G. Lupiáñez, On neutrosophic topology, Kybernetes, 37/6, (2008) 797-800.
- [14] F. Smarandache, A Unifying Field in Logics. Neutrosophy: Neutrosophic Probability, Set and Logic. Rehoboth: American Research Press, (1998).
- [15] F. Smarandache, Neutrosophic set, a generalization of the intuitionistic fuzzy sets, Inter. J. Pure Appl. Math., 24 (2005) 287 – 297.
- [16] F. Smarandache, Introduction to neutrosophic measure, neutrosophic measure neutrosophic integral, and neutrosophic probability (2013). <http://fs.gallup.unm.edu/eBooks-otherformats.htm> EAN: 9781599732534.
- [17] G. Selvachandran, Possibility Vague soft expert set theory. (2014) Submitted.
- [18] G. Selvachandran, Possibility intuitionistic fuzzy soft expert set theory and its application in decision making, Neural computing and Application. (2014) Submitted
- [19] H. Wang, F. Smarandache, Y. Zhang, and R. Sunderraman, Single valued Neutrosophic Sets, Multispace and Multistructure 4 (2010) 410-413.
- [20] H. L. Yang, Notes On generalized fuzzy soft sets, Journal of Mathematical Research and Exposition, 31/ 3 (2011) 567-570.
- [21] I. Deli, S. Broumi, Neutrosophic soft sets and neutrosophic soft matrices based on decision making, <http://arxiv:1404.0673>.
- [22] I. Deli, Y. Toktas, S. Broumi, Neutrosophic parameterized soft relations and their application, Neutrosophic Sets and Systems, Vol. 4, (2014) 25-34.
- [23] I. Deli, S. Broumi, Neutrosophic soft relations and some properties, Annals of Fuzzy Mathematics and Informatic, Vol. 9, No.1 (2015) 169-182.
- [24] I. Arockiarani and A. A. ArokiaLancy, Multi criteria decision making problem with soft expert set. International Journal of Computer Applications, Vol 78- No.15, (2013) 1-4 , from www.ijcaonline.org.

- [25] I. Deli, Interval-valued neutrosophic soft sets and its decision making <http://arxiv.org/abs/1402.3130>.
- [26] I. Deli, S. Broumi and A. Mumtaz, Neutrosophic soft multi-set theory and its decision making, *Neutrosophic Sets and Systems*, Vol. 5, (2014) 65-76.
- [27] I. Hanafy, A.A. Salama and K. Mahfouz, Correlation of neutrosophic data, *International Refereed Journal of Engineering and Science (IRJES)*, Vol.(1), Issue 2 (2012)
- [28] J. Ye, Similarity measure between interval neutrosophic sets and their applications in multicriteria decision making, *journal of intelligent and fuzzy systems* 26,(2014) 165-172.
- [29] J. Ye, Multiple attribute group decision –making method with completely unknown weights based on similarity measures under single valued neutrosophic environment, *Journal of intelligent and Fuzzy systems*,2014,DOI:10.3233/IFS-141252.
- [30] J. Ye, Single valued neutrosophic cross-entropy for multicriteria decision making problems, *Applied Mathematical Modelling*,38, (2014) 1170-1175.
- [31] J. Ye, Single valued neutrosophic minimum spanning tree and its clustering method, *Journal of intelligent Systems* 23(3), (2014)311-324.
- [32] J.Ye, Multicriteria decision-making method using the correlation coefficient under single-valued neutrosophic environment. *International Journal of General Systems*, Vol. 42, No. 4,(2013) 386–394, <http://dx.doi.org/10.1080/03081079.2012.761609>.
- [33] J. Ye, Some aggregation operators of interval neutrosophic linguistic numbers for multiple attribute decision making, *Journal of Intelligent and Fuzzy System* (2014), DOI:10.3233/IFS-141187
- [34] J. Ye, Single valued neutrosophic minimum spanning tree and its clustering method, *De Gruyter journal of intelligent system*, (2013) 1-24.
- [35] J. Ye, A Multicriteria decision-making method using aggregation operators for simplified neutrosophic sets, *Journal of Intelligent and Fuzzy System*, (2013), DOI:10.3233/IFS-130916.
- [36] K.T. Atanassov, Intuitionistic Fuzzy Sets. *Fuzzy sets and systems* 20(1),(1986) 87-96.
- [37] K. Alhazaymeh& N. Hassan, Possibility Vague Soft Set and its Application in Decision Making. *International Journal of Pure and Applied Mathematics* 77 (4), (2012) 549-563.
- [38] K. Alhazaymeh& N. Hassan, Application of generalized vague soft expert set in decision making, *International Journal of Pure and Applied Mathematics* 93(3), (2014) 361-367.
- [39] K. Alhazaymeh& N. Hassan, Generalized vague soft expert set, *International Journal of Pure and Applied Mathematics*, (in press).
- [40] K. Alhazaymeh& N. Hassan, Mapping on generalized vague soft expert set, *International Journal of Pure and Applied Mathematics*,Vol 93, No. 3 (2014) 369-376.
- [41] K.V. Babitha and J. J. Sunil, Generalized Intuitionistic Fuzzy Soft Sets and Its Applications “, *Gen. Math. Notes*, 7/ 2 (2011) 1-14.
- [42] L.A. Zadeh, Fuzzy sets, *Information and control*,Vol8 (1965) 338-356.
- [43] L. Peide, Y. Li, Y. Chen, Some generalized neutrosophic number hamacher Aggregation operators and their application to group decision making, *International Journal of Fuzzy Systems*,Vol,16,No.2,(2014) 212-255.
- [44] M. Bashir & A.R. Salleh& S. Alkhazaleh.Possibility intuitionistic fuzzy soft sets.*Advances in Decision Sciences*, 2012, Article ID 404325, 24 pages.
- [45] M. Bashir & A.R. Salleh. Fuzzy parameterized soft expert set. *Abstract and Applied Analysis*, , 2012, Article ID 258361, 12pages.

- [46] M. Bashir & A.R. Salleh, Possibility Fuzzy Soft Expert Set. *Open Journal of Applied Sciences* 12,(2012) 208-211.
- [47] M. Borah, T. J. Neog and D. K. Sut, A study on some operations of fuzzy soft sets, *International Journal of Modern Engineering Research*, 2/ 2 (2012) 157-168.
- [48] N. Hassan & K. Alhazaymeh, Vague soft expert set Theory. *AIP Conference Proceedings* 1522, 953 (2013) 953-958.
- [49] N. Çağman, S. Enginoğlu, F. Çıtak, Fuzzy Soft Set Theory and Its Applications. *Iranian Journal of Fuzzy System* 8(3) (2011) 137-147.
- [50] N. Çağman, Contributions to the theory of soft sets, *Journal of New Results in Science*, Vol 4, (2014) 33-41 from <http://jnrs.gop.edu.tr>
- [51] N. Çağman, S. Karataş, Intuitionistic fuzzy soft set theory and its decision making, *Journal of Intelligent and Fuzzy Systems* DOI:10.3233/IFS-2012-0601.
- [52] N. Çağman, I. Deli, Intuitionistic fuzzy parametrized soft set theory and its decision making, *Applied Soft Computing* 28 (2015) 109–113.
- [53] N. Çağman, F. Karaaslan, IFP –fuzzy soft set theory and its applications, Submitted.
- [54] N. Çağman, I. Deli, Product of FP-Soft Sets and its Applications, *Hacettepe Journal of Mathematics and Statistics*, 41/3 (2012) 365 - 374.
- [55] N. Çağman, I. Deli, Means of FP-soft sets and its applications, *Hacettepe Journal of Mathematics and Statistics*, 41/5 (2012) 615–625.
- [56] P. K. Maji, A. R. Roy and R. Biswas, Fuzzy soft sets, *Journal of Fuzzy Mathematics*, 9/3 (2001) 589-602.
- [57] P. K. Maji, R. Biswas and A. R. Roy, Intuitionistic fuzzy soft sets, *The Journal of Fuzzy Mathematics*, 9/3 (2001) 677-692.
- [58] P. K. Maji, R. Biswas and A. R. Roy, Soft set theory, *Comput.Math.Appl.*,45,(2003) 555-562.
- [59] P. K. Maji, Neutrosophic soft sets, *Annals of Fuzzy Mathematics*, Vol. 5,No 1,(2013) 157-168.
- [60] P. Majumdar, S. K. Samanta, Generalized Fuzzy Soft Sets, *Computers and Mathematics with Applications*, 59 (2010) 1425-1432
- [61] R. Sahin and A. Kucuk, Generalized Neutrosophic soft set and its integration to decision making problem, *Appl. Math. Inf. Sci.* 8(6) (2014) 2751-2759.
- [62] R. Şahin and A. Küçük, On Similarity and entropy of neutrosophic soft sets, *Journal of Intelligent and Fuzzy Systems*, DOI: 10.3233/IFS-141211.
- [63] R.Nagarajan, Subramanian, Cyclic fuzzy neutrosophic soft group, *International Journal of Scientific Research*, vol 3,issue 8,(2014) 234-244.
- [64] S. Alkhazaleh& A.R. Salleh, Fuzzy soft expert set and its application. *Applied Mathematics* 5(2014) 1349-1368.
- [65] S. Alkhazaleh& A.R. Salleh, Soft expert Sets. *Advances in Decision Sciences* 2011, Article ID 757868, 12 pages.
- [66] S. Alkhazaleh, A.R. Salleh& N. Hassan, Possibility Fuzzy Soft Sets. *Advances in Decision Sciences* (2011) Article ID 479756, 18 pages.
- [67] S. Alkhazaleh, E. Marei, Mappings on neutrosophic soft classes, *Neutrosophic Sets & Systems*, Issue 2, (2014) p3.
- [68] S. Broumi and F. Smarandache, Intuitionistic neutrosophic soft set, *Journal of Information and Computing Science*, 8/ 2 (2013) 130-140.
- [69] S. Broumi, Generalized neutrosophic soft set, *International Journal of Computer Science, Engineering and Information Technology*, 3/2 (2013) 17-30.

- [70] S. Broumi and F. Smarandache, More on intuitionistic neutrosophic soft sets, *Computer Science and Information Technology*, 1/4 (2013) 257-268.
- [71] S. Broumi, Generalized neutrosophic soft set, *International Journal of Computer Science, Engineering and Information Technology*, 3(2) (2013) 17-30.
- [72] S. Broumi, F. Smarandache, Correlation Coefficient of Interval Neutrosophic set, *Periodical of Applied Mechanics and Materials*, Vol. 436, 2013, with the title *Engineering Decisions and Scientific Research Aerospace, Robotics, Biomechanics, Mechanical Engineering and Manufacturing; Proceedings of the International Conference ICMERA, Bucharest, October 2013*.
- [73] S. Broumi, F. Smarandache, Several Similarity Measures of Neutrosophic Sets, *Neutrosophic Sets and Systems*, 1, (2013) 54-62.
- [74] S. Broumi, I. Deli, and F. Smarandache, Relations on interval valued neutrosophic soft sets, *Journal of New Results in Science*, 5 (2014) 1-20.
- [75] S. Broumi, I. Deli, F. Smarandache, Neutrosophic parameterized soft set theory and its decision making problem, *Italian Journal of Pure and Applied Mathematics* N. 32, (2014) 1 -12.
- [76] S. Broumi, F. Smarandache, On Neutrosophic implications, *Neutrosophic Sets and Systems*, Vol. 2, (2014) 9-17.
- [77] S. Broumi, F. Smarandache, Rough neutrosophic sets. *Italian Journal of Pure and Applied Mathematics*, N.32, (2014) 493-502.
- [78] S. Broumi, R. Sahin and F. Smarandache, Generalized interval neutrosophic soft set and its decision making problem, *Journal of New Results in Science* No 7, (2014) 29-47.
- [79] S. Broumi, F. Smarandache and P. K. Maji, Intuitionistic neutrosophic soft set over rings, *Mathematics and Statistics* 2(3): (2014) 120-126, DOI: 10.13189/ms.2014.020303.
- [80] S. Broumi, F. Smarandache, Single valued neutrosophic trapezoid linguistic aggregation operators based multi-attribute decision making, *Bulletin of Pure & Applied Sciences- Mathematics and Statistics*, Volume : 33e, Issue : 2, (2014) 135-155.
- [81] S. Broumi, F. Smarandache, Interval-Valued Neutrosophic Soft Rough Set, *International Journal of Computational Mathematics*. Volume 2015 (2015), Article ID 232919, 13 pages <http://dx.doi.org/10.1155/2015/232919>.
- [82] S. Broumi, F. Smarandache, Lower and upper soft interval valued neutrosophic rough approximations of an IVNSS-relation, *Sisom& Acoustics*, (2014) 8 pages.
- [83] S. Broumi, J. Ye and F. Smarandache, An Extended TOPSIS method for multiple attribute decision making based on interval neutrosophic uncertain linguistic variables, *Neutrosophic Sets and Systems*, Vol 8, (2015) 23-32.
- [84] S. Broumi, F. Smarandache, New operations on interval neutrosophic sets, *Journal of new theory*, N 1, (2015) 24-37, from <http://www.newtheory.org>.
- [85] S. Broumi, F. Smarandache, Neutrosophic refined similarity measure based on cosine function, *Neutrosophic Sets and Systems*, 6, (2014) 41-47.
- [86] S. Broumi and F. Smarandache, Cosine similarity measure of interval valued neutrosophic sets, *Neutrosophic Sets and Systems*, Vol. 5, (2014) 15-20.
- [87] S. Broumi, Single valued neutrosophic soft expert soft set and its application *Journal of New Theory* 3, (2015) 67-88., From <http://www.newtheory.org>.
- [88] S. Broumi, F. Smarandache, Intuitionistic Fuzzy Soft Expert Sets and its Application in Decision Making, *Journal of New Theory*, Number: 1, (2015) 89-105, From <http://www.newtheory.org>.

- [89] S. Broumi, F. Smarandache, Mapping on Intuitionistic Fuzzy Soft Expert Sets and its Application in Decision Making, Journal of New Results in science, Number: 9, (2015) 1-10, From <http://jnrs.gop.edu.tr/>
- [90] S. Broumi, F. Smarandache, Possibility Single valued neutrosophic soft expert soft set and its application, Journal of New Theory 4, (2015) 6-29., From <http://www.newtheory.org>.
- [91] Şahin, M., Alkhazaleh, S. and Uluçay, V. Neutrosophic soft expert sets. Applied Mathematics, 6,(2015) 116-127. <http://dx.doi.org/10.4236/am.2015.61012>
- [92] T. A. Albinaa and I. Arockiarani, Soft expert *pg SET, Journal of Global Research in Mathematical Archives, Vol 2, No. 3,(2014) 29-35.

Single Valued Neutrosophic Graphs

Said Broumi, Mohamed Talea, Assia Bakali, Florentin Smarandache

Said Broumi, Mohamed Talea, Assia Bakali, Florentin Smarandache (2016). Single Valued Neutrosophic Graphs. In *New Trends in Neutrosophic Theory and Applications*, vol. I, eds.: Florentin Smarandache, Surapati Pramanik, 187-202

Abstract

The notion of single valued neutrosophic sets is a generalization of fuzzy sets, intuitionistic fuzzy sets. We apply the concept of single valued neutrosophic sets, an instance of neutrosophic sets, to graphs. We introduce certain types of single valued neutrosophic graphs (SVNG) and investigate some of their properties with proofs and examples.

Keywords

Single valued neutrosophic set, single valued neutrosophic graph, strong single valued neutrosophic graph, constant single valued neutrosophic graph, complete single valued neutrosophic graph.

1. Introduction

Neutrosophic sets (NSs) proposed by Smarandache [12, 13] is a powerful mathematical tool for dealing with incomplete, indeterminate and inconsistent information in real world. they are a generalization of the theory of fuzzy sets [24], intuitionistic fuzzy sets [21, 23] and interval valued intuitionistic fuzzy sets [22]. The neutrosophic sets are characterized by a truth-membership function (t), an indeterminacy-membership function (i) and a falsity-membership function (f) independently, which are within the real standard or nonstandard unit interval $]^{-0}, 1^{+}[$. In order to practice NS in real life applications conveniently, Wang et al. [16] introduced the concept of a single-valued neutrosophic sets (SVNS), a subclass of the neutrosophic sets. The SVNS is a generalization of intuitionistic fuzzy sets, in which three membership functions are independent and their value belong to the unit interval $[0, 1]$. Some more work on single valued neutrosophic sets and their extensions may be found on [2, 3, 4, 5, 15, 17, 19, 20, 27, 28, 29, 30].

Graph theory has now become a major branch of applied mathematics and it is generally regarded as a branch of combinatorics. Graph is a widely used tool for solving a combinatorial problem in different areas such as geometry, algebra, number theory, topology, optimization, and computer science. Most important thing which is to be noted is that, when we have uncertainty regarding either the set of vertices or edges or both, the model becomes a fuzzy graph.

Lots of works on fuzzy graphs and intuitionistic fuzzy graphs [6, 7, 8, 25, 27] have been carried out and all of them have considered the vertex sets and edge sets as fuzzy and /or intuitionistic fuzzy sets. But, when the relations between nodes (or vertices) in problems are indeterminate, the fuzzy graphs and intuitionistic fuzzy graphs are failed. For this purpose, Samarandache [9, 10, 11, 14, 34] have defined four main categories of neutrosophic graphs, two based on literal indeterminacy (I), which called them; I-edge neutrosophic graph and I-vertex neutrosophic graph, these concepts are studied deeply and has gained popularity among the researchers due to its applications via real world problems [1, 33, 35]. The two others graphs are based on (t, i, f) components and called them; The (t, i, f)-Edge neutrosophic graph and the (t, i, f)-vertex neutrosophic graph, these concepts are not developed at all. In the literature the study of single valued neutrosophic graphs (SVN-graph) is still blank, we shall focus on the study of single valued neutrosophic graphs in this paper.

In this paper, some certain types of single valued neutrosophic graphs are developed and some interesting properties are explored.

2. Preliminaries

In this section, we mainly recall some notions related to neutrosophic sets, single valued neutrosophic sets, fuzzy graph and intuitionistic fuzzy graph relevant to the present work. See especially [6, 7, 12, 13, 16] for further details and background.

Definition 2.1 [12]. Let X be a space of points (objects) with generic elements in X denoted by x ; then the neutrosophic set A (NS A) is an object having the form $A = \{ \langle x: T_A(x), I_A(x), F_A(x) \rangle, x \in X \}$, where the functions $T, I, F: X \rightarrow]^{-}0, 1^{+}[$ define respectively the a truth-membership function, an indeterminacy-membership function, and a falsity-membership function of the element $x \in X$ to the set A with the condition:

$$^{-}0 \leq T_A(x) + I_A(x) + F_A(x) \leq 3^{+}. \tag{1}$$

The functions $T_A(x), I_A(x)$ and $F_A(x)$ are real standard or nonstandard subsets of $]^{-}0, 1^{+}[$.

Since it is difficult to apply NSs to practical problems, Wang et al. [16] introduced the concept of a SVNS, which is an instance of a NS and can be used in real scientific and engineering applications.

Definition 2.2 [16]. Let X be a space of points (objects) with generic elements in X denoted by x . A single valued neutrosophic set A (SVNS A) is characterized by truth-membership function $T_A(x)$, an indeterminacy-membership function $I_A(x)$, and a falsity-membership function $F_A(x)$. For each point x in X $T_A(x), I_A(x), F_A(x) \in [0, 1]$. A SVNS A can be written as

$$A = \{ \langle x: T_A(x), I_A(x), F_A(x) \rangle, x \in X \} \tag{2}$$

Definition 2.3[6]. A fuzzy graph is a pair of functions $G = (\sigma, \mu)$ where σ is a fuzzy subset of a non empty set V and μ is a symmetric fuzzy relation on σ . i.e $\sigma: V \rightarrow [0, 1]$ and

$\mu: V \times V \rightarrow [0, 1]$ such that $\mu(uv) \leq \sigma(u) \wedge \sigma(v)$ for all $u, v \in V$ where uv denotes the edge between u and v and $\sigma(u) \wedge \sigma(v)$ denotes the minimum of $\sigma(u)$ and $\sigma(v)$. σ is called the fuzzy vertex set of V and μ is called the fuzzy edge set of E .

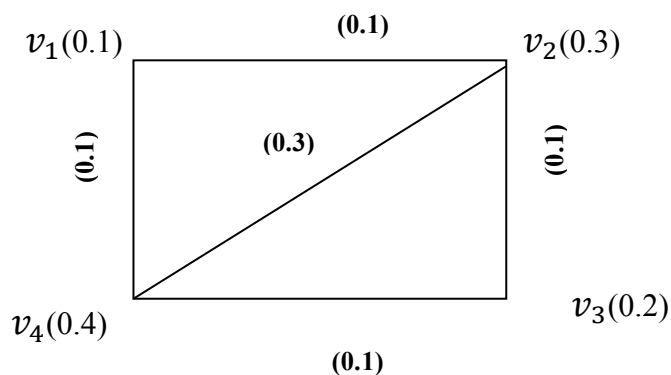

Figure 1: *Fuzzy Graph*

Definition 2.4 [6]. The fuzzy subgraph $H = (\tau, \rho)$ is called a fuzzy subgraph of $G = (\sigma, \mu)$

If $\tau(u) \leq \sigma(u)$ for all $u \in V$ and $\rho(u, v) \leq \mu(u, v)$ for all $u, v \in V$.

Definition 2.5 [7]. An Intuitionistic fuzzy graph is of the form $G = (V, E)$ where

- i. $V = \{v_1, v_2, \dots, v_n\}$ such that $\mu_1: V \rightarrow [0,1]$ and $\gamma_1: V \rightarrow [0,1]$ denote the degree of membership and nonmembership of the element $v_i \in V$, respectively, and $0 \leq \mu_1(v_i) + \gamma_1(v_i) \leq 1$ for every $v_i \in V, (i = 1, 2, \dots, n)$,
- ii. $E \subseteq V \times V$ where $\mu_2: V \times V \rightarrow [0,1]$ and $\gamma_2: V \times V \rightarrow [0,1]$ are such that $\mu_2(v_i, v_j) \leq \min [\mu_1(v_i), \mu_1(v_j)]$ and $\gamma_2(v_i, v_j) \geq \max [\gamma_1(v_i), \gamma_1(v_j)]$ and $0 \leq \mu_2(v_i, v_j) + \gamma_2(v_i, v_j) \leq 1$ for every $(v_i, v_j) \in E, (i, j = 1, 2, \dots, n)$

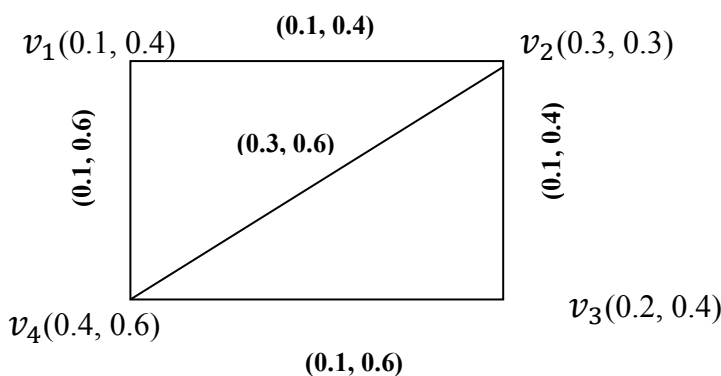

Figure 2: *Intuitionistic Fuzzy Graph*

Definition 2.6 [31]. Let $A = (T_A, I_A, F_A)$ and $B = (T_B, I_B, F_B)$ be single valued neutrosophic sets on a set X . If $A = (T_A, I_A, F_A)$ is a single valued neutrosophic relation on a set X , then $A = (T_A, I_A, F_A)$ is called a single valued neutrosophic relation on $B = (T_B, I_B, F_B)$ if

$$T_B(x, y) \leq \min(T_A(x), T_A(y))$$

$$I_B(x, y) \geq \max(I_A(x), I_A(y)) \text{ and}$$

$$F_B(x, y) \geq \max(F_A(x), F_A(y)) \text{ for all } x, y \in X.$$

A single valued neutrosophic relation A on X is called symmetric if $T_A(x, y) = T_A(y, x)$, $I_A(x, y) = I_A(y, x)$, $F_A(x, y) = F_A(y, x)$ and $T_B(x, y) = T_B(y, x)$, $I_B(x, y) = I_B(y, x)$ and $F_B(x, y) = F_B(y, x)$, for all $x, y \in X$.

3. Single Valued Neutrosophic Graphs

Throught this paper, we denote $G^* = (V, E)$ a crisp graph, and $G = (A, B)$ a single valued neutrosophic graph

Definition 3.1. A single valued neutrosophic graph (SVN-graph) with underlying set V is defined to be a pair $G = (A, B)$ where

1.The functions $T_A:V \rightarrow [0, 1]$, $I_A:V \rightarrow [0, 1]$ and $F_A:V \rightarrow [0, 1]$ denote the degree of truth-membership, degree of indeterminacy-membership and falsity-membership of the element $v_i \in V$, respectively, and

$$0 \leq T_A(v_i) + I_A(v_i) + F_A(v_i) \leq 3 \text{ for all } v_i \in V (i=1, 2, \dots, n)$$

2. The functions $T_B: E \subseteq V \times V \rightarrow [0, 1]$, $I_B: E \subseteq V \times V \rightarrow [0, 1]$ and $F_B: E \subseteq V \times V \rightarrow [0, 1]$ are defined by

$$T_B(\{v_i, v_j\}) \leq \min [T_A(v_i), T_A(v_j)],$$

$$I_B(\{v_i, v_j\}) \geq \max [I_A(v_i), I_A(v_j)] \text{ and}$$

$$F_B(\{v_i, v_j\}) \geq \max [F_A(v_i), F_A(v_j)]$$

Denotes the degree of truth-membership, indeterminacy-membership and falsity-membership of the edge $(v_i, v_j) \in E$ respectively, where

$$0 \leq T_B(\{v_i, v_j\}) + I_B(\{v_i, v_j\}) + F_B(\{v_i, v_j\}) \leq 3 \text{ for all } \{v_i, v_j\} \in E (i, j = 1, 2, \dots, n)$$

We call A the single valued neutrosophic vertex set of V , B the single valued neutrosophic edge set of E , respectively, Note that B is a symmetric single valued neutrosophic relation on A . We use the notation (v_i, v_j) for an element of E Thus, $G = (A, B)$ is a single valued neutrosophic graph of $G^* = (V, E)$ if

$$T_B(v_i, v_j) \leq \min [T_A(v_i), T_A(v_j)],$$

$$I_B(v_i, v_j) \geq \max [I_A(v_i), I_A(v_j)] \text{ and}$$

$$F_B(v_i, v_j) \geq \max [F_A(v_i), F_A(v_j)] \quad \text{for all } (v_i, v_j) \in E$$

Example 3.2. Consider a graph G^* such that $V = \{v_1, v_2, v_3, v_4\}$, $E = \{v_1v_2, v_2v_3, v_3v_4, v_4v_1\}$. Let A be a single valued neutrosophic subset of V and let B a single valued neutrosophic subset of E denoted by

	v_1	v_2	v_3	v_4
T_A	0.5	0.6	0.2	0.4
I_A	0.1	0.3	0.3	0.2
F_A	0.4	0.2	0.4	0.5

	v_1v_2	v_2v_3	v_3v_4	v_4v_1
T_B	0.2	0.3	0.2	0.1
I_B	0.3	0.3	0.3	0.2
F_B	0.4	0.4	0.4	0.5

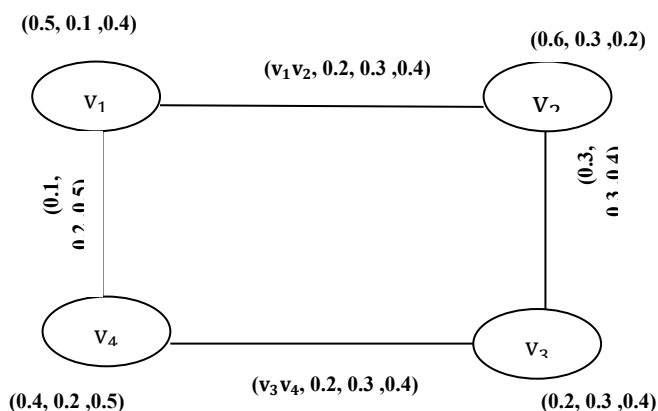

Figure 3: G : Single valued neutrosophic graph

- In figure 3, (i) $(v_1, 0.5, 0.1, 0.4)$ is a single valued neutrosophic vertex or SVN-vertex
- (ii) $(v_1v_2, 0.2, 0.3, 0.4)$ is a single valued neutrosophic edge or SVN-edge
- (iii) $(v_1, 0.5, 0.1, 0.4)$ and $(v_2, 0.6, 0.3, 0.2)$ are single valued neutrosophic adjacent vertices.
- (iv) $(v_1v_2, 0.2, 0.3, 0.4)$ and $(v_1v_4, 0.1, 0.2, 0.5)$ are a single valued neutrosophic adjacent edge.

Note 1. (i) When $T_{Bij} = I_{Bij} = F_{Bij}$ for some i and j , then there is no edge between v_i and v_j .

Otherwise there exists an edge between v_i and v_j .

(ii) If one of the inequalities is not satisfied in (1) and (2), then G is not an SVNG

The single valued neutrosophic graph G depicted in figure 3 is represented by the following adjacency matrix M_G

$$M_G = \begin{bmatrix} (0.5, 0.1, 0.4) & (0.2, 0.3, 0.4) & (0, 0, 0) & (0.1, 0.2, 0.5) \\ (0.2, 0.3, 0.4) & (0.6, 0.3, 0.2) & (0.3, 0.3, 0.4) & (0, 0, 0) \\ (0, 0, 0) & (0.3, 0.3, 0.4) & (0.2, 0.3, 0.4) & (0.2, 0.3, 0.4) \\ (0.1, 0.2, 0.5) & (0, 0, 0) & (0.2, 0.3, 0.4) & (0.4, 0.2, 0.5) \end{bmatrix}$$

Definition 3.3. A partial SVN-subgraph of SVN-graph $G = (A, B)$ is a SVN-graph $H = (V', E')$ such that

- (i) $V' \subseteq V$, where $T'_{Ai} \leq T_{Ai}$, $I'_{Ai} \geq I_{Ai}$, $F'_{Ai} \geq F_{Ai}$ for all $v_i \in V$.
- (ii) $E' \subseteq E$, where $T'_{Bij} \leq T_{Bij}$, $I'_{Bij} \geq I_{Bij}$, $F'_{Bij} \geq F_{Bij}$ for all $(v_i v_j) \in E$.

Definition 3.4. A SVN-subgraph of SVN-graph $G = (V, E)$ is a SVN-graph $H = (V', E')$ such that

- (i) $V' = V$, where $T'_{Ai} = T_{Ai}$, $I'_{Ai} = I_{Ai}$, $F'_{Ai} = F_{Ai}$ for all v_i in the vertex set of V' .
- (ii) $E' = E$, where $T'_{Bij} = T_{Bij}$, $I'_{Bij} = I_{Bij}$, $F'_{Bij} = F_{Bij}$ for every $(v_i v_j) \in E$ in the edge set of E' .

Example 3.5. G_1 in Figure 4 is a SVN-graph. H_1 in Figure 5 is a partial SVN-subgraph and

H_2 in Figure 6 is a SVN-subgraph of G_1

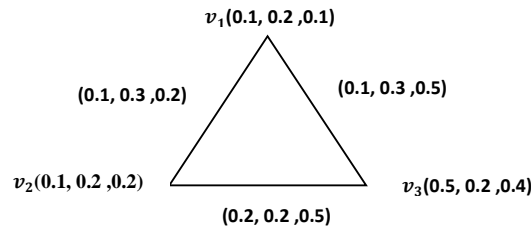

Figure 4: G_1 , a single valued neutrosophic graph

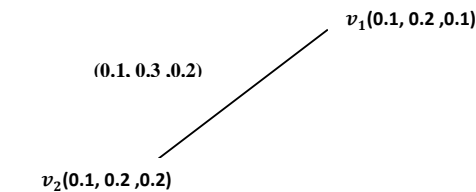
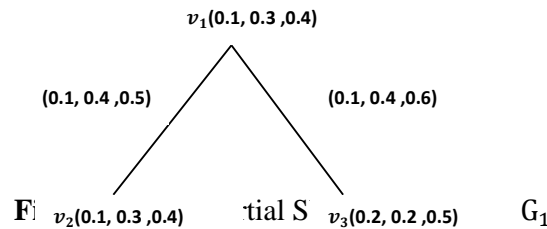

Figure 6: H_2 , a SVN-subgraph of G_1 .

Definition 3.6. The two vertices are said to be adjacent in a single valued neutrosophic graph $G = (A, B)$ if $T_B(\mathbf{42}_i, \mathbf{42}_j) = \min [T_A(\mathbf{42}_i), T_A(\mathbf{42}_j)]$, $I_B(\mathbf{42}_i, \mathbf{42}_j) = \max [I_A(\mathbf{42}_i), I_A(\mathbf{42}_j)]$ and

$F_B(v_i, v_j) = \max [F_A(v_i), F_A(v_j)]$. In this case, v_i and v_j are said to be neighbours and (v_i, v_j) is incident at v_i and v_j also.

Definition 3.7. A path P in a single valued neutrosophic graph $G=(A, B)$ is a sequence of distinct vertices $v_0, v_1, v_2, \dots, v_n$ such that $T_B(v_{i-1}, v_i) > 0$, $I_B(v_{i-1}, v_i) > 0$ and $F_B(v_{i-1}, v_i) > 0$ for $0 \leq i \leq 1$. Here $n \geq 1$ is called the length of the path P . A single node or vertex v_i may also be considered as a path. In this case the path is of the length $(0, 0, 0)$. The consecutive pairs (v_{i-1}, v_i) are called edges of the path. We call P a cycle if $v_0 = v_n$ and $n \geq 3$.

Definition 3.8. A single valued neutrosophic graph $G=(A, B)$ is said to be connected if every pair of vertices has at least one single valued neutrosophic path between them, otherwise it is disconnected.

Definition 3.9. A vertex $v_j \in V$ of single valued neutrosophic graph $G=(A, B)$ is said to be an isolated vertex if there is no effective edge incident at v_j .

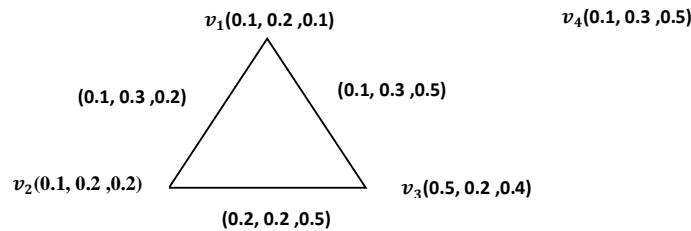

Figure 7: Example of single valued neutrosophic graph

In figure 7, the single valued neutrosophic vertex v_4 is an isolated vertex.

Definition 3.10. A vertex in a single valued neutrosophic $G=(A, B)$ having exactly one neighbor is called a **pendent vertex**. Otherwise, it is called **non-pendent vertex**. An edge in a single valued neutrosophic graph incident with a pendent vertex is called a **pendent edge**. Otherwise it is called **non-pendent edge**. A vertex in a single valued neutrosophic graph adjacent to the pendent vertex is called a **support** of the pendent edge

Definition 3.11. A single valued neutrosophic graph $G=(A, B)$ that has neither self loops nor parallel edge is called **simple single valued neutrosophic graph**.

Definition 3.12. When a vertex v_i is end vertex of some edges (v_i, v_j) of any SVN-graph $G=(A, B)$. Then v_i and (v_i, v_j) are said to be **incident** to each other.

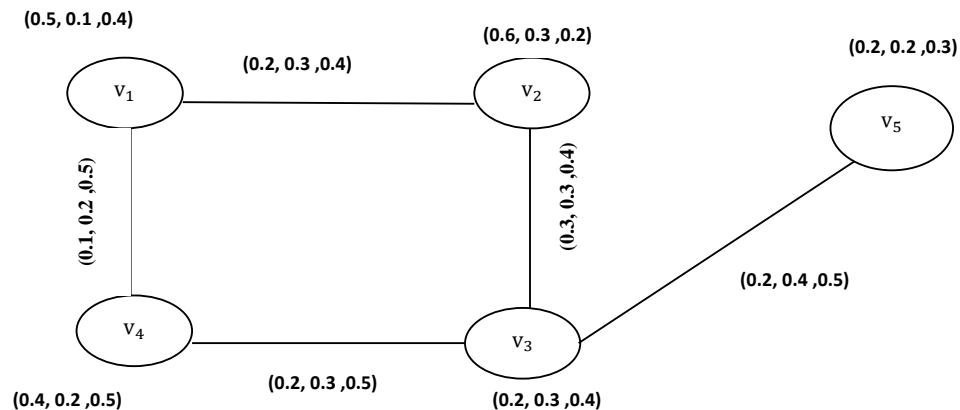

Figure 8: Incident SVN-graph.

In this graph v_2v_3, v_3v_4 and v_3v_5 are incident on v_3 .

Definition 3.13. Let $G = (A, B)$ be a single valued neutrosophic graph. Then the degree of any vertex v is sum of degree of truth-membership, sum of degree of indeterminacy-membership and sum of degree of falsity-membership of all those edges which are incident on vertex v denoted by $d(v) = (d_T(v), d_I(v), d_F(v))$ where

$d_T(v) = \sum_{u \neq v} T_B(u, v)$ denotes degree of truth-membership vertex.

$d_I(v) = \sum_{u \neq v} I_B(u, v)$ denotes degree of indeterminacy-membership vertex.

$d_F(v) = \sum_{u \neq v} F_B(u, v)$ denotes degree of falsity-membership vertex.

Example 3.14. Let us consider a single valued neutrosophic graph $G = (A, B)$ of $G^* = (V, E)$ where $V = \{v_1, v_2, v_3, v_4\}$ and $E = \{v_1v_2, v_2v_3, v_3v_4, v_4v_1\}$.

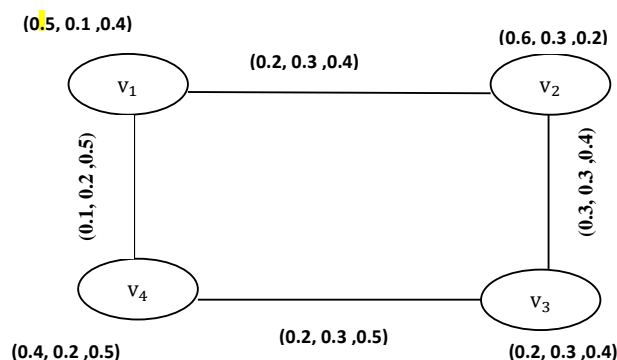

Figure 9: Degree of vertex of single valued neutrosophic graph

We have, the degree of each vertex as follows:

$$d(v_1) = (0.3, 0.5, 0.9), d(v_2) = (0.5, 0.6, 0.8), d(v_3) = (0.5, 0.6, 0.9), d(v_4) = (0.3, 0.5, 1)$$

Definition 3.15. A single valued neutrosophic graph $G = (A, B)$ is called constant if degree of each vertex is $k = (k_1, k_2, k_3)$. That is, $d(v) = (k_1, k_2, k_3)$ for all $v \in V$.

Example 3.16. Consider a single valued neutrosophic graph G such that $V = \{v_1, v_2, v_3, v_4\}$ and $E = \{v_1v_2, v_2v_3, v_3v_4, v_4v_1\}$.

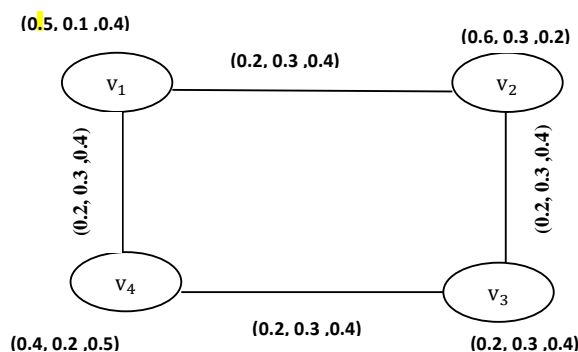

Figure 10: Constant SVN-graph.

Clearly, G is constant SVN-graph since the degree of v_1, v_2, v_3 and v_4 is $(0.4, 0.6, 0.8)$.

Definition 3.17. A single valued neutrosophic graph $G = (A, B)$ of $G^* = (V, E)$ is called strong single valued neutrosophic graph if

$$T_B(v_i, v_j) = \min [T_A(v_i), T_A(v_j)]$$

$$I_B(v_i, v_j) = \max [I_A(v_i), I_A(v_j)]$$

$$F_B(v_i, v_j) = \max [F_A(v_i), F_A(v_j)]$$

For all $(v_i, v_j) \in E$.

Example 3.18. Consider a graph G^* such that $V = \{v_1, v_2, v_3, v_4\}$, $E = \{v_1v_2, v_2v_3, v_3v_4, v_4v_1\}$. Let A be a single valued neutrosophic subset of V and let B a single valued neutrosophic subset of E denoted by

	v_1	v_2	v_3	v_4
T_A	0.5	0.6	0.2	0.4
I_A	0.1	0.3	0.3	0.2
F_A	0.4	0.2	0.4	0.5

	v_1v_2	v_2v_3	v_3v_4	v_4v_1
T	0.5	0.2	0.2	0.4
I	0.3	0.3	0.3	0.2
F	0.4	0.4	0.5	0.5

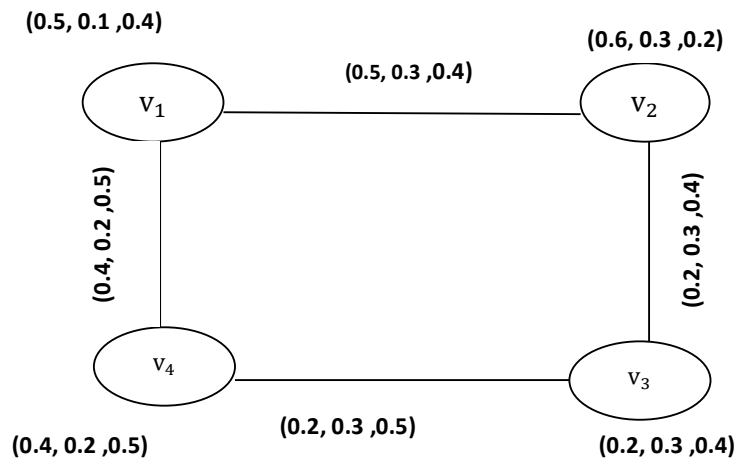

Figure 11: Strong SVN-graph

By routing computations, it is easy to see that G is a strong single valued neutrosophic of G^* .

Proposition 3.19. A single valued neutrosophic graph is the generalization of fuzzy graph

Proof: Suppose $G = (V, E)$ be a single valued neutrosophic graph. Then by setting the indeterminacy- membership and falsity- membership values of vertex set and edge set equals to zero reduces the single valued neutrosophic graph to fuzzy graph.

Proposition 3.20. A single valued neutrosophic graph is the generalization of intuitionistic fuzzy graph.

Proof: Suppose $G = (V, E)$ be a single valued neutrosophic graph. Then by setting the indeterminacy- membership value of vertex set and edge set equals to zero reduces the single valued neutrosophic graph to intuitionistic fuzzy graph.

Definition 3.21. The complement of a single valued neutrosophic graph $G(A, B)$ on G^* is a single valued neutrosophic graph \bar{G} on G^* where:

1. $\bar{A} = A$
2. $\bar{T}_A(v_i) = T_A(v_i), \bar{I}_A(v_i) = I_A(v_i), \bar{F}_A(v_i) = F_A(v_i),$ for all $v_i \in V.$
3. $\bar{T}_B(v_i, v_j) = \min [T_A(v_i), T_A(v_j)] - T_B(v_i, v_j)$
 $\bar{I}_B(v_i, v_j) = \max [I_A(v_i), I_A(v_j)] - I_B(v_i, v_j)$ and
 $\bar{F}_B(v_i, v_j) = \max [F_A(v_i), F_A(v_j)] - F_B(v_i, v_j),$ For all $(v_i, v_j) \in E$

Remark 3.22. if $G = (V, E)$ is a single valued neutrosophic graph on G^* . Then from above definition, it follow that $\bar{\bar{G}}$ is given by the single valued neutrosophic graph $\bar{\bar{G}} = (\bar{\bar{V}}, \bar{\bar{E}})$ on G^* where $\bar{\bar{V}} = V$ and $\bar{\bar{T}}_B(v_i, v_j) = \min [T_A(v_i), T_A(v_j)] - T_B(v_i, v_j),$

$$\bar{\bar{I}}_B(v_i, v_j) = \min [I_A(v_i), I_A(v_j)] - I_B(v_i, v_j), \text{ and}$$

$$\bar{\bar{F}}_B(v_i, v_j) = \min [F_A(v_i), F_A(v_j)] - F_B(v_i, v_j) \text{ For all } (v_i, v_j) \in E.$$

Thus $\bar{\bar{T}}_B = T_B, \bar{\bar{I}}_B = I_B,$ and $\bar{\bar{F}}_B = F_B$ on $V,$ where $E = (T_B, I_B, F_B)$ is the single valued neutrosophic relation on $V.$ For any single valued neutrosophic graph $G, \bar{\bar{G}}$ is strong single valued neutrosophic graph and $G \subseteq \bar{\bar{G}}.$

Proposition 3.23. $G = \bar{\bar{G}}$ if and only if G is a strong single valued neutrosophic graph.

Proof. it is obvious.

Definition 3.24. A strong single valued neutrosophic graph G is called self complementary if $G \cong \bar{G}.$ Where \bar{G} is the complement of single valued neutrosophic graph $G.$

Example 3.25. Consider a graph $G^* = (V, E)$ such that $V = \{v_1, v_2, v_3, v_4\}, E = \{v_1v_2, v_2v_3, v_3v_4, v_1v_4\}.$ Consider a single valued neutrosophic graph $G.$

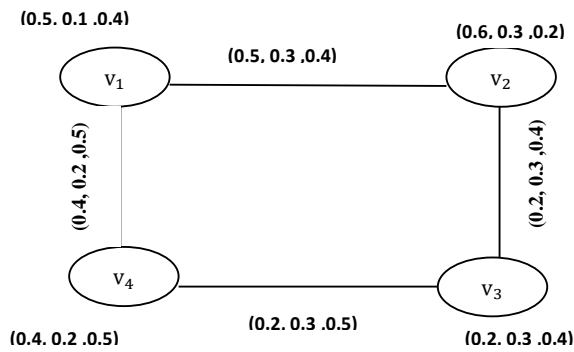

Figure 12: G: Strong SVN- graph

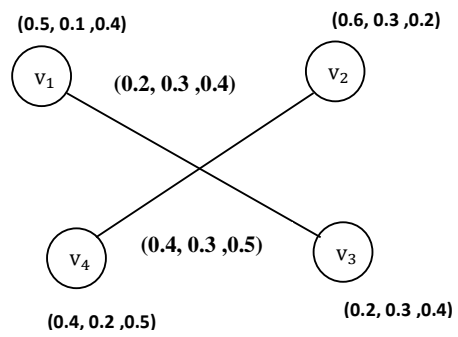

Figure 13: \bar{G} Strong SVN- graph

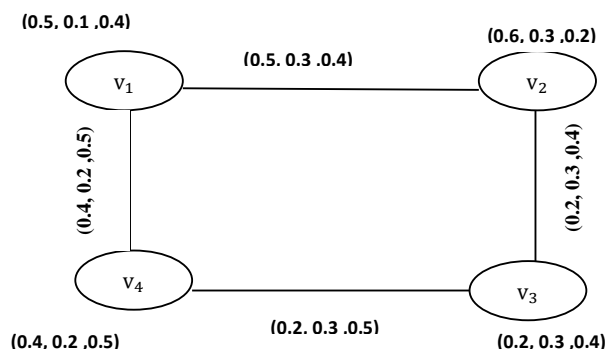

Figure 14: $\bar{\bar{G}}$ Strong SVN- graph

Clearly, $G \cong \bar{\bar{G}}$. Hence G is self complementary.

Proposition 3.26. Let $G = (A, B)$ be a **strong** single valued neutrosophic graph. If

$$T_B(v_i, v_j) = \min [T_A(v_i), T_A(v_j)],$$

$$I_B(v_i, v_j) = \max [I_A(v_i), I_A(v_j)] \text{ and}$$

$$F_B(v_i, v_j) = \max [F_A(v_i), F_A(v_j)] \text{ for all } v_i, v_j \in V. \text{ Then } G \text{ is self complementary.}$$

Proof. Let $G = (A, B)$ be a strong single valued neutrosophic graph such that

$$T_B(v_i, v_j) = \min [T_A(v_i), T_A(v_j)]$$

$$I_B(v_i, v_j) = \max [I_A(v_i), I_A(v_j)]$$

$$F_B(v_i, v_j) = \max [F_A(v_i), F_A(v_j)]$$

For all $v_i, v_j \in V$. Then $G \approx \bar{\bar{G}}$ under the identity map $I: V \rightarrow V$. Hence G is self complementary.

Proposition 3.27. Let G be a self complementary single valued neutrosophic graph. Then

$$\sum_{v_i \neq v_j} T_B(v_i, v_j) = \frac{1}{2} \sum_{v_i \neq v_j} \min [T_A(v_i), T_A(v_j)]$$

$$\sum_{v_i \neq v_j} I_B(v_i, v_j) = \frac{1}{2} \sum_{v_i \neq v_j} \max [I_A(v_i), I_A(v_j)]$$

$$\sum_{v_i \neq v_j} F_B(v_i, v_j) = \frac{1}{2} \sum_{v_i \neq v_j} \max [F_A(v_i), F_A(v_j)]$$

Proof

If G be a self complementary single valued neutrosophic graph. Then there exist an isomorphism $f: V_1 \rightarrow V_1$ satisfying

$$\overline{T_{V_1}}(f(v_i)) = T_{V_1}(f(v_i)) = T_{V_1}(v_i)$$

$$\overline{I_{V_1}}(f(v_i)) = I_{V_1}(f(v_i)) = I_{V_1}(v_i)$$

$$\overline{F_{V_1}}(f(v_i)) = F_{V_1}(f(v_i)) = F_{V_1}(v_i) \text{ for all } v_i \in V_1. \text{ And}$$

$$\overline{T_{E_1}}(f(v_i), f(v_j)) = T_{E_1}(f(v_i), f(v_j)) = T_{E_1}(v_i, v_j)$$

$$\overline{I_{E_1}}(f(v_i), f(v_j)) = I_{E_1}(f(v_i), f(v_j)) = I_{E_1}(v_i, v_j)$$

$$\overline{F_{E_1}}(f(v_i), f(v_j)) = F_{E_1}(f(v_i), f(v_j)) = F_{E_1}(v_i, v_j) \text{ for all } (v_i, v_j) \in E_1$$

We have

$$\overline{T_{E_1}}(f(v_i), f(v_j)) = \min [\overline{T_{V_1}}(f(v_i)), \overline{T_{V_1}}(f(v_j))] - T_{E_1}(f(v_i), f(v_j))$$

$$\text{i.e, } T_{E_1}(v_i, v_j) = \min [T_{V_1}(v_i), T_{V_1}(v_j)] - T_{E_1}(f(v_i), f(v_j))$$

$$T_{E_1}(v_i, v_j) = \min [T_{V_1}(v_i), T_{V_1}(v_j)] - T_{E_1}(v_i, v_j)$$

$$\text{That is } \sum_{v_i \neq v_j} T_{E_1}(v_i, v_j) + \sum_{v_i \neq v_j} T_{E_1}(v_i, v_j) = \sum_{v_i \neq v_j} \min [T_{V_1}(v_i), T_{V_1}(v_j)]$$

$$\sum_{v_i \neq v_j} I_{E_1}(v_i, v_j) + \sum_{v_i \neq v_j} I_{E_1}(v_i, v_j) = \sum_{v_i \neq v_j} \max [I_{V_1}(v_i), I_{V_1}(v_j)]$$

$$\sum_{v_i \neq v_j} F_{E_1}(v_i, v_j) + \sum_{v_i \neq v_j} F_{E_1}(v_i, v_j) = \sum_{v_i \neq v_j} \max [F_{V_1}(v_i), F_{V_1}(v_j)]$$

$$2 \sum_{v_i \neq v_j} T_{E_1}(v_i, v_j) = \sum_{v_i \neq v_j} \min [T_{V_1}(v_i), T_{V_1}(v_j)]$$

$$2 \sum_{v_i \neq v_j} I_{E_1}(v_i, v_j) = \sum_{v_i \neq v_j} \max [I_{V_1}(v_i), I_{V_1}(v_j)]$$

$$2 \sum_{v_i \neq v_j} F_{E_1}(v_i, v_j) = \sum_{v_i \neq v_j} \max [F_{V_1}(v_i), F_{V_1}(v_j)]$$

From these equations, Proposition 3.27 holds

Proposition 3.28. Let G_1 and G_2 be strong single valued neutrosophic graph, $\overline{G_1} \approx \overline{G_2}$ (isomorphism)

Proof. Assume that G_1 and G_2 are isomorphic, there exist a bijective map $f: V_1 \rightarrow V_2$ satisfying

$$T_{V_1}(v_i) = T_{V_2}(f(v_i)),$$

$$I_{V_1}(v_i) = I_{V_2}(f(v_i)),$$

$$F_{V_1}(v_i) = F_{V_2}(f(v_i)) \text{ for all } v_i \in V_1. \text{ And}$$

$$T_{E_1}(v_i, v_j) = T_{E_2}(f(v_i), f(v_j)),$$

$$I_{E_1}(v_i, v_j) = I_{E_2}(f(v_i), f(v_j)),$$

$$F_{E_1}(v_i, v_j) = F_{E_2}(f(v_i), f(v_j)) \text{ for all } (v_i, v_j) \in E_1$$

By definition 3.21, we have

$$\overline{T_{E_1}}(\mathbf{42}_i, \mathbf{42}_j) = \min [T_{V_1}(\mathbf{42}_i), T_{V_1}(\mathbf{42}_j)] - T_{E_1}(\mathbf{42}_i, \mathbf{42}_j)$$

$$\begin{aligned}
 &= \min [T_{V_2}(f(v_i)), T_{V_2}(f(v_j))] - T_{E_2}(f(v_i), f(v_j)), \\
 &= \overline{T_{E_2}}(f(v_i), f(v_j)), \\
 \overline{I_{E_1}}(v_i, v_j) &= \max [I_{V_1}(v_i), I_{V_1}(v_j)] - I_{E_1}(v_i, v_j) \\
 &= \max [I_{V_2}(f(v_i)), I_{V_2}(f(v_j))] - I_{E_2}(f(v_i), f(v_j)), \\
 &= \overline{I_{E_2}}(f(v_i), f(v_j)), \\
 \overline{F_{E_1}}(v_i, v_j) &= \min [F_{V_1}(v_i), F_{V_1}(v_j)] - F_{E_1}(v_i, v_j) \\
 &= \min [F_{V_2}(f(v_i)), F_{V_2}(f(v_j))] - F_{E_2}(f(v_i), f(v_j)), \\
 &= \overline{F_{E_2}}(f(v_i), f(v_j)),
 \end{aligned}$$

For all $(v_i, v_j) \in E_1$. Hence $\overline{G_1} \approx \overline{G_2}$. The converse is straightforward.

4. COMPLETE SINGLE VALUED NEUTROSOPHIC GRAPHS

For the sake of simplicity we denote $T_A(v_i)$ by T_{Ai} , $I_A(v_i)$ by I_{Ai} , and $F_A(v_i)$ by F_{Ai} . Also $T_B(v_i, v_j)$ by T_{Bij} , $I_B(v_i, v_j)$ by I_{Bij} and $F_B(v_i, v_j)$ by F_{Bij} .

Definition 4.1. A single valued neutrosophic graph $G = (A, B)$ is called complete if

$$T_{Bij} = \min (T_{Ai}, T_{Aj}), I_{Bij} = \max (I_{Ai}, I_{Aj}) \text{ and } F_{Bij} = \max (F_{Ai}, F_{Aj}) \text{ for all } v_i, v_j \in V.$$

Example 4.2. Consider a graph $G^* = (V, E)$ such that $V = \{v_1, v_2, v_3, v_4\}$, $E = \{v_1v_2, v_1v_3, v_2v_3, v_1v_4, v_3v_4, v_2v_4\}$. Then $G = (A, B)$ is a complete single valued neutrosophic graph of G^* .

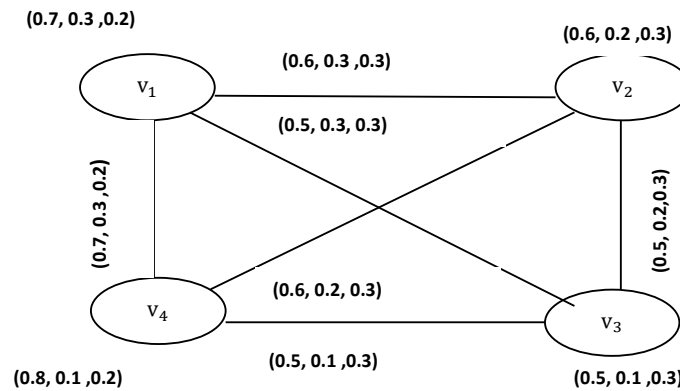

Figure 13: Complete single valued neutrosophic graph

Definition 4.3. The complement of a complete single valued neutrosophic graph $G = (A, B)$ of $G^* = (V, E)$ is a single valued neutrosophic complete graph $\overline{G} = (\overline{A}, \overline{B})$ on $G^* = (V, \overline{E})$ where

1. $\overline{V} = V$
2. $\overline{T_A}(v_i) = T_A(v_i)$, $\overline{I_A}(v_i) = I_A(v_i)$, $\overline{F_A}(v_i) = F_A(v_i)$, for all $v_j \in V$.
3. $\overline{T_B}(v_i, v_j) = \min [T_A(v_i), T_A(v_j)] - T_B(v_i, v_j)$
 $\overline{I_B}(v_i, v_j) = \max [I_A(v_i), I_A(v_j)] - I_B(v_i, v_j)$ and
 $\overline{F_B}(v_i, v_j) = \max [F_A(v_i), F_A(v_j)] - F_B(v_i, v_j)$ for all $(v_i, v_j) \in E$

Proposition 4.4:

The complement of complete SVN-graph is a SVN-graph with no edge. Or if G is a complete then in \bar{G} the edge is empty.

Proof

Let $G = (A, B)$ be a complete SVN-graph.

So $T_{Bij} = \min(T_{Ai}, T_{Aj})$, $I_{Bij} = \max(I_{Ai}, I_{Aj})$ and $F_{Bij} = \max(F_{Ai}, F_{Aj})$ for all $v_i, v_j \in V$

Hence in \bar{G} ,

$$\begin{aligned}\bar{T}_{Bij} &= \min [T_{Ai}, T_{Aj}] - T_{Bij} \text{ for all } i, j, \dots, n \\ &= \min [T_{Ai}, T_{Aj}] - \min [T_{Ai}, T_{Aj}] \text{ for all } i, j, \dots, n \\ &= 0 \quad \text{for all } i, j, \dots, n\end{aligned}$$

and

$$\begin{aligned}\bar{I}_{Bij} &= \max [I_{Ai}, I_{Aj}] - I_{Bij} \text{ for all } i, j, \dots, n \\ &= \max [I_{Ai}, I_{Aj}] - \max [I_{Ai}, I_{Aj}] \text{ for all } i, j, \dots, n \\ &= 0 \quad \text{for all } i, j, \dots, n\end{aligned}$$

Also

$$\begin{aligned}\bar{F}_{Bij} &= \max [F_{Ai}, F_{Aj}] - F_{Bij} \text{ for all } i, j, \dots, n \\ &= \max [F_{Ai}, F_{Aj}] - \max [F_{Ai}, F_{Aj}] \text{ for all } i, j, \dots, n \\ &= 0 \quad \text{for all } i, j, \dots, n\end{aligned}$$

Thus $(\bar{T}_{Bij}, \bar{I}_{Bij}, \bar{F}_{Bij}) = (0, 0, 0)$

Hence, the edge set of \bar{G} is empty if G is a complete SVN-graph.

4. CONCLUSION

Neutrosophic sets is a generalization of the notion of fuzzy sets and intuitionistic fuzzy sets. Neutrosophic models gives more precisions, flexibility and compatibility to the system as compared to the classical, fuzzy and/or intuitionistic fuzzy models. In this paper, we have introduced certain types of single valued neutrosophic graphs, such as strong single valued neutrosophic graph, constant single valued neutrosophic graph and complete single valued neutrosophic graphs. In future study, we plan to extend our research to regular and irregular single valued neutrosophic graphs, bipolar single valued neutrosophic graphs, interval valued neutrosophic graphs, strong interval valued neutrosophic, regular and irregular interval valued neutrosophic.

References

1. A. V. Devadoss, A. Rajkumar & N. J. P. Praveena. A Study on Miracles through Holy Bible using Neutrosophic Cognitive Maps (NCMS). *International Journal of Computer Applications*, 69(3) (2013).
2. A. Aydođdu, On Similarity and Entropy of Single Valued Neutrosophic Sets, *Gen. Math. Notes*, Vol. 29, No. 1, July 2015, pp. 67-74.
3. Q. Ansari, R. Biswas & S. Aggarwal, (2012). Neutrosophic classifier: An extension of fuzzy classifier. Elsevier- *Applied Soft Computing*, 13 (2013) 563-573, <http://dx.doi.org/10.1016/j.asoc.2012.08.002>
4. A. Q. Ansari, R. Biswas & S. Aggarwal. (Poster Presentation) Neutrosophication of Fuzzy Models, *IEEE Workshop On Computational Intelligence: Theories, Applications and Future Directions* (hosted by IIT Kanpur), 14th July'13.
5. A. Q. Ansari, R. Biswas & S. Aggarwal Extension to fuzzy logic representation: Moving towards neutrosophic logic - A new laboratory rat, *Fuzzy Systems (FUZZ)*, 2013 IEEE International Conference, 1–8, DOI:10.1109/FUZZ-IEEE.2013.6622412.
6. A. Nagoor Gani. and M. Basheer Ahamed, Order and Size in Fuzzy Graphs, *Bulletin of Pure and Applied Sciences*, Vol 22E (No.1) 2003; p.145-148.
7. A. Nagoor Gani. and S. Shajitha Begum, Degree, Order and Size in Intuitionistic Fuzzy Graphs, *International Journal of Algorithms, Computing and Mathematics*, (3)3 (2010).
8. A. Nagoor Gani and S.R Latha, On Irregular Fuzzy Graphs, *Applied Mathematical Sciences*, Vol.6, 2012, no.11,517-523.
9. F. Smarandache. Refined Literal Indeterminacy and the Multiplication Law of Sub-Indeterminacies, *Neutrosophic Sets and Systems*, Vol. 9, 58-2015,
10. F. Smarandache, Types of Neutrosophic Graphs and neutrosophic Algebraic Structures together with their Applications in Technology, seminar, Universitatea Transilvania din Brasov, Facultatea de Design de Prodsi si Mediu, Brasov, Romania 06 June 2015.
11. F. Smarandache, Symbolic Neutrosophic Theory, *Europeanova asbl, Brussels*, 195p, 2015.
12. F. Smarandache , Neutrosophic set - a generalization of the intuitionistic fuzzy set, *Granular Computing*, 2006 IEEE International Conference, 38 – 42,2006,DOI: 10.1109/GRC.2006.1635754.
13. F. Smarandache, A geometric interpretation of the neutrosophic set — A generalization of the intuitionistic fuzzy set *Granular Computing (GrC)*, 2011 IEEE International Conference , 602 – 606, 2011, DOI 10.1109/GRC.2011.6122665.
14. Gaurav Garg, Kanika Bhutani, Megha Kumar and Swati Aggarwal, Hybrid model for medical diagnosis using Neutrosophic Cognitive Maps with Genetic Algorithms, *FUZZ-IEEE 2015* (IEEE International conference on fuzzy systems).
15. H. Wang., Y. Zhang, R. Sunderraman, Truth-value based interval neutrosophic sets, *Granular Computing*, 2005 IEEE International Conference , P274 - 277 Vol. 1,2005DOI: 10.1109/GRC.2005.1547284.
16. H. Wang, F. Smarandache, Y. Zhang, and R. Sunderraman, Single valued Neutrosophic Sets, *Multispace and Multistructure* 4 (2010) 410-413.
17. A. Deli, M. Ali, F. Smarandache , Bipolar neutrosophic sets and their application based on multi-criteria decision making problems, *Advanced Mechatronic Systems (ICAMechS)*, 2015 International Conference, 249 - 254, DOI: 10.1109/ICAMechS.2015.7287068.
18. A. Turksen, Interval valued fuzzy sets based on normal forms, *Fuzzy Sets and Systems*, vol. 20, p. 191-210 (1986).
19. J. Ye, vector similarity measures of simplified neutrosophic sets and their application in multicriteria decision making, *International Journal of Fuzzy Systems*, Vol. 16, No. 2, p.204-211 (2014).
20. J. Ye, Single-Valued Neutrosophic Minimum Spanning Tree and Its Clustering Method, *Journal of Intelligent Systems* 23(3): 311–324, (2014).
21. K. Atanassov, “Intuitionistic fuzzy sets,” *Fuzzy Sets and Systems*, vol. 20, p. 87-96 (1986).

22. K. Atanassov and G. Gargov, "Interval valued intuitionistic fuzzy sets," *Fuzzy Sets and Systems*, vol.31, pp. 343-349 (1989).
23. K. Atanassov. *Intuitionistic fuzzy sets: theory and applications*. Physica, New York, 1999.
24. L. Zadeh, *Fuzzy sets*, *Inform and Control*, 8(1965), 338-353
25. P. Bhattacharya, Some remarks on fuzzy graphs, *Pattern Recognition Letters* 6: 297-302, 1987.
26. R. Parvathi and M. G. Karunambigai, *Intuitionistic Fuzzy Graphs*, *Computational Intelligence, Theory and applications*, International Conference in Germany, Sept 18 -20, 2006.
27. R. Rıdvan, A. Küçük, Subsethood measure for single valued neutrosophic sets, *Journal of Intelligent & Fuzzy Systems*, vol. 29, no. 2, pp. 525-530, 2015, DOI: 10.3233/IFS-141304
28. S. Aggarwal, R. Biswas, A. Q. Ansari, Neutrosophic modeling and control , *Computer and Communication Technology (ICCCT)*, 2010 International Conference , 718 – 723, DOI:10.1109/ICCCT.2010.5640435
29. S. Broumi, F. Smarandache, New distance and similarity measures of interval neutrosophic sets, *Information Fusion (FUSION)*, 2014 IEEE 17th International Conference, 2014,p 1 – 7.
30. S. Broumi, F. Smarandache, Single valued neutrosophic trapezoid linguistic aggregation operators based multi-attribute decision making, *Bulletin of Pure & Applied Sciences- Mathematics and Statistics*,(2014)135-155, DOI : 10.5958/2320-3226.2014.00006.X
31. S. Broumi, M. Talea, F. Smarandache, *Single Valued Neutrosophic Graphs: Degree, Order and Size*, IEEE WCCI 2016, under process.
32. Y. Hai-Long, G. She, Yanhonge, L. Xiuwu, On single valued neutrosophic relations, *Journal of Intelligent & Fuzzy Systems*, vol. Preprint, no. Preprint, p. 1-12 (2015)
33. W. B. Vasantha Kandasamy and F. Smarandache, *Fuzzy Cognitive Maps and Neutrosophic Congtive Maps*,2013.
34. W. B. Vasantha Kandasamy, K. Ilanthenral and Florentin Smarandache, *Neutrosophic Graphs: A New Dimension to Graph Theory*, Kindle Edition, 2015.
35. W.B. Vasantha Kandasamy and F. Smarandache "Analysis of social aspects of migrant laborers living with HIV/AIDS using Fuzzy Theory and Neutrosophic Cognitive Maps", Xiquan, Phoenix (2004).

Application of Dijkstra Algorithm for Solving Interval Valued Neutrosophic Shortest Path Problem

Said Broumi, Mohamed Talea, Assia Bakali, Florentin Smarandache

Said Broumi, Mohamed Talea, Assia Bakali, Florentin Smarandache (2016). Application of Dijkstra Algorithm for Solving Interval Valued Neutrosophic Shortest Path Problem. IEEE Symposium Series on Computational Intelligence (SSCI), 6; DOI: 10.1109/SSCI.2016.7850151

Abstract— In this paper, the authors propose an extended version of Dijkstra’ algorithm for finding the shortest path on a network where the edge weights are characterized by an interval valued neutrosophic numbers. Finally, a numerical example is given to explain the proposed algorithm.

Keywords—Dijkstra algorithm; interval valued neutrosophic number; Shortest path problem; Network;

I. INTRODUCTION

Smarandache [1] originally proposed the concept of a neutrosophic set from a philosophical point of view. The concept of the neutrosophic set (NS for short) has the ability to handle uncertain, incomplete, inconsistent, the indeterminate in a more accurate way. The theory of neutrosophic sets are a generalization of the theory of fuzzy sets [3], intuitionistic fuzzy sets [4] and interval- valued intuitionistic fuzzy sets [6]. The concept of the neutrosophic sets is expressed by a truth-membership degree (T), an indeterminacy-membership degree (I) and a falsity-membership degree (F) independently, which are within the real standard or nonstandard unit interval $]0,1^+[$. The concept of neutrosophic set is difficult to apply it real scientific and engineering areas. For this purpose. Smarandache [1] introduced the concept of SVNS, an instance of neutrosophic set, whose functions of truth, indeterminacy and falsity are within $[0, 1]$. In fact sometimes the degree of truth-membership, indeterminacy-membership and falsity-membership about a certain statement can not be defined exactly in the real situations, but expressed by several possible interval values. So the interval valued neutrosophic set (IVNS) was required. For this purpose, Wang et al.[8] introduced the concept of interval valued neutrosophic set (IVNS for short), which is more precise and more flexible

than the single valued neutrosophic set. The interval valued neutrosophic sets (IVNS) is a generalization of the concept of single valued neutrosophic set, in which three membership functions are independent, and their values belong to the unite interval $[0, 1]$.

Some more literature about neutrosophic sets, interval valued neutrosophic sets and their applications in divers fields can be found in [9]. In addition, the operations on interval valued neutrosophic sets and their ranking methods are presented in [10-11]

The selection of shortest path problem (SPP) is one of classic problems in graph theory. Several algorithms have been proposed for solving the shortest path problem in a network. The shortest path problem appears in various disciplines such as transportation, road networks and other applications. The shortest path problems could be classified into three types [12]:

- 1) Problem of finding shortest path from a single source in which the aim is to find shortest path from source node to all other nodes around the graph.
- 2) Problem of finding shortest path to a single source in which the aim is to find the shortest path between each connected pair in the graph.
- 3) Problem of finding shortest path between each two nodes in which the aim is to find shortest path between connected pair in the graph.

In a network, the shortest path problem concentrates at finding the path from one source node to destination node with minimum weight. The edge length of the network may represent the real life quantities such as, cost, time, etc. In classical shortest path problem, it is assumed that decision maker is certain about the parameters (time, distance, etc)

between different nodes. But in real life situations, there always exist uncertainty about the parameters between different nodes. For this purpose, several algorithms have been developed the shortest path under different types of input data, including, fuzzy sets, interval valued fuzzy sets, interval valued intuitionistic fuzzy sets and vague sets [13-18]. One of the well-known algorithms in solving shortest path problem is Dijkstra algorithm [19]. Dijkstra 'algorithm finds the shortest path from source node to other nodes in a graph, the so-called single source shortest path problem.

Recently, several articles have been published on neutrosophic graph theory [20-28]. In addition, Broumi et al. [29-32] proposed some algorithms dealt with shortest path problem in a network where the edge weights are characterized by a neutrosophic numbers including single valued neutrosophic number, bipolar neutrosophic numbers and interval valued neutrosophic numbers.

The main purpose of this article is to introduce an extended version of Dijkstra algorithm for solving shortest path problem on a network where the edge weights are characterized by an interval valued neutrosophic numbers. The decision maker can determine the shortest path and the shortest distance of each node from source node by using the proposed method. This method is more efficient due to the fact that the summing operation and the ranking of IVNNs can be done in an easy and straight manner.

The article is organized as follows. Some basic concepts of neutrosophic sets, single valued neutrosophic set and interval valued neutrosophic sets are introduced in section 2. In section 3, a network terminology is introduced. The extended version of Dijkstra'algorithm for solving the shortest path with connected edges in neutrosophic data is proposed in section 4. Section 5 illustrates a numerical example which is solved by the proposed method. Conclusions and further research are given in section 6.

II. PRELIMINARIES

In this section, we introduced some basic concepts and definitions of single valued neutrosophic sets and interval valued neutrosophic sets from the literature [1, 7, 8, 10, 11]

Definition 2.1 [1]. Let X be an universe of discourse of points with generic elements in X denoted by x. Hence, the neutrosophic set A (NS A) is an object having the form $A = \{< x: T_A(x), I_A(x), F_A(x) >, x \in X\}$, where the functions $T, I, F: X \rightarrow]0, 1^+]$ define respectively the truth-membership function, the indeterminacy- membership and the falsity-membership function of the element $x \in X$ to the set A with the condition:

$$^0 \leq T_A(x) + I_A(x) + F_A(x) \leq 3^+ \tag{1}$$

The functions $T_A(x), I_A(x)$ and $F_A(x)$ are real standard or non-standard subset of $]0, 1^+]$.

Since it is difficult to apply NSs to practical problems, Wang et al. [7] introduced the concept of a SVN, which is an

instance of Neutrosophic set and can be utilized in real scientific and engineering applications.

Definition 2. 2[7] Let X be an universe of discourse of points (objects) with generic elements in X denoted by x. the single valued neutrosophic set A (SVNS A) is characterized by truth-membership function $T_A(x)$, an indeterminacy-membership function $I_A(x)$, and a falsity-membership function $F_A(x)$.

For each point x in X, $T_A(x), I_A(x), F_A(x) \in [0, 1]$. A SVN A can be expressed as

$$A = \{< x: T_A(x), I_A(x), F_A(x) >, x \in X \} \tag{2}$$

Definition 2.3 [8]. Let X be an universe of discourse of points (object) with generic elements in X denoted by x. An interval valued neutrosophic set A (IVNS A) is characterized by an interval truth-membership function

$T_A(x) = [T_A^L, T_A^U]$, an interval indeterminacy-membership

function $I_A(x) = [I_A^L, I_A^U]$, and an interval falsity

membership function $F_A(x) = [F_A^L, F_A^U]$. For each point x

in X $T_A(x), I_A(x), F_A(x) \in [0, 1]$. An IVNS A can be expressed as

$$A = \{< x: T_A(x), I_A(x), F_A(x) >, x \in X \} \tag{3}$$

Definition 2.4[11]. Let $\tilde{A}_1 = < [T_1^L, T_1^U], [I_1^L, I_1^U], [F_1^L, F_1^U] >$ and $\tilde{A}_2 = < [T_2^L, T_2^U], [I_2^L, I_2^U], [F_2^L, F_2^U] >$ be two interval valued neutrosophic numbers. Then, the operations for IVNNs are defined as below:

(i)

$$\tilde{A}_1 \oplus \tilde{A}_2 = < [T_1^L + T_2^L - T_1^L T_2^L, T_1^U + T_2^U - T_1^U T_2^U], [I_1^L I_2^L, I_1^U I_2^U], [F_1^L F_2^L, F_1^U F_2^U] > \tag{4}$$

(ii)

$$\tilde{A}_1 \otimes \tilde{A}_2 = < [T_1^L T_2^L, T_1^U T_2^U], [I_1^L + I_2^L - I_1^L I_2^L, I_1^U + I_2^U - I_1^U I_2^U], [F_1^L + F_2^L - F_1^L F_2^L, F_1^U + F_2^U - F_1^U F_2^U] > \tag{5}$$

(iii)

$$\lambda \tilde{A} = < [1 - (1 - T_1^L)^\lambda, 1 - (1 - T_1^U)^\lambda], [(I_1^L)^\lambda, (I_1^U)^\lambda], [(F_1^L)^\lambda, (F_1^U)^\lambda] > \tag{6}$$

(iv)

$$\tilde{A}_1^\lambda = < [(T_1^L)^\lambda, (T_1^U)^\lambda], [1 - (1 - I_1^L)^\lambda, 1 - (1 - I_1^U)^\lambda], [1 - (1 - F_1^L)^\lambda, 1 - (1 - F_1^U)^\lambda] > \tag{7}$$

where $\lambda > 0$

Definition 2.5 [8]. An interval valued neutrosophic number $\tilde{A}_1 = < [T_1^L, T_1^U], [I_1^L, I_1^U], [F_1^L, F_1^U] >$ is said to be empty if and only if $T_1^L = 0, T_1^U = 0, I_1^L = 1, I_1^U = 1$, and $F_1^L = 1, F_1^U = 1$ and is denoted by

$$0_n = \{<x, <[0, 0], [1, 1], [1, 1]>: x \in X\} \quad (7)$$

A convenient method for comparing two interval valued neutrosophic numbers is by use of score function.

Definition 2.6 [10]. Let $\tilde{A}_1 = <[T_1^L, T_1^U], [I_1^L, I_1^U], [F_1^L, F_1^U]>$ be an interval valued neutrosophic number. Then, the score function $s(\tilde{A}_1)$ and accuracy function $H(\tilde{A}_1)$ of an IVNN are defined as follows:

$$(i) \quad s(\tilde{A}_1) = \left(\frac{1}{4}\right) \times [2 + T_1^L + T_1^U - 2I_1^L - 2I_1^U - F_1^L - F_1^U] \quad (8)$$

$$(ii) \quad H(\tilde{A}_1) = \frac{T_1^L + T_1^U - I_1^U(1 - T_1^U) - I_1^L(1 - T_1^L) - F_1^U(1 - I_1^U) - F_1^L(1 - I_1^L)}{2} \quad (9)$$

Definition 2.7 [10]. Let $\tilde{A}_1 = <[T_1^L, T_1^U], [I_1^L, I_1^U], [F_1^L, F_1^U]>$ and $\tilde{A}_2 = <[T_2^L, T_2^U], [I_2^L, I_2^U], [F_2^L, F_2^U]>$ are two interval valued neutrosophic numbers. Then, we define a ranking method as follows:

- i. If $s(\tilde{A}_1) > s(\tilde{A}_2)$, then \tilde{A}_1 is greater than \tilde{A}_2 , that is, \tilde{A}_1 is superior to \tilde{A}_2 , denoted by $\tilde{A}_1 \succ \tilde{A}_2$
- ii. If $s(\tilde{A}_1) = s(\tilde{A}_2)$, and $H(\tilde{A}_1) > H(\tilde{A}_2)$ then \tilde{A}_1 is greater than \tilde{A}_2 , that is, \tilde{A}_1 is superior to \tilde{A}_2 , denoted by $\tilde{A}_1 \succ \tilde{A}_2$.

III. NETWORK TERMINOLOGY

In this subsection we consider a directed network $G = (V, E)$ where V denotes a finite set of nodes $V = \{1, 2, \dots, n\}$ and E denotes a set of m directed edges $E \subseteq V \times V$. Each edge is denoted by an ordered pair (i, j) where $i, j \in V$ and $i \neq j$. In this network, two nodes denoted s (source) and t (target) are specified, which represent the source node and the destination node. The path is defined as sequence $P_{ij} = \{i = i_1, (i_1, i_2), i_2, \dots, i_{l-1}, (i_{l-1}, i_l), i_l = j\}$ of alternating nodes and edges. The existence of at least one P_{si} in $G = (V, E)$ is supposed for every $i \in V - \{s\}$.

d_{ij} denotes an interval valued neutrosophic number assigned with the edge (i, j) , corresponding to the length necessary to traverse (i, j) from i to j . In real problems, the lengths correspond to the time, the distance, the cost, etc. Hence, the interval valued neutrosophic distance along the path is denoted as $d(P)$ and is expressed as follows:

$$D(P) = \sum_{(i,j) \in P} d_{ij} \quad (10)$$

Remark: A node i is called predecessor of node j if

- (i) Node i and node j is connected directly.
- (ii) The direction of path connected the node i and the node j is from i to j .

IV. INTERVAL VALUED NEUTROSOPHIC DIJKSTRA ALGORITHM

In this subsection, we modified the fuzzy Dijkstra's algorithm adapted from [33] for computing the shortest path on a network where the edge weights are characterized by an interval valued neutrosophic numbers.

This algorithm finds the shortest path and the shortest distance between a source node and any other node in the network. The interval valued neutrosophic Dijkstra' algorithm forwards from a node i to an immediately successive node j using a neutrosophic labeling procedure. Let \tilde{u}_i be the shortest distance from node 1 to node i and $s(\tilde{d}_{ij}) \geq 0$ be the length of (i, j) edge. Then, the neutrosophic label for node j is defined as:

$$[\tilde{u}_j, i] = [\tilde{u}_i \oplus \tilde{d}_{ij}, i]. \quad S(\tilde{d}_{ij}) \geq 0. \quad (11)$$

Here label $[\tilde{u}_j, i]$ mean we are coming from nodes i after covering a distance \tilde{u}_j from the starting node. Dijkstra' algorithm classified the nodes into two classes: temporary set (T) and permanent set (P). A temporary neutrosophic label can be changed into another temporary neutrosophic label, if shortest path to the same neutrosophic node is checked. If no better path can be found then, the status of temporary neutrosophic label is replaced to permanent status.

In the following, we introduce the four steps of interval valued neutrosophic Dijkstra' algorithm as follows:

Step 1: Assign to source node (say node 1) the permanent label $P < [0, 0], [1, 1], [1, 1]>, -$. Set $i=1$.

Making a node permanent means that it has been included in the short path.

P denotes a permanent label, while $-$ means that there is no sequence to the source node.

Step 2: Determine the temporary neutrosophic label $[\tilde{u}_i \oplus \tilde{d}_{ij}, i]$ for each node j that can be arrived from i , provided j is not permanently labeled. If node j is previously labeled as $[\tilde{u}_j, k]$ through another node K , and if $S(\tilde{u}_i \oplus \tilde{d}_{ij}) < S(\tilde{u}_j)$ change $[\tilde{u}_j, k]$ with $[\tilde{u}_i \oplus \tilde{d}_{ij}, i]$.

Step 3: When all the nodes are permanently labeled, the algorithm terminates. Otherwise, choose the label $[\tilde{u}_r, s]$ with shortest distance (\tilde{u}_r) from the list of temporary neutrosophic labels. Set $i=r$ and repeat step 2.

Step 4: Select the shortest path between source node 1 and the destination node j by tracing backward through the network using the label's information.

Remark:

At each iteration among all temporary nodes, make those nodes permanent which have smallest distance. Note that at any iteration we can not move to permanent node, however,

reverse is possible. After all the nodes have permanent labels and only one temporary node remains, make it permanent. After describing the interval valued neutrosophic Dijkstra’ algorithm, in next section a numerical example is given to explain the proposed algorithm. The flow diagram of interval valued neutrosophic Dijkstra algorithm is depicted in figure1

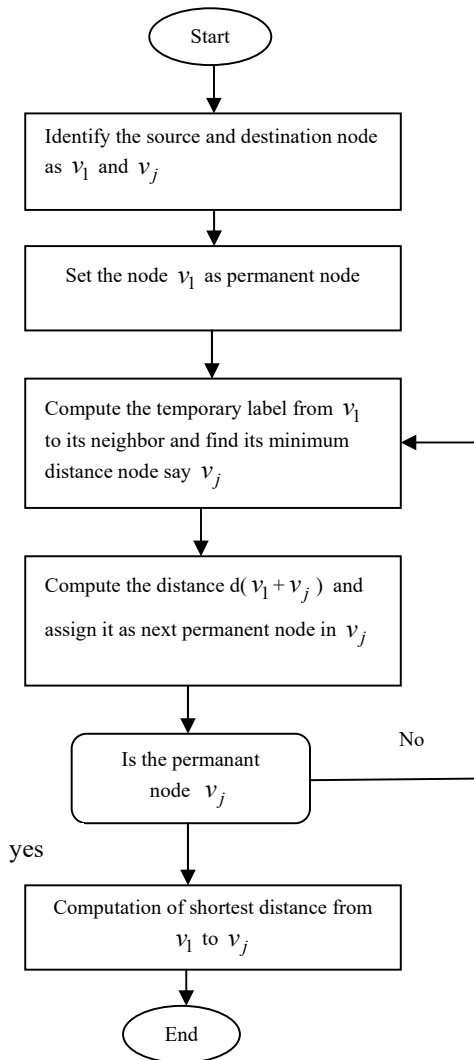

Fig. 1. Flow diagram representing the interval valued neutrosophic Dijkstra algorithm.

V. ILLUSTRATIVE EXAMPLE

In this subsection, an hypothetical example is used to verify the proposed approach. For this, we consider the network shown in figure2, then, we computed the shortest path from node 1 to node 6 where edges is represented by an interval valued neutrosophic numbers is computed. The extended Dijkstra algorithm is applied to the following network.

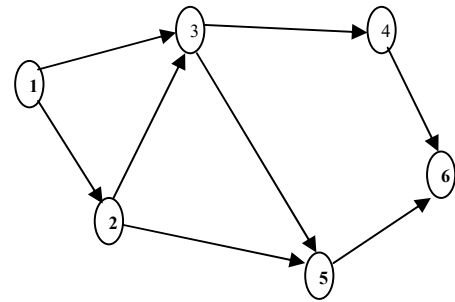

Fig.2. A network with interval valued neutrosophic weights In this network each edge has been assigned to interval valued neutrosophic number as follows:

Table 1. Weights of the graphs

Edges	Interval valued neutrosophic distance
1-2	< [0.1,0.2], [0.2, 0.3], [0.4, 0.5]>
1-3	< [0.2,0.4], [0.3, 0.5], [0.1, 0.2]>
2-3	< [0.3,0.4], [0.1, 0.2], [0.3,0.5]>
2-5	< [0.1,0.3], [0.3, 0.4], [0.2, 0.3]>
3-4	< [0.2, 0.3], [0.2, 0.5], [0.4, 0.5]>
3-5	< [0.3, 0.6], [0.1, 0.2], [0.1, 0.4]>
4-6	< [0.4, 0.6], [0.2, 0.4], [0.1, 0.3]>
5-6	< [0.2, 0.3], [0.3, 0.4], [0.1, 0.5]>

Following the interval valued neutrosophic Dijkstra’s algorithm, the details of calculations are defined below.

Iteration 0: Assign the permanent label <[0, 0], [1, 1], [1, 1]>, -] to node1 .

Iteration 1: Node 2 and node 3 can be arrived from (the last permanently labeled) node 1. Hence, the list of labeled nodes (Temporary and permanently) is available in the following table

Nodes	Label	Status
1	<[0, 0], [1, 1], [1, 1]>, -]	P
2	<[0.1, 0.2], [0.2, 0.3], [0.4, 0.5]>, 1]	T
3	<[0.2, 0.4], [0.3, 0.5], [0.1, 0.2]>, 1]	T

In order to compare <[0.1, 0.2], [0.2, 0.3], [0.4, 0.5]>and <[0.2, 0.4], [0.3, 0.5], [0.1, 0.2]> we use Eq.8

$$S (<[0.1, 0.2], [0.2, 0.3], [0.4, 0.5]>) = 0.1$$

$$S (<[0.2, 0.4], [0.3, 0.5], [0.1, 0.2]>) = 0.175$$

Since the rank of [<[0.1, 0.2], [0.2, 0.3], [0.4, 0.5]>, 1] is less than [<[0.2, 0.4], [0.3, 0.5], [0.1, 0.2]>, 1]. Hence, the status of node 2 is replaced by the permanent status.

Iteration 2: Node 3 and node 5 can be arrived from node 2. Hence, the list of labeled nodes (temporary and permanent) is available in the following table

Nodes	Label	Status
1	[<[0, 0], [1, 1], [1, 1]>, -]	P
2	[<[0.1, 0.2], [0.2, 0.3], [0.4, 0.5]>, 1]	P
3	[<[0.2, 0.4], [0.3, 0.5], [0.1, 0.2]>, 1] or [<[0.37, 0.52], [0.02, 0.06], [0.12, 0.25]>, 2]	T
5	[<[0.19, 0.44], [0.06, 0.12], [0.08, 0.15]>, 2]	T

$S (<[0.37, 0.52], [0.02, 0.06], [0.12, 0.25] >) = 0.59$
 $S (<[0.19, 0.44], [0.06, 0.12], [0.08, 0.15] >) = 0.51$
 Among the temporary labels [<[0.2, 0.4], [0.3, 0.5], [0.1, 0.2]>, 1] or [<[0.37, 0.52], [0.02, 0.06], [0.12, 0.25]>, 2], [<[0.19, 0.44], [0.06, 0.12], [0.08, 0.15]>, 2] and since the rank of [<[0.2, 0.4], [0.3, 0.5], [0.1, 0.2]> is less than of [<[0.37, 0.52], [0.02, 0.06], [0.12, 0.25]> and [<[0.19, 0.44], [0.06, 0.12], [0.08, 0.15]>, So the status of node 3 is replaced by a permanent status.

Iteration 3 : Node 4 and node 5 can be arrived from node 3. Hence, the list of labeled nodes (temporary and permanently) is available in the following table

Nodes	Label	Status
1	[<[0, 0], [1, 1], [1, 1]>, -]	P
2	[<[0.1, 0.2], [0.2, 0.3], [0.4, 0.5]>, 1]	P
3	[<[0.2, 0.4], [0.3, 0.5], [0.1, 0.2]>, 1]	P
4	[<[0.36, 0.58], [0.06, 0.25], [0.04, 0.1]>, 3]	T
5	[<[0.19, 0.44], [0.06, 0.12], [0.08, 0.15]>, 2] or [<[0.44, 0.76], [0.03, 0.1], [0.01, 0.08]>, 3]	T

$S (<[0.36, 0.58], [0.06, 0.25], [0.04, 0.1] >) = 0.54$
 $S (<[0.44, 0.76], [0.03, 0.1], [0.01, 0.08] >) = 0.71$
 Among the temporary labels [<[0.36, 0.58], [0.06, 0.25], [0.04, 0.1]>, 3] or [<[0.19, 0.44], [0.06, 0.12], [0.08, 0.15]>, 2], [<[0.44, 0.76], [0.03, 0.1], [0.01, 0.08]>, 3] and since the rank of [<[0.19, 0.44], [0.06, 0.12], [0.08, 0.15]>, is less than of [<[0.36, 0.58], [0.06, 0.25], [0.04, 0.1]> and [<[0.44, 0.76], [0.03, 0.1], [0.01, 0.08]>. So the status of node 5 is replaced by a permanent status.

Iteration 4: Node 6 can be arrived from node 5. Hence, the list of labeled nodes (temporary and permanent) is available in the following table.

Nodes	Label	Status
1	[<[0, 0], [1, 1], [1, 1]>, -]	P
2	[<[0.1, 0.2], [0.2, 0.3], [0.4, 0.5]>, 1]	P
3	[<[0.2, 0.4], [0.3, 0.5], [0.1, 0.2]>, 1]	P
4	[<[0.36, 0.58], [0.06, 0.25], [0.04, 0.1]>, 3]	T
5	[<[0.19, 0.44], [0.06, 0.12], [0.08, 0.15]>, 2]	P
6	[<[0.35, 0.60], [0.01, 0.04], [0.008, 0.075]>, 5]	T

Since, there exist one permanent node from where we can arrive at node 6. So, make temporary label [<[0.35, 0.60], [0.01, 0.04], [0.008, 0.075]>, 5] as permanent.

Iteration 5: The only temporary node is 4, this node can be arrived from node 3 and node 6. Hence, the list of labeled nodes (temporary and permanent) is available in the following table

Nodes	label	status
1	[<[0, 0], [1, 1], [1, 1]>, -]	P
2	[<[0.1, 0.2], [0.2, 0.3], [0.4, 0.5]>, 1]	P
3	[<[0.2, 0.4], [0.3, 0.5], [0.1, 0.2]>, 1]	P
4	[<[0.36, 0.58], [0.06, 0.25], [0.04, 0.1]>, 3] or [<[0.61, 0.84], [0.002, 0.016], [0.01, 0.023]>, 6]	T
5	[<[0.19, 0.44], [0.06, 0.12], [0.08, 0.15]>, 2]	P
6	[<[0.35, 0.60], [0.01, 0.04], [0.008, 0.075]>, 5]	P

In order to compare [<[0.36, 0.58], [0.06, 0.25], [0.04, 0.1]> and [<[0.61, 0.84], [0.002, 0.016], [0.01, 0.023]> we use the Eq.8

$S (<[0.36, 0.58], [0.06, 0.25], [0.04, 0.1] >) = 0.54$ and
 $S (<[0.61, 0.84], [0.002, 0.016], [0.01, 0.023] >) = 0.84$
 Since the rank of [<[0.36, 0.58], [0.06, 0.25], [0.04, 0.1]>, 3] is less than [<[0.61, 0.84], [0.002, 0.016], [0.01, 0.023]>, 6].

And the node 4 is the only one temporary node remains then, the status of node 4 is replaced by a permanent status.

Nodes	Label	Status
1	[<[0, 0], [1, 1], [1, 1]>, -]	P
2	[<[0.1, 0.2], [0.2, 0.3], [0.4, 0.5]>, 1]	P
3	[<[0.2, 0.4], [0.3, 0.5], [0.1, 0.2]>, 1]	P
4	[<[0.36, 0.58], [0.06, 0.25], [0.04, 0.1]>, 3]	T
5	[<[0.19, 0.44], [0.06, 0.12], [0.08, 0.15]>, 2]	P
6	[<[0.35, 0.60], [0.01, 0.04], [0.008, 0.075]>, 5]	P

Based on the step 4, the shortest path from node 1 to node 6 is determined using the following sequence.

(6) → [< [0.35, 0.60], [0.01, 0.04], [0.008, 0.075]>, 5] → (5)
 → [<[0.19, 0.44], [0.06, 0.12], [0.08, 0.15]>, 2] → (2)
 → [<[0.1, 0.2], [0.2, 0.3], [0.4, 0.5]>, 1] → (1)
 Hence, the required shortest path is 1 → 2 → 5 → 6

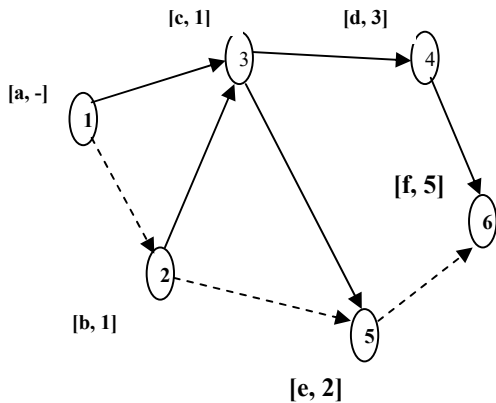

Fig 3. Network with interval valued neutrosophic shortest distance of each node from node 1.

Where, the neutrosophic label of each node is:

- [a, -] = $[< [0, 0], [1, 1], [1, 1] >, -]$
- [b, 1] = $[< [0.1, 0.2], [0.2, 0.3], [0.4, 0.5], 1]$
- [c, 1] = $[< [0.2, 0.4], [0.3, 0.5], [0.1, 0.2] >, 1]$
- [d, 3] = $[< [0.36, 0.58], [0.06, 0.25], [0.04, 0.1] >, 3]$
- [e, 2] = $[< [0.19, 0.44], [0.06, 0.12], [0.08, 0.15] >, 2]$
- [f, 5] = $[< [0.35, 0.60], [0.01, 0.04], [0, 0.075] >, 5]$

VI. CONCLUSION

This paper extended the single valued neutrosophic Dijkstra’s algorithm for solving the shortest path problem of a network where the edge weights are characterized by an interval valued neutrosophic number. The use of interval valued neutrosophic numbers as weights in the graph express more precision than single valued neutrosophic numbers. Finally, a numerical example has been solved to check the efficiency of the proposed method. In future, we will research the application of this algorithm.

REFERENCES

[1] F. Smarandache, A unifying field in logic. Neutrosophy: neutrosophic probability, set and logic, American Research Press, Rehoboth, 1998.

[2] F. Smarandache, A Geometric Interpretation of the Neutrosophic set-A generalization of the Intuitionistic fuzzy set, Granular Computing (GrC), 2011 IEEE International Conference, 2011, pp.602-606.

[3] L. Zadeh, Fuzzy Sets. Inform and Control, 8, 1965, pp.338-353.

[4] K. Atanassov, Intuitionistic Fuzzy Sets, Fuzzy Sets and Systems, Vol 20, 1986, pp.87-96.

[5] I. Turksen, Interval Valued Fuzzy Sets Based on Normal forms, Fuzzy Sets and Systems, Vol 20, 1986, pp.191-120.

[6] K. Atanassov and G. Gargov, Interval valued intuitionistic fuzzy sets. Fuzzy Sets and systems, vol.31, 1989, pp.343-349.

[7] H. Wang, F. Smarandache, Y. Zhang and R. Sunderraman, Single Valued Neutrosophic Sets, Multispace and Multistructure 4, 2010, pp.410-413.

[8] H. Wang, F.Smarandache, Y. Q. Zhang and R.Sunderraman, Interval Neutrosophic Sets and Logic: Theory and Application in Computing. Hexis, phoenix, AZ, 2005.

[9] <http://fs.gallup.unm.edu/NSS>

[10] R. Şahin and P.D.Liu,Maximizing Deviation Method for Neutrosophic Multiple Attribute Decision Making with Incomplete Weight Information, Neural Computing and Applications, 2015.DOI:10.1007/s00521-015-1995-8

[11] H.Y. Zhang, J. Q. Wang and X.H. Chen, Interval Neutrosophic Sets and Their Application in Multicriteria Decision Making Problems, Scientific World Journal, 2014. DOI: 10.1155/2014/65953.

[12] Y. Gao, shortest path problem with uncertain arc lengths. Computers and Mathematics with Applications 62, 2011, pp.2591-2600.

[13] A. Sengupta, T. K. Pal, Solving the shortest Path Problem with Interval Arcs, fuzzy Optimization and Decision Making, 5, 2006, pp.71-89.

[14] P. Jayagowri and G. G. Ramani, Using Trapezoidal Intuitionistic Fuzzy Number to Find Optimized Path in a network, volum 2014, Advances in Fuzzy Systems, 2014, 6 pages.

[15] A. Kumar and M. Kaur, A New Algorithm for Solving shortest Path Problem on a Network with Imprecise Edge Weight, Applications and Applied Mathematics, Vol.6, issue 2,2011,pp.602-619.

[16] A. Kumar and M. Kaur, Solution of Fuzzy Maximal Flow Problems using Fuzzy Linear Programming, World Academy of science and Technology, 87, 2011,pp.28-31

[17] S. Majumder and A. Pal, shortest Path Problem on Intuitionistic Fuzzy Network, Annals of Pure And Applied Mathematics, Vol. 5, No. 1, November 2013, pp. 26-36.

[18] S. Okada and M. Gen, Fuzzy shortest path problems, Computers and industrial Engineering, Vol 27, N 1-4, 1994, pp.465-468.

[19] E. W.Dijkstra, A Note on two Problems in Connexion with Graphs, Numerische Mathematik,1959, pp.269-271.

[20] S. Broumi, M. Talea, A. Bakali and F. Smarandache, Single Valued Neutrosophic Graphs, Journal of New Theory, N 10, 2016, pp. 86-101.

[21] S. Broumi, M.Talea, A. Bakali and F. Smarandache, On Bipolar Single Valued Neutrosophic Graphs, Journal of New Theory, N11, 2016, pp.84-102.

[22] S. Broumi, M. Talea, A. Bakali, F. Smarandache, Interval Valued Neutrosophic Graphs, (2016) in press.

[23] S. Broumi, A. Bakali, M. Talea and F. Smarandache, Isolated Single Valued Neutrosophic Graphs, Neutrosophic Sets and Systems, Vol .11, 2016, pp.74-78.

[24] S. Broumi, F. Smarandache, M. Talea and A. Bakali, An Introduction to Bipolar Single Valued Neutrosophic Graph Theory, Applied Mechanics and Materials, Vol.841, 2016, pp.184-191.

[25] S. Broumi, M.Talea, F. Smarandache and A. Bakali, Single Valued Neutrosophic Graphs: Degree, Order and Size, IEEE World Congress on Computational Intelligence, 2016, pp.2444-2451.

[26] F.Smarandache, symbolic Neutrosophic Theory, Europanova asbl, Brussels, 2015, 195p.

[27] F. Smarandache, Types of Neutrosophic Graphes and Neutrosophic Algebraic Structures together with their Applications in Technology,Seminar, Universitatea Transilvania din Brasov, Facultatea de Design de Proddussi Mediu, Brasov, Romania 06 June 2015.

[28] W. B. Kandasamy, Ilanthenral and F.Smarandache, Neutrosophic Graphs: A New Dimension to Graph Theory, Kindle Edition, USA, 2015, 127p.

[29] S. Broumi, A. Bakali, M. Talea, and F. smarandache, A Computation of Shortest Path Problem in a Network with Single Valued Neutrosophic Number Based On Ranking Method, 2016 (Submitted).

[30] S. Broumi, A. Bakali, M. Talea , F. Smarandache and M. Ali, Shortest Path Problem Under Bipolar Neutrosophic Setting, Applied Mechanics and Materials ,Vol .859, pp.59-66.

[31] S.Broumi, A.Bakali, M. Talea and F. Smarandache, Shortest Path Problem Under Interval Valued Neutrosophic Setting, 2016 (submitted).

[32] S. Broumi, A. Bakali, M. Talea and F. Smaranadche, Applying Dijkstra’s Algorithm for Solving Neutrosophic Shortest Path Problem, 2016(submitted)

[33] N.Bhatia, Algorithms for Some Fuzzy Network Problems Using Ranking Function, (master Thesis, Thapar university Pataiala-147004(PUNJAB), School of Mathematics and Computer Applications, 2009.

Shortest Path Problem Under Triangular Fuzzy Neutrosophic Information

Said Broumi, Mohamed Talea, Assia Bakali, Florentin Smarandache, Luige Vladareanu

Said Broumi, Mohamed Talea, Assia Bakali, Florentin Smarandache, Luige Vladareanu (2016). Shortest Path Problem Under Triangular Fuzzy Neutrosophic Information. 10th International Conference on Software, Knowledge, Information Management & Applications (SKIMA), 6

Abstract— In this paper, we develop a new approach to deal with neutrosophic shortest path problem in a network in which each edge weight (or length) is represented as triangular fuzzy neutrosophic number. The proposed algorithm also gives the shortest path length from source node to destination node using ranking function. Finally, an illustrative example is also included to demonstrate our proposed approach.

Keywords— *triangular fuzzy neutrosophic sets; score function; Shortest path problem*

I. INTRODUCTION

In 1995, Smarandache talked for the first time about neutrosophy and he in 1999 and 2005 [1, 2] defined one of the most important new mathematical tool which is a neutrosophic set theory for handling problems involving imprecise, incomplete, indeterminate and inconsistent information cannot be dealt with fuzzy sets as well as intuitionistic fuzzy sets Smarandache [3] introduced the concept of neutrosophic set and neutrosophic logic as generalization of the concepts of fuzzy sets [4], intuitionistic fuzzy sets [5]. The concept of neutrosophic set is characterized by three independent membership degrees namely truth-membership degree (T), indeterminacy-membership degree (I), and falsity-membership degree (F). which are lies between nonstandard unit interval $]^{-0}, 1^{+}[$.

From scientific or engineering point of view, the neutrosophic set and set- theoretic operator will be difficult to apply in the real application. For this purpose, a subclass of the neutrosophic sets called single-valued neutrosophic sets (SVNS for short) was proposed by Wang et al [6]. The concept of single valued neutrosophic sets has caught attention to the researcher on various topics such as to be such as the decision making problem, medical diagnosis and so on. Later

on, Smarandache extended the neutrosophic set to neutrosophic overset, underset, and offset [7]. Additional literature on neutrosophic sets can be found in [7, 8, 9, 10, 11, 12, 13, 14, 15, 16, 17, 18, 19]. However, in uncertain and complex situations, the truth-membership, the indeterminacy-membership and the falsity-membership independently of SVNS cannot be represented with exact real numbers or interval numbers. Moreover, triangular fuzzy number can handle effectively fuzzy data rather than interval number. For this purpose. Biswas et al. [20] proposed the concept of triangular fuzzy neutrosophic sets (TFNS) by combining triangular fuzzy numbers (TFNs) and single valued neutrosophic set (SVNS) and define some of its operational rules and developed triangular fuzzy neutrosophic number weighted arithmetic averaging and triangular fuzzy neutrosophic number weighted arithmetic geometric averaging operators to solve multi-attribute decision making problem. In TFNS the truth, indeterminacy and the falsity-membership functions are expressed with triangular fuzzy numbers instead of real numbers. Also, Ye [21] defined trapezoidal fuzzy neutrosophic set and developed trapezoidal fuzzy neutrosophic number weighted arithmetic averaging and trapezoidal fuzzy neutrosophic number weighted arithmetic geometric averaging operators to solve multi-attribute decision making problem. Recently, Broumi et al. [22, 23, 24] presented the concept of single valued neutrosophic graph, The single valued neutrosophic graph model allows the attachment of truth-membership (t), indeterminacy-membership (i) and falsity- membership degrees (f) both to vertices and edges. The single valued neutrosophic graph is the generalization of fuzzy graph and intuitionistic fuzzy graph. In addition, Broumi et al. [25, 26] proposed the concept of interval valued neutrosophic graph as a generalization the

concept of the fuzzy graph, intuitionistic fuzzy graph, interval valued fuzzy graph and single valued neutrosophic graph. Also, Broumi et al. [27, 28] proposed the concept of bipolar neutrosophic graph as a generalization the concept of the fuzzy graph, bipolar fuzzy graph, single valued neutrosophic graph. Smarandache [29, 30] proposed another variant of neutrosophic graphs based on literal indeterminacy .

In graph theory, the shortest path problem is the problem of finding a path between two nodes (or vertices) such that sum of the weight of its constituent edges is minimized. This problem has been studied for a long time and has attracted researchers from various areas of interests such operation research, computer science, communication network and various other problem. There are many shortest path problems [31-39] that have been studied with different types of input data, including fuzzy set, intuitionistic fuzzy sets, trapezoidal intuitionistic fuzzy sets vague set. Up to present, few research papers deal with shortest path in neutrosophic environment. Broumi et al. [40] proposed an algorithm for solving neutrosophic shortest path problem based on score function. The same authors in [41] proposed a study of neutrosophic shortest path with single valued trapezoidal neutrosophic number on a network. In addition Broumi et al. [42] proposed develop an algorithm to find the shortest path on a network in which the weights of the edges are represented by bipolar neutrosophic numbers. Motivated by the works done in [40-42], in this paper a new method is proposed for solving shortest path problems in a network which the edges length are characterized by single valued triangular neutrosophic numbers.

The rest of the paper has been organized in the following way. In Section 2, a brief overview of neutrosophic sets, single valued neutrosophic sets and triangular fuzzy neutrosophic sets. In section 3, we give the network terminology. In Section 4, an algorithm is proposed for finding the shortest path and shortest distance in triangular fuzzy neutrosophic graph. In section 5 an illustrative example is provided to find the shortest path and shortest distance between the source node and destination node. Finally, in Section 6 we provide conclusion and proposal for further research

II. PRELIMINARIES

In this section we give the definition and some important results regarding neutrosophic sets, single valued neutrosophic sets and triangular fuzzy neutrosophic sets

Definition 2.1 [3]. Let X be a space of points (objects) with generic elements in X denoted by x; then the neutrosophic set A (NS A) is an object having the form $A = \{< x: T_A(x), I_A(x), F_A(x) >, x \in X\}$, where the functions T, I, F: $X \rightarrow]0, 1+[$ define respectively the truth-membership function, an indeterminacy-membership function, and a falsity-membership function of the element $x \in X$ to the set A with the condition:

$$0 \leq T_A(x) + I_A(x) + F_A(x) \leq 3^+ \tag{1}$$

The functions $T_A(x), I_A(x)$ and $F_A(x)$ are real standard or nonstandard subsets of $]0, 1+[$.

Since it is difficult to apply NSs to practical problems, Wang et al. [14] introduced the concept of a SVN, which is an instance of a NS and can be used in real scientific and engineering applications.

Definition 2.2 [4]. Let X be a space of points (objects) with generic elements in X denoted by x. A single valued neutrosophic set A (SVNS A) is characterized by truth-membership function $T_A(x)$, an indeterminacy-membership function $I_A(x)$, and a falsity-membership function $F_A(x)$.

For each point x in X $T_A(x), I_A(x), F_A(x) \in [0, 1]$. A SVN A can be written as

$$A = \{< x: T_A(x), I_A(x), F_A(x) >, x \in X\} \tag{2}$$

And for every $x \in X$

$$0 \leq T_A(x) + I_A(x) + F_A(x) \leq 3. \tag{3}$$

Definition 2.3 [21]. Assume that X be the finite universe of discourse and F $[0, 1]$ be the set of all triangular fuzzy numbers on $[0, 1]$. A triangular fuzzy neutrosophic set (TFNNS) \tilde{A} in X is represented

$$\tilde{A} = \{< x: \tilde{T}_A(x), \tilde{I}_A(x), \tilde{F}_A(x) >, x \in X\} \tag{4}$$

Where $\tilde{T}_A(x): X \rightarrow F[0, 1]$, $\tilde{I}_A(x): X \rightarrow F[0, 1]$ and $\tilde{F}_A(x): X \rightarrow F[0, 1]$. The triangular fuzzy numbers

$$\tilde{T}_A(x) = (T_A^1(x), T_A^2(x), T_A^3(x)), \tag{5}$$

$$\tilde{I}_A(x) = (I_A^1(x), I_A^2(x), I_A^3(x)) \text{ and} \tag{6}$$

$\tilde{F}_A(x) = (F_A^1(x), F_A^2(x), F_A^3(x))$, respectively, denote the truth-membership, indeterminacy-membership and a falsity-membership degree of x in \tilde{A} and for every $x \in X$

$$0 \leq T_A^3(x) + I_A^3(x) + F_A^3(x) \leq 3. \tag{7}$$

For notational convenience, the triangular fuzzy neutrosophic value (TFNV) \tilde{A} is denoted by

$$\tilde{A} \equiv \langle (a, b, c), (e, f, g), (r, s, t) \rangle \text{ where,}$$

$$(T_A^1(x), T_A^2(x), T_A^3(x)) = (a, b, c), \tag{8}$$

$$(I_A^1(x), I_A^2(x), I_A^3(x)) = (e, f, g), \text{ and} \tag{9}$$

$$(F_A^1(x), F_A^2(x), F_A^3(x)) = (r, s, t) \tag{10}$$

Definition 2.4 [21]. A triangular fuzzy neutrosophic number $\tilde{A} \equiv \langle (a, b, c), (e, f, g), (r, s, t) \rangle$ is said to be zero triangular fuzzy neutrosophic number if and only if $(a, b, c) = (0, 0, 0)$, $(e, f, g) = (1, 1, 1)$ and $(r, s, t) = (1, 1, 1)$

Definition 2.5 [20]. Let $\tilde{A}_1 \equiv \langle (a_1, b_1, c_1), (e_1, f_1, g_1), (r_1, s_1, t_1) \rangle$ and $\tilde{A}_2 \equiv \langle (a_2, b_2, c_2), (e_2, f_2, g_2), (r_2, s_2, t_2) \rangle$ be two TFNVs in the set of real numbers. and $o \in \mathbb{R}$. Then, the operations rules are defined as follows;

(i)

$$\tilde{A}_1 \oplus \tilde{A}_2 \equiv \left\langle (a_1 + a_2, b_1 + b_2, c_1 + c_2), (e_1 e_2, f_1 f_2, g_1 g_2), (r_1 r_2, s_1 s_2, t_1 t_2) \right\rangle \quad (12)$$

(ii)

$$\tilde{A}_1 \otimes \tilde{A}_2 \equiv \left\langle (a_1 a_2, b_1 b_2, c_1 c_2), (e_1 : e_2, f_1 : f_2, g_1 : g_2), (r_1 \cdot r_2, s_1 \cdot s_2, t_1 \cdot t_2) \right\rangle \quad (13)$$

(iii) $o\tilde{A} \equiv \left\langle (10^o(a_1), 10^o(b_1), 10^o(c_1)), (e_1^o, f_1^o, g_1^o), (r_1^o, s_1^o, t_1^o) \right\rangle$ (14)

(iv) $\tilde{A}_1^o \equiv \left\langle (a_1^o, b_1^o, c_1^o), (10(10 e_1)^o, 10(10 f_1)^o, 10(10 g_1)^o), (10(10 r_1)^o, 10(10 s_1)^o, 10(10 t_1)^o) \right\rangle$ (15)

where $o \in \mathbb{R}$. **Ye [21]** introduced the concept of score function and accuracy function. The score function S and the accuracy function H are applied to compare the grades of TFNS. These functions shows that greater is the value, the greater is the TFNS and by using these concept paths can be ranked.

Definition 2.6. Let $\tilde{A}_1 \equiv \langle (a_1, b_1, c_1), (e_1, f_1, g_1), (r_1, s_1, t_1) \rangle$ be a TFNV, then, the score function $S(\tilde{A}_1)$ and an accuracy function $H(\tilde{A}_1)$ of TFNV are defined as follows:

(i)

$$s(\tilde{A}_1) \equiv \frac{1}{12} \cdot (a_1 + 2b_1 + c_1) \cdot (e_1 + 2f_1 + g_1) \cdot (r_1 + 2s_1 + t_1) \quad - \quad (16)$$

(ii) $H(\tilde{A}_1) \equiv \frac{1}{4} \cdot (a_1 + 2b_1 + c_1) \cdot (r_1 + 2s_1 + t_1) \quad - \quad (17)$

In order to make a comparisons between two TFNV, **Ye [21]**, presented the order relations between two TFNVs.

Definition 2.7. Let $\tilde{A}_1 \equiv \langle (a_1, b_1, c_1), (e_1, f_1, g_1), (r_1, s_1, t_1) \rangle$ and $\tilde{A}_2 \equiv \langle (a_2, b_2, c_2), (e_2, f_2, g_2), (r_2, s_2, t_2) \rangle$ be two TFNVs in the set of real numbers. Then, we define a ranking method as follows:

- i. If $s(\tilde{A}_1) > s(\tilde{A}_2)$, then \tilde{A}_1 is greater than \tilde{A}_2 , that is, \tilde{A}_1 is superior to \tilde{A}_2 , denoted by $\tilde{A}_1 \succ \tilde{A}_2$

- ii. If $s(\tilde{A}_1) \equiv s(\tilde{A}_2)$, and $H(\tilde{A}_1) > H(\tilde{A}_2)$ then \tilde{A}_1 is greater than \tilde{A}_2 , that is, \tilde{A}_1 is superior to \tilde{A}_2 , denoted by $\tilde{A}_1 \succ \tilde{A}_2$.

III. NETWORK TERMINOLOGY

Consider a directed network $G(V, E)$ consisting of a finite set of nodes $V = \{1, 2, \dots, n\}$ and a set of m directed edges $E \subseteq V \times V$. Each edge is denoted by an ordered pair (i, j) where $i, j \in V$ and $i \neq j$. In this network, we specify two nodes, denoted by s and t , which are the source node and the destination node, respectively. We define a path $P_{ij} = \{i = i_1, (i_1, i_2), i_2, \dots, i_{l-1}, (i_{l-1}, i_l), i_l = j\}$ of alternating nodes and edges. The existence of at least one path P_{si} in $G(V, E)$ is assumed for every $i \in V - \{s\}$.

d_{ij} denotes triangular fuzzy neutrosophic number associated with the edge (i, j) , corresponding to the length necessary to traverse (i, j) from i to j . the neutrosophic distance along the path P is denoted as $d(P)$ is defined as

$$d(P) = \bigvee_{(i,j) \in P} d_{ij} \quad (18)$$

Remark : A node i is said to be predecessor node of node j if

- (i) Node i is directly connected to node j .
- (ii) The direction of path connecting node i and j from i to j .

III. TRIANGULAR FUZZY NEUTROSOPHIC PATH PROBLEM

In this paper the edge length in a network is considered to be a neutrosophic number, namely, triangular fuzzy neutrosophic number.

The algorithm for the shortest path proceeds in 6 steps.

Step 1 Assume $\tilde{d}_1 = \langle (0, 0, 0), (1, 1, 1), (1, 1, 1) \rangle$ and label the source node (say node 1) as $[\tilde{d}_1 = \langle (0, 0, 0), (1, 1, 1), (1, 1, 1) \rangle, -]$.

Step 2 Find $\tilde{d}_j = \text{minimum} \{ \tilde{d}_i \oplus \tilde{d}_{ij} \}; j = 2, 3, \dots, n$.

Step 3 If minimum occurs corresponding to unique value of i i.e., $i = r$ then label node j as $[\tilde{d}_j, r]$. If minimum occurs corresponding to more than one values of i then it represents that there are more than one interval valued neutrosophic path between source node and node j but triangular fuzzy neutrosophic distance along path is \tilde{d}_j , so choose any value of i .

Step 4 Let the destination node (node n) be labeled as $[\tilde{d}_n, l]$, then the triangular fuzzy neutrosophic shortest distance between source node is \tilde{d}_n .

Step 5 Since destination node is labeled as $[\tilde{d}_n, l]$, so, to find the triangular fuzzy neutrosophic shortest path between source node and destination node, check the label of node l . Let it be

$[\tilde{d}_i, p]$, now check the label of node p and so on. Repeat the same procedure until node 1 is obtained.

Step 6 Now the triangular fuzzy neutrosophic shortest path can be obtained by combining all the nodes obtained by the step 5.

Remark 5.1 Let $\tilde{A}_i; i=1, 2, \dots, n$ be a set of triangular fuzzy neutrosophic numbers, if $S(\tilde{A}_k) < S(\tilde{A}_i)$, for all i, the triangular fuzzy neutrosophic number is the minimum of \tilde{A}_k

IV. ILLUSTRATIVE EXAMPLE

In order to illustrate the above procedure consider a small example network shown in Fig. 2, where each arc length is represented as triangular fuzzy neutrosophic number as shown in Table 2. The problem is to find the shortest distance and shortest path between source node and destination node on the network.

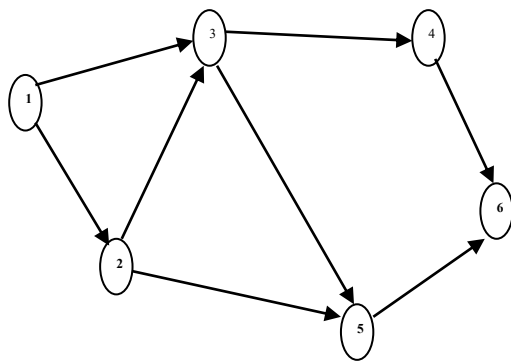

Fig.1 A network with triangular fuzzy neutrosophic edges

In this network each edge have been assigned to triangular fuzzy neutrosophic number as follows:

Edges	triangular fuzzy neutrosophic distance
1-2	$\langle(0.1, 0.2, 0.3), (0.2, 0.3, 0.5), (0.4, 0.5, 0.6)\rangle$
1-3	$\langle(0.2, 0.4, 0.5), (0.3, 0.5, 0.6), (0.1, 0.2, 0.3)\rangle$
2-3	$\langle(0.3, 0.4, 0.6), (0.1, 0.2, 0.3), (0.3, 0.5, 0.7)\rangle$
2-5	$\langle(0.1, 0.3, 0.4), (0.3, 0.4, 0.5), (0.2, 0.3, 0.6)\rangle$
3-4	$\langle(0.2, 0.3, 0.5), (0.2, 0.5, 0.6), (0.4, 0.5, 0.6)\rangle$
3-5	$\langle(0.3, 0.6, 0.7), (0.1, 0.2, 0.3), (0.1, 0.4, 0.5)\rangle$
4-6	$\langle(0.4, 0.6, 0.8), (0.2, 0.4, 0.5), (0.1, 0.3, 0.4)\rangle$
5-6	$\langle(0.2, 0.3, 0.4), (0.3, 0.4, 0.5), (0.1, 0.3, 0.5)\rangle$

Table 1. weights of the triangular fuzzy neutrosophic graphs

Solution since node 6 is the destination node, so n= 6. assume $\tilde{d}_1 = \langle(0, 0, 0), (1, 1, 1), (1, 1, 1)\rangle$ and label the source node (say node 1) as $[\langle(0, 0, 0), (1, 1, 1), (1, 1, 1)\rangle, -]$, the value of $\tilde{d}_j; j=2, 3, 4, 5, 6$ can be obtained as follows:

Iteration 1 Since only node 1 is the predecessor node of node 2, so putting i = 1 and j = 2 in step 2 of the proposed algorithm, the value of \tilde{d}_2 is

$$\tilde{d}_2 = \text{minimum}\{\tilde{d}_1 \oplus \tilde{d}_{12}\} = \text{minimum}\{\langle(0, 0, 0), (1, 1, 1), (1, 1, 1)\rangle \cap \langle(0.1, 0.2, 0.3), (0.2, 0.3, 0.5), (0.4, 0.5, 0.6)\rangle = \langle(0.1, 0.2, 0.3), (0.2, 0.3, 0.5), (0.4, 0.5, 0.6)\rangle$$

Since minimum occurs corresponding to i = 1, so label node 2 as $[\langle(0.1, 0.2, 0.3), (0.2, 0.3, 0.5), (0.4, 0.5, 0.6)\rangle, 1]$

$$\tilde{d}_2 = \langle(0.1, 0.2, 0.3), (0.2, 0.3, 0.5), (0.4, 0.5, 0.6)\rangle$$

Iteration 2 The predecessor node of node 3 are node 1 and node 2, so putting i = 1, 2 and j = 3 in step 2 of the proposed algorithm, the value of \tilde{d}_3 is $\tilde{d}_3 =$

$$\text{minimum}\{\tilde{d}_1 \oplus \tilde{d}_{13}, \tilde{d}_2 \oplus \tilde{d}_{23}\} = \text{minimum}\{\langle(0, 0, 0), (1, 1, 1), (1, 1, 1)\rangle \cap \langle(0.2, 0.4, 0.5), (0.3, 0.5, 0.6), (0.1, 0.2, 0.3)\rangle, \langle(0.1, 0.2, 0.3), (0.2, 0.3, 0.5), (0.4, 0.5, 0.6)\rangle \cap \langle(0.3, 0.4, 0.6), (0.1, 0.2, 0.3), (0.3, 0.5, 0.7)\rangle\} = \text{minimum}\{\langle(0.2, 0.4, 0.5), (0.3, 0.5, 0.6), (0.1, 0.2, 0.3)\rangle, \langle(0.37, 0.52, 0.72), (0.02, 0.06, 0.15), (0.12, 0.25, 0.42)\rangle\}$$

$$S(\langle(0.2, 0.4, 0.5), (0.3, 0.5, 0.6), (0.1, 0.2, 0.3)\rangle)$$

$$s(\tilde{A}_1) \equiv \frac{1}{12} \cdot \frac{1}{8} \cdot (a_1 \cdot 2b_1 \cdot c_1) \cdot (e_1 \cdot 2f_1 \cdot g_1) \cdot (r_1 \cdot 2s_1 \cdot t_1) = 0.57$$

$$S(\langle(0.37, 0.52, 0.72), (0.02, 0.06, 0.15), (0.12, 0.25, 0.42)\rangle) = 0.73$$

Since $S(\langle(0.2, 0.4, 0.5), (0.3, 0.5, 0.6), (0.1, 0.2, 0.3)\rangle) < S(\langle(0.37, 0.52, 0.72), (0.02, 0.06, 0.15), (0.12, 0.25, 0.42)\rangle)$

$$\text{So, minimum}\{\langle(0.2, 0.4, 0.5), (0.3, 0.5, 0.6), (0.1, 0.2, 0.3)\rangle, \langle(0.37, 0.52, 0.72), (0.02, 0.06, 0.15), (0.12, 0.25, 0.42)\rangle\} = \langle(0.2, 0.4, 0.5), (0.3, 0.5, 0.6), (0.1, 0.2, 0.3)\rangle$$

Since minimum occurs corresponding to i = 1, so label node 3 as $[\langle(0.2, 0.4, 0.5), (0.3, 0.5, 0.6), (0.1, 0.2, 0.3)\rangle, 1]$

$$\tilde{d}_3 = \langle(0.2, 0.4, 0.5), (0.3, 0.5, 0.6), (0.1, 0.2, 0.3)\rangle$$

Iteration 3. The predecessor node of node 4 is node 3, so putting i = 3 and j = 4 in step 2 of the proposed algorithm, the value of \tilde{d}_4 is $\tilde{d}_4 = \text{minimum}\{\tilde{d}_3 \oplus \tilde{d}_{34}\} = \text{minimum}\{\langle(0.2, 0.4, 0.5), (0.3, 0.5, 0.6), (0.1, 0.2, 0.3)\rangle$

$$\cap \langle(0.2, 0.3, 0.5), (0.2, 0.5, 0.6), (0.4, 0.5, 0.6)\rangle\} = \langle(0.36, 0.58, 0.75), (0.06, 0.25, 0.36), (0.04, 0.1, 0.18)\rangle$$

So $\text{minimum}\{\langle(0.2, 0.4, 0.5), (0.3, 0.5, 0.6), (0.1, 0.2, 0.3)\rangle \cap \langle(0.2, 0.3, 0.5), (0.2, 0.5, 0.6), (0.4, 0.5, 0.6)\rangle\} = \langle(0.36, 0.58, 0.75), (0.06, 0.25, 0.36), (0.04, 0.1, 0.18)\rangle$

Since minimum occurs corresponding to i = 3, so label node 4 as $[\langle(0.36, 0.58, 0.75), (0.06, 0.25, 0.36), (0.04, 0.1, 0.18)\rangle, 3]$

$$\tilde{d}_4 = \langle(0.36, 0.58, 0.75), (0.06, 0.25, 0.36), (0.04, 0.1, 0.18)\rangle$$

Iteration 4 The predecessor node of node 5 are node 2 and node 3, so putting i= 2, 3 and j= 5 in step 2 of the proposed algorithm, the value of \tilde{d}_5 is $\tilde{d}_5 =$

$$\text{minimum}\{\tilde{d}_2 \oplus \tilde{d}_{25}, \tilde{d}_3 \oplus \tilde{d}_{35}\} = \text{minimum}\{\langle(0.1, 0.2, 0.3), (0.2, 0.3, 0.5), (0.4, 0.5, 0.6)\rangle \cap \langle(0.1, 0.3, 0.4), (0.3, 0.4, 0.5), (0.1, 0.3, 0.5)\rangle\}$$

$(0.5), (0.2, 0.3, 0.6)\rangle, \langle(0.2, 0.4, 0.5), (0.3, 0.5, 0.6), (0.1, 0.2, 0.3)\rangle \cap \langle(0.3, 0.6, 0.7), (0.1, 0.2, 0.3), (0.1, 0.4, 0.5)\rangle =$
 $\text{Minimum}\{\langle(0.19, 0.44, 0.58), (0.06, 0.12, 0.25), (0.02, 0.06, 0.18)\rangle, \langle(0.44, 0.76, 0.85), (0.03, 0.1, 0.18), (0.01, 0.08, 0.15)\rangle\}$
 $S(\langle(0.19, 0.44, 0.58), (0.06, 0.12, 0.25), (0.02, 0.06, 0.18)\rangle) = 0.73$
 $S(\langle(0.44, 0.76, 0.85), (0.03, 0.1, 0.18), (0.01, 0.08, 0.15)\rangle) = 0.84$
 Since $S(\langle(0.19, 0.44, 0.58), (0.06, 0.12, 0.25), (0.02, 0.06, 0.18)\rangle) < S(\langle(0.44, 0.76, 0.85), (0.03, 0.1, 0.18), (0.01, 0.08, 0.15)\rangle)$
 $\text{Minimum}\{\langle(0.19, 0.44, 0.58), (0.06, 0.12, 0.25), (0.02, 0.06, 0.18)\rangle, \langle(0.44, 0.76, 0.85), (0.03, 0.1, 0.18), (0.01, 0.08, 0.15)\rangle\}$
 $= \langle(0.19, 0.44, 0.58), (0.06, 0.12, 0.25), (0.02, 0.06, 0.18)\rangle$
 $\tilde{d}_5 = \langle(0.19, 0.44, 0.58), (0.06, 0.12, 0.25), (0.02, 0.06, 0.18)\rangle$
 Since minimum occurs corresponding to $i=2$, so label node 5 as $[\langle(0.19, 0.44, 0.58), (0.06, 0.12, 0.25), (0.02, 0.06, 0.18)\rangle, 2]$

Iteration 5. The predecessor node of node 6 are node 4 and node 5, so putting $i = 4, 5$ and $j = 6$ in step 2 of the proposed algorithm, the value of \tilde{d}_6 is $\tilde{d}_6 =$

$\text{minimum}\{\tilde{d}_4 \oplus \tilde{d}_{46}, \tilde{d}_5 \oplus \tilde{d}_{56}\} = \text{minimum}\{\langle(0.36, 0.58, 0.75), (0.06, 0.25, 0.36), (0.04, 0.1, 0.18)\rangle \cap \langle(0.4, 0.6, 0.8), (0.2, 0.4, 0.5), (0.1, 0.3, 0.4)\rangle, \langle(0.19, 0.44, 0.58), (0.06, 0.12, 0.25), (0.02, 0.06, 0.18)\rangle \cap \langle(0.2, 0.3, 0.4), (0.3, 0.4, 0.5), (0.1, 0.3, 0.5)\rangle\}$
 $= \text{minimum}\{\langle(0.616, 0.832, 0.95), (0.012, 0.1, 0.18), (0.004, 0.03, 0.072)\rangle, \langle(0.352, 0.608, 0.748), (0.018, 0.048, 0.125), (0.002, 0.018, 0.09)\rangle\}$
 $S(\langle(0.616, 0.832, 0.95), (0.012, 0.1, 0.18), (0.004, 0.03, 0.072)\rangle) = 0.89$
 $S(\langle(0.352, 0.608, 0.748), (0.018, 0.048, 0.125), (0.002, 0.018, 0.09)\rangle) = 0.83$
 Since $S(\langle(0.352, 0.608, 0.748), (0.018, 0.048, 0.125), (0.002, 0.018, 0.09)\rangle) < S(\langle(0.616, 0.832, 0.95), (0.012, 0.1, 0.18), (0.004, 0.03, 0.072)\rangle)$
 $\text{minimum}\{\langle(0.616, 0.832, 0.95), (0.012, 0.1, 0.18), (0.004, 0.03, 0.072)\rangle, \langle(0.352, 0.608, 0.748), (0.018, 0.048, 0.125), (0.002, 0.03, 0.054)\rangle\} = \langle(0.352, 0.608, 0.748), (0.018, 0.048, 0.125), (0.002, 0.018, 0.09)\rangle$
 $\tilde{d}_6 = \langle(0.352, 0.608, 0.748), (0.018, 0.048, 0.125), (0.002, 0.018, 0.09)\rangle$

Since minimum occurs corresponding to $i = 5$, so label node 6 as $[\langle(0.352, 0.608, 0.748), (0.018, 0.048, 0.125), (0.002, 0.018, 0.09)\rangle, 5]$

$\tilde{d}_6 = \langle(0.352, 0.608, 0.748), (0.018, 0.048, 0.125), (0.002, 0.018, 0.09)\rangle$

Since node 6 is the destination node of the given network, so the triangular fuzzy neutrosophic shortest distance between node 1 and node 6 is $\langle(0.352, 0.608, 0.748), (0.018, 0.048, 0.125), (0.002, 0.018, 0.09)\rangle$

Now the triangular fuzzy neutrosophic shortest path between node 1 and node 6 can be obtained by using the following procedure:

Since node 6 is labeled by $[\langle(0.352, 0.608, 0.748), (0.018, 0.048, 0.125), (0.002, 0.018, 0.09)\rangle, 5]$, which represents that we are coming from node 5. Node 5 is labeled by $[\langle(0.19, 0.44, 0.58), (0.06, 0.12, 0.25), (0.02, 0.06, 0.18)\rangle, 2]$, which represents that we are coming from node 2. Node 2 is labeled by $[\langle(0.1, 0.2, 0.3), (0.2, 0.3, 0.5), (0.4, 0.5, 0.6)\rangle, 1]$ which represents that we are coming from node 1. Now the triangular fuzzy neutrosophic shortest path between node 1 and node 6 is obtaining by joining all the obtained nodes. Hence the triangular fuzzy neutrosophic shortest path is $1^\circ 2^\circ 5^\circ 6$. The triangular fuzzy neutrosophic shortest distance and the neutrosophic shortest path of all nodes from node 1 is shown in the table 2 and the labeling of each node is shown in figure 4

Node	\tilde{d}_i	Triangular fuzzy neutrosophic shortest path between jth and 1st node
2	$\langle(0.1, 0.2, 0.3), (0.2, 0.3, 0.5), (0.4, 0.5, 0.6)\rangle$	$1^\circ 2$
3	$\langle(0.2, 0.4, 0.5), (0.3, 0.5, 0.6), (0.1, 0.2, 0.3)\rangle$	$1^\circ 3$
4	$\langle(0.36, 0.58, 0.75), (0.06, 0.25, 0.36), (0.04, 0.1, 0.18)\rangle$	$1^\circ 3 4$
5	$\langle(0.19, 0.44, 0.58), (0.06, 0.12, 0.25), (0.02, 0.06, 0.18)\rangle$	$1^\circ 2 5$
6	$\langle(0.352, 0.608, 0.748), (0.018, 0.048, 0.125), (0.002, 0.018, 0.09)\rangle$	$1^\circ 2 5^\circ 6$

Table2. Tabular representation of different triangular fuzzy neutrosophic distance and shortest path.

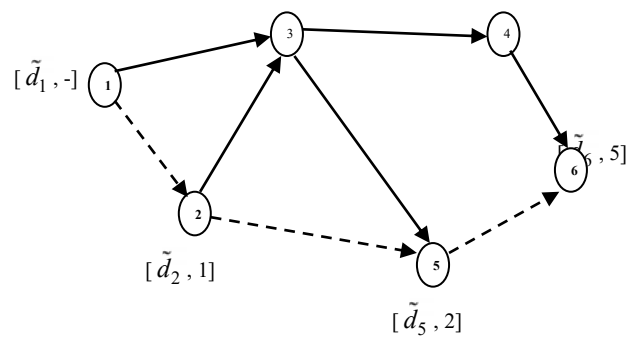

Fig.2. Network with triangular fuzzy neutrosophic shortest distance of each node from node 1

V. CONCLUSION

In this paper, an algorithm has been developed for solving shortest path problem on a network where the edges are characterized by triangular fuzzy neutrosophic. We have explained the method by an example with the help of a hypothetical data. Further, we plan to extend the following

algorithm of triangular fuzzy neutrosophic number shortest path problem in a trapezoidal neutrosophic environment.

REFERENCES

- [1] F. Smarandache, "Neutrosophic set - a generalization of the intuitionistic fuzzy set," *Granular Computing*, 2006 IEEE International Conference, 2006, p. 38 – 42.
- [2] F. Smarandache, *A unifying field in logic. Neutrosophy: Neutrosophic probability, set, logic*, American Research Press, Rehoboth, fourth edition, 2005
- [3] F. Smarandache, "A geometric interpretation of the neutrosophic set — A generalization of the intuitionistic fuzzy set," *Granular Computing (GrC)*, 2011 IEEE International Conference, 2011, pp.602–606 .
- [4] L. Zadeh, *Fuzzy sets*. Inform and Control, 8, 1965, pp.338-353
- [5] K. Atanassov, "Intuitionistic fuzzy sets," *Fuzzy Sets and Systems*, vol. 20, 1986, pp. 87-96.
- [6] H. Wang, F. Smarandache, Y. Zhang, and R. Sunderraman, "Single valued Neutrosophic Sets," *Multispace and Multistructure* 4, 2010, pp. 410-413.
- [7] Florentin Smarandache, *Neutrosophic Overset, Neutrosophic Underset, and Neutrosophic Offset*. Similarly for Neutrosophic Over-/Under-/Off-Logic, Probability, and Statistics, 168 p., Pons Editions, Bruxelles, Belgique, 2016; <https://arxiv.org/ftp/arxiv/papers/1607/1607.00234.pdf>
- [8] A. Q. Ansari, R. Biswas & S. Aggarwal, "Neutrosophication of Fuzzy Models," *IEEE Workshop On Computational Intelligence: Theories, Applications and Future Directions* (hosted by IIT Kanpur), 14th July 2013.
- [9] A. Q. Ansari, R. Biswas & S. Aggarwal, "Extension to fuzzy logic representation: Moving towards neutrosophic logic - A new laboratory rat," *Fuzzy Systems (FUZZ)*, 2013 IEEE International Conference, 2013, pp.1 –8.
- [10] G. Garg, K. Bhutani, M. Kumar and S. Aggarwal, "Hybrid model for medical diagnosis using Neutrosophic Cognitive Maps with Genetic Algorithms," *FUZZ-IEEE*, 2015, 6page.
- [11] I. Deli, S. Yusuf, F. Smarandache and M. Ali, *Interval valued bipolar neutrosophic sets and their application in pattern recognition*, IEEE World Congress on Computational Intelligence 2016.
- [12] I. Deli and Y. Subas, *A Ranking methods of single valued neutrosophic numbers and its application to multi-attribute decision making problems*, *International Journal of Machine Learning and Cybernetics*, 2016, 1-14.
- [13] J. Ye, *Single-Valued Neutrosophic Minimum Spanning Tree and Its Clustering Method*" *Journal of Intelligent Systems* 23(3), 2014, pp. 311–324.
- [14] J. Ye. *Single- valued neutrosophic similarity measures based on cotangent function and their application in the fault diagnosis of stream turbine*. *Neural Computing and Applications*, 2014. DOI 10.1007/s00521-014-1787-6.
- [15] M. Ali, and F. Smarandache, "Complex Neutrosophic Set," *Neural Computing and Applications*, Vol. 25, 2016, pp.1-18.
- [16] Y. Subas, *Neutrosophic numbers and their application to multi-attribute decision making problems (in Turkish)*, Master Thesis, 7 Arak university, Graduate School of Natural and Applied Science, 2015.
- [17] R. Chatterje, P.Majumdar, S. K.Samanta, *Single Valued neutrosophic multisets*, *Annals of !fuzzy Mathematics and Informatics*, 2015, 15 pages.
- [18] P. Biswas, S. Pramanik and B. C. Giri, *Cosine Similarity Measure Based Multi-attribute Decision-Making with Trapezoidal fuzzy Neutrosophic numbers*, *Neutrosophic sets and systems*, 8, 2014, pp.47-57.
- [19] S. Broumi, F. Smarandache, "New distance and similarity measures of interval neutrosophic sets," *Information Fusion (FUSION)*, 2014 IEEE 17th International Conference, 2014, pp. 1 – 7.
- [20] P. Biswas, S. Pramanik and B. C. Giri, *Aggregation of Triangular Fuzzy Neutrosophic Set Information and its Application to Multiattribute Decision Making*, *Neutrosophic sets and systems*, 12, 2016, pp.20-40.
- [21] J. Ye. *Trapezoidal fuzzy neutrosophic set and its application to multiple attribute decision making*. *Soft Computing*, 2015. DOI 10.1007/s00500-015-1818-y.
- [22] S. Broumi, M. Talea, A. Bakali, F. Smarandache, "Single Valued Neutrosophic Graphs," *Journal of New Theory*, N 10, 2016, pp. 86-101.
- [23] S. Broumi, M. Talea, F. Smarandache and A. Bakali, *Single Valued Neutrosophic Graphs: Degree, Order and Size*. *IEEE World Congress on Computational Intelligence*, 2016, pp.2444-2451.
- [24] S. Broumi, A. Bakali, M. Talea, and F. Smarandache, *Isolated Single Valued Neutrosophic Graphs*. *Neutrosophic Sets and Systems*, Vol. 11, 2016, pp.74-78.
- [25] S. Broumi, M. Talea, A. Bakali, F. Smarandache, *Interval Valued Neutrosophic Graphs*, *SISOM(2016)* in press.
- [26] S. Broumi, F. Smarandache, M. Talea and A. Bakali, *Decision-Making Method Based On the Interval Valued Neutrosophic Graph*, *Future technologie*, 2016, IEEE, In press
- [27] S. Broumi, M. Talea, A. Bakali, F. Smarandache, "On Bipolar Single Valued Neutrosophic Graphs," *Journal of New Theory*, N11, 2016, pp.84-102.
- [28] S. Broumi, F. Smarandache, M. Talea and A. Bakali, *An Introduction to Bipolar Single Valued Neutrosophic Graph Theory*. *Applied Mechanics and Materials*, vol.841,2016, 184-191.
- [29] F. Smarandache, "Refined Literal Indeterminacy and the Multiplication Law of Sub-Indeterminacies," *Neutrosophic Sets and Systems*, Vol. 9, 2015, pp.58.63.
- [30] F. Smarandache, "Types of Neutrosophic Graphs and neutrosophic Algebraic Structures together with their Applications in Technology," seminar, *Universitatea Transilvania din Brasov, Facultatea de Design de Produs si Mediu*, Brasov, Romania 06 June 2015.
- [31] A. Ngoor and M. M. Jabarulla, *Multiple labeling Approach For Finding shortest Path with Intuitionistic Fuzzy Arc Length*, *International Journal of Scientific and Engineering Research*, V3, Issue 11, pp.102-106, 2012.
- [32] S. Okada and T. Soper, "A shortest path problem on a network with fuzzy arc lengths", *Fuzzy sets and systems*, 109, 2000, pp.129-140.
- [33] A. Kumar, and M. Kaur, *Solution of fuzzy maximal flow problems using fuzzy linear programming*. *World Academy of Science and Technology*. 87: 28-31, (2011).
- [34] S. Majumdar and A. Pal, *Shortest Path Problem on Intuitionistic Fuzzy Network*, *Annals of Pure and Applied Mathematics*, Vol. 5, No. 1, November 2013, pp. 26-36.
- [35] A. Kumar and M. Kaur, *A New Algorithm for Solving Shortest Path Problem on a Network with Imprecise Edge Weight*, *Applications and Applied Mathematics*, Vol. 6, Issue 2, 2011, pp. 602 – 619.
- [36] A.K. Yadav, B.R. Biswas, *On searching fuzzy shortest path in a network*, *International Journal of Recent Trends in Engineering* 2 (3), 2009, pp. 16–18.
- [37] P. Jayagowri and G. Geetha Ramani, *Using Trapezoidal Intuitionistic Fuzzy Number to Find Optimized Path in a Network*, *Volume 2014, Advances in Fuzzy Systems*, 2014, 6 pages.
- [38] F. Hernandez, M. Teresa Lamata, J. L. Verdegay, and A. Y. kami, *The shortest path problem on networks with fuzzy parameters*. *Fuzzy Sets and Systems*. 158, 2007:pp.1561-1570.
- [39] G. Kumar, R. K. Bajaj and N. Gandotra, "Algorithm for shortest path problem in a network with interval valued intuitionistic trapezoidal fuzzy number", *Procedia Computer Science* 70, 2015, pp.123-129.
- [40] S. Broumi, A. Bakali, M. Talea and F. Smarandache, *Computation of Shortest Path Problem in a Network with Single Valued Neutrosophic Number Based on Ranking Method* (submitted).
- [41] S. Broumi, A. Bakali, M. Talea and F. Smarandache, *Computation of Shortest Path Problem in a Network with SV-trapezoidal neutrosophic numbers*, (submitted).
- [42] S. Broumi, A. Bakali, M. Talea and F. Smarandache, M. Ali, *Shortest Path Problem Under Bipolar Neutrosophic Setting*, 2016. In press.

Generalized Bipolar Neutrosophic Graphs of Type 1

Said Broumi, Mohamed Talea, Assia Bakali, Florentin Smarandache

Said Broumi, Mohamed Talea, Assia Bakali, Florentin Smarandache (2017). Generalized Bipolar Neutrosophic Graphs of Type 1. 20th International Conference on Information Fusion Xi'an, China, 7

Abstract—In this research paper, based on the notion of generalized single valued neutrosophic graphs of type 1, we presented a new type of neutrosophic graphs called generalized bipolar neutrosophic graphs of type 1 (GBNG1) and presented a matrix representation for it and studied some properties of this new concept. The concept of GBNG1 is an extension of generalized fuzzy graphs of type 1 (GFG1) and generalized single valued neutrosophic of type 1 (GSVNG1).

Keywords—Bipolar neutrosophic graph; Generalized bipolar neutrosophic graphs of type 1; Matrix representation.

I. INTRODUCTION

Smarandache [5] proposed the concept of neutrosophic set theory (in short NS) as a means of expressing the inconsistencies and indeterminacies that exist in most real-life problem. The proposed concept generalized the concept of fuzzy sets [13], intuitionistic fuzzy sets [11], interval-valued fuzzy sets [9] and interval-valued intuitionistic fuzzy sets [12]. In neutrosophic set, every element is characterized three membership degrees: truth membership degree T, an indeterminate membership degree I and a false membership degree F, where the degrees are totally independent, the three degree are inside the unit interval $]0, 1+[$. To practice NS in real life problems, The single valued neutrosophic set was proposed by Smarandache in [5]. After, Wang et al.[8] discussed some interesting properties related to single valued neutrosophic sets. In [10], Deli et al. proposed the concept of bipolar neutrosophic sets and discussed some interesting properties. Some more literature about the extension of neutrosophic sets and their applications in various fields can be found in [6, 15, 26, 27, 28 29, 30, 31, 41, 42].

Graphs are models of relations between objects. The objects are represented by vertices and relations by edges. In a crisp graphs two vertices are either related or not related to each other, mathematically, the degree of relationship is either 0 or 1. While in fuzzy graphs, the degree of relationship takes

values from $[0, 1]$. In the literature, many extensions of fuzzy graphs have been studied deeply such as bipolar fuzzy [1, 3, 16, 40]. All these types of graphs have a common property that each edge must have a membership value less than or equal to the minimum membership of the nodes it connects. Samanta et al. [35] proposed two concept of fuzzy graphs called generalized fuzzy graphs 1 (GFG1) and generalized fuzzy graphs 2 (GFG2) and studied some major properties such as completeness and regularity with proved results. When the description of the objects or relationships, or both happens to possess indeterminacy and inconsistency. The fuzzy graphs and theirs extensions cannot deal with it. So, for this purpose, Smarandache [4,7] proposed the two concepts of neutrosophic graphs, one based on literal indeterminacy (I) whereas the other is based neutrosophic truth-values (T, I, F) on to deal with such situations. Subsequently, Broumi et al. [23, 24, 25] introduced the concept of single valued neutrosophic graphs (in short SVNGs) and investigate some interesting properties with proofs and illustrations. Later on the same authors [32, 33] proposed the concept of bipolar single neutrosophic graphs (in short BSVNGs) and studying some interesting properties. Later on, others researchers proposed other structures of neutrosophic graphs [18, 19, 17, 20, 22, 23, 39]. Followed the concept of Broumi et al [23], several studies appeared in [2, 14, 21, 36, 37, 38]

Similar to the bipolar fuzzy graphs, which have a common property that each edge must have a membership value less than or equal to the minimum membership of the nodes it connects. Also, the bipolar neutrosophic graphs presented in the literature [32, 43] have a common property that edge positive truth-membership value is less than the minimum of its end vertex values, whereas the edge positive indeterminate-membership value is less than the maximum of its end vertex values or is greater than the maximum of its end vertex values. And the edge positive false-membership value is less than the minimum of its end vertex values or is greater than the maximum of its end vertex values. In [34], Broumi et al. have

discussed the removal of the edge degree restriction of single valued neutrosophic graphs and presented a new class of single valued neutrosophic graph called generalized single valued neutrosophic graph of type 1, which is an extension of generalized fuzzy graph of type 1 [35]. Motivated by the concept of generalized single valued neutrosophic graph of type 1 (GSVNG1) introduced in [34]. The main contribution of this paper is to extend the concept of generalized single valued neutrosophic graph of type 1 to generalized bipolar neutrosophic graphs of type 1 (GBNG1) to model systems having an indeterminate information and introduced a matrix representation of GBNG1.

This paper is organized as follows: Section 2, focuses on some fundamental concepts related to neutrosophic sets, single valued neutrosophic sets, bipolar neutrosophic sets and generalized single valued neutrosophic graphs type 1. Section 3, provides the concept of generalized bipolar neutrosophic graphs of type 1 with an illustrative example. Section 4 deals with the representation matrix of generalized bipolar neutrosophic graphs of type 1 followed by conclusion, in section 5.

II. PRELIMINARIES

This section presented some definitions from [5,8,10, 32 34] related to neutrosophic sets, single valued neutrosophic sets, bipolar neutrosophic sets, and generalized single valued neutrosophic graphs of type 1, which will be helpful for the rest of the sections.

Definition 2.1 [5]. Let X be a space of points (objects) with generic elements in X denoted by x ; then the neutrosophic set A (NS A) is an object having the form $A = \{ \langle x: T_A(x), I_A(x), F_A(x) \rangle, x \in X \}$, where the functions $T, I, F: X \rightarrow]0, 1+[$ define respectively the truth-membership function, indeterminate-membership function, and false-membership function of the element $x \in X$ to the set A with the condition:

$$0 \leq T_A(x) + I_A(x) + F_A(x) \leq 3 \quad (1)$$

The functions $T_A(x), I_A(x)$ and $F_A(x)$ are real standard or nonstandard subsets of $]0, 1+[$.

Since it is difficult to apply NSs to practical problems, Smarandache [5] introduced the concept of a SVNS, which is an instance of a NS and can be used in real scientific and engineering applications.

Definition 2.2 [8]. Let X is a space of points (objects) with generic elements in X denoted by x . A single valued neutrosophic set A (SVNS A) is characterized by truth-membership function $T_A(x)$, an indeterminate-membership function $I_A(x)$, and a false-membership function $F_A(x)$. For each point x in $X, T_A(x), I_A(x), F_A(x) \in [0, 1]$. A SVNS A can be written as

$$A = \{ \langle x: T_A(x), I_A(x), F_A(x) \rangle, x \in X \} \quad (2)$$

Definition 2.3 [10]. A bipolar neutrosophic set A in X is defined as an object of the form

$$A = \{ \langle x, (T_A^+(x), I_A^+(x), F_A^+(x), T_A^-(x), I_A^-(x), F_A^-(x)) \rangle : x \in X \},$$

where $T_A^+, I_A^+, F_A^+ : X \rightarrow [1, 0]$ and $T_A^-, I_A^-, F_A^- : X \rightarrow [-1, 0]$. The positive membership degree $T_A^+(x), I_A^+(x), F_A^+(x)$ denotes the truth membership, indeterminate membership and false membership of an element $x \in X$ corresponding to a bipolar neutrosophic set A and the negative membership degree $T_A^-(x), I_A^-(x), F_A^-(x)$ denotes the truth membership, indeterminate membership and false membership of an element $x \in X$ to some implicit counter-property corresponding to a bipolar neutrosophic set A . For convenience a bipolar neutrosophic number is represented by

$$A = \langle T_A^+, I_A^+, F_A^+, T_A^-, I_A^-, F_A^- \rangle \quad (3)$$

Definition 2.4 [34]. Let V be a non-void set. Two functions are considered as follows:

$$\rho = (\rho_T, \rho_I, \rho_F) : V \rightarrow [0, 1]^3 \text{ and}$$

$$\omega = (\omega_T, \omega_I, \omega_F) : V \times V \rightarrow [0, 1]^3. \text{ We suppose}$$

$$A = \{ (\rho_T(x), \rho_T(y)) \mid \omega_T(x, y) \geq 0 \},$$

$$B = \{ (\rho_I(x), \rho_I(y)) \mid \omega_I(x, y) \geq 0 \},$$

$$C = \{ (\rho_F(x), \rho_F(y)) \mid \omega_F(x, y) \geq 0 \},$$

We have considered ω_T, ω_I and $\omega_F \geq 0$ for all set A, B, C , since it is possible to have edge degree = 0 (for T , or I , or F). The triad (V, ρ, ω) is defined to be generalized single valued neutrosophic graph of type 1 (GSVNG1) if there are functions $\alpha : A \rightarrow [0, 1], \beta : B \rightarrow [0, 1]$ and $\delta : C \rightarrow [0, 1]$ such that $\omega_T(x, y) = \alpha((\rho_T(x), \rho_T(y)))$
 $\omega_I(x, y) = \beta((\rho_I(x), \rho_I(y)))$
 $\omega_F(x, y) = \delta((\rho_F(x), \rho_F(y)))$ where $x, y \in V$.

Here $\rho(x) = (\rho_T(x), \rho_I(x), \rho_F(x)), x \in V$ are the truth-membership, indeterminate-membership and false-membership of the vertex x and $\omega(x, y) = (\omega_T(x, y), \omega_I(x, y), \omega_F(x, y)), x, y \in V$ are the truth-membership, indeterminate-membership and false-membership values of the edge (x, y) .

Definition 2.5 [32]. A bipolar single valued neutrosophic graph of a graph $G^* = (V, E)$ is a pair $G = (A, B)$, where $A = (T_A^+, I_A^+, F_A^+, T_A^-, I_A^-, F_A^-)$ is a bipolar single valued neutrosophic set in V and $B = (T_B^+, I_B^+, F_B^+, T_B^-, I_B^-, F_B^-)$ is a bipolar single valued neutrosophic set in \tilde{V}^2 such that

$$T_B^+(v_i, v_j) \leq \min(T_A^+(v_i), T_A^+(v_j))$$

$$I_B^+(v_i, v_j) \geq \max(I_A^+(v_i), I_A^+(v_j))$$

$$F_B^+(v_i, v_j) \geq \max(F_A^+(v_i), F_A^+(v_j)) \text{ and}$$

$$T_B^-(v_i, v_j) \geq \max(T_A^-(v_i), T_A^-(v_j))$$

$$I_B^-(v_i, v_j) \leq \min(I_A^-(v_i), I_A^-(v_j))$$

$$F_B^-(v_i, v_j) \leq \min(F_A^-(v_i), F_A^-(v_j)) \text{ for all } v_i, v_j \in \tilde{V}^2.$$

III. GENERALIZED BIPOLAR NEUTROSOPHIC GRAPH OF TYPE 1

In this section, based on the generalized single valued neutrosophic graphs of type 1 proposed by Broumi et al. [34], the definition of generalized bipolar neutrosophic graphs type 1 is defined as follow:

Definition 3.1. Let V be a non-void set. Two functions are considered, as follows:

$$\rho = (\rho_T^+, \rho_I^+, \rho_F^+, \rho_T^-, \rho_I^-, \rho_F^-): V \rightarrow [-1, 1]^6 \text{ and}$$

$$\omega = (\omega_T^+, \omega_I^+, \omega_F^+, \omega_T^-, \omega_I^-, \omega_F^-): V \times V \rightarrow [-1, 1]^6. \text{ We suppose}$$

$$A = \{(\rho_T^+(x), \rho_T^+(y)) \mid \omega_T^+(x, y) \geq 0\},$$

$$B = \{(\rho_I^+(x), \rho_I^+(y)) \mid \omega_I^+(x, y) \geq 0\},$$

$$C = \{(\rho_F^+(x), \rho_F^+(y)) \mid \omega_F^+(x, y) \geq 0\},$$

$$D = \{(\rho_T^-(x), \rho_T^-(y)) \mid \omega_T^-(x, y) \leq 0\},$$

$$E = \{(\rho_I^-(x), \rho_I^-(y)) \mid \omega_I^-(x, y) \leq 0\},$$

$$F = \{(\rho_F^-(x), \rho_F^-(y)) \mid \omega_F^-(x, y) \leq 0\},$$

We have considered $\omega_T^+, \omega_I^+, \omega_F^+ \geq 0$ and $\omega_T^-, \omega_I^-, \omega_F^- \leq 0$ for all sets A, B, C, D, E, F since it is possible to have edge degree = 0 (for T^+ or I^+ or F^+ , T^- or I^- or F^-).

The triad (V, ρ, ω) is defined to be generalized bipolar neutrosophic graph of type 1 (GBNG1) if there are functions $\alpha: A \rightarrow [0, 1], \beta: B \rightarrow [0, 1], \delta: C \rightarrow [0, 1]$ and $\xi: D \rightarrow [-1, 0], \sigma: E \rightarrow [-1, 0], \psi: F \rightarrow [-1, 0]$ such that

$$\omega_T^+(x, y) = \alpha((\rho_T^+(x), \rho_T^+(y))),$$

$$\omega_I^+(x, y) = \beta((\rho_I^+(x), \rho_I^+(y))),$$

$$\omega_F^+(x, y) = \delta((\rho_F^+(x), \rho_F^+(y))),$$

$$\omega_T^-(x, y) = \xi((\rho_T^-(x), \rho_T^-(y))),$$

$$\omega_I^-(x, y) = \sigma((\rho_I^-(x), \rho_I^-(y))),$$

$$\omega_F^-(x, y) = \psi((\rho_F^-(x), \rho_F^-(y))) \text{ where } x, y \in V.$$

Here $\rho(x) = (\rho_T^+(x), \rho_I^+(x), \rho_F^+(x), \rho_T^-(x), \rho_I^-(x), \rho_F^-(x))$, $x \in V$ are the positive and negative truth-membership, indeterminate-membership and false-membership of the vertex x and $\omega(x, y) = (\omega_T^+(x, y), \omega_I^+(x, y), \omega_F^+(x, y), \omega_T^-(x, y), \omega_I^-(x, y), \omega_F^-(x, y))$, $x, y \in V$ are the positive and negative truth-membership, indeterminate-membership and false-membership values of the edge (x, y) .

Example 3.2: Let the vertex set be $V = \{x, y, z, t\}$ and edge set be $E = \{(x, y), (x, z), (x, t), (y, t)\}$

Table 1. Positive and negative truth- membership, indeterminate-membership and false-membership of the vertex set.

	x	y	z	t
ρ_T^+	0.5	0.9	0.3	0.8
ρ_I^+	0.3	0.2	0.1	0.5
ρ_F^+	0.1	0.6	0.8	0.4
ρ_T^-	-0.6	-0.1	-0.4	-0.9
ρ_I^-	-0.4	-0.3	-0.2	-0.6
ρ_F^-	-0.2	-0.7	-0.9	-0.5

Let us consider functions $\alpha(m, n) = \max(m_T^+, n_T^+)$, $\beta(m, n) = \frac{(m_I^+ + n_I^+)}{2}$, $\delta(m, n) = \min(m_F^+, n_F^+)$, $\xi(m, n) = \min(m_T^-, n_T^-)$, $\sigma(m, n) = \frac{(m_I^- + n_I^-)}{2}$, and $\psi(m, n) = \max(m_F^-, n_F^-)$, Here,

$$A = \{(0.5, 0.9), (0.5, 0.3), (0.5, 0.8), (0.9, 0.8)\}$$

$$B = \{(0.3, 0.2), (0.3, 0.1), (0.3, 0.5), (0.2, 0.5)\}$$

$$C = \{(0.1, 0.6), (0.1, 0.8), (0.1, 0.4), (0.6, 0.4)\}$$

$$D = \{(-0.6, -0.1), (-0.6, -0.4), (-0.6, -0.9), (-1, -0.9)\}$$

$$E = \{(-0.4, -0.3), (-0.4, -0.2), (-0.4, -0.6), (-0.3, -0.6)\}$$

$$F = \{(-0.2, -0.7), (-0.2, -0.9), (-0.2, -0.5), (-0.7, -0.5)\}$$

Then

Table 2. Positive and negative truth- membership, indeterminate-membership and false-membership of the edge set.

ω	(x, y)	(x, z)	(x, t)	(y, t)
$\omega_T^+(x, y)$	0.9	0.5	0.8	0.9
$\omega_I^+(x, y)$	0.25	0.2	0.4	0.35
$\omega_F^+(x, y)$	0.1	0.1	0.1	0.4
$\omega_T^-(x, y)$	-0.6	-0.6	-0.9	-0.9
$\omega_I^-(x, y)$	-0.35	-0.3	-0.25	-0.45
$\omega_F^-(x, y)$	-0.2	-0.2	-0.2	-0.5

The corresponding generalized bipolar neutrosophic graph of type 1 is shown in Fig.2

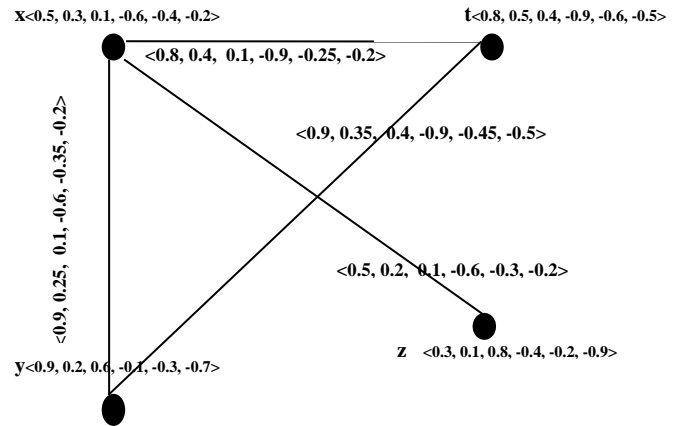

Fig 2. A BNG of type 1.

The easier way to represent any graph is to use the matrix representation. The adjacency matrices, incident matrices are the widely matrices used. In the following section, GBNG1 is represented by adjacency matrix.

IV. MATRIX REPRESENTATION OF GENERALIZED BIPOLAR NEUTROSOPHIC GRAPH OF TYPE 1

Because positive and negative truth- membership, indeterminate-membership and false-membership of the vertices are considered independents. In this section, we extended the representation matrix of generalized single valued neutrosophic graphs of type 1 proposed in [34] to the case of generalized bipolar neutrosophic graphs of type 1.

The generalized bipolar neutrosophic graph (GBNG1) has one property that edge membership values ($T^+, I^+, F^+, T^-, I^-, F^-$) depends on the membership values ($T^+, I^+, F^+, T^-, I^-, F^-$).

F^-) of adjacent vertices. Suppose $\zeta=(V, \rho, \omega)$ is a GBNG1 where vertex set $V=\{v_1, v_2, \dots, v_n\}$. The functions

$\alpha :A \rightarrow [0, 1]$ is taken such that $\omega_T^+(x, y) = \alpha((\rho_T^+(x), \rho_T^+(y)))$, where $x, y \in V$ and $A = \{(\rho_T^+(x), \rho_T^+(y)) \mid \omega_T^+(x, y) \geq 0\}$,
 $\beta :B \rightarrow [0, 1]$ is taken such that $\omega_I^+(x, y) = \beta((\rho_I^+(x), \rho_I^+(y)))$, where $x, y \in V$ and $B = \{(\rho_I^+(x), \rho_I^+(y)) \mid \omega_I^+(x, y) \geq 0\}$,
 $\delta :C \rightarrow [0, 1]$ is taken such that $\omega_F^+(x, y) = \delta((\rho_F^+(x), \rho_F^+(y)))$, where $x, y \in V$ and $C = \{(\rho_F^+(x), \rho_F^+(y)) \mid \omega_F^+(x, y) \geq 0\}$,
 $\xi :D \rightarrow [-1, 0]$ is taken such that $\omega_T^-(x, y) = \xi((\rho_T^-(x), \rho_T^-(y)))$, where $x, y \in V$ and $D = \{(\rho_T^-(x), \rho_T^-(y)) \mid \omega_T^-(x, y) \leq 0\}$,
 $\sigma :E \rightarrow [-1, 0]$ is taken such that $\omega_I^-(x, y) = \sigma((\rho_I^-(x), \rho_I^-(y)))$, where $x, y \in V$ and $E = \{(\rho_I^-(x), \rho_I^-(y)) \mid \omega_I^-(x, y) \leq 0\}$, and
 $\psi :F \rightarrow [-1, 0]$ is taken such that $\omega_F^-(x, y) = \psi((\rho_F^-(x), \rho_F^-(y)))$, where $x, y \in V$ and $F = \{(\rho_F^-(x), \rho_F^-(y)) \mid \omega_F^-(x, y) \leq 0\}$,

The GBNG1 can be represented by $(n+1) \times (n+1)$ matrix $M_{G_1}^{T,I,F} = [a^{T,I,F}(i, j)]$ as follows:

The positive and negative truth-membership (T^+, T^-), indeterminate-membership (I^+, I^-) and false-membership (F^+, F^-), values of the vertices are provided in the first row and first column. The $(i+1, j+1)$ -th-entry are the membership (T^+, T^-), indeterminate-membership (I^+, I^-) and the false-membership (F^+, F^-) values of the edge (x_i, x_j) , $i, j=1, \dots, n$ if $i \neq j$.

The (i, i) -th entry is $\rho(x_i) = (\rho_T^+(x_i), \rho_I^+(x_i), \rho_F^+(x_i), \rho_T^-(x_i), \rho_I^-(x_i), \rho_F^-(x_i))$ where $i=1, 2, \dots, n$. The positive and negative truth-membership (T^+, T^-), indeterminate-membership (I^+, I^-) and false-membership (F^+, F^-), values of the edge can be computed easily using the functions $\alpha, \beta, \delta, \xi, \sigma$ and ψ which are in $(1, 1)$ -position of the matrix. The matrix representation of GBNG1, denoted by $M_{G_1}^{T,I,F}$, can be written as sixth matrix representation $M_{G_1}^{T+}, M_{G_1}^{I+}, M_{G_1}^{F+}, M_{G_1}^{T-}, M_{G_1}^{I-}, M_{G_1}^{F-}$.

The $M_{G_1}^{T+}$ can be represented as follows:

Table3. Matrix representation of T^+ -GBNG1

α	$v_1(\rho_T^+(v_1))$	$v_2(\rho_T^+(v_2))$	$v_n(\rho_T^+(v_n))$
$v_1(\rho_T^+(v_1))$	$\rho_T^+(v_1)$	$\alpha(\rho_T^+(v_1), \rho_T^+(v_2))$	$\alpha(\rho_T^+(v_1), \rho_T^+(v_n))$
$v_2(\rho_T^+(v_2))$	$\alpha(\rho_T^+(v_2), \rho_T^+(v_1))$	$\rho_T^+(v_2)$	$\alpha(\rho_T^+(v_2), \rho_T^+(v_n))$
...
$v_n(\rho_T^+(v_n))$	$\alpha(\rho_T^+(v_n), \rho_T^+(v_1))$	$\alpha(\rho_T^+(v_n), \rho_T^+(v_2))$	$\rho_T^+(v_n)$

The $M_{G_1}^{I+}$ can be represented as follows

Table 4. Matrix representation of I^+ -GBNG1

β	$v_1(\rho_I^+(v_1))$	$v_2(\rho_I^+(v_2))$	$v_n(\rho_I^+(v_n))$
$v_1(\rho_I^+(v_1))$	$\rho_I^+(v_1)$	$\beta(\rho_I^+(v_1), \rho_I^+(v_2))$	$\beta(\rho_I^+(v_1), \rho_I^+(v_n))$
$v_2(\rho_I^+(v_2))$	$\beta(\rho_I^+(v_2), \rho_I^+(v_1))$	$\rho_I^+(v_2)$	$\beta(\rho_I^+(v_2), \rho_I^+(v_n))$
...
$v_n(\rho_I^+(v_n))$	$\beta(\rho_I^+(v_n), \rho_I^+(v_1))$	$\beta(\rho_I^+(v_n), \rho_I^+(v_2))$	$\rho_I^+(v_n)$

The $M_{G_1}^{F+}$ can be represented as follows

Table5. Matrix representation of F^+ -GBNG1

δ	$v_1(\rho_F^+(v_1))$	$v_2(\rho_F^+(v_2))$	$v_n(\rho_F^+(v_n))$
$v_1(\rho_F^+(v_1))$	$\rho_F^+(v_1)$	$\delta(\rho_F^+(v_1), \rho_F^+(v_2))$	$\delta(\rho_F^+(v_1), \rho_F^+(v_n))$
$v_2(\rho_F^+(v_2))$	$\delta(\rho_F^+(v_2), \rho_F^+(v_1))$	$\rho_F^+(v_2)$	$\delta(\rho_F^+(v_2), \rho_F^+(v_n))$
...
$v_n(\rho_F^+(v_n))$	$\delta(\rho_F^+(v_n), \rho_F^+(v_1))$	$\delta(\rho_F^+(v_n), \rho_F^+(v_2))$	$\rho_F^+(v_n)$

The $M_{G_1}^{T-}$ can be represented as follows

Table6. Matrix representation of T^- -GBNG1

ξ	$v_1(\rho_T^-(v_1))$	$v_2(\rho_T^-(v_2))$	$v_n(\rho_T^-(v_n))$
$v_1(\rho_T^-(v_1))$	$\rho_T^-(v_1)$	$\xi(\rho_T^-(v_1), \rho_T^-(v_2))$	$\xi(\rho_T^-(v_1), \rho_T^-(v_n))$
$v_2(\rho_T^-(v_2))$	$\xi(\rho_T^-(v_2), \rho_T^-(v_1))$	$\rho_T^-(v_2)$	$\xi(\rho_T^-(v_2), \rho_T^-(v_n))$
...
$v_n(\rho_T^-(v_n))$	$\xi(\rho_T^-(v_n), \rho_T^-(v_1))$	$\xi(\rho_T^-(v_n), \rho_T^-(v_2))$	$\rho_T^-(v_n)$

The $M_{G_1}^{I-}$ can be represented as follows

Table7. Matrix representation of I^- -GBNG1

σ	$v_1(\rho_I^-(v_1))$	$v_2(\rho_I^-(v_2))$	$v_n(\rho_I^-(v_n))$
$v_1(\rho_I^-(v_1))$	$\rho_I^-(v_1)$	$\sigma(\rho_I^-(v_1), \rho_I^-(v_2))$	$\sigma(\rho_I^-(v_1), \rho_I^-(v_n))$
$v_2(\rho_I^-(v_2))$	$\sigma(\rho_I^-(v_2), \rho_I^-(v_1))$	$\rho_I^-(v_2)$	$\sigma(\rho_I^-(v_2), \rho_I^-(v_n))$
...
$v_n(\rho_I^-(v_n))$	$\sigma(\rho_I^-(v_n), \rho_I^-(v_1))$	$\sigma(\rho_I^-(v_n), \rho_I^-(v_2))$	$\rho_I^-(v_n)$

The $M_{G_1}^{F-}$ can be represented as follows

Table8. Matrix representation of F^- -GBNG1

ψ	$v_1(\rho_F^-(v_1))$	$v_2(\rho_F^-(v_2))$	$v_n(\rho_F^-(v_n))$
$v_1(\rho_F^-(v_1))$	$\rho_F^-(v_1)$	$\psi(\rho_F^-(v_1), \rho_F^-(v_2))$	$\psi(\rho_F^-(v_1), \rho_F^-(v_n))$
$v_2(\rho_F^-(v_2))$	$\psi(\rho_F^-(v_2), \rho_F^-(v_1))$	$\rho_F^-(v_2)$	$\psi(\rho_F^-(v_2), \rho_F^-(v_n))$
...
$v_n(\rho_F^-(v_n))$	$\psi(\rho_F^-(v_n), \rho_F^-(v_1))$	$\psi(\rho_F^-(v_n), \rho_F^-(v_2))$	$\rho_F^-(v_n)$

Remark 1: If $\rho_T^-(x) = \rho_I^-(x) = \rho_F^-(x) = 0$, the generalized bipolar neutrosophic graphs of type 1 is reduced to generalized single valued neutrosophic graph of type 1 (GSVNG1).

Remark 2: If $\rho_T^-(x) = \rho_I^-(x) = \rho_F^-(x) = 0$, and $\rho_I^+(x) = \rho_F^+(x) = 0$, the generalized bipolar neutrosophic graphs type 1 is reduced to generalized fuzzy graph of type 1 (GFG1).

Here the generalized bipolar neutrosophic graph of type 1 (GBNG1) can be represented by the matrix representation depicted in table 15. The matrix representation can be written

as sixth matrices one containing the entries as $T^+, I^+, F^+, T^-, I^-, F^-$ (see table 9, 10,11,12,13 and 14).

Table9. T^+ - matrix representation of GBNG1

$\alpha = \max(x, y)$	x(0.5)	y(0.9)	z(0.3)	t(0.8)
x(0.5)	0.5	0.9	0.5	0.8
y(0.9)	0.9	0.9	0	0.9
z(0.3)	0.5	0	0.3	0
t(0.8)	0.8	0.9	0	0.8

Table10. I^+ - matrix representation of GBNG1

$\beta = (x+y)/2$	x(0.3)	y(0.2)	z(0.1)	t(0.5)
x(0.3)	0.3	0.25	0.2	0.4
y(0.2)	0.25	0.2	0	0.35
z(0.1)	0.2	0	0.1	0
t(0.5)	0.4	0.35	0	0.5

Table11. F^+ - matrix representation of GBNG1

$\delta = \min(x, y)$	x(0.1)	y(0.6)	z(0.8)	t(0.4)
x(0.1)	0.1	0.1	0.1	0.1
y(0.6)	0.1	0.6	0	0.4
z(0.8)	0.1	0	0.8	0
t(0.4)	0.1	0.4	0	0.4

Table12. T^- - matrix representation of GBNG1

$\xi = \min(x, y)$	x(-0.6)	y(-0.1)	z(-0.4)	t(-0.9)
x(-0.6)	-0.6	-0.6	-0.6	-0.9
y(-0.1)	-0.6	-0.1	0	-0.9
z(-0.4)	-0.6	0	-0.4	0
t(-0.9)	-0.9	-0.9	0	-0.9

Table13. I^- - matrix representation of GBNG1

$\sigma = (x+y)/2$	x(-0.4)	y(-0.3)	z(-0.2)	t(-0.6)
x(-0.4)	-0.4	-0.35	-0.3	-0.25
y(-0.3)	-0.35	-0.3	0	-0.45
z(-0.2)	-0.3	0	-0.2	0
t(-0.6)	-0.5	-0.45	0	-0.6

Table14. F^- - matrix representation of GBNG1

$\psi = \max(x, y)$	x(-0.2)	y(-0.7)	z(-0.9)	t(-0.5)
x(-0.2)	-0.2	-0.2	-0.2	-0.2
y(-0.7)	-0.2	-0.7	0	-0.5
z(-0.9)	-0.2	0	-0.9	0
t(-0.5)	-0.2	-0.5	0	-0.5

The matrix representation of GBNG1 can be represented as follows:

Table15. Matrix representation of GBNG1.

$(\alpha, \beta, \delta, \xi, \sigma, \psi)$	x(0.5, 0.3, 0.1, -0.6, -0.4, -0.2)	y(0.9, 0.2, 0.6, -0.1, -0.3, -0.7)	z(0.3, 0.1, 0.8, -0.4, -0.2, -0.9)	t(0.8, 0.5, 0.4, -0.9, -0.6, -0.5)
x(0.5, 0.3, 0.1, -0.6, -0.4, -0.2)	(0.5, 0.3, 0.1, -0.6, -0.4, -0.2)	(0.9, 0.25, 0.1, -0.6, -0.35, -0.2)	(0.5, 0.2, 0.1, -0.6, -0.3, -0.2)	(0.8, 0.4, 0.1, -0.9, -0.5, -0.2)
y(0.9, 0.2, 0.6, -0.1, -0.3, -0.7)	(0.9, 0.25, 0.1, -0.6, -0.35, -0.2)	(0.9, 0.2, 0.6, -0.1, -0.3, -0.7)	(0, 0, 0, 0, 0, 0)	(0.9, 0.35, 0.4, -0.9, -0.45, -0.5)
z(0.3, 0.1, 0.8, -0.4, -0.2, -0.9)	(0.5, 0.2, 0.1, -0.6, -0.3, -0.2)	(0, 0, 0, 0, 0, 0)	(0.3, 0.1, 0.8, -0.4, -0.2, -0.9)	(0, 0, 0, 0, 0, 0)
t(0.8, 0.5, 0.4, -0.9, -0.6, -0.5)	(0.8, 0.4, 0.1, -0.9, -0.5, -0.2)	(0.9, 0.35, 0.4, -0.9, -0.45, -0.5)	(0, 0, 0, 0, 0, 0)	(0.8, 0.5, 0.4, -0.9, -0.6, -0.5)

Theorem 1. Let $M_{G_1}^{T^+}$ be matrix representation of T^+ -GBNG1, then the degree of vertex

$$D_{T^+}(x_k) = \sum_{j=1, j \neq k}^n a_{T^+}(k+1, j+1), x_k \in V \text{ or}$$

$$D_{T^+}(x_p) = \sum_{i=1, i \neq p}^n a_{T^+}(i+1, p+1), x_p \in V.$$

Proof: It is similar as in theorem 1 of [34].

Theorem 2. Let $M_{G_1}^{I^+}$ be matrix representation of I^+ -GBNG1, then the degree of vertex

$$D_{I^+}(x_k) = \sum_{j=1, j \neq k}^n a_{I^+}(k+1, j+1), x_k \in V \text{ or}$$

$$D_{I^+}(x_p) = \sum_{i=1, i \neq p}^n a_{I^+}(i+1, p+1), x_p \in V.$$

Proof: It is similar as in theorem 1 of [34].

Theorem 3. Let $M_{G_1}^{F^+}$ be matrix representation of F^+ -GBNG1, then the degree of vertex

$$D_{F^+}(x_k) = \sum_{j=1, j \neq k}^n a_{F^+}(k+1, j+1), x_k \in V \text{ or}$$

$$D_{F^+}(x_p) = \sum_{i=1, i \neq p}^n a_{F^+}(i+1, p+1), x_p \in V.$$

Proof: It is similar as in theorem 1 of [34].

Theorem 4. Let $M_{G_1}^{T^-}$ be matrix representation of T^- -GBNG1, then the degree of vertex

$$D_{T^-}(x_k) = \sum_{j=1, j \neq k}^n a_{T^-}(k+1, j+1), x_k \in V \text{ or}$$

$$D_{T^-}(x_p) = \sum_{i=1, i \neq p}^n a_{T^-}(i+1, p+1), x_p \in V.$$

Proof: It is similar as in theorem 1 of [34].

Theorem 5. Let $M_{G_1}^{I^-}$ be matrix representation of I^- -GBNG1, then the degree of vertex

$$D_{I^-}(x_k) = \sum_{j=1, j \neq k}^n a_{I^-}(k+1, j+1), x_k \in V \text{ or}$$

$$D_{I^-}(x_p) = \sum_{i=1, i \neq p}^n a_{I^-}(i+1, p+1), x_p \in V.$$

Proof: It is similar as in theorem 1 of [34].

Theorem 6. Let $M_{G_1}^{F^-}$ be matrix representation of F^- -GBNG1, then the degree of vertex

$$D_{F^-}(x_k) = \sum_{j=1, j \neq k}^n a_{F^-}(k+1, j+1), x_k \in V \text{ or}$$

$$D_{F^-}(x_p) = \sum_{i=1, i \neq p}^n a_{F^-}(i+1, p+1), x_p \in V.$$

Proof: It is similar as in theorem 1 of [34]

V. CONCLUSION

In this article, we have extended the concept of generalized single valued neutrosophic graph of type 1 (GSVNG1) to generalized bipolar neutrosophic graph of type 1 (GBNG1) and showed a matrix representation of it. The concept of GBNG1 can be applied to the case of tri-polar neutrosophic graphs and multi-polar neutrosophic graphs. In the future works, we plan to study the concept of completeness, the concept of regularity and to define the concept of generalized bipolar neutrosophic graphs of type 2.

REFERENCES

- [1] A. Shannon, K. Atanassov, A First Step to a Theory of the Intuitionistic Fuzzy Graphs, Proc. of the First Workshop on Fuzzy Based Expert Systems (D. akov, Ed.), Sofia, 1994, pp.59-61.
- [2] A. Hassan, M. A. Malik, The Classes of bipolar single valued neutrosophic graphs, TWMS Journal of Applied and Engineering Mathematics" (TWMS J. of Apl. & Eng. Math.), 2016 accepted.
- [3] D. Ezhilmaran, K. Sankar, Morphism of bipolar intuitionistic fuzzy graphs, Journal of Discrete Mathematical Sciences & Cryptography, Vol. 18, No. 5, 2015, pp. 605–621.
- [4] F. Smarandache, Refined Literal Indeterminacy and the Multiplication Law of Sub-Indeterminacies, Neutrosophic Sets and Systems, Vol. 9, 2015, pp.58-63.
- [5] F. Smarandache, Neutrosophy. Neutrosophic Probability, Set, and Logic, ProQuest Information & Learning, Ann Arbor, Michigan, USA, 105 p., 1998.
- [6] F. Smarandache, Neutrosophic overset, neutrosophic underset, Neutrosophic offset. Similarly for Neutrosophic Over-/Under-/OffLogic, Probability, and Statistic, Pons Editions, Brussels, 2016, 170p.
- [7] F. Smarandache: Symbolic Neutrosophic Theory (Europanova asbl, Brussels, 195 p, Belgium 2015.
- [8] H. Wang, F. Smarandache, Y. Zhang, and R. Sunderraman, "Single valued Neutrosophic Sets, Multispace and Multistructure 4, 2010, pp. 410-413.
- [9] I. Turksen, Interval valued fuzzy sets based on normal forms, Fuzzy Sets and Systems, vol. 20, 1986, pp. 191-210.
- [10] I. Deli, M. Ali, F. Smarandache: Bipolar neutrosophic sets and their application based on multi-criteria decision making problems, in: Advanced Mechatronic Systems (ICAMechS), 249- 254 (2015), DOI: 10.1109/ICAMechS.2015.7287068.
- [11] K. Atanassov, Intuitionistic fuzzy sets, Fuzzy Sets and Systems, vol. 20, 1986, pp. 87-96.
- [12] K. Atanassov and G. Gargov, Interval valued intuitionistic fuzzy sets, Fuzzy Sets and Systems, vol.31, 1989, pp. 343-349.
- [13] L. Zadeh, Fuzzy sets. Inform and Control, 8, 1965, pp.338-353.
- [14] M. A. Malik, A. Hassan, Single valued neutrosophic trees, TWMS Journal of Applied and Engineering Mathematics" (TWMS J. of Apl. & Eng. Math, 2016 accepted.
- [15] M.Sahin, S. Alkhazaleh and V. Ulucay, Neutrosophic soft expert sets, Applied Mathematics 6(1), 2015, pp.116–127.
- [16] M. Akram, Bipolar fuzzy graphs, in: Information Sciences, vol. 181, no. 24, 2011, and pp.5548–5564.
- [17] M. Akram and G. Shahzadi, Operations on single-valued neutrosophic graphs, Journal of Uncertain System, 11, 2017, pp.1-26, in press.
- [18] N.Shah, Some Studies in Neutrosophic Graphs, Neutrosophic Sets and Systems, Vol. 12, 2016, pp.54-64.
- [19] N. Shah and A. Hussain, Neutrosophic Soft Graphs, Neutrosophic Sets and Systems, Vol. 11, 2016, pp.31-44.
- [20] P. K. Maji, Neutrosophic soft set, Annals of Fuzzy Mathematics and Informatics, 5/1, 2013, pp. 157-168.
- [21] P. K. Singh, Three-way fuzzy concept lattice representation using neutrosophic set, International Journal of Machine Learning and Cybernetics, 2016, pp. 1–11.
- [22] R. Dhavaseelan, R.Vikramaprasad, V.Krishnaraj, Certain Types of neutrosophic graphs, International Journal of Mathematical Sciences & Applications, Vol. 5, No. 2, ,2015, pp. 333-339.
- [23] S. Broumi, M. Talea, A. Bakali, F. Smarandache, "Single Valued Neutrosophic Graphs," Journal of New Theory, N 10, 2016, pp. 86-101.
- [24] S. Broumi, M. Talea, F. Smarandache and A. Bakali, Single Valued Neutrosophic Graphs: Degree, Order and Size. IEEE International Conference on Fuzzy Systems (FUZZ), 2016, pp. 2444-2451.
- [25] S. Broumi, A. Bakali, M. Talea, and F. Smarandache, Isolated Single Valued Neutrosophic Graphs. Neutrosophic Sets and Systems, Vol. 11, 2016, pp.74-78.
- [26] S. Broumi, M. Talea, A. Bakali, F. Smarandache, Interval Valued Neutrosophic Graphs, Critical Review, XII, 2016, pp.5-33.
- [27] S. Broumi, F. Smarandache, M. Talea and A. Bakali, Decision-Making Method Based On the Interval Valued Neutrosophic Graph, Future Technologie, 2016, IEEE, pp. 44-50.
- [28] S. Broumi, F. Smarandache, M. Talea and A. Bakali, Operations on Interval Valued Neutrosophic Graphs, chapter in book- New Trends in Neutrosophic Theory and Applications- Florentin Smarandache and Surpati Pramanik (Editors), 2016, pp. 231-254. ISBN 978-1-59973-498-9.
- [29] S. Broumi, A. Bakali, M. Talea, F. Smarandache and M. Ali, Shortest Path Problem under Bipolar Neutrosophic Setting, Applied Mechanics and Materials, Vol. 859, 2016, pp. 59-66.
- [30] S. Broumi, A. Bakali, M. Talea, F. Smarandache and L. Vladareanu, Computation of Shortest Path Problem in a Network with SV-Trapezoidal Neutrosophic Numbers, Proceedings of the 2016 International Conference on Advanced Mechatronic Systems, Melbourne, Australia, 2016, pp.417-422.
- [31] S. Broumi, A. Bakali, M. Talea, F. Smarandache and L. Vladareanu, Applying Dijkstra Algorithm for Solving Neutrosophic Shortest Path Problem, Proceedings of the 2016 International Conference on Advanced Mechatronic Systems, Melbourne, Australia, November 30 - December 3, 2016, pp.412-416.
- [32] S. Broumi, M. Talea, A. Bakali, F. Smarandache, On Bipolar Single Valued Neutrosophic Graphs, *Journal of New Theory*, No. 11, 2016, pp.84-102.
- [33] S. Broumi, F. Smarandache, M. Talea and A. Bakali, An Introduction to Bipolar Single Valued Neutrosophic Graph Theory. Applied Mechanics and Materials, vol.841,2016, pp.184-191.
- [34] S. Broumi, A. Bakali, M. Talea, A. Hassan and F. Smarandache, Generalized single valued neutrosophic of type 1, 2016, submitted.
- [35] S.Samanta, B. Sarkar, D. Shin and M. Pal, Completeness and regularity of generalized fuzzy graphs, SpringerPlus, 2016, DOI 10.1186/s40064-016-3558-6.
- [36] S. Mehra and M. Singh, Single valued neutrosophic signedgarphs, International Journal of computer Applications, Vol. 157, N. 9, 2017, p. 31, in press.
- [37] S. Ashraf, S. Naz, H. Rashmanlou, and M. A. Malik, Regularity of graphs in single valued neutrosophic environment, Journal of Intelligent & Fuzzy Systems, 2017, in press.
- [38] S. Naz, H. Rashmanlou, and M. A. Malik, Operations on single valued neutrosophic graphs with application, Journal of Intelligent & Fuzzy Systems, 2017, in press.

- [39] S. Fathi, H. Elchawalby and A. A. Salama, A neutrosophic graph similarity measures, chapter in book- New Trends in Neutrosophic Theory and Applications- Florentin Smarandache and Surpati Pramanik (Editors), 2016, pp. 223-230. ISBN 978-1-59973-498-9.
- [40] T.Pathinathan, J.Arockiaraj, and J.Rosline, Hesitancy Fuzzy Graphs, Indian Journal of Science and Technology, 8(35), 2015, pp.1-5.
- [41] V. Uluçay, M. Şahin, S Broumi, A. Bakali, M. Talea and F Smarandache, Decision-Making Method based on Neutrosophic Soft Expert Graphs, 2016, unpublished.
- [42] More information on <http://fs.gallup.unm.edu/NSS/>.

Introducing a Theory of Neutrosophic Evolution: Degrees of Evolution, Indeterminacy, and Involution

Florentin Smarandache

Florentin Smarandache (2017). Introducing a Theory of Neutrosophic Evolution: Degrees of Evolution, Indeterminacy, and Involution. *Progress in Physics* 13(2), 130-135

During the process of adaptation of a being (plant, animal, or human), to a new environment or conditions, the being partially evolves, partially devolves (degenerates), and partially is indeterminate i.e. neither evolving nor devolving, therefore unchanged (neutral), or the change is unclear, ambiguous, vague, as in neutrosophic logic. Thank to adaptation, one therefore has: evolution, involution, and indeterminacy (or neutrality), each one of these three neutrosophic components in some degree. The degrees of evolution/indeterminacy/involution are referred to both: the structure of the being (its body parts), and functionality of the being (functionality of each part, or inter-functionality of the parts among each other, or functionality of the being as a whole). We therefore introduce now for the first time the Neutrosophic Theory of Evolution, Involution, and Indeterminacy (or Neutrality).

1 Introduction

During the 2016–2017 winter, in December-January, I went to a cultural and scientific trip to Galápagos Archipelago, Ecuador, in the Pacific Ocean, and visited seven islands and islets: Mosquera, Isabela, Fernandina, Santiago, Sombrero Chino, Santa Cruz, and Rabida, in a cruise with Golondrina Ship. I had extensive discussions with our likeable guide, señor Milton Ulloa, about natural habitats and their transformations.

After seeing many animals and plants, that evolved differently from their ancestors that came from the continental land, I consulted, returning back to my University of New Mexico, various scientific literature about the life of animals and plants, their reproductions, and about multiple theories of evolutions. I used the online scientific databases that UNM Library has subscribed to, such as MathSciNet, Web of Science, EBSCO, Thomson Gale (Cengage), ProQuest, IEEE/IET Electronic Library, IEEE Xplore Digital Library etc., and DOAJ, Amazon Kindle, Google Play Books as well, doing searches for keywords related to origins of life, species, evolution, controversial ideas about evolution, adaptation and in-adaptation, life curiosities, mutations, genetics, embryology, and so on.

My general conclusion was that each evolution theory had some degree of truth, some degree of indeterminacy, and some degree of untruth (as in neutrosophic logic), depending on the types of species, environment, timespan, and other hidden parameters that may exist.

And all these degrees are different from a species to another species, from an environment to another environment, from a timespan to another timespan, and in general from a parameter to another parameter.

By environment, one understands: geography, climate, preys and predators of that species, i.e. the whole ecosystem.

I have observed that the animals and plants (and even human beings) not only evolve, but also *devolve* (i.e. involute back, decline, atrophy, pass down, regress, degenerate). Some traits increase, other traits decrease, while others remain unchanged (neutrality).

One also sees: adaptation by physical or functional evolution of a body part, and physical or functional involution of another body part, while other body parts and functions remain unchanged. After evolution, a new process starts, re-evaluation, and so on.

In the society it looks that the most opportunistic (which is the fittest!) succeeds, not the smartest. And professional deformation signifies evolution (specialization in a narrow field), and involution (incapability of doing things in another field).

The paper is organized as follows: some information on taxonomy, species, a short list of theories of origin of life, another list of theories and ideas about evolution. Afterwards the main contribution of this paper, the *theory of neutrosophic evolution*, the dynamicity of species, several examples of evolution, involution, and indeterminacy (neutrality), neutrosophic selection, refined neutrosophic theory of evolution, and the paper ends with open questions on evolution/neutrality/involution.

2 Taxonomy

Let's recall several notions from classical biology.

The **taxonomy** is a classification, from a scientifically point of view, of the living things, and it classifies them into three categories: **species**, **genus**, and **family**.

3 Species

A **species** means a group of organisms, living in a specific area, sharing many characteristics, and able to reproduce with

each other.

In some cases, the distinction between a population subgroup to be a different species, or not, is unclear, as in the *Sorites Paradoxes* in the frame of *neutrosophy*: the frontier between <A> (where <A> can be a species, a genus, or a family), and <nonA> (which means that is not <A>) is vague, incomplete, ambiguous. Similarly, for the distinction between a series and its subseries.

4 Theories of origin of life

Louis Pasteur (1822–1895) developed in 1860 the theory of *precellular (prebiotic) evolution*, which says that life evolved from non-living chemical combinations that, over long time, arose spontaneously.

In the late 19th century a theory, called *abiogenesis*, promulgated that the living organisms originated from lifeless matter spontaneously, without any living parents' action.

Carl R. Woese (b. 1928) has proposed in 1970's that the *progenotes* were the very first living cells, but their biological specificity was small. The genes were considered probable (rather than identical) proteins.

John Burdon Sanderson Haldane (1872–1964) proposed in 1929 the *theory that the viruses were precursors to the living cells* [1].

John Bernal and A. G. Cairns-Smith stated in 1966 the *mineral theory*: that life evolved from inorganic crystals found in the clay, by natural selection [2].

According to the *little bags theory of evolution*, the life is considered as having evolved from organic chemicals that happened to get trapped in some tiny vesicles.

Eigen and Schuster, adepts of the *hypercycle theory*, asserted in 1977 that the precursors of single cells were these little bags, and their chemical reactions cycles were equivalent to the life's functionality [3].

Other theories about the origin of life have been proposed in the biology literature, such as: *primordial soup*, *dynamic state theory*, and *phenotype theory*, but they were later dismissed by experiments.

5 Theories and ideas about evolution

The theory of *fixism* says that species are fixed, they do not evolve or devolve, and therefore the today's species are identical to the past species.

Of course, the *creationism* is a fixism theory, from a religious point of view. Opposed to the fixism is the theory of *transformism*, antecedent to the evolutionary doctrine, in the pre-Darwinian period, which asserts that plants and animals are modified and transformed gradually from one species into another through many generations [22].

Jean Baptiste Pierre Antoine de Monet Lamarck (1749–1829), in 1801, ahead of Charles Darwin, is associated with the *theory of inheritance of acquired characteristics* (or *use-inheritance*), and even of *acquired habits*. Which is called

Lamarckism or *Lamarckian Evolution*.

If an animal repeatedly stresses in the environment, its body part under stress will modify in order to overcome the environmental stress, and the modification will be transmitted to its offspring.

For example: the giraffe having a long neck in order to catch the tree leaves [4].

Herbert Spencer (1820–1903) used for the first time the term evolution in biology, showing that a population's gene pool changes from a generation to another generation, producing new species after a time [5].

Charles Darwin (1809–1882) introduced the natural selection, meaning that individuals that are more endowed with characteristics for reproduction and survival will prevail ("selection of the fittest"), while those less endowed would perish [6].

Darwin had also explained the structure similarities of leaving things in genera and families, due to the common descent of related species [7].

In his *gradualism* (or *phyletic gradualism*), Darwin said that species evolve slowly, rather than suddenly.

The adaptation of an organism means nervous response change, after being exposed to a permanent stimulus.

In the *modern gradualism*, from the genetic point of view, the beneficial genes of the individuals best adapted to the environment, will have a higher frequency into the population over a period of time, giving birth to a new species [8].

Herbert Spencer also coined the phrase survival of the fittest in 1864, that those individuals the best adapted to the environment are the most likely to survive and reproduce. Alfred Russel Wallace (1823–1913) coined in 1888 the terms *Darwinism* (individuals the most adapted to environment pass their characteristics to their offspring), and Darwinian fitness (the better adapted, the better surviving chance) [9].

One has upward evolution (*anagenesis*, coined by Alpheus Hyatt, 1838–1902, in 1889), as the progressive evolution of the species into another [10], and a *branching evolution* (*cladogenesis*, coined in 1953 by Sir Julian Sorell Huxley, 1887–1975), when the population diverges and new species evolve [11].

George John Romanes (1848–1894) coined the word *neo-Darwinism*, related to natural selection and the theory of genetics that explains the *synthetic theory of evolution*. What counts for the natural selection is the gene frequency in the population [12]. The Darwinism is put together with the paleontology, systematics, embryology, molecular biology, and genetics.

In the 19th century Gregor Johann Mendel (1822–1884) set the base of *genetics*, together with other scientists, among them Thomas Hunt Morgan (1866–1945).

The *Mendelism* is the study of heredity according to the chromosome theory: the living thing reproductive cells contain factors which transmit to their offspring particular characteristics [13].

August Weismann (1834–1914) in year 1892 enounced the germ plasm theory, saying that the offspring do not inherit the acquired characteristics of the parents [14].

Hugo de Vries (1848–1935) published a book in 1901 on *mutation theory*, considering that randomly genetic mutations may produce new forms of living things. Therefore, new species may occur suddenly [15].

Louis Antoine Marie Joseph Dollo (1857–1931) enunciated the *Dollo's principle (law or rule)* that evolution is irreversible, i.e. the lost functions and structures in species are not regained by future evolving species.

In the present, the *synergetic theory of evolution* considers that one has a natural or artificial multipolar selection, which occurs at all life levels, from the molecule to the ecosystem — not only at the population level.

But nowadays it has been discovered organisms that have re-evolved structured similar to those lost by their ancestors [16].

Life is... complicated!

The genetic assimilation (for *Baldwin Effect*, after James Mark Baldwin, 1861–1934) considered that an advantageous trait (or phenotype) may appear in several individuals of a population in response to the environmental cues, which would determine the gene responsible for the trait to spread through this population [17].

The British geneticist Sir Ronald A. Fisher (1890–1962) elaborated in 1930 the *evolutionary or directional determinism*, when a trait of individuals is preferred for the new generations (for example the largest grains to replant, chosen by farmers) [18].

The *theory of speciation* was associated with Ernst Mayr (b. 1904) and asserts that because of geographic isolation new species arise, that diverge genetically from the larger original population of sexually reproducing organisms. A subgroup becomes new species if its distinct characteristics allow it to survive and its genes do not mix with other species [19].

In the 20th century, Trofim Denisovitch Lysenko (1898–1976) revived the Lamarckism to the *Lysenkoism* school of genetics, proclaiming that the new characteristics acquired by parents will be passed on to the offspring [20].

Richard Goldschmidt (1878–1958) in 1940 has coined the terms of macroevolution, which means evolution from a long timespan (geological) perspective, and microevolution, which means evolution from a small timespan (a few generations) perspective with observable changes [1].

Sewall Wright (1889–1988), in the mid 20th century, developed the *founders effect of principle*, that in isolated places population arrived from the continent or from another island, becomes little by little distinct from its original place population. This is explained because the founders are few in number and therefore the genetic pool is smaller in diversity, whence their offspring are more similar in comparison to the offspring of the original place population.

The founders effect or principle is regarded as a particular case of the *genetic drift* (authored by the same biologist, Sewall Wright), which tells that the change in gene occurs by chance [21].

The mathematician John Maynard Smith has applied the game theory to animal behavior and in 1976 he stated the *evolutionary stable strategy* in a population. It means that, unless the environment changes, the best strategy will evolve, and persist for solving problems.

Other theories related to evolution such as: *punctuated equilibrium* (instantaneous evolution), *hopeful monsters*, and *saltation (quantum) speciation* (that new species suddenly occur; by Ernst Mayr) have been criticized by the majority of biologists.

6 Open research

By genetic engineering it is possible to make another combination of genes, within the same number of chromosomes. Thus, it is possible to mating a species with another closer species, but their offspring is sterile (the offspring cannot reproduce).

Despite the tremendous genetic engineering development in the last decades, there has not been possible to prove by experiments in the laboratory that: from an inorganic matter one can make organic matter that may reproduce and assimilate energy; nor was possible in the laboratory to transform a species into a new species that has a number of chromosomes different from the existent species.

7 Involution

According to several online dictionaries, **involution** means:

- Decay, retrogression or shrinkage in size; or return to a former state [Collins Dictionary of Medicine, Robert M. Youngson, 2005];

- Returning of an enlarged organ to normal size; or turning inward of the edges of a part; mental decline associated with advanced age (psychiatry) [Medical Dictionary for the Health Professions and Nursing, Farlex, 2012];

- Having rolled-up margins (for the plant organs) [Collins Dictionary of Biology, 3rd edition, W. G. Hale, V. A. Saunders, J. P. Margham, 2005];

- A retrograde change of the body or of an organ [Dorland's Medical Dictionary for Health Consumers, Saunders, an imprint of Elsevier, Inc., 2007];

- A progressive decline or degeneration of normal physiological functioning [The American Heritage, Houghton Mifflin Company, 2007].

8 Theory of Neutrosophic Evolution

During the process of adaptation of a being (plant, animal, or human) B , to a new environment η ,

- B partially *evolves*;

— *B* partially *devolves* (involves, regresses, degenerates);

— and *B* partially remains *indeterminate* which means *neutral* (unchanged), or ambiguous — i.e. not sure if it is evolution or involution.

Any action has a reaction. We see, thank to adaptation: evolution, involution, and neutrality (indeterminacy), each one of these three *neutrosophic components* in some degree.

The degrees of evolution/indeterminacy/involution are referred to both: the **structure** of *B* (its body parts), and **functionality** of *B* (functionality of each part, or inter-functionality of the parts among each other, or functionality of *B* as a whole).

Adaptation to new environment conditions means **de-adaptation** from the old environment conditions.

Evolution in one direction means involution in the opposite direction.

Loosing in one direction, one has to gain in another direction in order to survive (for equilibrium). And reciprocally.

A species, with respect to an environment, can be:

- in equilibrium, disequilibrium, or indetermination;
- stable, unstable, or indeterminate (ambiguous state);
- optimal, suboptimal, or indeterminate.

One therefore has a **Neutrosophic Theory of Evolution, Involution, and Indeterminacy** (neutrality, or fluctuation between Evolution and Involution). The evolution, the involution, and the indeterminate-evolution depend not only on natural selection, but also on many other factors such as: artificial selection, friends and enemies, bad luck or good luck, weather change, environment juncture etc.

9 Dynamicity of the species

If the species is in indeterminate (unclear, vague, ambiguous) state with respect to its environment, it tends to converge towards one extreme:

- either to equilibrium/stability/optimality, or to disequilibrium/instability/suboptimality with respect to an environment;
- therefore the species either rises up gradually or suddenly by mutation towards equilibrium/stability/optimality;
- or the species deeps down gradually or suddenly by mutation to disequilibrium/instability/suboptimality and perish.

The **attraction point** in this neutrosophic dynamic system is, of course, the state of equilibrium/stability/optimality. But even in this state, the species is not fixed, it may get, due to new conditions or accidents, to a degree of disequilibrium/instability/suboptimality, and from this new state again the struggle on the long way back of the species to its attraction point.

10 Several examples of evolution, involution, and indeterminacy (neutrality)

10.1 Cormorants example

Let's take the flightless cormorants (*Nannopterum harrisi*) in Galápagos Islands, their wings and tail have atrophied (hence **devolved**) due to their no need to fly (for they having no predators on the land), and because their permanent need to dive on near-shore bottom after fish, octopi, eels etc.

Their avian breastbone vanished (**involution**), since no flying muscles to support were needed.

But their neck got longer, their legs stronger, and their feet got huge webbed in order to catch fish underwater (**evolution**).

Yet, the flightless cormorants kept several of their ancestors' habits (functionality as a whole): make nests, hatch the eggs etc. (hence **neutrality**).

10.2 Cosmos example

The astronauts, in space, for extended period of time get accustomed to low or no gravity (**evolution**), but they lose bone density (**involution**). Yet other body parts do not change, or it has not been find out so far (**neutrality/indeterminacy**).

10.3 Example of evolution and involution

The whales **evolved** with respect to their teeth from pig-like teeth to cusped teeth. Afterwards, the whales **devolved** from cusped teeth back to conical teeth without cusps.

10.4 Penguin example

The Galápagos Penguin (*Spheniscus mendiculus*) evolved from the Humboldt Penguin by shrinking its size at 35 cm high (adaptation by involution) in order to be able to stay cool in the equatorial sun.

10.5 Frigate birds example

The Galápagos Frigate birds are birds that lost their ability to dive for food, since their feathers are not waterproof (**involution**), but they became masters of faster-and-maneuverable flying by stealing food from other birds, called kleptoparasite feeding (**evolution**).

10.6 Example of Darwin's finches

The 13 Galápagos species of Darwin's Finches manifest various degrees of evolution upon their beak, having different shapes and sizes for each species in order to gobble different types of foods (hence **evolution**):

- for cracking hard seeds, a thick beak (ground finch);
- for insects, flowers and cacti, a long and slim beak (another finch species).

Besides their beaks, the finches look similar, proving they came from a common ancestor (hence **neutrality**).

If one experiments, let's suppose one moves the thick-beak ground finches back to an environment with soft seeds, where it is not needed a thick beak, then the thick beak will atrophy and, in time, since it becomes hard for the finches to use the heavy beak, the thin-beak finches will prevail (hence **involution**).

10.7 El Niño example

Professor of ecology, ethology, and evolution Martin Wikelski, from the University of Illinois at Urbana-Champaign, has published in *Nature* a curious report, regarding data he and his team collected about marine iguanas since 1987. During the 1997–1998 El Niño, the marine algae died, and because the lack of food, on one of the Galápagos islands some marine iguanas shrank a quarter of their length and lost half of their weight (adaptation by **involution**).

After plentiful of food became available again, the marine iguanas grew back to their original length and weight (re-adaptation by **evolution**).

[J. Smith, J. Brown, The Incredible Shrinking Iguanas, in Ecuador & The Galápagos Islands, Moon Handbook, Avalon Travel, p. 325.]

10.8 Bat example

The bats are the only mammals capable of naturally flying, due to the fact that their forelimbs have developed into webbed wings (**evolution** by transformation). But navigating and foraging in the darkness, have caused their eyes' functionality to diminish (**involution**), yet the bats "see" with their ears (**evolution** by transformation) using the echolocation (or the bio sonar) in the following way: the bats emit sounds by mouth (one emitter), and their ears receive echoes (two receivers); the time delay (between emission and reception of the sound) and the relative intensity of the received sound give to the bats information about the distance, direction, size and type of animal in its environment.

10.9 Mole example

For the moles, mammals that live underground, their eyes and ears have degenerated and become minuscule since their functions are not much needed (hence adaptation by **involution**), yet their forelimbs became more powerful and their paws larger for better digging (adaptation by **evolution**).

11 Neutrosophic selection

Neutrosophic selection with respect to a population of a species means that over a specific timespan a percentage of its individuals evolve, another percentage of individuals devolve, and a third category of individuals do not change or their change is indeterminate (not knowing if it is evolution or involution). We may have a natural or artificial neutrosophic selection.

12 Refined Neutrosophic Theory of Evolution

Refined Neutrosophic Theory of Evolution is an extension of the neutrosophic theory of evolution, when the degrees of evolution/indeterminacy/involution are considered separately with respect to each body part, and with respect to each body part functionality, and with respect to the whole organism functionality.

13 Open questions on evolution/neutrality/involution

13.1. How to measure the degree of evolution, degree of involution, and degree of indeterminacy (neutrality) of a species in a given environment and a specific timespan?

13.2. How to compute the degree of similarity to ancestors, degree of dissimilarity to ancestors, and degree of indeterminate similarity-dissimilarity to ancestors?

13.3. Experimental Question. Let's suppose that a partial population of species S_1 moves from environment η_1 to a different environment η_2 ; after a while, a new species S_2 emerges by adaptation to η_2 ; then a partial population S_2 moves back from η_2 to η_1 ; will S_2 evolve back (actually devolve to S_1)?

13.4. Are all species needed by nature, or they arrived by accident?

14 Conclusion

We have introduced for the first time the concept of *Neutrosophic Theory of Evolution, Indeterminacy (or Neutrality), and Involution*.

For each being, during a long timespan, there is a process of partial evolution, partial indeterminacy or neutrality, and partial involution with respect to the being body parts and functionalities.

The function creates the organ. The lack of organ functioning, brings atrophy to the organ.

In order to survive, the being has to adapt. One has adaptation by evolution, or adaptation by involution — as many examples have been provided in this paper. The being partially evolves, partially devolves, and partially remains unchanged (fixed) or its process of evolution-involution is indeterminate. There are species partially adapted and partially struggling to adapt.

References

1. Barbieri M. The Semantic Theory of Evolution. Chur, Switzerland, 1985.
2. Cairns-Smith A.G. The Origin of Life and the Nature of Primitive Gene. *Journal of Theoretical Biology*, 1966, v. X, 53–88.
3. Eigen M. and Schuster P. The Hypercycle. A Principle of Natural Self-Organization. *Naturwissenschaften*, 1977, v. LXIV, 541–565.
4. Lamarck J.B. Zoological Philosophy. 1809.
5. Reader J. The Rise of Life. New York, 1988
6. Sober E. The Nature of Selection. Cambridge, MA, 1984.
7. Kohn D. The Darwinian Heritage. Princeton, NJ, 1985.

8. Eldredge N. *Life Pulse: Episodes from the Story of the Fossil Record*. New York, 1987.
 9. Wallace A.R. *Darwinism: An Exposition of the Theory of Natural Selection with Some of its Applications* MacMillan, London, 1889.
 10. Brown J. *Biogeography*. St. Louis, MO, 1983.
 11. Delson E. *Ancestors: The Hard Evidence*. New York, 1985.
 12. Bowler P. *Evolution: The History of an Idea*. Berkeley, California, 1984.
 13. Olby R. *The Origins of Mendelism*. London-Chicago, 1985.
 14. Weismann A. *The Germ Plasm: A Theory of Heredity*. London, 1893.
 15. de Vries H. *Mutationstheorie [Mutation Theory]*. Leipzig. Veit und Co. 1901 & 1903.
 16. Milner R. *The Encyclopedia of Evolution: Humanity's Search for its Origins*. New York, 1987.
 17. Hitching F. *The Neck of the Giraffe: Where Darwin Went Wrong*. New Haven, Connecticut, 1987.
 18. Eldredge N. *Unfinished Synthesis*. Oxfrd Univ. Press, Oxford, 1985.
 19. Ereshefsky M. *The Units of Evolution: Essays on the Nature of Species*. Cambridge, Massachusetts, 1992.
 20. Joravsky D. *The Lysenko Affair*. Cambridge, Massachusetts, 1970.
 21. Magill F. *Magill's Survey of Science: Life Science Series*. Englewood Cliffs, NJ, 1991.
 22. *The Great Soviet Encyclopedia*. 3rd Edition, The Gale Group, Inc., 2010.
 23. Linfan Mao. *Biological n-System with Global Stability*. *International Conference on Applications of Mathematics in Topological Dynamics*, Section: "Physics, Biological and Chemical Systems", Kolkata, India, December 9–11, 2016.
 24. Smarandache F. *Galápagos sau Ținutul Broaștelor Țestoase Gigantice: Teoria Neutrosifică a Evoluției*. Editura Agora, Sibiu, 2017.
-

Neutrosophic Goal Programming

Ibrahim M. Hezam, Mohamed Abdel-Baset, Florentin Smarandache

Ibrahim M. Hezam, Mohamed Abdel-Baset, Florentin Smarandache (2017). Neutrosophic Goal Programming. In *Neutrosophic Operational Research*, vol. I, eds.: Prof. Florentin Smarandache, Dr. Mohamed Abdel-Basset, Dr. Yongquan Zhou, 63-76

Abstract

In this chapter, the goal programming in neutrosophic environment is introduced. The degree of acceptance, indeterminacy and rejection of objectives is considered simultaneous. In the two proposed models to solve Neutrosophic Goal Programming Problem (NGPP), our goal is to minimize the sum of the deviation in the model (I), while in the model (II), the neutrosophic goal programming problem NGPP is transformed into the crisp programming model using truth membership, indeterminacy membership, and falsity membership functions. Finally, the industrial design problem is given to illustrate the efficiency of the proposed models. The obtained results of Model (I) and Model (II) are compared with other methods.

Keywords

Neutrosophic optimization; Goal programming problem.

1 Introduction

Goal programming (GP) Models was originally introduced by Charnes and Cooper in early 1961 for a linear model . Multiple and conflicting goals can be used in goal programming. Also, GP allows the simultaneous solution of a system of Complex objectives, and the solution of the problem requires the establishment among these multiple objectives. In this case, the model must be solved in such a way that each of the objectives to be achieved. Therefore, the sum of the deviations from the ideal should be minimized in the objective function. It is important that measure deviations from the ideal should have a single scale, because deviations with different scales cannot be collected. However, the target value associated with each goal could be neutrosophic in the real-world application. In 1995, Smarandache [17] starting from philosophy (when [8]

fretted to distinguish between *absolute truth* and *relative truth* or between *absolute falsehood* and *relative falsehood* in logics, and respectively between *absolute membership* and *relative membership* or *absolute non-membership* and *relative non-membership* in set theory) [12] began to use the non-standard analysis. Also, inspired from the sport games (winning, defeating, or tie scores), from votes (pro, contra, null/black votes), from positive/negative/zero numbers, from yes/no/NA, from decision making and control theory (making a decision, not making, or hesitating), from accepted/rejected/pending, etc. and guided by the fact that the law of excluded middle did not work any longer in the modern logics. [12] combined the non-standard analysis with a tri-component logic/set/probability theory and with philosophy. How to deal with all of them at once, is it possible to unify them? [12].

Netrosophic theory means Neutrosophy applied in many fields in order to solve problems related to indeterminacy. Neutrosophy is a new branch of philosophy that studies the origin, nature, and scope of neutralities, as well as their interactions with different ideational spectra. This theory considers every entity $\langle A \rangle$ together with its opposite or negation $\langle \text{anti}A \rangle$ and with their spectrum of neutralities $\langle \text{neut}A \rangle$ in between them (i.e. entities supporting neither $\langle A \rangle$ nor $\langle \text{anti}A \rangle$). The $\langle \text{neut}A \rangle$ and $\langle \text{anti}A \rangle$ ideas together are referred to as $\langle \text{non}A \rangle$.

Neutrosophy is a generalization of Hegel's dialectics (the last one is based on $\langle A \rangle$ and $\langle \text{anti}A \rangle$ only). According to this theory every entity $\langle A \rangle$ tends to be neutralized and balanced by $\langle \text{anti}A \rangle$ and $\langle \text{non}A \rangle$ entities - as a state of equilibrium. In a classical way $\langle A \rangle$, $\langle \text{neut}A \rangle$, $\langle \text{anti}A \rangle$ are disjoint two by two. But, since in many cases the borders between notions are vague, imprecise, Sorites, it is possible that $\langle A \rangle$, $\langle \text{neut}A \rangle$, $\langle \text{anti}A \rangle$ (and $\langle \text{non}A \rangle$ of course) have common parts two by two, or even all three of them as well. Hence, in one hand, the Neutrosophic Theory is based on the triad $\langle A \rangle$, $\langle \text{neut}A \rangle$, and $\langle \text{anti}A \rangle$. In the other hand, Neutrosophic Theory studies the indeterminacy, labeled as I , with $nI = I$ for $n \geq 1$, and $mI + nI = (m+n)I$, in neutrosophic structures developed in algebra, geometry, topology etc.

The most developed fields of Neutrosophic theory are Neutrosophic Set, Neutrosophic Logic, Neutrosophic Probability, and Neutrosophic Statistics - that started in 1995, and recently Neutrosophic Precalculus and Neutrosophic Calculus, together with their applications in practice. Neutrosophic Set and Neutrosophic Logic are generalizations of the fuzzy set and respectively fuzzy logic (especially of intuitionistic fuzzy set and respectively intuitionistic fuzzy logic). In neutrosophic logic a proposition has a degree of truth (T), a degree of indeterminacy (I), and a degree of falsity (F), where T, I, F are standard or non-standard subsets of $]0, 1^+[$.

The important method for multi-objective decision making is goal programming approaches in practical decision making in real life. In a standard GP formulation, goals and constraints are defined precisely, but sometimes the system aim and conditions include some vague and undetermined situations. In particular, expressing the decision maker’s unclear target levels for the goals mathematically and the need to optimize all goals at the same needs to complicated calculations.

The neutrosophic approach for goal programming tries to solve this kind of unclear difficulties in this chapter.

The organization of the chapter is as follows. The next section introduces a brief some preliminaries. Sections 3 describe the formation of the Problem and develop two models to neutrosophic goal programming. Section 4 presents an industrial design problem is provided to demonstrate how the approach can be applied. Finally, conclusions are provided in section 5.

2 Some Preliminaries

Definition 1. [17]

A real fuzzy number \tilde{J} is a continuous fuzzy subset from the real line R whose triangular membership function $\mu_{\tilde{J}}(J)$ is defined by a continuous mapping from R to the closed interval $[0,1]$, where

- (1) $\mu_{\tilde{J}}(J) = 0$ for all $J \in (-\infty, a_1]$,
- (2) $\mu_{\tilde{J}}(J)$ is strictly increasing on $J \in [a_1, m]$,
- (3) $\mu_{\tilde{J}}(J) = 1$ for $J = m$,
- (4) $\mu_{\tilde{J}}(J)$ is strictly decreasing on $J \in [m, a_2]$,
- (5) $\mu_{\tilde{J}}(J) = 0$ for all $J \in [a_2, +\infty)$.

This will be elicited by:

$$\mu_{\tilde{J}}(J) = \begin{cases} \frac{J - a_1}{m - a_1}, & a_1 \leq J \leq m, \\ \frac{a_2 - J}{a_2 - m}, & m \leq J \leq a_2, \\ 0, & otherwise. \end{cases} \tag{1}$$

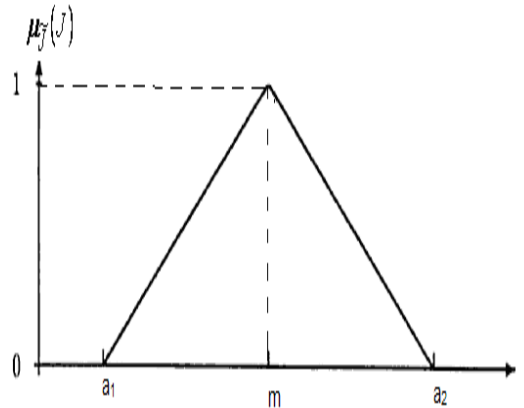

Fig. 1: Membership Function of Fuzzy Number J .

Where m is a given value a_1 and a_2 denote the lower and upper bounds. Sometimes, it is more convenient to use the notation explicitly highlighting the membership function parameters. In this case, we obtain

$$\mu(J; a_1, m, a_2) = \text{Max} \left\{ \text{Min} \left[\frac{J - a_1}{m - a_1}, \frac{a_2 - J}{a_2 - m} \right], 0 \right\} \tag{2}$$

In what follows, the definition of the α -level set or α -cut of the fuzzy number \tilde{J} is introduced.

Definition 2. [1]

Let $X = \{x_1, x_2, \dots, x_n\}$ be a fixed non-empty universe, an intuitionistic fuzzy set IFS A in X is defined as

$$A = \left\{ \langle x, \mu_A(x), \nu_A(x) \rangle \mid x \in X \right\} \tag{3}$$

which is characterized by a membership function $\mu_A : X \rightarrow [0,1]$ and a non-membership function $\nu_A : X \rightarrow [0,1]$ with the condition $0 \leq \mu_A(x) + \nu_A(x) \leq 1$ for all $x \in X$ where μ_A and ν_A represent, respectively, the degree of membership and non-membership of the element x to the set A . In addition, for each IFS A in X , $\pi_A(x) = 1 - \mu_A(x) - \nu_A(x)$ for all $x \in X$ is called the degree of hesitation of the element x to the set A . Especially, if $\pi_A(x) = 0$, then the IFS A is degraded to a fuzzy set.

Definition 3. [4] The α -level set of the fuzzy parameters \tilde{J} in problem (1) is defined as the ordinary set $L_\alpha(\tilde{J})$ for which the degree of membership function exceeds the level, α , $\alpha \in [0,1]$, where:

$$L_\alpha(\tilde{J}) = \{J \in R \mid \mu_{\tilde{J}}(J) \geq \alpha\} \tag{4}$$

For certain values α_j^* to be in the unit interval.

Definition 4. [10] Let X be a space of points (objects) and $x \in X$. A neutrosophic set A in X is defined by a truth-membership function (x), an indeterminacy-membership function (x) and a falsity-membership function (x). It has been shown in figure 2. (x), (x) and (x) are real standard or real nonstandard subsets of $]0-,1+[$. That is $T_A(x):X \rightarrow]0-,1+[$, $I_A(x):X \rightarrow]0-,1+[$ and $F_A(x):X \rightarrow]0-,1+[$. There is not restriction on the sum of (x), (x) and (x), so $0- \leq \sup T_A(x) \leq \sup I_A(x) \leq F_A(x) \leq 3+$.

In the following, we adopt the notations $\mu(x)$, $\sigma_A(x)$ and $v_A(x)$ instead of $T_A(x)$, $I_A(x)$ and $F_A(x)$, respectively. Also, we write SVN numbers instead of single valued neutrosophic numbers.

Definition 5. [10] Let X be a universe of discourse. A single valued neutrosophic set A over X is an object having the form

$$A = \{ \langle x, \mu_A(x), \sigma_A(x), v_A(x) \rangle : x \in X \},$$

where $\mu_A(x):X \rightarrow [0,1]$, $\sigma_A(x):X \rightarrow [0,1]$ and $v_A(x):X \rightarrow [0,1]$ with $0 \leq \mu_A(x) + \sigma_A(x) + v_A(x) \leq 3$ for all $x \in X$. The intervals $\mu(x)$, $\sigma_A(x)$ and $v_A(x)$ denote the truth-membership degree, the indeterminacy-membership degree and the falsity membership degree of x to A , respectively.

For convenience, a SVN number is denoted by $A=(a,b,c)$, where $a,b,c \in [0,1]$ and $a+b+c \leq 3$.

Definition 6. Let \tilde{J} be a neutrosophic number in the set of real numbers R , then its truth-membership function is defined as

$$T_{\tilde{J}}(J) = \begin{cases} \frac{J-a_1}{a_2-a_1}, & a_1 \leq J \leq a_2, \\ \frac{a_2-J}{a_3-a_2}, & a_2 \leq J \leq a_3, \\ 0, & \text{otherwise.} \end{cases} \tag{5}$$

its indeterminacy-membership function is defined as

$$I_j(J) = \begin{cases} \frac{J-b_1}{b_2-b_1}, & b_1 \leq J \leq b_2, \\ \frac{b_2-J}{b_3-b_2}, & b_2 \leq J \leq b_3, \\ 0, & \text{otherwise.} \end{cases} \quad (6)$$

and its falsity-membership function is defined as

$$F_j(J) = \begin{cases} \frac{J-c_1}{c_2-c_1}, & c_1 \leq J \leq c_2, \\ \frac{c_2-J}{c_3-c_2}, & c_2 \leq J \leq c_3, \\ 1, & \text{otherwise.} \end{cases} \quad (7)$$

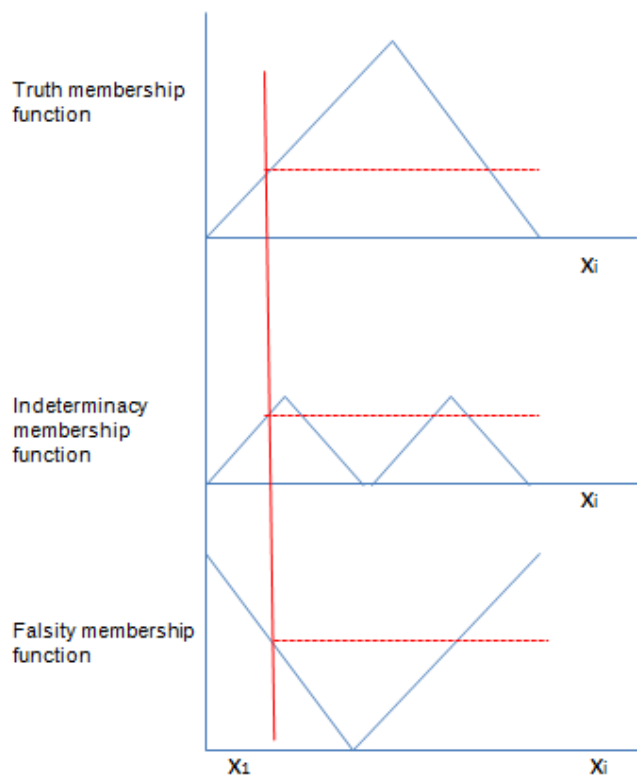

Fig. 2: Neutrosophication process [11]

3 Neutrosophic Goal Programming Problem

Goal programming can be written as:

$$\text{Find } x = (x_1, x_2, \dots, x_n)^T$$

To achieve:

$$z_i = t_i, \quad i = 1, 2, \dots, k \tag{8}$$

Subject to

$$x \in X$$

where t_i are scalars and represent the target achievement levels of the objective functions that the decision maker wishes to attain provided, X is feasible set of the constraints.

The achievement function of the (8) model is the following:

$$\text{Min } \sum_{i=1}^k (w_{1i} n_i + w_{2i} p_i) \tag{9}$$

Goal and constraints:

$$\begin{aligned} z_i + n_i - p_i &= t_i, \quad i \in \{1, 2, \dots, k\} \\ x \in X, \quad n, p &\geq 0, \quad n \cdot p = 0 \end{aligned}$$

n_i, p_i are negative and positive deviations from t_i target.

The NGPP can be written as:

$$\text{Find } x = (x_1, x_2, \dots, x_n)^T$$

So as to:

Minimize z_i with target value t_i , acceptance tolerance

a_i , indeterminacy tolerance d_i , rejection tolerance c_i ,

Subject to

$$x \in X$$

$$g_j(x) \leq b_j, \quad j = 1, 2, \dots, m$$

$$x_i \geq 0, \quad i = 1, 2, \dots, n$$

with truth-membership, indeterminacy-membership and falsity-membership functions:

$$\mu_i^I(z_i) = \begin{cases} 1, & \text{if } z_i \leq t_i, \\ 1 - \frac{z_i - t_i}{a_i}, & \text{if } t_i \leq z_i \leq t_i + a_i, \\ 0, & \text{if } z_i \geq t_i + a_i, \end{cases} \quad (10)$$

$$\sigma_i^I(z_i) = \begin{cases} 0, & \text{if } z_i \leq t_i, \\ \frac{z_i - t_i}{d_i}, & \text{if } t_i \leq z_i \leq t_i + d_i, \\ 1 - \frac{z_i - t_i}{a_i - d_i}, & \text{if } t_i + d_i \leq z_i \leq t_i + a_i, \\ 0, & \text{if } z_i \geq t_i + a_i \end{cases} \quad (11)$$

$$\nu_i^I(z_i) = \begin{cases} 0, & \text{if } z_i \leq t_i, \\ \frac{z_i - t_i}{C_i}, & \text{if } t_i \leq z_i \leq t_i + C_i, \\ 1, & \text{if } z_i \geq t_i + C_i \end{cases} \quad (12)$$

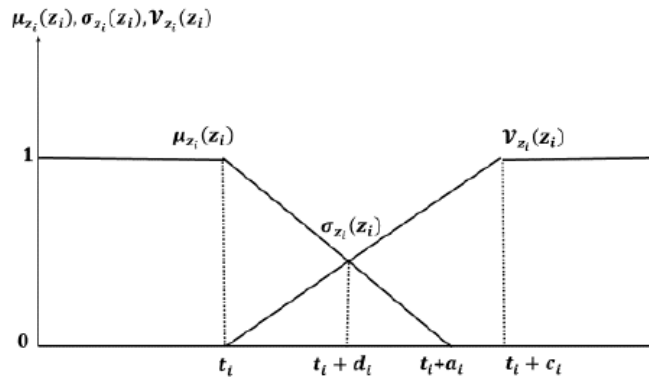

Fig. 3: Truth-membership, indeterminacy-membership and falsity-membership functions for z_i .

To maximize the degree the acceptance and indeterminacy of NGP objectives and constraints, also to minimize the degree of rejection of NGP objectives and constraints

$$\begin{aligned} & \text{Max } \mu_{z_i}(z_i), \quad i = 1, 2, \dots, k \\ & \text{Max } \sigma_{z_i}(z_i), \quad i = 1, 2, \dots, k \\ & \text{Min } \nu_{z_i}(z_i), \quad i = 1, 2, \dots, k \end{aligned} \quad (13)$$

Subject to

$$0 \leq \mu_{z_i}(z_i) + \sigma_{z_i}(z_i) + \nu_{z_i}(z_i) \leq 3, \quad i = 1, 2, \dots, k$$

$$\nu_{z_i}(z_i) \geq 0, \quad i = 1, 2, \dots, k$$

$$\mu_{z_i}(z_i) \geq \nu_{z_i}(z_i), \quad i = 1, 2, \dots, k$$

$$\mu_{z_i}(z_i) \geq \sigma_{z_i}(z_i), \quad i = 1, 2, \dots, k$$

$$g_j(x) \leq b_j, \quad j = 1, 2, \dots, m$$

$$x \in X$$

$$x_j \geq 0, \quad j = 1, 2, \dots, n$$

where $\mu_{z_i}(z_i)$, $\sigma_{z_i}(z_i)$, $\nu_{z_i}(z_i)$ are truth membership function, indeterminacy membership function, falsity membership function of Neutrosophic decision set respectively.

The highest degree of truth membership function is unity. So, for the defined the truth membership function $\mu_{z_i}(z_i)$, the flexible membership goals having the aspired level unity can be presented as

$$\mu_{z_i}(z_i) + n_{i1} - p_{i1} = 1$$

For case of indeterminacy (indeterminacy membership function), it can be written:

$$\sigma_{z_i}(z_i) + n_{i2} - p_{i2} = 0.5$$

For case of rejection (falsity membership function), it can be written

$$\mu_{z_i}(z_i) + n_{i3} - p_{i3} = 0$$

Here n_{i1}, p_{i1} , n_{i2}, p_{i2} , n_{i3} and p_{i3} are under-deviational and over-deviational variables.

Our goals are maximize the degree of the acceptance and indeterminacy of NGP objectives and constraints, and minimize the degree of rejection of NGP objectives and constraints.

Model (I). The minimization of the sum of the deviation can be formulated as:

$$\text{Min } \lambda = \sum_{i=1}^k w_{i1}n_{i1} + \sum_{i=1}^k w_{i2}n_{i2} + \sum_{i=1}^k w_{i3}p_{i3} \quad (14)$$

Subject to

$$\mu_{z_i}(z_i) + n_{i1} \geq 1, \quad i = 1, 2, \dots, k$$

$$\begin{aligned}
 &\sigma_{z_i}(z_i) + n_{i2} \geq 0.5, \quad i = 1, 2, \dots, k \\
 &\nu_{z_i}(z_i) - p_{i3} \leq 0, \quad i = 1, 2, \dots, k \\
 &\nu_{z_i}(z_i) \geq 0, \quad i = 1, 2, \dots, k \\
 &\mu_{z_i}(z_i) \geq \nu_{z_i}(z_i), \quad i = 1, 2, \dots, k \\
 &\mu_{z_i}(z_i) \geq \sigma_{z_i}(z_i), \quad i = 1, 2, \dots, k \\
 &0 \leq \mu_{z_i}(z_i) + \sigma_{z_i}(z_i) + \nu_{z_i}(z_i) \leq 3, \quad i = 1, 2, \dots, k \\
 &g_j(x) \leq b_j, \quad j = 1, 2, \dots, m \\
 &n_{i1}, n_{i2}, p_{i3} \geq 0, \quad i = 1, 2, \dots, k \\
 &x \in X \\
 &x_j \geq 0, \quad j = 1, 2, \dots, n
 \end{aligned}$$

On the other hand, neutrosophic goal programming NGP in Model (13) can be represented by crisp programming model using truth membership, indeterminacy membership, and falsity membership functions as:

$$\begin{aligned}
 &Max \alpha, Max \gamma, Min \beta \tag{15} \\
 &\mu_{z_i}(z_i) \geq \alpha, \quad i = 1, 2, \dots, k \\
 &\sigma_{z_i}(z_i) \geq \gamma, \quad i = 1, 2, \dots, k \\
 &\nu_{z_i}(z_i) \leq \beta, \quad i = 1, 2, \dots, k \\
 &z_i \leq t_i, \quad i = 1, 2, \dots, k \\
 &0 \leq \alpha + \gamma + \beta \leq 3 \\
 &\alpha, \gamma \geq 0, \quad \beta \leq 1 \\
 &g_j(x) \leq b_j, \quad j = 1, 2, \dots, m \\
 &x_j \geq 0, \quad j = 1, 2, \dots, n
 \end{aligned}$$

In model (15) the $Max \alpha, Max \gamma$ are equivalent to $Min(1-\alpha), Min(1-\gamma)$ respectively where $0 \leq \alpha, \gamma \leq 1$

$$Min \beta(1-\alpha)(1-\gamma) \tag{16}$$

Subject to

$$\begin{aligned}
 &z_i \leq t_i + a_i(a_i - d_i)\beta(1-\alpha)(1-\gamma), \quad i = 1, 2, \dots, k \\
 &z_i \leq t_i, \quad i = 1, 2, \dots, k
 \end{aligned}$$

$$\begin{aligned}
 &0 \leq \alpha + \gamma + \beta \leq 3 \\
 &\alpha, \gamma \geq 0, \beta \leq 1 \\
 &g_j(x) \leq b_j, j = 1, 2, \dots, m \\
 &x_j \geq 0, \quad j = 1, 2, \dots, n
 \end{aligned}$$

If we take $\beta(1-\alpha)(1-\gamma)=v$ the model (16) becomes:

Model (II).

$$\begin{aligned}
 &\text{Minimize } v && (17) \\
 &\text{Subject to} \\
 &z_i \leq t_i + a_i(a_i - d_i)v, \quad i = 1, 2, \dots, k \\
 &z_i \leq t_i, \quad i = 1, 2, \dots, k \\
 &0 \leq \alpha + \gamma + \beta \leq 3 \\
 &\alpha, \gamma \geq 0, \beta \leq 1 \\
 &g_j(x) \leq b_j, \quad j = 1, 2, \dots, m \\
 &x_j \geq 0, \quad j = 1, 2, \dots, n
 \end{aligned}$$

The crisp model (17) is solved by using any mathematical programming technique with v as parameter to get optimal solution of objective functions.

4 Illustrative Example

This industrial application selected from [15]. Let the Decision maker wants to remove about 98.5% biological oxygen demand (BOD) and the tolerances of acceptance, indeterminacy and rejection on this goal are 0.1, 0.2 and 0.3 respectively. Also, Decision maker wants to remove the said amount of BODS₅ within 300 (thousand \$) tolerances of acceptance, indeterminacy and rejection 200, 250, 300 (thousand \$) respectively. Then the neutrosophic goal programming problem is:

$$\begin{aligned}
 \min z_1(x_1, x_2, x_3, x_4) &= 19.4x_1^{-1.47} + 16.8x_2^{-1.66} \\
 &\quad + 91.5x_3^{-0.3} + 120x_4^{-0.33}, \\
 \min z_2(x_1, x_2, x_3, x_4) &= x_1x_2x_3x_4, \\
 s.t. : \\
 x_i &\geq 0, \quad i = 1, 2, 3, 4.
 \end{aligned}$$

With target 300, acceptance tolerance 200, indeterminacy tolerance 100 , and rejection tolerance 300 for the first objective z_1 .

Also, with target 0.015, acceptance tolerance 0.1, indeterminacy tolerance 0.05, and rejection tolerance 0.2 for the second objective z_2 .

Where x_i is the percentage BOD5(to remove 5 days BOD) after each step. Then after four processes the remaining percentage of BOD5 will be $x_i, i=1, 2, 3, 4$. The aim is to minimize the remaining percentage of BOD5 with minimum annual cost as much as possible. The annual cost of BOD5 removal by various treatments is primary clarifier, trickling filter, activated sludge, carbon adsorption. z_1 represent the annual cost. While z_2 represent removed from the wastewater.

The truth membership, indeterminacy membership, falsity membership functions were considered to be neutrosophic triangular.

The truth membership functions of the goals are obtained as follows:

$$\mu_1^I(z_1) = \begin{cases} 1, & \text{if } z_1 \leq 300, \\ 1 - \frac{z_1 - 300}{200}, & \text{if } 300 \leq z_1 \leq 500, \\ 0, & \text{if } z_1 \geq 500 \end{cases}$$

$$\mu_2^I(z_2) = \begin{cases} 1, & \text{if } z_2 \leq 0.015, \\ 1 - \frac{z_2 - 0.015}{0.1}, & \text{if } 0.015 \leq z_2 \leq 0.115, \\ 0, & \text{if } z_2 \geq 0.115. \end{cases}$$

The indeterminacy membership functions of the goals are given:

$$\sigma_1^I(z_1) = \begin{cases} 0, & \text{if } z_1 \leq 300, \\ \frac{z_1 - 300}{100}, & \text{if } 300 \leq z_1 \leq 400, \\ 1 - \frac{z_1 - 300}{100}, & \text{if } 400 \leq z_1 \leq 600, \\ 0, & \text{if } z_1 \geq 600 \end{cases}$$

$$\sigma_2^I(z_2) = \begin{cases} 0, & \text{if } z_2 \leq 0.015, \\ \frac{z_2 - 0.015}{0.05}, & \text{if } 0.015 \leq z_2 \leq 0.065, \\ 1 - \frac{z_2 - 0.015}{0.05}, & \text{if } 0.065 \leq z_2 \leq 0.215, \\ 0, & \text{if } z_2 \geq 0.215 \end{cases}$$

The falsity membership functions of the goals are obtained as follows:

$$v_1^I(z_1) = \begin{cases} 0, & \text{if } z_1 \leq 300, \\ \frac{z_1 - 300}{300}, & \text{if } 300 \leq z_1 \leq 600, \\ 1, & \text{if } z_1 \geq 600 \end{cases}$$

$$v_2^I(z_2) = \begin{cases} 0, & \text{if } z_2 \leq 0.015, \\ \frac{z_2 - 0.015}{0.2}, & \text{if } 0.015 \leq z_2 \leq 0.215, \\ 1, & \text{if } z_2 \geq 0.215 \end{cases}$$

The software LINGO 15.0 is used to solve this problem. Table (1) shows the comparison of the obtained results among the proposed models and the others methods.

Table 1: Comparison of optimal solution based on different methods:

Methods	z_1	z_2	x_1	x_2	x_3	x_4
FG ² P ² Ref[15]	363.8048	0.04692	0.705955	0.7248393	0.1598653	0.5733523
IFG ² P ² Ref[15]	422.1483	0.01504	0.638019	0.662717	0.09737155	0.3653206
Model (I)	317.666	0.1323	0.774182	0.7865418	0.2512332	0.8647621
Model (II)	417.6666	0.2150	2.628853	3.087266	0.181976E-01	1.455760

It is to be noted that model (I) offers better solutions than other methods.

5 Conclusions and Future Work

The main purpose of this chapter was to introduce goal programming in neutrosophic environment. The degree of acceptance, indeterminacy and rejection of objectives are considered simultaneously. Two proposed models to solve neutrosophic goal programming problem (NGPP), in the first model, our goal is to minimize the sum of the deviation, while the second model, neutrosophic goal programming NGP is transformed into crisp programming model using truth membership, indeterminacy membership, and falsity membership functions.

Finally, a numerical experiment is given to illustrate the efficiency of the proposed methods.

Moreover, the comparative study has been held of the obtained results and has been discussed. In the future studies, the proposed algorithm can be solved by metaheuristic algorithms.

References

- [1] O.M. Saad, B.M.A. Hassan, and I.M. Hizam, Optimizing the underground water confined steady flow using a fuzzy approach. In: International Journal of Mathematical Archive (IJMA) ISSN 2229-5046, vol. 2, 2011.
- [2] X. Xu, Y. Lei, and W. Dai, Intuitionistic fuzzy integer programming based on improved particle swarm optimization. In: Journal of Computer Appl., vol. 9, 2008.
- [3] A. Yücel, and Ali Fuat Güneri. A weighted additive fuzzy programming approach for multi-criteria supplier selection. In: Expert Systems with Applications 38, no. 5 (2011): 6281-6286.
- [4] I.M. Hizam, O. A. Raouf, M. M. Hadhoud: Solving Fractional Programming Problems Using Metaheuristic Algorithms Under Uncertainty. In: International Journal of Advanced Computing, vol. 46, 3, 2013, p. 1261--1270.
- [5] L. Yi, L. Wei-min, and X. Xiao-lai. Intuitionistic Fuzzy Bilevel Programming by Particle Swarm Optimization. In: Computational Intelligence and Industrial Application, 2008. PACIIA'08. Pacific-Asia Workshop on, IEEE, 2008, pp. 95–99.
- [6] Abdel-Baset, Mohamed, and Ibrahim M. Hezam. An Improved Flower Pollination Algorithm for Ratios Optimization Problems. In: Applied Mathematics & Information Sciences Letters An International Journal 3, no. 2 (2015): 83-91.
- [7] R. Irene Hepzibah, R and Vidhya Intuitionistic Fuzzy Multi-Objective linear Programming Problem(IFMOLPP) using Taylor Series. In: International Journal of Scientific and Engineering Research (IJSER), Vol. 3, Issue 6, June 2014.
- [8] A. Amid, S. H. Ghodsypour, and Ch. O'Brien. Fuzzy multiobjective linear model for supplier selection in a supply chain. In: International Journal of Production Economics 104, no. 2 (2006): 394-407.
- [9] D. Pintu, Tapan K. R. Multi-objective non-linear programming problem based on Neutrosophic Optimization Technique and its application in Riser Design Problem. In: Neutrosophic Sets and Systems, Vol. 9, 2015: 88-95.
- [10] Abdel-Basset, M., Mohamed, M. & Sangaiah, A.K. J Ambient Intell Human Comput (2017). DOI: <https://doi.org/10.1007/s12652-017-0548-7> .
- [11] S. Aggarwal, Ranjit B., and A. Q. Ansari. Neutrosophic modeling and control. In: Computer and Communication Technology (ICCCCT), 2010 International Conference on, pp. 718-723. IEEE, 2010.
- [12] Mohamed, Mai, et al. "Neutrosophic Integer Programming Problem." Neutrosophic Sets & Systems 15 (2017).
- [13] Dey, S., & Roy, T. K. "Intuitionistic Fuzzy Goal Programming Technique for Solving Non-Linear Multi-objective Structural Problem." Journal of Fuzzy Set Valued Analysis 2015, no. 3 (2015): 179-193.
- [14] Pramanik, P., & Roy, T. K. An intuitionistic fuzzy goal programming approach to vector optimization problem. Notes on Intuitionistic Fuzzy Sets 11, no. 1 (2005): 1-14.
- [15] Ghosh, P., & Roy, T. K. Intuitionistic Fuzzy Goal Geometric Programming Problem (IF G2 P2) based on Geometric Mean Method. In International Journal of Engineering Research and Technology, vol. 2, no. 11 (November-2013). ESRSA Publications, 2013.
- [16] IM Hezam, M Abdel-Baset, F. Smarandache. Taylor Series Approximation to Solve Neutrosophic Multiobjective Programming Problem. In: Neutrosophic Sets and Systems, Vol. 10, 2015:39-46.
- [17] El-Hefenawy, N., Metwally, M. A., Ahmed, Z. M., & El-Henawy, I. M. A Review on the Applications of Neutrosophic Sets. Journal of Computational and Theoretical Nanoscience, 13(1), (2016), pp. 936-944.

A Critical Path Problem in Neutrosophic Environment

Mai Mohamed, Mohamed Abdel-Baset, Florentin Smarandache, Yongquan Zhou

Mai Mohamed, Mohamed Abdel-Baset, Florentin Smarandache, Yongquan Zhou (2017). A Critical Path Problem in Neutrosophic Environment. In *Neutrosophic Operational Research*, vol. I, eds.: Prof. Florentin Smarandache, Dr. Mohamed Abdel-Basset, Dr. Yongquan Zhou, 167-174

Abstract

The Critical Path Method (CPM) is one of several related techniques for planning and managing of complicated projects in real world applications. In many situations, the data obtained for decision makers are only approximate, which gives rise of neutrosophic critical path problem. In this chapter, the proposed method has been made to find the critical path in network diagram, whose activity time uncertain. The vague parameters in the network are represented by triangular neutrosophic numbers, instead of crisp numbers. At the end of chapter, an illustrative example is provided to validate the proposed approach.

Keywords

Neutrosophic Sets; Project Management; CPM; Score and Accuracy Functions.

1 Introduction

Project management is concerned with selecting, planning, execution and control of projects in order to meet or exceed stakeholders' need or expectation from project. Two techniques of project management, namely Critical Path Method (CPM) and Program Evaluation and Review Technique (PERT) where

developed in 1950s. [1] The successful implementation of CPM requires clear determined time duration for each activity.

Steps involved in CPM include [2]:

- Develop Work Breakdown Structure of a project, estimate the resources needed and establish precedence relationship among activities.
- Translate the activities into network.
- Carry out network computation and prepare schedule of the activities.

In CPM, the main problem is wrongly calculated activity durations, of large projects that have many activities. The planned value of activity duration time may change under certain circumstances and may not be presented in a precise manner due to the error of the measuring technique or instruments etc. It has been obvious that neutrosophic set theory is more appropriate to model uncertainty that is associated with parameters such as activity duration time and resource availability in CPM.

This chapter is organized as follows: In section 2, the basic concepts neutrosophic sets are briefly reviewed. In section 3, the mathematical model of neutrosophic CPM and the proposed algorithm is presented. In section 4, a numerical example is illustrated. Finally, section 5 concludes the chapter with future work.

2 Preliminaries

In this section, the basic definitions involving neutrosophic set, single valued neutrosophic sets, triangular neutrosophic numbers and operations on triangular neutrosophic numbers are outlined.

Definition 1. [3, 5-7] Let X be a space of points (objects) and $x \in X$. A neutrosophic set A in X is defined by a truth-membership function $T_A(x)$, an indeterminacy-membership function $I_A(x)$ and a falsity-membership function $F_A(x)$. $T_A(x)$, $I_A(x)$ and $F_A(x)$ are real standard or real nonstandard subsets of $]0, 1^+[$. That is $T_A(x):X \rightarrow]0, 1^+[$, $I_A(x):X \rightarrow]0, 1^+[$ and $F_A(x):X \rightarrow]0, 1^+[$. There is no restriction on the sum of $T_A(x)$, $I_A(x)$ and $F_A(x)$, so $0^- \leq \sup T_A(x) + \sup I_A(x) + \sup F_A(x) \leq 3^+$.

Definition 2. [3, 8] Let X be a universe of discourse. A single valued neutrosophic set A over X is an object having the form $A = \{ \langle x, T_A(x), I_A(x), F_A(x) \rangle : x \in X \}$, where $T_A(x):X \rightarrow [0,1]$, $I_A(x):X \rightarrow [0,1]$ and $F_A(x):X \rightarrow [0,1]$ with $0 \leq T_A(x) + I_A(x) + F_A(x) \leq 3$ for all $x \in X$. The intervals $T_A(x)$, $I_A(x)$ and $F_A(x)$ denote the

truth-membership degree, the indeterminacy-membership degree and the falsity membership degree of x to A , respectively. For convenience, a SVN number is denoted by $A = (a, b, c)$, where $a, b, c \in [0, 1]$ and $a+b+c \leq 3$.

Definition 3. [4, 5] Let $\alpha_{\tilde{a}}, \theta_{\tilde{a}}, \beta_{\tilde{a}} \in [0, 1]$ and $a_1, a_2, a_3 \in \mathbf{R}$ such that $a_1 \leq a_2 \leq a_3$. Then a single valued triangular neutrosophic number, $\tilde{a} = \langle (a_1, a_2, a_3); \alpha_{\tilde{a}}, \theta_{\tilde{a}}, \beta_{\tilde{a}} \rangle$ is a special neutrosophic set on the real line set \mathbf{R} , whose truth-membership, indeterminacy-membership, and falsity-membership functions are given as follows:

$$\begin{aligned}
 T_{\tilde{a}}(x) &= \begin{cases} \alpha_{\tilde{a}} \left(\frac{x - a_1}{a_2 - a_1} \right) & \text{if } a_1 \leq x \leq a_2 \\ \alpha_{\tilde{a}} & \text{if } x = a_2 \\ \alpha_{\tilde{a}} \left(\frac{a_3 - x}{a_3 - a_2} \right) & \text{if } a_2 < x \leq a_3 \\ 0 & \text{otherwise} \end{cases} \quad (1)
 \end{aligned}$$

$$\begin{aligned}
 I_{\tilde{a}}(x) &= \begin{cases} \frac{(a_2 - x + \theta_{\tilde{a}}(x - a_1))}{(a_2 - a_1)} & \text{if } a_1 \leq x \leq a_2 \\ \theta_{\tilde{a}} & \text{if } x = a_2 \\ \frac{(x - a_2 + \theta_{\tilde{a}}(a_3 - x))}{(a_3 - a_2)} & \text{if } a_2 < x \leq a_3 \\ 1 & \text{otherwise} \end{cases} \quad (2)
 \end{aligned}$$

$$\begin{aligned}
 F_{\tilde{a}}(x) &= \begin{cases} \frac{(a_2 - x + \beta_{\tilde{a}}(x - a_1))}{(a_2 - a_1)} & \text{if } a_1 \leq x \leq a_2 \\ \beta_{\tilde{a}} & \text{if } x = a_2 \\ \frac{(x - a_2 + \beta_{\tilde{a}}(a_3 - x))}{(a_3 - a_2)} & \text{if } a_2 < x \leq a_3 \\ 1 & \text{otherwise} \end{cases} \quad (3)
 \end{aligned}$$

where $\alpha_{\tilde{a}}, \theta_{\tilde{a}}$ and $\beta_{\tilde{a}}$ denote the maximum truth-membership degree, minimum indeterminacy-membership degree and minimum falsity-membership degree respectively. A single valued triangular neutrosophic number $\tilde{a} = \langle (a_1, a_2, a_3); \alpha_{\tilde{a}}, \theta_{\tilde{a}}, \beta_{\tilde{a}} \rangle$ may express an ill-defined quantity about \mathbf{a} , which is approximately equal to \mathbf{a} .

Definition 4. Let $\tilde{a} = \langle (a_1, a_2, a_3); \alpha_{\tilde{a}}, \theta_{\tilde{a}}, \beta_{\tilde{a}} \rangle$ and $\tilde{b} = \langle (b_1, b_2, b_3); \alpha_{\tilde{b}}, \theta_{\tilde{b}}, \beta_{\tilde{b}} \rangle$ be two single valued triangular neutrosophic numbers and $\gamma \neq 0$ be any real number. Then,

$$\begin{aligned} \tilde{a} + \tilde{b} &= \langle (a_1 + b_1, a_2 + b_2, a_3 + b_3); \alpha_{\tilde{a}} \wedge \alpha_{\tilde{b}}, \theta_{\tilde{a}} \vee \theta_{\tilde{b}}, \beta_{\tilde{a}} \vee \beta_{\tilde{b}} \rangle \\ \tilde{a} - \tilde{b} &= \langle (a_1 - b_3, a_2 - b_2, a_3 - b_1); \alpha_{\tilde{a}} \wedge \alpha_{\tilde{b}}, \theta_{\tilde{a}} \vee \theta_{\tilde{b}}, \beta_{\tilde{a}} \vee \beta_{\tilde{b}} \rangle \\ \tilde{a} \tilde{b} &= \begin{cases} \langle (a_1 b_1, a_2 b_2, a_3 b_3); \alpha_{\tilde{a}} \wedge \alpha_{\tilde{b}}, \theta_{\tilde{a}} \vee \theta_{\tilde{b}}, \beta_{\tilde{a}} \vee \beta_{\tilde{b}} \rangle & \text{if } (a_3 > 0, b_3 > 0) \\ \langle (a_1 b_3, a_2 b_2, a_3 b_1); \alpha_{\tilde{a}} \wedge \alpha_{\tilde{b}}, \theta_{\tilde{a}} \vee \theta_{\tilde{b}}, \beta_{\tilde{a}} \vee \beta_{\tilde{b}} \rangle & \text{if } (a_3 < 0, b_3 > 0) \\ \langle (a_3 b_3, a_2 b_2, a_1 b_1); \alpha_{\tilde{a}} \wedge \alpha_{\tilde{b}}, \theta_{\tilde{a}} \vee \theta_{\tilde{b}}, \beta_{\tilde{a}} \vee \beta_{\tilde{b}} \rangle & \text{if } (a_3 < 0, b_3 < 0) \end{cases} \\ \frac{\tilde{a}}{\tilde{b}} &= \begin{cases} \langle (\frac{a_1}{b_3}, \frac{a_2}{b_2}, \frac{a_3}{b_1}); \alpha_{\tilde{a}} \wedge \alpha_{\tilde{b}}, \theta_{\tilde{a}} \vee \theta_{\tilde{b}}, \beta_{\tilde{a}} \vee \beta_{\tilde{b}} \rangle & \text{if } (a_3 > 0, b_3 > 0) \\ \langle (\frac{a_3}{b_3}, \frac{a_2}{b_2}, \frac{a_1}{b_1}); \alpha_{\tilde{a}} \wedge \alpha_{\tilde{b}}, \theta_{\tilde{a}} \vee \theta_{\tilde{b}}, \beta_{\tilde{a}} \vee \beta_{\tilde{b}} \rangle & \text{if } (a_3 < 0, b_3 > 0) \\ \langle (\frac{a_3}{b_1}, \frac{a_2}{b_2}, \frac{a_1}{b_3}); \alpha_{\tilde{a}} \wedge \alpha_{\tilde{b}}, \theta_{\tilde{a}} \vee \theta_{\tilde{b}}, \beta_{\tilde{a}} \vee \beta_{\tilde{b}} \rangle & \text{if } (a_3 < 0, b_3 < 0) \end{cases} \\ \gamma \tilde{a} &= \begin{cases} \langle (\gamma a_1, \gamma a_2, \gamma a_3); \alpha_{\tilde{a}}, \theta_{\tilde{a}}, \beta_{\tilde{a}} \rangle & \text{if } (\gamma > 0) \\ \langle (\gamma a_3, \gamma a_2, \gamma a_1); \alpha_{\tilde{a}}, \theta_{\tilde{a}}, \beta_{\tilde{a}} \rangle & \text{if } (\gamma < 0) \end{cases} \\ \tilde{a}^{-1} &= \langle (\frac{1}{a_3}, \frac{1}{a_2}, \frac{1}{a_1}); \alpha_{\tilde{a}}, \theta_{\tilde{a}}, \beta_{\tilde{a}} \rangle, \text{ where } (\tilde{a} \neq 0). \end{aligned}$$

3 Critical Path Method in Neutrosophic Environment and the Proposed Algorithm

Project network is a set of activities that must be performed according to precedence constraints determining which activities must start after the completion of specified other activities. Let us define some terms used in drawing network diagram of CPM:

- Activity: It is any portion of a project that has a definite beginning and ending and may use some resources such as time, labor, material, equipment, etc.
- Event or Node: Beginning and ending points of activities denoted by circles are called nodes or events.
- Critical Path: Is the longest path in the network.

The CPM in neutrosophic environment takes the following form:

A network $N = \langle E, A, \tilde{T} \rangle$, being a project model, is given. E is asset of events

(nodes) and $A \subset E \times E$ is a set of activities. \tilde{T} is a triangular neutrosophic number and stand for activity duration.

To obtain crisp model of neutrosophic CPM we should use the following equations:

We defined a method to compare any two single valued triangular neutrosophic numbers which is based on the score function and the accuracy function. Let $\tilde{a} = \langle (a_1, b_1, c_1), \alpha_{\tilde{a}}, \theta_{\tilde{a}}, \beta_{\tilde{a}} \rangle$ be a single valued triangular neutrosophic number, then

$$S(\tilde{a}) = \frac{1}{16} [a_1 + b_1 + c_1] \times (2 + \alpha_{\tilde{a}} - \theta_{\tilde{a}} - \beta_{\tilde{a}}) \tag{4}$$

and

$$A(\tilde{a}) = \frac{1}{16} [a_1 + b_1 + c_1] \times (2 + \alpha_{\tilde{a}} - \theta_{\tilde{a}} + \beta_{\tilde{a}}) \tag{5}$$

It is called the score and accuracy degrees of \tilde{a} , respectively. The neutrosophic CPM model can be represented by a crisp model using truth membership, indeterminacy membership, and falsity membership functions and the score and accuracy degrees of \tilde{a} , using equations (1), (2), (3) and (4), (5) respectively.

Notations of CPM solution:

\tilde{T}_i^e = Earliest occurrence time of predecessor event i ,

\tilde{T}_i^l = Latest occurrence time of predecessor event i ,

\tilde{T}_j^e = Earliest occurrence time of successor event j ,

\tilde{T}_j^l = Latest occurrence time of successor event j ,

\tilde{T}_{ij}^e / Start = Earliest start time of an activity ij ,

\tilde{T}_{ij}^e / Finish = Earliest finish time of an activity ij ,

\tilde{T}_{ij}^l / Start = Latest start time of an T_i^l activity ij ,

\tilde{T}_{ij}^l / Finish = Latest finish time of an activity ij ,

\tilde{T}_{ij} = Duration time of activity ij ,

Earliest and Latest occurrence time of an event:

\tilde{T}_j^e = maximum ($\tilde{T}_j^e + \tilde{T}_{ij}$), calculate all \tilde{T}_j^e for j th event, select maximum value.

$\tilde{T}_i^l = \text{minimum} (\tilde{T}_j^l - \tilde{T}_{ij}^l)$, calculate all T_i^l for i th event, select minimum value.

$$\tilde{T}_{ij}^e / \text{Start} = \tilde{T}_i^e,$$

$$\tilde{T}_{ij}^e / \text{Finish} = \tilde{T}_i^e + \tilde{T}_{ij},$$

$$\tilde{T}_{ij}^l / \text{Finish} = \tilde{T}_j^l,$$

$$\tilde{T}_{ij}^l / \text{Start} = \tilde{T}_j^l - \tilde{T}_{ij},$$

Critical path is the longest path in the network. At critical path, $\tilde{T}_i^e = \tilde{T}_i^l$, for all i , and don't care of the value of α, θ, β .

Slack or Float is cushion available on event/ activity by which it can be delayed without affecting the project completion time.

Slack for i th event = $\tilde{T}_i^l - \tilde{T}_i^e$, for events on critical path, slack is zero.

From the previous steps we can conclude the proposed algorithm as follows:

Step 1: To deal with uncertain, inconsistent and incomplete information about activity time, we considered activity time of CPM technique as triangular neutrosophic number.

Step 2: Draw CPM network diagram.

Step 3: Determine floats and critical path, which is the longest path in network.

Step 4: Determine expected project completion time.

4 Illustrative Examples

To explain the proposed approach in a better way, we solved numerical example and steps of solution are determined clearly.

1.1. Numerical Example 1

You are given the following data for a project:

Table 1. Input data for neutrosophic cpm.

Activity	Immediate Predecessors	Time (days)
A (1-2)	-----	$\tilde{3} = \langle (2,3,4); 0.6,0.3,0.1 \rangle$
B (1-3)	-----	$\tilde{5} = \langle (4,5,6); 0.8,0.2,0.4 \rangle$
C (2-4)	A	$\tilde{4} = \langle (1,4,8); 0.8,0.6,0.4 \rangle$
D (3-4)	B	$\tilde{6} = \langle (2,6,8); 0.6,0.4,0.2 \rangle$
E (4-5)	C,D	$\tilde{8} = \langle (6,8,10); 0.6,0.4,0.4 \rangle$

Step 1: Neutrosophic model of project take the following form:

$N = \langle E, A, \tilde{T} \rangle$, where E is asset of events (nodes) and $A \subset E \times E$ is a set of activities, \tilde{T} is a triangular neutrosophic number and stand for activity time.

Step 2: Draw network diagram of CPM.

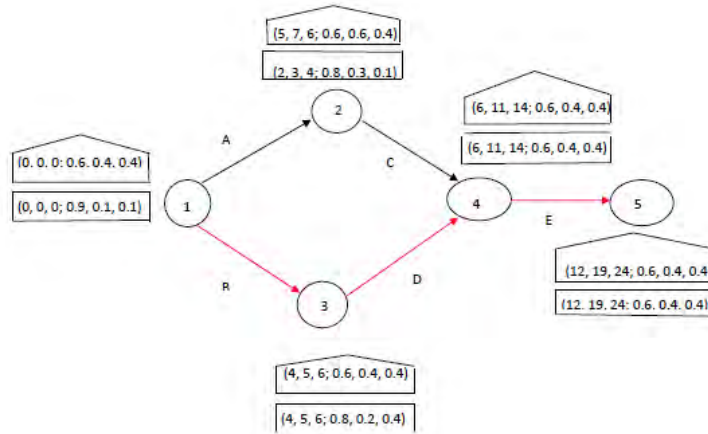
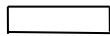
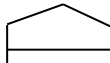

Fig.1. Network diagram of CPM



⇒ Determine earliest start/finish of each activity.



⇒ Determine latest start/finish of each activity.

Step 3: Determine critical path, which is the longest path in the network.

From Fig.1, we find that the critical path is B-D-E and is denoted by red line.

Step 4: Calculate project completion time.

The neutrosophic time of project completion = $(12, 19, 24; 0.6, 0.4, 0.4)t_A + t_C + t_G + t_j$ days.

To determine crisp value of project completion time we will use Eq.4, then the expected time of project completion in deterministic environment = 12 days.

5 Conclusion

Neutrosophic set is a generalization of classical set, fuzzy set and intuitionistic fuzzy set because it not only considers the truth-membership and falsity- membership but also an indeterminacy function which is very obvious in

real life situations. In this chapter, we have considered activity time of CPM as triangular neutrosophic numbers. In future, the research will be extended to deal with different project management techniques.

References

- [1] J. Lewis. Project Planning, Scheduling & Control, 4E: McGraw-Hill Pub. Co., 2005.
- [2] H. Maciej, J. Andrzej, & S. Roman. Fuzzy project scheduling system for software development. *Fuzzy sets and systems*, 67(1), 101-117, 1994.
- [3] Abdel-Basset, M., Mohamed, M. & Sangaiah, A.K. *J Ambient Intell Human Comput* (2017). DOI: <https://doi.org/10.1007/s12652-017-0548-7>.
- [4] Mohamed, Mai, et al. "Neutrosophic Integer Programming Problem." *Neutrosophic Sets & Systems* 15 (2017).
- [5] I. M. Hezam, M. Abdel-Baset, F. Smarandache. Taylor Series Approximation to Solve Neutrosophic Multiobjective Programming Problem, *Neutrosophic Sets and Systems. An International Journal in Information Science and Engineering*, Vol. 10, pp. 39-45, 2015.
- [6] N.. El-Hefenawy, M. Metwally, Z. Ahmed, I. El-Henawy. A Review on the Applications of Neutrosophic Sets. *Journal of Computational and Theoretical Nanoscience*, 13(1), 936-944, 2016.
- [7] M Abdel-Baset, I. Hezam, F. Smarandache, *Neutrosophic Goal Programming. Neutrosophic Sets & Systems*, vol. 11, 2016.

New Neutrosophic Sets via Neutrosophic Topological Spaces

Wadei Al-Omeri, Florentin Smarandache

Wadei Al-Omeri, Florentin Smarandache (2017). New Neutrosophic Sets via Neutrosophic Topological Spaces. In *Neutrosophic Operational Research*, vol. I, eds.: Prof. Florentin Smarandache, Dr. Mohamed Abdel-Basset, Dr. Yongquan Zhou, 189-209

Abstract

In Geographical information systems (GIS) there is a need to model spatial regions with indeterminate boundary and under indeterminacy. The purpose of this chapter is to construct the basic concepts of the so-called "neutrosophic sets via neutrosophic topological spaces (NTs)". After giving the fundamental definitions and the necessary examples we introduce the definitions of neutrosophic open sets, neutrosophic continuity, and obtain several preservation properties and some characterizations concerning neutrosophic mapping and neutrosophic connectedness. Possible applications to GIS topological rules are touched upon.

Keywords

Logic, Set Theory, Topology, Neutrosophic set theory, Neutrosophic topology, Neutrosophic open set, Neutrosophic semi-open set, Neutrosophic continuous function.

1 Introduction

Neutrosophy has laid the foundation for a whole family of new mathematical theories generalizing both their classical and fuzzy counterparts, such as a neutrosophic set theory. In various recent papers, F. Smarandache generalizes intuitionistic fuzzy sets (IFSs) and other kinds of sets to neutrosophic sets (NSs). F. Smarandache also defined the notion of neutrosophic topology on the non-standard interval. Indeed, an intuitionistic fuzzy topology is not necessarily a neutrosophic topology. Also, (Wang, Smarandache, Zhang, and

Sunderraman, 2005) introduced the notion of interval neutrosophic set, which is an instance of neutrosophic set and studied various properties. We study in this chapter relations between interval neutrosophic sets and topology. In this chapter, we introduce definitions of neutrosophic open sets. After given the fundamental definitions of neutrosophic set operations, we obtain several properties, and discussed the relationship between neutrosophic open sets and others, we introduce and study the concept of neutrosophic continuous functions. Finally, we extend the concepts of neutrosophic topological space.

2 Terminologies

We recollect some relevant basic preliminaries, and in particular, the work of Smarandache in [1, 2, 3], and Salama et al. [4, 5, 6, 7, 8, 9, 10, 11, 12, 13]. Smarandache introduced the neutrosophic components T, I, F , which represent the membership, indeterminacy, and non-membership values respectively, where $]0^-, 1^+[$ is a non-standard unit interval. Hanafy and Salama et al. [10, 11] considered some possible definitions for basic concepts of the neutrosophic crisp set and its operations. We now improve some results by the following.

Definition 2.1 [24] Let T, I, F be real standard or nonstandard subsets of $]0^-, 1^+[$, with

$$Sup-T=t-sup, \quad inf-T=t-inf$$

$$Sup-I=i-sup, \quad inf-I=i-inf$$

$$Sup-F=f-sup, \quad inf-F=f-inf$$

$$n-sup=t-sup+i-sup+f-sup$$

$$n-inf=t-inf+i-inf+f-inf.$$

T, I, F are called neutrosophic components.

We shall now consider some possible definitions for basic concepts of the neutrosophic set and its operations due to Salama et al.

Definition 2.2 [23] Let X be a non-empty fixed set. A neutrosophic set (NS for short) A is an object having the form

$$A = \{ \langle x, \mu_A(x), \sigma_A(x), \gamma_A(x) \rangle : x \in X \}$$

where $\mu_A(x), \sigma_A(x)$, and $\gamma_A(x)$ which represent the degree of membership function (namely $\mu_A(x)$), the degree of indeterminacy (namely $\sigma_A(x)$), and the

degree of non-membership (namely $\gamma_A(x)$) respectively of each element $x \in X$ to the set A .

A neutrosophic $A = \{\langle x, \mu_A(x), \sigma_A(x), \gamma_A(x) \rangle : x \in X\}$ can be identified to an ordered triple $\langle \mu_A(x), \sigma_A(x), \gamma_A(x) \rangle$ in $]0^-, 1^+[$ on X .

Remark 2.3 [23] For the sake of simplicity, we shall use the symbol

$$A = \{x, \mu_A(x), \sigma_A(x), \gamma_A(x)\}$$

for the NS $A = \{\langle x, \mu_A(x), \sigma_A(x), \gamma_A(x) \rangle : x \in X\}$.

Definition 2.4 [4] Let $A = \langle \mu_A(x), \sigma_A(x), \gamma_A(x) \rangle$ a NS on X , then the complement of the set $A(C(A))$ for short, maybe defined as three kinds of complements

1. $C(A) = \{\langle x, 1 - \mu_A(x), 1 - \gamma_A(x) \rangle : x \in X\}$,
2. $C(A) = \{\langle x, \gamma_A(x), \sigma_A(x), \mu_A(x) \rangle : x \in X\}$,
3. $C(A) = \{\langle x, \gamma_A(x), 1 - \sigma_A(x), \mu_A(x) \rangle : x \in X\}$,

One can define several relations and operations between GNSS as follows:

Since our main purpose is to construct the tools for developing neutrosophic set and neutrosophic topology, we must introduce the NSS 0_N and 1_N [23] in X as follows:

1- 0_N may be defined as four types:

1. $0_N = \{\langle x, 0, 0, 1 \rangle : x \in X\}$ or
2. $0_N = \{\langle x, 0, 1, 1 \rangle : x \in X\}$ or
3. $0_N = \{\langle x, 0, 1, 0 \rangle : x \in X\}$ or
4. $0_N = \{\langle x, 0, 0, 0 \rangle : x \in X\}$

2- 1_N may be defined as four types:

1. $1_N = \{\langle x, 1, 0, 0 \rangle : x \in X\}$ or

2. $1_N = \{\langle x, 1, 0, 1 \rangle : x \in X\}$ or

3. $1_N = \{\langle x, 1, 1, 0 \rangle : x \in X\}$ or

4. $1_N = \{\langle x, 1, 1, 1 \rangle : x \in X\}$

Definition 2.5 [23] Let X be a non-empty set, and GNSS A and B in the form $A = \{x, \mu_A(x), \sigma_A(x), \gamma_A(x)\}$, $B = \{x, \mu_B(x), \sigma_B(x), \gamma_B(x)\}$, then we may consider two possible definitions for subsets ($A \subseteq B$)

($A \subseteq B$) may be defined as

1. Type 1:

$$A \subseteq B \Leftrightarrow \mu_A(x) \leq \mu_B(x), \sigma_A(x) \geq \sigma_B(x), \text{ and } \gamma_A(x) \leq \gamma_B(x) \text{ or}$$

2. Type 1:

$$A \subseteq B \Leftrightarrow \mu_A(x) \leq \mu_B(x), \sigma_A(x) \geq \sigma_B(x), \text{ and } \gamma_A(x) \geq \gamma_B(x).$$

Definition 2.6 [23] Let $\{A_j : j \in J\}$ be an arbitrary family of NSS in X , then

1. $\cap A_j$ may be defined as two types:

-Type 1: $\cap A_j = \langle x, \bigwedge_{j \in J} \mu_{A_j}(x), \bigwedge_{j \in J} \sigma_{A_j}(x), \bigvee_{j \in J} \gamma_{A_j}(x) \rangle.$

-Type 2: $\cap A_j = \langle x, \bigwedge_{j \in J} \mu_{A_j}(x), \bigvee_{j \in J} \sigma_{A_j}(x), \bigvee_{j \in J} \gamma_{A_j}(x) \rangle.$

2. $\cup A_j$ may be defined as two types:

-Type 1: $\cup A_j = \langle x, \bigvee_{j \in J} \mu_{A_j}(x), \bigvee_{j \in J} \sigma_{A_j}(x), \bigwedge_{j \in J} \gamma_{A_j}(x) \rangle.$

-Type 2: $\cup A_j = \langle x, \bigvee_{j \in J} \mu_{A_j}(x), \bigwedge_{j \in J} \sigma_{A_j}(x), \bigwedge_{j \in J} \gamma_{A_j}(x) \rangle.$

Definition 2.7 [25] A neutrosophic topology (NI for short) and a non empty set X is a family τ of neutrosophic subsets in X satisfying the following axioms

1. $0_N, 1_N \in \tau$

2. $G_1 \cap G_2 \in \tau$ for any $G_1, G_2 \in \tau$

$$3. \cup G_i \in \tau, \forall \{G_i | j \in J\} \subseteq \tau.$$

In this case the pair (X, τ) is called a neutrosophic topological space (*NTS* for short) and any neutrosophic set in τ is known as neutrosophic open set (*NOS* for short) in X . The elements of τ are called open neutrosophic sets, A neutrosophic set F is closed if and only if it $C(F)$ is neutrosophic open [26-30].

Note that for any *NTS* A in (X, τ) , we have $Cl(A^c) = [Int(A)]^c$ and $Int(A^c) = [Cl(A)]^c$.

Example 2.8 [4] Let $X = \{a, b, c, d\}$, and $A = \{x, \mu_A(x), \sigma_A(x), \gamma_A(x)\}$

$$A = \{\langle x, 0.5, 0.5, 0.4 \rangle : x \in X\}$$

$$B = \{\langle x, 0.4, 0.6, 0.8 \rangle : x \in X\}$$

$$D = \{\langle x, 0.5, 0.6, 0.4 \rangle : x \in X\}$$

$$C = \{\langle x, 0.4, 0.5, 0.8 \rangle : x \in X\}$$

Then the family $\tau = \{0_n, 1_n, A, B, C, D\}$ of *NSs* in X is neutrosophic topology on X .

Definition 2.9 [23] Let (x, τ) be *NTS* and $A = \{x, \mu_A(x), \sigma_A(x), \gamma_A(x)\}$ be a *NS* in X .

Then the neutrosophic closure and neutrosophic interior of A are defined by

$$1. NCL(A) = \cap \{K : K \text{ is a NCS in } X \text{ and } A \subseteq K\}$$

$$2. NInt(A) = \cup \{G : G \text{ is a NOS in } X \text{ and } G \subseteq A\}$$

It can be also shown that $NCl(A)$ is *NCS* and $NInt(A)$ is a *NOS* in X

$$1. A \text{ is in } X \text{ if and only if } NCl(A).$$

$$2. A \text{ is NCS in } X \text{ if and only if } NInt(A) = A.$$

Proposition 2.10 [23] Let (x, τ) be a *NTS* and A, B be two neutrosophic sets in X . Then the following properties hold:

1. $NInt(A) \subseteq A$,
2. $A \subseteq NCl(A)$,
3. $A \subseteq B \Rightarrow NInt(A) \subseteq NInt(B)$,
4. $A \subseteq B \Rightarrow NCl(A) \subseteq NCl(B)$,
5. $NCl(NCl(A)) = NCl(A)$
 $NInt(NInt(A)) = NInt(A)$,
6. $NInt(A \cup B) = NInt(A) \cup NInt(B)$
 $NCl(A \cap B) = NCl(A) \cap NCl(B)$,
7. $NCl(A) \cup NCl(B) = NInt(A \cup B)$,

Definition 2.11 [23] Let $A = \{\mu_A(x), \sigma_A(x), \gamma_A(x)\}$ be a neutrosophic open sets and $B = \{\mu_B(x), \sigma_B(x), \gamma_B(x)\}$ be a neutrosophic set on a neutrosophic topological space (X, τ) then

1. A is called neutrosophic regular open iff $A = NInt(NCl(A))$.
2. If $B \in NCS(X)$ then B is called neutrosophic regular closed iff $A = NCl(NInt(A))$.

3 Neutrosophic Openness

Definition 3.1 A neutrosophic set (Ns) A in a neutrosophic topology (X, τ) is called

1. Neutrosophic semiopen set $(NSOS)$ if $A \subseteq NCl(NInt(A))$,
2. Neutrosophic preopen set $(NPOS)$ if $A \subseteq NInt(NCl(A))$,
3. Neutrosophic α -open set $(N\alpha OS)$ if $A \subseteq NInt(NCl(NInt(A)))$
4. Neutrosophic β -open set $(N\beta OS)$ if $A \subseteq NCl(NInt(NCl(A)))$

An (Ns) A is called neutrosophic semi-closed set, neutrosophic α -closed set, neutrosophic pre-closed set, and neutrosophic regular closed set, respectively (NSCS, $N\alpha$ CS, NPCS, and NRCS, resp.), if the complement of A is a NSOS, $N\alpha$ OS, NPOS, and NRCS, respectively.

Definition 3.2 In the following diagram, we provide relations between various types of neutrosophic openness (neutrosophic closedness): Opt

Remark 3.3 From above the following implication and none of these implications is reversible as shown by examples given below

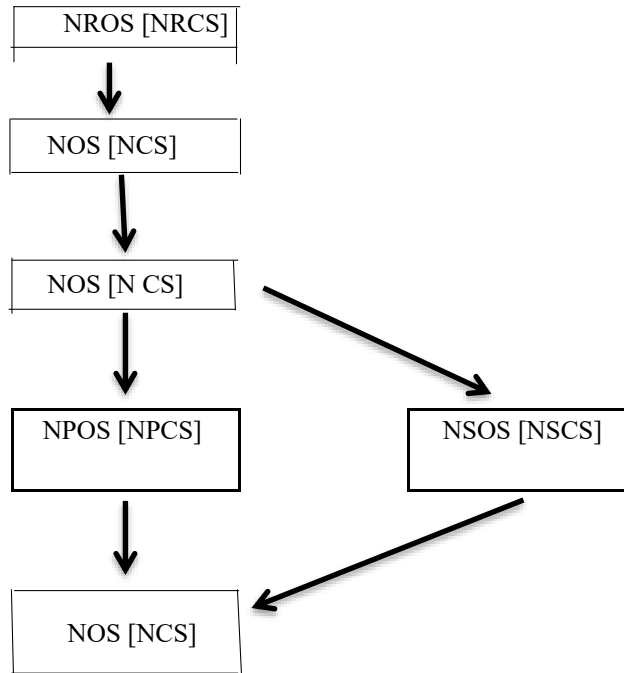

Reverse implications are not true in the above diagram. The following is a characterization of a $N\alpha$ OS.

Example 3.4 Let $X = \{a, b, c\}$ and:

$$A = \langle (0.5, 0.5, 0.5), (0.4, 0.5, 0.5), (0.4, 0.5, 0.5) \rangle,$$

$$B = \langle (0.3, 0.4, 0.4), (0.7, 0.5, 0.5), (0.3, 0.4, 0.4) \rangle.$$

Then $\tau = \{0_N, 1_N, A, B\}$ is a neutrosophic topology on X . Define the two neutrosophic closed sets C_1 and C_2 as follows,

$$C_1 = \langle (0.5, 0.5, 0.5), (0.6, 0.5, 0.5), (0.6, 0.5, 0.5) \rangle,$$

$$C_2 = \langle (0.7, 0.6, 0.6), (0.3, 0.5, 0.5), (0.7, 0.6, 0.6) \rangle.$$

Then the set A is neutrosophic open set (NOs) but not neutrosophic regular open set (NROs) since $A \neq NInt(NCl(A))$, and since $A \subseteq NInt(NCl(NInt(A)))$ where the $NInt(NCl(NInt(A)))$ is equal to:

$$\langle (0.5,0.5,0.5), (0.3,0.5,0.5), (0.7,0.6,0.6) \rangle$$

so that A is neutrosophic α -open set (N α Os).

Example 3.5 Let $X = \{a, b, c\}$ and:

$$A = \langle (0.5,0.5,0.5), (0.4,0.5,0.5), (0.4,0.5,0.5) \rangle ,$$

$$B = \langle (0.3,0.4,0.4), (0.7,0.5,0.5), (0.3,0.4,0.4) \rangle , \text{ and}$$

$$C = \langle (0.5,0.5,0.5), (0.4,0.5,0.5), (0.5,0.5,0.5) \rangle .$$

Then $\tau = \{0_N, 1_N, A, B\}$ is a neutrosophic topology on X . Define the two neutrosophic closed sets C_1 and C_2 as follows:

$$C_1 = \langle (0.5,0.5,0.5), (0.6,0.5,0.5), (0.6,0.5,0.5) \rangle ,$$

$$C_2 = \langle (0.7,0.6,0.6), (0.3,0.5,0.5), (0.7,0.6,0.6) \rangle .$$

Then the set C is neutrosophic semi open set (NSOs), since

$$C \subseteq NCl(NInt(C)) ,$$

where $NCl(NInt(C)) = \langle (0.5,0.5,0.5), (0.3,0.5,0.5), (0.7,0.6,0.6) \rangle$ but not neutrosophic α -open set (N α Os) since $C \not\subseteq NInt(NCl(NInt(C)))$ where the $NInt(NCl(NInt(C)))$ is equal $\langle (0.5,0.5,0.5), (0.4,0.5,0.5), (0.3,0.4,0.4) \rangle$, in the sense of $A \subseteq B \Leftrightarrow \mu_A(x) \leq \mu_B(x), \sigma_A(x) \geq \sigma_B(x), \text{ and } \gamma_A(x) \leq \gamma_B(x)$.

Example 3.6 Let $X = \{a, b, c\}$ and:

$$A = \langle (0.4,0.5,0.4), (0.5,0.5,0.5), (0.4,0.5,0.4) \rangle ,$$

$$B = \langle (0.7,0.6,0.5), (0.3,0.4,0.5), (0.3,0.4,0.4) \rangle , \text{ and}$$

$$C = \langle (0.5,0.5,0.5), (0.5,0.5,0.5), (0.5,0.5,0.5) \rangle .$$

Then $\tau = \{0_N, 1_N, A, B\}$ is a neutrosophic topology on X . Define the two neutrosophic closed sets C_1 and C_2 as follows:

$$C_1 = \langle (0.6,0.5,0.6), (0.5,0.5,0.5), (0.6,0.5,0.5) \rangle ,$$

$$C_2 = \langle (0.3,0.4,0.5), (0.7,0.6,0.5), (0.7,0.6,0.5) \rangle .$$

Then the set C is neutrosophic preopen set ($NPOs$), since $C \subseteq NInt(NCl(C))$, where $NInt(NCl(C)) = \langle (0.7, 0.6, 0.5), (0.5, 0.5, 0.5), (0.3, 0.4, 0.5) \rangle$ but not neutrosophic α -open set ($N\alpha Os$) since $C \not\subseteq NInt(NCl(NInt(C)))$ where the $NInt(NCl(NInt(C)))$ is equal $\langle (0, 0, 0), (1, 1, 1), (0, 0, 0) \rangle$.

Example 3.7 Let $X = \{a, b, c\}$ and:

$$A = \langle (0.5, 0.5, 0.5), (0.4, 0.5, 0.5), (0.4, 0.5, 0.5) \rangle,$$

$$B = \langle (0.3, 0.4, 0.4), (0.7, 0.5, 0.5), (0.3, 0.4, 0.4) \rangle, \text{ and}$$

$$C = \langle (0.3, 0.3, 0.3), (0.4, 0.5, 0.5), (0.3, 0.4, 0.4) \rangle.$$

Then $\tau = \{0_N, 1_N, A, B\}$ is a neutrosophic topology on X . Define the two neutrosophic closed sets C_1 and C_2 as follows,

$$C_1 = \langle (0.5, 0.5, 0.5), (0.6, 0.5, 0.5), (0.6, 0.5, 0.5) \rangle,$$

$$C_2 = \langle (0.7, 0.6, 0.6), (0.3, 0.5, 0.5), (0.7, 0.6, 0.6) \rangle.$$

Then the set C is neutrosophic β -open set ($N\beta Os$), since $C \subseteq NCl(NInt(NCl(C)))$, where

$$NCl(NInt(NCl(A))) = \langle (0.7, 0.6, 0.6), (0.3, 0.5, 0.5), (0.7, 0.6, 0.6) \rangle,$$

but not neutrosophic pre-open set ($NPOs$) neither neutrosophic semi-open set ($NSOs$) since $C \not\subseteq NCl(NInt(C))$ where the $NCl(NInt(C))$ is equal $\langle (0.5, 0.5, 0.5), (0.3, 0.5, 0.5), (0.7, 0.6, 0.6) \rangle$

Let (X, τ) be NTS and $A = \{A_1, A_2, A_3\}$ be a NS in X . Then the *-neutrosophic closure of A ($*-NCl(A)$ for short) and *-neutrosophic interior ($*-NInt(A)$ for short) of A are defined by

$$1. \alpha NCl(A) = \cap \{K : \text{isa NRCS in } X \text{ and } A \subseteq K\},$$

$$2. \alpha NInt(A) = \cup \{G : \text{Gisa NROS in } X \text{ and } G \subseteq A\},$$

$$3. pNCl(A) = \cap \{K : \text{isa NPCS in } X \text{ and } A \subseteq K\},$$

$$4. pNInt(A) = \cup \{G : \text{Gisa NPOS in } X \text{ and } G \subseteq A\},$$

$$5. sNCl(A) = \cap \{K : \text{isa NSCS in } X \text{ and } A \subseteq K\},$$

$$6. sNInt(A) = \cup \{G : \text{Gisa NSOS in } X \text{ and } G \subseteq A\},$$

7. $\beta NCI(A) = \cap \{K : \text{isaNC}\beta\text{CS in } X \text{ and } A \subseteq K\}$,
8. $\beta NInt(A) = \cup \{G : \text{GisaN}\beta\text{OS in } X \text{ and } G \subseteq A\}$,
9. $rNCI(A) = \cap \{K : \text{isaNRCS in } X \text{ and } A \subseteq K\}$,
10. $rNInt(A) = \cup \{G : \text{GisaNROS in } X \text{ and } G \subseteq A\}$.

Theorem 3.8 A NS A in a $NTs (X, \tau)$ is a $N\alpha OS$ if and only if it is both $NSOS$ and $NPOS$.

Proof. Necessity follows from the diagram given above. Suppose that A is both a $NSOS$ and a $NPOS$. Then $A \subseteq NCI(NInt(A))$, and so

$$NCI(A) \subseteq NCI(NCI(NInt(A))) = NCI(NInt(A))$$

It follows that $A \subseteq NInt(NCI(A)) \subseteq NInt(NCI(NInt(A)))$, so that A is a $N\alpha OS$. We give condition(s) for a NS to be a $N\alpha OS$.

Proposition 3.9 Let (X, τ) be a neutrosophic topology space NTs . Then arbitrary union of neutrosophic α -open sets is a neutrosophic α -open set, and arbitrary intersection of neutrosophic α -closed sets is a neutrosophic α -closed set.

Proof. Let $A = \{\langle x, \mu_{A_i}, \sigma_{A_i}, \gamma_{A_i} \rangle : i \in \Lambda\}$ be a collection of neutrosophic α -open sets. Then, for each $i \in \Lambda$, $A_i \subseteq NInt(NCI(NInt(A_i)))$. Its follows that

$$\begin{aligned} \bigcup A_i &\subseteq \bigcup NInt(NCI(NInt(A_i))) \subseteq NInt(\bigcup NCI(NInt(A_i))) \\ &= NInt(NCI(\bigcup NInt(A_i))) \subseteq NInt(NCI(NInt(\bigcup A_i))) \end{aligned}$$

Hence $\bigcup A_i$ is a neutrosophic α -open set. The second part follows immediately from the first part by taking complements.

Having shown that arbitrary union of neutrosophic α -open sets is a neutrosophic α -open set, it is natural to consider whether or not the intersection of neutrosophic α -open sets is a neutrosophic α -open set, and the following example shown that the intersection of neutrosophic α -open sets is not a neutrosophic α -open set.

Example 3.10 Let $X = \{a, b, c\}$ and

$$A = \langle (0.5, 0.5, 0.5), (0.4, 0.5, 0.5), (0.4, 0.5, 0.5) \rangle ,$$

$$B = \langle (0.3, 0.4, 0.4), (0.7, 0.5, 0.5), (0.3, 0.4, 0.4) \rangle .$$

Then $\tau = \{0_N, 1_N, A, B\}$ is a neutrosophic topology on X . Define the two neutrosophic closed sets C_1 and C_2 as follows,

$$C_1 = \langle (0.5, 0.5, 0.5), (0.6, 0.5, 0.5), (0.6, 0.5, 0.5) \rangle ,$$

$$C_2 = \langle (0.7, 0.6, 0.6), (0.3, 0.5, 0.5), (0.7, 0.6, 0.6) \rangle .$$

Then the set A and B are neutrosophic α -open set ($N\alpha$ Os) but $A \cap B$ is not neutrosophic α -open set. In fact $A \cap B$ is given by $\langle (0.3, 0.4, 0.4), (0.4, 0.5, 0.5), (0.4, 0.5, 0.5) \rangle ,$

$$\text{and } NInt(NCl(NInt(A \cap B))) = \langle (0.5, 0.5, 0.5), (0.7, 0.5, 0.5), (0.3, 0.4, 0.4) \rangle ,$$

so $A \cap BNInt(NCl(NInt(A \cap B)))$.

Theorem 3.11 Let A be a (Ns) in a neutrosophic topology space NTs (X, τ) . If B is a NSOS such that $B \subseteq A \subseteq NInt(NCl(B))$, then A is a $N\alpha$ OS.

Proof. Since B is a NSOS, we have $B \subseteq NCl(NInt(B))$. Thus, $A \subseteq NInt(NCl(A)) \subseteq NInt(NCl(NCl(NInt(B)))) = NInt(NCl(NInt(B))) \subseteq NInt(NCl(NInt(A)))$. and so is a $N\alpha$ OS

Proposition 3.12 In neutrosophic topology space NTs (X, τ) , a neutrosophic α -closed ($N\alpha$ Cs) if and only if $A = \alpha NCl(A)$.

Proof. Assume that A is neutrosophic α -closed set. Obviously,

$$A \in \{B_i \mid B_i \text{ is a neutrosophic } \alpha\text{-closed set and } A \subseteq B_i\} ,$$

and also

$$A = \{B_i \mid B_i \text{ is a neutrosophic } \alpha\text{-closed set and } A \subseteq B_i\} ,$$

$$= \alpha NCl(A) .$$

Conversely suppose that $A = \alpha NCl(A)$, which shows that

$$A \in \{B_i \mid B_i \text{ is a neutrosophic } \alpha\text{-closed set and } A \subseteq B_i\} .$$

Hence A is neutrosophic α -closed set.

Theorem 3.13 A neutrosophic set A in a NTS X is neutrosophic α -open (resp., neutrosophic preopen) if and only if for every $N\alpha Os_{p(\alpha,\beta)} \in A$, there exists a $N\alpha Os$ (resp., NPOs) $B_{p(\alpha,\beta)}$ such that $p(\alpha,\beta) \in B_{p(\alpha,\beta)} \subseteq A$.

Proof. If A is a $N\alpha Os$ (resp., NPOs), then we may take $B_{p(\alpha,\beta)} = A$ for every $p(\alpha,\beta) \in A$.

Conversely assume that for every NP $p(\alpha,\beta) \in A$, there exists a $N\alpha Os$ (resp., NPOs) $B_{p(\alpha,\beta)}$ such that $p(\alpha,\beta) \in B_{p(\alpha,\beta)} \subseteq A$. Then,

$$A = \bigcup \{p(\alpha,\beta) \mid p(\alpha,\beta) \in A\} \subseteq \bigcup \{B_{p(\alpha,\beta)} \mid p(\alpha,\beta) \in A\} \subseteq A,$$

and so $A = \bigcup \{B_{p(\alpha,\beta)} \mid p(\alpha,\beta) \in A\}$,

which is a $N\alpha Os$ (resp., NPOs) by Proposition 3.9.

Proposition 3.14 In a NTS (X, τ) , the following hold for neutrosophic α -closure:

1. $\alpha NCI(0_{\sim}) = 0_{\sim}$.
2. $\alpha NCI(A)$ is neutrosophic α -closed in (X, τ) for every Ns in A .
3. $\alpha NCI(A) \subseteq \alpha NCI(B)$ whenever $A \subseteq B$ for every Ns A and B in X .
4. $\alpha NCI(\alpha NCI(A)) = \alpha NCI(A)$ for every Ns A in X .

Proof. The proof is easy.

4 Neutrosophic Continuous Mapping

Definition 4.1 [25] Let (X, τ_1) and (Y, τ_2) be two $NTSs$, and let $f : X \rightarrow Y$ be a function. Then f is said to be strongly N -continuous iff the inverse image of every NOS in τ_2 is a NOS in τ_1 .

Definition 4.2 [25] Let (X, τ_1) and (Y, τ_2) be two $NTSs$, and let $f : X \rightarrow Y$ be a function. Then f is said to be continuous iff the preimage of each NS in τ_2 is a NS in τ_1 .

Example 4.3 [25] Let $X = \{a, b, c\}$ and $Y = \{a, b, c\}$. Define neutrosophic sets A and B as follows:

$$A = \langle (0.4, 0.4, 0.5), (0.2, 0.4, 0.3), (0.4, 0.4, 0.5) \rangle,$$

$$B = \langle (0.4, 0.5, 0.6), (0.3, 0.2, 0.3), (0.4, 0.5, 0.6) \rangle.$$

Then the family $\tau_1 = \{0_N, 1_N, A\}$ is a neutrosophic topology on X and $\tau_2 = \{0_N, 1_N, B\}$ is a neutrosophic topology on Y . Thus (X, τ_1) and (Y, τ_2) are neutrosophic topological spaces. Define $f : (X, \tau_1) \rightarrow (Y, \tau_2)$ as $f(a) = b$, $f(b) = a$, $f(c) = c$. Clearly f is N -continuous.

Now f is not neutrosophic continuous, since $f^{-1}(B) \notin \tau$ for $B \in \tau_2$.

Definition 4.4 Let f be a mapping from a NTS (X, τ) to a NTS (Y, κ) . Then f is called

1. a neutrosophic α -continuous mapping if $f^{-1}(B)$ is a $N\alpha$ Os in X for every NOs B in Y .
2. a neutrosophic pre-continuous mapping if $f^{-1}(B)$ is a NPOs in X for every NOs B in Y .
3. a neutrosophic semi-continuous mapping if $f^{-1}(B)$ is a NSOs in X for every NOs B in Y .
4. a neutrosophic β -continuous mapping if $f^{-1}(B)$ is a $N\beta$ Os in X for every NOs B in Y .

Theorem 4.5 For a mapping f from a NTS (X, τ) to a NTS (Y, κ) , the following are equivalent.

1. f is neutrosophic pre-continuous.
2. $f^{-1}(B)$ is NPCs in X for every NCs B in Y .
3. $NCl(NInt(f^{-1}(A))) \subseteq f^{-1}(NCl(A))$ for every neutrosophic set A in Y .

Proof. (1) \Rightarrow (2) The proof is straightforward.

(2) \Rightarrow (3) Let A be a NS in Y . Then $NCl(A)$ is neutrosophic closed.

It follows from (2) that $f^{-1}(NCl(A))$ is a NPCS in X so that

$$NCl(NInt(f^{-1}(A))) \subseteq NCl(NInt(f^{-1}(NCl(A)))) \subseteq f^{-1}(NCl(A)).$$

(3) \Rightarrow (1) Let A be a NOS in Y . Then \bar{A} is a NCS in Y , and so

$$NCl(NInt(f^{-1}(\bar{A}))) \subseteq f^{-1}(NCl(\bar{A})) = f^{-1}(\bar{A}).$$

This implies that

$$\begin{aligned} \overline{NInt(NCl(f^{-1}(A)))} &= \overline{NCl(NCl(f^{-1}(A)))} = \overline{NCl(NInt(f^{-1}(A)))} \\ &= NCl(NInt(f^{-1}(\bar{A}))) \subseteq f^{-1}(\bar{A}) = \overline{f^{-1}(A)}, \end{aligned}$$

and thus $f^{-1}(A) \subseteq NInt(NCl(f^{-1}(A)))$. Hence $f^{-1}(A)$ is a NPOS in X , and f is neutrosophic pre-continuous.

Theorem 4.6 Let f be a mapping from a NTS (X, τ) to a NTS (Y, κ) that satisfies

$$NCl(NInt(NCl(f^{-1}(B)))) \subseteq f^{-1}(NCl(B)), \text{ for every NS } B \text{ in } Y.$$

Then f is neutrosophic α -continuous.

Proof. Let B be a NOS in Y . Then B is a NCS in Y , which implies from hypothesis that

$$NCl(NInt(NCl(f^{-1}(\bar{B})))) \subseteq f^{-1}(NCl(\bar{B})) = f^{-1}(\bar{B}).$$

It follows that

$$\begin{aligned} \overline{NInt(NCl(NInt(f^{-1}(B))))} &= \overline{NCl(NCl(NInt(f^{-1}(B))))} \\ &= NCl(NInt(\overline{NInt(f^{-1}(B))})) \\ &= NCl(NInt(\overline{NCl(f^{-1}(B))})) \\ &= NCl(NInt(NCl(f^{-1}(\bar{B})))) \subseteq f^{-1}(\bar{B}) \end{aligned}$$

$$= \overline{f^{-1}(B)}$$

so that $f^{-1}(B) \subseteq NInt(NCl(NInt(f^{-1}(B))))$. This shows that $f^{-1}(B)$ is a N α OS in X . Hence, f is neutrosophic α -continuous.

Definition 4.7 Let $p(\alpha, \beta)$ be a NP of a NTS (X, τ) . A NS A of X is called a neutrosophic neighborhood (NH) of $p(\alpha, \beta)$ if there exists a NOS B in X such that $p(\alpha, \beta) \in B \subseteq A$.

Theorem 4.8 Let f be a mapping from a NTS (X, τ) to a NTS (Y, κ) . Then the following assertions are equivalent.

1. f is neutrosophic pre-continuous.
2. For each NP $p(\alpha, \beta) \in X$ and every NH A of $f(p(\alpha, \beta))$, there exists a NPOS B in X such that $p(\alpha, \beta) \in B \subseteq f^{-1}(A)$.
3. For each NP $p(\alpha, \beta) \in X$ and every NH A of $f(p(\alpha, \beta))$, there exists a NPOS B in X such that $p(\alpha, \beta) \in B$ and $f(B) \subseteq A$.

Proof. (1) \Rightarrow (2) Let $p(\alpha, \beta)$ be a NP in X and let A be a NH of $f(p(\alpha, \beta))$. Then there exists a NOS B in Y such that $f(p(\alpha, \beta)) \in B \subset A$. Since f is neutrosophic pre-continuous, we know that $f^{-1}(B)$ is a NPOS in X and

$$p(\alpha, \beta) \in f^{-1}(f(p(\alpha, \beta))) \subseteq f^{-1}(B) \subseteq f^{-1}(A).$$

Thus (2) is valid.

(2) \Rightarrow (3) Let $p(\alpha, \beta)$ be a NP in X and let A be a NH of $f(p(\alpha, \beta))$. The condition (2) implies that there exists a NPOS B in X such that $p(\alpha, \beta) \in B \subseteq f^{-1}(A)$ so that $p(\alpha, \beta) \in B$ and $f(B) \subseteq f(f^{-1}(A)) \subseteq A$. Hence (3) is true.

(3) \Rightarrow (1). Let B be a NOS in Y and let $p(\alpha, \beta) \in f^{-1}(B)$. Then $f(p(\alpha, \beta)) \in B$, and so B is a NH of $f(p(\alpha, \beta))$ since B is a NOS. It follows from (3) that there exists a NPOS A in X such that $p(\alpha, \beta) \in A$ and $f(A) \subseteq B$ so that,

$$p(\alpha, \beta) \in A \subseteq f^{-1}(f(A)) \subseteq f^{-1}(B).$$

Applying Theorem 3.13 induces that $f^{-1}(B)$ is a NPOS in X . Therefore, f is neutrosophic pre-continuous.

Theorem 4.9 Let f be a mapping from a $NTS (X, \tau)$ to a $NTS (Y, \kappa)$. Then the following assertions are equivalent.

1. f is neutrosophic α -continuous.
2. For each NP $p(\alpha, \beta) \in X$ and every NH A of $f(p(\alpha, \beta))$, there exists a N α OS B in X such that $p(\alpha, \beta) \in B \subseteq f^{-1}(A)$.
3. For each NP $p(\alpha, \beta) \in X$ and every NH A of $f(p(\alpha, \beta))$, there exists a N α OS B in X such that $p(\alpha, \beta) \in B$ and $f(B) \subseteq A$.

Proof. (1) \Rightarrow (2) Let $p(\alpha, \beta)$ be a NP in X and let A be a NH of $f(p(\alpha, \beta))$. Then there exists a NOS C in Y such that $f(p(\alpha, \beta)) \in B \subset A$. Since f is neutrosophic α -continuous, $B = f^{-1}(C)$ is a NPOS in X and

$$p(\alpha, \beta) \in f^{-1}(f(p(\alpha, \beta))) \subseteq B = f^{-1}(C) \subseteq f^{-1}(A).$$

Thus (2) is valid.

(2) \Rightarrow (3) Let $p(\alpha, \beta)$ be a NP in X and let A be a NH of $f(p(\alpha, \beta))$. Then there exists a N α OS B in X such that $p(\alpha, \beta) \in B \subseteq f^{-1}(A)$ by (2). Thus, we have $p(\alpha, \beta) \in B$ and $f(B) \subseteq f(f^{-1}(A)) \subseteq A$. Hence (3) is valid.

(3) \Rightarrow (1). Let B be a NOS in Y and we take $p(\alpha, \beta) \in f^{-1}(B)$. Then $f(p(\alpha, \beta)) \in f(f^{-1}(B)) \subseteq B$, Since B is NOS, it follows that B is a NH of $f(p(\alpha, \beta))$ so from (3), there exists a N α OS A such that $p(\alpha, \beta) \in A$ and $f(A) \subseteq B$ so that,

$$p(\alpha, \beta) \in A \subseteq f^{-1}(f(A)) \subseteq f^{-1}(B).$$

Using Theorem 3.13 induces that $f^{-1}(B)$ is a $N\alpha$ OS in X . Therefore, f is neutrosophic α -continuous.

Combining Theorems 4.6 and 4.9, we have the following characterization of neutrosophic α -continuous.

Theorem 4.10 Let f be a mapping from a NTS (X, τ) to a NTS (Y, κ) . Then the following assertions are equivalent.

1. f is neutrosophic α -continuous.
2. If C is a NCS in Y , then $f^{-1}(C)$ is a $N\alpha$ CS in X .
3. $NCl(NInt(NCl(f^{-1}(B)))) \subseteq f^{-1}(NCl(B))$ for every NS B in Y .
4. For each NP $p(\alpha, \beta) \in X$ and every NH A of $f(p(\alpha, \beta))$, there exists a $N\alpha$ OS B such that $p(\alpha, \beta) \in B \subseteq f^{-1}(A)$.
5. For each NP $p(\alpha, \beta) \in X$ and every NH A of $f(p(\alpha, \beta))$, there exists a $N\alpha$ OS B such that $p(\alpha, \beta) \in B$ and $f(B) \subseteq A$.

Some aspects of neutrosophic continuity, neutrosophic N-continuity, neutrosophic strongly neutrosophic continuity, neutrosophic perfectly neutrosophic continuity, neutrosophic strongly N-continuity are studied in [25] as well as in several papers. The relation among these types of neutrosophic continuity is given as follows, where N means neutrosophic:

Example 4.11 Let $X = Y = \{a, b, c\}$. Define neutrosophic sets A and B as follows $A = \langle (0.5, 0.5, 0.5), (0.4, 0.5, 0.5), (0.4, 0.5, 0.5) \rangle$, $B = \langle (0.3, 0.4, 0.4), (0.7, 0.5, 0.5), (0.3, 0.4, 0.4) \rangle$, $C = \langle (0.5, 0.5, 0.5), (0.4, 0.5, 0.5), (0.5, 0.5, 0.5) \rangle$ and $D = \langle (0.4, 0.5, 0.5), (0.5, 0.5, 0.5), (0.5, 0.5, 0.5) \rangle$. Then the family $\tau_1 = \{0_N, 1_N, A, B\}$ is a neutrosophic topology on X and $\tau_2 = \{0_N, 1_N, D\}$ is a neutrosophic topology on Y . Thus (X, τ_1) and (Y, τ_2) are neutrosophic topological spaces. Define $f: (X, \tau_1) \rightarrow (Y, \tau_2)$ as $f(a) = b$, $f(b) = a$, $f(c) = c$. Clearly f is neutrosophic semi-continuous, but not neutrosophic α -

continuous, since $f^{-1}(D) = C$ not not neutrosophic α -open set, i.e $C \notin NInt(NCl(NInt(C)))$ where the $NInt(NCl(NInt(C)))$ is equal $\langle(0.5,0.5,0.5),(0.4,0.5,0.5),(0.3,0.4,0.4)\rangle$.

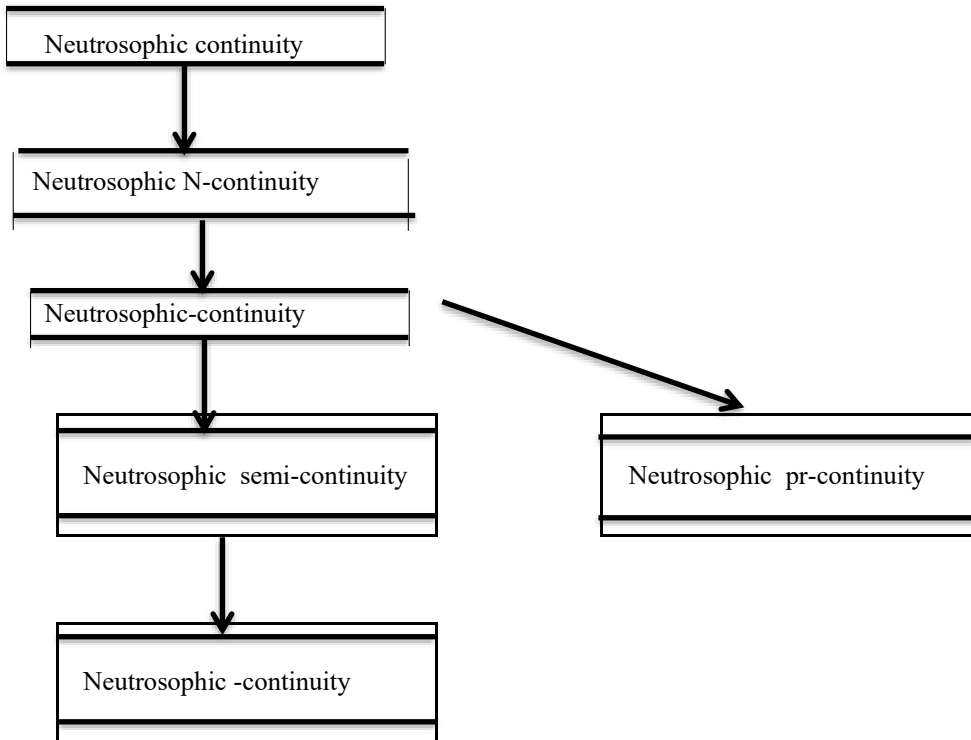

The reverse implications are not true in the above diagram in general as the following example.

Example 4.12 Let $X = Y = \{a, b, c\}$ and

$$A = \langle(0.4, 0.5, 0.4), (0.5, 0.5, 0.5), (0.4, 0.5, 0.4)\rangle,$$

$$B = \langle(0.7, 0.6, 0.5), (0.3, 0.4, 0.5), (0.3, 0.4, 0.4)\rangle, \text{ and}$$

$$C = \langle(0.5, 0.5, 0.5), (0.5, 0.5, 0.5), (0.5, 0.5, 0.5)\rangle.$$

Then $\tau_1 = \{0_N, 1_N, A, B\}$ is a neutrosophic topology on X and $\tau_2 = \{0_N, 1_N, C\}$ is a neutrosophic topology on Y . Thus (X, τ_1) and (Y, τ_2) are neutrosophic topological spaces. Define $f : (X, \tau_1) \rightarrow (Y, \tau_2)$ as identity

function. Then f is neutrosophic pre-continuous but not neutrosophic α -continuous, since $f^{-1}(C) = C$ is neutrosophic pre open set (NPOs) but not neutrosophic α -open set (N α Os).

Example 4.13 Let $X = Y = \{a, b, c\}$. Define neutrosophic sets A and B as follows $A = \langle (0.5, 0.5, 0.5), (0.4, 0.5, 0.5), (0.4, 0.5, 0.5) \rangle$, $B = \langle (0.3, 0.4, 0.4), (0.7, 0.5, 0.5), (0.3, 0.4, 0.4) \rangle$, and $D = \langle (0.3, 0.4, 0.4), (0.3, 0.3, 0.3), (0.4, 0.5, 0.5) \rangle$. $\tau_1 = \{0_N, 1_N, A, B\}$ is a neutrosophic topology on X and $\tau_2 = \{0_N, 1_N, D\}$ is a neutrosophic topology on Y . Define $f: (X, \tau_1) \rightarrow (Y, \tau_2)$ as $f(a) = c$, $f(b) = a$, $f(c) = b$. Clearly f is neutrosophic β -continuous, but not neutrosophic pre-continuous neither neutrosophic semi-continuous since

$$f^{-1}(D) = \langle (0.3, 0.3, 0.3), (0.4, 0.5, 0.5), (0.3, 0.4, 0.4) \rangle = C \text{ is neutrosophic } \beta\text{-open set (N } \beta \text{Os), since } C \subseteq NCl(NInt(NCl(C))),$$

where $NCl(NInt(NCl(A))) = \langle (0.7, 0.6, 0.6), (0.3, 0.5, 0.5), (0.7, 0.6, 0.6) \rangle$, but not neutrosophic pre-open set (NPOs) neither neutrosophic semi-open set (NSOs) since $CNCl(NInt(C))$ where the $NCl(NInt(C))$ is equal $\langle (0.5, 0.5, 0.5), (0.3, 0.5, 0.5), (0.7, 0.6, 0.6) \rangle$.

Theorem 4.14 Let f be a mapping from NTS (X, τ_1) to NTS (X, τ_2) . If f is both neutrosophic pre-continuous and neutrosophic semi-continuous, neutrosophic α -continuous.

Proof. Let B be an NOS in Y . Since f is both neutrosophic pre-continuous and neutrosophic semi-continuous, $f^{-1}(B)$ is both NPOS and NSOS in X . It follows from Theorem 3.8 that $f^{-1}(B)$ is a N α OS in X so that f is neutrosophic α -continuous.

5 Conclusion

In this chapter, we have introduced neutrosophic α -open sets, neutrosophic semi-open sets, and studied some of its basic properties. Also we study the relationship between the newly introduced sets namely introduced neutrosophic α -open sets and some of neutrosophic open sets that already exists. In this chapter also, we presented the basic definitions of the neutrosophic α -topological space and the neutrosophic α -compact space with some of their characterizations were deduced. Furthermore, we constructed a neutrosophic α -continuous function, with a study of a number its properties. Many different adaptations, tests, and experiments have been left for the future due to lack of time. There are some ideas that we would have liked to try during the description and the development of the neutrosophic topological space in the future work.

References

- [1] Florentin Smarandache, Neutrosophy and Neutro-sophic Logic, First International Conference on Neutrosophy, Neutrosophic Logic, Set, Probability, and Statistics, University of New Mexico, Gallup, NM 87301, USA(2002).
- [2] Florentin Smarandache, An introduction to the Neutrosophy probability applid in Quntum Physics, International Conference on introduction Neutro-soph Physics, Neutrosophic Logic, Set, Probabil- ity, and Statistics, University of New Mexico, Gallup, NM 87301, USA2-4 December (2011).
- [3] F. Smarandache, A Unifying Field in Logics: Neutro-sophic Logic. Neutrosophy, Neutrosophic Set, Neutro-sophic Probability. American Research Press, Reho-both, NM, (1999).
- [4] A.A. Salama and S.A. Alblowi, Generalized Neutrosophic Set and Generalized Neutrosophic Topological Spaces, Journal computer Sci. Engineering, Vol.(2) No. (7), (2012), pp. 29-32.
- [5] A.A. Salama and S.A. Alblowi, Neutrosophic set and neutrosophic topological space, ISORJ. Mathematics, Vol.(3), Issue(4), (2012), pp. 31-35.
- [6] A.A. Salama and S.A. Alblowi, Intuitionistic Fuzzy Ideals Topological Spaces, Advances in Fuzzy Mathematics , Vol.(7), Number 1, (2012), pp. 51-60.
- [7] A.A. Salama, and H. Elagamy, Neutrosophic Filters, International Journal of Computer Science Engineering and Information Technology Reseech (IJCSEITR), Vol.3, Issue(1), Mar (2013), pp. 307-312.
- [8] S. A. Alblowi, A. A. Salama, and Mohmed Eisa, New Concepts of Neutrosophic Sets, International Journal of Mathematics and Computer Applications Research (IJMCAR), Vol.3, Issue 4, Oct (2013), pp. 95-102.
- [9] I. Hanafy, A.A. Salama and K. Mahfouz, Correlation of neutrosophic Data, International Refereed Journal of Engineering and Science (IRJES), Vol.(1), Issue 2, (2012), pp. 39-43.

- [10] I.M. Hanafy, A.A. Salama and K.M. Mahfouz, Neutrosophic Crisp Events and Its Probability International Journal of Mathematics and Computer Applications Research (IJMCAR) Vol.(3), Issue 1, Mar (2013), pp. 171-178.
- [11] A. A. Salama, Neutrosophic Crisp Points and Neutrosophic Crisp Ideals, Neutrosophic Sets and Systems, Vol.1, No. 1, (2013) pp. 50-54.
- [12] A. A. Salama and F. Smarandache, Filters via Neutrosophic Crisp Sets, Neutrosophic Sets and Systems, Vol.1, No. 1, (2013) pp. 34-38.
- [13] S. A. Alblowi, A.A.Salama and Mohmed Eisa, New Concepts of Neutrosophic Sets, International Journal of Mathematics and Computer Applications Research (IJMCAR), Vol. 4, Issue 1, (2014) pp. 59-66.
- [14] A.A. Salama and S.A. Alblowi, Intuitionistic Fuzzy Ideals Topological Spaces, Advances in Fuzzy Mathematics , Vol.(7), Number 1, (2012) pp 51- 60. Inter. J. Pure Appl. Math., 24 (2005), pp. 287-297.
- [15] Debasis Sarker, Fuzzy ideal theory, Fuzzy local function and generated fuzzy topology, Fuzzy Sets and Systems 87, (1997), pp. 117-123.
- [16] L.A. Zadeh, Fuzzy Sets, Inform and Control 8, (1965), pp. 338-353.
- [17] K. Atanassov, intuitionistic fuzzy sets, in V.Sgurev, ed., VII ITKRS Session, Sofia June 1983 central Sci. and Techn. Library, Bulg. Academy of Sciences (1984).
- [18] K. Atanassov, intuitionistic fuzzy sets, Fuzzy Sets and Systems 20, (1986), pp. 87-96.
- [19] K. Atanassov, Review and new result on intuitionistic fuzzy sets, preprint IM-MFAIS-1-88, Sofia, (1988).
- [20] S. A. Alblowi, A.A.Salama and Mohmed Eisa, New Concepts of Neutrosophic Sets, International Journal of Mathematics and Computer Applications Research (IJMCAR), Vol. 4, Issue 1, (2014), pp. 59-66.
- [21] A. A. Salama, F.Smarandache and Valeri Kroumov, Neutrosophic crisp Sets and Neutrosophic crisp Topological Spaces, Neutrosophic Sets and Systems, Vlo.(2),(2014), pp. 25-30.
- [22] A. A. Salama, Basic Structure of Some Classes of Neutrosophic Crisp Nearly Open Sets and Possible Application to GIS Topology, Neutrosophic Sets and Systems, Vol. 7, (2015), pp. 18-22.
- [23] A. A. Salama, Said Broumi, S. A. Alblowi, Introduction to Neutrosophic Topological Spatial Region, Possible Application to GIS Topological Rules, I.J. Information Engineering and Electronic Business,6, (2014), pp. 15-21.
- [24] A. A. Salama, neutrosophic set- a generalization of the intuitionistic fuzzy set, University of New Mexico 705 Gurley Ave. Gallup, NM 87301, USA.
- [25] A. A. Salama, Florentin Smarandache and Valeri Kroumov, Neutrosophic Closed Set and Neutrosophic Continuous Functions Neutrosophic Sets and Systems, Vol. (4) 2014, pp. 4-8.
- [26] I. M. Hezam, M. Abdel-Baset, F. Smarandache. Taylor Series Approximation to Solve Neutrosophic Multiobjective Programming Problem. In: Neutrosophic Sets and Systems. An International Journal in Information Science and Engineering, Vol. 10 (2015), pp. 39-45.
- [27] El-Hefenawy, N., Metwally, M. A., Ahmed, Z. M., & El-Henawy, I. M. A Review on the Applications of Neutrosophic Sets. Journal of Computational and Theoretical Nanoscience, 13(1), (2016), pp. 936-944.
- [28] Abdel-Baset, M., Hezam, I. M., & Smarandache, F. Neutrosophic Goal Programming. In: Neutrosophic Sets & Systems, vol. 11 (2016).
- [29] Abdel-Baset, M., Mohamed, M. & Sangaiah, A.K. J Ambient Intell Human Comput (2017). DOI: <https://doi.org/10.1007/s12652-017-0548-7>
- [30] Mohamed, Mai, et al. "Neutrosophic Integer Programming Problem." Neutrosophic Sets & Systems 15 (2017).

Neutrosophic linear fractional programming problem

Mai Mohamed, Mohamed Abdel-Baset, Abdel-Nasser Hussein,
Florentin Smarandache

Mai Mohamed, Mohamed Abdel-Baset, Abdel-Nasser Hussein, Florentin Smarandache (2017). Neutrosophic linear fractional programming problem. *Octagon Mathematical Magazine* 25(1), 202-220

ABSTRACT. In this paper, a solution procedure is proposed to solve neutrosophic linear fractional programming (NLFP) problem where cost of the objective function, the resources and the technological coefficients are triangular neutrosophic numbers. Here, the NLFP problem is transformed into an equivalent crisp multi-objective linear fractional programming (MOLFP) problem. By using proposed approach, the transformed MOLFP problem is reduced to a single objective linear programming problem(LPP) which can be solved easily by suitable LP problem algorithm. The proposed procedure illustrated through a numerical example.

1 INTRODUCTION

Linear fractional programming (LFP) is a generalization of linear programming (LP) whereas the objective function in a linear program is a linear function; the objective function in a linear-fractional program is a ratio of two linear functions. Linear fractional programming is used to achieve the highest ratio of profit/cost, inventory/sales, actual cost/standard cost, output/employee, etc. Decision maker may not be able to specify the coefficients (some or all) of LFP problem due to incomplete and imprecise information which tend to be presented in real life situations. Also aspiration level of objective function and parameters of problem, hesitate decision maker. These situations can be modeled efficiently through neutrosophic environment. Neutrosophy is the study of neutralities as an extension of dialectics. Neutrosophic is the derivative of neutrosophy and it includes neutrosophic set, neutrosophic probability, neutrosophic statistics and neutrosophic logic. Neutrosophic theory means neutrosophy applied in many fields of sciences, in order to solve problems related to indeterminacy.

Key words and phrases. Linear fractional programming problem; Neutrosophic; Neutrosophic set; Triangular neutrosophic numbers.

Although intuitionistic fuzzy sets can only handle incomplete information not indeterminate, the neutrosophic set can handle both incomplete and indeterminate information. [1,6-8] Neutrosophic sets characterized by three independent degrees namely truth-membership degree (T), indeterminacy-membership degree(I), and falsity- membership degree (F), where T,I,F are standard or non-standard subsets of $]^{-}0, 1^{+}[$. The decision makers in neutrosophic set want to increase the degree of truth-membership and decrease the degree of indeterminacy and falsity membership. The structure of the paper is as follows: the next section is a preliminary discussion; the third section describes the LFP problem with Charnes and cooper's transformation; the fourth section presents multi-objective linear fractional programming problem; the fifth section presents neutrosophic linear fractional programming problem with solution procedure; the sixth section provides a numerical example to put on view how the approach can be applied; finally, the seventh section provides the conclusion.

2 PRELIMINARIES

In this section, the basic definitions involving neutrosophic set, single valued neutrosophic sets, neutrosophic numbers, triangular neutrosophic numbers and operations on triangular neutrosophic numbers are outlined.

Definition 1. [2] Let X be a space of points (objects) and $x \in X$. A neutrosophic set A in X is defined by a truth-membership function $TA(x)$, an indeterminacy-membership function $IA(x)$ and a falsity-membership function $FA(x)$. $TA(x)$, $IA(x)$ and $FA(x)$ are real standard or real nonstandard subsets of $]^{-}0, 1^{+}[$. That is $TA(x) : X \rightarrow]^{-}0, 1^{+}[$, $IA(x) : X \rightarrow]^{-}0, 1^{+}[$ and $FA(x) : X \rightarrow]^{-}0, 1^{+}[$. There is no restriction on the sum of $T_A(x)$, $I_A(x)$ and $F_A(x)$, so $0- \leq \sup T_A(x) + \sup I_A(x) + \sup F_A(x) \leq 3 +$.

Definition 2. [2] Let X be a universe of discourse. A single valued neutrosophic set A over X is an object having the form $A = \{ \langle x, T_A(x), I_A(x), F_A(x) \rangle : x \in X \}$, where $T_A(x) : X \rightarrow [0, 1]$, $I_A(x) : X \rightarrow [0, 1]$ and $F_A(x) : X \rightarrow [0, 1]$ with $0 \leq T_A(x) + I_A(x) + F_A(x) \leq 3$ for all $x \in X$. The intervals $T_A(x)$, $I_A(x)$ and $F_A(x)$ denote the truth-membership degree, the indeterminacy-membership degree and the falsity membership degree of x to A , respectively. For convenience, a SVN number is denoted by $A = (a, b, c)$,

where $a, b, c \in [0, 1]$ and $a + b + c \leq 3$.

Definition 3. Let \tilde{J} be a neutrosophic number in the set of real numbers R , then its truth-membership function is defined as

$$T_{\tilde{J}}(J) = \begin{cases} \frac{J-a_1}{a_2-a_1}, & a_1 \leq J \leq a_2 \\ \frac{a_2-J}{a_3-a_2}, & a_2 \leq J \leq a_3 \\ 0, & \text{otherwise} \end{cases} \tag{1}$$

Its indeterminacy-membership function is defined as

$$I_{\tilde{J}}(J) = \begin{cases} \frac{J-b_1}{b_2-b_1}, & b_1 \leq J \leq b_2 \\ \frac{b_2-J}{b_3-b_2}, & b_2 \leq J \leq b_3 \\ 0, & \text{otherwise} \end{cases} \tag{2}$$

And its falsity-membership function is defined as

$$F_{\tilde{J}}(J) = \begin{cases} \frac{J-c_1}{c_2-c_1}, & c_1 \leq J \leq c_2 \\ \frac{c_2-J}{c_3-c_2}, & c_2 \leq J \leq c_3 \\ 1, & \text{otherwise} \end{cases} \tag{3}$$

Definition 4. [3] A triangular neutrosophic number $\tilde{a} = \langle (a_1, b_1, c_1); \alpha_{\tilde{a}}, \theta_{\tilde{a}}, \beta_{\tilde{a}} \rangle$ is a special neutrosophic set on the real number set R and $\alpha_{\tilde{a}}, \theta_{\tilde{a}}, \beta_{\tilde{a}} \in [0, 1]$. The truth-membership, indeterminacy-membership and falsity-membership functions of \tilde{a} are defined as follows:

$$T_{\tilde{a}}(x) = \begin{cases} \frac{(x-a_1)\alpha_{\tilde{a}}}{(b_1-a_1)} & \text{if } a_1 \leq x \leq b_1 \\ \alpha_{\tilde{a}} & \text{if } x = b_1 \\ \frac{(c_1-x)\alpha_{\tilde{a}}}{(c_1-b_1)} & \text{if } b_1 < x < c_1 \\ 0 & \text{otherwise} \end{cases} \tag{4}$$

$$I_{\tilde{a}}(x) = \begin{cases} \frac{(b_1-x+\theta_{\tilde{a}}(x-a_1))}{(b_1-a_1)} & \text{if } a_1 \leq x \leq b_1 \\ \theta_{\tilde{a}} & \text{if } x = b_1 \\ \frac{(x-b_1+\theta_{\tilde{a}}(c_1-x))}{(c_1-b_1)} & \text{if } b_1 < x \leq c_1 \\ 1 & \text{otherwise} \end{cases} \tag{5}$$

$$F_{\tilde{a}}(x) = \begin{cases} \frac{(b_1-x+\beta_{\tilde{a}}(x-a_1))}{(b_1-a_1)} & \text{if } a_1 \leq x \leq b_1 \\ \beta_{\tilde{a}} & \text{if } x = b_1 \\ \frac{(x-b_1+\beta_{\tilde{a}}(c_1-x))}{(c_1-b_1)} & \text{if } b_1 < x \leq c_1 \\ 1 & \text{otherwise} \end{cases} \tag{6}$$

If $a_1 \geq 0$ and at least $c_1 > 0$ then $\tilde{a} = \langle (a_1, b_1, c_1); \alpha_{\tilde{a}}, \theta_{\tilde{a}}, \beta_{\tilde{a}} \rangle$ is called a positive triangular neutrosophic number, denoted by $\tilde{a} > 0$. Likewise, if $c_1 \leq 0$ and at least $a_1 < 0$, then $\tilde{a} = \langle (a_1, b_1, c_1); \alpha_{\tilde{a}}, \theta_{\tilde{a}}, \beta_{\tilde{a}} \rangle$ is called a negative triangular neutrosophic number, denoted by $\tilde{a} < 0$.

Definition 5. [3] Let $\tilde{a} = \langle (a_1, b_1, c_1); \alpha_{\tilde{a}}, \theta_{\tilde{a}}, \beta_{\tilde{a}} \rangle$ and $\tilde{b} = \langle (a_2, b_2, c_2); \alpha_{\tilde{b}}, \theta_{\tilde{b}}, \beta_{\tilde{b}} \rangle$ be two single valued triangular neutrosophic and $\gamma \neq 0$ be any real number. Then,

1.

$$\tilde{a} + \tilde{b} = \langle (a_1 + a_2, b_1 + b_2, c_1 + c_2); \alpha_{\tilde{a}} \wedge \alpha_{\tilde{b}}, \theta_{\tilde{a}} \vee \theta_{\tilde{b}}, \beta_{\tilde{a}} \vee \beta_{\tilde{b}} \rangle$$

2.

$$\tilde{a} - \tilde{b} = \langle (a_1 - c_2, b_1 - b_2, c_1 - a_2); \alpha_{\tilde{a}} \wedge \alpha_{\tilde{b}}, \theta_{\tilde{a}} \vee \theta_{\tilde{b}}, \beta_{\tilde{a}} \vee \beta_{\tilde{b}} \rangle$$

3.

$$\tilde{a}\tilde{b} = \begin{cases} \langle (a_1 a_2, b_1 b_2, c_1 c_2); \alpha_{\tilde{a}} \wedge \alpha_{\tilde{b}}, \theta_{\tilde{a}} \vee \theta_{\tilde{b}}, \beta_{\tilde{a}} \vee \beta_{\tilde{b}} \rangle & (c_1 > 0, c_2 > 0) \\ \langle (a_1 c_2, b_1 b_2, c_1 a_2); \alpha_{\tilde{a}} \wedge \alpha_{\tilde{b}}, \theta_{\tilde{a}} \vee \theta_{\tilde{b}}, \beta_{\tilde{a}} \vee \beta_{\tilde{b}} \rangle & (c_1 < 0, c_2 > 0) \\ \langle (c_1 c_2, b_1 b_2, a_1 a_2); \alpha_{\tilde{a}} \wedge \alpha_{\tilde{b}}, \theta_{\tilde{a}} \vee \theta_{\tilde{b}}, \beta_{\tilde{a}} \vee \beta_{\tilde{b}} \rangle & (c_1 < 0, c_2 < 0) \end{cases}$$

4.

$$\frac{\tilde{a}}{\tilde{b}} = \begin{cases} \left\langle \left(\frac{a_1}{c_2}, \frac{b_1}{b_2}, \frac{c_1}{a_2} \right); \alpha_{\tilde{a}} \wedge \alpha_{\tilde{b}}, \theta_{\tilde{a}} \vee \theta_{\tilde{b}}, \beta_{\tilde{a}} \vee \beta_{\tilde{b}} \right\rangle & (c_1 > 0, c_2 > 0) \\ \left\langle \left(\frac{c_1}{c_2}, \frac{b_1}{b_2}, \frac{a_1}{a_2} \right); \alpha_{\tilde{a}} \wedge \alpha_{\tilde{b}}, \theta_{\tilde{a}} \vee \theta_{\tilde{b}}, \beta_{\tilde{a}} \vee \beta_{\tilde{b}} \right\rangle & (c_1 < 0, c_2 > 0) \\ \left\langle \left(\frac{c_1}{a_2}, \frac{b_1}{b_2}, \frac{a_1}{c_2} \right); \alpha_{\tilde{a}} \wedge \alpha_{\tilde{b}}, \theta_{\tilde{a}} \vee \theta_{\tilde{b}}, \beta_{\tilde{a}} \vee \beta_{\tilde{b}} \right\rangle & (c_1 < 0, c_2 < 0) \end{cases}$$

5.

$$\gamma \tilde{a} = \begin{cases} \langle (\gamma a_1, \gamma b_1, \gamma c_1); \alpha_{\tilde{a}}, \theta_{\tilde{a}}, \beta_{\tilde{a}} \rangle & (\gamma > 0) \\ \langle (\gamma c_1, \gamma b_1, \gamma a_1); \alpha_{\tilde{a}}, \theta_{\tilde{a}}, \beta_{\tilde{a}} \rangle & (\gamma < 0) \end{cases}$$

3. LINEAR FRACTIONAL PROGRAMMING PROBLEM (LFPP)

In this section, the general form of LFP problem is discussed. Also, Charnes and Cooper's [4] linear transformation is summarized.

The linear fractional programming (LFP) problem can be written as:

$$MaxZ(x) = \frac{\sum c_j x_j + p}{\sum d_j x_j + q} = \frac{c^T x + p}{d^T x + q} = \frac{N(x)}{D(x)}, \tag{7}$$

Subject to

$$x \in S = \{x \in R^n : Ax \leq b, x \geq 0\}$$

Where $j = 1, 2, \dots, n$, $A \in R^{m \times n}$, $b \in R^m$, $c_j, d_j \in R^n$, and $p, q \in R$. For some values of x , $D(x)$ may be equal to zero. To avoid such cases, we requires that either $\{Ax \leq b, x \geq 0 \Rightarrow D(x) > 0\}$ or $\{Ax \leq b, x \geq 0 \Rightarrow D(x) < 0\}$. For convenience here, we consider the first case,

$$\text{i.e. } \{Ax \leq b, x \geq 0 \Rightarrow D(x) > 0\} \tag{8}$$

Using Charnes and Cooper's linear tranformation the previous LFP problem is equivalent to the following linear programming (LP) problem:

$$\text{Max } c^T y + pt,$$

Subject to

$$d^T y + qt = 1, Ay - bt = 0, t \geq 0, y \geq 0, y \in R^n, t \in R \tag{9}$$

Consider the fractional programming problem

$$\text{Max } Z(x) = \frac{N(x)}{D(x)}, \tag{10}$$

Subject to

$$Ax \leq b, x \geq 0, x \in \Delta = \{x : Ax \leq b, x \geq 0 \Rightarrow D(x) > 0\}$$

By the transformation $t = \frac{1}{D(x)}$, $y = tx$ we obtained the following:

$$\text{Max } tN\left(\frac{y}{t}\right),$$

Subject to

$$A\left(\frac{y}{t}\right) - b \leq 0, tD\left(\frac{y}{t}\right) = 1, t > 0, y \geq 0 \tag{11}$$

By replacing the equality constraint $tD\left(\frac{y}{t}\right) = 1$ by an inequality constraint $tD\left(\frac{y}{t}\right) \leq 1$. We obtain the following:

$$\text{Max } tN\left(\frac{y}{t}\right),$$

Subject to

$$A\left(\frac{y}{t}\right) - b \leq 0, tD\left(\frac{y}{t}\right) \leq 1, t > 0, y \geq 0 \tag{12}$$

If in equation (10), $N(x)$ is concave, $D(x)$ is concave and positive on Δ , and $N(x)$ is negative for each $x \in \Delta$, then

$$\text{Max}_{x \in \Delta} \frac{N(x)}{D(x)} \Leftrightarrow \text{Min}_{x \in \Delta} \frac{-N(x)}{D(x)} \Leftrightarrow \text{Max}_{x \in \Delta} \frac{D(x)}{-N(x)},$$

where $-N(x)$ is convex and positive. Now linear fractional program (10) transformed to the following LP problem:

$$\text{Max } tD\left(\frac{y}{t}\right),$$

Subject to

$$A\left(\frac{y}{t}\right) - b \leq 0, -tN\left(\frac{y}{t}\right) \leq 1, t > 0, y \geq 0 \tag{13}$$

4 MULTI-OBJECTIVE LINEAR FRACTIONAL PROGRAMMING PROBLEM

In this section, the general form of MOLFP problem is discussed and the procedure for converting MOLFP problem into MOLP problem is illustrated. The MOLFP problem can be written as follows:

$$\text{Max } z_i(x) = [z_1(x), z_2(x), \dots, z_k(x)],$$

Subject to

$$x \in \Delta = \{x : Ax \leq b, x \geq 0\} \tag{14}$$

With $b \in R^m$, $A \in R^{m \times n}$, and $z_i(x) = \frac{c_i x + p_i}{d_i x + q_i} = \frac{N_i(x)}{D_i(x)}$, $c_i, d_i \in R^n$ and $p_i, q_i \in R$, $i = 1, 2, \dots, k$.

Let I be the index set such that $I = \{i : N_i(x) \geq 0 \text{ for } x \in \Delta\}$ and $I^c = \{i : N_i(x) < 0 \text{ for } x \in \Delta\}$, where $I \cup I^c = \{1, 2, \dots, K\}$. Let $D(x)$ be positive on Δ where Δ is non-empty and bounded. For simplicity, let us take the least value of $1/(d_i x + q_i)$ and $1/[-(c_i x + p_i)]$ is t for $i \in I$ and $i \in I^c$, respectively i.e.

$$\frac{1}{(d_i x + q_i)} \geq t \text{ for } i \in I \text{ and } \frac{-1}{(c_i x + p_i)} \geq t \text{ for } i \in I^c \tag{15}$$

By using the transformation $y = tx$ ($t > 0$), and equation 15, MOLFP problem (14) may be written as follows:

$$\text{Max } z_i(y, t) = \left\{ tN_i\left(\frac{y}{t}\right), \text{ for } i \in I; tD_i\left(\frac{y}{t}\right), \text{ for } i \in I^c \right\}$$

Subject to

$$tD_i\left(\frac{y}{t}\right) \leq 1, \text{ for } i \in I, \quad -tN_i\left(\frac{y}{t}\right) \leq 1, \text{ for}$$

$$i \in I^c, \quad A\left(\frac{y}{t}\right) - b \leq 0, \quad t, y \geq 0 \tag{16}$$

If $i \in I$, then truth-membership function of each objective function can be written as:

$$T_i\left(tN_i\left(\frac{y}{t}\right)\right) = \begin{cases} 0 & \text{if } tN_i\left(\frac{y}{t}\right) \leq 0 \\ \frac{tN_i\left(\frac{y}{t}\right)}{z_i - a_i} & \text{if } 0 \leq tN_i\left(\frac{y}{t}\right) \leq z_i + a_i \\ 1 & \text{if } tN_i\left(\frac{y}{t}\right) \geq z_i + a_i \end{cases} \tag{17}$$

If $i \in I^c$, then truth-membership function of each objective function can be written as:

$$T_i\left(tD_i\left(\frac{y}{t}\right)\right) = \begin{cases} 0 & \text{if } tD_i\left(\frac{y}{t}\right) \leq 0 \\ \frac{tD_i\left(\frac{y}{t}\right)}{z_i - a_i} & \text{if } 0 \leq tD_i\left(\frac{y}{t}\right) \leq z_i + a_i \\ 1 & \text{if } tD_i\left(\frac{y}{t}\right) \geq z_i + a_i \end{cases} \tag{18}$$

If $i \in I$, then falsity-membership function of each objective function can be written as:

$$F_i\left(tN_i\left(\frac{y}{t}\right)\right) = \begin{cases} 1 & \text{if } tN_i\left(\frac{y}{t}\right) \leq 0 \\ 1 - \frac{tN_i\left(\frac{y}{t}\right)}{z_i - c_i} & \text{if } 0 \leq tN_i\left(\frac{y}{t}\right) \leq z_i + c_i \\ 1 & \text{if } tN_i\left(\frac{y}{t}\right) \geq z_i + c_i \end{cases} \tag{19}$$

If $i \in I^c$, then falsity-membership function of each objective function can be written as:

$$F_i\left(tD_i\left(\frac{y}{t}\right)\right) = \begin{cases} 1 & \text{if } tD_i\left(\frac{y}{t}\right) \leq 0 \\ 1 - \frac{tD_i\left(\frac{y}{t}\right)}{z_i - c_i} & \text{if } 0 \leq tD_i\left(\frac{y}{t}\right) \leq z_i + c_i \\ 1 & \text{if } tD_i\left(\frac{y}{t}\right) \geq z_i + c_i \end{cases} \tag{20}$$

If $i \in I$, then indeterminacy-membership function of each objective function can be written as:

$$I_i \left(tN_i \left(\frac{y}{t} \right) \right) = \begin{cases} 0 & \text{if } tN_i \left(\frac{y}{t} \right) \leq 0 \\ \frac{tN_i \left(\frac{y}{t} \right)}{z_i - d_i} & \text{if } 0 \leq tN_i \left(\frac{y}{t} \right) \leq z_i + d_i \\ 1 & \text{if } tN_i \left(\frac{y}{t} \right) \geq z_i + d_i \end{cases} \quad (21)$$

If $i \in I^c$, then indeterminacy-membership function of each objective function can be written as:

$$I_i \left(tD_i \left(\frac{y}{t} \right) \right) = \begin{cases} 0 & \text{if } tD_i \left(\frac{y}{t} \right) \leq 0 \\ \frac{tD_i \left(\frac{y}{t} \right)}{z_i - d_i} & \text{if } 0 \leq tD_i \left(\frac{y}{t} \right) \leq z_i + d_i \\ 1 & \text{if } tD_i \left(\frac{y}{t} \right) \geq z_i + d_i \end{cases} \quad (22)$$

Where a_i, d_i and c_i are acceptance tolerance, indeterminacy tolerance and rejection tolerance. Zimmermann [5] proved that if membership function $\mu_D(y, t)$ of complete solution set (y, t) , has a unique maximum value $\mu_D(y^*, t^*)$ then (y^*, t^*) which is an element of complete solution set (y, t) can be derived by solving linear programming with one variable λ . Using Zimmermann's min operator and membership functions, the model (14) transformed to the crisp model as:

$$Max \lambda$$

Subject to,

$$\begin{aligned} T_i \left(tN_i \left(\frac{y}{t} \right) \right) &\geq \lambda, & \text{for } i \in I \\ T_i \left(tD_i \left(\frac{y}{t} \right) \right) &\geq \lambda, & \text{for } i \in I^c \\ F_i \left(tN_i \left(\frac{y}{t} \right) \right) &\leq \lambda, & \text{for } i \in I \\ F_i \left(tD_i \left(\frac{y}{t} \right) \right) &\leq \lambda, & \text{for } i \in I^c \\ I_i \left(tN_i \left(\frac{y}{t} \right) \right) &\leq \lambda, & \text{for } i \in I \\ I_i \left(tD_i \left(\frac{y}{t} \right) \right) &\leq \lambda, & \text{for } i \in I^c \\ tD_i \left(\frac{y}{t} \right) &\leq 1, & \text{for } i \in I \\ -tN_i \left(\frac{y}{t} \right) &\leq 1, & \text{for } i \in I^c \\ A \left(\frac{y}{t} \right) - b &\leq 0, t, y, \lambda \geq 0. \end{aligned} \quad (23)$$

5 NEUTROSOPHIC LINEAR FRACTIONAL PROGRAMMING PROBLEM

In this section, we propose a procedure for solving neutrosophic linear fractional programming problem where the cost of the objective function, the resources, and the technological coefficients are triangular neutrosophic numbers.

Let us consider the NLFP problem:

$$Max z(\tilde{x}) = \frac{\sum \tilde{c}_j x_j + \tilde{p}}{\sum \tilde{d}_j x_j + \tilde{q}}$$

Subject to

$$\sum \tilde{a}_{ij} x_j \leq \tilde{b}_i, \quad i = 1, 2, \dots, m, \quad x_j \geq 0, \quad j = 1, 2, \dots, n \tag{24}$$

We assume that $\tilde{c}_j, \tilde{p}, \tilde{d}_j, \tilde{q}, \tilde{a}_{ij}$ and \tilde{b}_i are triangular neutrosophic numbers for each $i = 1, 2, \dots, m$ and $j = 1, 2, \dots, n$, therefore, the problem (24) can be written as:

$$Max z(\tilde{x}) = \frac{\sum (c_{j1}, c_{j2}, c_{j3}; \alpha_{\tilde{c}}, \theta_{\tilde{c}}, \beta_{\tilde{c}}) x_j + (p_1, p_2, p_3; \alpha_{\tilde{p}}, \theta_{\tilde{p}}, \beta_{\tilde{p}})}{\sum (d_{j1}, d_{j2}, d_{j3}; \alpha_{\tilde{d}}, \theta_{\tilde{d}}, \beta_{\tilde{d}}) x_j + (q_1, q_2, q_3; \alpha_{\tilde{q}}, \theta_{\tilde{q}}, \beta_{\tilde{q}})} \tag{25}$$

Subject to

$$\sum (a_{ij1}, a_{ij2}, a_{ij3}; \alpha_{\tilde{a}}, \theta_{\tilde{a}}, \beta_{\tilde{a}}) \leq (b_{i1}, b_{i2}, b_{i3}; \alpha_{\tilde{b}}, \theta_{\tilde{b}}, \beta_{\tilde{b}}),$$

$$i = 1, 2, \dots, m, \quad x_j \geq 0, \quad j = 1, 2, \dots, n$$

Where $\alpha, \theta, \beta \in [0, 1]$ and stand for truth-membership, indeterminacy and falsity-membership function of each neutrosophic number.

Here decision maker want to increase the degree of truth-membership and decrease the degree of indeterminacy and falsity membership. Using the concept of component wise optimization, the problem (25) reduces to an equivalent MOLFP as follows:

$$Max Z_1(x) = \frac{\sum c_{j1} x_j + p_1}{\sum d_{j3} x_j + q_3},$$

$$Max Z_2(x) = \frac{\sum c_{j2} x_j + p_2}{\sum d_{j2} x_j + q_2},$$

$$Max Z_3(x) = \frac{\sum c_{j3} x_j + p_3}{\sum d_{j1} x_j + q_1},$$

$$Max Z_4(x) = \frac{\sum \alpha_{\tilde{c}} x_j + \alpha_{\tilde{p}}}{\sum \beta_{\tilde{d}} x_j + \beta_{\tilde{q}}},$$

$$Max Z_5(x) = 1 - \frac{\sum \theta_{\bar{c}}x_j + \theta_{\bar{p}}}{\sum \theta_{\bar{d}}x_j + \theta_{\bar{q}}}, \tag{26}$$

$$Max Z_6(x) = 1 - \frac{\sum \beta_{\bar{c}}x_j + \beta_{\bar{p}}}{\sum \alpha_{\bar{d}}x_j + \alpha_{\bar{q}}}$$

Subject to

$$\sum a_{ij1}x_j \leq b_{i1}, \sum a_{ij2}x_j \leq b_{i2}, \sum a_{ij3}x_j \leq b_{i3}, \sum \alpha_{\bar{a}}x_j \leq \alpha_{\bar{b}},$$

$$\sum \theta_{\bar{a}}x_j \leq \theta_{\bar{b}}, \sum \beta_{\bar{a}}x_j \leq \beta_{\bar{b}}$$

$x_j \geq 0, i = 1, 2, \dots, m; j = 1, 2, \dots, n.$

Let us assume that z_1, z_2, z_3, z_4, z_5 and $z_6 \geq 0$ for the feasible region. Hence, the MOLFP problem can be converted into the following MOLP problem:

$$Max z_1(y, t) = \sum c_{j1}y_j + p_1t,$$

$$Max z_2(y, t) = \sum c_{j2}y_j + p_2t,$$

$$Max z_3(y, t) = \sum c_{j3}y_j + p_3t,$$

$$Max z_4(y, t) = \sum \alpha_{\bar{c}}y_j + \alpha_{\bar{p}}t,$$

$$Max z_5(y, t) = 1 - \left(\sum \theta_{\bar{c}}y_j - \theta_{\bar{p}}t \right),$$

$$Max z_6(y, t) = 1 - \left(\sum \beta_{\bar{c}}y_j - \beta_{\bar{p}}t \right),$$

Subject to

$$\sum d_{j3}y_j + q_3t \leq 1,$$

$$\sum d_{j2}y_j + q_2t \leq 1,$$

$$\sum d_{j1}y_j + q_1t \leq 1,$$

$$\sum \beta_{\bar{a}}y_j + \beta_{\bar{q}}t \leq 1,$$

$$\sum \theta_{\bar{a}} y_j + \theta_{\bar{q}} t \leq 1,$$

$$\sum \alpha_{\bar{a}} y_j + \alpha_{\bar{q}} t \leq 1,$$

$$\sum a_{ij1} y_j - b_{i1} t \leq 0,$$

$$\sum a_{ij2} y_j - b_{i2} t \leq 0,$$

$$\sum a_{ij3} y_j - b_{i3} t \leq 0,$$

$$\sum \alpha_{\bar{a}} y_j - \alpha_{\bar{b}} t \leq 0,$$

$$\sum \theta_{\bar{a}} y_j - \theta_{\bar{b}} t \leq 0,$$

$$\sum \beta_{\bar{a}} y_j - \beta_{\bar{b}} t \leq 0,$$

$$t, y_j \geq 0, i = 1, 2, \dots, m; j = 1, 2, \dots, n. \tag{27}$$

Solving the transformed MOLP problem for each objective function, we obtain $z_1^*, z_2^*, z_3^*, z_4^*, z_5^*$ and z_6^* . Using the membership functions defined in previous section, the above model reduces to:

$$\text{Max } \lambda$$

Subject to

$$\sum c_{j1} y_j + p_1 t - z_1^* \lambda \geq 0,$$

$$\sum c_{j2} y_j + p_2 t - z_2^* \lambda \geq 0,$$

$$\sum c_{j3} y_j + p_3 t - z_3^* \lambda \geq 0,$$

$$\sum \alpha_{\bar{c}} y_j + \alpha_{\bar{p}} t - z_4^* \lambda \geq 0,$$

$$1 - \left(\sum \theta_{\tilde{c}} y_j + \theta_{\tilde{p}} t \right) - z_5^* \lambda \leq 0,$$

$$1 - \left(\sum \beta_{\tilde{c}} y_j + \beta_{\tilde{p}} t \right) - z_6^* \lambda \leq 0,$$

$$\sum d_{j3} y_j + q_3 t \leq 1,$$

$$\sum d_{j2} y_j + q_2 t \leq 1,$$

$$\sum d_{j1} y_j + q_1 t \leq 1,$$

$$\sum \beta_{\tilde{d}} y_j + \beta_{\tilde{q}} t \leq 1,$$

$$\sum \theta_{\tilde{d}} y_j + \theta_{\tilde{q}} t \leq 1,$$

$$\sum \alpha_{\tilde{d}} y_j + \alpha_{\tilde{q}} t \leq 1,$$

$$\sum a_{ij1} y_j - b_{i1} t \leq 0,$$

$$\sum a_{ij2} y_j - b_{i2} t \leq 0,$$

$$\sum a_{ij3} y_j - b_{i3} t \leq 0,$$

$$\sum \alpha_{\tilde{d}} y_j - \alpha_{\tilde{b}} t \leq 0,$$

$$\sum \theta_{\tilde{d}} y_j - \theta_{\tilde{b}} t \leq 0,$$

$$\sum \beta_{\tilde{d}} y_j - \beta_{\tilde{b}} t \leq 0,$$

$$t, y_j \geq 0, i = 1, 2, \dots, m; j = 1, 2, \dots, n. \tag{28}$$

5.1 ALGORITHM

The proposed approach for solving NLFP problem can be summarized as follows:

- Step 1.** The NLFP problem is converted into MOLFP problem using component wise optimization of triangular neutrosophic numbers.
- Step 2.** The MOLFP problem is transformed into MOLP problem using the method proposed by Charnes and Cooper.
- Step 3.** Solve each objective function subject to the given set of constraints.
- Step 4.** Define membership functions for each objective function as in section four.
- Step 5.** Use Zimmermann's operator and membership functions to obtain crisp model.
- Step 6.** Solve crisp model by using suitable algorithm.

6 NUMERICAL EXAMPLE

A company manufactures 3 kinds of products I, II and III with profit around 8, 7 and 9 dollars per unit, respectively. However, the cost for each one unit of the products is around 8, 9 and 6 dollars, respectively. Also it is assumed that a fixed cost of around 1.5 dollars is added to the cost function due to expected duration through the process of production. Suppose the materials needed for manufacturing the products I, II and III are about 4, 3 and 5 units per pound, respectively. The supply for this raw material is restricted to about 28 pounds. Man-hours availability for product I is about 5 hours, for product II is about 3 hours, and that for III is about 3 hours in manufacturing per units. Total man-hours availability is around 20 hours daily. Determine how many products of I, II and III should be manufactured in order to maximize the total profit. Also during the whole process, the manager hesitates in prediction of parametric values due to some uncontrollable factors.

Let x_1, x_2 and x_3 units be the amount of I, II and III, respectively to be produced. After prediction of estimated parameters, the above problem can be formulated as the following NLFPP:

$$Max Z(\tilde{x}) = \frac{\tilde{8}x_1 + \tilde{7}x_2 + \tilde{9}x_3}{\tilde{8}x_1 + \tilde{9}x_2 + \tilde{6}x_3 + \tilde{1.5}}$$

Subject to

$$\tilde{4}x_1 + \tilde{3}x_2 + \tilde{5}x_3 \leq \tilde{28},$$

$$\tilde{5}x_1 + \tilde{3}x_2 + \tilde{3}x_3 \leq \tilde{20}, \quad x_1, x_2, x_3 \geq 0 \tag{29}$$

With $\tilde{8} = (7, 8, 9; 0.5, 0.8, 0.3)$, $\tilde{7} = (6, 7, 8; 0.2, 0.6, 0.5)$,
 $\tilde{9} = (8, 9, 10; 0.8, 0.1, 0.4)$, $\tilde{6} = (4, 6, 8; 0.75, 0.25, 0.1)$,
 $\tilde{1.5} = (1, 1.5, 2; 0.75, 0.5, 0.25)$, $\tilde{4} = (3, 4, 5; 0.4, 0.6, 0.5)$,
 $\tilde{3} = (2, 3, 4; 1, 0.25, 0.3)$, $\tilde{5} = (4, 5, 6; 0.3, 0.4, 0.8)$,
 $\tilde{28} = (25, 28, 30; 0.4, 0.25, 0.6)$, $\tilde{20} = (18, 20, 22; 0.9, 0.2, 0.6)$.

This problem is equivalent to the following M●LFPP:

$$\begin{aligned} \text{Max } z_1(x) &= \frac{7x_1 + 6x_2 + 8x_3}{9x_1 + 10x_2 + 8x_3 + 2}, \\ \text{Max } z_2(x) &= \frac{8x_1 + 7x_2 + 9x_3}{8x_1 + 9x_2 + 6x_3 + 1.5}, \\ \text{Max } z_3(x) &= \frac{9x_1 + 8x_2 + 10x_3}{7x_1 + 8x_2 + 4x_3 + 1}, \\ \text{Max } z_4(x) &= \frac{0.5x_1 + 0.2x_2 + 0.8x_3}{0.3x_1 + 0.4x_2 + 0.1x_3 + 0.25}, \\ \text{Max } z_5(x) &= 1 - \frac{0.8x_1 + 0.6x_2 + 0.1x_3}{0.8x_1 + 0.1x_2 + 0.25x_3 + 0.5}, \\ \text{Max } z_6(x) &= 1 - \frac{0.3x_1 + 0.5x_2 + 0.4x_3}{0.5x_1 + 0.8x_2 + 0.75x_3 + 0.75} \end{aligned} \tag{30}$$

Subject to

$$3x_1 + 2x_2 + 4x_3 \leq 25,$$

$$4x_1 + 3x_2 + 5x_3 \leq 28,$$

$$5x_1 + 4x_2 + 6x_3 \leq 30,$$

$$4x_1 + 2x_2 + 2x_3 \leq 18,$$

$$5x_1 + 3x_2 + 3x_3 \leq 20,$$

$$6x_1 + 4x_2 + 4x_3 \leq 22,$$

$$0.4x_1 + x_2 + 0.3x_3 \leq 0.4,$$

$$0.6x_1 + 0.25x_2 + 0.44x_3 \leq 0.25,$$

$$0.5x_1 + 0.3x_2 + 0.8x_3 \leq 0.5,$$

$$0.3x_1 + x_2 + x_3 \leq 0.9,$$

$$0.4x_1 + 0.25x_2 + 0.25x_3 \leq 0.2,$$

$$0.8x_1 + 0.3x_2 + 0.3x_3 \leq 0.6,$$

Using the transformation the problem is equivalent to the following MOLPP:

$$\text{Max } z_1(y, t) = 7y_1 + 6y_2 + 8y_3,$$

$$\text{Max } z_2(y, t) = 8y_1 + 7y_2 + 9y_3,$$

$$\text{Max } z_3(y, t) = 9y_1 + 8y_2 + 10y_3,$$

$$\text{Max } z_4(y, t) = 0.5y_1 + 0.2y_2 + 0.8y_3,$$

$$\text{Max } z_5(y, t) = 0.5y_1 + 0.15y_2 + 0.5,$$

$$\text{Max } z_6(y, t) = 0.2y_1 + 0.3y_2 + 0.35y_3 + 0.75, \quad (31)$$

Subject to

$$9y_1 + 10y_2 + 8y_3 + 2t \leq 1,$$

$$8y_1 + 9y_2 + 6y_3 + 1.5t \leq 1,$$

$$7y_1 + 8y_2 + 4y_3 + t \leq 1,$$

$$0.3y_1 + 0.4y_2 + 0.1y_3 + 0.25t \leq 1,$$

$$0.8y_1 + 0.1y_2 + 0.25y_3 + 0.5t \leq 1,$$

$$0.5y_1 + 0.8y_2 + 0.75y_3 + 0.75t \leq 1,$$

$$3y_1 + 2y_2 + 4y_3 - 25t \leq 0,$$

$$4y_1 + 3y_2 + 5y_3 - 28t \leq 0,$$

$$5y_1 + 4y_2 + 6y_3 - 30t \leq 0,$$

$$4y_1 + 2y_2 + 2y_3 - 18t \leq 0,$$

$$5y_1 + 3y_2 + 3y_3 - 20t \leq 0,$$

$$6y_1 + 4y_2 + 4y_3 - 22t \leq 0,$$

$$0.4y_1 + y_2 + 0.3y_3 - 0.4t \leq 0,$$

$$0.6y_1 + 0.25y_2 + 0.4y_3 - 0.25t \leq 0,$$

$$0.5y_1 + 0.3y_2 + 0.8y_3 - 0.5t \leq 0,$$

$$0.3y_1 + y_2 + y_3 - 0.9t \leq 0,$$

$$y_1, y_2, y_3, t \geq 0$$

Solving each objective at a time we get:

$$z_1 = 0.7143, \quad z_2 = 0.8036, \quad z_3 = 0.8929, \quad z_4 = 0.0714, \quad z_5 = 0.833, \quad z_6 = 0.7813$$

Now the previous problem reduced to the following LPP:

Subject to $Max \lambda$

$$7y_1 + 6y_2 + 8y_3 - z_1\lambda \geq 0,$$

$$8y_1 + 7y_2 + 9y_3 - z_2\lambda \geq 0,$$

$$9y_1 + 8y_2 + 10y_3 - z_3\lambda \geq 0,$$

$$0.5y_1 + 0.2y_2 + 0.8y_3 - z_4\lambda \geq 0,$$

$$0.5y_2 + 0.15y_3 + 0.5 - z_5\lambda \leq 0,$$

$$0.2y_1 + 0.3y_2 + 0.3y_3 + 0.75 - z_6\lambda \leq 0$$

$$9y_1 + 10y_2 + 8y_3 + 2t \leq 1,$$

$$8y_1 + 9y_2 + 6y_3 + 1.5t \leq 1,$$

$$7y_1 + 8y_2 + 4y_3 + t \leq 1,$$

$$0.3y_1 + 0.4y_2 + 0.1y_3 + 0.25t \leq 1,$$

$$0.8y_1 + 0.1y_2 + 0.25y_3 + 0.5t \leq 1,$$

$$0.5y_1 + 0.8y_2 + 0.75y_3 + 0.75t \leq 1,$$

$$3y_1 + 2y_2 + 4y_3 - 25t \leq 0,$$

$$4y_1 + 3y_2 + 5y_3 - 28t \leq 0,$$

$$5y_1 + 4y_2 + 6y_3 - 30t \leq 0,$$

$$4y_1 + 2y_2 + 2y_3 - 18t \leq 0,$$

$$5y_1 + 3y_2 + 3y_3 - 20t \leq 0,$$

$$6y_1 + 4y_2 + 4y_3 - 22t \leq 0,$$

$$0.4y_1 + y_2 + 0.3y_3 - 0.4t \leq 0,$$

$$0.6y_1 + 0.25y_2 + 0.4y_3 - 0.25t \leq 0,$$

$$0.5y_1 + 0.3y_2 + 0.8y_3 - 0.5t \leq 0,$$

$$0.3y_1 + y_2 + y_3 - 0.9t \leq 0,$$

$$y_1, y_2, y_3, t \geq 0, \lambda \in [0, 1] \tag{32}$$

Solving by LINGO we have $y_1 = 0, y_2 = 0, y_3 = 0, 0893, \lambda = 1, t = 0.1429$.

The optimal of original problem as $x_1 = 0, x_2 = 0, x_3 = 0.6249$.

7 CONCLUSION

In this paper, a method for solving the NLFP problem where the cost of the objective function, the resources and the technological coefficients are triangular neutrosophic numbers is proposed. In the proposed method, NLFP problem is transformed to a MOLFP problem and the resultant problem is converted to a LP problem. In future, the proposed approach can be extended for solving multi-objective neutrosophic linear fractional programming problems (MONLFPPs).

REFERENCES

- [1] Smarandache, F., (2005), *A Unifying Field in Logics: Neutrosophic Logic. Neutrosophy, Neutrosophic Set, Neutrosophic Probability: Neutrosophic Logic. Neutrosophy, Neutrosophic Set, Neutrosophic Probability: Infinite Study.*
- [2] Smarandache, F., (2004), *A geometric interpretation of the neutrosophic set-A generalization of the intuitionistic fuzzy set.*
- [3] Deli, Irfan and Subas, Yusuf, (2014), *Single valued neutrosophic numbers and their applications to multicriteria decision making problem.*
- [4] Charnes, Abraham and cooper, William, (1962), *Programming with linear fractional functional*, Naval Research logistics quarterly, 9 (3-4), 181-186.
- [5] Zimmermann, H-J., (2010), *Fuzzy set theory*, Wiley Interdisciplinary Reviews: Computational Statistics, 2(3), 317-332.
- [6] Hezam, I.M., Abdel-Baset, M., Smarandache, F., *Taylor Series Approximation to Solve Neutrosophic Multiobjective Programming Problem*, Neutrosophic sets and Systems, Vol. 10 (2015), pp. 39-45.
- [7] El-Hefenawy, N., Metwally, M.A., Ahmed, Z.M. and El-Henawy, I.M., (2016), *A Review on the Applications of Neutrosophic Sets*. Journal of Computational and Theoretical Nanoscience, 13(1), 936-944.
- [9] Abdel-Baset, M., Hezam, I.M. and Smarandache, F., *Neutrosophic Goal Programming*, Neutrosophic sets and Systems, Vol. 11, (2016), pp. 112-118.

Complex Neutrosophic Soft Set

Said Broumi, Florentin Smarandache, Mumtaz Ali, Assia Bakali, Mohamed Talea, Ganeshsree Selvachandran

Said Broumi, Florentin Smarandache, Mumtaz Ali, Assia Bakali, Mohamed Talea, Ganeshsree Selvachandran (2017). Complex Neutrosophic Soft Set. FUZZ-IEEE Conference on Fuzzy Systems, Naples, Italy, 9-12 July 2017, 6

Abstract—In this paper, we propose the complex neutrosophic soft set model, which is a hybrid of complex fuzzy sets, neutrosophic sets and soft sets. The basic set theoretic operations and some concepts related to the structure of this model are introduced, and illustrated. An example related to a decision making problem involving uncertain and subjective information is presented, to demonstrate the utility of this model.

Keywords—complex fuzzy sets; soft sets; complex neutrosophic sets; complex neutrosophic soft sets; decision making

I. INTRODUCTION

The neutrosophic set model (NS) proposed by Smarandache [1, 2] is a powerful tool to deal with incomplete, indeterminate and inconsistent information in the real world. It is a generalization of the theory of fuzzy sets [3], intuitionistic fuzzy sets [4, 5], interval-valued fuzzy sets [6] and interval-valued intuitionistic fuzzy sets [7]. A neutrosophic set is characterized by a truth-membership degree (t), an indeterminacy-membership degree (i) and a falsity-membership degree (f), all defined independently, and all of which lie in the real standard or nonstandard unit interval $]0, 1+[$. Since this interval is difficult to be used in real-life situations, Wang et al. [8] introduced single-valued neutrosophic sets (SVNSs) whose functions of truth, indeterminacy and falsity all lie in $[0, 1]$. Neutrosophic sets and its extensions such as single valued neutrosophic sets, interval neutrosophic sets, and intuitionistic neutrosophic sets have been applied in a wide variety of fields including decision making, computer science, engineering, and medicine [1-2, 8-27, 36-37].

The study of complex fuzzy sets were initiated by Ramot et al. [28]. Among the well-known complex fuzzy based models in literature are complex intuitionistic fuzzy sets (CIFs) [29, 30], complex vague soft sets (CVSSs) [31, 32] and complex intuitionistic fuzzy soft sets (CIFSSs) [33]. These models have been used to represent the uncertainty and periodicity aspects of an object simultaneously, in a single set. The complex-valued membership and non-membership functions in these models have the potential to be used to represent uncertainty in instances such as the wave function in quantum mechanics, impedance in electrical engineering, the changes in meteorological activities, and time-periodic decision making problems.

Recently, Ali and Smarandache [34] developed a hybrid model of complex fuzzy sets and neutrosophic sets, called complex neutrosophic sets. This model has the capability of handling the different aspects of uncertainty, such as incompleteness, indeterminacy and inconsistency, whilst simultaneously handling the periodicity aspect of the objects, all in a single set. The complex neutrosophic set is defined by complex-valued truth, indeterminacy and falsity membership functions. The complex-valued truth membership function consists of a truth amplitude term (truth membership) and a phase term which represents the periodicity of the object. Similarly, the complex-valued indeterminacy and falsity membership functions consists of an indeterminacy amplitude and a phase term, and a falsity amplitude and a phase term, respectively. The complex neutrosophic set is a generalized framework of all the other existing models in literature.

However, as the CNS model is an extension of ordinary fuzzy sets, it lacks adequate parameterization qualities. Adequate parameterization refers to the ability of a model to define the parameters in a more comprehensive manner, without any restrictions. Soft set theory works by defining the initial description of the parameters in an approximate manner, and allows for any form of parameterization that is preferred by the users. This includes using words and sentences, real numbers, functions and mappings, among others to describe the parameters. The absence of any restrictions on the approximate description in soft set theory makes it very convenient to be used and easily applicable in practice. The adequate parameterization capabilities of soft set theory and the lack of such capabilities in the existing CNS model served as the motivation to introduce the CNSS model in this paper. This is achieved by defining the complex neutrosophic set in a soft set setting.

The rest of the paper is organized as follows. In section 2, we present an overview of some basic definitions and properties which serves as the background to our work in this paper. In section 3, the main definition of the CNSS and some related concepts are presented. In section 4, the basic set theoretic operations for this model are defined. The utility of this model is demonstrated by applying it in a decision making problem in section 5. Concluding remarks are given in section 6.

II. PRELIMINARIES

In this section, we recapitulate some important concepts related to neutrosophic sets (NSs), and complex neutrosophic sets (CNSs). We refer the readers to [1, 8, 10, 34] for further details pertaining to these models.

Let X be a space of points (objects) with generic elements in X denoted by x .

Definition 1. [1] A neutrosophic set A is an object having the form $A = \{ \langle x, T_A(x), I_A(x), F_A(x) \rangle : x \in X \}$, where the functions $T, I, F : X \rightarrow]-0, 1^+[$, denote the truth, indeterminacy, and falsity membership functions, respectively, of the element $x \in X$ with respect to set A . These membership functions must satisfy the condition $-0 \leq T_A(x) + I_A(x) + F_A(x) \leq 3^+$. (1)

The functions $T_A(x), I_A(x)$, and $F_A(x)$ are real standard or nonstandard subsets of the interval $]0, 1^+[$. However, these intervals make it difficult to apply NSs to practical problems, and this led to the introduction of a single-valued neutrosophic set (SVNS) in [12]. This model is a special case of NSs and is better suited to handle real-life problems and applications.

Definition 2. [8] An SVNS A is a neutrosophic set that is characterized by a truth-membership function $T_A(x)$, an indeterminacy-membership function $I_A(x)$, and a falsity-membership function $F_A(x)$, where $T_A(x), I_A(x), F_A(x) \in [0, 1]$. A SVNS A can thus be written as

$$A = \{ \langle x, T_A(x), I_A(x), F_A(x) \rangle : x \in X \} \quad (2)$$

Definition 3. [8] The complement of a neutrosophic set A , denoted by A^c , is as defined below for all $x \in X$:

$$T_A^c(x) = F_A(x), I_A^c(x) = 1 - I_A(x), F_A^c(x) = T_A(x).$$

Definition 4. [10] Let U be an initial set and E be a set of parameters. Let $P(U)$ denote the power set of U , and let $A \rightarrow E$. A pair (F, A) is called a soft set over U , where F is a mapping given by $F: A \rightarrow P(U)$. In other words, a soft set is a parameterized family of subsets of the set U . Every $F(e)$, where $e \in E$, from this family may be considered as the set of e -elements of the soft set (F, A) .

Definition 5. [34] A complex neutrosophic set A defined on a universe of discourse X , is characterized by a truth membership function $T_A(x)$, an indeterminacy membership function $I_A(x)$, and a falsity membership function $F_A(x)$ that assigns a complex-valued grade for each of these membership function in A for any $x \in X$. The values of $T_A(x), I_A(x)$ and $F_A(x)$, and their sum may assume any values within a unit circle in the complex plane, and is of the form $T_A(x) = p_A(x)e^{i\mu_A(x)}, I_A(x) = q_A(x)e^{i\nu_A(x)}$, and $F_A(x) = r_A(x)e^{i\omega_A(x)}$. All the amplitude and phase terms are real-valued and $p_A(x), q_A(x), r_A(x) \in [0, 1]$, whereas $\mu_A(x), \nu_A(x), \omega_A(x) \in (0, 2\pi]$, such that the condition

$$0 \leq p_A(x) + q_A(x) + r_A(x) \leq 3 \quad (3)$$

is satisfied. A complex neutrosophic set A can thus be represented in set form as:

$$A = \{ \langle x, T_A(x) = a_T, I_A(x) = a_I, F_A(x) = a_F \rangle : x \in X \},$$

where $T_A: X \rightarrow \{a_T: a_T \in \mathbb{C}, |a_T| \leq 1\}$, $I_A: X \rightarrow \{a_I: a_I \in \mathbb{C}, |a_I| \leq 1\}$, $F_A: X \rightarrow \{a_F: a_F \in \mathbb{C}, |a_F| \leq 1\}$, and also $|T_A(x) + I_A(x) + F_A(x)| \leq 3$. (4)

The interval $(0, 2\pi]$ is chosen for the phase term to be in line with the original definition of a complex fuzzy set in which the amplitude terms lie in an interval of $(0, 1)$, and the phase terms lie in an interval of $(0, 2\pi]$.

Remark: In the definition above, i denotes the imaginary number $i = \sqrt{-1}$ and it is this imaginary number i that makes the CNS have complex-valued membership grades. The term $e^{i\theta}$ denotes the exponential form of a complex number and represents $e^{i\theta} = \cos \theta + i \sin \theta$.

Definition 6. [34] Let $A = \{ \langle x, T_A(x), I_A(x), F_A(x) \rangle : x \in X \}$ be a complex neutrosophic set over X . Then the complement of A , denoted by A^c , is defined as:

$$A^c = \{ \langle x, T_A^c(x), I_A^c(x), F_A^c(x) \rangle : x \in X \},$$

where $T_A^c(x) = r_A(x)e^{i(2\pi - \mu_A(x))}$, $I_A^c(x) = (1 - q_A(x))e^{i(2\pi - \nu_A(x))}$, and $F_A^c(x) = p_A(x)e^{i(2\pi - \omega_A(x))}$.

III. COMPLEX NEUTROSOPHIC SOFT SETS

In this section, we introduce the complex neutrosophic soft set (CNSS) model which is a hybrid of the CNS and soft set models. The formal definition of this model as well as some concepts related to this model are as given below:

Definition 7. Let U be universal set, E be a set of parameters under consideration, $A \subseteq E$, and ψ_A be a complex neutrosophic set over U for all $x \in U$. Then a complex neutrosophic soft set χ_A over U is defined as a mapping $\chi_A: E \rightarrow CN(U)$, where $CN(U)$ denotes the set of complex neutrosophic sets in U , and $\Psi_A(x) = \emptyset$ if $x \notin A$. Here $\Psi_A(x)$ is called a complex neutrosophic approximate function of χ_A and the values of $\Psi_A(x)$ is called the x -elements of the CNSS for all $x \in U$. Thus, χ_A can be represented by the set of ordered pairs of the following form:

$$\chi_A = \{(x, \Psi_A(x)) : x \in E, \Psi_A(x) \in CN(U)\},$$

where $\Psi_A(x) = (p_A(x)e^{i\mu_A(x)}, q_A(x)e^{i\nu_A(x)}, r_A(x)e^{i\omega_A(x)})$, p_A, q_A, r_A are real-valued and lie in $[0,1]$, and $\mu_A, \nu_A, \omega_A \in (0, 2\pi]$. This is done to ensure that the definition of the CNSS model is line with the original structure of the complex fuzzy set, on which the CNSS model is based on.

Example 1. Let U be a set of developing countries in the Southeast Asian (SEA) region, that are under consideration, E be a set of parameters that describe a country's economic indicators, and $A = \{e_1, e_2, e_3, e_4\} \subseteq E$, where these sets are as defined below:

$$U = \{u_1 = \text{Republic of Philippines}, u_2 = \text{Vietnam}, u_3 = \text{Myanmar}, u_4 = \text{Indonesia}\},$$

$$E = \{e_1 = \text{inflation rate}, e_2 = \text{population growth}, e_3 = \text{GDP growth rate}, e_4 = \text{unemployment rate}, e_5 = \text{export volume}\}.$$

The CNS $\Psi_A(e_1), \Psi_A(e_2), \Psi_A(e_3)$ and $\Psi_A(e_4)$ are defined as:

$$\Psi_A(e_1) = \left\{ \begin{array}{l} \left(\frac{(0.6e^{j0.8\pi}, 0.3e^{j\frac{3\pi}{4}}, 0.5e^{j0.3\pi})}{u_1}, \frac{(0.7e^{j0\pi}, 0.2e^{j0.9\pi}, 0.1e^{j\frac{2\pi}{3}})}{u_2} \right), \\ \left(\frac{(0.9e^{j0.1\pi}, 0.4e^{j\pi}, 0.7e^{j0.7\pi})}{u_3}, \frac{(0.3e^{j0.4\pi}, 0.2e^{j0.6\pi}, 0.7e^{j0.5\pi})}{u_4} \right) \end{array} \right\},$$

$$\Psi_A(e_2) = \left\{ \begin{array}{l} \left(\frac{(0.2e^{j0.2\pi}, 0.5e^{j\frac{3\pi}{4}}, 0.6e^{j0.3\pi})}{u_1}, \frac{(0.4e^{j0.3\pi}, 0.4e^{j0.4\pi}, 0.2e^{j\frac{2\pi}{3}})}{u_2} \right), \\ \left(\frac{(0.3e^{j0.1\pi}, 0.2e^{j0.1\pi}, 0.3e^{j0.7\pi})}{u_3}, \frac{(0.1e^{j0.4\pi}, 0.5e^{j1.2\pi}, 0.3e^{j0.1\pi})}{u_4} \right) \end{array} \right\},$$

$$\Psi_A(e_3) = \left\{ \begin{array}{l} \left(\frac{(0.4e^{j0.4\pi}, 0.1e^{j\frac{\pi}{4}}, 0.2e^{j0.1\pi})}{u_1}, \frac{(0.3e^{j0.2\pi}, 0.3e^{j0.4\pi}, 0.2e^{j\frac{\pi}{3}})}{u_2} \right), \\ \left(\frac{(0.2e^{j0.1\pi}, 0.4e^{j0.5\pi}, 0.5e^{j0.2\pi})}{u_3}, \frac{(0.5e^{j0.2\pi}, 0.4e^{j2\pi}, 0.6e^{j0.1\pi})}{u_4} \right) \end{array} \right\},$$

and

$$\Psi_A(e_4) = \left\{ \begin{array}{l} \left(\frac{(0.3e^{j0.2\pi}, 0.5e^{j\frac{\pi}{4}}, 0.5e^{j0.1\pi})}{u_1}, \frac{(0.1e^{j0\pi}, 0.6e^{j0.4\pi}, 0.4e^{j\frac{\pi}{3}})}{u_2} \right), \\ \left(\frac{(0.1e^{j0.1\pi}, 0.2e^{j0.2\pi}, 0.4e^{j0.2\pi})}{u_3}, \frac{(0.2e^{j0.2\pi}, 0.5e^{j0.3\pi}, 0.3e^{j0.1\pi})}{u_4} \right) \end{array} \right\}.$$

Then the complex neutrosophic soft set χ_A can be written as a collection of CNSs of the form:

$$\chi_A = \{\Psi_A(e_1), \Psi_A(e_2), \Psi_A(e_3), \Psi_A(e_4)\}.$$

Definition 8. Let χ_A and χ_B be two CNSSs over a universe U . Then we have the following:

- (i) χ_A is said to be an empty CNSS, denoted by $\chi_{A\emptyset}$, if $\Psi_A(x) = \emptyset$, for all $x \in U$;
- (ii) χ_A is said to be an absolute CNSS, denoted by χ_{AU} , if $\Psi_A(x) = U$ for all $x \in U$;
- (iii) χ_A is said to be a CNS-subset of χ_B , denoted by $\chi_A \subseteq \chi_B$, if for all $x \in U$, $\Psi_A(x) \subseteq \Psi_B(x)$, that is the following conditions are satisfied:

$$p_A(x) \leq p_B(x), q_A(x) \leq q_B(x), r_A(x) \leq r_B(x),$$

$$\text{and } \mu_A(x) \leq \mu_B(x), \nu_A(x) \leq \nu_B(x), \omega_A(x) \leq \omega_B(x).$$

- (iv) χ_A is said to be equal to χ_B , denoted by $\chi_A = \chi_B$, if for all $x \in U$ the following conditions are satisfied:

$$p_A(x) = p_B(x), q_A(x) = q_B(x), r_A(x) = r_B(x),$$

$$\text{and } \mu_A(x) = \mu_B(x), \nu_A(x) = \nu_B(x), \omega_A(x) = \omega_B(x).$$

Proposition 1. Let $\chi_A \in CN(U)$. Then the following hold:

- (i) $(\chi_A^c)^c = \chi_A$;
- (ii) $\chi_{A\emptyset}^c = \chi_{AU}$.

Proof. The proofs are straightforward from Definition 8.

IV. OPERATIONS ON COMPLEX NEUTROSOPHIC SOFT SETS

In this section we define the basic set theoretic operations on CNSSs, namely the complement, union and intersection.

Let χ_A and χ_B be two CNSSs over a universe U .

Definition 9. The complement of χ_A , denoted by χ_A^c , is a CNSS defined by $\chi_A^c = \{(x, \psi_A^c(x)) : x \in U\}$, where $\psi_A^c(x)$ is the complex neutrosophic complement of ψ_A .

Example 2. Consider Example 1. The complement of χ_A is given by $\chi_A^c = \{\psi_A^c(e_1), \psi_A^c(e_2), \psi_A^c(e_3), \psi_A^c(e_4)\}$. For the sake of brevity, we only give the complement for $\psi_A^c(e_1)$ below:

$$\psi_A^c(e_1) = \left\{ \frac{\left(0.5e^{j1.2\pi}, 0.7e^{j\frac{5\pi}{4}}, 0.6e^{j1.7\pi}\right)}{u_1}, \frac{\left(0.1e^{j2\pi}, 0.8e^{j1.1\pi}, 0.7e^{j\frac{4\pi}{3}}\right)}{u_2}, \frac{\left(0.7e^{j1.9\pi}, 0.6e^{j\pi}, 0.9e^{j1.3\pi}\right)}{u_3}, \frac{\left(0.7e^{j1.6\pi}, 0.8e^{j1.4\pi}, 0.3e^{j1.5\pi}\right)}{u_4} \right\}.$$

The complements for the rest of the CNSs can be found in a similar manner.

Definition 10. The union of χ_A and χ_B , denoted by $\chi_A \tilde{\cup} \chi_B$, is defined as:

$$\chi_C = \chi_A \tilde{\cup} \chi_B = \{(x, \psi_A(x) \tilde{\cup} \psi_B(x)) : x \in U\},$$

$$\chi_C(e) = \begin{cases} (x, \psi_A(x)) & \text{if } e \in A - B, \\ (x, \psi_B(x)) & \text{if } e \in B - A, \\ (x, \psi_A(x) \tilde{\cup} \psi_B(x)) & \text{if } e \in A \cap B, \end{cases}$$

where $C = A \cup B, x \in U$, and

$$\psi_A(x) \tilde{\cup} \psi_B(x) = \begin{cases} (p_A(x) \vee p_B(x))e^{i(\mu_A(x) \cup \mu_B(x))} \\ (q_A(x) \wedge q_B(x))e^{i(\nu_A(x) \cup \nu_B(x))} \\ (r_A(x) \wedge r_B(x))e^{i(\omega_A(x) \cup \omega_B(x))} \end{cases}$$

where \vee and \wedge denote the maximum and minimum operators respectively, whereas the phase terms of the truth, indeterminacy and falsity functions lie in the interval $(0, 2\pi]$, and can be calculated using any one of the following operators:

- (i) Sum: $\mu_{A \cup B}(x) = \mu_A(x) + \mu_B(x), \nu_{A \cup B}(x) = \nu_A(x) + \nu_B(x),$
and $\omega_{A \cup B}(x) = \omega_A(x) + \omega_B(x).$
- (ii) Max: $\mu_{A \cup B}(x) = \max(\mu_A(x), \mu_B(x)), \nu_{A \cup B}(x) = \max(\nu_A(x), \nu_B(x)),$
and $\omega_{A \cup B}(x) = \max(\omega_A(x), \omega_B(x)).$
- (iii) Min: $\mu_{A \cap B}(x) = \min(\mu_A(x), \mu_B(x)), \nu_{A \cap B}(x) = \min(\nu_A(x), \nu_B(x)),$
and $\omega_{A \cap B}(x) = \min(\omega_A(x), \omega_B(x)).$
- (iv) "The game of winner, neutral, and loser":

$$\mu_{A \cup B}(x) = \begin{cases} \mu_A(x) & \text{if } p_A(x) > p_B(x) \\ \mu_B(x) & \text{if } p_B(x) > p_A(x) \end{cases}$$

$$\nu_{A \cup B}(x) = \begin{cases} \nu_A(x) & \text{if } q_A(x) < q_B(x) \\ \nu_B(x) & \text{if } q_B(x) < q_A(x) \end{cases} \text{ and}$$

$$\omega_{A \cup B}(x) = \begin{cases} \omega_A(x) & \text{if } r_A(x) < r_B(x) \\ \omega_B(x) & \text{if } r_B(x) < r_A(x) \end{cases}.$$

All of the operators presented above are straightforward generalizations of the corresponding operators that were originally defined in [28]. The intersection between CNSs are defined in a similar manner in Definition 11.

Definition 11. The intersection of χ_A and χ_B , denoted by $\chi_A \tilde{\cap} \chi_B$, is defined as:

$$\chi_D = \chi_A \tilde{\cap} \chi_B = \{(x, \psi_A(x) \tilde{\cap} \psi_B(x)) : x \in U\},$$

$$\chi_D(e) = \begin{cases} (x, \psi_A(x)) & \text{if } e \in A - B, \\ (x, \psi_B(x)) & \text{if } e \in B - A, \\ (x, \psi_A(x) \tilde{\cap} \psi_B(x)) & \text{if } e \in A \cap B, \end{cases}$$

where $D = A \cup B, x \in U$, and

$$\psi_A(x) \tilde{\cap} \psi_B(x) = \begin{cases} (p_A(x) \wedge p_B(x))e^{i(\mu_A(x) \cup \mu_B(x))} \\ (q_A(x) \vee q_B(x))e^{i(\nu_A(x) \cup \nu_B(x))} \\ (r_A(x) \vee r_B(x))e^{i(\omega_A(x) \cup \omega_B(x))} \end{cases}$$

where \vee and \wedge denote the maximum and minimum operators respectively, whereas the phase terms of the truth, indeterminacy and falsity functions lie in the interval $(0, 2\pi]$, and can be calculated using any one of the following operators that were defined in Definition 10.

V. APPLICATION OF THE CNSS MODEL IN A DECISION MAKING PROBLEM

In Example 1, we presented an example related to the economic indicators of four countries. In this section, we use the same information to determine which one of the four countries that are studied has the strongest economic indicators. To achieve this, a modified algorithm and an accompanying score function is presented in Definition 12 and 13. This algorithm and score function are an adaptation of the corresponding concepts introduced in [35], which was then made compatible with the structure of the CNSS model. The steps involved in the decision making process, in the context of this example, until a final decision is reached, is as given below.

Definition 12. A comparison matrix is a matrix whose rows consists of the elements of the universal set $U = \{u_1, u_2, \dots, u_m\}$, whereas the columns consists of the corresponding parameters $E = \{e_1, e_2, \dots, e_n\}$ that are being considered in the problem. The entries of this matrix are c_{ij} , such that

$$c_{ij} = (\alpha_{amp} + \beta_{amp} - \gamma_{amp}) + (\alpha_{phase} + \beta_{phase} - \gamma_{phase}),$$

where the components of this formula are as defined below for all $b_k \in U$, such that $b_i \neq b_k$:

$$\alpha_{amp} = \text{the number of times the value of the amplitude term of } T_{b_i}(e_j) \geq T_{b_k}(e_j),$$

$$\beta_{amp} = \text{the number of times the value of the amplitude term of } I_{b_i}(e_j) \geq I_{b_k}(e_j),$$

$$\gamma_{amp} = \text{the number of times the value of the amplitude term of } F_{b_i}(e_j) \geq F_{b_k}(e_j),$$

and

α_{phase} = the number of times the value of the phase term of $T_{b_i}(e_j) \geq T_{b_k}(e_j)$,
 β_{phase} = the number of times the value of the phase term of $I_{b_i}(e_j) \geq I_{b_k}(e_j)$,
 γ_{phase} = the number of times the value of the phase term of $F_{b_i}(e_j) \geq F_{b_k}(e_j)$.

Definition 13. The score of an element u_i can be calculated by the score function S_i which is defined as $S_i = \sum_j c_{ij}$.

Next, we apply the algorithm and score function in a decision making problem. The steps are as given below:

Step 1: Define a CNSS

Construct a CNSS for the problem that is being studied, which includes the elements $u_i (i = 1, 2, \dots, m)$, and the set of parameters $e_j (j = 1, 2, \dots, n)$, that are being considered.

In the context of this example, the universal set U , set of parameters A , and the CNSS χ_A that were defined in Example 1 will be used.

Step 2: Construct and compute the comparison matrix

A comparison matrix is constructed, and the values of c_{ij} for each element u_i and the corresponding parameter e_j is calculated using the formula given in Definition 12. For this example, the comparison matrix is given in Table 1.

Table 1. Comparison matrix for χ_A

U	e_1	e_2	e_3	e_4
u_1	6	3	3	5
u_2	3	5	1	2
u_3	4	-3	1	-1
u_4	-1	7	5	8

Remark: In this example, the phase terms denotes the time taken for any change in the economic indicators to affect the performance of the economy. The magnitude of these phase terms would indicate the economic sectors that has the most influence on the economy and by extension, the sectors that the economy is dependent on. Therefore, the closer the phase term is to 0, the smaller it is, whereas the closer the phase term is to 2π , the larger it is. For example, phase terms of $\frac{3\pi}{4}$ is larger than the phase terms of $\frac{\pi}{3}$ and $\frac{\pi}{2}$. As such, the values of $\alpha_{phase}, \beta_{phase}$ and γ_{phase} was by

computing the number of times the value of the phase term of element b_{ij} exceeds the value of the phase term of element b_{kj} .

Step 3: Calculate the score function

Compute the scores S_i for each element $u_i (i = 1, 2, \dots, m)$ using Definition 13. The score values obtained are given in Table 2.

Table 2. Score function for χ_A

U	S_i
u_1	17
u_2	11
u_3	1
u_4	19

Step 4: Conclusion and discussion

The values of the score function are compared and the element with the maximum score will be chosen as the optimal alternative. In the event that there are more than one element with the maximum score, any of the elements may be chosen as the optimal alternative.

In the context of this example, $\max_{u_i \in U} \{S_i\} = u_4$. As such, it can be concluded that country u_4 i.e. Indonesia is the country with the strongest economic indicators, followed closely by the Republic of Phillipines and Vietnam, whereas Myanmar is identified as the country with the weakest and slowest growing economy, among the four South East Asian countries that were considered.

VI. CONCLUSION

In this paper, we introduced the complex neutrosophic soft set model which is a hybrid between the complex neutrosophic set and soft set models. This model has a more generalized framework than the fuzzy soft set, neutrosophic set, complex fuzzy set models and their respective generalizations. The basic set theoretic operations were defined. The CNSS model was then applied in a decision making problem involving to demonstrate its utility in representing the uncertainty and indeterminacy that exists when dealing with uncertain and subjective data.

REFERENCES

[1] F. Smarandache, "Neutrosophic set - a generalization of the intuitionistic fuzzy set," Granular Computing, 2006 IEEE International Conference, pp. 38 – 42, 2006.
 [2] F. Smarandache, "A geometric interpretation of the neutrosophic set — A generalization of the intuitionistic fuzzy set," Granular Computing (GrC), 2011 IEEE International Conference, pp.602– 606, 2011.
 [3] L. Zadeh, Fuzzy sets. Inform and Control, 8, pp.338-353, 1965.
 [4] K. Atanassov, "Intuitionistic fuzzy sets," Fuzzy Sets and Systems, vol. 20, pp. 87-96, 1986.
 [5] K. Atanassov, "Intuitionistic fuzzy sets: theory and applications," Physica, New York, 1999.
 [6] I. Turksen, "Interval valued fuzzy sets based on normal forms," Fuzzy Sets

and Systems, vol. 20, pp. 191-210, 1986.

- [7] K. Atanassov and G. Gargov, Interval valued intuitionistic fuzzy sets. *Fuzzy Sets and Systems*, vol.31, pp.343-349, 1989.
- [8] H. Wang, F. Smarandache, Y. Zhang, and R. Sunderraman, "Single valued Neutrosophic Sets," *Multispace and Multistructure* 4, pp. 410-413, 2010.
- [9] A. Q. Ansari, R. Biswas & S. Aggarwal, "Extension to fuzzy logic representation: Moving towards neutrosophic logic - A new laboratory rat," *Fuzzy Systems (FUZZ)*, 2013 IEEE International Conference, pp.1 -8, 2013.
- [10] D. Molodtsov, "Soft set theory—first results," *Computers & Mathematics with Applications*, vol. 37, no. 4-5, pp. 19–31, 1999.
- [11] G. Garg, K. Bhutani, M. Kumar and S. Aggarwal, "Hybrid model for medical diagnosis using Neutrosophic Cognitive Maps with Genetic Algorithms," *FUZZ-IEEE*, 2015, 6pages, 2015.
- [12] H. Wang, Y. Zhang, R. Sunderraman, "Truth-value based interval neutrosophic sets," *Granular Computing*, 2005 IEEE International Conference, vol. 1, pp. 274 – 277, 2005.
- [13] I. Deli, M. Ali, F. Smarandache, "Bipolar neutrosophic sets and their application based on multi-criteria decision making problems," *Advanced Mechatronic Systems (ICAMechS)*, 2015 International Conference, pp.249 – 254, 2015.
- [14] I. Deli, S. Yusuf, F. Smarandache and M. Ali, Interval valued bipolar neutrosophic sets and their application in pattern recognition, *IEEE World Congress on Computational Intelligence* 2016.
- [15] J. Ye, "Vector similarity measures of simplified neutrosophic sets and their application in multicriteria decision making," *International Journal of Fuzzy Systems*, vol. 16, no. 2, pp.204-211, 2014.
- [16] M. Ali, I. Deli, F. Smarandache, "The Theory of Neutrosophic Cubic Sets and Their Applications in Pattern Recognition," *Journal of Intelligent and Fuzzy Systems*, (In press), pp. 1-7, 2017.
- [17] P. K. Maji, R. Biswas, and A. R. Roy, "Fuzzy soft sets," *Journal of Fuzzy Mathematics*, vol. 9, no. 3, pp. 589–602, 2001.
- [18] P. K. Maji, R. Biswas, and A. R. Roy, "Intuitionistic fuzzy soft sets," *The Journal of Fuzzy Mathematics*, vol. 9, no. 3, pp. 677–692, 2001.
- [19] S. Broumi, M. Talea, A. Bakali, F. Smarandache, "Single Valued Neutrosophic Graphs," *Journal of New Theory*, vol. 10, pp. 86-101, 2016.
- [20] S. Broumi, M. Talea, A. Bakali, F. Smarandache, "On Bipolar Single Valued Neutrosophic Graphs," *Journal of New Theory*, vol. 11, pp.84-102, 2016.
- [21] S. Broumi, A. Bakali, M. Talea and F. Smarandache, On Strong Interval Valued Neutrosophic Graphs, *Critical Review*. Volume XII, 2016, pp.49-71.
- [22] S. Broumi, A. Bakali, M. Talea, and F. Smarandache, Isolated Single Valued Neutrosophic Graphs. *Neutrosophic Sets and Systems*, vol. 11, pp.74-78, 2016.
- [23] S. Broumi, F. Smarandache, M. Talea and A. Bakali, An Introduction to

Bipolar Single Valued Neutrosophic Graph Theory. *Applied Mechanics and Materials*, vol.841,184-191, 2016.

- [24] S. Broumi, M. Talea, F. Smarandache and A. Bakali, "Single Valued Neutrosophic Graphs: Degree, Order and Size," *IEEE International Conference on Fuzzy Systems (FUZZ)*, 2016, pp.2444-2451.
- [25] S. Broumi, F. Smarandache, "New distance and similarity measures of interval neutrosophic sets," *Information Fusion (FUSION)*, 2014 IEEE 17th International Conference, pp. 1 – 7, 2014.
- [26] J. Ye, "Single-Valued Neutrosophic Minimum Spanning Tree and Its Clustering Method," *Journal of Intelligent Systems* vol. 23, no. 3, pp. 311–324, 2014.
- [27] A. Q. Ansari, R. Biswas & S. Aggarwal, "Neutrosophication of Fuzzy Models," *IEEE Workshop On Computational Intelligence: Theories, Applications and Future Directions* (hosted by IIT Kanpur), 14th July'13.
- [28] D. Ramot, F. Menahem, L. Gideon and K. Abraham, "Complex Fuzzy Set", *IEEE Transactions on Fuzzy Systems*, vol. 10, no. 2, 2002.
- [29] A. Alkouri and A. Salleh, "Complex intuitionistic fuzzy sets," in *Proceedings of the International Conference on Fundamental and Applied Sciences (ICFAS '12)*, vol. 1482 of AIP Conference Proceedings, pp. 464–470, 2012.
- [30] A. Alkouri and A. R. Salleh, "Complex Atanassov's Intuitionistic fuzzy relation," *Abstract and Applied Analysis*, vol. 2013, Article ID 287382, 18 pages, 2013.
- [31] G. Selvachandran, P.K Maji, I. E. Abed and A. R. Salleh, Complex vague soft sets and its distance measures, *Journal of Intelligent & Fuzzy Systems*, vol. 31, no. 1, pp. 55-68, 2016.
- [32] G. Selvachandran, P.K Maji, I. E. Abed and A. R. Salleh, Relations between complex vague soft sets, *Applied Soft Computing*, vol. 47, pp. 438-448, 2016.
- [33] T. Kumar and R. K. Bajaj, On Complex Intuitionistic Fuzzy Soft Sets with Distance Measures and Entropies, *Journal of Mathematics*, vol. 2014, 12 pages, 2014.
- [34] M. Ali, and F. Smarandache, "Complex Neutrosophic Set," *Neural Computing and Applications*, vol. 25, pp.1-18, 2016.
- [35] S. Broumi and F. Smarandache, "Intuitionistic Neutrosophic Soft Set", *Journal of Information and Computing Science*, vol. 8, no. 2, pp. 130-140, 2013.
- [36] S. Broumi, A. Bakali, M. Talea, F. Smarandache and L. Vladareanu, Computation of Shortest Path Problem in a Network with SV-Trapezoidal Neutrosophic Numbers, *Proceedings of the 2016 International Conference on Advanced Mechatronic Systems*, Melbourne, Australia, 2016, pp.417-422.
- [37] S. Broumi, A. Bakali, M. Talea, F. Smarandache and L. Vladareanu, Applying Dijkstra Algorithm for Solving Neutrosophic Shortest Path Problem, *Proceedings of the 2016 International Conference on Advanced Mechatronic Systems*, Melbourne, Australia, 2016, pp.412-416.

Interval neutrosophic sets applied to ideals in BCK/BCI-algebras

Seok-Zun Song, Madad Khan, Florentin Smarandache, Young Bae Jun

Seok-Zun Song, Madad Khan, Florentin Smarandache, Young Bae Jun (2017). Interval neutrosophic sets applied to ideals in BCK/BCI-algebras. *Neutrosophic Sets and Systems* 18, 16-26

Abstract: For $i, j, k, l, m, n \in \{1, 2, 3, 4\}$, the notion of $(T(i, j), I(k, l), F(m, n))$ -interval neutrosophic ideals in

BCK/BCI -algebras is introduced, and their properties and relations are investigated.

Keywords: interval neutrosophic set; interval neutrosophic ideal.

1 Introduction

BCK -algebras entered into mathematics in 1966 through the work of Imai and Iséki [3], and have been applied to many branches of mathematics, such as group theory, functional analysis, probability theory and topology. Such algebras generalize Boolean rings as well as Boolean D -posets (= MV -algebras). Also, Iséki introduced the notion of a BCI -algebra which is a generalization of a BCK -algebra (see [4]). The neutrosophic set developed by Smarandache [7, 8, 9] is a formal framework which generalizes the concept of the classic set, fuzzy set [14], interval valued fuzzy set, intuitionistic fuzzy set [1], interval valued intuitionistic fuzzy set and paraconsistent set etc. Neutrosophic set theory is applied to various part, including algebra, topology, control theory, decision making problems, medicines and in many real life problems. Wang et al. [11, 12, 13] presented the concept of interval neutrosophic sets, which is more precise and more flexible than the single-valued neutrosophic set. An interval-valued neutrosophic set is a generalization of the concept of single-valued neutrosophic set, in which three membership (t, i, f) functions are independent, and their values belong to the unit interval $[0, 1]$. The interval neutrosophic set can represent uncertain, imprecise, incomplete and inconsistent information which exists in real world. Jun et al. [5] discussed interval neutrosophic sets in BCK/BCI -algebras, and introduced the notion of $(T(i, j), I(k, l), F(m, n))$ -interval neutrosophic subalgebras in BCK/BCI -algebras for $i, j, k, l, m, n \in \{1, 2, 3, 4\}$. They also introduced the notion of interval neutrosophic length of an interval neutrosophic set, and investigated related properties.

In this article, we apply the notion of interval neutrosophic sets to ideal theory in BCK/BCI -algebras. We introduce the notion of $(T(i, j), I(k, l), F(m, n))$ -interval neutrosophic ideals in BCK/BCI -algebras for $i, j, k, l, m, n \in \{1, 2, 3, 4\}$, and investigate their properties and relations.

2 Preliminaries

By a BCI -algebra (see [2, 6]) we mean a system $X := (X, *, 0)$ in which the following axioms hold:

- (I) $((x * y) * (x * z)) * (z * y) = 0$,
- (II) $(x * (x * y)) * y = 0$,
- (III) $x * x = 0$,
- (IV) $x * y = y * x = 0 \Rightarrow x = y$

for all $x, y, z \in X$. If a BCI -algebra X satisfies $0 * x = 0$ for all $x \in X$, then we say that X is a BCK -algebra (see [2, 6]).

A non-empty subset S of a BCK/BCI -algebra X is called a *subalgebra* (see [2, 6]) of X if $x * y \in S$ for all $x, y \in S$.

The collection of all BCK -algebras and all BCI -algebras are denoted by $\mathcal{B}_K(X)$ and $\mathcal{B}_I(X)$, respectively. Also $\mathcal{B}(X) := \mathcal{B}_K(X) \cup \mathcal{B}_I(X)$.

We refer the reader to the books [2] and [6] for further information regarding BCK/BCI -algebras.

By a *fuzzy structure* over a nonempty set X we mean an ordered pair (X, ρ) of X and a fuzzy set ρ on X .

Definition 2.1 ([10]). A fuzzy structure (X, μ) over $(X, *, 0) \in \mathcal{B}(X)$ is called a

- *fuzzy ideal* of $(X, *, 0)$ with type 1 (briefly, *1-fuzzy ideal* of $(X, *, 0)$) if

$$(\forall x \in X) (\mu(0) \geq \mu(x)), \tag{2.1}$$

$$(\forall x, y \in X) (\mu(x) \geq \min\{\mu(x * y), \mu(y)\}), \tag{2.2}$$

- *fuzzy ideal* of $(X, *, 0)$ with type 2 (briefl , *2-fuzzy ideal* of $(X, *, 0)$) if

$$(\forall x \in X) (\mu(0) \leq \mu(x)), \tag{2.3}$$

$$(\forall x, y \in X) (\mu(x) \leq \min\{\mu(x * y), \mu(y)\}), \tag{2.4}$$

- *fuzzy ideal* of $(X, *, 0)$ with type 3 (briefl , *3-fuzzy ideal* of $(X, *, 0)$) if it satisfie (2.1) and

$$(\forall x, y \in X) (\mu(x) \geq \max\{\mu(x * y), \mu(y)\}), \tag{2.5}$$

- *fuzzy ideal* of $(X, *, 0)$ with type 4 (briefl , *4-fuzzy ideal* of $(X, *, 0)$) if it satisfie (2.3) and

$$(\forall x, y \in X) (\mu(x) \leq \max\{\mu(x * y), \mu(y)\}). \tag{2.6}$$

Let X be a non-empty set. A neutrosophic set (NS) in X (see [8]) is a structure of the form:

$$A := \{ \langle x; A_T(x), A_I(x), A_F(x) \rangle \mid x \in X \}$$

where $A_T : X \rightarrow [0, 1]$ is a truth membership function, $A_I : X \rightarrow [0, 1]$ is an indeterminate membership function, and $A_F : X \rightarrow [0, 1]$ is a false membership function.

An interval neutrosophic set (INS) A in X is characterized by truth-membership function T_A , indeterminacy membership function I_A and falsity-membership function F_A . For each point x in X , $T_A(x), I_A(x), F_A(x) \in [0, 1]$ (see [12, 13]).

In what follows, let $(X, *, 0) \in \mathcal{B}(X)$ and $\mathcal{P}^*([0, 1])$ be the family of all subintervals of $[0, 1]$ unless otherwise specifie .

Definition 2.2 ([12, 13]). An *interval neutrosophic set* in a nonempty set X is a structure of the form:

$$\mathcal{I} := \{ \langle x, \mathcal{I}[T](x), \mathcal{I}[I](x), \mathcal{I}[F](x) \rangle \mid x \in X \}$$

where

$$\mathcal{I}[T] : X \rightarrow \mathcal{P}^*([0, 1])$$

which is called *interval truth-membership function*,

$$\mathcal{I}[I] : X \rightarrow \mathcal{P}^*([0, 1])$$

which is called *interval indeterminacy-membership function*, and

$$\mathcal{I}[F] : X \rightarrow \mathcal{P}^*([0, 1])$$

which is called *interval falsity-membership function*.

For the sake of simplicity, we will use the notation $\mathcal{I} := (\mathcal{I}[T], \mathcal{I}[I], \mathcal{I}[F])$ for the interval neutrosophic set

$$\mathcal{I} := \{ \langle x, \mathcal{I}[T](x), \mathcal{I}[I](x), \mathcal{I}[F](x) \rangle \mid x \in X \}.$$

Given an interval neutrosophic set $\mathcal{I} := (\mathcal{I}[T], \mathcal{I}[I], \mathcal{I}[F])$ in X , we consider the following functions (see [5]):

$$\mathcal{I}[T]_{\text{inf}} : X \rightarrow [0, 1], x \mapsto \inf\{\mathcal{I}[T](x)\}$$

$$\mathcal{I}[I]_{\text{inf}} : X \rightarrow [0, 1], x \mapsto \inf\{\mathcal{I}[I](x)\}$$

$$\mathcal{I}[F]_{\text{inf}} : X \rightarrow [0, 1], x \mapsto \inf\{\mathcal{I}[F](x)\}$$

and

$$\mathcal{I}[T]_{\text{sup}} : X \rightarrow [0, 1], x \mapsto \sup\{\mathcal{I}[T](x)\}$$

$$\mathcal{I}[I]_{\text{sup}} : X \rightarrow [0, 1], x \mapsto \sup\{\mathcal{I}[I](x)\}$$

$$\mathcal{I}[F]_{\text{sup}} : X \rightarrow [0, 1], x \mapsto \sup\{\mathcal{I}[F](x)\}.$$

3 Interval neutrosophic ideals

Definition 3.1. For any $i, j, k, l, m, n \in \{ 1, 2, 3, 4 \}$, an interval neutrosophic set $\mathcal{I} := (\mathcal{I}[T], \mathcal{I}[I], \mathcal{I}[F])$ in X is called a $(T(i, j), I(k, l), F(m, n))$ -*interval neutrosophic ideal* of X if the following assertions are valid.

- (1) $(X, \mathcal{I}[T]_{\text{inf}})$ is an i -fuzzy ideal of $(X, *, 0)$ and $(X, \mathcal{I}[T]_{\text{sup}})$ is a j -fuzzy ideal of $(X, *, 0)$,
- (2) $(X, \mathcal{I}[I]_{\text{inf}})$ is a k -fuzzy ideal of $(X, *, 0)$ and $(X, \mathcal{I}[I]_{\text{sup}})$ is an l -fuzzy ideal of $(X, *, 0)$,
- (3) $(X, \mathcal{I}[F]_{\text{inf}})$ is an m -fuzzy ideal of $(X, *, 0)$ and $(X, \mathcal{I}[F]_{\text{sup}})$ is an n -fuzzy ideal of $(X, *, 0)$.

Example 3.2. Consider a BCK -algebra $X = \{0, 1, 2, 3\}$ with the binary operation $*$ which is given in Table 1 (see [6]).

Table 1: Cayley table for the binary operation “ $*$ ”

$*$	0	1	2	3
0	0	0	0	0
1	1	0	0	1
2	2	2	0	2
3	3	3	3	0

(1) Let $\mathcal{I} := (\mathcal{I}[T], \mathcal{I}[I], \mathcal{I}[F])$ be an interval neutrosophic set in $(X, *, 0)$ for which $\mathcal{I}[T], \mathcal{I}[I]$ and $\mathcal{I}[F]$ are given as follows:

$$\mathcal{I}[T] : X \rightarrow \mathcal{P}^*([0, 1]) \quad x \mapsto \begin{cases} [0.4, 0.6] & \text{if } x = 0, \\ [0.3, 0.6] & \text{if } x = 1, \\ [0.2, 0.7] & \text{if } x = 2, \\ [0.1, 0.8] & \text{if } x = 3, \end{cases}$$

$$\mathcal{I}[I] : X \rightarrow \mathcal{P}^*([0, 1]) \quad x \mapsto \begin{cases} [0.5, 0.6] & \text{if } x = 0, \\ [0.4, 0.6] & \text{if } x = 1, \\ [0.2, 0.9] & \text{if } x = 2, \\ [0.5, 0.7] & \text{if } x = 3, \end{cases}$$

and

$$\mathcal{I}[F] : X \rightarrow \mathcal{P}^*([0, 1]) \quad x \mapsto \begin{cases} [0.4, 0.5] & \text{if } x = 0, \\ [0.3, 0.5] & \text{if } x = 1, \\ [0.1, 0.7] & \text{if } x = 2, \\ [0.2, 0.8] & \text{if } x = 3. \end{cases}$$

$$\mathcal{I}[I] : X \rightarrow \mathcal{P}^*([0, 1]) \quad x \mapsto \begin{cases} [0.22, 0.65] & \text{if } x = 0, \\ [0.52, 0.55] & \text{if } x = a, \\ [0.62, 0.65] & \text{if } x = b, \\ [0.62, 0.55] & \text{if } x = c, \end{cases}$$

and

It is routine to verify that $\mathcal{I} := (\mathcal{I}[T], \mathcal{I}[I], \mathcal{I}[F])$ is a $(T(1, 4), I(1, 4), F(1, 4))$ -interval neutrosophic ideal of $(X, *, 0)$.

(2) Let $\mathcal{I} := (\mathcal{I}[T], \mathcal{I}[I], \mathcal{I}[F])$ be an interval neutrosophic set in $(X, *, 0)$ for which $\mathcal{I}[T], \mathcal{I}[I]$ and $\mathcal{I}[F]$ are given as follows:

$$\mathcal{I}[T] : X \rightarrow \mathcal{P}^*([0, 1]) \quad x \mapsto \begin{cases} [0.1, 0.4] & \text{if } x = 0, \\ [0.2, 0.7] & \text{if } x = 1, \\ [0.3, 0.8] & \text{if } x = 2, \\ [0.4, 0.6] & \text{if } x = 3, \end{cases}$$

$$\mathcal{I}[I] : X \rightarrow \mathcal{P}^*([0, 1]) \quad x \mapsto \begin{cases} [0.2, 0.5] & \text{if } x = 0, \\ [0.5, 0.6] & \text{if } x = 1, \\ [0.6, 0.7] & \text{if } x = 2, \\ [0.3, 0.8] & \text{if } x = 3, \end{cases}$$

and

$$\mathcal{I}[F] : X \rightarrow \mathcal{P}^*([0, 1]) \quad x \mapsto \begin{cases} [0.3, 0.4] & \text{if } x = 0, \\ [0.4, 0.7] & \text{if } x = 1, \\ [0.6, 0.8] & \text{if } x = 2, \\ [0.4, 0.6] & \text{if } x = 3. \end{cases}$$

By routine calculations, we know that $\mathcal{I} := (\mathcal{I}[T], \mathcal{I}[I], \mathcal{I}[F])$ is a $(T(4, 4), I(4, 4), F(4, 4))$ -interval neutrosophic ideal of $(X, *, 0)$.

Example 3.3. Consider a *BCI*-algebra $X = \{0, a, b, c\}$ with the binary operation $*$ which is given in Table 2 (see [6]).

Table 2: Cayley table for the binary operation “ $*$ ”

$*$	0	a	b	c
0	0	a	b	c
a	a	0	c	b
b	b	c	0	a
c	c	b	a	0

Let $\mathcal{I} := (\mathcal{I}[T], \mathcal{I}[I], \mathcal{I}[F])$ be an interval neutrosophic set in $(X, *, 0)$ where $\mathcal{I}[T], \mathcal{I}[I]$ and $\mathcal{I}[F]$ are given as follows:

$$\mathcal{I}[T] : X \rightarrow \mathcal{P}^*([0, 1]) \quad x \mapsto \begin{cases} [0.33, 0.91] & \text{if } x = 0, \\ [0.72, 0.91] & \text{if } x = a, \\ [0.72, 0.82] & \text{if } x = b, \\ [0.55, 0.82] & \text{if } x = c, \end{cases}$$

$$\mathcal{I}[F] : X \rightarrow \mathcal{P}^*([0, 1]) \quad x \mapsto \begin{cases} (0.25, 0.63) & \text{if } x = 0, \\ [0.45, 0.63] & \text{if } x = a, \\ (0.35, 0.53] & \text{if } x = b, \\ [0.45, 0.53] & \text{if } x = c. \end{cases}$$

Routine calculations show that $\mathcal{I} := (\mathcal{I}[T], \mathcal{I}[I], \mathcal{I}[F])$ is a $(T(4, 1), I(4, 1), F(4, 1))$ -interval neutrosophic ideal of $(X, *, 0)$. But it is not a $(T(2, 1), I(2, 1), F(2, 1))$ -interval neutrosophic ideal of $(X, *, 0)$ since

$$\mathcal{I}[T]_{\text{inf}}(a) = 0.72 > 0.55 = \min\{\mathcal{I}[T]_{\text{inf}}(a * b), \mathcal{I}[T]_{\text{inf}}(b)\},$$

$$\mathcal{I}[I]_{\text{inf}}(b) = 0.62 > 0.52 = \min\{\mathcal{I}[I]_{\text{inf}}(b * c), \mathcal{I}[I]_{\text{inf}}(c)\},$$

and/or

$$\mathcal{I}[F]_{\text{inf}}(c) = 0.45 > 0.35 = \min\{\mathcal{I}[F]_{\text{inf}}(c * a), \mathcal{I}[F]_{\text{inf}}(a)\}.$$

Also, it is not a $(T(4, 3), I(4, 3), F(4, 3))$ -interval neutrosophic ideal of $(X, *, 0)$ since

$$\mathcal{I}[T]_{\text{sup}}(c) = 0.82 < 0.91 = \max\{\mathcal{I}[T]_{\text{inf}}(c * b), \mathcal{I}[T]_{\text{inf}}(b)\}$$

and/or

$$\mathcal{I}[F]_{\text{sup}}(b) = 0.35 < 0.62 = \max\{\mathcal{I}[F]_{\text{inf}}(b * a), \mathcal{I}[F]_{\text{inf}}(a)\}.$$

We also know that $\mathcal{I} := (\mathcal{I}[T], \mathcal{I}[I], \mathcal{I}[F])$ is not a $(T(2, 3), I(2, 3), F(2, 3))$ -interval neutrosophic ideal of $(X, *, 0)$.

Let $\mathcal{I} := (\mathcal{I}[T], \mathcal{I}[I], \mathcal{I}[F])$ be an interval neutrosophic set in X . We consider the following sets (see [5]):

$$U(\mathcal{I}[T]_{\psi}; \alpha_I) := \{x \in X \mid \mathcal{I}[T]_{\psi}(x) \geq \alpha_I\},$$

$$L(\mathcal{I}[T]_{\psi}; \alpha_S) := \{x \in X \mid \mathcal{I}[T]_{\psi}(x) \leq \alpha_S\},$$

$$U(\mathcal{I}[I]_{\psi}; \beta_I) := \{x \in X \mid \mathcal{I}[I]_{\psi}(x) \geq \beta_I\},$$

$$L(\mathcal{I}[I]_{\psi}; \beta_S) := \{x \in X \mid \mathcal{I}[I]_{\psi}(x) \leq \beta_S\},$$

and

$$U(\mathcal{I}[F]_{\psi}; \gamma_I) := \{x \in X \mid \mathcal{I}[F]_{\psi}(x) \geq \gamma_I\},$$

$$L(\mathcal{I}[F]_{\psi}; \gamma_S) := \{x \in X \mid \mathcal{I}[F]_{\psi}(x) \leq \gamma_S\},$$

where $\psi \in \{\text{inf}, \text{sup}\}$, and $\alpha_I, \alpha_S, \beta_I, \beta_S, \gamma_I$ and γ_S are numbers in $[0, 1]$.

Theorem 3.4. Given an interval neutrosophic set $\mathcal{I} := (\mathcal{I}[T], \mathcal{I}[I], \mathcal{I}[F])$ in $(X, *, 0)$, we have the following assertions:

- (1) If $\mathcal{I} := (\mathcal{I}[T], \mathcal{I}[I], \mathcal{I}[F])$ is a $(T(1, 4), I(1, 4), F(1, 4))$ -interval neutrosophic ideal of $(X, *, 0)$, then $U(\mathcal{I}[T]_{\text{inf}}; \alpha_I)$, $L(\mathcal{I}[T]_{\text{sup}}; \alpha_S)$, $U(\mathcal{I}[I]_{\text{inf}}; \beta_I)$, $L(\mathcal{I}[I]_{\text{sup}}; \beta_S)$, $U(\mathcal{I}[F]_{\text{inf}}; \gamma_I)$ and $L(\mathcal{I}[F]_{\text{sup}}; \gamma_S)$ are either empty or ideals of $(X, *, 0)$ for all $\alpha_I, \alpha_S, \beta_I, \beta_S, \gamma_I, \gamma_S \in [0, 1]$.
- (2) If $\mathcal{I} := (\mathcal{I}[T], \mathcal{I}[I], \mathcal{I}[F])$ is a $(T(4, 1), I(4, 1), F(4, 1))$ -interval neutrosophic ideal of $(X, *, 0)$, then $L(\mathcal{I}[T]_{\text{inf}}; \alpha_I)$, $U(\mathcal{I}[T]_{\text{sup}}; \alpha_S)$, $L(\mathcal{I}[I]_{\text{inf}}; \beta_I)$, $U(\mathcal{I}[I]_{\text{sup}}; \beta_S)$, $L(\mathcal{I}[F]_{\text{inf}}; \gamma_I)$ and $U(\mathcal{I}[F]_{\text{sup}}; \gamma_S)$ are either empty or ideals of $(X, *, 0)$ for all $\alpha_I, \alpha_S, \beta_I, \beta_S, \gamma_I, \gamma_S \in [0, 1]$.
- (3) If $\mathcal{I} := (\mathcal{I}[T], \mathcal{I}[I], \mathcal{I}[F])$ is a $(T(1, 1), I(1, 1), F(1, 1))$ -interval neutrosophic ideal of $(X, *, 0)$, then $U(\mathcal{I}[T]_{\text{inf}}; \alpha_I)$, $U(\mathcal{I}[T]_{\text{sup}}; \alpha_S)$, $U(\mathcal{I}[I]_{\text{inf}}; \beta_I)$, $U(\mathcal{I}[I]_{\text{sup}}; \beta_S)$, $U(\mathcal{I}[F]_{\text{inf}}; \gamma_I)$ and $U(\mathcal{I}[F]_{\text{sup}}; \gamma_S)$ are either empty or ideals of $(X, *, 0)$ for all $\alpha_I, \alpha_S, \beta_I, \beta_S, \gamma_I, \gamma_S \in [0, 1]$.
- (4) If $\mathcal{I} := (\mathcal{I}[T], \mathcal{I}[I], \mathcal{I}[F])$ is a $(T(4, 4), I(4, 4), F(4, 4))$ -interval neutrosophic ideal of $(X, *, 0)$, then $L(\mathcal{I}[T]_{\text{inf}}; \alpha_I)$, $L(\mathcal{I}[T]_{\text{sup}}; \alpha_S)$, $L(\mathcal{I}[I]_{\text{inf}}; \beta_I)$, $L(\mathcal{I}[I]_{\text{sup}}; \beta_S)$, $L(\mathcal{I}[F]_{\text{inf}}; \gamma_I)$ and $L(\mathcal{I}[F]_{\text{sup}}; \gamma_S)$ are either empty or ideals of $(X, *, 0)$ for all $\alpha_I, \alpha_S, \beta_I, \beta_S, \gamma_I, \gamma_S \in [0, 1]$.

Proof. (1) Assume that $\mathcal{I} := (\mathcal{I}[T], \mathcal{I}[I], \mathcal{I}[F])$ is a $(T(1, 4), I(1, 4), F(1, 4))$ -interval neutrosophic ideal of $(X, *, 0)$. Then $(X, \mathcal{I}[T]_{\text{inf}})$, $(X, \mathcal{I}[I]_{\text{inf}})$ and $(X, \mathcal{I}[F]_{\text{inf}})$ are 1-fuzzy ideals of X ; and $(X, \mathcal{I}[T]_{\text{sup}})$, $(X, \mathcal{I}[I]_{\text{sup}})$ and $(X, \mathcal{I}[F]_{\text{sup}})$ are 4-fuzzy ideals of X . Let $\alpha_I, \alpha_S \in [0, 1]$ be such that $U(\mathcal{I}[T]_{\text{inf}}; \alpha_I)$ and $L(\mathcal{I}[T]_{\text{sup}}; \alpha_S)$ are nonempty. Obviously, $0 \in U(\mathcal{I}[T]_{\text{inf}}; \alpha_I)$ and $0 \in L(\mathcal{I}[T]_{\text{sup}}; \alpha_S)$. Let $x, y \in X$ be such that $x * y \in U(\mathcal{I}[T]_{\text{inf}}; \alpha_I)$ and $y \in U(\mathcal{I}[T]_{\text{inf}}; \alpha_I)$. Then $\mathcal{I}[T]_{\text{inf}}(x * y) \geq \alpha_I$ and $\mathcal{I}[T]_{\text{inf}}(y) \geq \alpha_I$, and so

$$\mathcal{I}[T]_{\text{inf}}(x) \geq \min\{\mathcal{I}[T]_{\text{inf}}(x * y), \mathcal{I}[T]_{\text{inf}}(y)\} \geq \alpha_I,$$

that is, $x \in U(\mathcal{I}[T]_{\text{inf}}; \alpha_I)$. If $x * y \in L(\mathcal{I}[T]_{\text{sup}}; \alpha_S)$ and $y \in L(\mathcal{I}[T]_{\text{sup}}; \alpha_S)$, then $\mathcal{I}[T]_{\text{sup}}(x * y) \leq \alpha_S$ and $\mathcal{I}[T]_{\text{sup}}(y) \leq \alpha_S$, which imply that

$$\mathcal{I}[T]_{\text{sup}}(x) \leq \max\{\mathcal{I}[T]_{\text{sup}}(x * y), \mathcal{I}[T]_{\text{sup}}(y)\} \leq \alpha_S,$$

that is, $x \in L(\mathcal{I}[T]_{\text{sup}}; \alpha_S)$. Hence $U(\mathcal{I}[T]_{\text{inf}}; \alpha_I)$ and $L(\mathcal{I}[T]_{\text{sup}}; \alpha_S)$ are ideals of $(X, *, 0)$ for all $\alpha_I, \alpha_S \in [0, 1]$. Similarly, we can prove that $U(\mathcal{I}[I]_{\text{inf}}; \beta_I)$, $L(\mathcal{I}[I]_{\text{sup}}; \beta_S)$, $U(\mathcal{I}[F]_{\text{inf}}; \gamma_I)$ and $L(\mathcal{I}[F]_{\text{sup}}; \gamma_S)$ are either empty or subalgebras of $(X, *, 0)$ for all $\beta_I, \beta_S, \gamma_I, \gamma_S \in [0, 1]$. By the similarly way to the proof of (1), we can prove that (2), (3) and (4) are true. \square

Corollary 3.5. Given an interval neutrosophic set $\mathcal{I} := (\mathcal{I}[T], \mathcal{I}[I], \mathcal{I}[F])$ in $(X, *, 0)$, we have the following assertions:

- (1) If $\mathcal{I} := (\mathcal{I}[T], \mathcal{I}[I], \mathcal{I}[F])$ is a $(T(3, 4), I(3, 4), F(3, 4))$ -interval neutrosophic ideal of $(X, *, 0)$ or a $(T(i, 2), I(i, 2), F(i, 2))$ -interval neutrosophic ideal of $(X, *, 0)$ for $i \in \{1, 3\}$, then $U(\mathcal{I}[T]_{\text{inf}}; \alpha_I)$, $L(\mathcal{I}[T]_{\text{sup}}; \alpha_S)$, $U(\mathcal{I}[I]_{\text{inf}}; \beta_I)$, $L(\mathcal{I}[I]_{\text{sup}}; \beta_S)$, $U(\mathcal{I}[F]_{\text{inf}}; \gamma_I)$ and $L(\mathcal{I}[F]_{\text{sup}}; \gamma_S)$ are either empty or ideals of $(X, *, 0)$ for all $\alpha_I, \alpha_S, \beta_I, \beta_S, \gamma_I, \gamma_S \in [0, 1]$.
- (2) If $\mathcal{I} := (\mathcal{I}[T], \mathcal{I}[I], \mathcal{I}[F])$ is a $(T(4, 3), I(4, 3), F(4, 3))$ -interval neutrosophic ideal of $(X, *, 0)$ or a $(T(2, j), I(2, j), F(2, j))$ -interval neutrosophic ideal of $(X, *, 0)$ for $j \in \{1, 3\}$, then $L(\mathcal{I}[T]_{\text{inf}}; \alpha_I)$, $U(\mathcal{I}[T]_{\text{sup}}; \alpha_S)$, $L(\mathcal{I}[I]_{\text{inf}}; \beta_I)$, $U(\mathcal{I}[I]_{\text{sup}}; \beta_S)$, $L(\mathcal{I}[F]_{\text{inf}}; \gamma_I)$ and $U(\mathcal{I}[F]_{\text{sup}}; \gamma_S)$ are either empty or ideals of $(X, *, 0)$ for all $\alpha_I, \alpha_S, \beta_I, \beta_S, \gamma_I, \gamma_S \in [0, 1]$.
- (3) If $\mathcal{I} := (\mathcal{I}[T], \mathcal{I}[I], \mathcal{I}[F])$ is a $(T(3, 1), I(3, 1), F(3, 1))$ -interval neutrosophic ideal of $(X, *, 0)$ or a $(T(i, 3), I(i, 3), F(i, 3))$ -interval neutrosophic ideal of $(X, *, 0)$ for $i \in \{1, 3\}$, then $U(\mathcal{I}[T]_{\text{inf}}; \alpha_I)$, $U(\mathcal{I}[T]_{\text{sup}}; \alpha_S)$, $U(\mathcal{I}[I]_{\text{inf}}; \beta_I)$, $U(\mathcal{I}[I]_{\text{sup}}; \beta_S)$, $U(\mathcal{I}[F]_{\text{inf}}; \gamma_I)$ and $U(\mathcal{I}[F]_{\text{sup}}; \gamma_S)$ are either empty or ideals of $(X, *, 0)$ for all $\alpha_I, \alpha_S, \beta_I, \beta_S, \gamma_I, \gamma_S \in [0, 1]$.
- (4) If $\mathcal{I} := (\mathcal{I}[T], \mathcal{I}[I], \mathcal{I}[F])$ is a $(T(2, 4), I(2, 4), F(2, 4))$ -interval neutrosophic ideal of $(X, *, 0)$ or a $(T(i, 2), I(i, 2), F(i, 2))$ -interval neutrosophic ideal of $(X, *, 0)$ for $i \in \{2, 4\}$, then $L(\mathcal{I}[T]_{\text{inf}}; \alpha_I)$, $L(\mathcal{I}[T]_{\text{sup}}; \alpha_S)$, $L(\mathcal{I}[I]_{\text{inf}}; \beta_I)$, $L(\mathcal{I}[I]_{\text{sup}}; \beta_S)$, $L(\mathcal{I}[F]_{\text{inf}}; \gamma_I)$ and $L(\mathcal{I}[F]_{\text{sup}}; \gamma_S)$ are either empty or ideals of $(X, *, 0)$ for all $\alpha_I, \alpha_S, \beta_I, \beta_S, \gamma_I, \gamma_S \in [0, 1]$.

Proof. Straightforward since every 3-fuzzy (resp., 2-fuzzy) ideal is a 1-fuzzy (resp., 4-fuzzy) ideal. \square

Theorem 3.6. Given an interval neutrosophic set $\mathcal{I} := (\mathcal{I}[T], \mathcal{I}[I], \mathcal{I}[F])$ in $(X, *, 0)$, the following assertions are valid.

- (1) If $U(\mathcal{I}[T]_{\text{inf}}; \alpha_I)$, $L(\mathcal{I}[T]_{\text{sup}}; \alpha_S)$, $U(\mathcal{I}[I]_{\text{inf}}; \beta_I)$, $L(\mathcal{I}[I]_{\text{sup}}; \beta_S)$, $U(\mathcal{I}[F]_{\text{inf}}; \gamma_I)$ and $L(\mathcal{I}[F]_{\text{sup}}; \gamma_S)$ are nonempty ideals of $(X, *, 0)$ for all $\alpha_I, \alpha_S, \beta_I, \beta_S, \gamma_I, \gamma_S \in [0, 1]$, then $\mathcal{I} := (\mathcal{I}[T], \mathcal{I}[I], \mathcal{I}[F])$ is a $(T(1, 4), I(1, 4), F(1, 4))$ -interval neutrosophic ideal of $(X, *, 0)$.
- (2) If $U(\mathcal{I}[T]_{\text{inf}}; \alpha_I)$, $U(\mathcal{I}[T]_{\text{sup}}; \alpha_S)$, $U(\mathcal{I}[I]_{\text{inf}}; \beta_I)$, $U(\mathcal{I}[I]_{\text{sup}}; \beta_S)$, $U(\mathcal{I}[F]_{\text{inf}}; \gamma_I)$ and $U(\mathcal{I}[F]_{\text{sup}}; \gamma_S)$ are nonempty ideals of $(X, *, 0)$ for all $\alpha_I, \alpha_S, \beta_I, \beta_S, \gamma_I, \gamma_S \in [0, 1]$, then $\mathcal{I} := (\mathcal{I}[T], \mathcal{I}[I], \mathcal{I}[F])$ is a $(T(1, 1), I(1, 1), F(1, 1))$ -interval neutrosophic ideal of $(X, *, 0)$.
- (3) If $L(\mathcal{I}[T]_{\text{inf}}; \alpha_I)$, $U(\mathcal{I}[T]_{\text{sup}}; \alpha_S)$, $L(\mathcal{I}[I]_{\text{inf}}; \beta_I)$, $U(\mathcal{I}[I]_{\text{sup}}; \beta_S)$, $L(\mathcal{I}[F]_{\text{inf}}; \gamma_I)$ and $U(\mathcal{I}[F]_{\text{sup}}; \gamma_S)$ are nonempty ideals of $(X, *, 0)$ for all $\alpha_I, \alpha_S, \beta_I, \beta_S, \gamma_I, \gamma_S \in [0, 1]$, then $\mathcal{I} := (\mathcal{I}[T], \mathcal{I}[I], \mathcal{I}[F])$ is a $(T(4, 1), I(4, 1), F(4, 1))$ -interval neutrosophic ideal of $(X, *, 0)$.
- (4) If $L(\mathcal{I}[T]_{\text{inf}}; \alpha_I)$, $L(\mathcal{I}[T]_{\text{sup}}; \alpha_S)$, $L(\mathcal{I}[I]_{\text{inf}}; \beta_I)$, $L(\mathcal{I}[I]_{\text{sup}}; \beta_S)$, $L(\mathcal{I}[F]_{\text{inf}}; \gamma_I)$ and $L(\mathcal{I}[F]_{\text{sup}}; \gamma_S)$ are

nonempty ideals of $(X, *, 0)$ for all $\alpha_I, \alpha_S, \beta_I, \beta_S, \gamma_I, \gamma_S \in [0, 1]$, then $\mathcal{I} := (\mathcal{I}[T], \mathcal{I}[I], \mathcal{I}[F])$ is a $(T(4, 4), I(4, 4), F(4, 4))$ -interval neutrosophic ideal of $(X, *, 0)$.

Proof. (1) Suppose that $U(\mathcal{I}[T]_{\text{inf}}; \alpha_I), L(\mathcal{I}[T]_{\text{sup}}; \alpha_S), U(\mathcal{I}[I]_{\text{inf}}; \beta_I), L(\mathcal{I}[I]_{\text{sup}}; \beta_S), U(\mathcal{I}[F]_{\text{inf}}; \gamma_I)$ and $L(\mathcal{I}[F]_{\text{sup}}; \gamma_S)$ are nonempty ideals of $(X, *, 0)$ for all $\alpha_I, \alpha_S, \beta_I, \beta_S, \gamma_I, \gamma_S \in [0, 1]$. If $(X, \mathcal{I}[T]_{\text{inf}})$ is not a 1-fuzzy ideal of $(X, *, 0)$, then there exist $x, y \in X$ such that

$$\mathcal{I}[T]_{\text{inf}}(x) < \min\{\mathcal{I}[T]_{\text{inf}}(x * y), \mathcal{I}[T]_{\text{inf}}(y)\}.$$

If we take $\alpha_I = \min\{\mathcal{I}[T]_{\text{inf}}(x * y), \mathcal{I}[T]_{\text{inf}}(y)\}$, then $x * y, y \in U(\mathcal{I}[T]_{\text{inf}}; \alpha_I)$ but $x \notin U(\mathcal{I}[T]_{\text{inf}}; \alpha_I)$. This is a contradiction, and so $(X, \mathcal{I}[T]_{\text{inf}})$ is a 1-fuzzy ideal of $(X, *, 0)$. If $(X, \mathcal{I}[T]_{\text{sup}})$ is not a 4-fuzzy ideal of $(X, *, 0)$, then

$$\mathcal{I}[T]_{\text{sup}}(a) > \max\{\mathcal{I}[T]_{\text{sup}}(a * b), \mathcal{I}[T]_{\text{sup}}(b)\}$$

for some $a, b \in X$, and so $a * b, b \in L(\mathcal{I}[T]_{\text{sup}}; \alpha_S)$ and $a \notin L(\mathcal{I}[T]_{\text{sup}}; \alpha_S)$ by taking

$$\alpha_S := \max\{\mathcal{I}[T]_{\text{sup}}(a * b), \mathcal{I}[T]_{\text{sup}}(b)\}.$$

This is a contradiction, and therefore $(X, \mathcal{I}[T]_{\text{sup}})$ is a 4-fuzzy ideal of $(X, *, 0)$. Similarly, we can verify that $(X, \mathcal{I}[I]_{\text{inf}})$ is a 1-fuzzy ideal of $(X, *, 0)$ and $(X, \mathcal{I}[I]_{\text{sup}})$ is a 4-fuzzy ideal of $(X, *, 0)$, and $(X, \mathcal{I}[F]_{\text{inf}})$ is a 1-fuzzy ideal of $(X, *, 0)$ and $(X, \mathcal{I}[F]_{\text{sup}})$ is a 4-fuzzy ideal of $(X, *, 0)$. Consequently, $\mathcal{I} := (\mathcal{I}[T], \mathcal{I}[I], \mathcal{I}[F])$ is a $(T(1, 4), I(1, 4), F(1, 4))$ -interval neutrosophic ideal of $(X, *, 0)$. The assertions (2), (3) and (4) can be proved by the similar way to the proof of (1). \square

Theorem 3.7. *If an interval neutrosophic set $\mathcal{I} := (\mathcal{I}[T], \mathcal{I}[I], \mathcal{I}[F])$ in $(X, *, 0)$ is a $(T(2, 3), I(2, 3), F(2, 3))$ -interval neutrosophic ideal of $(X, *, 0)$, then $U(\mathcal{I}[T]_{\text{inf}}; \alpha_I)^c, L(\mathcal{I}[T]_{\text{sup}}; \alpha_S)^c, U(\mathcal{I}[I]_{\text{inf}}; \beta_I)^c, L(\mathcal{I}[I]_{\text{sup}}; \beta_S)^c, U(\mathcal{I}[F]_{\text{inf}}; \gamma_I)^c$ and $L(\mathcal{I}[F]_{\text{sup}}; \gamma_S)^c$ are either empty or ideals of $(X, *, 0)$ for all $\alpha_I, \alpha_S, \beta_I, \beta_S, \gamma_I, \gamma_S \in [0, 1]$.*

Proof. Let $\mathcal{I} := (\mathcal{I}[T], \mathcal{I}[I], \mathcal{I}[F])$ be a $(T(2, 3), I(2, 3), F(2, 3))$ -interval neutrosophic ideal of $(X, *, 0)$. Then

- (1) $(X, \mathcal{I}[T]_{\text{inf}}), (X, \mathcal{I}[I]_{\text{inf}})$ and $(X, \mathcal{I}[F]_{\text{inf}})$ are 2-fuzzy ideals of $(X, *, 0)$,
- (2) $(X, \mathcal{I}[T]_{\text{sup}}), (X, \mathcal{I}[I]_{\text{sup}})$ and $(X, \mathcal{I}[F]_{\text{sup}})$ are 3-fuzzy ideals of $(X, *, 0)$.

Let $\alpha_I, \alpha_S, \beta_I, \beta_S, \gamma_I, \gamma_S \in [0, 1]$ be such that $U(\mathcal{I}[T]_{\text{inf}}; \alpha_I)^c, L(\mathcal{I}[T]_{\text{sup}}; \alpha_S)^c, U(\mathcal{I}[I]_{\text{inf}}; \beta_I)^c, L(\mathcal{I}[I]_{\text{sup}}; \beta_S)^c, U(\mathcal{I}[F]_{\text{inf}}; \gamma_I)^c$ and $L(\mathcal{I}[F]_{\text{sup}}; \gamma_S)^c$ are nonempty. Then there exist $x, y, z, a, b, d \in X$ such that $x \in U(\mathcal{I}[T]_{\text{inf}}; \alpha_I)^c, a \in L(\mathcal{I}[T]_{\text{sup}}; \alpha_S)^c, y \in U(\mathcal{I}[I]_{\text{inf}}; \beta_I)^c, b \in L(\mathcal{I}[I]_{\text{sup}}; \beta_S)^c, z \in U(\mathcal{I}[F]_{\text{inf}}; \gamma_I)^c$ and $d \in L(\mathcal{I}[F]_{\text{sup}}; \gamma_S)^c$. Hence

$$\mathcal{I}[T]_{\text{inf}}(0) \leq \mathcal{I}[T]_{\text{inf}}(x) < \alpha_I \text{ and } \mathcal{I}[T]_{\text{sup}}(0) \geq \mathcal{I}[T]_{\text{sup}}(a) > \alpha_S,$$

$$\mathcal{I}[I]_{\text{inf}}(0) \leq \mathcal{I}[I]_{\text{inf}}(y) < \beta_I \text{ and } \mathcal{I}[I]_{\text{sup}}(0) \geq \mathcal{I}[I]_{\text{sup}}(b) > \beta_S,$$

$$\mathcal{I}[F]_{\text{inf}}(0) \leq \mathcal{I}[F]_{\text{inf}}(z) < \gamma_I \text{ and } \mathcal{I}[F]_{\text{sup}}(0) \geq \mathcal{I}[F]_{\text{sup}}(d) > \gamma_S,$$

and so $0 \in U(\mathcal{I}[T]_{\text{inf}}; \alpha_I)^c \cap L(\mathcal{I}[T]_{\text{sup}}; \alpha_S)^c, 0 \in U(\mathcal{I}[I]_{\text{inf}}; \beta_I)^c \cap L(\mathcal{I}[I]_{\text{sup}}; \beta_S)^c$, and $0 \in U(\mathcal{I}[F]_{\text{inf}}; \gamma_I)^c \cap L(\mathcal{I}[F]_{\text{sup}}; \gamma_S)^c$. Let $x, y \in X$ be such that $x * y \in U(\mathcal{I}[T]_{\text{inf}}; \alpha_I)^c$ and $y \in U(\mathcal{I}[T]_{\text{inf}}; \alpha_I)^c$. Then $\mathcal{I}[T]_{\text{inf}}(x * y) < \alpha_I$ and $\mathcal{I}[T]_{\text{inf}}(y) < \alpha_I$. Hence

$$\mathcal{I}[T]_{\text{inf}}(x) \leq \min\{\mathcal{I}[T]_{\text{inf}}(x * y), \mathcal{I}[T]_{\text{inf}}(y)\} < \alpha_I,$$

and so $x \in U(\mathcal{I}[T]_{\text{inf}}; \alpha_I)^c$. Thus $U(\mathcal{I}[T]_{\text{inf}}; \alpha_I)^c$ is an ideal of $(X, *, 0)$. Similarly, we can verify that

- If $x * y \in L(\mathcal{I}[T]_{\text{sup}}; \alpha_S)^c$ and $y \in L(\mathcal{I}[T]_{\text{sup}}; \alpha_S)^c$, then $x \in L(\mathcal{I}[T]_{\text{sup}}; \alpha_S)^c$,
- If $x * y \in U(\mathcal{I}[I]_{\text{inf}}; \beta_I)^c$ and $y \in U(\mathcal{I}[I]_{\text{inf}}; \beta_I)^c$, then $x \in U(\mathcal{I}[I]_{\text{inf}}; \beta_I)^c$,
- If $x * y \in L(\mathcal{I}[I]_{\text{sup}}; \beta_S)^c$ and $y \in L(\mathcal{I}[I]_{\text{sup}}; \beta_S)^c$, then $x \in L(\mathcal{I}[I]_{\text{sup}}; \beta_S)^c$,
- If $x * y \in U(\mathcal{I}[F]_{\text{inf}}; \gamma_I)^c$ and $y \in U(\mathcal{I}[F]_{\text{inf}}; \gamma_I)^c$, then $x \in U(\mathcal{I}[F]_{\text{inf}}; \gamma_I)^c$,
- If $x * y \in L(\mathcal{I}[F]_{\text{sup}}; \gamma_S)^c$ and $y \in L(\mathcal{I}[F]_{\text{sup}}; \gamma_S)^c$, then $x \in L(\mathcal{I}[F]_{\text{sup}}; \gamma_S)^c$.

Therefore $L(\mathcal{I}[T]_{\text{sup}}; \alpha_S)^c, U(\mathcal{I}[I]_{\text{inf}}; \beta_I)^c, L(\mathcal{I}[I]_{\text{sup}}; \beta_S)^c, U(\mathcal{I}[F]_{\text{inf}}; \gamma_I)^c$ and $L(\mathcal{I}[F]_{\text{sup}}; \gamma_S)^c$ are ideals of $(X, *, 0)$. \square

The converse of Theorem 3.7 is not true in general as seen in the following example.

Example 3.8. Consider a BCI-algebra $X = \{0, 1, a, b, c\}$ with the binary operation $*$ which is given in Table 3 (see [6]).

Table 3: Cayley table for the binary operation “ $*$ ”

$*$	0	1	a	b	c
0	0	0	a	b	c
1	1	0	a	b	c
a	a	a	0	c	b
b	b	b	c	0	a
c	c	c	b	a	0

Let $\mathcal{I} := (\mathcal{I}[T], \mathcal{I}[I], \mathcal{I}[F])$ be an interval neutrosophic set in $(X, *, 0)$ where $\mathcal{I}[T], \mathcal{I}[I]$ and $\mathcal{I}[F]$ are given as follows:

$$\mathcal{I}[T] : X \rightarrow \tilde{\mathcal{P}}([0, 1]), \quad x \mapsto \begin{cases} [0.25, 0.85] & \text{if } x = 0, \\ [0.45, 0.83] & \text{if } x = 1, \\ [0.55, 0.73] & \text{if } x = a, \\ [0.65, 0.73] & \text{if } x = b, \\ [0.65, 0.75] & \text{if } x = c, \end{cases}$$

$$\mathcal{I}[I] : X \rightarrow \tilde{\mathcal{P}}([0, 1]), \quad x \mapsto \begin{cases} [0.3, 0.75] & \text{if } x = 0, \\ [0.3, 0.70] & \text{if } x = 1, \\ [0.6, 0.63] & \text{if } x = a, \\ [0.5, 0.63] & \text{if } x = b, \\ [0.6, 0.68] & \text{if } x = c, \end{cases}$$

and

$$\mathcal{I}[F] : X \rightarrow \tilde{\mathcal{P}}([0, 1]), \quad x \mapsto \begin{cases} [0.44, 0.9] & \text{if } x = 0, \\ [0.55, 0.9] & \text{if } x = 1, \\ [0.55, 0.7] & \text{if } x = a, \\ [0.66, 0.8] & \text{if } x = b, \\ [0.66, 0.7] & \text{if } x = c. \end{cases}$$

Then

$$U(\mathcal{I}[T]_{\text{inf}}; \alpha_I)^c = \begin{cases} \emptyset & \text{if } \alpha_I \in [0, 0.25], \\ \{0\} & \text{if } \alpha_I \in (0.25, 0.45], \\ \{0, 1\} & \text{if } \alpha_I \in (0.45, 0.55], \\ \{0, 1, a\} & \text{if } \alpha_I \in (0.55, 0.65], \\ X & \text{if } \alpha_I \in (0.65, 1.0], \end{cases}$$

$$L(\mathcal{I}[T]_{\text{sup}}; \alpha_S)^c = \begin{cases} \emptyset & \text{if } \alpha_S \in [0.85, 1.0], \\ \{0\} & \text{if } \alpha_S \in [0.83, 0.85), \\ \{0, 1\} & \text{if } \alpha_S \in [0.75, 0.83), \\ \{0, 1, c\} & \text{if } \alpha_S \in [0.73, 0.75), \\ X & \text{if } \alpha_S \in [0, 0.73), \end{cases}$$

$$U(\mathcal{I}[I]_{\text{inf}}; \beta_I)^c = \begin{cases} \emptyset & \text{if } \beta_I \in [0, 0.3], \\ \{0, 1\} & \text{if } \beta_I \in (0.3, 0.5], \\ \{0, 1, b\} & \text{if } \beta_I \in (0.5, 0.6], \\ X & \text{if } \beta_I \in (0.6, 1.0], \end{cases}$$

$$L(\mathcal{I}[I]_{\text{sup}}; \beta_S)^c = \begin{cases} \emptyset & \text{if } \beta_S \in [0.75, 1.0], \\ \{0\} & \text{if } \beta_S \in [0.70, 0.75), \\ \{0, 1\} & \text{if } \beta_S \in [0.68, 0.70), \\ \{0, 1, c\} & \text{if } \beta_S \in [0.63, 0.68), \\ X & \text{if } \beta_S \in [0, 0.63), \end{cases}$$

$$U(\mathcal{I}[F]_{\text{inf}}; \gamma_I)^c = \begin{cases} \emptyset & \text{if } \gamma_I \in [0, 0.44], \\ \{0\} & \text{if } \gamma_I \in (0.44, 0.55], \\ \{0, 1, a\} & \text{if } \gamma_I \in (0.55, 0.66], \\ X & \text{if } \gamma_I \in (0.66, 1.0], \end{cases}$$

$$L(\mathcal{I}[F]_{\text{sup}}; \gamma_S)^c = \begin{cases} \emptyset & \text{if } \gamma_S \in [0.9, 1.0], \\ \{0, 1\} & \text{if } \gamma_S \in [0.8, 0.9), \\ \{0, 1, b\} & \text{if } \gamma_S \in [0.7, 0.8), \\ X & \text{if } \gamma_S \in [0, 0.7). \end{cases}$$

Hence the nonempty sets $U(\mathcal{I}[T]_{\text{inf}}; \alpha_I)^c$, $L(\mathcal{I}[T]_{\text{sup}}; \alpha_S)^c$, $U(\mathcal{I}[I]_{\text{inf}}; \beta_I)^c$, $L(\mathcal{I}[I]_{\text{sup}}; \beta_S)^c$, $U(\mathcal{I}[F]_{\text{inf}}; \gamma_I)^c$ and $L(\mathcal{I}[F]_{\text{sup}}; \gamma_S)^c$ are ideals of $(X, *, 0)$ for all $\alpha_I, \alpha_S, \beta_I, \beta_S,$

$\gamma_I, \gamma_S \in [0, 1]$. But $\mathcal{I} := (\mathcal{I}[T], \mathcal{I}[I], \mathcal{I}[F])$ is not a $(T(2, 3), I(2, 3), F(2, 3))$ -interval neutrosophic ideal of $(X, *, 0)$ since

$$\mathcal{I}[T]_{\text{inf}}(c) = 0.65 > 0.55 = \min\{\mathcal{I}[T]_{\text{inf}}(c * a), \mathcal{I}[T]_{\text{inf}}(a)\},$$

$$\mathcal{I}[T]_{\text{sup}}(a) = 0.73 < 0.75 = \max\{\mathcal{I}[T]_{\text{sup}}(a * c), \mathcal{I}[T]_{\text{sup}}(c)\},$$

$$\mathcal{I}[I]_{\text{inf}}(c) = 0.6 > 0.5 = \min\{\mathcal{I}[I]_{\text{inf}}(c * a), \mathcal{I}[I]_{\text{inf}}(a)\},$$

$$\mathcal{I}[I]_{\text{sup}}(a) = 0.63 < 0.68 = \max\{\mathcal{I}[I]_{\text{sup}}(a * c), \mathcal{I}[I]_{\text{sup}}(c)\},$$

$$\mathcal{I}[F]_{\text{inf}}(c) = 0.66 > 0.55 = \min\{\mathcal{I}[F]_{\text{inf}}(c * a), \mathcal{I}[F]_{\text{inf}}(a)\},$$

and/or

$$\mathcal{I}[F]_{\text{sup}}(a) = 0.7 < 0.8 = \max\{\mathcal{I}[F]_{\text{sup}}(a * c), \mathcal{I}[F]_{\text{sup}}(c)\}.$$

Using the similar way to the proof of Theorem 3.7, we have the following theorems.

Theorem 3.9. Given an interval neutrosophic set $\mathcal{I} := (\mathcal{I}[T], \mathcal{I}[I], \mathcal{I}[F])$ in $(X, *, 0)$, we have the following assertions:

- (1) If $\mathcal{I} := (\mathcal{I}[T], \mathcal{I}[I], \mathcal{I}[F])$ is a $(T(2, 2), I(2, 2), F(2, 2))$ -interval neutrosophic ideal of $(X, *, 0)$, then $U(\mathcal{I}[T]_{\text{inf}}; \alpha_I)^c$, $U(\mathcal{I}[T]_{\text{sup}}; \alpha_S)^c$, $U(\mathcal{I}[I]_{\text{inf}}; \beta_I)^c$, $U(\mathcal{I}[I]_{\text{sup}}; \beta_S)^c$, $U(\mathcal{I}[F]_{\text{inf}}; \gamma_I)^c$ and $U(\mathcal{I}[F]_{\text{sup}}; \gamma_S)^c$ are either empty or ideals of $(X, *, 0)$ for all $\alpha_I, \alpha_S, \beta_I, \beta_S, \gamma_I, \gamma_S \in [0, 1]$.
- (2) If $\mathcal{I} := (\mathcal{I}[T], \mathcal{I}[I], \mathcal{I}[F])$ is a $(T(3, 2), I(3, 2), F(3, 2))$ -interval neutrosophic ideal of $(X, *, 0)$, then $L(\mathcal{I}[T]_{\text{inf}}; \alpha_I)^c$, $U(\mathcal{I}[T]_{\text{sup}}; \alpha_S)^c$, $L(\mathcal{I}[I]_{\text{inf}}; \beta_I)^c$, $U(\mathcal{I}[I]_{\text{sup}}; \beta_S)^c$, $L(\mathcal{I}[F]_{\text{inf}}; \gamma_I)^c$ and $U(\mathcal{I}[F]_{\text{sup}}; \gamma_S)^c$ are either empty or ideals of $(X, *, 0)$ for all $\alpha_I, \alpha_S, \beta_I, \beta_S, \gamma_I, \gamma_S \in [0, 1]$.
- (3) If $\mathcal{I} := (\mathcal{I}[T], \mathcal{I}[I], \mathcal{I}[F])$ is a $(T(3, 3), I(3, 3), F(3, 3))$ -interval neutrosophic ideal of $(X, *, 0)$, then $L(\mathcal{I}[T]_{\text{inf}}; \alpha_I)^c$, $L(\mathcal{I}[T]_{\text{sup}}; \alpha_S)^c$, $L(\mathcal{I}[I]_{\text{inf}}; \beta_I)^c$, $L(\mathcal{I}[I]_{\text{sup}}; \beta_S)^c$, $L(\mathcal{I}[F]_{\text{inf}}; \gamma_I)^c$ and $L(\mathcal{I}[F]_{\text{sup}}; \gamma_S)^c$ are either empty or ideals of $(X, *, 0)$ for all $\alpha_I, \alpha_S, \beta_I, \beta_S, \gamma_I, \gamma_S \in [0, 1]$.

Using the similar way to the proofs of Theorems 3.4 and 3.7, we have the following theorem.

Theorem 3.10. Given an interval neutrosophic set $\mathcal{I} := (\mathcal{I}[T], \mathcal{I}[I], \mathcal{I}[F])$ in $(X, *, 0)$, we have the following assertions:

- (1) If $\mathcal{I} := (\mathcal{I}[T], \mathcal{I}[I], \mathcal{I}[F])$ is a $(T(1, 2), I(1, 2), F(1, 2))$ -interval neutrosophic ideal of $(X, *, 0)$, then $U(\mathcal{I}[T]_{\text{inf}}; \alpha_I)$, $U(\mathcal{I}[T]_{\text{sup}}; \alpha_S)^c$, $U(\mathcal{I}[I]_{\text{inf}}; \beta_I)$, $U(\mathcal{I}[I]_{\text{sup}}; \beta_S)^c$, $U(\mathcal{I}[F]_{\text{inf}}; \gamma_I)$ and $U(\mathcal{I}[F]_{\text{sup}}; \gamma_S)^c$ are either empty or ideals of $(X, *, 0)$ for all $\alpha_I, \alpha_S, \beta_I, \beta_S, \gamma_I, \gamma_S \in [0, 1]$.

(2) If $\mathcal{I} := (\mathcal{I}[T], \mathcal{I}[I], \mathcal{I}[F])$ is a $(T(1, 3), I(1, 3), F(1, 3))$ -interval neutrosophic ideal of $(X, *, 0)$, then $U(\mathcal{I}[T]_{\text{inf}}; \alpha_I)$, $L(\mathcal{I}[T]_{\text{sup}}; \alpha_S)^c$, $U(\mathcal{I}[I]_{\text{inf}}; \beta_I)$, $L(\mathcal{I}[I]_{\text{sup}}; \beta_S)^c$, $U(\mathcal{I}[F]_{\text{inf}}; \gamma_I)$ and $L(\mathcal{I}[F]_{\text{sup}}; \gamma_S)^c$ are either empty or ideals of $(X, *, 0)$ for all $\alpha_I, \alpha_S, \beta_I, \beta_S, \gamma_I, \gamma_S \in [0, 1]$.

(3) If $\mathcal{I} := (\mathcal{I}[T], \mathcal{I}[I], \mathcal{I}[F])$ is a $(T(2, 1), I(2, 1), F(2, 1))$ -interval neutrosophic ideal of $(X, *, 0)$, then $U(\mathcal{I}[T]_{\text{inf}}; \alpha_I)^c$, $U(\mathcal{I}[T]_{\text{sup}}; \alpha_S)$, $U(\mathcal{I}[I]_{\text{inf}}; \beta_I)^c$, $U(\mathcal{I}[I]_{\text{sup}}; \beta_S)$, $U(\mathcal{I}[F]_{\text{inf}}; \gamma_I)^c$ and $U(\mathcal{I}[F]_{\text{sup}}; \gamma_S)$ are either empty or ideals of $(X, *, 0)$ for all $\alpha_I, \alpha_S, \beta_I, \beta_S, \gamma_I, \gamma_S \in [0, 1]$.

(4) If $\mathcal{I} := (\mathcal{I}[T], \mathcal{I}[I], \mathcal{I}[F])$ is a $(T(3, 1), I(3, 1), F(3, 1))$ -interval neutrosophic ideal of $(X, *, 0)$, then $L(\mathcal{I}[T]_{\text{inf}}; \alpha_I)^c$, $U(\mathcal{I}[T]_{\text{sup}}; \alpha_S)$, $L(\mathcal{I}[I]_{\text{inf}}; \beta_I)^c$, $U(\mathcal{I}[I]_{\text{sup}}; \beta_S)$, $L(\mathcal{I}[F]_{\text{inf}}; \gamma_I)^c$ and $U(\mathcal{I}[F]_{\text{sup}}; \gamma_S)$ are either empty or ideals of $(X, *, 0)$ for all $\alpha_I, \alpha_S, \beta_I, \beta_S, \gamma_I, \gamma_S \in [0, 1]$.

(5) If $\mathcal{I} := (\mathcal{I}[T], \mathcal{I}[I], \mathcal{I}[F])$ is a $(T(2, 4), I(2, 4), F(2, 4))$ -interval neutrosophic ideal of $(X, *, 0)$, then $U(\mathcal{I}[T]_{\text{inf}}; \alpha_I)^c$, $L(\mathcal{I}[T]_{\text{sup}}; \alpha_S)$, $U(\mathcal{I}[I]_{\text{inf}}; \beta_I)^c$, $L(\mathcal{I}[I]_{\text{sup}}; \beta_S)$, $U(\mathcal{I}[F]_{\text{inf}}; \gamma_I)^c$ and $L(\mathcal{I}[F]_{\text{sup}}; \gamma_S)$ are either empty or ideals of $(X, *, 0)$ for all $\alpha_I, \alpha_S, \beta_I, \beta_S, \gamma_I, \gamma_S \in [0, 1]$.

(6) If $\mathcal{I} := (\mathcal{I}[T], \mathcal{I}[I], \mathcal{I}[F])$ is a $(T(3, 4), I(3, 4), F(3, 4))$ -interval neutrosophic ideal of $(X, *, 0)$, then $L(\mathcal{I}[T]_{\text{inf}}; \alpha_I)^c$, $L(\mathcal{I}[T]_{\text{sup}}; \alpha_S)$, $L(\mathcal{I}[I]_{\text{inf}}; \beta_I)^c$, $L(\mathcal{I}[I]_{\text{sup}}; \beta_S)$, $L(\mathcal{I}[F]_{\text{inf}}; \gamma_I)^c$ and $L(\mathcal{I}[F]_{\text{sup}}; \gamma_S)$ are either empty or ideals of $(X, *, 0)$ for all $\alpha_I, \alpha_S, \beta_I, \beta_S, \gamma_I, \gamma_S \in [0, 1]$.

(7) If $\mathcal{I} := (\mathcal{I}[T], \mathcal{I}[I], \mathcal{I}[F])$ is a $(T(4, 2), I(4, 2), F(4, 2))$ -interval neutrosophic ideal of $(X, *, 0)$, then $L(\mathcal{I}[T]_{\text{inf}}; \alpha_I)$, $U(\mathcal{I}[T]_{\text{sup}}; \alpha_S)^c$, $L(\mathcal{I}[I]_{\text{inf}}; \beta_I)$, $U(\mathcal{I}[I]_{\text{sup}}; \beta_S)^c$, $L(\mathcal{I}[F]_{\text{inf}}; \gamma_I)$ and $U(\mathcal{I}[F]_{\text{sup}}; \gamma_S)^c$ are either empty or ideals of $(X, *, 0)$ for all $\alpha_I, \alpha_S, \beta_I, \beta_S, \gamma_I, \gamma_S \in [0, 1]$.

(8) If $\mathcal{I} := (\mathcal{I}[T], \mathcal{I}[I], \mathcal{I}[F])$ is a $(T(4, 3), I(4, 3), F(4, 3))$ -interval neutrosophic ideal of $(X, *, 0)$, then $L(\mathcal{I}[T]_{\text{inf}}; \alpha_I)$, $L(\mathcal{I}[T]_{\text{sup}}; \alpha_S)^c$, $L(\mathcal{I}[I]_{\text{inf}}; \beta_I)$, $L(\mathcal{I}[I]_{\text{sup}}; \beta_S)^c$, $L(\mathcal{I}[F]_{\text{inf}}; \gamma_I)$ and $L(\mathcal{I}[F]_{\text{sup}}; \gamma_S)^c$ are either empty or ideals of $(X, *, 0)$ for all $\alpha_I, \alpha_S, \beta_I, \beta_S, \gamma_I, \gamma_S \in [0, 1]$.

neutrosophic ideal $\mathcal{I} := (\mathcal{I}[T], \mathcal{I}[I], \mathcal{I}[F])$ of $(X, *, 0)$ satisfies

$$\begin{cases} \mathcal{I}[T]_{\text{inf}}(x) \geq \mathcal{I}[T]_{\text{inf}}(y) \\ \mathcal{I}[T]_{\text{sup}}(x) \leq \mathcal{I}[T]_{\text{sup}}(y) \\ \mathcal{I}[I]_{\text{inf}}(x) \geq \mathcal{I}[I]_{\text{inf}}(y) \\ \mathcal{I}[I]_{\text{sup}}(x) \leq \mathcal{I}[I]_{\text{sup}}(y) \\ \mathcal{I}[F]_{\text{inf}}(x) \geq \mathcal{I}[F]_{\text{inf}}(y) \\ \mathcal{I}[F]_{\text{sup}}(x) \leq \mathcal{I}[F]_{\text{sup}}(y) \end{cases} \quad (3.1)$$

for all $x, y \in X$ with $x \leq y$.

Proof. If $\mathcal{I} := (\mathcal{I}[T], \mathcal{I}[I], \mathcal{I}[F])$ is a $(T(1, 4), I(1, 4), F(1, 4))$ -interval neutrosophic ideal of $(X, *, 0)$, then $(X, \mathcal{I}[T]_{\text{inf}})$, $(X, \mathcal{I}[I]_{\text{inf}})$ and $(X, \mathcal{I}[F]_{\text{inf}})$ are 1-fuzzy ideals of $(X, *, 0)$, and $(X, \mathcal{I}[T]_{\text{sup}})$, $(X, \mathcal{I}[I]_{\text{sup}})$ and $(X, \mathcal{I}[F]_{\text{sup}})$ are 4-fuzzy ideals of $(X, *, 0)$. Let $x, y \in X$ be such that $x \leq y$. Then $x * y = 0$, and so

$$\begin{aligned} \mathcal{I}[T]_{\text{inf}}(x) &\geq \min\{\mathcal{I}[T]_{\text{inf}}(x * y), \mathcal{I}[T]_{\text{inf}}(y)\} \\ &= \min\{\mathcal{I}[T]_{\text{inf}}(0), \mathcal{I}[T]_{\text{inf}}(y)\} = \mathcal{I}[T]_{\text{inf}}(y), \end{aligned}$$

$$\begin{aligned} \mathcal{I}[T]_{\text{sup}}(x) &\leq \max\{\mathcal{I}[T]_{\text{sup}}(x * y), \mathcal{I}[T]_{\text{sup}}(y)\} \\ &= \max\{\mathcal{I}[T]_{\text{sup}}(0), \mathcal{I}[T]_{\text{sup}}(y)\} = \mathcal{I}[T]_{\text{sup}}(y), \end{aligned}$$

$$\begin{aligned} \mathcal{I}[I]_{\text{inf}}(x) &\geq \min\{\mathcal{I}[I]_{\text{inf}}(x * y), \mathcal{I}[I]_{\text{inf}}(y)\} \\ &= \min\{\mathcal{I}[I]_{\text{inf}}(0), \mathcal{I}[I]_{\text{inf}}(y)\} = \mathcal{I}[I]_{\text{inf}}(y), \end{aligned}$$

$$\begin{aligned} \mathcal{I}[I]_{\text{sup}}(x) &\leq \max\{\mathcal{I}[I]_{\text{sup}}(x * y), \mathcal{I}[I]_{\text{sup}}(y)\} \\ &= \max\{\mathcal{I}[I]_{\text{sup}}(0), \mathcal{I}[I]_{\text{sup}}(y)\} = \mathcal{I}[I]_{\text{sup}}(y), \end{aligned}$$

$$\begin{aligned} \mathcal{I}[F]_{\text{inf}}(x) &\geq \min\{\mathcal{I}[F]_{\text{inf}}(x * y), \mathcal{I}[F]_{\text{inf}}(y)\} \\ &= \min\{\mathcal{I}[F]_{\text{inf}}(0), \mathcal{I}[F]_{\text{inf}}(y)\} = \mathcal{I}[F]_{\text{inf}}(y), \end{aligned}$$

$$\begin{aligned} \mathcal{I}[F]_{\text{sup}}(x) &\leq \max\{\mathcal{I}[F]_{\text{sup}}(x * y), \mathcal{I}[F]_{\text{sup}}(y)\} \\ &= \max\{\mathcal{I}[F]_{\text{sup}}(0), \mathcal{I}[F]_{\text{sup}}(y)\} = \mathcal{I}[F]_{\text{sup}}(y). \end{aligned}$$

This completes the proof. □

Using the similar way to the proof of Proposition 3.11, we have the following proposition.

Proposition 3.12. Given an interval neutrosophic set $\mathcal{I} := (\mathcal{I}[T], \mathcal{I}[I], \mathcal{I}[F])$ in $(X, *, 0)$, we have the following assertions:

Proposition 3.11. Every $(T(1, 4), I(1, 4), F(1, 4))$ -interval

(1) If $\mathcal{I} := (\mathcal{I}[T], \mathcal{I}[I], \mathcal{I}[F])$ is a $(T(1, 1), I(1, 1), F(1, 1))$ -

interval neutrosophic ideal of $(X, *, 0)$, then

$$\begin{cases} \mathcal{I}[T]_{\text{inf}}(x) \geq \mathcal{I}[T]_{\text{inf}}(y) \\ \mathcal{I}[T]_{\text{sup}}(x) \geq \mathcal{I}[T]_{\text{sup}}(y) \\ \mathcal{I}[I]_{\text{inf}}(x) \geq \mathcal{I}[I]_{\text{inf}}(y) \\ \mathcal{I}[I]_{\text{sup}}(x) \geq \mathcal{I}[I]_{\text{sup}}(y) \\ \mathcal{I}[F]_{\text{inf}}(x) \geq \mathcal{I}[F]_{\text{inf}}(y) \\ \mathcal{I}[F]_{\text{sup}}(x) \geq \mathcal{I}[F]_{\text{sup}}(y) \end{cases} \quad (3.2)$$

for all $x, y \in X$ with $x \leq y$.

(2) If $\mathcal{I} := (\mathcal{I}[T], \mathcal{I}[I], \mathcal{I}[F])$ is a $(T(4, 1), I(4, 1), F(4, 1))$ -interval neutrosophic ideal of $(X, *, 0)$, then

$$\begin{cases} \mathcal{I}[T]_{\text{inf}}(x) \leq \mathcal{I}[T]_{\text{inf}}(y) \\ \mathcal{I}[T]_{\text{sup}}(x) \geq \mathcal{I}[T]_{\text{sup}}(y) \\ \mathcal{I}[I]_{\text{inf}}(x) \leq \mathcal{I}[I]_{\text{inf}}(y) \\ \mathcal{I}[I]_{\text{sup}}(x) \geq \mathcal{I}[I]_{\text{sup}}(y) \\ \mathcal{I}[F]_{\text{inf}}(x) \leq \mathcal{I}[F]_{\text{inf}}(y) \\ \mathcal{I}[F]_{\text{sup}}(x) \geq \mathcal{I}[F]_{\text{sup}}(y) \end{cases} \quad (3.3)$$

for all $x, y \in X$ with $x \leq y$.

(2) If $\mathcal{I} := (\mathcal{I}[T], \mathcal{I}[I], \mathcal{I}[F])$ is a $(T(4, 4), I(4, 4), F(4, 4))$ -interval neutrosophic ideal of $(X, *, 0)$, then

$$\begin{cases} \mathcal{I}[T]_{\text{inf}}(x) \leq \mathcal{I}[T]_{\text{inf}}(y) \\ \mathcal{I}[T]_{\text{sup}}(x) \leq \mathcal{I}[T]_{\text{sup}}(y) \\ \mathcal{I}[I]_{\text{inf}}(x) \leq \mathcal{I}[I]_{\text{inf}}(y) \\ \mathcal{I}[I]_{\text{sup}}(x) \leq \mathcal{I}[I]_{\text{sup}}(y) \\ \mathcal{I}[F]_{\text{inf}}(x) \leq \mathcal{I}[F]_{\text{inf}}(y) \\ \mathcal{I}[F]_{\text{sup}}(x) \leq \mathcal{I}[F]_{\text{sup}}(y) \end{cases} \quad (3.4)$$

for all $x, y \in X$ with $x \leq y$.

Proposition 3.13. For every $(i, j) \in \{(2, 2), (2, 3), (3, 2), (3, 3)\}$, Every $(T(i, j), I(i, j), F(i, j))$ -interval neutrosophic ideal $\mathcal{I} := (\mathcal{I}[T], \mathcal{I}[I], \mathcal{I}[F])$ of $(X, *, 0)$ satisfies

$$\begin{cases} \mathcal{I}[T]_{\text{inf}}(x) = \mathcal{I}[T]_{\text{inf}}(0) \\ \mathcal{I}[T]_{\text{sup}}(x) = \mathcal{I}[T]_{\text{sup}}(0) \\ \mathcal{I}[I]_{\text{inf}}(x) = \mathcal{I}[I]_{\text{inf}}(0) \\ \mathcal{I}[I]_{\text{sup}}(x) = \mathcal{I}[I]_{\text{sup}}(0) \\ \mathcal{I}[F]_{\text{inf}}(x) = \mathcal{I}[F]_{\text{inf}}(0) \\ \mathcal{I}[F]_{\text{sup}}(x) = \mathcal{I}[F]_{\text{sup}}(0) \end{cases} \quad (3.5)$$

for all $x, y \in X$ with $x \leq y$.

Proof. Assume that $\mathcal{I} := (\mathcal{I}[T], \mathcal{I}[I], \mathcal{I}[F])$ is a $(T(2, 3), I(2, 3), F(2, 3))$ -interval neutrosophic ideal of $(X, *, 0)$. Then $(X, \mathcal{I}[T]_{\text{inf}})$, $(X, \mathcal{I}[I]_{\text{inf}})$ and $(X, \mathcal{I}[F]_{\text{inf}})$ are 2-fuzzy ideals of $(X, *, 0)$, and $(X, \mathcal{I}[T]_{\text{sup}})$, $(X, \mathcal{I}[I]_{\text{sup}})$ and $(X, \mathcal{I}[F]_{\text{sup}})$ are

3-fuzzy ideals of $(X, *, 0)$. Let $x, y \in X$ be such that $x \leq y$. Then $x * y = 0$, and thus

$$\begin{aligned} \mathcal{I}[T]_{\text{inf}}(x) &\leq \min\{\mathcal{I}[T]_{\text{inf}}(x * y), \mathcal{I}[T]_{\text{inf}}(y)\} \\ &= \min\{\mathcal{I}[T]_{\text{inf}}(0), \mathcal{I}[T]_{\text{inf}}(y)\} = \mathcal{I}[T]_{\text{inf}}(0), \end{aligned}$$

$$\begin{aligned} \mathcal{I}[T]_{\text{sup}}(x) &\geq \max\{\mathcal{I}[T]_{\text{sup}}(x * y), \mathcal{I}[T]_{\text{sup}}(y)\} \\ &= \max\{\mathcal{I}[T]_{\text{sup}}(0), \mathcal{I}[T]_{\text{sup}}(y)\} = \mathcal{I}[T]_{\text{sup}}(0), \end{aligned}$$

$$\begin{aligned} \mathcal{I}[I]_{\text{inf}}(x) &\leq \min\{\mathcal{I}[I]_{\text{inf}}(x * y), \mathcal{I}[I]_{\text{inf}}(y)\} \\ &= \min\{\mathcal{I}[I]_{\text{inf}}(0), \mathcal{I}[I]_{\text{inf}}(y)\} = \mathcal{I}[I]_{\text{inf}}(0), \end{aligned}$$

$$\begin{aligned} \mathcal{I}[I]_{\text{sup}}(x) &\geq \max\{\mathcal{I}[I]_{\text{sup}}(x * y), \mathcal{I}[I]_{\text{sup}}(y)\} \\ &= \max\{\mathcal{I}[I]_{\text{sup}}(0), \mathcal{I}[I]_{\text{sup}}(y)\} = \mathcal{I}[I]_{\text{sup}}(0), \end{aligned}$$

$$\begin{aligned} \mathcal{I}[F]_{\text{inf}}(x) &\leq \min\{\mathcal{I}[F]_{\text{inf}}(x * y), \mathcal{I}[F]_{\text{inf}}(y)\} \\ &= \min\{\mathcal{I}[F]_{\text{inf}}(0), \mathcal{I}[F]_{\text{inf}}(y)\} = \mathcal{I}[F]_{\text{inf}}(0), \end{aligned}$$

$$\begin{aligned} \mathcal{I}[F]_{\text{sup}}(x) &\geq \max\{\mathcal{I}[F]_{\text{sup}}(x * y), \mathcal{I}[F]_{\text{sup}}(y)\} \\ &= \max\{\mathcal{I}[F]_{\text{sup}}(0), \mathcal{I}[F]_{\text{sup}}(y)\} = \mathcal{I}[F]_{\text{sup}}(0). \end{aligned}$$

It follows that $\mathcal{I}[T]_{\text{inf}}(x) = \mathcal{I}[T]_{\text{inf}}(0)$, $\mathcal{I}[T]_{\text{sup}}(x) = \mathcal{I}[T]_{\text{sup}}(0)$, $\mathcal{I}[I]_{\text{inf}}(x) = \mathcal{I}[I]_{\text{inf}}(0)$, $\mathcal{I}[I]_{\text{sup}}(x) = \mathcal{I}[I]_{\text{sup}}(0)$, $\mathcal{I}[F]_{\text{inf}}(x) = \mathcal{I}[F]_{\text{inf}}(0)$ and $\mathcal{I}[F]_{\text{sup}}(x) = \mathcal{I}[F]_{\text{sup}}(0)$ for all $x, y \in X$ with $x \leq y$. Similarly, we can verify that (3.5) is true for $(i, j) \in \{(2, 2), (3, 2), (3, 3)\}$. \square

Using the similar way to the proof of Propositions 3.11 and 3.13, we have the following proposition.

Proposition 3.14. Given an interval neutrosophic set $\mathcal{I} := (\mathcal{I}[T], \mathcal{I}[I], \mathcal{I}[F])$ in $(X, *, 0)$, we have the following assertions:

(1) If $\mathcal{I} := (\mathcal{I}[T], \mathcal{I}[I], \mathcal{I}[F])$ is a $(T(1, j), I(1, j), F(1, j))$ -interval neutrosophic ideal of $(X, *, 0)$ for $j \in \{2, 3\}$, then

$$\begin{cases} \mathcal{I}[T]_{\text{inf}}(x) \geq \mathcal{I}[T]_{\text{inf}}(y) \\ \mathcal{I}[T]_{\text{sup}}(x) = \mathcal{I}[T]_{\text{sup}}(0) \\ \mathcal{I}[I]_{\text{inf}}(x) \geq \mathcal{I}[I]_{\text{inf}}(y) \\ \mathcal{I}[I]_{\text{sup}}(x) = \mathcal{I}[I]_{\text{sup}}(0) \\ \mathcal{I}[F]_{\text{inf}}(x) \geq \mathcal{I}[F]_{\text{inf}}(y) \\ \mathcal{I}[F]_{\text{sup}}(x) = \mathcal{I}[F]_{\text{sup}}(0) \end{cases} \quad (3.6)$$

for all $x, y \in X$ with $x \leq y$.

(2) If $\mathcal{I} := (\mathcal{I}[T], \mathcal{I}[I], \mathcal{I}[F])$ is a $(T(i, 1), I(i, 1), F(i, 1))$ -

interval neutrosophic ideal of $(X, *, 0)$ for $i \in \{2, 3\}$, then and so

$$\left\{ \begin{array}{l} \mathcal{I}[T]_{\text{inf}}(x) = \mathcal{I}[T]_{\text{inf}}(0) \\ \mathcal{I}[T]_{\text{sup}}(x) \geq \mathcal{I}[T]_{\text{sup}}(y) \\ \mathcal{I}[I]_{\text{inf}}(x) = \mathcal{I}[I]_{\text{inf}}(0) \\ \mathcal{I}[I]_{\text{sup}}(x) \geq \mathcal{I}[I]_{\text{sup}}(y) \\ \mathcal{I}[F]_{\text{inf}}(x) = \mathcal{I}[F]_{\text{inf}}(0) \\ \mathcal{I}[F]_{\text{sup}}(x) \geq \mathcal{I}[F]_{\text{sup}}(y) \end{array} \right. \quad (3.7)$$

for all $x, y \in X$ with $x \leq y$.

(3) If $\mathcal{I} := (\mathcal{I}[T], \mathcal{I}[I], \mathcal{I}[F])$ is a $(T(i, 4), I(i, 4), F(i, 4))$ -interval neutrosophic ideal of $(X, *, 0)$ for $i \in \{2, 3\}$, then

$$\left\{ \begin{array}{l} \mathcal{I}[T]_{\text{inf}}(x) = \mathcal{I}[T]_{\text{inf}}(0) \\ \mathcal{I}[T]_{\text{sup}}(x) \leq \mathcal{I}[T]_{\text{sup}}(y) \\ \mathcal{I}[I]_{\text{inf}}(x) = \mathcal{I}[I]_{\text{inf}}(0) \\ \mathcal{I}[I]_{\text{sup}}(x) \leq \mathcal{I}[I]_{\text{sup}}(y) \\ \mathcal{I}[F]_{\text{inf}}(x) = \mathcal{I}[F]_{\text{inf}}(0) \\ \mathcal{I}[F]_{\text{sup}}(x) \leq \mathcal{I}[F]_{\text{sup}}(y) \end{array} \right. \quad (3.8)$$

for all $x, y \in X$ with $x \leq y$.

(4) If $\mathcal{I} := (\mathcal{I}[T], \mathcal{I}[I], \mathcal{I}[F])$ is a $(T(4, j), I(4, j), F(4, j))$ -interval neutrosophic ideal of $(X, *, 0)$ for $j \in \{2, 3\}$, then

$$\left\{ \begin{array}{l} \mathcal{I}[T]_{\text{inf}}(x) \leq \mathcal{I}[T]_{\text{inf}}(y) \\ \mathcal{I}[T]_{\text{sup}}(x) = \mathcal{I}[T]_{\text{sup}}(0) \\ \mathcal{I}[I]_{\text{inf}}(x) \leq \mathcal{I}[I]_{\text{inf}}(y) \\ \mathcal{I}[I]_{\text{sup}}(x) = \mathcal{I}[I]_{\text{sup}}(0) \\ \mathcal{I}[F]_{\text{inf}}(x) \leq \mathcal{I}[F]_{\text{inf}}(y) \\ \mathcal{I}[F]_{\text{sup}}(x) = \mathcal{I}[F]_{\text{sup}}(0) \end{array} \right. \quad (3.9)$$

for all $x, y \in X$ with $x \leq y$.

Proposition 3.15. Every $(T(1, 4), I(1, 4), F(1, 4))$ -interval neutrosophic ideal $\mathcal{I} := (\mathcal{I}[T], \mathcal{I}[I], \mathcal{I}[F])$ of $(X, *, 0)$ satisfies

$$\left\{ \begin{array}{l} \mathcal{I}[T]_{\text{inf}}(x) \geq \min\{\mathcal{I}[T]_{\text{inf}}(y), \mathcal{I}[T]_{\text{inf}}(z)\} \\ \mathcal{I}[T]_{\text{sup}}(x) \leq \max\{\mathcal{I}[T]_{\text{sup}}(y), \mathcal{I}[T]_{\text{sup}}(z)\} \\ \mathcal{I}[I]_{\text{inf}}(x) \geq \min\{\mathcal{I}[I]_{\text{inf}}(y), \mathcal{I}[I]_{\text{inf}}(z)\} \\ \mathcal{I}[I]_{\text{sup}}(x) \leq \max\{\mathcal{I}[I]_{\text{sup}}(y), \mathcal{I}[I]_{\text{sup}}(z)\} \\ \mathcal{I}[F]_{\text{inf}}(x) \geq \min\{\mathcal{I}[F]_{\text{inf}}(y), \mathcal{I}[F]_{\text{inf}}(z)\} \\ \mathcal{I}[F]_{\text{sup}}(x) \leq \max\{\mathcal{I}[F]_{\text{sup}}(y), \mathcal{I}[F]_{\text{sup}}(z)\} \end{array} \right. \quad (3.10)$$

for all $x, y, z \in X$ with $x * y \leq z$.

Proof. Let $x, y, z \in X$ be such that $x * y \leq z$. Then $(x * y) * z = 0$,

$$\begin{aligned} \mathcal{I}[T]_{\text{inf}}(x) &\geq \min\{\mathcal{I}[T]_{\text{inf}}(x * y), \mathcal{I}[T]_{\text{inf}}(y)\} \\ &\geq \min\{\min\{\mathcal{I}[T]_{\text{inf}}((x * y) * z), \mathcal{I}[T]_{\text{inf}}(z)\}, \\ &\quad \mathcal{I}[T]_{\text{inf}}(y)\} \\ &= \min\{\min\{\mathcal{I}[T]_{\text{inf}}(0), \mathcal{I}[T]_{\text{inf}}(z)\}, \mathcal{I}[T]_{\text{inf}}(y)\} \\ &= \min\{\mathcal{I}[T]_{\text{inf}}(y), \mathcal{I}[T]_{\text{inf}}(z)\}, \end{aligned}$$

$$\begin{aligned} \mathcal{I}[T]_{\text{sup}}(x) &\leq \max\{\mathcal{I}[T]_{\text{sup}}(x * y), \mathcal{I}[T]_{\text{sup}}(y)\} \\ &\leq \max\{\max\{\mathcal{I}[T]_{\text{sup}}((x * y) * z), \mathcal{I}[T]_{\text{sup}}(z)\}, \\ &\quad \mathcal{I}[T]_{\text{sup}}(y)\} \\ &= \max\{\max\{\mathcal{I}[T]_{\text{sup}}(0), \mathcal{I}[T]_{\text{sup}}(z)\}, \mathcal{I}[T]_{\text{sup}}(y)\} \\ &= \max\{\mathcal{I}[T]_{\text{sup}}(y), \mathcal{I}[T]_{\text{sup}}(z)\}, \end{aligned}$$

$$\begin{aligned} \mathcal{I}[I]_{\text{inf}}(x) &\geq \min\{\mathcal{I}[I]_{\text{inf}}(x * y), \mathcal{I}[I]_{\text{inf}}(y)\} \\ &\geq \min\{\min\{\mathcal{I}[I]_{\text{inf}}((x * y) * z), \mathcal{I}[I]_{\text{inf}}(z)\}, \\ &\quad \mathcal{I}[I]_{\text{inf}}(y)\} \\ &= \min\{\min\{\mathcal{I}[I]_{\text{inf}}(0), \mathcal{I}[I]_{\text{inf}}(z)\}, \mathcal{I}[I]_{\text{inf}}(y)\} \\ &= \min\{\mathcal{I}[I]_{\text{inf}}(y), \mathcal{I}[I]_{\text{inf}}(z)\}, \end{aligned}$$

$$\begin{aligned} \mathcal{I}[I]_{\text{sup}}(x) &\leq \max\{\mathcal{I}[I]_{\text{sup}}(x * y), \mathcal{I}[I]_{\text{sup}}(y)\} \\ &\leq \max\{\max\{\mathcal{I}[I]_{\text{sup}}((x * y) * z), \mathcal{I}[I]_{\text{sup}}(z)\}, \\ &\quad \mathcal{I}[I]_{\text{sup}}(y)\} \\ &= \max\{\max\{\mathcal{I}[I]_{\text{sup}}(0), \mathcal{I}[I]_{\text{sup}}(z)\}, \mathcal{I}[I]_{\text{sup}}(y)\} \\ &= \max\{\mathcal{I}[I]_{\text{sup}}(y), \mathcal{I}[I]_{\text{sup}}(z)\}, \end{aligned}$$

$$\begin{aligned} \mathcal{I}[F]_{\text{inf}}(x) &\geq \min\{\mathcal{I}[F]_{\text{inf}}(x * y), \mathcal{I}[F]_{\text{inf}}(y)\} \\ &\geq \min\{\min\{\mathcal{I}[F]_{\text{inf}}((x * y) * z), \mathcal{I}[F]_{\text{inf}}(z)\}, \\ &\quad \mathcal{I}[F]_{\text{inf}}(y)\} \\ &= \min\{\min\{\mathcal{I}[F]_{\text{inf}}(0), \mathcal{I}[F]_{\text{inf}}(z)\}, \mathcal{I}[F]_{\text{inf}}(y)\} \\ &= \min\{\mathcal{I}[F]_{\text{inf}}(y), \mathcal{I}[F]_{\text{inf}}(z)\}, \end{aligned}$$

$$\begin{aligned} \mathcal{I}[F]_{\text{sup}}(x) &\leq \max\{\mathcal{I}[F]_{\text{sup}}(x * y), \mathcal{I}[F]_{\text{sup}}(y)\} \\ &\leq \max\{\max\{\mathcal{I}[F]_{\text{sup}}((x * y) * z), \mathcal{I}[F]_{\text{sup}}(z)\}, \\ &\quad \mathcal{I}[F]_{\text{sup}}(y)\} \\ &= \max\{\max\{\mathcal{I}[F]_{\text{sup}}(0), \mathcal{I}[F]_{\text{sup}}(z)\}, \mathcal{I}[F]_{\text{sup}}(y)\} \\ &= \max\{\mathcal{I}[F]_{\text{sup}}(y), \mathcal{I}[F]_{\text{sup}}(z)\}. \end{aligned}$$

This completes the proof. □

Using the similar way to the proof of Proposition 3.15, we have the following proposition.

Proposition 3.16. Given an interval neutrosophic set $\mathcal{I} := (\mathcal{I}[T], \mathcal{I}[I], \mathcal{I}[F])$ in $(X, *, 0)$, we have the following assertions:

(1) If $\mathcal{I} := (\mathcal{I}[T], \mathcal{I}[I], \mathcal{I}[F])$ is a $(T(1, 1), I(1, 1), F(1, 1))$ -

interval neutrosophic ideal of $(X, *, 0)$, then

$$\left\{ \begin{array}{l} \mathcal{I}[T]_{\text{inf}}(x) \geq \min\{\mathcal{I}[T]_{\text{inf}}(y), \mathcal{I}[T]_{\text{inf}}(z)\} \\ \mathcal{I}[T]_{\text{sup}}(x) \geq \max\{\mathcal{I}[T]_{\text{sup}}(y), \mathcal{I}[T]_{\text{sup}}(z)\} \\ \mathcal{I}[I]_{\text{inf}}(x) \geq \min\{\mathcal{I}[I]_{\text{inf}}(y), \mathcal{I}[I]_{\text{inf}}(z)\} \\ \mathcal{I}[I]_{\text{sup}}(x) \geq \max\{\mathcal{I}[I]_{\text{sup}}(y), \mathcal{I}[I]_{\text{sup}}(z)\} \\ \mathcal{I}[F]_{\text{inf}}(x) \geq \min\{\mathcal{I}[F]_{\text{inf}}(y), \mathcal{I}[F]_{\text{inf}}(z)\} \\ \mathcal{I}[F]_{\text{sup}}(x) \geq \max\{\mathcal{I}[F]_{\text{sup}}(y), \mathcal{I}[F]_{\text{sup}}(z)\} \end{array} \right.$$

for all $x, y, z \in X$ with $x * y \leq z$.

(2) If $\mathcal{I} := (\mathcal{I}[T], \mathcal{I}[I], \mathcal{I}[F])$ is a $(T(4, 1), I(4, 1), F(4, 1))$ -interval neutrosophic ideal of $(X, *, 0)$, then

$$\left\{ \begin{array}{l} \mathcal{I}[T]_{\text{inf}}(x) \leq \min\{\mathcal{I}[T]_{\text{inf}}(y), \mathcal{I}[T]_{\text{inf}}(z)\} \\ \mathcal{I}[T]_{\text{sup}}(x) \geq \max\{\mathcal{I}[T]_{\text{sup}}(y), \mathcal{I}[T]_{\text{sup}}(z)\} \\ \mathcal{I}[I]_{\text{inf}}(x) \leq \min\{\mathcal{I}[I]_{\text{inf}}(y), \mathcal{I}[I]_{\text{inf}}(z)\} \\ \mathcal{I}[I]_{\text{sup}}(x) \geq \max\{\mathcal{I}[I]_{\text{sup}}(y), \mathcal{I}[I]_{\text{sup}}(z)\} \\ \mathcal{I}[F]_{\text{inf}}(x) \leq \min\{\mathcal{I}[F]_{\text{inf}}(y), \mathcal{I}[F]_{\text{inf}}(z)\} \\ \mathcal{I}[F]_{\text{sup}}(x) \geq \max\{\mathcal{I}[F]_{\text{sup}}(y), \mathcal{I}[F]_{\text{sup}}(z)\} \end{array} \right.$$

for all $x, y, z \in X$ with $x * y \leq z$.

(3) If $\mathcal{I} := (\mathcal{I}[T], \mathcal{I}[I], \mathcal{I}[F])$ is a $(T(4, 4), I(4, 4), F(4, 4))$ -interval neutrosophic ideal of $(X, *, 0)$, then

$$\left\{ \begin{array}{l} \mathcal{I}[T]_{\text{inf}}(x) \leq \min\{\mathcal{I}[T]_{\text{inf}}(y), \mathcal{I}[T]_{\text{inf}}(z)\} \\ \mathcal{I}[T]_{\text{sup}}(x) \leq \max\{\mathcal{I}[T]_{\text{sup}}(y), \mathcal{I}[T]_{\text{sup}}(z)\} \\ \mathcal{I}[I]_{\text{inf}}(x) \leq \min\{\mathcal{I}[I]_{\text{inf}}(y), \mathcal{I}[I]_{\text{inf}}(z)\} \\ \mathcal{I}[I]_{\text{sup}}(x) \leq \max\{\mathcal{I}[I]_{\text{sup}}(y), \mathcal{I}[I]_{\text{sup}}(z)\} \\ \mathcal{I}[F]_{\text{inf}}(x) \leq \min\{\mathcal{I}[F]_{\text{inf}}(y), \mathcal{I}[F]_{\text{inf}}(z)\} \\ \mathcal{I}[F]_{\text{sup}}(x) \leq \max\{\mathcal{I}[F]_{\text{sup}}(y), \mathcal{I}[F]_{\text{sup}}(z)\} \end{array} \right.$$

for all $x, y, z \in X$ with $x * y \leq z$.

Proposition 3.17. For every $(i, j) \in \{(2, 2), (2, 3), (3, 2), (3, 3)\}$, Every $(T(i, j), I(i, j), F(i, j))$ -interval neutrosophic ideal $\mathcal{I} := (\mathcal{I}[T], \mathcal{I}[I], \mathcal{I}[F])$ of $(X, *, 0)$ satisfies

$$\left\{ \begin{array}{l} \mathcal{I}[T]_{\text{inf}}(x) = \mathcal{I}[T]_{\text{inf}}(0) \\ \mathcal{I}[T]_{\text{sup}}(x) = \mathcal{I}[T]_{\text{sup}}(0) \\ \mathcal{I}[I]_{\text{inf}}(x) = \mathcal{I}[I]_{\text{inf}}(0) \\ \mathcal{I}[I]_{\text{sup}}(x) = \mathcal{I}[I]_{\text{sup}}(0) \\ \mathcal{I}[F]_{\text{inf}}(x) = \mathcal{I}[F]_{\text{inf}}(0) \\ \mathcal{I}[F]_{\text{sup}}(x) = \mathcal{I}[F]_{\text{sup}}(0) \end{array} \right. \quad (3.11)$$

for all $x, y, z \in X$ with $x * y \leq z$.

Proof. Assume that $\mathcal{I} := (\mathcal{I}[T], \mathcal{I}[I], \mathcal{I}[F])$ is a $(T(2, 3), I(2, 3), F(2, 3))$ -interval neutrosophic ideal of $(X, *, 0)$. Then $(X, \mathcal{I}[T]_{\text{inf}})$, $(X, \mathcal{I}[I]_{\text{inf}})$ and $(X, \mathcal{I}[F]_{\text{inf}})$ are 2-fuzzy ideals of

$(X, *, 0)$, and $(X, \mathcal{I}[T]_{\text{sup}})$, $(X, \mathcal{I}[I]_{\text{sup}})$ and $(X, \mathcal{I}[F]_{\text{sup}})$ are 3-fuzzy ideals of $(X, *, 0)$. Let $x, y, z \in X$ be such that $x * y \leq z$. Then $(x * y) * z = 0$, and thus

$$\begin{aligned} \mathcal{I}[T]_{\text{inf}}(x) &\leq \min\{\mathcal{I}[T]_{\text{inf}}(x * y), \mathcal{I}[T]_{\text{inf}}(y)\} \\ &\leq \min\{\min\{\mathcal{I}[T]_{\text{inf}}((x * y) * z), \mathcal{I}[T]_{\text{inf}}(z)\}, \\ &\quad \mathcal{I}[T]_{\text{inf}}(y)\} \\ &= \min\{\min\{\mathcal{I}[T]_{\text{inf}}(0), \mathcal{I}[T]_{\text{inf}}(z)\}, \mathcal{I}[T]_{\text{inf}}(y)\} \\ &= \mathcal{I}[T]_{\text{inf}}(0), \end{aligned}$$

$$\begin{aligned} \mathcal{I}[T]_{\text{sup}}(x) &\geq \max\{\mathcal{I}[T]_{\text{sup}}(x * y), \mathcal{I}[T]_{\text{sup}}(y)\} \\ &\geq \max\{\max\{\mathcal{I}[T]_{\text{sup}}((x * y) * z), \mathcal{I}[T]_{\text{sup}}(z)\}, \\ &\quad \mathcal{I}[T]_{\text{sup}}(y)\} \\ &= \max\{\max\{\mathcal{I}[T]_{\text{sup}}(0), \mathcal{I}[T]_{\text{sup}}(z)\}, \mathcal{I}[T]_{\text{sup}}(y)\} \\ &= \mathcal{I}[T]_{\text{sup}}(0), \end{aligned}$$

$$\begin{aligned} \mathcal{I}[I]_{\text{inf}}(x) &\leq \min\{\mathcal{I}[I]_{\text{inf}}(x * y), \mathcal{I}[I]_{\text{inf}}(y)\} \\ &\leq \min\{\min\{\mathcal{I}[I]_{\text{inf}}((x * y) * z), \mathcal{I}[I]_{\text{inf}}(z)\}, \\ &\quad \mathcal{I}[I]_{\text{inf}}(y)\} \\ &= \min\{\min\{\mathcal{I}[I]_{\text{inf}}(0), \mathcal{I}[I]_{\text{inf}}(z)\}, \mathcal{I}[I]_{\text{inf}}(y)\} \\ &= \mathcal{I}[I]_{\text{inf}}(0), \end{aligned}$$

$$\begin{aligned} \mathcal{I}[I]_{\text{sup}}(x) &\geq \max\{\mathcal{I}[I]_{\text{sup}}(x * y), \mathcal{I}[I]_{\text{sup}}(y)\} \\ &\geq \max\{\max\{\mathcal{I}[I]_{\text{sup}}((x * y) * z), \mathcal{I}[I]_{\text{sup}}(z)\}, \\ &\quad \mathcal{I}[I]_{\text{sup}}(y)\} \\ &= \max\{\max\{\mathcal{I}[I]_{\text{sup}}(0), \mathcal{I}[I]_{\text{sup}}(z)\}, \mathcal{I}[I]_{\text{sup}}(y)\} \\ &= \mathcal{I}[I]_{\text{sup}}(0), \end{aligned}$$

$$\begin{aligned} \mathcal{I}[F]_{\text{inf}}(x) &\leq \min\{\mathcal{I}[F]_{\text{inf}}(x * y), \mathcal{I}[F]_{\text{inf}}(y)\} \\ &\leq \min\{\min\{\mathcal{I}[F]_{\text{inf}}((x * y) * z), \mathcal{I}[F]_{\text{inf}}(z)\}, \\ &\quad \mathcal{I}[F]_{\text{inf}}(y)\} \\ &= \min\{\min\{\mathcal{I}[F]_{\text{inf}}(0), \mathcal{I}[F]_{\text{inf}}(z)\}, \mathcal{I}[F]_{\text{inf}}(y)\} \\ &= \mathcal{I}[F]_{\text{inf}}(0), \end{aligned}$$

$$\begin{aligned} \mathcal{I}[F]_{\text{sup}}(x) &\geq \max\{\mathcal{I}[F]_{\text{sup}}(x * y), \mathcal{I}[F]_{\text{sup}}(y)\} \\ &\geq \max\{\max\{\mathcal{I}[F]_{\text{sup}}((x * y) * z), \mathcal{I}[F]_{\text{sup}}(z)\}, \\ &\quad \mathcal{I}[F]_{\text{sup}}(y)\} \\ &= \max\{\max\{\mathcal{I}[F]_{\text{sup}}(0), \mathcal{I}[F]_{\text{sup}}(z)\}, \mathcal{I}[F]_{\text{sup}}(y)\} \\ &= \mathcal{I}[F]_{\text{sup}}(0). \end{aligned}$$

Since $\mathcal{I}[T]_{\text{inf}}(0) \leq \mathcal{I}[T]_{\text{inf}}(x)$, $\mathcal{I}[T]_{\text{sup}}(0) \geq \mathcal{I}[T]_{\text{sup}}(x)$, $\mathcal{I}[I]_{\text{inf}}(0) \leq \mathcal{I}[I]_{\text{inf}}(x)$, $\mathcal{I}[I]_{\text{sup}}(0) \geq \mathcal{I}[I]_{\text{sup}}(x)$, $\mathcal{I}[F]_{\text{inf}}(0) \leq \mathcal{I}[F]_{\text{inf}}(x)$ and $\mathcal{I}[F]_{\text{sup}}(0) \geq \mathcal{I}[F]_{\text{sup}}(x)$, it follows that $\mathcal{I}[T]_{\text{inf}}(0) = \mathcal{I}[T]_{\text{inf}}(x)$, $\mathcal{I}[T]_{\text{sup}}(0) = \mathcal{I}[T]_{\text{sup}}(x)$, $\mathcal{I}[I]_{\text{inf}}(0) = \mathcal{I}[I]_{\text{inf}}(x)$, $\mathcal{I}[I]_{\text{sup}}(0) = \mathcal{I}[I]_{\text{sup}}(x)$, $\mathcal{I}[F]_{\text{inf}}(0) = \mathcal{I}[F]_{\text{inf}}(x)$, $\mathcal{I}[F]_{\text{sup}}(0) = \mathcal{I}[F]_{\text{sup}}(x)$.

$\mathcal{I}[F]_{\text{inf}}(x)$ and $\mathcal{I}[F]_{\text{sup}}(0) = \mathcal{I}[F]_{\text{sup}}(x)$. Similarly, we can verify that (3.11) is true for $(i, j) \in \{(2, 2), (3, 2), (3, 3)\}$. \square

Using the similar way to the proof of Propositions 3.15 and 3.17, we have the following proposition.

Proposition 3.18. *Given an interval neutrosophic set $\mathcal{I} := (\mathcal{I}[T], \mathcal{I}[I], \mathcal{I}[F])$ in $(X, *, 0)$, we have the following assertions:*

(1) *If $\mathcal{I} := (\mathcal{I}[T], \mathcal{I}[I], \mathcal{I}[F])$ is a $(T(1, j), I(1, j), F(1, j))$ -interval neutrosophic ideal of $(X, *, 0)$ for $j \in \{2, 3\}$, then*

$$\left\{ \begin{array}{l} \mathcal{I}[T]_{\text{inf}}(x) \geq \min\{\mathcal{I}[T]_{\text{inf}}(y), \mathcal{I}[T]_{\text{inf}}(z)\} \\ \mathcal{I}[T]_{\text{sup}}(x) = \mathcal{I}[T]_{\text{sup}}(0) \\ \mathcal{I}[I]_{\text{inf}}(x) \geq \min\{\mathcal{I}[I]_{\text{inf}}(y), \mathcal{I}[I]_{\text{inf}}(z)\} \\ \mathcal{I}[I]_{\text{sup}}(x) = \mathcal{I}[I]_{\text{sup}}(0) \\ \mathcal{I}[F]_{\text{inf}}(x) \geq \min\{\mathcal{I}[F]_{\text{inf}}(y), \mathcal{I}[F]_{\text{inf}}(z)\} \\ \mathcal{I}[F]_{\text{sup}}(x) = \mathcal{I}[F]_{\text{sup}}(0) \end{array} \right.$$

for all $x, y, z \in X$ with $x * y \leq z$.

(2) *If $\mathcal{I} := (\mathcal{I}[T], \mathcal{I}[I], \mathcal{I}[F])$ is a $(T(i, 1), I(i, 1), F(i, 1))$ -interval neutrosophic ideal of $(X, *, 0)$ for $i \in \{2, 3\}$, then*

$$\left\{ \begin{array}{l} \mathcal{I}[T]_{\text{inf}}(x) = \mathcal{I}[T]_{\text{inf}}(0) \\ \mathcal{I}[T]_{\text{sup}}(x) \geq \min\{\mathcal{I}[T]_{\text{sup}}(y), \mathcal{I}[T]_{\text{sup}}(z)\} \\ \mathcal{I}[I]_{\text{inf}}(x) = \mathcal{I}[I]_{\text{inf}}(0) \\ \mathcal{I}[I]_{\text{sup}}(x) \geq \min\{\mathcal{I}[I]_{\text{sup}}(y), \mathcal{I}[I]_{\text{sup}}(z)\} \\ \mathcal{I}[F]_{\text{inf}}(x) = \mathcal{I}[F]_{\text{inf}}(0) \\ \mathcal{I}[F]_{\text{sup}}(x) \geq \min\{\mathcal{I}[F]_{\text{sup}}(y), \mathcal{I}[F]_{\text{sup}}(z)\} \end{array} \right.$$

for all $x, y, z \in X$ with $x * y \leq z$.

(3) *If $\mathcal{I} := (\mathcal{I}[T], \mathcal{I}[I], \mathcal{I}[F])$ is a $(T(i, 4), I(i, 4), F(i, 4))$ -interval neutrosophic ideal of $(X, *, 0)$ for $i \in \{2, 3\}$, then*

$$\left\{ \begin{array}{l} \mathcal{I}[T]_{\text{inf}}(x) = \mathcal{I}[T]_{\text{inf}}(0) \\ \mathcal{I}[T]_{\text{sup}}(x) \leq \max\{\mathcal{I}[T]_{\text{sup}}(y), \mathcal{I}[T]_{\text{sup}}(z)\} \\ \mathcal{I}[I]_{\text{inf}}(x) = \mathcal{I}[I]_{\text{inf}}(0) \\ \mathcal{I}[I]_{\text{sup}}(x) \leq \max\{\mathcal{I}[I]_{\text{sup}}(y), \mathcal{I}[I]_{\text{sup}}(z)\} \\ \mathcal{I}[F]_{\text{inf}}(x) = \mathcal{I}[F]_{\text{inf}}(0) \\ \mathcal{I}[F]_{\text{sup}}(x) \leq \max\{\mathcal{I}[F]_{\text{sup}}(y), \mathcal{I}[F]_{\text{sup}}(z)\} \end{array} \right.$$

for all $x, y, z \in X$ with $x * y \leq z$.

(4) *If $\mathcal{I} := (\mathcal{I}[T], \mathcal{I}[I], \mathcal{I}[F])$ is a $(T(4, j), I(4, j), F(4, j))$ -interval neutrosophic ideal of $(X, *, 0)$ for $j \in \{2, 3\}$, then*

$$\left\{ \begin{array}{l} \mathcal{I}[T]_{\text{inf}}(x) \leq \max\{\mathcal{I}[T]_{\text{inf}}(y), \mathcal{I}[T]_{\text{inf}}(z)\} \\ \mathcal{I}[T]_{\text{sup}}(x) = \mathcal{I}[T]_{\text{sup}}(0) \\ \mathcal{I}[I]_{\text{inf}}(x) \leq \max\{\mathcal{I}[I]_{\text{inf}}(y), \mathcal{I}[I]_{\text{inf}}(z)\} \\ \mathcal{I}[I]_{\text{sup}}(x) = \mathcal{I}[I]_{\text{sup}}(0) \\ \mathcal{I}[F]_{\text{inf}}(x) \leq \max\{\mathcal{I}[F]_{\text{inf}}(y), \mathcal{I}[F]_{\text{inf}}(z)\} \\ \mathcal{I}[F]_{\text{sup}}(x) = \mathcal{I}[F]_{\text{sup}}(0) \end{array} \right.$$

for all $x, y, z \in X$ with $x * y \leq z$.

4 Acknowledgments

The first author, S.Z. Song, was supported by Basic Science Research Program through the National Research Foundation of Korea (NRF) funded by the Ministry of Education (No. 2016R1D1A1B02006812).

References

- [1] K. Atanassov, Intuitionistic fuzzy sets, *Fuzzy Sets and Systems* 20 (1986) 87–96.
- [2] Y.S. Huang, *BCI-algebra*, Science Press, Beijing, 2006.
- [3] Y. Imai and K. Iséki, On axiom systems of propositional calculi, *Proc. Japan Acad.* 42 (1966) 19–21.
- [4] K. Iséki, An algebra related with a propositional calculus, *Proc. Japan Acad.* 42 (1966) 26–29.
- [5] Y.B. Jun, S.J. Kim and F. Smarandache, Interval neutrosophic sets with applications in *BCK/BCI-algebras*, *New Mathematics & Natural Computation* (submitted).
- [6] J. Meng and Y.B. Jun, *BCK-algebras*, Kyungmoon Sa Co., Seoul, 1994.
- [7] F. Smarandache, *Neutrosophy, Neutrosophic Probability, Set, and Logic*, ProQuest Information & Learning, Ann Arbor, Michigan, USA, 105 p., 1998. <http://fs.gallup.unm.edu/eBook-neutrosophics6.pdf> (last edition online).
- [8] F. Smarandache, *A Unifying Field in Logics: Neutrosophic Logic. Neutrosophy, Neutrosophic Set, Neutrosophic Probability*, (American Research Press, Rehoboth, NM, 1999).
- [9] F. Smarandache, Neutrosophic set-a generalization of the intuitionistic fuzzy set, *Int. J. Pure Appl. Math.* 24(3) (2005) 287–297.
- [10] S.Z. Song, S.J. Kim and Y.B. Jun, Hyperfuzzy ideals in *BCK/BCI-algebras*, *Mathematics* 2017, 5, 81.
- [11] H. Wang, F. Smarandache, Y.Q. Zhang and R. Sunderraman, *Interval Neutrosophic Sets and Logic: Theory and Applications in Computing*, Hexis; Neutrosophic book series, No. 5, 2005.
- [12] H. Wang, F. Smarandache, Y.Q. Zhang and R. Sunderraman, *Interval Neutrosophic Sets and Logic: Theory and Applications in Computing*, (Hexis, Phoenix, Ariz, USA, 2005).
- [13] H. Wang, Y. Zhang and R. Sunderraman, Truth-value based interval neutrosophic sets, *Granular Computing*, 2005 IEEE International Conference, 1(2005) 274–277 DOI: 10.1109/GRC.2005.1547284.
- [14] L.A. Zadeh, Fuzzy sets, *Information and Control* 8 (1965) 338–353.

Bipolar Complex Neutrosophic Graphs of Type 1

Said Broumi, Assia Bakali, Mohamed Talea, Florentin Smarandache, V. Venkateswara Rao

Said Broumi, Assia Bakali, Mohamed Talea, Florentin Smarandache, V. Venkateswara Rao (2018). Bipolar Complex Neutrosophic Graphs of Type 1. In *New Trends in Neutrosophic Theory and Applications*, vol. II, eds.: Florentin Smarandache, Surapati Pramanik, 189-209

ABSTRACT

In this paper, we introduced a new neutrosophic graphs called bipolar complex neutrosophic graphs of type 1 (BCNG1) and presented a matrix representation for it and studied some properties of this new concept. The concept of BCNG1 is an extension of generalized fuzzy graphs of type 1 (GFG1), generalized single valued neutrosophic graphs of type 1 (GSVNG1), Generalized bipolar neutrosophic graphs of type 1 (GBNG1) and complex neutrosophic graph of type 1 (CNG1).

KEYWORDS: Bipolar complex neutrosophic set; Bipolar complex neutrosophic graph of type 1; Matrix representation.

1. INTRODUCTION

In 1998, (Smarandache, 1998), introduced a new theory called Neutrosophy, which is basically a branch of philosophy that focus on the origin, nature, and scope of neutralities and their interactions with different ideational spectra. Based on the neutrosophy, Smarandache defined the concept of neutrosophic set which is characterized by a degree of truth membership T , a degree of indeterminate- membership I and a degree false-membership F . The concept of neutrosophic set theory is a generalization of the concept of classical sets, fuzzy sets (Zadeh, 1965), intuitionistic fuzzy sets (Atanassov, 1986), interval-valued fuzzy sets (Turksen, 1986). Neutrosophic sets is mathematical tool used to handle problems like imprecision, indeterminacy and inconsistency of data. Specially, the indeterminacy presented in the neutrosophic sets is independent on the truth and falsity values. To easily apply the neutrosophic sets to real scientific and engineering areas, (Smarandache, 1998) proposed the single valued neutrosophic sets as subclass of neutrosophic sets. Later on, (Wang et al., 2010) provided the set-theoretic operators and various properties of single valued neutrosophic sets. The concept of neutrosophic sets and their extensions such as bipolar neutrosophic sets, complex neutrosophic sets, bipolar complex neutrosophic sets (Broumi et al.2017) and so on have been applied successfully in several fields (<http://fs.gallup.unm.edu/NSS/>).

Graphs are the most powerful tool used in representing information involving relationship between objects and concepts. In a crisp graphs two vertices are either related or not related to each other, mathematically, the degree of relationship is either 0 or 1. While in fuzzy graphs, the degree of relationship takes values from $[0, 1]$. In (Shannon and Atanassov, 1994) introduced the concept of intuitionistic fuzzy graphs (IFGs) using five types of Cartesian products. The concept fuzzy graphs and their extensions have a common property that each edge must have a membership value less than or equal to the minimum membership of the nodes it connects.

When description of the object or their relations or both is indeterminate and inconsistent, it cannot be handled by fuzzy graphs and their particular types (Sharma et al., 2013; Arindam et al., 2012, 2013). So, for this reason, (Smarandache, 2015) proposed the concept of neutrosophic graphs based on literal indeterminacy (I) to deal with such situations. Then, (Smarandache, 2015, 2015a) introduced another version of neutrosophic graph theory using the neutrosophic truth-values (T, I, F) and proposed three structures of neutrosophic graphs: neutrosophic edge graphs, neutrosophic vertex graphs and neutrosophic vertex-edge graphs. Later on (Smarandache, 2016) proposed new version of neutrosophic graphs such as neutrosophic offgraph, neutrosophic bipolar/tripolar/multipolar graph. Presently, works on neutrosophic vertex-edge graphs and neutrosophic edge graphs are progressing rapidly. (Broumi et al., 2016) combined the concept of single valued neutrosophic sets and graph theory, and introduced certain types of single valued neutrosophic graphs (SVNG) such as strong single valued neutrosophic graph, constant single valued neutrosophic graph, complete single valued neutrosophic graph and investigate some of their properties with proofs and examples. Also, (Broumi et al., 2016a) also introduced neighborhood degree of a vertex and closed neighborhood degree of vertex in single valued neutrosophic graph as a generalization of neighborhood degree of a vertex and closed neighborhood degree of vertex in fuzzy graph and intuitionistic fuzzy graph. In addition, (Broumi et al., 2016b) proved a necessary and sufficient condition for a single valued neutrosophic graph to be an isolated single valued neutrosophic graph. After Broumi, the studies on the single valued neutrosophic graph theory have been studied increasingly (Broumi et al., 2016c, 2016d, 2016e, 2016g, 2016h, 2016i; Samanta et al., 2016; Mehra, 2017; Ashraf et al., 2016; Fathi et al., 2016)

Recently, (Smarandache, 2017) initiated the idea of removal of the edge degree restriction of fuzzy graphs, intuitionistic fuzzy graphs and single valued neutrosophic graphs. (Samanta et al., 2016) introduced a new concept named the generalized fuzzy graphs (GFG) and defined two types of GFG, also the authors studied some major properties such as completeness and regularity with proved results. In this paper, the authors claims that fuzzy graphs and their extension defined by many researches are limited to represent for some systems such as social network. Later on (Broumi et al., 2017) have discussed the removal of the edge degree restriction of single valued neutrosophic graphs and defined a new class of single valued neutrosophic graph called generalized single valued neutrosophic graph of type 1, which is an extension of generalized fuzzy graph of type 1 (Samanta et al., 2016). Later on (Broumi et al., 2017a) introduced the concept of generalized bipolar neutrosophic of type 1. In addition, (Broumi et al., 2017b) combined the concept of complex neutrosophic sets with generalized single valued neutrosophic of type 1 (GSVNG1) and introduced the complex neutrosophic graph of type 1 (CNG1). Up to day, to our best knowledge, there is no research on bipolar complex neutrosophic graphs.

The main objective of this paper is to extend the concept of complex neutrosophic graph of type 1 (CNG1) introduced in (Broumi et al., 2017b) to bipolar complex neutrosophic graphs of type 1 and showed a matrix representation of BCNG1.

The remainder of this paper is organized as follows. In Section 2, we review some basic concepts about neutrosophic sets, single valued neutrosophic sets, complex neutrosophic sets, bipolar complex neutrosophic sets, generalized fuzzy graph, generalized single valued neutrosophic graphs of type 1, generalized bipolar neutrosophic graphs of type 1 and complex neutrosophic graph of type 1. In Section 3, the concept of complex neutrosophic graphs of type 1 is proposed with an illustrative example. In section 4 a representation matrix of complex neutrosophic graphs of type 1 is introduced. Finally, Section 5 outlines the conclusion of this paper and suggests several directions for future research.

2. PRELIMINARIES

In this section, we mainly recall some notions related to neutrosophic sets, single valued neutrosophic sets, complex neutrosophic sets, bipolar complex neutrosophic sets, generalized fuzzy graph, generalized single valued neutrosophic graphs of type 1, generalized bipolar neutrosophic graphs of type 1 and complex neutrosophic graph of type 1 relevant to the present work. See especially (Smarandache, 1998; Wang et al. 2010; Deli et al., 2015; Ali and Smarandache, 2015; Broumi et al., 2017, 2017b, 2017c; Samanta et al. 2016) for further details and background.

Definition 2.1 (Smarandache, 1998). Let X be a space of points and let $x \in X$. A neutrosophic set A in X is characterized by a truth membership function T , an indeterminacy membership function I , and a falsity membership function F . T, I, F are real standard or nonstandard subsets of $]^{-0}, 1^{+}[$, and $T, I, F: X \rightarrow]^{-0}, 1^{+}[$. The neutrosophic set can be represented as

$$A = \{(x, T_A(x), I_A(x), F_A(x)) : x \in X\} \quad (1)$$

There is no restriction on the sum of T, I, F , So

$$^{-0} \leq T_A(x) + I_A(x) + F_A(x) \leq 3^{+}. \quad (2)$$

From philosophical point of view, the neutrosophic set takes the value from real standard or non-standard subsets of $]^{-0}, 1^{+}[$. Thus it is necessary to take the interval $[0, 1]$ instead of $]^{-0}, 1^{+}[$. For technical applications. It is difficult to apply $]^{-0}, 1^{+}[$ in the real life applications such as engineering and scientific problems.

Definition 2.2 (Wang et al. 2010). Let X be a space of points (objects) with generic elements in X denoted by x . A single valued neutrosophic set A (SVNS A) is characterized by truth-membership function $T_A(x)$, an indeterminate-membership function $I_A(x)$, and a false-membership function $F_A(x)$. For each point x in X , $T_A(x), I_A(x), F_A(x) \in [0, 1]$. A SVNS A can be written as

$$A = \{(x, T_A(x), I_A(x), F_A(x)) : x \in X\} \quad (3)$$

Definition 2.3 (Deli et al., 2015). A bipolar neutrosophic set A in X is defined as an object of the form

$A = \{ \langle x, (T_A^+(x), I_A^+(x), F_A^+(x), T_A^-(x), I_A^-(x), F_A^-(x)) \rangle : x \in X \}$, where $T_A^+, I_A^+, F_A^+ : X \rightarrow [1, 0]$ and $T_A^-, I_A^-, F_A^- : X \rightarrow [-1, 0]$. The positive membership degree $T_A^+(x), I_A^+(x), F_A^+(x)$ denotes the truth membership, indeterminate membership and false membership of an element $\in X$ corresponding to a bipolar neutrosophic set A and the negative membership degree $T_A^-(x), I_A^-(x), F_A^-(x)$ denotes the truth membership, indeterminate membership and false membership of an element $\in X$ to some implicit counter-property corresponding to a bipolar neutrosophic set A . For convenience a bipolar neutrosophic number is represented by

$$A = \langle (T_A^+, I_A^+, F_A^+, T_A^-, I_A^-, F_A^-) \rangle \quad (4)$$

Definition 2.4 (Ali and Smarandache, 2015)

A complex neutrosophic set A defined on a universe of discourse X , which is characterized by a truth membership function $T_A(x)$, an indeterminacy membership function $I_A(x)$, and a falsity membership function $F_A(x)$ that assigns a complex-valued grade of $T_A(x), I_A(x)$, and $F_A(x)$ in A for any $x \in X$. The values $T_A(x), I_A(x)$, and $F_A(x)$ and their sum may all within the unit circle in the complex plane and so is of the following form,

$$T_A(x) = p_A(x) \cdot e^{j\mu_A(x)},$$

$$I_A(x) = q_A(x) \cdot e^{j\nu_A(x)} \text{ and}$$

$$F_A(x) = r_A(x) \cdot e^{j\omega_A(x)}$$

Where, $p_A(x), q_A(x), r_A(x)$ and $\mu_A(x), \nu_A(x), \omega_A(x)$ are respectively, real valued and $p_A(x), q_A(x), r_A(x) \in [0, 1]$ such that

$$0 \leq p_A(x) + q_A(x) + r_A(x) \leq 3$$

The complex neutrosophic set A can be represented in set form as

$$A = \left\{ (x, T_A(x) = a_T, I_A(x) = a_I, F_A(x) = a_F) : x \in X \right\}$$

where $T_A: X \rightarrow \{a_T: a_T \in \mathbb{C}, |a_T| \leq 1\}$,

$I_A: X \rightarrow \{a_I: a_I \in \mathbb{C}, |a_I| \leq 1\}$,

$F_A: X \rightarrow \{a_F: a_F \in \mathbb{C}, |a_F| \leq 1\}$ and

$$|T_A(x) + I_A(x) + F_A(x)| \leq 3.$$

Definition 2.5 (Ali and Smarandache, 2015) The union of two complex neutrosophic sets as follows:

Let A and B be two complex neutrosophic sets in X, where $A = \{(x, T_A(x), I_A(x), F_A(x)) : x \in X\}$ and

$$B = \{(x, T_B(x), I_B(x), F_B(x)) : x \in X\}.$$

Then, the union of A and B is denoted as $A \cup_N B$ and is given as

$$A \cup_N B = \{(x, T_{A \cup B}(x), I_{A \cup B}(x), F_{A \cup B}(x)) : x \in X\}$$

Where the truth membership function $T_{A \cup B}(x)$, the indeterminacy membership function $I_{A \cup B}(x)$ and the falsehood membership function $F_{A \cup B}(x)$ is defined by

$$T_{A \cup B}(x) = [(p_A(x) \vee p_B(x))] \cdot e^{j\mu_{T_{A \cup B}}(x)},$$

$$I_{A \cup B}(x) = [(q_A(x) \wedge q_B(x))] \cdot e^{j\nu_{I_{A \cup B}}(x)},$$

$$F_{A \cup B}(x) = [(r_A(x) \wedge r_B(x))] \cdot e^{j\omega_{F_{A \cup B}}(x)}$$

Where \vee and \wedge denotes the max and min operators respectively.

The phase term of complex truth membership function, complex indeterminacy membership function and complex falsity membership function belongs to $(0, 2\pi)$ and, they are defined as follows:

a) Sum:

$$\mu_{A \cup B}(x) = \mu_A(x) + \mu_B(x),$$

$$\nu_{A \cup B}(x) = \nu_A(x) + \nu_B(x),$$

$$\omega_{A \cup B}(x) = \omega_A(x) + \omega_B(x).$$

b) Max:

$$\mu_{A \cup B}(x) = \max(\mu_A(x), \mu_B(x)),$$

$$\nu_{A \cup B}(x) = \max(\nu_A(x), \nu_B(x)),$$

$$\omega_{A \cup B}(x) = \max(\omega_A(x), \omega_B(x)).$$

c) Min:

$$\mu_{A \cup B}(x) = \min(\mu_A(x), \mu_B(x)),$$

$$v_{A \cup B}(x) = \min(v_A(x), v_B(x)),$$

$$\omega_{A \cup B}(x) = \min(\omega_A(x), \omega_B(x)).$$

d) “The game of winner, neutral, and loser”:

$$\mu_{A \cup B}(x) = \begin{cases} \mu_A(x) & \text{if } p_A > p_B \\ \mu_B(x) & \text{if } p_B > p_A \end{cases},$$

$$v_{A \cup B}(x) = \begin{cases} v_A(x) & \text{if } q_A < q_B \\ v_B(x) & \text{if } q_B < q_A \end{cases},$$

$$\omega_{A \cup B}(x) = \begin{cases} \omega_A(x) & \text{if } r_A < r_B \\ \omega_B(x) & \text{if } r_B < r_A \end{cases}.$$

The game of winner, neutral, and loser is the generalization of the concept “winner take all” introduced by Ramot et al. in (2002) for the union of phase terms.

Definition 2.6 (Ali and Smarandache, 2015) Intersection of complex neutrosophic sets

Let A and B be two complex neutrosophic sets in X, $A = \{(x, T_A(x), I_A(x), F_A(x)) : x \in X\}$ and $B = \{(x, T_B(x), I_B(x), F_B(x)) : x \in X\}$.

Then the intersection of A and B is denoted as $A \cap_N B$ and is define as

$$A \cap_N B = \{(x, T_{A \cap B}(x), I_{A \cap B}(x), F_{A \cap B}(x)) : x \in X\}$$

Where the truth membership function $T_{A \cap B}(x)$, the indeterminacy membership function $I_{A \cap B}(x)$ and the falsehood membership function $F_{A \cap B}(x)$ is given as:

$$T_{A \cap B}(x) = [(p_A(x) \wedge p_B(x))] \cdot e^{j \cdot \mu_{T_{A \cap B}}(x)},$$

$$I_{A \cap B}(x) = [(q_A(x) \vee q_B(x))] \cdot e^{j \cdot \nu_{I_{A \cap B}}(x)},$$

$$F_{A \cap B}(x) = [(r_A(x) \vee r_B(x))] \cdot e^{j \cdot \omega_{F_{A \cap B}}(x)}$$

Where \vee and \wedge denotes denotes the max and min operators respectively

The phase terms $e^{j \cdot \mu_{T_{A \cap B}}(x)}$, $e^{j \cdot \nu_{I_{A \cap B}}(x)}$ and $e^{j \cdot \omega_{F_{A \cap B}}(x)}$ was calculated on the same lines by winner, neutral, and loser game.

Definition 2.7(Broumi et al., 2017c). A bipolar complex neutrosophic set A in X is defined as an object of the form

$A = \{ \langle x, T_1^+ e^{iT_2^+}, I_1^+ e^{iI_2^+}, F_1^+ e^{iF_2^+}, T_1^- e^{iT_2^-}, I_1^- e^{iI_2^-}, F_1^- e^{iF_2^-} \rangle : x \in X \}$, where $T_1^+, I_1^+, F_1^+ : X \rightarrow [1, 0]$ and $T_1^-, I_1^-, F_1^- : X \rightarrow [-1, 0]$. The positive membership degree $T_1^+(x), I_1^+(x), F_1^+(x)$ denotes the truth membership, indeterminate membership and false membership of an element $x \in X$ corresponding to a bipolar complex neutrosophic set A and the negative membership degree $T_1^-(x), I_1^-(x), F_1^-(x)$ denotes the truth membership, indeterminate membership and false membership of an element $x \in X$ to some implicit counter-property corresponding to a bipolar complex neutrosophic set A. For convenience a bipolar complex neutrosophic number is represented by

$$A = \langle T_1^+ e^{iT_2^+}, I_1^+ e^{iI_2^+}, F_1^+ e^{iF_2^+}, T_1^- e^{iT_2^-}, I_1^- e^{iI_2^-}, F_1^- e^{iF_2^-} \rangle$$

Definition 2.8 (Broumi et al., 2017c). The union of two bipolar complex neutrosophic sets as follows:

Let A and B be two bipolar complex neutrosophic sets in X, where

$A = (T_1^+ e^{iT_2^+}, I_1^+ e^{iI_2^+}, F_1^+ e^{iF_2^+}, T_1^- e^{iT_2^-}, I_1^- e^{iI_2^-}, F_1^- e^{iF_2^-})$ and

$$B = (T_3^+ e^{iT_4^+}, I_3^+ e^{iI_4^+}, F_3^+ e^{iF_4^+}, T_3^- e^{iT_4^-}, I_3^- e^{iI_4^-}, F_3^- e^{iF_4^-})$$

Then the union of A and B is denoted as $A \cup_{BN} B$ and is given as

$$A \cup_{BN} B = \left\{ (x, T_{A \cup B}^+(x), I_{A \cup B}^+(x), F_{A \cup B}^+(x), T_{A \cup B}^-(x), I_{A \cup B}^-(x), F_{A \cup B}^-(x)) : x \in X \right\}$$

Where positive the truth membership function $T_{A \cup B}^+(x)$, positive the indeterminacy membership function $I_{A \cup B}^+(x)$ and positive the falsehood membership function $F_{A \cup B}^+(x)$, negative the truth membership function $T_{A \cup B}^-(x)$, negative the indeterminacy membership function $I_{A \cup B}^-(x)$ and negative the falsehood membership function $F_{A \cup B}^-(x)$ is defined by

$$T_{A \cup B}^+(x) = (T_1^+ \vee T_3^+) e^{i(T_2^+ \cup T_4^+)},$$

$$T_{A \cup B}^-(x) = (T_1^- \wedge T_3^-) e^{i(T_2^- \cup T_4^-)},$$

$$I_{A \cup B}^+(x) = (I_1^+ \wedge I_3^+) e^{i(I_2^+ \cup I_4^+)},$$

$$T_{A \cup B}^-(x) = (I_1^- \vee I_3^-) e^{i(I_2^- \cup I_4^-)},$$

$$F_{A \cup B}^+(x) = (F_1^+ \wedge F_3^+) e^{i(F_2^+ \cup F_4^+)},$$

$$F_{A \cup B}^-(x) = (F_1^- \vee F_3^-) e^{i(F_2^- \cup F_4^-)}$$

Where \vee and \wedge denotes the max and min operators respectively

The phase term of bipolar complex truth membership function, bipolar complex indeterminate membership function and bipolar complex false -membership function belongs to $(0, 2\pi)$ and, they are defined as follows:

e) Sum:

$$T_{A \cup B}^+(x) = T_A^+(x) + T_B^+(x)$$

$$T_{A \cup B}^-(x) = T_A^-(x) + T_B^-(x)$$

$$I_{A \cup B}^+(x) = I_A^+(x) + I_B^+(x)$$

$$I_{A \cup B}^-(x) = I_A^-(x) + I_B^-(x)$$

$$F_{A \cup B}^+(x) = F_A^+(x) + F_B^+(x)$$

$$F_{A \cup B}^-(x) = F_A^-(x) + F_B^-(x)$$

f) Max and min:

$$T_{A \cup B}^+(x) = \max(T_A^+(x), T_B^+(x))$$

$$T_{A \cup B}^-(x) = \min(T_A^-(x), T_B^-(x))$$

$$I_{A \cup B}^+(x) = \min(I_A^+(x), I_B^+(x))$$

$$I_{A \cup B}^-(x) = \max(I_A^-(x), I_B^-(x))$$

$$F_{A \cup B}^+(x) = \min(F_A^+(x), F_B^+(x))$$

$$F_{A \cup B}^-(x) = \max(F_A^-(x), F_B^-(x))$$

g) "The game of winner, neutral, and loser":

$$T_{A \cup B}^+(x) = \begin{cases} T_A^+(x) & \text{if } p_A > p_B \\ T_B^+(x) & \text{if } p_B > p_A \end{cases},$$

$$T_{A \cup B}^-(x) = \begin{cases} T_A^-(x) & \text{if } p_A < p_B \\ T_B^-(x) & \text{if } p_B < p_A \end{cases}$$

$$I_{A \cup B}^+(x) = \begin{cases} I_A^+(x) & \text{if } q_A < q_B \\ I_B^+(x) & \text{if } q_B < q_A \end{cases},$$

$$I^-_{A \cup B}(x) = \begin{cases} I^-_A(x) & \text{if } q_A > q_B \\ I^-_B(x) & \text{if } q_B > q_A \end{cases}$$

$$F^+_{A \cup B}(x) = \begin{cases} F^+_A(x) & \text{if } r_A < r_B \\ F^+_B(x) & \text{if } r_B < r_A \end{cases}$$

$$F^-_{A \cup B}(x) = \begin{cases} F^-_A(x) & \text{if } r_A > r_B \\ F^-_B(x) & \text{if } r_B > r_A \end{cases}$$

Example 2.9: Let $X = \{x_1, x_2\}$ be a universe of discourse. Let A and B be two bipolar complex neutrosophic sets in X as shown below:

$$A = \left(\frac{0.5e^{i.0.7}, 0.2e^{i.\pi}, 0.4e^{i.0.1}, -0.7e^{i.-0.4}, -0.3e^{i.-\frac{\pi}{3}}, -0.2e^{i.0}}{x_1} \right), \left(\frac{0.6e^{i.0.8}, 0.3e^{i.\frac{\pi}{3}}, 0.1e^{i.0.3}, -0.8e^{i.-0.5}, -0.4e^{i.-\frac{2\pi}{3}}, -0.1e^{i.-0.1}}{x_2} \right)$$

And

$$B = \left(\frac{0.9e^{i.0.6}, 0.3e^{i.\pi}, 0.1e^{i.0.3}, -0.6e^{i.-0.6}, -0.2e^{i.-2\pi}, -0.3e^{i.-0.3}}{x_1} \right), \left(\frac{0.8e^{i.0.9}, 0.4e^{i.\frac{3\pi}{4}}, 0.2e^{i.0.2}, -0.5e^{i.-0.6}, -0.1e^{i.-\frac{\pi}{3}}, -0.2e^{i.-0.1}}{x_2} \right)$$

Then

$$A \cup_{BN} B = \left(\frac{0.9e^{i.0.7}, 0.2e^{i.\pi}, 0.1e^{i.0.1}, -0.7e^{i.-0.6}, -0.2e^{i.-\frac{\pi}{3}}, -0.2e^{i.0}}{x_1} \right), \left(\frac{0.8e^{i.0.9}, 0.3e^{i.\frac{\pi}{3}}, 0.1e^{i.0.2}, -0.8e^{i.-0.6}, -0.1e^{i.-\frac{\pi}{3}}, -0.1e^{i.-0.1}}{x_2} \right)$$

Definition 2.10(Broumi et al., 2017c) The intersection of two bipolar complex neutrosophic sets as follows:

Let A and B be two bipolar complex neutrosophic sets in X , where

$$A = (T_1^+ e^{iT_2^+}, I_1^+ e^{iI_2^+}, F_1^+ e^{iF_2^+}, T_1^- e^{iT_2^-}, I_1^- e^{iI_2^-}, F_1^- e^{iF_2^-}) \text{ and}$$

$$B = (T_3^+ e^{iT_4^+}, I_3^+ e^{iI_4^+}, F_3^+ e^{iF_4^+}, T_3^- e^{iT_4^-}, I_3^- e^{iI_4^-}, F_3^- e^{iF_4^-})$$

Then the intersection of A and B is denoted as $A \cap_{BN} B$ and is given as

$$A \cap_{BN} B = \{ \langle x, T^+_{A \cap B}(x), I^+_{A \cap B}(x), F^+_{A \cap B}(x), T^-_{A \cap B}(x), I^-_{A \cap B}(x), F^-_{A \cap B}(x) \rangle : x \in X \}$$

Where positive the truth membership function $T^+_{A \cap B}(x)$, positive the indeterminacy membership function $I^+_{A \cap B}(x)$ and positive the falsehood membership function $F^+_{A \cap B}(x)$, negative the truth membership function $T^-_{A \cap B}(x)$, negative the indeterminacy membership function $I^-_{A \cap B}(x)$ and negative the falsehood membership function $F^-_{A \cap B}(x)$ is defined by

$$T^+_{A \cap B}(x) = (T_1^+ \wedge T_3^+) e^{i(T_2^+ \cap T_4^+)},$$

$$T^-_{A \cap B}(x) = (T_1^- \vee T_3^-) e^{i(T_2^- \cap T_4^-)},$$

$$\begin{aligned}
 I_{A \cap B}^+ (x) &= (I_1^+ \vee I_3^+) e^{i(I_2^+ \cap I_4^+)}, \\
 T_{A \cap B}^- (x) &= (I_1^- \wedge I_3^-) e^{i(I_2^- \cap I_4^-)}, \\
 F_{A \cap B}^+ (x) &= (F_1^+ \vee F_3^+) e^{i(F_2^+ \cap F_4^+)}, \\
 F_{A \cap B}^- (x) &= (F_1^- \wedge F_3^-) e^{i(F_2^- \cap F_4^-)}
 \end{aligned}$$

Where \vee and \wedge denotes the max and min operators respectively

The phase term of bipolar complex truth membership function, bipolar complex indeterminacy membership function and bipolar complex falsity membership function belongs to $(0, 2\pi)$ and, they are defined as follows:

h) Sum:

$$\begin{aligned}
 T_{A \cap B}^+ (x) &= T_A^+ (x) + T_B^+ (x) \\
 T_{A \cap B}^- (x) &= T_A^- (x) + T_B^- (x) \\
 I_{A \cap B}^+ (x) &= I_A^+ (x) + I_B^+ (x) \\
 I_{A \cap B}^- (x) &= I_A^- (x) + I_B^- (x) \\
 F_{A \cap B}^+ (x) &= F_A^+ (x) + F_B^+ (x) \\
 F_{A \cap B}^- (x) &= F_A^- (x) + F_B^- (x)
 \end{aligned}$$

i) Max and min:

$$\begin{aligned}
 T_{A \cap B}^+ (x) &= \min(T_A^+ (x), T_B^+ (x)) \\
 T_{A \cap B}^- (x) &= \max(T_A^- (x), T_B^- (x)) \\
 I_{A \cap B}^+ (x) &= \max(I_A^+ (x), I_B^+ (x)) \\
 I_{A \cap B}^- (x) &= \min(I_A^- (x), I_B^- (x)) \\
 F_{A \cap B}^+ (x) &= \max(F_A^+ (x), F_B^+ (x)) \\
 F_{A \cap B}^- (x) &= \min(F_A^- (x), F_B^- (x))
 \end{aligned}$$

j) “The game of winner, neutral, and loser”:

$$\begin{aligned}
 T_{A \cap B}^+ (x) &= \begin{cases} T_A^+ (x) & \text{if } p_A < p_B \\ T_B^+ (x) & \text{if } p_B < p_A \end{cases}, \\
 T_{A \cap B}^- (x) &= \begin{cases} T_A^- (x) & \text{if } p_A > p_B \\ T_B^- (x) & \text{if } p_B > p_A \end{cases} \\
 I_{A \cap B}^+ (x) &= \begin{cases} I_A^+ (x) & \text{if } q_A > q_B \\ I_B^+ (x) & \text{if } q_B > q_A \end{cases}, \\
 I_{A \cap B}^- (x) &= \begin{cases} I_A^- (x) & \text{if } q_A < q_B \\ I_B^- (x) & \text{if } q_B < q_A \end{cases} \\
 F_{A \cap B}^+ (x) &= \begin{cases} F_A^+ (x) & \text{if } r_A > r_B \\ F_B^+ (x) & \text{if } r_B > r_A \end{cases} \\
 F_{A \cap B}^- (x) &= \begin{cases} F_A^- (x) & \text{if } r_A < r_B \\ F_B^- (x) & \text{if } r_B < r_A \end{cases}
 \end{aligned}$$

Example 2.11: Let $X = \{x_1, x_2\}$ be a universe of discourse. Let A and B be two bipolar complex neutrosophic sets in X as shown below:

$$A = \left(\frac{0.5e^{i.0.7}, 0.2e^{i.\pi}, 0.4e^{i.0.1}, -0.7e^{i.-0.4}, -0.3e^{i.\frac{-\pi}{3}}, -0.2e^{i.0}}{x_1} \right)$$

$$\left(\frac{0.6e^{i.0.8}, 0.3e^{i.\frac{\pi}{3}}, 0.1e^{i.0.3}, -0.8e^{i.-0.5}, -0.4e^{i.-\frac{2\pi}{3}}, -0.1e^{i.-0.1}}{x_2} \right)$$

And

$$B = \left(\frac{0.9e^{i.0.6}, 0.3e^{i.\pi}, 0.1e^{i.0.3}, -0.6e^{i.-0.6}, -0.2e^{i.-2\pi}, -0.3e^{i.-0.3}}{x_1} \right) \left(\frac{0.8e^{i.0.9}, 0.4e^{i.\frac{3\pi}{4}}, 0.2e^{i.0.2}, -0.5e^{i.-0.6}, -0.1e^{i.-\frac{\pi}{3}}, -0.2e^{i.-0.1}}{x_2} \right)$$

Then

$$A \cap_{BN} B = \left(\frac{0.5e^{i.0.6}, 0.3e^{i.\pi}, 0.4e^{i.0.3}, -0.6e^{i.-0.4}, -0.3e^{i.-2\pi}, -0.3e^{i.-0.3}}{x_1} \right) \left(\frac{0.6e^{i.0.8}, 0.4e^{i.\frac{3\pi}{4}}, 0.2e^{i.0.3}, -0.5e^{i.-0.5}, -0.4e^{i.-\frac{2\pi}{3}}, -0.2e^{i.-0.1}}{x_2} \right)$$

Definition 2.12 (Samanta et al.2016). Let V be a non-void set. Two function are considered as follows:

$\rho:V \rightarrow [0, 1]$ and $\omega:V \times V \rightarrow [0, 1]$. We suppose

$A = \{(\rho(x), \rho(y)) \mid \omega(x, y) > 0\}$,

We have considered $\omega_T, > 0$ for all set A

The triad (V, ρ, ω) is defined to be generalized fuzzy graph of first type (GFG1) if there is function $\alpha:A \rightarrow [0, 1]$ such that $\omega(x, y) = \alpha((\rho(x), \rho(y)))$ Where $x, y \in V$.

The $\rho(x), x \in V$ are the membership of the vertex x and $\omega(x, y), x, y \in V$ are the membership values of the edge (x, y) .

Definition 2.13 (Broumi et al., 2017). Let V be a non-void set. Two function are considered as follows:

$\rho = (\rho_T, \rho_I, \rho_F):V \rightarrow [0, 1]^3$ and

$\omega = (\omega_T, \omega_I, \omega_F):V \times V \rightarrow [0, 1]^3$. Suppose

$A = \{(\rho_T(x), \rho_T(y)) \mid \omega_T(x, y) \geq 0\}$,

$B = \{(\rho_I(x), \rho_I(y)) \mid \omega_I(x, y) \geq 0\}$,

$C = \{(\rho_F(x), \rho_F(y)) \mid \omega_F(x, y) \geq 0\}$,

We have considered ω_T, ω_I and $\omega_F \geq 0$ for all set A, B, C, since its is possible to have edge degree = 0 (for T, or I, or F).

The triad (V, ρ, ω) is defined to be generalized single valued neutrosophic graph of type 1 (GSVNG1) if there are functions

$\alpha:A \rightarrow [0, 1]$, $\beta:B \rightarrow [0, 1]$ and $\delta:C \rightarrow [0, 1]$ such that

$\omega_T(x, y) = \alpha((\rho_T(x), \rho_T(y)))$

$\omega_I(x, y) = \beta((\rho_I(x), \rho_I(y)))$

$\omega_F(x, y) = \delta((\rho_F(x), \rho_F(y)))$ where $x, y \in V$.

Here $\rho(x) = (\rho_T(x), \rho_I(x), \rho_F(x))$, $x \in V$ are the truth- membership, indeterminate-membership and false-membership of the vertex x and $\omega(x, y) = (\omega_T(x, y), \omega_I(x, y), \omega_F(x, y))$, $x, y \in V$ are the truth-membership, indeterminate-membership and false-membership values of the edge (x, y) .

Definition 2.14 (Broumi et al., 2017b) Let V be a non-void set. Two functions are considered as follows:

$$\rho=(\rho_T, \rho_I, \rho_F):V \rightarrow [0, 1]^3 \text{ and } \omega=(\omega_T, \omega_I, \omega_F):V \times V \rightarrow [0, 1]^3 . \text{ Suppose}$$

$$A= \{(\rho_T(x), \rho_T(y)) \mid \omega_T(x, y) \geq 0\},$$

$$B= \{(\rho_I(x), \rho_I(y)) \mid \omega_I(x, y) \geq 0\},$$

$$C= \{(\rho_F(x), \rho_F(y)) \mid \omega_F(x, y) \geq 0\},$$

We have considered ω_T, ω_I and $\omega_F \geq 0$ for all set A, B, C , since its is possible to have edge degree = 0 (for T , or I , or F).

The triad (V, ρ, ω) is defined to be complex neutrosophic graph of type 1 (CNG1) if there are functions

$$\alpha:A \rightarrow [0, 1], \beta:B \rightarrow [0, 1] \text{ and } \delta:C \rightarrow [0, 1] \text{ such that}$$

$$\omega_T(x, y) = \alpha((\rho_T(x), \rho_T(y)))$$

$$\omega_I(x, y) = \beta((\rho_I(x), \rho_I(y)))$$

$$\omega_F(x, y) = \delta((\rho_F(x), \rho_F(y)))$$

Where $x, y \in V$.

Here $\rho(x) = (\rho_T(x), \rho_I(x), \rho_F(x))$, $x \in V$ are the complex truth-membership, complex indeterminate-membership and complex false-membership of the vertex x and $\omega(x, y) = (\omega_T(x, y), \omega_I(x, y), \omega_F(x, y))$, $x, y \in V$ are the complex truth-membership, complex indeterminate-membership and complex false-membership values of the edge (x, y) .

Definition 2.15 (Broumi et al., 2017b). Let V be a non-void set. Two function are considered as follows:

$$\rho=(\rho_T^+, \rho_I^+, \rho_F^+, \rho_T^-, \rho_I^-, \rho_F^-):V \rightarrow [0, 1]^3 \times [-1, 0]^3 \text{ and}$$

$$\omega=(\omega_T^+, \omega_I^+, \omega_F^+, \omega_T^-, \omega_I^-, \omega_F^-):V \times V \rightarrow [0, 1]^3 \times [-1, 0]^3 . \text{ We suppose}$$

$$A= \{(\rho_T^+(x), \rho_T^+(y)) \mid \omega_T^+(x, y) \geq 0\},$$

$$B= \{(\rho_I^+(x), \rho_I^+(y)) \mid \omega_I^+(x, y) \geq 0\},$$

$$C= \{(\rho_F^+(x), \rho_F^+(y)) \mid \omega_F^+(x, y) \geq 0\},$$

$$D= \{(\rho_T^-(x), \rho_T^-(y)) \mid \omega_T^-(x, y) \leq 0\},$$

$$E= \{(\rho_I^-(x), \rho_I^-(y)) \mid \omega_I^-(x, y) \leq 0\},$$

$$F= \{(\rho_F^-(x), \rho_F^-(y)) \mid \omega_F^-(x, y) \leq 0\},$$

We have considered $\omega_T^+, \omega_I^+, \omega_F^+ \geq 0$ and $\omega_T^-, \omega_I^-, \omega_F^- \leq 0$ for all set A, B, C, D, E, F since its is possible to have edge degree = 0 (for T^+ or I^+ or F^+, T^- or I^- or F^-).

The triad (V, ρ, ω) is defined to be generalized bipolar neutrosophic graph of first type (GBNG1) if there are functions

$$\alpha:A \rightarrow [0, 1], \beta:B \rightarrow [0, 1], \delta:C \rightarrow [0, 1] \text{ and } \xi:D \rightarrow [-1, 0], \sigma:E \rightarrow [-1, 0], \psi:F \rightarrow [-1, 0] \text{ such that}$$

$$\omega_T^+(x, y) = \alpha((\rho_T^+(x), \rho_T^+(y))),$$

$$\omega_T^-(x, y) = \xi((\rho_T^-(x), \rho_T^-(y))),$$

$$\omega_I^+(x, y) = \beta((\rho_I^+(x), \rho_I^+(y))),$$

$$\omega_I^-(x, y) = \sigma((\rho_I^-(x), \rho_I^-(y))),$$

$$\omega_F^+(x, y) = \delta((\rho_F^+(x), \rho_F^+(y))),$$

$$\omega_F^-(x, y) = \psi((\rho_F^-(x), \rho_F^-(y)))$$

Where $x, y \in V$.

Here $\rho(x) = (\rho_T^+(x), \rho_I^+(x), \rho_F^+(x), \rho_T^-(x), \rho_I^-(x), \rho_F^-(x))$, $x \in V$ are the positive and negative membership, indeterminacy and non-membership of the vertex x and $\omega(x, y) = (\omega_T^+(x, y),$

$\omega_I^+(x, y), \omega_F^+(x, y), \omega_T^-(x, y), \omega_I^-(x, y), \omega_F^-(x, y)$, $x, y \in V$ are the positive and negative membership, indeterminacy membership and non-membership values of the edge (x, y) .

3. Bipolar Complex Neutrosophic Graph of Type 1

In this section, based on the concept of bipolar complex neutrosophic sets (Broumi et al., 2017c) and the concept of generalized single valued neutrosophic graph of type 1 (Broumi et al., 2017), we define the concept of bipolar complex neutrosophic graph of type 1 as follows:

Definition 3.1. Let V be a non-void set. Two function are considered as follows:

$$\rho = (\rho_T^+, \rho_I^+, \rho_F^+, \rho_T^-, \rho_I^-, \rho_F^-) : V \rightarrow [-1, 1]^6 \text{ and}$$

$$\omega = (\omega_T^+, \omega_I^+, \omega_F^+, \omega_T^-, \omega_I^-, \omega_F^-) : V \times V \rightarrow [-1, 1]^6 . \text{ We suppose}$$

$$A = \{(\rho_T^+(x), \rho_T^+(y)) \mid \omega_T^+(x, y) \geq 0\},$$

$$B = \{(\rho_I^+(x), \rho_I^+(y)) \mid \omega_I^+(x, y) \geq 0\},$$

$$C = \{(\rho_F^+(x), \rho_F^+(y)) \mid \omega_F^+(x, y) \geq 0\},$$

$$D = \{(\rho_T^-(x), \rho_T^-(y)) \mid \omega_T^-(x, y) \leq 0\},$$

$$E = \{(\rho_I^-(x), \rho_I^-(y)) \mid \omega_I^-(x, y) \leq 0\},$$

$$F = \{(\rho_F^-(x), \rho_F^-(y)) \mid \omega_F^-(x, y) \leq 0\},$$

We have considered $\omega_T^+, \omega_I^+, \omega_F^+ \geq 0$ and $\omega_T^-, \omega_I^-, \omega_F^- \leq 0$ for all set A, B, C, D, E, F since its is possible to have edge degree = 0 (for T^+ or I^+ or F^+, T^- or I^- or F^-).

The triad (V, ρ, ω) is defined to be bipolar complex neutrosophic graph of first type (BCNG1) if there are functions

$$\alpha : A \rightarrow [0, 1], \beta : B \rightarrow [0, 1], \delta : C \rightarrow [0, 1] \text{ and } \xi : D \rightarrow [-1, 0], \sigma : E \rightarrow [-1, 0], \psi : F \rightarrow [-1, 0] \text{ such that}$$

$$\omega_T^+(x, y) = \alpha((\rho_T^+(x), \rho_T^+(y))),$$

$$\omega_T^-(x, y) = \xi((\rho_T^-(x), \rho_T^-(y))),$$

$$\omega_I^+(x, y) = \beta((\rho_I^+(x), \rho_I^+(y))),$$

$$\omega_I^-(x, y) = \sigma((\rho_I^-(x), \rho_I^-(y))),$$

$$\omega_F^+(x, y) = \delta((\rho_F^+(x), \rho_F^+(y))),$$

$$\omega_F^-(x, y) = \psi((\rho_F^-(x), \rho_F^-(y)))$$

Where $x, y \in V$.

Here $\rho(x) = (\rho_T^+(x), \rho_I^+(x), \rho_F^+(x), \rho_T^-(x), \rho_I^-(x), \rho_F^-(x))$, $x \in V$ are the positive and negative complex truth-membership, indeterminate and false-membership of the vertex x and $\omega(x, y) = (\omega_T^+(x, y), \omega_I^+(x, y), \omega_F^+(x, y), \omega_T^-(x, y), \omega_I^-(x, y), \omega_F^-(x, y))$, $x, y \in V$ are the positive and negative complex truth-membership, indeterminate and false-membership values of the edge (x, y) .

Example 3.2: Let the vertex set be $V = \{x, y, z, t\}$ and edge set be $E = \{(x, y), (x, z), (x, t), (y, t)\}$

	x	y	z	t
ρ_T^+	$0.5e^{i.0.8}$	$0.9e^{i.0.9}$	$0.3e^{i.0.3}$	$0.8e^{i.0.1}$
ρ_I^+	$0.3e^{i.\frac{3\pi}{4}}$	$0.2e^{i.\frac{\pi}{4}}$	$0.1e^{i.2\pi}$	$0.5e^{i.\pi}$
ρ_F^+	$0.1e^{i.0.3}$	$0.6e^{i.0.5}$	$0.8e^{i.0.5}$	$0.4e^{i.0.7}$
ρ_T^-	$-0.6e^{i.-0.6}$	$-1e^{i.-\pi}$	$-0.4e^{i.-0.1}$	$-0.9e^{i.-0.1}$
ρ_I^-	$-0.4e^{i.-2\pi}$	$-0.3e^{i.0}$	$-0.2e^{i.-0.3}$	$-0.6e^{i.-0.2}$
ρ_F^-	$-0.2e^{i.-0.3}$	$-0.7e^{i.-0.6}$	$-0.9e^{i.-2\pi}$	$-0.5e^{i.-\pi}$

Table 1: Bipolar complex truth-membership, bipolar complex indeterminate-membership and bipolar complex false-membership of the vertex set.

Let us consider the function

$$\alpha(m, n) = (m_T^+ \vee n_T^+) \cdot e^{j \cdot \mu_{T_{\text{mun}}}}$$

$$\beta(m, n) = (m_I^+ \wedge n_I^+) \cdot e^{j \cdot \mu_{I_{\text{mun}}}}$$

$$\delta(m, n) = (m_F^+ \wedge n_F^+) \cdot e^{j \cdot \mu_{F_{\text{mun}}}}$$

$$\xi(m, n) = (m_T^- \wedge n_T^-) \cdot e^{j \cdot \mu_{T_{\text{mun}}}}$$

$$\sigma(m, n) = (m_I^- \vee n_I^-) \cdot e^{j \cdot \mu_{I_{\text{mun}}}}$$
 and

$$\psi(m, n) = (m_F^- \vee n_F^-) \cdot e^{j \cdot \mu_{F_{\text{mun}}}}$$

Here,

$$A = \{(0.5e^{i \cdot 0.8}, 0.9e^{i \cdot 0.9}), (0.5e^{i \cdot 0.8}, 0.3e^{i \cdot 0.3}), (0.5e^{i \cdot 0.8}, 0.8e^{i \cdot 0.1}), (0.9e^{i \cdot 0.9}, 0.8e^{i \cdot 0.1})\}$$

$$B = \{(0.3e^{i \cdot \frac{3\pi}{4}}, 0.2e^{i \cdot \frac{\pi}{4}}), (0.3e^{i \cdot \frac{3\pi}{4}}, 0.1e^{i \cdot 2\pi}), (0.3e^{i \cdot \frac{3\pi}{4}}, 0.5e^{i \cdot \pi}), (0.2e^{i \cdot \frac{\pi}{4}}, 0.5e^{i \cdot \pi})\}$$

$$C = \{(0.1e^{i \cdot 0.3}, 0.6e^{i \cdot 0.5}), (0.1e^{i \cdot 0.3}, 0.8e^{i \cdot 0.5}), (0.1e^{i \cdot 0.3}, 0.4e^{i \cdot 0.7}), (0.6e^{i \cdot 0.5}, 0.4e^{i \cdot 0.7})\}$$

$$D = \{(-0.6e^{i \cdot -0.6}, -1e^{i \cdot -\pi}), (-0.6e^{i \cdot -0.6}, -0.4e^{i \cdot -0.1}), (-0.6e^{i \cdot -0.6}, -0.9e^{i \cdot -0.1}), (-1e^{i \cdot -\pi}, -0.9e^{i \cdot -0.1})\}$$

$$E = \{(-0.4e^{i \cdot -2\pi}, -0.3e^{i \cdot 0}), (-0.4e^{i \cdot -2\pi}, -0.2e^{i \cdot -0.3}), (-0.4e^{i \cdot -2\pi}, -0.6e^{i \cdot -0.2}), (-0.3e^{i \cdot 0}, -0.6e^{i \cdot -0.2})\}$$

$$F = \{(-0.2e^{i \cdot -0.3}, -0.7e^{i \cdot -0.6}), (-0.2e^{i \cdot -0.3}, -0.9e^{i \cdot -2\pi}), (-0.2e^{i \cdot -0.3}, -0.5e^{i \cdot -\pi}), (-0.7e^{i \cdot -0.6}, -0.5e^{i \cdot -\pi})\}$$

Then

ω	(x, y)	(x, z)	(x, t)	(y, t)
$\omega_T^+(x, y)$	$0.9e^{i \cdot 0.9}$	$0.5e^{i \cdot 0.8}$	$0.8e^{i \cdot 0.8}$	$0.9e^{i \cdot 0.9}$
$\omega_I^+(x, y)$	$0.2e^{i \cdot \frac{\pi}{4}}$	$0.1e^{i \cdot \frac{3\pi}{4}}$	$0.3e^{i \cdot \frac{3\pi}{4}}$	$0.2e^{i \cdot \frac{\pi}{4}}$
$\omega_F^+(x, y)$	$0.1e^{i \cdot 0.3}$	$0.1e^{i \cdot 0.3}$	$0.1e^{i \cdot 0.3}$	$0.4e^{i \cdot 0.5}$
$\omega_T^-(x, y)$	$-1e^{i \cdot -\pi}$	$-0.6e^{i \cdot -0.6}$	$-0.9e^{i \cdot -0.6}$	$-1e^{i \cdot -\pi}$
$\omega_I^-(x, y)$	$-0.3e^{i \cdot 0}$	$-0.2e^{i \cdot -2\pi}$	$-0.4e^{i \cdot -2\pi}$	$-0.3e^{i \cdot 0}$
$\omega_F^-(x, y)$	$-0.2e^{i \cdot -0.3}$	$-0.2e^{i \cdot -0.3}$	$-0.2e^{i \cdot -0.3}$	$-0.5e^{i \cdot -0.6}$

Table 2: Bipolar complex truth-membership, bipolar complex indeterminate-membership and bipolar complex false-membership of the edge set.

The corresponding complex neutrosophic graph is shown in Fig.2

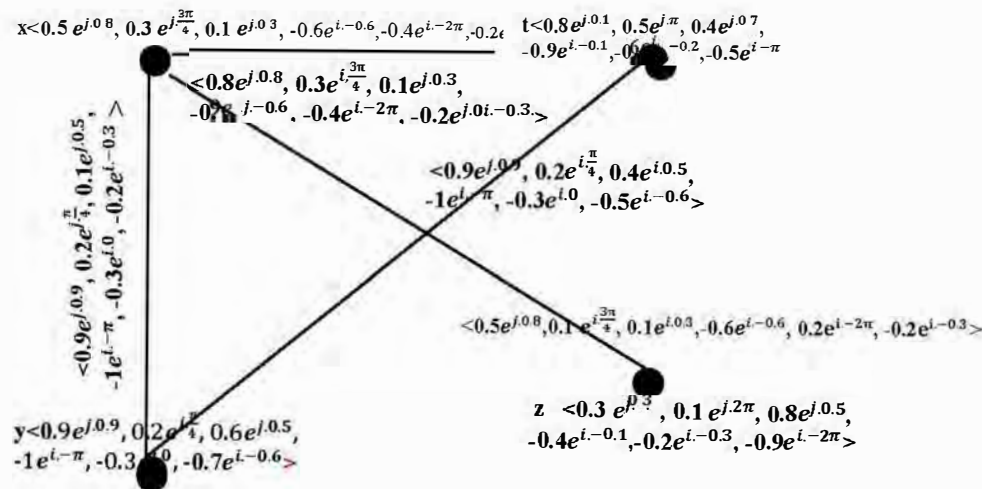

Fig 2. BCNG of type 1.

4. Matrix Representation of Bipolar Complex Neutrosophic Graph of Type 1

In this section, bipolar complex truth-membership, bipolar complex indeterminate-membership, and bipolar complex false-membership are considered independent. So, we adopted the representation matrix of complex neutrosophic graphs of type 1 presented in (Broumi et al., 2017b).

The bipolar complex neutrosophic graph (BCNG1) has one property that edge membership values $(T^+, I^+, F^+, T^-, I^-, F^-)$ depends on the membership values $(T^+, I^+, F^+, T^-, I^-, F^-)$ of adjacent vertices. Suppose $\zeta=(V, \rho, \omega)$ is a BCNG1 where vertex set $V=\{v_1, v_2, \dots, v_n\}$. The functions

$\alpha :A \rightarrow [0, 1]$ is taken such that $\omega_T^+(x, y) = \alpha ((\rho_T^+(x), \rho_T^+(y)))$, where $x, y \in V$ and $A = \{(\rho_T^+(x), \rho_T^+(y)) | \omega_T^+(x, y) \geq 0\}$,

$\beta :B \rightarrow [0, 1]$ is taken such that $\omega_I^+(x, y) = \beta ((\rho_I^+(x), \rho_I^+(y)))$, where $x, y \in V$ and $B = \{(\rho_I^+(x), \rho_I^+(y)) | \omega_I^+(x, y) \geq 0\}$,

$\delta :C \rightarrow [0, 1]$ is taken such that $\omega_F^+(x, y) = \delta ((\rho_F^+(x), \rho_F^+(y)))$, where $x, y \in V$ and $C = \{(\rho_F^+(x), \rho_F^+(y)) | \omega_F^+(x, y) \geq 0\}$,

$\xi :D \rightarrow [-1, 0]$ is taken such that $\omega_T^-(x, y) = \xi ((\rho_T^-(x), \rho_T^-(y)))$, where $x, y \in V$ and $D = \{(\rho_T^-(x), \rho_T^-(y)) | \omega_T^-(x, y) \leq 0\}$,

$\sigma :E \rightarrow [-1, 0]$ is taken such that $\omega_I^-(x, y) = \sigma ((\rho_I^-(x), \rho_I^-(y)))$, where $x, y \in V$ and $E = \{(\rho_I^-(x), \rho_I^-(y)) | \omega_I^-(x, y) \leq 0\}$, and

$\psi :F \rightarrow [-1, 0]$ is taken such that $\omega_F^-(x, y) = \psi ((\rho_F^-(x), \rho_F^-(y)))$, where $x, y \in V$ and $F = \{(\rho_F^-(x), \rho_F^-(y)) | \omega_F^-(x, y) \leq 0\}$,

The BCNG1 can be represented by $(n+1) \times (n+1)$ matrix $M_{G_1}^{T,I,F} = [a^{T,I,F}(i,j)]$ as follows:

The positive and negative bipolar complex truth-membership (T^+, T^-) , indeterminate-membership (I^+, I^-) and false-membership (F^+, F^-) , values of the vertices are provided in the first row and first column. The $(i+1, j+1)$ -th-entry are the bipolar complex truth-membership (T^+, T^-) , indeterminate-membership (I^+, I^-) and the false-membership (F^+, F^-) values of the edge (x_i, x_j) , $i, j=1, \dots, n$ if $i \neq j$.

The (i, i) -th entry is $\rho(x_i) = (\rho_T^+(x_i), \rho_I^+(x_i), \rho_F^+(x_i), \rho_T^-(x_i), \rho_I^-(x_i), \rho_F^-(x_i))$ where $i=1, 2, \dots, n$. The positive and negative bipolar complex truth-membership (T^+, T^-) , indeterminate-membership (I^+, I^-) and false-membership (F^+, F^-) , values of the edge can be computed easily using the functions $\alpha, \beta, \delta, \xi, \sigma$ and ψ which are in $(1,1)$ -position of the matrix. The matrix representation of BCNG1, denoted by $M_{G_1}^{T,I,F}$, can be written as sixth matrix representation $M_{G_1}^{T^+}, M_{G_1}^{I^+}, M_{G_1}^{F^+}, M_{G_1}^{T^-}, M_{G_1}^{I^-}, M_{G_1}^{F^-}$.

The $M_{G_1}^{T^+}$ is represented in Table 3.

Table 3. Matrix representation of T^+ -BCNG1

α	$v_1(\rho_T^+(v_1))$	$v_2(\rho_T^+(v_2))$	$v_n(\rho_T^+(v_n))$
$v_1(\rho_T^+(v_1))$	$\rho_T^+(v_1)$	$\alpha(\rho_T^+(v_1), \rho_T^+(v_2))$	$\alpha(\rho_T^+(v_1), \rho_T^+(v_n))$
$v_2(\rho_T^+(v_2))$	$\alpha(\rho_T^+(v_2), \rho_T^+(v_1))$	$\rho_T^+(v_2)$	$\alpha(\rho_T^+(v_2), \rho_T^+(v_n))$
...
$v_n(\rho_T^+(v_n))$	$\alpha(\rho_T^+(v_n), \rho_T^+(v_1))$	$\alpha(\rho_T^+(v_n), \rho_T^+(v_2))$	$\rho_T^+(v_n)$

The $M_{G_1}^{I^+}$ is presented in Table 4. Table4. Matrix representation of I^+ - BCNG

β	$v_1(\rho_I^+(v_1))$	$v_2(\rho_I^+(v_2))$	$v_n(\rho_I^+(v_n))$
$v_1(\rho_I^+(v_1))$	$\rho_I^+(v_1)$	$\beta(\rho_I^+(v_1), \rho_I^+(v_2))$	$\beta(\rho_I^+(v_1), \rho_I^+(v_n))$
$v_2(\rho_I^+(v_2))$	$\beta(\rho_I^+(v_2), \rho_I^+(v_1))$	$\rho_I^+(v_2)$	$\beta(\rho_I^+(v_2), \rho_I^+(v_2))$
...
$v_n(\rho_I^+(v_n))$	$\beta(\rho_I^+(v_n), \rho_I^+(v_1))$	$\beta(\rho_I^+(v_n), \rho_I^+(v_2))$	$\rho_I^+(v_n)$

1

The $M_{G_1}^{F^+}$ is presented in Table 5.

Table5. Matrix representation of F^+ - BCNG1

δ	$v_1(\rho_F^+(v_1))$	$v_2(\rho_F^+(v_2))$	$v_n(\rho_F^+(v_n))$
$v_1(\rho_F^+(v_1))$	$\rho_F^+(v_1)$	$\delta(\rho_F^+(v_1), \rho_F^+(v_2))$	$\delta(\rho_F^+(v_1), \rho_F^+(v_n))$
$v_2(\rho_F^+(v_2))$	$\delta(\rho_F^+(v_2), \rho_F^+(v_1))$	$\rho_F^+(v_2)$	$\delta(\rho_F^+(v_2), \rho_F^+(v_2))$
...
$v_n(\rho_F^+(v_n))$	$\delta(\rho_F^+(v_n), \rho_F^+(v_1))$	$\delta(\rho_F^+(v_n), \rho_F^+(v_2))$	$\rho_F^+(v_n)$

The $M_{G_1}^{T^-}$ is shown in table 6.

Table 6. Matrix representation of T^- - BCNG1

ξ	$v_1(\rho_T^-(v_1))$	$v_2(\rho_T^-(v_2))$	$v_n(\rho_T^-(v_n))$
$v_1(\rho_T^-(v_1))$	$\rho_T^-(v_1)$	$\xi(\rho_T^-(v_1), \rho_T^-(v_2))$	$\xi(\rho_T^-(v_1), \rho_T^-(v_n))$
$v_2(\rho_T^-(v_2))$	$\xi(\rho_T^-(v_2), \rho_T^-(v_1))$	$\rho_T^-(v_2)$	$\xi(\rho_T^-(v_2), \rho_T^-(v_2))$
...
$v_n(\rho_T^-(v_n))$	$\xi(\rho_T^-(v_n), \rho_T^-(v_1))$	$\xi(\rho_T^-(v_n), \rho_T^-(v_2))$	$\rho_T^-(v_n)$

The $M_{G_1}^{I^-}$ is shown in Table 7.

Table 7. Matrix representation of I^- - BCNG1

σ	$v_1(\rho_I^-(v_1))$	$v_2(\rho_I^-(v_2))$	$v_n(\rho_I^-(v_n))$
$v_1(\rho_I^-(v_1))$	$\rho_I^-(v_1)$	$\sigma(\rho_I^-(v_1), \rho_I^-(v_2))$	$\sigma(\rho_I^-(v_1), \rho_I^-(v_n))$
$v_2(\rho_I^-(v_2))$	$\sigma(\rho_I^-(v_2), \rho_I^-(v_1))$	$\rho_I^-(v_2)$	$\sigma(\rho_I^-(v_2), \rho_I^-(v_2))$
...
$v_n(\rho_I^-(v_n))$	$\sigma(\rho_I^-(v_n), \rho_I^-(v_1))$	$\sigma(\rho_I^-(v_n), \rho_I^-(v_2))$	$\rho_I^-(v_n)$

The $M_{G_1}^{F^-}$ is presented in Table 8.

Table8. Matrix representation of F^- - BCNG1

ψ	$v_1(\rho_F^-(v_1))$	$v_2(\rho_F^-(v_2))$	$v_n(\rho_F^-(v_n))$
$v_1(\rho_F^-(v_1))$	$\rho_F^-(v_1)$	$\psi(\rho_F^-(v_1), \rho_F^-(v_2))$	$\psi(\rho_F^-(v_1), \rho_F^-(v_n))$
$v_2(\rho_F^-(v_2))$	$\psi(\rho_F^-(v_2), \rho_F^-(v_1))$	$\rho_F^-(v_2)$	$\psi(\rho_F^-(v_2), \rho_F^-(v_2))$
...
$v_n(\rho_F^-(v_n))$	$\psi(\rho_F^-(v_n), \rho_F^-(v_1))$	$\psi(\rho_F^-(v_n), \rho_F^-(v_2))$	$\rho_F^-(v_n)$

Remark1:if $\rho_T^-(x) = \rho_I^-(x) = \rho_F^-(x) = 0$, the bipolar complex neutrosophic graphs of type 1 is reduced to complex neutrosophic graph of type 1 (CNG1).

Remark2:if $\rho_T^-(x) = \rho_I^-(x) = \rho_F^-(x) = 0$, and $\rho_I^+(x) = \rho_F^+(x) = 0$, the bipolar complex neutrosophic graphs of type 1 is reduced to generalized fuzzy graph of type 1 (GFG1).

Remark3:if the phase terms of bipolar complex neutrosophic values of the vertices equals 0, the bipolar complex neutrosophic graphs of type 1 is reduced to generalized bipolar neutrosophic graph of type 1 (GBNG1).

Remark4:if $\rho_T^-(x) = \rho_I^-(x) = \rho_F^-(x) = 0$, and the phase terms of positive truth-membership, indeterminate-membership and false-membership of the vertices equals 0, the bipolar complex neutrosophic graphs of type 1 is reduced to generalized single valued neutrosophic graph of type 1 (GSVNG1).

Here the bipolar complex neutrosophic graph of type 1 (BCNG1) can be represented by the matrix representation depicted in table 15. The matrix representation can be written as six matrices one containing the entries as $T^+, I^+, F^+, T^-, I^-, F^-$ (see table 9, 10, 11, 12, 13 and 14).

Table 9. T^+ - matrix representation of BCNG1

α	$x(0.5 e^{j.0.8})$	$y(0.9 e^{j.0.9})$	$z(0.3 e^{j.0.3})$	$t(0.8 e^{j.0.1})$
$x(0.5 e^{i.0.8})$	$0.5 e^{j.0.8}$	$0.9 e^{j.0.9}$	$0.5 e^{j.0.3}$	$0.8 e^{i.0.8}$
$y(0.9 e^{i.0.9})$	$0.9 e^{j.0.9}$	$0.9 e^{j.0.9}$	0	$0.9 e^{j.0.9}$
$z(0.3 e^{i.0.3})$	$0.5 e^{j.0.8}$	0	$0.3 e^{j.0.3}$	0
$t(0.8 e^{i.0.1})$	$0.8 e^{j.0.8}$	$0.9 e^{j.0.9}$	0	$0.8 e^{j.0.1}$

Table 10. I^+ - matrix representation of BCNG1

β	$x(0.3 e^{j.\frac{3\pi}{4}})$	$y(0.2 e^{j.\frac{\pi}{4}})$	$z(0.1 e^{j.2\pi})$	$t(0.5 e^{j.\pi})$
$x(0.3 e^{j.\frac{3\pi}{4}})$	$0.3 e^{j.\frac{3\pi}{4}}$	$0.2 e^{j.\frac{\pi}{4}}$	$0.1 e^{j.\frac{3\pi}{4}}$	$0.1 e^{j.\frac{3\pi}{4}}$
$y(0.2 e^{j.\frac{\pi}{4}})$	$0.2 e^{j.\frac{\pi}{4}}$	$0.2 e^{j.\frac{\pi}{4}}$	0	$0.2 e^{j.\frac{\pi}{4}}$
$z(0.1 e^{j.2\pi})$	$0.1 e^{j.\frac{3\pi}{4}}$	0	$0.1 e^{j.2\pi}$	0
$t(0.5 e^{j.\pi})$	$0.3 e^{j.2\pi}$	$0.2 e^{j.\frac{\pi}{4}}$	0	$0.5 e^{j.\pi}$

Table 11: F^+ - matrix representation of BCNG1

δ	$x(0.1 e^{i.0.3})$	$y(0.6 e^{j.0.5})$	$z(0.8 e^{j.0.5})$	$t(0.4e^{j.0.7})$
$x(0.1 e^{j.0.3})$	$0.1 e^{i.0.3}$	$0.1 e^{i.0.3}$	$0.1 e^{j.0.3}$	$0.1 e^{j.0.3}$
$y(0.6 e^{j.0.5})$	$0.1 e^{i.0.3}$	$0.6 e^{j.0.5}$	0	$0.4e^{j.0.5}$
$z(0.8 e^{j.0.5})$	$0.1 e^{i.0.3}$	0	$0.8 e^{j.0.5}$	0
$t(0.4e^{j.0.7})$	$0.1 e^{i.0.3}$	$0.4e^{j.0.5}$	0	$0.4e^{j.0.7}$

Table 12: T^- - matrix representation of BCNG1

ξ	$x(-0.6 e^{i.-0.6})$	$y(-1 e^{i.-\pi})$	$z(-0.4 e^{i.-0.1})$	$t(-0.9e^{i.-0.1})$
$x(-0.6 e^{i.-0.6})$	$-0.6 e^{i.-0.6}$	$-1 e^{i.-\pi}$	$-0.6 e^{i.-0.6}$	$-0.9 e^{i.-0.6}$
$y(-1 e^{i.-\pi})$	$-1 e^{i.-\pi}$	$-1 e^{i.-\pi}$	0	$-1 e^{i.-\pi}$
$z(-0.4 e^{i.-0.1})$	$-0.6 e^{i.-0.6}$	0	$-0.4 e^{i.-0.1}$	0
$t(-0.9e^{i.-0.1})$	$-0.9 e^{i.-0.6}$	$-1 e^{i.-\pi}$	0	$-0.9e^{i.-0.1}$

Table 13: I^- - matrix representation of BCNG1

σ	$x(-0.4 e^{i.-2\pi})$	$y(-0.3 e^{i.0})$	$z(-0.2 e^{i.-0.3})$	$t(-0.6e^{i.-0.2})$
$x(-0.4e^{i.-2\pi})$	$-0.4 e^{i.-2\pi}$	$-0.3e^{i.0}$	$-0.2e^{i.-2\pi}$	$-0.4e^{i.-2\pi}$
$y(-0.3e^{i.0})$	$-0.3 e^{i.0}$	$-0.3 e^{i.0}$	0	$-0.3 e^{i.0}$
$z(-0.2 e^{i.-0.3})$	$-0.2 e^{i.-2\pi}$	0	$-0.2 e^{i.-0.3}$	0
$t(-0.6e^{i.-0.2})$	$-0.4 e^{i.-2\pi}$	$-0.3 e^{i.0}$	0	$-0.6e^{i.-0.2}$

Table 14: F^- - matrix representation of BCNG1

ψ	$x(-0.2 e^{i.-2\pi})$	$y(-0.7 e^{i.-0.6})$	$z(-0.9 e^{i.-2\pi})$	$t(-0.5e^{i.-\pi})$
$x(-0.2e^{i.-2\pi})$	$-0.2 e^{i.-2\pi}$	$-0.2e^{i.-0.3}$	$-0.2 e^{i.-0.3}$	$-0.2e^{i.-0.3}$
$y(-0.7 e^{i.-0.6})$	$-0.2 e^{i.-0.3}$	$-0.7 e^{i.-0.6}$	0	$-0.5e^{i.-0.6}$
$z(-0.9 e^{i.-2\pi})$	$-0.2 e^{i.-0.3}$	0	$-0.9 e^{i.-2\pi}$	0
$t(-0.5e^{i.-\pi})$	$-0.2 e^{i.-0.3}$	$-0.3 e^{i.0}$	0	$-0.5e^{i.-\pi}$

The matrix representation of GBNG1 is shown in Table 15.

Table 15. Matrix representation of BCNG1.

$(\alpha, \beta, \delta, \xi, \sigma, \psi)$	$x < 0.5 e^{j.0.8}, 0.3 e^{j.\frac{3\pi}{4}}, 0.1 e^{j.0.3}, -0.6 e^{i.-0.6}, -0.4 e^{i.-2\pi}, -0.2 e^{i.-0.3} >$	$y < 0.9 e^{i.0.9}, 0.2 e^{i.\frac{\pi}{4}}, 0.6 e^{i.0.5}, -1 e^{i.-\pi}, -0.3 e^{i.0}, -0.7 e^{i.-0.6} >$	$z < 0.3 e^{i.0.3}, 0.1 e^{i.2\pi}, 0.8 e^{i.0.5}, -0.4 e^{i.-0.1}, -0.2 e^{i.-0.3}, -0.9 e^{i.-2\pi} >$	$t < 0.8 e^{i.0.1}, 0.5 e^{i.\pi}, 0.4 e^{i.0.7}, -0.9 e^{i.-0.1}, -0.6 e^{i.-0.2}, -0.5 e^{i.-\pi}, -0.7 e^{i.-0.6} >$
$x < 0.5 e^{j.0.8}, 0.3 e^{j.\frac{3\pi}{4}}, 0.1 e^{j.0.3}, -0.6 e^{i.-0.6}, -0.4 e^{i.-2\pi}, -0.2 e^{i.-0.3} >$	$< 0.5 e^{j.0.8}, 0.3 e^{j.\frac{3\pi}{4}}, 0.1 e^{j.0.3}, -0.6 e^{i.-0.6}, -0.4 e^{i.-2\pi}, -0.2 e^{i.-0.3} >$	$< 0.9 e^{i.0.9}, 0.2 e^{i.\frac{\pi}{4}}, 0.1 e^{i.0.5}, -1 e^{i.-\pi}, -0.3 e^{i.0}, -0.2 e^{i.-0.3} >$	$< 0.5 e^{i.0.8}, 0.1 e^{i.\frac{3\pi}{4}}, 0.1 e^{i.0.3}, -0.6 e^{i.-0.6}, -0.2 e^{i.-2\pi}, -0.2 e^{i.-0.3} >$	$< 0.8 e^{j.0.8}, 0.3 e^{i.\frac{3\pi}{4}}, 0.1 e^{i.0.3}, -0.9 e^{i.-0.6}, -0.4 e^{i.-2\pi}, -0.2 e^{i.0i.-0.3} >$
$y < 0.9 e^{i.0.9}, 0.2 e^{i.\frac{\pi}{4}}, 0.6 e^{i.0.5}, -1 e^{i.-\pi}, -0.3 e^{i.0}, -0.7 e^{i.-0.6} >$	$< 0.9 e^{i.0.9}, 0.2 e^{i.\frac{\pi}{4}}, 0.1 e^{i.0.5}, -1 e^{i.-\pi}, -0.3 e^{i.0}, -0.2 e^{i.-0.3} >$	$< 0.9 e^{j.0.9}, 0.2 e^{i.\frac{\pi}{4}}, 0.6 e^{i.0.5}, -1 e^{i.-\pi}, -0.3 e^{i.0}, -0.7 e^{i.-0.6} >$	$(0, 0, 0, 0, 0, 0)$	$< 0.9 e^{j.0.9}, 0.2 e^{i.\frac{\pi}{4}}, 0.4 e^{i.0.5}, -1 e^{i.-\pi}, -0.3 e^{i.0}, -0.5 e^{i.-0.6} >$
$z < 0.3 e^{i.0.3}, 0.1 e^{i.2\pi}, 0.8 e^{i.0.5}, -0.4 e^{i.-0.1}, -0.2 e^{i.-0.3}, -0.9 e^{i.-2\pi} >$	$< 0.5 e^{j.0.8}, 0.1 e^{i.\frac{3\pi}{4}}, 0.1 e^{i.0.3}, -0.6 e^{i.-0.6}, -0.2 e^{i.-2\pi}, -0.2 e^{i.-0.3} >$	$(0, 0, 0, 0, 0, 0)$	$z < 0.3 e^{i.0.3}, 0.1 e^{i.2\pi}, 0.8 e^{i.0.5}, -0.4 e^{i.-0.1}, -0.2 e^{i.-0.3}, -0.9 e^{i.-2\pi} >$	$(0, 0, 0, 0, 0, 0)$
$t < 0.8 e^{i.0.1}, 0.5 e^{i.\pi}, 0.4 e^{i.0.7}, -0.9 e^{i.-0.1}, -0.6 e^{i.-0.2}, -0.5 e^{i.-\pi}, -0.7 e^{i.-0.6} >$	$< 0.8 e^{j.0.8}, 0.3 e^{i.\frac{3\pi}{4}}, 0.1 e^{i.0.3}, -0.9 e^{i.-0.6}, -0.4 e^{i.-2\pi}, -0.2 e^{i.0i.-0.3} >$	$< 0.9 e^{j.0.9}, 0.2 e^{i.\frac{\pi}{4}}, 0.4 e^{i.0.5}, -1 e^{i.-\pi}, -0.3 e^{i.0}, -0.5 e^{i.-0.6} >$	$(0, 0, 0, 0, 0, 0)$	$< 0.8 e^{j.0.1}, 0.5 e^{i.\pi}, 0.4 e^{i.0.7}, -0.9 e^{i.-0.1}, -0.6 e^{i.-0.2}, -0.5 e^{i.-\pi}, -0.7 e^{i.-0.6} >$

Table 15: Matrix representation of BCNG1.

Theorem 1. Let $M_{G_l}^{T^+}$ be matrix representation of T^+ -BCNG1, then the degree of vertex

$$D_{T^+}(x_k) = \sum_{j=1, j \neq k}^n a_{T^+}(k+1, j+1), x_k \in V \text{ or}$$

$$D_{T^+}(x_p) = \sum_{i=1, i \neq p}^n a_{T^+}(i+1, p+1), x_p \in V.$$

Proof: It is similar as in theorem 1 of (Broumi et al., 2017b).

Theorem 2. Let $M_{G_l}^{I^+}$ be matrix representation of I^+ -BCNG1, then the degree of vertex

$$D_{I^+}(x_k) = \sum_{j=1, j \neq k}^n a_{I^+}(k+1, j+1), x_k \in V \text{ or}$$

$$D_{I^+}(x_p) = \sum_{i=1, i \neq p}^n a_{I^+}(i+1, p+1), x_p \in V.$$

Proof: It is similar as in theorem 1 of (Broumi et al., 2017b).

Theorem 3. Let $M_{G_l}^{F^+}$ be matrix representation of F^+ - BCNG1, then the degree of vertex

$$D_{F^+}(x_k) = \sum_{j=1, j \neq k}^n a_{F^+}(k+1, j+1), x_k \in V \text{ or}$$

$$D_{F^+}(x_p) = \sum_{i=1, i \neq p}^n a_{F^+}(i+1, p+1), x_p \in V.$$

Proof: It is similar as in theorem 1 of (Broumi et al., 2017b)

Theorem 4. Let $M_{G_l}^{T^-}$ be matrix representation of T^- - BCNG1, then the degree of vertex

$$D_{T^-}(x_k) = \sum_{j=1, j \neq k}^n a_{T^-}(k+1, j+1), x_k \in V \text{ or}$$

$$D_{T^-}(x_p) = \sum_{i=1, i \neq p}^n a_{T^-}(i+1, p+1), x_p \in V.$$

Proof: It is similar as in theorem 1 of (Broumi et al., 2017b).

Theorem 5. Let $M_{G_l}^{I^-}$ be matrix representation of I^- - BCNG1, then the degree of vertex

$$D_{I^-}(x_k) = \sum_{j=1, j \neq k}^n a_{I^-}(k+1, j+1), x_k \in V \text{ or}$$

$$D_{I^-}(x_p) = \sum_{i=1, i \neq p}^n a_{I^-}(i+1, p+1), x_p \in V.$$

Proof: It is similar as in theorem 1 of (Broumi et al., 2017b).

Theorem 6. Let $M_{G_l}^{F^-}$ be matrix representation of F^- - BCNG1, then the degree of vertex

$$D_{F^-}(x_k) = \sum_{j=1, j \neq k}^n a_{F^-}(k+1, j+1), x_k \in V \text{ or}$$

$$D_{F^-}(x_p) = \sum_{i=1, i \neq p}^n a_{F^-}(i+1, p+1), x_p \in V.$$

Proof: It is similar as in theorem 1 of (Broumi et al., 2017b)

5. CONCLUSION

In this article, we have extended the concept of complex neutrosophic graph of type 1 (CNG1) to bipolar complex neutrosophic graph of type 1(BCNG1) and presented a matrix representation of it. The concept of BCNG1 is a generalization of Generalized fuzzy graph of type 1 (GFG1), generalized bipolar neutrosophic graph of type 1 (GBNG1), generalized single valued neutrosophic graph of type 1 (GSVNG1) and complex neutrosophic graph of type 1(CNG1). This concept can be applied to the case of tri-polar neutrosophic graphs and multi-polar neutrosophic graphs. In the future works, we plan to study the concept of completeness, the concept of regularity and to define the concept of bipolar complex neutrosophic graphs of type 2.

ACKNOWLEDGMENT

The authors are very grateful to the chief editor and reviewers for their comments and suggestions, which is helpful in improving the paper.

REFERENCES.

- Ali, M., & Smarandache, F. (2015). Complex neutrosophic set. *Neural Computing and Applications*. doi:10.1007/s00521-015-2154-y.
- Atanassov, K. (1986). Intuitionistic fuzzy sets. *Fuzzy Sets and Systems*, 20, 1986, 87-96.
- Arindam, D. & Anita, P. (2012). Vertex coloring of a fuzzy graph using alpa cut. *International Journal of Management, IT and Engineering*, 2(8), 340-352.
- Arindam, D. and Anita, P. (2013). Fuzzy graph coloring technique to classify the accidental zone of a traffic control. *Annals of Pure and Applied Mathematics*, 3(2), 169-178.

- Ashraf, S., Naz, S., Rashmanlou, H., & Malik, M. A. (2016). Regularity of graphs in single valued neutrosophic environment, in press
- Broumi, S., Talea, M., Bakali, A., & Smarandache, F. (2016). Single valued neutrosophic graphs. *Journal of New Theory*, 10, 86-101.
- Broumi, S., Talea, M., Smarandache, F. & Bakali, A. (2016a). Single Valued Neutrosophic Graphs: Degree, order and size. IEEE International Conference on Fuzzy Systems (FUZZ), 2444-2451.
- Broumi, S., Bakali, A., Talea, M., & Smarandache, F. (2016b). Isolated single valued neutrosophic graphs. *Neutrosophic Sets and Systems*, 11, 2016, 74-78.
- Broumi, S., Bakali, A., Talea, M., Smarandache, F. & Kishore Kumar, P. K. (2016c). A new concept of matrix algorithm for mst in undirected interval valued neutrosophic graph. Chapter in book- Neutrosophic Operational Research- Volume II-Florentin Smarandache, Mohamed Abdel-Basset and Victor Chang(Editors), 2017, pp. 54-69. ISBN 978-1-59973-537-
- Broumi, S., Smarandache, F., Talea, M. & Bakali, A. (2016d). Decision-making method based on the interval valued neutrosophic graph. *Future Technologie, IEEE*, 44-50.
- Broumi, S., Bakali, A., Talea, M., Smarandache, F. & Ali, M. (2016e). Shortest path problem under bipolar neutrosophic setting. *Applied Mechanics and Materials*, 859, 59-66.
- Broumi, S., Bakali, A., Talea, M., Smarandache, F. & Vladareanu, L.(2016f). Computation of shortest path problem in a network with sv-trapezoidal neutrosophic numbers. Proceedings of the 2016 International Conference on Advanced Mechatronic Systems, Melbourne, Australia, 417-422.
- Broumi, S., Bakali, A., Talea, M., Smarandache, F. & Vladareanu, L. (2016g). Applying Dijkstra algorithm for solving neutrosophic shortest path problem. Proceedings of the 2016 International Conference on Advanced Mechatronic Systems, Melbourne, Australia, November 30 - December 3, 412-416.
- Broumi, S., Talea, M., Bakali, A., & Smarandache, F. (2016h). On bipolar single valued neutrosophic graphs, *Journal of New Theory*, 11, 84-102.
- Broumi, S., Smarandache, F., Talea, M. & Bakali, A. (2016i). An introduction to bipolar single valued neutrosophic graph theory. *Applied Mechanics and Materials*, 841, 184-191.
- Broumi, S., Bakali, A., Talea, M., Hassan, A. & Smarandache, F. (2017). Generalized single valued neutrosophic graphs of type 1. 2017, submitted.
- Broumi, S., Bakali, A., Talea, M., & Smarandache, F. (2017a). Generalized bipolar neutrosophic graph of type 1. 2017, submitted.
- Broumi, S., Bakali, A., Talea, M., & Smarandache, F. (2017b). Complex neutrosophic graph of type 1, submitted.
- Broumi, S., Bakali, A., Talea, M., Smarandache, F., Ulucay, V., Khan, & M, Mumtaz, A. (2017c). Bipolar complex neutrosophic sets, submitted.
- Deli, I., Ali, M., & Smarandache, F. (2015). Bipolar neutrosophic sets and their application based on multi-criteria decision making problems. *Advanced Mechatronic Systems (ICAMEchS)*, 249- 254, DOI: 10.1109/ICAMEchS.2015.7287068.
- Fathi, S., Elchawalby, H. & Salama, A. A. (2016). A neutrosophic graph similarity measures, chapter in book- *New Trends in Neutrosophic Theory and Applications*- Florentin Smarandache and Surapati Pramanik (Editors), 223-230. ISBN 978-1-59973-498-9.
- Mehra, S. & Singh, M. (2017). Single valued neutrosophic signed graphs. *International Journal of Computer Applications*, 157(9), 31-34.
- Ramot, D., Menahem, F., Gideon, L. & Abraham, K. (2002). Complex fuzzy set. *IEEE Transactions on Fuzzy Systems*, 10 (2), 171-186. doi: 10.1109/91.995119 .
- Shannon, A., Atanassov, K. (1994). A first step to a theory of the intuitionistic fuzzy graphs. Proc. of the First Workshop on Fuzzy Based Expert Systems (D. akov, Ed.), Sofia, 59-61.
- Sharma, A.K., Padamwar, B.V., Dewangan, C. L. (2013). Trends in fuzzy graphs. *International Journal of Innovative Research in Science. Engineering and Technology*, 2(9), 4636-4640.
- Smarandache, F. (2015). Refined literal indeterminacy and the multiplication law of sub-indeterminacies. *Neutrosophic Sets and Systems*, 9, 58.63.
- Smarandache, F. (2015a). Types of Neutrosophic Graphs and neutrosophic Algebraic Structures together with their Applications in Technology, seminar, Universitatea Transilvania in Brasov, Facultatea de Design de Produsii Mediu, Brasov, Romania 06 June 2015.
- Smarandache, F. (1998). Neutrosophy. neutrosophic probability, set, and logic. ProQuest Information & Learning, Ann Arbor, Michigan, USA, 105 p., 1998; <http://fs.gallup.unm.edu/eBook-neutrosophics6.pdf> (last edition online)

- Abdel-Basset, M., Mohamed, M., Smarandache, F., & Chang, V. (2018). Neutrosophic Association Rule Mining Algorithm for Big Data Analysis. *Symmetry*, *10*(4), 106.
- Abdel-Basset, M., & Mohamed, M. (2018). The Role of Single Valued Neutrosophic Sets and Rough Sets in Smart City: Imperfect and Incomplete Information Systems. *Measurement*. Volume 124, August 2018, Pages 47-55
- Abdel-Basset, M., Gunasekaran, M., Mohamed, M., & Smarandache, F. A novel method for solving the fully neutrosophic linear programming problems. *Neural Computing and Applications*, 1-11.
- Abdel-Basset, M., Manogaran, G., Gamal, A., & Smarandache, F. (2018). A hybrid approach of neutrosophic sets and DEMATEL method for developing supplier selection criteria. *Design Automation for Embedded Systems*, 1-22.
- Abdel-Basset, M., Mohamed, M., & Chang, V. (2018). NMCDA: A framework for evaluating cloud computing services. *Future Generation Computer Systems*, *86*, 12-29.
- Abdel-Basset, M., Mohamed, M., Zhou, Y., & Hezam, I. (2017). Multi-criteria group decision making based on neutrosophic analytic hierarchy process. *Journal of Intelligent & Fuzzy Systems*, *33*(6), 4055-4066.
- Abdel-Basset, M.; Mohamed, M.; Smarandache, F. An Extension of Neutrosophic AHP–SWOT Analysis for Strategic Planning and Decision-Making. *Symmetry* 2018, *10*, 116.
- Smarandache, F. (2016). Neutrosophic overset, neutrosophic underset, Neutrosophic off set, Similarly for Neutrosophic Over-/Under-/OffLogic, Probability, and Statistic, Pons Editions, Brussels, 170p.
- Smarandache, F. (2017). Nidusidearum. Scilogs, III: Viva la Neutrosophia!, Brussels, ,134p.
- Smarandache, F. (2015). Symbolic neutrosophic theory. Europanova, asbl, Brussels, 195 p., Belgium.
- Samanta, S., Sarkar, B., Shin, D. & Pal, M. (2016). Completeness and regularity of generalized fuzzy graphs. Springer Plus. doi: 10.1186/s40064-016-3558-6.
- Turksen, I. (1986). Interval valued fuzzy sets based on normal forms. *Fuzzy Sets and Systems*, *20*, 191-210.
- Wang, H., Smarandache, F., Zhang, Y., & Sunderraman, R. (2010). Single valued neutrosophic sets. *Multispace and Multistructure*, *4*, 410 - 413.
- Zadeh, L. A. (1965). Fuzzy Sets. *Information and Control*, *8*(3), 338-353.

A Novel Extension of Neutrosophic Sets and Its Application in BCK/BCI-Algebras

Seok-Zun Song, Madad Khan, Florentin Smarandache, Young Bae Jun

Seok-Zun Song, Madad Khan, Florentin Smarandache, Young Bae Jun (2018). A Novel Extension of Neutrosophic Sets and Its Application in BCK/BCI-Algebras. In *New Trends in Neutrosophic Theory and Applications*, vol. II, eds.: Florentin Smarandache, Surapati Pramanik, 308-326

ABSTRACT

Generalized neutrosophic set is introduced, and applied it to BCK/BCI-algebras. The notions of generalized neutrosophic subalgebras and generalized neutrosophic ideals in BCK/BCI-algebras are introduced, and related properties are investigated. Characterizations of generalized neutrosophic subalgebra/ideal are considered. Relation between generalized neutrosophic subalgebra and generalized neutrosophic ideal is discussed. In a BCK-algebra, conditions for a generalized neutrosophic subalgebra to be a generalized neutrosophic ideal are provided. Conditions for a generalized neutrosophic set to be a generalized neutrosophic ideal are also provided. Homomorphic image and preimage of generalized neutrosophic ideal are considered.

KEYWORDS: Generalized neutrosophic set, generalized neutrosophic subalgebra, generalized neutrosophic ideal.

1 Introduction

Zadeh (1965) introduced the degree of membership/truth (t) in 1965 and defined the fuzzy set. As a generalization of fuzzy sets, Atanassov (1986) introduced the degree of nonmembership/falsehood (f) in 1986 and defined the intuitionistic fuzzy set. Smarandache introduced the degree of indeterminacy/neutrality (i) as independent component in 1995 (published in 1998) and defined the neutrosophic set on three components

$$(t, i, f) = (\text{truth, indeterminacy, falsehood}).$$

For more detail, refer to the site

<http://fs.gallup.unm.edu/FlorentinSmarandache.htm>.

The concept of neutrosophic set (NS) developed by Smarandache (1999) and Smarandache (2005) is a more general platform which extends the concepts of the classic set and fuzzy set, intuitionistic fuzzy set and interval valued intuitionistic fuzzy set. Neutrosophic set theory is applied to various part (refer to the site <http://fs.gallup.unm.edu/neutrosophy.htm>). Agboola and Davvaz (2015) introduced the concept of neutrosophic *BCI/BCK*-algebras, and presented elementary properties of neutrosophic *BCI/BCK*-algebras. Saeid and Jun (2017) gave relations between an $(\in, \in \vee q)$ -neutrosophic subalgebra and a $(q, \in \vee q)$ -neutrosophic subalgebra, and discussed characterization of an $(\in, \in \vee q)$ -neutrosophic subalgebra by using neutrosophic \in -subsets. They provided conditions for an $(\in, \in \vee q)$ -neutrosophic subalgebra to be a $(q, \in \vee q)$ -neutrosophic subalgebra, and investigated properties on neutrosophic q -subsets and neutrosophic $\in \vee q$ -subsets. Jun (2017) considered neutrosophic subalgebras of several types in *BCK/BCI*-algebras.

In this paper, we consider a generalization of Smarandache’s neutrosophic sets. We introduce the notion of generalized neutrosophic sets and apply it to *BCK/BCI*-algebras. We introduce the notions of generalized neutrosophic subalgebras and generalized neutrosophic ideals in *BCK/BCI*-algebras, and investigate related properties. We consider characterizations of generalized neutrosophic subalgebra/ideal, and discussed relation between generalized neutrosophic subalgebra and generalized neutrosophic ideal. We provide conditions for a generalized neutrosophic subalgebra to be a generalized neutrosophic ideal in a *BCK*-algebra. We also provide conditions for a generalized neutrosophic set to be a generalized neutrosophic ideal, and consider homomorphic image and preimage of generalized neutrosophic ideal.

2 PRELIMINARIES

By a *BCI-algebra* we mean an algebra $(X, *, 0)$ of type $(2, 0)$ satisfying the conditions:

$$(a1) \ ((x * y) * (x * z)) * (z * y) = 0,$$

$$(a2) \ (x * (x * y)) * y = 0,$$

$$(a3) \ x * x = 0,$$

$$(a4) \ x * y = y * x = 0 \Rightarrow x = y,$$

for all $x, y, z \in X$. If a *BCI*-algebra X satisfies the condition

$$(a5) \ 0 * x = 0 \text{ for all } x \in X,$$

then we say that X is a *BCK-algebra*. A partial ordering “ \leq ” on X is defined by

$$(\forall x, y \in X) \ (x \leq y \iff x * y = 0).$$

In a *BCK/BCI*-algebra X , the following properties are satisfied:

$$(\forall x \in X) \ (x * 0 = x), \tag{2.1}$$

$$(\forall x, y, z \in X) \ ((x * y) * z = (x * z) * y). \tag{2.2}$$

A nonempty subset S of a BCK/BCI -algebra X is called a *subalgebra* of X if $x * y \in S$ for all $x, y \in S$. A nonempty subset I of a BCK/BCI -algebra X is called an *ideal* of X if

$$0 \in I, \tag{2.3}$$

$$(\forall x, y \in X) (x * y \in I, y \in I \Rightarrow x \in I). \tag{2.4}$$

We refer the reader to the books (Meng & Jun, 1994) and (Huang, 2006) for further information regarding BCK/BCI -algebras.

For any family $\{a_i \mid i \in \Lambda\}$ of real numbers, we define

$$\bigvee \{a_i \mid i \in \Lambda\} := \begin{cases} \max\{a_i \mid i \in \Lambda\} & \text{if } \Lambda \text{ is finite,} \\ \sup\{a_i \mid i \in \Lambda\} & \text{otherwise.} \end{cases}$$

$$\bigwedge \{a_i \mid i \in \Lambda\} := \begin{cases} \min\{a_i \mid i \in \Lambda\} & \text{if } \Lambda \text{ is finite,} \\ \inf\{a_i \mid i \in \Lambda\} & \text{otherwise.} \end{cases}$$

If $\Lambda = \{1, 2\}$, we will also use $a_1 \vee a_2$ and $a_1 \wedge a_2$ instead of $\bigvee \{a_i \mid i \in \Lambda\}$ and $\bigwedge \{a_i \mid i \in \Lambda\}$, respectively.

By a *fuzzy set* in a nonempty set X we mean a function $\mu : X \rightarrow [0, 1]$, and the *complement* of μ , denoted by μ^c , is the fuzzy set in X given by $\mu^c(x) = 1 - \mu(x)$ for all $x \in X$. A fuzzy set μ in a BCK/BCI -algebra X is called a *fuzzy subalgebra* of X if $\mu(x * y) \geq \mu(x) \wedge \mu(y)$ for all $x, y \in X$. A fuzzy set μ in a BCK/BCI -algebra X is called a *fuzzy ideal* of X if

$$(\forall x \in X) (\mu(0) \geq \mu(x)), \tag{2.5}$$

$$(\forall x, y \in X) (\mu(x) \geq \mu(x * y) \wedge \mu(y)). \tag{2.6}$$

Let X be a non-empty set. A neutrosophic set (NS) in X (Smarandache, 1999) is a structure of the form:

$$A := \{ \langle x; A_T(x), A_I(x), A_F(x) \rangle \mid x \in X \}$$

where $A_T : X \rightarrow [0, 1]$ is a truth membership function, $A_I : X \rightarrow [0, 1]$ is an indeterminate membership function, and $A_F : X \rightarrow [0, 1]$ is a false membership function. For the sake of simplicity, we shall use the symbol $A = (A_T, A_I, A_F)$ for the neutrosophic set

$$A := \{ \langle x; A_T(x), A_I(x), A_F(x) \rangle \mid x \in X \}.$$

3 GENERALIZED NEUTROSOPHIC SETS

Definition 3.1. A *generalized neutrosophic set* (GNS) in a non-empty set X is a structure of the form:

$$A := \{ \langle x; A_T(x), A_{IT}(x), A_{IF}(x), A_F(x) \rangle \mid x \in X, A_{IT}(x) + A_{IF}(x) \leq 1 \}$$

where $A_T : X \rightarrow [0, 1]$ is a truth membership function, $A_F : X \rightarrow [0, 1]$ is a false membership function, $A_{IT} : X \rightarrow [0, 1]$ is an indeterminate membership function which is familiar with truth membership function, and $A_{IF} : X \rightarrow [0, 1]$ is an indeterminate membership function which is familiar with false membership function.

Example 3.2. Let $X = \{a, b, c\}$ be a set. Then

$$A = \{\langle a; 0.4, 0.6, 0.3, 0.7 \rangle, \langle b; 0.6, 0.2, 0.5, 0.7 \rangle, \langle c; 0.1, 0.3, 0.5, 0.6 \rangle\}$$

is a GNS in X . But

$$B = \{\langle a; 0.4, 0.6, 0.3, 0.7 \rangle, \langle b; 0.6, 0.3, 0.9, 0.7 \rangle, \langle c; 0.1, 0.3, 0.5, 0.6 \rangle\}$$

is not a GNS in X since $B_{IT}(b) + B_{IF}(b) = 0.3 + 0.9 = 1.2 > 1$.

For the sake of simplicity, we shall use the symbol $A = (A_T, A_{IT}, A_{IF}, A_F)$ for the generalized neutrosophic set

$$A := \{\langle x; A_T(x), A_{IT}(x), A_{IF}(x), A_F(x) \rangle \mid x \in X, A_{IT}(x) + A_{IF}(x) \leq 1\}.$$

Note that every GNS $A = (A_T, A_{IT}, A_{IF}, A_F)$ in X satisfies the condition:

$$(\forall x \in X) (0 \leq A_T(x) + A_{IT}(x) + A_{IF}(x) + A_F(x) \leq 3).$$

If $A = (A_T, A_{IT}, A_{IF}, A_F)$ is a GNS in X , then $\Box A = (A_T, A_{IT}, A_{IT}^c, A_T^c)$ and $\Diamond A = (A_F^c, A_{IF}^c, A_{IF}, A_F)$ are also GNSs in X .

Example 3.3. Given a set $X = \{0, 1, 2, 3, 4\}$, we know that

$$A = \{\langle 0; 0.4, 0.6, 0.3, 0.7 \rangle, \langle 1; 0.6, 0.2, 0.5, 0.7 \rangle, \langle 2; 0.1, 0.3, 0.5, 0.6 \rangle, \langle 3; 0.9, 0.1, 0.8, 0.6 \rangle, \langle 4; 0.3, 0.6, 0.2, 0.9 \rangle\}$$

is a GNS in X . Then

$$\Box A = \{\langle 0; 0.4, 0.6, 0.4, 0.6 \rangle, \langle 1; 0.6, 0.2, 0.8, 0.4 \rangle, \langle 2; 0.1, 0.3, 0.7, 0.9 \rangle, \langle 3; 0.9, 0.1, 0.9, 0.1 \rangle, \langle 4; 0.3, 0.6, 0.4, 0.7 \rangle\}$$

and

$$\Diamond A = \{\langle 0; 0.3, 0.7, 0.3, 0.7 \rangle, \langle 1; 0.3, 0.5, 0.5, 0.7 \rangle, \langle 2; 0.4, 0.5, 0.5, 0.6 \rangle, \langle 3; 0.4, 0.2, 0.8, 0.6 \rangle, \langle 4; 0.1, 0.8, 0.2, 0.9 \rangle\}$$

are GNSs in X .

4 APPLICATIONS IN BCK/BCI-ALGEBRAS

In what follows, let X denote a BCK/BCI -algebra unless otherwise specified.

Definition 4.1. A GNS $A = (A_T, A_{IT}, A_{IF}, A_F)$ in X is called a *generalized neutrosophic subalgebra* of X if the following conditions are valid.

$$(\forall x, y \in X) \left(\begin{array}{l} A_T(x * y) \geq A_T(x) \wedge A_T(y) \\ A_{IT}(x * y) \geq A_{IT}(x) \wedge A_{IT}(y) \\ A_{IF}(x * y) \leq A_{IF}(x) \vee A_{IF}(y) \\ A_F(x * y) \leq A_F(x) \vee A_F(y) \end{array} \right). \tag{4.1}$$

Example 4.2. Consider a BCK -algebra $X = \{0, 1, 2, 3\}$ with the Cayley table which is given in Table 1.

Table 1: Cayley table for the binary operation “ $*$ ”

$*$	0	1	2	3
0	0	0	0	0
1	1	0	0	1
2	2	1	0	2
3	3	3	3	0

Then the GNS

$$A = \{ \langle 0; 0.6, 0.7, 0.2, 0.3 \rangle, \langle 1; 0.6, 0.6, 0.3, 0.3 \rangle, \langle 2; 0.4, 0.5, 0.4, 0.7 \rangle, \langle 3; 0.6, 0.3, 0.6, 0.5 \rangle \}$$

in X is a generalized neutrosophic subalgebra of X .

Given a GNS $A = (A_T, A_{IT}, A_{IF}, A_F)$ in X and $\alpha_T, \alpha_{IT}, \beta_F, \beta_{IF} \in [0, 1]$, consider the following sets.

$$\begin{aligned} U(T, \alpha_T) &:= \{x \in X \mid A_T(x) \geq \alpha_T\}, \\ U(IT, \alpha_{IT}) &:= \{x \in X \mid A_{IT}(x) \geq \alpha_{IT}\}, \\ L(F, \beta_F) &:= \{x \in X \mid A_F(x) \leq \beta_F\}, \\ L(IF, \beta_{IF}) &:= \{x \in X \mid A_{IF}(x) \leq \beta_{IF}\}. \end{aligned}$$

Theorem 4.3. *If a GNS $A = (A_T, A_{IT}, A_{IF}, A_F)$ is a generalized neutrosophic subalgebra of X , then the set $U(T, \alpha_T)$, $U(IT, \alpha_{IT})$, $L(F, \beta_F)$ and $L(IF, \beta_{IF})$ are subalgebras of X for all $\alpha_T, \alpha_{IT}, \beta_F, \beta_{IF} \in [0, 1]$ whenever they are non-empty.*

Proof. Assume that $U(T, \alpha_T)$, $U(IT, \alpha_{IT})$, $L(F, \beta_F)$ and $L(IF, \beta_{IF})$ are nonempty for all $\alpha_T, \alpha_{IT}, \beta_F, \beta_{IF} \in [0, 1]$. Let $x, y \in X$. If $x, y \in U(T, \alpha_T)$, then $A_T(x) \geq \alpha_T$ and $A_T(y) \geq \alpha_T$. It follows that

$$A_T(x * y) \geq A_T(x) \wedge A_T(y) \geq \alpha_T$$

and so that $x * y \in U(T, \alpha_T)$. Hence $U(T, \alpha_T)$ is a subalgebra of X . Similarly, if $x, y \in U(IT, \alpha_{IT})$, then $x * y \in U(IT, \alpha_{IT})$, that is, $U(IT, \alpha_{IT})$ is a subalgebra of X . Suppose that $x, y \in L(F, \beta_F)$. Then $A_F(x) \leq \beta_F$ and $A_F(y) \leq \beta_F$, which imply that

$$A_F(x * y) \leq A_F(x) \vee A_F(y) \leq \beta_F,$$

that is, $x * y \in L(F, \beta_F)$. Hence $L(F, \beta_F)$ is a subalgebra of X . Similarly we can verify that $L(IF, \beta_{IF})$ is a subalgebra of X . □

Corollary 4.4. *If a GNS $A = (A_T, A_{IT}, A_{IF}, A_F)$ is a generalized neutrosophic subalgebra of X , then the set*

$$A(\alpha_T, \alpha_{IT}, \beta_F, \beta_{IF}) := \{x \in X \mid A_T(x) \geq \alpha_T, A_{IT}(x) \geq \alpha_{IT}, A_F(x) \leq \beta_F, A_{IF}(x) \leq \beta_{IF}\}$$

is a subalgebra of X for all $\alpha_T, \alpha_{IT}, \beta_F, \beta_{IF} \in [0, 1]$.

Proof. Straightforward. □

Theorem 4.5. *Let $A = (A_T, A_{IT}, A_{IF}, A_F)$ be a GNS in X such that $U(T, \alpha_T)$, $U(IT, \alpha_{IT})$, $L(F, \beta_F)$ and $L(IF, \beta_{IF})$ are subalgebras of X for all $\alpha_T, \alpha_{IT}, \beta_F, \beta_{IF} \in [0, 1]$ whenever they are non-empty. Then $A = (A_T, A_{IT}, A_{IF}, A_F)$ is a generalized neutrosophic subalgebra of X .*

Proof. Assume that $U(T, \alpha_T)$, $U(IT, \alpha_{IT})$, $L(F, \beta_F)$ and $L(IF, \beta_{IF})$ are subalgebras for all $\alpha_T, \alpha_{IT}, \beta_F, \beta_{IF} \in [0, 1]$. If there exist $x, y \in X$ such that

$$A_T(x * y) < A_T(x) \wedge A_T(y),$$

then $x, y \in U(T, t_\alpha)$ and $x * y \notin U(T, t_\alpha)$ for $t_\alpha = A_T(x) \wedge A_T(y)$. This is a contradiction, and so

$$A_T(x * y) \geq A_T(x) \wedge A_T(y)$$

for all $x, y \in X$. Similarly, we can prove

$$A_{IT}(x * y) \geq A_{IT}(x) \wedge A_{IT}(y)$$

for all $x, y \in X$. Suppose that

$$A_{IF}(x * y) > A_{IF}(x) \vee A_{IF}(y)$$

for some $x, y \in X$. Then there exists $f_\beta \in [0, 1)$ such that

$$A_{IF}(x * y) > f_\beta \geq A_{IF}(x) \vee A_{IF}(y),$$

which induces a contradiction since $x, y \in L(IF, f_\beta)$ and $x * y \notin L(IF, f_\beta)$. Thus

$$A_{IF}(x * y) \leq A_{IF}(x) \vee A_{IF}(y)$$

for all $x, y \in X$. Similar way shows that

$$A_F(x * y) \leq A_F(x) \vee A_F(y)$$

for all $x, y \in X$. Therefore $A = (A_T, A_{IT}, A_{IF}, A_F)$ is a generalized neutrosophic subalgebra of X . □

Since $[0, 1]$ is a completely distributive lattice under the usual ordering, we have the following theorem.

Theorem 4.6. *The family of generalized neutrosophic subalgebras of X forms a complete distributive lattice under the inclusion.*

Proposition 4.7. *Every generalized neutrosophic subalgebra $A = (A_T, A_{IT}, A_{IF}, A_F)$ of X satisfies the following assertions:*

- (1) $(\forall x \in X) (A_T(0) \geq A_T(x), A_{IT}(0) \geq A_{IT}(x)),$
- (2) $(\forall x \in X) (A_{IF}(0) \leq A_{IF}(x), A_F(0) \leq A_F(x)).$

Proof. Since $x * x = 0$ for all $x \in X$, it is straightforward. □

Theorem 4.8. *Let $A = (A_T, A_{IT}, A_{IF}, A_F)$ be a GNS in X . If there exists a sequence $\{a_n\}$ in X such that $\lim_{n \rightarrow \infty} A_T(a_n) = 1 = \lim_{n \rightarrow \infty} A_{IT}(a_n)$ and $\lim_{n \rightarrow \infty} A_F(a_n) = 0 = \lim_{n \rightarrow \infty} A_{IF}(a_n)$, then $A_T(0) = 1 = A_{IT}(0)$ and $A_F(0) = 0 = A_{IF}(0)$.*

Proof. Using Proposition 4.7, we know that $A_T(0) \geq A_T(a_n), A_{IT}(0) \geq A_{IT}(a_n), A_{IF}(0) \leq A_{IF}(a_n)$ and $A_F(0) \leq A_F(a_n)$ for every positive integer n . It follows that

$$\begin{aligned} 1 &\geq A_T(0) \geq \lim_{n \rightarrow \infty} A_T(a_n) = 1, \\ 1 &\geq A_{IT}(0) \geq \lim_{n \rightarrow \infty} A_{IT}(a_n) = 1, \\ 0 &\leq A_{IF}(0) \leq \lim_{n \rightarrow \infty} A_{IF}(a_n) = 0, \\ 0 &\leq A_F(0) \leq \lim_{n \rightarrow \infty} A_F(a_n) = 0. \end{aligned}$$

Thus $A_T(0) = 1 = A_{IT}(0)$ and $A_F(0) = 0 = A_{IF}(0)$. □

Proposition 4.9. *If every GNS $A = (A_T, A_{IT}, A_{IF}, A_F)$ in X satisfies:*

$$(\forall x, y \in X) \left(\begin{array}{l} A_T(x * y) \geq A_T(y), \quad A_{IT}(x * y) \geq A_{IT}(y) \\ A_{IF}(x * y) \leq A_{IF}(y), \quad A_F(x * y) \leq A_F(y) \end{array} \right), \tag{4.2}$$

then $A = (A_T, A_{IT}, A_{IF}, A_F)$ is constant on X .

Proof. Using (2.1) and (4.2), we have $A_T(x) = A_T(x * 0) \geq A_T(0)$, $A_{IT}(x) = A_{IT}(x * 0) \geq A_{IT}(0)$, $A_{IF}(x) = A_{IF}(x * 0) \leq A_{IF}(0)$, and $A_F(x) = A_F(x * 0) \leq A_F(0)$. It follows from Proposition 4.7 that $A_T(x) = A_T(0)$, $A_{IT}(x) = A_{IT}(0)$, $A_{IF}(x) = A_{IF}(0)$ and $A_F(x) = A_F(0)$ for all $x \in X$. Hence $A = (A_T, A_{IT}, A_{IF}, A_F)$ is constant on X . □

A mapping $f : X \rightarrow Y$ of *BCK/BCI*-algebras is called a *homomorphism* (?) if $f(x * y) = f(x) * f(y)$ for all $x, y \in X$. Note that if $f : X \rightarrow Y$ is a homomorphism, then $f(0) = 0$. Let $f : X \rightarrow Y$ be a homomorphism of *BCK/BCI*-algebras. For any GNS $A = (A_T, A_{IT}, A_{IF}, A_F)$ in Y , we define a new GNS $A^f = (A_T^f, A_{IT}^f, A_{IF}^f, A_F^f)$ in X , which is called the *induced GNS*, by

$$(\forall x \in X) \left(\begin{array}{l} A_T^f(x) = A_T(f(x)), \quad A_{IT}^f(x) = A_{IT}(f(x)) \\ A_{IF}^f(x) = A_{IF}(f(x)), \quad A_F^f(x) = A_F(f(x)) \end{array} \right). \tag{4.3}$$

Theorem 4.10. *Let $f : X \rightarrow Y$ be a homomorphism of *BCK/BCI*-algebras. If a GNS $A = (A_T, A_{IT}, A_{IF}, A_F)$ in Y is a generalized neutrosophic subalgebra of Y , then the induced GNS $A^f = (A_T^f, A_{IT}^f, A_{IF}^f, A_F^f)$ in X is a generalized neutrosophic subalgebra of X .*

Proof. For any $x, y \in X$, we have

$$\begin{aligned} A_T^f(x * y) &= A_T(f(x * y)) = A_T(f(x) * f(y)) \\ &\geq A_T(f(x)) \wedge A_T(f(y)) = A_T^f(x) \wedge A_T^f(y), \end{aligned}$$

$$\begin{aligned} A_{IT}^f(x * y) &= A_{IT}(f(x * y)) = A_{IT}(f(x) * f(y)) \\ &\geq A_{IT}(f(x)) \wedge A_{IT}(f(y)) = A_{IT}^f(x) \wedge A_{IT}^f(y), \end{aligned}$$

$$\begin{aligned} A_{IF}^f(x * y) &= A_{IF}(f(x * y)) = A_{IF}(f(x) * f(y)) \\ &\leq A_{IF}(f(x)) \vee A_{IF}(f(y)) = A_{IF}^f(x) \vee A_{IF}^f(y), \end{aligned}$$

and

$$\begin{aligned} A_F^f(x * y) &= A_F(f(x * y)) = A_F(f(x) * f(y)) \\ &\leq A_F(f(x)) \vee A_F(f(y)) = A_F^f(x) \vee A_F^f(y). \end{aligned}$$

Therefore $A^f = (A_T^f, A_{IT}^f, A_{IF}^f, A_F^f)$ is a generalized neutrosophic subalgebra of X . □

Theorem 4.11. *Let $f : X \rightarrow Y$ be an onto homomorphism of BCK/BCI-algebras and let $A = (A_T, A_{IT}, A_{IF}, A_F)$ be a GNS in Y . If the induced GNS $A^f = (A_T^f, A_{IT}^f, A_{IF}^f, A_F^f)$ in X is a generalized neutrosophic subalgebra of X , then $A = (A_T, A_{IT}, A_{IF}, A_F)$ is a generalized neutrosophic subalgebra of Y .*

Proof. Let $x, y \in Y$. Then $f(a) = x$ and $f(b) = y$ for some $a, b \in X$. Then

$$\begin{aligned} A_T(x * y) &= A_T(f(a) * f(b)) = A_T(f(a * b)) = A_T^f(a * b) \\ &\geq A_T^f(a) \wedge A_T^f(b) = A_T(f(a)) \wedge A_T(f(b)) \\ &= A_T(x) \wedge A_T(y), \end{aligned}$$

$$\begin{aligned} A_{IT}(x * y) &= A_{IT}(f(a) * f(b)) = A_{IT}(f(a * b)) = A_{IT}^f(a * b) \\ &\geq A_{IT}^f(a) \wedge A_{IT}^f(b) = A_{IT}(f(a)) \wedge A_{IT}(f(b)) \\ &= A_{IT}(x) \wedge A_{IT}(y), \end{aligned}$$

$$\begin{aligned} A_{IF}(x * y) &= A_{IF}(f(a) * f(b)) = A_{IF}(f(a * b)) = A_{IF}^f(a * b) \\ &\leq A_{IF}^f(a) \vee A_{IF}^f(b) = A_{IF}(f(a)) \vee A_{IF}(f(b)) \\ &= A_{IF}(x) \vee A_{IF}(y), \end{aligned}$$

and

$$\begin{aligned} A_F(x * y) &= A_F(f(a) * f(b)) = A_F(f(a * b)) = A_F^f(a * b) \\ &\leq A_F^f(a) \vee A_F^f(b) = A_F(f(a)) \vee A_F(f(b)) \\ &= A_F(x) \vee A_F(y). \end{aligned}$$

Hence $A = (A_T, A_{IT}, A_{IF}, A_F)$ is a generalized neutrosophic subalgebra of Y . □

Definition 4.12. A GNS $A = (A_T, A_{IT}, A_{IF}, A_F)$ in X is called a *generalized neutrosophic ideal* of X if the following conditions are valid.

$$(\forall x \in X) \left(\begin{array}{l} A_T(0) \geq A_T(x), A_{IT}(0) \geq A_{IT}(x) \\ A_{IF}(0) \leq A_{IF}(x), A_F(0) \leq A_F(x) \end{array} \right), \tag{4.4}$$

$$(\forall x, y \in X) \left(\begin{array}{l} A_T(x) \geq A_T(x * y) \wedge A_T(y) \\ A_{IT}(x) \geq A_{IT}(x * y) \wedge A_{IT}(y) \\ A_{IF}(x) \leq A_{IF}(x * y) \vee A_{IF}(y) \\ A_F(x) \leq A_F(x * y) \vee A_F(y) \end{array} \right). \tag{4.5}$$

Example 4.13. Consider a BCK-algebra $X = \{0, 1, 2, 3\}$ with the Cayley table which is given in Table 2.

Table 2: Cayley table for the binary operation “*”

*	0	1	2	3	4
0	0	0	0	0	0
1	1	0	1	0	0
2	2	2	0	0	0
3	3	3	3	0	0
4	4	3	4	1	0

Let

$$A = \{ \langle 0; 0.8, 0.7, 0.2, 0.1 \rangle, \langle 1; 0.3, 0.6, 0.2, 0.6 \rangle, \langle 2; 0.8, 0.4, 0.5, 0.3 \rangle, \langle 3; 0.3, 0.2, 0.7, 0.8 \rangle, \langle 4; 0.3, 0.2, 0.7, 0.8 \rangle \}.$$

be a GNS in X . By routine calculations, we know that A is a generalized neutrosophic ideal of X .

Lemma 4.14. *Every generalized neutrosophic ideal $A = (A_T, A_{IT}, A_{IF}, A_F)$ of X satisfies:*

$$(\forall x, y \in X) \left(x \leq y \Rightarrow \begin{cases} A_T(x) \geq A_T(y), & A_{IT}(x) \geq A_{IT}(y) \\ A_{IF}(x) \leq A_{IF}(y), & A_F(x) \leq A_F(y) \end{cases} \right). \tag{4.6}$$

Proof. Let $x, y \in X$ be such that $x \leq y$. Then $x * y = 0$, and so

$$\begin{aligned} A_T(x) &\geq A_T(x * y) \wedge A_T(y) = A_T(0) \wedge A_T(y) = A_T(y), \\ A_{IT}(x) &\geq A_{IT}(x * y) \wedge A_{IT}(y) = A_{IT}(0) \wedge A_{IT}(y) = A_{IT}(y), \\ A_{IF}(x) &\leq A_{IF}(x * y) \vee A_{IF}(y) = A_{IF}(0) \vee A_{IF}(y) = A_{IF}(y), \\ A_F(x) &\leq A_F(x * y) \vee A_F(y) = A_F(0) \vee A_F(y) = A_F(y). \end{aligned}$$

This completes the proof. □

Lemma 4.15. *Let $A = (A_T, A_{IT}, A_{IF}, A_F)$ be a generalized neutrosophic ideal of X . If the inequality $x * y \leq z$ holds in X , then $A_T(x) \geq A_T(y) \wedge A_T(z)$, $A_{IT}(x) \geq A_{IT}(y) \wedge A_{IT}(z)$, $A_{IF}(x) \leq A_{IF}(y) \vee A_{IF}(z)$ and $A_F(x) \leq A_F(y) \vee A_F(z)$.*

Proof. Let $x, y, z \in X$ be such that $x * y \leq z$, Then $(x * y) * z = 0$, and so

$$\begin{aligned} A_T(x) &\geq \bigwedge \{ A_T(x * y), A_T(y) \} \\ &\geq \bigwedge \left\{ \bigwedge \{ A_T((x * y) * z), A_T(z) \}, A_T(y) \right\} \\ &= \bigwedge \left\{ \bigwedge \{ A_T(0), A_T(z) \}, A_T(y) \right\} \\ &= \bigwedge \{ A_T(y), A_T(z) \}, \end{aligned}$$

$$\begin{aligned}
 A_{IT}(x) &\geq \bigwedge \{A_{IT}(x * y), A_{IT}(y)\} \\
 &\geq \bigwedge \left\{ \bigwedge \{A_{IT}((x * y) * z), A_{IT}(z)\}, A_{IT}(y) \right\} \\
 &= \bigwedge \left\{ \bigwedge \{A_{IT}(0), A_{IT}(z)\}, A_{IT}(y) \right\} \\
 &= \bigwedge \{A_{IT}(y), A_{IT}(z)\},
 \end{aligned}$$

$$\begin{aligned}
 A_{IF}(x) &\leq \bigvee \{A_{IF}(x * y), A_{IF}(y)\} \\
 &\leq \bigvee \left\{ \bigvee \{A_{IF}((x * y) * z), A_{IF}(z)\}, A_{IF}(y) \right\} \\
 &= \bigvee \left\{ \bigvee \{A_{IF}(0), A_{IF}(z)\}, A_{IF}(y) \right\} \\
 &= \bigvee \{A_{IF}(y), A_{IF}(z)\},
 \end{aligned}$$

and

$$\begin{aligned}
 A_F(x) &\leq \bigvee \{A_F(x * y), A_F(y)\} \\
 &\leq \bigvee \left\{ \bigvee \{A_F((x * y) * z), A_F(z)\}, A_F(y) \right\} \\
 &= \bigvee \left\{ \bigvee \{A_F(0), A_F(z)\}, A_F(y) \right\} \\
 &= \bigvee \{A_F(y), A_F(z)\}.
 \end{aligned}$$

This completes the proof. □

Proposition 4.16. *Let $A = (A_T, A_{IT}, A_{IF}, A_F)$ be a generalized neutrosophic ideal of X . If the inequality*

$$(\dots((x * a_1) * a_2) * \dots) * a_n = 0$$

holds in X , then

$$\begin{aligned}
 A_T(x) &\geq \bigwedge \{A_T(a_i) \mid i = 1, 2, \dots, n\}, \\
 A_{IT}(x) &\geq \bigwedge \{A_{IT}(a_i) \mid i = 1, 2, \dots, n\}, \\
 A_{IF}(x) &\leq \bigvee \{A_{IF}(a_i) \mid i = 1, 2, \dots, n\}, \\
 A_F(x) &\leq \bigvee \{A_F(a_i) \mid i = 1, 2, \dots, n\}.
 \end{aligned}$$

Proof. It is straightforward by using induction on n and Lemmas 4.14 and 4.15. □

Theorem 4.17. *In a BCK-algebra X , every generalized neutrosophic ideal is a generalized neutrosophic subalgebra.*

Proof. Let $A = (A_T, A_{IT}, A_{IF}, A_F)$ be a generalized neutrosophic ideal of a BCK -algebra X . Since $x * y \leq x$ for all $x, y \in X$, we have $A_T(x * y) \geq A_T(x)$, $A_{IT}(x * y) \geq A_{IT}(x)$, $A_{IF}(x * y) \leq A_{IF}(x)$ and $A_F(x * y) \leq A_F(x)$ by Lemma 4.14. It follows from (4.5) that

$$A_T(x * y) \geq A_T(x) \geq A_T(x * y) \wedge A_T(y) \geq A_T(x) \wedge A_T(y),$$

$$A_{IT}(x * y) \geq A_{IT}(x) \geq A_{IT}(x * y) \wedge A_{IT}(y) \geq A_{IT}(x) \wedge A_{IT}(y),$$

$$A_{IF}(x * y) \leq A_{IF}(x) \leq A_{IF}(x * y) \vee A_{IF}(y) \leq A_{IF}(x) \vee A_{IF}(y),$$

and

$$A_F(x * y) \leq A_F(x) \leq A_F(x * y) \vee A_F(y) \leq A_F(x) \vee A_F(y).$$

Therefore $A = (A_T, A_{IT}, A_{IF}, A_F)$ is a generalized neutrosophic subalgebra of X . □

The converse of Theorem 4.17 is not true. For example, the generalized neutrosophic subalgebra A in Example 4.2 is not a generalized neutrosophic ideal of X since

$$A_T(2) = 0.4 \not\geq 0.6 = A_T(2 * 1) \wedge A_T(1)$$

and/or

$$A_F(2) = 0.7 \not\leq 0.3 = A_F(2 * 1) \vee A_F(1).$$

We give a condition for a generalized neutrosophic subalgebra to be a generalized neutrosophic ideal.

Theorem 4.18. *Let $A = (A_T, A_{IT}, A_{IF}, A_F)$ be a generalized neutrosophic subalgebra of X such that*

$$\begin{aligned} A_T(x) &\geq A_T(y) \wedge A_T(z), \\ A_{IT}(x) &\geq A_{IT}(y) \wedge A_{IT}(z), \\ A_{IF}(x) &\leq A_{IF}(y) \vee A_{IF}(z), \\ A_F(x) &\leq A_F(y) \vee A_F(z) \end{aligned}$$

for all $x, y, z \in X$ satisfying the inequality $x * y \leq z$. Then $A = (A_T, A_{IT}, A_{IF}, A_F)$ is a generalized neutrosophic ideal of X .

Proof. Recall that $A_T(0) \geq A_T(x)$, $A_{IT}(0) \geq A_{IT}(x)$, $A_{IF}(0) \leq A_{IF}(x)$ and $A_F(0) \leq A_F(x)$ for all $x \in X$ by Proposition 4.7. Let $x, y \in X$. Since $x * (x * y) \leq y$, it follows from the hypothesis that

$$\begin{aligned} A_T(x) &\geq A_T(x * y) \wedge A_T(y), \\ A_{IT}(x) &\geq A_{IT}(x * y) \wedge A_{IT}(y), \\ A_{IF}(x) &\leq A_{IF}(x * y) \vee A_{IF}(y), \\ A_F(x) &\leq A_F(x * y) \vee A_F(y). \end{aligned}$$

Hence $A = (A_T, A_{IT}, A_{IF}, A_F)$ is a generalized neutrosophic ideal of X . □

Theorem 4.19. *A GNS $A = (A_T, A_{IT}, A_{IF}, A_F)$ in X is a generalized neutrosophic ideal of X if and only if the fuzzy sets A_T, A_{IT}, A_{IF}^c and A_F^c are fuzzy ideals of X .*

Proof. Assume that $A = (A_T, A_{IT}, A_{IF}, A_F)$ is a generalized neutrosophic ideal of X . Clearly, A_T and A_{IT} are fuzzy ideals of X . For every $x, y \in X$, we have

$$A_{IF}^c(0) = 1 - A_{IF}(0) \geq 1 - A_{IF}(x) = A_{IF}^c(x),$$

$$A_F^c(0) = 1 - A_F(0) \geq 1 - A_F(x) = A_F^c(x),$$

$$\begin{aligned} A_{IF}^c(x) &= 1 - A_{IF}(x) \geq 1 - A_{IF}(x * y) \vee A_{IF}(y) \\ &= \bigwedge \{1 - A_{IF}(x * y), 1 - A_{IF}(y)\} \\ &= \bigwedge \{A_{IF}^c(x * y), A_{IF}^c(y)\} \end{aligned}$$

and

$$\begin{aligned} A_F^c(x) &= 1 - A_F(x) \geq 1 - A_F(x * y) \vee A_F(y) \\ &= \bigwedge \{1 - A_F(x * y), 1 - A_F(y)\} \\ &= \bigwedge \{A_F^c(x * y), A_F^c(y)\}. \end{aligned}$$

Therefore A_T, A_{IT}, A_{IF}^c and A_F^c are fuzzy ideals of X .

Conversely, let $A = (A_T, A_{IT}, A_{IF}, A_F)$ be a GNS in X for which A_T, A_{IT}, A_{IF}^c and A_F^c are fuzzy ideals of X . For every $x \in X$, we have $A_T(0) \geq A_T(x), A_{IT}(0) \geq A_{IT}(x),$

$$1 - A_{IF}(0) = A_{IF}^c(0) \geq A_{IF}^c(x) = 1 - A_{IF}(x), \text{ that is, } A_{IF}(0) \leq A_{IF}(x)$$

and

$$1 - A_F(0) = A_F^c(0) \geq A_F^c(x) = 1 - A_F(x), \text{ that is, } A_F(0) \leq A_F(x).$$

Let $x, y \in X$. Then

$$A_T(x) \geq A_T(x * y) \wedge A_T(y),$$

$$A_{IT}(x) \geq A_{IT}(x * y) \wedge A_{IT}(y),$$

$$\begin{aligned} 1 - A_{IF}(x) &= A_{IF}^c(x) \geq A_{IF}^c(x * y) \wedge A_{IF}^c(y) \\ &= \bigwedge \{1 - A_{IF}(x * y), 1 - A_{IF}(y)\} \\ &= 1 - \bigvee \{A_{IF}(x * y), A_{IF}(y)\}, \end{aligned}$$

and

$$\begin{aligned} 1 - A_F(x) &= A_F^c(x) \geq A_F^c(x * y) \wedge A_F^c(y) \\ &= \bigwedge \{1 - A_F(x * y), 1 - A_F(y)\} \\ &= 1 - \bigvee \{A_F(x * y), A_F(y)\}, \end{aligned}$$

that is, $A_{IF}(x) \leq A_{IF}(x * y) \vee A_{IF}(y)$ and $A_F(x) \leq A_F(x * y) \vee A_F(y)$. Hence $A = (A_T, A_{IT}, A_{IF}, A_F)$ is a generalized neutrosophic ideal of X . \square

Theorem 4.20. *If a GNS $A = (A_T, A_{IT}, A_{IF}, A_F)$ in X is a generalized neutrosophic ideal of X , then $\square A = (A_T, A_{IT}, A_{IT}^c, A_T^c)$ and $\diamond A = (A_{IF}^c, A_F^c, A_F, A_{IF})$ are generalized neutrosophic ideals of X .*

Proof. Assume that $A = (A_T, A_{IT}, A_{IF}, A_F)$ is a generalized neutrosophic ideal of X and let $x, y \in X$. Note that $\square A = (A_T, A_{IT}, A_{IT}^c, A_T^c)$ and $\diamond A = (A_{IF}^c, A_F^c, A_F, A_{IF})$ are GNSs in X . Let $x, y \in X$. Then

$$\begin{aligned} A_{IT}^c(x * y) &= 1 - A_{IT}(x * y) \leq 1 - \bigwedge \{A_{IT}(x), A_{IT}(y)\} \\ &= \bigvee \{1 - A_{IT}(x), 1 - A_{IT}(y)\} \\ &= \bigvee \{A_{IT}^c(x), A_{IT}^c(y)\}, \end{aligned}$$

$$\begin{aligned} A_T^c(x * y) &= 1 - A_T(x * y) \leq 1 - \bigwedge \{A_T(x), A_T(y)\} \\ &= \bigvee \{1 - A_T(x), 1 - A_T(y)\} \\ &= \bigvee \{A_T^c(x), A_T^c(y)\}, \end{aligned}$$

$$\begin{aligned} A_{IF}^c(x * y) &= 1 - A_{IF}(x * y) \geq 1 - \bigvee \{A_{IF}(x), A_{IF}(y)\} \\ &= \bigwedge \{1 - A_{IF}(x), 1 - A_{IF}(y)\} \\ &= \bigwedge \{A_{IF}^c(x), A_{IF}^c(y)\} \end{aligned}$$

and

$$\begin{aligned} A_F^c(x * y) &= 1 - A_F(x * y) \geq 1 - \bigvee \{A_F(x), A_F(y)\} \\ &= \bigwedge \{1 - A_F(x), 1 - A_F(y)\} \\ &= \bigwedge \{A_F^c(x), A_F^c(y)\}. \end{aligned}$$

Therefore $\square A = (A_T, A_{IT}, A_{IT}^c, A_T^c)$ and $\diamond A = (A_{IF}^c, A_F^c, A_F, A_{IF})$ are generalized neutrosophic ideals of X . \square

Theorem 4.21. *If a GNS $A = (A_T, A_{IT}, A_{IF}, A_F)$ is a generalized neutrosophic ideal of X , then the set $U(T, \alpha_T)$, $U(IT, \alpha_{IT})$, $L(F, \beta_F)$ and $L(IF, \beta_{IF})$ are ideals of X for all $\alpha_T, \alpha_{IT}, \beta_F, \beta_{IF} \in [0, 1]$ whenever they are non-empty.*

Proof. Assume that $U(T, \alpha_T)$, $U(IT, \alpha_{IT})$, $L(F, \beta_F)$ and $L(IF, \beta_{IF})$ are nonempty for all $\alpha_T, \alpha_{IT}, \beta_F, \beta_{IF} \in [0, 1]$. It is clear that $0 \in U(T, \alpha_T)$, $0 \in U(IT, \alpha_{IT})$, $0 \in L(F, \beta_F)$ and $0 \in L(IF, \beta_{IF})$. Let $x, y \in X$. If $x * y \in U(T, \alpha_T)$ and $y \in U(T, \alpha_T)$, then $A_T(x * y) \geq \alpha_T$ and $A_T(y) \geq \alpha_T$. Hence

$$A_T(x) \geq A_T(x * y) \wedge A_T(y) \geq \alpha_T,$$

and so $x \in U(T, \alpha_T)$. Similarly, if $x * y \in U(IT, \alpha_{IT})$ and $y \in U(IT, \alpha_{IT})$, then $x \in U(IT, \alpha_{IT})$. If $x * y \in L(F, \beta_F)$ and $y \in L(F, \beta_F)$, then $A_F(x * y) \leq \beta_F$ and $A_F(y) \leq \beta_F$. Hence

$$A_F(x) \leq A_F(x * y) \vee A_F(y) \leq \beta_F,$$

and so $x \in L(F, \beta_F)$. Similarly, if $x * y \in L(IF, \beta_{IF})$ and $y \in L(IF, \beta_{IF})$, then $x \in L(IF, \beta_{IF})$. This completes the proof. \square

Theorem 4.22. *Let $A = (A_T, A_{IT}, A_{IF}, A_F)$ be a GNS in X such that $U(T, \alpha_T)$, $U(IT, \alpha_{IT})$, $L(F, \beta_F)$ and $L(IF, \beta_{IF})$ are ideals of X for all $\alpha_T, \alpha_{IT}, \beta_F, \beta_{IF} \in [0, 1]$. Then $A = (A_T, A_{IT}, A_{IF}, A_F)$ is a generalized neutrosophic ideal of X .*

Proof. Let $\alpha_T, \alpha_{IT}, \beta_F, \beta_{IF} \in [0, 1]$ be such that $U(T, \alpha_T)$, $U(IT, \alpha_{IT})$, $L(F, \beta_F)$ and $L(IF, \beta_{IF})$ are ideals of X . For any $x \in X$, let $A_T(x) = \alpha_T$, $A_{IT}(x) = \alpha_{IT}$, $A_{IF}(x) = \beta_{IF}$ and $A_F(x) = \beta_F$. Since $0 \in U(T, \alpha_T)$, $0 \in U(IT, \alpha_{IT})$, $0 \in L(F, \beta_F)$ and $0 \in L(IF, \beta_{IF})$, we have $A_T(0) \geq \alpha_T = A_T(x)$, $A_{IT}(0) \geq \alpha_{IT} = A_{IT}(x)$, $A_{IF}(0) \leq \beta_{IF} = A_{IF}(x)$ and $A_F(0) \leq \beta_F = A_F(x)$. If there exist $a, b \in X$ such that $A_T(a * b) < A_T(a) \wedge A_T(b)$, then $a, b \in U(T, \alpha_0)$ and $a * b \notin U(T, \alpha_0)$ where $\alpha_0 := A_T(a) \wedge A_T(b)$. This is a contradiction, and hence $A_T(x * y) \geq A_T(x) \wedge A_T(y)$ for all $x, y \in X$. Similarly, we can verify $A_{IT}(x * y) \geq A_{IT}(x) \wedge A_{IT}(y)$ for all $x, y \in X$. Suppose that $A_{IF}(a * b) > A_{IF}(a) \vee A_{IF}(b)$ for some $a, b \in X$. Taking $\beta_0 := A_{IF}(a) \vee A_{IF}(b)$ induces $a, b \in L(IF, \beta_{IF})$ and $a * b \notin L(IF, \beta_{IF})$, a contradiction. Thus $A_{IF}(x * y) \leq A_{IF}(x) \vee A_{IF}(y)$ for all $x, y \in X$. Similarly we have $A_F(x * y) \leq A_F(x) \vee A_F(y)$ for all $x, y \in X$. Consequently, $A = (A_T, A_{IT}, A_{IF}, A_F)$ is a generalized neutrosophic ideal of X . \square

Let Λ be a nonempty subset of $[0, 1]$.

Theorem 4.23. *Let $\{I_t \mid t \in \Lambda\}$ be a collection of ideals of X such that*

- (1) $X = \bigcup_{t \in \Lambda} I_t$,
- (2) $(\forall s, t \in \Lambda) (s > t \iff I_s \subset I_t)$.

Let $A = (A_T, A_{IT}, A_{IF}, A_F)$ be a GNS in X given as follows:

$$(\forall x \in X) \begin{pmatrix} A_T(x) = \bigvee \{t \in \Lambda \mid x \in I_t\} = A_{IT}(x) \\ A_{IF}(x) = \bigwedge \{t \in \Lambda \mid x \in I_t\} = A_F(x) \end{pmatrix}. \tag{4.7}$$

Then $A = (A_T, A_{IT}, A_{IF}, A_F)$ is a generalized neutrosophic ideal of X .

Proof. According to Theorem 4.22, it is sufficient to show that $U(T, t)$, $U(IT, t)$, $L(F, s)$ and $L(IF, s)$ are ideals of X for every $t \in [0, A_T(0) = A_{IT}(0)]$ and $s \in [A_{IF}(0) = A_F(0), 1]$. In order to prove $U(T, t)$ and $U(IT, t)$ are ideals of X , we consider two cases:

- (i) $t = \bigvee\{q \in \Lambda \mid q < t\}$,
- (ii) $t \neq \bigvee\{q \in \Lambda \mid q < t\}$.

For the first case, we have

$$x \in U(T, t) \iff (\forall q < t)(x \in I_q) \iff x \in \bigcap_{q < t} I_q,$$

$$x \in U(IT, t) \iff (\forall q < t)(x \in I_q) \iff x \in \bigcap_{q < t} I_q.$$

Hence $U(T, t) = \bigcap_{q < t} I_q = U(IT, t)$, and so $U(T, t)$ and $U(IT, t)$ are ideals of X . For the second case, we claim that $U(T, t) = \bigcup_{q \geq t} I_q = U(IT, t)$. If $x \in \bigcup_{q \geq t} I_q$, then $x \in I_q$ for some $q \geq t$. It follows that $A_{IT}(x) = A_T(x) \geq q \geq t$ and so that $x \in U(T, t)$ and $x \in U(IT, t)$. This shows that $\bigcup_{q \geq t} I_q \subseteq U(T, t) = U(IT, t)$. Now, assume that $x \notin \bigcup_{q \geq t} I_q$. Then $x \notin I_q$ for all $q \geq t$. Since $t \neq \bigvee\{q \in \Lambda \mid q < t\}$, there exists $\varepsilon > 0$ such that $(t - \varepsilon, t) \cap \Lambda = \emptyset$. Hence $x \notin I_q$ for all $q > t - \varepsilon$, which means that if $x \in I_q$, then $q \leq t - \varepsilon$. Thus $A_{IT}(x) = A_T(x) \leq t - \varepsilon < t$, and so $x \notin U(T, t) = U(IT, t)$. Therefore $U(T, t) = U(IT, t) \subseteq \bigcup_{q \geq t} I_q$. Consequently, $U(T, t) = U(IT, t) = \bigcup_{q \geq t} I_q$ which is an ideal of X . Next we show that $L(F, s)$ and $L(IF, s)$ are ideals of X . We consider two cases as follows:

- (iii) $s = \bigwedge\{r \in \Lambda \mid s < r\}$,
- (iv) $s \neq \bigwedge\{r \in \Lambda \mid s < r\}$.

Case (iii) implies that

$$x \in L(IF, s) \iff (\forall s < r)(x \in I_r) \iff x \in \bigcap_{s < r} I_r,$$

$$x \in U(F, s) \iff (\forall s < r)(x \in I_r) \iff x \in \bigcap_{s < r} I_r.$$

It follows that $L(IF, s) = L(F, s) = \bigcap_{s < r} I_r$, which is an ideal of X . Case (iv) induces $(s, s + \varepsilon) \cap \Lambda = \emptyset$ for some $\varepsilon > 0$. If $x \in \bigcup_{s \geq r} I_r$, then $x \in I_r$ for some $r \leq s$, and so $A_{IF}(x) = A_F(x) \leq r \leq s$, that is, $x \in L(IF, s)$ and $x \in L(F, s)$. Hence $\bigcup_{s \geq r} I_r \subseteq L(IF, s) = L(F, s)$. If $x \notin \bigcup_{s \geq r} I_r$, then $x \notin I_r$ for all $r \leq s$ which implies that $x \notin I_r$ for all $r \leq s + \varepsilon$, that is, if $x \in I_r$ then $r \geq s + \varepsilon$. Hence $A_{IF}(x) = A_F(x) \geq s + \varepsilon > s$, and so $x \notin L(A_{IF}, s) = L(A_F, s)$. Hence $L(A_{IF}, s) = L(A_F, s) = \bigcup_{s \geq r} I_r$ which is an ideal of X . This completes the proof. \square

Theorem 4.24. *Let $f : X \rightarrow Y$ be a homomorphism of BCK/BCI-algebras. If a GNS $A = (A_T, A_{IT}, A_{IF}, A_F)$ in Y is a generalized neutrosophic ideal of Y , then the new GNS $A^f = (A_T^f, A_{IT}^f, A_{IF}^f, A_F^f)$ in X is a generalized neutrosophic ideal of X .*

Proof. We first have

$$\begin{aligned} A_T^f(0) &= A_T(f(0)) = A_T(0) \geq A_T(f(x)) = A_T^f(x), \\ A_{IT}^f(0) &= A_{IT}(f(0)) = A_{IT}(0) \geq A_{IT}(f(x)) = A_{IT}^f(x), \\ A_{IF}^f(0) &= A_{IF}(f(0)) = A_{IF}(0) \leq A_{IF}(f(x)) = A_{IF}^f(x), \\ A_F^f(0) &= A_F(f(0)) = A_F(0) \leq A_F(f(x)) = A_F^f(x) \end{aligned}$$

for all $x \in X$. Let $x, y \in X$. Then

$$\begin{aligned} A_T^f(x) &= A_T(f(x)) \geq A_T(f(x) * f(y)) \wedge A_T(f(y)) \\ &= A_T(f(x * y)) \wedge A_T(f(y)) \\ &= A_T^f(x * y) \wedge A_T^f(y), \end{aligned}$$

$$\begin{aligned} A_{IT}^f(x) &= A_{IT}(f(x)) \geq A_{IT}(f(x) * f(y)) \wedge A_{IT}(f(y)) \\ &= A_{IT}(f(x * y)) \wedge A_{IT}(f(y)) \\ &= A_{IT}^f(x * y) \wedge A_{IT}^f(y), \end{aligned}$$

$$\begin{aligned} A_{IF}^f(x) &= A_{IF}(f(x)) \leq A_{IF}(f(x) * f(y)) \vee A_{IF}(f(y)) \\ &= A_{IF}(f(x * y)) \vee A_{IF}(f(y)) \\ &= A_{IF}^f(x * y) \vee A_{IF}^f(y) \end{aligned}$$

and

$$\begin{aligned} A_F^f(x) &= A_F(f(x)) \leq A_F(f(x) * f(y)) \vee A_F(f(y)) \\ &= A_F(f(x * y)) \vee A_F(f(y)) \\ &= A_F^f(x * y) \vee A_F^f(y). \end{aligned}$$

Therefore $A^f = (A_T^f, A_{IT}^f, A_{IF}^f, A_F^f)$ in X is a generalized neutrosophic ideal of X . □

Theorem 4.25. *Let $f : X \rightarrow Y$ be an onto homomorphism of BCK/BCI-algebras and let $A = (A_T, A_{IT}, A_{IF}, A_F)$ be a GNS in Y . If the induced GNS $A^f = (A_T^f, A_{IT}^f, A_{IF}^f, A_F^f)$ in X is a generalized neutrosophic ideal of X , then $A = (A_T, A_{IT}, A_{IF}, A_F)$ is a generalized neutrosophic ideal of Y .*

Proof. For any $x \in Y$, there exists $a \in X$ such that $f(a) = x$. Then

$$\begin{aligned} A_T(0) &= A_T(f(0)) = A_T^f(0) \geq A_T^f(a) = A_T(f(a)) = A_T(x), \\ A_{IT}(0) &= A_{IT}(f(0)) = A_{IT}^f(0) \geq A_{IT}^f(a) = A_{IT}(f(a)) = A_{IT}(x), \\ A_{IF}(0) &= A_{IF}(f(0)) = A_{IF}^f(0) \leq A_{IF}^f(a) = A_{IF}(f(a)) = A_{IF}(x), \\ A_F(0) &= A_F(f(0)) = A_F^f(0) \leq A_F^f(a) = A_F(f(a)) = A_F(x). \end{aligned}$$

Let $x, y \in Y$. Then $f(a) = x$ and $f(b) = y$ for some $a, b \in X$. It follows that

$$\begin{aligned} A_T(x) &= A_T(f(a)) = A_T^f(a) \\ &\geq A_T^f(a * b) \wedge A_T^f(b) \\ &= A_T(f(a * b)) \wedge A_T(f(b)) \\ &= A_T(f(a) * f(b)) \wedge A_T(f(b)) \\ &= A_T(x * y) \wedge A_T(y), \end{aligned}$$

$$\begin{aligned} A_{IT}(x) &= A_{IT}(f(a)) = A_{IT}^f(a) \\ &\geq A_{IT}^f(a * b) \wedge A_{IT}^f(b) \\ &= A_{IT}(f(a * b)) \wedge A_{IT}(f(b)) \\ &= A_{IT}(f(a) * f(b)) \wedge A_{IT}(f(b)) \\ &= A_{IT}(x * y) \wedge A_{IT}(y), \end{aligned}$$

$$\begin{aligned} A_{IF}(x) &= A_{IF}(f(a)) = A_{IF}^f(a) \\ &\leq A_{IF}^f(a * b) \vee A_{IF}^f(b) \\ &= A_{IF}(f(a * b)) \vee A_{IF}(f(b)) \\ &= A_{IF}(f(a) * f(b)) \vee A_{IF}(f(b)) \\ &= A_{IF}(x * y) \vee A_{IF}(y), \end{aligned}$$

and

$$\begin{aligned} A_F(x) &= A_F(f(a)) = A_F^f(a) \\ &\leq A_F^f(a * b) \vee A_F^f(b) \\ &= A_F(f(a * b)) \vee A_F(f(b)) \\ &= A_F(f(a) * f(b)) \vee A_F(f(b)) \\ &= A_F(x * y) \vee A_F(y). \end{aligned}$$

Therefore $A = (A_T, A_{IT}, A_{IF}, A_F)$ is a generalized neutrosophic ideal of Y . □

REFERENCES

- Abdel-Basset, M., Mohamed, M., Smarandache, F., & Chang, V. (2018). Neutrosophic Association Rule Mining Algorithm for Big Data Analysis. *Symmetry*, 10(4), 106.
- Abdel-Basset, M., & Mohamed, M. (2018). The Role of Single Valued Neutrosophic Sets and Rough Sets in Smart City: Imperfect and Incomplete Information Systems. Measurement. Volume 124, August 2018, Pages 47-55
- Abdel-Basset, M., Gunasekaran, M., Mohamed, M., & Smarandache, F. A novel method for solving the fully neutrosophic linear programming problems. *Neural Computing and Applications*, 1-11.
- Abdel-Basset, M., Manogaran, G., Gamal, A., & Smarandache, F. (2018). A hybrid approach of neutrosophic sets and DEMATEL method for developing supplier selection criteria. *Design Automation for Embedded Systems*, 1-22.
- Abdel-Basset, M., Mohamed, M., & Chang, V. (2018). NMCDA: A framework for evaluating cloud computing services. *Future Generation Computer Systems*, 86, 12-29.
- Abdel-Basset, M., Mohamed, M., Zhou, Y., & Hezam, I. (2017). Multi-criteria group decision making based on neutrosophic analytic hierarchy process. *Journal of Intelligent & Fuzzy Systems*, 33(6), 4055-4066.
- Abdel-Basset, M.; Mohamed, M.; Smarandache, F. An Extension of Neutrosophic AHP–SWOT Analysis for Strategic Planning and Decision-Making. *Symmetry* 2018, 10, 116.
- Agboola, A. A. A., & Davvaz, B. (2015). Introduction to neutrosophic BCI/BCK -algebras. *International Journal of Mathematics and Mathematical Sciences*. doi: 10.1155/2015/370267
- Atanassov, K. (1986). Intuitionistic fuzzy sets. *Fuzzy Sets and Systems*, 20(1), 87–96.
- Huang, Y. S. (2006). *BCI-algebra*. Beijing: Science Press.
- Jun, Y. B. (2017). Neutrosophic subalgebras of several types in BCK/BCI -algebras. *Annals of Fuzzy Mathematics and Informatics*, 14(1), 75–86.
- Meng, J., & Jun, Y. B. (1994). *BCK-algebras*. Seoul: Kyung Moon Sa Co.
- Saeid, A. B., & Y.B, J. (2017). Neutrosophic subalgebras of BCK/BCI -algebras based on neutrosophic points. *Annals of Fuzzy Mathematics and Informatics*, 14(1), 87–97.
- Smarandache, F. (1999). *A unifying field in logics. Neutrosophy: Neutrosophic probability, set and logic*. Rehoboth: American Research Press.
- Smarandache, F. (2005). Neutrosophic set, a generalization of intuitionistic fuzzy sets. *International Journal of Pure and Applied Mathematics*, 24(5), 287–297.
- Zadeh, L. (1965). Fuzzy sets. *Information and Control*, 8(3), 338–353.

Bipolar Neutrosophic Minimum Spanning Tree

Said Broumi, Mohamed Talea, Assia Bakali, Florentin Smarandache, Kifayat Ullah

Said Broumi, Mohamed Talea, Assia Bakali, Florentin Smarandache, Kifayat Ullah (2018). Bipolar Neutrosophic Minimum Spanning Tree. Smart Application and Data Analysis for Smart Cities (SADASC'18); DOI: 10.2139/ssrn.3127519

Abstract The aim of this article is to introduce a matrix algorithm for finding minimum spanning tree (MST) in the environment of undirected bipolar neutrosophic connected graphs (UBNCG). Some weights are assigned to each edge in the form of bipolar neutrosophic number (BNN). The new algorithm is described by a flow chart and a numerical example by considering some hypothetical graph. By a comparison, the advantage of proposed matrix algorithm over some existing algorithms are also discussed.

Keywords—Neutrosophic sets, bipolar neutrosophic sets, spanning tree problem, score function.

I. INTRODUCTION

The concept of neutrosophic set (NS) in 1998 was proposed by Smarandache [1], from the philosophical point of view, to represent uncertain, imprecise, incomplete, inconsistent, and indeterminate information that are exist in the real world. The concept of the classic set, fuzzy set and intuitionistic fuzzy set (IFS) is generalized by the concept of neutrosophic set. Within the real standard or non-standard unit interval $]0, 1+[$, the neutrosophic sets are categorized into three membership functions called truth-membership function (t), an indeterminate-membership function (i) and a false-membership function (f). For the first, Smarandache [1] introduced the single valued neutrosophic set (SVNS) to apply in science and engineering applications. Later on, some properties related to single valued neutrosophic sets was studied by Wang et al.[2].For dealing with real, scientific, and engineering applications, the neutrosophic set model is an important tool because it can handle not only incomplete information but also the inconsistent information and indeterminate information. One may refer to regarding the basic theory of NS, SVNS and their extensions with applications in several fields. Many researches making particularizations on the T, I, F components

which leads to define particular case of neutrosophic sets such as simplified neutrosophic sets [20], interval valued neutrosophic sets [22], bipolar neutrosophic sets [23], trapezoidal neutrosophic set [24], rough neutrosophic set [25] and so on. As a special case of NSs, Ye[24] introduced the concept of single-valued trapezoidal neutrosophic set. In addition, a new ranking method to define the concept of cut sets for SVTNNs were proposed by Deli and Subas [26]. The authors applied it for solving MCDM problem. Mumtaz et al.[28] defined the concept of bipolar neutrosophic soft sets and applied it to decision making problem.

Prim and Kruskal algorithm are the common algorithms for searching the minimum spanning tree including in classical graph theory. A new theory is developed and called single valued neutrosophic graph theory (SVNGT) by applying the concept of single valued neutrosophic sets on graph theory. The concept of SVNGT and their extensions finds its applications in diverse fields [6-19]. To search the minimum spanning tree in neutrosophic environment recently few researchers have used neutrosophic methods. Ye [4] developed a method to find minimum spanning tree of a graph where nodes (samples) are represented in the form of SVNS and distance between two nodes which represents the dissimilarity between the corresponding samples has been derived. To cluster the data represented by double-valued neutrosophic information, Kandasamy [3] proposed a double-valued Neutrosophic Minimum Spanning Tree (DVN-MST) clustering algorithm. A solution approach of the optimum spanning tree problems considering the inconsistency, incompleteness and indeterminacy of the information, which was proposed by Mandal and Basu [5]. The authors consider a network problem with multiple criteria, which are represented by weight of each edge in neutrosophic set. The approach proposed by the authors is based on similarity measure. In another paper, Mullai [20] discussed the MST problem on a graph in which a bipolar

neutrosophic number is associated to each edge as its edge length, and illustrated it by a numerical example.

The main objective of this paper is to present a neutrosophic version of Kruskal algorithm for searching the cost minimum spanning tree of an undirected graph in which a bipolar neutrosophic number is associated to each edge as its edge length.

The rest of the paper is organized as follows. The concepts of neutrosophic sets, single valued neutrosophic sets, bipolar neutrosophic sets and the score function of bipolar neutrosophic number are briefly presented in section 2. A novel approach for finding the minimum spanning tree of neutrosophic undirected graph is proposed in section 3. A numerical example is presented to illustrate the proposed method in Section 4. A comparative study with existing methods is proposed in section 5, Finally, the main conclusion is presented in section 6.

II. Preliminaries

Some of the important background knowledge for the materials that are presented in this paper is presented in this section. These results can be found in [1, 2, 23].

Definition 2.1 [1] Let ξ be a universal set. The neutrosophic set A on the universal set ξ categorized into three membership functions called the true $T_A(x)$, indeterminate $I_A(x)$ and false $F_A(x)$ contained in real standard or non-standard subset of $]-0, 1+[$ respectively.

$$-0 \leq \sup T_A(x) + \sup I_A(x) + \sup F_A(x) \leq 3+(1)$$

Definition 2.2 [2] Let ξ be a universal set. The single valued neutrosophic sets (SVNs) A on the universal ξ is denoted as following

$$A = \{ \langle x: T_A(x), I_A(x), F_A(x) \rangle \mid x \in \xi \} \quad (2)$$

The functions $T_A(x) \in [0, 1]$, $I_A(x) \in [0, 1]$ and $F_A(x) \in [0, 1]$ are named degree of true, indeterminate and false membership of x in A , satisfy the following condition:

$$0 \leq T_A(x) + I_A(x) + F_A(x) \leq 3 \quad (3)$$

Definition 2.3 [23]. A bipolar neutrosophic set A in ξ is defined as an object of the form

$A = \{ \langle x, T^p(x), I^p(x), F^p(x), T^n(x), I^n(x), F^n(x) \rangle \mid x \in X \}$, where $T^p, I^p, F^p: \xi \rightarrow [1, 0]$ and $T^n, I^n, F^n: \xi \rightarrow [-1, 0]$. The positive membership degree $T^p(x), I^p(x), F^p(x)$ denotes the true membership, indeterminate membership and false membership of an element $\in \xi$ corresponding to a bipolar neutrosophic set A and the negative membership degree $T^n(x), I^n(x), F^n(x)$ denotes the true membership, indeterminate membership and false membership of an element $\in \xi$ to some implicit counter-property corresponding to a bipolar neutrosophic set A .

To compare two Bipolar neutrosophic numbers (abbr.BNNs), Deli et al.[23] introduced the concept of score function and in case where the score value of two BNNs are same, they can be distinguished by using accuracy function and certainty function as follow

Definition 2.4[23]. Let $\tilde{A} = \langle T^p, I^p, F^p, T^n, I^n, F^n \rangle$ be a bipolar neutrosophic number, then, the score function $s(\tilde{A})$, accuracy function $a(\tilde{A})$ and certainty function $c(\tilde{A})$ of a BNN are defined as follows:

$$(i) \quad s(\tilde{A}) = \left(\frac{1}{6} \right) \times [T^p + 1 - I^p + 1 - F^p + 1 + T^n - I^n - F^n] \quad (4)$$

$$(ii) \quad a(\tilde{A}) = T^p - F^p + T^n - F^n \quad (5)$$

$$(iii) \quad c(\tilde{A}) = T^p - F^n \quad (6)$$

For any two BNNs \tilde{A}_1 and \tilde{A}_2 :

- i. If $s(\tilde{A}_1) > s(\tilde{A}_2)$, then \tilde{A}_1 is greater than \tilde{A}_2 , that is, \tilde{A}_1 is superior to \tilde{A}_2 , denoted by $\tilde{A}_1 \succ \tilde{A}_2$
- ii. If $s(\tilde{A}_1) = s(\tilde{A}_2)$ and $a(\tilde{A}_1) > a(\tilde{A}_2)$, then \tilde{A}_1 is greater than \tilde{A}_2 , that is, \tilde{A}_1 is superior to \tilde{A}_2 , denoted by $\tilde{A}_1 \succ \tilde{A}_2$
- iii. If $s(\tilde{A}_1) = s(\tilde{A}_2)$, $a(\tilde{A}_1) = a(\tilde{A}_2)$, and $c(\tilde{A}_1) > c(\tilde{A}_2)$ then \tilde{A}_1 is greater than \tilde{A}_2 , that is, \tilde{A}_1 is superior to \tilde{A}_2 , denoted by $\tilde{A}_1 \succ \tilde{A}_2$
- iv. If $s(\tilde{A}_1) = s(\tilde{A}_2)$, $a(\tilde{A}_1) = a(\tilde{A}_2)$, and $c(\tilde{A}_1) = c(\tilde{A}_2)$ then \tilde{A}_1 is equal to \tilde{A}_2 , that is, \tilde{A}_1 is indifferent to \tilde{A}_2 , denoted by $\tilde{A}_1 = \tilde{A}_2$

III. MINIMUM SPANNING TREE ALGORITHM OF BN- UNDIRECTED GRAPH

In this section, a neutrosophic version of Kruskal algorithm is proposed to handle minimum spanning tree in a bipolar neutrosophic environment. In the following, we propose a bipolar neutrosophic minimum spanning tree algorithm, whose steps are defined below:

Algorithm:

Input: The weight matrix $M = [W_{ij}]_{n \times n}$ for the undirected weighted neutrosophic graph G .

Output: Minimum cost Spanning tree T of G .

Step 1: Input neutrosophic adjacency matrix A .

Step 2: Translate the BN-matrix into score matrix $[S_{ij}]_{n \times n}$ by using score of bipolar neutrosophic number.

Step 3: Iterate step 4 and step 5 until all $(n-1)$ entries matrix of S are either marked or set to zero or other words all the nonzero elements are marked.

Step 4: Find the score matrix S either columns-wise or row-wise to find the unmarked minimum entries S_{ij} , which is the weight of the corresponding edge e_{ij} in S .

Step 5: If the corresponding edge e_{ij} of selected S_{ij} produce a cycle with the previous marked entries of the score matrix S then set $S_{ij} = 0$ else mark S_{ij} .

Step 6: Building the graph T including only the marked entries from the score matrix S which shall be desired minimum cost spanning tree of G .

Step 7: Stop.

An illustrative flow chart of the given algorithm is presented in fig. 3.

IV. NUMERICAL EXAMPLE

In this section, a numerical example is explained based on the above algorithm. Consider a hypothetical graph with edge values are given in the table below.

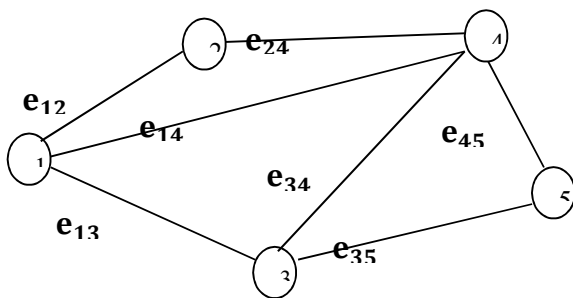

Fig 2. Undirected bipolar neutrosophic- graphs

E	Edge length
e_{12}	$\langle 0.3, 0.1, 0.2, -0.8, -0.5, -0.1 \rangle$
e_{13}	$\langle 0.4, 0.5, 0.4, -0.2, -0.4, -0.5 \rangle$
e_{14}	$\langle 0.6, 0.7, 0.8, -0.6, -0.4, -0.4 \rangle$
e_{24}	$\langle 0.4, 0.8, 0.3, -0.2, -0.5, -0.7 \rangle$
e_{34}	$\langle 0.2, 0.3, 0.7, -0.2, -0.4, -0.4 \rangle$
e_{35}	$\langle 0.4, 0.6, 0.5, -0.4, -0.4, -0.3 \rangle$
e_{45}	$\langle 0.5, 0.4, 0.3, -0.4, -0.5, -0.8 \rangle$

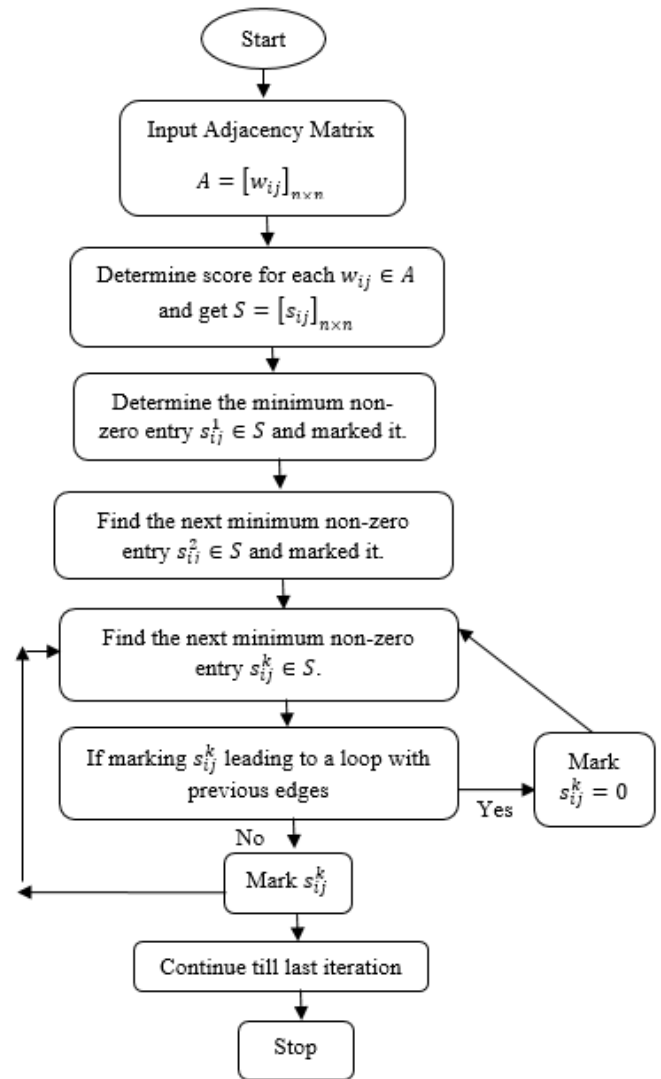

Fig. 3 (Flow chart describing proposed algorithm)

The BN- adjacency matrix A is given below:

$$= \begin{bmatrix} 0 & \langle 0.3, 0.1, 0.2, -0.8, -0.5, -0.1 \rangle \\ \langle 0.3, 0.1, 0.2, -0.8, -0.5, -0.1 \rangle & 0 \\ \langle 0.4, 0.5, 0.4, -0.2, -0.4, -0.5 \rangle & 0 \\ \langle 0.6, 0.7, 0.8, -0.6, -0.4, -0.4 \rangle & \langle 0.4, 0.8, 0.3, -0.2, -0.5, -0.7 \rangle \\ 0 & 0 \\ \langle 0.4, 0.5, 0.4, -0.2, -0.4, -0.5 \rangle & \langle 0.6, 0.7, 0.8, -0.6, -0.4, -0.4 \rangle \\ 0 & \langle 0.4, 0.8, 0.3, -0.2, -0.5, -0.7 \rangle \\ 0 & \langle 0.2, 0.3, 0.7, -0.2, -0.4, -0.4 \rangle \\ \langle 0.2, 0.3, 0.7, -0.2, -0.4, -0.4 \rangle & 0 \\ \langle 0.4, 0.6, 0.5, -0.4, -0.4, -0.3 \rangle & \langle 0.5, 0.4, 0.3, -0.4, -0.5, -0.8 \rangle \\ 0 & \\ 0 & \\ \langle 0.4, 0.6, 0.5, -0.4, -0.4, -0.3 \rangle & \\ \langle 0.5, 0.4, 0.3, -0.4, -0.5, -0.8 \rangle & \\ 0 & \end{bmatrix}$$

Hence, using the score function introduced in definition 2.1, we get the score matrix

$$S = \begin{bmatrix} 0 & 0.47 & 0.53 & 0.38 & 0 \\ 0.47 & 0 & 0 & 0.55 & 0 \\ 0.53 & 0 & 0 & 0.52 & 0.43 \\ 0.38 & 0.55 & 0.52 & 0 & 0.62 \\ 0 & 0 & 0.43 & 0.62 & 0 \end{bmatrix}$$

Fig. 4. Score matrix

Clearly from figure 4, it is observed that 0.38 is the least value so edge (1, 4) is marked as red as shown in figure 5. This process shall be continued until last iteration.

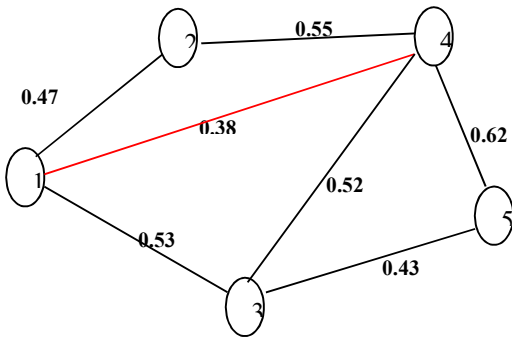

Fig. 5

Clearly from the figure 6, the next non zero minimum entries 0.43 is marked and colored corresponding edge (3, 5) is given in figure 7.

$$S = \begin{bmatrix} 0 & 0.47 & 0.53 & 0.38 & 0 \\ 0.47 & 0 & 0 & 0.55 & 0 \\ 0.53 & 0 & 0 & 0.52 & 0.43 \\ 0.38 & 0.55 & 0.52 & 0 & 0.62 \\ 0 & 0 & 0.43 & 0.62 & 0 \end{bmatrix}$$

Fig. 6

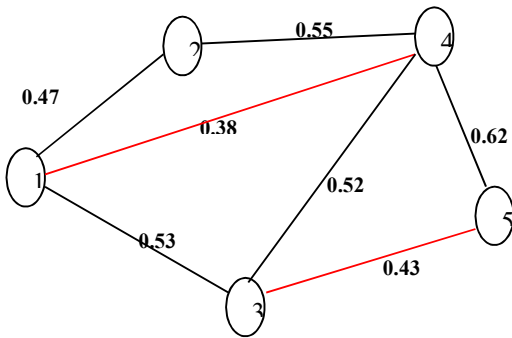

Fig 7

$$S = \begin{bmatrix} 0 & 0.47 & 0.53 & 0.38 & 0 \\ 0.47 & 0 & 0 & 0.55 & 0 \\ 0.53 & 0 & 0 & 0.52 & 0.43 \\ 0.38 & 0.55 & 0.52 & 0 & 0.62 \\ 0 & 0 & 0.43 & 0.62 & 0 \end{bmatrix}$$

Fig.8

Clearly from the figure 8, the next minimum non-zero element 0.47 is marked and the colored corresponding edge is given in figure 9.

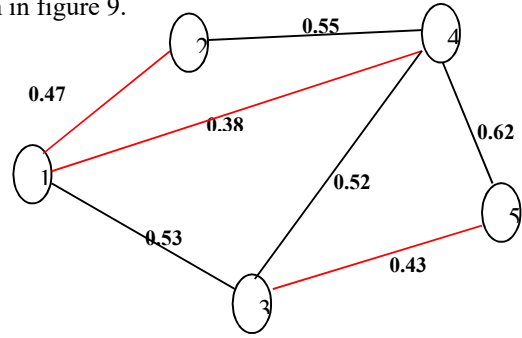

Fig 9

Clearly from the figure 10. The next minimum non-zero element 0.52 is marked, and colored corresponding edge (3, 4) is given in figure 11.

$$S = \begin{bmatrix} 0 & 0.47 & 0.53 & 0.38 & 0 \\ 0.47 & 0 & 0 & 0.55 & 0 \\ 0.53 & 0 & 0 & 0.52 & 0.43 \\ 0.38 & 0.55 & 0.52 & 0 & 0.62 \\ 0 & 0 & 0.43 & 0.62 & 0 \end{bmatrix}$$

Fig.10

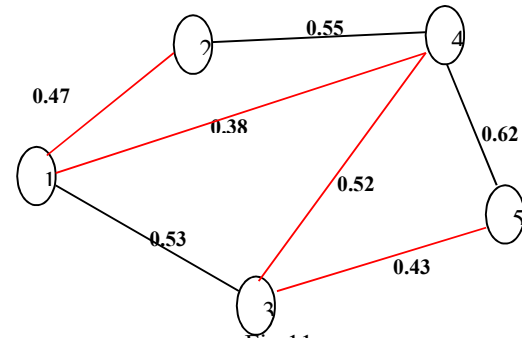

Fig.11

Clearly from the figure 12. The next minimum non-zero element 0.53 is marked. But while drawing the edges it produces the cycle. So we reject and mark it as 0 instead of 0.53

$$S = \begin{bmatrix} 0 & 0.47 & 0.53 & 0.38 & 0 \\ 0.47 & 0 & 0 & 0.55 & 0 \\ 0.53 & 0 & 0 & 0.52 & 0.43 \\ 0.38 & 0.55 & 0.52 & 0 & 0.62 \\ 0 & 0 & 0.43 & 0.62 & 0 \end{bmatrix}$$

Fig .12

The next least value is 0.55 but including this edge results in the formation of a cycle. So this value is marked as zero as shown in the figure 13.

$$S = \begin{bmatrix} 0 & 0.47 & 0.53 & 0.38 & 0 \\ 0.47 & 0 & 0 & 0.55 & 0 \\ 0.53 & 0 & 0 & 0.52 & 0.43 \\ 0.38 & 0.55 & 0.52 & 0 & 0.62 \\ 0 & 0 & 0.43 & 0.62 & 0 \end{bmatrix}$$

Fig .13

Clearly from the figure 14. The next minimum non-zero element 0.62 is marked. But while drawing the edges it produces the cycle. So we reject and mark it as 0 instead of 0.62.

$$S = \begin{bmatrix} 0 & 0.47 & 0.53 & 0.38 & 0 \\ 0.47 & 0 & 0 & 0.55 & 0 \\ 0.53 & 0 & 0 & 0.52 & 0.43 \\ 0.38 & 0.55 & 0.52 & 0 & 0.62 \\ 0 & 0 & 0.43 & 0.62 & 0 \end{bmatrix}$$

Fig .14

After the above steps, the final path of minimum cost of spanning tree of G is given in figure 15.

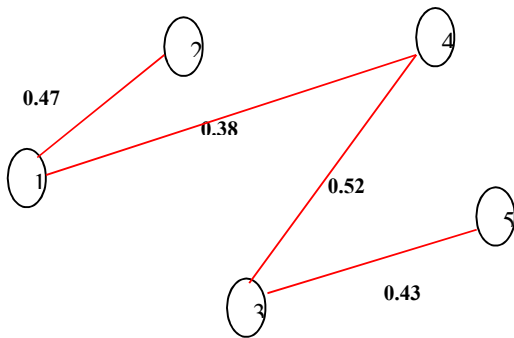

Fig .15. Final path of minimum cost of spanning tree of G .

Following the steps of proposed algorithm presented in section 3. Therefore the crisp minimum cost spanning tree is 1,8 and the final path of minimum cost of spanning tree is {2,1}, {1, 4}, {4, 3}, {3, 5}.

V. COMPARATIVE STUDY

In this section, the same process is carried out by the algorithm of Mullai et al [20]. The results obtained in different iterations by this existing algorithm are illustrated below.

Let $C_1 = \{1\}$ and $\bar{C}_1 = \{2, 3, 4, 5\}$

Iteration 2:

Let $C_2 = \{1, 4\}$ and $\bar{C}_2 = \{2, 3, 5\}$

Iteration 3:

Let $C_3 = \{1, 4, 3\}$ and $\bar{C}_3 = \{2, 5\}$

Iteration 4:

Let $C_4 = \{1, 4, 5, 3\}$ and $\bar{C}_4 = \{2\}$

Based on these iterations of Mullai’s algorithm, we have the following MST.

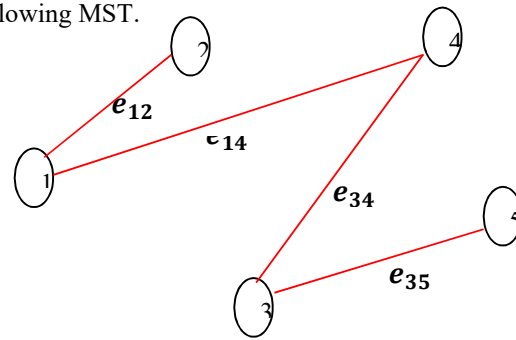

Fig .16.MST obtained by Mullai’s Algorithm

This comparison makes the point that that both the existing and new algorithm leads to the same results.

The advantage of new algorithm over existing algorithm is that the new algorithm is matrix based and can be easily performed in MATLAB while Mullai’s algorithm is based on edge comparison and is difficult to be performed.

VI. CONCLUSION

This paper considers a minimum spanning tree problem under the situation where the weights of edges are represented by BNNs. It is discussed how proposed algorithm is better in formulation and implementation. This work can be extended to the case of directed neutrosophic graphs and other types of neutrosophic graphs such as interval valued bipolar neutrosophic graphs

ACKNOWLEDGMENT

The authors are very grateful to the chief editor and reviewers for their comments and suggestions, which is helpful in improving the paper.

REFERENCES

- [1] F. Smarandache, Neutrosophy. Neutrosophic Probability, Set, and Logic, ProQuest Information & Learning, Ann Arbor, Michigan, USA, 1998, 105 pages.
- [2] H. Wang, F.Smarandache, Y. Zhang andR. Sunderraman, Single valued Neutrosophic Sets. Multisspace and Multistructure 4,2010,pp. 410-413.
- [3] I. Kandasamy, Double-Valued Neutrosophic Sets, their Minimum Spanning Trees, and Clustering Algorithm, Journal of Intelligent system 2016, pp.1-17.
- [4] J. Ye, single valued neutrosophic minimum spanning tree and its clustering method, Journal of Intelligent system 23, 2014, pp.311-324
- [5] K. Mandal and K. Basu, Improved similarity measure in neutrosophic environment and its application in finding minimum spanning tree, Journal of Intelligent & Fuzzy System 31, 2016, pp. 1721-1730.
- [6] S. Broumi, A. Bakali, M. Talea, F. Smarandache, and L. Vladareanu, Computation of Shortest Path Problem in a Network with SV-Trapezoidal Neutrosophic Numbers. Proceedings of the 2016 International Conference on Advanced Mechatronic Systems, Melbourne, Australia, 2016, pp. 417-422.
- [7] S. Broumi, A. Bakali, T. Mohamed, F. Smarandache and L. Vladareanu, Shortest Path Problem Under Triangular Fuzzy Neutrosophic Information, 10th International Conference on Software, Knowledge, Information Management & Applications (SKIMA),2016,pp.169-174.

- [8] S. Broumi, A. Bakali, M. Talea, F. Smarandache, and L. Vladareanu, Applying Dijkstra Algorithm for Solving Neutrosophic Shortest Path Problem. Proceedings of the 2016 International Conference on Advanced Mechatronic Systems, Melbourne, Australia, November 30 - December 3, (2016) 412-416.
- [9] S. Broumi, F. Smarandache, M. Talea and A. Bakali, Operations on Interval Valued Neutrosophic Graphs, chapter in book- New Trends in Neutrosophic Theory and Applications- Florentin Smarandache and Surpati Pramanik (Editors), 2016, pp. 231-254. ISBN 978-1-59973-498-9
- [10] S. Broumi, A. Bakali, M. Talea, F. Smarandache and M. Ali, Shortest Path Problem under Bipolar Neutrosophic Setting, Applied Mechanics and Materials, Vol. 859, 2016, pp 59-66.
- [11] S. Broumi, A. Bakali, M. Talea and F. Smarandache and P.K, Kishore Kumar, Shortest Path Problem on Single Valued Neutrosophic Graphs, 2017 International Symposium on Networks, Computers and Communications (ISNCC), 2017(in press)
- [12] S. Broumi, A. Bakali, M. Talea, F. Smarandache, and L. Vladareanu, Applying Dijkstra Algorithm for Solving Neutrosophic Shortest Path Problem. Proceedings of the 2016 International Conference on Advanced Mechatronic Systems, Melbourne, Australia, November 30 - December 3, (2016) 412-416.
- [13] S. Broumi, M. Talea, A. Bakali, F. Smarandache, On Bipolar Single Valued Neutrosophic Graphs, *Journal of New Theory*, N11, 2016, pp.84-102.
- [14] S. Broumi, M. Talea, A. Bakali, F. Smarandache, Interval Valued Neutrosophic Graphs, *Critical Review*, XII, 2016. pp. 5-33.
- [15] S. Broumi, F. Smarandache, M. Talea and A. Bakali, An Introduction to Bipolar Single Valued Neutrosophic Graph Theory. Applied Mechanics and Materials, vol.841, 2016, 184-191.
- [16] S. Broumi, M. Talea, A. Bakali, F. Smarandache, Single Valued Neutrosophic Graphs, *Journal of New Theory*, N 10, 2016, pp. 86-101.
- [17] S. Broumi, F. Smarandache, M. Talea and A. Bakali, Decision-Making Method Based On the Interval Valued Neutrosophic Graph, *Future Technologie*, 2016, IEEE, pp. 44-50.
- [18] S. Broumi, M. Talea, F. Smarandache and A. Bakali, Single Valued Neutrosophic Graphs: Degree, Order and Size. IEEE International Conference on Fuzzy Systems (FUZZ), 2016, pp. 2444-2451.
- [19] S. Broumi, A. Bakali, M, Talea, and F, Smarandache, Isolated Single Valued Neutrosophic Graphs. *Neutrosophic Sets and Systems*, Vol. 11, 2016, pp.74-78.
- [20] M. Mullai, S. Broumi, A. Stephen, Shortest path problem by minimal spanning tree algorithm using bipolar neutrosophic numbers, *International Journal of Mathematic Trends and Technology*, Vol 46, N2, 2017, pp.80-87.
- [21] J. J. Peng, J. Q. Wang, J. Wang, H. Y. Zwang, X. H. Chen, Simplified neutrosophic sets and their applications in multi-criteria group decision-making problems, *International journal of Systems science*, Vol. 47, 2015, pp. 2342-2358.
- [22] J. Ye, Similarity measures between interval neutrosophic sets and their applications in multicriteria decision-making, *Journal of Intelligent and Fuzzy Systems*, 26, 2014, pp. 165 172.
- [23] I. Deli, M. Ali, F. Smarandache, Bipolar Neutrosophic Sets And Their Application Based On Multi-Criteria Decision Making Problems, Proceedings of the 2015 International Conference on Advanced Mechatronic Systems, 2015, pp. 249-254.
- [24] J. Ye, Trapezoidal neutrosophic set and its application to multiple attribute decision-making, *Neural Computing and Applications*, July 2015, Volume 26, Issue 5, 2015, pp. 1157-1166.
- [25] S. Broumi, F. Smarandache, M. Dhar, Rough Neutrosophic sets, *Neutrosophic Sets and Systems*, Vol. 3, 2014.
- [26] I. Deli, Y. Subas, A ranking method of single valued neutrosophic numbers and its applications to multi-attribute decision making problems, *Int. J. Mach. Learn. and Cyber* 2016.
- [27] <http://fs.gallup.unm.edu/NSS>
- [28] A. Mumtaz, S. Le Hoang, I. Deli and T. Nguyen Dang, Bipolar neutrosophic soft sets and applications in decision making, *Journal of Intelligent & Fuzzy Systems*, vol. 33, no. 6, 2017, pp. 4077-4087.

Interval Complex Neutrosophic Graph of Type 1

Said Broumi, Assia Bakali, Mohamed Talea, Florentin Smarandache, V. Venkateswara Rao

Said Broumi, Assia Bakali, Mohamed Talea, Florentin Smarandache, V. Venkateswara Rao (2018). Interval Complex Neutrosophic Graph of Type 1. In *Neutrosophic Operational Research*, vol. III, eds.: Prof. Florentin Smarandache, Dr. Mohamed Abdel-Basset, Dr. Victor Chang, 87-106

Abstract

The neutrosophic set theory, proposed by smarandache, can be used as a general mathematical tool for dealing with indeterminate and inconsistent information. By applying the concept of neutrosophic sets on graph theory, several studies of neutrosophic models have been presented in the literature. In this paper, the concept of complex neutrosophic graph of type 1 is extended to interval complex neutrosophic graph of type 1 (ICNG1). We have proposed a representation of ICNG1 by adjacency matrix and studied some properties related to this new structure. The concept of ICNG1 generalized the concept of generalized fuzzy graphs of type 1 (GFG1), generalized single valued neutrosophic graphs of type 1 (GSVNG1) generalized interval valued neutrosophic graphs of type 1 (GIVNG1) and complex neutrosophic graph type 1(CNG1).

Keywords

Neutrosophic set; complex neutrosophic set; interval complex neutrosophic set; interval complex neutrosophic graph of type 1; adjacency matrix.

1 Introduction

Crisp set, fuzzy sets [14] and intuitionistic fuzzy sets [13] already acts as a mathematical tool. But Smarandache [5, 6] gave a momentum by introducing

the concept of neutrosophic sets (NSs in short). Neutrosophic sets came as a glitter in this field as their vast potential to intimate imprecise, incomplete, uncertainty and inconsistent information of the world. Neutrosophic sets associates a degree of membership (T), indeterminacy(I) and non- membership (F) for an element each of which belongs to the non-standard unit interval $] -0, 1+[$. Due to this characteristics, the practical implement of NSs becomes difficult. So, for this reason, Smarandache [5, 6] and Wang et al. [10] introduced the concept of a single valued Neutrosophic sets (SVNS), which is an instance of a NS and can be used in real scientific and engineering applications. Wang et al. [12] defined the concept of interval valued neutrosophic sets as generalization of SVNS. In [11], the readers can found a rich literature on single valued neutrosophic sets and their applications in divers fields.

Graph representations are widely used for dealing with structural information, in different domains such as networks, image interpretation, pattern recognition operations research. In a crisp graphs two vertices are either related or not related to each other, mathematically, the degree of relationship is either 0 or 1. While in fuzzy graphs, the degree of relationship takes values from $[0, 1]$. In [1] Atanassov defined the concept of intuitionistic fuzzy graphs (IFGs) with vertex sets and edge sets as IFS. The concept of fuzzy graphs and their extensions have a common property that each edge must have a membership value less than or equal to the minimum membership of the nodes it connects.

Fuzzy graphs and their extensions such as hesitant fuzzy graph, intuitionistic fuzzy graphs ..etc, deal with the kinds of real life problems having some uncertainty measure. All these graphs cannot handle the indeterminate relationship between object. So, for this reason, Smarandache [3,9] defined a new form of graph theory called neutrosophic graphs based on literal indeterminacy (I) to deal with such situations. The same author [4] initiated a new graphical structure of neutrosophic graphs based on (T, I, F) components and proposed three structures of neutrosophic graphs such as neutrosophic edge graphs, neutrosophic vertex graphs and neutrosophic vertex-edge graphs. In [8] Smarandache defined a new classes of neutrosophic graphs including neutrosophic offgraph, neutrosophic bipolar/tripolar/ multipolar graph. Single valued neutrosophic graphs with vertex sets and edge sets as SVN were first introduced by Broumi [33] and defined some of its properties. Also, Broumi et al. [34] defined certain degrees of SVNG and established some of their properties. The same author proved a necessary and sufficient condition for a single valued neutrosophic graph to be an isolated-SVNG [35]. In addition, Broumi et al. [47] defined the concept of the interval valued neutrosophic graph as a generalization of SVNG and analyzed some properties of it. Recently, Several extension of

single valued neutrosophic graphs, interval valued neutrosophic graphs and their application have been studied deeply [17-19, 21-22, 36-45, 48-49,54-56].

In [7] Smarandache initiated the idea of removal of the edge degree restriction of fuzzy graphs, intuitionistic fuzzy graphs and single valued neutrosophic graphs. Samanta et al [53] discussed the concept of generalized fuzzy graphs (GFG) and studied some properties of it . The authors claim that fuzzy graphs and their extension defined by many researches are limited to represented for some systems such as social network. Employing the idea initiated by smarandache [7], Broumi et al. [46, 50,51]proposed a new structures of neutrosophic graphs such as generalized single valued neutrosophic graph of type1(GSVNG1), generalized interval valued neutrosophic graph of type1(GIVNG1), generalized bipolar neutrosophic graph of type 1, all these types of graphs are a generalization of generalized fuzzy graph of type1[53]. In [2], Ramot defined the concept of complex fuzzy sets as an extension of the fuzzy set in which the range of the membership function is extended from the subset of the real number to the unit disc. Later on, some extensions of complex fuzzy set have been studied well in the litteratur e[20,23,26,28,29,58-68].In [15],Ali and Smarandache proposed the concept of complex neutrosophic set in short CNS. The concept of complex neutrosophic set is an extension of complex intuitionistic fuzzy sets by adding by adding complex-valued indeterminate membership grade to the definition of complex intuitionistic fuzzy set. The complex-valued truth membership function, complex-valued indeterminacy membership function, and complex-valued falsity membership function are totally independent. The complex fuzzy set has only one extra phase term, complex intuitionistic fuzzy set has two additional phase terms while complex neutrosophic set has three phase terms. The complex neutrosophic sets (CNS) are used to handle the information of uncertainty and periodicity simultaneously. When the values of the membership function indeterminacy-membership function and the falsity-membership function in a CNS are difficult to be expressed as exact single value in many real-world problems, interval complex neutrosophic sets can be used to characterize the uncertain information more sufficiently and accurately. So for this purpose, Ali et al [16] defined the concept of interval complex neutrosophic sets (ICNs) and examined its characteristics. Recently, Broumi et al.[52]defined the concept of complex neutrosophic graphs of type 1 with vertex sets and edge sets as complex neutrosophic sets.

In this paper, an extended version of complex neutrosophic graph of type 1(ICNG1) is introduced. To the best of our knowledge, there is no research on interval complex neutrosophic graph of type 1 in literature at present.

The remainder of this paper is organized as follows. In Section 2, some fundamental and basic concepts regarding neutrosophic sets, single valued neutrosophic sets, complex neutrosophic set, interval complex neutrosophic set and complex neutrosophic graphs of type 1 are presented. In Section 3, ICNG1 is proposed and provided by a numerical example. In section 4 a representation matrix of ICNG1 is introduced and finally we draw conclusions in section 5.

2 Fundamental and Basic Concepts

In this section we give some definitions regarding neutrosophic sets, single valued neutrosophic sets, complex neutrosophic set, interval complex neutrosophic set and complex neutrosophic graphs of type 1

Definition 2.1 [5, 6]

Let ζ be a space of points and let $x \in \zeta$. A neutrosophic set $A \in \zeta$ is characterized by a truth membership function T , an indeterminacy membership function I , and a falsity membership function F . The values of T, I, F are real standard or nonstandard subsets of $]0, 1^+[$, and $T, I, F: \zeta \rightarrow]0, 1^+[$. A neutrosophic set can therefore be represented as

$$A = \{(x, T_A(x), I_A(x), F_A(x)) : x \in \zeta\} \quad (1)$$

Since $T, I, F \in [0, 1]$, the only restriction on the sum of T, I, F is as given below:

$$0 \leq T_A(x) + I_A(x) + F_A(x) \leq 3^+ \quad (2)$$

From philosophical point of view, the NS takes on value from real standard or non-standard subsets of $]0, 1^+[$. However, to deal with real life applications such as engineering and scientific problems, it is necessary to take values from the interval $[0, 1]$ instead of $]0, 1^+[$.

Definition 2.2 [10]

Let ζ be a space of points (objects) with generic elements in ζ denoted by x . A single valued neutrosophic set A (SVNS A) is characterized by truth-membership function $T_A(x)$, an indeterminacy-membership function $I_A(x)$, and a falsity-membership function $F_A(x)$. For each point x in ζ , $T_A(x), I_A(x), F_A(x) \in [0, 1]$. The SVNS A can therefore be written as

$$A = \{(x, T_A(x), I_A(x), F_A(x)) : x \in \zeta\} \quad (3)$$

Definition 2.3 [15]

A complex neutrosophic set A defined on a universe of discourse X , which is characterized by a truth membership function $T_A(x)$, an indeterminacy-membership function $I_A(x)$, and a falsity-membership function $F_A(x)$ that assigns a complex-valued membership grade to $T_A(x), I_A(x), F_A(x)$ for any $x \in X$. The values of $T_A(x), I_A(x), F_A(x)$ and their sum may be any values within a unit circle

in the complex plane and is therefore of the form $T_A(x) = p_A(x)e^{i\mu_A(x)}$, $I_A(x) = q_A(x)e^{i\nu_A(x)}$, and $F_A(x) = r_A(x)e^{i\omega_A(x)}$. All the amplitude and phase terms are real-valued and $p_A(x), q_A(x), r_A(x) \in [0, 1]$, whereas $\mu_A(x), \nu_A(x), \omega_A(x) \in (0, 2\pi]$, such that the condition.

$$0 \leq p_A(x) + q_A(x) + r_A(x) \leq 3 \tag{4}$$

is satisfied. A complex neutrosophic set A can thus be represented in set form as:

$$A = \{ \langle x, T_A(x) = a_T, I_A(x) = a_I, F_A(x) = a_F \rangle : x \in X \}, \tag{5}$$

Where $T_A: X \rightarrow \{a_T: a_T \in \mathbb{C}, |a_T| \leq 1\}$, $I_A: X \rightarrow \{a_I: a_I \in \mathbb{C}, |a_I| \leq 1\}$, $F_A: X \rightarrow \{a_F: a_F \in \mathbb{C}, |a_F| \leq 1\}$, and also

$$|T_A(x) + I_A(x) + F_A(x)| \leq 3. \tag{6}$$

Let A and B be two CNSs in X , which are as defined as follow $A = \{ \langle x, T_A(x), I_A(x), F_A(x) \rangle : x \in X \}$ and $B = \{ \langle x, T_B(x), I_B(x), F_B(x) \rangle : x \in X \}$.

Definition 2.4 [15]

Let A and B be two CNSs in X . The union, intersection and complement of two CNSs are defined as:

The union of A and B denoted as $A \cup_N B$, is defined as:

$$A \cup_N B = \{ \langle x, T_{A \cup B}(x), I_{A \cup B}(x), F_{A \cup B}(x) \rangle : x \in X \}, \tag{7}$$

Where, $T_{A \cup B}(x), I_{A \cup B}(x), F_{A \cup B}(x)$ are given by

$$T_{A \cup B}(x) = \max(p_A(x), p_B(x)) \cdot e^{i(\mu_A(x) \cup \mu_B(x))}$$

$$I_{A \cup B}(x) = \min(q_A(x), q_B(x)) \cdot e^{i(\nu_A(x) \cup \nu_B(x))},$$

$$F_{A \cup B}(x) = \min(r_A(x), r_B(x)) \cdot e^{i(\omega_A(x) \cup \omega_B(x))}.$$

The intersection of A and B denoted as $A \cap_N B$, is defined as:

$$A \cap_N B = \{ \langle x, T_{A \cap B}(x), I_{A \cap B}(x), F_{A \cap B}(x) \rangle : x \in X \}, \tag{8}$$

Where $T_{A \cap B}(x), I_{A \cap B}(x), F_{A \cap B}(x)$ are given by

$$T_{A \cap B}(x) = \min(p_A(x), p_B(x)) \cdot e^{i(\mu_A(x) \cap \mu_B(x))} \tag{9}$$

$$I_{A \cap B}(x) = \max(q_A(x), q_B(x)) \cdot e^{i(\nu_A(x) \cap \nu_B(x))}, \tag{10}$$

$$F_{A \cap B}(x) = \max(r_A(x), r_B(x)) \cdot e^{i(\omega_A(x) \cap \omega_B(x))}. \tag{11}$$

The union and the intersection of the phase terms of the complex truth, falsity and indeterminacy membership functions can be calculated using any one of the following operations:

Sum:

$$\mu_{A \cup B}(x) = \mu_A(x) + \mu_B(x), \tag{12}$$

$$\nu_{A \cup B}(x) = \nu_A(x) + \nu_B(x), \tag{13}$$

$$\omega_{A \cup B}(x) = \omega_A(x) + \omega_B(x). \tag{14}$$

Max:

$$\mu_{A \cup B}(x) = \max(\mu_A(x), \mu_B(x)), \tag{15}$$

$$v_{A \cup B}(x) = \max(v_A(x), v_B(x)), \tag{16}$$

$$\omega_{A \cup B}(x) = \max(\omega_A(x), \omega_B(x)). \tag{17}$$

Min:

$$\mu_{A \cup B}(x) = \min(\mu_A(x), \mu_B(x)), \tag{18}$$

$$v_{A \cup B}(x) = \min(v_A(x), v_B(x)), \tag{19}$$

$$\omega_{A \cup B}(x) = \min(\omega_A(x), \omega_B(x)). \tag{20}$$

“The game of winner, neutral, and loser”:

$$\mu_{A \cup B}(x) = \begin{cases} \mu_A(x) & \text{if } p_A > p_B \\ \mu_B(x) & \text{if } p_B > p_A \end{cases}, \tag{21}$$

$$v_{A \cup B}(x) = \begin{cases} v_A(x) & \text{if } q_A < q_B \\ v_B(x) & \text{if } q_B < q_A \end{cases}, \tag{22}$$

$$\omega_{A \cup B}(x) = \begin{cases} \omega_A(x) & \text{if } r_A < r_B \\ \omega_B(x) & \text{if } r_B < r_A \end{cases}. \tag{23}$$

Definition 2.5 [16]

An interval complex neutrosophic set A defined on a universe of discourse ζ , which is characterized by an interval truth membership function $\tilde{T}_A(x) = [T_A^L(x), T_A^U(x)]$, an interval indeterminacy-membership function $\tilde{I}_A(x)$, and an interval falsity-membership function $\tilde{F}_A(x)$ that assigns a complex-valued membership grade to $\tilde{T}_A(x), \tilde{I}_A(x), \tilde{F}_A(x)$ for any $x \in \zeta$. The values of $\tilde{T}_A(x), \tilde{I}_A(x), \tilde{F}_A(x)$ and their sum may be any values within a unit circle in the complex plane and is therefore of the form $\tilde{T}_A(x) = [p_A^L(x), p_A^U(x)].e^{i[\mu_A^L(x), \mu_A^U(x)]}$, $\tag{24}$

$$\tilde{I}_A(x) = [q_A^L(x), q_A^U(x)].e^{i[v_A^L(x), v_A^U(x)]} \tag{25}$$

$$\text{and } \tilde{F}_A(x) = [r_A^L(x), r_A^U(x)].e^{i[\omega_A^L(x), \omega_A^U(x)]} \tag{26}$$

All the amplitude and phase terms are real-valued and $p_A^L(x), p_A^U(x), q_A^L(x), q_A^U(x), r_A^L(x)$ and $r_A^U(x) \in [0, 1]$, whereas $\mu_A(x), v_A(x), \omega_A(x) \in (0, 2\pi]$, such that the condition

$$0 \leq p_A^U(x) + q_A^U(x) + r_A^U(x) \leq 3 \tag{27}$$

is satisfied. An interval complex neutrosophic set \tilde{A} can thus be represented in set form as:

$$\tilde{A} = \{ \langle x, T_A(x) = a_T, I_A(x) = a_I, F_A(x) = a_F \rangle : x \in \zeta \}, \tag{28}$$

Where $T_A: \zeta \rightarrow \{a_T: a_T \in C, |a_T| \leq 1\}$, $I_A: \zeta \rightarrow \{a_I: a_I \in C, |a_I| \leq 1\}$, $F_A: \zeta \rightarrow \{a_F: a_F \in C, |a_F| \leq 1\}$, and also $|T_A^U(x) + I_A^U(x) + F_A^U(x)| \leq 3$. (29)

Definition 2.6 [16]

Let A and B be two ICNSs in ζ . The union, intersection and complement of two ICNSs are defined as:

The union of A and B denoted as $A \cup_N B$, is defined as:

$$A \cup_N B = \left\{ (x, \tilde{T}_{A \cup B}(x), \tilde{I}_{A \cup B}(x), \tilde{F}_{A \cup B}(x)) : x \in X \right\}, \tag{30}$$

Where, $\tilde{T}_{A \cup B}(x)$, $\tilde{I}_{A \cup B}(x)$, $\tilde{F}_{A \cup B}(x)$ are given by

$$\begin{aligned} T_{A \cup B}^L(x) &= [(p_A^L(x) \vee p_B^L(x))] \cdot e^{j \cdot \mu_{T_{A \cup B}}^L(x)}, \\ T_{A \cup B}^U(x) &= [(p_A^U(x) \vee p_B^U(x))] \cdot e^{j \cdot \mu_{T_{A \cup B}}^U(x)} \end{aligned} \tag{31}$$

$$\begin{aligned} I_{A \cup B}^L(x) &= [(q_A^L(x) \wedge q_B^L(x))] \cdot e^{j \cdot \mu_{I_{A \cup B}}^L(x)}, \\ I_{A \cup B}^U(x) &= [(q_A^U(x) \wedge q_B^U(x))] \cdot e^{j \cdot \mu_{I_{A \cup B}}^U(x)}, \end{aligned} \tag{32}$$

$$\begin{aligned} F_{A \cup B}^L(x) &= [(r_A^L(x) \wedge r_B^L(x))] \cdot e^{j \cdot \mu_{F_{A \cup B}}^L(x)}, \\ F_{A \cup B}^U(x) &= [(r_A^U(x) \wedge r_B^U(x))] \cdot e^{j \cdot \mu_{F_{A \cup B}}^U(x)} \end{aligned} \tag{33}$$

The intersection of A and B denoted as $A \cap_N B$, is defined as:

$$A \cap_N B = \left\{ (x, \tilde{T}_{A \cap B}(x), \tilde{I}_{A \cap B}(x), \tilde{F}_{A \cap B}(x)) : x \in X \right\}, \tag{34}$$

Where, $\tilde{T}_{A \cap B}(x)$, $\tilde{I}_{A \cap B}(x)$, $\tilde{F}_{A \cap B}(x)$ are given by

$$\begin{aligned} T_{A \cap B}^L(x) &= [(p_A^L(x) \wedge p_B^L(x))] \cdot e^{j \cdot \mu_{T_{A \cap B}}^L(x)}, \\ T_{A \cap B}^U(x) &= [(p_A^U(x) \wedge p_B^U(x))] \cdot e^{j \cdot \mu_{T_{A \cap B}}^U(x)} \end{aligned} \tag{35}$$

$$\begin{aligned} I_{A \cap B}^L(x) &= [(q_A^L(x) \vee q_B^L(x))] \cdot e^{j \cdot \mu_{I_{A \cap B}}^L(x)}, \\ I_{A \cap B}^U(x) &= [(q_A^U(x) \vee q_B^U(x))] \cdot e^{j \cdot \mu_{I_{A \cap B}}^U(x)}, \end{aligned} \tag{36}$$

$$\begin{aligned} F_{A \cap B}^L(x) &= [(r_A^L(x) \vee r_B^L(x))] \cdot e^{j \cdot \mu_{F_{A \cap B}}^L(x)}, \\ F_{A \cap B}^U(x) &= [(r_A^U(x) \vee r_B^U(x))] \cdot e^{j \cdot \mu_{F_{A \cap B}}^U(x)} \end{aligned} \tag{37}$$

The union and the intersection of the phase terms of the complex truth, falsity and indeterminacy membership functions can be calculated using any one of the following operations:

Sum:

$$\begin{aligned} \mu_{A \cup B}^L(x) &= \mu_A^L(x) + \mu_B^L(x), \\ \mu_{A \cup B}^U(x) &= \mu_A^U(x) + \mu_B^U(x), \end{aligned} \tag{38}$$

$$\begin{aligned} v_{A \cup B}^L(x) &= v_A^L(x) + v_B^L(x), \\ v_{A \cup B}^U(x) &= v_A^U(x) + v_B^U(x), \end{aligned} \tag{39}$$

$$\begin{aligned} \omega_{A \cup B}^L(x) &= \omega_A^L(x) + \omega_B^L(x), \\ \omega_{A \cup B}^U(x) &= \omega_A^U(x) + \omega_B^U(x), \end{aligned} \tag{40}$$

Max:

$$\begin{aligned} \mu_{A \cup B}^L(x) &= \max(\mu_A^L(x), \mu_B^L(x)), \\ \mu_{A \cup B}^U(x) &= \max(\mu_A^U(x), \mu_B^U(x)), \end{aligned} \tag{41}$$

$$\begin{aligned} v_{A \cup B}^L(x) &= \max(v_A^L(x), v_B^L(x)), \\ v_{A \cup B}^U(x) &= \max(v_A^U(x), v_B^U(x)), \end{aligned} \tag{42}$$

$$\begin{aligned} \omega_{A \cup B}^L(x) &= \max(\omega_A^L(x), \omega_B^L(x)), \\ \omega_{A \cup B}^U(x) &= \max(\omega_A^U(x), \omega_B^U(x)), \end{aligned} \tag{43}$$

Min:

$$\begin{aligned} \mu_{A \cup B}^L(x) &= \min(\mu_A^L(x), \mu_B^L(x)), \\ \mu_{A \cup B}^U(x) &= \min(\mu_A^U(x), \mu_B^U(x)), \end{aligned} \tag{44}$$

$$\begin{aligned} v_{A \cup B}^L(x) &= \min(v_A^L(x), v_B^L(x)), \\ v_{A \cup B}^U(x) &= \min(v_A^U(x), v_B^U(x)), \end{aligned} \tag{45}$$

$$\begin{aligned} \omega_{A \cup B}^L(x) &= \min(\omega_A^L(x), \omega_B^L(x)), \\ \omega_{A \cup B}^U(x) &= \min(\omega_A^U(x), \omega_B^U(x)), \end{aligned} \tag{46}$$

“The game of winner, neutral, and loser”:

$$\mu_{A \cup B}(x) = \begin{cases} \mu_A(x) & \text{if } p_A > p_B \\ \mu_B(x) & \text{if } p_B > p_A \end{cases}, \tag{47}$$

$$v_{A \cup B}(x) = \begin{cases} v_A(x) & \text{if } q_A < q_B \\ v_B(x) & \text{if } q_B < q_A \end{cases}, \tag{48}$$

$$\omega_{A \cup B}(x) = \begin{cases} \omega_A(x) & \text{if } r_A < r_B \\ \omega_B(x) & \text{if } r_B < r_A \end{cases}. \tag{49}$$

Definition 2.7 [52]

Consider V be a non-void set. Two function are considered as follows:

$$\rho=(\rho_T, \rho_I, \rho_F):V \rightarrow [0, 1]^3 \text{ and}$$

$$\omega=(\omega_T, \omega_I, \omega_F):V \times V \rightarrow [0, 1]^3 . \text{ We suppose}$$

$$A= \{(\rho_T(x), \rho_T(y)) \mid \omega_T(x, y) \geq 0\}, \tag{50}$$

$$B= \{(\rho_I(x), \rho_I(y)) \mid \omega_I(x, y) \geq 0\}, \tag{51}$$

$$C= \{(\rho_F(x), \rho_F(y)) \mid \omega_F(x, y) \geq 0\}, \tag{52}$$

considered ω_T, ω_I and $\omega_F \geq 0$ for all set A,B, C since its is possible to have edge degree = 0 (for T, or I, or F).

The triad (V, ρ, ω) is defined to be complex neutrosophic graph of type 1 (CNG1) if there are functions

$$\alpha:A \rightarrow [0, 1], \beta:B \rightarrow [0, 1] \text{ and } \delta:C \rightarrow [0, 1] \text{ such that}$$

$$\omega_T(x, y) = \alpha((\rho_T(x), \rho_T(y))) \tag{53}$$

$$\omega_I(x, y) = \beta((\rho_I(x), \rho_I(y))) \tag{54}$$

$$\omega_F(x, y) = \delta((\rho_F(x), \rho_F(y))) \text{ where } x, y \in V. \tag{55}$$

For each $\rho(x) = (\rho_T(x), \rho_I(x), \rho_F(x)), x \in V$ are called the complex truth, complex indeterminacy and complex falsity-membership values, respectively, of the vertex x. likewise for each edge $(x, y) : \omega(x, y) = (\omega_T(x, y), \omega_I(x, y), \omega_F(x, y))$ are called the complex membership, complex indeterminacy membership and complex falsity values of the edge.

3 Interval Complex Neutrosophic Graph of Type 1

In this section, based on the concept of complex neutrosophic graph of type 1 [52], we define the concept of interval complex neutrosophic graph of type 1 as follows:

Definition 3.1.

Consider V be a non-void set. Two function are considered as follows:

$$\rho=([\rho_T^L, \rho_T^U], [\rho_I^L, \rho_I^U], [\rho_F^L, \rho_F^U]):V \rightarrow [0, 1]^3 \text{ and}$$

$$\omega=([\omega_T^L, \omega_T^U], [\omega_I^L, \omega_I^U], [\omega_F^L, \omega_F^U]):V \times V \rightarrow [0, 1]^3 . \text{ We suppose}$$

$$A= \{([\rho_T^L(x), \rho_T^U(x)], [\rho_T^L(y), \rho_T^U(y)]) \mid \omega_T^L(x, y) \geq 0 \text{ and } \omega_T^U(x, y) \geq 0 \}, \tag{56}$$

$$B= \{([\rho_I^L(x), \rho_I^U(x)], [\rho_I^L(y), \rho_I^U(y)]) \mid \omega_I^L(x, y) \geq 0 \text{ and } \omega_I^U(x, y) \geq 0\}, \tag{57}$$

$$C= \{([\rho_F^L(x), \rho_F^U(x)], [\rho_F^L(y), \rho_F^U(y)]) \mid \omega_F^L(x, y) \geq 0 \text{ and } \omega_F^U(x, y) \geq 0\}, \tag{58}$$

We have considered ω_T, ω_I and $\omega_F \geq 0$ for all set A,B, C , since its is possible to have edge degree = 0 (for T, or I, or F).

The triad (V, ρ, ω) is defined to be an interval complex neutrosophic graph of type 1 (ICNG1) if there are functions

$\alpha:A \rightarrow [0, 1], \beta:B \rightarrow [0, 1]$ and $\delta:C \rightarrow [0, 1]$ such that

$$\omega_T(x, y) = [\omega_T^L(x, y), \omega_T^U(x, y)] = \alpha([\rho_T^L(x), \rho_T^U(x)], [\rho_T^L(y), \rho_T^U(y)]) \tag{59}$$

$$\omega_I(x, y) = [\omega_I^L(x, y), \omega_I^U(x, y)] = \beta([\rho_I^L(x), \rho_I^U(x)], [\rho_I^L(y), \rho_I^U(y)]) \tag{60}$$

$$\omega_F(x, y) = [\omega_F^L(x, y), \omega_F^U(x, y)] = \delta([\rho_F^L(x), \rho_F^U(x)], [\rho_F^L(y), \rho_F^U(y)]) \text{ where } x, y \in V. \tag{61}$$

For each $\rho(x) = ([\rho_T^L(x), \rho_T^U(x)], [\rho_I^L(x), \rho_I^U(x)], [\rho_F^L(x), \rho_F^U(x)])$, $x \in V$ are called the interval complex truth, interval complex indeterminacy and interval complex falsity-membership values, respectively, of the vertex x . likewise for each edge $(x, y) : \omega(x, y) = (\omega_T(x, y), \omega_I(x, y), \omega_F(x, y))$ are called the interval complex membership, interval complex indeterminacy membership and interval complex falsity values of the edge.

Example 3.2

Consider the vertex set be $V = \{x, y, z, t\}$ and edge set be $E = \{(x, y), (x, z), (x, t), (y, t)\}$

	x	y	z	t
$[\rho_T^L, \rho_T^U]$	$[0.5, 0.6]e^{j\pi[0.8,0.9]}$	$[0.9, 1]e^{j\pi[0.7,0.8]}$	$[0.3, 0.4]e^{j\pi[0.2,0.5]}$	$[0.8, 0.9]e^{j\pi[0.1,0.3]}$
$[\rho_I^L, \rho_I^U]$	$[0.3, 0.4]e^{j\pi[0.1,0.2]}$	$[0.2, 0.3]e^{j\pi[0.5,0.6]}$	$[0.1, 0.2]e^{j\pi[0.3,0.6]}$	$[0.5, 0.6]e^{j\pi[0.2,0.8]}$
$[\rho_F^L, \rho_F^U]$	$[0.1, 0.2]e^{j\pi[0.5,0.7]}$	$[0.6, 0.7]e^{j\pi[0.2,0.3]}$	$[0.8, 0.9]e^{j\pi[0.2,0.4]}$	$[0.4, 0.5]e^{j\pi[0.3,0.7]}$

Table 1. Interval Complex truth-membership, indeterminacy-membership and falsity-membership of the vertex set.

Given the following functions

$$\alpha(m, n) = [m_T^L(u) \vee n_T^L(u), m_T^U(u) \vee n_T^U(u)] \cdot e^{j\pi\mu_{A \cup B}(u)} \tag{62}$$

$$\beta(m, n) = [m_I^L(u) \wedge n_I^L(u), m_I^U(u) \wedge n_I^U(u)] \cdot e^{j\pi\nu_{A \cup B}(u)} \tag{63}$$

$$\delta(m, n) = [m_F^L(u) \wedge n_F^L(u), m_F^U(u) \wedge n_F^U(u)] \cdot e^{j\pi\omega_{A \cup B}(u)} \tag{64}$$

Here,

$A = \{([0.5, 0.6]e^{j\pi[0.8,0.9]}, [0.9, 1]e^{j\pi[0.7,0.8]}), ([0.5, 0.6]e^{j\pi[0.8,0.9]}, [0.3, 0.4]e^{j\pi[0.2,0.5]}), ([0.5, 0.6]e^{j\pi[0.8,0.9]}, [0.8, 0.9]e^{j\pi[0.1,0.3]}), ([0.9, 1.0]e^{j\pi[0.7,0.8]}, [0.8, 0.9]e^{j\pi[0.1,0.3]})\}$

$B = \{([0.3, 0.4]e^{j\pi[0.1,0.2]}, [0.2, 0.3]e^{j\pi[0.5,0.6]}), ([0.3, 0.4]e^{j\pi[0.1,0.2]}, [0.1,$

$$0.2]e^{j.\pi[0.3,0.6]), ([0.3, 0.4]e^{j.\pi[0.1,0.2]}, [0.5, 0.6]e^{j.\pi[0.2,0.8]}), ([0.2, 0.3]e^{j.\pi[0.5,0.6]}, [0.5, 0.6]e^{j.\pi[0.2,0.8]})\}$$

$$C=\{([0.1, 0.2]e^{j.\pi[0.5,0.7]}, [0.6, 0.7]e^{j.\pi[0.2,0.3]}), ([0.1, 0.2]e^{j.\pi[0.5,0.7]}, [0.8, 0.9]e^{j.\pi[0.2,0.4]}), ([0.1, 0.2]e^{j.\pi[0.5,0.7]}, [0.4, 0.5]e^{j.\pi[0.3,0.7]}), ([0.6, 0.7]e^{j.\pi[0.2,0.3]}, [0.4, 0.5]e^{j.\pi[0.3,0.7]})\}.$$

Then

ω	(x, y)	(x, z)	(x, t)	(y, t)
$[\omega_T^L, \omega_T^U]$	$[0.9, 1]e^{j.\pi[0.8,0.9]}$	$[0.5, 0.6]e^{j.\pi[0.8,0.9]}$	$[0.8,0.9]e^{j.\pi[0.8,0.9]}$	$[0.9,1]e^{j.\pi[0.8,0.9]}$
$[\omega_I^L, \omega_I^U]$	$[0.2,0.3]e^{j.\pi[0.5,0.6]}$	$[0.1,0.2]e^{j.\pi[0.3,0.6]}$	$[0.3,0.4]e^{j.\pi[0.2,0.8]}$	$[0.2, 0.3]e^{j.\pi[0.5,0.8]}$
$[\omega_F^L, \omega_F^U]$	$[0.1, 0.2]e^{j.\pi[0.5,0.7]}$	$[0.1,0.2]e^{j.\pi[0.5,0.7]}$	$[0.1,0.2]e^{j.\pi[0.5,0.7]}$	$[0.4,0.5]e^{j.\pi[0.5,0.7]}$

Table 2. Interval Complex truth-membership, indeterminacy-membership and falsity-membership of the edge set.

The figure 2 show the interval complex neutrosophic graph of type 1

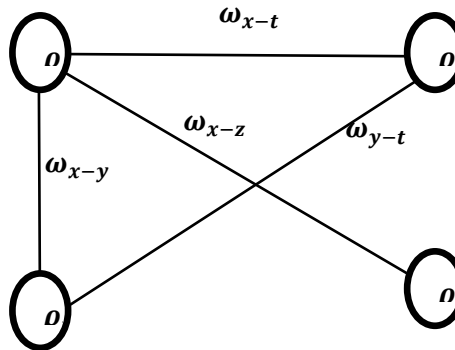

Fig 2. Interval complex neutrosophicgraph of type 1.

In classical graph theory, any graph can be represented by adjacency matrices, and incident matrices. In the following section ICNG1 is represented by adjacency matrix.

4 Representation of interval complex neutrosophic graph of Type 1 by adjacency matrix

In this section, interval truth-membership, interval indeterminate-membership and interval false-membership are considered independents. Based on the representation of complex neutrosophic graph of type 1 by adjacency matrix [52],

we propose a matrix representation of interval complex neutrosophic graph of type 1 as follow:

The interval complex neutrosophic graph (ICNG1) has one property that edge membership values (T, I, F) depends on the membership values (T, I, F) of adjacent vertices. Suppose $\xi=(V, \rho, \omega)$ is a ICNG1 where vertex set $V=\{v_1, v_2, \dots, v_n\}$. The functions

$\alpha :A \rightarrow (0, 1]$ is taken such that

$\omega_T^L(x, y) = \alpha((\rho_T^L(x), \rho_T^L(y)))$, $\omega_T^U(x, y) = \alpha((\rho_T^U(x), \rho_T^U(y)))$, where $x, y \in V$ and

$$A = \{([\rho_T^L(x), \rho_T^U(x)], [\rho_T^L(y), \rho_T^U(y)]) \mid \omega_T^L(x, y) \geq 0 \text{ and } \omega_T^U(x, y) \geq 0 \},$$

$\beta :B \rightarrow (0, 1]$ is taken such that

$\omega_I^L(x, y) = \beta((\rho_I^L(x), \rho_I^L(y)))$, $\omega_I^U(x, y) = \beta((\rho_I^U(x), \rho_I^U(y)))$, where $x, y \in V$ and

$$B = \{([\rho_I^L(x), \rho_I^U(x)], [\rho_I^L(y), \rho_I^U(y)]) \mid \omega_I^L(x, y) \geq 0 \text{ and } \omega_I^U(x, y) \geq 0 \}$$

and

$\delta :C \rightarrow (0, 1]$ is taken such that

$\omega_F^L(x, y) = \delta((\rho_F^L(x), \rho_F^L(y)))$, $\omega_F^U(x, y) = \delta((\rho_F^U(x), \rho_F^U(y)))$, where $x, y \in V$ and

$$C = \{([\rho_F^L(x), \rho_F^U(x)], [\rho_F^L(y), \rho_F^U(y)]) \mid \omega_F^L(x, y) \geq 0 \text{ and } \omega_F^U(x, y) \geq 0 \}.$$

The ICNG1 can be represented by $(n+1) \times (n+1)$ matrix $M_{G_1}^{T,I,F} = [a^{T,I,F}(i, j)]$ as follows:

The interval complex truth membership (T), interval complex indeterminacy-membership (I) and the interval complex falsity-membership (F) values of the vertices are provided in the first row and first column. The $(i+1, j+1)$ -th-entry are the interval complex truth membership (T), interval complex indeterminacy-membership (I) and the interval complex falsity-membership (F) values of the edge (x_i, x_j) , $i, j=1, \dots, n$ if $i \neq j$.

The (i, i) -th entry is $\rho(x_i) = (\rho_T(x_i), \rho_I(x_i), \rho_F(x_i))$, where $i=1, 2, \dots, n$. the interval complex truth membership (T), interval complex indeterminacy-membership (I) and the interval complex falsity-membership (F) values of the edge can be computed easily using the functions α, β and δ which are in $(1,1)$ -position of the matrix. The matrix representation of ICNG1, denoted by $M_{G_1}^{T,I,F}$, can be written as three matrix representation $M_{G_1}^T, M_{G_1}^I$ and $M_{G_1}^F$. For convenience representation $v_i(\rho_T(v_i)) = [\rho_T^L(v_i), \rho_T^U(v_i)]$, $v_i(\rho_I(v_i)) = [\rho_I^L(v_i), \rho_I^U(v_i)]$ and $v_i(\rho_F(v_i)) = [\rho_F^L(v_i), \rho_F^U(v_i)]$, for $i=1, \dots, n$

The $M_{G_1}^T$ can be therefore represented as follows

α	$v_1(\rho_T(v_1))$	$v_2(\rho_T(v_2))$	$v_n(\rho_T(v_n))$
$v_1(\rho_T(v_1))$	$[\rho_T^L(v_1), \rho_T^U(v_1)]$	$\alpha(\rho_T(v_1), \rho_T(v_2))$	$\alpha(\rho_T(v_1), \rho_T(v_n))$
$v_2(\rho_T(v_2))$	$\alpha(\rho_T(v_2), \rho_T(v_1))$	$[\rho_T^L(v_2), \rho_T^U(v_2)]$	$\alpha(\rho_T(v_2), \rho_T(v_2))$
...
$v_n(\rho_T(v_n))$	$\alpha(\rho_T(v_n), \rho_T(v_1))$	$\alpha(\rho_T(v_n), \rho_T(v_2))$	$[\rho_T^L(v_n), \rho_T^U(v_n)]$

Table 3. Matrix representation of T-ICNGI

The $M_{G_1}^I$ can be therefore represented as follows

β	$v_1(\rho_I(v_1))$	$v_2(\rho_I(v_2))$	$v_n(\rho_I(v_n))$
$v_1(\rho_I(v_1))$	$[\rho_I^L(v_1), \rho_I^U(v_1)]$	$\beta(\rho_I(v_1), \rho_I(v_2))$	$\beta(\rho_I(v_1), \rho_I(v_n))$
$v_2(\rho_I(v_2))$	$\beta(\rho_I(v_2), \rho_I(v_1))$	$[\rho_I^L(v_2), \rho_I^U(v_2)]$	$\beta(\rho_I(v_2), \rho_I(v_2))$
...
$v_n(\rho_I(v_n))$	$\beta(\rho_I(v_n), \rho_I(v_1))$	$\beta(\rho_I(v_n), \rho_I(v_2))$	$[\rho_I^L(v_n), \rho_I^U(v_n)]$

Table 4. Matrix representation of I-ICNGI

The $M_{G_1}^F$ can be therefore represented as follows

δ	$v_1(\rho_F(v_1))$	$v_2(\rho_F(v_2))$	$v_n(\rho_F(v_n))$
$v_1(\rho_F(v_1))$	$[\rho_F^L(v_1), \rho_F^U(v_1)]$	$\delta(\rho_F(v_1), \rho_F(v_2))$	$\delta(\rho_F(v_1), \rho_F(v_n))$
$v_2(\rho_F(v_2))$	$\delta(\rho_F(v_2), \rho_F(v_1))$	$[\rho_F^L(v_2), \rho_F^U(v_2)]$	$\delta(\rho_F(v_2), \rho_F(v_2))$
...
$v_n(\rho_F(v_n))$	$\delta(\rho_F(v_n), \rho_F(v_1))$	$\delta(\rho_F(v_n), \rho_F(v_2))$	$[\rho_F^L(v_n), \rho_F^U(v_n)]$

Table 5. Matrix representation of F-ICNGI

Here the Interval complex neutrosophic graph of first type (ICNG1) can be represented by the matrix representation depicted in table 9. The matrix representation can be written as three interval complex matrices one containing the entries as T, I, F (see table 6, 7 and 8).

$\alpha = \max(x, y)$	$x([0.5, 0.6]. e^{j.\pi[0.8,0.9]})$	$y([0.9, 1]. e^{j.\pi[0.7,0.8]})$	$z([0.3, 0.4]. e^{j.\pi[0.2,0.5]})$	$t([0.8, 0.9]. e^{j.\pi[0.1,0.3]})$
$x([0.5, 0.6]. e^{j.\pi[0.8,0.9]})$	$[0.5, 0.6]. e^{j.\pi[0.8,0.9]}$	$[0.9, 1]. e^{j.\pi[0.8,0.9]}$	$[0.5, 0.6]. e^{j.\pi[0.8,0.9]}$	$[0.8, 0.9]. e^{j.\pi[0.8,0.9]}$
$y([0.9, 1]. e^{j.\pi[0.7,0.8]})$	$[0.9, 1]. e^{j.\pi[0.8,0.9]}$	$[0.9, 1]. e^{j.\pi[0.7,0.8]}$	[0, 0]	$[0.9, 1]. e^{j.\pi[0.7,0.8]}$
$z([0.3, 0.4]. e^{j.\pi[0.2,0.5]})$	$[0.5, 0.6]. e^{j.\pi[0.8,0.9]}$	[0, 0]	$[0.3, 0.4]. e^{j.\pi[0.2,0.5]}$	[0, 0]
$t([0.8, 0.9]. e^{j.\pi[0.1,0.3]})$	$[0.8, 0.9]. e^{j.\pi[0.8,0.9]}$	$[0.9, 1]. e^{j.\pi[0.7,0.8]}$	[0, 0]	$[0.8, 0.9]. e^{j.\pi[0.1,0.3]}$

Table 6: Lower and upper Truth- matrix representation of ICNG1

$\beta = \min(x, y)$	$x([0.3, 0.4]. e^{j.\pi[0.1,0.2]})$	$y([0.2, 0.3]. e^{j.\pi[0.5,0.6]})$	$z([0.1, 0.2]. e^{j.\pi[0.3,0.6]})$	$t([0.5, 0.6]. e^{j.\pi[0.2,0.8]})$
$x([0.3, 0.4]. e^{j.\pi[0.1,0.2]})$	$[0.3, 0.4]. e^{j.\pi[0.1,0.2]}$	$[0.2, 0.3]. e^{j.\pi[0.5,0.6]}$	$[0.1, 0.2]. e^{j.\pi[0.3,0.6]}$	$[0.3, 0.4]. e^{j.\pi[0.3,0.6]}$
$y([0.2, 0.3]. e^{j.\pi[0.5,0.6]})$	$[0.2, 0.3]. e^{j.\pi[0.5,0.6]}$	$[0.2, 0.3]. e^{j.\pi[0.5,0.6]}$	[0, 0]	$[0.2, 0.3]. e^{j.\pi[0.5,0.8]}$
$z([0.1, 0.2]. e^{j.\pi[0.3,0.6]})$	$[0.1, 0.2]. e^{j.\pi[0.3,0.6]}$	[0, 0]	$[0.1, 0.2]. e^{j.\pi[0.3,0.6]}$	[0, 0]
$t([0.5, 0.6]. e^{j.\pi[0.2,0.8]})$	$[0.3, 0.4]. e^{j.\pi[0.2,0.8]}$	$[0.2, 0.3]. e^{j.\pi[0.5,0.8]}$	[0, 0]	$[0.5, 0.6]. e^{j.\pi[0.2,0.8]}$

Table 7: Lower and upper Indeterminacy- matrix representation of ICNG1

$\delta = \min(x, y)$	$x([0.1, 0.2]. e^{j.\pi[0.5,0.7]})$	$y([0.6, 0.7]. e^{j.\pi[0.2,0.3]})$	$z([0.8, 0.9]. e^{j.\pi[0.2,0.4]})$	$t([0.4, 0.5]. e^{j.\pi[0.3,0.7]})$
$x([0.1, 0.2]. e^{j.\pi[0.5,0.7]})$	$[0.1, 0.2]. e^{j.\pi[0.5,0.7]}$	$[0.1, 0.2]. e^{j.\pi[0.5,0.7]}$	$[0.1, 0.2]. e^{j.\pi[0.8,0.9]}$	$[0.1, 0.2]. e^{j.\pi[0.5,0.7]}$
$y([0.6, 0.7]. e^{j.\pi[0.2,0.3]})$	$[0.1, 0.2]. e^{j.\pi[0.5,0.7]}$	$[0.6, 0.7]. e^{j.\pi[0.2,0.3]}$	[0, 0]	$[0.4, 0.5]. e^{j.\pi[0.3,0.7]}$
$z([0.8, 0.9]. e^{j.\pi[0.2,0.4]})$	$[0.1, 0.2]. e^{j.\pi[0.8,0.9]}$	[0, 0]	$[0.8, 0.9]. e^{j.\pi[0.2,0.4]}$	[0, 0]
$t([0.4, 0.5]. e^{j.\pi[0.3,0.7]})$	$[0.1, 0.2]. e^{j.\pi[0.5,0.7]}$	$[0.4, 0.5]. e^{j.\pi[0.3,0.7]}$	[0, 0]	$[0.4, 0.5]. e^{j.\pi[0.3,0.7]}$

Table 8: Lower and upper Falsity- matrix representation of ICNG1

The matrix representation of ICNG1 can be represented as follows:

(α, β, δ)	$\mathbf{X}(\langle [0.5, 0.6]. e^{j.\pi[0.8,0.9]}, [0.3, 0.4]. e^{j.\pi[0.1,0.2]}, [0.1, 0.2]. e^{j.\pi[0.5,0.7]} \rangle)$	$y(\langle [0.5, 0.6]. e^{j.\pi[0.8,0.9]}, [0.3, 0.4]. e^{j.\pi[0.1,0.2]}, [0.1, 0.2]. e^{j.\pi[0.5,0.7]} \rangle)$	$z(\langle [0.5, 0.6]. e^{j.\pi[0.8,0.9]}, [0.3, 0.4]. e^{j.\pi[0.1,0.2]}, [0.1, 0.2]. e^{j.\pi[0.5,0.7]} \rangle)$	$t(\langle [0.5, 0.6]. e^{j.\pi[0.8,0.9]}, [0.3, 0.4]. e^{j.\pi[0.1,0.2]}, [0.1, 0.2]. e^{j.\pi[0.5,0.7]} \rangle)$
$\mathbf{X}(\langle [0.5, 0.6]. e^{j.\pi[0.8,0.9]}, [0.3, 0.4]. e^{j.\pi[0.1,0.2]}, [0.1, 0.2]. e^{j.\pi[0.5,0.7]} \rangle)$	$\langle [0.5, 0.6]. e^{j.\pi[0.8,0.9]}, [0.3, 0.4]. e^{j.\pi[0.1,0.2]}, [0.1, 0.2]. e^{j.\pi[0.5,0.7]} \rangle$	$\langle [0.9, 0.1]. e^{j.\pi[0.8,0.9]}, [0.2, 0.3]. e^{j.\pi[0.5,0.6]}, [0.1, 0.2]. e^{j.\pi[0.5,0.7]} \rangle$	$\langle [0.5, 0.6]. e^{j.\pi[0.8,0.9]}, [0.1, 0.2]. e^{j.\pi[0.3,0.6]}, [0.1, 0.2]. e^{j.\pi[0.8,0.9]} \rangle$	$\langle [0.8, 0.9]. e^{j.\pi[0.8,0.9]}, [0.3, 0.4]. e^{j.\pi[0.2,0.8]}, [0.1, 0.2]. e^{j.\pi[0.5,0.7]} \rangle$
$y(\langle [0.5, 0.6]. e^{j.\pi[0.8,0.9]}, [0.3, 0.4]. e^{j.\pi[0.1,0.2]}, [0.1, 0.2]. e^{j.\pi[0.5,0.7]} \rangle)$	$\langle [0.9, 0.1]. e^{j.\pi[0.8,0.9]}, [0.2, 0.3]. e^{j.\pi[0.5,0.6]}, [0.1, 0.2]. e^{j.\pi[0.5,0.7]} \rangle$	$\langle [0.5, 0.6]. e^{j.\pi[0.8,0.9]}, [0.3, 0.4]. e^{j.\pi[0.1,0.2]}, [0.1, 0.2]. e^{j.\pi[0.5,0.7]} \rangle$	$\langle [0, 0], [0, 0], [0, 0] \rangle$	$\langle [0.9, 0.1]. e^{j.\pi[0.7,0.8]}, [0.2, 0.3]. e^{j.\pi[0.5,0.8]}, [0.4, 0.5]. e^{j.\pi[0.3,0.7]} \rangle$
$z(\langle [0.5, 0.6]. e^{j.\pi[0.8,0.9]}, [0.3, 0.4]. e^{j.\pi[0.1,0.2]}, [0.1, 0.2]. e^{j.\pi[0.5,0.7]} \rangle)$	$\langle [0.5, 0.6]. e^{j.\pi[0.8,0.9]}, [0.1, 0.2]. e^{j.\pi[0.3,0.6]}, [0.1, 0.2]. e^{j.\pi[0.8,0.9]} \rangle$	$\langle [0, 0], [0, 0], [0, 0] \rangle$	$\langle [0.5, 0.6]. e^{j.\pi[0.8,0.9]}, [0.3, 0.4]. e^{j.\pi[0.1,0.2]}, [0.1, 0.2]. e^{j.\pi[0.5,0.7]} \rangle$	$\langle [0, 0], [0, 0], [0, 0] \rangle$
$t(\langle [0.5, 0.6]. e^{j.\pi[0.8,0.9]}, [0.3, 0.4]. e^{j.\pi[0.1,0.2]}, [0.1, 0.2]. e^{j.\pi[0.5,0.7]} \rangle)$	$\langle [0.8, 0.9]. e^{j.\pi[0.8,0.9]}, [0.3, 0.4]. e^{j.\pi[0.2,0.8]}, [0.1, 0.2]. e^{j.\pi[0.5,0.7]} \rangle$	$\langle [0.9, 0.1]. e^{j.\pi[0.7,0.8]}, [0.2, 0.3]. e^{j.\pi[0.5,0.8]}, [0.4, 0.5]. e^{j.\pi[0.3,0.7]} \rangle$	$\langle [0, 0], [0, 0], [0, 0] \rangle$	$\langle [0.5, 0.6]. e^{j.\pi[0.8,0.9]}, [0.3, 0.4]. e^{j.\pi[0.1,0.2]}, [0.1, 0.2]. e^{j.\pi[0.5,0.7]} \rangle$

Table 9: Matrix representation of ICNG1.

Remark 1

If $\rho_T^L(x)=\rho_T^U(x), \rho_I^L(x)=\rho_I^U(x)=0$ and $\rho_F^L(x)=\rho_F^U(x) = 0$ and the interval valued phase terms equals zero, the interval complex neutrosophic graphs type 1 is reduced to generalized fuzzy graphs type 1 (GFG1).

Remark 2

If $\rho_T^L(x)=\rho_T^U(x), \rho_I^L(x)=\rho_I^U(x)$ and $\rho_F^L(x)=\rho_F^U(x)$ and the interval valued phase terms equals zero, the interval complex neutrosophic graphs type 1 is reduced to generalized single valued graphs type 1 (GSVNG1).

Remark 3

If $\rho_T^L(x)=\rho_T^U(x), \rho_I^L(x)=\rho_I^U(x)$ and $\rho_F^L(x)=\rho_F^U(x)$ the interval complex neutrosophic graphs type 1 is reduced to complex neutrosophic graphs type 1 (CNG1).

Remark 4

If $\rho_T^L(x) \neq \rho_T^U(x)$, $\rho_I^L(x) \neq \rho_I^U(x)$ and $\rho_F^L(x) \neq \rho_F^U(x)$ and the interval valued phase terms equals zero, the interval complex neutrosophic graphs type 1 is reduced to generalized interval valued graphs type 1 (GIVNG1).

Theorem 1

Given the $M_{G_1}^T$ be matrix representation of T-ICNG1, then the degree of vertex $D_T(x_k) = [\sum_{j=1, j \neq k}^n a_T^L(k+1, j+1), \sum_{j=1, j \neq k}^n a_T^U(k+1, j+1)]$, $x_k \in V$ or

$$D_T(x_p) = [\sum_{i=1, i \neq p}^n a_T^L(i+1, p+1), \sum_{i=1, i \neq p}^n a_T^U(i+1, p+1)] x_p \in V.$$

Proof

Similar to that of theorem 1 of [52].

Theorem 2

Given the $M_{G_1}^I$ be a matrix representation of I-ICNG1, then the degree of vertex $D_I(x_k) = [\sum_{j=1, j \neq k}^n a_I^L(k+1, j+1), \sum_{j=1, j \neq k}^n a_I^U(k+1, j+1)]$, $x_k \in V$

or $D_I(x_p) = [\sum_{i=1, i \neq p}^n a_I^L(i+1, p+1), \sum_{i=1, i \neq p}^n a_I^U(i+1, p+1)]$, $x_p \in V$.

Proof

Similar to that of theorem 1 of [52].

Theorem 3

Given the $M_{G_1}^F$ be a matrix representation of ICNG1, then the degree of vertex

$$D_F(x_k) = [\sum_{j=1, j \neq k}^n a_F^L(k+1, j+1), \sum_{j=1, j \neq k}^n a_F^U(k+1, j+1)]$$
, $x_k \in V$

or

$$D_F(x_p) = [\sum_{i=1, i \neq p}^n a_F^L(i+1, p+1), \sum_{i=1, i \neq p}^n a_F^U(i+1, p+1)]$$
, $x_p \in V$.

Proof

Similar to that of theorem 1 of [52].

Theorem 4

Given the $M_{G_1}^{T,I,F}$ be a matrix representation of ICNG1, then the degree of vertex $D(x_k) = (D_T(x_k), D_I(x_k), D_F(x_k))$ where

$$D_T(x_k) = [\sum_{j=1, j \neq k}^n a_T^L(k+1, j+1), \sum_{j=1, j \neq k}^n a_T^U(k+1, j+1)]$$
, $x_k \in V$.

$$D_I(x_k) = [\sum_{j=1, j \neq k}^n a_I^L(k+1, j+1), \sum_{j=1, j \neq k}^n a_I^U(k+1, j+1)], x_k \in V.$$

$$D_F(x_k) = [\sum_{j=1, j \neq k}^n a_F^L(k+1, j+1), \sum_{j=1, j \neq k}^n a_F^U(k+1, j+1)], x_k \in V.$$

Proof

The proof is obvious.

5 Conclusion

In this article, we have introduced the concept of interval complex neutrosophic graph of type 1 as generalization of the concept of single valued neutrosophic graph type 1 (GSVNG1), interval valued neutrosophic graph type 1 (GIVNG1) and complex neutrosophic graph of type 1 (CNG1). Next, we processed to presented a matrix representation of it. In the future works, we plan to study some more properties and applications of ICNG type 1 define the concept of interval complex neutrosophic graphs type 2.

References

- [1] Shannon A, Atanassov K, "A First Step to a Theory of the Intuitionistic Fuzzy Graphs." Proc. of the First Workshop on Fuzzy Based Expert Systems (D. akov, Ed.), Sofia, (1994):59-61.
- [2] Ramot D, Menahem F, Gideon L, and Abraham K, "Complex Fuzzy Set." IEEE Transactions on Fuzzy Systems, Vol 10, No 2, 2002.
- [3] Smarandache F, "Refined Literal Indeterminacy and the Multiplication Law of Sub-Indeterminacies." Neutrosophic Sets and Systems 9, (2015):58.63.
- [4] Smarandache F, "Types of Neutrosophic Graphs and neutrosophic Algebraic Structures together with their Applications in Technology." seminar, Universitatea Transilvania din Brasov, Facultatea de Design de Produs si Mediu, Brasov, Romania 06 June 2015.
- [5] Smarandache F, "Neutrosophic set - a generalization of the intuitionistic fuzzy set." Granular Computing, 2006 IEEE International Conference (2006):38 – 42.
- [6] Smarandache F, "Neutrosophy. Neutrosophic Probability, Set, and Logic." ProQuest Information & Learning, Ann Arbor, Michigan, USA, 105 p., 1998; <http://fs.gallup.unm.edu/eBook-neutrosophics6.pdf> (last edition online)
- [7] Smarandache F, "Nidus idearum. Scilogs, III: Viva la Neutrosophia! ." Brussels, 2017, 134p. ISBN 978-1-59973-508-5
- [8] Smarandache F, "Neutrosophic overset, neutrosophic underset, Neutrosophic offset, Similarly for Neutrosophic Over-/Under-/OffLogic, Probability, and Statistic." Pons Editions, Brussels, 2016, 170p.
- [9] Smarandache F, "Symbolic Neutrosophic Theory." (Europanova asbl, Brussels, 195 p., Belgium 2015.

- [10] Wang H, Smarandache F, Zhang Y, and Sunderraman R, "Single valued Neutrosophic Sets, Multisspace and Multistructure 4, (2010):410-413.
- [11] <http://fs.gallup.unm.edu/NSS/>.
- [12] H .Wang, F. Smarandache, Y.Q .Zhang and R. Sunderraman, Interval neutrosophic Sets and Logic: Theory and Applications in Computing." Hexis, Phoenix, AZ, 2005.
- [13] Atanassov K, "Intuitionistic fuzzy sets, Fuzzy Sets and Systems, vol. 20 (1986):87-96.
- [14] Zadeh L," Fuzzy sets. Inform and Control, 8 (1965):338-353.
- [15] Ali M, Smarandache F,"Complex neutrosophic set." Neural Computing and Applications 2015; DOI:10.1007/s00521-015-2154-y.
- [16] Ali M, Dat L.Q, Son L. H, Smarandache F,"Interval Complex Neutrosophic Set: Formulation and Applications in Decision-Making."Int. J. Fuzzy Syst, DOI 10.1007/s40815-017-0380-4
- [17] Malik M. A, Hassan A, Broumi S and Smarandache F, "Regular Single Valued Neutrosophic Hypergraphs."Neutrosophic Sets and Systems 13, (2016):18-23.
- [18] Mullai M, Broumi S, Stephen A, " Shortest path problem by minimal spanning tree algorithm using bipolar neutrosophic numbers." International Journal of Mathematic Trends and Technology, Vol 46, N2 (2017): 80-87.
- [19] Akram M , Sitara M, "Interval-Valued Neutrosophic Graph Structures." Punjab University Journal of Mathematics 50(1), (2018):113-137
- [20] Sethi N, Das S. K and Panda D.C, "Probabilistic interpretation of complex fuzzy set." International Journal of Computer Science, Engineering and Information Technology (IJCEIT), Vol.2, No.2 (2012):31-44
- [21] Shah N, "Some Studies in Neutrosophic Graphs."Neutrosophic Sets and Systems, Vol. 12 (2016):54-64.
- [22] Shah N and Hussain A, "Neutrosophic Soft Graphs." Neutrosophic Sets and Systems 11, (2016):31-44.
- [23] Yazdanbakhsh O, Dick S," systematic review of complex fuzzy sets and logic." Fuzzy Sets and Systems
- [24] Singh P. K, "Three-way fuzzy concept lattice representation using neutrosophic set." International Journal of Machine Learning and Cybernetics (2016): 1–11.
- [25] Singh P.K," Interval-Valued Neutrosophic Graph Representation of Concept Lattice and Its (α,β,γ) -Decomposition." Arab J Sci Eng (2017), page 18 DOI 10.1007/s13369-017-2718-5
- [26] Thirunavukarasu P, Sureshand R, Viswanathan K. K, "Energy of a complex fuzzy graph." International J. of Math. Sci. & Engg. Appls. (IJMSEA) 10 No. I(2016): 243-248.
- [27] Thirunavukarasu P, Suresh R and Thamilmani P, "Application of complex fuzzy sets." JP Journal of Applied Mathematics 6, Issues 1 & 2 (2013):5-22.
- [28] Husban R and Salleh A. R," Complex vague set." Accepted in: Global Journal of Pure and Applied Mathematics (2015).
- [29] Husban R, "Complex vague set." MSc Research Project, Faculty of Science and Technology, University Kebangsaan Malaysia, (2014).
- [30] Şahin R , "An approach to neutrosophic graph theory with applications." Soft Computing, (2017):1–13, doi.org/10.1007/s00500-017-2875-1
- [31] Al-Qudah Y and Hassan N,"Operations on complex multi-fuzzy sets."Journal of Intelligent & Fuzzy Systems 33 (2017):1527–1540.
- [32] Broumi S, & Smarandache F, "Correlation coefficient of interval neutrosophic set." In Applied Mechanics and Materials, Trans Tech Publications 436, (2013):511-517
- [33] Broumi S, Talea M, Bakali A, Smarandache F, "Single Valued Neutrosophic Graphs."Journal of New Theory, N 10, (20.16): 86-101.
- [34] Broumi S, Talea M, Smarandache F, and Bakali A, "Single Valued Neutrosophic Graphs: Degree, Order and Size." IEEE International Conference on Fuzzy Systems (FUZZ), (2016): 2444-2451.

- [35] Broumi S, Bakali A, Talea M, Smarandache F, "Isolated Single Valued Neutrosophic Graphs." *Neutrosophic Sets and Systems* 11, (2016): 74-78.
- [36] Broumi S, Smarandache F, Talea M, and Bakali A, "Decision-Making Method Based On the Interval Valued Neutrosophic Graph." *Future Technologic, IEEE*, (2016):44-50.
- [37] Broumi S, Bakali A, Talea M, Smarandache F, and Ali M, "Shortest Path Problem under Bipolar Neutrosophic Setting." *Applied Mechanics and Materials* 859, (2016):59-66.
- [38] Broumi S, Bakali A, Talea M, Smarandache F, and Vladareanu L, "Computation of Shortest Path Problem in a Network with SV-Trapezoidal Neutrosophic Numbers." *Proceedings of the 2016 International Conference on Advanced Mechatronic Systems, Melbourne, Australia*, (2016):417-422.
- [39] Broumi S, Bakali A, Talea M, Smarandache F, and Vladareanu L, "Applying Dijkstra Algorithm for Solving Neutrosophic Shortest Path Problem." *Proceedings of the 2016 International Conference on Advanced Mechatronic Systems, Melbourne, Australia, November 30 - December 3*,(2016):412-416.
- [40] Broumi S, M. Talea, Bakali A, Smarandache F, "On Bipolar Single Valued Neutrosophic Graphs." *Journal of New Theory* 11, (2016): 84-102.
- [41] Broumi S, Smarandache F, Talea M, and Bakali A, "An Introduction to Bipolar Single Valued Neutrosophic Graph Theory." *Applied Mechanics and Materials* 841 (2016):184-191.
- [42] Broumi S, Smarandache F, Talea M and Bakali A, "Operations on Interval Valued Neutrosophic Graphs." chapter in book- *New Trends in Neutrosophic Theory and Applications- Florentin Smarandache and Surpati Pramanik (Editors)* (2016):231-254. ISBN 978-1-59973-498-9
- [43] Broumi S, Bakali A, Talea M and Smarandache F and Kishore Kumar P.K, "Shortest Path Problem on Single Valued Neutrosophic Graphs." *2017 International Symposium on Networks, Computers and Communications (ISNCC)* (2017):1- 8
- [44] Broumi S, Bakali A, Talea M, Smarandache F, "Complex Neutrosophic Graphs of Type 1, 2017 IEEE International Conference on INnovations in Intelligent SysTems and Applications (INISTA), Gdynia Maritime University, Gdynia, Poland (2017):432-437
- [45] Broumi S, Smarandache F, Talea M and Bakali A, "Operations on Interval Valued Neutrosophic Graphs." chapter in book- *New Trends in Neutrosophic Theory and Applications- Florentin Smarandache and Surpati Pramanik (Editors)* (2016): 231-254. ISBN 978-1-59973-498-9
- [46] Broumi S, Bakali A, Talea M, Smarandache F and Hassan A, "generalized single valued neutrosophic graphs of first type." *SISOM & ACOUSTICS 2017, Bucharest 18-19 May*
- [47] Broumi S, Talea M, Bakali A, Smarandache F, "Interval Valued Neutrosophic Graphs, *Critical Review*, XII(2016): 5-33.
- [48] Broumi S, Dey A, Bakali A, Talea M, Smarandache F, Son L. H and Koley D, "Uniform Single Valued Neutrosophic Graphs." *Neutrosophic Sets and Systems*, Vol. 17,(2017):42-49.
- [49] Broumi S, Bakali A, Talea M, Smarandache F, and Verma R, "Computing Minimum Spanning Tree in Interval Valued Bipolar Neutrosophic Environment." *International Journal of Modeling and Optimization*, Vol. 7, No. 5 (2017):300-304
- [50] Broumi S, Bakali A, Talea M, Smarandache F, "Generalized Bipolar Neutrosophic Graphs of Type 1." *20th International Conference on Information Fusion, Xi'an*,(2017):1714-1720
- [51] Broumi S, Bakali A, Talea M and Smarandache F and Hassan A, "Generalized Interval Valued Neutrosophic Graphs of First Type 1." *2017 IEEE International Conference on Innovations in Intelligent SysTems and Applications (INISTA), Gdynia Maritime University, Gdynia, Poland* (2017):413-419.
- [52] Broumi S, Bakali A, Talea M and Smarandache F, "Complex Neutrosophic Graphs of Type 1." *2017 IEEE International Conference on Innovations in Intelligent SysTems and Applications (INISTA), Gdynia Maritime University, Gdynia, Poland* (2017):432-437.

- [53] Samanta S, Sarkar B, Shin D and Pal M, "Completeness and regularity of generalized fuzzy graphs." Springer Plus, 2016, DOI 10.1186/s40064-016-3558-6.
- [54] Mehra S and Singh M, "Single valued neutrosophic signed graphs." International Journal of Computer Applications, Vol 157, N.9, (2017):31-34.
- [55] Ashraf S, Naz S, Rashmanlou H, and Malik M. A, "Regularity of graphs in single valued neutrosophic environment." Journal of Intelligent & Fuzzy Systems, (2017):1-14
- [56] Fathi S, Elchawalby H and Salama A. A, "A neutrosophic graph similarity measures." chapter in book- New Trends in Neutrosophic Theory and Applications- Florentin Smarandache and Surpati Pramanik (Editors)(2016): 223-230.
- [57] Vasantha Kandasamy W. B, Ilanthenral K and Smarandache F, "Neutrosophic Graphs: A New Dimension to Graph Theory Kindle Edition, 2015.
- [58] Abdel-Basset, Mohamed, et al. "A novel group decision-making model based on triangular neutrosophic numbers." Soft Computing (2017): 1-15. DOI: <https://doi.org/10.1007/s00500-017-2758-5>
- [59] Hussian, Abdel-Nasser, et al. "Neutrosophic Linear Programming Problems." Peer Reviewers: 15.
- [60] Abdel-Basset, Mohamed, Mai Mohamed, and Arun Kumar Sangaiah. "Neutrosophic AHP-Delphi Group decision making model based on trapezoidal neutrosophic numbers." Journal of Ambient Intelligence and Humanized Computing (2017): 1-17. DOI: <https://doi.org/10.1007/s12652-017-0548-7>
- [61] Mohamed, Mai, et al. "A Critical Path Problem in Neutrosophic Environment." Peer Reviewers: 167.
- [62] Mohamed, Mai, et al. "A Critical Path Problem Using Triangular Neutrosophic Number." Peer Reviewers: 155.
- [63] Mohamed, Mai, et al. "Using Neutrosophic Sets to Obtain PERT Three-Times Estimates in Project Management." Peer Reviewers: 143.
- [64] Mohamed, Mai, et al. "Neutrosophic Integer Programming Problem." Neutrosophic Sets & Systems 15 (2017).
- [65] Abdel-Baset, Mohamed, Ibrahim M. Hezam, and Florentin Smarandache. "Neutrosophic goal programming." Neutrosophic Sets Syst 11 (2016): 112-118.
- [66] Hezam, Ibrahim M., Mohamed Abdel-Baset, and Florentin Smarandache. "Taylor series approximation to solve neutrosophic multiobjective programming problem." Neutrosophic Sets and Systems 10 (2015): 39-46.
- [67] El-Hefenawy, Nancy, et al. "A review on the applications of neutrosophic sets." Journal of Computational and Theoretical Nanoscience 13.1 (2016): 936-944.
- [68] Abdel-Basset, M., Mohamed, M., Zhou, Y., & Hezam, I. (2017). Multi-criteria group decision making based on neutrosophic analytic hierarchy process. Journal of Intelligent & Fuzzy Systems, 33(6), 4055-4066.

NC-Cross Entropy Based MADM Strategy in Neutrosophic Cubic Set Environment

Surapati Pramanik, Shyamal Dalapati, Shariful Alam, Florentin Smarandache,
Tapan Kumar Roy

Surapati Pramanik, Shyamal Dalapati, Shariful Alam, Florentin Smarandache, Tapan Kumar Roy (2018). NC-Cross Entropy Based MADM Strategy in Neutrosophic Cubic Set Environment. *Mathematics* 6, 67; DOI: 10.3390/math6050067

Abstract: The objective of the paper is to introduce a new cross entropy measure in a neutrosophic cubic set (NCS) environment, which we call NC-cross entropy measure. We prove its basic properties. We also propose weighted NC-cross entropy and investigate its basic properties. We develop a novel multi attribute decision-making (MADM) strategy based on a weighted NC-cross entropy measure. To show the feasibility and applicability of the proposed multi attribute decision-making strategy, we solve an illustrative example of the multi attribute decision-making problem.

Keywords: single valued neutrosophic set (SVNS); interval neutrosophic set (INS); neutrosophic cubic set (NCS); multi attribute decision-making (MADM); NC-cross entropy measure

1. Introduction

In 1998, Smarandache [1] introduced a neutrosophic set by considering membership (truth), indeterminacy, non-membership (falsity) functions as independent components to uncertain, inconsistent and incomplete information. In 2010, Wang et al. [2] defined a single valued neutrosophic set (SVNS), a subclass of neutrosophic sets to deal with real and scientific and engineering applications. In the medical domain, Ansari et al. [3] employed a neutrosophic set and neutrosophic inference to knowledge based systems. Several researchers applied neutrosophic sets effectively for image segmentation problems [4–9]. Neutrosophic sets are also applied for integrating geographic information system data [10] and for binary classification problems [11].

Pramanik and Chackrabarti [12] studied the problems faced by construction workers in West Bengal in order to find its solutions using neutrosophic cognitive maps [13]. Based on the experts' opinion and the notion of indeterminacy, the authors formulated a neutrosophic cognitive map and studied the effect of two instantaneous state vectors separately on a connection matrix and neutrosophic adjacency matrix. Mondal and Pramanik [14] identified some of the problems of Hijras (third gender), namely, absence of social security, education problems, bad habits, health problems, stigma and discrimination, access to information and service problems, violence, issues of the Hijra community, and sexual behavior problems. Based on the experts' opinion and the notion of indeterminacy, the authors formulated a neutrosophic cognitive map and presented the effect of two instantaneous state vectors separately on a connection matrix and neutrosophic adjacency matrix.

Pramanik and Roy [15] studied the game theoretic model [16] of the Jammu and Kashmir conflict between India and Pakistan in a SVNS environment. The authors examined the progress and the

status of the conflict, as well as the dynamics of the relationship by focusing on the influence of United States of America, India and China in crisis dynamics. The authors investigated the possible solutions. The authors also explored the possibilities and developed arguments for an application of the principle of neutrosophic game theory to present a standard 2×2 zero-sum game theoretic model to identify an optimal solution.

Maria Sodenkamp applied the concept of SVN S s in multi attribute decision-making (MADM) in her Ph. D. thesis in 2013 [17]. In 2018, Pranab Biswas [18] studied various strategies for MADM in SVN S environment in his Ph. D. thesis. Kharal [19] presented a MADM strategy in a single valued neutrosophic environment and presented the application of the proposed strategy for the evaluation of university professors for tenure and promotions. Mondal and Pramanik [20] extended the teacher selection strategy [21] in SVN S environments. Mondal and Pramanik [22] also presented MADM strategy to school choice problems in SVN S environments. Mondal and Pramanik [23] and presented an MADM decision-making model for clay-brick selection in a construction field based on grey relational analysis in SVN S environments. Biswas et al. [24–26] presented several MADM strategies in single valued neutrosophic environments such as technique for order of preference by similarity to ideal solution (TOPSIS) [24], grey relational analysis [25], and entropy based MADM [26]. Several studies [27–30]—using similarity measures based MADM—have been proposed in SVN S environments. Several studies enrich the study of MADM in SVN S environments such as projection and bidirectional projection measure based MADM [31], maximizing deviation method [32], Frank prioritized Bonferroni mean operator based MADM [33], biparametric distance measures based MADM [34], prospect theory based MADM [35], multi-objective optimization by ratio analysis plus the full multiplicative form (MULTIMOORA) [36], weighted aggregated sum product assessment (WASPAS) [37,38], complex proportional assessment (COPRAS) [39], TODIM [40], projection based TODIM [41], outranking [42], analytic hierarchy process (AHP) [43], and Visekriterijumska optimizacija i KOmpromisno Resenje (VIKOR) [44].

In 2005, Wang et al. [45] introduced the interval neutrosophic set (INS) by considering membership function, non-membership function and indeterminacy function as independent functions that assume the values in interval form. Pramanik and Mondal [46] extended the single valued neutrosophic grey relational analysis method to interval neutrosophic environments and applied it to an MADM problem. The authors employed an information entropy method, which is used to obtain the unknown attribute weights and presented a numerical example. Dey et al. [47] investigated an extended grey relational analysis strategy for MADM problems in uncertain interval neutrosophic linguistic environments. The authors solved a numerical example and compared the obtained results with results obtained from the other existing strategies in the literature. Dey et al. [48] developed two MADM strategies in INS environment based on the combination of angle cosine and projection method. The authors presented an illustrative numerical example in the Khadi institution to demonstrate the effectiveness of the proposed MADM strategies. Several studies enrich the development of MADM in INS environments such as VIKOR [49], TOPSIS [50, 51], outranking strategy [52], similarity measure [29, 53–55], weighted correlation coefficient based MADM strategy [56], and generalized weighted aggregation operator based MADM strategy [57]. The study in recent trends in neutrosophic theory and applications can be found in [58].

Ali et al. [59] proposed the neutrosophic cubic set (NCS) by hybridizing NS and INS. Banerjee et al. [60] developed the grey relational analysis based MADM strategy in NCS environments. Pramanik et al. [61] presented an Extended TOPSIS strategy for MADM in NCS environments with neutrosophic cubic information. Zhan et al. [62] developed an MADM strategy based on two weighted average operators in NCS environments. Lu and Ye [63] presented three cosine measures between NCSs and established three MADM strategies in NCS environments. Shi and Ye [64] introduced Dombi aggregation operators of NCSs and applied for an MADM problem. Ye [65] presents operations and an aggregation method of neutrosophic cubic numbers for MADM. For multi attribute group decision-making (MAGDM), Pramanik et al. [66] defined a similarity measure for NCSs and proved some of its basic properties and developed a new MAGDM strategy with linguistic variables in NCS environments. To develop TODIM, Pramanik et al. [67]

proposed the score and accuracy functions for NCSs and proved their basic properties, and developed a strategy for ranking of neutrosophic cubic numbers based on the score and accuracy functions. In the same study, Pramanik et al. [67] presented a numerical example and presented a comparison analysis. In the same study, Pramanik et al. [67] conducted a sensitivity analysis to reflect the impact of ranking order of the alternatives for different values of attenuation factor of losses for MAGDM strategies.

Pramanik et al. [68] proposed a new VIKOR strategy for MAGDM in NCS environments. The authors also presented sensitivity analysis to reflect the impact of different values of the decision-making mechanism coefficient on ranking order of the alternatives.

Cross entropy measure is an important measure to calculate the divergence of any variable from prior one variable. In 1968, Zadeh [69] first proposed fuzzy entropy to deal with the divergence of two fuzzy variables. Thereafter, Deluca and Termini [70] introduced some axioms of fuzzy entropy involving Shannon's function [71]. Szmidt and Kacprzyk [72] proposed an entropy measure for intuitionistic fuzzy sets (IFSs) by employing a geometric interpretation of IFS. Majumder and Samanta [73] introduced a SVNS based entropy measure and similarity measure. Furthermore, Aydogdu [74] proposed an entropy measure for INSs. Ye and Du [75] proposed some entropy measures for INS based on the distances as the extension of the entropy measures of interval valued IFS. Shang and Jiang [76] defined cross entropy in a fuzzy environment between two fuzzy variables. Vlachos and Sergiadis [77] defined intuitionistic fuzzy cross-entropy. Ye [78] employed intuitionistic fuzzy cross entropy to multi criteria decision-making (MCDM). Maheshwari and Srivastava [79] proposed new cross entropy in intuitionistic fuzzy environment and employed it to medical diagnosis. Zhang et al. [80] defined entropy and cross entropy measure for interval-intuitionistic sets and discuss their properties. Ye [81] proposed an interval intuitionistic fuzzy cross entropy measure and employed it to solve MCDM problems.

Ye [82] defined cross entropy for SVNSs and employed it solve to MCDM problems. To remove the drawbacks of cross entropy [82], Ye [83] proposed another cross entropy for SVNSs. In the same study, Ye [83] also proposed new cross entropy for INSs. Tian et al. [84] proposed a cross entropy for INS environments and employed it to MCDM problems. Sahin [85] proposed an interval neutrosophic cross entropy measure based on fuzzy cross entropy and single valued neutrosophic cross entropy measures and applied it to MCDM problems. Recently, Pramanik et al. [86] proposed a novel cross entropy, namely, NS-cross entropy in SVNS environments and proved its basic properties. In the same research, Pramanik et al. [86] also proposed weighted NS-cross entropy and employed it to MAGDM problem. Furthermore, Dalapati et al. [87] extended NS-cross entropy in INS environments and employed it for solving MADM problems. Pramanik et al. [88] developed two new MADM strategies based on cross entropy measures in bipolar neutrosophic sets (BNSs) and interval BNS environments.

1.1. Research Gap: NC-Cross Entropy-Based MADM Strategy in NCS Environments

This study answers the following research questions:

1. Is it possible to introduce an NC-cross entropy measure in NCS environments?
2. Is it possible to introduce a weighted cross entropy measure in NCS environments?
3. Is it possible to develop a novel MADM strategy based on weighted NC-cross entropy?

1.2. Motivation

The studies [59–68] reveal that cross entropy measure is not proposed in NCS environments. Since MADM strategy is not studied in the literature, we move to propose a comprehensive NC-cross entropy-based strategy for tackling MADM in the NCS environment. This study develops a novel NC-cross entropy-based MADM strategy.

The objectives of the paper are:

1. To introduce a NC-cross entropy measure and establish its basic properties in an NCS environment.

2. To introduce a weighted NC- cross measure and establish its basic properties in NCS environments.
3. To develop a novel MADM strategy based on weighted NC-cross entropy measure in NCS environments.

To fill the research gap, we propose NC-cross entropy-based MADM.

The remainder of the paper is presented as follows: in Section 2, we describe the basic definitions and operation of SVNNS, INNS, and NCSs. In Section 3, we propose an NC-cross entropy measure and a weighted NC-cross entropy measure and establish their basic properties. Section 4 is devoted to developing MADM strategy using NC-cross entropy. Section 5 provides an illustrative numerical example to show the applicability and validity of the proposed strategy in NCS environments. Section 6 presents briefly the contribution of the paper. Section 7 offers conclusions and the future scope of research.

2. Preliminaries

In this section, some basic concepts and definitions of SVNNS, INN and NCS are presented that will be utilized to develop the paper.

Definition 1. Single valued neutrosophic set (SVNS)

Assume that U is a space of points (objects) with generic elements $u \in U$. A SVNNS [2] H in U is characterized by a truth-membership function $T_H(u)$, an indeterminacy-membership function $I_H(u)$, and a falsity-membership function $F_H(u)$, where $T_H(u), I_H(u), F_H(u) \in [0,1]$ for each point u in U . Therefore, a SVNNS A is expressed as

$$H = \{u, T_H(u), I_H(u), F_H(u) | u \in U\}, \tag{1}$$

whereas the sum of $T_H(u), I_H(u)$ and $F_H(u)$ satisfies the condition:

$$0 \leq T_H(u) + I_H(u) + F_H(u) \leq 3 \tag{2}$$

The order triplet $\langle T, I, F \rangle$ is called a single valued neutrosophic number (SVNN).

Example 1. Let H be any SVNNS in U ; then, H can be expressed as: $H = \{u, (0.7, 0.3, 0.5) | u \in U\}$ and SVNN presented $H = \langle 0.7, 0.3, 0.5 \rangle$.

Definition 2. Inclusion of SVNNS

The inclusion of any two SVNNSs [2] H_1 and H_2 in U is denoted by $H_1 \subseteq H_2$ and defined as follows:

$$H_1 \subseteq H_2 \text{ iff } T_{H_1}(u) \leq T_{H_2}(u), I_{H_1}(u) \geq I_{H_2}(u), F_{H_1}(u) \geq F_{H_2}(u) \text{ for all } u \in U. \tag{3}$$

Example 2. Let H_1 and H_2 be any two SVNNs in U presented as follows: $H_1 = \langle (0.7, 0.3, 0.5) \rangle$ and $H_2 = \langle (0.8, 0.2, 0.4) \rangle$ for all $u \in U$. Using the property of inclusion of two SVNNs, we conclude that $H_1 \subseteq H_2$.

Definition 3. Equality of two SVNNS

The equality of any two SVNNSs [2] H_1 and H_2 in U denoted by $H_1 = H_2$ is defined as:

$$T_{H_1}(u) = T_{H_2}(u), I_{H_1}(u) = I_{H_2}(u) \text{ and } F_{H_1}(u) = F_{H_2}(u) \text{ for all } u \in U. \tag{4}$$

Definition 4. Complement of any SVNNS

The complement of any SVNNS [2] H in U denoted by H^c and defined as follows:

$$H^c = \{u, 1 - T_H, 1 - I_H, 1 - F_H \mid u \in U\}. \tag{5}$$

Example 3. Let H be any SVN in U presented as follows:

$H = \langle 0.7, 0.3, 0.5 \rangle$. Then, the compliment of H is obtained as $H^c = \langle (0.3, 0.7, 0.5) \rangle$.

Definition 5. Union of two SVNSs

The union of two SVNSs [2] H_1 and H_2 is a neutrosophic set H_3 (say) written as $H_3 = H_1 \cup H_2$.

Here,

$$\begin{aligned} T_{H_3}(u) &= \max\{T_{H_1}(u), T_{H_2}(u)\}, \quad I_{H_3}(u) = \min\{I_{H_1}(u), I_{H_2}(u)\}, \\ F_{H_3}(u) &= \min\{F_{H_1}(u), F_{H_2}(u)\}, \quad \forall u \in U. \end{aligned} \tag{6}$$

Example 4. Let H_1 and H_2 be two SVNSs in U presented as follows:

Let $H_1 = \langle (0.6, 0.3, 0.4) \rangle$ and $H_2 = \langle (0.7, 0.3, 0.6) \rangle$ be two SVNSs. Then union of them is obtained using Equation (6) as follows: $H_1 \cup H_2 = \langle (0.7, 0.3, 0.4) \rangle$.

Definition 6. Intersection of any two SVNSs

The intersection of two SVNSs [2] H_1 and H_2 denoted by H_4 and defined as $H_4 = H_1 \cap H_2$.

Here,

$$\begin{aligned} T_{H_4}(u) &= \min\{T_{H_1}(u), T_{H_2}(u)\}, \quad I_{H_4}(u) = \max\{I_{H_1}(u), I_{H_2}(u)\}, \\ F_{H_4}(u) &= \max\{F_{H_1}(u), F_{H_2}(u)\}, \quad \forall u \in U. \end{aligned} \tag{7}$$

Example 5. Let H_1 and H_2 be two SVNSs in U presented as follows:

$H_1 = \langle (0.6, 0.3, 0.4) \rangle$ and $H_2 = \langle (0.7, 0.3, 0.6) \rangle$. Then, the intersection of them is obtained using Equation (7) as follows:

$$H_1 \cap H_2 = \langle (0.6, 0.3, 0.6) \rangle.$$

Definition 7. Some operations of SVNS

Let H_1 and H_2 be any two SVNSs [2]. Then, addition and multiplication are defined as:

$$H_1 \oplus H_2 = \langle T_{H_1}(u) + T_{H_2}(u) - T_{H_1}(u) \cdot T_{H_2}(u), I_{H_1}(u) \cdot I_{H_2}(u), F_{H_1}(u) \cdot F_{H_2}(u) \rangle, \forall u \in U. \tag{8}$$

$$H_1 \otimes H_2 = \langle T_{H_1}(u) \cdot T_{H_2}(u), I_{H_1}(u) + I_{H_2}(u) - I_{H_1}(u) \cdot I_{H_2}(u), F_{H_1}(u) + F_{H_2}(u) - F_{H_1}(u) \cdot F_{H_2}(u) \rangle, \forall u \in U. \tag{9}$$

Example 6. Let H_1 and H_2 be two SVNSs in U presented as follows:

$H_1 = \langle (0.6, 0.3, 0.4) \rangle$ and $H_2 = \langle (0.7, 0.3, 0.6) \rangle$.

Then, using Equations (8) and (9), we obtained $H_1 \oplus H_2$ and $H_1 \otimes H_2$ as follows:

1. $H_1 \oplus H_2 = \langle (0.88, 0.09, 0.24) \rangle$.
2. $H_1 \otimes H_2 = \langle (0.42, 0.51, 0.76) \rangle$.

Definition 8. Interval neutrosophic set (INS)

Assume that U is a space of points (objects) with generic element $u \in U$. An INS [45] J in U is characterized by a truth-membership function $T_J(u)$, an indeterminacy-membership function $I_J(u)$, and a falsity-membership function $F_J(u)$, where $T_J(u) = [T_J^-(u), T_J^+(u)]$, $I_J(u) = [I_J^-(u), I_J^+(u)]$, $F_J(u) = [F_J^-(u), F_J^+(u)]$ for each point u in U . Therefore, a INSs J can be expressed as

$$J = \{u, [T_J^-(u), T_J^+(u)], [I_J^-(u), I_J^+(u)], [F_J^-(u), F_J^+(u)] \mid u \in U\}, \tag{10}$$

where $T_j^-(u), T_j^+(u), I_j^-(u), I_j^+(u), F_j^-(u), F_j^+(u) \subseteq [0, 1]$.

Definition 9. Inclusion of two INSs

Let $J_1 = \{u, [T_{J_1}^-(u), T_{J_1}^+(u)], [I_{J_1}^-(u), I_{J_1}^+(u)], [F_{J_1}^-(u), F_{J_1}^+(u)] \mid u \in U\}$ and

$$J_2 = \{u, [T_{J_2}^-(u), T_{J_2}^+(u)], [I_{J_2}^-(u), I_{J_2}^+(u)], [F_{J_2}^-(u), F_{J_2}^+(u)] \mid u \in U\}$$
 be any two INSs [45] (11)

in U , then $J_1 \subseteq J_2$ iff $T_{J_1}^-(u) \leq T_{J_2}^-(u), T_{J_1}^+(u) \leq T_{J_2}^+(u), I_{J_1}^-(u) \geq I_{J_2}^-(u), I_{J_1}^+(u) \geq I_{J_2}^+(u),$

$$F_{J_1}^-(u) \geq F_{J_2}^-(u), F_{J_1}^+(u) \geq F_{J_2}^+(u)$$
 for all $u \in U$.

Definition 10. Complement of an INS

The complement J^c of an INS [45] $J = \{u, [T_j^-(u), T_j^+(u)], [I_j^-(u), I_j^+(u)], [F_j^-(u), F_j^+(u)] \mid u \in U\}$ is defined as follows:

$$J^c = \{u, [1 - T_j^+(u), 1 - T_j^-(u)], [1 - I_j^+(u), 1 - I_j^-(u)], [1 - F_j^+(u), 1 - F_j^-(u)] \mid u \in U\}. \tag{12}$$

Definition 11. Equality of two INSs

Let $J_1 = \{u, [T_{J_1}^-(u), T_{J_1}^+(u)], [I_{J_1}^-(u), I_{J_1}^+(u)], [F_{J_1}^-(u), F_{J_1}^+(u)] \mid u \in U\}$ and

$$J_2 = \{u, [T_{J_2}^-(u), T_{J_2}^+(u)], [I_{J_2}^-(u), I_{J_2}^+(u)], [F_{J_2}^-(u), F_{J_2}^+(u)] \mid u \in U\}$$
 be any two INSs [45] (13)

in U , then $J_1 = J_2$ iff $T_{J_1}^-(u) = T_{J_2}^-(u), T_{J_1}^+(u) = T_{J_2}^+(u), I_{J_1}^-(u) = I_{J_2}^-(u), I_{J_1}^+(u) = I_{J_2}^+(u),$

$$F_{J_1}^-(u) = F_{J_2}^-(u), F_{J_1}^+(u) = F_{J_2}^+(u)$$
 for all $u \in U$.

Definition 12. Neutrosophic cubic set (NCS)

Assume that U is a space of points (objects) with generic elements $u_i \in U$. A NCS [59] Q in U is a hybrid structure of INS and SVN that can be expressed as follows:

$$Q = \{u_i, \langle [T_Q^-(u_i), T_Q^+(u_i)], [I_Q^-(u_i), I_Q^+(u_i)], [F_Q^-(u_i), F_Q^+(u_i)], (T_Q(u_i), I_Q(u_i), F_Q(u_i)) \rangle \mid u_i \in U\}. \tag{14}$$

Here, $([T_Q^-(u_i), T_Q^+(u_i)], [I_Q^-(u_i), I_Q^+(u_i)], [F_Q^-(u_i), F_Q^+(u_i)])$ and $(T_Q(u_i), I_Q(u_i), F_Q(u_i))$ are INSs and SVN, respectively, in U . NCS can be simply presented as

$$\langle [T_Q^-(u), T_Q^+(u)], [I_Q^-(u), I_Q^+(u)], [F_Q^-(u), F_Q^+(u)], (T_Q(u), I_Q(u), F_Q(u)) \rangle. \tag{15}$$

We call Equation (15) a neutrosophic cubic number (NCN).

Definition 13. Inclusion of two NCSs

Let $Q_1 = \{u_i, \langle [T_{Q_1}^-(u_i), T_{Q_1}^+(u_i)], [I_{Q_1}^-(u_i), I_{Q_1}^+(u_i)], [F_{Q_1}^-(u_i), F_{Q_1}^+(u_i)], (T_{Q_1}(u_i), I_{Q_1}(u_i), F_{Q_1}(u_i)) \rangle \mid u_i \in U\}$

and

$$Q_2 = \{u_i, \langle [T_{Q_2}^-(u_i), T_{Q_2}^+(u_i)], [I_{Q_2}^-(u_i), I_{Q_2}^+(u_i)], [F_{Q_2}^-(u_i), F_{Q_2}^+(u_i)], (T_{Q_2}(u_i), I_{Q_2}(u_i), F_{Q_2}(u_i)) \rangle \mid u_i \in U\}$$
 (16)

be any two NCSs [59] in U . Then, $Q_1 \subseteq Q_2$ iff $T_{Q_1}^-(u_i) \leq T_{Q_2}^-(u_i), T_{Q_1}^+(u_i) \leq T_{Q_2}^+(u_i),$

$$\bar{I}_{Q_1}(u_i) \geq \bar{I}_{Q_2}(u_i), \quad I_{Q_1}^+(u_i) \geq I_{Q_2}^+(u_i), \quad F_{Q_1}^-(u_i) \geq F_{Q_2}^-(u_i), \quad F_{Q_1}^+(u_i) \geq F_{Q_2}^+(u_i) \quad \text{and}$$

$$T_{Q_1}(u_i) \leq T_{Q_2}(u_i), I_{Q_1}(u_i) \geq I_{Q_2}(u_i), F_{Q_1}(u_i) \geq F_{Q_2}(u_i) \quad \text{for all } u_i \in U.$$

Definition 14. Equality of two NCSs

Let $Q_1 = \{u_i, < [T_{Q_1}^-(u_i), T_{Q_1}^+(u_i)], [I_{Q_1}^-(u_i), I_{Q_1}^+(u_i)], [F_{Q_1}^-(u_i), F_{Q_1}^+(u_i)], (T_{Q_1}(u_i), I_{Q_1}(u_i), F_{Q_1}(u_i)) > | u_i \in U\}$.

and

$$Q_2 = \{u_i, < [T_{Q_2}^-(u_i), T_{Q_2}^+(u_i)], [I_{Q_2}^-(u_i), I_{Q_2}^+(u_i)], [F_{Q_2}^-(u_i), F_{Q_2}^+(u_i)], (T_{Q_2}(u_i), I_{Q_2}(u_i), F_{Q_2}(u_i)) > | u_i \in U$$

be any two NCSs [59] in U. Then $Q_1 = Q_2$ iff $T_{Q_1}^-(u_i) = T_{Q_2}^-(u_i), T_{Q_1}^+(u_i) = T_{Q_2}^+(u_i),$ (17)

$$\bar{I}_{Q_1}(u_i) = \bar{I}_{Q_2}(u_i), \quad I_{Q_1}^+(u_i) = I_{Q_2}^+(u_i), \quad F_{Q_1}^-(u_i) = F_{Q_2}^-(u_i), \quad F_{Q_1}^+(u_i) = F_{Q_2}^+(u_i) \quad \text{and}$$

$$T_{Q_1}(u_i) = T_{Q_2}(u_i), I_{Q_1}(u_i) = I_{Q_2}(u_i), F_{Q_1}(u_i) = F_{Q_2}(u_i) \quad \text{for all } u_i \in U.$$

Definition 15. Complement of an NCS

Let $Q = \{u_i, < [T_Q^-(u_i), T_Q^+(u_i)], [I_Q^-(u_i), I_Q^+(u_i)], [F_Q^-(u_i), F_Q^+(u_i)], (T_Q(u_i), I_Q(u_i), F_Q(u_i)) > | u_i \in U\}$ be any NCS [59] in U. Then, complement Q^c of Q is defined as follows:

$$Q^c = \{u_i, < [1 - T_Q^+(u_i), 1 - T_Q^-(u_i)], [1 - I_Q^-(u_i), 1 - I_Q^+(u_i)], [1 - F_Q^-(u_i), 1 - F_Q^+(u_i)], (1 - T_Q(u_i), 1 - I_Q(u_i), 1 - F_Q(u_i)) > | u_i \in U\}. \quad (18)$$

3. NC-Cross-entropy measure in NCS environment

Definition 16. NC-cross entropy measure

Let Q_1 and Q_2 be any two NCSs in $U = \{u_1, u_2, u_3, \dots, u_n\}$. Then, neutrosophic cubic cross-entropy measure of Q_1 and Q_2 is denoted by $CE_{NC}(Q_1, Q_2)$ and defined as follows:

$$\begin{aligned}
 CE_{NC}(Q_1, Q_2) = & \frac{1}{8} \left\{ \sum_{i=1}^n \left[\frac{2|T_{Q_1}^-(u_i) - T_{Q_2}^-(u_i)|}{\sqrt{1+|T_{Q_1}^-(u_i)|^2} + \sqrt{1+|T_{Q_2}^-(u_i)|^2}} + \frac{2|(1-T_{Q_1}^-(u_i)) - (1-T_{Q_2}^-(u_i))|}{\sqrt{1+|(1-T_{Q_1}^-(u_i))|^2} + \sqrt{1+|(1-T_{Q_2}^-(u_i))|^2}} \right] + \right. \\
 & \left[\frac{2|T_{Q_1}^+(u_i) - T_{Q_2}^+(u_i)|}{\sqrt{1+|T_{Q_1}^+(u_i)|^2} + \sqrt{1+|T_{Q_2}^+(u_i)|^2}} + \frac{2|(1-T_{Q_1}^+(u_i)) - (1-T_{Q_2}^+(u_i))|}{\sqrt{1+|(1-T_{Q_1}^+(u_i))|^2} + \sqrt{1+|(1-T_{Q_2}^+(u_i))|^2}} \right] + \\
 & \left[\frac{2|I_{Q_1}^-(u_i) - I_{Q_2}^-(u_i)|}{\sqrt{1+|I_{Q_1}^-(u_i)|^2} + \sqrt{1+|I_{Q_2}^-(u_i)|^2}} + \frac{2|(1-I_{Q_1}^-(u_i)) - (1-I_{Q_2}^-(u_i))|}{\sqrt{1+|(1-I_{Q_1}^-(u_i))|^2} + \sqrt{1+|(1-I_{Q_2}^-(u_i))|^2}} \right] + \\
 & \left[\frac{2|I_{Q_1}^+(u_i) - I_{Q_2}^+(u_i)|}{\sqrt{1+|I_{Q_1}^+(u_i)|^2} + \sqrt{1+|I_{Q_2}^+(u_i)|^2}} + \frac{2|(1-I_{Q_1}^+(u_i)) - (1-I_{Q_2}^+(u_i))|}{\sqrt{1+|(1-I_{Q_1}^+(u_i))|^2} + \sqrt{1+|(1-I_{Q_2}^+(u_i))|^2}} \right] + \\
 & \left[\frac{2|F_{Q_1}^-(u_i) - F_{Q_2}^-(u_i)|}{\sqrt{1+|F_{Q_1}^-(u_i)|^2} + \sqrt{1+|F_{Q_2}^-(u_i)|^2}} + \frac{2|(1-F_{Q_1}^-(u_i)) - (1-F_{Q_2}^-(u_i))|}{\sqrt{1+|(1-F_{Q_1}^-(u_i))|^2} + \sqrt{1+|(1-F_{Q_2}^-(u_i))|^2}} \right] + \\
 & \left[\frac{2|F_{Q_1}^+(u_i) - F_{Q_2}^+(u_i)|}{\sqrt{1+|F_{Q_1}^+(u_i)|^2} + \sqrt{1+|F_{Q_2}^+(u_i)|^2}} + \frac{2|(1-F_{Q_1}^+(u_i)) - (1-F_{Q_2}^+(u_i))|}{\sqrt{1+|(1-F_{Q_1}^+(u_i))|^2} + \sqrt{1+|(1-F_{Q_2}^+(u_i))|^2}} \right] + \\
 & \left[\frac{2|T_{Q_1}(u_i) - T_{Q_2}(u_i)|}{\sqrt{1+|T_{Q_1}(u_i)|^2} + \sqrt{1+|T_{Q_2}(u_i)|^2}} + \frac{2|(1-T_{Q_1}(u_i)) - (1-T_{Q_2}(u_i))|}{\sqrt{1+|(1-T_{Q_1}(u_i))|^2} + \sqrt{1+|(1-T_{Q_2}(u_i))|^2}} \right] + \\
 & \left. \left[\frac{2|I_{Q_1}(u_i) - I_{Q_2}(u_i)|}{\sqrt{1+|I_{Q_1}(u_i)|^2} + \sqrt{1+|I_{Q_2}(u_i)|^2}} + \frac{2|(1-I_{Q_1}(u_i)) - (1-I_{Q_2}(u_i))|}{\sqrt{1+|(1-I_{Q_1}(u_i))|^2} + \sqrt{1+|(1-I_{Q_2}(u_i))|^2}} \right] + \right. \\
 & \left. \left[\frac{2|F_{Q_1}(u_i) - F_{Q_2}(u_i)|}{\sqrt{1+|F_{Q_1}(u_i)|^2} + \sqrt{1+|F_{Q_2}(u_i)|^2}} + \frac{2|(1-F_{Q_1}(u_i)) - (1-F_{Q_2}(u_i))|}{\sqrt{1+|(1-F_{Q_1}(u_i))|^2} + \sqrt{1+|(1-F_{Q_2}(u_i))|^2}} \right] \right\}
 \end{aligned}
 \tag{19}$$

Theorem 1. Let Q_1, Q_2 be any two NCSs in U . The NC-cross entropy measure $CE_{NC}(Q_1, Q_2)$ satisfies the following properties:

- (i) $CE_{NC}(Q_1, Q_2) \geq 0$.
- (ii) $CE_{NC}(Q_1, Q_2) = 0$ iff $T_{Q_1}^-(u_i) = T_{Q_2}^-(u_i)$, $T_{Q_1}^+(u_i) = T_{Q_2}^+(u_i)$, $I_{Q_1}^-(u_i) = I_{Q_2}^-(u_i)$, $I_{Q_1}^+(u_i) = I_{Q_2}^+(u_i)$, $F_{Q_1}^-(u_i) = F_{Q_2}^-(u_i)$, $F_{Q_1}^+(u_i) = F_{Q_2}^+(u_i)$ and $T_{Q_1}(u_i) = T_{Q_2}(u_i)$, $I_{Q_1}(u_i) = I_{Q_2}(u_i)$, $F_{Q_1}(u_i) = F_{Q_2}(u_i)$ for all $\forall u_i \in U$.
- (iii) $CE_{NC}(Q_1, Q_2) = CE_{NC}(Q_1^c, Q_2^c)$,
- (iv) $CE_{NC}(Q_1, Q_2) = CE_{NC}(Q_2, Q_1)$.

Proof of Theorem 1.

- (i)

For all values of $u_i \in U$, $|T_{Q_1}(u_i)| \geq 0$, $|T_{Q_2}(u_i)| \geq 0$, $|T_{Q_1}(u_i) - T_{Q_2}(u_i)| \geq 0$, $\sqrt{1 + |T_{Q_1}(u_i)|^2} \geq 0$, $\sqrt{1 + |T_{Q_2}(u_i)|^2} \geq 0$, $|1 - T_{Q_1}(u_i)| \geq 0$, $|1 - T_{Q_2}(u_i)| \geq 0$, $|1 - T_{Q_1}(u_i) - (1 - T_{Q_2}(u_i))| \geq 0$, $\sqrt{1 + |1 - T_{Q_1}(u_i)|^2} \geq 0$, $\sqrt{1 + |1 - T_{Q_2}(u_i)|^2} \geq 0$.

Then,

$$\left[\frac{2|T_{Q_1}(u_i) - T_{Q_2}(u_i)|}{\sqrt{1 + |T_{Q_1}(u_i)|^2} + \sqrt{1 + |T_{Q_2}(u_i)|^2}} + \frac{2|1 - T_{Q_1}(u_i) - (1 - T_{Q_2}(u_i))|}{\sqrt{1 + |1 - T_{Q_1}(u_i)|^2} + \sqrt{1 + |1 - T_{Q_2}(u_i)|^2}} \right] \geq 0 \tag{20}$$

Similarly,

$$\left[\frac{2|I_{Q_1}(u_i) - I_{Q_2}(u_i)|}{\sqrt{1 + |I_{Q_1}(u_i)|^2} + \sqrt{1 + |I_{Q_2}(u_i)|^2}} + \frac{2|(1 - I_{Q_1}(u_i)) - (1 - I_{Q_2}(u_i))|}{\sqrt{1 + |1 - I_{Q_1}(u_i)|^2} + \sqrt{1 + |1 - I_{Q_2}(u_i)|^2}} \right] \geq 0 \tag{21}$$

and

$$\left[\frac{2|F_{Q_1}(u_i) - F_{Q_2}(u_i)|}{\sqrt{1 + |F_{Q_1}(u_i)|^2} + \sqrt{1 + |F_{Q_2}(u_i)|^2}} + \frac{2|(1 - F_{Q_1}(u_i)) - (1 - F_{Q_2}(u_i))|}{\sqrt{1 + |1 - F_{Q_1}(u_i)|^2} + \sqrt{1 + |1 - F_{Q_2}(u_i)|^2}} \right] \geq 0 \tag{22}$$

Again,

For all values of $u_i \in U$, $|T_{Q_1}^-(u_i)| \geq 0$, $|T_{Q_2}^-(u_i)| \geq 0$, $|T_{Q_1}^-(u_i) - T_{Q_2}^-(u_i)| \geq 0$, $\sqrt{1 + |T_{Q_1}^-(u_i)|^2} \geq 0$, $\sqrt{1 + |T_{Q_2}^-(u_i)|^2} \geq 0$, $|1 - T_{Q_1}^-(u_i)| \geq 0$, $|1 - T_{Q_2}^-(u_i)| \geq 0$, $|1 - T_{Q_1}^-(u_i) - (1 - T_{Q_2}^-(u_i))| \geq 0$, $\sqrt{1 + |1 - T_{Q_1}^-(u_i)|^2} \geq 0$, $\sqrt{1 + |1 - T_{Q_2}^-(u_i)|^2} \geq 0$

$$\Rightarrow \left[\frac{2|T_{Q_1}^-(u_i) - T_{Q_2}^-(u_i)|}{\sqrt{1 + |T_{Q_1}^-(u_i)|^2} + \sqrt{1 + |T_{Q_2}^-(u_i)|^2}} + \frac{2|(1 - T_{Q_1}^-(u_i)) - (1 - T_{Q_2}^-(u_i))|}{\sqrt{1 + |1 - T_{Q_1}^-(u_i)|^2} + \sqrt{1 + |1 - T_{Q_2}^-(u_i)|^2}} \right] \geq 0 \tag{23}$$

and

$$|T_{Q_1}^+(u_i)| \geq 0, |T_{Q_2}^+(u_i)| \geq 0, |T_{Q_1}^+(u_i) - T_{Q_2}^+(u_i)| \geq 0, \sqrt{1 + |T_{Q_1}^+(u_i)|^2} \geq 0, \sqrt{1 + |T_{Q_2}^+(u_i)|^2} \geq 0, |1 - T_{Q_1}^+(u_i)| \geq 0, |1 - T_{Q_2}^+(u_i)| \geq 0, |1 - T_{Q_1}^+(u_i) - (1 - T_{Q_2}^+(u_i))| \geq 0, \sqrt{1 + |1 - T_{Q_1}^+(u_i)|^2} \geq 0, \sqrt{1 + |1 - T_{Q_2}^+(u_i)|^2} \geq 0$$

$$\tag{24}$$

$$\Rightarrow \left[\frac{2|T_{Q_1}^+(u_i) - T_{Q_2}^+(u_i)|}{\sqrt{1 + |T_{Q_1}^+(u_i)|^2} + \sqrt{1 + |T_{Q_2}^+(u_i)|^2}} + \frac{2|(1 - T_{Q_1}^+(u_i)) - (1 - T_{Q_2}^+(u_i))|}{\sqrt{1 + |1 - T_{Q_1}^+(u_i)|^2} + \sqrt{1 + |1 - T_{Q_2}^+(u_i)|^2}} \right] \geq 0$$

Similarly, we can show that

$$\left[\frac{2|I_{Q_1}^-(u_i) - I_{Q_2}^-(u_i)|}{\sqrt{1 + |I_{Q_1}^-(u_i)|^2} + \sqrt{1 + |I_{Q_2}^-(u_i)|^2}} + \frac{2|(1 - I_{Q_1}^-(u_i)) - (1 - I_{Q_2}^-(u_i))|}{\sqrt{1 + |1 - I_{Q_1}^-(u_i)|^2} + \sqrt{1 + |1 - I_{Q_2}^-(u_i)|^2}} \right] \geq 0 \tag{25}$$

$$\left[\frac{2|I_{Q_1}^+(u_i) - I_{Q_2}^+(u_i)|}{\sqrt{1+|I_{Q_1}^+(u_i)|^2} + \sqrt{1+|I_{Q_2}^+(u_i)|^2}} + \frac{2|(1-I_{Q_1}^+(u_i)) - (1-I_{Q_2}^+(u_i))|}{\sqrt{1+(1-I_{Q_1}^+(u_i))^2} + \sqrt{1+(1-I_{Q_2}^+(u_i))^2}} \right] \geq 0 \tag{26}$$

$$\left[\frac{2|F_{Q_1}^-(u_i) - F_{Q_2}^-(u_i)|}{\sqrt{1+|F_{Q_1}^-(u_i)|^2} + \sqrt{1+|F_{Q_2}^-(u_i)|^2}} + \frac{2|(1-F_{Q_1}^-(u_i)) - (1-F_{Q_2}^-(u_i))|}{\sqrt{1+(1-F_{Q_1}^-(u_i))^2} + \sqrt{1+(1-F_{Q_2}^-(u_i))^2}} \right] \geq 0 \tag{27}$$

and

$$\left[\frac{2|F_{Q_1}^+(u_i) - F_{Q_2}^+(u_i)|}{\sqrt{1+|F_{Q_1}^+(u_i)|^2} + \sqrt{1+|F_{Q_2}^+(u_i)|^2}} + \frac{2|(1-F_{Q_1}^+(u_i)) - (1-F_{Q_2}^+(u_i))|}{\sqrt{1+(1-F_{Q_1}^+(u_i))^2} + \sqrt{1+(1-F_{Q_2}^+(u_i))^2}} \right] \geq 0 \tag{28}$$

Adding Equation (20) to Equation (28), we obtain $CE_{NC}(Q_1, Q_2) \geq 0$.

(ii).

$$\left[\frac{2|T_{Q_1}(u_i) - T_{Q_2}(u_i)|}{\sqrt{1+|T_{Q_1}(u_i)|^2} + \sqrt{1+|T_{Q_2}(u_i)|^2}} + \frac{2|(1-T_{Q_1}(u_i)) - (1-T_{Q_2}(u_i))|}{\sqrt{1+(1-T_{Q_1}(u_i))^2} + \sqrt{1+(1-T_{Q_2}(u_i))^2}} \right] = 0, \tag{29}$$

$\Leftrightarrow T_{Q_1}(u_i) = T_{Q_2}(u_i)$

$$\left[\frac{2|I_{Q_1}(u_i) - I_{Q_2}(u_i)|}{\sqrt{1+|I_{Q_1}(u_i)|^2} + \sqrt{1+|I_{Q_2}(u_i)|^2}} + \frac{2|(1-I_{Q_1}(u_i)) - (1-I_{Q_2}(u_i))|}{\sqrt{1+(1-I_{Q_1}(u_i))^2} + \sqrt{1+(1-I_{Q_2}(u_i))^2}} \right] = 0, \tag{30}$$

$\Leftrightarrow I_{Q_1}(u_i) = I_{Q_2}(u_i)$

$$\left[\frac{2|F_{Q_1}(u_i) - F_{Q_2}(u_i)|}{\sqrt{1+|F_{Q_1}(u_i)|^2} + \sqrt{1+|F_{Q_2}(u_i)|^2}} + \frac{2|(1-F_{Q_1}(u_i)) - (1-F_{Q_2}(u_i))|}{\sqrt{1+(1-F_{Q_1}(u_i))^2} + \sqrt{1+(1-F_{Q_2}(u_i))^2}} \right] = 0, \tag{31}$$

$\Leftrightarrow F_{Q_1}(u_i) = F_{Q_2}(u_i)$, For all values of $u_i \in U$.

Again,

$$\left[\frac{2|T_{Q_1}^-(u_i) - T_{Q_2}^-(u_i)|}{\sqrt{1+|T_{Q_1}^-(u_i)|^2} + \sqrt{1+|T_{Q_2}^-(u_i)|^2}} + \frac{2|(1-T_{Q_1}^-(u_i)) - (1-T_{Q_2}^-(u_i))|}{\sqrt{1+(1-T_{Q_1}^-(u_i))^2} + \sqrt{1+(1-T_{Q_2}^-(u_i))^2}} \right] = 0 \tag{32}$$

$\Leftrightarrow T_{Q_1}^-(u_i) = T_{Q_2}^-(u_i)$,

$$\left[\frac{2|T_{Q_1}^+(u_i) - T_{Q_2}^+(u_i)|}{\sqrt{1+|T_{Q_1}^+(u_i)|^2} + \sqrt{1+|T_{Q_2}^+(u_i)|^2}} + \frac{2|(1-T_{Q_1}^+(u_i)) - (1-T_{Q_2}^+(u_i))|}{\sqrt{1+(1-T_{Q_1}^+(u_i))^2} + \sqrt{1+(1-T_{Q_2}^+(u_i))^2}} \right] = 0 \tag{33}$$

$\Leftrightarrow T_{Q_1}^+(u_i) = T_{Q_2}^+(u_i)$,

$$\left[\frac{2|I_{Q_1}^-(u_i) - I_{Q_2}^-(u_i)|}{\sqrt{1+|I_{Q_1}^-(u_i)|^2} + \sqrt{1+|I_{Q_2}^-(u_i)|^2}} + \frac{2|(1-I_{Q_1}^-(u_i)) - (1-I_{Q_2}^-(u_i))|}{\sqrt{1+(1-I_{Q_1}^-(u_i))^2} + \sqrt{1+(1-I_{Q_2}^-(u_i))^2}} \right] = 0 \tag{34}$$

$\Leftrightarrow I_{Q_1}^-(u_i) = I_{Q_2}^-(u_i)$,

$$\left[\frac{2|I_{Q_1}^+(u_i) - I_{Q_2}^+(u_i)|}{\sqrt{1+|I_{Q_1}^+(u_i)|^2} + \sqrt{1+|I_{Q_2}^+(u_i)|^2}} + \frac{2|(1-I_{Q_1}^+(u_i)) - (1-I_{Q_2}^+(u_i))|}{\sqrt{1+|(1-I_{Q_1}^+(u_i))|^2} + \sqrt{1+|(1-I_{Q_2}^+(u_i))|^2}} \right] = 0 \tag{35}$$

$$\Leftrightarrow I_{Q_1}^+(u_i) = I_{Q_2}^+(u_i),$$

$$\left[\frac{2|F_{Q_1}^-(u_i) - F_{Q_2}^-(u_i)|}{\sqrt{1+|F_{Q_1}^-(u_i)|^2} + \sqrt{1+|F_{Q_2}^-(u_i)|^2}} + \frac{2|(1-F_{Q_1}^-(u_i)) - (1-F_{Q_2}^-(u_i))|}{\sqrt{1+|(1-F_{Q_1}^-(u_i))|^2} + \sqrt{1+|(1-F_{Q_2}^-(u_i))|^2}} \right] = 0 \tag{36}$$

$$\Leftrightarrow F_{Q_1}^-(u_i) = F_{Q_2}^-(u_i),$$

$$\left[\frac{2|F_{Q_1}^+(u_i) - F_{Q_2}^+(u_i)|}{\sqrt{1+|F_{Q_1}^+(u_i)|^2} + \sqrt{1+|F_{Q_2}^+(u_i)|^2}} + \frac{2|(1-F_{Q_1}^+(u_i)) - (1-F_{Q_2}^+(u_i))|}{\sqrt{1+|(1-F_{Q_1}^+(u_i))|^2} + \sqrt{1+|(1-F_{Q_2}^+(u_i))|^2}} \right] = 0 \tag{37}$$

$$\Leftrightarrow F_{Q_1}^+(u_i) = F_{Q_2}^+(u_i), \text{ for all values of } u_i \in U.$$

From, Equation (29) to Equation (37), we obtain $CE_{NC}(Q_1, Q_2) = 0$ iff $T_{Q_1}^-(u_i) = T_{Q_2}^-(u_i)$, $T_{Q_1}^+(u_i) = T_{Q_2}^+(u_i)$, $I_{Q_1}^-(u_i) = I_{Q_2}^-(u_i)$, $I_{Q_1}^+(u_i) = I_{Q_2}^+(u_i)$, $F_{Q_1}^-(u_i) = F_{Q_2}^-(u_i)$, $F_{Q_1}^+(u_i) = F_{Q_2}^+(u_i)$ and $T_{Q_1}(u_i) = T_{Q_2}(u_i), I_{Q_1}(u_i) = I_{Q_2}(u_i), F_{Q_1}(u_i) = F_{Q_2}(u_i)$ for all $\forall u_i \in U$.

(iii).

Using Definition (1), Definition (4) and Definition (10), we obtain the following expression:

$$CE_{NC}(Q_1^c, Q_2^c) = \frac{1}{8} \left\{ \sum_{i=1}^n \left[\left(\frac{2|T_{Q_1^c}^-(u_i) - T_{Q_2^c}^-(u_i)|}{\sqrt{1+|T_{Q_1^c}^-(u_i)|^2} + \sqrt{1+|T_{Q_2^c}^-(u_i)|^2}} + \frac{2|(1-T_{Q_1^c}^-(u_i)) - (1-T_{Q_2^c}^-(u_i))|}{\sqrt{1+|(1-T_{Q_1^c}^-(u_i))|^2} + \sqrt{1+|(1-T_{Q_2^c}^-(u_i))|^2}} \right) + \right. \right.$$

$$\left. \left[\frac{2|T_{Q_1^c}^+(u_i) - T_{Q_2^c}^+(u_i)|}{\sqrt{1+|T_{Q_1^c}^+(u_i)|^2} + \sqrt{1+|T_{Q_2^c}^+(u_i)|^2}} + \frac{2|(1-T_{Q_1^c}^+(u_i)) - (1-T_{Q_2^c}^+(u_i))|}{\sqrt{1+|(1-T_{Q_1^c}^+(u_i))|^2} + \sqrt{1+|(1-T_{Q_2^c}^+(u_i))|^2}} \right] + \right.$$

$$\left[\frac{2|I_{Q_1^c}^-(u_i) - I_{Q_2^c}^-(u_i)|}{\sqrt{1+|I_{Q_1^c}^-(u_i)|^2} + \sqrt{1+|I_{Q_2^c}^-(u_i)|^2}} + \frac{2|(1-I_{Q_1^c}^-(u_i)) - (1-I_{Q_2^c}^-(u_i))|}{\sqrt{1+|(1-I_{Q_1^c}^-(u_i))|^2} + \sqrt{1+|(1-I_{Q_2^c}^-(u_i))|^2}} \right] + \right.$$

$$\left[\frac{2|I_{Q_1^c}^+(u_i) - I_{Q_2^c}^+(u_i)|}{\sqrt{1+|I_{Q_1^c}^+(u_i)|^2} + \sqrt{1+|I_{Q_2^c}^+(u_i)|^2}} + \frac{2|(1-I_{Q_1^c}^+(u_i)) - (1-I_{Q_2^c}^+(u_i))|}{\sqrt{1+|(1-I_{Q_1^c}^+(u_i))|^2} + \sqrt{1+|(1-I_{Q_2^c}^+(u_i))|^2}} \right] + \right.$$

$$\left. \left[\frac{2|F_{Q_1^c}^-(u_i) - F_{Q_2^c}^-(u_i)|}{\sqrt{1+|F_{Q_1^c}^-(u_i)|^2} + \sqrt{1+|F_{Q_2^c}^-(u_i)|^2}} + \frac{2|(1-F_{Q_1^c}^-(u_i)) - (1-F_{Q_2^c}^-(u_i))|}{\sqrt{1+|(1-F_{Q_1^c}^-(u_i))|^2} + \sqrt{1+|(1-F_{Q_2^c}^-(u_i))|^2}} \right] + \right.$$

$$\begin{aligned}
 & \left[\frac{2|F_{Q_1^+}(u_i) - F_{Q_2^+}(u_i)|}{\sqrt{1+|F_{Q_1^+}(u_i)|^2} + \sqrt{1+|F_{Q_2^+}(u_i)|^2}} + \frac{2|(1-F_{Q_1^+}(u_i)) - (1-F_{Q_2^+}(u_i))|}{\sqrt{1+(1-F_{Q_1^+}(u_i))^2} + \sqrt{1+(1-F_{Q_2^+}(u_i))^2}} \right] + \\
 & \left[\frac{2|T_{Q_1^c}(u_i) - T_{Q_2^c}(u_i)|}{\sqrt{1+|T_{Q_1^c}(u_i)|^2} + \sqrt{1+|T_{Q_2^c}(u_i)|^2}} + \frac{2|(1-T_{Q_1^c}(u_i)) - (1-T_{Q_2^c}(u_i))|}{\sqrt{1+(1-T_{Q_1^c}(u_i))^2} + \sqrt{1+(1-T_{Q_2^c}(u_i))^2}} \right] + \\
 & \left. \left[\frac{2|I_{Q_1^c}(u_i) - I_{Q_2^c}(u_i)|}{\sqrt{1+|I_{Q_1^c}(u_i)|^2} + \sqrt{1+|I_{Q_2^c}(u_i)|^2}} + \frac{2|(1-I_{Q_1^c}(u_i)) - (1-I_{Q_2^c}(u_i))|}{\sqrt{1+(1-I_{Q_1^c}(u_i))^2} + \sqrt{1+(1-I_{Q_2^c}(u_i))^2}} \right] + \right. \\
 & \left. \left[\frac{2|F_{Q_1^c}(u_i) - F_{Q_2^c}(u_i)|}{\sqrt{1+|F_{Q_1^c}(u_i)|^2} + \sqrt{1+|F_{Q_2^c}(u_i)|^2}} + \frac{2|(1-F_{Q_1^c}(u_i)) - (1-F_{Q_2^c}(u_i))|}{\sqrt{1+(1-F_{Q_1^c}(u_i))^2} + \sqrt{1+(1-F_{Q_2^c}(u_i))^2}} \right] \right\} \\
 & = \frac{1}{8} \left\{ \sum_{i=1}^n \left[\frac{2|(1-T_{Q_1^-}(u_i)) - (1-T_{Q_2^-}(u_i))|}{\sqrt{1+(1-T_{Q_1^-}(u_i))^2} + \sqrt{1+(1-T_{Q_2^-}(u_i))^2}} + \frac{2|T_{Q_1^-}(u_i) - T_{Q_2^-}(u_i)|}{\sqrt{1+|T_{Q_1^-}(u_i)|^2} + \sqrt{1+|T_{Q_2^-}(u_i)|^2}} \right] + \right. \\
 & \left[\frac{2|(1-T_{Q_1^+}(u_i)) - (1-T_{Q_2^+}(u_i))|}{\sqrt{1+(1-T_{Q_1^+}(u_i))^2} + \sqrt{1+(1-T_{Q_2^+}(u_i))^2}} + \frac{2|T_{Q_1^+}(u_i) - T_{Q_2^+}(u_i)|}{\sqrt{1+|T_{Q_1^+}(u_i)|^2} + \sqrt{1+|T_{Q_2^+}(u_i)|^2}} \right] + \\
 & \left[\frac{2|(1-I_{Q_1^-}(u_i)) - (1-I_{Q_2^-}(u_i))|}{\sqrt{1+(1-I_{Q_1^-}(u_i))^2} + \sqrt{1+(1-I_{Q_2^-}(u_i))^2}} + \frac{2|I_{Q_1^-}(u_i) - I_{Q_2^-}(u_i)|}{\sqrt{1+|I_{Q_1^-}(u_i)|^2} + \sqrt{1+|I_{Q_2^-}(u_i)|^2}} \right] + \\
 & \left[\frac{2|(1-I_{Q_1^+}(u_i)) - (1-I_{Q_2^+}(u_i))|}{\sqrt{1+(1-I_{Q_1^+}(u_i))^2} + \sqrt{1+(1-I_{Q_2^+}(u_i))^2}} + \frac{2|I_{Q_1^+}(u_i) - I_{Q_2^+}(u_i)|}{\sqrt{1+|I_{Q_1^+}(u_i)|^2} + \sqrt{1+|I_{Q_2^+}(u_i)|^2}} \right] + \\
 & \left[\frac{2|(1-F_{Q_1^-}(u_i)) - (1-F_{Q_2^-}(u_i))|}{\sqrt{1+(1-F_{Q_1^-}(u_i))^2} + \sqrt{1+(1-F_{Q_2^-}(u_i))^2}} + \frac{2|F_{Q_1^-}(u_i) - F_{Q_2^-}(u_i)|}{\sqrt{1+|F_{Q_1^-}(u_i)|^2} + \sqrt{1+|F_{Q_2^-}(u_i)|^2}} \right] + \\
 & \left[\frac{2|(1-F_{Q_1^+}(u_i)) - (1-F_{Q_2^+}(u_i))|}{\sqrt{1+(1-F_{Q_1^+}(u_i))^2} + \sqrt{1+(1-F_{Q_2^+}(u_i))^2}} + \frac{2|F_{Q_1^+}(u_i) - F_{Q_2^+}(u_i)|}{\sqrt{1+|F_{Q_1^+}(u_i)|^2} + \sqrt{1+|F_{Q_2^+}(u_i)|^2}} \right] + \\
 & \left. \left[\frac{2|(1-T_{Q_1}(u_i)) - (1-T_{Q_2}(u_i))|}{\sqrt{1+(1-T_{Q_1}(u_i))^2} + \sqrt{1+(1-T_{Q_2}(u_i))^2}} + \frac{2|T_{Q_1}(u_i) - T_{Q_2}(u_i)|}{\sqrt{1+|T_{Q_1}(u_i)|^2} + \sqrt{1+|T_{Q_2}(u_i)|^2}} \right] + \right.
 \end{aligned}$$

$$\begin{aligned}
 & \left[\frac{2|(1-I_{Q_1}(u_i))-(1-I_{Q_2}(u_i))|}{\sqrt{1+|(1-I_{Q_1}(u_i))|^2} + \sqrt{1+|(1-I_{Q_2}(u_i))|^2}} + \frac{2|I_{Q_1}(u_i)-I_{Q_2}(u_i)|}{\sqrt{1+|I_{Q_1}(u_i)|^2} + \sqrt{1+|I_{Q_2}(u_i)|^2}} \right] + \\
 & \left[\frac{2|(1-F_{Q_1}(u_i))-(1-F_{Q_2}(u_i))|}{\sqrt{1+|(1-F_{Q_1}(u_i))|^2} + \sqrt{1+|(1-F_{Q_2}(u_i))|^2}} + \frac{2|F_{Q_1}(u_i)-F_{Q_2}(u_i)|}{\sqrt{1+|F_{Q_1}(u_i)|^2} + \sqrt{1+|F_{Q_2}(u_i)|^2}} \right] \Bigg\} \\
 & = \frac{1}{8} \sum_{i=1}^n \left\{ \left[\frac{2|T_{Q_1}^-(u_i)-T_{Q_2}^-(u_i)|}{\sqrt{1+|T_{Q_1}^-(u_i)|^2} + \sqrt{1+|T_{Q_2}^-(u_i)|^2}} + \frac{2|(1-T_{Q_1}^-(u_i))-(1-T_{Q_2}^-(u_i))|}{\sqrt{1+|(1-T_{Q_1}^-(u_i))|^2} + \sqrt{1+|(1-T_{Q_2}^-(u_i))|^2}} \right] + \right. \\
 & \left[\frac{2|T_{Q_1}^+(u_i)-T_{Q_2}^+(u_i)|}{\sqrt{1+|T_{Q_1}^+(u_i)|^2} + \sqrt{1+|T_{Q_2}^+(u_i)|^2}} + \frac{2|(1-T_{Q_1}^+(u_i))-(1-T_{Q_2}^+(u_i))|}{\sqrt{1+|(1-T_{Q_1}^+(u_i))|^2} + \sqrt{1+|(1-T_{Q_2}^+(u_i))|^2}} \right] + \\
 & \left[\frac{2|I_{Q_1}^-(u_i)-I_{Q_2}^-(u_i)|}{\sqrt{1+|I_{Q_1}^-(u_i)|^2} + \sqrt{1+|I_{Q_2}^-(u_i)|^2}} + \frac{2|(1-I_{Q_1}^-(u_i))-(1-I_{Q_2}^-(u_i))|}{\sqrt{1+|(1-I_{Q_1}^-(u_i))|^2} + \sqrt{1+|(1-I_{Q_2}^-(u_i))|^2}} \right] + \\
 & \left[\frac{2|I_{Q_1}^+(u_i)-I_{Q_2}^+(u_i)|}{\sqrt{1+|I_{Q_1}^+(u_i)|^2} + \sqrt{1+|I_{Q_2}^+(u_i)|^2}} + \frac{2|(1-I_{Q_1}^+(u_i))-(1-I_{Q_2}^+(u_i))|}{\sqrt{1+|(1-I_{Q_1}^+(u_i))|^2} + \sqrt{1+|(1-I_{Q_2}^+(u_i))|^2}} \right] + \\
 & \left[\frac{2|F_{Q_1}^-(u_i)-F_{Q_2}^-(u_i)|}{\sqrt{1+|F_{Q_1}^-(u_i)|^2} + \sqrt{1+|F_{Q_2}^-(u_i)|^2}} + \frac{2|(1-F_{Q_1}^-(u_i))-(1-F_{Q_2}^-(u_i))|}{\sqrt{1+|(1-F_{Q_1}^-(u_i))|^2} + \sqrt{1+|(1-F_{Q_2}^-(u_i))|^2}} \right] + \\
 & \left[\frac{2|F_{Q_1}^+(u_i)-F_{Q_2}^+(u_i)|}{\sqrt{1+|F_{Q_1}^+(u_i)|^2} + \sqrt{1+|F_{Q_2}^+(u_i)|^2}} + \frac{2|(1-F_{Q_1}^+(u_i))-(1-F_{Q_2}^+(u_i))|}{\sqrt{1+|(1-F_{Q_1}^+(u_i))|^2} + \sqrt{1+|(1-F_{Q_2}^+(u_i))|^2}} \right] + \\
 & \left[\frac{2|T_{Q_1}(u_i)-T_{Q_2}(u_i)|}{\sqrt{1+|T_{Q_1}(u_i)|^2} + \sqrt{1+|T_{Q_2}(u_i)|^2}} + \frac{2|(1-T_{Q_1}(u_i))-(1-T_{Q_2}(u_i))|}{\sqrt{1+|(1-T_{Q_1}(u_i))|^2} + \sqrt{1+|(1-T_{Q_2}(u_i))|^2}} \right] + \\
 & \left[\frac{2|I_{Q_1}(u_i)-I_{Q_2}(u_i)|}{\sqrt{1+|I_{Q_1}(u_i)|^2} + \sqrt{1+|I_{Q_2}(u_i)|^2}} + \frac{2|(1-I_{Q_1}(u_i))-(1-I_{Q_2}(u_i))|}{\sqrt{1+|(1-I_{Q_1}(u_i))|^2} + \sqrt{1+|(1-I_{Q_2}(u_i))|^2}} \right] + \\
 & \left[\frac{2|F_{Q_1}(u_i)-F_{Q_2}(u_i)|}{\sqrt{1+|F_{Q_1}(u_i)|^2} + \sqrt{1+|F_{Q_2}(u_i)|^2}} + \frac{2|(1-F_{Q_1}(u_i))-(1-F_{Q_2}(u_i))|}{\sqrt{1+|(1-F_{Q_1}(u_i))|^2} + \sqrt{1+|(1-F_{Q_2}(u_i))|^2}} \right] \Bigg\} = CE_{NC}(Q_1, Q_2)
 \end{aligned}$$

(iv).

Since $\forall u_i \in U$, for a single valued part, we obtain:

$$\begin{aligned}
 |T_{Q_1}(u_i)-T_{Q_2}(u_i)| &= |T_{Q_2}(u_i)-T_{Q_1}(u_i)|, & |I_{Q_1}(u_i)-I_{Q_2}(u_i)| &= |I_{Q_2}(u_i)-I_{Q_1}(u_i)|, & |F_{Q_1}(u_i)-F_{Q_2}(u_i)| &= |F_{Q_2}(u_i)-F_{Q_1}(u_i)|, \\
 |(1-T_{Q_1}(u_i))-(1-T_{Q_2}(u_i))| &= |(1-T_{Q_2}(u_i))-(1-T_{Q_1}(u_i))|, & |(1-I_{Q_1}(u_i))-(1-I_{Q_2}(u_i))| &= |(1-I_{Q_2}(u_i))-(1-I_{Q_1}(u_i))|,
 \end{aligned}$$

$$\left| (1 - F_{Q_1}(u_i)) - (1 - F_{Q_2}(u_i)) \right| = \left| (1 - F_{Q_2}(u_i)) - (1 - F_{Q_1}(u_i)) \right|.$$

Then,

$$\begin{aligned} \sqrt{1 + |T_{Q_1}(u_i)|^2} + \sqrt{1 + |T_{Q_2}(u_i)|^2} &= \sqrt{1 + |T_{Q_2}(u_i)|^2} + \sqrt{1 + |T_{Q_1}(u_i)|^2} , \\ \sqrt{1 + |I_{Q_1}(u_i)|^2} + \sqrt{1 + |I_{Q_2}(u_i)|^2} &= \sqrt{1 + |I_{Q_2}(u_i)|^2} + \sqrt{1 + |I_{Q_1}(u_i)|^2} , \quad \sqrt{1 + |F_{Q_1}(u_i)|^2} + \sqrt{1 + |F_{Q_2}(u_i)|^2} = \sqrt{1 + |F_{Q_2}(u_i)|^2} + \sqrt{1 + |F_{Q_1}(u_i)|^2} , \\ \sqrt{1 + |(1 - T_{Q_1}(u_i))|^2} + \sqrt{1 + |(1 - T_{Q_2}(u_i))|^2} &= \sqrt{1 + |(1 - T_{Q_2}(u_i))|^2} + \sqrt{1 + |(1 - T_{Q_1}(u_i))|^2} , \\ \sqrt{1 + |(1 - I_{Q_1}(u_i))|^2} + \sqrt{1 + |(1 - I_{Q_2}(u_i))|^2} &= \sqrt{1 + |(1 - I_{Q_2}(u_i))|^2} + \sqrt{1 + |(1 - I_{Q_1}(u_i))|^2} , \\ \sqrt{1 + |(1 - F_{Q_1}(u_i))|^2} + \sqrt{1 + |(1 - F_{Q_2}(u_i))|^2} &= \sqrt{1 + |(1 - F_{Q_2}(u_i))|^2} + \sqrt{1 + |(1 - F_{Q_1}(u_i))|^2} , \quad \forall u_i \in U. \end{aligned}$$

For the interval neutrosophic part, we obtain

$$\begin{aligned} |T_{Q_1}^-(u_i) - T_{Q_2}^-(u_i)| &= |T_{Q_2}^-(u_i) - T_{Q_1}^-(u_i)| , \quad |I_{Q_1}^-(u_i) - I_{Q_2}^-(u_i)| = |I_{Q_2}^-(u_i) - I_{Q_1}^-(u_i)| , \quad |F_{Q_1}^-(u_i) - F_{Q_2}^-(u_i)| = |F_{Q_2}^-(u_i) - F_{Q_1}^-(u_i)| , \\ |(1 - T_{Q_1}^-(u_i)) - (1 - T_{Q_2}^-(u_i))| &= |(1 - T_{Q_2}^-(u_i)) - (1 - T_{Q_1}^-(u_i))| , \quad |(1 - I_{Q_1}^-(u_i)) - (1 - I_{Q_2}^-(u_i))| = |(1 - I_{Q_2}^-(u_i)) - (1 - I_{Q_1}^-(u_i))| , \\ |(1 - F_{Q_1}^-(u_i)) - (1 - F_{Q_2}^-(u_i))| &= |(1 - F_{Q_2}^-(u_i)) - (1 - F_{Q_1}^-(u_i))| . \end{aligned}$$

Then, we obtain

$$\begin{aligned} \sqrt{1 + |T_{Q_1}^-(u_i)|^2} + \sqrt{1 + |T_{Q_2}^-(u_i)|^2} &= \sqrt{1 + |T_{Q_2}^-(u_i)|^2} + \sqrt{1 + |T_{Q_1}^-(u_i)|^2} , \\ \sqrt{1 + |I_{Q_1}^-(u_i)|^2} + \sqrt{1 + |I_{Q_2}^-(u_i)|^2} &= \sqrt{1 + |I_{Q_2}^-(u_i)|^2} + \sqrt{1 + |I_{Q_1}^-(u_i)|^2} , \\ \sqrt{1 + |F_{Q_1}^-(u_i)|^2} + \sqrt{1 + |F_{Q_2}^-(u_i)|^2} &= \sqrt{1 + |F_{Q_2}^-(u_i)|^2} + \sqrt{1 + |F_{Q_1}^-(u_i)|^2} , \\ \sqrt{1 + |(1 - T_{Q_1}^-(u_i))|^2} + \sqrt{1 + |(1 - T_{Q_2}^-(u_i))|^2} &= \sqrt{1 + |(1 - T_{Q_2}^-(u_i))|^2} + \sqrt{1 + |(1 - T_{Q_1}^-(u_i))|^2} , \\ \sqrt{1 + |(1 - I_{Q_1}^-(u_i))|^2} + \sqrt{1 + |(1 - I_{Q_2}^-(u_i))|^2} &= \sqrt{1 + |(1 - I_{Q_2}^-(u_i))|^2} + \sqrt{1 + |(1 - I_{Q_1}^-(u_i))|^2} , \\ \sqrt{1 + |(1 - F_{Q_1}^-(u_i))|^2} + \sqrt{1 + |(1 - F_{Q_2}^-(u_i))|^2} &= \sqrt{1 + |(1 - F_{Q_2}^-(u_i))|^2} + \sqrt{1 + |(1 - F_{Q_1}^-(u_i))|^2} , \quad \forall u_i \in U. \end{aligned}$$

Similarly, $|T_{Q_1}^+(u_i) - T_{Q_2}^+(u_i)| = |T_{Q_2}^+(u_i) - T_{Q_1}^+(u_i)|$, $|I_{Q_1}^+(u_i) - I_{Q_2}^+(u_i)| = |I_{Q_2}^+(u_i) - I_{Q_1}^+(u_i)|$, $|F_{Q_1}^+(u_i) - F_{Q_2}^+(u_i)| = |F_{Q_2}^+(u_i) - F_{Q_1}^+(u_i)|$, $|1 - T_{Q_1}^+(u_i)| - (1 - T_{Q_2}^+(u_i))| = |(1 - T_{Q_2}^+(u_i)) - (1 - T_{Q_1}^+(u_i))|$, $|1 - I_{Q_1}^+(u_i)| - (1 - I_{Q_2}^+(u_i))| = |(1 - I_{Q_2}^+(u_i)) - (1 - I_{Q_1}^+(u_i))|$, $|1 - F_{Q_1}^+(u_i)| - (1 - F_{Q_2}^+(u_i))| = |(1 - F_{Q_2}^+(u_i)) - (1 - F_{Q_1}^+(u_i))|$, then

$$\begin{aligned} \sqrt{1 + |T_{Q_1}^+(u_i)|^2} + \sqrt{1 + |T_{Q_2}^+(u_i)|^2} &= \sqrt{1 + |T_{Q_2}^+(u_i)|^2} + \sqrt{1 + |T_{Q_1}^+(u_i)|^2} , \\ \sqrt{1 + |I_{Q_1}^+(u_i)|^2} + \sqrt{1 + |I_{Q_2}^+(u_i)|^2} &= \sqrt{1 + |I_{Q_2}^+(u_i)|^2} + \sqrt{1 + |I_{Q_1}^+(u_i)|^2} , \\ \sqrt{1 + |F_{Q_1}^+(u_i)|^2} + \sqrt{1 + |F_{Q_2}^+(u_i)|^2} &= \sqrt{1 + |F_{Q_2}^+(u_i)|^2} + \sqrt{1 + |F_{Q_1}^+(u_i)|^2} , \\ \sqrt{1 + |(1 - T_{Q_1}^+(u_i))|^2} + \sqrt{1 + |(1 - T_{Q_2}^+(u_i))|^2} &= \sqrt{1 + |(1 - T_{Q_2}^+(u_i))|^2} + \sqrt{1 + |(1 - T_{Q_1}^+(u_i))|^2} , \\ \sqrt{1 + |(1 - I_{Q_1}^+(u_i))|^2} + \sqrt{1 + |(1 - I_{Q_2}^+(u_i))|^2} &= \sqrt{1 + |(1 - I_{Q_2}^+(u_i))|^2} + \sqrt{1 + |(1 - I_{Q_1}^+(u_i))|^2} , \\ \sqrt{1 + |(1 - F_{Q_1}^+(u_i))|^2} + \sqrt{1 + |(1 - F_{Q_2}^+(u_i))|^2} &= \sqrt{1 + |(1 - F_{Q_2}^+(u_i))|^2} + \sqrt{1 + |(1 - F_{Q_1}^+(u_i))|^2} , \quad \forall u_i \in U. \end{aligned}$$

Thus, $CE_{NC}(Q_1, Q_2) = CE_{NC}(Q_2, Q_1)$. □

Definition 17. Weighted NC-cross-entropy measure

We consider the weight w_i ($i = 1, 2, 3, \dots, n$) of u_i ($i = 1, 2, 3, \dots, n$) with $w_i \in [0, 1]$ and $\sum_{i=1}^n w_i = 1$.

Then, a neutrosophic cubic weighted cross entropy measure between Q_1 and Q_2 can be defined as

$$\begin{aligned}
 CE_{NC}^w(Q_1, Q_2) = & \frac{1}{8} \left\langle \sum_{i=1}^n w_i \left\{ \left[\frac{2|T_{Q_1}^-(u_i) - T_{Q_2}^-(u_i)|}{\sqrt{1+|T_{Q_1}^-(u_i)|^2} + \sqrt{1+|T_{Q_2}^-(u_i)|^2}} + \frac{2|(1-T_{Q_1}^-(u_i)) - (1-T_{Q_2}^-(u_i))|}{\sqrt{1+|(1-T_{Q_1}^-(u_i))|^2} + \sqrt{1+|(1-T_{Q_2}^-(u_i))|^2}} \right] + \right. \\
 & \left[\frac{2|T_{Q_1}^+(u_i) - T_{Q_2}^+(u_i)|}{\sqrt{1+|T_{Q_1}^+(u_i)|^2} + \sqrt{1+|T_{Q_2}^+(u_i)|^2}} + \frac{2|(1-T_{Q_1}^+(u_i)) - (1-T_{Q_2}^+(u_i))|}{\sqrt{1+|(1-T_{Q_1}^+(u_i))|^2} + \sqrt{1+|(1-T_{Q_2}^+(u_i))|^2}} \right] + \\
 & \left[\frac{2|I_{Q_1}^-(u_i) - I_{Q_2}^-(u_i)|}{\sqrt{1+|I_{Q_1}^-(u_i)|^2} + \sqrt{1+|I_{Q_2}^-(u_i)|^2}} + \frac{2|(1-I_{Q_1}^-(u_i)) - (1-I_{Q_2}^-(u_i))|}{\sqrt{1+|(1-I_{Q_1}^-(u_i))|^2} + \sqrt{1+|(1-I_{Q_2}^-(u_i))|^2}} \right] + \\
 & \left[\frac{2|I_{Q_1}^+(u_i) - I_{Q_2}^+(u_i)|}{\sqrt{1+|I_{Q_1}^+(u_i)|^2} + \sqrt{1+|I_{Q_2}^+(u_i)|^2}} + \frac{2|(1-I_{Q_1}^+(u_i)) - (1-I_{Q_2}^+(u_i))|}{\sqrt{1+|(1-I_{Q_1}^+(u_i))|^2} + \sqrt{1+|(1-I_{Q_2}^+(u_i))|^2}} \right] + \\
 & \left[\frac{2|F_{Q_1}^-(u_i) - F_{Q_2}^-(u_i)|}{\sqrt{1+|F_{Q_1}^-(u_i)|^2} + \sqrt{1+|F_{Q_2}^-(u_i)|^2}} + \frac{2|(1-F_{Q_1}^-(u_i)) - (1-F_{Q_2}^-(u_i))|}{\sqrt{1+|(1-F_{Q_1}^-(u_i))|^2} + \sqrt{1+|(1-F_{Q_2}^-(u_i))|^2}} \right] + \\
 & \left[\frac{2|F_{Q_1}^+(u_i) - F_{Q_2}^+(u_i)|}{\sqrt{1+|F_{Q_1}^+(u_i)|^2} + \sqrt{1+|F_{Q_2}^+(u_i)|^2}} + \frac{2|(1-F_{Q_1}^+(u_i)) - (1-F_{Q_2}^+(u_i))|}{\sqrt{1+|(1-F_{Q_1}^+(u_i))|^2} + \sqrt{1+|(1-F_{Q_2}^+(u_i))|^2}} \right] + \\
 & \left[\frac{2|T_{Q_1}(u_i) - T_{Q_2}(u_i)|}{\sqrt{1+|T_{Q_1}(u_i)|^2} + \sqrt{1+|T_{Q_2}(u_i)|^2}} + \frac{2|(1-T_{Q_1}(u_i)) - (1-T_{Q_2}(u_i))|}{\sqrt{1+|(1-T_{Q_1}(u_i))|^2} + \sqrt{1+|(1-T_{Q_2}(u_i))|^2}} \right] + \\
 & \left[\frac{2|I_{Q_1}(u_i) - I_{Q_2}(u_i)|}{\sqrt{1+|I_{Q_1}(u_i)|^2} + \sqrt{1+|I_{Q_2}(u_i)|^2}} + \frac{2|(1-I_{Q_1}(u_i)) - (1-I_{Q_2}(u_i))|}{\sqrt{1+|(1-I_{Q_1}(u_i))|^2} + \sqrt{1+|(1-I_{Q_2}(u_i))|^2}} \right] + \\
 & \left. \left. \left[\frac{2|F_{Q_1}(u_i) - F_{Q_2}(u_i)|}{\sqrt{1+|F_{Q_1}(u_i)|^2} + \sqrt{1+|F_{Q_2}(u_i)|^2}} + \frac{2|(1-F_{Q_1}(u_i)) - (1-F_{Q_2}(u_i))|}{\sqrt{1+|(1-F_{Q_1}(u_i))|^2} + \sqrt{1+|(1-F_{Q_2}(u_i))|^2}} \right] \right\} \right\rangle. \tag{38}
 \end{aligned}$$

Theorem 2. Let Q_1, Q_2 be any two NCSs in U . Then, weighted NC-cross entropy measure $CE_{NC}^w(Q_1, Q_2)$ satisfies the following properties:

- (i) $CE_{NC}^w(Q_1, Q_2) \geq 0$.
- (ii) $CE_{NC}^w(Q_1, Q_2) = 0$ iff $T_{Q_1}^-(u_i) = T_{Q_2}^-(u_i), T_{Q_1}^+(u_i) = T_{Q_2}^+(u_i), I_{Q_1}^-(u_i) = I_{Q_2}^-(u_i), I_{Q_1}^+(u_i) = I_{Q_2}^+(u_i), F_{Q_1}^-(u_i) = F_{Q_2}^-(u_i), F_{Q_1}^+(u_i) = F_{Q_2}^+(u_i)$ and $T_{Q_1}(u_i) = T_{Q_2}(u_i), I_{Q_1}(u_i) = I_{Q_2}(u_i), F_{Q_1}(u_i) = F_{Q_2}(u_i) \forall u_i \in U$.
- (iii) $CE_{NC}^w(Q_1, Q_2) = CE_{NC}^w(Q_1^c, Q_2^c)$.
- (iv) $CE_{NC}^w(Q_1, Q_2) = CE_{NC}^w(Q_2, Q_1)$.

Proof of Theorem 2.

(i).

For all values of $u_i \in U$, $|T_{Q_1}(u_i)| \geq 0$, $|T_{Q_2}(u_i)| \geq 0$, $|T_{Q_1}(u_i) - T_{Q_2}(u_i)| \geq 0$, $\sqrt{1 + |T_{Q_1}(u_i)|^2} \geq 0$, $\sqrt{1 + |T_{Q_2}(u_i)|^2} \geq 0$, $|1 - T_{Q_1}(u_i)| \geq 0$, $|1 - T_{Q_2}(u_i)| \geq 0$, $|(1 - T_{Q_1}(u_i)) - (1 - T_{Q_2}(u_i))| \geq 0$, $\sqrt{1 + |(1 - T_{Q_1}(u_i))|^2} \geq 0$, $\sqrt{1 + |(1 - T_{Q_2}(u_i))|^2} \geq 0$.

Then,

$$\left[\frac{2|T_{Q_1}(u_i) - T_{Q_2}(u_i)|}{\sqrt{1 + |T_{Q_1}(u_i)|^2} + \sqrt{1 + |T_{Q_2}(u_i)|^2}} + \frac{2|(1 - T_{Q_1}(u_i)) - (1 - T_{Q_2}(u_i))|}{\sqrt{1 + |(1 - T_{Q_1}(u_i))|^2} + \sqrt{1 + |(1 - T_{Q_2}(u_i))|^2}} \right] \geq 0 \tag{39}$$

Similarly,

$$\left[\frac{2|I_{Q_1}(u_i) - I_{Q_2}(u_i)|}{\sqrt{1 + |I_{Q_1}(u_i)|^2} + \sqrt{1 + |I_{Q_2}(u_i)|^2}} + \frac{2|(1 - I_{Q_1}(u_i)) - (1 - I_{Q_2}(u_i))|}{\sqrt{1 + |(1 - I_{Q_1}(u_i))|^2} + \sqrt{1 + |(1 - I_{Q_2}(u_i))|^2}} \right] \geq 0 \tag{40}$$

and

$$\left[\frac{2|F_{Q_1}(u_i) - F_{Q_2}(u_i)|}{\sqrt{1 + |F_{Q_1}(u_i)|^2} + \sqrt{1 + |F_{Q_2}(u_i)|^2}} + \frac{2|(1 - F_{Q_1}(u_i)) - (1 - F_{Q_2}(u_i))|}{\sqrt{1 + |(1 - F_{Q_1}(u_i))|^2} + \sqrt{1 + |(1 - F_{Q_2}(u_i))|^2}} \right] \geq 0 \tag{41}$$

Again,

for all values of $u_i \in U$, $|T_{Q_1}^-(u_i)| \geq 0$, $|T_{Q_2}^-(u_i)| \geq 0$, $|T_{Q_1}^-(u_i) - T_{Q_2}^-(u_i)| \geq 0$, $\sqrt{1 + |T_{Q_1}^-(u_i)|^2} \geq 0$, $\sqrt{1 + |T_{Q_2}^-(u_i)|^2} \geq 0$, $|1 - T_{Q_1}^-(u_i)| \geq 0$, $|1 - T_{Q_2}^-(u_i)| \geq 0$, $|(1 - T_{Q_1}^-(u_i)) - (1 - T_{Q_2}^-(u_i))| \geq 0$, $\sqrt{1 + |(1 - T_{Q_1}^-(u_i))|^2} \geq 0$, $\sqrt{1 + |(1 - T_{Q_2}^-(u_i))|^2} \geq 0$

$$\Rightarrow \left[\frac{2|T_{Q_1}^-(u_i) - T_{Q_2}^-(u_i)|}{\sqrt{1 + |T_{Q_1}^-(u_i)|^2} + \sqrt{1 + |T_{Q_2}^-(u_i)|^2}} + \frac{2|(1 - T_{Q_1}^-(u_i)) - (1 - T_{Q_2}^-(u_i))|}{\sqrt{1 + |(1 - T_{Q_1}^-(u_i))|^2} + \sqrt{1 + |(1 - T_{Q_2}^-(u_i))|^2}} \right] \geq 0$$

and

$|T_{Q_1}^+(u_i)| \geq 0$, $|T_{Q_2}^+(u_i)| \geq 0$, $|T_{Q_1}^+(u_i) - T_{Q_2}^+(u_i)| \geq 0$, $\sqrt{1 + |T_{Q_1}^+(u_i)|^2} \geq 0$, $\sqrt{1 + |T_{Q_2}^+(u_i)|^2} \geq 0$, $|1 - T_{Q_1}^+(u_i)| \geq 0$, $|1 - T_{Q_2}^+(u_i)| \geq 0$, $|(1 - T_{Q_1}^+(u_i)) - (1 - T_{Q_2}^+(u_i))| \geq 0$, $\sqrt{1 + |(1 - T_{Q_1}^+(u_i))|^2} \geq 0$, $\sqrt{1 + |(1 - T_{Q_2}^+(u_i))|^2} \geq 0$

$$\Rightarrow \left[\frac{2|T_{Q_1}^+(u_i) - T_{Q_2}^+(u_i)|}{\sqrt{1 + |T_{Q_1}^+(u_i)|^2} + \sqrt{1 + |T_{Q_2}^+(u_i)|^2}} + \frac{2|(1 - T_{Q_1}^+(u_i)) - (1 - T_{Q_2}^+(u_i))|}{\sqrt{1 + |(1 - T_{Q_1}^+(u_i))|^2} + \sqrt{1 + |(1 - T_{Q_2}^+(u_i))|^2}} \right] \geq 0$$

Similarly, we can show that

$$\left[\frac{2|I_{Q_1}^-(u_i) - I_{Q_2}^-(u_i)|}{\sqrt{1 + |I_{Q_1}^-(u_i)|^2} + \sqrt{1 + |I_{Q_2}^-(u_i)|^2}} + \frac{2|(1 - I_{Q_1}^-(u_i)) - (1 - I_{Q_2}^-(u_i))|}{\sqrt{1 + |(1 - I_{Q_1}^-(u_i))|^2} + \sqrt{1 + |(1 - I_{Q_2}^-(u_i))|^2}} \right] \geq 0 \tag{44}$$

$$\left[\frac{2|I_{Q_1}^+(u_i) - I_{Q_2}^+(u_i)|}{\sqrt{1+|I_{Q_1}^+(u_i)|^2} + \sqrt{1+|I_{Q_2}^+(u_i)|^2}} + \frac{2|(1-I_{Q_1}^+(u_i)) - (1-I_{Q_2}^+(u_i))|}{\sqrt{1+|(1-I_{Q_1}^+(u_i))|^2} + \sqrt{1+|(1-I_{Q_2}^+(u_i))|^2}} \right] \geq 0 \tag{45}$$

$$\left[\frac{2|F_{Q_1}^-(u_i) - F_{Q_2}^-(u_i)|}{\sqrt{1+|F_{Q_1}^-(u_i)|^2} + \sqrt{1+|F_{Q_2}^-(u_i)|^2}} + \frac{2|(1-F_{Q_1}^-(u_i)) - (1-F_{Q_2}^-(u_i))|}{\sqrt{1+|(1-F_{Q_1}^-(u_i))|^2} + \sqrt{1+|(1-F_{Q_2}^-(u_i))|^2}} \right] \geq 0 \tag{46}$$

and

$$\left[\frac{2|F_{Q_1}^+(u_i) - F_{Q_2}^+(u_i)|}{\sqrt{1+|F_{Q_1}^+(u_i)|^2} + \sqrt{1+|F_{Q_2}^+(u_i)|^2}} + \frac{2|(1-F_{Q_1}^+(u_i)) - (1-F_{Q_2}^+(u_i))|}{\sqrt{1+|(1-F_{Q_1}^+(u_i))|^2} + \sqrt{1+|(1-F_{Q_2}^+(u_i))|^2}} \right] \geq 0 \tag{47}$$

Adding Equation (39) to Equation (47), and using $w_i \in [0,1], \sum_{i=1}^n w_i = 1$, we have $CE_{NC}^w(Q_1, Q_2) \geq 0$. Hence, this completes the proof.

(ii).

$$\left[\frac{2|T_{Q_1}(u_i) - T_{Q_2}(u_i)|}{\sqrt{1+|T_{Q_1}(u_i)|^2} + \sqrt{1+|T_{Q_2}(u_i)|^2}} + \frac{2|(1-T_{Q_1}(u_i)) - (1-T_{Q_2}(u_i))|}{\sqrt{1+|(1-T_{Q_1}(u_i))|^2} + \sqrt{1+|(1-T_{Q_2}(u_i))|^2}} \right] = 0, \tag{48}$$

$$(2|T_{Q_1}(u_i) - T_{Q_2}(u_i)|) \left[\frac{1}{\sqrt{1+|T_{Q_1}(u_i)|^2} + \sqrt{1+|T_{Q_2}(u_i)|^2}} + \frac{1}{\sqrt{1+|(1-T_{Q_1}(u_i))|^2} + \sqrt{1+|(1-T_{Q_2}(u_i))|^2}} \right] = 0,$$

$$\Leftrightarrow T_{Q_1}(u_i) = T_{Q_2}(u_i)$$

$$\left[\frac{2|I_{Q_1}(u_i) - I_{Q_2}(u_i)|}{\sqrt{1+|I_{Q_1}(u_i)|^2} + \sqrt{1+|I_{Q_2}(u_i)|^2}} + \frac{2|(1-I_{Q_1}(u_i)) - (1-I_{Q_2}(u_i))|}{\sqrt{1+|(1-I_{Q_1}(u_i))|^2} + \sqrt{1+|(1-I_{Q_2}(u_i))|^2}} \right] = 0, \tag{49}$$

$$\Leftrightarrow I_{Q_1}(u_i) = I_{Q_2}(u_i)$$

$$\left[\frac{2|F_{Q_1}(u_i) - F_{Q_2}(u_i)|}{\sqrt{1+|F_{Q_1}(u_i)|^2} + \sqrt{1+|F_{Q_2}(u_i)|^2}} + \frac{2|(1-F_{Q_1}(u_i)) - (1-F_{Q_2}(u_i))|}{\sqrt{1+|(1-F_{Q_1}(u_i))|^2} + \sqrt{1+|(1-F_{Q_2}(u_i))|^2}} \right] = 0, \tag{50}$$

$$\Leftrightarrow F_{Q_1}(u_i) = F_{Q_2}(u_i), \text{ For all values of } u_i \in U.$$

Again,

$$\left[\frac{2|T_{Q_1}^-(u_i) - T_{Q_2}^-(u_i)|}{\sqrt{1+|T_{Q_1}^-(u_i)|^2} + \sqrt{1+|T_{Q_2}^-(u_i)|^2}} + \frac{2|(1-T_{Q_1}^-(u_i)) - (1-T_{Q_2}^-(u_i))|}{\sqrt{1+|(1-T_{Q_1}^-(u_i))|^2} + \sqrt{1+|(1-T_{Q_2}^-(u_i))|^2}} \right] = 0, \tag{51}$$

$$\Leftrightarrow T_{Q_1}^-(u_i) = T_{Q_2}^-(u_i)$$

$$\left[\frac{2|T_{Q_1}^+(u_i) - T_{Q_2}^+(u_i)|}{\sqrt{1+|T_{Q_1}^+(u_i)|^2} + \sqrt{1+|T_{Q_2}^+(u_i)|^2}} + \frac{2|(1-T_{Q_1}^+(u_i)) - (1-T_{Q_2}^+(u_i))|}{\sqrt{1+|(1-T_{Q_1}^+(u_i))|^2} + \sqrt{1+|(1-T_{Q_2}^+(u_i))|^2}} \right] = 0, \tag{52}$$

$$\Leftrightarrow T_{Q_1}^+(u_i) = T_{Q_2}^+(u_i)$$

$$\left[\frac{2|\bar{I}_{Q_1}(u_i) - \bar{I}_{Q_2}(u_i)|}{\sqrt{1+|\bar{I}_{Q_1}(u_i)|^2} + \sqrt{1+|\bar{I}_{Q_2}(u_i)|^2}} + \frac{2|(1-\bar{I}_{Q_1}(u_i)) - (1-\bar{I}_{Q_2}(u_i))|}{\sqrt{1+(1-\bar{I}_{Q_1}(u_i))|^2} + \sqrt{1+(1-\bar{I}_{Q_2}(u_i))|^2}} \right] = 0, \tag{53}$$

$$\Leftrightarrow \bar{I}_{Q_1}(u_i) = \bar{I}_{Q_2}(u_i)$$

$$\left[\frac{2|I_{Q_1}^+(u_i) - I_{Q_2}^+(u_i)|}{\sqrt{1+|I_{Q_1}^+(u_i)|^2} + \sqrt{1+|I_{Q_2}^+(u_i)|^2}} + \frac{2|(1-I_{Q_1}^+(u_i)) - (1-I_{Q_2}^+(u_i))|}{\sqrt{1+(1-I_{Q_1}^+(u_i))|^2} + \sqrt{1+(1-I_{Q_2}^+(u_i))|^2}} \right] = 0, \tag{54}$$

$$\Leftrightarrow I_{Q_1}^+(u_i) = I_{Q_2}^+(u_i)$$

$$\left[\frac{2|F_{Q_1}^-(u_i) - F_{Q_2}^-(u_i)|}{\sqrt{1+|F_{Q_1}^-(u_i)|^2} + \sqrt{1+|F_{Q_2}^-(u_i)|^2}} + \frac{2|(1-F_{Q_1}^-(u_i)) - (1-F_{Q_2}^-(u_i))|}{\sqrt{1+(1-F_{Q_1}^-(u_i))|^2} + \sqrt{1+(1-F_{Q_2}^-(u_i))|^2}} \right] = 0, \tag{55}$$

$$\Leftrightarrow F_{Q_1}^-(u_i) = F_{Q_2}^-(u_i)$$

$$\left[\frac{2|F_{Q_1}^+(u_i) - F_{Q_2}^+(u_i)|}{\sqrt{1+|F_{Q_1}^+(u_i)|^2} + \sqrt{1+|F_{Q_2}^+(u_i)|^2}} + \frac{2|(1-F_{Q_1}^+(u_i)) - (1-F_{Q_2}^+(u_i))|}{\sqrt{1+(1-F_{Q_1}^+(u_i))|^2} + \sqrt{1+(1-F_{Q_2}^+(u_i))|^2}} \right] = 0, \tag{56}$$

$$\Leftrightarrow F_{Q_1}^+(u_i) = F_{Q_2}^+(u_i), \text{ for all values of } u_i \in U.$$

Using Equation (48) to Equation (56) and $w_i \in [0,1], \sum_{i=1}^n w_i = 1, w_i \geq 0$, we have $CE_{NC}^w(Q_1, Q_2) = 0$ iff

$T_{Q_1}^-(u_i) = T_{Q_2}^-(u_i), T_{Q_1}^+(u_i) = T_{Q_2}^+(u_i), \bar{I}_{Q_1}(u_i) = \bar{I}_{Q_2}(u_i), I_{Q_1}^+(u_i) = I_{Q_2}^+(u_i), F_{Q_1}^-(u_i) = F_{Q_2}^-(u_i), F_{Q_1}^+(u_i) = F_{Q_2}^+(u_i)$
and $T_{Q_1}(u_i) = T_{Q_2}(u_i), I_{Q_1}(u_i) = I_{Q_2}(u_i), F_{Q_1}(u_i) = F_{Q_2}(u_i)$ for all $u_i \in U$.

(iii).

Using Definition (20), Definition (4), and Definition (10), we obtain the following expression:

$$CE_{NC}^w(Q_1^c, Q_2^c) = \frac{1}{8} \left\langle \sum_{i=1}^n w_i \left[\frac{2|T_{Q_1^c}^-(u_i) - T_{Q_2^c}^-(u_i)|}{\sqrt{1+|T_{Q_1^c}^-(u_i)|^2} + \sqrt{1+|T_{Q_2^c}^-(u_i)|^2}} + \frac{2|(1-T_{Q_1^c}^-(u_i)) - (1-T_{Q_2^c}^-(u_i))|}{\sqrt{1+(1-T_{Q_1^c}^-(u_i))|^2} + \sqrt{1+(1-T_{Q_2^c}^-(u_i))|^2}} \right] + \right.$$

$$\left[\frac{2|T_{Q_1^c}^+(u_i) - T_{Q_2^c}^+(u_i)|}{\sqrt{1+|T_{Q_1^c}^+(u_i)|^2} + \sqrt{1+|T_{Q_2^c}^+(u_i)|^2}} + \frac{2|(1-T_{Q_1^c}^+(u_i)) - (1-T_{Q_2^c}^+(u_i))|}{\sqrt{1+(1-T_{Q_1^c}^+(u_i))|^2} + \sqrt{1+(1-T_{Q_2^c}^+(u_i))|^2}} \right] +$$

$$\left[\frac{2|I_{Q_1^c}^-(u_i) - I_{Q_2^c}^-(u_i)|}{\sqrt{1+|I_{Q_1^c}^-(u_i)|^2} + \sqrt{1+|I_{Q_2^c}^-(u_i)|^2}} + \frac{2|(1-I_{Q_1^c}^-(u_i)) - (1-I_{Q_2^c}^-(u_i))|}{\sqrt{1+(1-I_{Q_1^c}^-(u_i))|^2} + \sqrt{1+(1-I_{Q_2^c}^-(u_i))|^2}} \right] +$$

$$\left[\frac{2|I_{Q_1^c}^+(u_i) - I_{Q_2^c}^+(u_i)|}{\sqrt{1+|I_{Q_1^c}^+(u_i)|^2} + \sqrt{1+|I_{Q_2^c}^+(u_i)|^2}} + \frac{2|(1-I_{Q_1^c}^+(u_i)) - (1-I_{Q_2^c}^+(u_i))|}{\sqrt{1+(1-I_{Q_1^c}^+(u_i))|^2} + \sqrt{1+(1-I_{Q_2^c}^+(u_i))|^2}} \right] \Bigg\rangle$$

$$\begin{aligned}
 & \left[\frac{2|F_{Q_1^c}^-(u_i) - F_{Q_2^c}^-(u_i)|}{\sqrt{1+|F_{Q_1^c}^-(u_i)|^2} + \sqrt{1+|F_{Q_2^c}^-(u_i)|^2}} + \frac{2|(1-F_{Q_1^c}^-(u_i)) - (1-F_{Q_2^c}^-(u_i))|}{\sqrt{1+(1-F_{Q_1^c}^-(u_i))^2} + \sqrt{1+(1-F_{Q_2^c}^-(u_i))^2}} \right] + \\
 & \left[\frac{2|F_{Q_1^c}^+(u_i) - F_{Q_2^c}^+(u_i)|}{\sqrt{1+|F_{Q_1^c}^+(u_i)|^2} + \sqrt{1+|F_{Q_2^c}^+(u_i)|^2}} + \frac{2|(1-F_{Q_1^c}^+(u_i)) - (1-F_{Q_2^c}^+(u_i))|}{\sqrt{1+(1-F_{Q_1^c}^+(u_i))^2} + \sqrt{1+(1-F_{Q_2^c}^+(u_i))^2}} \right] + \\
 & \left[\frac{2|T_{Q_1^c}(u_i) - T_{Q_2^c}(u_i)|}{\sqrt{1+|T_{Q_1^c}(u_i)|^2} + \sqrt{1+|T_{Q_2^c}(u_i)|^2}} + \frac{2|(1-T_{Q_1^c}(u_i)) - (1-T_{Q_2^c}(u_i))|}{\sqrt{1+(1-T_{Q_1^c}(u_i))^2} + \sqrt{1+(1-T_{Q_2^c}(u_i))^2}} \right] + \\
 & \left[\frac{2|I_{Q_1^c}(u_i) - I_{Q_2^c}(u_i)|}{\sqrt{1+|I_{Q_1^c}(u_i)|^2} + \sqrt{1+|I_{Q_2^c}(u_i)|^2}} + \frac{2|(1-I_{Q_1^c}(u_i)) - (1-I_{Q_2^c}(u_i))|}{\sqrt{1+(1-I_{Q_1^c}(u_i))^2} + \sqrt{1+(1-I_{Q_2^c}(u_i))^2}} \right] + \\
 & \left. \left[\frac{2|F_{Q_1^c}(u_i) - F_{Q_2^c}(u_i)|}{\sqrt{1+|F_{Q_1^c}(u_i)|^2} + \sqrt{1+|F_{Q_2^c}(u_i)|^2}} + \frac{2|(1-F_{Q_1^c}(u_i)) - (1-F_{Q_2^c}(u_i))|}{\sqrt{1+(1-F_{Q_1^c}(u_i))^2} + \sqrt{1+(1-F_{Q_2^c}(u_i))^2}} \right] \right\} \\
 & = \frac{1}{8} \left\langle \sum_{i=1}^n w_i \left[\frac{2|(1-T_{Q_1}^-(u_i)) - (1-T_{Q_2}^-(u_i))|}{\sqrt{1+(1-T_{Q_1}^-(u_i))^2} + \sqrt{1+(1-T_{Q_2}^-(u_i))^2}} + \frac{2|T_{Q_1}^-(u_i) - T_{Q_2}^-(u_i)|}{\sqrt{1+|T_{Q_1}^-(u_i)|^2} + \sqrt{1+|T_{Q_2}^-(u_i)|^2}} \right] + \right. \\
 & \left[\frac{2|(1-T_{Q_1}^+(u_i)) - (1-T_{Q_2}^+(u_i))|}{\sqrt{1+(1-T_{Q_1}^+(u_i))^2} + \sqrt{1+(1-T_{Q_2}^+(u_i))^2}} + \frac{2|T_{Q_1}^+(u_i) - T_{Q_2}^+(u_i)|}{\sqrt{1+|T_{Q_1}^+(u_i)|^2} + \sqrt{1+|T_{Q_2}^+(u_i)|^2}} \right] + \\
 & \left[\frac{2\|(1-I_{Q_1}^-(u_i)) - (1-I_{Q_2}^-(u_i))\|}{\sqrt{1+(1-I_{Q_1}^-(u_i))^2} + \sqrt{1+(1-I_{Q_2}^-(u_i))^2}} + \frac{2|I_{Q_1}^-(u_i) - I_{Q_2}^-(u_i)|}{\sqrt{1+|I_{Q_1}^-(u_i)|^2} + \sqrt{1+|I_{Q_2}^-(u_i)|^2}} \right] + \\
 & \left[\frac{2\|(1-I_{Q_1}^+(u_i)) - (1-I_{Q_2}^+(u_i))\|}{\sqrt{1+(1-I_{Q_1}^+(u_i))^2} + \sqrt{1+(1-I_{Q_2}^+(u_i))^2}} + \frac{2|I_{Q_1}^+(u_i) - I_{Q_2}^+(u_i)|}{\sqrt{1+|I_{Q_1}^+(u_i)|^2} + \sqrt{1+|I_{Q_2}^+(u_i)|^2}} \right] + \\
 & \left[\frac{2|(1-F_{Q_1}^-(u_i)) - (1-F_{Q_2}^-(u_i))|}{\sqrt{1+(1-F_{Q_1}^-(u_i))^2} + \sqrt{1+(1-F_{Q_2}^-(u_i))^2}} + \frac{2|F_{Q_1}^-(u_i) - F_{Q_2}^-(u_i)|}{\sqrt{1+|F_{Q_1}^-(u_i)|^2} + \sqrt{1+|F_{Q_2}^-(u_i)|^2}} \right] + \\
 & \left[\frac{2|(1-F_{Q_1}^+(u_i)) - (1-F_{Q_2}^+(u_i))|}{\sqrt{1+(1-F_{Q_1}^+(u_i))^2} + \sqrt{1+(1-F_{Q_2}^+(u_i))^2}} + \frac{2|F_{Q_1}^+(u_i) - F_{Q_2}^+(u_i)|}{\sqrt{1+|F_{Q_1}^+(u_i)|^2} + \sqrt{1+|F_{Q_2}^+(u_i)|^2}} \right] + \\
 & \left. \left[\frac{2|(1-T_{Q_1}(u_i)) - (1-T_{Q_2}(u_i))|}{\sqrt{1+(1-T_{Q_1}(u_i))^2} + \sqrt{1+(1-T_{Q_2}(u_i))^2}} + \frac{2|T_{Q_1}(u_i) - T_{Q_2}(u_i)|}{\sqrt{1+|T_{Q_1}(u_i)|^2} + \sqrt{1+|T_{Q_2}(u_i)|^2}} \right] + \right.
 \end{aligned}$$

$$\begin{aligned}
 & \left[\frac{2|(1-I_{Q_1}(u_i))-(1-I_{Q_2}(u_i))|}{\sqrt{1+|(1-I_{Q_1}(u_i))|^2} + \sqrt{1+|(1-I_{Q_2}(u_i))|^2}} + \frac{2|I_{Q_1}(u_i)-I_{Q_2}(u_i)|}{\sqrt{1+|I_{Q_1}(u_i)|^2} + \sqrt{1+|I_{Q_2}(u_i)|^2}} \right] + \\
 & \left. \left[\frac{2|(1-F_{Q_1}(u_i))-(1-F_{Q_2}(u_i))|}{\sqrt{1+|(1-F_{Q_1}(u_i))|^2} + \sqrt{1+|(1-F_{Q_2}(u_i))|^2}} + \frac{2|F_{Q_1}(u_i)-F_{Q_2}(u_i)|}{\sqrt{1+|F_{Q_1}(u_i)|^2} + \sqrt{1+|F_{Q_2}(u_i)|^2}} \right] \right\} \\
 = & \frac{1}{8} \left\langle \sum_{i=1}^n w_i \left[\frac{2|T_{Q_1}^-(u_i)-T_{Q_2}^-(u_i)|}{\sqrt{1+|T_{Q_1}^-(u_i)|^2} + \sqrt{1+|T_{Q_2}^-(u_i)|^2}} + \frac{2|(1-T_{Q_1}^-(u_i))-(1-T_{Q_2}^-(u_i))|}{\sqrt{1+|(1-T_{Q_1}^-(u_i))|^2} + \sqrt{1+|(1-T_{Q_2}^-(u_i))|^2}} \right] + \right. \\
 & \left. \left[\frac{2|T_{Q_1}^+(u_i)-T_{Q_2}^+(u_i)|}{\sqrt{1+|T_{Q_1}^+(u_i)|^2} + \sqrt{1+|T_{Q_2}^+(u_i)|^2}} + \frac{2|(1-T_{Q_1}^+(u_i))-(1-T_{Q_2}^+(u_i))|}{\sqrt{1+|(1-T_{Q_1}^+(u_i))|^2} + \sqrt{1+|(1-T_{Q_2}^+(u_i))|^2}} \right] + \right. \\
 & \left. \left[\frac{2|I_{Q_1}^-(u_i)-I_{Q_2}^-(u_i)|}{\sqrt{1+|I_{Q_1}^-(u_i)|^2} + \sqrt{1+|I_{Q_2}^-(u_i)|^2}} + \frac{2|(1-I_{Q_1}^-(u_i))-(1-I_{Q_2}^-(u_i))|}{\sqrt{1+|(1-I_{Q_1}^-(u_i))|^2} + \sqrt{1+|(1-I_{Q_2}^-(u_i))|^2}} \right] + \right. \\
 & \left. \left[\frac{2|I_{Q_1}^+(u_i)-I_{Q_2}^+(u_i)|}{\sqrt{1+|I_{Q_1}^+(u_i)|^2} + \sqrt{1+|I_{Q_2}^+(u_i)|^2}} + \frac{2|(1-I_{Q_1}^+(u_i))-(1-I_{Q_2}^+(u_i))|}{\sqrt{1+|(1-I_{Q_1}^+(u_i))|^2} + \sqrt{1+|(1-I_{Q_2}^+(u_i))|^2}} \right] + \right. \\
 & \left. \left[\frac{2|F_{Q_1}^-(u_i)-F_{Q_2}^-(u_i)|}{\sqrt{1+|F_{Q_1}^-(u_i)|^2} + \sqrt{1+|F_{Q_2}^-(u_i)|^2}} + \frac{2|(1-F_{Q_1}^-(u_i))-(1-F_{Q_2}^-(u_i))|}{\sqrt{1+|(1-F_{Q_1}^-(u_i))|^2} + \sqrt{1+|(1-F_{Q_2}^-(u_i))|^2}} \right] + \right. \\
 & \left. \left[\frac{2|F_{Q_1}^+(u_i)-F_{Q_2}^+(u_i)|}{\sqrt{1+|F_{Q_1}^+(u_i)|^2} + \sqrt{1+|F_{Q_2}^+(u_i)|^2}} + \frac{2|(1-F_{Q_1}^+(u_i))-(1-F_{Q_2}^+(u_i))|}{\sqrt{1+|(1-F_{Q_1}^+(u_i))|^2} + \sqrt{1+|(1-F_{Q_2}^+(u_i))|^2}} \right] + \right. \\
 & \left. \left[\frac{2|T_{Q_1}(u_i)-T_{Q_2}(u_i)|}{\sqrt{1+|T_{Q_1}(u_i)|^2} + \sqrt{1+|T_{Q_2}(u_i)|^2}} + \frac{2|(1-T_{Q_1}(u_i))-(1-T_{Q_2}(u_i))|}{\sqrt{1+|(1-T_{Q_1}(u_i))|^2} + \sqrt{1+|(1-T_{Q_2}(u_i))|^2}} \right] + \right. \\
 & \left. \left[\frac{2|I_{Q_1}(u_i)-I_{Q_2}(u_i)|}{\sqrt{1+|I_{Q_1}(u_i)|^2} + \sqrt{1+|I_{Q_2}(u_i)|^2}} + \frac{2|(1-I_{Q_1}(u_i))-(1-I_{Q_2}(u_i))|}{\sqrt{1+|(1-I_{Q_1}(u_i))|^2} + \sqrt{1+|(1-I_{Q_2}(u_i))|^2}} \right] + \right. \\
 & \left. \left[\frac{2|F_{Q_1}(u_i)-F_{Q_2}(u_i)|}{\sqrt{1+|F_{Q_1}(u_i)|^2} + \sqrt{1+|F_{Q_2}(u_i)|^2}} + \frac{2|(1-F_{Q_1}(u_i))-(1-F_{Q_2}(u_i))|}{\sqrt{1+|(1-F_{Q_1}(u_i))|^2} + \sqrt{1+|(1-F_{Q_2}(u_i))|^2}} \right] \right\} = CE_{NC}^{w_c}(Q_1, Q_2), \forall u_i \in U.
 \end{aligned}$$

(iv).

Since $\forall u_i \in U$, for single valued parts, we obtain:

$$\begin{aligned}
 |T_{Q_1}(u_i)-T_{Q_2}(u_i)| &= |T_{Q_2}(u_i)-T_{Q_1}(u_i)|, & |I_{Q_1}(u_i)-I_{Q_2}(u_i)| &= |I_{Q_2}(u_i)-I_{Q_1}(u_i)|, & |F_{Q_1}(u_i)-F_{Q_2}(u_i)| &= |F_{Q_2}(u_i)-F_{Q_1}(u_i)|, \\
 |(1-T_{Q_1}(u_i))-(1-T_{Q_2}(u_i))| &= |(1-T_{Q_2}(u_i))-(1-T_{Q_1}(u_i))|, & |(1-I_{Q_1}(u_i))-(1-I_{Q_2}(u_i))| &= |(1-I_{Q_2}(u_i))-(1-I_{Q_1}(u_i))|, \\
 |(1-F_{Q_1}(u_i))-(1-F_{Q_2}(u_i))| &= |(1-F_{Q_2}(u_i))-(1-F_{Q_1}(u_i))|.
 \end{aligned}$$

Then, we obtain

$$\begin{aligned} \sqrt{1+|T_{Q_1}(u_i)|^2} + \sqrt{1+|T_{Q_2}(u_i)|^2} &= \sqrt{1+|T_{Q_2}(u_i)|^2} + \sqrt{1+|T_{Q_1}(u_i)|^2} , \\ \sqrt{1+|I_{Q_1}(u_i)|^2} + \sqrt{1+|I_{Q_2}(u_i)|^2} &= \sqrt{1+|I_{Q_2}(u_i)|^2} + \sqrt{1+|I_{Q_1}(u_i)|^2} , \\ \sqrt{1+|F_{Q_1}(u_i)|^2} + \sqrt{1+|F_{Q_2}(u_i)|^2} &= \sqrt{1+|F_{Q_2}(u_i)|^2} + \sqrt{1+|F_{Q_1}(u_i)|^2} , \\ \sqrt{1+|(1-T_{Q_1}(u_i))|^2} + \sqrt{1+|(1-T_{Q_2}(u_i))|^2} &= \sqrt{1+|(1-T_{Q_2}(u_i))|^2} + \sqrt{1+|(1-T_{Q_1}(u_i))|^2} , \\ \sqrt{1+|(1-I_{Q_1}(u_i))|^2} + \sqrt{1+|(1-I_{Q_2}(u_i))|^2} &= \sqrt{1+|(1-I_{Q_2}(u_i))|^2} + \sqrt{1+|(1-I_{Q_1}(u_i))|^2} , \\ \sqrt{1+|(1-F_{Q_1}(u_i))|^2} + \sqrt{1+|(1-F_{Q_2}(u_i))|^2} &= \sqrt{1+|(1-F_{Q_2}(u_i))|^2} + \sqrt{1+|(1-F_{Q_1}(u_i))|^2} , \quad \forall u_i \in U. \end{aligned}$$

For interval neutrosophic part, we have

$$\begin{aligned} |T_{Q_1}^-(u_i) - T_{Q_2}^-(u_i)| &= |T_{Q_2}^-(u_i) - T_{Q_1}^-(u_i)| , \quad |I_{Q_1}^-(u_i) - I_{Q_2}^-(u_i)| = |I_{Q_2}^-(u_i) - I_{Q_1}^-(u_i)| , \quad |F_{Q_1}^-(u_i) - F_{Q_2}^-(u_i)| = |F_{Q_2}^-(u_i) - F_{Q_1}^-(u_i)| , \\ |(1-T_{Q_1}^-(u_i)) - (1-T_{Q_2}^-(u_i))| &= |(1-T_{Q_2}^-(u_i)) - (1-T_{Q_1}^-(u_i))| , \quad |(1-I_{Q_1}^-(u_i)) - (1-I_{Q_2}^-(u_i))| = |(1-I_{Q_2}^-(u_i)) - (1-I_{Q_1}^-(u_i))| , \\ |(1-F_{Q_1}^-(u_i)) - (1-F_{Q_2}^-(u_i))| &= |(1-F_{Q_2}^-(u_i)) - (1-F_{Q_1}^-(u_i))| . \end{aligned}$$

Then, we obtain

$$\begin{aligned} \sqrt{1+|T_{Q_1}^-(u_i)|^2} + \sqrt{1+|T_{Q_2}^-(u_i)|^2} &= \sqrt{1+|T_{Q_2}^-(u_i)|^2} + \sqrt{1+|T_{Q_1}^-(u_i)|^2} , \\ \sqrt{1+|I_{Q_1}^-(u_i)|^2} + \sqrt{1+|I_{Q_2}^-(u_i)|^2} &= \sqrt{1+|I_{Q_2}^-(u_i)|^2} + \sqrt{1+|I_{Q_1}^-(u_i)|^2} , \\ \sqrt{1+|F_{Q_1}^-(u_i)|^2} + \sqrt{1+|F_{Q_2}^-(u_i)|^2} &= \sqrt{1+|F_{Q_2}^-(u_i)|^2} + \sqrt{1+|F_{Q_1}^-(u_i)|^2} , \\ \sqrt{1+|(1-T_{Q_1}^-(u_i))|^2} + \sqrt{1+|(1-T_{Q_2}^-(u_i))|^2} &= \sqrt{1+|(1-T_{Q_2}^-(u_i))|^2} + \sqrt{1+|(1-T_{Q_1}^-(u_i))|^2} , \\ \sqrt{1+|(1-I_{Q_1}^-(u_i))|^2} + \sqrt{1+|(1-I_{Q_2}^-(u_i))|^2} &= \sqrt{1+|(1-I_{Q_2}^-(u_i))|^2} + \sqrt{1+|(1-I_{Q_1}^-(u_i))|^2} , \\ \sqrt{1+|(1-F_{Q_1}^-(u_i))|^2} + \sqrt{1+|(1-F_{Q_2}^-(u_i))|^2} &= \sqrt{1+|(1-F_{Q_2}^-(u_i))|^2} + \sqrt{1+|(1-F_{Q_1}^-(u_i))|^2} , \quad \forall u_i \in U. \end{aligned}$$

Similarly, $|T_{Q_1}^+(u_i) - T_{Q_2}^+(u_i)| = |T_{Q_2}^+(u_i) - T_{Q_1}^+(u_i)|$, $|I_{Q_1}^+(u_i) - I_{Q_2}^+(u_i)| = |I_{Q_2}^+(u_i) - I_{Q_1}^+(u_i)|$, $|F_{Q_1}^+(u_i) - F_{Q_2}^+(u_i)| = |F_{Q_2}^+(u_i) - F_{Q_1}^+(u_i)|$, $|(1-T_{Q_1}^+(u_i)) - (1-T_{Q_2}^+(u_i))| = |(1-T_{Q_2}^+(u_i)) - (1-T_{Q_1}^+(u_i))|$, $|(1-I_{Q_1}^+(u_i)) - (1-I_{Q_2}^+(u_i))| = |(1-I_{Q_2}^+(u_i)) - (1-I_{Q_1}^+(u_i))|$, $|(1-F_{Q_1}^+(u_i)) - (1-F_{Q_2}^+(u_i))| = |(1-F_{Q_2}^+(u_i)) - (1-F_{Q_1}^+(u_i))|$, then

$$\begin{aligned} \sqrt{1+|T_{Q_1}^+(u_i)|^2} + \sqrt{1+|T_{Q_2}^+(u_i)|^2} &= \sqrt{1+|T_{Q_2}^+(u_i)|^2} + \sqrt{1+|T_{Q_1}^+(u_i)|^2} , \\ \sqrt{1+|I_{Q_1}^+(u_i)|^2} + \sqrt{1+|I_{Q_2}^+(u_i)|^2} &= \sqrt{1+|I_{Q_2}^+(u_i)|^2} + \sqrt{1+|I_{Q_1}^+(u_i)|^2} , \\ \sqrt{1+|F_{Q_1}^+(u_i)|^2} + \sqrt{1+|F_{Q_2}^+(u_i)|^2} &= \sqrt{1+|F_{Q_2}^+(u_i)|^2} + \sqrt{1+|F_{Q_1}^+(u_i)|^2} , \\ \sqrt{1+|(1-T_{Q_1}^+(u_i))|^2} + \sqrt{1+|(1-T_{Q_2}^+(u_i))|^2} &= \sqrt{1+|(1-T_{Q_2}^+(u_i))|^2} + \sqrt{1+|(1-T_{Q_1}^+(u_i))|^2} , \\ \sqrt{1+|(1-I_{Q_1}^+(u_i))|^2} + \sqrt{1+|(1-I_{Q_2}^+(u_i))|^2} &= \sqrt{1+|(1-I_{Q_2}^+(u_i))|^2} + \sqrt{1+|(1-I_{Q_1}^+(u_i))|^2} , \\ \sqrt{1+|(1-F_{Q_1}^+(u_i))|^2} + \sqrt{1+|(1-F_{Q_2}^+(u_i))|^2} &= \sqrt{1+|(1-F_{Q_2}^+(u_i))|^2} + \sqrt{1+|(1-F_{Q_1}^+(u_i))|^2} , \quad \forall u_i \in U. \end{aligned}$$

In addition, $w_i \in [0,1], \sum_{i=1}^n w_i = 1, w_i \geq 0$.

Thus, $CE_{NC}^w(Q_1, Q_2) = CE_{NC}^w(Q_2, Q_1)$.

hence completing the proof. \square

4. MADM Strategy Using Proposed NC-Cross Entropy Measure in the NCS Environment

In this section, we develop an MADM strategy using the proposed NC-cross entropy measure.

Description of the MADM problem:

Let $A = \{A_1, A_2, A_3, \dots, A_m\}$ and $G = \{G_1, G_2, G_3, \dots, G_n\}$ be the discrete set of alternatives and attribute, respectively. Let $W = \{w_1, w_2, w_3, \dots, w_n\}$ be the weight vector of attributes G_j ($j = 1, 2, 3, \dots, n$), where $w_j \geq 0$ and $\sum_{j=1}^n w_j = 1$.

Now, we describe the steps of MADM strategy using NC-cross entropy measure.

Step: 1. Formulate the decision matrices

For MADM with neutrosophic cubic information, the rating values of the alternatives A_i ($i=1,2,3,\dots,m$) on the basis of criterion G_j ($j=1,2,3,\dots,n$) by the decision-maker can be expressed in NCN as $a_{ij} = \langle [T_{ij}^-, T_{ij}^+], [I_{ij}^-, I_{ij}^+], [F_{ij}^-, F_{ij}^+], (T_{ij}, I_{ij}, F_{ij}) \rangle$ ($i = 1, 2, 3, \dots, m; j = 1, 2, 3, \dots, n$). We present these rating values of alternatives provided by the decision-maker in matrix form as follows:

$$M = \begin{pmatrix} & G_1 & G_2 & \dots & G_n \\ A_1 & a_{11} & a_{12} & \dots & a_{1n} \\ A_2 & a_{21} & a_{22} & & a_{2n} \\ \cdot & \cdot & \dots & \cdot & \cdot \\ A_m & a_{m1} & a_{m2} & \dots & a_{mn} \end{pmatrix} \tag{57}$$

Step: 2. Formulate priori/ideal decision matrix

In the MADM process, the priori decision matrix is used to select the best alternative from the set of feasible alternatives. In the decision-making situation, we use the following decision matrix as priori decision matrix.

$$P = \begin{pmatrix} & G_1 & G_2 & \dots & G_n \\ A_1 & a_{11}^* & a_{12}^* & \dots & a_{1n}^* \\ A_2 & a_{21}^* & a_{22}^* & & a_{2n}^* \\ \cdot & \cdot & \dots & \cdot & \cdot \\ A_m & a_{m1}^* & a_{m2}^* & \dots & a_{mn}^* \end{pmatrix} \tag{58}$$

where, $a_{ij}^* = \langle [1,1],[0,0],[0,0] \rangle$ for benefit type attributes and $a_{ij}^* = \langle [0,0],[1,1],[1,1] \rangle$ for cost type attributes, ($i = 1, 2, 3, \dots, m; j = 1, 2, 3, \dots, n$).

Step: 3. Formulate the weighted NC-cross entropy matrix

Using Equation (38), we calculate weighted NC-cross entropy values between decision matrix and priori matrix. The cross entropy value can be presented in matrix form as follows:

$${}^{NC}M_{CE}^w = \begin{pmatrix} CE_{NC}^w(A_1) \\ CE_{NC}^w(A_2) \\ \dots \\ CE_{NC}^w(A_m) \end{pmatrix} \tag{59}$$

Step: 4. Rank the priority

Smaller value of the cross entropy reflects that an alternative is closer to the ideal alternative. Therefore, the preference ranking order of all the alternatives can be determined according to the increasing order of the cross entropy values $CE_{NC}^w(A_i)$ ($i = 1, 2, 3, \dots, m$). The smallest cross entropy value reflects the best alternative and the greatest cross entropy value reflects the worst alternative.

A conceptual model of the proposed strategy is shown in Figure 1.

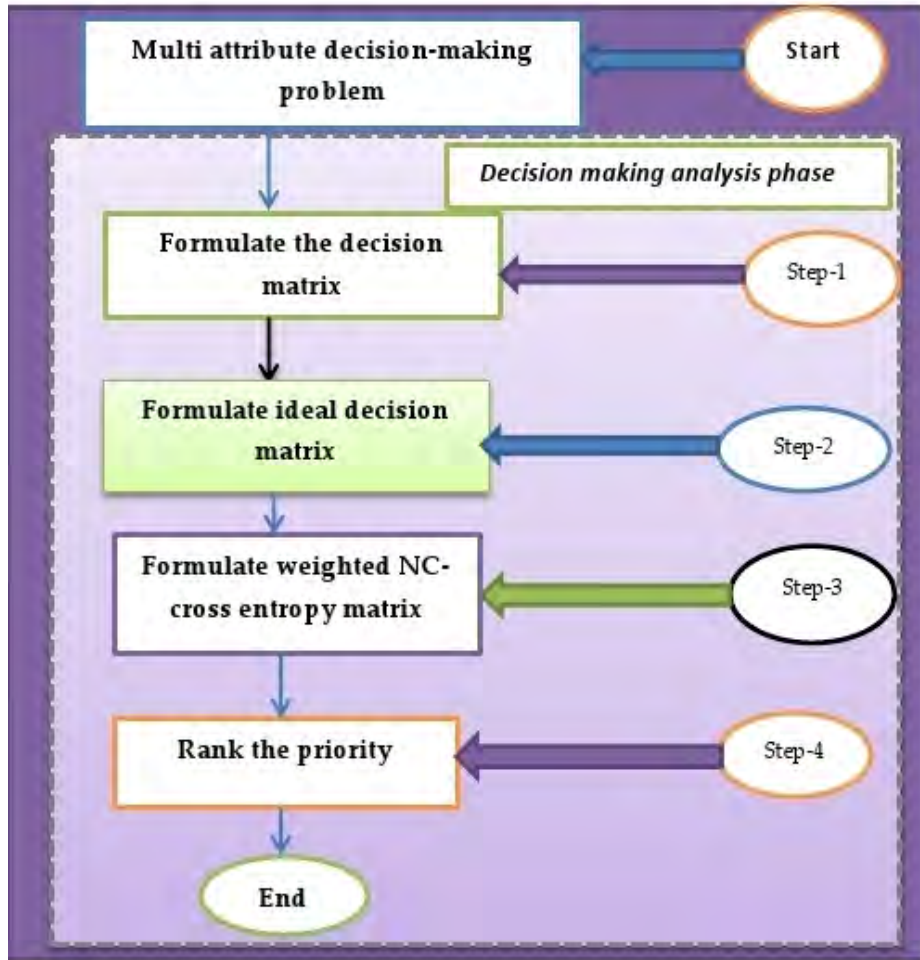

Figure 1. A flow chart of the NC-cross entropy based MADM strategy.

5. Illustrative Example

In this section, we solve an illustrative example of an MADM problem to reflect the feasibility and efficiency of our proposed strategy in NCSs environments.

Now, we use an example [89] for cultivation and analysis. A venture capital firm intends to make evaluation and selection to five enterprises with the investment potential:

- (1) Automobile company (A_1)
- (2) Military manufacturing enterprise (A_2)
- (3) TV media company (A_3)
- (4) Food enterprises (A_4)
- (5) Computer software company (A_5)

On the basis of four attributes namely:

- (1) Social and political factor (G_1)
- (2) The environmental factor (G_2)
- (3) Investment risk factor (G_3)
- (4) The enterprise growth factor (G_4).

Weight vector of attributes is $W = \{.24, .25, .23, .28\}$.

The steps of decision-making strategy to rank alternatives are presented as follows:

Step: 1. Formulate the decision matrix

The decision-maker represents the rating values of alternative A_i ($i = 1, 2, 3, 4, 5$) with respect to the attribute G_j ($j = 1, 2, 3, 4$) in terms of NCNs and constructs the decision matrix M as follows:

$$M = \begin{pmatrix} A_1 <[.6,.8],[2,.3],[3,.4],[8,.3,4]> <[.5,.6],[2,.4],[4,.4],[6,.4,4]> <[.6,.8],[2,.3],[2,.4],[8,.4,4]> <[.6,.7],[3,.4],[3,.4],[7,.4,5]> \\ A_2 <[.5,.7],[2,.3],[3,.4],[7,.3,4]> <[.7,.8],[2,.3],[2,.4],[8,.3,4]> <[.6,.8],[2,.4],[3,.4],[8,.4,4]> <[.6,.8],[2,.3],[2,.3],[8,.2,3]> \\ A_3 <[.6,.8],[2,.4],[3,.4],[8,.4,4]> <[.6,.8],[2,.3],[2,.3],[8,.3,3]> <[.8,.9],[3,.5],[3,.5],[9,.5,5]> <[.6,.7],[2,.3],[2,.4],[7,.3,4]> \\ A_4 <[.5,.7],[4,.5],[3,.5],[7,.5,5]> <[.4,.6],[1,.3],[3,.4],[6,.3,4]> <[.5,.6],[1,.2],[3,.4],[6,.2,4]> <[.5,.7],[3,.4],[4,.5],[7,.4,5]> \\ A_5 <[.7,.8],[2,.4],[2,.3],[8,.4,4]> <[.4,.6],[2,.4],[2,.4],[6,.4,4]> <[.5,.7],[2,.4],[3,.4],[7,.4,4]> <[.6,.8],[4,.5],[4,.5],[8,.5,5]> \end{pmatrix} \tag{60}$$

Step: 3. Formulate priori/ideal decision matrix

Priori/ideal decision matrix

$$M^1 = \begin{pmatrix} A_1 <[1,1],[0,0],[0,0],[1,0,0]> <[1,1],[0,0],[0,0],[1,0,0]> <[1,1],[0,0],[0,0],[1,0,0]> <[1,1],[0,0],[0,0],[1,0,0]> \\ A_2 <[1,1],[0,0],[0,0],[1,0,0]> <[1,1],[0,0],[0,0],[1,0,0]> <[1,1],[0,0],[0,0],[1,0,0]> <[1,1],[0,0],[0,0],[1,0,0]> \\ A_3 <[1,1],[0,0],[0,0],[1,0,0]> <[1,1],[0,0],[0,0],[1,0,0]> <[1,1],[0,0],[0,0],[1,0,0]> <[1,1],[0,0],[0,0],[1,0,0]> \\ A_4 <[1,1],[0,0],[0,0],[1,0,0]> <[1,1],[0,0],[0,0],[1,0,0]> <[1,1],[0,0],[0,0],[1,0,0]> <[1,1],[0,0],[0,0],[1,0,0]> \\ A_5 <[1,1],[0,0],[0,0],[1,0,0]> <[1,1],[0,0],[0,0],[1,0,0]> <[1,1],[0,0],[0,0],[1,0,0]> <[1,1],[0,0],[0,0],[1,0,0]> \end{pmatrix} \tag{61}$$

Step: 4. Calculate the weighted INS cross entropy matrix

Using Equation (38), we calculate weighted NC-cross entropy values between ideal matrixes (61) and decision matrix (60):

$${}^{NC}M_{CE}^w = \begin{pmatrix} 0.66 \\ 0.58 \\ 0.60 \\ 0.74 \\ 0.71 \end{pmatrix} \tag{62}$$

Step: 5. Rank the priority

The position of cross entropy values of alternatives arranging in increasing order is $0.58 < 0.60 < 0.66 < 0.71 < 0.74$. Since the smallest values of cross entropy indicate that the alternative is closer to the ideal alternative, the ranking priority of alternatives is $A_2 > A_3 > A_1 > A_5 > A_4$. Hence, military manufacturing enterprise (A_2) is the best alternative for investment.

Graphical representation of alternatives versus cross entropy is shown in Figure 2. From the Figure 2, we see that A_2 is the best preference alternative and A_4 is the least preference alternative.

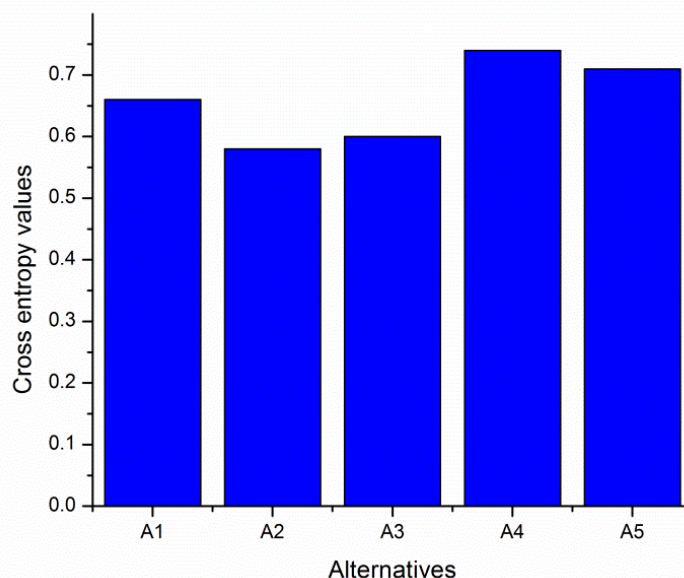

Figure 2. Bar diagram of alternatives versus cross entropy values of alternatives.

Figure 3 presents relation between cross entropy value and preference ranking of the alternative.

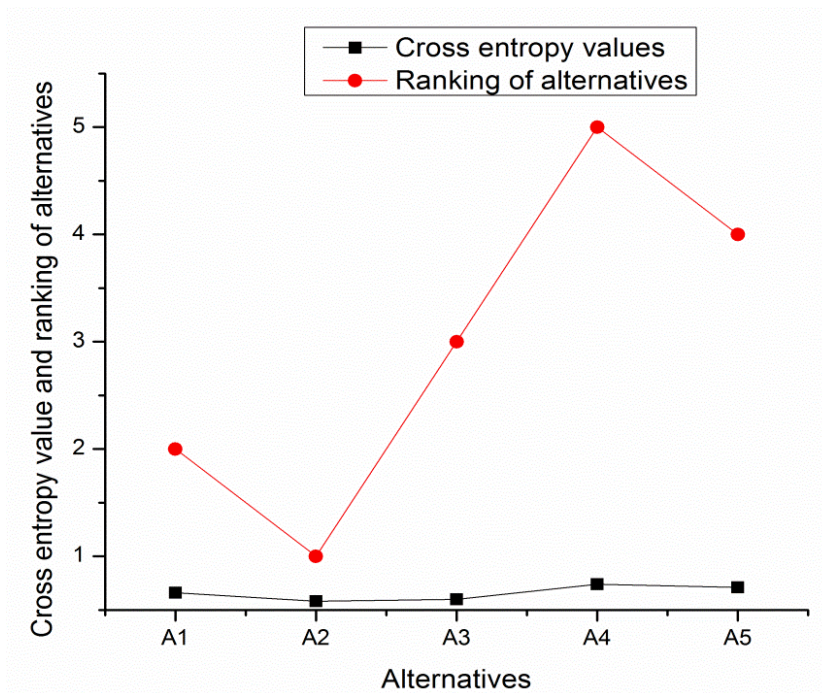

Figure 3. Graphical representation of cross entropy values and ranking of alternatives.

6. Contributions of the Paper

The contributions of the paper are summarized as follows:

1. We have introduced an NC-cross entropy measure and proved its basic properties in NCS environments.
2. We have introduced a weighted NC-cross entropy measure and proved its basic properties in NCS environments.
3. We have developed a novel MADM strategy based on weighted NC- cross entropy to solve MADM problems.
4. We solved an illustrative example of MADM problem using proposed strategies.

7. Conclusions

We have introduced NC-cross entropy measure in NCS environments. We have proved the basic properties of the proposed NC-cross entropy measure. We have also introduced weighted NC-cross entropy measure and established its basic properties. Using the weighted NC-cross entropy measure, we developed a novel MADM strategy. We have also solved an MADM problem to illustrate the proposed MADM strategy. The proposed NC-cross entropy based MADM strategy can be employed to solve a variety of problems such as logistics center selection [90,91], weaver selection [92], teacher selection [21], brick selection [93], renewable energy selection [94], etc. The proposed NC-cross entropy based MADM strategy can also be extended to MAGDM strategy using suitable aggregation operators.

References

1. Smarandache, F. *Neutrosophy, Neutrosophic Probability, Set, and Logic*; American Research Press: Rehoboth, DE, USA, 1998.
2. Wang, H.; Smarandache, F.; Zhang, Y.; Sunderraman, R. Single valued neutrosophic sets. *Multi-Space Multi-Struct.* **2010**, *4*, 410–413.
3. Ansari, A.Q.; Biswas, R.; Aggarwal, S. Proposal for applicability of neutrosophic set theory in medical AI. *Int. J. Comput. Appl.* **2011**, *27*, 5–11.
4. Guo, Y.; Cheng, H. New neutrosophic approach to image segmentation. *Pattern Recognit.* **2009**, *42*, 587–595.
5. Cheng, H.D.; Guo, Y.; Zhang, Y. A novel image segmentation approach based on neutrosophic set and improved fuzzy c-mean algorithm. *New Math. Nat. Comput.* **2011**, *7*, 155–171.
6. Guo, Y.; Sengur, A.; Ye, J. A novel image thresholding algorithm based on neutrosophic similarity score. *Measurement* **2014**, *58*, 175–186.
7. Guo, Y.; Sengur, A. A novel image segmentation algorithm based on neutrosophic similarity clustering. *Appl. Soft Comput.* **2014**, *25*, 391–398.
8. Guo, Y.; Sengur, A.; Tain, J. A novel breast ultrasound image segmentation algorithm based on neutrosophic similarity score and level set. *Comput. Methods Programs Biomed.* **2016**, *123*, 43–53.
9. Mathew, J.; Simon, P. Color texture image segmentation based on neutrosophic set and nonsubsampling contourlet transformation. In Proceedings of the International Conference on Applied Algorithms, Kolkata, India, 13–15 January 2014; pp. 164–173.
10. Kraipeerapun, P.; Fung, C.C.; Brown, W. Assessment of uncertainty in mineral prospectivity prediction using interval neutrosophic sets. In *Computational Intelligence and Security, Proceedings of the International Conference on Computational and Information Science, Xian, China, 15–19 December 2005*; Springer: Berlin/Heidelberg, Germany, 2005; Volume 3802, pp. 1074–1079.
11. Kraipeerapun, P.; Fung, C.C. Binary classification using ensemble networks and interval neutrosophic sets. *Neurocomputing* **2009**, *72*, 2845–2856.
12. Pramanik, S.; Chakrabarti, S. A study on problems of construction workers in West Bengal based on neutrosophic cognitive maps. *Int. J. Innov. Res. Sci. Eng. Technol.* **2013**, *2*, 6387–6394.
13. Kandasamy, W.B.V.; Smarandache, F. *Fuzzy Cognitive Maps and Neutrosophic Cognitive Map*; Xiquan: Phoenix, AZ, USA, 2003.
14. Mondal, K.; Pramanik, S. A study on problems of Hijras in West Bengal based on neutrosophic cognitive maps. *Neutrosophic Sets Syst.* **2014**, *5*, 21–26.
15. Pramanik, S.; Roy, T.K. Neutrosophic game theoretic approach to Indo-Pak conflict over Jammu-Kashmir. *Neutrosophic Sets Syst.* **2014**, *2*, 82–101.
16. Pramanik, S.; Roy, T.K. Game theoretic model to the Jammu-Kashmir conflict between India and Pakistan. *Int. J. Math. Arch.* **2013**, *4*, 162–170.
17. Sodenkamp, S. Models, Methods and Applications of Group Multiple-Criteria Decision Analysis in Complex and Uncertain Systems. Ph.D. Dissertation, University of Paderborn, Paderborn, Germany, 2013.
18. Biswas, P. Multi-Attribute Decision Making in Neutrosophic Environment. Ph.D. Dissertation, Jadavpur University, Kolkata, India, 19 February 2018.
19. Kharal, A. A neutrosophic multi-criteria decision-making method. *New Math. Nat. Comput.* **2014**, *10*, 143–162.
20. Mondal, K.; Pramanik, S. Multi-criteria group decision-making approach for teacher recruitment in higher education under simplified neutrosophic environment. *Neutrosophic Sets Syst.* **2014**, *6*, 28–34.
21. Pramanik, S.; Mukhopadhyaya, D. Grey relational analysis-based intuitionistic fuzzy multi-criteria group decision-making approach for teacher selection in higher education. *Int. J. Comput. Appl.* **2011**, *34*, 21–29.
22. Mondal, K.; Pramanik, S. Neutrosophic decision-making model of school choice. *Neutrosophic Sets Syst.* **2015**, *7*, 62–68.
23. Mondal, K.; Pramanik, S. Neutrosophic decision-making model for clay-brick selection in construction field based on grey relational analysis. *Neutrosophic Sets Syst.* **2015**, *9*, 72–79.
24. Biswas, P.; Pramanik, S.; Giri, B.C. TOPSIS method for multi-attribute group decision-making under single valued neutrosophic environment. *Neural Comput. Appl.* **2016**, *27*, 727–737, doi:10.1007/s00521-015-1891-2.
25. Biswas, P.; Pramanik, S.; Giri, B.C. Entropy based grey relational analysis method for multi-attribute decision-making under single valued neutrosophic assessments. *Neutrosophic Sets Syst.* **2014**, *2*, 102–110.

26. Biswas, P.; Pramanik, S.; Giri, B.C. A new methodology for neutrosophic multi-attribute decision-making with unknown weight information. *Neutrosophic Sets Syst.* **2014**, *3*, 42–50.
27. Jiang, W.; Shou, Y. A novel single-valued neutrosophic set similarity measure and its application in multi criteria decision-making. *Symmetry* **2017**, *9*, 127, doi:10.3390/sym9080127.
28. Mondal, K.; Pramanik, S. Neutrosophic tangent similarity measure and its application to multiple attribute decision-making. *Neutrosophic Sets Syst.* **2015**, *9*, 85–92.
29. Ye, J.; Zhang, Q. S. Single valued neutrosophic similarity measures for multiple attribute decision making. *Neutrosophic Sets Syst.* **2014**, *2*, 48–54.
30. Broumi, S.; Smarandache, F. Several similarity measures of neutrosophic sets. *Neutrosophic Sets Syst.* **2013**, *1*, 54–62.
31. Ye, J. Projection and bidirectional projection measures of single valued neutrosophic sets and their decision—Making method for mechanical design scheme. *J. Exp. Theor. Artif. Intell.* **2016**, doi:10.1080/0952813X.2016.1259263.
32. Sahin, R.; Liu, P. Maximizing deviation method for neutrosophic multiple attribute decision-making with incomplete weight information. *Neural Comput. Appl.* **2016**, *27*, 2017–2029.
33. Ji, P.; Wang, J.Q.; Zhang, H.Y. Frank prioritized Bonferroni mean operator with single-valued neutrosophic sets and its application in selecting third-party logistics providers. *Neural Comput. Appl.* **2016**, doi:10.1007/s00521-016-2660-6.
34. Garg, H.; Nancy. Some new biparametric distance measures on single-valued neutrosophic sets with applications to pattern recognition and medical diagnosis. *Information* **2017**, *8*, 162, doi:10.3390/info8040162.
35. Sun, R.; Hu, J.; Chen, X. Novel single-valued neutrosophic decision-making approaches based on prospect theory and their applications in physician selection. *Soft Comput.* **2017**, doi:10.1007/s00500-017-2949-0.
36. Stanujkic, D.; Zavadskas, E.K.; Smarandache, F.; Brauers, W.K.M.; Karabasevic, D. A neutrosophic extension of the MULTIMOORA Method. *Informatica* **2017**, *28*, 181–192.
37. Zavadskas, E.K.; Baušys, R.; Stanujkic, D. Selection of lead-zinc flotation circuit design by applying WASPAS method with single-valued neutrosophic set. *Acta Montan. Slovaca* **2016**, *21*, 85–92.
38. Zavadskas, E.K.; Bausys, R.; Lazauskas, M. Sustainable assessment of alternative sites for the construction of a waste incineration plant by applying WASPAS method with single-valued neutrosophic set. *Sustainability* **2015**, *7*, 15923–15936.
39. Bausys, R.; Zavadskas, E.K.; Kaklauskas, A. Application of neutrosophic set to multicriteria decision-making by COPRAS. *J. Econ. Comput. Econ. Cybern. Stud. Res.* **2015**, *49*, 91–106.
40. Xu, D. S.; Wei, C. G. W. TODIM method for single-valued neutrosophic multiple attribute decision-making. *Information* **2017**, *8*, 125, doi:10.3390/info8040125.
41. Ji, P.; Zhang, H.Y.; Wang, J.Q. A projection-based TODIM method under multi-valued neutrosophic environments and its application in personnel selection. *Neural Comput. Appl.* **2018**, *29*, 221–234.
42. Peng, J.J.; Wang, J.Q.; Zhang, H.Y.; Chen, X.H. An outranking approach for multi-criteria decision-making problems with simplified neutrosophic sets. *Appl. Soft Comput.* **2014**, *25*, 336–346.
43. Abdel-Basset, M.; Mohamed, M.; Smarandache, F. An extension of neutrosophic AHP–SWOT analysis for strategic planning and decision-making. *Symmetry* **2018**, *10*, 116, doi:10.3390/sym10040116.
44. Poursmaeil, H.; Shivanian, E.; Khorram, E.; Fathabadi, H.S. An extended method using TOPSIS and VIKOR for multiple attribute decision-making with multiple decision-makers and single valued neutrosophic numbers. *Adv. Appl. Stat.* **2017**, *50*, 261–292.
45. Wang, H.; Smarandache, F.; Zhang, Y.Q.; Sunderraman, R. *Interval Neutrosophic Sets and Logic: Theory and Applications in Computing*; Hexis: Phoenix, AZ, USA, 2005.
46. Pramanik, S.; Mondal, K. Interval neutrosophic multi-attribute decision-making based on grey relational analysis. *Neutrosophic Sets Syst.* **2015**, *9*, 13–22.
47. Dey, P.P.; Pramanik, S.; Giri, B.C. An extended grey relational analysis based multiple attribute decision-making in interval neutrosophic uncertain linguistic setting. Neutrosophic soft multi-attribute decision-making based on grey relational projection method. *Neutrosophic Sets Syst.* **2016**, *11*, 21–30.
48. Dey, P.P.; Pramanik, S.; Giri, B.C. Extended projection-based models for solving multiple attribute decision-making problems with interval-valued neutrosophic information. In *New Trends in Neutrosophic Theory and Applications*; Smarandache, F., Pramanik, S., Eds.; Pons Editions: Brussels, Belgium, 2016; pp. 127–140.

49. Huang, Y.; Wei, G.W.; Wei, C. VIKOR method for interval neutrosophic multiple attribute group decision-making. *Information* **2017**, *8*, 144, doi:10.3390/info8040144.
50. Broumi, S.; Ye, J.; Smarandache, F. An extended TOPSIS method for multiple attribute decision-making based on interval neutrosophic uncertain linguistic variables. *Neutrosophic Sets Syst.* **2015**, *8*, 23–32.
51. Garg, H.; Nancy. Non-linear programming method for multi-criteria decision-making problems under interval neutrosophic set environment. *Appl. Intell.* **2017**, doi:10.1007/s10489-017-1070-5.
52. Zhang, H.Y.; Wang, J.Q.; Chen, X.H. An outranking approach for multi-criteria decision-making problems with interval-valued neutrosophic sets. *Neural Comput. Appl.* **2016**, *27*, 615–627.
53. Pramanik, S.; Biswas, P.; Giri, B.C. Hybrid vector similarity measures and their applications to multi-attribute decision-making under neutrosophic environment. *Neural Comput. Appl.* **2017**, *28*, 1163–1176, doi:10.1007/s00521-015-2125-3.
54. Mondal, K.; Pramanik, S.; Giri, B.C. Interval neutrosophic tangent similarity measure based MADM strategy and its application to MADM Problems. *Neutrosophic Sets Syst.* **2018**, *19*, in press.
55. Ye, J. Similarity measures between interval neutrosophic sets and their applications in multi criteria decision-making. *J. Intell. Fuzzy Syst.* **2014**, *26*, 165–172.
56. Zhang, H.; Ji, P.; Wang, J.; Chen, X. An Improved weighted correlation coefficient based on integrated weight for interval neutrosophic sets and its application in multi criteria decision-making problems. *Int. J. Comput. Intell. Syst.* **2015**, *8*, 1027–1043.
57. Zhao, A.W.; Du, J.G.; Guan, H.J. Interval valued neutrosophic sets and multi-attribute decision-making based on generalized weighted aggregation operator. *J. Intell. Fuzzy Syst.* **2015**, *29*, 2697–2706.
58. Smarandache, F.; Pramanik, S. (Eds.) *New Trends in Neutrosophic Theory and Applications*; Pons Editions: Brussels, Belgium, 2016; pp. 15–161, ISBN 978-1-59973-498-9.
59. Ali, M.; Deli, I.; Smarandache, F. The theory of neutrosophic cubic sets and their applications in pattern recognition. *J. Intell. Fuzzy Syst.* **2016**, *30*, 1957–1963.
60. Banerjee, D.; Giri, B.C.; Pramanik, S.; Smarandache, F. GRA for multi attribute decision-making in neutrosophic cubic set environment. *Neutrosophic Sets Syst.* **2017**, *15*, 60–69.
61. Pramanik, S.; Dey, P.P.; Giri, B.C.; Smarandache, F. An Extended TOPSIS for multi-attribute decision-making problems with neutrosophic cubic information. *Neutrosophic Sets Syst.* **2017**, *17*, 20–28.
62. Zhan, J.; Khan, M.; Gulistan, M. Applications of neutrosophic cubic sets in multi-criteria decision-making. *Int. J. Uncertain. Quantif.* **2017**, *7*, 377–394.
63. Lu, Z.; Ye, J. Cosine measures of neutrosophic cubic sets for multiple attribute decision-making. *Symmetry* **2017**, *9*, 121.
64. Shi, L.; Ye, J. Dombi aggregation operators of neutrosophic cubic sets for multiple attribute decision-making. *Algorithms* **2018**, *11*, 29, doi:10.3390/a11030029.
65. Ye, J. Linguistic neutrosophic cubic numbers and their multiple attribute decision-making method. *Information* **2017**, *8*, 110.
66. Pramanik, S.; Dalapati, S.; Alam, S.; Roy, T.K.; Smarandache, F. Neutrosophic cubic MCGDM method based on similarity measure. *Neutrosophic Sets Syst.* **2017**, *16*, 44–56.
67. Pramanik, S.; Dalapati, S.; Alam, S.; Roy, T.K. NC-TODIM-based MAGDM under a neutrosophic cubic set environment. *Information* **2017**, *8*, 149, doi:10.3390/info8040149.
68. Pramanik, S.; Dalapati, S.; Alam, S.; Roy, T.K. NC-VIKOR based MAGDM under neutrosophic cubic set environment. *Neutrosophic Sets Syst.* **2018**, *19*, in press.
69. Zadeh, L.A. Probability measures of fuzzy events. *J. Math. Anal. Appl.* **1968**, *23*, 421–427.
70. De Luca, A.; Termini, S. A definition of non-probabilistic entropy in the setting of fuzzy sets theory. *Inf. Control* **1972**, *20*, 301–312.
71. Shannon, C.E. A mathematical theory of communication. *Bell. Syst. Tech. J.* **1948**, *27*, 379–423.
72. Szmiedt, E.; Kacprzyk, J. Entropy for intuitionistic fuzzy sets. *Fuzzy Sets Syst.* **2001**, *118*, 467–477.
73. Majumder, P.; Samanta, S.K. On similarity and entropy of neutrosophic sets. *J. Intell. Fuzzy Syst.* **2014**, *26*, 1245–1252.
74. Aydoğdu, A. On entropy and similarity measure of interval valued neutrosophic sets. *Neutrosophic Sets Syst.* **2015**, *9*, 47–49.
75. Ye, J.; Du, S. Some distances, similarity and entropy measures for interval valued neutrosophic sets and their relationship. *Int. J. Mach. Learn. Cybern.* **2017**, doi:10.1007/s13042-017-0719-z.
76. Shang, X.G.; Jiang, W.S. A note on fuzzy information measures. *Pattern Recognit. Lett.* **1997**, *18*, 425–432.

77. Vlachos, I.K.; Sergiadis, G.D. Intuitionistic fuzzy information applications to pattern recognition. *Pattern Recognit. Lett.* **2007**, *28*, 197–206.
78. Ye, J. Multicriteria fuzzy decision-making method based on the intuitionistic fuzzy cross-entropy. In Proceedings of the International Conference on Intelligent Human-Machine Systems and Cybernetics, Hangzhou, China, 26–27 August 2009; pp. 59–61.
79. Maheshwari, S.; Srivastava, A. Application of intuitionistic fuzzy cross entropy measure in decision-making for medical diagnosis. *World Acad. Sci. Eng. Technol. Int. J. Math. Comput. Phys. Electr. Comput. Eng.* **2015**, *9*, 254–258
80. Zhang, Q.S.; Jiang, S.; Jia, B.; Luo, S. Some information measures for interval-valued intuitionistic fuzzy sets. *Inf. Sci.* **2010**, *180*, 5130–5145.
81. Ye, J. Fuzzy cross entropy of interval valued intuitionistic fuzzy sets and its optimal decision-making method based on the weights of alternatives. *Expert Syst. Appl.* **2011**, *38*, 6179–6183.
82. Ye, J. Single valued neutrosophic cross-entropy for multi criteria decision-making problems. *Appl. Math. Model.* **2013**, *38*, 1170–1175.
83. Ye, J. Improved cross entropy measures of single valued neutrosophic sets and interval neutrosophic sets and their multi criteria decision-making methods. *Cybern. Inf. Technol.* **2015**, *15*, 13–26, doi:10.1515/cait-2015-0051.
84. Tian, Z.P.; Zhang, H.Y.; Wang, J.; Wang, J.Q.; Chen, X.H. Multi-criteria decision-making method based on a cross-entropy with interval neutrosophic sets. *Int. J. Syst. Sci.* **2016**, *47*, 3598–3608, doi:10.1080/00207721.2015.1102359.
85. Sahin, R. Cross-entropy measure on interval neutrosophic sets and its applications in multi criteria decision-making. *Neural Comput. Appl.* **2017**, *28*, 1177–1187, doi:10.1007/s00521-015-2131-5.
86. Pramanik, S.; Dalapati, S.; Alam, S.; Smarandache, F.; Roy, T.K. NS-Cross Entropy-Based MAGDM under Single-Valued Neutrosophic Set Environment. *Information* **2018**, *9*, 37.
87. Dalapati, S.; Pramanik, S.; Alam, S.; Smarandache, F.; Roy, T.K. IN-cross entropy based MAGDM strategy under interval neutrosophic set environment. *Neutrosophic Sets Syst.* **2017**, *18*, 43–57, doi:10.5281/zenodo.1175162.
88. Pramanik, S.; Dey, P.P.; Smarandache, F.; Ye, J. Cross entropy measures of bipolar and interval bipolar neutrosophic sets and their application for multi-attribute decision-making. *Axioms* **2018**, *7*, 21, doi:10.3390/axioms7020021.
89. He, X.; Liu, W.F. An intuitionistic fuzzy multi-attribute decision-making method with preference on alternatives. *Oper. Res. Manag. Sci.* **2013**, *22*, 36–40.
90. Pramanik, S.; Dalapati, S.; Roy, T.K. Logistics center location selection approach based on neutrosophic multi-criteria decision-making. In *New Trends in Neutrosophic Theory and Applications*; Smarandache, F., Pramanik, S., Eds.; Pons Asbl: Brussels, Belgium, 2016; Volume 1, pp. 161–174, ISBN 978-1-59973-498-9.
91. Pramanik, S.; Dalapati, S.; Roy, T.K. Neutrosophic Multi-Attribute Group Decision Making Strategy for Logistics Center Location Selection. In *Neutrosophic Operational Research Volume III*; Smarandache, F., Basset, M.A., Chang, V., Eds.; Pons Asbl: Brussels, Belgium, 2018; pp. 13–32, ISBN 978-1-59973-537-5.
92. Dey, P.P.; Pramanik, S.; Giri, B.C. Multi-criteria group decision-making in intuitionistic fuzzy environment based on grey relational analysis for weaver selection in Khadi institution. *J. Appl. Quant. Methods* **2015**, *10*, 1–14.
93. Mondal, K.; Pramanik, S. Intuitionistic fuzzy multi criteria group decision-making approach to quality-brick selection problem. *J. Appl. Quant. Methods* **2014**, *9*, 35–50.
94. San Cristóbal, J.R. Multi-criteria decision-making in the selection of a renewable energy project in Spain: The VIKOR method. *Renew. Energy* **2011**, *36*, 498–502.

On I-open sets and I-continuous functions in ideal Bitopological spaces

M. Caldas, Saeid Jafari, Nimitha Rajesh, Florentin Smarandache

M. Caldas, Saeid Jafari, Nimitha Rajesh, Florentin Smarandache (2018). On I-open sets and I-continuous functions in ideal Bitopological spaces. International Conference on Topology and its Applications, Nafpaktos, Greece, 44-56

ABSTRACT. The aim of this paper is to introduce and characterize the concepts of \mathcal{I} -open sets and their related notions in ideal bitopological spaces.

1. INTRODUCTION AND PRELIMINARIES

The concept of ideals in topological spaces has been introduced and studied by Kuratowski [19] and Vaidyanathasamy [24]. Hamlett and Janković (see [12], [13], [17] and [18]) used topological ideals to generalize many notions and properties in general topology. The research in this direction continued by many researchers such as M. E. Abd El-Monsef, A. Al-Omari, F. G. Arenas, M. Caldas, J. Dontchev, M. Ganster, D. N. Georgiou, T. R. Hamlett, E. Hatir, S. D. Iliadis, S. Jafari, D. Jankovic, E. F. Lashien, M. Maheswari, , H. Maki, A. C. Megaritis, F. I. Michael, A. A. Nasef, T. Noiri, B. K. Papadopoulos, M. Parimala, G. A. Prinos, M. L. Puertas, M. Rajamani, N. Rajesh, D. Rose, A. Selvakumar, Jun-Iti Umehara and many others (see [1], [2], [5], [7], [8], [9], [10], [11], [14], [15], [18], [23], [21], [22]). An ideal \mathcal{I} on a topological space (X, τ) is a nonempty collection of subsets of X which satisfies (i) $A \in \mathcal{I}$ and $B \subset A$ implies $B \in \mathcal{I}$ and (ii) $A \in \mathcal{I}$ and $B \in \mathcal{I}$ implies $A \cup B \in \mathcal{I}$. Given a topological space (X, τ) with an ideal \mathcal{I} on X and if $\mathcal{P}(X)$ is the set of all subsets of X , a set operator $(.)^*: \mathcal{P}(X) \rightarrow \mathcal{P}(X)$, called the local function [24] of A with respect to τ and \mathcal{I} , is defined as follows: for $A \subset X$, $A^*(\tau, \mathcal{I}) = \{x \in X | U \cap A \notin \mathcal{I} \text{ for every } U \in \tau(x)\}$, where $\tau(x) = \{U \in \tau | x \in U\}$. If \mathcal{I} is an ideal on X , then $(X, \tau_1, \tau_2, \mathcal{I})$ is called an ideal bitopological space. Let A be a subset of a bitopological space (X, τ_1, τ_2) . We denote the closure of A and the interior of A with respect to τ_i by $\tau_i\text{-Cl}(A)$ and $\tau_i\text{-Int}(A)$, respectively. A subset A of a bitopological space (X, τ_1, τ_2) is said to be (i, j) -preopen [16] if $A \subset \tau_i\text{-Int}(\tau_j\text{-Cl}(A))$, where $i, j = 1, 2$ and $i \neq j$. A subset S of an ideal topological space (X, τ, \mathcal{I}) is said to be (i, j) -pre- \mathcal{I} -open [4] if $S \subset \tau_i\text{-Int}(\tau_j\text{-Cl}^*(S))$. A subset A of a bitopological space (X, τ_1, τ_2) is said to be (i, j) -preopen [16] (resp. (i, j) -semi- \mathcal{I} -open [3]) if $A \subset \tau_i\text{-Int}(\tau_j\text{-Cl}(A))$ (resp. $S \subset \tau_j\text{-Cl}^*(\tau_i\text{-Int}(S))$), where $i, j = 1, 2$

and $i \neq j$. The complement of an (i, j) -semi- \mathcal{I} -open set is called an (i, j) -semi- \mathcal{I} -closed set. A function $f : (X, \tau_1, \tau_2, \mathcal{I}) \rightarrow (Y, \sigma_1, \sigma_2)$ is said to be (i, j) -pre- \mathcal{I} -continuous [4] if the inverse image of every σ_i -open set in (Y, σ_1, σ_2) is (i, j) -pre- \mathcal{I} -open in $(X, \tau_1, \tau_2, \mathcal{I})$, where $i \neq j, i, j=1, 2$.

2. (i, j) - \mathcal{I} -OPEN SETS

Definition 2.1. A subset A of an ideal bitopological space $(X, \tau_i, \tau_2, \mathcal{I})$ is said to be (i, j) - \mathcal{I} -open if $A \subset \tau_i\text{-Int}(A_j^*)$.

The family of all (i, j) - \mathcal{I} -open subsets of $(X, \tau_i, \tau_2, \mathcal{I})$ is denoted by $(i, j)\text{-IO}(X)$.

Remark 2.2. It is clear that $(1, 2)$ - \mathcal{I} -openness and τ_1 -openness are independent notions.

Example 2.3. Let $X = \{a, b, c\}, \tau_1 = \{\emptyset, \{a\}, \{a, b\}, X\}, \tau_2 = \{\emptyset, \{a\}, \{a, c\}, X\}$ and $\mathcal{I} = \{\emptyset, \{a\}\}$. Then $\tau_1\text{-Int}(\{a, b\}_2^*) = \tau_1\text{-Int}(\{b\}) = \emptyset \supsetneq \{a, b\}$. Therefore $\{a, b\}$ is a τ_1 -open set but not $(1, 2)$ - \mathcal{I} -open.

Example 2.4. Let $X = \{a, b, c\}, \tau_1 = \{\emptyset, \{a, b\}, X\}, \tau_2 = \{\emptyset, \{a\}, \{a, b\}, X\}$ and $\mathcal{I} = \{\emptyset, \{b\}\}$. Then $\tau_1\text{-Int}(\{a\}_2^*) = \tau_1\text{-Int}(X) = X \supset \{a\}$. Therefore, $\{a\}$ is $(1, 2)$ - \mathcal{I} -open set but not τ_1 -open.

Remark 2.5. Similarly $(1, 2)$ - \mathcal{I} -openness and τ_2 -openness are independent notions.

Example 2.6. Let $X = \{a, b, c\}, \tau_1 = \{\emptyset, \{a\}, \{c\}, \{a, c\}, X\}, \tau_2 = \{\emptyset, \{b\}, \{c\}, \{b, c\}, X\}$ and $\mathcal{I} = \{\emptyset, \{c\}\}$. Then $\tau_1\text{-Int}(\{b, c\}_2^*) = \tau_1\text{-Int}(\{a, b\}) = \{a\} \supsetneq \{b, c\}$. Therefore, $\{b, c\}$ is a τ_2 -open set but not $(1, 2)$ - \mathcal{I} -open.

Example 2.7. Let $X = \{a, b, c\}, \tau_1 = \{\emptyset, \{a\}, \{c\}, \{a, c\}\}, \tau_2 = \{\emptyset, \{b\}, \{b, c\}, X\}$ and $\mathcal{I} = \{\emptyset, \{c\}\}$. Then $\tau_1\text{-Int}(\{a\}_2^*) = \tau_1\text{-Int}(\{a\}) = \{a\} \supset \{a\}$. Therefore, $\{a\}$ is an $(1, 2)$ - \mathcal{I} -open set but not τ_2 -open.

Proposition 2.8. Every (i, j) - \mathcal{I} -open set is (i, j) -pre- \mathcal{I} -open.

Proof. Let A be an (i, j) - \mathcal{I} -open set. Then $A \subset \tau_i\text{-Int}(A_j^*) \subset \tau_i\text{-Int}(A \cup A_j^*) = \tau_i\text{-Int}(\tau_j\text{-Cl}^*(A))$. Therefore, $A \in (i, j)\text{-PIO}(X)$. \square

Example 2.9. Let $X = \{a, b, c\}, \tau_1 = \{\emptyset, \{a\}, \{c\}, \{a, c\}, X\}, \tau_2 = \{\emptyset, \{b, c\}, X\}$ and $\mathcal{I} = \{\emptyset, \{c\}\}$. Then the set $\{c\}$ is $(1, 2)$ -preopen but not $(1, 2)$ - \mathcal{I} -open.

Remark 2.10. The intersection of two (i, j) - \mathcal{I} -open sets need not be (i, j) - \mathcal{I} -open as shown in the following example.

Example 2.11. Let $X = \{a, b, c\}, \tau_1 = \{\emptyset, \{a\}, \{c\}, \{a, c\}, X\}, \tau_2 = \{\emptyset, \{b\}, \{b, c\}, X\}$ and $\mathcal{I} = \{\emptyset, \{a\}\}$. Then $\{a, b\}, \{a, c\} \in (1, 2)\text{-IO}(X)$ but $\{a, b\} \cap \{a, c\} = \{a\} \notin (1, 2)\text{-IO}(X)$.

Theorem 2.12. For an ideal bitopological space $(X, \tau_1, \tau_2, \mathcal{I})$ and $A \subset X$, we have:

- (1) If $\mathcal{I} = \{\emptyset\}$, then $A_j^*(\mathcal{I}) = \tau_j\text{-Cl}(A)$ and hence each of (i, j) - \mathcal{I} -open set and (i, j) -preopen set are coincide.
- (2) If $\mathcal{I} = \mathcal{P}(X)$, then $A_j^*(\mathcal{I}) = \emptyset$ and hence A is (i, j) - \mathcal{I} -open if and only if $A = \emptyset$.

Theorem 2.13. For any (i, j) - \mathcal{I} -open set A of an ideal bitopological space $(X, \tau_1, \tau_2, \mathcal{I})$, we have $A_j^* = (\tau_i\text{-Int}(A_j^*))_j^*$.

Proof. Since A is (i, j) - \mathcal{I} -open, $A \subset \tau_i\text{-Int}(A_j^*)$. Then $A_j^* \subset (\tau_i\text{-Int}(A_j^*))_j^*$. Also we have $\tau_i\text{-Int}(A_j^*) \subset A_j^*$, $(\tau_i\text{-Int}(A_j^*))^* \subset (A_j^*)^* \subset A_j^*$. Hence we have, $A_j^* = (\tau_i\text{-Int}(A_j^*))_j^*$. □

Definition 2.14. A subset F of an ideal bitopological space $(X, \tau_1, \tau_2, \mathcal{I})$ is called (i, j) - \mathcal{I} -closed if its complement is (i, j) - \mathcal{I} -open.

Theorem 2.15. For $A \subset (X, \tau_1, \tau_2, \mathcal{I})$ we have $((\tau_i\text{-Int}(A))_j^*)^c \neq \tau_i\text{-Int}((A^c)_j^*)$ in general.

Example 2.16. Let $X = \{a, b, c\}$, $\tau_1 = \{\emptyset, \{a\}, \{a, b\}, X\}$, $\tau_2 = \{\emptyset, \{a, c\}, X\}$ and $\mathcal{I} = \{\emptyset, \{b\}\}$. Then $((\tau_1\text{-Int}(\{a, b\}))_2^*)^c = (\{a, b\}_2^*)^c = X^c = \emptyset$ (*) and $\tau_1\text{-Int}((\{a, b\}^c)_2^*) = \tau_1\text{-Int}(\{c\}_2^*) = \tau_1\text{-Int}(X) = X$ (**). Hence from (*) and (**), we get $((\tau_1\text{-Int}(\{a, b\}))_2^*)^c \neq \tau_1\text{-Int}((\{a, b\}^c)_2^*)$.

Theorem 2.17. If $A \subset (X, \tau_1, \tau_2, \mathcal{I})$ is (i, j) - \mathcal{I} -closed, then $A \supset (\tau_i\text{-Int}(A))_j^*$.

Proof. Let A be (i, j) - \mathcal{I} -closed. Then $B = A^c$ is (i, j) - \mathcal{I} -open. Thus, $B \subset \tau_i\text{-Int}(B_j^*)$, $B \subset \tau_i\text{-Int}(\tau_j\text{-Cl}(B))$, $B^c \supset \tau_j\text{-Cl}(\tau_i\text{-Int}(B^c))$, $A \supset \tau_j\text{-Cl}(\tau_i\text{-Int}(A))$. That is, $\tau_j\text{-Cl}(\tau_i\text{-Int}(A)) \subset A$, which implies that $(\tau_i\text{-Int}(A))_j^* \subset \tau_j\text{-Cl}(\tau_i\text{-Int}(A)) \subset A$. Therefore, $A \supset (\tau_i\text{-Int}(A))_j^*$. □

Theorem 2.18. Let $A \subset (X, \tau_1, \tau_2, \mathcal{I})$ and $(X \setminus (\tau_i\text{-Int}(A))_j^*) = \tau_i\text{-Int}((X \setminus A)_j^*)$. Then A is (i, j) - \mathcal{I} -closed if and only if $A \supset (\tau_i\text{-Int}(A))_j^*$.

Proof. It is obvious. □

Theorem 2.19. Let $(X, \tau_1, \tau_2, \mathcal{I})$ be an ideal bitopological space and $A, B \subset X$. Then:

- (i) If $\{U_\alpha : \alpha \in \Delta\} \subset (i, j)$ - $\mathcal{IO}(X)$, then $\bigcup\{U_\alpha : \alpha \in \Delta\} \in (i, j)$ - $\mathcal{IO}(X)$.
- (ii) If $A \in (i, j)$ - $\mathcal{IO}(X)$, $B \in \tau_i$ and $A_j^* \cap B \subset (A \cap B)_j^*$, then $A \cap B \in (i, j)$ - $\mathcal{IO}(X)$.
- (iii) If $A \in (i, j)$ - $\mathcal{IO}(X)$, $B \in \tau_i$ and $B \cap A_j^* = B \cap (B \cap A)_j^*$, then $A \cap B \subset \tau_i\text{-Int}(B \cap (B \cap A)_j^*)$.

Proof. (i) Since $\{U_\alpha : \alpha \in \Delta\} \subset (i, j)$ - $\mathcal{IO}(X)$, then $U_\alpha \subset \tau_i\text{-Int}((U_\alpha)_j^*)$, for every $\alpha \in \Delta$. Thus, $\bigcup(U_\alpha) \subset \bigcup(\tau_i\text{-Int}((U_\alpha)_j^*)) \subset \tau_i\text{-Int}(\bigcup(U_\alpha)_j^*) \subset \tau_i\text{-Int}(\bigcup U_\alpha)_j^*$, for every $\alpha \in \Delta$. Hence $\bigcup\{U_\alpha : \alpha \in \Delta\} \in (i, j)$ - $\mathcal{IO}(X)$.

(ii) Given $A \in (i, j)\text{-IO}(X)$ and $B \in \tau_i$, that is $A \subset \tau_i\text{-Int}(A_j^*)$. Then $A \cap B \subset \tau_i\text{-Int}(A_j^*) \cap B = \tau_i\text{-Int}(A_j^* \cap B)$. Since $B \in \tau_i$ and $A_j^* \cap B \subset (A \cap B)_j^*$, we have $A \cap B \subset \tau_i\text{-Int}((A \cap B)_j^*)$. Hence, $A \cap B \in (i, j)\text{-IO}(X)$.

(iii) Given $A \in (i, j)\text{-IO}(X)$ and $B \in \tau_i$, That is $A \subset \tau_i\text{-Int}(A_j^*)$. We have to prove $A \cap B \subset \tau_i\text{-Int}(B \cap (B \cap A)_j^*)$. Thus, $A \cap B \subset \tau_i\text{-Int}(A_j^*) \cap B = \tau_i\text{-Int}(A_j^* \cap B) = \tau_i\text{-Int}(B \cap A_j^*)$. Since $B \cap A_j^* = B \cap (B \cap A)_j^*$. Hence $A \cap B \subset \tau_i\text{-Int}(B \cap (B \cap A)_j^*)$. \square

Corollary 2.20. *The union of $(i, j)\text{-I-closed}$ set and τ_j -closed set is $(i, j)\text{-I-closed}$.*

Proof. It is obvious. \square

Theorem 2.21. *If $A \subset (X, \tau_1, \tau_2, \mathcal{I})$ is $(i, j)\text{-I-open}$ and $(i, j)\text{-semiclosed}$, then $A = \tau_i\text{-Int}(A_j^*)$.*

Proof. Given A is $(i, j)\text{-I-open}$. Then $A \subset \tau_i\text{-Int}(A_j^*)$. Since $(i, j)\text{-semiclosed}$, $\tau_i\text{-Int}(A_j^*) \subset \tau_i\text{-Int}(\tau_j\text{-Cl}(A)) \subset A$. Thus $\tau_i\text{-Int}(A_j^*) \subset A$. Hence we have, $A = \tau_i\text{-Int}(A_j^*)$. \square

Theorem 2.22. *Let $A \in (i, j)\text{-IO}(X)$ and $B \in (i, j)\text{-IO}(Y)$, then $A \times B \in (i, j)\text{-IO}(X \times Y)$, if $A_j^* \times B_j^* = (A \times B)_j^*$.*

Proof. $A \times B \subset \tau_i\text{-Int}(A_j^*) \times \tau_i\text{-Int}(B_j^*) = \tau_i\text{-Int}(A_j^* \times B_j^*)$, from hypothesis. Then $A \times B = \tau_i\text{-Int}((A \times B)_j^*)$; hence, $A \times B \in (i, j)\text{-IO}(X \times Y)$. \square

Theorem 2.23. *If $(X, \tau_1, \tau_2, \mathcal{I})$ is an ideal bitopological space, $A \in \tau_i$ and $B \in (i, j)\text{-IO}(X)$, then there exists a τ_i -open subset G of X such that $A \cap G = \emptyset$, implies $A \cap B = \emptyset$.*

Proof. Since $B \in (i, j)\text{-IO}(X)$, then $B \subset \tau_i\text{-Int}(B_j^*)$. By taking $G = \tau_i\text{-Int}(B_j^*)$ to be a τ_i -open set such that $B \subset G$. But $A \cap G = \emptyset$, then $G \subset X \setminus A$ implies that $\tau_i\text{-Cl}(G) \subset X \setminus A$. Hence $B \subset (X \setminus A)$. Therefore, $A \cap B = \emptyset$. \square

Definition 2.24. *A subset A of $(X, \tau_1, \tau_2, \mathcal{I})$ is said to be:*

- (i) τ_i^* -closed if $A_i^* \subset A$.
- (ii) τ_i -*-perfect $A_i^* = A$.

Theorem 2.25. *For a subset $A \subset (X, \tau_1, \tau_2, \mathcal{I})$, we have*

- (i) If A is τ_j^* -closed and $A \in (i, j)\text{-IO}(X)$, then $\tau_i\text{-Int}(A) = \tau_i\text{-Int}(A_j^*)$.
- (ii) If A is τ_j -*-perfect, then $A = \tau_i\text{-Int}(A_j^*)$ for every $A \in (i, j)\text{-IO}(X)$.

Proof. (i) Let A be τ_j -*-closed and $A \in (i, j)\text{-IO}(X)$. Then $A_j^* \subset A$ and $A \subset \tau_i\text{-Int}(A_j^*)$. Hence $A \subset \tau_i\text{-Int}(A_j^*) \Rightarrow \tau_i\text{-Int}(A) \subset \tau_i\text{-Int}(\tau_i\text{-Int}(A_j^*)) \Rightarrow \tau_i\text{-Int}(A) \subset \tau_i\text{-Int}(A_j^*)$. Also, $A_j^* \subset A$. Then $\tau_i\text{-Int}(A_j^*) \subset$

$\tau_i\text{-Int}(A)$. Hence $\tau_i\text{-Int}(A) = \tau_i\text{-Int}(A_j^*)$.

(ii) Let A be $\tau_j\text{-*}$ -perfect and $A \in (i, j)\text{-IO}(X)$. We have, $A_j^* = A$, $\tau_i\text{-Int}(A_j^*) = \tau_i\text{-Int}(A)$, $\tau_i\text{-Int}(A_j^*) \subset A$. Also we have $A \subset \tau_i\text{-Int}(A_j^*)$. Hence we have, $A = \tau_i\text{-Int}(A_j^*)$. \square

Definition 2.26. Let $(X, \tau_1, \tau_2, \mathcal{I})$ be an ideal bitopological space, S a subset of X and x be a point of X . Then

- (i) x is called an $(i, j)\text{-}\mathcal{I}$ -interior point of S if there exists $V \in (i, j)\text{-IO}(X, \tau_1, \tau_2)$ such that $x \in V \subset S$.
- ii) the set of all $(i, j)\text{-}\mathcal{I}$ -interior points of S is called $(i, j)\text{-}\mathcal{I}$ -interior of S and is denoted by $(i, j)\text{-}\mathcal{I}\text{Int}(S)$.

Theorem 2.27. Let A and B be subsets of $(X, \tau_1, \tau_2, \mathcal{I})$. Then the following properties hold:

- (i) $(i, j)\text{-}\mathcal{I}\text{Int}(A) = \cup\{T : T \subset A \text{ and } A \in (i, j)\text{-IO}(X)\}$.
- (ii) $(i, j)\text{-}\mathcal{I}\text{Int}(A)$ is the largest $(i, j)\text{-}\mathcal{I}$ -open subset of X contained in A .
- (iii) A is $(i, j)\text{-}\mathcal{I}$ -open if and only if $A = (i, j)\text{-}\mathcal{I}\text{Int}(A)$.
- (iv) $(i, j)\text{-}\mathcal{I}\text{Int}((i, j)\text{-}\mathcal{I}\text{Int}(A)) = (i, j)\text{-}\mathcal{I}\text{Int}(A)$.
- (v) If $A \subset B$, then $(i, j)\text{-}\mathcal{I}\text{Int}(A) \subset (i, j)\text{-}\mathcal{I}\text{Int}(B)$.
- (vi) $(i, j)\text{-}\mathcal{I}\text{Int}(A) \cup (i, j)\text{-}\mathcal{I}\text{Int}(B) \subset (i, j)\text{-}\mathcal{I}\text{Int}(A \cup B)$.
- (vii) $(i, j)\text{-}\mathcal{I}\text{Int}(A \cap B) \subset (i, j)\text{-}\mathcal{I}\text{Int}(A) \cap (i, j)\text{-}\mathcal{I}\text{Int}(B)$.

Proof. (i). Let $x \in \cup\{T : T \subset A \text{ and } A \in (i, j)\text{-IO}(X)\}$. Then, there exists $T \in (i, j)\text{-IO}(X, x)$ such that $x \in T \subset A$ and hence $x \in (i, j)\text{-}\mathcal{I}\text{Int}(A)$. This shows that $\cup\{T : T \subset A \text{ and } A \in (i, j)\text{-IO}(X)\} \subset (i, j)\text{-}\mathcal{I}\text{Int}(A)$. For the reverse inclusion, let $x \in (i, j)\text{-}\mathcal{I}\text{Int}(A)$. Then there exists $T \in (i, j)\text{-IO}(X, x)$ such that $x \in T \subset A$. we obtain $x \in \cup\{T : T \subset A \text{ and } A \in (i, j)\text{-IO}(X)\}$. This shows that $(i, j)\text{-}\mathcal{I}\text{Int}(A) \subset \cup\{T : T \subset A \text{ and } A \in (i, j)\text{-IO}(X)\}$. Therefore, we obtain $(i, j)\text{-}\mathcal{I}\text{Int}(A) = \cup\{T : T \subset A \text{ and } A \in (i, j)\text{-IO}(X)\}$.

The proof of (ii)-(v) are obvious.

(vi). Clearly, $(i, j)\text{-}\mathcal{I}\text{Int}(A) \subset (i, j)\text{-}\mathcal{I}\text{Int}(A \cup B)$ and $(i, j)\text{-}\mathcal{I}\text{Int}(B) \subset (i, j)\text{-}\mathcal{I}\text{Int}(A \cup B)$. Then by (v) we obtain $(i, j)\text{-}\mathcal{I}\text{Int}(A) \cup (i, j)\text{-}\mathcal{I}\text{Int}(B) \subset (i, j)\text{-}\mathcal{I}\text{Int}(A \cup B)$.

(vii). Since $A \cap B \subset A$ and $A \cap B \subset B$, by (v), we have $(i, j)\text{-}\mathcal{I}\text{Int}(A \cap B) \subset (i, j)\text{-}\mathcal{I}\text{Int}(A)$ and $(i, j)\text{-}\mathcal{I}\text{Int}(A \cap B) \subset (i, j)\text{-}\mathcal{I}\text{Int}(B)$. By (v) $(i, j)\text{-}\mathcal{I}\text{Int}(A \cap B) \subset (i, j)\text{-}\mathcal{I}\text{Int}(A) \cap (i, j)\text{-}\mathcal{I}\text{Int}(B)$. \square

Definition 2.28. Let $(X, \tau_1, \tau_2, \mathcal{I})$ be an ideal bitopological space, S a subset of X and x be a point of X . Then

- (i) x is called an $(i, j)\text{-}\mathcal{I}$ -cluster point of S if $V \cap S \neq \emptyset$ for every $V \in (i, j)\text{-IO}(X, x)$.
- (ii) the set of all $(i, j)\text{-}\mathcal{I}$ -cluster points of S is called $(i, j)\text{-}\mathcal{I}$ -closure of S and is denoted by $(i, j)\text{-}\mathcal{I}\text{Cl}(S)$.

Theorem 2.29. Let A and B be subsets of $(X, \tau_1, \tau_2, \mathcal{I})$. Then the following properties hold:

- (i) $(i, j)\text{-}\mathcal{I}Cl(A) = \cap\{F : A \subset F \text{ and } F \in (i, j)\text{-}\mathcal{I}C(X)\}$.
- (ii) $(i, j)\text{-}\mathcal{I}Cl(A)$ is the smallest $(i, j)\text{-}\mathcal{I}$ -closed subset of X containing A .
- (iii) A is $(i, j)\text{-}\mathcal{I}$ -closed if and only if $A = (i, j)\text{-}\mathcal{I}Cl(A)$.
- (iv) $(i, j)\text{-}\mathcal{I}Cl((i, j)\text{-}\mathcal{I}Cl(A)) = (i, j)\text{-}\mathcal{I}Cl(A)$.
- (v) If $A \subset B$, then $(i, j)\text{-}\mathcal{I}Cl(A) \subset (i, j)\text{-}\mathcal{I}Cl(B)$.
- (vi) $(i, j)\text{-}\mathcal{I}Cl(A \cup B) = (i, j)\text{-}\mathcal{I}Cl(A) \cup (i, j)\text{-}\mathcal{I}Cl(B)$.
- (vii) $(i, j)\text{-}\mathcal{I}Cl(A \cap B) \subset (i, j)\text{-}\mathcal{I}Cl(A) \cap (i, j)\text{-}\mathcal{I}Cl(B)$.

Proof. (i). Suppose that $x \notin (i, j)\text{-}\mathcal{I}Cl(A)$. Then there exists $F \in (i, j)\text{-}\mathcal{I}O(X)$ such that $V \cap S \neq \emptyset$. Since $X \setminus V$ is $(i, j)\text{-}\mathcal{I}$ -closed set containing A and $x \notin X \setminus V$, we obtain $x \notin \cap\{F : A \subset F \text{ and } F \in (i, j)\text{-}\mathcal{I}C(X)\}$. Then there exists $F \in (i, j)\text{-}\mathcal{I}C(X)$ such that $A \subset F$ and $x \notin F$. Since $X \setminus V$ is $(i, j)\text{-}\mathcal{I}$ -closed set containing x , we obtain $(X \setminus F) \cap A = \emptyset$. This shows that $x \notin (i, j)\text{-}\mathcal{I}Cl(A)$. Therefore, we obtain $(i, j)\text{-}\mathcal{I}Cl(A) = \cap\{F : A \subset F \text{ and } F \in (i, j)\text{-}\mathcal{I}C(X)\}$.

The other proofs are obvious. □

Theorem 2.30. *Let $(X, \tau_1, \tau_2, \mathcal{I})$ be an ideal bitopological space and $A \subset X$. A point $x \in (i, j)\text{-}\mathcal{I}Cl(A)$ if and only if $U \cap A \neq \emptyset$ for every $U \in (i, j)\text{-}\mathcal{I}O(X, x)$.*

Proof. Suppose that $x \in (i, j)\text{-}\mathcal{I}Cl(A)$. We shall show that $U \cap A \neq \emptyset$ for every $U \in (i, j)\text{-}\mathcal{I}O(X, x)$. Suppose that there exists $U \in (i, j)\text{-}\mathcal{I}O(X, x)$ such that $U \cap A = \emptyset$. Then $A \subset X \setminus U$ and $X \setminus U$ is $(i, j)\text{-}\mathcal{I}$ -closed. Since $A \subset X \setminus U$, $(i, j)\text{-}\mathcal{I}Cl(A) \subset (i, j)\text{-}\mathcal{I}Cl(X \setminus U)$. Since $x \in (i, j)\text{-}\mathcal{I}Cl(A)$, we have $x \in (i, j)\text{-}\mathcal{I}Cl(X \setminus U)$. Since $X \setminus U$ is $(i, j)\text{-}\mathcal{I}$ -closed, we have $x \in X \setminus U$; hence $x \notin U$, which is a contradiction that $x \in U$. Therefore, $U \cap A \neq \emptyset$. Conversely, suppose that $U \cap A \neq \emptyset$ for every $U \in (i, j)\text{-}\mathcal{I}O(X, x)$. We shall show that $x \in (i, j)\text{-}\mathcal{I}Cl(A)$. Suppose that $x \notin (i, j)\text{-}\mathcal{I}Cl(A)$. Then there exists $U \in (i, j)\text{-}\mathcal{I}O(X, x)$ such that $U \cap A = \emptyset$. This is a contradiction to $U \cap A \neq \emptyset$; hence $x \in (i, j)\text{-}\mathcal{I}Cl(A)$. □

Theorem 2.31. *Let $(X, \tau_1, \tau_2, \mathcal{I})$ be an ideal bitopological space and $A \subset X$. Then the following properties hold:*

- (i) $(i, j)\text{-}\mathcal{I}Int(X \setminus A) = X \setminus (i, j)\text{-}\mathcal{I}Cl(A)$;
- (i) $(i, j)\text{-}\mathcal{I}Cl(X \setminus A) = X \setminus (i, j)\text{-}\mathcal{I}Int(A)$.

Proof. (i). Let $x \in (i, j)\text{-}\mathcal{I}Cl(A)$. There exists $V \in (i, j)\text{-}\mathcal{I}O(X, x)$ such that $V \cap A \neq \emptyset$; hence we obtain $x \in (i, j)\text{-}\mathcal{I}Int(X \setminus A)$. This shows that $X \setminus (i, j)\text{-}\mathcal{I}Cl(A) \subset (i, j)\text{-}\mathcal{I}Int(X \setminus A)$. Let $x \in (i, j)\text{-}\mathcal{I}Int(X \setminus A)$. Since $(i, j)\text{-}\mathcal{I}Int(X \setminus A) \cap A = \emptyset$, we obtain $x \notin (i, j)\text{-}\mathcal{I}Cl(A)$; hence $x \in X \setminus (i, j)\text{-}\mathcal{I}Cl(A)$. Therefore, we obtain $(i, j)\text{-}\mathcal{I}Int(X \setminus A) = X \setminus (i, j)\text{-}\mathcal{I}Cl(A)$.

(ii). Follows from (i). □

Definition 2.32. A subset B_x of an ideal bitopological space $(X, \tau_1, \tau_2, \mathcal{I})$ is said to be an (i, j) - \mathcal{I} -neighbourhood of a point $x \in X$ if there exists an (i, j) - \mathcal{I} -open set U such that $x \in U \subset B_x$.

Theorem 2.33. A subset of an ideal bitopological space $(X, \tau_1, \tau_2, \mathcal{I})$ is (i, j) - \mathcal{I} -open if and only if it is an (i, j) - \mathcal{I} -neighbourhood of each of its points.

Proof. Let G be an (i, j) - \mathcal{I} -open set of X . Then by definition, it is clear that G is an (i, j) - \mathcal{I} -neighbourhood of each of its points, since for every $x \in G$, $x \in G \subset G$ and G is (i, j) - \mathcal{I} -open. Conversely, suppose G is an (i, j) - \mathcal{I} -neighbourhood of each of its points. Then for each $x \in G$, there exists $S_x \in (i, j)\text{-}\mathcal{IO}(X)$ such that $S_x \subset G$. Then $G = \bigcup\{S_x : x \in G\}$. Since each S_x is (i, j) - \mathcal{I} -open and arbitrary union of (i, j) - \mathcal{I} -open sets is (i, j) - \mathcal{I} -open, G is (i, j) - \mathcal{I} -open in $(X, \tau_1, \tau_2, \mathcal{I})$. \square

3. (i, j) - \mathcal{I} -CONTINUOUS FUNCTIONS

Definition 3.1. A function $f : (X, \tau_1, \tau_2, \mathcal{I}) \rightarrow (Y, \sigma_1, \sigma_2)$ is said to be (i, j) - \mathcal{I} -continuous if for every $V \in \sigma_i$, $f^{-1}(V) \in (i, j)\text{-}\mathcal{IO}(X)$.

Remark 3.2. Every (i, j) - \mathcal{I} -continuous function is (i, j) -precontinuous but the converse is not true, in general.

Example 3.3. Let $X = \{a, b, c\}$, $\tau_1 = \{\emptyset, \{a\}, \{c\}, \{a, c\}, X\}$, $\tau_2 = \{\emptyset, \{b, c\}, X\}$, $\sigma_1 = \mathcal{P}(X)$, $\sigma_2 = \{\emptyset, \{a\}, \{a, c\}, X\}$ and $\mathcal{I} = \{\emptyset, \{c\}\}$. Then the identity function $f : (X, \tau_1, \tau_2, \mathcal{I}) \rightarrow (X, \sigma_1, \sigma_2)$ is $(1, 2)$ -precontinuous but not $(1, 2)$ - \mathcal{I} -continuous, because $\{c\} \in \sigma_1$, but $f^{-1}(\{c\}) = \{c\} \notin (1, 2)\text{-}\mathcal{IO}(X)$.

Remark 3.4. It is clear that $(1, 2)$ - \mathcal{I} -continuity and τ_1 -continuity (resp. τ_2 -continuity) are independent notions.

Example 3.5. Let $X = \{a, b, c\}$, $\tau_1 = \{\emptyset, \{b\}, X\}$, $\tau_2 = \{\emptyset, \{a, b\}, X\}$, $\sigma_1 = \{\emptyset, \{b\}, \{c\}, \{b, c\}, X\}$, $\sigma_2 = \{\emptyset, \{a\}, \{a, b\}, X\}$ and $\mathcal{I} = \{\emptyset, \{b\}\}$. Then the identity function $f : (X, \tau_1, \tau_2, \mathcal{I}) \rightarrow (X, \sigma_1, \sigma_2)$ is τ_1 -continuous but not $(1, 2)$ - \mathcal{I} -continuous, because $\{b\} \in \sigma_1$, but $f^{-1}(\{b\}) = \{b\} \notin (1, 2)\text{-}\mathcal{IO}(X)$.

Example 3.6. Let $X = \{a, b, c\}$, $\tau_1 = \{\emptyset, \{a, b\}, X\}$, $\tau_2 = \{\emptyset, \{a\}, \{a, b\}, X\}$, $\sigma_1 = \{\emptyset, \{b\}, \{b, c\}, X\}$, $\sigma_2 = \{\emptyset, \{b, c\}, X\}$ and $\mathcal{I} = \{\emptyset, \{b\}\}$. Then the identity function $f : (X, \tau_1, \tau_2, \mathcal{I}) \rightarrow (X, \sigma_1, \sigma_2)$ is $(1, 2)$ - \mathcal{I} -continuous but not τ_1 -continuous, because $f^{-1}(\{a\}) = \{a\} \in (1, 2)\text{-}\mathcal{IO}(X)$, but $\{a\} \notin \sigma_1$.

Example 3.7. Let $X = \{a, b, c\}$, $\tau_1 = \{\emptyset, \{a\}, \{a, c\}, X\}$, $\tau_2 = \{\emptyset, \{b\}, \{c\}, \{b, c\}, X\}$, $\sigma_1 = \{\emptyset, \{b, c\}, X\}$, $\sigma_2 = \{\emptyset, \{b\}, \{b, c\}, X\}$ and $\mathcal{I} = \{\emptyset, \{c\}\}$. Then the identity function $f : (X, \tau_1, \tau_2, \mathcal{I}) \rightarrow (X, \sigma_1, \sigma_2)$ is τ_2 -continuous but not $(1, 2)$ - \mathcal{I} -continuous, because $\{b\} \in \sigma_2$ but $f^{-1}(\{b\}) = \{b\} \notin (1, 2)\text{-}\mathcal{IO}(X)$.

Example 3.8. Let $X = \{a, b, c\}$, $\tau_1 = \{\emptyset, \{a\}, \{c\}, \{a, c\}, X\}$, $\tau_2 = \{\emptyset, \{b\}, \{b, c\}, X\}$, $\sigma_1 = \{\emptyset, \{a, c\}, X\}$, $\sigma_2 = \{\emptyset, \{b, c\}, X\}$ and $\mathcal{I} = \{\emptyset, \{c\}\}$. Then the identity function $f : (X, \tau_1, \tau_2, \mathcal{I}) \rightarrow (X, \sigma_1, \sigma_2)$ is $(1, 2)$ - \mathcal{I} -continuous but not τ_2 -continuous, because $\{a\} \notin \sigma_2$ but $f^{-1}(\{a\}) = \{a\} \in (1, 2)$ - $\mathcal{I}O(X)$.

Theorem 3.9. For a function $f : (X, \tau_1, \tau_2, \mathcal{I}) \rightarrow (Y, \sigma_1, \sigma_2)$, the following statements are equivalent:

- (i) f is pairwise \mathcal{I} -continuous;
- (ii) For each point x in X and each σ_j -open set F in Y such that $f(x) \in F$, there is a (i, j) - \mathcal{I} -open set A in X such that $x \in A$, $f(A) \subset F$;
- (iii) The inverse image of each σ_j -closed set in Y is (i, j) - \mathcal{I} -closed in X ;
- (iv) For each subset A of X , $f((i, j)\text{-}\mathcal{I}Cl(A)) \subset \sigma_j\text{-}Cl(f(A))$;
- (v) For each subset B of Y , $(i, j)\text{-}\mathcal{I}Cl(f^{-1}(B)) \subset f^{-1}(\sigma_j\text{-}Cl(B))$;
- (vi) For each subset C of Y , $f^{-1}(\sigma_j\text{-}Int(C)) \subset (i, j)\text{-}\mathcal{I}Int(f^{-1}(C))$.

Proof. (i) \Rightarrow (ii): Let $x \in X$ and F be a σ_j -open set of Y containing $f(x)$. By (i), $f^{-1}(F)$ is (i, j) - \mathcal{I} -open in X . Let $A = f^{-1}(F)$. Then $x \in A$ and $f(A) \subset F$.

(ii) \Rightarrow (i): Let F be σ_j -open in Y and let $x \in f^{-1}(F)$. Then $f(x) \in F$. By (ii), there is an (i, j) - \mathcal{I} -open set U_x in X such that $x \in U_x$ and $f(U_x) \subset F$. Then $x \in U_x \subset f^{-1}(F)$. Hence $f^{-1}(F)$ is (i, j) - \mathcal{I} -open in X .

(i) \Leftrightarrow (iii): This follows due to the fact that for any subset B of Y , $f^{-1}(Y \setminus B) = X \setminus f^{-1}(B)$.

(iii) \Rightarrow (iv): Let A be a subset of X . Since $A \subset f^{-1}(f(A))$ we have $A \subset f^{-1}(\sigma_j\text{-}Cl(f(A)))$. Now, $(i, j)\text{-}\mathcal{I}Cl(f(A))$ is σ_j -closed in Y and hence $f^{-1}(\sigma_j\text{-}Cl(f(A))) \subset f^{-1}(\sigma_j\text{-}Cl(f(A)))$, for $(i, j)\text{-}\mathcal{I}Cl(A)$ is the smallest (i, j) - \mathcal{I} -closed set containing A . Then $f((i, j)\text{-}\mathcal{I}Cl(A)) \subset \sigma_j\text{-}Cl(f(A))$.

(iv) \Rightarrow (iii): Let F be any (i, j) -pre- \mathcal{I} -closed subset of Y . Then $f((i, j)\text{-}\mathcal{I}Cl(f^{-1}(F))) \subset (i, j)\text{-}\sigma_i\text{-}Cl(f(f^{-1}(F))) = (i, j)\text{-}\sigma_i\text{-}Cl(F) = F$. Therefore, $(i, j)\text{-}\mathcal{I}Cl(f^{-1}(F)) \subset f^{-1}(F)$. Consequently, $f^{-1}(F)$ is (i, j) - \mathcal{I} -closed in X .

(iv) \Rightarrow (v): Let B be any subset of Y . Now, $f((i, j)\text{-}\mathcal{I}Cl(f^{-1}(B))) \subset \sigma_i\text{-}Cl(f(f^{-1}(B))) \subset \sigma_i\text{-}Cl(B)$. Consequently, $(i, j)\text{-}\mathcal{I}Cl(f^{-1}(B)) \subset f^{-1}(\sigma_i\text{-}Cl(B))$.

(v) \Rightarrow (iv): Let $B = f(A)$ where A is a subset of X . Then, $(i, j)\text{-}\mathcal{I}Cl(A) \subset (i, j)\text{-}\mathcal{I}Cl(f^{-1}(B)) \subset f^{-1}(\sigma_i\text{-}Cl(B)) = f^{-1}(\sigma_i\text{-}Cl(f(A)))$. This shows that $f((i, j)\text{-}\mathcal{I}Cl(A)) \subset \sigma_i\text{-}Cl(f(A))$.

(i) \Rightarrow (vi): Let B be a σ_j -open set in Y . Clearly, $f^{-1}(\sigma_i\text{-}Int(B))$ is (i, j) - \mathcal{I} -open and we have $f^{-1}(\sigma_i\text{-}Int(B)) \subset (i, j)\text{-}\mathcal{I}Int(f^{-1}\sigma_i\text{-}Int(B)) \subset (i, j)\text{-}\mathcal{I}Int(f^{-1}B)$.

(vi) \Rightarrow (i): Let B be a σ_j -open set in Y . Then $\sigma_i\text{-}Int(B) = B$ and $f^{-1}(B) \setminus f^{-1}(\sigma_i\text{-}Int(B)) \subset (i, j)\text{-}\mathcal{I}Int(f^{-1}(B))$. Hence we have $f^{-1}(B)$

$= (i, j)\text{-}\mathcal{I}\text{Int}(f^{-1}(B))$. This shows that $f^{-1}(B)$ is $(i, j)\text{-}\mathcal{I}$ -open in X . \square

Theorem 3.10. *Let $f : (X, \tau_1, \tau_2, \mathcal{I}) \rightarrow (Y, \sigma_1, \sigma_2)$ be $(i, j)\text{-}\mathcal{I}$ -continuous and σ_i -open function, then the inverse image of each $(i, j)\text{-}\mathcal{I}$ -open set in Y is $(i, j)\text{-preopen}$ in X .*

Proof. Let A be $(i, j)\text{-}\mathcal{I}$ -open. Then $A \subset \tau_i\text{-Int}(A_j^*)$. We have to prove $f^{-1}(A)$ is $(i, j)\text{-preopen}$ which implies $f^{-1}(A) \subset \tau_i\text{-Int}(\tau_j\text{-Cl}(f^{-1}(A)))$. For this, $f(A) = f(\tau_i\text{-Int}(A_j^*)) = \tau_i\text{-Int}(f(\tau_i\text{-Int}(A_j^*))) \subset \tau_i\text{-Int}(f(A_j^*))$, $A \subset f^{-1}(\tau_i\text{-Int}(f(A_j^*))) \subset \tau_i\text{-Int}(f^{-1}(\tau_i\text{-Int}(f(A_j^*))))_j^* \subset \tau_i\text{-Int}(A_j^*)_j^* \subset \tau_i\text{-Int}(A_j^*) \subset \tau_i\text{-Int}(A \cup A_j^*) = \tau_i\text{-Int}(\tau_j\text{-Cl}^*(A))$. Hence $f^{-1}(A) \subset \tau_i\text{-Int}(\tau_j\text{-Cl}^*(f^{-1}(A)))$. Therefore, $f^{-1}(A)$ is $(i, j)\text{-preopen}$ in X . \square

Theorem 3.11. *Let $f : (X, \tau_1, \tau_2, \mathcal{I}) \rightarrow (Y, \sigma_1, \sigma_2)$ be $(i, j)\text{-}\mathcal{I}$ -continuous and $f^{-1}(V_j^*) \subset (f^{-1}(V))_j^*$, for each $V \subset Y$. Then the inverse image of each $(i, j)\text{-}\mathcal{I}$ -open set is $(i, j)\text{-}\mathcal{I}$ -open.*

Remark 3.12. *The composition of two $(i, j)\text{-}\mathcal{I}$ -continuous functions need not be $(i, j)\text{-}\mathcal{I}$ -continuous, in general.*

Example 3.13. *Let $X = \{a, b, c\}$, $\tau_i = \{\emptyset, \{a, b\}, X\}$, $\tau_2 = \{\emptyset, \{a\}, \{a, b\}, X\}$, $\sigma_1 = \{\emptyset, \{b\}, \{b, c\}, X\}$, $\sigma_2 = \{\emptyset, \{b, c\}, X\}$, $\gamma_1 = \{\emptyset, \{a\}, \{c\}, \{a, c\}, X\}$, $\gamma_2 = \{\emptyset, \{b, c\}, X\}$, $\mathcal{I} = \{\emptyset, \{b\}\}$, $\mathcal{J} = \{\emptyset, \{c\}\}$ and let the function $f : (X, \tau_1, \tau_2, \mathcal{I}) \rightarrow (Y, \sigma_1, \sigma_2)$ is defined by $f(a) = b$, $f(b) = a$ and $f(c) = c$ and $g : (Y, \sigma_1, \sigma_2, \mathcal{J}) \rightarrow (Z, \gamma_1, \gamma_2)$ is defined by $g(a) = c$, $g(b) = a$ and $g(c) = a$. It is clear that both f and g are $(1, 2)\text{-}\mathcal{I}$ -continuous. However, the composition function $g \circ f$ is not $(1, 2)\text{-}\mathcal{I}$ -continuous, because $\{a\} \in \gamma_1$, but $(g \circ f)^{-1}(\{a\}) = \{c\} \notin (1, 2)\text{-}\mathcal{IO}(X)$.*

Theorem 3.14. *Let $f : (X, \tau_1, \tau_2, \mathcal{I}) \rightarrow (Y, \sigma_1, \sigma_2)$ and $g : (Y, \sigma_1, \sigma_2, \mathcal{J}) \rightarrow (Z, \mu_1, \mu_2)$. Then $g \circ f$ is $(i, j)\text{-}\mathcal{I}$ -continuous, if f is $(i, j)\text{-}\mathcal{I}$ -continuous and g is σ_j -continuous.*

Proof. Let $V \in \mu_j$. Since g is μ_j -continuous, then $g^{-1}(V) \in \sigma_j$. On the other hand, since f is $(i, j)\text{-}\mathcal{I}$ -continuous, we have $f^{-1}(g^{-1}(V)) \in (i, j)\text{-}\mathcal{IO}(X)$. Since $(g \circ f)^{-1}(V) = f^{-1}(g^{-1}(V))$, we obtain that $g \circ f$ is $(i, j)\text{-}\mathcal{I}$ -continuous. \square

4. $(i, j)\text{-}\mathcal{I}$ -OPEN AND $(i, j)\text{-}\mathcal{I}$ -CLOSED FUNCTIONS

Definition 4.1. *A function $f : (X, \tau_1, \tau_2) \rightarrow (Y, \sigma_1, \sigma_2, \mathcal{I})$ is said to be:*

- (i) *pairwise \mathcal{I} -open if $f(U)$ is a $(i, j)\text{-}\mathcal{I}$ -open set of Y for every τ_i -open set U of X .*
- (ii) *pairwise \mathcal{I} -closed if $f(U)$ is a $(i, j)\text{-}\mathcal{I}$ -closed set of Y for every τ_i -closed set U of X .*

Proposition 4.2. *Every $(i, j)\text{-}\mathcal{I}$ -open function is $(i, j)\text{-preopen}$ function but the converse is not true in general.*

Example 4.3. Let $X = \{a, b, c\}$, $\tau_1 = \{\emptyset, \{a\}, \{b, c\}, X\}$, $\tau_2 = \{\emptyset, \{b\}, \{a, b\}, \{b, c\}, X\}$, $\sigma_1 = \{\emptyset, \{a\}, X\}$, $\sigma_2 = \{\emptyset, \{b\}, \{c\}, \{b, c\}, X\}$ and $\mathcal{I} = \{\emptyset, \{a\}\}$. Then the function $f : (X, \tau_1, \tau_2) \rightarrow (X, \sigma_1, \sigma_2, \mathcal{I})$ is defined by $f(a) = b$, $f(b) = a$ and $f(c) = c$ is $(1, 2)$ -preopen but not $(1, 2)$ - \mathcal{I} -open, because $\{a\} \notin \tau_1$, but $f(\{a\}) = \{b\} \notin (1, 2)\text{-}\mathcal{IO}(Y)$.

Remark 4.4. Each of (i, j) - \mathcal{I} -open function and τ_i -open function are independent.

Example 4.5. Let $X = \{a, b, c\}$, $\tau_1 = \{\emptyset, \{b\}, \{b, c\}, X\}$, $\tau_2 = \{\emptyset, \{b, c\}, X\}$, $\sigma_1 = \{\emptyset, \{a\}, \{a, b\}, X\}$, $\sigma_2 = \{\emptyset, \{a\}, \{a, c\}, X\}$ and $\mathcal{I} = \{\emptyset, \{b\}\}$ on Y . Then the identity function $f : (X, \tau_1, \tau_2) \rightarrow (X, \sigma_1, \sigma_2, \mathcal{I})$ is $(1, 2)$ - \mathcal{I} -open function but not τ_1 -open, because $\{a\} \notin \tau_1$, but $f(\{a\}) = \{a\} \in (1, 2)\text{-}\mathcal{IO}(Y)$.

Example 4.6. Let $X = \{a, b, c\}$, $\tau_1 = \{\emptyset, \{a\}, \{b, c\}, X\}$, $\tau_2 = \{\emptyset, \{b, c\}, X\}$, $\sigma_1 = \{\emptyset, \{a\}, \{c\}, \{a, c\}, X\}$, $\sigma_2 = \{\emptyset, \{b\}, \{c\}, \{b, c\}, X\}$ and $\mathcal{I} = \{\emptyset, \{c\}\}$ on Y . Then the identity function $f : (X, \tau_1, \tau_2) \rightarrow (X, \sigma_1, \sigma_2, \mathcal{I})$ is defined by $f(a) = b = f(b)$ and $f(c) = c$ is τ_1 -open but not $(1, 2)$ - \mathcal{I} -open function, because $\{a\} \in \tau_1$, but $f(\{a\}) = \{b\} \notin (1, 2)\text{-}\mathcal{IO}(Y)$.

Theorem 4.7. For a function $f : (X, \tau_1, \tau_2) \rightarrow (Y, \sigma_1, \sigma_2, \mathcal{I})$, the following statements are equivalent:

- (i) f is pairwise \mathcal{I} -open;
- (ii) $f(\tau_i\text{-Int}(U)) \subset (i, j)\text{-}\mathcal{I}\text{Int}(f(U))$ for each subset U of X ;
- (iii) $\tau_i\text{-Int}(f^{-1}(V)) \subset f^{-1}((i, j)\text{-}\mathcal{I}\text{Int}(V))$ for each subset V of Y .

Proof. (i) \Rightarrow (ii): Let U be any subset of X . Then $\tau_i\text{-Int}(U)$ is a τ_i -open set of X . Then $f(\tau_i\text{-Int}(U))$ is a (i, j) - \mathcal{I} -open set of Y . Since $f(\tau_i\text{-Int}(U)) \subset f(U)$, $f(\tau_i\text{-Int}(U)) = (i, j)\text{-}\mathcal{I}\text{Int}(f(\tau_i\text{-Int}(U))) \subset (i, j)\text{-}\mathcal{I}\text{Int}(f(U))$.

(ii) \Rightarrow (iii): Let V be any subset of Y . Then $f^{-1}(V)$ is a subset of X . Hence $f(\tau_i\text{-Int}(f^{-1}(V))) \subset (i, j)\text{-}\mathcal{I}\text{Int}(f(f^{-1}(V))) \subset (i, j)\text{-}\mathcal{I}\text{Int}(V)$. Then $\tau_i\text{-Int}(f^{-1}(V)) \subset f^{-1}(f(\tau_i\text{-Int}(f^{-1}(V)))) \subset f^{-1}((i, j)\text{-}\mathcal{I}\text{Int}(V))$.

(iii) \Rightarrow (i): Let U be any τ_i -open set of X . Then $\tau_i\text{-Int}(U) = U$ and $f(U)$ is a subset of Y . Now, $V = \tau_i\text{-Int}(V) \subset \tau_i\text{-Int}(f^{-1}(f(V))) \subset f^{-1}((i, j)\text{-}\mathcal{I}\text{Int}(f(V)))$. Then $f(V) \subset f(f^{-1}((i, j)\text{-}\mathcal{I}\text{Int}(f(V)))) \subset (i, j)\text{-}\mathcal{I}\text{Int}(f(V))$ and $(i, j)\text{-}\mathcal{I}\text{Int}(f(V)) \subset f(V)$. Hence $f(V)$ is a (i, j) - \mathcal{I} -open set of Y ; hence f is pairwise \mathcal{I} -open. \square

Theorem 4.8. Let $f : (X, \tau_1, \tau_2) \rightarrow (Y, \sigma_1, \sigma_2, \mathcal{I})$ be a function. Then f is a pairwise \mathcal{I} -closed function if and only if for each subset V of X , $(i, j)\text{-}\mathcal{I}\text{Cl}(f(V)) \subset f(\tau_i\text{Cl}(V))$.

Proof. Let f be a pairwise \mathcal{I} -closed function and V any subset of X . Then $f(V) \subset f(\tau_i\text{-Cl}(V))$ and $f(\tau_i\text{-Cl}(V))$ is a (i, j) - \mathcal{I} -closed set of Y . We have $(i, j)\text{-}\mathcal{I}\text{Cl}(f(V)) \subset (i, j)\text{-}\mathcal{I}\text{Cl}(f(\tau_i\text{-Cl}(V))) = f(\tau_i\text{-Cl}(V))$. Conversely, let V be a τ_i -open set of X . Then $f(V) \subset (i, j)\text{-}\mathcal{I}\text{Cl}(f(V)) \subset f(\tau_i\text{-Cl}(V)) = f(V)$; hence $f(V)$ is a (i, j) - \mathcal{I} -closed subset of Y . Therefore, f is a pairwise \mathcal{I} -closed function. \square

Theorem 4.9. *Let $f : (X, \tau_1, \tau_2) \rightarrow (Y, \sigma_1, \sigma_2, \mathcal{I})$ be a function. Then f is a pairwise \mathcal{I} -closed function if and only if for each subset V of Y , $f^{-1}((i, j)\text{-}\mathcal{I}\text{Cl}(V)) \subset \tau_i\text{-Cl}(f^{-1}(V))$.*

Proof. Let V be any subset of Y . Then by Theorem 4.8, $(i, j)\text{-}\mathcal{I}\text{Cl}(V) \subset f(\tau_i\text{-Cl}(f^{-1}(V)))$. Since f is bijection, $f^{-1}((i, j)\text{-}\mathcal{I}\text{Cl}(V)) = f^{-1}((i, j)\text{-}\mathcal{I}\text{Cl}(f(f^{-1}(V)))) \subset f^{-1}(f(\tau_i\text{-Cl}(f^{-1}(V)))) = \tau_i\text{-Cl}(f^{-1}(V))$. Conversely, let U be any subset of X . Since f is bijection, $(i, j)\text{-}\mathcal{I}\text{Cl}(f(U)) = f(f^{-1}((i, j)\text{-}\mathcal{I}\text{Cl}(f(U)))) \subset f(\tau_i\text{-Cl}(f^{-1}(f(U)))) = f(\tau_i\text{-Cl}(U))$. Therefore, by Theorem 4.8, f is a pairwise \mathcal{I} -closed function. \square

Theorem 4.10. *Let $f : (X, \tau_1, \tau_2) \rightarrow (Y, \sigma_1, \sigma_2, \mathcal{I})$ be a pairwise \mathcal{I} -open function. If V is a subset of Y and U is a τ_i -closed subset of X containing $f^{-1}(V)$, then there exists a $(i, j)\text{-}\mathcal{I}$ -closed set F of Y containing V such that $f^{-1}(F) \subset U$.*

Proof. Let V be any subset of Y and U a τ_i -closed subset of X containing $f^{-1}(V)$, and let $F = Y \setminus (f(X \setminus U))$. Then $f(X \setminus U) \subset f(f^{-1}(X \setminus U)) \subset X \setminus U$ and $X \setminus U$ is a τ_i -open set of X . Since f is pairwise \mathcal{I} -open, $f(X \setminus U)$ is a $(i, j)\text{-}\mathcal{I}$ -open set of Y . Hence F is an $(i, j)\text{-}\mathcal{I}$ -closed set of Y and $f^{-1}(F) = f^{-1}(Y \setminus (f(X \setminus U))) \subset U$. \square

Theorem 4.11. *Let $f : (X, \tau_1, \tau_2) \rightarrow (Y, \sigma_1, \sigma_2, \mathcal{I})$ be a pairwise \mathcal{I} -closed function. If V is a subset of Y and U is a open subset of X containing $f^{-1}(V)$, then there exists $(i, j)\text{-}\mathcal{I}$ -open set F of Y containing V such that $f^{-1}(F) \subset U$.*

Proof. The proof is similar to the Theorem 4.10. \square

REFERENCES

- [1] M. E. Abd El-Monsef, E. F. Lashien and A. A. Nasef, *On I-open sets and I-continuous functions*, Kyungpook Math. J., 32(1992), 21-30.
- [2] F. G. Arenas, J. Dontchev, M. L. Puertas, *Idealization of some weak separation axioms*, Acta Math. Hungar. 89 (2000), no. 1-2, 47-53.
- [3] S. Bose, *Semiopen sets, semi continuity and semiopen mappings in bitopological spaces*, Bull. Cal. Math. Soc., 73(1981), 237-246.
- [4] M. Caldas, S. Jafari and N. Rajesh, *Preopen sets in ideal Bitopological spaces*, Bol. Soc. Parana. Mat. (3) 29 (2011), no. 2, 61-68.
- [5] M. Caldas, S. Jafari and N. Rajesh, *Some fundamental properties of β -open sets in ideal bitopological spaces*, Eur. J. Pure Appl. Math. 6 (2013), no. 2, 247-255.
- [6] A. I. El-Maghrabi, M. Caldas, S. Jafari, R. M. Latif, A. Nasef, N. Rajesh and S. Shanthi, *Properties of ideal bitopological α -open sets*, Dedicated to Prof. Valeriu Popa on the occasion of his 80th birthday, Journal of scientific studies and research series, Mathematics and Informatics, Romania (to appear)
- [7] J. Dontchev, M. Ganster, *On compactness with respect to countable extensions of ideals and the generalized Banach category theorem*, Third Iberoamerican Conference on Topology and its Applications (Valencia, 1999). Acta Math. Hungar. 88 (2000), no. 1-2, 53-58.
- [8] J. Dontchev, M. Ganster and T. Noiri, *Unified operation approach of generalized closed sets via topological ideals*, Math. Japonica 49 (3) (1999), 395-401.

- [9] J. Dontchev, M. Ganster and D. Rose, *Ideal Resolvability*, Topology Appl. 93 (1999) , 1-16.
- [10] D. N. Georgiou and B. K. Papadopoulos, *Ideals and its [their] applications*, J. Inst. Math. Comput. Sci. Math. Ser. 9 (1996), no. 1, 105-117.
- [11] D. N. Georgiou, S. D. Iliadis, A. C. Megaritis, G. A. Prinos, *Ideal-convergence classes*, Topology Appl. 222 (2017), 217-226.
- [12] T. R. Hamlett and D. Janković, *Ideals in topological spaces and the set operator*, Boll. U.M.I., 7(1990), 863-874.
- [13] T. R. Hamlett and D. Janković, *Ideals in General Topology, General Topology and Applications*, (Middletown, CT, 1988), 115-125; SE: Lecture Notes in Pure & Appl. Math., 123(1990), Dekker, New York.
- [14] E. Hatir, A. Al-omari, S. Jafari, δ -local function and its properties in ideal topological spaces, Fasc. Math. No. 53 (2014), 53-64.
- [15] S. Jafari, A. Selvakumar, M. Parimala, *Operation approach of g^* -closed sets in ideal topological spaces*, An. Univ. Oradea Fasc. Mat. 22 (2015), no. 1, 119-123.
- [16] M. Jelic, *A decomposition of pairwise continuity*, J. Inst. Math. Comput. Sci. Math. Sci., 3(1990), 25-29.
- [17] D. Janković and T. R. Hamlett, *New topologies from old via ideals*, Amer. Math. Monthly, 97(1990), 295-310.
- [18] D. Janković and T. R. Hamlett, *Compatible extensions of ideals*, Boll. U.M.I., 7(6-B)(1992), 453-465.
- [19] K. Kuratowski, *Topology*, Academic semiss, New York, (1966).
- [20] N. Levine, *Semi-open sets and semi-continuity in topological spaces*, Amer. Math. Monthly 70(1963), 36-41.
- [21] F. I. Michael, *On semiopen sets with respect to an ideal*, European. J. Pure and Applied Math. 6(1)(2013), 53-58.
- [22] T. Noiri, M. Rajamani, M. Maheswari, *A decomposition of pairwise continuity via ideals*, Bol. Soc. Parana. Mat. (3) 34 (2016), no. 1, 141-149.
- [23] H. Maki, Jun-Iti Umehara, *Topological ideals and operations*, Questions Answers Gen. Topology 29 (2011), no. 1, 57-71.
- [24] R. Vaidyanathaswamy, *The localisation theory in set topology*, Proc. Indian Acad. Sci., 20(1945), 51-61.

Neutrosophic \mathfrak{N} -ideals in semigroups

Balasubramanian Elavarasan, Florentin Smarandache, Young Bae Jun

Balasubramanian Elavarasan, Florentin Smarandache, Young Bae Jun (2019). Neutrosophic \mathfrak{N} -ideals in semigroups. *Neutrosophic Sets and Systems* 28, 273-280

Abstract: The aim of this paper is to introduce the notion of neutrosophic \mathfrak{N} –ideals in semigroups and investigate their properties. Conditions for neutrosophic \mathfrak{N} –structure to be a neutrosophic \mathfrak{N} –ideal are provided. We also discuss the concept of characteristic neutrosophic \mathfrak{N} –structure of semigroups and its related properties.

Keywords: Semigroup; neutrosophic \mathfrak{N} – structure; neutrosophic \mathfrak{N} – ideals, neutrosophic \mathfrak{N} –product.

1. Introduction

Throughout this paper, S denotes a semigroup and for any subsets A and B of S , the multiplication of A and B is defined as $AB = \{ab|a \in A \text{ and } b \in B\}$. A nonempty subset A of S is called a subsemigroup of S if $A^2 \subseteq A$. A subsemigroup A of S is called a left (resp., right) ideal of S if $AX \subseteq A$ (resp., $XA \subseteq A$). A subset A of S is called two-sided ideal or ideal of S if it is both a left and right ideal of S .

L.A. Zadeh introduced the concept of fuzzy subsets of a well-defined set in his paper [17] for modeling the vague concepts in the real world. K. T. Atanassov [1] introduced the notion of an Intuitionistic fuzzy set as a generalization of a fuzzy set. In fact from his point of view for each element of the universe there are two degrees, one a degree of membership to a vague subset and the other is a degree of non-membership to that given subset. Many researchers have been working on the theory of this subject and developed it in interesting different branches.

As a more general platform which extends the notions of the classic set and fuzzy set, intuitionistic fuzzy set and interval valued (intuitionistic) fuzzy set, Smarandache introduced the notion of neutrosophic sets (see [15, 16]), which is useful mathematical tool for dealing with incomplete, inconsistent and indeterminate information. This concept has been extensively studied and investigated by several authors in different fields (see [2 – 8] and [10 – 14]).

For further particulars on neutrosophic set theory, we refer the readers to the site <http://fs.gallup.unm.edu/FlorentinSmarandache.htm>

In [9], M. Khan et al. introduced the notion of neutrosophic \mathfrak{N} –subsemigroup in semigroup and investigated several properties. It motivates us to define the notion of neutrosophic \mathfrak{N} –ideal in semigroup. In this paper, the notion of neutrosophic \mathfrak{N} –ideals in semigroups is introduced and several properties are investigated. Conditions for neutrosophic \mathfrak{N} –structure to be neutrosophic \mathfrak{N} –ideal are provided. We also discuss the concept of characteristic neutrosophic \mathfrak{N} –structure of semigroups and its related properties.

2. Neutrosophic \aleph - structures

This section explains some basic definitions of neutrosophic \aleph – structures of a semigroup S that have been used in the sequel and introduce the notion of neutrosophic \aleph – ideals in semigroups.

The collection of function from a set S to $[-1, 0]$ is denoted by $\mathfrak{F}(S, [-1, 0])$. An element of $\mathfrak{F}(S, [-1, 0])$ is called a negative-valued function from S to $[-1, 0]$ (briefly, \aleph – function on S). By a \aleph –structure, we mean an ordered pair (S, g) of S and a \aleph –function g on S .

For any family $\{x_i \mid i \in \Lambda\}$ of real numbers, we define:

$$\bigvee \{x_i \mid i \in \Lambda\} := \begin{cases} \max \{x_i \mid i \in \Lambda\} & \text{if } \Lambda \text{ is finite} \\ \sup \{x_i \mid i \in \Lambda\} & \text{if } \Lambda \text{ is infinite} \end{cases}$$

and

$$\bigwedge \{x_i \mid i \in \Lambda\} := \begin{cases} \min \{x_i \mid i \in \Lambda\} & \text{if } \Lambda \text{ is finite} \\ \inf \{x_i \mid i \in \Lambda\} & \text{if } \Lambda \text{ is infinite} \end{cases}$$

For any real numbers x and y , we also use $x \vee y$ and $x \wedge y$ instead of $\bigvee \{x, y\}$ and $\bigwedge \{x, y\}$ respectively.

Definition 2.1. [9] A neutrosophic \aleph – structure over S defined to be the structure:

$$\mathbf{S}_N := \frac{S}{(T_N, I_N, F_N)} = \left\{ \frac{x}{(T_N(x), I_N(x), F_N(x))} \mid x \in S \right\},$$

where T_N, I_N and F_N are \aleph – functions on S which are called the negative truth membership function, the negative indeterminacy membership function and the negative falsity membership function, respectively, on S . It is clear that for any neutrosophic \aleph – structure \mathbf{S}_N over S , we have $-3 \leq T_N(y) + I_N(y) + F_N(y) \leq 0$ for all $y \in S$.

Definition 2.2. [9] Let $\mathbf{S}_N := \frac{S}{(T_N, I_N, F_N)}$ and $\mathbf{S}_M := \frac{S}{(T_M, I_M, F_M)}$ be neutrosophic \aleph –structures over S . Then

(i) \mathbf{S}_N is called a neutrosophic \aleph – substructure of \mathbf{S}_M over S , denote by $\mathbf{S}_N \subseteq \mathbf{S}_M$, if $T_N(s) \geq T_M(s), I_N(s) \leq I_M(s), F_N(s) \geq F_M(s)$ for all $s \in S$.

If $\mathbf{S}_N \subseteq \mathbf{S}_M$ and $\mathbf{S}_M \subseteq \mathbf{S}_N$, then we say that $\mathbf{S}_N = \mathbf{S}_M$.

(ii) The neutrosophic \aleph – product of \mathbf{S}_N and \mathbf{S}_M is defined to be a neutrosophic \aleph –structure over S

$$\mathbf{S}_N \odot \mathbf{S}_M := \frac{S}{(T_{N \circ M}, I_{N \circ M}, F_{N \circ M})} = \left\{ \frac{s}{(T_{N \circ M}(s), I_{N \circ M}(s), F_{N \circ M}(s))} \mid s \in S \right\},$$

where

$$T_{N \circ M}(s) = \begin{cases} \bigwedge_{s=uv} \{T_N(u) \vee T_M(v)\} & \text{if } \exists u, v \in S \text{ such that } s = uv \\ 0 & \text{otherwise,} \end{cases}$$

$$I_{N \circ M}(s) = \begin{cases} \bigvee_{s=uv} \{I_N(u) \wedge I_M(v)\} & \text{if } \exists u, v \in S \text{ such that } s = uv \\ 0 & \text{otherwise,} \end{cases}$$

$$F_{N \circ M}(s) = \begin{cases} \bigwedge_{s=uv} \{F_N(u) \vee F_M(v)\} & \text{if } \exists u, v \in S \text{ such that } s = uv \\ 0 & \text{otherwise.} \end{cases}$$

For $s \in S$, the element $\frac{s}{(T_{N \circ M}, I_{N \circ M}, F_{N \circ M})}$ is simply denoted by $(\mathbf{S}_N \odot \mathbf{S}_M)(s) = (T_{N \circ M}(s), I_{N \circ M}(s), F_{N \circ M}(s))$ for the sake of convenience.

(iii) The union of \mathbf{S}_N and \mathbf{S}_M is defined to be a neutrosophic \aleph –structure over S

$$\mathbf{S}_{NUM} = (S; T_{NUM}, I_{NUM}, F_{NUM}),$$

where

$$T_{NUM}(a) = T_N(a) \wedge T_M(a),$$

$$I_{N \cup M}(a) = I_N(a) \vee I_M(a),$$

$$F_{N \cup M}(a) = F_N(a) \wedge F_M(a) \text{ for all } a \in S.$$

(iv) The intersection of S_N and S_M is defined to be a neutrosophic \aleph -structure over S

$$S_{N \cap M} = (S; T_{N \cap M}, I_{N \cap M}, F_{N \cap M}),$$

where

$$T_{N \cap M}(a) = T_N(a) \vee T_M(a),$$

$$I_{N \cap M}(a) = I_N(a) \wedge I_M(a),$$

$$F_{N \cap M}(a) = F_N(a) \vee F_M(a) \text{ for all } a \in S.$$

Definition 2.3. [9] A neutrosophic \aleph -structure S_N over S is called a neutrosophic \aleph -subsemigroup of S if it satisfies:

$$(\forall a, b \in S) \begin{pmatrix} T_N(ab) \leq T_N(a) \vee T_N(b) \\ I_N(ab) \geq I_N(a) \vee I_N(b) \\ F_N(ab) \leq F_N(a) \vee F_N(b) \end{pmatrix}.$$

Definition 2.4. A neutrosophic \aleph -structure S_N over S is called a neutrosophic \aleph -left (resp., right) ideal of S if it satisfies:

$$(\forall a, b \in S) \begin{pmatrix} T_N(ab) \leq T_N(a) \text{ (resp., } T_N(ab) \leq T_N(b)) \\ I_N(ab) \geq I_N(a) \text{ (resp., } I_N(ab) \geq I_N(b)) \\ F_N(ab) \leq F_N(a) \text{ (resp., } F_N(ab) \leq F_N(b)) \end{pmatrix}.$$

If S_N is both a neutrosophic \aleph -left and neutrosophic \aleph -right ideal of S , then it called a neutrosophic \aleph -ideal of S .

It is clear that every neutrosophic \aleph -left and neutrosophic \aleph -right ideal of S is a neutrosophic \aleph -subsemigroup of S , but neutrosophic \aleph -subsemigroup of S is need not to be either a neutrosophic \aleph -left or a neutrosophic \aleph -right ideal of S as can be seen by the following example.

Example 2.5. Let $S = \{0, 1, 2, 3, 4, 5\}$ be a semigroup with the following multiplication table:

.	0	1	2	3	4	5
0	0	0	0	0	0	0
1	0	1	1	1	1	1
2	0	1	2	3	1	1
3	0	1	1	1	2	3
4	0	1	4	5	1	1
5	0	1	1	1	4	5

Then $S_N = \left\{ \frac{0}{(-0.9, -0.1, -0.8)}, \frac{1}{(-0.5, -0.2, -0.6)}, \frac{2}{(-0.1, -0.8, -0.1)}, \frac{3}{(-0.3, -0.6, -0.4)}, \frac{4}{(-0.1, -0.8, -0.1)}, \frac{5}{(-0.4, -0.3, -0.5)} \right\}$ is a neutrosophic \aleph -subsemigroup of S , but not a neutrosophic \aleph -left ideal of S as $T_N(3.5) \not\leq T_N(5), I_N(3.5) \not\geq I_N(5)$ and $F_N(3.5) \not\leq F_N(5)$.

□

Example 2.6. Let $S = \{a, b, c, d\}$ be a semigroup with the following multiplication table:

.	a	b	c	d
a	a	a	a	a
b	a	a	a	a
c	a	a	b	a
d	a	a	b	b

Then $S_N = \left\{ \frac{a}{(-0.9, -0.1, -0.8)}, \frac{b}{(-0.5, -0.2, -0.6)}, \frac{c}{(-0.3, -0.3, -0.4)}, \frac{d}{(-0.4, -0.2, -0.5)} \right\}$ is a neutrosophic \aleph -ideal of S . □

Definition 2.7. For a subset A of S , consider the neutrosophic \aleph – structure

$$\chi_A(S_N) = \frac{S}{(\chi_A(T)_N, \chi_A(I)_N, \chi_A(F)_N)}$$

where

$$\chi_A(T)_N : S \rightarrow [-1, 0], s \rightarrow \begin{cases} -1 & \text{if } s \in A \\ 0 & \text{otherwise} \end{cases}$$

$$\chi_A(I)_N : S \rightarrow [-1, 0], s \rightarrow \begin{cases} 0 & \text{if } s \in A \\ -1 & \text{otherwise} \end{cases}$$

$$\chi_A(F)_N : S \rightarrow [-1, 0], s \rightarrow \begin{cases} -1 & \text{if } s \in A \\ 0 & \text{otherwise} \end{cases}$$

which is called the characteristic neutrosophic \aleph – structure of S .

Definition 2.8. [9] Let S_N be a neutrosophic \aleph – structure over S and let $\alpha, \beta, \gamma \in [-1, 0]$ be such that $-3 \leq \alpha + \beta + \gamma \leq 0$. Consider the following sets:

$$T_N^\alpha = \{s \in S : T_N(s) \leq \alpha\},$$

$$I_N^\beta = \{s \in S : I_N(s) \geq \beta\},$$

$$F_N^\gamma = \{s \in S : F_N(s) \leq \gamma\}.$$

The set $S_N(\alpha, \beta, \gamma) := \{s \in S \mid T_N(s) \leq \alpha, I_N(s) \geq \beta, F_N(s) \leq \gamma\}$ is called a (α, β, γ) -level set of S_N . Note that $S_N(\alpha, \beta, \gamma) = T_N^\alpha \cap I_N^\beta \cap F_N^\gamma$.

3. Neutrosophic \aleph – ideals

Theorem 3.1 Let S_N be a neutrosophic \aleph – structure over S and let $\alpha, \beta, \gamma \in [-1, 0]$ be such that $-3 \leq \alpha + \beta + \gamma \leq 0$. If S_N is a neutrosophic \aleph – left (resp., right) ideal of S , then (α, β, γ) – level set of S_N is a neutrosophic left (resp., right) ideal of S whenever it is non-empty.

Proof: Assume that $S_N(\alpha, \beta, \gamma) \neq \emptyset$ for $\alpha, \beta, \gamma \in [-1, 0]$ with $-3 \leq \alpha + \beta + \gamma \leq 0$. Let S_N be a neutrosophic \aleph – left ideal of S and let $x, y \in S_N(\alpha, \beta, \gamma)$. Then $T_N(xy) \leq T_N(x) \leq \alpha; I_N(xy) \geq I_N(x) \geq \beta$ and $F_N(xy) \leq F_N(x) \leq \gamma$ which imply $xy \in S_N(\alpha, \beta, \gamma)$. Therefore $S_N(\alpha, \beta, \gamma)$ is a neutrosophic \aleph – left ideal of S . □

Theorem 3.2. Let S_N be a neutrosophic \aleph – structure over S and let $\alpha, \beta, \gamma \in [-1, 0]$ be such that $-3 \leq \alpha + \beta + \gamma \leq 0$. If $T_N^\alpha; I_N^\beta$ and F_N^γ are left (resp., right) ideals of S , then S_N is a neutrosophic \aleph –left (resp., right) ideal of S whenever it is non-empty.

Proof: If there are $a, b \in S$ such that $T_N(ab) > T_N(a)$. Then $T_N(ab) > t_\alpha \geq T_N(a)$ for some $t_\alpha \in [-1, 0]$. Thus $a \in T_N^{t_\alpha}(a)$, but $ab \notin T_N^{t_\alpha}(a)$, a contradiction. So $T_N(ab) \leq T_N(a)$. Similar way we can get $T_N(ab) \leq T_N(b)$.

If there are $a, b \in S$ such that $I_N(ab) < I_N(a)$. Then $I_N(ab) < t_\beta \leq I_N(a)$ for some $t_\beta \in (-1, 0]$. Thus $a \in I_N^{t_\beta}(a)$, but $ab \notin I_N^{t_\beta}(a)$, a contradiction. So $I_N(ab) \geq I_N(a)$. Similar way we can get $I_N(ab) \geq I_N(b)$.

If there are $a, b \in S$ such that $F_N(ab) > F_N(a)$. Then $F_N(ab) > t_\gamma \geq F_N(a)$ for some $t_\gamma \in [-1, 0]$. Thus $a \in F_N^{t_\gamma}(a)$, but $ab \notin F_N^{t_\gamma}(a)$, a contradiction. So $F_N(ab) \leq F_N(a)$. Similar way we can get $F_N(ab) \leq F_N(b)$.

Hence S_N is a neutrosophic \aleph –left ideal of S . □

Theorem 3.3. Let S be a semigroup. Then the intersection of two neutrosophic \aleph –left (resp., right) ideals of S is also a neutrosophic \aleph –left (resp., right) ideal of S .

Proof: Let $S_N := \frac{S}{(T_N, I_N, F_N)}$ and $S_M := \frac{S}{(T_M, I_M, F_M)}$ be neutrosophic \aleph –left ideals of S . Then for any $x, y \in S$, we have

$$\begin{aligned} T_{N \cap M}(xy) &= T_N(xy) \vee T_M(xy) \leq T_N(y) \vee T_M(y) = T_{N \cap M}(y), \\ I_{N \cap M}(xy) &= I_N(xy) \wedge I_M(xy) \geq I_N(y) \wedge I_M(y) = I_{N \cap M}(y), \\ F_{N \cap M}(xy) &= F_N(xy) \vee F_M(xy) \leq F_N(y) \vee F_M(y) = F_{N \cap M}(y). \end{aligned}$$

Therefore $X_{N \cap M}$ is a neutrosophic \mathfrak{N} -left ideal of S .

□

Corollary 3.4. Let S be a semigroup. Then $\{X_{N_i} | i \in \mathbb{N}\}$ is a family of neutrosophic \mathfrak{N} -left (resp., right) ideals of S , then so is $X_{\cap N_i}$.

Theorem 3.5. For any non-empty subset A of S , the following conditions are equivalent:

- (i) A is a neutrosophic \mathfrak{N} -left (resp., right) ideal of S ,
- (ii) The characteristic neutrosophic \mathfrak{N} -structure $\chi_A(X_N)$ over S is a neutrosophic \mathfrak{N} -left (resp., right) ideal of S .

Proof: Assume that A is a neutrosophic \mathfrak{N} -left ideal of S . For any $x, y \in A$.

If $y \notin A$, then $\chi_A(T)_N(xy) \leq 0 = \chi_A(T)_N(y)$; $\chi_A(I)_N(xy) \geq -1 = \chi_A(I)_N(y)$ and $\chi_A(F)_N(xy) \leq 0 = \chi_A(F)_N(y)$. Otherwise $y \in A$. Then $xy \in A$, so $\chi_A(T)_N(xy) = -1 = \chi_A(T)_N(y)$; $\chi_A(I)_N(xy) = 0 = \chi_A(I)_N(y)$ and $\chi_A(F)_N(xy) = -1 = \chi_A(F)_N(y)$. Therefore $\chi_A(S_N)$ is a neutrosophic \mathfrak{N} -left ideal of S .

Conversely, assume that $\chi_A(S_N)$ is a neutrosophic \mathfrak{N} -left ideal of S . Let $a \in A$ and $x \in S$. Then $\chi_A(T)_N(xa) \leq \chi_A(T)_N(a) = -1$, $\chi_A(I)_N(xa) \geq \chi_A(I)_N(a) = 0$ and $\chi_A(F)_N(xa) \leq \chi_A(F)_N(a) = -1$. Thus $\chi_A(T)_N(xa) = -1$, $\chi_A(I)_N(xa) = 0$ and $\chi_A(F)_N(xa) = -1$ and hence $xa \in A$. Therefore A is a neutrosophic \mathfrak{N} -left ideal of S . □

Theorem 3.6. Let $\chi_A(S_N)$ and $\chi_B(S_N)$ be characteristic neutrosophic \mathfrak{N} -structure over S for subsets A and B of S . Then

- (i) $\chi_A(S_N) \cap \chi_B(S_N) = \chi_{A \cap B}(S_N)$.
- (ii) $\chi_A(S_N) \odot \chi_B(S_N) = \chi_{AB}(S_N)$.

Proof: (i) Let $s \in S$.

If $s \in A \cap B$, then

$$\begin{aligned} (\chi_A(T)_N \cap \chi_B(T)_N)(s) &= \chi_A(T)_N(s) \vee \chi_B(T)_N(s) = -1 = \chi_{A \cap B}(T)_N(s), \\ (\chi_A(I)_N \cap \chi_B(I)_N)(s) &= \chi_A(I)_N(s) \wedge \chi_B(I)_N(s) = 0 = \chi_{A \cap B}(I)_N(s), \\ (\chi_A(F)_N \cap \chi_B(F)_N)(s) &= \chi_A(F)_N(s) \vee \chi_B(F)_N(s) = -1 = \chi_{A \cap B}(F)_N(s). \end{aligned}$$

Hence $\chi_A(S_N) \cap \chi_B(S_N) = \chi_{A \cap B}(S_N)$.

If $s \notin A \cap B$, then $s \notin A$ or $s \notin B$. Thus

$$\begin{aligned} (\chi_A(T)_N \cap \chi_B(T)_N)(s) &= \chi_A(T)_N(s) \vee \chi_B(T)_N(s) = 0 = \chi_{A \cap B}(T)_N(s), \\ (\chi_A(I)_N \cap \chi_B(I)_N)(s) &= \chi_A(I)_N(s) \wedge \chi_B(I)_N(s) = -1 = \chi_{A \cap B}(I)_N(s), \\ (\chi_A(F)_N \cap \chi_B(F)_N)(s) &= \chi_A(F)_N(s) \vee \chi_B(F)_N(s) = 0 = \chi_{A \cap B}(F)_N(s). \end{aligned}$$

Hence $\chi_A(S_N) \cap \chi_B(S_N) = \chi_{A \cap B}(S_N)$.

- (ii) Let $x \in S$. If $x \in AB$, then $x = ab$ for some $a \in A$ and $b \in B$.

Now

$$\begin{aligned} (\chi_A(T)_N \circ \chi_B(T)_N)(x) &= \bigwedge_{x=st} \{ \chi_A(T)_N(s) \vee \chi_B(T)_N(t) \} \\ &\leq \chi_A(T)_N(a) \vee \chi_B(T)_N(b) \\ &= -1 = \chi_{AB}(T)_N(x), \\ (\chi_A(I)_N \circ \chi_B(I)_N)(x) &= \bigvee_{x=st} \{ \chi_A(I)_N(s) \wedge \chi_B(I)_N(t) \} \\ &\geq \chi_A(I)_N(a) \wedge \chi_B(I)_N(b) \\ &= 0 = \chi_{AB}(I)_N(x), \\ (\chi_A(F)_N \circ \chi_B(F)_N)(x) &= \bigwedge_{x=st} \{ \chi_A(F)_N(s) \vee \chi_B(F)_N(t) \} \end{aligned}$$

$$\begin{aligned} &\leq \chi_A(F)_N(a) \vee (\chi_B(F)_N(b)) \\ &= -1 = \chi_{AB}(F)_N(x). \end{aligned}$$

Therefore $\chi_A(S_N) \odot \chi_B(S_N) = \chi_{AB}(S_N)$. □

Note 3.7. Let $S_N := \frac{S}{(T_N, I_N, F_N)}$ and $S_M := \frac{S}{(T_M, I_M, F_M)}$ be neutrosophic \aleph -structures over S . Then for any subsets A and B of S , we have

$$(i) \chi_{A \cap B}(S_N \cap S_M) = (S: \chi_{A \cap B}(T)_{N \cap M}, \chi_{A \cap B}(I)_{N \cap M}, \chi_{A \cap B}(F)_{N \cap M}),$$

where

$$\begin{aligned} \chi_{A \cap B}(T)_{N \cap M}(s) &= \chi_{A \cap B}(T)_N(s) \vee \chi_{A \cap B}(T)_M(s), \\ \chi_{A \cap B}(I)_{N \cap M}(s) &= \chi_{A \cap B}(I)_N(s) \wedge \chi_{A \cap B}(I)_M(s), \\ \chi_{A \cap B}(F)_{N \cap M}(s) &= \chi_{A \cap B}(F)_N(s) \vee \chi_{A \cap B}(F)_M(s) \text{ for } s \in S. \end{aligned}$$

$$(ii) \chi_{A \cup B}(S_N \cap S_M) = (S: \chi_{A \cup B}(T)_{N \cup M}, \chi_{A \cup B}(I)_{N \cup M}, \chi_{A \cup B}(F)_{N \cup M}),$$

where

$$\begin{aligned} \chi_{A \cup B}(T)_{N \cup M}(s) &= \chi_{A \cup B}(T)_N(s) \wedge \chi_{A \cup B}(T)_M(s), \\ \chi_{A \cup B}(I)_{N \cup M}(s) &= \chi_{A \cup B}(I)_N(s) \vee \chi_{A \cup B}(I)_M(s), \\ \chi_{A \cup B}(F)_{N \cup M}(s) &= \chi_{A \cup B}(F)_N(s) \wedge \chi_{A \cup B}(F)_M(s) \text{ for } s \in S. \end{aligned}$$

Theorem 3.8. Let S_M be a neutrosophic \aleph -structure over S . Then S_M is a neutrosophic \aleph -left ideal of S if and only if $S_N \odot S_M \subseteq S_M$ for any neutrosophic \aleph -structure S_N over S .

Proof: Assume that S_M is a neutrosophic \aleph -left ideal of S and let $s, t, u \in S$. If $s = tu$, then

$$T_M(s) = T_M(tu) \leq T_M(u) \leq T_M(t) \vee T_M(u) \text{ which implies } T_M(s) \leq T_{N \circ M}(s). \text{ Otherwise } s \neq tu.$$

Then $T_M(s) \leq 0 = T_{N \circ M}(s)$.

$$I_M(s) = I_M(tu) \geq I_M(u) \geq I_M(t) \wedge I_M(u) \text{ which implies } I_M(s) \geq I_{N \circ M}(s). \text{ Otherwise } s \neq tu.$$

Then $I_M(s) \geq -1 = I_{N \circ M}(s)$.

$$F_M(s) = F_M(tu) \leq F_M(u) \leq F_M(t) \vee F_M(u) \text{ which implies } F_M(s) \leq F_{N \circ M}(s). \text{ Otherwise } s \neq tu.$$

Then $F_M(s) \leq 0 = F_{N \circ M}(s)$.

Conversely, assume that S_M is a neutrosophic \aleph -structure over S such that $S_N \odot S_M \subseteq S_M$ for any neutrosophic \aleph -structure S_N over S . Let $x, y \in S$. If $a = xy$, then

$$T_M(xy) = T_M(a) \leq (\chi_X(T)_N \circ T_M)(a) = \bigwedge_{a=st} \{\chi_X(T)_N(s) \vee T_M(t)\} \leq \chi_X(T)_N(x) \vee T_M(y) = T_M(y),$$

$$I_M(xy) = I_M(a) \geq (\chi_X(I)_N \circ I_M)(a) = \bigvee_{a=st} \{\chi_X(I)_N(s) \wedge I_M(t)\} \geq \chi_X(I)_N(x) \wedge I_M(y) = I_M(y),$$

$$F_M(xy) = F_M(a) \leq (\chi_X(F)_N \circ F_M)(a) = \bigwedge_{a=st} \{\chi_X(F)_N(s) \vee F_M(t)\} \leq \chi_X(F)_N(x) \vee F_M(y) = F_M(y).$$

Therefore S_M is a neutrosophic \aleph -left ideal of S . □

Similarly, we have the following.

Theorem 3.9. Let S_M be a neutrosophic \aleph -structure over S . Then S_M is a neutrosophic \aleph -left ideal of S if and only if $S_M \odot S_N \subseteq S_M$ for any neutrosophic \aleph -structure S_N over S .

Theorem 3.10. Let S_M and S_N be neutrosophic \aleph -structures over S . If S_M is a neutrosophic \aleph -left ideal of S , then so is the $S_M \odot S_N$.

Proof: Assume that S_M is a neutrosophic \aleph -left ideal of S and let $x, y \in S$. If there exist $a, b \in S$ such that $y = ab$, then $xy = x(ab) = (xa)b$.

Now,

$$(T_N \circ T_M)(y) = \bigwedge_{y=ab} \{T_N(a) \vee T_M(b)\}$$

$$\begin{aligned}
 &\leq \bigwedge_{xy=(xa)b} \{T_N(xa) \vee T_M(b)\} \\
 &= \bigwedge_{xy=cb} \{T_N(c) \vee T_M(b)\} = (T_N \circ T_M)(xy), \\
 (I_N \circ I_M)(y) &= \bigvee_{y=ab} \{I_M(b) \wedge I_M(b)\} \\
 &\geq \bigvee_{xy=(xa)b} \{I_M(xa) \wedge I_M(b)\} \\
 &= \bigvee_{xy=cb} \{I_M(c) \wedge I_M(b)\} = (I_N \circ I_M)(xy), \\
 (F_N \circ F_M)(y) &= \bigwedge_{y=ab} \{F_N(a) \vee F_M(b)\} \\
 &\leq \bigwedge_{xy=(xa)b} \{F_N(xa) \vee F_M(b)\} \\
 &= \bigwedge_{xy=cb} \{F_N(c) \vee F_M(b)\} = (F_N \circ F_M)(xy).
 \end{aligned}$$

Therefore $S_M \odot S_N$ is a neutrosophic \mathfrak{N} – left ideal of S . □

Similarly, we have the following.

Theorem 3.11. Let S_M and S_N be neutrosophic \mathfrak{N} – structures over S . If S_M is a neutrosophic \mathfrak{N} – right ideal of S , then so is the $S_M \odot S_N$.

Conclusions

In this paper, we have introduced the notion of neutrosophic \mathfrak{N} –ideals in semigroups and investigated their properties, and discussed characterizations of neutrosophic \mathfrak{N} –ideals by using the notion of neutrosophic \mathfrak{N} – product, also provided conditions for neutrosophic \mathfrak{N} –structure to be a neutrosophic \mathfrak{N} – ideal in semigroup. We have also discussed the concept of characteristic neutrosophic \mathfrak{N} –structure of semigroups and its related properties. Using this notions and results in this paper, we will define the concept of neutrosophic \mathfrak{N} –bi-ideals in semigroups and study their properties in future.

Acknowledgments: The authors express their sincere thanks to the referees for valuable comments and suggestions which improve the paper a lot.

Reference

1. Atanassov, K. T. Intuitionistic fuzzy sets. *Fuzzy Sets and Systems* **1986**, 20, 87-96.
2. Abdel-Baset, M.; Chang, V.; Gamal, A. Evaluation of the green supply chain management practices: A novel neutrosophic approach. *Computers in Industry* **2019**, 108, 210-220.
3. Abdel-Baset, M.; Chang, V.; Gamal, A.; Smarandache, F. An integrated neutrosophic ANP and VIKOR method for achieving sustainable supplier selection: A case study in importing field. *Computers in Industry* **2019**, 106, 94-110.
4. Abdel-Basset, M.; Manogaran, G.; Gamal, A.; Smarandache, F. A group decision making framework based on neutrosophic TOPSIS approach for smart medical device selection. *Journal of medical systems* **2019**, 43(2), 38.

5. Abdel-Basset, M.; Mohamed, R.; Zaid, A. E. N. H. Smarandache, F. A Hybrid Plithogenic Decision-Making Approach with Quality Function Deployment for Selecting Supply Chain Sustainability Metrics. *Symmetry* **2019**, 11(7), 903.
6. Abdel-Basset, M.; Nabeeh, N. A.; El-Ghareeb, H. A.; Aboelfetouh, A. Utilising neutrosophic theory to solve transition difficulties of IoT-based enterprises. *Enterprise Information Systems* **2019**, 1-21.
7. Abdel-Basset, M.; Saleh, M.; Gamal, A.; Smarandache, F. An approach of TOPSIS technique for developing supplier selection with group decision making under type-2 neutrosophic number. *Applied Soft Computing* **2019**, 77, 438-452.
8. Jun, Y. B.; Lee, K. J.; Song, S. Z. \aleph -Ideals of BCK/BCI-algebras. *J. Chungcheong Math. Soc.* **2009**, 22, 417-437.
9. Khan, M. S.; Anis; Smarandache, F.; Jun, Y. B. Neutrosophic \aleph -structures and their applications in semigroups. *Annals of Fuzzy Mathematics and Informatics*, reprint.
10. Muhiuddin, G.; Ahmad, N.; Al-Kenani; Roh, E. H.; Jun, Y. B. Implicative neutrosophic quadruple BCK-algebras and ideals, *Symmetry* **2019**, 11, 277.
11. Muhiuddin, G.; Bordbar, H.; Smarandache, F.; Jun, Y. B. Further results on (2; 2)-neutrosophic subalgebras and ideals in BCK/BCI- algebras, *Neutrosophic Sets and Systems* **2018**, Vol. 20, 36-43.
12. Muhiuddin, G.; Kim, S. J.; Jun, Y. B. Implicative N-ideals of BCK-algebras based on neutrosophic N-structures, *Discrete Mathematics, Algorithms and Applications* **2019**, Vol. 11, No. 01, 1950011.
13. Muhiuddin, G.; Smarandache, F.; Jun, Y. B. Neutrosophic quadruple ideals in neutrosophic quadruple BCI-algebras, *Neutrosophic Sets and Systems* **2019**, 25, 161-173 (2019).
14. Nabeeh, N. A.; Abdel-Basset, M.; El-Ghareeb, H. A.; Aboelfetouh, A. Neutrosophic multi-criteria decision making approach for iot-based enterprises. *IEEE Access* **2019**, 7, 59559 - 59574.
15. Smarandache, F. A. Unifying Field in Logics: Neutrosophic Logic. Neutrosophy, Neutrosophic Set, Neutrosophic Probability. *American Research Press* 1999, Rehoboth, NM.
16. Smarandache, F. Neutrosophic set-a generalization of the intuitionistic fuzzy set. *Int. J. Pure Appl. Math.* **2005**, 24(3), 287-297.
17. Zadeh, L. A. Fuzzy sets. *Information and Control* **1965**, 8, 338 - 353.

Neutrosophic complex $\alpha\psi$ connectedness in neutrosophic complex topological spaces

M. Karthika, M. Parimala, Saeid Jafari, Florentin Smarandache, Mohammed Alshumrani,
Cenap Ozel, R. Udhayakumar

M. Karthika, M. Parimala, Saeid Jafari, Florentin Smarandache, Mohammed Alshumrani, Cenap Ozel, R. Udhayakumar (2019). Neutrosophic complex $\alpha\psi$ connectedness in neutrosophic complex topological spaces. *Neutrosophic Sets and Systems* 29, 158-164

Abstract: Neutrosophic topological structure can be applied in many fields, viz. physics, chemistry, data science, etc., but it is difficult to apply the object with periodicity. So, we present this concept to overcome this problem and novelty of our work is to extend the range of membership, indeterminacy and non-membership from closed interval $[0, 1]$ to unit circle in the neutrosophic complex plane and modify the existing definition of neutrosophic complex topology proposed by [17], because we can't apply the existing definition to some set theoretic operations, such as union and intersection. Also, we introduce the new notion of neutrosophic complex $\alpha\psi$ -connectedness in neutrosophic complex topological spaces and investigate some of its properties. Numerical example also provided to prove the nonexistence

Keywords: neutrosophic sets; neutrosophic complex topology; neutrosophic complex $\alpha\psi$ -closed set; neutrosophic complex $\alpha\psi$ -connectedness between neutrosophic sets.

1. Introduction

In 1965, Zadeh [25] introduced fuzzy sets, after that there have been a number of developments in this fundamental concept. Atanassov [3] introduced the notion of intuitionistic fuzzy sets, which is generalized form of fuzzy set. Using the generalized concept of fuzzy sets, D. Coker [5] introduced the notion of intuitionistic fuzzy topological spaces. F. Smarandache [21, 22] introduced and studied neutrosophic sets. Applications of neutrosophic sets has been studied by many researchers [1, 2, 14]. Shortly, Salama et.al [19] introduced and studied Neutrosophic topology. Since then more research have been identified in the field of neutrosophic topology [4, 8, 11, 15, 18, 23], neutrosophic complex topology [10], neutrosophic ideals [17], etc. Kuratowski [9] introduced connectedness between sets in general topology. Thereafter various weak and strong form of connectedness between sets have been introduced and studied, such as b-connectedness [7], p-connectedness between sets [20], GO-connectedness between sets [19]. Parimala et.al, [16] initiated and investigated the concept of neutrosophic-closed sets. Wadei Al-Omeri [24], presented the concept of generalized closed and pre-closed sets in neutrosophic topological space and

extended their discussions on pre- $T_{1/2}$ space and generalized pre- $T_{1/2}$. They also initiated the concept of generalized neutrosophic connected and of their properties.

R. Devi [17] brought the concept complex topological space and investigated some properties of complex topological spaces. Topological set with real values are not sufficient for the complex plane, this led to define this proposed concept. Every neutrosophic complex set contains a membership, indeterminacy and non-membership function in neutrosophic complex topology and each membership function in neutrosophic complex set contain amplitude and phase term. Similarly, indeterminacy and non-membership functions in neutrosophic complex set contain amplitude and phase terms. The null neutrosophic complex set has 0 as amplitude and phase value in membership and indeterminacy and 1 as amplitude and phase value in non-membership. The unit neutrosophic complex set has 1 as amplitude and phase value in membership and indeterminacy and 0 as amplitude and phase value in non-membership. The only open and closed set in neutrosophic complex topological space is 0 and 1. The remaining neutrosophic complex sets are not both open and closed. If it is both open and closed sets then it can't be a connected in neutrosophic complex topology. In this work, we define the concepts of neutrosophic complex $\alpha\psi$ -connectedness between neutrosophic complex sets in neutrosophic complex topological spaces and also study some of its properties.

2. Preliminaries

We recall the following basic definitions in particular the work of R. Devi [17] which are useful for the sequel.

Definition 2.1. Let $X \neq \emptyset$ and I be the unit circle in the complex plane. A neutrosophic complex set (NCS) A is defined as $A = \{ \langle x_1, P_A(x_1), Q_A(x_1), R_A(x_1) \rangle : x_1 \in X \}$ where the mappings $P_A(x_1), Q_A(x_1), R_A(x_1)$ denote the degree of membership, the degree of indeterminacy and the degree of non-membership for each element x_1 in X to the set A , respectively, and $0 \leq P_A(x) + Q_A(x) + R_A(x) \leq 3$ for each $x_1 \in X$. Here $P_A(x_1) = T_A(x_1)e^{j\mu_A(x_1)}$, $Q_A(x_1) = I_A(x_1)e^{j\sigma_A(x_1)}$, $R_A(x_1) = F_A(x_1)e^{j\nu_A(x_1)}$ and $T_A(x_1), I_A(x_1), F_A(x_1)$ are amplitude terms, $\mu_A(x_1), \sigma_A(x_1), \nu_A(x_1)$ are the phase terms.

Definition 2.2. Two NCSs A and B are of the form $A = \{ \langle x_1, P_A(x_1), Q_A(x_1), R_A(x_1) \rangle : x_1 \in X \}$ and

$B = \{ \langle x_1, P_B(x_1), Q_B(x_1), R_B(x_1) \rangle : x_1 \in X \}$. Then

$A \subseteq B$ if and only if $P_A(x) \leq P_B(x), Q_A(x) \geq Q_B(x)$ and $R_A(x) \geq R_B(x)$.

$\bar{A} = \{ \langle x_1, R_A(x_1), Q_A(x_1), P_A(x_1) \rangle : x_1 \in X \}$.

$A \cap B = \{ \langle x_1, P_A(x_1) \wedge P_B(x_1), Q_A(x_1) \vee Q_B(x_1), R_A(x_1) \vee R_B(x_1) \rangle : x_1 \in X \}$.

$A \cup B = \{ \langle x_1, P_A(x_1) \vee P_B(x_1), Q_A(x_1) \wedge Q_B(x_1), R_A(x_1) \wedge R_B(x_1) \rangle : x_1 \in X \}$

Where

$$P_A(x_1) \vee P_B(x_1) = (T_A \vee T_B)(x_1)e^{j(\mu_A \vee \mu_B)(x_1)}, \quad P_A(x_1) \wedge P_B(x_1) = (T_A \wedge T_B)(x_1)e^{j(\mu_A \wedge \mu_B)(x_1)},$$

$$Q_A(x_1) \wedge Q_B(x_1) = (I_A \wedge I_B)(x_1)e^{j(\sigma_A \wedge \sigma_B)(x_1)},$$

$$Q_A(x_1) \vee Q_B(x_1) = (I_A \vee I_B)(x_1)e^{j(\sigma_A \vee \sigma_B)(x_1)},$$

$$R_A(x_1) \wedge R_B(x_1) = (F_A \wedge F_B)(x_1)e^{j(\nu_A \wedge \nu_B)(x_1)}$$

$$R_A(x_1) \vee R_B(x_1) = (F_A \vee F_B)(x_1)e^{j(\nu_A \vee \nu_B)(x_1)}$$

Definition 2.3. A subset A of a neutrosophic complex topological space (X, τ) is called

- i. A neutrosophic complex semi-generalized closed (briefly, NCsg-closed) set if complex semi closure of $(A) \subseteq U$ whenever $A \subseteq U$ and U is semi-open in (X, τ) ;
- ii. A neutrosophic complex ψ -closed set if complex semi closure of $(A) \subseteq U$ whenever $A \subseteq U$ and U is neutrosophic complex semi-generalized open in (X, τ) ;
- iii. A neutrosophic complex $\alpha\psi$ -closed (briefly, N C $\alpha\psi$ CS) set if complex ψ closure $(A) \subseteq U$ whenever $A \subseteq U$ and U is neutrosophic complex α -open in (X, τ) .

Definition 2.4. Two neutrosophic complex sets A and B of X are said to be q-complex coincident ($ACqB$ for short) if and only if there exist an element y in X such that $A(y) \cap B(y) \neq \emptyset$.

Definition 2.5. For any two neutrosophic complex sets A and B of X, $A \subseteq B$ iff A and B^C are not q-coincident (B^C is the usual complement of the set B).

Remark 2.6. Every neutrosophic complex closed (resp. neutrosophic complex open) set is neutrosophic complex $\alpha\psi$ -closed (resp. neutrosophic complex $\alpha\psi$ -open) but the converse may not be true.

3. On neutrosophic complex $\alpha\psi$ -connectedness between neutrosophic complex sets

In this section, modified definition of neutrosophic complex topology and definition of neutrosophic complex $\alpha\psi$ -connectedness between sets are presented, some of its properties also investigated and counter examples are also provided.

Definition 3.1. A neutrosophic complex topology (NCT) on a nonempty set X is a family τ of NCSs in X satisfying the following conditions:

$$(T1) \quad 0, 1 \in \tau \text{ where } 0 = \langle x, 0e^{j0}, 1e^{j1}, 1e^{j1} \rangle, 1 = \langle x, 1e^{j1}, 0e^{j0}, 0e^{j0} \rangle$$

$$(T2) \quad A \cap B \in \tau \text{ for any } A, B \in \tau ;$$

$$(T3) \quad \cup A_i \in \tau \text{ for any arbitrary family } \{A_i : i \in J\} \subseteq \tau$$

Definition 3.2. A neutrosophic complex topological space (X, τ) is said to be neutrosophic complex $\alpha\psi$ -connected between neutrosophic complex sets A and B if there is no neutrosophic complex $\alpha\psi$ -closed neutrosophic complex $\alpha\psi$ -open set F in X such that $A \subset F$ and $\neg(FqB)$.

Theorem 3.3. If a neutrosophic complex topological space (X, τ) is neutrosophic complex $\alpha\psi$ -connected between neutrosophic complex sets A and B, then it is neutrosophic complex connected between A and B.

Proof: If (X, τ) is not neutrosophic complex connected between A and B, then there exists an neutrosophic complex closed open set F in X such that $A \subset F$ and $\neg(FqB)$. Then every neutrosophic complex closed open set F in X is a neutrosophic complex $\alpha\psi$ -closed neutrosophic complex $\alpha\psi$ -open set F in X. If F is an neutrosophic $\alpha\psi$ -closed $\alpha\psi$ -open set in X such that $A \subset F$ and $\neg(FqB)$ then (X, τ) is not neutrosophic $\alpha\psi$ -connected between A and B, which contradicts our hypothesis. Hence (X, τ) is a neutrosophic complex connected between A and B.

Remark 3.4. Following example clears that the converse of the above theorem may be false.

Example 3.5.

Let $X = \{a, b\}$ and $U = \{ \langle a, 0.5e^{0.5j}, 0.4e^{0.4j}, 0.4e^{0.4j} \rangle, \langle b, 0.6e^{0.6j}, 0.4e^{0.4j}, 0.4e^{0.4j} \rangle \}$,
 $A = \{ \langle a, 0.2e^{0.2j}, 0.7e^{0.7j}, 0.7e^{0.7j} \rangle, \langle b, 0.3e^{0.5j}, 0.6e^{0.6j}, 0.6e^{0.6j} \rangle \}$ and
 $B = \{ \langle a, 0.5e^{0.5j}, 0.4e^{0.4j}, 0.4e^{0.4j} \rangle, \langle b, 0.4e^{0.4j}, 0.5e^{0.5j}, 0.5e^{0.5j} \rangle \}$ be neutrosophic complex sets on X. Let $\tau = \{0, 1, U\}$ be a neutrosophic complex topology on X. Then (X, τ)

is neutrosophic complex connected between A and B but it is not neutrosophic complex $\alpha\psi$ -connected between A and B.

Theorem 3.6. A NCT (X, τ) is neutrosophic complex $\alpha\psi$ -connected if and only if it is neutrosophic complex $\alpha\psi$ -connected between every pair of its non-empty neutrosophic complex sets.

Proof. Necessity: Let A, B be any pair of neutrosophic complex subsets of X. Suppose (X, τ) is not neutrosophic complex $\alpha\psi$ -connected between neutrosophic complex sets A and B. Then there exists a neutrosophic complex $\alpha\psi$ -closed complex $\alpha\psi$ -open set F of X such that A is a subset of F and $\neg(\text{FCqB})$. Since neutrosophic complex sets A and B are neutrosophic non-empty, it follows that F is a neutrosophic non-empty proper neutrosophic complex $\alpha\psi$ -closed complex $\alpha\psi$ -open set of X. Hence (X, τ) is not neutrosophic complex $\alpha\psi$ -connected.

Sufficiency: Suppose (X, τ) is not neutrosophic complex $\alpha\psi$ -connected. Then there exist a neutrosophic non empty proper neutrosophic complex $\alpha\psi$ -closed complex $\alpha\psi$ -open set F of X. Consequently (X, τ) is not neutrosophic complex $\alpha\psi$ -connected between F and F^C , a contradiction.

Remark 3.7. If a neutrosophic topological space (X, τ) is neutrosophic complex $\alpha\psi$ -connected between a pair of its neutrosophic complex subsets, it is not necessarily that (X, τ) is neutrosophic complex $\alpha\psi$ -connected between every pair of its neutrosophic complex subsets, as the following example shows.

Example 3.8.

Let $X = \{a, b\}$ and $U = \{ \langle a, 0.5e^{0.5j}, 0.4e^{0.4j}, 0.4e^{0.4j} \rangle, \langle b, 0.6e^{0.6j}, 0.4e^{0.4j}, 0.4e^{0.4j} \rangle \}$,
 $A = \{ \langle a, 0.4e^{0.4j}, 0.3e^{0.3j}, 0.3e^{0.3j} \rangle, \langle b, 0.6e^{0.6j}, 0.4e^{0.4j}, 0.4e^{0.4j} \rangle \}$
 $B = \{ \langle a, 0.5e^{0.5j}, 0.2e^{0.2j}, 0.2e^{0.2j} \rangle, \langle b, 0.4e^{0.4j}, 0.4e^{0.4j}, 0.4e^{0.4j} \rangle \}$
 $C = \{ \langle a, 0.2e^{0.2j}, 0.7e^{0.7j}, 0.7e^{0.7j} \rangle, \langle b, 0.3e^{0.3j}, 0.6e^{0.6j}, 0.6e^{0.6j} \rangle \}$ and
 $D = \{ \langle a, 0.5e^{0.5j}, 0.4e^{0.4j}, 0.4e^{0.4j} \rangle, \langle b, 0.4e^{0.4j}, 0.5e^{0.5j}, 0.5e^{0.5j} \rangle \}$ be neutrosophic sets on X. Let $\tau = \{0, 1, U\}$ be a neutrosophic complex topology on X. Then (X, τ) is a neutrosophic complex connected between neutrosophic complex sets A and B but it is not neutrosophic complex connected between neutrosophic complex sets C and D. Also (X, τ) is not neutrosophic complex $\alpha\psi$ -connected.

Theorem 3.9. An NCT (X, τ) is neutrosophic complex $\alpha\psi$ -connected between neutrosophic complex sets A and B if and only if there is no neutrosophic complex $\alpha\psi$ -closed complex $\alpha\psi$ -open set F in X such that $A \subset F \subset B^C$.

Proof. Necessity: Let (X, τ) be an neutrosophic complex $\alpha\psi$ -connected between neutrosophic complex sets A and B. Suppose on the contrary that F is an neutrosophic complex $\alpha\psi$ -closed complex $\alpha\psi$ -open set in X such that $A \subset F \subset B^C$. Now $F \subset B^C$ which implies that $\neg(\text{FCqB})$. Therefore F is a neutrosophic complex $\alpha\psi$ -closed complex $\alpha\psi$ -open set in X such that $A \subset F$ and $\neg(\text{FCqB})$. Hence (X, τ) is not neutrosophic complex $\alpha\psi$ -connected between neutrosophic complex sets A and B, which is a contradiction.

Sufficiency: Suppose on the contrary that (X, τ) is not a neutrosophic complex $\alpha\psi$ -connected between neutrosophic complex sets A and B. Then there is a neutrosophic complex $\alpha\psi$ -closed complex $\alpha\psi$ -open set F in X such that $A \subset F$ and $\neg(\text{FCqB})$. Now, $\neg(\text{FCqB})$ which implies that $F \subset B^C$. Therefore F is a neutrosophic complex $\alpha\psi$ -closed complex $\alpha\psi$ -open set in X such that $A \subset F \subset B^C$, which contradicts our assumption.

Theorem 3.10. If a NCT (X, τ) is neutrosophic complex $\alpha\psi$ -connected between neutrosophic complex sets A and B, then A and B are neutrosophic non-empty in complex plane.

Proof. Let (X, τ) be a neutrosophic complex $\alpha\psi$ -connected between neutrosophic complex sets A and B. Suppose the neutrosophic complex sets A or B or both are empty set then the intersection of A and B is empty, which is contradiction to the definition of connectedness. The only open and closed sets in neutrosophic complex sets are 0 and 1. We know that every neutrosophic complex connected space is a $\alpha\psi$ -connected between A and B. Therefore (X, τ) is not a neutrosophic complex $\alpha\psi$ -connected between neutrosophic complex sets A and B. This leads to the contradiction to the hypothesis.

Theorem 3.11. Let (X, τ) be a NCT and A,B be two neutrosophic complex sets in X. If $A \subset B$ then (X, τ) is a neutrosophic complex $\alpha\psi$ -connected between A and B.

Proof. If B is any neutrosophic complex $\alpha\psi$ -closed complex $\alpha\psi$ -open set of X such that A and B^c are not q-coincident and A is a subset of B. This is contradiction to the given statement A is complex q-coincident with B. Therefore (X, τ) is neutrosophic complex $\alpha\psi$ -connected between A and B.

Remark 3.12. Example 3.13 shows that the converse of the above theorem may not hold.

Example 3.13.

Let $X = \{a,b\}$ and $U = \{ \langle a, 0.2e^{0.2j}, 0.6e^{0.6j}, 0.6e^{0.6j} \rangle, \langle b, 0.3e^{0.3j}, 0.5e^{0.5j}, 0.5e^{0.5j} \rangle \}$,
 $A = \{ \langle a, 0.4e^{0.4j}, 0.3e^{0.3j}, 0.3e^{0.3j} \rangle, \langle b, 0.3e^{0.3j}, 0.6e^{0.6j}, 0.6e^{0.6j} \rangle \}$ and
 $B = \{ \langle a, 0.2e^{0.2j}, 0.5e^{0.5j}, 0.5e^{0.5j} \rangle, \langle b, 0.5e^{0.5j}, 0.4e^{0.4j}, 0.4e^{0.4j} \rangle \}$ be neutrosophic complex sets on X. Let $\tau = \{0, 1, U\}$ be a neutrosophic complex topology on X. Then (X, τ) is neutrosophic complex $\alpha\psi$ -connected between neutrosophic sets A and B but $\neg(AqB)$.

4. On subspace of neutrosophic complex topology and subset of neutrosophic complex set

Theorem 4.1. If a NCT (X, τ) is a neutrosophic complex $\alpha\psi$ -connected between neutrosophic complex sets A and B such that A and B are subset of A_1 and B_1 respectively, then (X, τ) is a neutrosophic complex $\alpha\psi$ -connected between A_1 and B_1 .

Proof. Let (X, τ) be a neutrosophic complex $\alpha\psi$ -connected between neutrosophic complex sets A and B such that A and B are subset of A_1 and B_1 respectively. Suppose (X, τ) is not a neutrosophic complex $\alpha\psi$ -connected between A_1 and B_1 . Then there exist a set A_1 such that A_1 a subset of complement of B_1 and intersection of A and B_1 is empty. Also intersection of A and B is empty since A is a subset of A_1 and A_1 is a subset of complement of B_1 . This is contradiction to the assumption that (X, τ) is a neutrosophic complex $\alpha\psi$ -connected between neutrosophic complex sets A and B. Hence (X, τ) is a neutrosophic complex $\alpha\psi$ -connected between A_1 and B_1 .

Theorem 4.2. A NCT (X, τ) is a neutrosophic complex $\alpha\psi$ -connected between neutrosophic complex sets A and B if and only if it is neutrosophic complex $\alpha\psi$ -connected between $NC\alpha\psi cl(A)$ and $NC\alpha\psi cl(B)$.

Proof. Necessity: Let (X, τ) be a neutrosophic complex $\alpha\psi$ -connectedness between A and B. On the contrary, (X, τ) is not a neutrosophic complex $\alpha\psi$ -connected between $NC\alpha\psi cl(A)$ and $NC\alpha\psi cl(B)$. We know that every neutrosophic complex set A and B are subset of $NC\alpha\psi cl(A)$ and $NC\alpha\psi cl(B)$, respectively. Therefore there does not exist neutrosophic complex $\alpha\psi$ -connected between A and B. Follows from Theorem 4.1, because A is a subset of $NC\alpha\psi cl(A)$ and B is a subset of $NC\alpha\psi cl(B)$.

Sufficiency: Suppose (X, τ) is not a neutrosophic complex $\alpha\psi$ -connected between neutrosophic complex sets A and B. Then there is a neutrosophic complex $\alpha\psi$ -closed complex $\alpha\psi$ -open set F of X such that $A \subset F$ and $\neg(\text{FCqB})$. Since F is a neutrosophic complex $\alpha\psi$ -closed and $A \subset F$, $\text{NC}\alpha\psi \text{cl}(A) \subset F$. Now, $\neg(\text{FCqB})$ which implies that $F \subset B^C$. Therefore $F = \text{NC}\alpha\psi \text{int}(F) \subset \text{NC}\alpha\psi \text{int}(B^C) = (\text{NC}\alpha\psi \text{cl}(B))^C$. Hence $(\text{FCqN}\alpha\psi \text{cl}(B))$ and X is not a neutrosophic complex $\alpha\psi$ -connected between $\text{NC}\alpha\psi \text{cl}(A)$ and $\text{NC}\alpha\psi \text{cl}(B)$.

Theorem 4.3. Let (Y, τ_Y) be a subspace of a NCT (X, τ) and A;B be neutrosophic complex subsets of Y. If (Y, τ_Y) is a neutrosophic complex $\alpha\psi$ -connectedness between A and B then so is (X, τ)

Proof. Suppose, on the contrary, that (X, τ) is not a neutrosophic complex $\alpha\psi$ -connected between neutrosophic sets A and B. Then there exist a neutrosophic complex $\alpha\psi$ -closed complex $\alpha\psi$ -open set F of X such that $A \subset F$ and $\neg(\text{FCqB})$. Put $F_Y = F \cap Y$. Then F_Y is neutrosophic complex $\alpha\psi$ -closed complex $\alpha\psi$ -open set in Y such that $A \subset F_Y$ and $\neg(\text{FCqB})$. Hence (Y, τ_Y) is not a neutrosophic complex $\alpha\psi$ -connected between A and B, a contradiction.

Theorem 4.4. Let (Y, τ_Y) be a neutrosophic complex subspace of a NCT (X, τ) and A, B be neutrosophic subsets of Y. If (X, τ) is a neutrosophic complex $\alpha\psi$ -connected between neutrosophic complex sets A and B, then so is (Y, τ_Y) .

Proof. If (Y, τ_Y) is not a neutrosophic complex $\alpha\psi$ -connected between neutrosophic complex sets A and B, then there exist a neutrosophic complex $\alpha\psi$ -closed complex $\alpha\psi$ -open set F of Y such that $A \subset F$ and $\neg(\text{FCqB})$. Since Y is a neutrosophic complex closed open in X, F is a neutrosophic complex $\alpha\psi$ -closed complex $\alpha\psi$ -open set in X. Hence X cannot be neutrosophic complex $\alpha\psi$ -connected between neutrosophic complex sets A and B, a contradiction.

5. Conclusions

Neutrosophic topology is an extension of fuzzy topology. Neutrosophic complex topology is an extension of neutrosophic topology and complex neutrosophic set. In neutrosophic complex set, membership degree stands for truth value with periodicity, indeterminacy stands for indeterminacy with periodicity and non-membership stands for falsity with periodicity. In this paper, we modified the definition proposed by [17] and we presented the new concept of neutrosophic complex $\alpha\psi$ -connectedness between NCSs in NCTs using new definition and some properties of neutrosophic complex $\alpha\psi$ -connectedness is investigated along with numerical example. Also this work encourages that in future, this concept can be extended to various connectednesses and analyse the properties with application.

References

1. Abdel-Basset, M.; Mohamed, R.; Zaided, A.; Smarandache, F. A Hybrid Plithogenic Decision-Making Approach with Quality Function Deployment for Selecting Supply Chain Sustainability Metrics. *Symmetry*, **2019**, *11*(7), 903.
2. Abdel-Basset, M.; Saleh, M.; Gamal, A.; Smarandache, F. An approach of TOPSIS technique for developing supplier selection with group decision making under type-2 neutrosophic number. *Applied Soft Computing*, **2019**, *77*, 438-452.
3. Atanassov, K.T. Intuitionistic fuzzy sets. *Fuzzy sets and systems*, **1986**, *20*(1), 87-96.

4. Bera, T.; Mahapatra, N.K. On Neutrosophic Soft Topological Space. *Neutrosophic sets and systems*, **2018**, *19*, 3-15.
5. Coker, D. An introduction to fuzzy topological spaces. *Fuzzy sets and systems*, **1997**, *88*, 81-89.
6. Dubey, K. K.; Panwar, O. S. Some properties of s-connectedness between sets and s-connected mapping. *Indian J. pure Math.*, **1984**, *154*, 343-354.
7. El-Atik, A.A.; Abu Donia, H.M.; Salama, A.A. On b-connectedness and b-disconnectedness and their applications, *J. Egyptian Math. Soc.*, **2013**, *21*, 63-67.
8. Fatimah M. Mohammed, Shaymaa F. Matar. Fuzzy Neutrosophic α^m -Closed Sets in Fuzzy Neutrosophic Topological Spaces. *Neutrosophic sets and systems*, **2018**, *21*, 56-66.
9. Kuratowski, K. *Topology Vol. II*, Academic Press: New York, 1966.
10. Narmada devi, R. Neutrosophic complex N-continuity. *Ann.Fuzzy.Math.inform.*, **2017**, *13(1)*, 109-122.
11. Parimala, M.; Jeevitha, R.; Jafari, S.; Smarandache, F.; Udhayakumar, R. Neutrosophic $\alpha\psi$ -Homeomorphism in Neutrosophic Topological Spaces. *Information*, **2018**, *9*, 187.
12. Parimala, M.; Perumal, R. Weaker form of open sets in nano ideal topological spaces. *Global Journal of Pure and Applied Mathematics*, **2016**, *12(1)*, 302-305.
13. Parimala, M.; Jeevitha, R.; Selvakumar, A. A New Type of Weakly Closed Set in Ideal Topological paces. *International Journal of Mathematics and its Applications*, **2017**, *5(4-C)*, 301-312.
14. Parimala, M.; Karthika,M.; Jafari, S.; Smarandache ,F.; Udhayakumar,R. Decision-Making via Neutrosophic Support Soft Topological Spaces, *Symmetry*, **2018**, *10*, 2-10.
15. Parimala, M.; Karthika, M.; Dhavaseelan, R.; Jafari, S. On neutrosophic supra pre-continuous functions in neutrosophic topological spaces. *New Trends in Neutrosophic Theory and Applications*, **2018**, *2*, 371-383.
16. Parimala, M.; Smarandache, F.; Jafari, S.; Udhayakumar,R. On neutrosophic $\alpha\psi$ -closed sets. *Information*, **2018**, *9*, 103, 1-7.
17. Parimala, M.; Karthika, M.; Jafari, S.; Smarandache, F.; Udhayakumar, R. Neutrosophic Nano ideal topological structure. *Neutrosophic sets and systems*, **2019**, *24*, 70-76.
18. Riad K. Al-Hamido.; Qays Hatem Imran.; Kareem A. Alghurabi.; Gharibah, T. On Neutrosophic Crisp Semi Alpha Closed Sets. *Neutrosophic sets and systems*, **2018**, *21*, 28-35.
19. Salama, A.A.; Alblowi, S.A. Neutrosophic Set and Neutrosophic Topological Spaces. *IOSR J. Math.*, **2012**, *3*, 31-35.
20. Santhi,R.; Arun Prakash, K. On intuitionistic fuzzy Semi-Generalized Closed Sets and its Applications. *Int. J. Contemp. Math. Sciences*, **2010**, *5(34)*, 1677-1688.
21. Smarandache. F. Neutrosophy and Neutrosophic Logic. First International Conference on Neutrosophy, Neutrosophic Logic Set, Probability and Statistics, University of New Mexico, Gallup, NM, USA, **2002**.
22. Smarandache, F. A Unifying Field in Logics. Neutrosophic Logic: Neutrosophy, Neutrosophic Set, Neutrosophic Probability, Rehoboth: American Research Press. **1999**.
23. Wadei F. Al-Omeri, S. Jafari,S. Neutrosophic pre-continuous multifunctions and almost pre-continuous multifunctions. *Neutrosophic sets and systems*, **2019**, *27*, 53-6.
24. Wadei F. Al-Omeri.; Jafari, S. On generalized closed sets and generalized pre-closed sets in neutrosophic topological spaces, *Mathematics*,**2018**, *7(1)*, 1-12.
25. Zadeh,L.A. Fuzzy sets.*Information and Control*, **1965**, *8*, 338-353.

Introduction of some new results on interval-valued neutrosophic graphs

Said Broumi, Mohamed Talea, Assia Bakali, Florentin Smarandache,
Quek Shio Gai, Ganeshsree Selvachandran

Said Broumi, Mohamed Talea, Assia Bakali, Florentin Smarandache, Quek Shio Gai, Ganeshsree Selvachandran (2019). Introduction of some new results on interval-valued neutrosophic graphs. *Journal of Information and Optimization Sciences*, 24; DOI: 10.1080/02522667.2018.1541782

Abstract

In this paper, inspired by the concept of generalized single-valued neutrosophic graphs (GSVNG) of the first type, we define yet another generalization of neutrosophic graph called the generalized interval-valued neutrosophic graph of 1 type (GIVNG1) in addition to our previous work on complex neutrosophic graph (CNG1) in [47]. We will also show a matrix representation for this new generalization. Many of the fundamental properties and characteristics of this new concept is also studied. Like the concept CNG1 in [47], the concept of GIVNG1 is another extension of generalized fuzzy graphs 1 (GFG1) and GSVNG1.

Keywords: Interval-Valued Neutrosophic Graph, Generalized Interval Valued Neutrosophic Graph Of First Type, Matrix Representation; Neutrosophic Graph

1. Introduction

In order to efficiently handle real life scenarios that contains uncertain information, neutrosophic set (NS) theory, established by Smarandache [32], is put forward from the perspective of philosophical standpoints through regarding the degree of indeterminacy or neutrality as an independent element. As a result, many extended forms of fuzzy sets such as classical fuzzy sets [45], intuitionistic fuzzy sets [3-4], interval-valued fuzzy sets [40] and interval-valued intuitionistic fuzzy sets [5] could be seen as reduced forms of NS theory. In a NS, a true membership degree T , an indeterminacy membership degree I and a falsity membership degree F constitute the whole independent membership degrees owned by each element. However, it is noticed that the range of T , I and F falls within a real standard or nonstandard unit interval $]0, 1^+[$, hence it is difficult in applying NSs to many kinds of real world situations due to the limitation of T , I and F . Therefore, an updated form called single

valued neutrosophic sets (SVNSs) was designed by Smarandache firstly [32]. Then, several properties in terms of SVNSs were further explored by Wang et al. [43]. In addition, it is relatively tough for experts to provide the three membership degrees with exact values, sometimes the form of interval numbers outperform the exact values in many practical situations. Inspired by this issue, Wang et al. [43] constructed interval neutrosophic sets concept (INSs) that performs better in precision and flexibility. Thus, INSs could be regarded as an extension of SVNSs. Moreover, some recent works about NSs, INSs and SVNSs along with their applications could be found in [13-15, 22,35, 53-59].

To studying the relationship between objects or events, the concept of Graph is thus created. In classical crisp graph theory, each of the two vertices (representing object or event) can assign two crisp value, 0 (not related/connected) or 1 (related/connected). The approach of fuzzy graph is a generalization the classical graph by allowing the degree of relationship (i.e. the membership value) to be anywhere in $[0,1]$ for the edges, and it also assign membership values for the vertices. In the context of fuzzy graph, there is a rule that must be satisfied by all the edges and vertices, as follows:

the membership value of an edge must always be less than or equal to both the membership values of its two adjacent vertices. ()*

In over one hundred research papers, the further generalization of fuzzy graphs were studied, such as intuitionistic graphs, interval valued fuzzy graphs [7, 25, 28, 29] and interval-valued intuitionistic fuzzy graphs [24]. However, such generalization still preserve (*) that was established since the period of fuzzy graphs.

As a result, Samanta et al. [39] analysed the concept of generalized fuzzy graphs (GFG), which was derived from the concept of fuzzy graph while removing the confinement of (*). He had also studied some major advantages of GFG, such as completeness and regularity, by some proven facts. These authors had further developed GFG into two types, namely: generalized fuzzy graphs of first type (GFG1), generalized fuzzy graphs based on second type (GFG2). Each type of GFG can likewise be created by matrices just as in the case of some fuzzy graphs. The authors had also justified that the concept of fuzzy graphs on previous literatures are limited to representing some very particular systems such as social network, and therefore GFG is claimed to be capable to put to use on a much wider range of different scenario.

On the other hand, when the description of an object or a relation is both indeterminate and uncertain, it may be handled by fuzzy[23],

intuitionistic fuzzy, interval-valued fuzzy, interval-valued intuitionistic fuzzy graphs and Set-valued graphs [2]. So, for this purpose, another new concept: neutrosophic graphs based on literal indeterminacy (I), were proposed by Smarandache [34] to deal with such situations. Such concept was published in a book by the same author collaborating with Vasantha et al.[42]. Later on, Smarandache[30-31] further introduced yet a new concept for neutrosophic graph theory, this time using the neutrosophic truth-values (T, I, F) . He also gave various characterization on neutrosophic graph, such as the neutrosophic edge graphs, neutrosophic vertex graphs and neutrosophic vertex-edge graphs. Later on[33], Smarandache himself further generalized the concept of neutrosophic graphs, and yield even more new structures such as neutrosophic offgraph, neutrosophic bipolar graphs, neutrosophic tripolar graphs and neutrosophic multipolar graphs. After which, the study of neutrosophic vertex-edge graphs has captured the attention of most researchers, and thus having more generalizations derived from it.

In 2016, using the concepts of SVN S s, Broumi et al.[8] investigated on the concept of single-valued neutrosophic graphs, and formulated certain types of single-valued neutrosophic graphs (SVNGs). After that, Broumi et al.introduced in [9,10,16,17,36]: the necessity of neighbourhood degree of a vertices and closed neighborhood degree of vertices in single-valued neutrosophic graph, isolated-SVNGs, Bipolar-SVNGs, complete bipolar-SVNGs, regular bipolar-SVNGs, uniform-SVNGs. In[11-12,18], also they studied the concept of interval-valued neutrosophic graphs and the importance of strong interval-valued neutrosophic graph, where different methods such as union, join, intersection and complement have been further investigated. In [35], Broumi et al. proposed some computing procedure in Matlab for neutrosophic operational matrices. Broumi et al.[37] developed a Matlab toolbox for interval valued neutrosophic matrices for computer applications. Akram and Shahzadi [6] introduced a new version of SVNGs that are different from those proposed in [8,36],and studied some of their properties. Ridvan[20] presented a new approach to neutrosophic graph theory with applications. Malarvizhi and Divya[38] presented the the ideas of antipodal single valued neutrosophic graph. Karaaslan and Davvaz[21] explore some interesting properties of single-valued neutrosophic graphs.Krishnaraj et al.[1] introduced the concept of perfect and status in single valued neutrosophic graphs and investigated some of their properties.

Krishnaraj et al. [26] also analysed the concepts self-centered single valued neutrosophic graphs and discussed the properties of this concept

with various examples, while Mohmed Ali et al.[41]extended it further to interval valued neutrosophic graphs[11].Kalyan and Majumdar [27] introduce the concept of single valued neutrosophic digraphs and implemented it in solving a multicriterion decision making problems.

The interval-valued neutrosophic graphs studied in the literature [11, 12], like the concept of fuzzy graph, is nonetheless bounded with the following condition familiar to (*):

*The edge membership value is lessser than the minimum of its end vertex values, whereas the edge indeterminacy-membership value is lesser than the maximum of its end vertex values or greater than the maximum of its end vertex values. Also the edge non-membership value is lesser than the minimum of its end vertex values or is greater than the maximum of its end vertex values. (**)*

Broumi et al.[19]had thus followed the approach of Samanta et al. [39], by suggesting the removal of (**) and presented the logic of generalized single-valued neutrosophic graph of type1 (GSVNG1). This is also a generalization from generalized fuzzy graph of type1 [39].

The main goal of this work is to further generalize the method of GSVNG1 to interval-valued neutrosophic graphs of first type (GIVNG1), for which all the true, indeterminacy, and false membership values, are inconsistent. Similarly, the appropriate matrix representation of GIVNG1 will also be given.

The results in this article is further derived from a conference paper [46] that we have published one year ago in IEEE. On the other hand, we have just published a paper on complex neutrosophic graph (CNG1), which is another extension of GFG1 and GSVNG1 in [47]. The approach of GIVNG1 and CNG1, however, are distint from one another. This is because the concept of CNG1 extends the existing theory by generalizing real numbers into complex numbers, while all the entries remain single valued; whereas in this paper, the concept of GIVNG1 extends the existing theory by generalizing the single valued entries into inter-valued entries, while all those inter-valued entries remains as real numbers

Thus, following the format of our recent conference paper [46], this paper has been aligned likewise: In Section 2, the concept on neutrosophic sets, single- valued neutrosophic sets, interval valued neutrosophic graph and generalized single-valued neutrosophic graphs of type 1 are described in detail, which serves as cornerstones for all the contents in later parts of the article. In Section 3, we present the ideas of GIVNG1 illustrated with an example. Section 4 gives the appropriate way to represent the matrix of GIVNG1.

2. Some preliminary results

In this part, we briefly include some basic definitions in [19, 32, 43,47] related to NS, SVN_Ss, interval- valued neutrosophic graphs (IVNG) and generalized single-valued neutrosophic graphs of type 1 (GSNG1).

Definition 2.1 [32]. Let X be a series of points with basic elements in X presented by x ; then the neutrosophic set (NS) A (is an object in the form $A = \{ \langle x: T_A(x), I_A(x), F_A(x) \rangle, x \in X \}$, defines the functions $T, I, F: X \rightarrow]^{-}0,1^{+}[$ [denoted by the truth-membership, indeterminacy-membership, and falsity-membership of the element $x \in X$ to the set A showing the condition:

$$^{-}0 \leq T_A(x) + I_A(x) + F_A(x) \leq 3^{+}. \tag{1}$$

The functions $T_A(x), I_A(x)$ and $F_A(x)$ are absolute standard or non-standard subsets of $]^{-}0,1^{+}[$.

As it is very complex in applying NSs to real issues, Smarandache [32] developed the notion of a SVN_S, which is an occurrence of a NS and can be employed in practical scientific and engineering applications.

Definition 2.2 [43]. Let X be a series of points (objects) with basic elements in X presented by x . A single valued neutrosophic set A (SVNS A) is characterized by truth-membership $T_A(x)$, an indeterminacy-membership $I_A(x)$, and a falsity-membership $F_A(x)$. $\forall x \in X, T_A(x), I_A(x), F_A(x) \in [0, 1]$. A SVN_S A can be rewritten as

$$A = \{ \langle x: T_A(x), I_A(x), F_A(x) \rangle, x \in X \} \tag{2}$$

Definition 2.3 [19] Suppose the following conditions are expected:

- a) V is a null-void set.
- b) $\rho_T, \rho_I, \rho_F: V \rightarrow [0,1]$
- c) $E = \{ (\rho_T(u), \rho_T(v)) \mid u, v \in V \}$,
 $F = \{ (\rho_I(u), \rho_I(v)) \mid u, v \in V \}$,
 $G = \{ (\rho_F(u), \rho_F(v)) \mid u, v \in V \}$.
- d) $\alpha: E \rightarrow [0, 1], \beta: F \rightarrow [0, 1], \delta: G \rightarrow [0, 1]$ are three functions.
- e) $\rho = (\rho_T, \rho_I, \rho_F)$; and
 $\omega = (\omega_T, \omega_I, \omega_F)$ with
 $\omega_T(u, v) = \alpha((\rho_T(x), \rho_T(v)))$,
 $\omega_I(u, v) = \beta((\rho_I(x), \rho_I(v)))$,
 $\omega_F(u, v) = \delta((\rho_F(x), \rho_F(v))), \forall u, v \in V$.

Then:

- i) The structure $\xi = \langle V, \rho, \omega \rangle$ is considered to a GSVNG1.
Remark: ρ which depends on ρ_T, ρ_I, ρ_F . And ω which depends on α, β . Hence there are 7 mutually alone parameters in total which make up a CNG1: $V, \rho_T, \rho_I, \rho_F, \alpha, \beta, \delta$.
- ii) $\forall v \in V, v$ is considered to be a *vertex* of ξ . The whole set V is termed as the *vertex set* of ξ .
- iii) $\forall u, v \in V, (u, v)$ is considered to be a *directed edge* of ξ .
 In special, (u, v) is considered to be a *loop* of ξ .
- iv) For all vertex v : $\rho_T(v), \rho_I(v), \rho_F(v)$ are considered to be the *T, I, and F membership value*, respectively of that vertex v . Moreover, if $\rho_T(v) = \rho_I(v) = \rho_F(v) = 0$, then v is supposed to be a *null vertex*.
- v) Correspondingly, for all edge (u, v) : $\omega_T(u, v), \omega_I(u, v), \omega_F(u, v)$ considered to have T, I, and F respectively membership value, of that directed edge (u, v) . In addition, if $\omega_T(u, v) = \omega_I(u, v) = \omega_F(u, v) = 0$, then (u, v) is considered to be a *null directed edge*.

Remark : It obeys that: $V \times V \rightarrow [0,1]$.

3. Concepts related to Generalized Interval Valued Neutrosophic Graph of First Type

In the modelling of real life scenarios with neutrosophic system (i.e. neutrosophic sets, neutrosophic graphs, etc), the truth-membership value, indeterminate-membership value, and false-membership value are often taken to mean the *ratio out of a population* who find reasons to “agree”, “be neutral” and “disagree”. It can also be by any 3 analogous descriptions, such as “seek excitement” “loft around” and “relax”. However, there are real life situations where even such ratio out of the population are subject to conditions. One typical example will be having the highest and the lowest value. For example “It is expected that 20% to 30% of the population of country X will disagree with the Prime Minister’s decision”.

To model such an event, therefore, we generalize Definition 2.3 so that the truth-membership value, indeterminate-membership value, and false-membership value can be any closed subinterval of $[0,1]$, instead of a single number from $[0,1]$. Such generalization is further derived from [46], which is a conference paper that we have just published on this topic.

Note: For all the other parts of this work, we will define:

$$\Delta_1 = \{[x, y]: 0 \leq x \leq y \leq 1\}$$

Definition 3.1 [46]. Let the statements below holds good:

- a) V is considered as a non-empty set.
- b) $\tilde{\rho}_T, \tilde{\rho}_I, \tilde{\rho}_F$ are three functions, each from V to Δ_1 .
- c) $E = \{(\tilde{\rho}_T(u), \tilde{\rho}_T(v)) \mid u, v \in V\}$,
 $F = \{(\tilde{\rho}_I(u), \tilde{\rho}_I(v)) \mid u, v \in V\}$,
 $G = \{(\tilde{\rho}_F(u), \tilde{\rho}_F(v)) \mid u, v \in V\}$.
- d) $\alpha: E \rightarrow \Delta_1, \beta: F \rightarrow \Delta_1, \delta: G \rightarrow \Delta_1$ are three functions.
- e) $\tilde{\rho} = (\tilde{\rho}_T, \tilde{\rho}_I, \tilde{\rho}_F)$; and
 $\tilde{\omega} = (\tilde{\omega}_T, \tilde{\omega}_I, \tilde{\omega}_F)$ with
 $\tilde{\omega}_T(u, v) = \alpha((\tilde{\rho}_T(x), \tilde{\rho}_T(v)))$,
 $\tilde{\omega}_I(u, v) = \alpha((\tilde{\rho}_I(x), \tilde{\rho}_I(v)))$,
 $\tilde{\omega}_F(u, v) = \alpha((\tilde{\rho}_F(x), \tilde{\rho}_F(v)))$,
 for every $u, v \in V$.

Then:

- i) The structure $\xi = \langle V, \tilde{\rho}, \tilde{\omega} \rangle$ is said to be a *generalized interval-valued neutrosophic graph of type 1 (GIVNG1)*.
- ii) For each $x \in V$, x is termed to be a *vertex* of ξ . The spanned set V is named the *vertex set* of ξ .
- iii) $\forall u, v \in V$, (u, v) is termed to be a *directed edge* of ξ . In particular, (u, v) is said to be a *loop* of ξ .
- iv) \forall vertex v : $\tilde{\rho}_T(v), \tilde{\rho}_I(v), \tilde{\rho}_F(v)$ are said to be the *truth-membership value, indeterminate-membership value, and false-membership value*, respectively, of that vertex v . Moreover, if $\tilde{\rho}_T(v) = \tilde{\rho}_I(v) = \tilde{\rho}_F(v) = [0,0]$, then v is deemed as *void vertex*.
- v) Similarly, for each edge (u, v) : $\tilde{\omega}_T(u, v), \tilde{\omega}_I(u, v), \tilde{\omega}_F(u, v)$ are said to be the *T, I, and F membership value* respectively of that directed edge (u, v) . Moreover, if $\tilde{\omega}_T(u, v) = \tilde{\omega}_I(u, v) = \tilde{\omega}_F(u, v) = [0,0]$, then (u, v) is said to be a *void directed edge*.

Remark : It follows that : $V \times V \rightarrow \Delta_1$.

Note that every vertex v in a GIVNG1 have a single, undirected loop, whether void or not. Also each of the distinct vertices u, v in a GIVNG1 posses *two* directed edges, resulting from (u, v) and (v, u) , whether void or not.

We study that in classical graph theory, we handle ordinary (or undirected) graphs, and also some simple graphs. Further we relate our GIVNG1 with it, we now give the below definition.

Definition 3.2. [46] Given $\xi = \langle V, \tilde{\rho}, \tilde{\omega} \rangle$ be a GIVNG1.

- a) If $\tilde{\omega}_T(a,b) = \tilde{\omega}_T(b,a)$, $\tilde{\omega}_I(a,b) = \tilde{\omega}_I(b,a)$ and $\tilde{\omega}_F(a,b) = \tilde{\omega}_F(b,a)$, then $\{a, b\} = \{(a, b), (b, a)\}$ is said to be an (*ordinary*) *edge* of ξ . Moreover, $\{a, b\}$ is said to be a *void* (*ordinary*) *edge* if both (a, b) and (b, a) are void.
- b) If $\tilde{\omega}_T(u,v) = \tilde{\omega}_T(v,u)$, $\tilde{\omega}_I(u,v) = \tilde{\omega}_I(v,u)$ and $\tilde{\omega}_F(u,v) = \tilde{\omega}_F(v,u)$ holds good for all $v \in V$, then ξ is considered to be *ordinary* (or *undirected*), else it is considered to be *directed*.
- c) When all the loops of ξ are becoming void, then ξ is considered to be *simple*.

In the following section, we discuss a real life scenario, for which GSVNG1 is insufficient to model it - it can only be done by using GIVNG1.

Example 3.3. Part 3.3.1 The scenario

Country X has 4 cities $\{a, b, c, d\}$. The cities are connected with each other by some roads, there are villages along the four roads (all of them are two way) $\{a, b\}$, $\{c, b\}$, $\{a, c\}$ and $\{d, b\}$. As for the other roads, such as $\{c, b\}$, they are either non-existent, or there are no population living along them (e.g. industrial area, national park, or simply forest). The legal driving age of Country X is 18. The prime minister of Country X would like to suggest an amendment of the legal driving age from 18 to 16. Before conducting a countrywide survey involving all the citizens, the prime minister discuss with all members of the parliament about the expected outcomes.

The culture and living standard of all the cities and villages differ from one another. In particular:

The public transport in c is so developed that few will have to drive. The people are rich enough to buy even air tickets. People in d tend to be more open minded in culture. Moreover, sports car exhibitions and shows are commonly held there. A fatal road accident just happened along $\{c,b\}$, claiming the lives of five unlicensed teenagers racing at 200km/h. $\{a, c\}$ is governed by an opposition leader who is notorious for being very uncooperative in all parliament affairs.

Eventually the parliament meeting was concluded with the following predictions:

		Expected percentage of citizens that will -					
		support		be neutral		Against	
		at least	at most	at least	at most	at least	at most
Cities	<i>a</i>	0.1	0.4	0.2	0.6	0.3	0.7
	<i>b</i>	0.3	0.5	0.2	0.5	0.2	0.5
	<i>c</i>	0.1	0.2	0.0	0.3	0.1	0.2
	<i>d</i>	0.5	0.7	0.2	0.4	0.1	0.2
Villages along the roads	{ <i>a,b</i> }	0.2	0.3	0.1	0.4	0.4	0.7
	{ <i>c,b</i> }	0.1	0.2	0.1	0.2	0.5	0.8
	{ <i>a,c</i> }	0.1	0.7	0.1	0.8	0.1	0.7
	{ <i>d,b</i> }	0.2	0.3	0.3	0.6	0.2	0.5

Without loss of generality: It is either $\{c, d\}$ does not exist, or there are no people living there, so all the six values – support (least, most), neutral (least, most), against(least, most), are all zero.

Part 3.3.2 Representing with GIVNG1

When we start from step a to e in def. 3.1 , to illustrate the schema with a special GIVNG1

- a) Take $V_0 = \{a, b, c, d\}$
- b) In line with the scenario, present the three functions

$\tilde{\rho}_T, \tilde{\rho}_I, \tilde{\rho}_F$, as illustrated in the following table.

	<i>a</i>	<i>b</i>	<i>c</i>	<i>d</i>
$\tilde{\rho}_T$	[0.1,0.4]	[0.3,0.5]	[0.1,0.2]	[0.5,0.7]
$\tilde{\rho}_I$	[0.2,0.6]	[0.2,0.5]	[0.0,0.3]	[0.2,0.4]
$\tilde{\rho}_F$	[0.3,0.7]	[0.2,0.5]	[0.1,0.2]	[0.1,0.2]

- c) By statement c) from Definition 3.1: Let

$$E_0 = \{(\tilde{\rho}_T(u), \tilde{\rho}_T(v)) \mid u, v \in \{a, b, c, d\}\}$$

$$F_0 = \{(\tilde{\rho}_I(u), \tilde{\rho}_I(v)) \mid u, v \in \{a, b, c, d\}\}$$

$$G_0 = \{(\tilde{\rho}_F(u), \tilde{\rho}_F(v)) \mid u, v \in \{a, b, c, d\}\}$$

- d) In accordance with the scenario, define

$$\alpha : E_0 \rightarrow \Delta_1, \beta : F_0 \rightarrow \Delta_1, \delta : G_0 \rightarrow \Delta_1,$$

as illustrated in the following tables.

$\alpha((\tilde{\rho}_T(u), \tilde{\rho}_T(v))) :$

v	a	b	c	d
u				
a	0	[0.2,0.3]	[0.1,0.7]	0
b	[0.2,0.3]	0	[0.1,0.2]	[0.2,0.3]
c	[0.1,0.7]	[0.1,0.2]	0	0
d	0	[0.2,0.3]	0	0

$\alpha((\tilde{\rho}_I(u), \tilde{\rho}_I(v))) :$

v	a	b	c	d
u				
a	0	[0.1,0.4]	[0.1,0.8]	0
b	[0.1,0.4]	0	[0.1,0.2]	[0.3,0.6]
c	[0.1,0.8]	[0.1,0.2]	0	0
d	0	[0.3,0.6]	0	0

$\alpha((\tilde{\rho}_F(u), \tilde{\rho}_F(v))) :$

v	a	b	c	d
u				
a	0	[0.4,0.7]	[0.1,0.7]	0
b	[0.4,0.7]	0	[0.5,0.8]	[0.2,0.5]
c	[0.1,0.7]	[0.5,0.8]	0	0
d	0	[0.2,0.5]	0	0

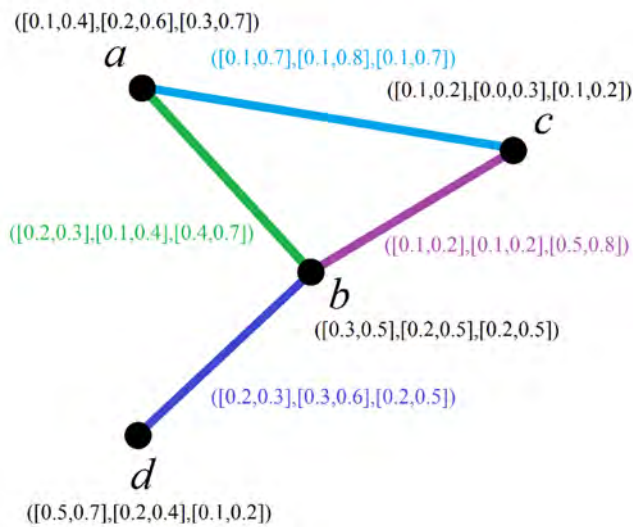

Figure 1

e) By statement e) from Definition 3.1, let

$$\begin{aligned} \tilde{\rho}_0 &= (\tilde{\rho}_T, \tilde{\rho}_I, \tilde{\rho}_F); \text{ and} \\ \tilde{\omega}_0 &= (\tilde{\omega}_T, \tilde{\omega}_I, \tilde{\omega}_F) \text{ with} \\ \tilde{\omega}_T(u, v) &= \alpha((\tilde{\rho}_T(u), \tilde{\rho}_T(v))), \\ \tilde{\omega}_I(u, v) &= \beta((\tilde{\rho}_I(u), \tilde{\rho}_I(v))), \\ \tilde{\omega}_F(u, v) &= \delta((\tilde{\rho}_F(u), \tilde{\rho}_F(v))), \end{aligned}$$

for all $u, v \in V_0$. We now have formed $\langle V_0, \tilde{\rho}_0, \tilde{\omega}_0 \rangle$, which is a GIVNG1.

The way of showing the concepts of $\langle V_0, \tilde{\rho}_0, \tilde{\omega}_0 \rangle$ is by exerting a diagram that is similar with graphs as in classical graph theory, as given in the figure 1 below

That is to say, only the non-void edges (whether directed or ordinary) and vertices been drawn in the picture shown above.

Also, understanding the fact that, in classical graph theory GT, a graph is denoted by adjacency matrix, for which the entries are either a positive integer (connected) or 0 (which is not connected).

This motivates us to present a GIVNG1, by a matrix as well. However, instead of a single value which defines the value that is either 0 or 1, there are *three* values to handle: $\tilde{\omega}_T, \tilde{\omega}_I, \tilde{\omega}_F$, with each of them being elements of Δ_1 . Moreover, each of the vertices themselves also contains $\tilde{\rho}_T, \tilde{\rho}_I, \tilde{\rho}_F$, which should be taken into account as well.

4. Illustration of GIVNG1 by virtue adjacency matrix

Section 4.1 Algorithms representing GIVNG1

In light of two ways that are similar to other counterparts, the focal point of interest in the following part is to express the notion of GIVNG1.

Suppose $\xi = \langle V, \tilde{\rho}, \tilde{\omega} \rangle$ is a GIVNG1 where $V = \{v_1, v_2, \dots, v_n\}$ denotes the vertex set (i.e. GIVNG1 has finite vertices). Remember that GIVNG1 has its edge membership values (T, I, F) depending on the membership values (T, I, F) of adjacent vertices, in accordance with the functions α, β, δ .

Furthermore:

$$\begin{aligned} \tilde{\omega}_T(u, v) &= \alpha((\tilde{\rho}_T(u), \tilde{\rho}_T(v))) \text{ for all } v \in V, \text{ where} \\ \alpha: E &\rightarrow \Delta_I, \text{ and } E = \{(\tilde{\rho}_T(u), \tilde{\rho}_T(v)) \mid u, v \in V\}, \\ \tilde{\omega}_I(u, v) &= \beta((\tilde{\rho}_I(u), \tilde{\rho}_I(v))) \text{ for all } u, v \in V, \text{ where} \\ \beta: F &\rightarrow \Delta_I, \text{ and } F = \{(\tilde{\rho}_I(u), \tilde{\rho}_I(v)) \mid u, v \in V\}, \\ \tilde{\omega}_F(u, v) &= \delta((\tilde{\rho}_F(u), \tilde{\rho}_F(v))) \text{ for all } u, v \in V, \text{ where} \\ \delta: G &\rightarrow \Delta_I, \text{ and } G = \{(\tilde{\rho}_F(u), \tilde{\rho}_F(v)) \mid u, v \in V\}. \end{aligned}$$

First we will form an $n \times n$ matrix as presented

$$\tilde{\mathbf{S}} = [\tilde{\mathbf{a}}_{i,j}]_n = \begin{pmatrix} \tilde{\mathbf{a}}_{1,1} & \tilde{\mathbf{a}}_{1,2} & \cdots & \tilde{\mathbf{a}}_{1,n} \\ \tilde{\mathbf{a}}_{2,1} & \tilde{\mathbf{a}}_{2,2} & & \tilde{\mathbf{a}}_{2,n} \\ \vdots & & \ddots & \vdots \\ \tilde{\mathbf{a}}_{n,1} & \tilde{\mathbf{a}}_{n,2} & \cdots & \tilde{\mathbf{a}}_{n,n} \end{pmatrix},$$

For each $i, j, \tilde{\mathbf{a}}_{i,j} = (\tilde{\omega}_T(v_i, v_j), \tilde{\omega}_I(v_i, v_j), \tilde{\omega}_F(v_i, v_j))$

That is to say, for an element of the matrix $\tilde{\mathbf{S}}$, different from taking numbers 0 or 1 according to classical literatures, we usually take the element as an ordered set involving 3 closed subintervals of $[0,1]$.

Remark : Due to the fact that ξ could only have undirected loops, the dominating diagonal elements of $\tilde{\mathbf{S}}$ is not multiplied by 2, which is shown as adjacency matrices from classical literatures. It is noted that 0 represents void, 1 for directed ones and 2 for undirected ones.

At the same time, considering $\tilde{\rho}_T, \tilde{\rho}_I, \tilde{\rho}_F$ is included in ξ , which also deserves to be considered.

Therefore another matrix $\tilde{\mathbf{R}}$ is given in the following part.

$$\tilde{\mathbf{R}} = [\tilde{\mathbf{r}}_i]_{n,1} = \begin{pmatrix} \tilde{\mathbf{r}}_1 \\ \tilde{\mathbf{r}}_2 \\ \vdots \\ \tilde{\mathbf{r}}_n \end{pmatrix},$$

Where

$$\begin{aligned} \tilde{\mathbf{r}}_i &= (\tilde{\rho}_T(v_i), \tilde{\rho}_I(v_i), \tilde{\rho}_F(v_i)) \\ &= ([\rho_T^L(v_i), \rho_T^U(v_i)], [\rho_I^L(v_i), \rho_I^U(v_i)], [\rho_F^L(v_i), \rho_F^U(v_i)]) \forall. \end{aligned}$$

In order to complete the task of describing the whole ξ in our way, the matrix $\tilde{\mathbf{R}}$ is augmented with $\tilde{\mathbf{S}}$. Then $[\tilde{\mathbf{R}} | \tilde{\mathbf{S}}]$ is represented as an *adjacency matrix of GIVNG*, which is presented below.

$$[\mathbf{R} | \mathbf{S}] = \begin{pmatrix} \tilde{\mathbf{r}}_1 & \tilde{\mathbf{a}}_{1,1} & \tilde{\mathbf{a}}_{1,2} & \cdots & \tilde{\mathbf{a}}_{1,n} \\ \tilde{\mathbf{r}}_2 & \tilde{\mathbf{a}}_{2,1} & \tilde{\mathbf{a}}_{2,2} & & \tilde{\mathbf{a}}_{2,n} \\ \vdots & \vdots & & \ddots & \vdots \\ \tilde{\mathbf{r}}_n & \tilde{\mathbf{a}}_{n,1} & \tilde{\mathbf{a}}_{n,2} & \cdots & \tilde{\mathbf{a}}_{n,n} \end{pmatrix},$$

where $\tilde{\mathbf{a}}_{i,j} = (\tilde{\omega}_T(v_i, v_j), \tilde{\omega}_I(v_i, v_j), \tilde{\omega}_F(v_i, v_j))$,

and $\tilde{\mathbf{r}}_i = ([\rho_T^L(v_i), \rho_T^U(v_i)], [\rho_I^L(v_i), \rho_I^U(v_i)], [\rho_F^L(v_i), \rho_F^U(v_i)])$, $\forall i$ and j .

It is worth noticing $[\tilde{\mathbf{R}} | \tilde{\mathbf{S}}]$ is not a square matrix ($n \times (n + 1)$ matrix), thus this kind of representation will aid us to save another *divided* ordered set to denote the values of vertices as $\tilde{\rho}_T, \tilde{\rho}_I, \tilde{\rho}_F$.

For both edges and vertices, it is imperative to separately handle each of three kinds of membership values in several situations. Consequently, by means of three $n \times (n+1)$ matrices, we aim to give a brand-new way for expressing the whole ξ , denoted as $[\tilde{\mathbf{R}} | \tilde{\mathbf{S}}]_T, [\tilde{\mathbf{R}} | \tilde{\mathbf{S}}]_I$ and $[\tilde{\mathbf{R}} | \tilde{\mathbf{S}}]_F$, each of them is resulted from $[\tilde{\mathbf{R}} | \tilde{\mathbf{S}}]$ through taking a single kind of membership values from the corresponding elements.

$$\begin{aligned}
 [\tilde{\mathbf{R}} | \tilde{\mathbf{S}}]_T = [\tilde{\mathbf{R}}_T | \tilde{\mathbf{S}}_T] &= \begin{pmatrix} \tilde{\rho}_T(v_1) & \tilde{\omega}_T(v_1, v_1) & \tilde{\omega}_T(v_1, v_2) & \cdots & \tilde{\omega}_T(v_1, v_n) \\ \tilde{\rho}_T(v_2) & \tilde{\omega}_T(v_2, v_1) & \tilde{\omega}_T(v_2, v_2) & \cdots & \tilde{\omega}_T(v_2, v_n) \\ & \vdots & & \ddots & \vdots \\ \tilde{\rho}_T(v_n) & \tilde{\omega}_T(v_n, v_1) & \tilde{\omega}_T(v_n, v_2) & \cdots & \tilde{\omega}_T(v_n, v_n) \end{pmatrix}, \\
 [\tilde{\mathbf{R}} | \tilde{\mathbf{S}}]_I = [\tilde{\mathbf{R}}_I | \tilde{\mathbf{S}}_I] &= \begin{pmatrix} \tilde{\rho}_I(v_1) & \tilde{\omega}_I(v_1, v_1) & \tilde{\omega}_I(v_1, v_2) & \cdots & \tilde{\omega}_I(v_1, v_n) \\ \tilde{\rho}_I(v_2) & \tilde{\omega}_I(v_2, v_1) & \tilde{\omega}_I(v_2, v_2) & \cdots & \tilde{\omega}_I(v_2, v_n) \\ & \vdots & & \ddots & \vdots \\ \tilde{\rho}_I(v_n) & \tilde{\omega}_I(v_n, v_1) & \tilde{\omega}_I(v_n, v_2) & \cdots & \tilde{\omega}_I(v_n, v_n) \end{pmatrix}, \\
 [\tilde{\mathbf{R}} | \tilde{\mathbf{S}}]_F = [\tilde{\mathbf{R}}_F | \tilde{\mathbf{S}}_F] &= \begin{pmatrix} \tilde{\rho}_F(v_1) & \tilde{\omega}_F(v_1, v_1) & \tilde{\omega}_F(v_1, v_2) & \cdots & \tilde{\omega}_F(v_1, v_n) \\ \tilde{\rho}_F(v_2) & \tilde{\omega}_F(v_2, v_1) & \tilde{\omega}_F(v_2, v_2) & \cdots & \tilde{\omega}_F(v_2, v_n) \\ & \vdots & & \ddots & \vdots \\ \tilde{\rho}_F(v_n) & \tilde{\omega}_F(v_n, v_1) & \tilde{\omega}_F(v_n, v_2) & \cdots & \tilde{\omega}_F(v_n, v_n) \end{pmatrix}.
 \end{aligned}$$

$[\tilde{\mathbf{R}} | \tilde{\mathbf{S}}]_T, [\tilde{\mathbf{R}} | \tilde{\mathbf{S}}]_I$ and $[\tilde{\mathbf{R}} | \tilde{\mathbf{S}}]_F$ should be stated respectively with the *true adjacency matrix*, the *indeterminate adjacency matrix*, and *false adjacency matrix* of ξ .

Remark 1 : If $[\tilde{\mathbf{R}} | \tilde{\mathbf{S}}]_I = [\tilde{\mathbf{R}} | \tilde{\mathbf{S}}]_F = [[0, 0]]_{n, n+1}$, $\tilde{\mathbf{R}}_T = [[1, 1]]_{n, 1}$, all the entries of $\tilde{\mathbf{S}}_T$ are either $[1, 1]$ or $[0, 0]$, then ξ is reduced to a graph in classical literature. Moreover, if that $\tilde{\mathbf{S}}_T$ is symmetric and the main diagonal elements are being 0, we have ξ is further condensed to a simple ordinary graph in literature.

Remark 2 : If $[\tilde{\mathbf{R}} | \tilde{\mathbf{S}}]_I = [\tilde{\mathbf{R}} | \tilde{\mathbf{S}}]_F = [[0, 0]]_{n, n+1}$, and all the entries of $[\tilde{\mathbf{R}} | \tilde{\mathbf{S}}]_T = [[a_{i,j}, a_{i,j}]]_{n, n+1}$, then ξ is reduced to a generalized fuzzy graph type 1 (GFG1).

Remark 3 : If $[\tilde{\mathbf{R}} | \tilde{\mathbf{S}}]_T = [[a_{i,j}, a_{i,j}]]_{n, n+1}$, $[\tilde{\mathbf{R}} | \tilde{\mathbf{S}}]_I = [[b_{i,j}, b_{i,j}]]_{n, n+1}$, $[\tilde{\mathbf{R}} | \tilde{\mathbf{S}}]_F = [[c_{i,j}, c_{i,j}]]_{n, n+1}$, then ξ is thus reduced to GSVNG1.

Section 4.2 : Case study to illustrate our example in this paper

For our example in the set-up by the last way i.e. with three matrices:

$[\tilde{R} | \tilde{S}]_T, [\tilde{R} | \tilde{S}]_I$ and $[\tilde{R} | \tilde{S}]_F$:

$$\begin{aligned}
 [R|S]_T &= \begin{pmatrix} [0.1,0.4] & [0,0] & [0.2,0.3] & [0.1,0.7] & [0,0] \\ [0.3,0.5] & [0.2,0.3] & [0,0] & [0.1,0.2] & [0.2,0.3] \\ [0.1,0.2] & [0.1,0.7] & [0.1,0.2] & [0,0] & [0,0] \\ [0.1,0.7] & [0,0] & [0.2,0.3] & [0,0] & [0,0] \end{pmatrix} \\
 [R|S]_I &= \begin{pmatrix} [0.2,0.6] & [0,0] & [0.1,0.4] & [0.1,0.8] & [0,0] \\ [0.2,0.5] & [0.1,0.4] & [0,0] & [0.1,0.2] & [0.3,0.6] \\ [0.0,0.3] & [0.1,0.8] & [0.1,0.2] & [0,0] & [0,0] \\ [0.2,0.4] & [0,0] & [0.3,0.6] & [0,0] & [0,0] \end{pmatrix} \\
 [R|S]_F &= \begin{pmatrix} [0.3,0.7] & [0,0] & [0.4,0.7] & [0.1,0.7] & [0,0] \\ [0.2,0.5] & [0.4,0.7] & [0,0] & [0.5,0.8] & [0.2,0.5] \\ [0.1,0.2] & [0.1,0.7] & [0.5,0.8] & [0,0] & [0,0] \\ [0.1,0.2] & [0,0] & [0.2,0.5] & [0,0] & [0,0] \end{pmatrix}
 \end{aligned}$$

5. Postulated results on ordinary GIVNG1

We now illustrate some theoretical results that are derived from the definition of ordinary GIVNG1, as well as its indication with adjacency matrix. Since we focus on the basic GIVNG1, all the edges which we will be referring to are termed as ordinary edges.

Definition 5.1 The addition operation + is defined on Δ_1 as follows: $[x, y] + [z, t] = [x + y, z + t]$ for all $x, y, z, t \in [0,1]$.

Definition 5.2 Let $\xi = \langle V, \tilde{\rho}, \tilde{\omega} \rangle$ be an ordinary GIVNG1. Let $V = \{v_1, v_2, \dots, v_n\}$ to be the vertex set of ξ . Then, $\forall i$, the *degree* of v_i , symbolised as $\tilde{D}(v_i)$, is well-defined to be the ordered set

$$(\tilde{D}_T(v_i), \tilde{D}_I(v_i), \tilde{D}_F(v_i)),$$

for which, $\tilde{D}_T(v_i)$ represents the *degree* of v_i and

$$\begin{aligned}
 a) \quad \tilde{D}_T(v_i) &= \left[\sum_{r=1}^n \omega_T^L(v_i, v_r) + \omega_T^L(v_i, v_i), \sum_{r=1}^n \omega_T^U(v_i, v_r) + \omega_T^U(v_i, v_i) \right] \\
 b) \quad \tilde{D}_I(v_i) &= \left[\sum_{r=1}^n \omega_I^L(v_i, v_r) + \omega_I^L(v_i, v_i), \sum_{r=1}^n \omega_I^U(v_i, v_r) + \omega_I^U(v_i, v_i) \right] \\
 c) \quad \tilde{D}_F(v_i) &= \left[\sum_{r=1}^n \omega_F^L(v_i, v_r) + \omega_F^L(v_i, v_i), \sum_{r=1}^n \omega_F^U(v_i, v_r) + \omega_F^U(v_i, v_i) \right]
 \end{aligned}$$

Remark 1 : In resemblance to classical graph theory, each undirected loop has both its ends connected to the similar vertex and so is counted twice.

Remark 2 : Every value of $\tilde{D}_T(v_i)$, $\tilde{D}_I(v_i)$ and $\tilde{D}_F(v_i)$ are elements of Δ_1 instead of a single number.

Definition 5.3 : Given $\xi = \langle V, \tilde{\rho}, \tilde{\omega} \rangle$ and $V = \{v_1, v_2, \dots, v_n\}$ are respectively an ordinary GIVNG1 and the vertex set of ξ . Then, the *quantity of edges* in ξ , represented as E_ξ and we describe the ordered set $(\tilde{E}_T, \tilde{E}_I, \tilde{E}_F)$ for which

$$\begin{aligned}
 a) \quad \tilde{E}_T &= \left[\sum_{\{r,s\} \subseteq \{1,2,\dots,n\}} \omega_T^L(v_r, v_s), \sum_{\{r,s\} \subseteq \{1,2,\dots,n\}} \omega_T^U(v_r, v_s) \right] \\
 b) \quad \tilde{E}_I &= \left[\sum_{\{r,s\} \subseteq \{1,2,\dots,n\}} \omega_I^L(v_r, v_s), \sum_{\{r,s\} \subseteq \{1,2,\dots,n\}} \omega_I^U(v_r, v_s) \right] \\
 c) \quad \tilde{E}_F &= \left[\sum_{\{r,s\} \subseteq \{1,2,\dots,n\}} \omega_F^L(v_r, v_s), \sum_{\{r,s\} \subseteq \{1,2,\dots,n\}} \omega_F^U(v_r, v_s) \right]
 \end{aligned}$$

Remark 1 : We count each edge only once in classical graph theory, as given by $\{r,s\} \subseteq \{1,2,\dots,n\}$.

For instance, if $\tilde{\omega}_T(v_a, v_b)$ is added, we will not add $\tilde{\omega}_T(v_b, v_a)$ again since $\{a, b\} = \{b, a\}$.

Remark 2 : Each values of \tilde{E}_T , \tilde{E}_I and \tilde{E}_F are elements of Δ_1 instead of a single number, and need not be 0 or 1 as in classical graph literature. Consequently, it is called “amount” of edges, instead of the “number” of edges as in the classical reference.

$\tilde{E}_T, \tilde{E}_I, \tilde{E}_F$ are closed subintervals of $[0,1]$, and $\tilde{D}_T(v_i), \tilde{D}_I(v_i), \tilde{D}_F(v_i)$ are also closed subintervals of $[0,1]$ for each vertex v_i . These give rise to the following lemmas

Lemma 5.4 : Let $\xi = \langle V, \tilde{\rho}, \tilde{\omega} \rangle$ be an ordinary GIVNG1. Let $V = \{v_1, v_2, \dots, v_n\}$ to be the vertex set of ξ . Denote

$$\begin{aligned}
 a) \quad \tilde{\omega}_T(v_i, v_j) &= [\phi_{T,(i,j)}, \psi_{T,(i,j)}] \\
 b) \quad \tilde{\omega}_I(v_i, v_j) &= [\phi_{I,(i,j)}, \psi_{I,(i,j)}] \\
 c) \quad \tilde{\omega}_F(v_i, v_j) &= [\phi_{F,(i,j)}, \psi_{F,(i,j)}], \forall i, j
 \end{aligned}$$

For each i we have:

$$\begin{aligned}
 \text{i)} \quad \tilde{D}_T(v_i) &= \left[\sum_{r=1}^n \phi_{T,(i,r)} + \phi_{T,(i,i)}, \sum_{r=1}^n \psi_{T,(i,r)} + \psi_{T,(i,i)} \right], \\
 \text{ii)} \quad \tilde{D}_I(v_i) &= \left[\sum_{r=1}^n \phi_{I,(i,r)} + \phi_{I,(i,i)}, \sum_{r=1}^n \psi_{I,(i,r)} + \psi_{I,(i,i)} \right], \\
 \text{iii)} \quad \tilde{D}_F(v_i) &= \left[\sum_{r=1}^n \phi_{F,(i,r)} + \phi_{T,(i,i)}, \sum_{r=1}^n \psi_{F,(i,r)} + \psi_{F,(i,i)} \right].
 \end{aligned}$$

Furthermore:

$$\begin{aligned}
 \text{iv)} \quad \tilde{E}_T &= \left[\sum_{\{r,s\} \subseteq \{1,2,\dots,n\}} \phi_{T,(r,s)}, \sum_{\{r,s\} \subseteq \{1,2,\dots,n\}} \psi_{T,(r,s)} \right], \\
 \text{v)} \quad \tilde{E}_I &= \left[\sum_{\{r,s\} \subseteq \{1,2,\dots,n\}} \phi_{I,(r,s)}, \sum_{\{r,s\} \subseteq \{1,2,\dots,n\}} \psi_{I,(r,s)} \right], \\
 \text{vi)} \quad \tilde{E}_F &= \left[\sum_{\{r,s\} \subseteq \{1,2,\dots,n\}} \phi_{F,(r,s)}, \sum_{\{r,s\} \subseteq \{1,2,\dots,n\}} \psi_{F,(r,s)} \right].
 \end{aligned}$$

Proof : We can prove it directly by applying Def.5.1, Def. 5.2 and Def. 5.3. In the following two theorems, we introduce two theorems which both as a modified version of the well-known theorem in classical graph theory.

“We know that the sum of the degree of invariably its vertices is twice the number of its edges for any classical graph.”

Theorem 5.5 : Let $\xi = \langle V, \tilde{\rho}, \tilde{\omega} \rangle$ be an ordinary GIVNG1. Then

$$\sum_{r=1}^n \tilde{D}(v_r) = 2\tilde{E}_\xi$$

Proof : As $\tilde{D}(v_i) = (\tilde{D}_T(v_i), \tilde{D}_I(v_i), \tilde{D}_F(v_i))$ for all i , and $\tilde{E}_\xi = (\tilde{E}_T, \tilde{E}_I, \tilde{E}_F)$. It is enough to show that $2\tilde{E}_T = \sum_{r=1}^n \tilde{D}_T(v_r)$:

$$\begin{aligned}
 \tilde{E}_T &= \left[\sum_{\{r,s\} \subseteq \{1,2,\dots,n\}} \omega_T^L(v_r, v_s), \sum_{\{r,s\} \subseteq \{1,2,\dots,n\}} \omega_T^U(v_r, v_s) \right] \\
 &= \left[\sum_{\substack{\{r,s\} \subseteq \{1,2,\dots,n\} \\ r \neq s}} \omega_T^L(v_r, v_s) + \sum_{r=1}^n \omega_T^L(v_r, v_r), \right. \\
 &\quad \left. \sum_{\substack{\{r,s\} \subseteq \{1,2,\dots,n\} \\ r \neq s}} \omega_T^U(v_r, v_s) + \sum_{r=1}^n \omega_T^U(v_r, v_r) \right]
 \end{aligned}$$

Since $\{r, s\} = \{s, r\}$ for all s and r ,

$$\begin{aligned}
 2\tilde{E}_T &= \left[\begin{aligned} &2 \sum_{\substack{\{r,s\} \subseteq \{1,2,\dots,n\} \\ r \neq s}} \omega_T^L(v_r, v_s) + 2 \sum_{r=1}^n \omega_T^L(v_r, v_r), \\ &2 \sum_{\substack{\{r,s\} \subseteq \{1,2,\dots,n\} \\ r \neq s}} \omega_T^U(v_r, v_s) + 2 \sum_{r=1}^n \omega_T^U(v_r, v_r) \end{aligned} \right] \\
 &= \left[\begin{aligned} &\sum_{\substack{r \in \{1,2,\dots,n\} \\ s \in \{1,2,\dots,n\} \\ r \neq s}} \omega_T^L(v_r, v_s) + 2 \sum_{r=1}^n \omega_T^L(v_r, v_r), \\ &\sum_{\substack{r \in \{1,2,\dots,n\} \\ s \in \{1,2,\dots,n\} \\ r \neq s}} \omega_T^U(v_r, v_s) + 2 \sum_{r=1}^n \omega_T^U(v_r, v_r) \end{aligned} \right] \\
 &= \left[\begin{aligned} &\sum_{\substack{r \in \{1,2,\dots,n\} \\ s \in \{1,2,\dots,n\}}} \omega_T^L(v_r, v_s) + \sum_{r=1}^n \omega_T^L(v_r, v_r), \\ &\sum_{\substack{r \in \{1,2,\dots,n\} \\ s \in \{1,2,\dots,n\}}} \omega_T^U(v_r, v_s) + \sum_{r=1}^n \omega_T^U(v_r, v_r) \end{aligned} \right] \\
 &= \left[\begin{aligned} &\sum_{r=1}^n \sum_{s=1}^n \omega_T^L(v_r, v_s) + \sum_{r=1}^n \omega_T^L(v_r, v_r), \\ &\sum_{r=1}^n \sum_{s=1}^n \omega_T^U(v_r, v_s) + \sum_{r=1}^n \omega_T^U(v_r, v_r) \end{aligned} \right] \\
 &= \left[\begin{aligned} &\sum_{r=1}^n \left(\sum_{s=1}^n \omega_T^L(v_r, v_s) + \omega_T^L(v_r, v_r) \right), \\ &\sum_{r=1}^n \left(\sum_{s=1}^n \omega_T^U(v_r, v_s) + \omega_T^U(v_r, v_r) \right), \end{aligned} \right] \\
 &= \sum_{r=1}^n \tilde{D}_T(v_r).
 \end{aligned}$$

This finishes the proof. ■

6. Conclusion

The idea of GSVNG1 was extended to introduce the concept of generalized interval-valued neutrosophic graph of type 1 (GIVNG1). The matrix representation of GIVNG1 was also introduced. The future direction of this research includes the study of completeness, regularity of GIVNG1, and also denote the notion of generalized interval-valued neutrosophic graphs of type 2. As GIVNG1 (in this paper) and CNG1 (from [47]) are both extensions of the existing concepts of CFG1 and GSVNG1, but in two entirely different directions, the future direction of this research also includes further extensions from GIVNG1 and CNG1, that incorporates *both* the inter-valued entries (as in GIVNG1) and complexity of numbers (as in CNG1), and the study of scenarios that necessitate such extensions [48-52].

References

- [1] V. Krishnaraj, R. Vikramaprasad and R. Dhavaseelan, Perfect and Status in single valued neutrosophic graphs, *Journal of Mechanical Engineering and Technology (IJMET)*, Volume 9, Issue 1, (2018)1124–1132
- [2] K. Abhishek, Set-Valued Graphs: A Survey, *Journal of Discrete Mathematical Sciences and Cryptography*, 18:1-2, (2015)55-80, DOI: 10.1080/09720529.2014.894306
- [3] K. Atanassov, Intuitionistic Fuzzy Sets. *Fuzzy Sets and Systems*, Vol.20, , (1986). 87-96.
- [4] K. Atanassov, Intuitionistic fuzzy sets: theory and applications, *Physica*, New York, (1989).
- [5] K. Atanassov and G. Gargov, Interval Valued Intuitionistic Fuzzy Sets. *Fuzzy Sets and Systems*, Vol.31, (1989).343-349.
- [6] M. Akram and G. Shahzadi, Operations on single-valued neutrosophic graphs. *Journal of Uncertain System*, 11, (2017).1-26.
- [7] M. Akram and W. A. Dudek, Interval-valued fuzzy graphs. *Computers and Mathematics with Applications* 61, (2011).289–299.
- [8] S. Broumi, M. Talea, A. Bakali, F. Smarandache, Single Valued Neutrosophic Graphs. *Journal of New Theory*, N 10, (2016).86-101.

- [9] S.Broumi, M.Talea,F. Smarandache, and A. Bakali, Single Valued Neutrosophic Graphs: Degree, Order and Size. IEEE International Conference on Fuzzy Systems (FUZZ), (2016). 2444-2451.
- [10] S. Broumi, A. Bakali,M. Talea, and F.Smarandache, Isolated Single Valued Neutrosophic Graphs. NeutrosophicSets and Systems, Vol.11, (2016)74-78.
- [11] S.Broumi, M.Talea, A.Bakali, F. Smarandache, Interval valued neutrosophic graphs. Critical Review, XII, (2016).pp.5-33.
- [12] S. Broumi, F.Smarandache, M. Talea and A. Bakali, Decision-Making Method Based On the Interval Valued Neutrosophic Graph, FutureTechnologie, IEEE, (2016) 44-50.
- [13] S. Broumi,A.Bakali, M.Talea, F.Smarandache,M. Ali, Shortest Path Problem Under Bipolar Neutrosophic Setting, Applied Mechanics and Materials, Vol. 859, (2016). 59-66
- [14] S.Broumi,A.Bakali, M.Talea,F. SmarandacheandL.Vladareanu, Computation of Shortest Path Problem in a Network with SV-Trapezoidal NeutrosophicNumbers.Proceedings of the 2016 International Conference on Advanced Mechatronic Systems, Melbourne, Australia, (2016) 417-422.
- [15] S. Broumi, A.Bakali, M.Talea,F.SmarandacheandL.Vladareanu, Applying Dijkstra Algorithm for Solving NeutrosophicShortest Path Problem. Proceedings of the 2016 International Conference on Advanced Mechatronic Systems, Melbourne, Australia, November 30 - December 3, (2016).412-416.
- [16] S. Broumi, M. Talea, A. Bakali,and F. Smarandache, On Bipolar Single Valued Neutrosophic Graphs. *Journal Of New Theory*, N11, (2016)84-102.
- [17] S.Broumi, F.Smarandache, M. Talea, and A.Bakali, An Introduction to Bipolar Single Valued Neutrosophic Graph Theory. Applied Mechanics and Materials, vol.841, (2016) pp. 184-191.
- [18] S .Broumi, F. Smarandache, M. Talea, and A. Bakali, Operations on Interval Valued Neutrosophic Graphs, chapter in book- New Trends in Neutrosophic Theory and Applications- Florentin Smarandache and Surpati Pramanik (Editors), (2016). 231-254. ISBN 978-1-59973-498-9.
- [19] S. Broumi, A. Bakali, M. Talea, A. Hassan F. Smarandache, Generalized single valued neutrosophic first type, 2017, accepted

- [20] S. Ridvan, An approach to neutrosophic graph theory with applications, *Soft Comput*, 2017, DOI 10.1007/s00500-017-2875-1
- [21] F. Karaaslan, and B. Davvaz, Properties of single-valued neutrosophic graphs, *Journal of Intelligent & Fuzzy Systems*, vol. 34, no. 1, (2018). pp. 57-79
- [22] <http://fs.gallup.unm.edu/NSS/>.
- [23] E. Kartheek, S. S. Basha, The minimum dominating energy of a fuzzy graph, *Journal of Information and Optimization Sciences* Vol. 38, No. 3 & 4, (2017). 443–453.
- [24] S. N. Mishra and A. Pal, Product of Interval-Valued Intuitionistic fuzzy graph. *Annals of pure and applied mathematics* 5, (2013). 37-46.
- [25] B. A. Mohideen, Strong and regular interval-valued fuzzy graphs. *Journal of Fuzzy Set Valued Analysis*, No.3, (2015). 215-223.
- [26] V. Krishnaraj, R. Vikramaprasad, and R. Dhavaseelan, Self-Centered Single Valued Neutrosophic Graphs, *International Journal of Applied Engineering Research Volume 12, Number 24* (2017). 15536-15543
- [27] K. Sinha, P. Majumdar: Entropy based Single Valued Neutrosophic Digraph and its applications, *Neutrosophic Sets and Systems*, vol. 19, (2018). 119-126.
- [28] H. Rashmanlou, Y.B. Jun, Complete interval-valued fuzzy graphs. *Annals of Fuzzy Mathematics and Informatics* 6, (2013). 677 – 687.
- [29] A. Shannon, K. Atanassov, A First Step to a Theory of the Intuitionistic Fuzzy Graphs. *Proc. of the First Workshop on Fuzzy Based Expert Systems* (D. akov, Ed.), Sofia, (1994). 59-61.
- [30] F. Smarandache, Refined Literal Indeterminacy and the Multiplication Law of Sub-Indeterminacies. *Neutrosophic Sets and Systems*, Vol. 9, (2015). 58.63.
- [31] F. Smarandache, Types of Neutrosophic Graphs and neutrosophic Algebraic Structures together with their Applications in Technology. seminar, Universitatea Transilvania din Brasov, Facultatea de Design de Producers Mediu, Brasov, Romania, (2015).
- [32] F. Smarandache, Neutrosophy. Neutrosophic Probability, Set, and Logic. ProQuest Information & Learning, Ann Arbor, Michigan, USA, (1998). 105 p.

- [33] F. Smarandache, Neutrosophic overset, neutrosophic underset, Neutrosophic offset, Similarly for Neutrosophic Over-/Under-/OffLogic, Probability, and Statistic. Pons Editions, Brussels, (2016). 170p.
- [34] F. Smarandache, Symbolic Neutrosophic Theory, Europanovaasbl, Brussels, (2015). 195 p., Belgium.
- [35] S. Broumi, L.H. Son, A. Bakali, M. Talea, F. Smarandache, G. Selvachandran, Computing Operational Matrices in Neutrosophic Environments: A Matlab Toolbox, Neutrosophic Sets and Systems, Vol. 18, (2017). 58-66
- [36] S. Broumi, A. Dey, A. Bakali, M. Talea, F. Smarandache, L. H. Son, D. Koley, Uniform Single Valued Neutrosophic Graphs, Neutrosophic Sets and Systems, Vol. 17, (2017). 42-49
- [37] S. Broumi, A. Bakali, M. Talea, F. Smarandache, A Matlab Toolbox for interval valued neutrosophic matrices for computer applications, Uluslararası Yönetim Bilişim Sistemlerive Bilgisayar Bilimleri Dergisi, 1(1), (2017). 1-21
- [38] J. Malarvizhi and G. Divya, On Antipodal Single Valued Neutrosophic Graph, Annals of Pure and Applied Mathematics, Vol. 15, No. 2(2017). 235-242
- [39] S. Samanta, B. Sarkar, D. Shin, and M. Pal, Completeness and regularity of generalized fuzzy graphs, (2016). SpringerPlus, DOI 10.1186/s40064-016-3558-6.
- [40] I. Turksen, Interval Valued Fuzzy Sets based on Normal Forms, Fuzzy Sets and Systems, Vol. 20, (1986) 191-210
- [41] A. Mhomed Ali, V. J. Sudhakar, G. Sathish Kumar and D. Vinoth, Self-centred interval valued signed neutrosophic graph, International Journal of Mathematical Archive-9(9), 2018, 44-50.
- [42] W. B. Vasantha Kandasamy, K. Ilanthenral and F. Smarandache, Neutrosophic Graphs: A New Dimension to Graph Theory Kindle Edition, (2015).
- [43] H. Wang, F. Smarandache, Y. Zhang, and R. Sunderraman, Single valued Neutrosophic Sets, Multispace and Multistructure 4, (2010). 410-413.
- [44] H. Wang, F. Smarandache, Y. Q. Zhang, and R. Sunderraman, Interval neutrosophic Sets and Logic: Theory and Applications in Computing. Hexis, Phoenix, AZ, (2005).
- [45] L. Zadeh, Fuzzy sets. Inform and Control, 8, (1965) 338-353

- [46] S.Broumi, M. Talea, AssiaBakali, Ali Hassan and F.Smarandache, Generalized Interval Valued Neutrosophic Graphs of First Type, 2017 IEEE International Conference on Innovations in Intelligent Systems and Applications (INISTA), Gdynia, Maritime University, Gdynia, Poland, 3-5 July, (2017). 413-419.
- [47] G. Quek, S. Broumi, G. Selvachandran, A.Bakali, M. Talea and F. Smarandache, 2018, Some Results on the Graph Theory for Complex Neutrosophic Sets, *Symmetry*, 10(6), pp 190.
- [48] X. D.Peng, J.G. Dai, A Bibliometric Analysis of Neutrosophic Set: Two Decades Review from 1998-2017, *Artificial Intelligence Review*, DOI: 10.1007/s10462-018-9652-0, 2018
- [49] X.D.Peng, G. Selvachandran. Pythagorean fuzzy set: state of the art and future directions, *Artificial Intelligence Review*, DOI: 10.1007/s10462-017-9596-9, 2017.
- [50] X. D. Peng, J.G. Dai. Approaches to single-valued neutrosophic MADM based on MABAC, TOPSIS and new similarity measure with score function, *Neural Computing and Applications*, 2018, 29(10), 939-954.
- [51] X.D. Peng, C. Liu. Algorithms for neutrosophic soft decision making based on EDAS, new similarity measure and level soft set, *Journal of Intelligent & Fuzzy Systems*, 32 (1), (2017).955-968.
- [52] X.D.Peng, Y. Yang. Algorithms for interval-valued fuzzy soft sets in stochastic multi-criteria decision making based on regret theory and prospect theory with combined weight, *Applied Soft Computing*, 54,(2017). 415-430.
- [53] S. Broumi, A. Bakali, M.Talea, F. Smarandache, K. P. Krishnan Kishore, R.Şahin, Shortest Path Problem Under Interval Valued Neutrosophic Setting, *Journal of Fundamental and Applied Sciences*, 10(4S), (2018).168-174
- [54] A.Dey, S. Broumi, L. H.Son, A.Bakali, M. Talea, F.Smarandache, A new algorithm for finding minimum spanning trees with undirected neutrosophic graphs, *Granular Computing*, 2018,<https://doi.org/10.1007/s41066-018-0084-7>
- [55] M.Abdel-Basset, M. Mohamed & F. Smarandache, An Extension of Neutrosophic AHP–SWOT Analysis for Strategic Planning and Decision-Making. *Symmetry*, 10(4), 116(2018).

- [56] M. Abdel-Basset, M. Mohamed, F. Smarandache & V. Chang, Neutrosophic Association Rule Mining Algorithm for Big Data Analysis. *Symmetry*, 10(4), 106 (2018).
- [57] M. Abdel-Basset, M. Mohamed & V. Chang, NMCDA: A framework for evaluating cloud computing services. *Future Generation Computer Systems*, 86, (2018). 12-29.
- [58] A. Hassan, M. A. Malik, S. Broumi, A. Bakali, M. Talea, F. Smarandache, Special types of bipolar single valued neutrosophic graphs, *Annals of Fuzzy Mathematics and Informatics*, Volume 14, No. 1, (2017). 55-73.
- [59] S. Broumi, K. Ullah, A. Bakali, M. Talea, P. K. Singh, T. Mahmood, F. Smarandache, A. Bahnasse, S. K. Patro & A. Oliveira, Novel System and Method for Telephone Network Planning based on Neutrosophic Graph, *Global Journal of Computer Science and Technology: E Network, Web & Security*, Volume 18, 2 (1), (2018). 1-10

Neutrosophic Set is a Generalization of Intuitionistic Fuzzy Set, Inconsistent Intuitionistic Fuzzy Set (Picture Fuzzy Set, Ternary Fuzzy Set), Pythagorean Fuzzy Set (Atanassov's Intuitionistic Fuzzy Set of second type), q-Rung Orthopair Fuzzy Set, Spherical Fuzzy Set, and n-HyperSpherical Fuzzy Set, while Neutrosophication is a Generalization of Regret Theory, Grey System Theory, and Three-Ways Decision (revisited)

Florentin Smarandache

Florentin Smarandache (2019). Neutrosophic Set is a Generalization of Intuitionistic Fuzzy Set, Inconsistent Intuitionistic Fuzzy Set (Picture Fuzzy Set, Ternary Fuzzy Set), Pythagorean Fuzzy Set (Atanassov's Intuitionistic Fuzzy Set of second type), q-Rung Orthopair Fuzzy Set, Spherical Fuzzy Set, and n-HyperSpherical Fuzzy Set, while Neutrosophication is a Generalization of Regret Theory, Grey System Theory, and Three-Ways Decision (revisited). *Journal of New Theory* 29, 1-35

Abstract. In this paper we prove that Neutrosophic Set (NS) is an extension of Intuitionistic Fuzzy Set (IFS) no matter if the sum of single-valued neutrosophic components is < 1 , or > 1 , or $= 1$. For the case when the sum of components is 1 (as in IFS), after applying the neutrosophic aggregation operators one gets a different result from that of applying the intuitionistic fuzzy operators, since the intuitionistic fuzzy operators ignore the indeterminacy, while the neutrosophic aggregation operators take into consideration the indeterminacy at the same level as truth-membership and falsehood-nonmembership are taken. NS is also more flexible and effective because it handles, besides independent components, also partially independent and partially dependent components, while IFS cannot deal with these. Since there are many types of indeterminacies in our world, we can construct different approaches to various neutrosophic concepts.

Neutrosophic Set (NS) is also a generalization of Inconsistent Intuitionistic Fuzzy Set (IIFS) { which is equivalent to the Picture Fuzzy Set (PFS) and Ternary Fuzzy Set (TFS) }, Pythagorean Fuzzy Set (PyFS) {Atanassov's Intuitionistic Fuzzy Set of second type}, Spherical Fuzzy Set (SFS), n-HyperSpherical Fuzzy Set (n-HSFS), and q-Rung Orthopair Fuzzy Set (q-ROFS). And Refined Neutrosophic Set (RNS) is an extension of Neutrosophic Set. And all these sets are more general than Intuitionistic Fuzzy Set.

We prove that Atanassov's Intuitionistic Fuzzy Set of second type (AIFS2), and Spherical Fuzzy Set (SFS) do not have independent components. And we show that n-HyperSphericalFuzzy Set that we now introduce for the first time, Spherical Neutrosophic Set (SNS) and n-HyperSpherical Neutrosophic Set (n-HSNS) {the last one also introduced now for the first time} are generalizations of IFS2 and SFS.

The main distinction between Neutrosophic Set (NS) and all previous set theories are: a) the *independence* of all three neutrosophic components {truth-membership (T), indeterminacy-

membership (I), falsehood-nonmembership (F)} with respect to each other in NS – while in the previous set theories their components are dependent of each other; and b) the importance of *indeterminacy* in NS - while in previous set theories indeterminacy is completely or partially ignored.

Neutrosophy is a particular case of Refined Neutrosophy, and consequently Neutrosophication is a particular case of Refined Neutrosophication. Also, Regret Theory, Grey System Theory, and Three-Ways Decision are particular cases of Neutrosophication and of Neutrosophic Probability. We have extended the Three-Ways Decision to n-Ways Decision, which is a particular case of Refined Neutrosophy.

In 2016 Smarandache defined for the first time the Refined Fuzzy Set (RFS) and Refined Fuzzy Intuitionistic Fuzzy Set (RIFS). We now, further on, define for the first time: Refined Inconsistent Intuitionistic Fuzzy Set (RIIFS) {Refined Picture Fuzzy Set (RPFS), Refined Ternary Fuzzy Set (RTFS)}, Refined Pythagorean Fuzzy Set (RPyFS) {Refined Atanassov's Intuitionistic Fuzzy Set of type 2 (RAIFS2)}, Refined Spherical Fuzzy Set (RSFS), Refined n-HyperSpherical Fuzzy Set (R-n-HSFS), and Refined q-Rung Orthopair Fuzzy Set (R-q-ROFS).

Keywords: Neutrosophic Set, Intuitionistic Fuzzy Set, Inconsistent Intuitionistic Fuzzy Set, Picture Fuzzy Set, Ternary Fuzzy Set, Pythagorean Fuzzy Set, Atanassov's Intuitionistic Fuzzy Set of second type, Spherical Fuzzy Set, n-HyperSpherical Neutrosophic Set, q-Rung Orthopair Fuzzy Set, truth-membership, indeterminacy-membership, falsehood-nonmembership, Regret Theory, Grey System Theory, Three-Ways Decision, n-Ways Decision, Neutrosophy, Neutrosophication, Neutrosophic Probability, Refined Neutrosophy, Refined Neutrosophication.

1. Introduction

This paper recalls ideas about the distinctions between neutrosophic set and intuitionistic fuzzy set presented in previous versions of this paper [1, 2, 3, 4, 5].

Mostly, in this paper we respond to Atanassov and Vassiliev's paper [6] about the fact that neutrosophic set is a generalization of intuitionistic fuzzy set.

We use the notations employed in the neutrosophic environment [1, 2, 3, 4, 5] since they are better descriptive than the Greek letters used in intuitionistic fuzzy environment, i.e.:

truth-membership (T), indeterminacy-membership (I), and falsehood-nonmembership (F).

We also use the triplet components in this order: (T, I, F).

Neutrosophic "Fuzzy" Set (as named by Atanassov and Vassiliev [6]) is commonly called "Single-Valued" Neutrosophic Set (i.e. the neutrosophic components are single-valued numbers) by the neutrosophic community that now riches about 1,000 researchers, from 60 countries around the world, which have produced about 2,000 publications (papers, conference presentations, book chapters, books, MSc theses, and PhD dissertations).

The NS is more complex and more general than previous (crisp / fuzzy / intuitionistic fuzzy / picture fuzzy / ternary fuzzy set / Pythagorean fuzzy / Atanassov's intuitionistic fuzzy set of second type / spherical fuzzy / q-Rung orthopair fuzzy) sets, because:

- A new branch of philosophy was born, called *Neutrosophy* [7], which is a generalization of Dialectics (and of YinYang Chinese philosophy), where not only the dynamics of opposites are studied, but the dynamics of opposites together with their neutrals as well, i.e. ($\langle A \rangle$, $\langle \text{neut}A \rangle$, $\langle \text{anti}A \rangle$), where $\langle A \rangle$ is an item, $\langle \text{anti}A \rangle$ its opposite, and $\langle \text{neut}A \rangle$ their neutral (indeterminacy between them).
Neutrosophy show the significance of neutrality/indeterminacy ($\langle \text{neut}A \rangle$) that gave birth to neutrosophic set / logic / probability / statistics / measure / integral and so on, that have many practical applications in various fields.
- The sum of the Single-Valued Neutrosophic Set/Logic components was allowed to be up to 3 (this shows the importance of independence of the neutrosophic components among themselves), which permitted the characterization of paraconsistent/conflictual sets/propositions (by letting the sum of components > 1), and of paradoxical sets/propositions, represented by the neutrosophic triplet (1, 1, 1).
- NS can distinguish between *absolute* truth/indeterminacy/falsehood and *relative* truth/indeterminacy/falsehood using nonstandard analysis, which generated the Nonstandard Neutrosophic Set (NNS).
- Each neutrosophic component was allowed to take values outside of the interval [0, 1], that culminated with the introduction of the neutrosophic overset/underset/offset [8].
- NS was enlarged by Smarandache to Refined Neutrosophic Set (RNS), where each neutrosophic component was refined / split into sub-components [9], i.e. T was refined/split into T_1, T_2, \dots, T_p ; I was refined / split into I_1, I_2, \dots, I_p ; and F was refined split into F_1, F_2, \dots, F_s ; where $p, r, s \geq 1$ are integers and $p + r + s \geq 4$; all T_j, I_k, F_l are subsets of [0, 1] with no other restriction.
- RNS permitted the extension of the Law of Included Middle to the neutrosophic Law of Included Multiple-Middle [10].
- Classical Probability and Imprecise Probability were extended to Neutrosophic Probability [11], where for each event E one has: the chance that event E occurs ($\text{ch}(E)$), indeterminate-chance that event E occurs or not ($\text{ch}(\text{neut}E)$), and the chance that the event E does not occur ($\text{ch}(\text{anti}E)$), with: $0 \leq \sup\{\text{ch}(E)\} + \sup\{\text{ch}(\text{neut}E)\} + \sup\{\text{ch}(\text{anti}E)\} \leq 3$.
- Classical Statistics was extended to Neutrosophic Statistics [12] that deals with indeterminate / incomplete / inconsistent / vague data regarding samples and populations.

And so on (see below more details). Several definitions are recalled for paper's self-containment.

2. Refinements of Fuzzy Types Sets

In 2016 Smarandache [8] introduced for the first time the Refined Fuzzy Set (RFS) and Refined Fuzzy Intuitionistic Fuzzy Set (RIFS).

Let \mathcal{U} be a universe of discourse, and let $A \subset \mathcal{U}$ be a subset.

We give general definitions, meaning that the components may be any subsets of $[0, 1]$. In particular cases, the components may be single numbers, hesitant sets, intervals and so on included in $[0, 1]$.

3. Fuzzy Set (FS)

$A_{FS} = \{ x(T_A(x)), x \in \mathcal{U} \}$, where $T_A: \mathcal{U} \rightarrow \mathcal{P}([0, 1])$ is the membership degree of the generic element x with respect to the set A , and $\mathcal{P}([0, 1])$ is the powerset of $[0, 1]$, is called a Fuzzy Set.

4. Refined Fuzzy Set (RFS)

We have split/refined the membership degree $T_A(x)$ into sub-membership degrees. Then:

$A_{RFS} = \{x(T_A^1(x), T_A^2(x), \dots, T_A^p(x)), p \geq 2, x \in U\}$, where $T_A^1(x)$ is a sub-membership degree of type 1 of the element x with respect to the set A , $T_A^2(x)$ is a sub-membership degree of type 2 of the element x with respect to the set A , ..., $T_A^p(x)$ is a sub-membership degree of type p of the element x with respect to the set A , and $T_A^j(x) \subseteq [0,1]$ for $1 \leq j \leq p$, and $\sum_{j=1}^p \sup T_x^j \leq 1$ for all $x \in U$.

5. Intuitionistic Fuzzy Set (IFS)

Let \mathcal{U} be a universe of discourse, and let $A \subset \mathcal{U}$ be a subset. Then:

$A_{IFS} = \{ x(T_A(x), F_A(x)), x \in \mathcal{U} \}$, where $T_A(x), F_A(x): \mathcal{U} \rightarrow \mathcal{P}([0, 1])$ are the membership degree respectively the nonmembership of the generic element x with respect to the set A , and $\mathcal{P}([0, 1])$ is the powerset of $[0, 1]$, and $\sup T_A(x) + \sup F_A(x) \leq 1$ for all $x \in U$, is called an Intuitionistic Fuzzy Set.

6. Refined Intuitionistic Fuzzy Set (RIFS)

We have split/refined the membership degree $T_A(x)$ into sub-membership degrees, and the nonmembership degree $F_A(x)$. Then:

$A_{RIFS} = \{x(T_A^1(x), T_A^2(x), \dots, T_A^p(x); F_A^1(x), F_A^2(x), \dots, F_A^s(x)), p + s \geq 3, x \in U\}$, with p, s positive nonzero integers, $\sum_{j=1}^p \sup T_x^j + \sum_{l=1}^s \sup F_x^l \leq 1$, and $T_A^j(x), F_A^l(x) \subseteq [0,1]$ for $1 \leq j \leq p$ and $1 \leq l \leq s$.

Where $T_A^1(x)$ is a sub-membership degree of type 1 of the element x with respect to the set A , $T_A^2(x)$ is a sub-membership degree of type 2 of the element x with respect to the set A , ..., $T_A^p(x)$ is a sub-membership degree of type p of the element x with respect to the set A .

And $F_A^1(x)$ is a sub-nonmembership degree of type 1 of the element x with respect to the set A , $F_A^2(x)$ is a sub-nonmembership degree of type 2 of the element x with respect to the set A , ..., $F_A^s(x)$ is a sub-nonmembership degree of type s of the element x with respect to the set A .

7. Inconsistent Intuitionistic Fuzzy Set (IIFS) { Picture Fuzzy Set (PFS), Ternary Fuzzy Set (TFS) }

Are defined as below:

$$A_{IIIFS} = A_{PFS} = A_{TFs} = \{ \langle x, T_A(x), I_A(x), F_A(x) \rangle \mid x \in \mathcal{U} \},$$

where $T_A(x), I_A(x), F_A(x) \in P([0,1])$ and the sum $0 \leq \sup T_A(x) + \sup I_A(x) + \sup F_A(x) \leq 1$, for all $x \in \mathcal{U}$.

In these sets, the denominations are:

$T_A(x)$ is called *degree of membership* (or validity, or positive membership);

$I_A(x)$ is called *degree of neutral membership*;

$F_A(x)$ is called *degree of nonmembership* (or nonvalidity, or negative membership).

The *refusal degree* is: $R_A(x) = 1 - T_A(x) - I_A(x) - F_A(x) \in [0, 1]$, for all $x \in \mathcal{U}$.

8. Refined Inconsistent Intuitionistic Fuzzy Set (RIIFS) { Refined Picture Fuzzy Set (RPFS), Refined Ternary Fuzzy Set (RTFS) }

$$A_{RIIFS} = A_{RPFS} = A_{RTFS} = \{ \langle x(T_A^1(x), T_A^2(x), \dots, T_A^p(x); I_A^1(x), I_A^2(x), \dots, I_A^r(x); F_A^1(x), F_A^2(x), \dots, F_A^s(x)), p + r + s \geq 4, x \in U \rangle \},$$

with p, r, s positive nonzero integers, and $T_A^j(x), I_A^k(x), F_A^l(x) \subseteq [0,1]$, for $1 \leq j \leq p, 1 \leq k \leq r$, and $1 \leq l \leq s, 0 \leq \sum_1^p \sup T_A^j(x) + \sum_1^r \sup I_A^k(x) + \sum_1^s \sup F_A^l(x) \leq 1$.

$T_A^j(x)$ is called *degree of sub-membership* (or sub-validity, or positive sub-membership) of type j of the element x with respect to the set A ;

$I_A^k(x)$ is called *degree of sub-neutral membership* of type k of the element x with respect to the set A ;

$F_A^l(x)$ is called *degree of sub-nonmembership* (or sub-nonvalidity, or negative sub-membership) of type l of the element x with respect to the set A ;

and the *refusal degree* is:

$$R_A(x) = [1,1] - \sum_1^p T_A^j(x) - \sum_1^r I_A^k(x) - \sum_1^s F_A^l(x) \subseteq [0,1], \text{ for all } x \in \mathcal{U}.$$

9. Definition of single-valued Neutrosophic Set (NS)

Introduced by Smarandache [13, 14, 15] in 1998. Let U be a universe of discourse, and a set $A_{NS} \subseteq U$.

Then $A_{NS} = \{ \langle x, T_A(x), I_A(x), F_A(x) \rangle \mid x \in U \}$, where $T_A(x), I_A(x), F_A(x) : U \rightarrow [0, 1]$ represent the degree of truth-membership, degree of indeterminacy-membership, and degree of false-nonmembership respectively, with $0 \leq T_A(x) + I_A(x) + F_A(x) \leq 3$.

The neutrosophic components $T_A(x)$, $I_A(x)$, $F_A(x)$ are independent with respect to each other.

10. Definition of single-valued Refined Neutrosophic Set (RNS)

Introduced by Smarandache [9] in 2013. Let U be a universe of discourse, and a set $A_{RNS} \subseteq U$. Then

$A_{RNS} = \{ \langle x, T_{1A}(x), T_{2A}(x), \dots, T_{pA}(x); I_{1A}(x), I_{2A}(x), \dots, I_{rA}(x); F_{1A}(x), F_{2A}(x), \dots, F_{sA}(x) \rangle \mid x \in U \}$, where all $T_{jA}(x)$, $1 \leq j \leq p$, $I_{kA}(x)$, $1 \leq k \leq r$, $F_{lA}(x)$, $1 \leq l \leq s$, $: U \rightarrow [0, 1]$, and

$T_{jA}(x)$ represents the j -th sub-membership degree,

$I_{kA}(x)$ represents the k -th sub-indeterminacy degree,

$F_{lA}(x)$ represents the l -th sub-nonmembership degree,

with $p, r, s \geq 1$ integers, where $p + r + s = n \geq 4$, and:

$$0 \leq \sum_{j=1}^p T_{jA}(x) + \sum_{k=1}^r I_{kA}(x) + \sum_{l=1}^s F_{lA}(x) \leq n.$$

All neutrosophic sub-components $T_{jA}(x)$, $I_{kA}(x)$, $F_{lA}(x)$ are independent with respect to each other.

Refined Neutrosophic Set is a generalization of Neutrosophic Set.

11. Definition of single-valued Intuitionistic Fuzzy Set (IFS)

Introduced by Atanassov [16, 17, 18] in 1983. Let U be a universe of discourse, and a set $A_{IFS} \subseteq U$. Then $A_{IFS} = \{ \langle x, T_A(x), F_A(x) \rangle \mid x \in U \}$, where $T_A(x)$, $F_A(x) : U \rightarrow [0, 1]$ represent the degree of membership and degree of nonmembership respectively, with $T_A(x) + F_A(x) \leq 1$, and $I_A(x) = 1 - T_A(x) - F_A(x)$ represents degree of indeterminacy (in previous publications it was called degree of hesitancy).

The intuitionistic fuzzy components $T_A(x)$, $I_A(x)$, $F_A(x)$ are dependent with respect to each other.

12. Definition of single-valued Inconsistent Intuitionistic Fuzzy Set (equivalent to single-valued Picture Fuzzy Set, and with single-valued Ternary Fuzzy Set)

The single-valued *Inconsistent Intuitionistic Fuzzy Set* (IIFS), introduced by Hindde and Patching [19] in 2008, and the single-valued *Picture Fuzzy Set* (PFS), introduced by Cuong [20] in 2013, indeed coincide, as Atanassov and Vassiliev have observed; also we add that single-valued *Ternary Fuzzy Set*, introduced by Wang, Ha and Liu [21] in 2015 also coincide with them. All these three notions are defined as follows.

Let \mathcal{U} be a universe of discourse, and let's consider a subset $A \subseteq \mathcal{U}$.

Then $A_{IIFS} = A_{PFS} = A_{TFS} = \{ \langle x, T_A(x), I_A(x), F_A(x) \rangle \mid x \in \mathcal{U} \}$,

where $T_A(x), I_A(x), F_A(x) \in [0, 1]$, and the sum $0 \leq T_A(x) + I_A(x) + F_A(x) \leq 1$, for all $x \in \mathcal{U}$.

In these sets, the denominations are:

$T_A(x)$ is called *degree of membership* (or validity, or positive membership);

$I_A(x)$ is called *degree of neutral membership*;

$F_A(x)$ is called *degree of nonmembership* (or nonvalidity, or negative membership).

The *refusal degree* is: $R_A(x) = 1 - T_A(x) - I_A(x) - F_A(x) \in [0, 1]$, for all $x \in \mathcal{U}$.

The IIFS (PFS, TFS) components $T_A(x), I_A(x), F_A(x), R_A(x)$ are dependent with respect to each other.

Wang, Ha and Liu’s [21] assertion that “neutrosophic set theory is difficult to handle the voting problem, as the sum of the three components is greater than 1” is not true, since the sum of the three neutrosophic components is not necessarily greater than 1, but it can be less than or equal to any number between 0 and 3, i.e. $0 \leq T_A(x) + I_A(x) + F_A(x) \leq 3$, so for example the sum of the three neutrosophic components can be less than 1, or equal to 1, or greater than 1 depending on each application.

13. Inconsistent Intuitionistic Fuzzy Set and the Picture Fuzzy Set and Ternary Fuzzy Set are particular cases of the Neutrosophic Set

The *Inconsistent Intuitionistic Fuzzy Set* and the *Picture Fuzzy Set* and *Ternary Fuzzy Set* are particular cases of the *Neutrosophic Set* (NS). Because, in neutrosophic set, similarly taking single-valued components $T_A(x), I_A(x), F_A(x) \in [0, 1]$, one has the sum $T_A(x) + I_A(x) + F_A(x) \leq 3$, which means that $T_A(x) + I_A(x) + F_A(x)$ can be equal to or less than any number between 0 and 3.

Therefore, in the particular case when choosing the sum equal to $1 \in [0, 3]$ and getting $T_A(x) + I_A(x) + F_A(x) \leq 1$, one obtains IIFS and PFS and TFS.

14. Single-valued Intuitionistic Fuzzy Set is a particular case of single-valued Neutrosophic Set

Single-valued Intuitionistic Fuzzy Set is a particular case of single-valued Neutrosophic Set, because we can simply choose the sum to be equal to 1:

$$T_A(x) + I_A(x) + F_A(x) = 1.$$

15. Inconsistent Intuitionistic Fuzzy Set and Picture Fuzzy Set and Ternary Fuzzy Set are also particular cases of single-valued Refined Neutrosophic Set.

The *Inconsistent Intuitionistic Fuzzy Set* (IIFS), *Picture Fuzzy Set* (PFS), and *Ternary Fuzzy Set* (TFS), that coincide with each other, are in addition particular case(s) of *Single-Valued Refined Neutrosophic Set* (RNS).

We may define:

$$A_{IIFS} \equiv A_{PFS} = A_{TFS} = \{x, T_A(x), I_{1_A}(x), I_{2_A}(x), F_A(x) | x \in \mathcal{U}\},$$

with $T_A(x), I_{1_A}(x), I_{2_A}(x), F_A(x) \in [0, 1]$,

and the sum $T_A(x) + I_{1_A}(x) + I_{2_A}(x) + F_A(x) = 1$, for all $x \in \mathcal{U}$;

where:

$T_A(x)$ is the degree of positive membership (validity, etc.);

I_{1_A} is the degree of neutral membership;

$I_{2_A}(x)$ is the refusal degree;

$F_A(x)$ is the degree of negative membership (non-validity, etc.).

$n = 4$, and as a particular case of the sum $T_A(x) + I_{1_A}(x) + I_{2_A}(x) + F_A(x) \leq 4$, where the sum can be any positive number up to 4, we take the positive number 1 for the sum:

$$T_A(x) + I_{1_A}(x) + I_{2_A}(x) + F_A(x) = 1.$$

16. Independence of Neutrosophic Components vs. Dependence of Intuitionistic Fuzzy Components

Section 4, equations (46) - (51) in Atanassov’s and Vassiliev’s paper [6] is reproduced below:

“4. Interval valued intuitionistic fuzzy sets, intuitionistic fuzzy sets, and neutrosophic fuzzy sets

(...) the concept of a Neutrosophic Fuzzy Set (NFS) is introduced, as follows:

$$A^n = \{x, \mu_A^n(x), \nu_A^n(x), \pi_A^n(x) | x \in E\}, \quad (46)$$

where $\mu_A^n(x), \nu_A^n(x), \pi_A^n(x) \in [0, 1]$, and have the same sense as IFS.

Let

$$\sup_{y \in E} \mu_A^n(y) + \sup_{y \in E} \nu_A^n(y) + \sup_{y \in E} \pi_A^n(y) \neq 0. \quad (47)$$

Then we define:

$$\mu_A^i(x) = \frac{\mu_A^n(x)}{\sup_{y \in E} \mu_A^n(y) + \sup_{y \in E} \nu_A^n(y) + \sup_{y \in E} \pi_A^n(y)}; \quad (48)$$

$$\nu_A^i(x) = \frac{\nu_A^n(x)}{\sup_{y \in E} \mu_A^n(y) + \sup_{y \in E} \nu_A^n(y) + \sup_{y \in E} \pi_A^n(y)}; \quad (49)$$

$$\pi_A^i(x) = \frac{\pi_A^n(x)}{\sup_{y \in E} \mu_A^n(y) + \sup_{y \in E} \nu_A^n(y) + \sup_{y \in E} \pi_A^n(y)}; \quad (50)$$

$$I_A^i(x) = 1 - \mu_A^i(y) - \nu_A^i(y) - \pi_A^i(y). \quad (51)''$$

Using the neutrosophic component common notations, $T_A(x) \equiv \mu_A^n(x)$, $I_A(x) \equiv \pi_A^n(x)$, and $F_A(x) \equiv \nu_A^n(x)$, the refusal degree $R_A(x)$, and $A_N \equiv A^n$ for the neutrosophic set, and

considering the triplet's order (T, I, F), with the universe of discourse $\mathcal{U} \equiv E$, we can re-write the above formulas as follows:

$$A_N = \{ \langle x_1, T_A(x), I_A(x), F_A(x) \rangle \mid x \in \mathcal{U} \}, \tag{46}'$$

where $T_A(x), I_A(x), F_A(x) \in [0, 1]$, for all $x \in \mathcal{U}$.

Neutrosophic *Fuzzy Set* is commonly named *Single-Valued Neutrosophic Set* (SVNS), i.e. the components are single-valued numbers.

The authors, Atanassov and Vassiliev, assert that $T_A(x), I_A(x), F_A(x)$ “have the same sense as IFS” (Intuitionistic Fuzzy Set).

But this is untrue, since in IFS one has $T_A(x) + I_A(x) + F_A(x) \leq 1$, therefore the IFS components $T_A(x), I_A(x), F_A(x)$ are dependent, while in SVNS (Single-Valued Neutrosophic Set), one has $T_A(x) + I_A(x) + F_A(x) \leq 3$, what the authors omit to mention, therefore the SVNS components $T_A(x), I_A(x), F_A(x)$ are independent, and this makes a big difference, as we'll see below.

In general, for the *dependent components*, if one component's value changes, the other components values also change (in order for their total sum to keep being up to 1). While for the *independent components*, if one component changes, the other components do not need to change since their total sum is always up to 3.

Let's re-write the equations (47) - (51) from authors' paper:

Assume

$$\sup_{y \in \mathcal{U}} T_A(y) + \sup_{y \in \mathcal{U}} I_A(y) + \sup_{y \in \mathcal{U}} F_A(y) \neq 0. \tag{47}'$$

The authors have defined:

$$T_A^{IIFS}(x) = \frac{T_A(x)}{\sup_{y \in \mathcal{U}} T_A(y) + \sup_{y \in \mathcal{U}} I_A(y) + \sup_{y \in \mathcal{U}} F_A(y)}; \tag{48}'$$

$$I_A^{IIFS}(x) = \frac{I_A(x)}{\sup_{y \in \mathcal{U}} T_A(y) + \sup_{y \in \mathcal{U}} I_A(y) + \sup_{y \in \mathcal{U}} F_A(y)}; \tag{50}'$$

$$F_A^{IIFS}(x) = \frac{F_A(x)}{\sup_{y \in \mathcal{U}} T_A(y) + \sup_{y \in \mathcal{U}} I_A(y) + \sup_{y \in \mathcal{U}} F_A(y)}. \tag{49}'$$

These mathematical transfigurations, which transform [change in form] the neutrosophic components $T_A(x), I_A(x), F_A(x) \in [0, 1]$, whose sum

$T_A(x) + I_A(x) + F_A(x) \leq 3$, into inconsistent intuitionistic fuzzy components:

$$T_A^{IIFS}(x), I_A^{IIFS}(x), F_A^{IIFS}(x) \in [0, 1],$$

whose sum $T_A^{IIFS}(x) + I_A^{IIFS}(x) + F_A^{IIFS}(x) \leq 1$,

and the refusal degree

$$R_A^{IIFS}(x) = 1 - T_A^{IIFS}(x) - I_A^{IIFS}(x) - F_A^{IIFS}(x) \in [0, 1], \tag{51}'$$

distort the original application, i.e. the original neutrosophic application and its intuitionistic fuzzy transformed application are not equivalent, see below.

This is because, in this case, *the change in form brings a change in content*.

17. By Transforming the Neutrosophic Components into Intuitionistic Fuzzy Components the Independence of the Neutrosophic Components is Lost

In reference paper [6], Section 4, Atanassov and Vassilev convert the neutrosophic components into intuitionistic fuzzy components.

But, converting a single-valued neutrosophic triplet (T_1, I_1, F_1) , with $T_1, I_1, F_1 \in [0, 1]$ and $T_1 + I_1 + F_1 \leq 3$ that occurs into a neutrosophic application α_N , to a single-valued intuitionistic triplet (T_2, I_2, F_2) , with $T_2, I_2, F_2 \in [0, 1]$ and $T_2 + I_2 + F_2 \leq 1$ (or $T_2 + I_2 + F_2 = 1$) that would occur into an intuitionistic fuzzy application α_{IF} , is just a *mathematical artifact*, and there could be constructed many such mathematical operators [the authors present four of them], even more: it is possible to convert from the sum $T_1 + I_1 + F_1 \leq 3$ to the sum $T_2 + I_2 + F_2$ equals to any positive number – but they are just *abstract transformations*.

The neutrosophic application α_N will not be equivalent to the resulting intuitionistic fuzzy application α_{IF} , since while in α_N the neutrosophic components T_1, I_1, F_1 are independent (because their sum is up to 3), in α_{IF} the intuitionistic fuzzy components T_2, I_2, F_2 are dependent (because their sum is 1). Therefore, the independence of components is lost.

And the *independence* of the neutrosophic components is the main distinction between neutrosophic set vs. intuitionistic fuzzy set.

Therefore, the resulted intuitionistic fuzzy application α_{IF} after the mathematical transformation is just a subapplication (particular case) of the original neutrosophic application α_N .

18. Degree of Dependence/Independence between the Components

The degree of dependence/independence between components was introduced by Smarandache [22] in 2006.

In general, the sum of two components x and y that vary in the unitary interval $[0, 1]$ is:

$0 \leq x+y \leq 2-d(x,y)$, where $d(x,y)$ is the degree of dependence between x and y , while $1-d(x,y)$ is the degree of independence between x and y .

NS is also flexible because it handles, besides independent components, also partially independent and partially dependent components, while IFS cannot deal with these.

For example, if T and F are totally dependent, then $0 \leq T + F \leq 1$, while if component I is independent from them, thus $0 \leq I \leq 1$, then $0 \leq T + I + F \leq 2$. Therefore the components T, I, F in general are partially dependent and partially independent.

19. Intuitionistic Fuzzy Operators ignore the Indeterminacy, while Neutrosophic Operators give Indeterminacy the same weight as to Truth-Membership and Falsehood-Nonmembership

Indeterminacy in intuitionistic fuzzy set is ignored by the intuitionistic fuzzy aggregation operators, while the neutrosophic aggregation operators treats the indeterminacy at the same weight as the other two neutrosophic components (truth-membership and falsehood-membership).

Thus, even if we have two single-valued triplets, with the sum of each three components equal to 1 { therefore triplets that may be treated both as *intuitionistic fuzzy triplet*, and *neutrosophic triplet* in the same time (since in neutrosophic environment the sum of the neutrosophic components can be any number between 0 and 3, whence in particular we may take the sum 1) }, after applying the intuitionistic fuzzy aggregation operators we get a different result from that obtained after applying the neutrosophic aggregation operators.

20. Intuitionistic Fuzzy Operators and Neutrosophic Operators

Let the intuitionistic fuzzy operators be denoted as: negation (\neg_{IF}), intersection (\wedge_{IF}), union (\vee_{IF}), and implication (\rightarrow_{IF}), and

the neutrosophic operators [complement, intersection, union, and implication respectively] be denoted as: negation (\neg_N), intersection (\wedge_N), union (\vee_N), and implication (\rightarrow_N).

Let $A_1 = (a_1, b_1, c_1)$ and $A_2 = (a_2, b_2, c_2)$ be two triplets such that $a_1, b_1, c_1, a_2, b_2, c_2 \in [0, 1]$ and $a_1 + b_1 + c_1 = a_2 + b_2 + c_2 = 1$.

The intuitionistic fuzzy operators and neutrosophic operators are based on *fuzzy t-norm* (\wedge_F) and *fuzzy t-conorm* (\vee_F). We'll take for this article the simplest ones:

$$a_1 \wedge_F a_2 = \min\{a_1, a_2\} \text{ and } a_1 \vee_F a_2 = \max\{a_1, a_2\},$$

where \wedge_F is the fuzzy intersection (t-norm) and \vee_F is the fuzzy union (t-conorm).

For the intuitionistic fuzzy implication and neutrosophic implication, we extend the classical implication:

$$A_1 \rightarrow A_2 \text{ that is classically equivalent to } \neg A_1 \vee A_2,$$

where \rightarrow is the classical implication, \neg the classical negation (complement),
and \vee the classical union,

to the intuitionistic fuzzy environment and respectively to the neutrosophic environment.

But taking other fuzzy t-norm and fuzzy t-conorm, the conclusion will be the same, i.e. the results of intuitionistic fuzzy aggregation operators are different from the results of neutrosophic aggregation operators applied on the same triplets.

Intuitionistic Fuzzy Aggregation Operators { the simplest used intuitionistic fuzzy operations }:

Intuitionistic Fuzzy Negation:

$$\neg_{IF} (a_1, b_1, c_1) = (c_1, b_1, a_1)$$

Intuitionistic Fuzzy Intersection:

$$(a_1, b_1, c_1) \wedge_{IF} (a_2, b_2, c_2) = (\min\{a_1, a_2\}, 1 - \min\{a_1, a_2\} - \max\{c_1, c_2\}, \max\{c_1, c_2\})$$

Intuitionistic Fuzzy Union:

$$(a_1, b_1, c_1) \vee_{IF} (a_2, b_2, c_2) = (\max\{a_1, a_2\}, 1 - \max\{a_1, a_2\} - \min\{c_1, c_2\}, \min\{c_1, c_2\})$$

Intuitionistic Fuzzy Implication:

$$(a_1, b_1, c_1) \rightarrow_{IF} (a_2, b_2, c_2) \text{ is intuitionistically fuzzy equivalent to } \neg_{IF}(a_1, b_1, c_1) \vee_{IF} (a_2, b_2, c_2)$$

Neutrosophic Aggregation Operators { the simplest used neutrosophic operations }:

Neutrosophic Negation:

$$\neg_N (a_1, b_1, c_1) = (c_1, 1-b_1, a_1)$$

Neutrosophic Intersection:

$$(a_1, b_1, c_1) \wedge_N (a_2, b_2, c_2) = (\min\{a_1, a_2\}, \max\{b_1, b_2\}, \max\{c_1, c_2\})$$

Neutrosophic Union:

$$(a_1, b_1, c_1) \vee_N (a_2, b_2, c_2) = (\max\{a_1, a_2\}, \min\{b_1, b_2\}, \min\{c_1, c_2\})$$

Neutrosophic Implication:

$$(a_1, b_1, c_1) \rightarrow_N (a_2, b_2, c_2) \text{ is neutrosophically equivalent to } \neg_N(a_1, b_1, c_1) \vee_N (a_2, b_2, c_2)$$

21. Numerical Example of Triplet Components whose Summation is 1

Let $A_1 = (0.3, 0.6, 0.1)$ and $A_2 = (0.4, 0.1, 0.5)$ be two triplets, each having the sum:

$$0.3 + 0.6 + 0.1 = 0.4 + 0.1 + 0.5 = 1.$$

Therefore, they can both be treated as neutrosophic triplets and as intuitionistic fuzzy triplets simultaneously. We apply both, the intuitionistic fuzzy operators and then the neutrosophic operators and we prove that we get different results, especially with respect with Indeterminacy component that is ignored by the intuitionistic fuzzy operators.

21.1. Complement/Negation

Intuitionistic Fuzzy:

$$\neg_{IF}(0.3, 0.6, 0.1) = (0.1, 0.6, 0.3),$$

and $\neg_{IF}(0.4, 0.1, 0.5) = (0.5, 0.1, 0.4).$

Neutrosophic:

$$\neg_N(0.3, 0.6, 0.1) = (0.1, 1 - 0.6, 0.3) = (0.1, 0.4, 0.3) \neq (0.1, 0.6, 0.3),$$

and $\neg_N(0.4, 0.1, 0.5) = (0.5, 1 - 0.1, 0.4) = (0.5, 0.9, 0.4) \neq (0.5, 0.1, 0.4).$

21.2. Intersection:

Intuitionistic Fuzzy

$$(0.3, 0.6, 0.1) \wedge_{IF} (0.4, 0.1, 0.5) = (\min\{0.3, 0.4\}, 1 - \min\{0.3, 0.4\} - \max\{0.1, 0.5\}, \max\{0.1, 0.5\}) = (0.3, 0.2, 0.5)$$

As we see, the indeterminacies 0.6 of A_1 and 0.1 of A_2 were completely ignored into the above calculations, which is unfair. Herein, the resulting indeterminacy from intersection is just what is left from truth-membership and falsehood-nonmembership $\{1 - 0.3 - 0.5 = 0.2\}$.

Neutrosophic

$$(0.3, 0.6, 0.1) \wedge_N (0.4, 0.1, 0.5) = (\min\{0.3, 0.4\}, \max\{0.6, 0.1\}, \max\{0.1, 0.5\}) = (0.3, 0.6, 0.5) \neq (0.3, 0.2, 0.5)$$

In the neutrosophic environment the indeterminacies 0.6 of A_1 and 0.1 of A_2 are given full consideration in calculating the resulting intersection's indeterminacy: $\max\{0.6, 0.1\} = 0.6.$

21.3. Union:

Intuitionistic Fuzzy:

$$(0.3, 0.6, 0.1) \vee_{IF} (0.4, 0.1, 0.5) = (\max\{0.3, 0.4\}, 1 - \max\{0.3, 0.4\} - \min\{0.1, 0.5\}, \max\{0.1, 0.5\}) = (0.4, 0.5, 0.1)$$

Again, the indeterminacies 0.6 of A_1 and 0.1 of A_2 were completely ignored into the above calculations, which is not fair. Herein, the resulting indeterminacy from the union is just what is left from truth-membership and falsehood-nonmembership $\{1 - 0.4 - 0.1 = 0.5\}$.

Neutrosophic:

$$(0.3, 0.6, 0.1) \vee_N (0.4, 0.1, 0.5) = (\max\{0.3, 0.4\}, \min\{0.6, 0.1\}, \min\{0.1, 0.5\}) = (0.4, 0.1, 0.1) \neq (0.4, 0.5, 0.1)$$

Similarly, in the neutrosophic environment the indeterminacies 0.6 of A_1 and 0.1 of A_2 are given full consideration in calculating the resulting union's indeterminacy: $\min\{0.6, 0.1\} = 0.1$.

21.4. Implication:

Intuitionistic Fuzzy

$$(0.3, 0.6, 0.1) \rightarrow_{IF} (0.4, 0.1, 0.5) = \neg_{IF}(0.3, 0.6, 0.1) \vee_{IF} (0.4, 0.1, 0.5) = (0.1, 0.6, 0.3) \vee_{IF} (0.4, 0.1, 0.5) = (0.4, 0.3, 0.3)$$

Similarly, indeterminacies of A_1 and A_2 are completely ignored.

Neutrosophic

$$(0.3, 0.6, 0.1) \rightarrow_N (0.4, 0.1, 0.5) = \neg_N(0.3, 0.6, 0.1) \vee_N (0.4, 0.1, 0.5) = (0.1, 0.4, 0.3) \vee_N (0.4, 0.1, 0.5) = (0.4, 0.1, 0.3) \neq (0.4, 0.3, 0.3)$$

While in the neutrosophic environment the indeterminacies of A_1 and A_2 are taken into calculations.

21.5. Remark:

We have proven that even when the sum of the triplet components is equal to 1, as demanded by intuitionistic fuzzy environment, the results of the intuitionistic fuzzy operators are different from those of the neutrosophic operators – because the indeterminacy is ignored into the intuitionistic fuzzy operators.

22. Simple Counterexample 1, Showing Different Results between Neutrosophic Operators and Intuitionistic Fuzzy Operators Applied on the Same Sets (with component sums > 1 or < 1)

Let the universe of discourse $\mathcal{U} = \{x_1, x_2\}$, and two neutrosophic sets included in \mathcal{U} :

$$A_N = \{x_1(0.8, 0.3, 0.5), x_2(0.9, 0.2, 0.6)\}, \text{ and}$$

$$B_N = \{x_1(0.2, 0.1, 0.3), x_2(0.6, 0.2, 0.1)\}.$$

Whence, for A_N one has, after using Atanassov and Vassiliev's transformations (48)' - (51)':

$$T_A^{IIFS}(x_1) = \frac{0.8}{0.9+0.3+0.6} = \frac{0.8}{1.8} \approx 0.44;$$

$$I_A^{IIFS}(x_1) = \frac{0.3}{1.8} \approx 0.17;$$

$$F_A^{IIFS}(x_1) = \frac{0.5}{1.8} \approx 0.28.$$

The refusal degree for x_1 with respect to A_N is:

$$R_A^{IIFS}(x_1) = 1 - 0.44 - 0.17 - 0.28 = 0.11.$$

Then:

$$T_A^{IIFS}(x_2) = \frac{0.9}{1.8} = 0.50;$$

$$I_A^{IIFS}(x_2) = \frac{0.2}{1.8} \approx 0.11;$$

$$F_A^{IIFS}(x_2) = \frac{0.6}{1.8} \approx 0.33.$$

The refusal degree for x_2 with respect to A_N is:

$$R_A^{IIFS}(x_2) = 1 - 0.50 - 0.11 - 0.33 = 0.06.$$

Then:

$$A_{IIFS} = \{x_1(0.44, 0.17, 0.28), x_2(0.50, 0.11, 0.33)\}.$$

For B_N one has:

$$T_B^{IIFS}(x_1) = \mu_B^i(x_1) = \frac{0.2}{0.6+0.2+0.3} = \frac{0.2}{1.1} \approx 0.18;$$

$$I_B^{IIFS}(x_1) = \nu_B^i(x_1) = \frac{0.1}{1.1} \approx 0.09;$$

$$F_B^{IIFS}(x_1) = \pi_B^i(x_1) = \frac{0.3}{1.1} \approx 0.27.$$

The refusal degree for x_1 with respect to B_N is:

$$R_B^{IIFS}(x_1) = 1 - 0.18 - 0.09 - 0.27 = 0.46.$$

$$T_B^{IIFS}(x_2) = \frac{0.6}{1.1} \approx 0.55;$$

$$I_B^{IIFS}(x_2) = \frac{0.2}{1.1} \approx 0.18;$$

$$F_B^{IIFS}(x_2) = \frac{0.1}{1.1} \approx 0.09.$$

The refusal degree for x_2 with respect to the set B_N is:

$$R_B^{IIFS}(x_2) = 1 - 0.55 - 0.18 - 0.09 = 0.18.$$

Therefore:

$$B_{IIFS} = \{x_1(0.18, 0.09, 0.27), x_2(0.55, 0.18, 0.09)\}.$$

Therefore, the neutrosophic sets:

$$A_N = \{x_1(0.8, 0.3, 0.5), x_2(0.9, 0.2, 0.6)\} \text{ and}$$

$$B_N = \{x_1(0.2, 0.1, 0.3), x_2(0.6, 0.2, 0.1)\},$$

where transformed (restricted), using Atanassov and Vassiliev’s transformations (48)-(51), into inconsistent intuitionistic fuzzy sets respectively as follows:

$$A_{IIFS}^{(t)} = \{x_1(0.44, 0.17, 0.28), x_2(0.50, 0.11, 0.33)\} \text{ and}$$

$$B_{IIFS}^{(t)} = \{x_1(0.18, 0.09, 0.27), x_2(0.55, 0.18, 0.09)\},$$

where the upper script (t) means “after Atanassov and Vassiliev’s transformations”.

We shall remark that the set B_N , as neutrosophic set (where the sum of the components is allowed to also be strictly less than 1 as well), happens to be in the same time an inconsistent intuitionistic fuzzy set, or $B_N \equiv B_{IIFS}$.

Therefore, B_N transformed into $B_{IIFS}^{(t)}$ was a distortion of B_N , since we got different IIFS components:

$$x_1^{B_N}(0.2, 0.1, 0.3) \equiv x_1^{B_{IIFS}}(0.2, 0.1, 0.3) \neq x_1^{B_{IIFS}^{(t)}}(0.18, 0.09, 0.27).$$

Similarly:

$$x_2^{B_N}(0.6, 0.2, 0.1) \equiv x_2^{B_{IIFS}}(0.6, 0.2, 0.1) \neq x_2^{B_{IIFS}^{(t)}}(0.55, 0.18, 0.09).$$

Further on, we show that the NS operators and IIFS operators, applied on these sets, give *different results*. For each individual set operation (intersection, union, complement/negation, inclusion/implication, and equality/equivalence) there exist classes of operators, not a single one. We choose the simplest one in each case, which is based on min / max (fuzzy t-norm / fuzzy t-conorm).

22.1. Intersection

Neutrosophic Sets (min / max / max)

$$x_1^A \wedge_N x_1^B = (0.8, 0.3, 0.5) \wedge_N (0.2, 0.1, 0.3) \\ = (\min\{0.8, 0.2\}, \max\{0.3, 0.1\}, \max\{0.5, 0.3\}) = (0.2, 0.3, 0.5).$$

$$x_2^A \wedge_N x_2^B = (0.9, 0.2, 0.6) \wedge_N (0.6, 0.2, 0.1) = (0.6, 0.2, 0.6).$$

Therefore:

$$A_N \wedge_N B_N = \{x_1(0.2, 0.3, 0.5), x_2(0.6, 0.2, 0.6)\} \stackrel{\text{def}}{=} C_N.$$

Inconsistent Intuitionistic Fuzzy Set (min / max / max)

$$x_1^A \wedge_{IIFS} x_1^B = (0.44, 0.17, 0.28) \wedge_{IIFS} (0.18, 0.09, 0.27) = \\ (\min\{0.44, 0.18\}, \max\{0.17, 0.09\}, \max\{0.28, 0.27\}) = \\ (0.18, 0.17, 0.28)$$

$$x_2^A \wedge_{IIFS} x_2^B = (0.50, 0.11, 0.33) \wedge_{IIFS} (0.55, 0.18, 0.09) \\ = (0.50, 0.18, 0.33).$$

Since in IIFS the sum of components is not allowed to surpass 1, we normalize:

$$\left(\frac{0.50}{1.01}, \frac{0.11}{1.01}, \frac{0.33}{1.01}\right) \approx (0.495, 0.109, 0.326).$$

Therefore:

$$A_{IIFS} \wedge_{IIFS} B_{IIFS} = \{x_1(0.18, 0.17, 0.28), x_2(0.495, 0.109, 0.326)\} \stackrel{\text{def}}{=} C_{IIFS}.$$

Also:

$$T_{A_N \wedge_N B_N}(x_1) = 0.2 < 0.3 = I_{A_N \wedge_N B_N}(x_1),$$

while

$$T_{A_{IIFS} \wedge_{IIFS} B_{IIFS}}(x_1) = 0.18 > 0.17 = I_{A_{IIFS} \wedge_{IIFS} B_{IIFS}}(x_1),$$

and other discrepancies can be seen.

Inconsistent Intuitionistic Fuzzy Set (with min / min / max, as used by Cuong [20] in order to avoid the sum of components surpassing 1; but this is in discrepancy with the IIFS/PFS union that uses max / min / min, not max /max / min):

$$\begin{aligned} x_1^A \wedge_{IIFS2} x_1^B &= (0.44, 0.17, 0.28) \wedge_{IIFS2} (0.18, 0.09, 0.27) = \\ &= (\min\{0.44, 0.18\}, \min\{0.17, 0.09\}, \max\{0.28, 0.27\}) = \\ &= (0.18, 0.09, 0.28) \end{aligned}$$

$$\begin{aligned} x_2^A \wedge_{IIFS2} x_2^B &= (0.50, 0.11, 0.33) \wedge_{IIFS2} (0.55, 0.18, 0.09) \\ &= (0.50, 0.11, 0.33). \end{aligned}$$

Therefore:

$$A_{IIFS} \wedge_{IIFS2} B_{IIFS} = \{x_1(0.18, 0.09, 0.28), x_2(0.50, 0.11, 0.33)\} \stackrel{\text{def}}{=} C_{IIFS2}$$

We see that:

$$A_N \wedge_N B_N \neq A_{IIFS} \wedge_{IIFS} B_{IIFS}, \text{ or } C_N \neq C_{IIFS};$$

$$\text{and } A_N \wedge_N B_N \neq A_{IIFS2} \wedge_{IIFS2} B_{IIFS2}, C_N \neq C_{IIFS2}. \text{ Also } C_{IIFS} \neq C_{IIFS2}.$$

Let's transform the above neutrosophic set C_N , resulted from the application of the neutrosophic intersection operator,

$$C_N = \{x_1(0.2, 0.3, 0.5), x_2(0.6, 0.2, 0.6)\},$$

into an inconsistent intuitionistic fuzzy set, employing the same equations (48) – (50) of transformations [denoted by (t)], provided by Atanassov and Vassiliev, which are equivalent {using (T, I, F)-notations} to (48)'-(50)'

$$(t)T_C^{IIFS}(x_1) = \frac{0.2}{0.6+0.3+0.6} = \frac{0.2}{1.5} \simeq 0.13;$$

$$(t)I_C^{IIFS}(x_1) = \frac{0.3}{1.5} = 0.20;$$

$$(t)F_C^{IIFS}(x_1) = \frac{0.5}{1.5} \simeq 0.33.$$

$$(t)T_C^{IIFS}(x_2) = \frac{0.6}{1.5} \simeq 0.40;$$

$$(t)I_C^{IIFS}(x_2) = \frac{0.2}{1.5} \simeq 0.13;$$

$$(t)F_C^{IIFS}(x_2) = \frac{0.6}{1.5} \simeq 0.40.$$

Whence the results of neutrosophic and IIFS/PFS are totally different:

$$C_{IIFS}^{(t)} = \{x_1(0.13, 0.20, 0.33), x_2(0.40, 0.13, 0.40)\} \neq \{x_1(0.18, 0.17, 0.28), x_2(0.495, 0.109, 0.326)\} \equiv C_{IIFS},$$

and

$$C_{IIFS}^{(t)} \neq \{x_1(0.18, 0.09, 0.28), x_2(0.50, 0.11, 0.33)\} = C_{IIFS2}.$$

22.2. Union

Neutrosophic Sets (max / min / min)

$$\begin{aligned} x_1^A \vee_N x_1^B &= (0.8, 0.3, 0.5) \vee_N (0.2, 0.1, 0.3) \\ &= (\max\{0.8, 0.2\}, \min\{0.3, 0.1\}, \min\{0.5, 0.3\}) = (0.8, 0.1, 0.3). \end{aligned}$$

$$x_2^A \vee_N x_2^B = (0.9, 0.2, 0.6) \vee_N (0.6, 0.2, 0.1) = (0.9, 0.2, 0.1).$$

Therefore:

$$A_N \vee_N B_N = \{x_1(0.8, 0.1, 0.3), x_2(0.9, 0.2, 0.1)\} \stackrel{\text{def}}{=} D_N.$$

Inconsistent Intuitionistic Fuzzy Sets (max / min / min [3])

$$\begin{aligned} x_1^A \vee_{IIFS} x_1^B &= (0.44, 0.17, 0.28) \vee_{IIFS} (0.18, 0.09, 0.27) \\ &= (\max\{0.44, 0.18\}, \min\{0.17, 0.09\}, \min\{0.28, 0.27\}) \\ &= (0.44, 0.09, 0.27). \end{aligned}$$

$$\begin{aligned} x_2^A \vee_{IIFS} x_2^B &= (0.50, 0.11, 0.33) \vee_{IIFS} (0.55, 0.18, 0.09) \\ &= (0.55, 0.11, 0.09). \end{aligned}$$

Therefore:

$$A_{IIFS} \vee_{IIFS} B_{IIFS} = \{x_1(0.44, 0.09, 0.27), x_2(0.55, 0.11, 0.09)\} \stackrel{\text{def}}{=} D_{IIFS}$$

a) We see that the results are totally different:

$$A_N \vee_N B_N \neq A_{IIFS} \vee_{IIFS} B_{IIFS}, \text{ or } D_N \neq D_{IIFS}.$$

b) Let's transform the above neutrosophic set, D_N , resulted from the application of neutrosophic union operator,

$$D_N = \{x_1(0.8, 0.1, 0.3), x_2(0.9, 0.2, 0.1)\},$$

into an inconsistent intuitionistic fuzzy set, employing the same equations (48) -(50) of transformation [denoted by (t)], provided by Atanassov and Vassiliev, which are equivalent [using (T, I, F) notations] to (48)'-(50)':

$$(t)T_D^{IIFS}(x_1) = \frac{0.8}{0.9+0.2+0.3} = \frac{0.8}{1.4} \simeq 0.57;$$

$$(t)I_D^{IIFS}(x_1) = \frac{0.1}{1.4} \simeq 0.07;$$

$$(t)F_D^{IIFS}(x_1) = \frac{0.3}{1.4} \simeq 0.21.$$

$$(t)T_D^{IIFS}(x_2) = \frac{0.9}{1.4} \simeq 0.64;$$

$$(t)I_D^{IIFS}(x_2) = \frac{0.2}{1.4} \simeq 0.14;$$

$$(t)F_D^{IIFS}(x_2) = \frac{0.1}{1.4} \simeq 0.07.$$

Whence:

$$D_{IIFS}^{(t)} = \{x_1(0.57, 0.07, 0.21), x_2(0.64, 0.14, 0.07)\} \\ \neq \{x_1(0.44, 0.09, 0.27), x_2(0.55, 0.11, 0.09)\} \equiv D_{IIFS}.$$

The results again are totally different.

22.3. Corollary

Therefore, no matter if we first transform the neutrosophic components into inconsistent intuitionistic fuzzy components (as suggested by Atanassov and Vassiliev) and then apply the IIFS operators, or we first apply the neutrosophic operators on neutrosophic components, and then later transform the result into IIFS components, in both ways the obtained results in the neutrosophic environment are totally different from the results obtained in the IIFS environment.

24. Normalization

Further on, the authors propose the normalization of the neutrosophic components, where Atanassov and Vassiliev's [6] equations (57) – (59) are equivalent, using neutrosophic notations, to the following.

Let \mathcal{U} be a universe of discourse, a set $A \subseteq \mathcal{U}$, and a generic element $x \in \mathcal{U}$, with the neutrosophic components:

$x(T_A(x), I_A(x), F_A(x))$, where

$T_A(x), I_A(x), F_A(x) \in [0, 1]$, and

$T_A(x) + I_A(x) + F_A(x) \leq 3$, for all $x \in U$.

Suppose $T_A(x) + I_A(x) + F_A(x) \neq 0$, for all $x \in U$.

Then, by the below normalization of neutrosophic components, Atanassov and Vassiliev obtain the following intuitionistic fuzzy components $(T_A^{IFS}, I_A^{IFS}, F_A^{IFS})$:

$$T_A^{IFS}(x) = \frac{T_A(x)}{T_A(x)+I_A(x)+F_A(x)} \in [0, 1] \tag{57}'$$

$$I_A^{IFS}(x) = \frac{I_A(x)}{T_A(x)+I_A(x)+F_A(x)} \in [0, 1] \tag{58}'$$

$$F_A^{IFS}(x) = \frac{F_A(x)}{T_A(x)+I_A(x)+F_A(x)} \in [0, 1] \tag{59}'$$

and

$$T_A^{IFS}(x) + I_A^{IFS}(x) + F_A^{IFS}(x) = 1, \text{ for all } x \in U.$$

16.1. Counterexample 2

Let's come back to the previous *Counterexample 1*.

$U = \{x_1, x_2\}$ be a universe of discourse, and let two neutrosophic sets included in U :

$A_N = \{x_1(0.8, 0.3, 0.5), x_2(0.9, 0.2, 0.6)\}$, and

$B_N = \{x_1(0.2, 0.1, 0.3), x_2(0.6, 0.2, 0.1)\}$.

Let's normalize their neutrosophic components, as proposed by Atanassov and Vassiliev, in order to restrain them to intuitionistic fuzzy components:

$$\begin{aligned} A_{IFS} &= \left\{ x_1 \left(\frac{0.8}{0.8 + 0.3 + 0.5}, \frac{0.3}{1.6}, \frac{0.5}{1.6} \right), x_2 \left(\frac{0.9}{1.7}, \frac{0.2}{1.7}, \frac{0.6}{1.7} \right) \right\} \\ &\approx \{x_1(0.50, 0.19, 0.31), x_2(0.53, 0.12, 0.35)\} \\ &\equiv \{x_1(0.50, 0.31), x_2(0.53, 0.35)\}, \end{aligned}$$

since the indeterminacy (called *hesitant degree* in IFS) is neglected.

$$\begin{aligned}
 B_{IFS} &= \left\{ x_1 \left(\frac{0.2}{0.6}, \frac{0.1}{0.6}, \frac{0.3}{0.6} \right), x_2 \left(\frac{0.6}{0.9}, \frac{0.2}{0.9}, \frac{0.1}{0.9} \right) \right\} \\
 &\approx \{x_1(0.33, 0.17, 0.50), x_2(0.67, 0.22, 0.11)\} \\
 &\equiv \{x_1(0.33, 0.50), x_2(0.67, 0.11)\},
 \end{aligned}$$

since the indeterminacy (hesitance degree) is again neglected.

The intuitionistic fuzzy operators are applied only on truth-membership and false-nonmembership (but not on indeterminacy).

24.1.1. Intersection

Intuitionistic Fuzzy Intersection (min / max)

$$\begin{aligned}
 x_1^A \wedge_{IFS} x_1^B &= (0.50, 0.31) \wedge_{IFS} (0.33, 0.50) = \\
 &(\min\{0.50, 0.33\}, \max\{0.31, 0.50\}) = (0.33, 0.50) \equiv (0.33, 0.17, 0.50)
 \end{aligned}$$

after adding the indeterminacy which is what's left up to 1, i.e. $1 - 0.33 - 0.50 = 0.17$.

$$\begin{aligned}
 x_2^A \wedge_{IFS} x_2^B &= (0.53, 0.35) \wedge_{IFS} (0.67, 0.11) \\
 &= (\min\{0.53, 0.63\}, \max\{0.35, 0.11\}) = (0.53, 0.35) \\
 &\equiv (0.53, 0.12, 0.35),
 \end{aligned}$$

after adding the indeterminacy.

The results of NS and IFS intersections are clearly very different:

$$\begin{aligned}
 A_N \wedge_N B_N &= \{x_1(0.2, 0.3, 0.5), x_2(0.6, 0.2, 0.6)\} \\
 &\neq \{x_1(0.33, 0.17, 0.50), x_2(0.53, 0.12, 0.35)\} = A_{IFS} \wedge_{IFS} B_{IFS}
 \end{aligned}$$

Even more distinction, between the NS intersection and IFS intersection of the same elements (whose sums of components equal 1) $x_1^A = (0.50, 0.19, 0.31)$ and $x_1^B = (0.33, 0.17, 0.50)$

one obtains unequal results, using the (min / max / max) operator:

$$x_1^A \wedge_N x_1^B = (0.50, 0.19, 0.31) \wedge_N (0.33, 0.17, 0.50) = (0.33, 0.19, 0.50),$$

while

$$\begin{aligned}
 x_1^A \wedge_{IFS} x_1^B &= (0.50, 0.19, 0.31) \wedge_{IFS} (0.33, 0.17, 0.50) \\
 &\equiv (0.50, 0.31) \wedge_{IFS} (0.33, 0.50) \text{ \{after ignoring the indeterminacy in IFS\}}
 \end{aligned}$$

$$= (0.33, 0.50) \equiv (0.33, 0.17, 0.50) \neq (0.33, 0.19, 0.50).$$

24.1.2. Union

Intuitionistic Fuzzy Union (max / min / min)

$$\begin{aligned} x_1^A \vee_{IFS} x_1^B &= (0.50, 0.31) \vee_{IFS} (0.33, 0.50) \\ &= (\max\{0.50, 0.33\}, \min\{0.31, 0.50\}) = (0.50, 0.31) \\ &\equiv (0.50, 0.19, 0.31), \end{aligned}$$

after adding the indeterminacy.

$$\begin{aligned} x_2^A \vee_{IFS} x_2^B &= (0.53, 0.35) \vee_{IF} (0.67, 0.11) \\ &= (\max\{0.53, 0.67\}, \min\{0.35, 0.11\}) = (0.67, 0.11) \\ &\equiv (0.67, 0.22, 0.11), \end{aligned}$$

after adding the indeterminacy.

The results of NS and IFS unions are clearly very different:

$$\begin{aligned} A_N \vee_N B_N &= \{x_1(0.8, 0.1, 0.3), x_2(0.9, 0.2, 0.1)\} \\ &\neq \{x_1(0.50, 0.19, 0.31), x_2(0.67, 0.22, 0.11)\} = A_{IFS} \vee_{IF} B_{IFS}. \end{aligned}$$

Even more distinction, for the NS and IFS union of the same elements:

$$x_1^A \vee_N x_1^B = (0.50, 0.19, 0.31) \vee_N (0.33, 0.17, 0.50) = (0.50, 0.17, 0.31),$$

while

$$\begin{aligned} x_1^A \vee_{IFS} x_1^B &= (0.50, 0.19, 0.31) \vee_{IFS} (0.33, 0.17, 0.50) \equiv \\ &(0.50, 0.31) \vee_{IFS} (0.33, 0.50) \\ &= (0.50, 0.31) \equiv (0.50, 0.19, 0.31) \text{ \{after adding indeterminacy\}} \neq (0.50, 0.17, 0.31). \end{aligned}$$

25. Indeterminacy Makes a Big Difference between NS and IFS

The authors [6] assert that,

“Therefore, the NFS can be *represented* by an IFS” (page 5),

but this is not correct, since it should be:

The NFS (neutrosophic fuzzy set \equiv single-valued neutrosophic set) can be *restrained* (degraded) to an IFS (intuitionistic fuzzy set), yet the independence of components is lost and the results of the

aggregation operators are totally different between the neutrosophic environment and intuitionistic fuzzy environment, since Indeterminacy is ignored by IFS operators.

Since in single-valued neutrosophic set the neutrosophic components are *independent* (their sum can be up to 3, and if a component increases or decreases, it does not change the others), while in intuitionistic fuzzy set the components are *dependent* (in general if one changes, one or both the other components change in order to keep their sum equal to 1). Also, applying the neutrosophic operators is a better aggregation since the indeterminacy (I) is involved into all neutrosophic (complement/negation, intersection, union, inclusion/inequality/implication, equality/equivalence) operators while all intuitionistic fuzzy operators *ignore* (do not take into calculation) the indeterminacy.

That is why the results after applying the neutrosophic operators and intuitionistic fuzzy operators on the same sets are *different* as proven above.

26. Paradoxes cannot be Represented by the Intuitionistic Fuzzy Logic

No previous set/logic theories, including IFS or Intuitionistic Fuzzy Logic (IFL), since the sum of components was not allowed above 1, could characterize a paradox, which is a proposition that is true ($T = 1$) and false ($F = 1$) simultaneously, therefore the paradox is 100% indeterminate ($I = 1$). In Neutrosophic Logic (NL) a paradoxical proposition P_{NL} is represented as: $P_{NL}(I, I, I)$.

If one uses Atanassov and Vassiliev’s transformations (for example the normalization) [6], we get $P_{IFL}(1/3, 1/3, 1/3)$, but this one cannot represent a paradox, since a paradox is 100% true and 100% false, not 33% true and 33% false.

27. Single-Valued Atanassov’s Intuitionistic Fuzzy Set of second type, also called Single-Valued Pythagorean Fuzzy Set

Single-Valued Atanassov’s Intuitionistic Fuzzy Sets of second type (AIFS2) [23], also called Single-Valued Pythagorean Fuzzy Set (PyFS) [24], is defined as follows (using T, I, F notations for the components):

Definition of IFS2 (PyFS)

It is a set $A_{AIFS2} \equiv A_{PyFS}$ from the universe of discourse U such that:

$$A_{AIFS2} \equiv A_{PyFS} = \{ \langle x, T_A(x), F_A(x) \rangle \mid x \in U \},$$

where, for all $x \in U$, the functions $T_A(x), F_A(x) : U \rightarrow [0, 1]$, represent the degree of membership (truth) and degree on nonmembership (falsity) respectively, that satisfy the conditions:

$$0 \leq T_A^2(x) + F_A^2(x) \leq 1,$$

whence the hesitancy degree is:

$$I_A(x) = \sqrt{1 - T_A^2(x) - F_A^2(x)} \in [0, 1].$$

28. Single-Valued Refined Pythagorean Fuzzy Set (RPyFS)

We propose now for the first time the Single-Valued Refined Pythagorean Fuzzy Set (RPyFS):

$$A_{RAIFS2} = A_{RPyFS} = \{ x(T_A^1(x), T_A^2(x), \dots, T_A^p(x); F_A^1(x), F_A^2(x), \dots, F_A^s(x)), p + s \geq 3, x \in U \}$$

where p and s are positive nonzero integers, and for all $x \in U$, the functions

$T_A^1(x), T_A^2(x), \dots, T_A^p(x), F_A^1(x), F_A^2(x), \dots, F_A^s(x) : U \rightarrow [0, 1]$, represent the degrees of sub-membership (sub-truth) of types $1, 2, \dots, p$, and degrees on sub-nonmembership (sub-falsity) of types $1, 2, \dots, s$ respectively, that satisfy the condition:

$$0 \leq \sum_1^p (T_A^j)^2 + \sum_1^s (F_A^l)^2 \leq 1,$$

whence the refined hesitancy degree is:

$$I_A(x) = \sqrt{1 - \sum_1^p (T_A^j)^2 - \sum_1^s (F_A^l)^2} \in [0,1].$$

The Single-Valued Refined Pythagorean Fuzzy Set is a particular case of the Single-Valued Refined Neutrosophic Set.

29. The components of Atanassov’s Intuitionistic Fuzzy Set of second type (Pythagorean Fuzzy Set) are not Independent

Princy R and Mohana K assert in [23] that:

“the truth and falsity values and hesitancy value can be independently considered as membership and non-membership and hesitancy degrees respectively”.

But this is untrue, since in IFS2 (PyFS) the components are not independent, because they are connected (dependent on each other) through this inequality:

$$T_A^2(x) + F_A^2(x) \leq 1.$$

30. Let's see a Counterexample 3:

If $T = 0.9$, then $T^2 = 0.9^2 = 0.81$, whence $F^2 \leq 1 - T^2 = 1 - 0.81 = 0.19$, or $F \leq \sqrt{0.19} \approx 0.44$.

Therefore, if $T = 0.9$, then F is restricted to be less than equal to $\sqrt{0.19}$.

While in NS if $T = 0.9$, F can be equal to any number in $[0, 1]$, F can be even equal to 1.

Also, hesitancy degree clearly depends on T and F , because the formula of hesitancy degree is an equation depending on T and F , as below:

$$I_A(x) = \sqrt{1 - T_A^2(x) - F_A^2(x)} \in [0,1].$$

If $T = 0.9$ and $F = 0.2$, then hesitancy

$$I = \sqrt{1 - 0.9^2 - 0.2^2} = \sqrt{0.15} \approx 0.39.$$

Again, in NS if $T = 0.9$ and $F = 0.2$, I can be equal to any number in $[0, 1]$, not only to $\sqrt{0.15}$.

31. Neutrosophic Set is a Generalization of Pythagorean Fuzzy Set

In the definition of PyFS, one has $T_A(x), F_A(x) \in [0, 1]$, which involves that $T_A(x)^2, F_A(x)^2 \in [0, 1]$ too;

we denote $T_A^{NS}(x) = T_A(x)^2, F_A^{NS}(x) = F_A(x)^2$, and

$I_A^{NS}(x) = I_A(x)^2 = 1 - T_A(x)^2 - F_A(x)^2 \in [0,1]$, where “NS” stands for Neutrosophic Set.

Therefore, one gets: $T_A^{NS}(x) + I_A^{NS}(x) + F_A^{NS}(x) = 1$,

which is a particular case of the neutrosophic set, since in NS the sum of the components can be any number between 0 and 3, hence into PyFS has been chosen the sum of the components be equal to 1.

32. Spherical Fuzzy Set (SFS)

Definition of Spherical Fuzzy Set

A Single-Valued Spherical Fuzzy Set (SFS) [25, 26], of the universe of discourse U , is defined as follows:

$$A_{SFS} = \{ \langle x, T_A(x), I_A(x), F_A(x) \rangle \mid x \in U \},$$

where, for all $x \in U$, the functions $T_A(x), I_A(x), F_A(x) : U \rightarrow [0, 1]$, represent the degree of membership (truth), the degree of hesitancy, and degree on nonmembership (falsity) respectively, that satisfy the conditions:

$$0 \leq T_A^2(x) + I_A^2(x) + F_A^2(x) \leq 1,$$

whence the refusal degree is:

$$R_A(x) = \sqrt{1 - T_A^2(x) - I_A^2(x) - F_A^2(x)} \in [0, 1].$$

33. Single-Valued n-HyperSpherical Fuzzy Set (n-HSFS)

Smarandache (2019) generalized for the first time the spherical fuzzy set to n-hyperspherical fuzzy set.

Definition of n-HyperSpherical Fuzzy Set.

A Single-Valued n-HyperSpherical Fuzzy Set (n-HSFS), of the universe of discourse U , is defined as follows:

$$A_{n\text{-HSFS}} = \{ \langle x, T_A(x), I_A(x), F_A(x) \rangle \mid x \in U \},$$

where, for all $x \in U$, the functions $T_A(x), I_A(x), F_A(x) : U \rightarrow [0, 1]$, represent the degree of membership (truth), the degree of hesitancy, and degree on nonmembership (falsity) respectively, that satisfy the conditions:

$$0 \leq T_A^n(x) + I_A^n(x) + F_A^n(x) \leq 1, \text{ for } n \geq 1,$$

whence the refusal degree is:

$$R_A(x) = \sqrt{1 - T_A^n(x) - I_A^n(x) - F_A^n(x)} \in [0, 1].$$

It is clear that 2-HyperSpherical Fuzzy Set (i.e. when $n = 2$) is a spherical fuzzy set.

34. The n-HyperSpherical Fuzzy Set is a particular case of the Neutrosophic Set.

Because, $T_A(x), I_A(x), F_A(x) \in [0, 1]$ implies that, for $n \geq 1$ one has

$T_A^n(x), I_A^n(x), F_A^n(x) \in [0, 1]$ too, so they are neutrosophic components as well; therefore each n-HSFS is a NS.

But the reciprocal is not true, since if at least one component is 1 and from the other two components at least one is > 0 , for example $T_A(x) = 1$, and $I_A(x) > 0, F_A(x) \in [0, 1]$, then $T_A^n(x) + I_A^n(x) + F_A^n(x) > 1$ for $n \geq 1$. Therefore, there are infinitely many triplets T, I, F that are NS components, but they are not n-HSFS components.

35. The components of the Spherical Fuzzy Set are not Independent

Princy R and Mohana K assert in [23] that:

“In spherical fuzzy sets, while the squared sum of membership, non-membership and hesitancy parameters can be between 0 and 1, each of them can be defined between 0 and 1 independently.”

But this is again untrue, the above parameters cannot be defined independently.

36. Counterexample 4

If $T = 0.9$ then F cannot be for example equal to 0.8 ,

since $0.9^2 + 0.8^2 = 1.45 > 1$,

but the sum of the squares of components is not allowed to be greater than 1.

So F depends on T in this example.

Two components are independent if no matter what value gets one component will not affect the other component's value.

37. Neutrosophic Set is a generalization of the Spherical Fuzzy Set

In [25] Gündođlu and Kahraman assert about:

“superiority of SFS [i.e. Spherical Fuzzy Set] with respect to Pythagorean, intuitionistic fuzzy and neutrosophic sets”;

also:

“SFSs are a generalization of Pythagorean Fuzzy Sets (PFS) and neutrosophic sets”.

While it is *true* that the spherical fuzzy set is a generalizations of Pythagorean fuzzy set and of intuitionistic fuzzy set, it is *false* that spherical fuzzy set is a generalization of neutrosophic set.

Actually it's the opposite: neutrosophic set is a generalization of spherical fuzzy set. We prove it bellow.

Proof

In the definition of the spherical fuzzy set one has:

$T_A(x), I_A(x), F_A(x) \in [0, 1]$, which involves that $T_A(x)^2, I_A(x)^2, F_A(x)^2 \in [0, 1]$ too.

Let's denote: $T_A^{NS}(x) = T_A(x)^2, I_A^{NS}(x) = I_A(x)^2, F_A^{NS}(x) = F_A(x)^2$, where “NS” stands for neutrosophic set, whence we obtain, using SFS definition:

$$0 \leq T_A^{NS}(x) + I_A^{NS}(x) + F_A^{NS}(x) \leq 1,$$

which is a particular case of the single-valued neutrosophic set, where the sum of the components T, I, F can be any number between 0 and 3. So now we can choose the sum up to 1.

38. Counterexample 5

If we take $T_A(x) = 0.9, I_A(x) = 0.4, F_A(x) = 0.5$, for some given element x , which are neutrosophic components, they are not spherical fuzzy set components because $0.9^2 + 0.4^2 + 0.5^2 = 1.22 > 1$.

There are infinitely many values for $T_A(x), I_A(x), F_A(x)$ in $[0, 1]$ whose sum of squares is strictly greater than 1, therefore they are not spherical fuzzy set components, but they are neutrosophic components.

The elements of a spherical fuzzy set form a 1/8 of a sphere of radius 1, centred into the origin $O(0,0,0)$ of the Cartesian system of coordinates, on the positive $Ox (T), Oy (I), Oz (F)$ axes.

While the standard neutrosophic set is a cube of side 1, that has the vertexes: $(0,0,0), (1,0,0), (0,1,0), (0,0,1), (1,1,0), (1,0,1), (0,1,1), (1,1,1)$.

The neutrosophic cube strictly includes the 1/8 fuzzy sphere.

39. Single-Valued Refined Spherical Fuzzy Set (RSFS)

We introduce now for the first time the Single-Valued Refined Spherical Fuzzy Set.

$$A_{RSFS} = \{x(T_A^1(x), T_A^2(x), \dots, T_A^p(x); I_A^1(x), I_A^2(x), \dots, I_A^r(x); F_A^1(x), F_A^2(x), \dots, F_A^s(x)), p + r + s \geq 4, x \in U\},$$

where p, r, s are nonzero positive integers, and for all $x \in U$, the functions $T_A^1(x), T_A^2(x), \dots, T_A^p(x), I_A^1(x), I_A^2(x), \dots, I_A^r(x), F_A^1(x), F_A^2(x), \dots, F_A^s(x) : U \rightarrow [0, 1]$, represent the degrees of sub-membership (sub-truth) of types $1, 2, \dots, p$, the degrees of sub-hesitancy of types $1, 2, \dots, r$, and degrees on sub-nonmembership (sub-falsity) of types $1, 2, \dots, s$ respectively, that satisfy the condition:

$$0 \leq \sum_1^p (T_A^j)^2 + \sum_1^r (I_A^k)^2 + \sum_1^s (F_A^l)^2 \leq 1,$$

whence the refined refusal degree is:

$$R_A(x) = \sqrt{1 - \sum_1^p (T_A^j)^2 - \sum_1^r (I_A^k)^2 - \sum_1^s (F_A^l)^2} \in [0, 1].$$

The Single-Valued Refined Spherical Fuzzy Set is a particular case of the Single-Valued Refined Neutrosophic Set.

40. Single-Valued Spherical Neutrosophic Set

Spherical Neutrosophic Set (SNS) was introduced by Smarandache [27] in 2017.

A Single-Valued Spherical Neutrosophic Set (SNS), of the universe of discourse U , is defined as follows:

$$A_{SNS} = \{ \langle x, T_A(x), I_A(x), F_A(x) \rangle \mid x \in U \},$$

where, for all $x \in U$, the functions $T_A(x), I_A(x), F_A(x) : U \rightarrow [0, \sqrt{3}]$, represent the degree of membership (truth), the degree of indeterminacy, and degree on nonmembership (falsity) respectively, that satisfy the conditions:

$$0 \leq T_A^2(x) + I_A^2(x) + F_A^2(x) \leq 3.$$

The Spherical Neutrosophic Set is a generalization of Spherical Fuzzy Set, because we may restrain the SNS's components to the unit interval $T_A(x), I_A(x), F_A(x) \in [0, 1]$, and the sum of the squared components to 1, i.e. $0 \leq T_A^2(x) + I_A^2(x) + F_A^2(x) \leq 1$.

Further on, if replacing $I_A(x) = 0$ into the Spherical Fuzzy Set, we obtain as particular case the Pythagorean Fuzzy Set.

41. Single-Valued n-HyperSpherical Neutrosophic Set (n-HSNS)

Definition of n-HyperSpherical Neutrosophic Set (Smarandache, 2019)

We introduce now for the first time the Single-Valued n-HyperSpherical Neutrosophic Set (n-HSNS), which is a generalization of the Spherical Neutrosophic Set and of n-HyperSpherical Fuzzy Set, of the universe of discourse U , for $n \geq 1$, is defined as follows:

$$A_{n-HNS} = \{ \langle x, T_A(x), I_A(x), F_A(x) \rangle \mid x \in U \},$$

where, for all $x \in U$, the functions $T_A(x), I_A(x), F_A(x) : U \rightarrow [0, \sqrt[n]{3}]$, represent the degree of membership (truth), the degree of indeterminacy, and degree on nonmembership (falsity) respectively, that satisfy the conditions:

$$0 \leq T_A^n(x) + I_A^n(x) + F_A^n(x) \leq 3.$$

42. Single-Valued Refined Refined n-HyperSpherical Neutrosophic Set (R-n-HSNS)

We introduce now for the first time the Single-Valued Refined n-HyperSpherical Neutrosophic Set (R-n-HSNS), which is a generalization of the n-HyperSpherical Neutrosophic Set and of Refined n-HyperSpherical Fuzzy Set.

On the universe of discourse U, for $n \geq 1$, we define it as:

$$A_{R-n-HSNS} = \{x(T_A^1(x), T_A^2(x), \dots, T_A^p(x); I_A^1(x), I_A^2(x), \dots, I_A^r(x); F_A^1(x), F_A^2(x), \dots, F_A^s(x)), p + r + s \geq 4, x \in U\},$$

where p, r, s are nonzero positive integers, and for all $x \in U$, the functions

$$T_A^1(x), T_A^2(x), \dots, T_A^p(x), I_A^1(x), I_A^2(x), \dots, I_A^r(x), F_A^1(x), F_A^2(x), \dots, F_A^s(x) : U \rightarrow [0, m^{1/n}],$$

represent the degrees of sub-membership (sub-truth) of types $1, 2, \dots, p$, the degrees of sub-indeterminacy of types $1, 2, \dots, r$, and degrees on sub-nonmembership (sub-falsity) of types $1, 2, \dots, s$ respectively, that satisfy the condition:

$$0 \leq \sum_1^p (T_A^j)^n + \sum_1^r (I_A^k)^n + \sum_1^s (F_A^l)^n \leq m, \text{ where } p + r + s = m.$$

43. Neutrosophic Set is a Generalization of q-Rung Orthopair Fuzzy Set (q-ROFS).

Definition of q-Rung Orthopair Fuzzy Set.

Using the same T, I, F notations one has as follows.

A *Single-Valued q-Rung Orthopair Fuzzy Set (q-ROFS)* [28], of the universe of discourse U, for a given real number $q \geq 1$, is defined as follows:

$$A_{q-ROFS} = \{ \langle x, T_A(x), F_A(x) \rangle \mid x \in U \},$$

where, for all $x \in U$, the functions $T_A(x), F_A(x) : U \rightarrow [0, 1]$, represent the degree of membership (truth), and degree on nonmembership (falsity) respectively, that satisfy the conditions:

$$0 \leq T_A(x)^q + F_A(x)^q \leq 1.$$

Since $T_A(x), F_A(x) \in [0, 1]$, then for any real number $q \geq 1$ one has $T_A(x)^q, F_A(x)^q \in [0, 1]$ too.

Let's denote: $T_A^{NS}(x) = T_A(x)^q, F_A^{NS}(x) = F_A(x)^q$, whence it results that:

$$0 \leq T_A^{NS}(x) + F_A^{NS}(x) \leq 1, \text{ where what's left may be Indeterminacy.}$$

But this is a particular case of the neutrosophic set, where the sum of components T, I, F can be any number between 0 and 3, and for q-ROFS is it taken to be up to 1. Therefore, any Single-Valued q-Rung Orthopair Fuzzy Set is also a Neutrosophic Set, but the reciprocal is not true. See the next counterexample.

44. Counterexample 6.

Let's consider a real number $1 \leq q < \infty$, and a set of single-valued triplets of the form

(T, I, F) , with $T, I, F \in [0, 1]$ that represent the components of the elements of a given set.

The components of the form $(1, F)$, with $F > 0$, and of the form $(T, 1)$, with $T > 0$, constitute NS components as follows: $(1, I, F)$, with $F > 0$ and any $I \in [0, 1]$, and respectively

$(T, I, 1)$, with $T > 0$ and any $I \in [0, 1]$, since the sum of the components is allowed to be greater than 1, i.e. $1 + I + F > 1$ and respectively $T + I + 1 > 1$.

But they cannot be components of the elements of a q-ROFS set, since:

$I^q + F^q = 1 + F^q > 1$, because $F > 0$ and $1 \leq q < \infty$; but in q-ROFS the sum has to be ≤ 1 .

Similarly, $T^q + I^q = T^q + 1 > 1$, because $T > 0$ and $1 \leq q < \infty$; but in q-ROFS the sum has to be ≤ 1 .

45. Refined q-Rung Orthopair Fuzzy Set (R-q-ROFS)

We propose now for the first time the Single-Valued Refined q-Rung Orthopair Fuzzy Set (R-q-ROFS):

$$A_{R-q-ROFS} = \{x(T_A^1(x), T_A^2(x), \dots, T_A^p(x), F_A^1(x), F_A^2(x), \dots, F_A^s(x)), p + s \geq 3, x \in U\},$$

where p and s are positive nonzero integers, and for all $x \in U$, the functions

$T_A^1(x), T_A^2(x), \dots, T_A^p(x), F_A^1(x), F_A^2(x), \dots, F_A^s(x) : U \rightarrow [0, 1]$, represent the degrees of sub-membership (sub-truth) of types $1, 2, \dots, p$, and degrees on sub-nonmembership (sub-falsity) of types $1, 2, \dots, s$ respectively, that satisfy the condition:

$$0 \leq \sum_1^p (T_A^j)^q + \sum_1^s (F_A^l)^q \leq 1, \text{ for } q \geq 1,$$

whence the refined hesitancy degree is:

$$I_A(x) = [1 - \sum_1^p (T_A^j)^q - \sum_1^s (F_A^l)^q]^{1/q} \in [0, 1].$$

The Single-Valued Refined q-Rung Fuzzy Set is a particular case of the Single-Valued Refined Neutrosophic Set.

46. Regret Theory is a Neutrosophication Model

Regret Theory (2010) [29] is actually a Neutrosophication (1998) Model, when the decision making area is split into three parts, the opposite ones (upper approximation area, and lower approximation area) and the neutral one (border area, in between the upper and lower area).

47. Grey System Theory as a Neutrosophication

A Grey System [30] is referring to a *grey area* (as $\langle \text{neutA} \rangle$ in neutrosophy), between extremes (as $\langle \text{A} \rangle$ and $\langle \text{antiA} \rangle$ in neutrosophy).

According to the Grey System Theory, a system with perfect information ($\langle \text{A} \rangle$) may have a unique solution, while a system with no information ($\langle \text{antiA} \rangle$) has no solution. In the middle ($\langle \text{neutA} \rangle$), or grey area, of these opposite systems, there may be many available

solutions (with partial information known and partial information unknown) from which an approximate solution can be extracted.

48. Three-Ways Decision as particular cases of Neutrosophication and of Neutrosophic Probability [31, 32, 33, 34, 35, 36]

48.1. Neutrosophication

Let $\langle A \rangle$ be an attribute value, $\langle antiA \rangle$ the opposite of this attribute value, and $\langle neutA \rangle$ the neutral (or indeterminate) attribute value between the opposites $\langle A \rangle$ and $\langle antiA \rangle$.

For examples: $\langle A \rangle = big$, then $\langle antiA \rangle = small$, and $\langle neutA \rangle = medium$; we may rewrite:

$(\langle A \rangle, \langle neutA \rangle, \langle antiA \rangle) = (big, medium, small)$;

or $(\langle A \rangle, \langle neutA \rangle, \langle antiA \rangle) = (truth \text{ (denoted as } T), indeterminacy \text{ (denoted as } I), falsehood \text{ (denoted as } F))$ as in Neutrosophic Logic,

or $(\langle A \rangle, \langle neutA \rangle, \langle antiA \rangle) = (membership, indeterminate-membership, nonmembership)$ as in Neutrosophic Set,

or $(\langle A \rangle, \langle neutA \rangle, \langle antiA \rangle) = (chance \text{ that an event occurs, indeterminate-chance that the event occurs or not, chance that the event does not occur})$ as in Neutrosophic Probability,

and so on.

And let's by "Concept" to mean: an item, object, idea, theory, region, universe, set, notion etc. that is characterized by this attribute.

The process of **neutrosophication** {Smarandache, 2019, [37]} means:

a) converting a *Classical Concept*

{ denoted as $(I_{\langle A \rangle}, 0_{\langle neutA \rangle}, 0_{\langle antiA \rangle})$ -**ClassicalConcept**, or **ClassicalConcept** $(I_{\langle A \rangle}, 0_{\langle neutA \rangle}, 0_{\langle antiA \rangle})$ }, which means that the concept is, with respect to the above attribute,

$$100\% \langle A \rangle, 0\% \langle neutA \rangle, \text{ and } 0\% \langle antiA \rangle,$$

into a *Neutrosophic Concept*

{ denoted as $(T_{\langle A \rangle}, I_{\langle neutA \rangle}, F_{\langle antiA \rangle})$ -**NeutrosophicConcept**, or **NeutrosophicConcept** $(T_{\langle A \rangle}, I_{\langle neutA \rangle}, F_{\langle antiA \rangle})$ }, which means that the concept is, with respect to the above attribute,

$$T\% \langle A \rangle, I\% \langle neutA \rangle, \text{ and } F\% \langle antiA \rangle,$$

which more accurately reflects our imperfect, non-idealistic reality,

where all T, I, F are subsets of $[0, 1]$ with no other restriction;

b) or converting a *Fuzzy Concept*, or *Intuitionistic Fuzzy Concept* into a *Neutrosophic Concept*;

- c) or converting other Concepts such as *Inconsistent Intuitionistic Fuzzy (Picture Fuzzy, Ternary Fuzzy) Concept*, or *Pythagorean Fuzzy Concept*, or *Spherical Fuzzy Concept*, or *q-Rung Orthopair Fuzzy* etc.

into a *Neutrosophic Concept* or into a *Refined Neutrosophic Concept* (i.e. $T_1\% \langle A_1 \rangle$, $T_2\% \langle A_2 \rangle$, ..., $I_1\% \langle \text{neut}A_1 \rangle$, $I_2\% \langle \text{neut}A_2 \rangle$, ..., and $F_1\% \langle \text{anti}A_1 \rangle$, $F_2\% \langle \text{anti}A_2 \rangle$, ...),

where all $T_1, T_2, \dots; I_1, I_2, \dots; F_1, F_2, \dots$ are subsets of $[0, 1]$ with no other restriction.

- d) or converting a *crisp real number* (r) into a *neutrosophic real number* of the form $r = a + bI$, where “ P ” means (literal or numerical) indeterminacy, a and b are real numbers, and “ a ” represents the determinate part of the crisp real number r , while bI the indeterminate part of r ;

- e) or converting a *crisp complex number* (c) into a *neutrosophic complex number* of the form $c = a_1 + b_1i + (a_2 + b_2i)I = a_1 + a_2I + (b_1 + b_2I)i$, where “ P ” means (literal or numerical) indeterminacy, $i = \sqrt{-1}$, with a_1, a_2, b_1, b_2 real numbers, and “ $a_1 + b_1i$ ” represents the determinate part of the complex real number c , while $a_2 + b_2i$ the indeterminate part of c ;

(we may also interpret that as: a_1 is the determinate part of the real-part of c , and b_1 is the determinate part of the imaginary-part of c ; while a_2 is the indeterminate part of the real-part of c , and b_2 is the indeterminate part of the imaginary-part of c);

- f) converting a *crisp, fuzzy, or intuitionistic fuzzy, or inconsistent intuitionistic fuzzy (picture fuzzy, ternary fuzzy set), or Pythagorean fuzzy, or spherical fuzzy, or q-rung orthopair fuzzy number* and other numbers into a *quadruple neutrosophic number* of the form $a + bT + cI + dF$, where a, b, c, d are real or complex numbers, while T, I, F are the neutrosophic components.

While the process of **deneutrosophication** means going backwards with respect to any of the above processes of neutrosophication.

Example 1:

Let the attribute $\langle A \rangle =$ cold temperature, then $\langle \text{anti}A \rangle =$ hot temperature, and $\langle \text{neut}A \rangle =$ medium temperature.

Let the concept be a country M , such that its northern part (30% of country’s territory) is cold, its southern part is hot (50%), and in the middle there is a buffer zone with medium temperature (20%). We write:

$$M(0.3_{\text{cold temperature}}, 0.2_{\text{medium temperature}}, 0.5_{\text{hot temperature}})$$

where we took single-valued numbers for the neutrosophic components $T_M = 0.3, I_M = 0.2, F_M = 0.5$, and the neutrosophic components are considered dependent so their sum is equal to 1.

48.2. Three-Ways Decision is a particular case of Neutrosophication

Neutrosophy (based on $\langle A \rangle, \langle \text{neut}A \rangle, \langle \text{anti}A \rangle$) was proposed by Smarandache [1] in 1998, and Three-Ways Decision by Yao [31] in 2009.

In Three-Ways Decision, the universe set is split into three different distinct areas, in regard to the decision process, representing:

Acceptance, Noncommitment, and Rejection respectively.

In this case, the decision attribute value $\langle A \rangle = \text{Acceptance}$, whence $\langle \text{neut}A \rangle = \text{Noncommitment}$, and $\langle \text{anti}A \rangle = \text{Rejection}$.

The classical concept = *UniverseSet*.

Therefore, we got the *NeutrosophicConcept*($T_{\langle A \rangle}$, $I_{\langle \text{neut}A \rangle}$, $F_{\langle \text{anti}A \rangle}$), denoted as:

UniverseSet($T_{\text{Acceptance}}$, $I_{\text{Noncommitment}}$, $F_{\text{Rejection}}$),

where $T_{\text{Acceptance}} = \text{universe set's zone of acceptance}$, $I_{\text{Noncommitment}} = \text{universe set's zone of noncommitment (indeterminacy)}$, $F_{\text{Rejection}} = \text{universe set's zone of rejection}$.

48.3. Three-Ways Decision as a particular case of Neutrosophic Probability

Let's consider the event, taking a decision on a universe set.

According to Neutrosophic Probability (NP) [1, 11] one has:

$NP(\text{decision}) = (\text{the universe set's elements for which the chance of the decision may be accept; the universe set's elements for which there may be an indeterminate-chance of the decision; the universe set's elements for which the chance of the decision may be reject })$.

48.4. Refined Neutrosophy

Refined Neutrosophy was introduced by Smarandache [9] in 2013 and it is described as follows:

$\langle A \rangle$ is refined (split) into subcomponents $\langle A_1 \rangle$, $\langle A_2 \rangle$, ..., $\langle A_p \rangle$;

$\langle \text{neut}A \rangle$ is refined (split) into subcomponents $\langle \text{neut}A_1 \rangle$, $\langle \text{neut}A_2 \rangle$, ..., $\langle \text{neut}A_r \rangle$;

and $\langle \text{anti}A \rangle$ is refined (split) into subcomponents $\langle \text{anti}A_1 \rangle$, $\langle \text{anti}A_2 \rangle$, ..., $\langle \text{anti}A_s \rangle$;

where $p, r, s \geq 1$ are integers, and $p + r + s \geq 4$.

Refined Neutrosophy is a generalization of Neutrosophy.

Example 2.

If $\langle A \rangle = \text{voting in country M}$, then $\langle A_1 \rangle = \text{voting in Region 1 of country M for a given candidate}$, $\langle A_2 \rangle = \text{voting in Region 2 of country M for a given candidate}$, and so on.

Similarly, $\langle \text{neut}A_1 \rangle = \text{not voting (or casting a white or a black vote) in Region 1 of country M}$, $\langle A_2 \rangle = \text{not voting in Region 2 of country M}$, and so on.

And $\langle \text{anti}A_1 \rangle = \text{voting in Region 1 of country M against the given candidate}$, $\langle A_2 \rangle = \text{voting in Region 2 of country M against the given candidate}$, and so on.

48.5. Extension of Three-Ways Decision to n-Ways Decision

n-Way Decision was introduced by Smarandache [37] in 2019.

In n-Ways Decision, the universe set is split into $n \geq 4$ different distinct areas, in regard to the decision process, representing:

Levels of Acceptance, Levels of Noncommitment, and Levels of Rejection respectively.

Levels of Acceptance may be: Very High Level of Acceptance ($\langle A_1 \rangle$), High Level of Acceptance ($\langle A_2 \rangle$), Medium Level of Acceptance ($\langle A_3 \rangle$), etc.

Similarly, Levels of Noncommitment may be: Very High Level of Noncommitment ($\langle \text{neut}A_1 \rangle$), High Level of Noncommitment ($\langle \text{neut}A_2 \rangle$), Medium Level of Noncommitment ($\langle \text{neut}A_3 \rangle$), etc.

And Levels of Rejection may be: Very High Level of Rejection ($\langle \text{anti}A_1 \rangle$), High Level of Rejection ($\langle \text{anti}A_2 \rangle$), Medium Level of Rejection ($\langle \text{anti}A_3 \rangle$), etc.

Then the *Refined Neutrosophic Concept*

{ denoted as $(T1_{\langle A1 \rangle}, T2_{\langle A2 \rangle}, \dots, Tp_{\langle Ap \rangle}; I1_{\langle \text{neut}A1 \rangle}, I2_{\langle \text{neut}A2 \rangle}, \dots, Ir_{\langle \text{neut}Ar \rangle};$

$F1_{\langle \text{anti}A1 \rangle}, F2_{\langle \text{anti}A2 \rangle}, Fs_{\langle \text{anti}As \rangle})$ -*Refined Neutrosophic Concept,*

or *Refined Neutrosophic Concept* $(T1_{\langle A1 \rangle}, T2_{\langle A2 \rangle}, \dots, Tp_{\langle Ap \rangle}; I1_{\langle \text{neut}A1 \rangle}, I2_{\langle \text{neut}A2 \rangle}, \dots, Ir_{\langle \text{neut}Ar \rangle}; F1_{\langle \text{anti}A1 \rangle}, F2_{\langle \text{anti}A2 \rangle}, Fs_{\langle \text{anti}As \rangle})$,

which means that the concept is, with respect to the above attribute value levels,

$$T1\% \langle A1 \rangle, T2\% \langle A2 \rangle, \dots, Tp\% \langle Ap \rangle;$$

$$I1\% \langle \text{neut}A1 \rangle, I2\% \langle \text{neut}A2 \rangle, \dots, Ir\% \langle \text{neut}Ar \rangle;$$

$$F1\% \langle \text{anti}A1 \rangle, F2\% \langle \text{anti}A2 \rangle, Fs\% \langle \text{anti}As \rangle;$$

which more accurately reflects our imperfect, non-idealistic reality,

with where $p, r, s \geq 1$ are integers, and $p + r + s \geq 4$,

where all $T1, T2, \dots, Tp, I1, I2, \dots, Ir, F1, F2, \dots, Fs$ are subsets of $[0, 1]$ with no other restriction.

49. Many More Distinctions between Neutrosophic Set (NS) and Intuitionistic Fuzzy Set (IFS) and other type sets

49.1. Neutrosophic Set can distinguish between absolute and relative

- *absolute membership* (i.e. membership in all possible worlds; we have extended Leibniz’s absolute truth to absolute membership), and
- *relative membership* (membership in at least one world, but not in all), because $NS(\text{absolute membership element}) = 1^+$

while

- NS (relative membership element) = 1.

This has application in philosophy (see the *neutrosophy*). That's why the unitary standard interval $[0, 1]$ used in IFS has been extended to the unitary non-standard interval $]^{-0}, 1^{+}[$ in NS.

Similar distinctions for *absolute* or *relative non-membership*, and *absolute* or *relative indeterminate appurtenance* are allowed in NS.

While IFS cannot distinguish the absoluteness from relativeness of the components.

49.2. In NS, there is no restriction on T, I, F other than they be subsets of $]^{-0}, 1^{+}[$, thus:

$$^{-0} \leq \inf T + \inf I + \inf F \leq \sup T + \sup I + \sup F \leq 3^{+}.$$

The inequalities (2.1) and (2.4) [17] of IFS are relaxed in NS.

This non-restriction allows paraconsistent, dialetheist, and incomplete information to be characterized in NS {i.e. the sum of all three components if they are defined as points, or sum of superior limits of all three components if they are defined as subsets can be >1 (for paraconsistent information coming from different sources), or < 1 for incomplete information}, while that information cannot be described in IFS because in IFS the components T (membership), I (indeterminacy), F (non-membership) are restricted either to $t + i + f = 1$ or to $t^2 + i^2 + f^2 \leq 1$, if T, I, F are all reduced to the points (single-valued numbers) t, i, f respectively, or to $\sup T + \sup I + \sup F = 1$ if T, I, F are subsets of $[0, 1]$. Of course, there are cases when paraconsistent and incomplete informations can be normalized to 1, but this procedure is not always suitable.

In IFS paraconsistent, dialetheist, and incomplete information cannot be characterized.

This most important distinction between IFS and NS is showed in the below **Neutrosophic Cube** $A'B'C'D'E'F'G'H'$ introduced by J. Dezert [38] in 2002.

Because in technical applications only the classical interval $[0,1]$ is used as range for the neutrosophic parameters t, i, f , we call the cube $ABCDEDGH$ the **technical neutrosophic cube** and its extension $A'B'C'D'E'D'G'H'$ the **neutrosophic cube** (or **nonstandard neutrosophic cube**), used in the fields where we need to differentiate between *absolute* and *relative* (as in philosophy) notions.

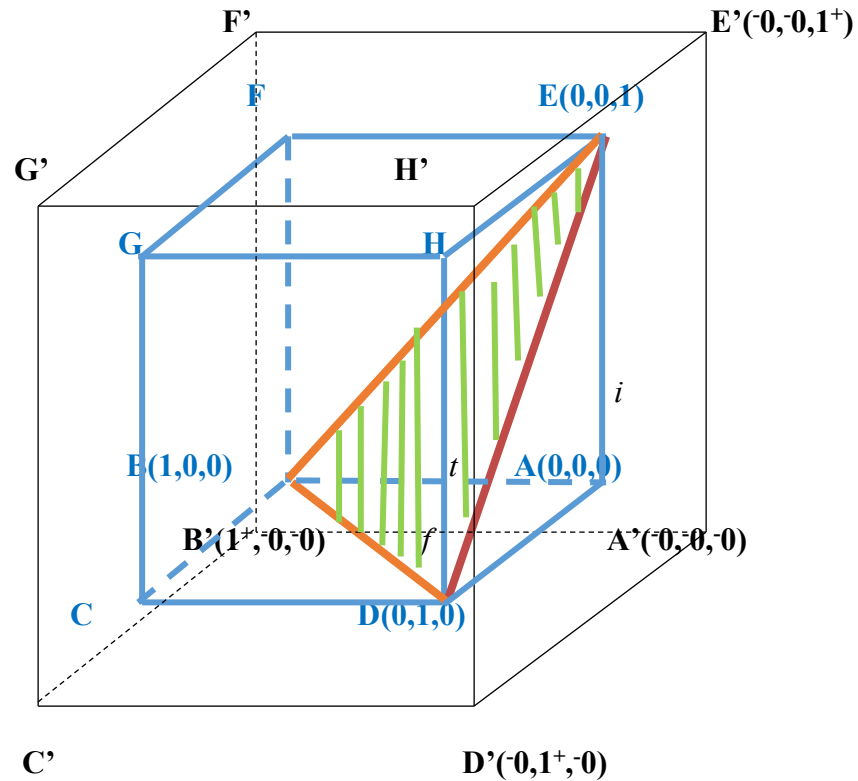

Fig. 1. Neutrosophic Cube

Let's consider a 3D Cartesian system of coordinates, where t is the truth axis with value range in $]^{-0,1^+}$, f is the false axis with value range in $]^{-0,1^+}$, and similarly i is the indeterminate axis with value range in $]^{-0,1^+}$.

We now divide the technical neutrosophic cube $ABCDEDGH$ into three disjoint regions:

- a) The shaded equilateral triangle BDE , whose sides are equal to $\sqrt{2}$, which represents the geometrical locus of the points whose sum of the coordinates is 1.

If a point Q is situated on the sides or inside of the triangle BDE , then $t_Q + i_Q + f_Q = 1$ as in Atanassov-intuitionistic fuzzy set ($A-IFS$).

It is clear that IFS triangle is a restriction of (strictly included in) the NS cube.

- b) The pyramid $EABD$ {situated in the right side of the ΔEBD , including its faces ΔABD (base), ΔEBA , and ΔEDA (lateral faces), but excluding its face ΔBDE } is the locus of the points whose sum of coordinates is less than 1.

If $P \in EABD$ then $t_p + i_p + f_p < 1$ as in inconsistent intuitionistic fuzzy set (with incomplete information).

- c) In the left side of ΔBDE in the cube there is the solid $EFGCDEBD$ (excluding ΔBDE) which is the locus of points whose sum of their coordinates is greater than 1 as in the paraconsistent set.

If a point $R \in EFGCDEBD$, then $t_R + i_R + f_R > 1$.

It is possible to get the **sum of coordinates strictly less than 1 or strictly greater than 1**. For example having three independent sources of information:

- We have a source which is capable to find only the degree of membership of an element; but it is unable to find the degree of non-membership;
- Another source which is capable to find only the degree of non-membership of an element;
- Or a source which only computes the indeterminacy.

Thus, when we put the results together of these sources, it is possible that their sum is not 1, but smaller or greater.

Also, in information fusion, when dealing with indeterminate models (i.e. elements of the fusion space which are indeterminate/unknown, such as intersections we don't know if they are empty or not since we don't have enough information, similarly for complements of indeterminate elements, etc.): if we compute the believe in that element (truth), the disbelieve in that element (falsehood), and the indeterminacy part of that element, then the sum of these three components is strictly less than 1 (the difference to 1 is the missing information).

49.3) Relation (2.3) from interval-valued intuitionistic fuzzy set is relaxed in NS, i.e. the intervals do not necessarily belong to $\text{Int}[0,1]$ but to $[0,1]$, even more general to $]0, 1^+[$.

49.4) In NS the components T, I, F can also be **nonstandard subsets** included in the unitary non-standard interval $]0, 1^+[$, not only *standard* subsets included in the unitary standard interval $[0, 1]$ as in IFS.

49.5) NS, like dialetheism, can describe **paradoxist elements**, $\text{NS}(\text{paradoxist element}) = (1, 1, 1)$, while IFL cannot describe a paradox because the sum of components should be 1 in IFS.

49.6) The connectors/operators in IFS are defined with respect to T and F only, i.e. membership and nonmembership only (hence the Indeterminacy is what's left from 1), while in NS they can be defined with respect to any of them (no restriction).

But, for interval-valued intuitionistic fuzzy set one cannot find any left indeterminacy.

49.7) Component "P", indeterminacy, can be split into more subcomponents in order to better catch the vague information we work with, and such, for example, one can get more accurate answers to the *Question-Answering Systems* initiated by Zadeh (2003).

{In Belnap's four-valued logic (1977) indeterminacy is split into Uncertainty (*U*) and Contradiction (*C*), but they were interrelated.}

Even more, one can split "I" into Contradiction, Uncertainty, and Unknown, and we get a five-valued logic.

In a general Refined Neutrosophic Logic, T can be split into subcomponents T_1, T_2, \dots, T_p , and I into I_1, I_2, \dots, I_r , and F into F_1, F_2, \dots, F_s , where $p, r, s \geq 1$ and $p + r + s = n \geq 3$. Even more: T, I, and/or F (or any of their subcomponents T_j, I_k , and/or F_l) can be countable or uncountable infinite sets.

49.8) Indeterminacy is independent from membership/truth and non-membership/falsehood in NS/NI, while in IFS/IFL it is not.

In neutrosophics there are two types of indeterminacies:

a) *Numerical Indeterminacy (or Degree of Indeterminacy)*, which has the form $(t, i, f) \neq (1, 0, 0)$, where t, i, f are numbers, intervals, or subsets included in the unit interval $[0, 1]$, and it is the base for the (t, i, f) -Neutrosophic Structures.

b) *Non-numerical Indeterminacy (or Literal Indeterminacy)*, which is the letter "I" standing for unknown (non-determinate), such that $I^2 = I$, and used in the composition of the neutrosophic number $N = a + bI$, where a and b are real or complex numbers, and a is the determinate part of number N , while bI is the indeterminate part of N . The neutrosophic numbers are the base for the I -Neutrosophic Structures.

49.9) NS has a better and clear terminology (name) as "neutrosophic" (which means the neutral part: i.e. neither true/membership nor false/nonmembership), while IFS's name "intuitionistic" produces confusion with Intuitionistic Logic, which is something different (see the article by Didier Dubois et al. [39], 2005).

49.10) The Neutrosophic Set was extended [Smarandache, 2007] to **Neutrosophic Overset** (when some neutrosophic component is > 1), and to **Neutrosophic Underset** (when some neutrosophic component is < 0), and to **Neutrosophic Offset** (when some neutrosophic components are off the interval $[0, 1]$, i.e. some neutrosophic component > 1 and some neutrosophic component < 0). In IFS the degree of a component is not allowed to be outside of the classical interval $[0, 1]$.

This is no surprise with respect to the classical fuzzy set/logic, intuitionistic fuzzy set/logic, or classical and imprecise probability where the values are not allowed outside the interval $[0, 1]$, since our real-world has numerous examples and applications of over/under/off neutrosophic components.

Example:

In a given company a full-time employer works 40 hours per week. Let's consider the last week period.

Helen worked part-time, only 30 hours, and the other 10 hours she was absent without payment; hence, her membership degree was $30/40 = 0.75 < 1$.

John worked full-time, 40 hours, so he had the membership degree $40/40 = 1$, with respect to this company.

But George worked overtime 5 hours, so his membership degree was $(40+5)/40 = 45/40 = 1.125 > 1$. Thus, we need to make distinction between employees who work overtime, and those who work full-time or part-time. That's why we need to associate a degree of membership greater than 1 to the overtime workers.

Now, another employee, Jane, was absent without pay for the whole week, so her degree of membership was $0/40 = 0$.

Yet, Richard, who was also hired as a full-time, not only didn't come to work last week at all (0 worked hours), but he produced, by accidentally starting a devastating fire, much damage to the company, which was estimated at a value half of his salary (i.e. as he would have gotten for working 20 hours). Therefore, his membership degree has to be less than Jane's (since Jane produced no damage). Whence, Richard's degree of membership with respect to this company was $-20/40 = -0.50 < 0$.

Therefore, the membership degrees > 1 and < 0 are real in our world, so we have to take them into consideration.

Then, similarly, the Neutrosophic Logic/Measure/Probability/Statistics etc. were extended to respectively Neutrosophic Over/Under/Off Logic, Measure, Probability, Statistics etc. {Smarandache, 2007 [8]}.

49.11) **Neutrosophic Tripolar** (and in general **Multipolar**) **Set and Logic** {Smarandache, 2007 [8]} of the form:

$$(<T^+_1, T^+_2, \dots, T^+_n; T^0; T^-_n, \dots, T^-_{-2}, T^-_{-1} >, <I^+_1, I^+_2, \dots, I^+_n; I^0; I^-_n, \dots, I^-_{-2}, I^-_{-1} >, <F^+_1, F^+_2, \dots, F^+_n; F^0; F^-_n, \dots, F^-_{-2}, F^-_{-1} >)$$

where we have multiple positive/neutral/negative degrees of T, I, and F respectively.

49.12) The **Neutrosophic Numbers** have been introduced by W.B. Vasantha Kandasamy and F. Smarandache [40] in 2003, which are numbers of the form $N = a + bI$, where a, b are real or complex numbers, while "I" is the indeterminacy part of the neutrosophic number N, such that $I^2 = I$ and $\alpha I + \beta I = (\alpha + \beta)I$.

Of course, indeterminacy "I" is different from the imaginary unit $i = \sqrt{-1}$. In general one has $I^n = I$ if $n > 0$, and it is undefined if $n \leq 0$.

49.13) Also, **Neutrosophic Refined Numbers** were introduced (Smarandache [31], 2015) as: $a + b_1I_1 + b_2I_2 + \dots + b_mI_m$, where a, b_1, b_2, \dots, b_m are real or complex numbers, while the I_1, I_2, \dots, I_m are types of sub-indeterminacies, for $m \geq 1$.

49.14) The algebraic structures using neutrosophic numbers gave birth to the **I-Neutrosophic Algebraic Structures** [see for example "neutrosophic groups", "neutrosophic rings", "neutrosophic vector space", "neutrosophic matrices, bimatrices, ..., n-matrices", etc.], introduced by W.B. Vasantha Kandasamy, Ilanthenral K., F. Smarandache [41] et al. since 2003.

Example of Neutrosophic Matrix:
$$\begin{bmatrix} 1 & 2+I & -5 \\ 0 & 1/3 & I \\ -1+4I & 6 & 5I \end{bmatrix}.$$

Example of Neutrosophic Ring: $(\{a+bI, \text{ with } a, b \in \mathbb{R}\}, +, \cdot)$, where of course $(a+bI)+(c+dI) = (a+c)+(b+d)I$, and $(a+bI) \cdot (c+dI) = (ac) + (ad+bc+bd)I$.

49.15) Also, to **Refined I-Neutrosophic Algebraic Structures**, which are structures using sets of refined neutrosophic numbers [41].

49.16) Types of Neutrosophic Graphs (and Trees):

a-c) Indeterminacy “I” led to the definition of the **Neutrosophic Graphs** (graphs which have: either at least one indeterminate edge, or at least one indeterminate vertex, or both some indeterminate edge and some indeterminate vertex), and **Neutrosophic Trees** (trees which have: either at least one indeterminate edge, or at least one indeterminate vertex, or both some indeterminate edge and some indeterminate vertex), which have many applications in social sciences.

Another type of neutrosophic graph is when at least one edge has a neutrosophic (t, i, f) truth-value. As a consequence, the Neutrosophic Cognitive Maps (Vasantha & Smarandache, 2003) and Neutrosophic Relational Maps (Vasantha & Smarandache, 2004) are generalizations of fuzzy cognitive maps and respectively fuzzy relational maps, Neutrosophic Relational Equations (Vasantha & Smarandache, 2004), Neutrosophic Relational Data (Wang, Smarandache, Sunderraman, Rogatko - 2008), etc.

A Neutrosophic Cognitive Map is a neutrosophic directed graph with concepts like policies, events etc. as vertices, and causalities or indeterminates as edges. It represents the causal relationship between concepts.

An edge is said indeterminate if we don’t know if it is any relationship between the vertices it connects, or for a directed graph we don’t know if it is a directly or inversely proportional relationship. We may write for such edge that $(t, i, f) = (0, 1, 0)$.

A vertex is indeterminate if we don’t know what kind of vertex it is since we have incomplete information. We may write for such vertex that $(t, i, f) = (0, 1, 0)$.

Example of Neutrosophic Graph (edges V_1V_3, V_1V_5, V_2V_3 are indeterminate and they are drawn as dotted):

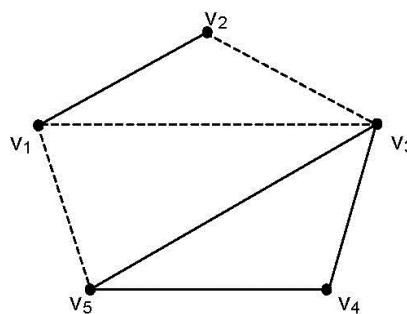

Fig. 2. Neutrosophic Graph { with I (indeterminate) edges }

and its neutrosophic adjacency matrix is:

$$\begin{bmatrix} 0 & 1 & I & 0 & I \\ 1 & 0 & I & 0 & 0 \\ I & I & 0 & 1 & 1 \\ 0 & 0 & 1 & 0 & 1 \\ I & 0 & 1 & 1 & 0 \end{bmatrix}$$

Fig. 3. Neutrosophic Adjacency Matrix of the Neutrosophic Graph

The edges mean: 0 = no connection between vertices, 1 = connection between vertices, I = indeterminate connection (not known if it is, or if it is not).

Such notions are not used in the fuzzy theory.

Example of Neutrosophic Cognitive Map (NCM), which is a generalization of the Fuzzy Cognitive Maps.

Let's have the following vertices:

- C₁ - Child Labor
- C₂ - Political Leaders
- C₃ - Good Teachers
- C₄ - Poverty
- C₅ - Industrialists
- C₆ - Public practicing/encouraging Child Labor
- C₇ - Good Non-Governmental Organizations (NGOs)

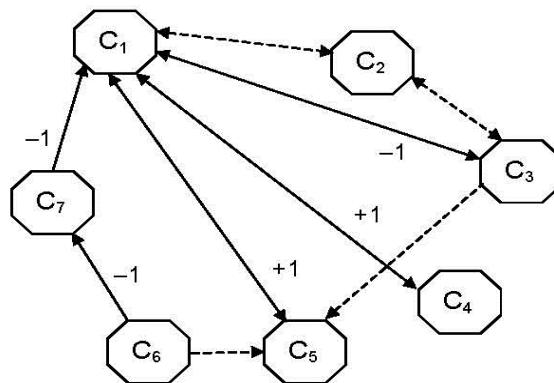

Fig. 4. Neutrosophic Cognitive Map

The corresponding neutrosophic adjacency matrix related to this neutrosophic cognitive map is:

$$\begin{bmatrix} 0 & I & -1 & 1 & 1 & 0 & 0 \\ I & 0 & I & 0 & 0 & 0 & 0 \\ -1 & I & 0 & 0 & I & 0 & 0 \\ 1 & 0 & 0 & 0 & 0 & 0 & 0 \\ 1 & 0 & 0 & 0 & 0 & 0 & 0 \\ 0 & 0 & 0 & 0 & I & 0 & -1 \\ -1 & 0 & 0 & 0 & 0 & 0 & 0 \end{bmatrix}$$

Fig. 4. Neutrosophic Adjacency Matrix of the Neutrosophic Cognitive Map

The edges mean: 0 = no connection between vertices, 1 = directly proportional connection, -1 = inversely proportionally connection, and I = indeterminate connection (not knowing what kind of relationship is between the vertices that the edge connects).

Such **literal indeterminacy** (letter **I**) does not occur in previous set theories, including intuitionistic fuzzy set; they had only *numerical indeterminacy*.

d) Another type of neutrosophic graphs (and trees) [Smarandache, 2015, [41]]:

An edge of a graph, let's say from A to B (i.e. how A influences B), may have a neutrosophic value (t, i, f) ,

where t means the positive influence of A on B,

i means the indeterminate influence of A on B,

and f means the negative influence of A on B.

Then, if we have, let's say: A->B->C such that A->B has the neutrosophic value (t_1, i_1, f_1) and B->C has the neutrosophic value (t_2, i_2, f_2) , then A->C has the neutrosophic value $(t_1, i_1, f_1) \wedge (t_2, i_2, f_2)$, where \wedge is the AND neutrosophic operator.

e) Also, again a different type of graph: we can consider a vertex A as: t% belonging/membership to the graph, i% indeterminate membership to the graph, and f% nonmembership to the graph.

13.f) Any of the previous types of graphs (or trees) put together.

13.g) **Tripolar (and Multipolar) Graph**, which is a graph whose vertexes or edges have the form $(\langle T^+, T^0, T^- \rangle, \langle I^+, I^0, I^- \rangle, \langle F^+, F^0, F^- \rangle)$ and respectively: $(\langle T_j^+, T_j^0, T_j^- \rangle, \langle I_j^+, I_j^0, I_j^- \rangle, \langle F_j^+, F_j^0, F_j^- \rangle)$.

49.17) The **Neutrosophic Probability** (NP), introduced in 1995, was extended and developed as a generalization of the classical and imprecise probabilities {Smarandache, 2013 [11]}. NP of an event \mathcal{E} is the chance that event \mathcal{E} occurs, the chance that event \mathcal{E} doesn't occur, and the chance of indeterminacy (not knowing if the event \mathcal{E} occurs or not).

In classical probability $n_{sup} \leq 1$, while in neutrosophic probability $n_{sup} \leq 3^+$.

In imprecise probability: the probability of an event is a subset T in $[0, 1]$, not a number p in $[0, 1]$, what's left is supposed to be the opposite, subset F (also from the unit interval $[0, 1]$); there is no indeterminate subset I in imprecise probability.

In neutrosophic probability one has, besides randomness, indeterminacy due to construction materials and shapes of the probability elements and space.

In consequence, neutrosophic probability deals with two types of variables: random variables and indeterminacy variables, and two types of processes: stochastic process and respectively indeterminate process.

49.18) And consequently the **Neutrosophic Statistics**, introduced in 1995 and developed in {Smarandache, 2014, [12]}, which is the analysis of the neutrosophic events.

Neutrosophic Statistics means statistical analysis of population or sample that has indeterminate (imprecise, ambiguous, vague, incomplete, unknown) data. For example, the population or sample size might not be exactly determinate because of some individuals that partially belong to the population or sample, and partially they do not belong, or individuals whose appurtenance is completely unknown. Also, there are population or sample individuals whose data could be indeterminate. It is possible to define the neutrosophic statistics in many ways, because there are various types of indeterminacies, depending on the problem to solve.

Neutrosophic statistics deals with neutrosophic numbers, neutrosophic probability distribution, neutrosophic estimation, neutrosophic regression.

The function that models the neutrosophic probability of a random variable x is called *neutrosophic distribution*: $NP(x) = (T(x), I(x), F(x))$, where $T(x)$ represents the probability that value x occurs, $F(x)$ represents the probability that value x does not occur, and $I(x)$ represents the indeterminate / unknown probability of value x .

49.19) Also, **Neutrosophic Measure** and **Neutrosophic Integral** were introduced {Smarandache, 2013, [11]}.

49.20) **Neutrosophy** {Smarandache, 1995, [1, 2, 3, 4, 5, 7]} opened a new field in philosophy.

Neutrosophy is a new branch of philosophy that studies the origin, nature, and scope of neutralities, as well as their interactions with different ideational spectra.

This theory considers every notion or idea $\langle A \rangle$ together with its opposite or negation $\langle \text{Anti-}A \rangle$ and the spectrum of "neutralities" $\langle \text{Neut-}A \rangle$ (i.e. notions or ideas located between the two extremes, supporting neither $\langle A \rangle$ nor $\langle \text{Anti-}A \rangle$). The $\langle \text{Neut-}A \rangle$ and $\langle \text{Anti-}A \rangle$ ideas together are referred to as $\langle \text{Non-}A \rangle$.

According to this theory every idea $\langle A \rangle$ tends to be neutralized and balanced by $\langle \text{Anti-}A \rangle$ and $\langle \text{Non-}A \rangle$ ideas - as a state of equilibrium.

In a classical way $\langle A \rangle$, $\langle \text{Neut-}A \rangle$, $\langle \text{Anti-}A \rangle$ are disjoint two by two.

But, since in many cases the borders between notions are vague, imprecise, Sorites, it is possible that $\langle A \rangle$, $\langle \text{Neut-A} \rangle$, $\langle \text{Anti-A} \rangle$ (and $\langle \text{Non-A} \rangle$ of course) have common parts two by two as well.

Neutrosophy is the base of neutrosophic logic, neutrosophic set, neutrosophic probability and statistics used in engineering applications (especially for software and information fusion), medicine, military, cybernetics, physics.

We have extended dialectics (based on the opposites $\langle A \rangle$ and $\langle \text{antiA} \rangle$) to neutrosophy (based on $\langle A \rangle$, $\langle \text{antiA} \rangle$ and $\langle \text{neutA} \rangle$).

49.21) In consequence, we extended the thesis-antithesis-synthesis to thesis-antithesis-neutrothesis-neutrosynthesis {Smarandache, 2015 [41]}.

49.22) Neutrosophy extended the Law of Included Middle to the **Law of Included Multiple-Middle** {Smarandache, 2014 [10]} in accordance with the n-valued refined neutrosophic logic.

49.23) Smarandache (2015 [41]) introduced the **Neutrosophic Axiomatic System and Neutrosophic Deducibility**.

49.24) Then he introduced the **(t, i, f)-Neutrosophic Structure** (2015 [41]), which is a structure whose space, or at least one of its axioms (laws), has some indeterminacy of the form $(t, i, f) \neq (1, 0, 0)$.

Also, we defined the combined *(t, i, f)-I-Neutrosophic Algebraic Structures*, i.e. algebraic structures based on neutrosophic numbers of the form $a + bI$, but also having some indeterminacy [of the form $(t, i, f) \neq (1, 0, 0)$] related to the structure space (i.e. elements which only partially belong to the space, or elements we know nothing if they belong to the space or not) or indeterminacy [of the form $(t, i, f) \neq (1, 0, 0)$] related to at least one axiom (or law) acting on the structure space).

Even more, we generalized them to *Refined (t, i, f)- Refined I-Neutrosophic Algebraic Structures*, or *(t_j, i_k, f_l)-i_s-Neutrosophic Algebraic Structures*; where t_j means that t has been refined to j subcomponents t_1, t_2, \dots, t_j ; similarly for i_k, f_l and respectively i_s .

49.25) Smarandache and Ali [2014-2016] introduced the *Neutrosophic Triplet Structures* [42, 43, 44].

A **Neutrosophic Triplet**, is a triplet of the form:

$$\langle a, \text{neut}(a), \text{anti}(a) \rangle,$$

where $\text{neut}(a)$ is the neutral of a , i.e. an element (different from the identity element of the operation $*$) such that $a * \text{neut}(a) = \text{neut}(a) * a = a$,

while $\text{anti}(a)$ is the opposite of a , i.e. an element such that $a * \text{anti}(a) = \text{anti}(a) * a = \text{neut}(a)$.

Neutrosophy means not only indeterminacy, but also neutral (i.e. neither true nor false).

For example we can have neutrosophic triplet semigroups, neutrosophic triplet loops, etc.

Further on Smaradnache extended the neutrosophic triplet $\langle a, \text{neut}(a), \text{anti}(a) \rangle$ to a **m-valued refined neutrosophic triplet**,

in a similar way as it was done for $T_1, T_2, \dots; I_1, I_2, \dots; F_1, F_2, \dots$ (i.e. the refinement of neutrosophic components).

It will work in some cases, depending on the composition law $*$. It depends on each $*$ how many neutrals and anti's there is for each element "a".

We may have an m-tuple with respect to the element "a" in the following way:

$(a; neut_1(a), neut_2(a), \dots, neut_p(a); anti_1(a), anti_2(a), \dots, anti_p(a)),$

where $m = 1+2p,$

such that:

- all $neut_1(a), neut_2(a), \dots, neut_p(a)$ are distinct two by two, and each one is different from the unitary element with respect to the composition law $*$;

- also:

$$a * neut_1(a) = neut_1(a) * a = a$$

$$a * neut_2(a) = neut_2(a) * a = a$$

.....

$$a * neut_p(a) = neut_p(a) * a = a;$$

- and

$$a * anti_1(a) = anti_1(a) * a = neut_1(a)$$

$$a * anti_2(a) = anti_2(a) * a = neut_2(a)$$

.....

$$a * anti_p(a) = anti_p(a) * a = neut_p(a);$$

- where all $anti_1(a), anti_2(a), \dots, anti_p(a)$ are distinct two by two, and in case when there are duplicates, the duplicates are discarded.

49.26) As latest minute development, the crisp, fuzzy, intuitionistic fuzzy, inconsistent intuitionistic fuzzy (picture fuzzy, ternary fuzzy), and neutrosophic sets were extended by Smarandache [45] in 2017 to **plithogenic set**, which is:

A set P whose elements are characterized by many attributes' values. An attribute value v has a corresponding (fuzzy, intuitionistic fuzzy, picture fuzzy, or neutrosophic) degree of appurtenance $d(x,v)$ of the element x , to the set P , with respect to some given criteria. In order to obtain a better accuracy for the *plithogenic aggregation operators* in the plithogenic set, and for a more exact inclusion (partial order), a (fuzzy, intuitionistic fuzzy, picture fuzzy, or neutrosophic) *contradiction (dissimilarity) degree* is defined between each attribute value and the dominant (most important) attribute value. The plithogenic intersection and union are *linear combinations of the fuzzy operators t-norm and t-conorm*, while the plithogenic complement (negation), inclusion (inequality), equality (equivalence) are influenced by the attribute values contradiction (dissimilarity) degrees.

35. Conclusion

In this paper we proved that neutrosophic set is a generalization of intuitionistic fuzzy set and inconsistent intuitionistic fuzzy set (picture fuzzy set, ternary fuzzy set).

By transforming (restraining) the neutrosophic components into intuitionistic fuzzy components, as Atanassov and Vassiliev proposed, the *independence of the components is lost* and the *indeterminacy is ignored by the intuitionistic fuzzy aggregation operators*. Also, the result after applying the neutrosophic operators is different from the result obtained after applying the intuitionistic fuzzy operators (with respect to the same problem to solve).

We presented many distinctions between neutrosophic set and intuitionistic fuzzy set, and we showed that neutrosophic set is more general and more flexible than previous set theories. Neutrosophy's applications in various fields such neutrosophic probability, neutrosophic statistics, neutrosophic algebraic structures and so on were also listed {see also [46]}.

Neutrosophic Set (NS) is also a generalization of Inconsistent Intuitionistic Fuzzy Set (IIFS) { which is equivalent to the Picture Fuzzy Set (PFS) and Ternary Fuzzy Set (TFS) }, Pythagorean Fuzzy Set (PyFS) {Atanassov's Intuitionistic Fuzzy Set of second type}, Spherical Fuzzy Set (SFS), n-HyperSpherical Fuzzy Set (n-HSFS), and q-Rung Orthopair Fuzzy Set (q-ROFS). And Refined Neutrosophic Set (RNS) is an extension of Neutrosophic Set. And all these sets are more general than Intuitionistic Fuzzy Set.

Neutrosophy is a particular case of Refined Neutrosophy, and consequently Neutrosophication is a particular case of Refined Neutrosophication. Also, Regret Theory, Grey System Theory, and Three-Ways Decision are particular cases of Neutrosophication and of Neutrosophic Probability. We have extended the Three-Ways Decision to n-Ways Decision, which is a particular case of Refined Neutrosophy.

Acknowledgement

The author deeply thanks Dr. Said Broumi for revealing Atanassov and Vassiliev's paper [6] and for his comments.

References

- [1] Florentin Smarandache, *Definition of Neutrosophic Logic – A Generalization of the Intuitionistic Fuzzy Logic*, Proceedings of the Third Conference of the European Society for Fuzzy Logic and Technology, EUSFLAT 2003, September 10-12, 2003, Zittau, Germany; University of Applied Sciences at Zittau/Goerlitz, 141-146.
- [2-3-4] Florentin Smarandache, *Neutrosophic Set, A Generalization of the Intuitionistic Fuzzy Set*
 a. in International Journal of Pure and Applied Mathematics, Vol. 24, No. 3, 287-297, 2005;
 b. also in Proceedings of 2006 IEEE International Conference on Granular Computing, edited by Yan-Qing Zhang and Tsau Young Lin, Georgia State University, Atlanta, pp. 38-42, 2006;
 c. second version in Journal of Defense Resources Management, Brasov, Romania, No. 1, 107-116, 2010.
- [5] Florentin Smarandache, *A Geometric Interpretation of the Neutrosophic Set – A Generalization of the Intuitionistic Fuzzy Set*, 2011 IEEE International Conference on Granular Computing, edited by Tzung-Pei Hong, Yasuo Kudo, Mineichi Kudo, Tsau-Young Lin, Been-Chian Chien, Shyue-Liang Wang, Masahiro Inuiguchi, GuiLong Liu, IEEE Computer Society, National University of Kaohsiung, Taiwan, 602-606, 8-10 November 2011, <http://fs.unm.edu/IFS-generalized.pdf>

- [6] Krassimir Atanassov and Peter Vassilev, *Intuitionistic fuzzy sets and other fuzzy sets extensions representable by them*, Journal of Intelligent & Fuzzy Systems, xx (20xx) x–xx, 2019, IOS Press, DOI: 10.3233/JIFS-179426 (under press).
- [7] Florentin Smarandache, *Neutrosophy, A New Branch of Philosophy, Multiple-Valued Logic / An International Journal*, Vol. 8, No. 3, 297-384, 2002. This whole issue of this journal is dedicated to Neutrosophy and Neutrosophic Logic, <http://fs.unm.edu/Neutrosophy-A-New-Branch-of-Philosophy.pdf>
- [8] Florentin Smarandache, *Neutrosophic Overset, Neutrosophic Underset, and Neutrosophic Offset. Similarly for Neutrosophic Over-/Under-/Off- Logic, Probability, and Statistics*, 168 p., Pons Editions, Bruxelles, Belgique, 2016; <https://arxiv.org/ftp/arxiv/papers/1607/1607.00249.pdf>
- [9] Florentin Smarandache, *n-Valued Refined Neutrosophic Logic and Its Applications in Physics*, Progress in Physics, 143-146, Vol. 4, 2013; <https://arxiv.org/ftp/arxiv/papers/1407/1407.1041.pdf>
- [10] Florentin Smarandache, *Law of Included Multiple-Middle & Principle of Dynamic Neutrosophic Opposition*, by Florentin Smarandache, EuropaNova & Educational, Brussels-Columbus (Belgium-USA), 136 p., 2014; <http://fs.unm.edu/LawIncludedMultiple-Middle.pdf>
- [11] Florentin Smarandache, *Introduction to Neutrosophic Measure, Neutrosophic Integral and Neutrosophic Probability*, Sitech, 2013, <http://fs.gallup.unm.edu/NeutrosophicMeasureIntegralProbability.pdf>
- [12] Florentin Smarandache, *Introduction to Neutrosophic Statistics*, Sitech, 2014, <http://fs.gallup.unm.edu/NeutrosophicStatistics.pdf>.
- [13] Florentin Smarandache, *Neutrosophy. Neutrosophic Probability, Set, and Logic*. ProQuest Information and Learning, Ann Arbor, Michigan, USA, 105 p., 1998, 2000, 2002, 2005, 2006.
- [14] Florentin Smarandache, *A Unifying Field in Logics: Neutrosophic Logic*, Multiple-Valued Logic / An International Journal, Vol. 8, No. 3, 385-438, 2002, <http://fs.unm.edu/eBook-Neutrosophics6.pdf>
- [15] Florentin Smarandache, editor, *Proceedings of the First International Conference on Neutrosophy, Neutrosophic Logic, Neutrosophic Set, Neutrosophic Probability and Statistics*, University of New Mexico, Gallup Campus, Xiquan, Phoenix, 147 p., 2002, <http://fs.unm.edu/NeutrosophicProceedings.pdf>.
- [16] Krassimir Atanassov, *Intuitionistic fuzzy sets*, Fuzzy Sets and Systems, 20: 87-96, 1986.
- [17] Krassimir T. Atanassov, *Intuitionistic Fuzzy Sets*, Physica-Verlag, Heidelberg, N.Y., 1999.
- [18] Krassimir Atanassov, *Intuitionistic fuzzy sets*, VII ITKR's Session, Sofia, June 1983 (Deposited in Central Sci. - Techn. Library of Bulg. Acad. of Sci., 1697/84) (in Bulgarian); Reprinted: Int J Bioautomation **20**(S1) (2016), pp. S1-S6.

- [19] C. Hinde and R. Patching, *Inconsistent intuitionistic fuzzy sets. Developments in Fuzzy Sets, Intuitionistic Fuzzy Sets, Generalized Nets and Related Topics 1* (2008), 133–153.
- [20] B.C. Cuong and V. Kreinovich, *Picture fuzzy sets - a new concept for computational intelligence problems*, Proceedings of the Third World Congress on Information and Communication Technologies WICT'2013, Hanoi, Vietnam, December 15-18, 2013, pp. 1-6.
- [21] Chao Wang, Minghu Ha and Xiaqowei Liu, *A mathematical model of ternary fuzzy set for voting*, Journal of Intelligent & Fuzzy Systems, 29 (2015), 2381-2386.
- [22] Florentin Smarandache, *Degree of Dependence and Independence of the (Sub)Components of Fuzzy Set and Neutrosophic Set*, Neutrosophic Sets and Systems, vol. 11, 2016, pp. 95-97, doi.org/10.5281/zenodo.571359, <http://fs.unm.edu/NSS/DegreeOfDependenceAndIndependence.pdf>
- [23] Princy R, Mohana K, *Spherical Bipolar Fuzzy Sets and its Application in Multi Criteria Decision Making Problem*, Journal of New Theory, 2019 (under press).
- [24] R. R. Yager, *Pythagorean fuzzy subsets*, Joint IFSA World Congress and NAFIPS Annual Meeting (IFSA/NAFIPS), Edmonton, AB, Canada, pp. 57-61.
- [25] Fatma Kutlu Gündoğdu, Cengiz Kahraman, *A novel spherical fuzzy QFD method and its application to the linear delta robot technology development*, Engineering Applications of Artificial Intelligence, 87 (2020) 103348.
- [26] Abhishek Guleria, Rakesh Kumar Bajaj, *T-Spherical Fuzzy Graphs: Operations and Applications in Various Selection Processes*, Arabian Journal for Science and Engineering, <https://doi.org/10.1007/s13369-019-04107-y>
- [27] Florentin Smarandache, *Neutrosophic Perspectives: Triplets, Duplets, Multisets, Hybrid Operators, Modal Logic, Hedge Algebras. And Applications*, Second extended and improved edition, Pons Publishing House Brussels, 2017, <http://fs.unm.edu/NeutrosophicPerspectives-ed2.pdf>
- [28] Ronald R. Yager, *Generalized orthopair fuzzy sets*, IEEE Trans. Fuzzy Syst., vol. 25, no. 5, pp. 1222-1230, Oct. 2017.
- [29] H. Bleichrodt, A. Cillo, E. Diecidue, *A quantitative measurement of regret theory*, Manage. Sci. 56(1) (2010) 161-175.
- [30] J. L. Deng, *Introduction to Grey System Theory*, The Journal of Grey System, 1(1): 1-24, 1989.
- [31] Y. Yao, *Three-way decision: an interpretation of rules in rough set theory*, in Proceeding of 4th International Conference on Rough Sets and Knowledge Technology, LNAI, Vol. 5589, Springer Berlin Heidelberg, 2009, pp. 642–649.

[32] Florentin Smarandache, *Three-Ways Decision is a particular case of Neutrosophication*, in volume *Nidus Idearum. Scilogs, VII: superluminal physics, vol. vii*, Pons Ed., Brussels, pp. 97 - 102, 2019.

[33] Prem Kumar Singh, *Three-way fuzzy concept lattice representation using neutrosophic set*, International Journal of Machine Learning and Cybernetics, 2017, Vol 8, Issue 1, pp. 69-79.

[34] Prem Kumar Singh, *Three-way n -valued neutrosophic concept lattice at different granulation*, International Journal of Machine Learning and Cybernetics, November 2018, Vol 9, Issue 11, pp. 1839-1855.

[35] Prem Kumar Singh, *Complex neutrosophic concept lattice and its applications to Air quality analysis*, Chaos, Solitons and Fractals, Elsevier, 2018, Vol 109, pp. 206-213.

[36] Prem Kumar Singh, *Interval-valued neutrosophic graph representation of concept lattice and its (α, β, γ) -decomposition*, Arabian Journal for Science and Engineering, Springer, 2018, Vol. 43, Issue 2, pp. 723-740.

[37] Florentin Smarandache, *Extension of Three-Ways Decision to n -Ways Decision*, in NIDUS IDEARUM. scilogs, VII: superluminal physics Brussels, 2019, <http://fs.unm.edu/NidusIdearum7.pdf>

[38] Jean Dezert, *Open Questions to Neutrosophic Inferences*, Multiple-Valued Logic / An International Journal, Vol. 8, No. 3, 439-472, June 2002.

[39] Didier Dubois, S. Gottwald, P. Hajek, Henry Prade, *Terminological difficulties in fuzzy set theory – The case of intuitionistic fuzzy sets*, Fuzzy Sets and Systems, 156 (2005), 585-491.

[40] W. B. Vasantha Kandasamy, Florentin Smarandache, *Fuzzy Cognitive Maps and Neutrosophic Cognitive Maps*, ProQuest Information & Learning, Ann Arbor, Michigan, USA, 2003.

[41] Florentin Smarandache, *Symbolic Neutrosophic Theory*, Europa Nova, Bruxelles, 194 p., 2015; <https://arxiv.org/ftp/arxiv/papers/1512/1512.00047.pdf>

[42] Florentin Smarandache, Mumtaz Ali, *The Neutrosophic Triplet Group and its Application to Physics*, presented by F. S. to Universidad Nacional de Quilmes, Department of Science and Technology, Bernal, Buenos Aires, Argentina, 02 June 2014.

[43] Florentin Smarandache and Mumtaz Ali, *Neutrosophic Triplet Group*, Neural Computing and Applications, Springer, 1-7, 2016, DOI: 10.1007/s00521-016-2535-x, <http://fs.unm.edu/NeutrosophicTriplets.htm>

[44] F. Smarandache, M. Ali, *Neutrosophic triplet as extension of matter plasma, unmatter plasma, and antimatter plasma*, 69th annual gaseous electronics conference, Bochum, Germany, Veranstaltungszentrum & Audimax, Ruhr-Universität, 10–14 Oct. 2016, <http://meetings.aps.org/Meeting/GEC16/Session/HT6.111>

[45] Florentin Smarandache, *Plithogeny, Plithogenic Set, Logic, Probability, and Statistics*, Infinite Study Publ. Hse., GoogleLLC, Mountain View, California, USA, 2017,
<https://arxiv.org/ftp/arxiv/papers/1808/1808.03948.pdf> Harvard SAO/NASA ADS:
http://adsabs.harvard.edu/cgi-bin/bib_query?arXiv:1808.03948

[46] Florentin Smarandache, *Neutrosophic Set as Generalization of Intuitionistic Fuzzy Set, Picture Fuzzy Set and Spherical Fuzzy Set, and its Physical Applications*, 2019 Joint Fall Meeting of the Texas Sections of American Physical Society (APS), AAPT and Zone 13 of the SPS, Friday–Saturday, October 25–26, 2019; Lubbock, Texas, USA,
<http://meetings.aps.org/Meeting/TSF19/scheduling?ukey=1480464-TSF19-otUQvu>

[This version is slightly updated with respect to the previously published versions.]

Aplicación de la teoría neutrosófica para el tratamiento de la incertidumbre en la gestión del riesgo en la cadena de suministro

Application of the Neutrosophical Theory to Deal with Uncertainty in Supply Chain Risk Management

Rafael Rojas-Gualdrón, Florentín Smarandache, Carlos Díaz-Bohorquez

Rafael Rojas-Gualdrón, Florentín Smarandache, Carlos Díaz-Bohorquez (2019). Aplicación de la teoría neutrosófica para el tratamiento de la incertidumbre en la gestión del riesgo en la cadena de suministro. Application of the Neutrosophical Theory to Deal with Uncertainty in Supply Chain Risk Management. *Aglala* 10(2), 19

Resumen

Debido a la creciente complejidad e interrelación de las cadenas de suministro modernas, la probabilidad de ocurrencia e impacto esperado de un riesgo se han vuelto difíciles o incluso imposibles de predecir, llevando a los investigadores a buscar minimizar el impacto que genera la incertidumbre en la gestión del riesgo en la cadena de suministro, la cual debido a su complejidad aún no presenta una solución absoluta y se encuentra abierta a nuevos aportes. El presente artículo se propone realizar una revisión de literatura con el objetivo de evaluar la aplicación de la teoría neutrosófica en el tratamiento de la incertidumbre enfocada en la gestión del riesgo en la cadena de suministro valiéndose para esto de una conceptualización sobre el riesgo, la incertidumbre, la cadena de suministro y la teoría neutrosófica, y buscando establecer una relación entre ellas al ilustrar como la incertidumbre del mundo real hace que los riesgos a los que se ve expuesta una cadena de suministro no puedan ser cuantificados por medio de la matemática convencional, pero si en el dominio de la neutrosofía. Se presentan además algunos artículos con aplicaciones exitosas en la toma de decisiones bajo algún grado de incertidumbre para finalmente llegar a uno en el cual convergen estos

conceptos, llegando a la conclusión de que por medio de esta nueva teoría es posible cuantificar los riesgos en función de la opinión cualitativa de expertos para ser incluida en modelos cuantitativos de optimización en la gestión de riesgos de la cadena de suministro.

Palabras clave: Gestión de la Cadena de Suministro, Gestión del Riesgo, Evaluación del Riesgo, Cuantificación de la Incertidumbre, Teoría Neutrosófica.

Abstract

Due to the increasing complexity and interrelation of modern supply chains, the probability of occurrence and expected impact of a risk has become difficult or even impossible to predict, leading researchers to seek to minimize the impact generated by uncertainty in supply chain risk management, which due to its complexity does not yet present an absolute solution and is open to new contributions. This article proposes to review the literature with the objective of evaluating the application of the neutrosophical theory in the treatment of uncertainty focused on supply chain risk management, using a conceptualization of risk, uncertainty, supply chain and the neutrosophical theory, and seeking to establish a relationship between them by illustrating how the uncertainty of the real world means that the risks to which a supply chain is exposed cannot be quantified by means of conventional mathematics, but in the domain of neutrosophy. There are also some articles with successful applications in decision-making under some degree of uncertainty to finally reach one in which these concepts converge, reaching the conclusion that through this new theory it is possible to quantify the risks based on the qualitative opinion of experts to be included in quantitative models of optimization in supply chain risk management.

Keywords: Supply Chain Management, Risk Management, Risk Assessment, Uncertainty Quantification, Neutrosophic Theories.

Introducción

Desde el año 1982 cuando Keith Oliver, un consultor en Booz Allen Hamilton, introdujo al dominio público el concepto de cadena de suministro (Oliver & Webber, 1982) en una entrevista para el Financial Times, el término comenzó a afianzarse e incluirse en el

léxico de los negocios para luego convertirse en tema de una gran cantidad de publicaciones y popularizarse rápidamente como un término regular en los nombres de los puestos de algunos funcionarios.

Por otro lado, los conceptos de riesgo y evaluación del riesgo tienen una larga historia. Hace ya más de 2400 años, los griegos ofrecían sus capacidades para evaluar riesgos antes de tomar decisiones (Bernstein, 1996). No obstante, la evaluación y la gestión de riesgos como un área específica de conocimiento es relativamente joven, con no más 40 años de existencia. Desde entonces ha tenido un desarrollo considerable, apareciendo nuevos y cada vez más sofisticados enfoques y métodos analíticos que han venido siendo aplicados a diferentes campos (Aven, 2016).

La contratación de servicios por medio de terceros, el manejo de menores niveles de inventario, algunas políticas como el Just-In-Time y ciclos de vida de los productos cada vez más cortos han incrementado considerablemente los riesgos a los que se ven expuestas las cadenas de suministro (SCR) (Colicchia & Strozzi, 2012; Trkman, Oliveira, & McCormack, 2016). La fuente de dichos riesgos puede deberse a desastres naturales o simplemente a fallas humanas, pero en ambos casos pueden generar un impacto negativo en las organizaciones bien sea a nivel financiero, operacional, o cualquier otro que lleve a interrumpir el normal funcionamiento de los negocios (Craighead, Blackhurst, Rungtusanatham, & Handfield, 2007; Rajesh & Ravi, 2015). Esta realidad ha hecho que en los últimos años, la gestión del riesgo en la cadena de suministro (SCRM) se haya venido convirtiendo en un tema de interés (Yiyi, 2018), debido a que esta gestión se encarga de desarrollar estrategias para la identificación, evaluación, tratamiento y monitoreo de los riesgos que afectan las cadenas de suministro (Ho, Zheng, Yildiz, & Talluri, 2015; Neiger, Rotaru, & Churilov, 2009; Tummala & Schoenherr, 2011).

La aparición de estos nuevos riesgos se convierte en un reto para las empresas que deben aprender a gestionar los cambios en su entorno provocados bien sea por innovaciones tecnológicas (Henderson & Clark, 1990), cambios en políticas y regulaciones (K. Smith & Grimm, 1987) o por crisis que se presentan en el mercado (Haveman, 1992). Algunas de estas organizaciones se han ido adaptando, mientras muchas otras aun sufren el efecto de fuertes fuerzas inerciales provocadas por los cambios mencionados anteriormente. Como se ha sugerido, no son estos cambios en el entorno en sí mismos los que los hacen difíciles de

manejar, sino la incapacidad asociada de los gerentes para evaluar lo que significan estos cambios (Knight, 1965). La elaboración de estrategias en este entorno cambiante se convierte en un desafío para que los gerentes relacionen las opciones estratégicas con su comprensión del entorno (Bower, 1970), en el cual no se puede comprender la situación que está en juego y la información del entorno como un conjunto de señales fácilmente reconocibles. Por lo tanto la realización de estrategias bajo incertidumbre puede ser comprendida como un balance entre el marco que debería guiar la comprensión de un entorno ambiguo y las opciones sobre cómo responder a él (Kaplan, 2008). Este grado de desconocimiento acerca del comportamiento a futuro del entorno, el cual implica una previsibilidad imperfecta de los hechos, es decir, un evento en el que no se conoce la probabilidad de que ocurra determinada situación es lo que conocemos como incertidumbre.

El tratamiento de la incertidumbre, principalmente en la toma de decisiones, ha sido abordado desde diferentes perspectivas debido a que no existe un modelo que sea válido para todos los casos. Existen modelos con enfoques probabilísticos como las redes bayesianas, modelos con enfoques posibilísticos que utilizan, por ejemplo, la lógica difusa, entre otros modelos. En los últimos años, se ha generado una tendencia hacia la investigación en el tratamiento de la incertidumbre por medio de la teoría neutrosófica (Smarandache, 1995), la cual estudia el origen, naturaleza y alcance de las neutralidades. La lógica y los conjuntos neutrosóficos por su parte, constituyen una generalización de la lógica y los conjuntos difusos (L. Zadeh, 1965), y especialmente de la lógica intuicionista (Atanassov, 1999), con múltiples aplicaciones en el campo de la toma de decisiones, segmentación de imágenes y aprendizaje automático, por citar solo algunos ejemplos (Smarandache & Leyva-Vasquez, 2018).

Gestión del riesgo en la cadena de suministro

Si bien numerosas discusiones y estudios han considerado la definición de gestión de riesgo en la cadena de suministro (SCRM), todavía no hay consenso (Diehl & Spinler, 2013; Sodhi, Son, & Tang, 2012). Sin embargo, podemos definir SCRM como la intersección entre la gestión de la cadena de suministro y la gestión del riesgo, como se puede observar en la figura 1, por lo cual procedemos a definir cada uno de estos términos.



Figura 1. Descripción Conceptual de SCRM (Paulsson, 2004)

Gestión de la cadena de suministro

La definición adoptada oficialmente por el Consejo de Profesionales de Gestión de la Cadena de Suministro (Council of Supply Chain Management Professionals, 2019) nos indica que esta abarca la planificación y la gestión de toda actividad relacionada con el aprovisionamiento y adquisición, la conversión y toda actividad logística, incluyendo las actividades de coordinación y colaboración con los socios del canal, entre ellos proveedores, intermediarios, prestadores de servicios externos y clientes. En resumen, la gestión de la cadena de suministro integra la gestión de la oferta y la demanda dentro y entre las empresas.

Gestión del riesgo

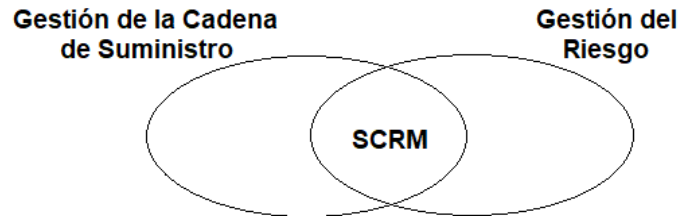
La gestión del riesgo es dividida por Ritchie y Brindley (2007) en tres dimensiones:

1. Probabilidad de ocurrencia.
2. Impacto esperado.
3. Detección de causas.

$$\text{Riesgo} = \text{Probabilidad de ocurrencia} \times \text{Impacto esperado} \times \text{Detección}$$

Las empresas suelen clasificar el riesgo en una cantidad reducida de niveles debido a que la probabilidad de ocurrencia y el impacto esperado no se pueden estimar de una forma exacta y precisa. Para ello generalmente se valen de matrices de riesgo e impacto como la que se observa en la figura 2, las cuales aumentan la visibilidad de los riesgos y facilitan la toma de decisiones (Kester, 2013), valiéndose de un análisis de riesgos cualitativos y cuantitativos presentes en la cadena de suministro, considerando las probabilidades de ocurrencia e impacto esperado como valores subjetivos y objetivos respectivamente (Norman & Lindroth, 2004). Estos dos elementos son críticos para determinar la necesidad de una acción para combatir un riesgo en la cadena de suministro. Comúnmente se consideran tres niveles de riesgo: el primero, presenta una condición segura en la cual tanto la probabilidad

de ocurrencia como el impacto esperado de un riesgo son bajos, se conoce como riesgo de bajo nivel y no requiere ningún esfuerzo para su gestión; el segundo, en el cual existen probabilidades e impactos considerables, conocido como riesgo de nivel medio y amerita un seguimiento; el tercer nivel de dificultad, en el cual la probabilidad de ocurrencia o el impacto esperado o ambos son moderados o altos y requiere un manejo cuidadoso (Khojasteh, 2018).



Figura 2. Matriz de riesgo e impacto

Definición de gestión de riesgo en la cadena de suministro (SCRM)

SCRM puede tener diversas definiciones. Por ejemplo, Tang (2006), describió SCRM como “la gestión del riesgo de la cadena de suministro a través de la coordinación o la colaboración entre los socios de la cadena de suministro para garantizar la rentabilidad y la continuidad”. Thun & Hoenig (2011) informaron que una característica específica de SCRM, a diferencia de la gestión de riesgos tradicional, es que “SCRM se caracteriza por una orientación hacia la colaboración entre empresas con el objetivo de identificar y reducir los riesgos no solo a nivel de la empresa, sino enfocado hacia toda la cadena de suministro”. Más adelante, Ho et al. (2015) definen SCRM como la implementación de estrategias para gestionar tanto los riesgos diarios como los riesgos excepcionales a lo largo de la cadena de suministros basados en la evaluación continua de riesgos con el objetivo de reducir la vulnerabilidad y garantizar la continuidad.

Clasificación de los riesgos que afectan la cadena de suministro

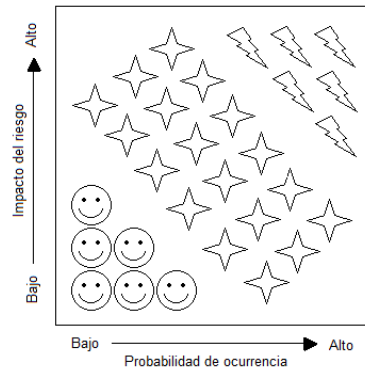
Se puede clasificar los riesgos que afectan la cadena de suministro en tres componentes principales:

1. *Riesgos de suministro*: son aquellos riesgos que ocurren del lado de los proveedores y que pueden entorpecer el normal funcionamiento de la cadena al presentar retrasos e interrupciones en suministro del material de entrada.
2. *Riesgo de demanda*: son aquellos riesgos que ocurren del lado de los clientes y que pueden generar variaciones en la demanda.
3. *Riesgo de proceso*: son aquellos riesgos que ocurren en el propio proceso de las organizaciones y que pueden ocurrir durante la fabricación o el almacenamiento.

Cuantificación de los riesgos

En situaciones reales, nos enfrentamos a condiciones inciertas debido a la falta de datos y la falta de conocimiento sobre la mayoría de los parámetros (Mohajeri & Fallah, 2016). También se considera la incertidumbre en términos de probabilidad y posibilidad. En casos probabilísticos, la función de distribución se puede encontrar a través de experimentos, donde se utilizan enfoques de programación estocástica para hacer frente a la aleatoriedad de los parámetros (Liu & Iwamura, 1998).

Debido a la falta de información y de conocimiento sobre la mayoría de los parámetros que enfrentamos en situaciones reales debemos considerar la incertidumbre en términos de probabilidad y posibilidad (Mohajeri & Fallah, 2016). Para los fenómenos que podemos describir de forma probabilística la función de distribución se puede calcular a través de experimentos utilizando un enfoque de programación estocástica para enfrentar la naturaleza aleatoria de los parámetros (Liu & Iwamura, 1998). Para aquellos casos que no pueden ser descritos de esta forma se introduce en 1978 por primera vez la teoría de la posibilidad (L. Zadeh, 1978) como una extensión de la teoría de conjuntos difusos y de la lógica difusa. La teoría de la posibilidad se utiliza para medir parámetros subjetivos relacionados con los argumentos de conjuntos difusos y son de utilidad en casos que involucran información incompleta o parámetros desconocidos (Mohajeri & Fallah, 2016).

Heckman, Hsieh, & Schwartz (2015) exponen que, en un problema de optimización estocástica, para tomar decisiones que restringen el alcance del riesgo, a menudo se requiere cuantificar el riesgo.

En ocasiones, los tomadores de decisiones necesitan cuantificar parámetros imprecisos sujetos a incertidumbre buscando evaluar y comparar diferentes soluciones que

limiten el alcance de los riesgos, valiéndose para esto del uso de la desviación estándar, algunos enfoques de varianza media y el valor condicional de los riesgos intentando describir la interacción de la incertidumbre y el alcance de su daño o beneficio relacionado (Khojasteh, 2018). Al no existir medidas cuantitativas que reflejen la compleja realidad en la que se encuentran las cadenas de suministro se hace necesario medirlas por medio de la probabilidad y la gravedad de los efectos adversos que provocan o al alcance de las pérdidas que producen (Fishburn, 1984; Haimes, Kaplan, & Lambert, 2002; Morgan, Henrion, & Small, 1992).

Cuantificación de la incertidumbre

Podemos definir la cuantificación de la incertidumbre como la fusión de la teoría de la probabilidad y la estadística con el mundo real. Esta junto a la estimación de parámetros son dos tareas cruciales en la práctica de modelado de sistemas (Wang, Wang, Wang, Gao, & Yu, 2017).

Debido a la falta de conocimiento sobre algunos parámetros físicos importantes, la variabilidad aleatoria en las circunstancias de operación o simplemente a la ignorancia absoluta acerca de cual es la forma correcta de realizar un modelo, en los últimos años muchos modelos de ingeniería que venían siendo trabajados de forma determinística han ido incorporando algún elemento de incertidumbre para explicar estos fenómenos (Duell, Grzybowska, Rey, & Waller, 2019; Ramalho, Ekel, Pedrycz, Pereira Junior, & Soares, 2019) con el fin de proporcionar predicciones más precisas sobre el comportamiento de los diferentes sistemas (Sullivan, 2015).

Incetidumbre aleatoria y epistémica

La incertidumbre puede ser dividida en dos componentes: la incertidumbre aleatoria y la incertidumbre epistémica (Celik & Ellingwood, 2010). La incertidumbre aleatoria se refiere a aquella que posee un fenómeno que es inherentemente variable y proviene del latín *alea* que significa dado. Por otro lado, la incertidumbre epistémica hace referencia a la incertidumbre que surge por la falta de conocimiento y proviene del griego *episteme* que significa conocimiento. En un modelo la incertidumbre epistémica se presenta al no conocerse con seguridad si un modelo es correcto o el más indicado lo cual genera dudas significativas de si el modelo se puede considerar estructuralmente correcto. También se

puede presentar si se cree que el modelo es un reflejo fiel de la realidad, pero no hay seguridad sobre los valores que deben tomar los parámetros que contiene.

Si bien en algunas ocasiones no parece muy clara la diferencia entre incertidumbre aleatoria y epistémica podemos utilizar el ejemplo del lanzamiento del dado para ilustrarla. Es conocido por todos que el lanzamiento de un dado es un evento incierto de forma aleatoria que puede modelarse como una probabilidad. Pero ¿y si tenemos en cuenta que no sabemos hasta que punto el dado tiene las medidas perfectas o hasta que punto la velocidad del viento puede influir en el lanzamiento? Es allí donde las dudas que provienen de la falta de conocimiento generan la incertidumbre epistémica. Por otro lado, algunas formas de incertidumbre son más epistémicas que aleatorias, por ejemplo, cuando los físicos no han podido llegar a un consenso sobre la teoría de todo, demuestran una falta de conocimiento sobre las leyes de la física en nuestro universo (Phillips & Elman, 2015) y su correcta descripción matemática. Aun así, sin importar la interpretación que le demos, la teoría de la probabilidad es una poderosa herramienta para describir la incertidumbre (Sullivan, 2015).

Usos comunes de la cuantificación de la incertidumbre

Muchos objetivos comunes de la cuantificación de la incertidumbre se pueden ilustrar en el contexto de un sistema, F , que asigna las entradas x en algún espacio X a las salidas $y = F(x)$ en algún espacio Y . Algunos objetivos comunes de la cuantificación de la incertidumbre incluyen:

- *La confiabilidad o problema de certificación.* Supongamos un conjunto $Y_{fail} \subseteq Y$ como un conjunto de fallos, es decir, el resultado $F(x) \in Y_{fail}$ es indeseable de alguna manera (Cheng, Wang, & Yan, 2016). Dada la información apropiada sobre las entradas x y el proceso de envío F , determine la probabilidad de falla,

$$P_{\mu}[F(x) \in Y_{fail}]$$

Además, en el caso de una falla, ¿cuán grande será la desviación del desempeño aceptable y cuáles son las consecuencias?

- *El problema de predicción* (Zuber, Cabral, McFadyen, Mauger, & Mathews, 2018). Dualmente al problema de confiabilidad, dada una probabilidad máxima aceptable de error $\epsilon > 0$, encuentre un conjunto $Y_{\epsilon} \subseteq Y$ tal que

$$P_{\mu}[F(X) \in Y_{\epsilon}] \geq 1 - \epsilon$$

es decir, la predicción $F(x) \in Y_\varepsilon$ está equivocada con la probabilidad como máximo ε .

- *Un problema inverso, como la estimación del estado a menudo para una cantidad que está cambiando en el tiempo o la identificación de parámetros* (Parlitz, Schumann-Bischoff, & Luther, 2014) generalmente para una cantidad que no está cambiando, o es un parámetro del modelo no físico. Dado el conjunto Y de observaciones de salida que puede estar corrompida o no ser confiable de alguna manera, ¿será posible determinar las entradas correspondientes X de manera que $F(X) = Y$? ¿En qué sentido son algunas estimaciones para X más o menos confiables que otras?

- *La reducción del modelo o el problema de calibración del modelo* (Kurmann, 2005). Formular otra función F_h de tal manera que $F_h \approx F$ en un sentido apropiado. La cuantificación de la precisión de la aproximación puede ser en sí misma un problema de certificación o predicción.

Un problema de cuantificación de la incertidumbre puede convertirse fácilmente en varios problemas acoplados. Los problemas típicos que se deben enfrentar al abordar estos problemas incluyen la alta dimensión de los espacios de parámetros asociados con problemas prácticos (Hidalgo, Manzur, Olavarrieta, & Farías, 2007); la aproximación de integrales (valores esperados) por cuadratura numérica; el costo de evaluar funciones que a menudo corresponden a costosas simulaciones por computadora o experimentos físicos; y la incertidumbre epistémica (Samaniego, 2010) no despreciable sobre la forma correcta de los ingredientes vitales en el análisis, como las funciones y las medidas de probabilidad en integrales clave (Sullivan, 2015).

La teoría neutrosófica

La neutrosofía (Smarandache, 1998) es definida por Leyva-Vasquez y Smarandache (2018) como “una nueva rama de la filosofía que estudia el origen, naturaleza y alcance de las neutralidades, así como sus interacciones con diferentes espectros ideacionales: $\langle A \rangle$ es una idea, proposición, teoría, evento, concepto o entidad, $\langle \text{anti}A \rangle$ es el opuesto de $\langle A \rangle$ y $\langle \text{neut}A \rangle$ significa ni $\langle A \rangle$ ni $\langle \text{anti}A \rangle$, es decir, la neutralidad entre los dos extremos (Smarandache, 1998)”. Etimológicamente neutrosofía proviene del latín “neuter” que significa neutral y del griego “sophia” que significa conocimiento y se define como el conocimiento de los pensamientos neutrales (Smarandache, 1995). Su teoría fundamental

afirma que toda idea $\langle A \rangle$ tiende a ser neutralizada, disminuida o balanceada por $\langle \text{no}A \rangle$ como un estado de equilibrio. Cabe destacar que $\langle \text{not}A \rangle$ se refiere a todo aquello que no es A , es decir, $\langle \text{anti}A \rangle$ o $\langle \text{neut}A \rangle$. En su forma clásica $\langle A \rangle$, $\langle \text{neut}A \rangle$ y $\langle \text{anti}A \rangle$ son disjuntos de dos en dos. Como en varios casos los límites entre conceptos son vagos e imprecisos, es posible que $\langle A \rangle$, $\langle \text{neut}A \rangle$ y $\langle \text{anti}A \rangle$ tengan partes comunes de dos en dos también.

Esta teoría ha constituido la base para la lógica neutrosófica (Smarandache, 1998), los conjuntos neutrosóficos (Haibin, Smarandache, Zhang, & Sunderraman, 2010), la probabilidad neutrosófica, la estadística neutrosófica y múltiples aplicaciones prácticas (Smarandache, 2003).

Antecedentes

El conjunto difuso fue introducido por L. Zadeh (1965) planteando que cada elemento tiene un grado de pertenencia, es decir, añade a la teoría clásica de conjuntos una función de pertenencia (Del Brio & Molina, 2001). La función de pertenencia o inclusión $U_A(t)$ indica el grado n en que la variable t está incluida en el concepto representado por la etiqueta A (Klir & Yuan, 1995). Para la definición de estas funciones de pertenencia se utilizan convenientemente ciertas familias de funciones, por coincidir con el significado lingüístico de las etiquetas más utilizadas. Las más utilizadas con mayor frecuencia son triangular, trapezoidal y gaussiana las cuales se observan en la figura 3.



Figura 3. Representación gráfica de las funciones de pertenencia.

El conjunto difuso intuicionista en un universo X fue introducido por Atanassov (1986) como una generalización de los conjuntos difusos donde, además del grado de pertenencia $\mu_A(x) \in [0,1]$ de cada elemento x a un conjunto A , se consideró un grado de no

pertenencia $\nu A(x) \in [0,1]$, pero tal que para $x \in X, \mu A(x) + \nu A(x) \leq 1$.

El conjunto difuso y el conjunto difuso intuicionista son casos particulares del conjunto neutrosófico.

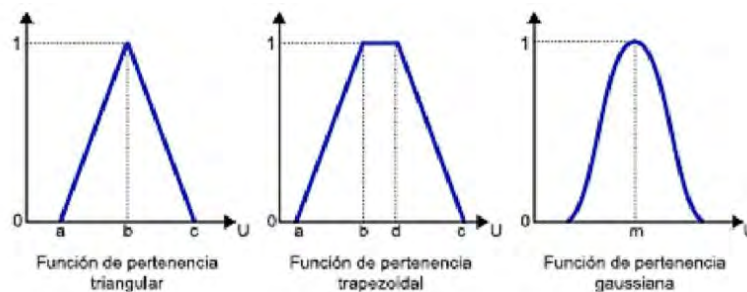
Aplicaciones

En los últimos años, se ha aplicado la teoría neutrosófica en varios campos del conocimiento, principalmente para el tratamiento de la incertidumbre. Sólo por citar algunos casos, ha sido utilizada en medicina para la evaluación de los efectos tóxicos de los medicamentos biotransformados en el hígado (Basha, Tharwat, Abdalla, & Hassanien, 2019) utilizando un sistema de clasificación basado en reglas neutrosóficas, el cual genera una buena solución al problema de las clases superpuestas al generar tres componentes diferentes de los cuales dos tratarán con la falsedad e indeterminación de los datos siempre generando mejores resultados que otros modelos convencionales. Su aplicabilidad la encontramos también en un estudio de la sostenibilidad del transporte público (P. Smith, 2019) donde se ilustra un enfoque de toma de decisiones de atributos múltiples (*Multiple Attribute Decision Making*, MADM) para seleccionar sistemas de transporte de sostenibilidad bajo incertidumbre, es decir, con información parcial o incompleta que involucra conjuntos neutrosóficos de valor único. También podemos encontrar su aplicación en la selección de proveedores (Abdel-Baset, Chang, Gamal, & Smarandache, 2019) donde se propone un marco de trabajo que integra ANP (*Analytic Network Process*) con VIKOR (*ViseKriterijumska Optimizacija I Kompromisno Resenje*) en un ambiente neutrosófico al utilizar los números neutrosóficos triangulares para representar variables lingüísticas que permiten considerar todos los aspectos de una toma de decisiones incluyendo inseguridad y falsedad.

El uso de la teoría neutrosófica integrada con la gestión del riesgo en la cadena de suministro es propuesto por Abdel-Baset, Gunasekaran, Mohamed y Chilamkurti (2019), en una investigación que tiene en cuenta los entornos inclementes que enfrentan las cadenas de suministro hoy, con un énfasis actual y duradero en la mejora continua, lo que se traduce en un aumento en los riesgos que se deben considerar para la cadena de suministro, haciendo necesaria su medición y evaluación para poder ser gestionados. Los riesgos son parámetros intangibles y difíciles de medir, y casi todos los temas de investigación utilizaron

una estimación cualitativa, generalmente descriptiva, que no ofrece una medición precisa del riesgo. Otros investigadores utilizaron métodos cuantitativos para medir los riesgos en la cadena de suministro, pero sin considerar la indeterminación que generalmente existe en el mundo real, por lo cual, sus resultados no fueron precisos y tampoco sus decisiones de gestión de riesgos.

Esta investigación integra AHP (*Analytic Hierarchy Process*) con la técnica TOPSIS (*Technique for Order of Preference by Similarity to Ideal Solution*) utilizando un conjunto neutrosófico para tratar mejor la incertidumbre, vaguedad e inconsistencia de la información. El método propuesto fue validado por medio de la aplicación a un estudio de caso real. El proceso de evaluación de los riesgos de la cadena de suministro se presenta utilizando números neutrosóficos triangulares en las matrices de comparación que más adelante son transformados a su valor nítido equivalente por medio de una función de puntuación. Esta metodología muestra muchas ventajas para realizar transacciones con información vaga, incierta e inconsistente que generalmente existe en el proceso de estimación de riesgos de la cadena de suministro.

Conclusiones

Debido a los intensos cambios que enfrentan las cadenas de suministro y a la presión constante de incrementar su eficiencia, los riesgos en la cadena de suministro han ido en aumento. Una cadena de suministro se extiende hoy a muchos países y conlleva varios tipos de riesgos. Todos estos riesgos deben ser medidos y gestionados. El riesgo es de parámetros intangibles y es difícil de medir, razón por la cual en los temas de investigación se suele utilizar una estimación cualitativa que generalmente es descriptiva y no ofrece una medición precisa del riesgo y su incertidumbre.

Se puede apreciar la posibilidad que ofrece la teoría neutrosófica para realizar la cuantificación de los riesgos que afectan la cadena de suministro y que se encuentran expuestos a incertidumbre epistémica debido a las opiniones diversas y en gran parte cualitativas de los expertos en el área, logrando ajustar los parámetros de impacto esperado y probabilidad de ocurrencia de cada riesgo para ser utilizados en modelos de toma de decisiones para la selección de estrategias en la gestión del riesgo en la cadena de suministro.

Referencias bibliográficas

- Abdel-Baset, M., Chang, V., Gamal, A., & Smarandache, F. (2019). An integrated neutrosophic ANP and VIKOR method for achieving sustainable supplier selection: A case study in importing field. *COMPUTERS IN INDUSTRY*, 106, 94–110. <https://doi.org/10.1016/j.compind.2018.12.017>
- Abdel-Basset, M., Gunasekaran, M., Mohamed, M., & Chilamkurti, N. (2019). A framework for risk assessment, management and evaluation: Economic tool for quantifying risks in supply chain. *FUTURE GENERATION COMPUTER SYSTEMS-THE INTERNATIONAL JOURNAL OF ESCIENCE*, 90, 489–502. <https://doi.org/10.1016/j.future.2018.08.035>
- Atanassov, K. (1986). *Intuitionistic fuzzy sets. Fuzzy Sets and Systems*.
- Atanassov, K. (1999). *Intuitionistic Fuzzy: Sets, Theory and Applications*. Springer.
- Aven, T. (2016). Risk assessment and risk management: Review of recent advances on their foundation. *European Journal of Operational Research*, 253(1), 1–13.
- Bal, M., Shalla, M., & Olgun, N. (2018). Neutrosophic triplet cosets and quotient groups. *Symmetry*, 10(4), 126.
- Basha, S. H., Tharwat, A., Abdalla, A., & Hassanien, A. E. (2019). Neutrosophic rule-based prediction system for toxicity effects assessment of biotransformed hepatic drugs. *EXPERT SYSTEMS WITH APPLICATIONS*, 121, 142–157. <https://doi.org/10.1016/j.eswa.2018.12.014>
- Bernstein, P. L. (1996). The new religion of risk management. *Harvard Business Review*, 74(2), 47.
- Bower, J. (1970). *Managing the Resource Allocation Process: A Study of Corporate Planning and Investment*. Harvard Business School.
- Celik, O. C., & Ellingwood, B. R. (2010). Seismic fragilities for non-ductile reinforced concrete frames – Role of aleatoric and epistemic uncertainties. *Structural Safety*, 32(1), 1–12. <https://doi.org/10.1016/J.STRUSAFE.2009.04.003>
- Cheng, Q., Wang, S., & Yan, C. (2016). Robust optimal design of chilled water systems in buildings with quantified uncertainty and reliability for minimized life-cycle cost. *ENERGY AND BUILDINGS*, 126, 159–169.

<https://doi.org/10.1016/j.enbuild.2016.05.032>

Colicchia, C., & Strozzi, F. (2012). Supply chain risk management: a new methodology for a systematic literature review. *Supply Chain Management: An International Journal*, 17(4), 403–418.

Council of Supply Chain Management Professionals. (2019). SCM Definitions and Glossary. https://doi.org/10.1007/978-1-349-95810-8_371

Craighead, C. W., Blackhurst, J., Rungtusanatham, M. J., & Handfield, R. B. (2007). The severity of supply chain disruptions: design characteristics and mitigation capabilities. *Decision Sciences*, 38(1), 131–156.

Del Brio, B. M., & Molina, A. S. (2001). *Redes neuronales y sistemas borrosos*. Ra-ma.

Diehl, D., & Spinler, S. (2013). Defining a common ground for supply chain risk management - a case study in the fast-moving consumer goods industry. *INTERNATIONAL JOURNAL OF LOGISTICS-RESEARCH AND APPLICATIONS*, 16(4), 311–327. <https://doi.org/10.1080/13675567.2013.813443>

Duell, M., Grzybowska, H., Rey, D., & Waller, S. T. (2019). Strategic dynamic traffic assignment incorporating travel demand uncertainty. *TRANSPORTMETRICA B-TRANSPORT DYNAMICS*, 7(1), 950–966. <https://doi.org/10.1080/21680566.2018.1519468>

Fishburn, P. C. (1984). Foundations of Risk Measurement. I. Risk As Probable Loss. *Management Science*, 30(4), 396–406. <https://doi.org/10.1287/mnsc.30.4.396>

Haibin, W., Smarandache, F., Zhang, Y., & Sunderraman, R. (2010). *Single valued neutrosophic sets*. Infinite Study.

Haimes, Y. Y., Kaplan, S., & Lambert, J. H. (2002). Risk Filtering, Ranking, and Management Framework Using Hierarchical Holographic Modeling. *Risk Analysis*, 22(2), 383–397. <https://doi.org/10.1111/0272-4332.00020>

Haveman, H. (1992). Between a rock and a hard place: Organizational change and performance under conditions of fundamental environmental transformation. *Administrative Science Quarterly*, 37, 37–45.

Heckman, C. R., Hsieh, M. A., & Schwartz, I. B. (2015). Going With the Flow: Enhancing

- Stochastic Switching Rates in Multitype Systems. *JOURNAL OF DYNAMIC SYSTEMS MEASUREMENT AND CONTROL-TRANSACTIONS OF THE ASME*, 137(3, SI). <https://doi.org/10.1115/1.4027828>
- Henderson, R., & Clark, K. (1990). Architectural innovation: The reconfiguration of existing product technologies and the failure of established firms. *Administrative Science Quarterly*, 35, 9–31.
- Hidalgo, P., Manzur, E., Olavarrieta, S., & Farías, P. (2007). Cuantificación de las distancias culturales entre países: un análisis de Latinoamérica. *Cuadernos de Administración*, 20(33).
- Ho, W., Zheng, T., Yildiz, H., & Talluri, S. (2015). Supply chain risk management: a literature review. *INTERNATIONAL JOURNAL OF PRODUCTION RESEARCH*, 53(16), 5031–5069. <https://doi.org/10.1080/00207543.2015.1030467>
- Kaplan, S. (2008). Framing Contests: Strategy Making Under Uncertainty. *ORGANIZATION SCIENCE*, 19(5), 729–752. <https://doi.org/10.1287/orsc.1070.0340>
- Kester, Q. (2013). Application of Formal Concept Analysis to Visualization of the Evaluation of Risks Matrix in Software Engineering Projects. *International Journal of Science, Engineering and Technology Research*, 2(1).
- Khojasteh, Y. (2018). *Supply Chain Risk Management. Advanced Tools, Models, and Developments*. <https://doi.org/10.1007/978-981-10-4106-8>
- Klir, G. J., & Yuan, B. (1995). *Fuzzy sets and fuzzy logic: theory and applications* (Vol. 574). Prentice Hall PTR New Jersey.
- Knight, F. (1965). Risk, Uncertainty and Profit. *New York: Harper and Row*.
- Kurmann, A. (2005). Quantifying the uncertainty about the fit of a new Keynesian pricing model. *JOURNAL OF MONETARY ECONOMICS*, 52(6), 1119–1134. <https://doi.org/10.1016/j.jmoneco.2005.08.004>
- Leyva-Vasquez, M., & Smarandache, F. (2018). *Neutrosophia: Nuevos avances en el tratamiento de la incertidumbre*.
- Liu, B., & Iwamura, K. (1998). Chance constrained programming with fuzzy parameters. *Fuzzy Sets and Systems*, 94(2), 227–237. <https://doi.org/10.1016/S0165->

0114(96)00236-9

- Mohajeri, A., & Fallah, M. (2016). A carbon footprint-based closed-loop supply chain model under uncertainty with risk analysis: A case study. *TRANSPORTATION RESEARCH PART D-TRANSPORT AND ENVIRONMENT*, 48, 425–450.
<https://doi.org/10.1016/j.trd.2015.09.001>
- Morgan, M., Henrion, M., & Small, M. (1992). *Uncertainty: a guide to dealing with uncertainty in quantitative risk and policy analysis*.
- Neiger, D., Rotaru, K., & Churilov, L. (2009). Supply chain risk identification with value-focused process engineering. *Journal of Operations Management*, 27(2), 154–168.
- Norman, A., & Lindroth, R. (2004). Categorization of Supply Chain Risk and Risk Management. *Supply Chain Risk*.
- Oliver, R. K., & Webber, M. D. (1982). Supply-chain management: logistics catches up with strategy. *Outlook*, 5(1), 42–47.
- Parlitz, U., Schumann-Bischoff, J., & Luther, S. (2014). Quantifying uncertainty in state and parameter estimation. *PHYSICAL REVIEW E*, 89(5).
<https://doi.org/10.1103/PhysRevE.89.050902>
- Paulsson, U. (2004). Supply Chain Risk Management. In *Supply Chain Risk* (pp. 79–90).
- Phillips, E. G., & Elman, H. C. (2015). A stochastic approach to uncertainty in the equations of MHD kinematics. *JOURNAL OF COMPUTATIONAL PHYSICS*, 284, 334–350.
<https://doi.org/10.1016/j.jcp.2014.12.002>
- Rajesh, R., & Ravi, V. (2015). Modeling enablers of supply chain risk mitigation in electronic supply chains: A Grey--DEMATEL approach. *Computers & Industrial Engineering*, 87, 126–139.
- Ramalho, F. D., Ekel, P. Y., Pedrycz, W., Pereira Junior, J. G., & Soares, G. L. (2019). Multicriteria decision making under conditions of uncertainty in application to multiobjective allocation of resources. *INFORMATION FUSION*, 49, 249–261.
<https://doi.org/10.1016/j.inffus.2018.12.010>
- Ritchie, B., & Brindley, C. (2007). Supply chain risk management and performance: A guiding framework for future development. *International Journal of Operations & Production*

Management, 27(3).

Samaniego, Á. (2010). Incertidumbre en los proyectos de investigación y desarrollo (I+D): Un estudio de la literatura. *Contaduría y Administración*.

Smarandache, F. (1995). *Neutrosophic logic and set*, mss.

Smarandache, F. (1999). *A unifying field in logics. neutrosophy: Neutrosophic probability, set and logic*. American Research Press, Rehoboth.

Smarandache, F. (2002). Neutrosophy, A New Branch of Philosophy. *Multiple Valued Logic*, 8(3), 297–384.

Smarandache, F. (2003). *A Unifying Field in Logics: Neutrosophic Logic. Neutrosophy, Neutrosophic Set, Neutrosophic Probability: Neutrosophic Logic: Neutrosophy, Neutrosophic Set, Neutrosophic Probability*. Infinite Study.

Smarandache, F., & Leyva-Vasquez, M. (2018). Fundamentos de la lógica y los conjuntos neutrosóficos y supapel en la inteligencia artificial. *Neutrosophic Computing and Machine Learning*.

Smith, K., & Grimm, C. (1987). Environmental variation, strategic change and firm performance: A study of railroad deregulation. *Strategic Management Journal*, 8, 363–37.

Smith, P. (2019). Exploring public transport sustainability with neutrosophic logic. *TRANSPORTATION PLANNING AND TECHNOLOGY*, 42(3), 257–273. <https://doi.org/10.1080/03081060.2019.1576383>

Sodhi, M. S., Son, B.-G., & Tang, C. S. (2012). Researchers' Perspectives on Supply Chain Risk Management. *PRODUCTION AND OPERATIONS MANAGEMENT*, 21(1), 1–13. <https://doi.org/10.1111/j.1937-5956.2011.01251.x>

Sullivan, T. J. (2015). Introduction to Uncertainty Quantification. In *Texts in Applied Mathematics*. https://doi.org/https://doi.org/10.1007/978-3-319-23395-6_1

Tang, C. S. (2006). Robust strategies for mitigating supply chain disruptions. *International Journal of Logistics Research and Applications*, 9(1), 33–45. <https://doi.org/10.1080/13675560500405584>

Thun, J.-H., & Hoenig, D. (2011). An empirical analysis of supply chain risk management in

- the German automotive industry. *International Journal of Production Economics*, 131(1), 242–249. <https://doi.org/10.1016/J.IJPE.2009.10.010>
- Trkman, P., Oliveira, M. P. V. de, & McCormack, K. (2016). Value-oriented supply chain risk management: you get what you expect. *Industrial Management & Data Systems*, 116(5), 1061–1083.
- Tummala, R., & Schoenherr, T. (2011). Assessing and managing risks using the supply chain risk management process (SCRMP). *Supply Chain Management: An International Journal*, 16(6), 474–483.
- Wang, H., Wang, C., Wang, Y., Gao, X., & Yu, C. (2017). Bayesian forecasting and uncertainty quantifying of stream flows using Metropolis–Hastings Markov Chain Monte Carlo algorithm. *Journal of Hydrology*, 549, 476–483. <https://doi.org/10.1016/J.JHYDROL.2017.03.073>
- Yiyi, F. (2018). A review of supply chain risk management: definition, theory, and research agenda. *International Journal of Physical Distribution & Logistics Management*, 48(3), 205–230. <https://doi.org/10.1108/IJPDLM-01-2017-0043>
- Zadeh, L. (1965). Fuzzy Sets. *Information and Control*, 8(3), 338–353.
- Zadeh, L. . (1978). Fuzzy sets as a basis for a theory of possibility. *Fuzzy Sets and Systems*, 1(1), 3–28. [https://doi.org/10.1016/0165-0114\(78\)90029-5](https://doi.org/10.1016/0165-0114(78)90029-5)
- Zuber, J., Cabral, B. J., McFadyen, I., Mauger, D. M., & Mathews, D. H. (2018). Analysis of RNA nearest neighbor parameters reveals interdependencies and quantifies the uncertainty in RNA secondary structure prediction. *RNA*, 24(11), 1568–1582. <https://doi.org/10.1261/rna.065102.117>

On Neutrosophic Refined EQ-Filters

Mohammad Hamidi, Arsham Borumand Saeid, Florentin Smarandache

Mohammad Hamidi, Arsham Borumand Saeid, Florentin Smarandache (2019). On Neutrosophic Refined EQ-Filters. *Journal of Intelligent & Fuzzy Systems* 37, 1181-1196; DOI:10.3233/JIFS-182618

Abstract. This study introduces the notion of n -valued refined neutrosophic (EQ -subalgebras) EQ -(pre)filters and investigates some of their properties. We show how to construct n -valued refined neutrosophic EQ -(pre)filters and determine the relationship between n -valued refined neutrosophic EQ -(pre)filters and EQ -(pre)filters with respect to (α, β, γ) -level set. Finally, the extension of n -valued refined neutrosophic EQ -(pre)filters are considered via homomorphisms and some applications of n -valued refined neutrosophic EQ -(pre)filters are presented.

Keywords: n -valued refined neutrosophic EQ -subalgebras, n -valued refined neutrosophic EQ -(pre)filters

1. Introduction

The concept of neutrosophic was introduced by F. Smarandache in 1995. He presented the concept of neutrosophic set(NS), as a generalization of intuitionistic fuzzy sets, as a mathematical tool for handling problems involving imprecise, indeterminacy and inconsistent data [14, 15]. Neutrosophy is the base of all neutrosophics which investigates the scope of neutralities, as well as their interactions with different ideational spectra and it is used in other science such as engineering applications (especially for software and information fusion), medicine, cybernetics and physics. NS and neutrosophic logic(NL) are as a generalizations of the fuzzy set and respectively fuzzy logic (especially of intuitionistic fuzzy set and respectively intuitionistic fuzzy logic) so are tools for publications on advanced studies in neutrosophy. NL considers every idea $\langle X \rangle$ together with its opposite or negation $\langle antiX \rangle$ and with their spectrum of neutralities $\langle neutX \rangle$ and a proposition has a degree of truth $T(Th)$, indeterminacy $I(Iy)$

and falsity $F(Fy)$, where T, I, F are standard or non-standard subsets of $]^{-0}, 1^{+}[$. Smarandache have defined in 1995 two types of n -valued logic. Firstly, we recall the n -symbol-valued refined neutrosophic logic. In this type, T can be split into many types of sub-truths: T_1, T_2, \dots, T_p , I into many types of sub-indeterminacies: I_1, I_2, \dots, I_r , and F into many types of sub-falsities: F_1, F_2, \dots, F_s , where for all integers $p, r, s \geq 1$ we have $p + r + s = n$. Secondly, recall the n -numerical-valued refined neutrosophic logic. In the same way, but all sub-components T_j, I_k, F_l are not symbols, but subsets of $[0, 1]$, for all $j \in 1, 2, \dots, p$, all $k \in 1, 2, \dots, r$ and all $l \in 1, 2, \dots, s$. For instance one of applications of NL, can refer if $\langle X \rangle$ is a physical entity such as, theorem, theory, space, field, idea, concept, notion, object, law, property, state etc, then neutrosophic physics(NP) is a blending of two or three of these entities $\langle X \rangle$, $\langle antiX \rangle$ and $\langle neutX \rangle$ that hold together. Indeed, NP is an extension of paradoxist physics(PP), since paradoxist physics is a combination of physical contradictories $\langle X \rangle$ and $\langle antiX \rangle$ only that hold together, without referring to their neutrality $\langle neutX \rangle$. PP describes collections of objects that are individually characterized by contradictory

properties, are composed of contradictory sub-elements or, or are characterized neither by a property nor by the opposite of that property. Such theorems are called paradoxist entities. There are many cases in the scientific (and also in humanistic) fields that some of these items $\langle X \rangle$, $\langle antiX \rangle$ and $\langle neutx \rangle$ simultaneously coexist blended. Further materials regarding applications of neutrosophic field are available in the literature too [16].

V. Novák presented the concept of EQ -algebras as generalization class of residuated lattices (from the algebraic point of view) which aims at becoming the algebra of truth values for fuzzy type theory (FTT) [9, 10]. Its original motivation comes from fuzzy type theory, in which the main connective is fuzzy equality and stems from the equational style of proof in logic [17]. EQ -algebras are intended to become algebras of truth values for FTT where the main connective is a fuzzy equality. The motivation stems from the fact that until now, the truth values in FTT were assumed to form either an IMTL-, BL-, or MV-algebra, all of them being special kinds of residuated lattices in which the basic operations are the monoidal operation (multiplication) and its residuum. Further materials regarding EQ -algebras are available in the literature too [2, 3, 8, 11]. Algebras including EQ -algebras have played an important role in recent years and have had its comprehensive applications in many aspects including dynamical systems and genetic code of biology [1]. There is the main difference between residuated lattices and EQ -algebras such as implication operation and (strong) conjunction, so their many similar or identical properties. Filter theory plays an important role in studying various logical algebras and in proof of the completeness of various logic algebras. Filters are very important in the Many researchers have studied the filter theory of various logical algebras [5–7].

Regarding these points, this paper aims to introduce the notation of n -valued refined neutrosophic EQ -subalgebras and n -valued refined neutrosophic EQ -filters. We investigate some properties of n -valued refined neutrosophic EQ -subalgebras and n -valued refined neutrosophic EQ -filters and prove them. Indeed, we show that how to construct n -valued refined neutrosophic EQ -subalgebras and n -valued refined neutrosophic EQ -filters. We apply the concept of homomorphisms in EQ -algebras and with this regard, new n -valued refined neutrosophic EQ -subalgebras and n -valued refined neutrosophic EQ -filters are generated. Indeed, this paper tries to extend the concepts of EQ -algebras and their

properties to n -valued refined neutrosophic EQ -algebras and their main properties. Moreover, it pays to applications of the notation of n -valued refined neutrosophic EQ -subalgebras and implements this application with all the details on a computer network.

2. Preliminaries

In this section, we recall some definitions and results that are indispensable to our paper.

Definition 2.1. [4] An algebra $\mathcal{E} = (E, \wedge, \odot, \sim, 1)$ of type $(2, 2, 2, 0)$ is called an EQ -algebra, if for all $x, y, z, t \in E$:

- (E1) $(E, \wedge, 1)$ is a commutative idempotent monoid (i.e. \wedge -semilattice with top element “1”);
- (E2) $(E, \odot, 1)$ is a monoid and \odot is isotone w.r.t. “ \leq ” (where $x \leq y$ is defined as $x \wedge y = x$);
- (E3) $x \sim x = 1$; (reflexivity axiom)
- (E4) $((x \wedge y) \sim z) \odot (t \sim x) \leq z \sim (t \wedge y)$; (substitution axiom)
- (E5) $(x \sim y) \odot (z \sim t) \leq (x \sim z) \sim (y \sim t)$; (congruence axiom)
- (E6) $(x \wedge y \wedge z) \sim x \leq (x \wedge y) \sim x$; (monotonicity axiom)
- (E7) $x \odot y \leq x \sim y$, (boundedness axiom).

The binary operation “ \wedge ” is called meet (infimum), “ \odot ” is called multiplication and “ \sim ” is called fuzzy equality. $(E, \wedge, \odot, \sim, 1)$ is called a *separated EQ -algebra* if $1 = x \sim y$, implies that $x = y$.

Proposition 2.2. [4] Let \mathcal{E} be an EQ -algebra, $x \rightarrow y := (x \wedge y) \sim x$ and $\tilde{x} = x \sim 1$. Then for all $x, y, z \in E$, the following properties hold:

- (i) $x \odot y \leq x, y, \quad x \odot y \leq x \wedge y$;
- (ii) $x \sim y = y \sim x$;
- (iii) $(x \wedge y) \sim x \leq (x \wedge y \wedge z) \sim (x \wedge z)$;
- (iv) $x \rightarrow x = 1$;
- (v) $(x \sim y) \odot (y \sim z) \leq x \sim z$;
- (vi) $(x \rightarrow y) \odot (y \rightarrow z) \leq x \rightarrow z$;
- (vii) $x \leq \tilde{x}, \quad \tilde{1} = 1$.

Proposition 2.3. [4] Let \mathcal{E} be an EQ -algebra. Then for all $x, y, z, t \in E$, the following properties hold:

- (i) $x \odot (x \sim y) \leq \bar{y}$;
- (ii) $(z \rightarrow (x \wedge y)) \odot (x \sim t) \leq z \rightarrow (t \wedge y)$;
- (iii) $(y \rightarrow z) \odot (x \rightarrow y) \leq x \rightarrow z$;

- (iv) $(x \rightarrow y) \odot (y \rightarrow x) \leq x \sim y$;
- (v) if $x \leq y \rightarrow z$, then $x \odot y \leq \bar{z}$;
- (vi) if $x \leq y \leq z$, then $z \sim x \leq z \sim y$ and $x \sim z \leq x \sim y$;
- (vi) $x \rightarrow (y \rightarrow x) = 1$.

Definition 2.4. [4] Let $\mathcal{E} = (E, \wedge, \odot, \sim, 1)$ be a separated EQ -algebra. A subset F of E is called an EQ -filter of E if for all $a, b, c \in E$ it holds that

- (i) $1 \in F$,
- (ii) if $a, a \rightarrow b \in F$, then $b \in F$,
- (iii) if $a \rightarrow b \in F$, then $a \odot c \rightarrow b \odot c \in F$ and $c \odot a \rightarrow c \odot b \in F$.

Theorem 2.5. [4] Let F be a prefilter of separated EQ -algebra \mathcal{E} . Then for all $a, b, c \in E$ it holds that

- (i) if $a \in F$ and $a \leq b$, then $b \in F$;
- (ii) if $a, a \sim b \in F$, then $b \in F$;
- (iii) If $a, b \in F$, then $a \wedge b \in F$;
- (iv) If $a \sim b \in F$ and $b \sim c \in F$ then $a \sim c \in F$.

Definition 2.6.[18] Let \mathcal{E} be an EQ -algebras. A fuzzy subset μ of E is called a fuzzy prefilter of \mathcal{E} , if for all $x, y, z \in E$:

- (FH1) $\nu(1) \geq \nu(x)$;
- (FH2) $\nu(y) \geq \nu((x \wedge y) \sim y) \wedge \nu(x)$.

A fuzzy EQ -prefilter is called a fuzzy EQ -filter if it satisfies :

- (FH3) $\nu((x \wedge y) \sim y) \leq \nu(((x \odot z) \wedge (y \odot z)) \sim (y \odot z))$.

Definition 2.7.[16] Let X be a set. An n -valued refined neutrosophic set A in X (briefly n -VRNS) is a function $A : X \rightarrow \underbrace{[0, 1] \times [0, 1] \times \dots \times [0, 1]}_{n\text{-times}}$ with

the form $A = \{(x, T_A(x), I_A(x), F_A(x)) \mid x \in X\}$, where all $p, r, s \geq 1$ are integers and $p + r + s = n$. The functions $T_A = (T_1, T_2, \dots, T_p)$, $I_A = (I_1, I_2, \dots, I_r)$, $F_A = (F_1, F_2, \dots, F_s)$ define respectively the truth-membership function, an indeterminacy-membership function, and a falsity-membership function of the element $x \in X$ to the set A such that $\sum_{j=1}^p T_j(x) + \sum_{k=1}^r I_k(x) + \sum_{l=1}^s F_l(x) \in (0, n)$. Moreover, $Supp(A) = \{x \mid T_j(x) \neq 0, I_k(x) \neq 0, F_l(x) \neq 0\}$ is a crisp set.

3. n -Valued Refined Neutrosophic EQ -subalgebras

In the following, we present the concept of an n -valued refined neutrosophic EQ -subalgebra and prove some of their properties.

From now on, consider $\mathcal{E} = (E, \wedge, \odot, \sim, 1)$ is an EQ -algebra and $A : E \rightarrow \underbrace{[0, 1] \times [0, 1] \times \dots \times [0, 1]}_{n\text{-times}}$.

Definition 3.1. A map A in E , is called an n -valued refined neutrosophic EQ -subalgebra of \mathcal{E} , if for all $x, y \in E$, $1 \leq j \leq p$, $1 \leq k \leq r$ and $1 \leq l \leq s$,

- (i) $T_j(x \wedge y) = T_j(x) \wedge T_j(y)$, $I_k(x \wedge y) = I_k(x) \wedge I_k(y)$ and $F_l(x \wedge y) = F_l(x) \vee F_l(y)$,
- (ii) $T_j(x \sim y) \geq T_j(x) \wedge T_j(y)$, $I_k(x \sim y) \geq I_k(x) \wedge I_k(y)$ and $F_l(x \sim y) \leq F_l(x) \vee F_l(y)$.

From now on, when we say (\mathcal{E}, A) is an n -valued refined neutrosophic EQ -subalgebra, means that $\mathcal{E} = (E, \wedge, \odot, \sim, 1)$ is an EQ -algebra and A is an n -valued refined neutrosophic EQ -subalgebra of \mathcal{E} .

Theorem 3.2. For all $x, y \in E$, $1 \leq j \leq p$, $1 \leq k \leq r$ and $1 \leq l \leq s$,

- (i) if $x \leq y$, then $T_j(x) \leq T_j(y)$, $I_k(x) \leq I_k(y)$ and $F_l(x) \geq F_l(y)$,
- (ii) $T_j(x) \leq T_j(1)$, $I_k(x) \leq I_k(1)$ and $F_l(x) \geq F_l(1)$,
- (iii) $T_j(x \odot y) \leq T_j(x) \wedge T_j(y)$, $I_k(x \odot y) \leq I_k(x) \wedge I_k(y)$ and $F_l(x \odot y) \geq F_l(x) \vee F_l(y)$,
- (iv) $T_j(x \rightarrow y) \geq T_j(x) \wedge T_j(y)$, $I_k(x \rightarrow y) \geq I_k(x) \wedge I_k(y)$ and $F_l(x \rightarrow y) \leq F_l(x) \vee F_l(y)$.

Proof. (i), (ii) Let $x, y \in E$. Since $x \leq y$, we get that $x \wedge y = x$ and so $T_j(x) \wedge T_j(y) = T_j(x \wedge y) = T_j(x)$. It follows that $T_j(x) \leq T_j(y)$. In a similar way $I_k(x) \leq I_k(y)$. Also, $x \leq y$, implies that $x \wedge y = x$ and so $F_l(x) \vee F_l(y) = F_l(x \wedge y) = F_l(x)$. Thus $F_l(x) \geq F_l(y)$.

(ii) Let $x \in E$. Since $x \leq 1$, by item (i), we have $T_j(x) \leq T_j(1)$, $I_k(x) \leq I_k(1)$ and $F_l(x) \geq F_l(1)$.

(iii) For all $x, y \in E$, $x \odot y \leq x \wedge y$ implies that $T_j(x \odot y) \leq T_j(x) \wedge T_j(y)$, $I_k(x \odot y) \leq I_k(x) \wedge I_k(y)$ and $F_l(x \odot y) \geq F_l(x) \vee F_l(y)$.

(iv) Since $(x \sim y) \leq (x \rightarrow y)$, we get that $T_j(x \rightarrow y) \geq T_j(x) \wedge T_j(y)$, $I_k(x \rightarrow y) \geq I_k(x) \wedge I_k(y)$ and $F_l(x \rightarrow y) \leq F_l(x) \vee F_l(y)$. \square

Example 3.3. Let $E = \{x_1, x_2, x_3, x_4, x_5, x_6\}$. Define operations “ \odot , \sim ” and “ \wedge ” on E as follows:

\wedge	x_1	x_2	x_3	x_4	x_5	x_6	\odot	x_1	x_2	x_3	x_4	x_5	x_6
x_1	x_1	x_1	x_1	x_1	x_1	x_1	x_1	x_1	x_1	x_1	x_1	x_1	x_1
x_2	x_1	x_2	x_2	x_2	x_2	x_2	x_2	x_1	x_1	x_1	x_1	x_1	x_2
x_3	x_1	x_2	x_3	x_3	x_3	x_3	x_3	x_1	x_1	x_1	x_1	x_2	x_3
x_4	x_1	x_2	x_3	x_4	x_4	x_4	x_4	x_1	x_1	x_1	x_2	x_2	x_4
x_5	x_1	x_2	x_3	x_4	x_5	x_5	x_5	x_1	x_1	x_2	x_2	x_2	x_5
x_6	x_1	x_2	x_3	x_4	x_5	x_6	x_6	x_1	x_2	x_3	x_4	x_5	x_6
\sim	x_1	x_2	x_3	x_4	x_5	x_6							
x_1	x_6	x_4	x_3	x_2	x_1	x_1							
x_2	x_4	x_6	x_3	x_2	x_2	x_2							
x_3	x_3	x_3	x_6	x_3	x_3	x_3							
x_4	x_2	x_2	x_3	x_6	x_4	x_4							
x_5	x_1	x_2	x_3	x_4	x_6	x_5							
x_6	x_1	x_2	x_3	x_4	x_5	x_6							

Then $\mathcal{E} = (E, \wedge, \odot, \sim, x_6)$ is an EQ -algebra. For all $1 \leq i \leq 6$, define a single valued neutrosophic set map A in E as follows, where $p + r + s = 100$:

$$T(x_i) = (T_1(x_i), T_2(x_i), \dots, T_p(x_i)), \text{ where } T_1(x_i) = 0.i \text{ and for all } 2 \leq j \leq p, T_j(x_i) = 0.i + \frac{j}{10^6},$$

$$I(x_i) = (I_1(x_i), I_2(x_i), \dots, I_r(x_i)), \text{ where } I_1(x_i) = 0.i1 \text{ and for all } 2 \leq k \leq r, I_k = 0.i1 + \frac{k}{10^6} \text{ and}$$

$$F(x_i) = (F_1(x_i), F_2(x_i), \dots, F_s(x_i)), \text{ where } F_1(x_i) = 0.(7 - i)11 \text{ and for all } 2 \leq l \leq s, F_l = 0.(7 - i)11 - \frac{l}{10^6}.$$

Hence (A, \mathcal{E}) is a 100-valued refined neutrosophic EQ -subalgebra.

Corollary 3.4. For all $x, y \in E, 1 \leq j \leq p, 1 \leq k \leq r$ and $1 \leq l \leq s$, if $x \leq y$, then $T_j(y \rightarrow x) = T_j(x \sim y), I_k(y \rightarrow x) = I_k(x \sim y)$ and $F_l(y \rightarrow x) = F_l(x \sim y)$.

3.1. n -valued refined Neutrosophic EQ -prefilters

In the following section, we define the concept of n -valued refined neutrosophic EQ -prefilters and show how to construct of n -valued refined neutrosophic EQ -prefilters.

Definition 3.5. A map A in E , is called an n -valued refined neutrosophic EQ -prefilter of \mathcal{E} , if for all $x, y \in E, 1 \leq j \leq p, 1 \leq k \leq r$ and $1 \leq l \leq s$,

- (i) $T_j(x) \leq T_j(1), I_k(x) \geq I_k(1)$ and $F_l(x) \leq F_l(1)$ (briefly n -VRNPF1),
- (ii) $T_j(x) \wedge T_j(x \rightarrow y) \leq T_j(y), I_k(x) \vee I_k(x \rightarrow y) \geq I_k(y)$ and $F_l(x) \wedge F_l(x \rightarrow y) \leq F_l(y)$ (briefly n -VRNPF2).

In the following theorem, we will show that how to construct of n -valued refined neutrosophic EQ -prefilters in EQ -algebras.

Theorem 3.6. Let A be an n -valued refined neutrosophic EQ -prefilter of $\mathcal{E}, x, y \in E, 1 \leq j \leq p, 1 \leq k \leq r$ and $1 \leq l \leq s$. If $x \leq y$, then

- (i) $T_j(x) \wedge T_j(x \rightarrow y) = T_j(x), I_k(x) \vee I_k(x \rightarrow y) = I_k(x)$ and $F_l(x) \wedge F_l(x \rightarrow y) = F_l(x)$,
- (ii) $T_j(x) \leq T_j(y), I_k(y) \leq I_k(x)$ and $F_l(x) \leq F_l(y)$,

Proof. (i) Since $x \leq y$ we get that $x \rightarrow y = 1$, so $T_j(x) \wedge T_j(x \rightarrow y) = T_j(x), I_k(x) \vee I_k(x \rightarrow y) = I_k(x)$ and $F_l(x) \wedge F_l(x \rightarrow y) = F_l(x)$.

(ii) Since $x \leq y$, by (i) we have $T_j(x) \wedge T_j(x \rightarrow y) = T_j(x)$. So by definition we get $T_j(x) = T_j(x) \wedge T_j(x \rightarrow y) \leq T_j(y)$. In a similar way $x \leq y$ implies that $F_l(x) \leq F_l(y)$. In addition, since $x \leq y$, we have $I_k(x) \vee I_k(x \rightarrow y) = I_k(x)$. Thus we get $I_k(y) \leq I_k(x) \vee I_k(x \rightarrow y) = I_k(x)$ and it follows that $I_k(x) \geq I_k(y)$. \square

Corollary 3.7. Let A be an n -valued refined neutrosophic EQ -prefilter of $\mathcal{E}, 0 \in E, 1 \leq j \leq p, 1 \leq k \leq r$ and $1 \leq l \leq s$. If for every $y \in E, 0 \wedge y = 0$, then we have

- (i) $T_j(0) \wedge T_j(0 \rightarrow y) = T_j(0), F_l(0) \wedge F_l(0 \rightarrow y) = F_l(0)$ and $I_k(0) \vee I_k(0 \rightarrow y) = I_k(0)$,
- (ii) $T_j(1) \wedge T_j(1 \rightarrow y) = T_j(\bar{y}), F_l(1) \wedge F_l(1 \rightarrow y) = F_l(\bar{y})$ and $I_k(1) \vee I_k(1 \rightarrow y) = I_k(\bar{y})$,
- (iii) $T_j(y) \wedge T_j(y \rightarrow 1) = T_j(y), F_l(y) \wedge F_l(y \rightarrow 1) = F_l(y)$ and $I_k(y) \vee I_k(y \rightarrow 1) = I_k(y)$,
- (iv) $T_j(y) \wedge T_j(y \rightarrow y) = T_j(y), F_l(y) \wedge F_l(y \rightarrow y) = F_l(y)$ and $I_k(y) \vee I_k(y \rightarrow y) = I_k(y)$,
- (v) $T_j(0) \leq T_j(1), F_l(0) \leq F_l(1)$ and $I_k(1) \leq I_k(0)$,
- (vi) $T_j(x) \leq T_j(y \rightarrow x), F_l(x) \leq F_l(y \rightarrow x)$ and $I_k(x \rightarrow y) \geq I_k(y)$,
- (vii) $T_j(x \odot y) \leq T_j(y \sim x), F_l(x \odot y) \leq F_l(y \sim x)$ and $I_k(x \odot y) \geq I_k(y \sim x)$.

Example 3.8. Let $E = \{1, 2, 3, 4, 5\}$. Define operations “ \odot, \sim ” and “ \wedge ” on E as follows:

\wedge	1 2 3 4 5	\odot	1 2 3 4 5	\sim	1 2 3 4 5
1	1 1 1 1 1	1	1 1 1 1 1	1	5 2 1 1 1
2	1 2 2 2 2	2	1 1 1 1 2	2	2 5 2 2 2
3	1 2 3 3 3	3	1 1 1 3 3	3	1 2 5 3 3
4	1 2 3 4 4	4	1 1 1 4 4	4	1 2 3 5 4
5	1 2 3 4 5	5	1 2 3 4 5	5	1 2 3 4 5

Then $\mathcal{E} = (E, \wedge, \odot, \sim, 5)$ is an EQ-algebra and obtain the operation “ \rightarrow ” as follows:

\rightarrow	1 2 3 4 5
1	5 5 5 5 5
2	2 5 5 5 5
3	1 2 5 5 5
4	1 2 3 5 5
4	1 2 3 4 5

For all $2 \leq j \leq p, 2 \leq k \leq r$ and $2 \leq l \leq s$, define a single valued neutrosophic set map A in E as follows, where $p + r + s = 1000$: $T(1) = (T_1(1), T_2(1), \dots, T_p(1))$, where $T_1(1) = 0.1$ and $T_j(1) = 0.1 + \frac{1}{10^5}$, $T(2) = (T_1(2), T_2(2), \dots, T_p(2))$, where $T_1(2) = 0.2$ and $T_j(2) = 0.2 + \frac{2}{10^5}$, $T(3) = (T_1(3), T_2(3), \dots, T_p(3))$, where $T_1(3) = 0.3$ and $T_j(3) = 0.3 + \frac{3}{10^5}$, $T(4) = (T_1(4), T_2(4), \dots, T_p(4))$, where $T_1(4) = 0.4$ and $T_j(4) = 0.4 + \frac{4}{10^5}$, $T(5) = (T_1(5), T_2(5), \dots, T_p(5))$, where $T_1(5) = 0.5$ and $T_j(5) = 0.5 + \frac{5}{10^5}$, $I(1) = (I_1(1), I_2(1), \dots, I_r(1))$, where $I_1(1) = 0.57$ and $I_j(1) = 0.57 - \frac{1}{10^5}$, $I(2) = (I_1(2), I_2(2), \dots, I_r(2))$, where $I_1(2) = 0.47$ and $I_j(2) = 0.47 - \frac{2}{10^5}$, $I(3) = (I_1(3), I_2(3), \dots, I_r(3))$, where $I_1(3) = 0.37$ and $I_j(3) = 0.37 - \frac{3}{10^5}$, $I(4) = (I_1(4), I_2(4), \dots, I_r(4))$, where $I_1(4) = 0.27$ and $I_j(4) = 0.27 - \frac{4}{10^5}$, $I(5) = (I_1(5), I_2(5), \dots, I_r(5))$, where $I_1(5) = 0.17$ and $I_j(5) = 0.17 - \frac{5}{10^5}$, $F(1) = (F_1(1), F_2(1), \dots, F_s(1))$, where $F_1(1) = 0.15$ and $F_j(1) = 0.15 + \frac{1}{10^5}$, $F(2) = (F_1(2), F_2(2), \dots, F_s(2))$, where $F_1(2) = 0.25$ and $F_j(2) = 0.25 + \frac{2}{10^5}$, $F(3) = (F_1(3), F_2(3), \dots, F_s(3))$, where $F_1(3) = 0.35$ and $F_j(3) = 0.35 + \frac{3}{10^5}$, $F(4) = (F_1(4), F_2(4), \dots, F_s(4))$, where $F_1(4) = 0.45$ and $F_j(4) = 0.45 + \frac{4}{10^5}$, $F(5) = (F_1(5), F_2(5), \dots, F_s(5))$, where $F_1(5) = 0.55$ and $F_j(5) = 0.55 + \frac{5}{10^5}$.

Hence A is a 1000-valued refined neutrosophic EQ-prefilter of \mathcal{E} .

Theorem 3.9. Let A be an n -valued refined neutrosophic EQ-prefilter of \mathcal{E} and $x, y \in E$. Then for all $1 \leq j \leq p, 1 \leq l \leq s$ and $1 \leq k \leq r$,

- (i) $T_j(x) \wedge T_j(x \sim y) \leq T_j(y)$, $F_l(x) \wedge F_l(x \sim y) \leq F_l(y)$ and $I_k(x) \vee I_k(x \sim y) \geq I_k(y)$,
- (ii) $T_j(x) \wedge T_j(x \odot y) \leq T_j(y)$, $F_l(x) \wedge F_l(x \odot y) \leq F_l(y)$ and $I_k(x) \vee I_k(x \odot y) \geq I_k(y)$,
- (iii) $T_j(x) \wedge T_j(x \wedge y) \leq T_j(y)$, $F_l(x) \wedge F_l(x \wedge y) \leq F_l(y)$ and $I_k(x) \vee I_k(x \wedge y) \geq I_k(y)$,
- (iv) $T_j(x) \wedge T_j(y) \leq T_j(x) \wedge T_j(x \rightarrow y)$ and $F_l(x) \wedge F_l(y) \leq F_l(x) \wedge F_l(x \rightarrow y)$,
- (v) $I_k(x) \vee I_k(x \rightarrow y) \leq I_k(x) \vee I_k(y)$,
- (vi) $T_j(x \odot y) \leq T_j(x) \wedge T_j(x)$ and $F_l(x \odot y) \leq F_l(x) \wedge F_l(x)$,
- (vii) $I_k(x \odot y) \geq I_k(x) \vee I_k(x)$.

Proof. (i), (ii), (iii) Let $x, y \in E$. Since $x \sim y \leq x \rightarrow y$ and T_j and F_l are monotone maps, we get that $T_j(x \sim y) \leq T_j(x \rightarrow y)$ and $F_l(x \sim y) \leq F_l(x \rightarrow y)$. Hence $T_j(x) \wedge T_j(x \sim y) \leq T_j(x) \wedge T_j(x \rightarrow y) \leq T_j(y)$ and $F_l(x) \wedge F_l(x \sim y) \leq F_l(y)$.

In addition, since I_k is an antimonotone map, $x \sim y \leq x \rightarrow y$ concludes that $I_k(x \sim y) \geq I_k(x \rightarrow y)$. Hence

$$I_k(x) \vee I_k(x \sim y) \geq I_k(x) \vee I_k(x \rightarrow y) \geq I_k(y).$$

In a similar way $x \wedge y \leq y$ and $x \odot y \leq x \rightarrow y$, imply that $T_j(x) \wedge T_j(x \odot y) \leq T_j(y)$, $T_j(x) \wedge T_j(x \wedge y) \leq T_j(y)$, $I_k(x) \vee I_k(x \odot y) \geq I_k(y)$, $I_k(x) \vee I_k(x \wedge y) \geq I_k(y)$, $F_l(x) \wedge F_l(x \odot y) \leq F_l(y)$ and $F_l(x) \wedge F_l(x \wedge y) \leq F_l(y)$.

(iv), (v) Let $x, y \in E$. Since $y \leq (x \rightarrow y)$, we get that

$$(T_j(x) \wedge T_j(y)) \leq (T_j(x) \wedge T_j(x \rightarrow y)) \leq T_j(y).$$

In a similar way we conclude that $I_k(y) \leq I_k(x) \vee I_k(x \rightarrow y) \leq I_k(x) \vee I_k(y)$ and $F_l(x) \wedge F_l(y) \leq F_l(x) \wedge F_l(x \rightarrow y)$.

(vi), (vii) Since $x \odot y \leq (x \wedge y)$ and T_j and F_l are monotone maps, then we get that $T_j(x \odot y) \leq T_j(x \wedge y) \leq T_j(x) \wedge T_j(y)$ and $F_l(x \odot y) \leq F_l(x) \wedge F_l(x)$. In a similar way since I_k is an antimonotone map, then we get that $I_k(x \odot y) \geq T_j(x \wedge y) \geq I_k(x) \vee I_k(y)$. \square

Theorem 3.10. Let A be an n -valued refined neutrosophic EQ-prefilter of \mathcal{E} and $x, y, z \in E$. For all $1 \leq j \leq p, 1 \leq l \leq s, 1 \leq k \leq r$, if $x \leq y$, then

- (i) $T_j(x) \wedge T_j(x \sim y) = T_j(x) \wedge T_j(y \rightarrow x)$ and $F_l(x) \wedge F_l(x \sim y) = F_l(x) \wedge F_l(y \rightarrow x)$,
- (ii) $T_j(z) \wedge T_j(z \rightarrow x) \leq T_j(y)$ and $F_l(z) \wedge F_l(z \rightarrow x) = F_l(x) \wedge F_l(z)$,
- (iii) $T_j(x) \wedge T_j(y \rightarrow z) = T_j(x) \wedge T_j(z)$ and $F_l(x) \wedge F_l(y \rightarrow z) = F_l(x) \wedge F_l(z)$,

- (iv) $I_k(x) \vee I_k(x \sim y) = I_k(x) \vee I_k(y \rightarrow x)$,
- (v) $I_k(z) \vee I_k(z \rightarrow x) = I_k(x) \vee I_k(z)$,
- (vi) $I_k(x) \vee I_k(y \rightarrow z) = I_k(x) \vee I_k(z)$.

Proof. (i) Let $x, y \in E$. Then $x \leq y$ follows that $x \sim y = y \rightarrow x$ and so $T_j(x) \wedge T_j(x \sim y) = T_j(x) \wedge T_j(y \rightarrow x)$. Similarly, $F_l(x) \wedge F_l(x \sim y) = F_l(x) \wedge F_l(y \rightarrow x)$, is obtained.

(ii) Let $x, y, z \in E$. Since $z \rightarrow x \leq z \rightarrow y$, we get that $T_j(z \rightarrow x) \leq T_j(z \rightarrow y)$, so $T_j(z) \wedge T_j(z \rightarrow x) \leq T_j(z) \wedge T_j(z \rightarrow y) \leq T_j(y)$ and $F_l(z) \wedge F_l(z \rightarrow x) = F_l(x) \wedge F_l(z)$.

(iii) Let $x, y, z \in E$. Since $y \rightarrow z \leq x \rightarrow z$, we get that $T_j(y \rightarrow z) \leq T_j(x \rightarrow z)$ and so $T_j(x) \wedge T_j(y \rightarrow z) \leq T_j(x) \wedge T_j(x \rightarrow z) \leq T_j(z)$. Moreover, $z \leq y \rightarrow z$ implies that $T_j(z) \leq T_j(y \rightarrow z)$, hence $T_j(z) \wedge T_j(x) \leq T_j(x) \wedge T_j(y \rightarrow z) \leq T_j(z) \wedge T_j(x)$ and so $T_j(x) \wedge T_j(y \rightarrow z) = T_j(z) \wedge T_j(x)$. Similarly, we prove $F_l(x) \wedge F_l(y \rightarrow z) = F_l(x) \wedge F_l(z)$.

(v) Let $x, y, z \in E$. Since $z \rightarrow x \leq z \rightarrow y$, we get that $I_k(z \rightarrow y) \leq I_k(z \rightarrow x)$ and so $I_k(z) \vee I_k(z \rightarrow y) \leq I_k(z) \vee I_k(z \rightarrow x)$. Moreover, $x \leq y$ implies that $I_k(x) \vee I_k(y) = I_k(x)$, hence by Theorem 3.9, $I_k(z) \vee I_k(x) \vee I_k(y) \leq I_k(z) \vee I_k(z \rightarrow x) \leq T_j(x) \vee I_k(z)$ and so $T_j(z) \wedge I_k(z \rightarrow x) = I_k(z) \vee I_k(x)$.

(iv) and (vi) in a similar way are obtained. \square

Theorem 3.11. *A is an n -valued refined neutrosophic EQ -prefilter of \mathcal{E} if and only if for all $x, y \in E$, $1 \leq j \leq p$, $1 \leq l \leq s$ and $1 \leq k \leq r$, the following hold:*

- (i) $T_j(x \wedge y) = T_j(x) \wedge T_j(y)$, $F_l(x \wedge y) = F_l(x) \wedge F_l(y)$ and $I_k(x \wedge y) = I_k(x) \vee I_k(y)$,
- (ii) $T_j(x) \wedge T_j(x \sim y) \leq T_j(x) \wedge T_j(y)$, $F_l(x) \wedge F_l(x \sim y) \leq F_l(x) \wedge F_l(y)$ and $I_k(x) \vee I_k(x \sim y) \geq I_k(x \wedge y)$.

Proof. \implies) Let A be an n -valued refined neutrosophic EQ -prefilter of \mathcal{E} . Then for all $x, y \in E$, $1 \leq j \leq p$, $1 \leq l \leq s$ and $1 \leq k \leq r$,

(i) Since T_j is a monotone map, $x \wedge y \leq x$ and $x \wedge y \leq y$, we obtain $T_j(x \wedge y) \leq T_j(x) \wedge T_j(y)$. In addition from $y \leq x \rightarrow (x \wedge y)$ and Theorem 3.9, we conclude that $T_j(x) \wedge T_j(y) \leq (T_j(x) \wedge T_j(x \rightarrow (x \wedge y))) \leq T_j(x \wedge y)$. Hence $T_j(x \wedge y) = T_j(x) \wedge T_j(y)$. In a similar way one can see that $F_l(x \wedge y) = F_l(x) \wedge F_l(y)$. Since I_k is an antimonotone map, $x \wedge y \leq x$ and $x \wedge y \leq y$, we obtain $I_k(x \wedge y) \geq I_k(x) \vee I_k(y)$. In addition from $y \leq x \rightarrow (x \wedge y)$, we conclude that

$$I_k(x) \vee I_k(y) \geq (I_k(x) \vee I_k(x \rightarrow (x \wedge y))) \geq I_k(x \wedge y).$$

Hence $I_k(x \wedge y) = I_k(x) \vee I_k(y)$.

(ii) Let $x, y \in E$. Then by Theorem 3.9, $T_j(x) \wedge T_j(x \sim y) \leq T_j(y)$. Since $x \sim y = y \sim x$, we obtain $T_j(x) \wedge T_j(x \sim y) = T_j(x) \wedge T_j(y \sim x) \leq T_j(x)$. So $T_j(x) \wedge T_j(x \sim y) \leq T_j(x) \wedge T_j(y)$. Similarly, $F_l(x) \wedge F_l(x \sim y) \leq F_l(x) \wedge F_l(y)$ is obtained.

Since $x \sim y = y \sim x$, we obtain $I_k(x) \vee I_k(x \sim y) = I_k(x) \vee I_k(y \sim x) \geq I_k(x)$. Moreover, $I_k(x) \vee I_k(x \sim y) \geq I_k(y)$ implies that $I_k(x) \vee I_k(x \sim y) \geq I_k(x) \vee I_k(y)$.

\iff) For $x = 1$, we have $T_j(1 \wedge y) = T_j(1) \wedge T_j(y)$, $F_l(1 \wedge y) = F_l(x) \wedge F_l(y)$ and $I_k(1 \wedge y) = I_k(1) \vee I_k(y)$, so for all $x \in E$, $T_j(x) \leq T_j(1)$, $I_k(x) \geq I_k(1)$ and $F_l(x) \leq F_l(1)$. Also it follows that for all $1 \leq j \leq p$, $1 \leq l \leq s$ and $1 \leq k \leq r$, T_j and F_l are monotone maps and I_k is an antimonotone map.

For all $x, y \in E$, $x \sim y \leq x \rightarrow y$ implies that $T_j(x) \wedge T_j(x \sim y) \leq T_j(x) \wedge T_j(x \rightarrow y)$, $F_l(x) \wedge F_l(x \sim y) \leq F_l(x) \wedge F_l(x \rightarrow y)$ and $I_k(x) \vee I_k(x \sim y) \geq I_k(x) \vee I_k(x \rightarrow y)$. If there exist $x, y \in E$ such that $T_j(x) \wedge T_j(x \rightarrow y) \not\leq T_j(y)$, $I_k(x) \vee I_k(x \rightarrow y) \not\geq I_k(y)$ and $F_l(x) \wedge F_l(x \rightarrow y) \not\leq F_l(y)$, then we get that $T_j(x) \wedge T_j(x \sim y) \not\leq T_j(y)$, $F_l(x) \wedge F_l(x \sim y) \not\leq F_l(y)$ and $I_k(x) \vee I_k(x \sim y) \not\geq I_k(x \wedge y)$, which is a contradiction. \square

Corollary 3.12. *Let $\mathcal{E} = (E, \wedge, \odot, \sim, 1)$ be an EQ -algebra, A be an n -valued refined neutrosophic EQ -prefilter of \mathcal{E} , $1 \leq k \leq r$ and $x, y \in E$. Then $x = y$, implies that $I_k(x) \vee I_k(x \sim y) = I_k(x \wedge y)$.*

In Example 4.2, for $x = 1$ and $y = 4$, we have $I_k(x) \vee I_k(x \sim y) = I_k(x \wedge y)$, while $x \neq y$.

4. n -valued refined Neutrosophic EQ -filters

In this section, we investigate the concept of n -valued refined neutrosophic EQ -filters as generalization of n -valued refined neutrosophic EQ -prefilters and prove some of their properties.

Definition 4.1. A map A in E , is called an n -valued refined neutrosophic EQ -filter of \mathcal{E} , if for all $x, y, z \in E$, $1 \leq j \leq p$, $1 \leq k \leq r$ and $1 \leq l \leq s$,

- (i) $T_j(x) \leq T_j(1)$, $I_k(x) \geq I_k(1)$ and $F_l(x) \leq F_l(1)$, (briefly n -VRNF1)
- (ii) $T_j(x) \wedge T_j(x \rightarrow y) \leq T_j(y)$, $I_k(x) \vee I_k(x \rightarrow y) \geq I_k(y)$ and $F_l(x) \wedge F_l(x \rightarrow y) \leq F_l(y)$ (briefly n -VRNF2),
- (iii) $T_j(x \rightarrow y) \leq T_j((x \odot z) \rightarrow (y \odot z))$, $I_k(x \rightarrow y) \geq I_k((x \odot z) \rightarrow (y \odot z))$, and

$$F_l(x \rightarrow y) \leq F_l((x \odot z) \rightarrow (y \odot z)) \text{ (briefly } n\text{-VRNF3)}.$$

In the following theorem, we will show that how to construct of n -valued refined neutrosophic EQ -prefilters in EQ -algebras.

Theorem 4.2. *Let A be an n -valued refined neutrosophic EQ -filter of \mathcal{E} and $x, y \in E$. Then for all $1 \leq j \leq p$ and $1 \leq k \leq r$ and $1 \leq l \leq s$,*

- (i) *If $T_j(x \rightarrow y) = T_j(1)$, $F_l(x \rightarrow y) = F_l(1)$ and $I_k(x \rightarrow y) = I_k(1)$, then for every $z \in E$, $T_j((x \odot z) \rightarrow (y \odot z)) = T_j(x \rightarrow y)$, $F_l((x \odot z) \rightarrow (y \odot z)) = F_l(x \rightarrow y)$ and $I_k((x \odot z) \rightarrow (y \odot z)) = I_k(x \rightarrow y)$.*
- (ii) *If $x \leq y$, then for every $z \in E$, $T_j((x \odot z) \rightarrow (y \odot z)) = T_j(x \rightarrow y)$, $F_l((x \odot z) \rightarrow (y \odot z)) = F_l(x \rightarrow y)$ and $I_k((x \odot z) \rightarrow (y \odot z)) = I_k(x \rightarrow y)$.*
- (iii) *If $T_j(x \rightarrow y) = T_j(0)$, $F_l(x \rightarrow y) = F_l(0)$ and $I_k(x \rightarrow y) = I_k(0)$, then for every $z \in E$, $T_j((x \odot z) \rightarrow (y \odot z)) \geq T_j(x \rightarrow y)$, $F_l((x \odot z) \rightarrow (y \odot z)) \geq F_l(x \rightarrow y)$ and $I_k((x \odot z) \rightarrow (y \odot z)) \leq I_k(x \rightarrow y)$.*

Proof. (i) by definition is obtained.

(ii) Since $x \leq y$ we get that $x \rightarrow y = 1$ and by definition $x \odot z \leq y \odot z$. Hence by item (i), we have $T_j((x \odot z) \rightarrow (y \odot z)) = T_j(x \rightarrow y)$, $F_l((x \odot z) \rightarrow (y \odot z)) = F_l(x \rightarrow y)$ and $I_k((x \odot z) \rightarrow (y \odot z)) = I_k(x \rightarrow y)$.

(iii) It is similar to the item (ii). □

Corollary 4.3. *Let A be an n -valued refined neutrosophic EQ -prefilter of \mathcal{E} , $1 \leq j \leq p$, $1 \leq k \leq r$, $1 \leq l \leq s$ and $0, x, y, z \in E$. If for every $y \in E$, $0 \wedge y = 0$, then*

- (i) $T_j(0 \rightarrow y) = T_j((0 \odot z) \rightarrow (y \odot z))$,
 $F_l(0 \rightarrow y) = F_l((0 \odot z) \rightarrow (y \odot z))$ and
 $I_k(0 \rightarrow y) = I_k((x \odot z) \rightarrow (y \odot z))$,
- (ii) $T_j(x \rightarrow x) = T_j((x \odot z) \rightarrow (y \odot z))$,
 $F_l(x \rightarrow x) = F_l((x \odot z) \rightarrow (y \odot z))$ and
 $I_k(x \rightarrow x) = I_k((x \odot z) \rightarrow (y \odot z))$,
- (iii) $T_j(x \rightarrow 1) = T_j((x \odot z) \rightarrow (y \odot z))$,
 $F_l(x \rightarrow 1) = F_l((x \odot z) \rightarrow (y \odot z))$ and
 $I_k(x \rightarrow 1) = I_k((x \odot z) \rightarrow (y \odot z))$.

Example 4.4. Let $E = \{0, 1, 2, 3, 4\}$. Define operations “ \odot ”, “ \sim ” and “ \wedge ” on E as follows:

\wedge	0 1 2 3 4	\odot	0 1 2 3 4	and	\sim	0 1 2 3 4
0	0 0 0 0 0	0	0 0 0 0 0		0	1 0 0 0 0
1	0 1 1 1 1	1	0 0 0 1 1		1	0 4 1 1 1
2	0 1 2 - 2	2	0 1 2 1 2		2	0 1 4 1 2
3	0 1 - 3 3	3	0 0 0 3 3		3	0 1 1 4 3
4	0 1 2 3 4	4	0 1 2 3 4		4	0 1 2 3 4

Then $\mathcal{E} = (E, \wedge, \odot, \sim, 4)$ is an EQ -algebra, where b and c are non-comparable. Now, with respect to the other operations one can obtain the operation implication “ \rightarrow ” as follows:

\rightarrow	0 1 2 3 4
0	4 4 4 4 4
1	0 4 4 4 4
2	0 1 4 3 4
3	0 1 2 4 4
4	0 1 2 3 4

For all $2 \leq j \leq p$, $2 \leq k \leq r$ and $2 \leq l \leq s$, define a single valued neutrosophic set map A in E as follows, where $p + r + s = n < 10^9$: $T(0) = (T_1(0), T_2(0), \dots, T_p(0))$, where $T_1(0) = 0.4$ and $T_j(0) = 0.4 + \frac{1}{10^9}$, $T(1) = (T_1(1), T_2(1), \dots, T_p(1))$, where $T_1(1) = 0.4$ and $T_j(1) = 0.4 + \frac{2}{10^9}$, $T(2) = (T_1(2), T_2(2), \dots, T_p(2))$, where $T_1(2) = 0.4$ and $T_j(2) = 0.4 + \frac{3}{10^9}$, $T(3) = (T_1(3), T_2(3), \dots, T_p(3))$, where $T_1(3) = 0.4$ and $T_j(3) = 0.4 + \frac{4}{10^9}$, $T(4) = (T_1(4), T_2(4), \dots, T_p(4))$, where $T_1(4) = 0.5$ and $T_j(4) = 0.5 + \frac{5}{10^9}$, $I(0) = (I_1(0), I_2(0), \dots, I_r(0))$, where $I_1(0) = 0.62$ and $I_j(0) = 0.62 - \frac{1}{10^5}$, $I(1) = (I_1(1), I_2(1), \dots, I_r(1))$, where $I_1(1) = 0.62$ and $I_j(1) = 0.62 - \frac{2}{10^5}$, $I(2) = (I_1(2), I_2(2), \dots, I_r(2))$, where $I_1(2) = 0.62$ and $I_j(2) = 0.62 - \frac{3}{10^5}$, $I(3) = (I_1(3), I_2(3), \dots, I_r(3))$, where $I_1(3) = 0.62$ and $I_j(3) = 0.62 - \frac{4}{10^5}$, $I(4) = (I_1(4), I_2(4), \dots, I_r(4))$, where $I_1(4) = 0.11$ and $I_j(4) = 0.11 - \frac{5}{10^5}$, $F(0) = (F_1(0), F_2(0), \dots, F_s(0))$, where $F_1(0) = 0.2$ and $F_j(0) = 0.2 + \frac{1}{10^5}$, $F(1) = (F_1(1), F_2(1), \dots, F_s(1))$, where $F_1(1) = 0.2$ and $F_j(1) = 0.2 + \frac{2}{10^5}$, $F(2) = (F_1(2), F_2(2), \dots, F_s(2))$, where $F_1(2) = 0.2$ and $F_j(2) = 0.2 + \frac{3}{10^5}$, $F(3) = (F_1(3), F_2(3), \dots, F_s(3))$, where $F_1(3) = 0.2$ and $F_j(3) = 0.2 + \frac{4}{10^5}$, $F(4) = (F_1(4), F_2(4), \dots, F_s(4))$, where $F_1(4) = 0.6$ and $F_j(4) = 0.6 + \frac{5}{10^5}$.

Hence A is an n -valued refined neutrosophic EQ -filter of \mathcal{E} .

Theorem 4.5. *Let A be an n -valued refined neutrosophic EQ -filter of \mathcal{E} and $x, y, z \in E$. Then for all $2 \leq j \leq p$, $2 \leq l \leq s$ and $2 \leq k \leq r$,*

- (i) $T_j(x \odot y) = T_j(x) \wedge T_j(y)$, $F_l(x \odot y) = F_l(x) \wedge F_l(y)$ and $I_k(x \odot y) = I_k(x) \vee I_k(y)$,
- (ii) $T_j(x \sim y) \leq T_j(y \rightarrow x)$, $F_l(x \sim y) \leq F_l(y \rightarrow x)$ and $I_k(x \sim y) \geq I_k(y \rightarrow x)$,
- (iii) $T_j(z) \wedge T_j(y) \leq T_j(x \rightarrow z)$, $F_l(z) \wedge F_l(y) \leq F_l(x \rightarrow z)$ and $I_k(z) \vee I_k(y) \geq I_k(x \rightarrow z)$,
- (iv) $T_j(x \sim y) \wedge T_j(y \sim z) \leq T_j(x \sim z)$, $F_l(x \sim y) \wedge F_l(y \sim z) \leq F_l(x \sim z)$ and $I_k(x \sim y) \vee I_k(y \sim z) \geq I_k(x \sim z)$.

Proof. (i) Let $x, y \in E$. Since A is an n -valued refined neutrosophic EQ -filter of \mathcal{E} , we get that

$$\begin{aligned} T_j(1 \rightarrow y) &\leq T_j((1 \odot x) \rightarrow (y \odot x)) \\ &= T_j(x \rightarrow (y \odot x)). \end{aligned}$$

In addition by (n-VRNF2), we have

$$T_j(x) \wedge T_j(x \rightarrow (y \odot x)) \leq T_j(y \odot x).$$

Hence

$$T_j(x) \wedge T_j(y) \leq T_j(x) \wedge T_j(1 \rightarrow y) \leq T_j(y \odot x).$$

Using Theorem 3.9 and obtain $T_j(x) \wedge T_j(y) = T_j(y \odot x)$. Similarly, $F_l(x \odot y) = F_l(x) \wedge F_l(y)$ is obtained.

By item (n-VRNF2), we have

$$I_k(1 \rightarrow y) \geq I_k(1 \odot x) \rightarrow (y \odot x).$$

Then $I_k(x) \vee I_k(1 \rightarrow y) \geq I_k(x) \vee I_k(x \rightarrow (y \odot x)) \geq I_k(y \odot x)$. It follows that $I_k(x) \vee I_k(y) \geq I_k(x) \vee I_k(1 \rightarrow y) \geq I_k(y \odot x)$. Therefore, Theorem 3.9 implies that $I_k(x) \vee I_k(y) = I_k(y \odot x)$.

(ii) Let $x, y \in E$. Then $x \sim y \leq (x \rightarrow y) \wedge (y \rightarrow x)$ implies that $T_j(x \sim y) \leq T_j(y \rightarrow x)$ $F_l(x \sim y) \leq F_l(y \rightarrow x)$ and $I_k(x \sim y) \geq I_k(y \rightarrow x)$.

(iii) Let $x, y, z \in E$. Since $(x \rightarrow y) \odot (y \rightarrow z) \leq (x \rightarrow z)$, by item (i), we get that

$$\begin{aligned} T_j(y) \wedge T_j(z) &\leq T_j(x \rightarrow y) \wedge T_j(y \rightarrow z) \\ &= T_j((x \rightarrow y) \odot (y \rightarrow z)) \\ &\leq T_j(x \rightarrow z). \end{aligned}$$

In a similar way, we get that $F_l(z) \wedge F_l(y) \leq F_l(x \rightarrow z)$ and $I_k(z) \vee I_k(y) \geq I_k(x \rightarrow z)$.

(iv) Let $x, y, z \in E$. Since $(x \sim y) \odot (y \sim z) \leq x \sim z$, we get that $T_j((x \sim y) \odot (y \sim z)) \leq T_j(x \sim z)$. Now by item (i), we get that $T_j(x \sim y) \wedge T_j(y \sim z) = T_j((x \sim y) \odot (y \sim z)) \leq T_j(x \sim z)$. $F_l(x \sim y) \wedge F_l(y \sim z) \leq F_l(x \sim z)$ and $I_k(x \sim y) \vee I_k(y \sim z) \geq I_k(x \sim z)$, in a similar way are obtained. \square

Example 4.6. Consider the EQ -algebra and the n -valued refined neutrosophic EQ -prefilter A of \mathcal{E} which are defined in Example 4.2. Since $0.1 = T_1(1) = T_1(4 \odot 3) \neq 0.3 = 0.4 \wedge 0.3 = T_1(4) \wedge T_1(3)$, we conclude that A is not an n -valued refined neutrosophic EQ -filter A of \mathcal{E} .

4.1. Some results in n -valued refined neutrosophic EQ -filters

From now of, we apply the concept of homomorphisms and (α, β, γ) -level sets to construct of n -valued refined neutrosophic EQ -filters.

Theorem 4.7. Let $\{x_i = (T_{x_i}, F_{x_i}, I_{x_i})\}_{i \in I}$ be a family of n -valued refined neutrosophic EQ -filters of \mathcal{E} . Then $\bigcap_{i \in I} x_i$ is an n -valued refined neutrosophic EQ -filter of \mathcal{E} .

Proof. Let $x \in E, i \in I, T_{x_i} = (T(1, x_i), T(2, x_i), \dots, T(p, x_i)), F_{x_i} = (F(1, x_i), F(2, x_i), \dots, F(r, x_i))$ and $I_{x_i} = (I(1, x_i), I(2, x_i), \dots, I(s, x_i))$. Since for all $1 \leq j \leq p, 1 \leq k \leq r$ and $1 \leq l \leq s, T(j, x_i)(x) \leq T(j, x_i)(1), I(k, x_i)(x) \geq I(k, x_i)(1), F(l, x_i)(x) \leq F(l, x_i)(1)$, we get that for all $i \in I, T_{x_i}(x) \leq T_{x_i}(1), F_{x_i}(x) \leq F_{x_i}(1), I_{x_i}(x) \geq I_{x_i}(1)$ and so $(\bigcap_{i \in I} T_{x_i})(x) = \bigwedge_{i \in I} T_{x_i}(x) \leq T_{x_i}(1), (\bigcap_{i \in I} F_{x_i})(x) = \bigwedge_{i \in I} F_{x_i}(x) \leq F_{x_i}(1)$ and $(\bigcap_{i \in I} I_{x_i})(x) = \bigwedge_{i \in I} I_{x_i}(x) \geq I_{x_i}(1)$. Let $x, y \in E$. Since for all $1 \leq j \leq p, 1 \leq k \leq r$ and $1 \leq l \leq s, T(j, x_i)(x) \wedge T(j, x_i)(x \rightarrow y) \leq T(j, x_i)(y), I(k, x_i)(x) \vee I(k, x_i)(x \rightarrow y) \geq I(k, x_i)(y)$ and $F(l, x_i)(x) \wedge F(l, x_i)(x \rightarrow y) \leq F(l, x_i)(y)$, we get that

$$\begin{aligned} (\bigcap_{i \in I} T_{x_i})(x) \wedge (\bigcap_{i \in I} T_{x_i})(x \rightarrow y) &= \bigwedge_{i \in I} T_{x_i}(x) \wedge \bigwedge_{i \in I} T_{x_i}(x \rightarrow y) \leq \bigwedge_{i \in I} T_{x_i}(y) = \bigcap_{i \in I} T_{x_i}(y), \\ (\bigcap_{i \in I} F_{x_i})(x) \wedge (\bigcap_{i \in I} F_{x_i})(x \rightarrow y) &= \bigwedge_{i \in I} F_{x_i}(x) \wedge \bigwedge_{i \in I} F_{x_i}(x \rightarrow y) \leq \bigwedge_{i \in I} F_{x_i}(y), \text{ and} \\ (\bigcap_{i \in I} I_{x_i})(x) \vee (\bigcap_{i \in I} I_{x_i})(x \rightarrow y) &= \bigwedge_{i \in I} I_{x_i}(x) \vee \bigwedge_{i \in I} I_{x_i}(x \rightarrow y) \geq \bigwedge_{i \in I} I_{x_i}(y) = \bigcap_{i \in I} I_{x_i}(y). \end{aligned}$$

Let $x, y, z \in E$. Since for all $1 \leq j \leq p, 1 \leq k \leq r$ and $1 \leq l \leq s,$

$$T(j, x_i)(x \rightarrow y) \leq T(j, x_i)((x \odot z) \rightarrow (y \odot z)),$$

$$I(k, x_i)(x \rightarrow y) \geq I(k, x_i)((x \odot z) \rightarrow (y \odot z)),$$

and $F(l, x_i)(x \rightarrow y) \leq F(l, x_i)((x \odot z) \rightarrow (y \odot z))$. $(\bigcap_{i \in I} T_{x_i})(x \rightarrow y) = \bigwedge_{i \in I} T_{x_i}(x \rightarrow y) \leq \bigwedge_{i \in I} T_{x_i}(x \odot z \rightarrow y \odot z) = \bigcap_{i \in I} T_{x_i}(x \odot z \rightarrow y \odot z), (\bigcap_{i \in I} F_{x_i})(x \rightarrow y) = \bigwedge_{i \in I} F_{x_i}(x \rightarrow y) \leq \bigwedge_{i \in I} F_{x_i}(x \odot z \rightarrow y \odot z) = \bigcap_{i \in I} F_{x_i}(x \odot z \rightarrow y \odot z)$

$y \odot z)$ and $(\bigwedge_{i \in I} I_{x_i})(x \rightarrow y) = \bigwedge_{i \in I} I_{x_i}(x \rightarrow y) \leq \bigwedge_{i \in I} I_{x_i}(x \odot z \rightarrow y \odot z) = \bigwedge_{i \in I} I_{x_i}(x \odot z \rightarrow y \odot z)$. Thus $\bigcap_{i \in I} x_i$ is an n -valued refined neutrosophic EQ -filter of \mathcal{E} . \square

Definition 4.8. Let A be an n -valued refined neutrosophic EQ -filter of \mathcal{E} and $\alpha, \beta, \gamma \in [0, 1]$. For all $1 \leq j \leq p, 1 \leq k \leq r$ and $1 \leq l \leq s$, consider $T_j^\alpha = \{x \in E \mid T_j(x) \geq \alpha\}$, $F_l^\beta = \{x \in E \mid F_l(x) \geq \beta\}$, $I_k^\gamma = \{x \in E \mid I_k(x) \leq \gamma\}$ and define $A^{(\alpha, \beta, \gamma)} = \{x \in E \mid T_j(x) \geq \alpha, F_l(x) \geq \beta, I_k(x) \leq \gamma, 1 \leq j \leq p, 1 \leq k \leq r, 1 \leq l \leq s\}$. For any $\alpha, \beta, \gamma \in [0, 1]$ the set $A^{(\alpha, \beta, \gamma)}$ is called an (α, β, γ) -level set.

Proposition 4.9. Let A be an n -valued refined neutrosophic EQ -filter of \mathcal{E} and $\alpha_1, \alpha_2, \beta_1, \beta_2, \gamma_1, \gamma_2, \alpha, \beta \in [0, 1]$. For all $1 \leq j \leq p, 1 \leq k \leq r$ and $1 \leq l \leq s$,

- (i) if $\alpha_1 \leq \alpha_2, \beta_1 \leq \beta_2$ and $\gamma_1 \leq \gamma_2$, then $T_j^{\alpha_2} \subseteq T_j^{\alpha_1}, F_l^{\beta_2} \subseteq F_l^{\beta_1}$ and $I_k^{\gamma_1} \subseteq I_k^{\gamma_2}$,
- (ii) if $\alpha_1 \leq \alpha_2, \beta_1 \leq \beta_2$ and $\gamma_2 \leq \gamma_1$, then $A^{(\alpha_2, \beta_2, \gamma_2)} \subseteq A^{(\alpha_1, \beta_1, \gamma_1)}$,
- (iii) if $x \in A^{(\alpha, \beta, \alpha)}$, then $T_j(x) \geq I_k(x)$,
- (iv) if $x \in A^{(\alpha, \beta, \beta)}$, then $F_l(x) \geq I_k(x)$,
- (v) if $x \in A^{(\alpha, \alpha, \alpha)}$, then $T_j(x) \wedge F_l(x) \geq I_k(x)$.

Proof. We prove only the item (v).

(v) Let $x \in A^{(\alpha, \alpha, \alpha)}$. Then $T_j(x) \geq \alpha, F_l(x) \geq \alpha$ and $I_k(x) \leq \alpha$. It follows that $T_j(x) \wedge F_l(x) \geq I_k(x)$. \square

Example 4.10. Consider the EQ -algebra $\mathcal{E} = (E, \wedge, \odot, \sim, 1)$, n -valued refined neutrosophic EQ -filter A of \mathcal{E} in Example 4. If $\alpha = 0.3, \beta = 0.1$ and $\gamma = 0.5$, then for all $1 \leq j \leq p, 1 \leq k \leq r$ and $1 \leq l \leq s$, $T_j^\alpha = E, F_l^\beta = E, I_k^\gamma = \{4\}$ and so $A^{(\alpha, \beta, \gamma)} = \{4\}$.

Theorem 4.11. Let A be an n -valued refined neutrosophic EQ -filter of \mathcal{E} and $\alpha, \beta, \gamma \in [0, 1]$. Then

- (i) if $\emptyset \neq A^{(\alpha, \beta, \gamma)}$, then $A^{(\alpha, \beta, \gamma)}$ is an EQ -filter of \mathcal{E} ,
- (ii) if $A^{(\alpha, \beta, \gamma)}$ is an EQ -filter of \mathcal{E} , then A is an n -valued refined neutrosophic EQ -filter in \mathcal{E} .

Proof. (i) $\emptyset \neq A^{(\alpha, \beta, \gamma)}$, implies that there exists $x \in A^{(\alpha, \beta, \gamma)}$. By Theorem 3.6, for all $1 \leq j \leq p, 1 \leq k \leq r$ and $1 \leq l \leq s$, we conclude that $\alpha \leq T_j(x) \leq T_j(1), \beta \leq F_l(x) \leq F_l(1)$ and $\gamma \geq I_k(x) \geq I_k(1)$. Therefore, $1 \in A^{(\alpha, \beta, \gamma)}$.

Let $x \in A^{(\alpha, \beta, \gamma)}$ and $x \leq y$. Since for all $1 \leq j \leq p, 1 \leq k \leq r$ and $1 \leq l \leq s$, T_j and F_l are monotone maps and I_k is an antimonotone map, we get

that $\alpha \leq T_j(x) \leq T_j(y), \beta \leq F_l(x) \leq F_l(y)$ and $\gamma \geq I_k(x) \geq I_k(y)$. Hence $y \in A^{(\alpha, \beta, \gamma)}$.

Let $x \in A^{(\alpha, \beta, \gamma)}$ and $x \rightarrow y \in A^{(\alpha, \beta, \gamma)}$. Since A is an n -valued refined neutrosophic EQ -filter of \mathcal{E} , by definition for all $1 \leq j \leq p, 1 \leq k \leq r$ and $1 \leq l \leq s$, we get that $\alpha \leq T_j(x) \wedge T_j(x \rightarrow y) \leq T_j(y), \beta \leq F_l(x) \wedge F_l(x \rightarrow y) \leq F_l(y)$ and $\gamma \geq I_k(x) \vee I_k(x \rightarrow y) \geq I_k(y)$. So $y \in A^{(\alpha, \beta, \gamma)}$.

Let $x \rightarrow y \in A^{(\alpha, \beta, \gamma)}$ and $z \in E$. Since A is an n -valued refined neutrosophic EQ -filter of \mathcal{E} , by definition for all $1 \leq j \leq p, 1 \leq k \leq r$ and $1 \leq l \leq s$, we get that $\alpha \leq T_j(x \rightarrow y) \leq T_j((x \odot z) \rightarrow (y \odot z)), \gamma \geq I_k(x \rightarrow y) \geq I_k((x \odot z) \rightarrow (y \odot z))$ and $\beta \leq F_l(x \rightarrow y) \leq F_l((x \odot z) \rightarrow (y \odot z))$. It follows that $(x \odot z) \rightarrow (y \odot z) \in A^{(\alpha, \beta, \gamma)}$ and so $A^{(\alpha, \beta, \gamma)}$ is an EQ -filter of \mathcal{E} .

(ii) Let $x, y, z \in E$. For all $1 \leq j \leq p, 1 \leq k \leq r$ and $1 \leq l \leq s$, consider $\alpha(j, x) = T_j(x), \beta(l, x) = F_l(x)$ and $\gamma(k, x) = I_k(x)$. Since $A^{(\alpha, \beta, \gamma)}$ is an EQ -filter of \mathcal{E} , $1 \in A^{(\alpha, \beta, \gamma)}$ implies that $T_j(1) \geq \alpha(j, x) = T_j(x), F_l(1) \geq \beta(l, x) = F_l(x), I_k(1) \leq \gamma(k, x) = I_k(x)$.

Let $\alpha(j, x \rightarrow y) = T_j(x \rightarrow y), \beta(l, x \rightarrow y) = F_l(x \rightarrow y), \gamma(k, x \rightarrow y) = I_k(x \rightarrow y), \alpha = \alpha(j, x) \wedge \alpha(j, x \rightarrow y), \beta = \beta(l, x) \wedge \beta(l, x \rightarrow y)$ and $\gamma = \gamma(k, x \vee \gamma_{x \rightarrow y})$. We have

$$T_j(x) = \alpha(j, x) \geq \alpha, T_j(x \rightarrow y) = \alpha(j, x \rightarrow y) \geq \alpha,$$

$$F_l(x) = \beta(l, x) \geq \beta, F_l(x \rightarrow y) = \beta(l, x \rightarrow y) \geq \beta$$

and

$$I_k(x) = \gamma(k, x) \leq \gamma, I_k(x \rightarrow y) = \gamma(k, x \rightarrow y) \leq \gamma,$$

so $x, x \rightarrow y \in A^{(\alpha, \beta, \gamma)}$. Since $A^{(\alpha, \beta, \gamma)}$ is an EQ -filter of \mathcal{E} we get $y \in A^{(\alpha, \beta, \gamma)}$. Thus we conclude that $T_j(y) \geq \alpha = \alpha_x \wedge \alpha_{x \rightarrow y} = T_j(x) \wedge T_j(x \rightarrow y), F_l(y) \geq \beta = \beta_x \wedge \beta_{x \rightarrow y} = F_l(x) \wedge F_l(x \rightarrow y)$ and

$$I_k(y) \leq \gamma = \gamma_x \vee \gamma_{x \rightarrow y} = I_k(x) \vee I_k(x \rightarrow y).$$

We have $T_j(x \rightarrow y) = \alpha_{x \rightarrow y} \geq \alpha_{x \rightarrow y}, F_l(x \rightarrow y) = \beta_{x \rightarrow y} \geq \beta_{x \rightarrow y}$ and $I_k(x \rightarrow y) = \gamma_{x \rightarrow y} \leq \gamma_{x \rightarrow y}$, so $x \rightarrow y \in A^{(\alpha_{x \rightarrow y}, \beta_{x \rightarrow y}, \gamma_{x \rightarrow y})}$. Since $A^{(\alpha_{x \rightarrow y}, \beta_{x \rightarrow y}, \gamma_{x \rightarrow y})}$ is an EQ -filter of \mathcal{E} we get $x \odot z \rightarrow y \odot z \in A^{(\alpha_{x \rightarrow y}, \beta_{x \rightarrow y}, \gamma_{x \rightarrow y})}$. Thus we conclude that

$$T_j((x \odot z) \rightarrow (y \odot z)) \geq \alpha_{x \rightarrow y} = T_j(x \rightarrow y),$$

$$F_l((x \odot z) \rightarrow (y \odot z)) \geq \beta_{x \rightarrow y} = F_l(x \rightarrow y)$$

and $I_k((x \odot z) \rightarrow (y \odot z)) \geq \gamma_{x \rightarrow y} = I_k(x \rightarrow y)$. It follows that A is an n -valued refined neutrosophic EQ -filter \mathcal{E} . \square

Corollary 4.12. Let A be an n -valued refined neutrosophic EQ -filter of \mathcal{E} , $\alpha, \beta, \gamma \in [0, 1]$ and $\emptyset \neq A^{(\alpha, \beta, \gamma)}$.

- (i) $A^{(\alpha, \beta, \gamma)}$ is an EQ -filter of \mathcal{E} if and only if A is an n -valued refined neutrosophic EQ -filter in \mathcal{E} .
- (ii) If $G_A = \{x \in E \mid T_j(1) = F_l(1) = 1, I_k(0) = 1, 1 \leq j \leq p, 1 \leq k \leq r, 1 \leq l \leq s\}$, then G_A is an EQ -filter in \mathcal{E}

Let $A = (T_A, F_A, I_A)$ be an n -valued refined neutrosophic EQ -filter in \mathcal{E} , $\alpha, \alpha', \beta, \beta'$,

$\gamma, \gamma' \in [0, 1]$ and $\emptyset \neq H \subseteq \mathcal{E}$. Consider $T_{A,H}^{[\alpha, \alpha']} =$

$$\begin{cases} \alpha & \text{if } x \in H, \\ \alpha' & \text{otherwise,} \end{cases} \quad F_{A,H}^{[\alpha, \alpha']} = \begin{cases} \beta & \text{if } x \in H \\ \beta' & \text{otherwise,} \end{cases} \quad \text{and}$$

$$I_{A,H}^{[\alpha, \alpha']} = \begin{cases} \gamma & \text{if } x \in H, \\ \gamma' & \text{otherwise.} \end{cases} \quad \text{Then we have the following corollary.}$$

Corollary 4.13. Let $A = (T_A, F_A, I_A)$ be an n -valued refined neutrosophic EQ -filter in \mathcal{E} . Then

- (i) $T_{A,H}^{[\alpha, \alpha']}, F_{A,G}^{[\alpha, \alpha']}$ and $I_{A,G}^{[\alpha, \alpha']}$ are fuzzy subsets,
- (ii) $T_{A,H}^{[\alpha, \alpha']}$ is a fuzzy filter in E if and only if G is an EQ -filter of \mathcal{E} ,
- (iii) $F_{A,H}^{[\alpha, \alpha']}$ is a fuzzy filter in E if and only if G is an EQ -filter of \mathcal{E} ,
- (iv) $I_{A,H}^{[\alpha, \alpha']}$ is a fuzzy filter in E if and only if G is an EQ -filter of \mathcal{E} .

Definition 4.14 Let $\mathcal{E} = (E, \wedge, \odot, \sim, 1)$ be an EQ -algebra, A be an n -valued refined neutrosophic EQ -filter of \mathcal{E} . Then A is said to be a normal n -valued refined neutrosophic EQ -filter of \mathcal{E} if there exists $x, y, z \in E$ such that for all $1 \leq j \leq p, 1 \leq k \leq r$ and $1 \leq l \leq s, T_j(x) = 1, I_k(y) = 1$ and $F_l(z) = 1$.

Example 4.15. Consider the EQ -algebra $\mathcal{E} = (E, \wedge, \odot, \sim, 4)$, which is defined in Example 4. For all $2 \leq j \leq p, 2 \leq k \leq r$ and $2 \leq l \leq s$, define a single valued neutrosophic set map A in E as follows, where $p + r + s = n < 10^9$:

$$T(0) = (T_1(0), T_2(0), \dots, T_p(0)), \text{ where } T_1(0) = 0.4 \text{ and } T_j(0) = 0.4 + \frac{1}{10^9}, T(1) = (T_1(1), T_2(1), \dots, T_p(1)), \text{ where } T_1(1) = 0.4 \text{ and } T_j(1) = 0.4 + \frac{2}{10^9}, T(2) = (T_1(2), T_2(2), \dots, T_p(2)), \text{ where } T_1(2) = 0.4 \text{ and } T_j(2) = 0.4 + \frac{3}{10^9}, T(3) = (T_1(3), T_2(3), \dots, T_p(3)), \text{ where } T_1(3) = 0.4 \text{ and } T_j(3) = 0.4 + \frac{4}{10^9}, T(4) = (T_1(4), T_2(4), \dots, T_p(4)), \text{ where } T_1(4) =$$

1 and $T_j(4) = 1, I(0) = (I_1(0), I_2(0), \dots, I_r(0))$, where $I_1(0) = 1$ and $I_j(0) = 1, I(1) = (I_1(1), I_2(1), \dots, I_r(1))$, where $I_1(1) = 1$ and $I_j(1) = 1, I(2) = (I_1(2), I_2(2), \dots, I_r(2))$, where $I_1(2) = 1$ and $I_j(2) = 1, I(3) = (I_1(3), I_2(3), \dots, I_r(3))$, where $I_1(3) = 1$ and $I_j(3) = 1, I(4) = (I_1(4), I_2(4), \dots, I_r(4))$, where $I_1(4) = 0.11$ and $I_j(4) = 0.11 - \frac{5}{10^5}, F(0) = (F_1(0), F_2(0), \dots, F_s(0))$, where $F_1(0) = 0.2$ and $F_j(0) = 0.2 + \frac{1}{10^5}, F(1) = (F_1(1), F_2(1), \dots, F_s(1))$, where $F_1(1) = 0.2$ and $F_j(1) = 0.2 + \frac{2}{10^5}, F(2) = (F_1(2), F_2(2), \dots, F_s(2))$, where $F_1(2) = 0.2$ and $F_j(2) = 0.2 + \frac{3}{10^5}, F(3) = (F_1(3), F_2(3), \dots, F_s(3))$, where $F_1(3) = 0.2$ and $F_j(3) = 0.2 + \frac{4}{10^5}, F(4) = (F_1(4), F_2(4), \dots, F_s(4))$, where $F_1(4) = 1$ and $F_j(4) = 1$,

Hence A is a normal n -valued refined neutrosophic EQ -filter of \mathcal{E} .

Theorem 4.16. Let $\mathcal{E} = (E, \wedge, \odot, \sim, 1)$ be an EQ -algebra and A be an n -valued refined neutrosophic EQ -filter of \mathcal{E} . Then A is a normal n -valued refined neutrosophic EQ -filter of \mathcal{E} if and only if for all $1 \leq j \leq p, 1 \leq k \leq r$ and $1 \leq l \leq s, T_j(1) = 1, F_l(1) = 1$ and $I_k(0) = 1$.

Corollary 4.17. Let $A = (T_A, I_A, F_A)$ be an n -valued refined neutrosophic EQ -filter of \mathcal{E} . Then

- (i) A is a normal n -valued refined neutrosophic EQ -filter of \mathcal{E} if and only if for all $1 \leq j \leq p, 1 \leq k \leq r$ and $1 \leq l \leq s, T_j, F_l$ and I_k are normal fuzzy subset.
- (ii) If there exists a sequence $\{(x_n, y_n, z_n)\}_{n=1}^\infty$ of elements E in such a way that for all $1 \leq j \leq p, 1 \leq k \leq r$ and $1 \leq l \leq s, \{(T_j(x_n), I_j(y_n), F_j(z_n))\} \rightarrow (1, 1, 1)$, then $A(1, 0, 1) = (1, 1, 1)$.

Corollary 4.18. Let $\{x_i = (T_{x_i}, F_{x_i}, I_{x_i})\}_{i \in I}$ be a family of normal n -valued refined neutrosophic EQ -filters of \mathcal{E} . Then $\bigcap_{i \in I} x_i$ is a normal n -valued refined neutrosophic EQ -filter of \mathcal{E} .

In the following, we consider an arbitrary valued refined neutrosophic EQ -filter of \mathcal{E} and try to construct a normal n -valued refined neutrosophic EQ -filters of \mathcal{E} .

Let $A = (T_A, I_A, F_A)$ be an n -valued refined neutrosophic EQ -filter of $\mathcal{E}, x \in E, q \in [1, +\infty), 1 \leq j \leq p, 1 \leq k \leq r$ and $1 \leq l \leq s$. Consider $T_j^{+q}(x) = \frac{1}{q}(q + T_j(x) - T_j(1)), F_l^{+q}(x) = \frac{1}{q}(q + F_l(x) - F_l(1))$ and $I_k^{+q}(x) = \frac{1}{q}(q + I_k(x) - I_k(0))$.

Theorem 4.19. Let $A = (T_j, I_k, F_l)$ be an n -valued refined neutrosophic EQ -filter of \mathcal{E} . Then

- (i) T_j^{+q}, F_A^{+q} and I_k^{+q} are normal EQ -filters of \mathcal{E} ,
- (ii) $(T_j^{+q})^{+q} = T_j^{+q}, (F_A^{+q})^{+q} = F_A^{+q}$ and $(I_k^{+q})^{+q} = I_k^{+q}$ if and only if $q = 1$,
- (iii) $(T_j^{+q})^{+q} = T_j$ if and only if T_j is a normal EQ -filter,
- (iv) $(F_A^{+q})^{+q} = F_l$ if and only if F_l is a normal EQ -filter,
- (v) $(I_k^{+q})^{+q} = I_k$ if and only if $I_k(0) = 1$.

Proof. (i) Let $x \in E$. Because $T_j(x) \leq T_j(1)$, then we have $T_j^{+q}(x) = \frac{1}{q}(q + T_j(x) - T_j(1)) \leq 1$. Assume that $x, y \in E$. Using (SVNF2), we get that $T_j^{+q}(x) \wedge T_j^{+q}(x \rightarrow y) = \frac{1}{q}(q + T_j(x) - T_j(1)) \wedge \frac{1}{q}(q + T_j(x \rightarrow y) - T_j(1)) \frac{1}{q}[(q + T_j(x) - T_j(1)) \wedge (q + T_j(x \rightarrow y) - T_j(1))] = \frac{1}{q}[(q \wedge q) + (T_j(x) \wedge T_j(x \rightarrow y)) - (T_j(1) \wedge T_j(1))] \leq \frac{1}{q}(q + T_j(y) - T_j(1)) = T_j^{+q}(y)$. Suppose that $x, y, z \in E$. Using (SVNF3), we get that $T_j^{+q}(x \rightarrow y) = \frac{1}{q}(q + T_j(x \rightarrow y) - T_j(1)) \leq \frac{1}{q}(q + T_j(x \odot z \rightarrow y \odot z) - T_j(1)) = T_j^{+q}(x \odot z \rightarrow y \odot z)$. Thus T_j^{+q} is an EQ -filter of \mathcal{E} . In addition the equality $T_j^{+q}(1) = \frac{1}{q}(q + T_j(1) - T_j(1)) = 1$, implies that T_j^{+q} is a normal EQ -filter of \mathcal{E} . In a similar way, we can see that F_A^{+q} and I_k^{+q} are normal EQ -filters of \mathcal{E} . (ii) Assume that $x \in E$. Then $(T_j^{+q})^{+q}(x) = [\frac{1}{q}(q + T_j(x) - T_j(1))]^{+q} = \frac{1}{q}[q + \frac{1}{q}(q + T_j(x) - T_j(1)) - \frac{1}{q}(q + T_j(1) - T_j(1))] = \frac{1}{q}(q + \frac{1}{q}(T_j(x) - T_j(1)))$. So $(T_j^{+q})^{+q}(x) = T_j^{+q}(x) \iff \frac{1}{q}(q + \frac{1}{q}(T_j(x) - T_j(1))) = \frac{1}{q}(q + T_j(x) - T_j(1)) \iff q = 1$. Similarly, $(F_A^{+q})^{+q} = F_A^{+q}$ and $(I_k^{+q})^{+q} = I_k^{+q}$ if and only if $q = 1$. (iii) Let $x \in E$. $(T_j^{+q})^{+q} = T_j$ if and only if $\frac{1}{q}(q + \frac{1}{q}(T_j(x) - T_j(1))) = T_j(x) \iff T_j(1) = (1 - q^2)T_j(x) + q^2 \iff q = 1 \iff T_j(1) = 1$. (iv) and (v) are similar to (iii). \square

Example 4.20. Let $E = \{0, 1, 2, 3, 4\}$. Define operations " \odot, \sim " and " \wedge " on E as follows:

\wedge	0 1 2 3 4	\odot	0 1 2 3 4	\sim	0 1 2 3 4
0	0 0 0 0 0	0	0 0 0 0 0	0	4 3 2 1 0
1	0 1 1 1 1	1	0 0 0 0 1	1	3 4 3 2 1
2	0 1 2 2 2	2	0 0 0 1 2	2	2 3 4 3 2
3	0 1 2 3 3	3	0 0 0 1 3	3	1 2 3 4 3
4	0 1 2 3 4	4	0 1 2 3 4	4	0 1 2 3 4

Then $\mathcal{E} = (E, \wedge, \odot, \sim, 4)$ is an EQ -algebra and define $T(0) = (T_1(0), T_2(0), \dots, T_p(0))$, where $T_1(0) = 0.41$ and $T_j(0) = 0.41 + \frac{1}{10^9}$, $T(1) = (T_1(1), T_2(1), \dots, T_p(1))$, where $T_1(1) = 0.42$ and $T_j(1) = 0.42 + \frac{2}{10^9}$, $T(2) = (T_1(2), T_2(2), \dots, T_p(2))$, where $T_1(2) = 0.43$ and $T_j(2) = 0.43 + \frac{3}{10^9}$, $T(3) = (T_1(3), T_2(3), \dots, T_p(3))$, where $T_1(3) = 0.44$ and $T_j(3) = 0.44 + \frac{4}{10^9}$, $T(4) = (T_1(4), T_2(4), \dots, T_p(4))$, where $T_1(4) = 0.5$ and $T_j(4) = 0.5 + \frac{5}{10^9}$, $I(0) = (I_1(0), I_2(0), \dots, I_r(0))$, where $I_1(0) = 0.69$ and $I_j(0) = 0.69 - \frac{1}{10^9}$, $I(1) = (I_1(1), I_2(1), \dots, I_r(1))$, where $I_1(1) = 0.68$ and $I_j(1) = 0.68 - \frac{2}{10^9}$, $I(2) = (I_1(2), I_2(2), \dots, I_r(2))$, where $I_1(2) = 0.67$ and $I_j(2) = 0.67 - \frac{3}{10^9}$, $I(3) = (I_1(3), I_2(3), \dots, I_r(3))$, where $I_1(3) = 0.66$ and $I_j(3) = 0.66 - \frac{4}{10^9}$, $I(4) = (I_1(4), I_2(4), \dots, I_r(4))$, where $I_1(4) = 0.65$ and $I_j(4) = 0.65 - \frac{5}{10^9}$, $F(0) = (F_1(0), F_2(0), \dots, F_s(0))$, where $F_1(0) = 0.21$ and $F_j(0) = 0.21 + \frac{1}{10^9}$, $F(1) = (F_1(1), F_2(1), \dots, F_s(1))$, where $F_1(1) = 0.22$ and $F_j(1) = 0.22 + \frac{2}{10^9}$, $F(2) = (F_1(2), F_2(2), \dots, F_s(2))$, where $F_1(2) = 0.23$ and $F_j(2) = 0.23 + \frac{3}{10^9}$, $F(3) = (F_1(3), F_2(3), \dots, F_s(3))$, where $F_1(3) = 0.24$ and $F_j(3) = 0.24 + \frac{4}{10^9}$, $F(4) = (F_1(4), F_2(4), \dots, F_s(4))$, where $F_1(4) = 0.25$ and $F_j(4) = 0.25 + \frac{5}{10^9}$.

$T^{+3}(0) = (T_1^{+3}(0), T_2^{+3}(0), \dots, T_p^{+3}(0))$, $T_1^{+3}(0) = 0.97$ and $T_j^{+3}(0) = 0.97 - \frac{4}{\epsilon}$, $T^{+3}(1) = (T_1^{+3}(1), T_2^{+3}(1), \dots, T_p^{+3}(1))$, $T_1^{+3}(1) = 0.973$ and $T_j^{+3}(1) = 0.973 - \frac{3}{\epsilon}$, $T^{+3}(2) = (T_1^{+3}(2), T_2^{+3}(2), \dots, T_p^{+3}(2))$, $T_1^{+3}(2) = 0.977$ and $T_j^{+3}(2) = 0.977 - \frac{2}{\epsilon}$, $T^{+3}(3) = (T_1^{+3}(3), T_2^{+3}(3), \dots, T_p^{+3}(3))$, $T_1^{+3}(3) = 0.98$ and $T_j^{+3}(3) = 0.98 - \frac{1}{\epsilon}$, $T^{+3}(4) = (T_1^{+3}(4), T_2^{+3}(4), \dots, T_p^{+3}(4))$, $T_1^{+3}(4) = 1$ and $T_j^{+3}(4) = 1$, $I^{+3}(0) = (I_1^{+3}(0), I_2^{+3}(0), \dots, I_r^{+3}(0))$, $I_1^{+3}(0) = 1$ and $I_j^{+3}(0) = 1$, $I^{+3}(1) = (I_1^{+3}(1), I_2^{+3}(1), \dots, I_r^{+3}(1))$, $I_1^{+3}(1) = 0.997$ and $I_j^{+3}(1) = 0.997 - \frac{1}{\epsilon}$, $I^{+3}(2) = (I_1^{+3}(2), I_2^{+3}(2), \dots, I_r^{+3}(2))$, $I_1^{+3}(2) = 0.993$ and $I_j^{+3}(2) = 0.993 - \frac{2}{\epsilon}$, $I^{+3}(3) = (I_1^{+3}(3), I_2^{+3}(3), \dots, I_r^{+3}(3))$, $I_1^{+3}(3) = 0.99$ and $I_j^{+3}(3) = 0.99 - \frac{3}{\epsilon}$, $I^{+3}(4) = (I_1^{+3}(4), I_2^{+3}(4), \dots, I_r^{+3}(4))$, $I_1^{+3}(4) = 0.987$ and $I_j^{+3}(4) = 0.987 - \frac{4}{\epsilon}$, $F^{+3}(0) = (F_1^{+3}(0), F_2^{+3}(0), \dots, F_s^{+3}(0))$, $F_1^{+3}(0) = 0.987$ and $F_j^{+3}(0) = 0.987 - \frac{4}{\epsilon}$, $F^{+3}(1) = (F_1^{+3}(1), F_2^{+3}(1), \dots, F_s^{+3}(1))$,

$$\begin{aligned}
 F_1^{+3}(1) &= 0.99 & \text{and} & & F_j^{+3}(1) &= 0.99 - \frac{3}{\epsilon}, \\
 F^{+3}(2) &= (F_1^{+3}(2), F_2^{+3}(2), \dots, F_s^{+3}(2)), \\
 F_1^{+3}(2) &= 0.993 & \text{and} & & F_j^{+3}(2) &= 0.993 - \frac{2}{\epsilon}, \\
 F^{+3}(3) &= (F_1^{+3}(3), F_2^{+3}(3), \dots, F_s^{+3}(3)), \\
 F_1^{+3}(3) &= 0.997 & \text{and} & & F_j^{+3}(3) &= 0.997 - \frac{1}{\epsilon}, \\
 F^{+3}(4) &= (F_1^{+3}(4), F_2^{+3}(4), \dots, F_s^{+3}(4)), \\
 F_1^{+3}(4) &= 1 \text{ and } F_j^{+3}(4) = 1.
 \end{aligned}$$

where, $\epsilon = 3 \times 10^9$.

Corollary 4.21. *Let $A = (T_A, I_A, F_A)$ be an n -valued refined neutrosophic EQ -filter of \mathcal{E} . Then*

- (i) $A^{+q} = (T_A^{+q}, I_A^{+q}, F_A^{+q})$ is a normal n -valued refined neutrosophic EQ -filter of \mathcal{E} ,
- (ii) $(A^{+q})^{+q} = A^{+q}$ if and only if $q = 1$,
- (iii) $(A^{+q})^{+q} = A$ if and only if A is a normal n -valued refined neutrosophic EQ -filter.

Let $A = (T_A, I_A, F_A)$ be an n -valued refined neutrosophic EQ -filter of \mathcal{E} and g be an endomorphism on \mathcal{E} . Now, we define $A^g = (T_A^g, I_A^g, F_A^g)$ by $T_A^g(x) = T_A(g(x))$, $F_A^g(x) = F_A(g(x))$ and $I_A^g(x) = I_A(g(x))$.

Theorem 4.22. *Let $A = (T_A, I_A, F_A)$ be an n -valued refined neutrosophic EQ -filter of \mathcal{E} and $x, y \in E$. Then*

- (i) if $x \leq y$, then $T_A^g(x) \leq T_A^g(y)$, $F_A^g(x) \leq F_A^g(y)$ and $I_A^g(x) \geq I_A^g(y)$,
- (ii) A^g is an n -valued refined neutrosophic EQ -filter of \mathcal{E} ,
- (iii) $T'_A(x) = \frac{1}{2}(T_A^g(x) + T_A(x))$ is a fuzzy filter in E ,
- (iv) $F'_A(x) = \frac{1}{2}(F_A^g(x) + F_A(x))$ is a fuzzy filter in E ,
- (v) $A'^g = (T'_A, I'_A, F'_A)$ is an n -valued refined neutrosophic EQ -filter of \mathcal{E} .

Proof. (i) Let $x, y \in E$. If $x \leq y$, then $g(x) \leq g(y)$. It follows that for all $1 \leq j \leq p, 1 \leq k \leq r$ and $1 \leq l \leq s$, $T_j(x) \leq T_j(y), F_k(x) \leq F_k(y), I_l(x) \geq I_l(y)$, so $T_A^g(x) = T_A(g(x)) \leq T_A(g(y))$, $F_A^g(x) = F_A(g(x)) \leq F_A(g(y))$ and $I_A^g(x) = I_A(g(x)) \geq I_A(g(y))$.

(ii) Since $g(x \rightarrow y) = g(x) \rightarrow g(y)$, we get that for all $1 \leq j \leq p, 1 \leq k \leq r$ and $1 \leq l \leq s$, $\wedge\{T_j(x), T_j(x \rightarrow y)\} \leq T_j(y), \vee\{I_k(x), I_k(x \rightarrow y)\} \geq I_k(y)$ and $\wedge\{F_l(x), F_l(x \rightarrow y)\} \leq F_l(y)$. So we have

$$\begin{aligned}
 T_A^g(x) \wedge T_A^g(x \rightarrow y) &= T_A(g(x)) \wedge T_A(g(x) \rightarrow g(y)) \\
 &\leq T_A(g(y)) = T_A^g(y), F_A^g(x) \wedge F_A^g(x \rightarrow y) = F_A(g(x)) \\
 &\wedge F_A(g(x) \rightarrow g(y)) \leq F_A(g(y)) = F_A^g(y)
 \end{aligned}$$

and $I_A^g(x) \vee I_A^g(x \rightarrow y) = I_k(g(x)) \vee I_k(g(x) \rightarrow g(y)) \leq I_k(g(y)) = I_A^g(y)$.

Let $z \in E$. Since $g(x \odot z \rightarrow y \odot z) = g(x \odot z) \rightarrow g(y \odot z)$, for all $1 \leq j \leq p, 1 \leq k \leq r$ and $1 \leq l \leq s$, we get that $T_j(x \rightarrow y) \leq T_j((x \odot z) \rightarrow (y \odot z)), I_k(x \rightarrow y) \geq I_k((x \odot z) \rightarrow (y \odot z))$, and $F_l(x \rightarrow y) \leq F_l((x \odot z) \rightarrow (y \odot z))$. Thus $T_A^g(x \rightarrow y) = T_A(g(x) \rightarrow g(y)) \leq T_A(g(x \odot z \rightarrow y \odot z)) = T_A(g(x \odot z) \rightarrow (y \odot z)) = T_A^g(x \odot z \rightarrow y \odot z), F_A^g(x \rightarrow y) = F_A(g(x) \rightarrow g(y)) \leq F_A(g(x \odot z \rightarrow y \odot z)) = F_A(g(x \odot z) \rightarrow (y \odot z)) = F_A^g(x \odot z \rightarrow y \odot z), I_A^g(x \rightarrow y) = I_A(g(x) \rightarrow g(y)) \geq I_A(g(x \odot z \rightarrow y \odot z)) = I_A(g(x \odot z) \rightarrow (y \odot z)) = I_A^g(x \odot z \rightarrow y \odot z)$.

(iii), (iv) Let $x \in E$. Since $g(1) = 1$, so for all $1 \leq j \leq p, T_j(x) + T_j(g(x)) \leq 2$ implies that $T'_A(x) = \frac{1}{2}(T_A^g(x) + T_j(x)) \leq T'_A(1)$. In a similar way $F'_A(x) \leq F'_A(1)$ and $I'_A(x) \geq I'_A(1)$ are obtained.

Suppose that $x, y \in E$. Then for all $1 \leq j \leq p, 1 \leq k \leq r$ and $1 \leq l \leq s$, we have $\wedge\{T'_j(x), T'_j(x \rightarrow y)\} \leq T'_j(y), \vee\{I'_k(x), I'_k(x \rightarrow y)\} \geq I'_k(y)$ and $\wedge\{F'_l(x), F'_l(x \rightarrow y)\} \leq F'_l(y)$. So $T'_A(x) \wedge T'_A(x \rightarrow y) = \frac{1}{2}(T_A^g(x) + T_A(x)) \wedge \frac{1}{2}(T_A^g(x \rightarrow y) + T_A(x \rightarrow y)) = \frac{1}{2}(T_A^g(x) \wedge T_A^g(x \rightarrow y)) + \frac{1}{2}(T_A(x) \wedge T_A(x \rightarrow y)) \leq \frac{1}{2}(T_A^g(y) + T_A(y)) = T'_A(y)$. We can show that $F'_A(x) \wedge F'_A(x \rightarrow y) \leq F'_A(y)$ and $I'_A(x) \vee I'_A(x \rightarrow y) \geq I'_A(y)$. Let $x, y, z \in E$. Then for all $1 \leq j \leq p, 1 \leq k \leq r$ and $1 \leq l \leq s$, we get that $T_j(x \rightarrow y) \leq T_j((x \odot z) \rightarrow (y \odot z)), I_k(x \rightarrow y) \geq I_k((x \odot z) \rightarrow (y \odot z))$, and $F_l(x \rightarrow y) \leq F_l((x \odot z) \rightarrow (y \odot z))$. Thus $T'_A(x \rightarrow y) = \frac{1}{2}(T_A^g(x \rightarrow y) + T_A(x \rightarrow y)) = \frac{1}{2}(T_A(g(x \odot z \rightarrow y \odot z)) + T_A(x \odot z \rightarrow y \odot z)) = \frac{1}{2}(T_A^g((x \odot z) \rightarrow (y \odot z)) + T_A(x \odot z \rightarrow y \odot z)) = T'_A(x \odot z \rightarrow y \odot z)$. In a similar way can see that $F'_A(x \rightarrow y) \leq F'_A(x \odot z \rightarrow y \odot z)$ and $I'_A(x \rightarrow y) \geq I'_A(x \odot z \rightarrow y \odot z)$.

(v) It is obtained from previous items. \square

Example 4.23. Let $E = \{a_1, a_2, a_3, a_4, a_5, a_6\}$. Define operations “ \odot ”, “ \sim ” and “ \wedge ” on E as follows:

\wedge	a_1	a_2	a_3	a_4	a_5	a_6	\odot	a_1	a_2	a_3	a_4	a_5	a_6
a_1	a_1	a_1	a_1	a_1	a_1	a_1	a_1	a_1	a_1	a_1	a_1	a_1	a_1
a_2	a_1	a_2	a_2	a_2	a_2	a_2	a_2	a_1	a_1	a_1	a_1	a_1	a_1
a_3	a_1	a_2	a_3	a_3	a_3	a_3	a_3	a_1	a_1	a_1	a_1	a_1	a_1
a_4	a_1	a_2	a_3	a_4	a_4	a_4	a_4	a_1	a_1	a_1	a_1	a_1	a_1
a_5	a_1	a_2	a_3	a_4	a_5	a_5	a_5	a_1	a_1	a_1	a_1	a_5	a_5
a_6	a_1	a_2	a_3	a_4	a_5	a_6	a_6	a_1	a_2	a_3	a_4	a_5	a_6

and

\sim	a_1	a_2	a_3	a_4	a_5	a_6
a_1	a_6	a_6	a_1	a_1	a_1	a_1
a_2	a_6	a_6	a_1	a_1	a_1	a_1
a_3	a_1	a_1	a_6	a_4	a_4	a_4
a_4	a_1	a_1	a_4	a_6	a_4	a_4
a_5	a_1	a_1	a_4	a_4	a_6	a_5
a_6	a_1	a_1	a_4	a_4	a_5	a_6

Now, we obtain the operation “ \rightarrow ” as follows:

\rightarrow	a_1	a_2	a_3	a_4	a_5	a_6
a_1	a_6	a_6	a_6	a_6	a_6	a_6
a_2	a_6	a_6	a_6	a_6	a_6	a_6
a_3	a_1	a_1	a_6	a_6	a_6	a_6
a_4	a_1	a_1	a_4	a_6	a_6	a_6
a_5	a_1	a_1	a_4	a_4	a_6	a_6
a_6	a_1	a_1	a_4	a_4	a_5	a_6

Then $\mathcal{E} = (E, \wedge, \otimes, \sim, a_6)$ is an EQ -algebra. Let $g \in \text{End}(E)$. Clearly $g(a_6) = a_6$. Since for any $1 \leq i \leq 4, 1 \leq i' \leq 6, g(a_1) = g(a_i \otimes a_{i'}) = g(a_i) \otimes g(a_{i'})$. So $a_1 = g(a_1) = g(a_5 \sim a_2) = g(a_5) \sim g(a_2) = g(a_5) \sim a_1 = a_1$ implies that $g(a_5) = a_1$. Hence for all $1 \leq i \leq 6$, define a single valued neutrosophic set map A in E as follows, where $p+r+s = n < 10^7$: $T(a_i) = (T_1(a_i), T_2(a_i), \dots, T_p(a_i))$, where $T_1(a_i) = 0.0i$ and for all $2 \leq j \leq p, T_j(a_i) = 0.0i + \frac{j}{10^7}$, $F(a_i) = (F_1(a_i), F_2(a_i), \dots, F_s(a_i))$, where $F_1(a_i) = 0.1i$ and for all $2 \leq k \leq r, F_k = 0.1i + \frac{k}{10^7}$, $I(a_i) = (I_1(a_i), I_2(a_i), \dots, I_r(a_i))$, where $I_1(a_i) = 0.(7-i)i$ and for all $2 \leq l \leq s, I_k = 0.(7-i)i - \frac{l}{10^7}$ and define a homomorphism g as follows:

g	a_1	a_2	a_3	a_4	a_5	a_6
	a_1	a_1	a_1	a_1	a_5	a_6

A simple computations show that (A, \mathcal{E}) is an n -valued refined neutrosophic EQ -prefilter. Now, for all $1 \leq i \leq 4$, we obtain an n -valued refined neutrosophic EQ -prefilter A^g in E as follows: $T^g(a_i) = (T_1^g(a_i), T_2^g(a_i), \dots, T_p^g(a_i))$, where $T_1^g(a_i) = 0.01$ and for all $2 \leq j \leq p, T_j^g(a_i) = 0.01 + \frac{j}{10^7}$, $T_1^g(a_5) = 0.05$ and for all $2 \leq j \leq p, T_j^g(a_5) = 0.05 + \frac{j}{10^7}$, $T_1^g(a_6) = 0.06$ and for all $2 \leq j \leq p, T_j^g(a_6) = 0.06 + \frac{j}{10^7}$, $F^g(a_i) = (F_1^g(a_i), F_2^g(a_i), \dots, F_s^g(a_i))$, where $F_1^g(a_i) = 0.11$ and for all $2 \leq k \leq r, F_k^g = 0.11 + \frac{k}{10^7}$, $F_1^g(a_5) = 0.15$ and for all $2 \leq k \leq r, F_j^g(a_5) = 0.15 + \frac{j}{10^7}$, $F_1^g(a_6) = 0.16$

and for all $2 \leq k \leq r, F_j^g(a_6) = 0.16 + \frac{j}{10^7}$, $I^g(a_i) = (I_1^g(a_i), I_2^g(a_i), \dots, I_r^g(a_i))$, where $I_1^g(a_i) = 0.61$ and for all $2 \leq l \leq s, I_k^g(a_i) = 0.61 - \frac{l}{10^7}$, $I_1^g(a_5) = 0.25$ and for all $2 \leq l \leq s, I_j^g(a_5) = 0.25 + \frac{l}{10^7}$, $I_1^g(a_6) = 0.16$ and for all $2 \leq l \leq s, I_j^g(a_6) = 0.16 + \frac{l}{10^7}$ and obtain an n -valued refined neutrosophic EQ -prefilter A'^g in E as follows:

$T'^g(a_1) = (T_1'^g(a_1), T_2'^g(a_1), \dots, T_p'^g(a_1))$,
 $T_1'^g(a_1) = 0.01$ and $T_j'^g(a_1) = 0.01 + \frac{j}{10^7}$,
 $T'^g(a_2) = (T_1'^g(a_2), T_2'^g(a_2), \dots, T_p'^g(a_2))$,
 $T_1'^g(a_2) = 0.015$ and $T_j'^g(a_2) = 0.015 + \frac{j}{10^9}$,
 $T'^g(a_3) = (T_1'^g(a_3), T_2'^g(a_3), \dots, T_p'^g(a_3))$,
 $T_1'^g(a_3) = 0.02$ and $T_j'^g(a_3) = 0.02 + \frac{j}{10^9}$,
 $T'^g(a_4) = (T_1'^g(a_4), T_2'^g(a_4), \dots, T_p'^g(a_4))$,
 $T_1'^g(a_4) = 0.025$ and $T_j'^g(a_4) = 0.025 + \frac{j}{10^9}$,
 $T'^g(a_5) = (T_1'^g(a_5), T_2'^g(a_5), \dots, T_p'^g(a_5))$,
 $T_1'^g(a_5) = 0.05$ and $T_j'^g(a_5) = 0.05 + \frac{j}{10^9}$,
 $T'^g(a_6) = (T_1'^g(a_6), T_2'^g(a_6), \dots, T_p'^g(a_6))$,
 $T_1'^g(a_6) = 0.06$ and $T_j'^g(a_6) = 0.06 + \frac{j}{10^9}$, $I'^g(a_1) = (I_1'^g(a_1), I_2'^g(a_1), \dots, I_r'^g(a_1))$, $I_1'^g(a_1) = 0.61$ and $I_j'^g(a_1) = 0.61 - \frac{j}{10^9}$, $I'^g(a_2) = (I_1'^g(a_2), I_2'^g(a_2), \dots, I_r'^g(a_2))$, $I_1'^g(a_2) = 0.565$ and $I_j'^g(a_2) = 0.565 - \frac{j}{10^9}$, $I'^g(a_3) = (I_1'^g(a_3), I_2'^g(a_3), \dots, I_r'^g(a_3))$, $I_1'^g(a_3) = 0.52$ and $I_j'^g(a_3) = 0.52 - \frac{j}{10^9}$, $I'^g(a_4) = (I_1'^g(a_4), I_2'^g(a_4), \dots, I_r'^g(a_4))$, $I_1'^g(a_4) = 0.475$ and $I_j'^g(a_4) = 0.475 - \frac{j}{10^9}$, $I'^g(a_5) = (I_1'^g(a_5), I_2'^g(a_5), \dots, I_r'^g(a_5))$, $I_1'^g(a_5) = 0.25$ and $I_j'^g(a_5) = 0.25 - \frac{j}{10^9}$, $I'^g(a_6) = (I_1'^g(a_6), I_2'^g(a_6), \dots, I_r'^g(a_6))$, $I_1'^g(a_6) = 0.16$ and $I_j'^g(a_6) = 0.16 - \frac{j}{10^9}$,
 $F'^g(a_1) = (F_1'^g(a_1), F_2'^g(a_1), \dots, F_s'^g(a_1))$,
 $F_1'^g(a_1) = 0.11$ and $F_j'^g(a_1) = 0.11 + \frac{k}{10^9}$,
 $F'^g(a_2) = (F_1'^g(a_2), F_2'^g(a_2), \dots, F_s'^g(a_2))$,
 $F_1'^g(a_2) = 0.115$ and $F_j'^g(a_2) = 0.115 + \frac{k}{10^9}$,
 $F'^g(a_3) = (F_1'^g(a_3), F_2'^g(a_3), \dots, F_s'^g(a_3))$,
 $F_1'^g(a_3) = 0.12$ and $F_j'^g(a_3) = 0.12 + \frac{k}{10^9}$,
 $F'^g(a_4) = (F_1'^g(a_4), F_2'^g(a_4), \dots, F_s'^g(a_4))$,
 $F_1'^g(a_4) = 0.125$ and $F_j'^g(a_4) = 0.125 + \frac{k}{10^9}$,
 $F'^g(a_5) = (F_1'^g(a_5), F_2'^g(a_5), \dots, F_s'^g(a_5))$,
 $F_1'^g(a_5) = 0.15$ and $F_j'^g(a_5) = 0.15 + \frac{k}{10^9}$,

Table 1
Operations on Computer site E

\wedge	\odot	\sim	\rightarrow
R. M. Q	H.Q	G.C.Q	I. N

Table 2
The relation among Symptoms and Problems

	$E.R$	$H.U$	$E.N$	$L.I$
N	(0.2, 0.3, 0.4)	(0.4, 0.5, 0.6)	(0.6, 0.7, 0.8)	(0.9, 0.8, 0.7)
$D.U$	(0.1, 0.3, 0.5)	(0.2, 0.4, 0.6)	(0.3, 0.5, 0.7)	(0.4, 0.6, 0.8)
$T.O.D$	(0.1, 0.4, 0.7)	(0.2, 0.5, 0.8)	(0.3, 0.6, 0.9)	(0.4, 0.7, 0.1)
$G.D.S$	(0.1, 0.5, 0.9)	(0.2, 0.6, 0.1)	(0.3, 0.7, 0.1)	(0.5, 0.9, 0.4)

$$F_i^g(a_6) = (F_1^g(a_6), F_2^g(a_6), \dots, F_s^g(a_6)),$$

$$F_1^g(a_6) = 0.16 \text{ and } F_j^g(a_6) = 0.16 + \frac{k}{10^9}.$$

4.2. Applications of code-based graphs

In this subsection, we describe some applications of the concept of n -valued refined neutrosophic EQ -prefilter. The concept of n -valued refined neutrosophic logics have some applications such as neutrosophic methods in general relativity, neutrosophic cosmological model, neutrosophic gravitation, qubit and generally quantum superposition of states, quantum states, neutrino-photon doublet, tunneling from the solid physics, etc. We present a mathematical modeling to use of the concept of n -valued refined neutrosophic EQ -prefilters. Consider an arbitrary set as a network-based environment and is equipped to some intended operations and is said it as a mathematical modeling. All parameters in network-based environment can be simulated to a function and these functions work under algebraic operations (in any mathematical modeling there is some options such that depend to operations on a given set). If any parameter has some cases, then we apply the notation of n -valued and based on valuations we present n -valued refined neutrosophic set. We restrict our model to a algebraic system and impose conditions on it as an n -valued refined neutrosophic EQ -prefilters. Filter theory plays an important role in studying various logical algebras and we extend this notations to n -valued refined neutrosophic EQ -prefilters.

Example 4.24. Let $E = \{PC_1, PC_2, PC_3, PC_4, PC_5\}$ be a computer site which users are engaged in computing in E and for all $1 \leq i \leq 5$, PC_i is a computer set. Consider operations " \odot , \sim " and " \wedge " on E in where RAM memory quality=R. M. Q, Hardware

quality =H.Q, Graphic card quality=G.C.Q and Influence=I. N. Now, define operations " \odot , \sim " and " \wedge " on E as follows:

\wedge	PC_1	PC_2	PC_3	PC_4	PC_5
PC_1	PC_1	PC_1	PC_1	PC_1	PC_1
PC_2	PC_1	PC_2	PC_2	PC_2	PC_2
PC_3	PC_1	PC_2	PC_3	PC_3	PC_3
PC_4	PC_1	PC_2	PC_3	PC_4	PC_4
PC_5	PC_1	PC_2	PC_3	PC_4	PC_5
\odot	PC_1	PC_2	PC_3	PC_4	PC_5
PC_1	PC_1	PC_1	PC_1	PC_1	PC_1
PC_2	PC_1	PC_1	PC_1	PC_1	PC_2
PC_3	PC_1	PC_1	PC_1	PC_3	PC_3
PC_4	PC_1	PC_1	PC_1	PC_4	PC_4
PC_5	PC_1	PC_2	PC_3	PC_4	PC_5
\sim	PC_1	PC_2	PC_3	PC_4	PC_5
PC_1	PC_5	PC_2	PC_1	PC_1	PC_1
PC_2	PC_2	PC_5	PC_2	PC_2	PC_2
PC_3	PC_1	PC_2	PC_5	PC_3	PC_3
PC_4	PC_1	PC_2	PC_3	PC_5	PC_4
PC_5	PC_1	PC_2	PC_3	PC_4	PC_5

Then $\mathcal{E} = (E, \wedge, \odot, \sim, PC_5)$ is an EQ -algebra and obtain the operation " \rightarrow " as follows:

\rightarrow	PC_1	PC_2	PC_3	PC_4	PC_5
PC_1	PC_5	PC_5	PC_5	PC_5	PC_5
PC_2	PC_2	PC_5	PC_5	PC_5	PC_5
PC_3	PC_1	PC_2	PC_5	PC_5	PC_5
PC_4	PC_1	PC_2	PC_3	PC_5	PC_5
PC_5	PC_1	PC_2	PC_3	PC_4	PC_5

Let E has some conflicts and $D = \{\text{Error} = E.R, \text{Hang up} = H.U, \text{Exit the network} = E.N, \text{Loss of information} = L.I\}$ be a set of its problems and $S = \{\text{Noise} = N., \text{Dissatisfaction of users} = D.U, \text{Get down the speed} = G.D.S, \text{Slow internet speed} = S.I.S\}$ be a set of symptoms of these problems. In Table 2, each symptom S_i is described by three numbers: truth-membership(effective percentage) T , indeterminacy-membership(percentage of the uncertainty of the effect) I and falsity-membership (percentage of no effect) F . For instance, $(N, E.R) = (0.2, 0.3, 0.4)$ shows that the degree of truth-membership is equal to $\frac{20}{100}$, the degree of indeterminacy-membership is equal to $\frac{30}{100}$ and the degree of falsity-membership is equal to $\frac{40}{100}$.

Table 3
The relation Between Conflict and Symptom

	<i>N</i>	<i>D.U</i>	<i>S.I.S</i>	<i>G.D.S</i>
<i>PC</i> ₁	(0.1, 0.55, 0.2)	(0.4, 0.5, 0.6)	(0.63, 0.7, 0.89)	(0.14, 0.84, 0.5)
	(0.11, 0.54, 0.21)	(0.46, 0.5, 0.6)	(0.16, 0.71, 0.8)	(0.15, 0.83, 0.5)
	(0.12, 0.53, 0.22)	(0.4, 0.5, 0.6)	(0.61, 0.7, 0.8)	(0.16, 0.82, 0.5)
	(0.13, 0.52, 0.23)	(0.4, 0.5, 0.6)	(0.46, 0.17, 0.8)	(0.17, 0.81, 0.5)
<i>PC</i> ₂	(0.2, 0.45, 0.3)	(0.31, 0.5, 0.76)	(0.22, 0.7, 0.8)	(0.21, 0.74, 0.6)
	(0.21, 0.44, 0.31)	(0.3, 0.5, 0.6)	(0.33, 0.7, 0.87)	(0.22, 0.73, 0.6)
	(0.22, 0.43, 0.32)	(0.2, 0.5, 0.65)	(0.49, 0.7, 0.8)	(0.72, 0.8, 0.6)
	(0.23, 0.42, 0.33)	(0.24, 0.5, 0.6)	(0.56, 0.7, 0.8)	(0.24, 0.71, 0.6)
<i>PC</i> ₃	(0.3, 0.35, 0.4)	(0.4, 0.54, 0.36)	(0.16, 0.7, 0.8)	(0.32, 0.68, 0.7)
	(0.31, 0.34, 0.41)	(0.4, 0.5, 0.6)	(0.26, 0.67, 0.8)	(0.33, 0.67, 0.7)
	(0.33, 0.33, 0.42)	(0.46, 0.5, 0.6)	(0.36, 0.7, 0.8)	(0.34, 0.66, 0.7)
	(0.33, 0.32, 0.43)	(0.4, 0.53, 0.6)	(0.46, 0.7, 0.8)	(0.35, 0.65, 0.7)
<i>PC</i> ₄	(0.4, 0.25, 0.5)	(0.14, 0.5, 0.62)	(0.06, 0.7, 0.48)	(0.51, 0.58, 0.8)
	(0.41, 0.24, 0.51)	(0.4, 0.5, 0.6)	(0.16, 0.7, 0.8)	(0.52, 0.57, 0.8)
	(0.42, 0.23, 0.52)	(0.4, 0.5, 0.61)	(0.88, 0.7, 0.28)	(0.53, 0.56, 0.8)
	(0.43, 0.22, 0.53)	(0.24, 0.15, 0.6)	(0.09, 0.72, 0.8)	(0.54, 0.55, 0.8)
<i>PC</i> ₅	(0.5, 0.15, 0.6)	(0.4, 0.5, 0.6)	(0.6, 0.7, 0.8)	(0.91, 0.48, 0.9)
	(0.51, 0.14, 0.61)	(0.4, 0.5, 0.6)	(0.6, 0.7, 0.8)	(0.92, 0.47, 0.9)
	(0.52, 0.13, 0.62)	(0.4, 0.5, 0.6)	(0.6, 0.7, 0.8)	(0.93, 0.46, 0.9)
	(0.53, 0.12, 0.63)	(0.4, 0.5, 0.6)	(0.6, 0.7, 0.8)	(0.94, 0.45, 0.9)

Table 4
Check List for *n*-VRNPF

	<i>N</i>	<i>D.U</i>	<i>S.I.S</i>	<i>G.D.S</i>
<i>A</i>	✓	×	×	✓

The researches obtained different days such as: Saturday, Sunday, Monday and Tuesday in a week as Table 3.

Now consider the 12-VRNS

$$A : E \rightarrow \underbrace{[0, 1] \times [0, 1] \times \dots \times [0, 1]}_{12\text{-times}}$$

where it shows this conflict in twelve days in a month. So we obtain the Table 4, where this table shows that *A* is a 12-VRNF with respect to problems *N* and *G.D.S*. It concludes that this conflict is based on noise and get down the speed.

5. Conclusion

The current paper considered the concept of *n*-valued refined neutrosophic *EQ*-algebras and introduce the concepts *n*-valued refined neutrosophic *EQ*-subalgebras, *n*-valued refined neutrosophic *EQ*-prefilters and *n*-valued refined neutrosophic *EQ*-filters.

- (i) It is showed that *n*-valued refined neutrosophic *EQ*-subalgebras preserve some

binary relation on *EQ*-algebras under some conditions.

- (ii) By using some properties of *n*-valued refined neutrosophic *EQ*-prefilters, we construct new *n*-valued refined neutrosophic *EQ*-prefilters.
- (iii) We considered *n*-valued refined neutrosophic *EQ*-filters as generalisation of *n*-valued refined neutrosophic *EQ*-prefilters and investigated the relations between them.
- (iv) We connected the concept of *EQ*-prefilters to *n*-valued refined neutrosophic *EQ*-prefilters and the concept of *EQ*-filters to *n*-valued refined neutrosophic *EQ*-filters, so we obtained such structures from this connection.

In our future studies, we hope to obtain more results regarding *n*-valued refined neutrosophic codes, *n*-valued refined neutrosophic graphs, *n*-valued refined neutrosophic hypergraphs and their applications. Also, we extend the current results for the underlying filtering systems under the network-based environment with time-delays, packet dropouts.

References

- [1] M. Akram, S. Shahzadi and A. Borumand Saeid, Neutrosophic hypergraphs, *TWMS J App Eng Math* **8**(1) (2018), 122–135.
- [2] M. Dyba and V. Novak, EQ-logics with delta connective, *Iran J Fuzzy System* **12**(2) (2015), 41–61.
- [3] M. El-Zekey, Representable Good EQ-algebras, *Soft Comput* **14** (2010), 1011–1023.
- [4] M. El-Zekey, V. Novak and R. Mesiar, On good EQ-algebras, *Fuzzy Sets and Systems* **178**(1) (2011), 1–23.
- [5] M. Hamidi and A. Borumand Saeid, Accessible single-valued neutrosophic graphs, *J Appl Math Comput* **57** (2018), 121–146.
- [6] M. Hamidi and A. Borumand Saeid, EQ-algebras based on hyper EQ-algebras, *Bol Soc Mat Mex* **24** (2018), 11–35.
- [7] M. Hamidi and A. Borumand Saeid, Achievable single-valued neutrosophic graphs in Wireless sensor networks, *New Mathematics and Natural Computation* **14**(2) (2018), 157–185.
- [8] Y.B. Jun and S.Z. Song, Hesitant fuzzy prefilters and filters of EQ-algebras, *Appl Math Sci* **(9)**11 (2015), 515–532.
- [9] V. Novak, EQ-algebras: Primary concepts and properties, in: *Proc Czech Japan Seminar, Ninth Meeting Kitakyushu & Nagasaki*, Graduate School of Information, Waseda University, 2006, pp. 219–223.
- [10] V. Novak and B. de Baets, EQ-algebras, *Fuzzy Sets and Systems* **160** (2009), 2956–2978.
- [11] V. Novak and M. Dyba, Non-commutative EQ-logics and their extensions, *Fuzzy Sets and Systems* **160** (2009), 2956–2978.
- [12] A. Rezaei, A. Borumand Saeid and F. Smarandache, Neutrosophic filters in BE-algebras, *Ratio Mathematica* **29** (2015), 65–79.
- [13] F. Smarandache, Neutrosophic set, a generalisation of the intuitionistic fuzzy sets, *Inter J Pure Appl Math* **24** (2005), 287–297.
- [14] F. Smarandache, Neutrosophic logic and set, mss, 1995.
- [15] F. Smarandache, Neutrosophy, Neutrosophic Probability, Set, and Logic, Amer Res Press, Rehoboth, USA, 1998.
- [16] F. Smarandache, n-valued refined neutrosophic logic and its applications in physics, *Progress in Physics* **4** (2013), 143–146.
- [17] G. Tourlakis, *Mathematical Logic*, New York, J Wiley & Sons, 2008.
- [18] X.L. Xin, P.F. He and Y.W. Yang, Characterizations of some fuzzy prefilters (Filters) in EQ-Algebras, *Hindawi Publishing Corporation The Scientific World Journal* (2014), 1–12.

Single-valued neutrosophic directed (Hyper)graphs and applications in networks

Mohammad Hamidi, Florentin Smarandache

Mohammad Hamidi, Florentin Smarandache (2019). Single-valued neutrosophic directed (Hyper)graphs and applications in networks. *Journal of Intelligent & Fuzzy Systems* 37, 2869-2885; DOI: 10.3233/JIFS-190036

Abstract. This paper considers networks as wireless sensor (hyper)networks and social (hyper)networks by single-valued neutrosophic (directed)(hyper)graphs. The notion of single-valued neutrosophic hypergraphs are extended to single-valued neutrosophic directed hypergraphs and conversely. We derived single-valued neutrosophic digraphs from single-valued neutrosophic directed hypergraphs via a positive equivalence relation. It tries to use single-valued neutrosophic directed hypergraphs and positive equivalence relation to create the sensor clusters and to access to cluster heads in wire-less sensor (hyper)networks. Finally, the concept of α -derivable single-valued neutrosophic digraph is considered as the energy-efficient protocol of wireless sensor networks and is applied this concept as a tool in wireless sensor (hyper)networks.

Keywords: Single-valued neutrosophic directed (graphs)hypergraphs, positive equivalence relation, α -(semiself-)derivable single-valued neutrosophic digraph, SN, WSN

1. Introduction

As a generalization of the classical set theory, fuzzy set theory was introduced by Zadeh [33] to deal with uncertainties. Fuzzy set theory is playing an important role in modeling and controlling unsure systems in nature, society and industry. Fuzzy set theory also plays a vital role in phenomena which is not easily characterized by classical set theory. Smarandache proposed the idea of neutrosophic sets and mingled the component logic, non-standard analysis, and philosophy, in 1998 [26, 27]. Smarandache [26] and Wang et al. presented the notion of single-valued neutrosophic sets in real life problems more conveniently [32]. A single-valued neutrosophic set has three components: truth membership degree, indeter-

minacy membership degree and falsity membership degree. These three components of a single-valued neutrosophic set are not dependent and their values are contained in the standard unit interval $[0, 1]$. Single-valued neutrosophic sets have been a new hot research topic and many researchers have addressed this issue. Majumdar and Samanta studied similarity and entropy of single-valued neutrosophic sets [16]. Smarandache [28, 29] have defined four main categories of neutrosophic graphs, two based on literal indeterminacy (I), whose name were; I -edge neutrosophic graph and I -vertex neutrosophic graph, these concepts have been deeply studied and have gained popularity among the researchers due to their applications in real world problems [10, 30]. Akram et al. defined the concepts of single-valued neutrosophic hypergraph, line graph of single-valued neutrosophic hypergraph, dual single-valued neutrosophic hypergraph, transversal single-valued

neutrosophic hypergraph [1, 3]. A directed hypergraph is a powerful tool to solve the problems that arise in different fields, including computer networks, social networks and collaboration networks. Akram et al. applied the concept of single-valued neutrosophic sets to directed hypergraphs and introduced certain new concepts, including single-valued neutrosophic directed hypergraphs, single-valued neutrosophic line directed graphs and dual single-valued neutrosophic directed hypergraphs. They described applications of single-valued neutrosophic directed hypergraphs in manufacturing and production networks, collaboration networks and social networks [2, 4]. Further materials regarding graph and hypergraph are available in the literature too [3, 5–7, 12–15, 17–25]. Wireless sensor networks (WSNs) have gained world wide attention in recent years, particularly with the proliferation of micro-electro-mechanical systems technology, which has facilitated the development of smart sensors. WSNs are used in numerous applications, such as environmental monitoring, habitat monitoring, prediction and detection of natural calamities, medical monitoring, and structural health monitoring. WSNs consist of tiny sensing devices that are spread over a large geographic area and can be used to collect and process environmental data such as temperature, humidity, light conditions, seismic activities, images of the environment, and so on.

Regarding these points, this paper aims to generalize the notion of single-valued neutrosophic directed graphs by considering the notion of a positive equivalence relation and trying to define a concept of derivable single-valued neutrosophic directed graphs. The relationships between derivable single-valued neutrosophic directed graphs and single-valued neutrosophic directed hypergraphs are considered as a natural question. The quotient of single-valued neutrosophic directed hypergraphs via equivalence relations is one of our motivations of this research. Moreover, by using a positive equivalence relation, we define a well-defined operation on single-valued neutrosophic directed hypergraphs that the quotient of any single-valued neutrosophic directed hypergraphs via this relation is a single-valued neutrosophic directed graph. We use single-valued neutrosophic directed hypergraphs to represent wireless sensor hypernetworks and social hypernetworks. By considering the concept of the wireless sensor networks, the use of wireless sensor hypernetworks appears to be a necessity for exploring these systems and representation their

relationships. We have introduced several valuable measures as truth-membership, indeterminacy and falsity-membership values for studying wireless sensor hypernetworks, such as node and hypergraph centralities as well as clustering coefficients for both hypernetworks and networks. Clustering is one of the basic approaches for designing energy-efficient, robust and highly scalable distributed sensor networks. A sensor network reduces the communication overhead by clustering, and decreases the energy consumption and the interference among the sensor nodes, so we via the concept of single-valued neutrosophic (hyper)graphs and equivalence relations considered the wireless sensor hypernetworks. A single-valued neutrosophic directed hypergraphs in a similar way, can also be used to study and understand the social networks, using people as nodes (or vertices) and relationships between two or more than two peoples as single valued neutrosophic directed hyperedges. The main our motivation in this study is a simulation and modeling of social network and sensor network to single-valued neutrosophic hypergraphs to solve a considered applied issue. Indeed single-valued neutrosophic directed hypergraphs connected some sets of nodes such that single-valued neutrosophic directed graphs could not connect them. For solving this problem, we modelify any (hyper)network to a single-valued neutrosophic directed hypergraph and by using a positive equivalence relation, convert the single-valued neutrosophic directed hypergraph to a single-valued neutrosophic directed graph. So we extract a single-valued neutrosophic directed graph from a (hyper)network by some algorithms in single-valued neutrosophic directed hypergraphs.

2. Preliminaries

In this section, we recall some definitions and results, which we need in what follows.

Let X be an arbitrary set. Then we denote $P^*(X) = P(X) \setminus \emptyset$, where $P(X)$ is the power set of X .

Definition 2.1. [9] A hypergraph on a finite set G is a pair $H = (G, \{E_i\}_{i=1}^m)$ such that for all $1 \leq i \leq m$,

we have, $E_i \in P^*(G)$ and $\bigcup_{i=1}^m E_i = G$.

The elements of G are called *vertices*, and the sets E_1, E_2, \dots, E_m are said the *hyperedges* of the hypergraph H . For any $1 \leq k \leq m$, if $|E_k| \geq 2$, then E_k is

represented by a solid line surrounding its vertices, if $|E_k| = 1$ by a cycle on the element (loop). If for all $1 \leq k \leq m$, $|E_k| = 2$, the hypergraph becomes an ordinary (undirected) graph.

Theorem 2.2. [12] *Let $H = (G, \{E_x\}_{x \in G})$ be a hypergraph, $\mathbb{N}^* = \mathbb{N} \cup \{0\}$ and $\eta = \eta^*$. Then for every $i \in \mathbb{N}^*$, there exists a relation “ $*_i$ ” on G/η such that $H/\eta = (G/\eta, *_i)$ is a graph.*

Definition 2.3. [31] Let X be a set. A single valued neutrosophic set A in X (SVN-S A) is a function $A : X \rightarrow [0, 1] \times [0, 1] \times [0, 1]$ with the form $A = \{(x, \alpha_A(x), \beta_A(x), \gamma_A(x)) \mid x \in X\}$, where the functions $\alpha_A, \beta_A, \gamma_A$ define respectively a truth-membership function, an indeterminacy-membership function and a falsity-membership function of the element $x \in X$ to the set A such that $0 \leq \alpha_A(x) + \beta_A(x) + \gamma_A(x) \leq 3$.

Moreover, $Supp(A) = \{x \mid \alpha_A(x) \neq 0, \beta_A(x) \neq 0, \gamma_A(x) \neq 0\}$ is a crisp set.

Definition 2.4. [8]

(i) A single valued neutrosophic hypergraph (SVN-HG) is defined to be a pair $\mathcal{H}' = (H, \{E_i\}_{i=1}^m)$, that $H = \{v_1, \dots, v_n\}$ is a finite set of vertices and $\{E_i = \{(v_j, \alpha_{E_i}(v_j), \beta_{E_i}(v_j), \gamma_{E_i}(v_j))\}_{j=1}^m\}$ is a finite family of non-trivial neutrosophic subsets of

the vertex H , such that $H = \bigcup_{i=1}^m supp(E_i)$.

Also $\{E_i\}_{i=1}^m$ is called the family of single valued neutrosophic hyperedges of \mathcal{H}' and H is the crisp vertex set of \mathcal{H}' .

(ii) Let $1 \leq \epsilon_1, \epsilon_2, \epsilon_3 \leq 1$, then $A^{(\epsilon_1, \epsilon_2, \epsilon_3)} = \{x \in X \mid \alpha_A(x) \geq \epsilon_1, \beta_A(x) \geq \epsilon_2, \gamma_A(x) \leq \epsilon_3\}$ is called an $(\epsilon_1, \epsilon_2, \epsilon_3)$ -level subset of A .

Definition 2.5. [11] Let G be a set and $F \subseteq P^*(G) \times P(G)$. Then $F = (T(F), H(F))$ is called a directed hyperedge or hyperarc, if $T(F) \cap H(F) = \emptyset$, where $T(F)$ is called the tail of F and $H(F)$ is called its head. A hypergraph $\mathcal{G}' = (G, \{F_i\}_{i=1}^n = \{(T(F_i), H(F_i))\}_{i=1}^n)$ is called a directed hypergraph (dihypergraph), if for every $1 \leq i \leq n$, F_i is a directed hyperedge.

Definition 2.6. [13] Let $\mathcal{G}' = (G, \{F_i\}_{i=1}^n)$ be a dihypergraph. Then define, $\alpha_1 = \{(x, x) \mid x \in G\}$ and for every integer $n \geq 2$, α_n is defined as follows:

$\alpha_n y \iff \exists 1 \leq k \leq n$ such that $\{x, y\} \subseteq T(F_k) \cup H(F_k)$, where for any $1 \leq i \neq k \leq n$, $x, y \notin T(F_i) \cup$

$H(F_i)$ and $n = |T(F_k)| = |H(F_k)|$. Obviously the relation $\alpha = \bigcup_{n \geq 1} \alpha_n$ is an equivalence relation on \mathcal{G}' .

We denote the set of all equivalence classes of α by \mathcal{G}'/α . Hence $\mathcal{G}'/\alpha = \{\alpha(x) \mid x \in G\}$.

Theorem 2.7. [13] *Let $\mathcal{G}' = (G, \{F_i\}_{i=1}^n)$ be a dihypergraph. Then there exists a relation “ $*$ ” on \mathcal{G}'/α such that $(\mathcal{G}'/\alpha, *)$ is a digraph.*

Definition 2.8. [1] A single-valued neutrosophic directed hypergraph (SVN-DHG) on a non-empty set X is defined as an ordered pair $\mathcal{G}' = (G = \{G_j\}_{j=1}^n, \{F_j(T(G_j), H(G_j))\}_{j=1}^n)$, where for all $1 \leq j \leq n$, $G_j = \{T(G_j) = \{(v_j, \alpha_G(v_j), \beta_G(v_j), \gamma_G(v_j))\}_{v_j \in X}, H(G_j) = \{(v'_j, \alpha_G(v'_j), \beta_G(v'_j), \gamma_G(v'_j))\}_{v'_j \in X}\}$ is a family of non-trivial single-valued neutrosophic subsets on X and $F_j(T(G_j), H(G_j)) = (\alpha_{F_j}, \beta_{F_j}, \gamma_{F_j})$ in such a way that

$$(i) \alpha_{F_j} \leq \bigwedge_{v_j \in T(G_j), v_{j'} \in H(G_j)} (\alpha_G(v_j) \wedge \alpha_G(v_{j'})),$$

$$(ii) \beta_{F_j} \leq \bigwedge_{v_j \in T(G_j), v_{j'} \in H(G_j)} (\beta_G(v_j) \wedge \beta_G(v_{j'})),$$

$$(iii) \gamma_{F_j} \leq \bigwedge_{v_j \in T(G_j), v_{j'} \in T(G_j)} (\gamma_G(v_j) \wedge \gamma_G(v_{j'}))$$

$$\text{and (iv) } X = \bigcup_{j=1}^n supp(G_j).$$

3. Derivable single-valued neutrosophic directed hypergraph

In this section, we apply the concept of single-valued neutrosophic hypergraphs, construct the single-valued neutrosophic directed hypergraphs and present an associated algorithm. The quotient single-valued neutrosophic hypergraph, is constructed via the equivalence relations and the notation of single-valued neutrosophic graphs is reintroduced.

Theorem 3.1 *From every SVN-HG $\mathcal{H}' = (H, \{E_i\}_{i=1}^m)$, (where for all $1 \leq i \leq m$, $|E_i| \geq 2$), can construct at least an SVN-DHG $\mathcal{G}' = (G = \{G_j\}_{j=1}^n, \{F_j(T(G_j), H(G_j))\}_{j=1}^n)$ such that*

- (i) $G = H$,
- (ii) $m = n$,

Table 1
Algorithm 1

1. Input the SVN-HG $\mathcal{H}' = (H, \{E_i\}_{i=1}^m)$ and equivalence relation R on H .
2. If $|H/R| = k$, then for all $1 \leq i \leq k$ and $1 \leq s, t \leq n$ set $G_i = \left\{ \{(x_i, \alpha_{x_i}, \beta_{x_i}, \gamma_{x_i})\}_{i=1}^s, \{(y_i, \alpha_{y_i}, \beta_{y_i}, \gamma_{y_i})\}_{i=1}^t \right\}$, where $s + t = k$ and $G_i \in H/R$.
3. For all $1 \leq i \leq k$, set $\alpha_{F_i} = \left(\bigwedge_{i=1}^t \alpha_{x_i} \right) \wedge \left(\bigwedge_{i=1}^s \alpha_{y_i} \right)$, $\beta_{F_i} = \left(\bigwedge_{i=1}^t \beta_{x_i} \right) \wedge \left(\bigwedge_{i=1}^s \beta_{y_i} \right)$ and $\gamma_{F_i} = \left(\bigvee_{i=1}^t \gamma_{x_i} \right) \wedge \left(\bigvee_{i=1}^s \gamma_{y_i} \right)$.
4. $\mathcal{G}' = (\{G_i\}_{i=1}^k, \{\alpha_{F_i}, \beta_{F_i}, \gamma_{F_i}\}_{i=1}^k)$ is an SVN-DHG.

(iii) for any $1 \leq i \leq m$, there exists $1 \leq j \leq n$, such that $T(G_j) \cup H(G_j) = E_i$.

Proof. Let $\mathcal{H}' = (H, \{E_i\}_{i=1}^m)$ be an SVN-HG. Then $H = \{v_1, v_2, \dots, v_n\}$ is a finite set of vertices and $\{E_i = \{(v_j, \alpha_{E_i}(v_j), \beta_{E_i}(v_j), \gamma_{E_i}(v_j))\}_{j=1}^m\}$ is a finite family of non-trivial neutrosophic subsets of the vertex H such that $H = \bigcup_{i=1}^m \text{supp}(E_i)$. For every $1 \leq i \leq m$ and $1 \leq j \leq n$, define an equivalence relation R_i on E_i and consider $v_j^i, v_{j'}^i \in E_i$ in such a way that $E_i = R_i(v_j^i) \cup R_i(v_{j'}^i)$. Now, for every $1 \leq i \leq m$, we set

$$T(G_j) = \{(R_i(v_j^i), \alpha_{R_i}(v_j), \beta_{R_i}(v_j), \gamma_{R_i}(v_j))\},$$

$$H(G_j) = \{(R_i(v_{j'}^i), \alpha_{R_i}(v_{j'}^i), \beta_{R_i}(v_{j'}^i), \gamma_{R_i}(v_{j'}^i))\}$$

and $F_j(T(G_j), H(G_j)) = (\alpha_{F_j}, \beta_{F_j}, \gamma_{F_j})$, where

$$\alpha_{F_j} = \left(\bigwedge_{xR_i(v_j^i)} \alpha_{R_i}(x) \right) \wedge \left(\bigwedge_{yR_i(v_{j'}^i)} \alpha_{R_i}(y) \right), \beta_{F_j} = \left(\bigwedge_{xR_i(v_j^i)} \beta_{R_i}(x) \right) \wedge \left(\bigwedge_{yR_i(v_{j'}^i)} \beta_{R_i}(y) \right) \text{ and}$$

$$\gamma_{F_j} = \left(\bigvee_{xR_i(v_j^i)} \gamma_{R_i}(x) \right) \wedge \left(\bigvee_{yR_i(v_{j'}^i)} \gamma_{R_i}(y) \right).$$

Some

modifications and computations show that $\mathcal{H}' = (H = \{E_j\}_{j=1}^m, \{F_i(T(E_i), H(E_i))\}_{i=1}^m)$, is a single-valued neutrosophic directed hypergraph (SVN-DHG), where for all $1 \leq j \leq m$, $G_j = E_j = \{(v_j, \alpha_{E_j}(v_j), \beta_{E_j}(v_j), \gamma_{E_j}(v_j))\}$. Clearly for any $1 \leq i \leq m$, $T(E_i) \cup H(E_i) = E_i$ and $H = \bigcup_{i=1}^m \text{supp}(E_i)$ implies that $G = \bigcup_{j=1}^m \text{supp}(G_j)$. □

Corollary 3.2. From all SVN-HG, $\mathcal{H}' = (H, \{E_i\}_{i=1}^m)$, can construct at least an SVN-DHG, $\mathcal{G}' = (G = \{G_j\}_{j=1}^n, \{F_j(T(G_j), H(G_j))\}_{j=1}^n)$ such that

(i) $G = H$,

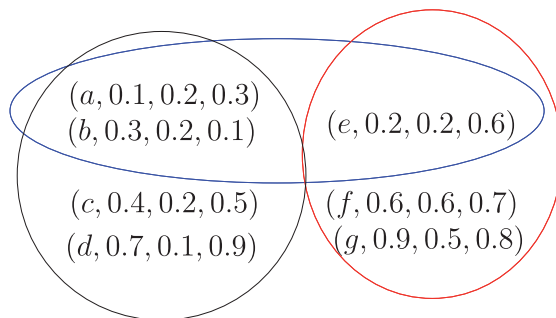

Fig. 1. SVN-HG

(ii) $n = m$,
(iii) for any $1 \leq i \leq m$, there exists $1 \leq j \leq n$, such that $T(G_j) \cup H(G_j) = E_i$.

Let $\mathcal{H}' = (H, \{E_i\}_{i=1}^m)$ be an SVN-HG. We will call the SVN-DHG $\mathcal{G}' = (G = \{G_j\}_{j=1}^n, \{F_j(T(G_j), H(G_j))\}_{j=1}^n)$ which satisfied in Corollary 3, by a derived single-valued neutrosophic directed hypergraph (derived SVN-DHG) from SVN-HG, $\mathcal{H}' = (H, \{E_i\}_{i=1}^m)$ and will show by $\mathcal{G}' = \mathcal{H}'^\uparrow$.

The method for the construction of an SVN-DHG \mathcal{G}' from an SVN-HG \mathcal{H}' is explained in Algorithm 1 in Table 1.

Example 3.3. Let $\mathcal{H}' = (\{a, b, c, d, e, f, g\}, \{E_1, E_2, E_3\})$ be an SVN-HG in Figure 1, where $E_1 = \{(a, 0.1, 0.2, 0.3), (b, 0.3, 0.2, 0.1), (e, 0.2, 0.2, 0.6)\}$, $E_2 = \{(a, 0.1, 0.2, 0.3), (b, 0.3, 0.2, 0.1), (c, 0.4, 0.2, 0.5), (d, 0.7, 0.1, 0.9)\}$ and $E_3 = \{(e, 0.2, 0.2, 0.6), (f, 0.6, 0.6, 0.7), (g, 0.9, 0.5, 0.8)\}$. Then, by Theorem 3, we obtain an SVN-DHG in Figure 2, where $G_1 = \{(a, 0.1, 0.2, 0.3), (b, 0.3, 0.2, 0.1)\}$, $\{(e, 0.2, 0.2, 0.6)\}$, $G_2 = \{(a, 0.1, 0.2, 0.3), (b, 0.3, 0.2, 0.1)\}$, $\{(c, 0.4, 0.2, 0.5), (d, 0.7, 0.1, 0.9)\}$, $G_3 = \{(e, 0.2, 0.2, 0.6)\}$, $\{(f, 0.6, 0.6, 0.7), (g, 0.9, 0.5, 0.8)\}$, $(\alpha_{F_1}, \beta_{F_1}, \gamma_{F_1}) = (0.1, 0.2, 0.3)$, $(\alpha_{F_2}, \beta_{F_2}, \gamma_{F_2}) = (0.1, 0.1, 0.3)$ and $(\alpha_{F_3}, \beta_{F_3}, \gamma_{F_3}) = (0.2, 0.2, 0.6)$.

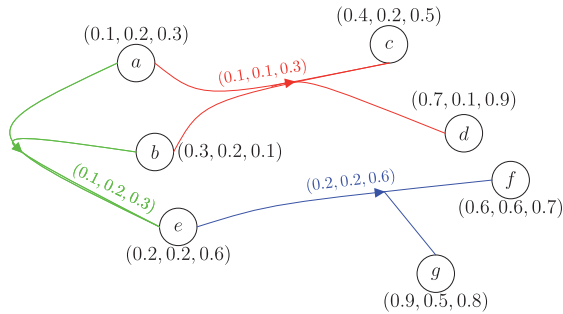

Fig. 2. Derived SVN-DHG \mathcal{H}'^\uparrow from Figure 1

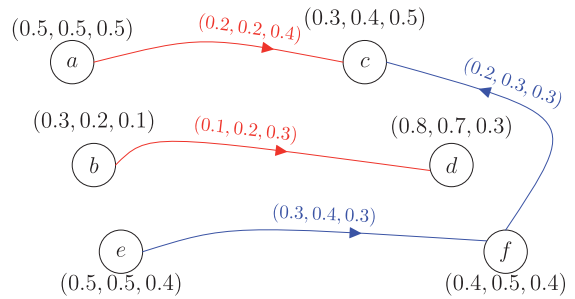

Fig. 3. SVN-DHG \mathcal{G}'

Definition 3.4. Let $\mathcal{G}' = (G = \{G_j\}_{j=1}^n, \{F_j(T(G_j), H(G_j))\}_{j=1}^n)$ be an SVN-DHG. We call \mathcal{G}' a derivable SVN-DHG, if there exists an SVN-HG as $\mathcal{H}' = (H, \{E_i\}_{i=1}^n)$ such that \mathcal{G}' is derived from \mathcal{H}' .

Theorem 3.5. Every SVN-DHG is a derivable SVN-DHG.

Proof. Let $\mathcal{G}' = (G = \{G_j\}_{j=1}^n, \{F_j(T(G_j), H(G_j))\}_{j=1}^n)$ be an SVN-DHG. Then consider $H = G$ and for every $1 \leq i \leq n$, $E_i = \bigcup_{i=1}^n (T(G_i) \cup H(G_i))$. Since $G = \bigcup_{j=1}^n \text{supp}(G_j)$, we get $H = \bigcup_{i=1}^n \text{supp}(E_i)$ and so $\mathcal{H}' = (H, \{E_i\}_{i=1}^n)$ is an SVN-HG. Now, if consider $\alpha_{F_i} = \bigwedge_{x \in E_i} \alpha_{E_i}(x)$, $\beta_{F_i} = \bigwedge_{x \in E_i} \beta_{E_i}(x)$ and $\gamma_{F_i} = \bigwedge_{x \in E_i} \gamma_{E_i}(x)$, then $\mathcal{G}' = (G = \{G_j\}_{j=1}^n, \{F_j(T(G_j), H(G_j))\}_{j=1}^n)$ is derived from $\mathcal{H}' = (H, \{E_i\}_{i=1}^n)$ and so it is a derivable SVN-DHG. \square

We will show the SVN-HG $\mathcal{H}' = (H, \{E_i\}_{i=1}^n)$ in Theorem 3.5, by $\mathcal{H}' = \mathcal{G}'^\downarrow$.

Corollary 3.6. Let \mathcal{G}' be an SVN-DHG. Then $(\mathcal{G}'^\downarrow)^\uparrow \cong \mathcal{G}'$.

Example 3.7. Consider the SVN-DHG, \mathcal{G}' in Figure 3, where $G_1 = \{(a, 0.5, 0.5, 0.5)\}, \{(c, 0.3, 0.4, 0.5)\}$, $G_2 = \{(b, 0.3, 0.2, 0.1)\}, \{(d, 0.8, 0.7, 0.3)\}$, $G_3 = \{(e, 0.5, 0.5, 0.4)\}, \{(f, 0.4, 0.5, 0.4)\}$, $G_4 = \{(f, 0.4, 0.5, 0.4)\}, \{(c, 0.3, 0.4, 0.5)\}$, $(\alpha_{F_1}, \beta_{F_1}, \gamma_{F_1}) = (0.2, 0.2, 0.4)$, $(\alpha_{F_2},$

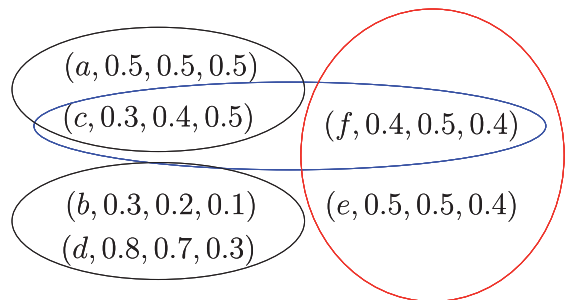

Fig. 4. SVN-HG \mathcal{G}'^\downarrow from Figure 3

$\beta_{F_2}, \gamma_{F_2}) = (0.1, 0.2, 0.3)$, $(\alpha_{F_3}, \beta_{F_3}, \gamma_{F_3}) = (0.3, 0.4, 0.3)$ and $(\alpha_{F_4}, \beta_{F_4}, \gamma_{F_4}) = (0.2, 0.3, 0.3)$.

Then, by Theorem 3, we obtain an SVN-HG in Figure 4, where $E_1 = \{(a, 0.5, 0.5, 0.5), (c, 0.3, 0.4, 0.5)\}$, $E_2 = \{(c, 0.3, 0.4, 0.5), (f, 0.4, 0.5, 0.4)\}$, $E_3 = \{(b, 0.3, 0.2, 0.1), (d, 0.8, 0.7, 0.3)\}$ and $E_4 = \{(f, 0.4, 0.5, 0.4), (e, 0.5, 0.5, 0.4)\}$.

Definition 3.8 (i) A single valued neutrosophic digraph(SVN-DG) is a pair $D = (V, A)$, where $V = \{(v_j, \alpha_V(v_j), \beta_V(v_j), \gamma_V(v_j))\}_{j=1}^n$, is a family of non-trivial single-valued neutrosophic subsets on V , $A = \{(v_i, v_j), (v_j, v_i) \mid v_i, v_j \in V\}$, such that (1), $\alpha_A(v_i, v_j) \leq \min\{\alpha_V(v_i), \alpha_V(v_j)\}$, (2), $\beta_A(v_i, v_j) \geq \max\{\beta_V(v_i), \beta_V(v_j)\}$, (3), $\gamma_A(v_i, v_j) \geq \max\{\gamma_V(v_i), \gamma_V(v_j)\}$ and for every $(v_i, v_j) \in A$, (4), $S_\alpha^\beta(A, v_i) = \alpha_A(v_i) + \beta_A(v_i) \geq S_\alpha^\beta(A, v_j) = \alpha_A(v_j) + \beta_A(v_j)$,

(ii) an SVN-DG is called a weak single-valued neutrosophic graph(WSVN-DG), if $\text{supp}(A) = V$;

(iii) an SVN-DG is called a regular single-valued neutrosophic graph(RSVN-DG), if it is a WSVN-DG and for any $v_i, v_j \in V$ have $\alpha_B(v_i, v_j) = \min\{\alpha_A(v_i), \alpha_A(v_j)\}$, $\beta_B(v_i, v_j) = \max\{\beta_A(v_i), \beta_A(v_j)\}$ and $\gamma_B(v_i, v_j) = \max\{\gamma_A(v_i), \gamma_A(v_j)\}$.

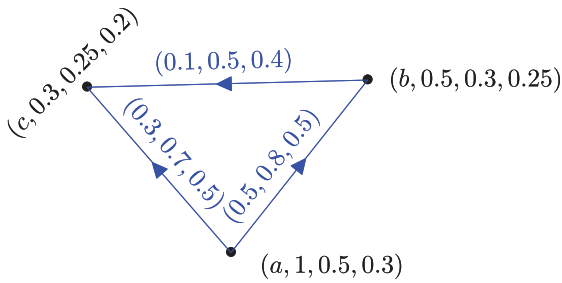

Fig. 5. SVN-DG K_3

Proposition 3.9. Let $V = \{a_1, a_2, \dots, a_n\}$. Consider the complete graph K_n and define $V = \{(a_i, \frac{1}{i}, \frac{1}{i+1}, \frac{1}{i+2})\}_{i=1}^n$.

- (i) If $A = \{(a_i, a_j), \frac{1}{ij}, \frac{i+j+2}{ij+j+i+1}, \frac{i+j+4}{ij+2j+2i+4}\}$, then $D = (V, A)$ is a WSVN-DG.
- (ii) If $A = \{(a_i, a_j), \frac{1}{j}, \frac{1}{i}, \frac{1}{i}\} \mid j < i\}$, then $D = (V, A)$ is an RSVN-DG.

Example 3.10. Let $V = \{a, b, c\}$. Then $D = (V, A)$ is an SVN-DG in Figure 5.

Corollary 3.11. Any finite set can be an RSVN-DG and a WSVN-DG.

Proof. Let G be a finite set and R be an equivalence relation on G . Then consider, $H = (G, \{R(x) \times R(y)\}_{x,y \in G})$, whence it is a complete graph. Applying Proposition 3, the proof is obtained. \square

Lemma 3.12. Let X be a finite set and $A = \{(x, \alpha_A(x), \beta_A(x), \gamma_A(x)) \mid x \in X\}$ be an SVN-S in X . If R is an equivalence relation on X , then $A/R = \{(R(x), T_{R(A)}(R(x)), I_{R(A)}(R(x)), F_{R(A)}(R(x)) \mid x \in X\}$ is an SVN-S, where $\alpha_{R(A)}(R(x)) = \alpha_A(t), \beta_{R(A)}(R(x)) =$

$$\beta_A(t) \text{ and } \gamma_{R(A)}(R(x)) = \gamma_A(t).$$

Proof. Let $X = \{x_1, x_2, \dots, x_n\}$ and $\mathcal{P} = \{R(x_1), R(x_2), \dots, R(x_k)\}$ be a partition of X , where $k \leq n$. Since for any $x_i \in X, \alpha_A(x_i) \leq 1, \beta_A(x_i) \leq 1$ and $\gamma_A(x_i) \leq 1$, we get that $\alpha_A(t) \leq 1, \beta_A(t) \leq 1$ and $\gamma_A(t) \leq 1$.

Hence for any $1 \leq i \leq k, 0 \leq \alpha_A(t) + \beta_A(t) + \gamma_A(t) \leq 3$ and so $R(A) = \{(R(x_i), \bigvee_{t \in R x_i} \alpha_A(t), \bigvee_{t \in R x_i} \beta_A(t), \bigvee_{t \in R x_i} \gamma_A(t))\}_{i=1}^k$ is a single-valued neutrosophic set in X/R . \square

Theorem 3.13 Let $V = \{v_1, v_2, \dots, v_n\}$ and $\mathcal{G}' = (G = \{G_j\}_{j=1}^n, \{F_j(T(G_j), H(G_j))\}_{j=1}^n)$ be an SVN-DHG. If R is an equivalence relation on H , then $\mathcal{G}'/R = (R(G) = \{G_j/R\}_{j=1}^{n'}, \{F_j/R(T(G_j/R), H(G_j/R))\}_{j=1}^{n'})$ is an SVN-DHG, where $n' \leq n$.

Proof. By Lemma 3, $\{R(v_j), \alpha_{R(F_i)}(R(v_j)), \beta_{R(F_i)}(R(v_j)), \gamma_{R(F_i)}(R(v_j))\}_{i=1}^n$ is a finite family of single-valued neutrosophic subsets of V/R . Since $V = \bigcup_{j=1}^n \text{supp}(G_j)$, we get that $\bigcup_{i=1}^{n'} \text{supp}(R(G_j)) = R(\bigcup_{j=1}^n \text{supp}(G_j)) = R(V)$. Now, for all $1 \leq i \leq n'$, define $F_i/R(T(F_i/R), H(F_i/R)) = (\alpha_{F_i/R}, \beta_{F_i/R}, \gamma_{F_i/R})$ as follows; if $R(x) \in T(G_i/R)$ and $R(y) \in H(G_i/R)$, then for all $a \in R(x), b \in R(y)$ there exist $1 \leq j \leq n, a' \in T(G_j), b' \in H(G_j)$ such that $(a, a') \in R, (b, b') \in R, \alpha_{F_i/R} = \bigwedge \alpha_{F_j}, \beta_{F_i/R} = \bigwedge \beta_{F_j}$ and $\gamma_{F_i/R} = \bigwedge \gamma_{F_j}$. It follows that \mathcal{G}'/R is an SVN-DHG. \square

Example 3.14. Consider the SVN-DHG \mathcal{G}' , in Figure 2. If R is an equivalence relation on G such that $R(a) = \{a\}, R(b) = \{b\}, R(c) = \{e, c\}$ and $R(d) = \{d, g, f\}$. Since $G_1 = \{(a, 0.1, 0.2, 0.3), (b, 0.3, 0.2, 0.1), \{(e, 0.2, 0.2, 0.6)\}$ and $R(c) = R(e)$, we get that $R(G_2) = \{(R(a), 0.1, 0.2, 0.3), (R(b), 0.3, 0.2, 0.1), \{(R(c), 0.4, 0.2, 0.6)\}$. In a similar a way, $G_2 = \{(a, 0.1, 0.2, 0.3), (b, 0.3, 0.2, 0.1), \{(c, 0.4, 0.2, 0.5), (d, 0.7, 0.1, 0.9)\}$ and $R(d) = R(g) = R(f)$ imply that $R(G_1) = \{(R(a), 0.1, 0.2, 0.3), (R(b), 0.3, 0.2, 0.1), \{(R(d), 0.9, 0.6, 0.9)\}$. Because $G_3 = \{(e, 0.2, 0.2, 0.6), \{(f, 0.6, 0.6, 0.7), (g, 0.9, 0.5, 0.8)\}$, $R(c) = R(e)$ and $R(d) = R(g) = R(f)$, we have $R(G_3) = \{(R(c), 0.4, 0.2, 0.6), \{(R(d), 0.9, 0.6, 0.9)\}$. Thus by Theorem 3, we obtain the SVN-DHG \mathcal{G}'/R , in Figure 6, where $(\alpha_{F_1}, \beta_{F_1}, \gamma_{F_1}) = (0.1, 0.1, 0.3), (\alpha_{F_1/R}, \beta_{F_1/R}, \gamma_{F_1/R}) =$

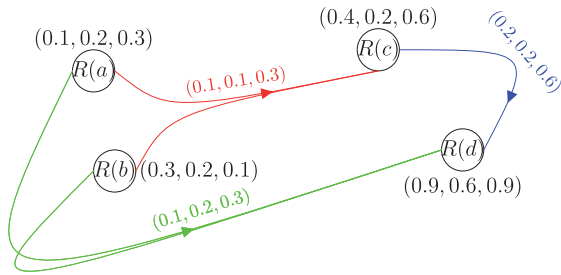

Fig. 6. SVN-DHG \mathcal{G}'/R from Figure 2

$$(0.1, 0.2, 0.3) \quad \text{and} \quad (\alpha_{F_1/R}, \beta_{F_1/R}, \gamma_{F_1/R}) = (0.2, 0.2, 0.6).$$

4. α -Derivable SVN-DG

In this section, we introduce the concept of α -derivable single-valued neutrosophic digraphs via the equivalence relation α on single-valued neutrosophic directed hypergraphs. It is shown that any single-valued neutrosophic digraph is not necessarily an α -derivable single-valued neutrosophic digraph and it is proved under some conditions. Furthermore, it can show that directed path graphs, directed cyclic graphs, directed star graphs, directed complete graphs can be single-valued neutrosophic directed graphs and can be α -derivable single-valued neutrosophic directed graphs. Also we define the concept of α -(semi)self derivable single-valued neutrosophic digraphs and prove that some class of directed graphs are not α -self derivable single-valued neutrosophic digraphs, while are α -semiself derivable single-valued neutrosophic digraphs.

Theorem 4.1. *Let $\mathcal{G}' = (G = \{G_j\}_{j=1}^n, \{F_j(T(G_j), H(G_j))\}_{j=1}^n)$ be an SVN-DHG. Then there exists a relation “*” on \mathcal{G}'/α such that $(\mathcal{G}'/\alpha, *)$ is an SVN-DG.*

Proof. By Theorem 3, $\mathcal{G}'/\alpha = (\alpha(G) = \{G_j/\alpha\}_{j=1}^n, \{F_i/\alpha(T(F_i/\alpha), H(F_i/\alpha))\}_{i=1}^n)$ is an SVN-DHG, where $\alpha_{\alpha(G_j)}(\alpha(x)) = \alpha_{G_j}(t)$, $\beta_{\alpha(G_j)}(\alpha(x)) = \beta_{G_j}(t)$ and $\gamma_{\alpha(G_j)}(\alpha(x)) = \gamma_{G_j}(t)$. Let $\alpha(x) = \alpha((x, \alpha_{G_j}(x), \beta_{G_j}(x), \gamma_{G_j}(x)))$ and $\alpha(y) = \alpha((y, \alpha_{G_j}(y), \beta_{G_j}(y), \gamma_{G_j}(y))) \in \mathcal{G}'/\alpha$.

Then define an operation “*” on \mathcal{G}'/α by

$$\alpha(x) * \alpha(y) = \begin{cases} (\alpha(x), \alpha(y)) & \text{if satisfies in T} \\ \emptyset & \text{otherwise,} \end{cases}$$

where $T : \exists 1 \leq k \leq n, \alpha(x) \cap T(G_k) \neq \emptyset$ and $\alpha(y) \cap H(G_k) \neq \emptyset$ and for any $x, y \in H$, $(\alpha(x), \alpha(y))$ is represented as an ordinary directed edge from vertex $\alpha(x)$ to vertex $\alpha(y)$ and $\emptyset = (\alpha(x), \alpha(x))$ means that there is no edge. We show that * is a well-defined relation. Let $\alpha(x) = \alpha(x')$ and $\alpha(y) = \alpha(y')$. Then there exists uniquely $1 \leq k, s \leq n$ such that $\{x, x'\} \subseteq T(G_k) \cup H(G_k)$, and $\{y, y'\} \subseteq T(G_s) \cup H(G_s)$. If $\alpha(x) * \alpha(y) = (\alpha(x), \alpha(y))$, then there exists $1 \leq m \leq n$ such that $\alpha(x) \cap T(G_m) \neq \emptyset$ and $\alpha(y) \cap H(G_m) \neq \emptyset$. It follows that $T(G_k) \cap T(G_m) \neq \emptyset$ and so $\alpha(x') \cap T(G_m) \neq \emptyset$. In a similar way $\alpha(y') \cap H(G_m) \neq \emptyset$ and so $\alpha(x') * \alpha(y') = (\alpha(x'), \alpha(y')) = (\alpha(x), \alpha(y))$. If $\alpha(x) * \alpha(y) = \emptyset$, then for any $1 \leq m \leq n, \alpha(x) \cap T(G_m) = \emptyset$ or $\alpha(y) \cap H(G_m) = \emptyset$. It follows that $T(G_k) \cap T(G_m) = \emptyset$ and so $\alpha(x') \cap T(G_m) = \emptyset$. In a similar way, $\alpha(y') \cap H(G_m) = \emptyset$ and so $\alpha(x') * \alpha(y') = (\alpha(x'), \alpha(y')) = (\alpha(x), \alpha(y))$. It is easy to see that $(\mathcal{G}'/\alpha, *)$ is a simple graph. Consider $(\overrightarrow{\alpha(x), \alpha(y)})$ as a directed edge from vertex $\alpha(x)$ to vertex $\alpha(y)$ and define an operation “*” on \mathcal{G}'/α by

$$\alpha(x) *' \alpha(y) = \begin{cases} \overrightarrow{(\alpha(x), \alpha(y))} & \text{if satisfies in A,} \\ \overrightarrow{(\alpha(y), \alpha(x))} & \text{if satisfies in B,} \end{cases}$$

where $A : S_{\alpha}^{\beta}(\alpha(G_j), \alpha(x)) \geq S_{\alpha}^{\beta}(\alpha(G_j), \alpha(y))$ and $B : S_{\alpha}^{\beta}(\alpha(G_j), \alpha(x)) \leq S_{\alpha}^{\beta}(\alpha(G_j), \alpha(y))$. Now, define $\alpha_{\alpha(G_i)}(\alpha(x), \alpha(y)) : \alpha(G) \times \alpha(G) \rightarrow [0, 1]$ by $\alpha_{\alpha(G_i)}(\alpha(x), \alpha(y)) = \bigwedge_{a \alpha x, b \alpha y} (\alpha_{\alpha(G_i)}(a) \wedge \alpha_{\alpha(G_i)}(b))$,

$$\beta_{\alpha(G_i)}(\alpha(x), \alpha(y)) = \bigwedge_{a \alpha x, b \alpha y} (\beta_{\alpha(G_i)}(a) \vee \beta_{\alpha(G_i)}(b))$$

$$\text{and } \gamma_{\alpha(G_i)}(\alpha(x), \alpha(y)) = \bigwedge_{a \alpha x, b \alpha y} (\gamma_{\alpha(G_i)}(a) \vee \gamma_{\alpha(G_i)}(b)).$$

It is easy to see that

$$\alpha_{\alpha(G_i)}(\alpha(x), \alpha(y)) \leq (\alpha_{\alpha(G_i)}(\alpha(x)) \wedge \alpha_{\alpha(G_i)}(\alpha(y))),$$

$$\beta_{\alpha(G_i)}(\alpha(x), \alpha(y)) \geq (\beta_{\alpha(G_i)}(\alpha(x)) \vee \beta_{\alpha(G_i)}(\alpha(y)))$$

and

$$\gamma_{\alpha(G_i)}(\alpha(x), \alpha(y)) \geq (\gamma_{\alpha(G_i)}(\alpha(x)) \vee \gamma_{\alpha(G_i)}(\alpha(y))).$$

Table 2
Algorithm 2

1. Input the SVN-HG $\mathcal{G}' = (\{G_i\}_{i=1}^k, \{\alpha_{F_i}, \beta_{F_i}, \gamma_{F_i}\}_{i=1}^k)$, where $G_i = \{(x_i, \alpha_{x_i}, \beta_{x_i}, \gamma_{x_i})\}_{i=1}^s, \{(x_i, \alpha_{x_i}, \beta_{x_i}, \gamma_{x_i})\}_{i=1}^t$.
2. Input the $x, y \in \mathcal{G}'$. If $\exists! 1 \leq i \leq k$ such that $x, y \in G_i$, then $y \in \alpha(x), |\alpha(x)| \geq 2$ and if $\exists! 1 \leq i' \leq k$ such that $x, y \in G_{i'} \cap G_j$, then $\alpha(x) = \{x\}$.
3. Input the $x, y \in \mathcal{G}'$. If for a fixed $1 \leq i \leq k$, we have $\alpha(x) \cap T(G_i) \neq \emptyset$ and $\alpha(y) \cap H(G_i) \neq \emptyset$, then $\alpha(x) * \alpha(y) = (\alpha(x), \alpha(y))$ and in else case $\alpha(x) * \alpha(y) = \emptyset$ (no edge).
4. Input the $x, y \in \mathcal{G}'$. If $S_\alpha^\beta(\alpha(G_j), \alpha(x)) \geq S_\alpha^\beta(\alpha(G_j), \alpha(y))$, then $\alpha(x) *' \alpha(y) = \overrightarrow{(\alpha(x), \alpha(y))}$ as a directed edge from vertex $\alpha(x)$ to vertex $\alpha(y)$, and in else case $\alpha(x) *' \alpha(y) = \overleftarrow{(\alpha(y), \alpha(x))}$, where $S_\alpha^\beta(G, x) = \alpha_G(x) + \beta_G(x)$.

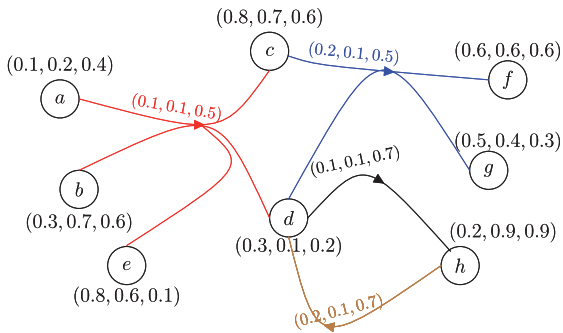

Fig. 7. SVN-DHG

Hence $(\mathcal{G}'/\alpha, *') = (\alpha(G), \{\alpha(v_j), \alpha_{\alpha(G_i)}(\alpha(v_j)), \beta_{\alpha(G_i)}(\alpha(v_j)), \gamma_{\alpha(G_i)}(\alpha(v_j))\}_{i=1}^n, *')$ is an SVN-DG. \square

The method for the construction of an SVN-DG \mathcal{G}'/α from an SVN-DHG \mathcal{G}' is explained in Algorithm 2 in Table 2.

Example 4.2. Let $G = \{a, b, c, d, e, f, g, h\}$. Consider the SVN-DHG, \mathcal{G}' in Figure 7, where $G_1 = \{(a, 0.1, 0.2, 0.4), (b, 0.3, 0.7, 0.6)\}, G_2 = \{(c, 0.8, 0.7, 0.6), (d, 0.3, 0.1, 0.2)\}, G_3 = \{(f, 0.6, 0.6, 0.6), (g, 0.5, 0.4, 0.3)\}, G_4 = \{(e, 0.8, 0.6, 0.1), (h, 0.2, 0.9, 0.9)\}$, $(\alpha_{F_1}, \beta_{F_1}, \gamma_{F_1}) = (0.1, 0.1, 0.5), (\alpha_{F_2}, \beta_{F_2}, \gamma_{F_2}) = (0.2, 0.1, 0.5), (\alpha_{F_3}, \beta_{F_3}, \gamma_{F_3}) = (0.1, 0.1, 0.7)$ and $(\alpha_{F_4}, \beta_{F_4}, \gamma_{F_4}) = (0.2, 0.1, 0.7)$.

Since

$$G_1 = (\{a, b\}, \{c, d, e\}), G_2 = (\{c, d\}, \{f, g\}),$$

$$G_3 = (\{d\}, \{h\}) \text{ and } G_4 = (\{h\}, \{e\}),$$

we get that

$$\alpha(a) = \{a, b\}, \alpha(c) = \{c\}, \alpha(d) = \{d\},$$

$$\alpha(e) = \{e\}, \alpha(f) = \{f, g\} \text{ and } \alpha(h) = \{h\}.$$

Hence we obtain $\mathcal{G}'/\alpha = \{\alpha(a), \alpha(c), \alpha(d), \alpha(e), \alpha(f), \alpha(h)\}$. Since

$$\begin{aligned} \alpha(a) \cap T(G_1) &\neq \emptyset \text{ and } \alpha(c) \cap H(G_1) \neq \emptyset, \\ \alpha(a) \cap T(G_1) &\neq \emptyset \text{ and } \alpha(d) \cap H(G_1) \neq \emptyset, \\ \alpha(a) \cap T(G_1) &\neq \emptyset \text{ and } \alpha(e) \cap H(G_1) \neq \emptyset, \\ \alpha(c) \cap T(G_2) &\neq \emptyset \text{ and } \alpha(f) \cap H(G_2) \neq \emptyset, \\ \alpha(d) \cap T(G_2) &\neq \emptyset \text{ and } \alpha(f) \cap H(G_2) \neq \emptyset, \\ \alpha(d) \cap T(G_3) &\neq \emptyset \text{ and } \alpha(h) \cap H(G_3) \neq \emptyset, \\ \alpha(h) \cap T(G_4) &\neq \emptyset \text{ and } \alpha(e) \cap H(G_4) \neq \emptyset, \end{aligned}$$

we get that

$$\begin{aligned} \alpha(a) * \alpha(c) &= (\alpha(a), \alpha(c)), \alpha(a) * \alpha(d) = (\alpha(a), \alpha(d)), \\ \alpha(a) * \alpha(e) &= (\alpha(a), \alpha(e)), \alpha(c) * \alpha(f) = (\alpha(c), \alpha(f)), \\ \alpha(d) * \alpha(f) &= (\alpha(d), \alpha(f)), \alpha(d) * \alpha(h) = (\alpha(d), \alpha(h)), \\ \text{and } \alpha(h) * \alpha(e) &= (\alpha(h), \alpha(e)). \end{aligned}$$

Since $S_\alpha^\beta(\alpha(G), \alpha(c)) \geq S_\alpha^\beta(\alpha(G), \alpha(a)), S_\alpha^\beta(\alpha(G), \alpha(c)) \geq S_\alpha^\beta(\alpha(G), \alpha(f)) S_\alpha^\beta(\alpha(G), \alpha(f)) \geq S_\alpha^\beta(\alpha(G), \alpha(d)), S_\alpha^\beta(\alpha(G), \alpha(d)) \leq S_\alpha^\beta(\alpha(G), \alpha(b)) S_\alpha^\beta(\alpha(G), \alpha(e)) \geq S_\alpha^\beta(\alpha(G), \alpha(h)), S_\alpha^\beta(\alpha(G), \alpha(e)) \geq S_\alpha^\beta(\alpha(G), \alpha(a)) S_\alpha^\beta(\alpha(G), \alpha(d)) \geq S_\alpha^\beta(\alpha(G), \alpha(a))$. So we obtain the SVN-DG, $(\mathcal{G}'/\alpha, *')$ in Figure 8.

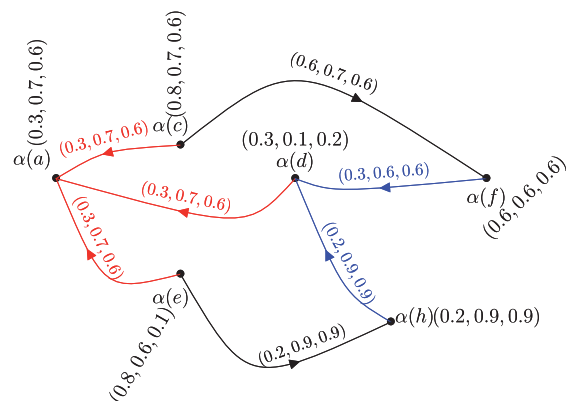

Fig. 8. SVN-DG $(\mathcal{G}'/\alpha, *')$

Definition 4.3. An SVN-DG $G = (V, A)$ is said to be:

(i) an α -subderivable SVN-DG if there exists a nontrivial SVN-DHG $\mathcal{G}' = (G = \{G_j\}_{j=1}^n, \{F_j(T(G_j), H(G_j))\}_{j=1}^n)$ such that $G = (V, A)$ is isomorphic to a subgraph of \mathcal{G}'/α and $\sum_{i=1}^m (\alpha_{F_i} + \beta_{F_i} + \gamma_{F_i}) \geq \sum_{i=1}^m (\alpha_{\alpha(F_i)} + \beta_{\alpha(F_i)} + \gamma_{\alpha(F_i)})$. An α -subderivable SVN-DG $G = (V, A)$ is called an α -derivable SVN-DG, if $G = (V, A) \cong \mathcal{G}'/\alpha$, also \mathcal{G}' is called an associated SVN-DHG with SVN-DG G ;

(ii) an α -semiself derivable SVN-DG, if it is an α -subderivable SVN-DG by itself;

(iii) an α -self derivable SVN-DG, if it is an α -derivable SVN-DG by itself.

Example 4.4. Consider the SVN-DG, $G = (V, A)$ in Figure 9, where $V = \{a, b, c\}$ and

$$A = \{(a, b), (0.2, 0.9, 0.4), (b, c), (0.1, 0.8, 0.6)\}.$$

Now we construct an SVN-DHG \mathcal{G}' in Figure 10.

Figure 8: SVN-DG $(\mathcal{G}'/\alpha, *)$

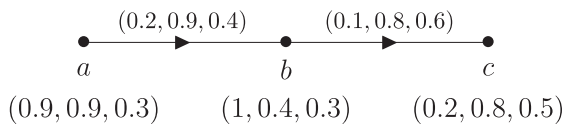

Fig. 9. SVN-DG G

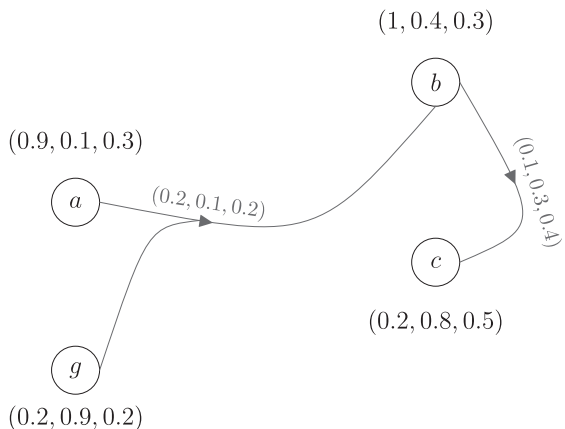

Fig. 10. SVN-DHG \mathcal{G}'

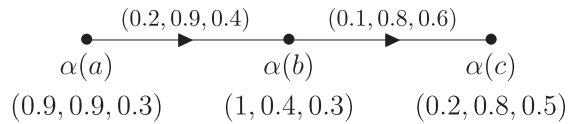

Fig. 11. SVN-DG G

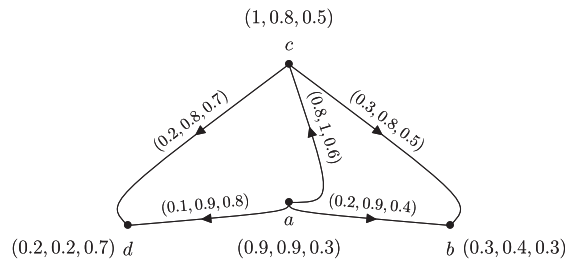

Fig. 12. SVN-DG G

Clearly $\mathcal{G}' = (G = \{G_j\}_{j=1}^2, \{F_j(T(G_j), H(G_j))\}_{j=1}^2)$ is a nontrivial SVN-DHG, where $G = \{a, b, c, g\}$, $G_1 = \{(a, 0.9, 0.1, 0.3), (g, 0.2, 0.9, 0.2)\}$, $G_2 = \{(b, 1, 0.4, 0.3)\}$, $F_1(T(G_1), H(G_1)) = (0.2, 0.1, 0.2)$, $F_2(T(G_2), H(G_2)) = (0.1, 0.3, 0.4)$. Computations show that $\alpha(a) = \{a, g\}$, $\alpha(b) = \{b\}$ and $\alpha(c) = \{c\}$. By Theorem 4, it is easy to see that digraph \mathcal{G}'/α is obtained in Figure 11. Clearly $\mathcal{G}'/\alpha \cong G$. Since $|G| \neq |V|$, we have digraph $G = (V, A)$ is an α -derivable SVN-DG and it is not an α -self derivable SVN-DG.

Example 4.5. Consider the SVN-DG, $G = (V, A)$ in Figure 12, where $V = \{a, b, c, d\}$ and $A = \{(a, b), (0.2, 0.9, 0.4), (a, c), (0.8, 1, 0.6), (a, d), (0.1, 0.9, 0.8), (c, d), (0.2, 0.8, 0.7), ((c, b), (0.3, 0.8, 0.5))\}$. Now we construct an SVN-DHG \mathcal{G}' in Figure 13. Clearly $\mathcal{G}' = (G =$

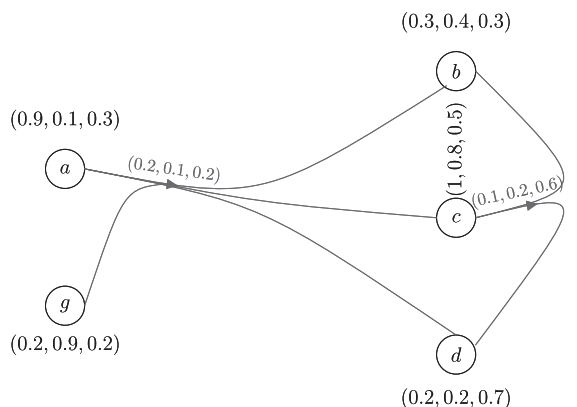

Fig. 13. SVN-DHG \mathcal{G}'

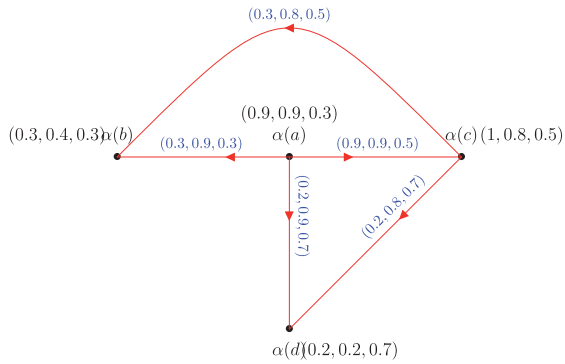

Fig. 14. SVN-DG, \mathcal{G}'/α

$\{G_j\}_{j=1}^2, \{F_j(T(G_j), H(G_j))\}_{j=1}^2$ is a nontrivial SVN-DHG, where $G = \{a, b, c, d, g\}$, $G_1 = \{(a, 0.9, 0.1, 0.3), (g, 0.2, 0.9, 0.2)\}$, $G_2 = \{(c, 1, 0.8, 0.5), (b, 0.3, 0.4, 0.3), (d, 0.2, 0.2, 0.7)\}$, $F_1(T(G_1), H(G_1)) = (0.2, 0.1, 0.2)$, $F_2(T(G_2), H(G_2)) = (0.1, 0.2, 0.6)$. Computations show that $\alpha(a) = \{a, g\}$, $\alpha(b) = \{b\}$, $\alpha(c) = \{c\}$ and $\alpha(d) = \{d\}$. By Theorem 4.1, it is easy to see that digraph \mathcal{G}'/α is obtained in Figure 14.

Clearly $\mathcal{G}'/\alpha \cong G$. Since $|G| = |V|$, we have digraph $G = (V, A)$ is an α -self derivable SVN-DG.

Let $V = \{a_1, a_2, \dots, a_n\}$. Then we denote the directed path graph in Figure 15 by DP_n .

Theorem 4.6. *If $DP_n = (V, E)$ is an SVN-DG, then for all $1 \leq i \leq n - 1$, $\alpha_V(a_i) \geq \alpha_V(a_{i+1})$ or $\beta_V(a_i) \geq \beta_V(a_{i+1})$;*

Proof. Since $A = \{(a_i, a_{i+1}) \mid 1 \leq i \leq n - 1\}$, we get that

$$S_\alpha^\beta(A, a_1) \geq S_\alpha^\beta(A, a_2) \geq S_\alpha^\beta(A, a_2) \geq \dots \geq S_\alpha^\beta(A, a_n).$$

Thus for all $1 \leq i \leq n - 1$, $\alpha_V(a_i) \geq \alpha_V(a_{i+1})$ or $\beta_V(a_i) \geq \beta_V(a_{i+1})$. \square

Theorem 4.7. *Let $2 \leq n \in \mathbb{N}$. Then*

- (i) SVN-DG, DP_n is an α -derivable SVN-DG.
- (ii) SVN-DG, DP_2 is not an α -self derivable SVN-DG.



Fig. 15. Path graph DP_n .

Proof. (i) Let $DP_n = (V, A)$ be a path SVN-DG, where $V = \{(a_j, \alpha_V(a_j)), \beta_V(a_j), \gamma_V(a_j)\}_{j=1}^n$. Then for any $a, b \notin V$ consider $G_1 = (\{(a_1, \alpha_V(a_1)), \beta_V(a_1), \gamma_V(a_1)\}, \{(a, t_1, t_2, t_3)\}, \{(a_2, \alpha_V(a_2)), \beta_V(a_2), \gamma_V(a_2)\})$, where $0 < t_1 \leq \alpha_V(a_1)$, $0 < t_2 \leq \beta_V(a_1)$ and $0 < t_3 \leq \gamma_V(a_1)$. Also for any $2 \leq i \leq n - 2$, $G_i = (\{(a_i, \alpha_V(a_i)), \beta_V(a_i), \gamma_V(a_i)\})$ and $G_{n-1} = (\{(a_{n-1}, \alpha_V(a_{n-1})), \beta_V(a_{n-1}), \gamma_V(a_{n-1})\}, \{(a_n, \alpha_V(a_n)), \beta_V(a_n), \gamma_V(a_n)\}, \{(b, s_1, s_2, s_3)\})$, where $0 < s_1 \leq \alpha_V(a_n)$, $0 < s_2 \leq \beta_V(a_n)$ and $0 < s_3 \leq \gamma_V(a_n)$. It can see that $\alpha(a_1) = \alpha(a) = \{a_1, a\}$, $\alpha(a_n) = \alpha(b) = \{a_n, b\}$ and for any $2 \leq i \leq n - 1$, $\alpha(a_i) = \{a_i\}$. If $G = V \cup \{(a, t_1, t_2, t_3), (b, s_1, s_2, s_3)\}$, then $\mathcal{G}' = (G = \{G_i\}_{i=1}^{n-1}, \{F_i(T(G_i), H(G_i))\}_{i=1}^{n-1})$ is a nontrivial SVN-DHG, where for any $1 \leq i \leq n - 1$ we have $F_i(T(G_i), H(G_i)) = (\bigwedge_{\alpha\alpha x, \beta\beta y} (\alpha_{\alpha(G_i)}(a) \wedge \alpha_{\alpha(G_i)}(b)), (\beta_{\alpha(G_i)}(a) \vee \beta_{\alpha(G_i)}(b)), (\gamma_{\alpha(G_i)}(a) \vee \gamma_{\alpha(G_i)}(b)))$. Since for any $1 \leq i \leq n$ which is an odd, we have $\alpha(a_i) \cap T(G_i) \neq \emptyset$ and for any $1 \leq i \leq n$ which is an even, we have $\alpha(a_i) \cap H(G_i) \neq \emptyset$, we get that $\alpha(a_i) * \alpha(a_{i+1}) = (\alpha(a_i), \alpha(a_{i+1})) = e_{ii+1}$, where for all $1 \leq i \leq n$, $\alpha(a_i) = (\alpha(a_i), \alpha_V(a_i), \beta_V(a_i), \gamma_V(a_i))$ and for all $1 \leq i \leq n - 1$, $e_i = F_i(T(G_i), H(G_i))_{i=1}^{n-1}$). Hence we obtain an SVN-DG in Figure 16. Clearly $\mathcal{G}'/\alpha \cong DP_n$ and so for any $n \geq 2$, DP_n is an α -derivable SVN-DG.

(ii) Let DP_2 be an α -self derivable SVN-DG. Then there exists an associated SVN-DHG, $\mathcal{G}' = (G, \{F_j(T(G_j), H(G_j))\}_{j=1}^n)$ with SVN-DG, DP_2 such that $\mathcal{G}'/\alpha \cong DP_2$ and $|G| = 2$. Suppose that $G = \{x, y\}$, since \mathcal{G}' is a nontrivial SVN-DHG, must be $2 \leq m$. But $|G| = 2$ implies that $m = 1$ which is a contradiction. \square

Corollary 4.8. *Let $2 \leq n \in \mathbb{N}$. Then DP_n is an α -derivable SVN-DG but is not an α -self derivable SVN-DG.*

We introduce SVN-DG G' in Figure 17. From now on, we apply the SVN-DG, G' in Figure 17, in the following Theorem.

Theorem 4.9. *Let $G' = (\{a, b\}, A')$ be an SVN-DG. Then the following properties hold.*

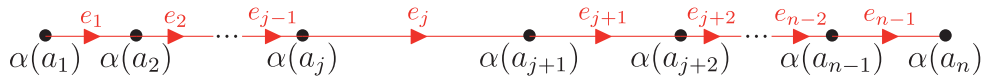

Fig. 16. SVN-DG G'/α .

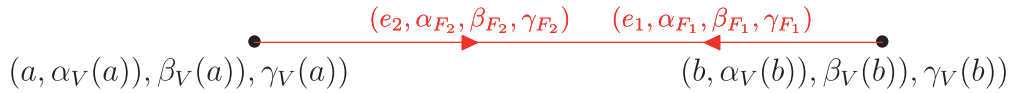

Fig. 17. SVN-DG G'

- (i) $S_\alpha^\beta(A', a) = S_\alpha^\beta(A', b)$;
- (ii) G' is not an α -derivable SVN-DG.

Proof. (i) Since $G' = (\{a, b\}, A')$ is an SVN-DG and $e_1, e_2 \in A'$, we get that $\alpha_V(a) + \beta_V(a) \geq \beta_V(b) + \alpha_V(b)$ and $\alpha_V(a) + \beta_V(a) \leq \alpha_V(b) + \beta_V(b)$. It follows that $S_\alpha^\beta(A', a) = S_\alpha^\beta(A', b)$.

(ii) Let $G' = (\{a, b\}, A')$ be an α -derivable SVN-DG. Then there exist a nontrivial SVN-DHG, $G' = (G = \{G_j\}_{j=1}^n, \{F_i(T(G_i), H(G_i))\}_{i=1}^m)$ and $1 \leq k, l \leq n$ such that $\{\alpha(x_k), \alpha(x_l)\} = G'/\alpha \cong G'$, where $G = \{x_1, x_2, \dots, x_n\}$. Since $|V| = 2$, we get $m = 2$. In addition, $\alpha(x_k) *' \alpha(x_l) = (\alpha(x_k), \alpha(x_l))$, $\alpha(x_l) *' \alpha(x_k) = (\alpha(x_l), \alpha(x_k))$ implies that there exists $1 \leq j \leq n$ such that $\alpha(x_k) \cap T(G_j) \neq \emptyset$ and $\alpha(x_l) \cap H(G_j) \neq \emptyset$ or $\alpha(x_k) \cap H(G_j) \neq \emptyset$ and $\alpha(x_l) \cap T(G_j) \neq \emptyset$. It follows that $H(G_1) \cap T(G_2) \neq \emptyset$ and $H(G_2) \cap T(G_1) \neq \emptyset$ and so $|G'/\alpha| \geq 3$ which is a contradiction. \square

Corollary 4.10. Let $G = (V, A)$ be an SVN-DG. If G is homeomorphic to SVN-DG, G' , then G is not an α -derivable SVN-DG.

Let $2 \leq n \in \mathbb{N}$, $V = \{v_1, v_2, v_3, \dots, v_n\}$ and $E = \{e_1, e_2, e_3, \dots, e_{n-1}\}$, where $e_i = v_1 v_{i+1}$, for every $1 \leq i \leq n - 1$, and $DS_n = (V, E)$ be a star directed graph as Figure 18.

Theorem 4.11. If $DS_n = (V, E)$ is an SVN-DG, then for all $2 \leq i \leq n$, $\alpha_V(v_1) \geq \alpha_V(v_i)$ or $\beta_V(v_1) \geq \beta_V(v_i)$.

Proof. Since $A = \{(v_1, v_i) \mid 1 \leq i \leq n\}$, for all $1 \leq i \leq n$, we have $S_\alpha^\beta(A, v_1) \geq S_\alpha^\beta(A, v_i)$. It follows that for all $2 \leq i \leq n$, $\alpha_V(v_1) \geq \alpha_V(v_i)$ or $\beta_V(v_1) \geq \beta_V(v_i)$. \square

Theorem 4.12. Let $2 \leq n \in \mathbb{N}$. Then

- (i) SVN-DG, DS_n is an α -derivable SVN-DG.
- (ii) SVN-DG, DS_2 is not an α -self derivable SVN-DG.

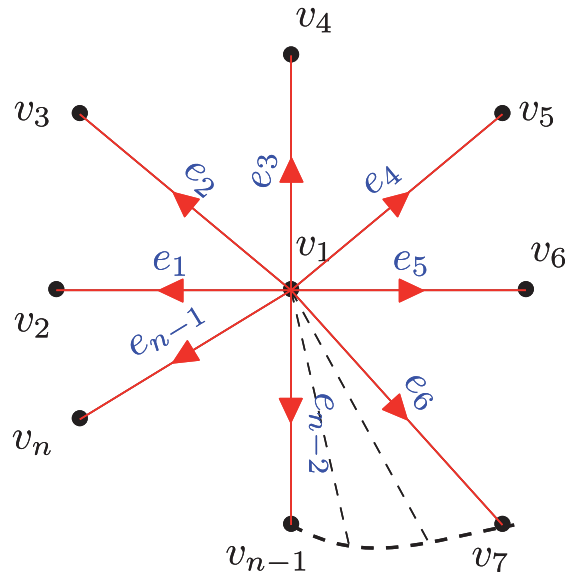

Fig. 18. Star digraph DS_n

- (iii) For all $n \geq 3$, SVN-DG, DS_n is an α -self derivable SVN-DG.

Proof. (i, ii) The proof is similar to Theorem 4 and Corollary 4.

(iii) Let $DS_n = (V, A)$ be a path SVN-DG, where $V = \{(v_j, \alpha_V(v_j)), \beta_V(v_j), \gamma_V(v_j)\}_{j=1}^n$. For simplifying we denote $(v_j, \alpha_V(v_j), \beta_V(v_j), \gamma_V(v_j))$ by v_j and consider

$$G_1 = (\{v_1\}, \{v_2, v_3, v_4\}), G_2 = (\{v_1\}, \{v_3, v_4, v_5\}),$$

and for all $3 \leq i \leq n - 3$, $G_i = (\{v_1\}, \{v_{i+3}\})$. One can see that for any $1 \leq i \leq n$, $\alpha(a_i) = \{a_i\}$ and $G' = (G = \{G_i\}_{i=1}^{n-3}, \{F_i(T(G_i), H(G_i))\}_{i=1}^{n-3})$ is a nontrivial SVN-DHG, where for any $1 \leq i \leq n - 3$, we have $F_i(T(G_i), H(G_i))_{i=1}^{n-3} = (\bigwedge_{\alpha\alpha x, \beta\alpha y} (\alpha_{\alpha(G_i)}(a) \wedge$

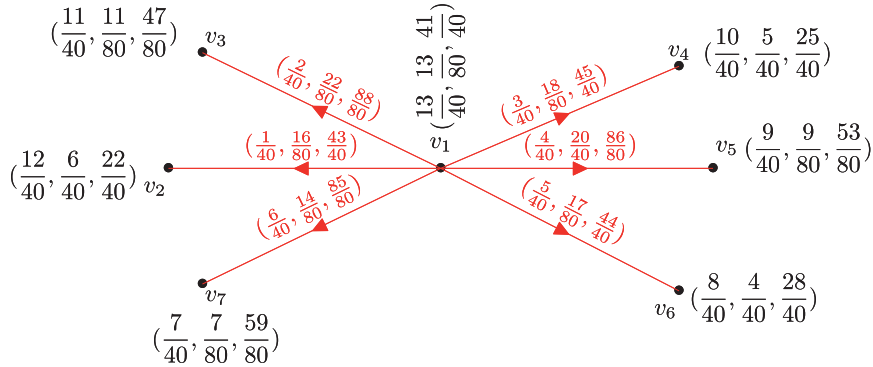

Fig. 19. SVN-DG, DS_7

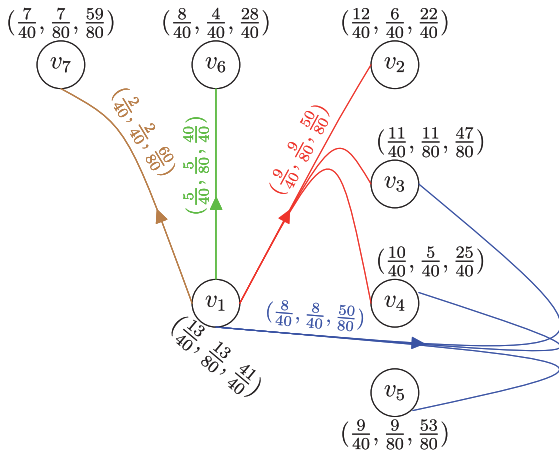

Fig. 20. SVN-DHG

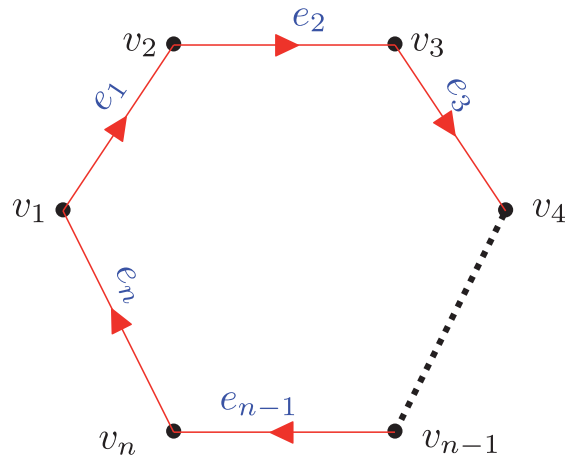

Fig. 21. Cycle digraph DC_n^*

$\alpha_{\alpha(G_i)}(b)$, $(4\beta_{\alpha(G_i)}(a) \vee \beta_{\alpha(G_i)}(b))$,
 $\alpha\alpha x, \beta\alpha y$
 $(\gamma_{\alpha(G_i)}(a) \vee \gamma_{\alpha(G_i)}(b))$. In a similar way
 $\alpha\alpha x, \beta\alpha y$

of Theorem 4.7, $\mathcal{G}'/\alpha \cong DS_n$ and so for any $n \geq 3$, DS_n is an α -self derivable SVN-DG. \square

Corollary 4.13. Let $2 \leq n \in \mathbb{N}$. Then DS_n is an α -derivable SVN-DG and for $3 \leq n$, it is an α -self derivable SVN-DG.

Example 4.14. Consider the SVN-DG, DS_7 in Figure 19. Now, construct the SVN-DHG, \mathcal{G}' in Figure 20. Clearly $G_1 = (\{v_1, \frac{13}{40}, \frac{13}{80}, \frac{41}{40}\})$, $\{v_2, \frac{12}{40}, \frac{6}{40}, \frac{22}{40}\}$, $\{v_3, \frac{11}{40}, \frac{11}{80}, \frac{47}{80}\}$, $\{v_4, \frac{10}{40}, \frac{5}{40}, \frac{25}{40}\}$, $G_2 = (\{v_1, \frac{13}{40}, \frac{13}{80}, \frac{41}{40}\})$, $\{v_3, \frac{11}{40}, \frac{11}{80}, \frac{47}{80}\}$, $\{v_4, \frac{10}{40}, \frac{5}{40}, \frac{25}{40}\}$, $\{v_5, \frac{9}{40}, \frac{9}{80}, \frac{53}{80}\}$ $G_3 = (\{v_1, \frac{13}{40}, \frac{13}{80}, \frac{41}{40}\})$, $\{v_6, \frac{8}{40}, \frac{4}{40}, \frac{28}{40}\}$ and $G_4 = (\{v_1, \frac{13}{40}, \frac{13}{80}, \frac{41}{40}\})$, $\{v_7, \frac{7}{40}, \frac{7}{80}, \frac{59}{80}\}$. Obviously, for all $1 \leq i \leq 6$, we have $\alpha(v_i) = \{v_i\}$ and

so $\mathcal{G}'/\alpha \cong DS_7$.

Let $3 \leq n \in \mathbb{N}$ and $V = \{v_1, v_2, \dots, v_n\}$. Then we denote the directed cyclic graph DC_n^* in Figure 21.

Theorem 4.15. If $DC_n^* = (V, A)$ is an SVN-DG, then for all $v, v' \in V$ $S_\alpha^\beta(A, v) = S_\alpha^\beta(A, v')$.

Proof. Since $DS_n = (V, E)$ is an SVN-DG, for every $1 \leq i \leq n$, we get that $\alpha_V(v_i) + \beta_V(v_i) \geq \alpha_V(v_{i+1}) + \beta_V(v_{i+1})$. Consider $e_n = (v_n, v_1)$, so $\alpha_V(v_n) + \beta_V(v_n) \geq \alpha_V(v_1) + \beta_V(v_1) \geq \alpha_V(v_2) + \beta_V(v_2) \geq \alpha_V(v_3) + \beta_V(v_3) \geq \alpha_V(v_4) + \beta_V(v_4) \geq \dots \geq \alpha_V(v_{n-1}) + \beta_V(v_{n-1}) \geq \alpha_V(v_n) + \beta_V(v_n) \geq \alpha_V(v_1) + \beta_V(v_1)$. Hence for all $v, v' \in V$ we get that $S_\alpha^\beta(A, v) = S_\alpha^\beta(A, v')$. \square

Theorem 4.16. Let $3 \leq n \in \mathbb{N}$. Then

- (i) SVN-DG, DC_3^* is not an α -derivable SVN-DG.
- (ii) SVN-DG, DC_n^* is not an α -derivable SVN-DG.

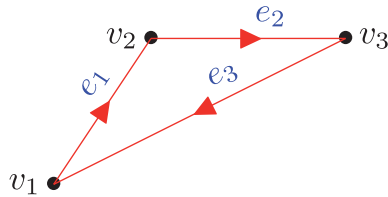

Fig. 22. Cycle digraph DC_3^*

- (ii3) SVN–DG, DC_n^* is not an α -self derivable SVN–DG.
- (iv) SVN–DG, DC_n^* is an α -semiself derivable SVN–DG.

Proof. (i) Consider the SVN–DG, DC_3^* in Figure 22. If DC_3^* is an α -derivable SVN–DG, then we can consider the smallest associated SVN–DHG $\mathcal{G}' = (G = \{G_j\}_{j=1}^n, \{F_j(T(G_j), H(G_j))\}_{j=1}^n)$, where there exists $1 \leq t \leq n$, in such a way that $2 \in \{|T(G_t)|, |H(G_t)|\}$ and for any $1 \leq i \neq t \leq n$, $|T(E_i)| = |H(E_i)| = 1$. Since for any $1 \leq i \leq n$, $ud(v_i) = id(v_i) = 1$ (output degree and input degree of v_i), for all $1 \leq i \neq j \leq n$ we get that $\{v_i, v_j\} \not\subseteq T(E_i)$, $\{v_i, v_j\} \not\subseteq H(E_i)$, $\{v_i, v_j\} \not\subseteq T(E_j)$ and $\{v_i, v_j\} \not\subseteq H(E_j)$. Hence there exists $x' \notin H$ such that $x' \in T(E_i) \cup H(E_i)$ and so $m = n = 3$. In addition, for some $1 \leq k \leq n$, $v_t \in (T(E_t) \cup H(E_t)) \cap (T(E_k) \cup H(E_k))$ implies that $\alpha(v_t) \neq \alpha(x')$ and for $1 \leq i \leq n$, $\alpha(v_i) = \{v_i\}$. It follows that $\mathcal{G}'/\alpha = \{\alpha(x'), \alpha(v_1), \dots, \alpha(v_n)\}$ and so $\mathcal{G}'/\alpha \not\cong DC_3^*$, which is a contradiction.

(ii) Since every SVN–DG, DC_n^* is homeomorphic to SVN–DG, DC_3^* , by item (i) we get that for every $4 \leq n \in \mathbb{N}$, SVN–DG, DC_n^* is not an α -derivable SVN–DG.

(iii) Since SVN–DG, DC_n^* is not an α -derivable SVN–DG, we get that it is not an α -self derivable SVN–DG.

(iv) Let $DC_n^* = (V, A)$ be a cyclic SVN–DG, where $V = \{(a_j, \alpha_V(a_j)), \beta_V(a_j)), \gamma_V(a_j)\}_{j=1}^n$. For simplifying we denote $(a_j, \alpha_V(a_j)), \beta_V(a_j), \gamma_V(a_j)$ by a_j and consider $G_1 = (\{a_1 a_2\}, \{a_3\})$, for any $2 \leq i \leq n - 2$, $G_i = (\{a_i\}, \{a_{i+1}\})$, $G_{n-1} = (\{a_n\}, \{a_1\})$ and $G_n = (\{a_1\}, \{a_2\})$. It can see that for any $1 \leq i \leq n$, $\alpha(a_i) = \{a_i\}$ and by Theorem 4, for all $v, v' \in V$ $S_\alpha^\beta(A, v) = S_\alpha^\beta(A, v')$. Also, $\mathcal{G}' = (V = \{G_i\}_{i=1}^{n-1}, \{F_i(T(G_i), H(G_i))\}_{i=1}^{n-1})$ is a nontrivial SVN–DHG, where for any $1 \leq i \leq n - 1$ we have $F_i(T(G_i), H(G_i))_{i=1}^{n-1} =$

$$\left(\bigwedge_{\alpha a x, \beta a y} (\alpha_{\alpha(G_i)}(a) \wedge \alpha_{\alpha(G_i)}(b)), \quad (\beta_{\alpha(G_i)}(a) \vee \beta_{\alpha(G_i)}(b)), \quad (\gamma_{\alpha(G_i)}(a) \vee \gamma_{\alpha(G_i)}(b)) \right).$$

In a similar way to Theorem 4, one can see that DC_n^* is isomorphic to a subgraph of \mathcal{G}'/α and

$$\beta_{F_i} + \gamma_{F_i} \geq \sum_{i=1}^m (\alpha_{\alpha(F_i)} + \beta_{\alpha(F_i)} + \gamma_{\alpha(F_i)}). \quad \square$$

Let $3 \leq n \in \mathbb{N}$ and $V = \{v_1, v_2, \dots, v_n\}$. Then we denote the directed complete graph by DK_n .

Corollary 4.17. Let $3 \leq n \in \mathbb{N}$. Then

- (i) for all $v, v' \in V$, we have $S_\alpha^\beta(A, v) = S_\alpha^\beta(A, v')$;
- (ii) SVN–DG, DK_n is not both an α -derivable SVN–and α -self derivable SVN–DG.
- (iii) SVN–DG, DK_n is an α -semiself derivable SVN–DG.

4.1. Applications of α -driveable SVN–DG

In this subsection, we describe some applications of the concept of α -derivable single-valued neutrosophic digraphs and single-valued neutrosophic dihypergraphs.

Graphs and hypergraphs can be used to describe the network systems. The network systems, including social networks, world wide web, neural networks are investigated by means of simple graphs and digraphs. The graphs take the nodes as a set of objects or people and the edges define the relations between them. In many cases, it is not possible to give full description of real world systems using the simple graphs or digraphs. For example, if a collaboration network is represented through a simple graph. We only know that whether the two researchers are working together or not. We can not know if three or more researchers, which are connected in the network, are coauthors of the same article or not. Further, in various situations, the given data contains the information of existence, indeterminacy and non-existence. We represented these systems by SVN–DG(SVN–DHG) that consist of sets of nodes representing the objects or group under investigation, joined together in pairs by links if the corresponding nodes or sets are related by some kind of relationship. Consequently, we will formally apply the SVN–DHG concept as a generalization for representing weighted networks and will call them weighted hypernetworks. A cluster in

WNS consists of three main different elements: sensor nodes (SNs), base station (BS), and cluster-heads (CH). The SNs are the set of sensors present in the network, arranged to sense the environment and collect the data. The main task of an SN in a sensor field is to detect events, perform quick local data processing, and then transmit the data. The BS is the data processing point for the data received from the sensor nodes, and where the data are accessed by the end-user. It is generally considered fixed and at a far distance from the sensor nodes. The CH acts as a gateway between the SNs and the BS. The function of the cluster-head is to perform common functions for all the nodes in the cluster, like aggregating the data before sending it to the BS. In some way, the CH is the sink for the cluster nodes, and the BS is the sink for the cluster-heads. This structure formed between the sensor nodes, the sink, and the base station can be replicated as many times as it is needed, creating the different layers of the hierarchical WSN. The SNs and the communication links between them can be represented by an undirected graph $G = (V, E)$, where each vertex $v \in V$ (the set of vertices in the graph) represents a sensor node with a unique ID. An edge $(u, v) \in E$ (the set of edges in the graph) represents a communication link if the corresponding nodes u and v are within the transmission range of each other. We apply the concept of SVN-DG for clustering WSNs via the notation of positive relation and obtain directed clustering graphs.

Example 4.18. (Lifetime in wireless sensor network) The proposed protocol weight-based clustering routing (WCR) is a clustering-based, energy-efficient protocol for wireless sensor networks. The objective of the protocol is to reduce the energy dissipation of nodes for routing data to the base station and prolong the network lifetime. In WCR, a cluster-head selection algorithm is designed for periodically selecting cluster-heads based on the node position information and residual energy of node. This cluster-head selection scheme is a central controlled algorithm performed by the base station which is assumed to have no energy constraint. Distributed weight-based energy-efficient hierarchical clustering (DWEHC) as an algorithm, aims at high energy efficiency by generating balanced cluster sizes and optimizing the intra cluster topology. DWEHC algorithm has been shown to generate more well-balanced clusters as well as to achieve significantly lower energy consumption in intra cluster and intra cluster communication. Let

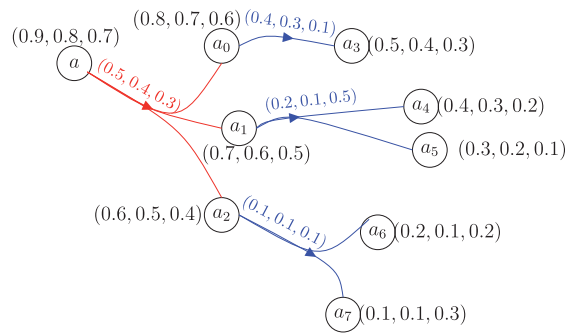

Fig. 23. DWEHC multi-hop intracluster topology

$H = \{a, a_0, a_1, a_2, a_3, a_4, a_5, a_6, a_7, a_8, a_9\}$ be a set of nodes in a wireless sensor networks as a hyper network. Figure 23, shows a multi-level cluster generated by DWEHC, where a is the cluster-head, first level children are a_0, a_1, a_2 , second level children are a_3, a_4, a_5, a_6 and a_7 . Let the degree of contribution in the energy-efficient protocol relationships of a is 90/100, degree of indeterminacy of energy-efficient protocol is 80/100 and degree of false-energy-efficient protocol is 70/100, i.e. the truth-energy-efficient protocol, indeterminacy-energy-efficient protocol and falsity-energy-efficient protocol values of the vertex of the wireless sensor network is (0.9, 0.8, 0.7).

Since $\alpha(a) = \{a\}, \alpha(a_0) = \{a_0\}, \alpha(a_1) = \{a_1\}, \alpha(a_2) = \{a_2\}, \alpha(a_3) = \{a_3\}, \alpha(a_4) = \{a_4, a_5\}$ and $\alpha(a_7) = \{a_6, a_7\}$, we get the α -derivable digraph \mathcal{G}'/α in Figure 24.

The directed graph model of SVN-DG \mathcal{G}'/α associated to a lifetime in wireless sensor network or DWEHC multi-hop intracluster topology \mathcal{G}' is explained in Algorithm 3 in Table 3 and in Figure 24.

Example 4.19. (Social networking) In social networks nodes represent people or groups of people, normally called actors, that are connected by pairs according to some pattern of contact or interactions between them. Such patterns can be of friendship, collaboration, business relationships, etc. There are some cases in which hypergraph representations of the social network are indispensable. Let $X = \{a_1, a_2, a_3, a_4, a_5, a_6, a_7\}$ be a society and $a_1, a_2, a_3, a_4, a_5, a_6, a_7$ be names of its people. These people create some groups as $E_1 = \{a_1, a_2, a_3\}, E_2 = \{a_4, a_3\}$ and $E_3 = \{a_4, a_5, a_6, a_7\}$. Let the degree of contribution in the business relationships of a_1 is 10/100, degree of indeterminacy of contribution is 15/100 and

Table 3
Algorithm 3

1. Consider the wireless sensor network and design a SVN-DHG model \mathcal{G}' .
3. By Algorithm 2 in Table 2, construct the SVN-DG \mathcal{G}'/α .

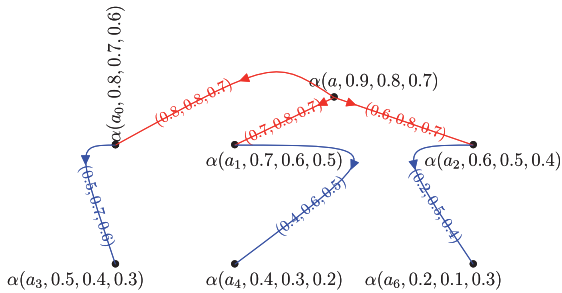

Fig. 24. Digraph \mathcal{G}'/α

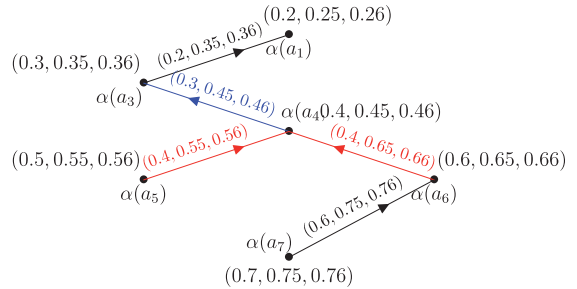

Fig. 27. SVN-DG $(\mathcal{G}'/\alpha, *)$

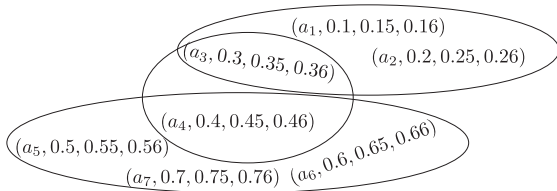

Fig. 25. Social network \mathcal{H}'

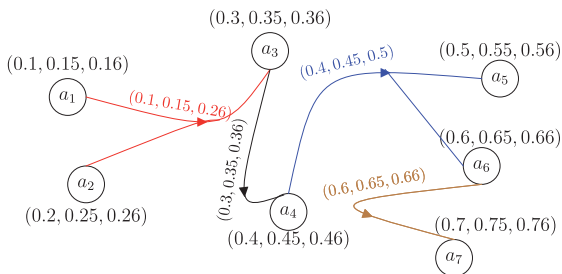

Fig. 26. SVN-DHG \mathcal{G}'

degree of false-contribution is $16/100$, i.e. the truth-membership, indeterminacy-membership and falsity-membership values of the vertex human is $(0.1, 0.15, 0.16)$. The likeness, indeterminacy and dislikeness of contribution in the business relationships this society is shown in the Figure 25.

By Theorem 3, the SVN-DHG \mathcal{G}' is obtained in Figure 26.

By Theorem 4, and some computations, we obtain the SVN-DG, $(\mathcal{G}'/\alpha, *)$ in Figure 27.

The mathematical model of SVN-DG \mathcal{G}'/α associated to a social network \mathcal{H}' is explained in Algorithm 4 in Table 4 and in Figure 27.

5. Conclusion

The current paper considered the concepts of single-valued neutrosophic hypergraphs(SVN-HG), single-valued neutrosophic directed hypergraphs(SVN-DHG) and constructed the single-valued neutrosophic directed hypergraphs from single-valued neutrosophic hypergraphs. Moreover

- (i) It is introduced the notation of derived SVN-DHG and is shown that every SVN-DHG is a derivable-SVN-DHG.
- (ii) We defined a concept of weak single valued neutrosophic digraph(WSVN-DG) and proved that any finite set can be a WSVN-DG.
- (iii) We defined an equivalence relation (titled α) on single-valued neutrosophic directed hypergraphs and investigated the relation between of SVN-DHG and SVN-DG via α .
- (iv) It is corresponded the single-valued neutrosophic directed (hyper)graphs with wireless sensor (hyper)networks such that the set of vertices (V) represent the sensors and the set of links (E) represents the connections between vertices.
- (v) Using the relation α , the sensor clusters of wireless sensor (hyper)networks are considered as a class of wireless sensor (hyper)networks under relation α .
- (vi) This study introduced the concept of α -(self-semi)derivable directed graph and investigated some conditions such that a single-valued neutrosophic directed graph is an α -(self-semi)derivable directed graph.

Table 4
Algorithm 4

-
1. Consider the social network and design a SVN–HG model $\mathcal{H}' = (H, \{E_i\}_{i=1}^m)$.
 2. By Algorithm 1 in Table 1, construct the SVN–DHG \mathcal{G}' .
 3. By Algorithm 2 in Table 2, construct the SVN–DG \mathcal{G}'/α .
-

(vii) Some algorithms are presented in such a way that analyze the application of single-valued neutrosophic directed (hyper)graph in (hyper)networks.

We hope that these results are helpful for further studies in single-valued neutrosophic directed (graphs)hypergraphs theory. In our future studies, we hope to obtain more results in coding theory and single-valued neutrosophic directed (hyper)graphs and their applications in (hyper)networks.

References

- [1] M. Akram, S. Shahzadi and A. Borumand Saeid, Neutrosophic hypergraphs, *TWMS J App Eng Math* **8**(1) (2018), 122–135.
- [2] M. Akram and A. Luqman, Certain concepts of bipolar fuzzy directed hypergraphs, *Mathematics* **5**(1) (2017).
- [3] M. Akram and A. Luqman, Certain network models using single-valued neutrosophic directed hypergraphs, *Journal of Intelligent and Fuzzy Systems* **33**(1) (2017), 575–588.
- [4] M. Akram and A. Luqman, Directed hypergraphs under mpolar fuzzy environment, *Journal of Intelligent and Fuzzy Systems* **34**(6) (2018), 4127–4137.
- [5] M. Akrama, M. Sarwara and R.A. Borzooei, A novel decision-making approach based on hypergraphs in intuitionistic fuzzy environment, *Journal of Intelligent & Fuzzy Systems* **35**(2) (2018), 1905–1922.
- [6] M. Akram and W.A. Dudek, Intuitionistic fuzzy hypergraphs with applications, *Information Sciences* **218** (2013), 182–193.
- [7] M. Akram and M. Sarwar, Novel applications of m-polar fuzzy hypergraphs, *Journal of Intelligent and Fuzzy Systems* **32**(3) (2016), 2747–2762.
- [8] M. Akram, S. Shahzadi and A. Borumand Saeid, single-valued neutrosophic hypergraph, *TWMS J App Eng Math* **8**(1) (2018), 122–135.
- [9] C. Berge, *Graphs and Hypergraphs*, North Holland, 1979.
- [10] A.V. Devadoss, A. Rajkumar and N.J.P. Praveena, A study on miracles through holy bible using neutrosophic cognitive maps (NCMS), *International Journal of Computer Applications* **69**(3) (2013).
- [11] G. Gallo, G. Longo and S. Pallottino, Directed hypergraphs and applications, *Discrete Appl. Math* **42** (1993), 177–201.
- [12] M. Hamidi and A. Borumand Saeid, Creating and computing graphs from hypergraphs, *Kragujevac Journal of Mathematics* **43**(1) (2019), 139–164.
- [13] M. Hamidi and A. Borumand saeid, On derivable trees, *Transactions on Combinatorics* (2019) (accepted).
- [14] M. Hamidi and A. Borumand Saeid, Accessible single-valued neutrosophic graphs, *J Appl Math Comput* **57** (2018), 121–146.
- [15] M. Hamidi and A. Borumand Saeid, Achievable single-valued neutrosophic graphs in wireless sensor networks, *New Mathematics and Natural Computation* **14**(2) (2018), 157–185.
- [16] P. Majumdar and S.K. Samanta, On similarity and entropy of neutrosophic sets, *Journal of Intelligent & Fuzzy Systems* **26**(3) (2014), 1245–1252.
- [17] H. Rashmanlou, S. Sahoo, R.A. Borzooei, M. Pal and A. Lakdashti, Computation of shortest path in a vague network by euclidean distance, *Journal of Multi-Valued Logic and Soft Computing* **30** (2017), 115–123.
- [18] S. Sahoo and M. Pal, Certain types of edge irregular intuitionistic fuzzy graphs, *Journal of Intelligent and Fuzzy Systems* **34**(1) (2018), 295–305.
- [19] S. Sahoo and M. Pal, Different types of products on intuitionistic fuzzy graphs, *Pacific Science Review A: Natural Science and Engineering* **17**(3) (2015), 87–96.
- [20] S. Sahoo and M. Pal, Intuitionistic fuzzy competition graph, *Journal of Applied Mathematics and Computing* **52** (2015), 37–57.
- [21] S. Sahoo and M. Pal, Intuitionistic fuzzy tolerance graph with application, *Journal of Applied Mathematics and Computing* **55** (2016), 495–511.
- [22] S. Sahoo and M. Pal, Modular and homomorphic product of intuitionistic fuzzy graphs and their degree, *International Journal of Computing Science and Mathematics* **8**(5) (2017), 395–404.
- [23] S. Sahoo and M. Pal, Product of intuitionistic fuzzy graphs and degree, *Journal of Intelligent and Fuzzy Systems* **32**(1) (2016), 1059–1067.
- [24] S. Sahoo, M. Pal, H. Rashmanlou and R.A. Borzooei, Covering and paired domination in intuitionistic fuzzy graphs, *Journal of Intelligent and Fuzzy Systems* **33**(6) (2017), 4007–4015.
- [25] S. Sahoo, G. Ghorai and M. Pal, Embedding and genus of intuitionistic fuzzy graphs on spheres, *Journal of Multi-Valued Logic and Soft Computing* **31** (2018), 139–154.
- [26] F. Smarandache, *Neutrosophy neutrosophic probability, Set and Logic*, Amer Res Press, Rehoboth, USA, 1998.
- [27] F. Smarandache, *A unifying field in logics*, Neutrosophy: Neutrosophic probability, set and logic, American Research Press, Rehoboth, 1999.
- [28] F. Smarandache, Refined literal indeterminacy and the multiplication law of sub-indeterminacies, *Neutrosophic Sets and Systems* **9** (2015), 58.
- [29] F. Smarandache, Symbolic Neutrosophic Theory, Europanova asbl, Brussels, p. 195.

- [30] W.B. Vasantha Kandasamy and K. Ilanthenral, Florentin Smarandache Neutrosophic Graphs, A New Dimension to Graph Theory, Kindle Edition, 2015.
- [31] H. Wang, F. Smarandache, Y. Zhang and R. Sunderraman, Single valued neutrosophic sets, *Multisspace and Multi-structure* **4** (2010), 410–413.
- [32] H. Wang, F. Smarandache, Y.Q. Zhang and R. Sunderraman, Single-valued neutrosophic sets, *Multisspace and Multi-structure* **4** (2010), 410–413.
- [33] L.A. Zadeh, Fuzzy sets, *Information and Control* **8**(3) (1965), 338–353.

A Novel Framework Using Neutrosophy for Integrated Speech and Text Sentiment Analysis

Kritika Mishra, Ilanthenral Kandasamy, W. B. Vasantha Kandasamy, Florentin Smarandache

Kritika Mishra, Ilanthenral Kandasamy, W. B. Vasantha Kandasamy, Florentin Smarandache (2020). A Novel Framework Using Neutrosophy for Integrated Speech and Text Sentiment Analysis. *Symmetry* 12, 1715; DOI: 10.3390/sym12101715

Abstract: With increasing data on the Internet, it is becoming difficult to analyze every bit and make sure it can be used efficiently for all the businesses. One useful technique using Natural Language Processing (NLP) is sentiment analysis. Various algorithms can be used to classify textual data based on various scales ranging from just positive-negative, positive-neutral-negative to a wide spectrum of emotions. While a lot of work has been done on text, only a lesser amount of research has been done on audio datasets. An audio file contains more features that can be extracted from its amplitude and frequency than a plain text file. The neutrosophic set is symmetric in nature, and similarly refined neutrosophic set that has the refined indeterminacies I_1 and I_2 in the middle between the extremes Truth T and False F . Neutrosophy which deals with the concept of indeterminacy is another not so explored topic in NLP. Though neutrosophy has been used in sentiment analysis of textual data, it has not been used in speech sentiment analysis. We have proposed a novel framework that performs sentiment analysis on audio files by calculating their Single-Valued Neutrosophic Sets (SVNS) and clustering them into positive-neutral-negative and combines these results with those obtained by performing sentiment analysis on the text files of those audio.

Keywords: sentiment analysis; Speech Analysis; Neutrosophic Sets; indeterminacy; Single-Valued Neutrosophic Sets (SVNS); clustering algorithm; K-means; hierarchical agglomerative clustering

1. Introduction

While many algorithms and techniques were developed for sentiment analysis in the previous years, from classification into just positive and negative categories to a wide spectrum of emotions, less attention has been paid to the concept of indeterminacy. Early stages of work were inclined towards Boolean logic which meant an absolute classification into positive or negative classes, 1 for positive and 0 for negative. Fuzzy logic uses the memberships of positive and negative that can vary in the range 0 to 1. Neutrosophy is the study of indeterminacies, meaning that not every given argument can be distinguished as positive or negative, it emphasizes the need for a neutral category. Neutrosophy theory was introduced in 1998 by Smarandache [1], and it is based on truth membership T , indeterminate membership I and false membership F that satisfies $0 \leq T + I + F \leq 3$, and the memberships are independent of each other. In case

of using neutrosophy in sentiment analysis, these memberships are relabelled as positive membership, neutral membership and negative membership.

Another interesting topic is the speech sentiment analysis, it involves processing audio. Audio files cannot be directly understood by models. Machine learning algorithms do not take raw audio files as input hence it is imperative to extract features from the audio files. An audio signal is a three-dimensional signal where the three axes represent amplitude, frequency and time. Previous work on detecting the sentiment of audio files is inclined towards emotion detection as the audio datasets are mostly labelled and created in a manner to include various emotions. Then using the dataset for training classifiers are built. Speech analysis is also largely associated with speech recognition. Speech analysis is the process of analyzing and extracting information from the audio files which are more efficient than the text translation itself. Features can be extracted from audio using Librosa package in python. A total of 193 features per audio file have been retrieved including Mel-Frequency Cepstral Coefficients (MFCC), Mel spectrogram, chroma, contrast, and tonnetz. The goal of this project is to establish a relationship between sentiment detected in audio and sentiment detected from the translation of the same audio to text. Work done in the domain of speech sentiment analysis is largely focused on labelled datasets because the datasets are created using actors and not collected like it is done for text where we can scrape tweets, blogs or articles. Hence the datasets are labelled as various emotions such as the Ryerson Audio-Visual Database of Emotional Speech and Song (RAVDESS) dataset which contains angry, happy, sad, calm, fearful, disgusted, and surprised classes of emotions. These datasets have no text translation provided hence no comparison can be established. With unlabelled datasets such as VoxCeleb1/2 which have been randomly collected from random YouTube videos, again the translation problem arises leading to no meaningful comparison scale. We need audio data along with the text data for comparison, so a dataset with audio translation was required. Hence LibriSpeech dataset [2] was chosen, it is a corpus of approximately 1000 h of 16 kHz read English speech.

The K-means clustering algorithm performs clustering of n values in K clusters, where each value belongs to a cluster. Since the dataset is unlabelled features extracted from the audio are clustered using the K-means clustering algorithm. Then the distance of each point from the centroid of each cluster is calculated. 1-distance implies the closeness of an audio file to every cluster. This closeness measure is used to generate Single Value Neutrosophic Sets (SVNS) for the audio. Since the data is unlabelled, we performed clustering of SVNS values using the K-means clustering.

Sentiment analysis of the text has various applications. It is used by businesses for analysing customer feedback of products and brands without having to go through all of them manually. An example of this real-life application could be social media monitoring where scraping and analysing tweets from Twitter on a certain topic or about a particular brand or personality and analysing them could very well indicate the general sentiment of the masses. Ever since internet technology started booming, data became abundant. While it is simpler to process and derive meaningful results from tabular data, it is the need for the hour to process unstructured data in the form of sentences, paragraphs or text files and PDFs. Hence NLP provides excellent sentiment analysis tools for the same. However, sentiment cannot be represented as a black and white picture with just positive and negative arguments alone. To factor in indeterminacy, we have the concept of neutrosophy which means the given argument may either be neutral or with no relation to the extremes. Work done previously related to neutrosophy will be explained in detail in the next section.

For the sentiment analysis of text part, the translation of the audio is provided as text files along with the dataset which mitigates the possibility of inefficient translation. In this paper, using Valence Aware Dictionary and Sentiment Reasoner (VADER), a lexicon and rule-based tool for sentiment analysis on the text files, SVNS values for text are generated. Then K-means clustering is applied to visualize the three clusters. The first step is the comparison of the two K-means plots indicating the formation of a cluster larger than the rest in audio SVNS implying the need for a neutral class. Then both the SVNS are combined

by averaging out the two scores respectively for P_x , I_x and N_x . Again K-means clustering and hierarchical agglomerative clustering is performed on these SVNS values to get the final clusters for each file.

Neutrosophic logic uses Single Valued Neutrosophic Sets (SVNS) to implement the concept of indeterminacy in sentiment analysis. For every sentence A , its representative SVNS is generated. SVNS looks like $\langle P_A, I_A, N_A \rangle$ where ' P_A ' is the positive sentiment score, ' I_A ' is the indeterminacy or neutrality score and ' N_A ' is the negative sentiment score. Neutrosophy was introduced to detect the paradox proposition.

In this paper, a new innovative approach is carried out in which we use unlabelled audio dataset and then generate SVNS for audio to analyse audio files from the neutrosophic logic framework. The higher-level architecture is shown in Figure 1.

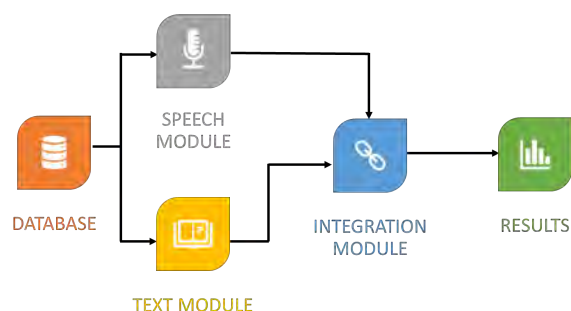

Figure 1. High level architecture.

Indeterminacy is a strong concept which has rightly indicated the importance of neutral or indeterminate class in text sentiment analysis. Coupling it with speech analysis is just an attempt to prove that not all audio can be segregated into positive and negative. There is a very good amount of neutrality present in the data that needs to be represented. We have used clustering to validate the presence of neutrality.

This paper is organized as follows: Section 1 is introductory in nature, the literature survey is provided in Section 2. In Section 3, the basic concepts related to speech sentiment analysis, text sentiment analysis and neutrosophy are recalled. The model description of the proposed framework that makes uses of neutrosophy to handle speech and text sentiment analysis is given in Section 4. In Section 5 the experimental results in terms of K-clustering and agglomerative clustering are provided. Results and discussions about combined SVNS are carried out in Section 6. The conclusions are provided in the last section.

2. Literature Survey

Emphasizing on the need and application of sentiment analysis in business and how it can play a crucial role in data monitoring on social media. The fuzzy logic model by Karen Howells and Ahmet Ertugan [3] attempts to form a five class classifier—strongly positive, positive, neutral, negative and strongly negative for tweets. It is proposed to add fuzzy logic classifier to the social bots used for data mining. It will result in the analysis of the overall positive, neutral and negative sentiments which will facilitate the companies to develop strategies to improve the customer feedback and improve the reputation of their products and brand. A study on application of sentiment analysis in the tourism industry [4] shows that most of the sentiment analysis methods perform better for positive class. One of the reasons

for this could be the fact that human language is inclined towards positivity. It is even more difficult to detect neutral sentiment. Ribeiro and others have pointed out a similar observation in [5] that twelve out of twenty-four methods are better in classifying positive sentiment and neutral sentiment is harder to identify. They also concluded from their experiments that VADER tool provides consistent results for three-classes (positive, neutral, negative) classification.

Similarly, Hutto and Gilbert in [6] did an excellent job in comparing VADER tool eleven sentiment analysis techniques depending on Naïve Bayes, Support Vector Machine (SVM) and maximum entropy algorithms. They concluded that VADER is simple to understand and does not function like a black box where the internal structure of process cannot be understood as in complex machine learning and deep learning sentiment analysis techniques. VADER also performs in par with these benchmark models and is highly efficient as it only requires a fraction of second for analysis because it uses a lexicon rule-based approach, whereas its counterpart SVM can take much more time. VADER is also computationally economical as it does not need any special technical specifications such as a GPU for processing. The transparency of the tool attracts a larger audience as its users include professionals from businesses and marketing as well as it allows researchers to experiment more. Hutto and Gilbert's analysis is applied in [7] to rule out the neutral tweets. They built an election prediction model for 2016 USA elections. They used VADER to remove all the neutral tweets that were scraped to focus on positive and negative sentiments towards Donald Trump and Hilary Clinton.

Fuzzy logic gives the measure of positive and negative sentiment in decimal figures, not as absolute values 0 or 1 like Boolean logic. If truth measure is T , then F is falsehood according to the intuitionistic fuzzy set and I is the degree of indeterminacy. Neutrosophy was proposed in [1], it was taken as $0 \leq T + I + F \leq 3$. The neutrosophy theory was introduced in 1998 by Smarandache [1]. Neutrality or indeterminacy was introduced in sentiment analysis to address uncertainties. The importance of neutrosophy in sentiment analysis for the benefit of its prime users such as NLP specialists was pointed out in [8]. To mathematically apply neutrosophic logic in real world problems, Single Valued Neutrosophic Sets (SVNS) were introduced in [9]. A SVNS for sentiment analysis represented by $\langle P_A, I_A, N_A \rangle$ where ' P_A ' is the positive sentiment score, ' I_A ' is the indeterminacy or neutrality score and ' N_A ' is the negative sentiment score.

Refined Neutrosophic sets were introduced in [10]. Furthermore, the concept of Double Valued Neutrosophic Sets (DVNS) was introduced in [11]. DVNS are an improvisation of SVNS. The indeterminacy score was split into two: one indicating indeterminacy of positive sentiment or ' T ' the truth measure and the other one indicating indeterminacy of negative sentiment or ' F ' the falsehood measure. DVNS are more accurate than SVNS. A minimum spanning tree clustering model was also introduced for double valued neutrosophic sets. Multi objective non-linear optimization on four-valued refined neutrosophic set was carried out in [12].

In [13] a detailed comparison between fuzzy logic and neutrosophic logic was shown by analyzing the #metoo movement. The tweets relevant to the movement are collected from Twitter. After cleaning, the tweets are then input in the VADER tool which generates SVNSs for each tweet. These SVNS are then visualized using clustering algorithms such as K-means and K-NN. Neutrosophic refined sets [10,14–16] have been developed and applied in various fields, including in sentiment analysis recently. However no one has till now attempted to do speech sentiment analysis using neutrosophy and combine it with text sentiment analysis.

A classifier with SVM in multi class mode was developed to classify a six class dataset by extracting linear prediction coefficients, derived cepstrum coefficients and mel frequency cepstral coefficients [17]. The model shows a considerable improvement and results are 91.7% accurate. After various experiments it was concluded in [18] that for emotion recognition convolutional neural networks capture rich features of the dataset when a large sized dataset is used. They also have higher accuracy compared to SVM. SVMs have certain limitations even though they can fit data with non-linearities. It was concluded that machine

learning is a better solution for analysing audio. In [19] a multiple classifier system was developed for speech emotion recognition. A multimodal system was developed in [20] to analyze audio, text and visual data together. Features such as MFCC, spectral centroid, spectral flux, beat sum, and beat histogram are extracted from the audio. For text, concepts were extracted based on various rules. For visual data, facial features were incorporated. All these features were then concatenated into a single vector and classified. A similar approach was presented in [21] to build multimodal classifier using audio, textual and visual features and comparing it to its bimodal subsets (audio+text, text+visual, audio+visual). The same set of features were extracted from audio using openSMILE software whereas for text convolutional neural networks were deployed. These features were then combined using decision level fusion. From these studies it can be very well inferred that using both audio and textual features for classification will yield better or sensitive results.

3. Basic Concepts

3.1. Neutrosophy

Neutrosophy is essentially a branch of philosophy. It is based on understanding the scope and dimensions of indeterminacy. Neutrosophy forms the basis of various related fields in statistical analysis, probability, set theory, etc. In some cases, indeterminacy may require more information or in others, it may not have any linking towards either positive or negative sentiment. To represent uncertain, imprecise, incomplete, inconsistent, and indeterminate information that is present in the real world, the concept of a neutrosophic set from the philosophical point of view has been proposed.

Single Valued Neutrosophic Sets (SVNS) is an instance of a Neutrosophic set. The concept of a neutrosophic set is as follows:

Definition 1. Consider X to be a space of points (data-points), with an element in X represented by x . A neutrosophic set A in X is denoted by a truth membership function $T_A(x)$, an indeterminacy membership function $I_A(x)$, and a falsity membership function $F_A(x)$. The functions $T_A(x)$, $I_A(x)$, and $F_A(x)$ are real standard or non-standard subsets of $]-0, 1 + [$; that is,

$$T_A(x) : X \rightarrow]-0, 1 + [$$

$$I_A(x) : X \rightarrow]-0, 1 + [$$

$$F_A(x) : X \rightarrow]-0, 1 + [$$

with the condition $-0 \leq \sup T_A(x) + \sup I_A(x) + \sup F_A(x) \leq 3^+$.

This definition of a neutrosophic set is difficult to apply in the real world in scientific and engineering fields. Therefore, the concept of SVNS, which is an instance of a neutrosophic set, has been introduced.

Definition 2. Consider X be a space of points (data-points) with element in X denoted by x . An SVNS A in X is characterized by truth membership function $T_A(x)$, indeterminacy membership function $I_A(x)$, and falsity membership function $F_A(x)$. For each point $x \in X$, there are $T_A(x), I_A(x), F_A(x) \in [0, 1]$, and $0 \leq T_A(x) + I_A(x) + F_A(x) \leq 3$. Therefore, an SVNS A can be represented by

$$A = \{ \langle x, T_A(x), I_A(x), F_A(x) \rangle | x \in X \}$$

The various distance measures and clustering algorithms defined over neutrosophic sets are given in [2,11,14].

3.2. Sentiment Analysis of Text and VADER Package

Sentiment analysis is a very efficient tool in judging the popular sentiment revolving around any particular product, services or brand. Sentiment analysis is also known as opinion mining. It is, in all conclusive trails, a process of determining the tone behind a line of text and to get an understanding of the attitude or polarity behind that opinion. Sentiment analysis is very helpful in social media understanding, as it enables us to pick up a review of the more extensive general assessment behind specific subjects. Most of the existing sentiment analysis tools classify the arguments into positive or negative sentiment based on a set of predefined rules or 'lexicons'. This enables the tool to calculate the overall leaning polarity of the text and thus makes a decision on the overall tone of the subject.

VADER is an easy-to-use, highly accurate and consistent tool for sentiment analysis. It is fully open source with the MIT License. It has a lexicon rule-based method to detect sentiment score for three classes: positive, neutral, and negative. It provides a compound score that lies in the range $[-1, 1]$. This compound score is used to calculate the overall sentiment of the input text. If the compound score ≥ 0.05 , then it is tagged as positive. If the compound score is ≤ -0.05 then it tagged as negative. The arguments with the compound score between $(-0.05, 0.05)$ is tagged as neutral. VADER uses Amazon's Mechanical Turk to acquire their ratings, which is an extremely efficient process. VADER has a built in dictionary with a list of positive and negative words. It then calculates the individual score by summing the pre-defined score for the positive and negative words present in the dictionary. VADER forms a particularly strong basis for social media texts since the tweets or comments posted on social media are often informal, with grammatical errors and contain a lot of other displays of strong emotion, such as emojis, more than one exclamation point, etc. As an example, the sentence, 'This is good!!!' will be rated as being 'more positive' than 'This is good!' by VADER. VADER was observed to be very fruitful when managing social media writings, motion picture reviews, and product reviews. This is on the grounds that VADER not just tells about the positivity and negativity score yet in addition tells us how positive or negative a text is.

VADER has a great deal of advantages over conventional strategies for sentiment analysis, including:

1. It works very well with social media content, yet promptly sums up to different areas.
2. Although it contains a human curated sentiment dictionary for analysis, it does not specifically require any training data.
3. It can be used with real time data due to its speed and efficiency.

The VADER package for Python analysis presents the negative, positive and indeterminate values for every single tweet. Every single tweet is represented as $\langle N_x, I_x, P_x \rangle$, where x belongs to the dataset.

3.3. Speech Analysis

An important component of this paper is speech analysis which involves processing audio. Audio files cannot be directly understood by models. Machine learning algorithms do not take raw audio files as input hence it is imperative to extract features from the audio files. An audio signal is a three-dimensional signal where the three axes represent amplitude, frequency and time. Extracting features from audio files helps in building classifiers for prediction and recommendation.

Python provides a package called librosa for the analysis of audio and music. In this work, librosa has been used to extract a total 193 features per audio file. To display an audio file as spectrogram, wave plot or colormap librosa.display is used.

Figure 2 is a wave plot of an audio file. The loudness (amplitude) of an audio file can be shown in wave plot.

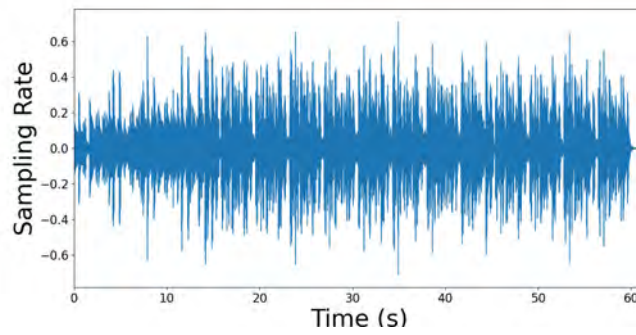

Figure 2. Wave plot of an audio file.

Figure 3 shows the spectrogram of the sample audio. Spectrogram is used to map different frequencies at a given point of time to its amplitude. It is a visual representation of the spectrum of frequencies of a sound.

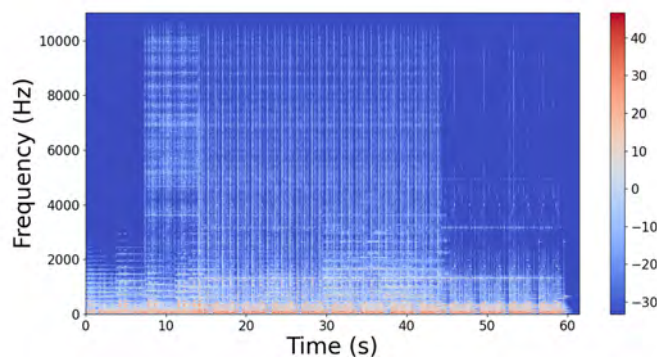

Figure 3. Spectrogram of an audio file.

The MFCC features of an audio file is shown in Figure 4. The MFCCs of a signal are a small set of features which concisely describe the overall shape of a spectral envelope. Sounds generated by a human are filtered by the shape of the vocal tract including the tongue, teeth etc. MFCCs represent the shape of the envelope that the vocal tract manifests on the short time power spectrum.

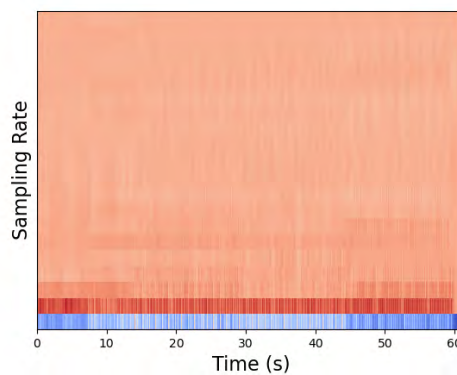

Figure 4. MFCC features of an audio file.

The chroma features of the sample audio file is represented in Figure 5. These represent the tonal content of audio files, that is the representation of pitch within the time window spread over the twelve chroma bands.

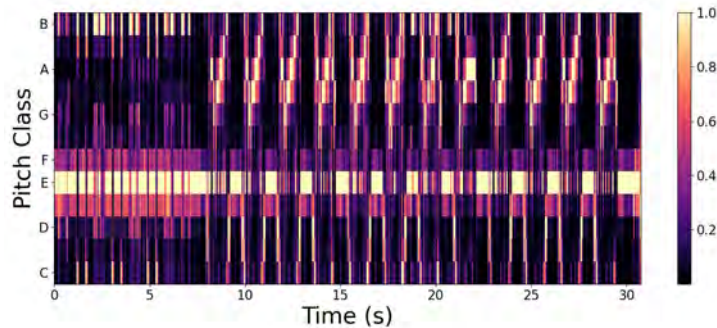

Figure 5. Chromagram of an audio file.

Figure 6 represents the mel spectrogram of the sample audio file. Mathematically, mel scale is the result of some non-linear transformation of the frequency scale. The purpose of the mel scale is that the difference in the frequencies as perceived by humans should be different for all ranges. For example, humans can easily identify the difference between 500 Hz and 1000 Hz but not between 8500 Hz and 9000 Hz.

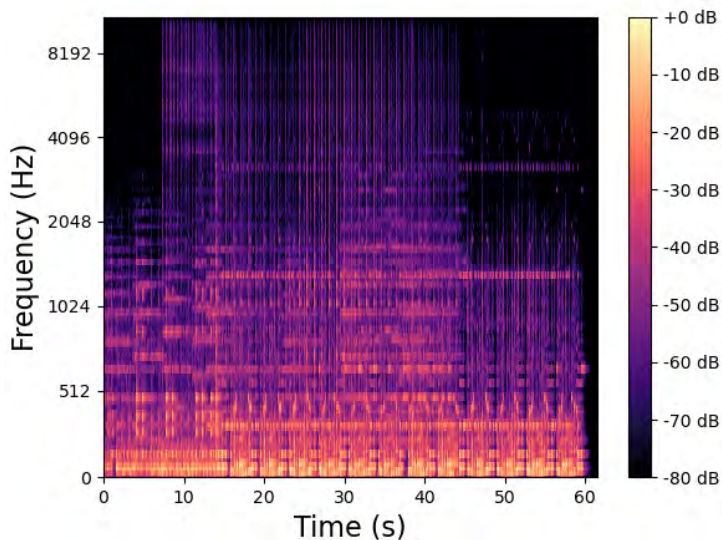

Figure 6. Mel spectrogram of an audio file.

The spectral contrast of the sample audio file is represented in Figure 7. Spectral contrast extracts the spectral peaks, valleys, and their differences in each sub-band. The spectral contrast features represent the relative spectral characteristics.

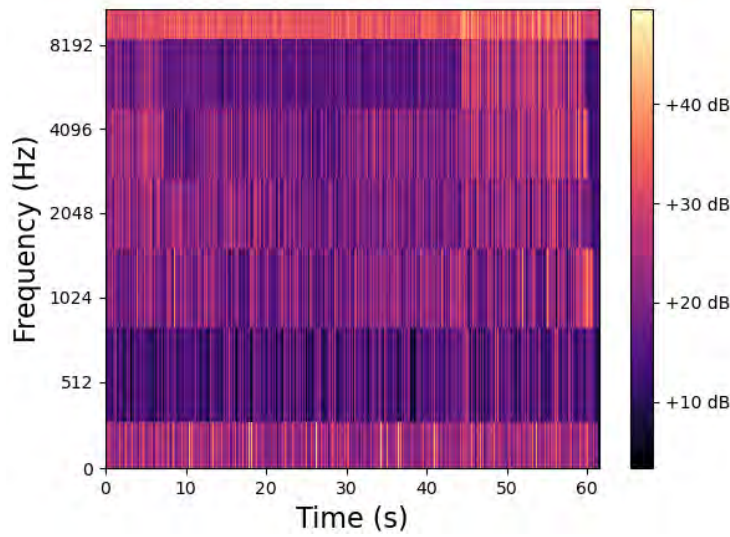

Figure 7. Spectral contrast of a sample audio file.

Figure 8 shows the tonnetz features of the sample audio file. The tonnetz is a pitch space defined by the network of relationships between musical pitches in just intonation. It estimates tonal centroids as coordinates in a six-dimensional interval space.

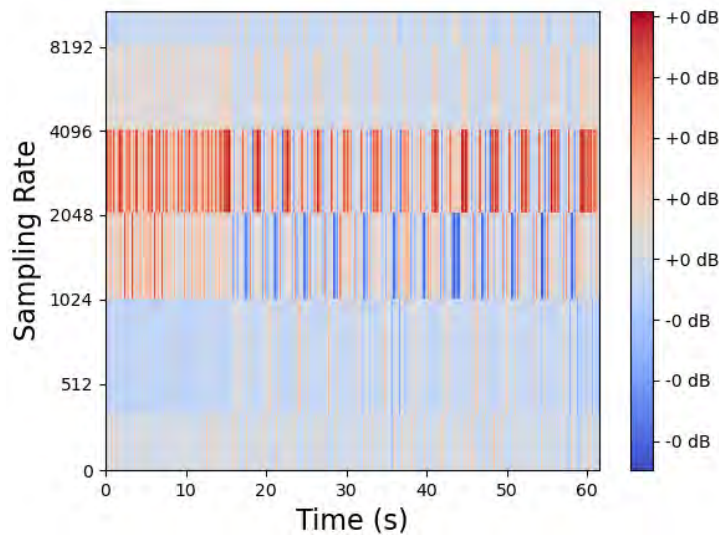

Figure 8. Tonnetz features of the sample audio file.

4. Model Description

4.1. Model Architecture

The research work follows a semi-hierarchical model where one step is followed by another but it is bifurcated into two wings one for audio and other for text and later on the SVNS are combined together in the integration module.

The overall architecture of the work is provided in Figure 9. The process begins with selecting an appropriate dataset with audio to text translations. For the audio section, convert the audio files into .wav format and extract features for further processing. Since the dataset is unlabelled the only suitable choice in the machine learning algorithms are clustering algorithms. For this module, K-means clustering was chosen. Then the Euclidean distance(x) of each point from the centre of each cluster is calculated and $1 - x$ is used as the measure of that specific class, SVNS values were obtained. Clustering was performed again to visualise the SVNS as clusters.

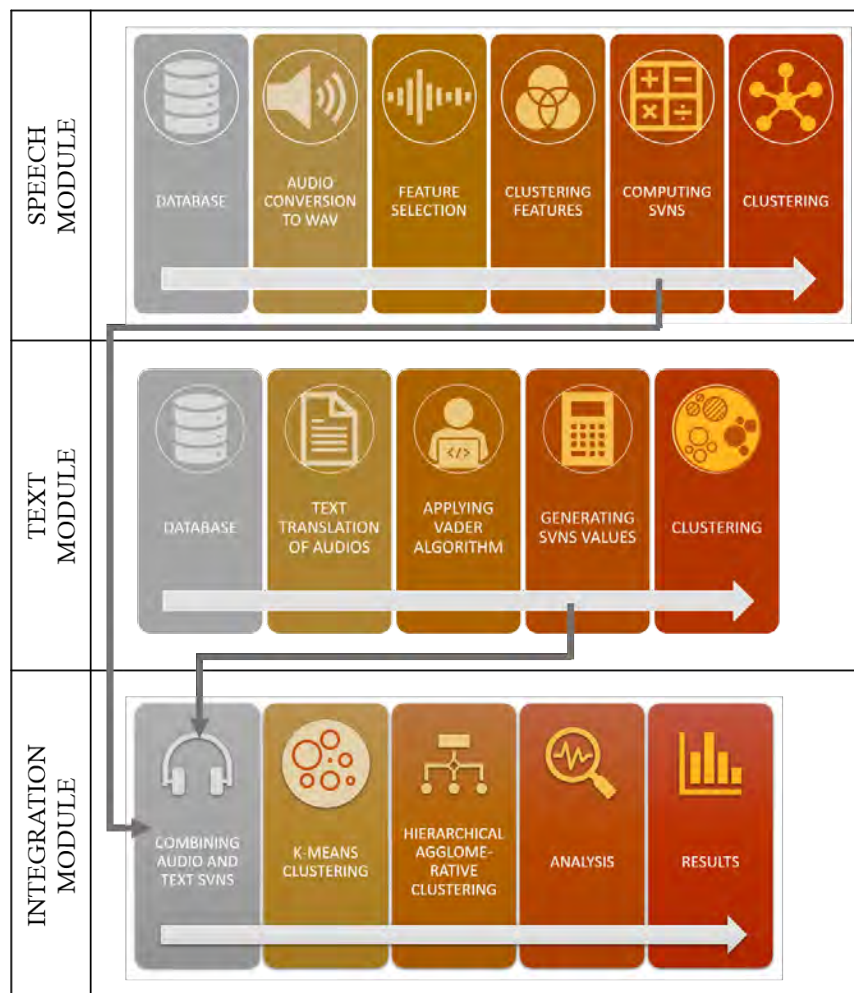

Figure 9. The model architecture.

For the text module, the text translations were considered and VADER tool was used to generate SVNS. After the generation of SVNS, it was clustered and visualized.

In the integration module the SVNS values obtained from speech module and text module was combined together, there by combining both the branches. The final SVNS are calculated by averaging the audio and text SVNS which are again clustered and visualized for comparison.

4.2. Data Processing

Dataset played a crucial role in this research work. The reason being we wanted to map audio SVNS to text SVNS for comparison so a dataset with audio translation was required. Hence LibriSpeech dataset [2] was chosen. LibriSpeech is a corpus of approximately 1000 h of 16kHz read English speech. The data is derived from read audiobooks from the LibriVox project, and has been carefully segmented and aligned. For this purpose the following folders have been used:

1. Dev-clean (337 MB with 2703 audio)
2. Train-clean (6.3 GB with 28,539 audio)

We used the dev clean (337MB) folder to test algorithms in the initial phase and then scaled up to train clean-100 (6.3 GB) to get the final results. We did not scale further due to hardware limitations. The reason for selecting the “clean” speech sets was to eliminate the more challenging audio and focus more on speech analysis. Since these are audio books, the dataset is structured in the following format. For example, 84-121123-0001.flac is present in the sub directory 121123 of directory 84, it implies that the reader ID for this audio file is 84 and the chapter is 121123. There is a separate chapters.txt which is provided along with the dataset that provides the details of the chapter. For example, 121123 is the chapter ‘Maximilian’ in the book ‘The Count of Monte Cristo’. In the same sub directory 121123 a text file is present, 84-121123.trans.txt which contains the audio to text translation of the audio files in that directory. The reason for choosing this dataset over others is that it provides audio to text translations of the audio files.

The processing of audio file from .flac format to .wav format was carried out. The dataset was available in .flac format. It was necessary to convert these files into .wav format for further processing and extracting features. For this ffmpeg was used in shell script with bash. Ffmpeg is a free and open-source project consisting of a vast software suite of libraries and programs for handling video, audio, and other multimedia files and streams.

4.3. Feature Extraction

The audio files were then fed into the python feature extraction script which extracted 193 features per audio file. Using the Librosa package in python following features were extracted

1. MFCC (40)
2. Chroma (12)
3. Mel (128)
4. Contrast (7)
5. Tonnetz (6)

The following npy files were generated as result:

1. X_dev_clean.npy (2703 × 193)
2. X_train_clean.npy (28,539 × 193)

Then these files were normalized using sklearn. The screenshot of the normalized audio features is given in Figure 10.

```

PS C:\Users\lenovo\Desktop\FINAL PROJECT> python .\open_npy.py
-----TRAIN-CLEAN-100-EXTRACTED FEATURES-----
      0      1      2      3      4      ...      188      189      190      191      192
0  -374.841675  90.883644 -32.072002  55.451000 -13.797498 ... -0.030792  0.221905 -0.027078 -0.044033 -0.037235
1  -345.454163  98.103493 -45.386734  60.288715 -19.570881 ... -0.029873  0.205216 -0.061167 -0.030727 -0.046656
2  -334.364380  97.877785 -46.952782  52.730156 -13.642296 ... -0.026842  0.207515 -0.001071 -0.045491 -0.026795
3  -342.814392  97.806534 -41.919743  53.055447 -13.609317 ... -0.025001  0.195355 -0.084089 -0.016605 -0.053410
4  -345.356476  100.976929 -37.766922  54.308933 -19.674908 ... -0.008987  0.102101 -0.170943  0.021752 -0.050499
...
...
28534 -390.570770  124.806870 -42.248779  37.204556 -14.912910 ... -0.000338  0.028475 -0.060838  0.000292  0.010075
28535 -436.929077  115.274879 -21.572580  23.254366 -2.032800 ...  0.008602 -0.058976 -0.053635 -0.019164  0.002361
28536 -403.047577  111.372551 -19.114309  19.278753 -3.343592 ... -0.006692  0.017377 -0.061804 -0.000229  0.016433
28537 -387.244202  106.519928 -23.511724  30.768705 -7.281405 ... -0.001545 -0.022095 -0.065700 -0.006205  0.012536
28538 -410.713165  111.369987 -26.162804  32.031174 -5.851342 ...  0.008477 -0.094988 -0.041821 -0.011928  0.003294

[28539 rows x 193 columns]
(28539, 193)
-----TRAIN-CLEAN-100-EXTRACTED FEATURES AFTER NORMALISING-----
[[-9.35036998e-01  2.26707902e-01 -8.00031343e-02 ... -6.75445015e-05
-1.09839875e-04 -9.28815936e-05]
[-9.14491304e-01  2.59700999e-01 -1.20148425e-01 ... -1.61921029e-04
-8.13413002e-05 -1.23508393e-04]
[-9.13837547e-01  2.67505751e-01 -1.28324718e-01 ... -2.92825894e-06
-1.24328879e-04 -7.32323293e-05]
...
[-9.41214486e-01  2.60082095e-01 -4.46365785e-02 ... -1.44327758e-04
-5.35823836e-07  3.83754429e-05]
[-9.37113573e-01  2.57773441e-01 -5.68973171e-02 ... -1.59184810e-04
-1.50163499e-05  3.03374937e-05]
[-9.40915433e-01  2.55140933e-01 -5.99371722e-02 ... -9.58091180e-05
-2.73253505e-05  7.54534336e-06]]
(28539, 193)

```

Figure 10. Normalized audio features.

4.4. Clustering and Visualization

4.4.1. K-Means

The K-means algorithms used for clustering SVNS values for sentiment analysis was proposed in [13]. It is a simple algorithm which produces the same results irrespective of the order of the dataset. The input is the SVNS values as dataset and the number of clusters (K) required. The algorithm then picks K SVNS values from the dataset randomly and assigns them as centroid. Then repeatedly the distance between other SVNS values and centroids are calculated and they are assigned to one cluster. This process continues till the centroid stops changing. Elbow method specifies what a good K (number of clusters) would be based on the sum of squared distance (SSE) between data points and their assigned clusters' centroids.

4.4.2. Hierarchical Agglomerative Clustering and Visualization

Hierarchical clustering is a machine learning algorithm used to group similar data together based on a similarity measure or the Euclidean distance between the data points. It is generally used for unlabelled data. There are two types of hierarchical clustering approaches: divisive and agglomerative. Hierarchical divisive clustering refers to top to down approach where all the data is assigned to one cluster and then partitioned further into clusters. In hierarchical agglomerative clustering all the data points are treated as individual clusters and then with every step data points closest to each other are identified and grouped together. This process is continued until all the data points are grouped into one cluster, creating a dendrogram. The algorithm for hierarchical agglomerative clustering of SVNS values is given in Algorithm 1.

Algorithm 1: Hierarchical agglomerative clustering.

Input: N number of SVNSs $\{s_1, \dots, s_N\}$
Output: Cluster
begin
 Step 1: Create a distance matrix X using Euclidean distance function $dist(s_i, s_j)$
 for $i \leftarrow 1, N$ **do**
 for $j \leftarrow i + 1, N$ **do**
 $x_i \leftarrow dist(s_i, s_j)$
 end
 end
 Step 2: $X \leftarrow \{x_1, x_2, \dots, x_N\}$
 Step 3: Perform clustering
 while $X.size > 1$ **do**
 $(x_{min1}, x_{min2}) \leftarrow minimum_dist(x_a, x_b) \forall x_a, x_b \in X$
 Remove x_{min1} and x_{min2} from X
 Add *center* $\{x_{min1}, x_{min2}\}$ to X
 Alter distance matrix X accordingly
 end
 Results in cluster automatically
end

4.5. Generating SVNS Values

4.5.1. Speech Module

Since the dataset was unlabelled, K-means algorithm was used for clustering. With K being set to 3, the clusters were obtained. Let the cluster centres be B_1, B_2 and B_3 . B_1, B_2 and B_3 were mapped as positive, neutral, and negative clusters, respectively. We randomly selected 30 samples from each cluster and mapped the maximum sentiment of the sample as the sentiment of the cluster. For every data point P , in the dataset distance was calculated to the centres of each cluster. 1-distance implied the closeness measure to each cluster or class (positive, neutral or negative). SVNS for audio were created using 1-distance and stored in a .csv file as $\langle P_A, I_A, N_A \rangle$.

4.5.2. Text Module

The next task is sentiment analysis of text translation using VADER. VADER is a tool used for sentiment analysis which provides a measure for positive, neutral and negative classes for each input sentence. Using VADER text translation for each audio was analysed and SVNS were generated and stored in .csv file as $\langle P_T, I_T, N_T \rangle$. Taking the csv file of text SVNS as input, K-means cluster with K, taken as 3, was performed.

4.5.3. Integration Module

Next, we proceed on to combine the SVNS, the audio SVNS values are represented by $\langle P_A, I_A, N_A \rangle$ and the text SVNS values are represented by $\langle P_T, I_T, N_T \rangle$ and the combined SVNS are represented by $\langle P_C, I_C, N_C \rangle$, where the component values are calculated as

$$\begin{aligned}
 P_C &= \frac{(P_T + P_A)}{2} \\
 I_C &= \frac{(I_T + I_A)}{2} \\
 N_C &= \frac{(N_T + N_A)}{2}
 \end{aligned}
 \tag{1}$$

Combined SVNS values were generated using equations given in Equation (1). The visualization of combined SVNS is carried out next. Using K-means clustering and hierarchical agglomerative clustering algorithms, the SVNS of audio, text and combined modules were visualized into 3 clusters.

5. Experimental Results and Data Visualisation

5.1. Speech Module

The elbow method specifies what a good K, the number of clusters would be based on the SSE between data points and their assigned clusters' centroids. The elbow chart of the audio were created to decide the most favourable number of clusters, they are given in Figure 11a,b for the dev-clean folder and train-clean folder, respectively.

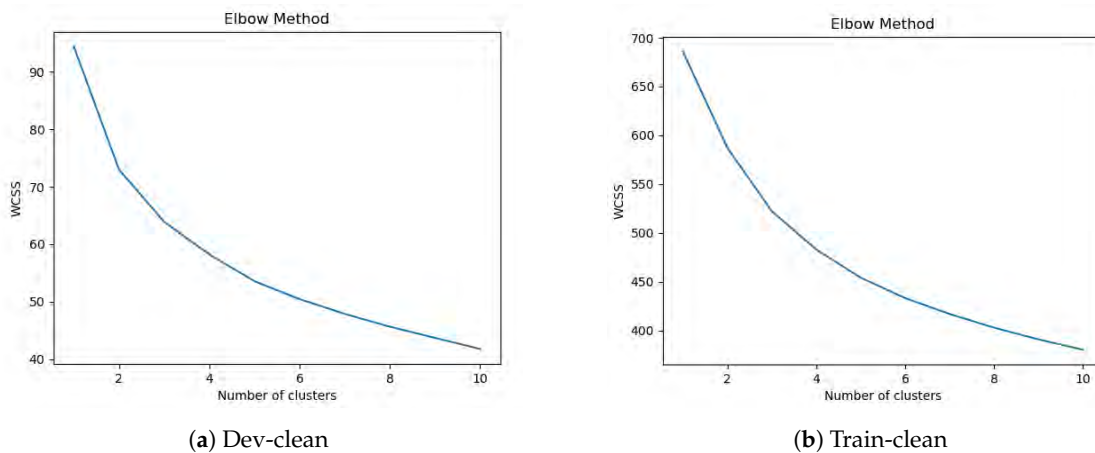

Figure 11. Elbow chart for dataset.

The elbow method generates the optimum number of clusters as three as shown in Figure 11a,b. Hence, the dataset is clustered into three clusters – positive, indeterminate and negative. The results for the clustering of the dataset into three is visualised in 2D and 3D in Figures 12a,b and 13a,b. The 2D visualization of the clusters is given in Figure 12a,b for dev-clean and train-clean respectively. Figure 13a,b are the K-Means clustering in 3D for dev-clean and train-clean respectively.

Once clusters are formed, we calculate the Euclidean distance of each data point from the centre of the cluster. Let the cluster centres be B_1, B_2 and B_3 . For every data point P in the dataset distance was calculated to the centres of each cluster. 1-distance implied the closeness measure to each cluster or class (positive, neutral or negative). Euclidean distance d can be calculated using the formula given Equation (2).

$$d = \sqrt{(x_2 - x_1)^2 + (y_2 - y_1)^2}
 \tag{2}$$

The sample SVNS values generated from the audio features is given in Figure 14a.

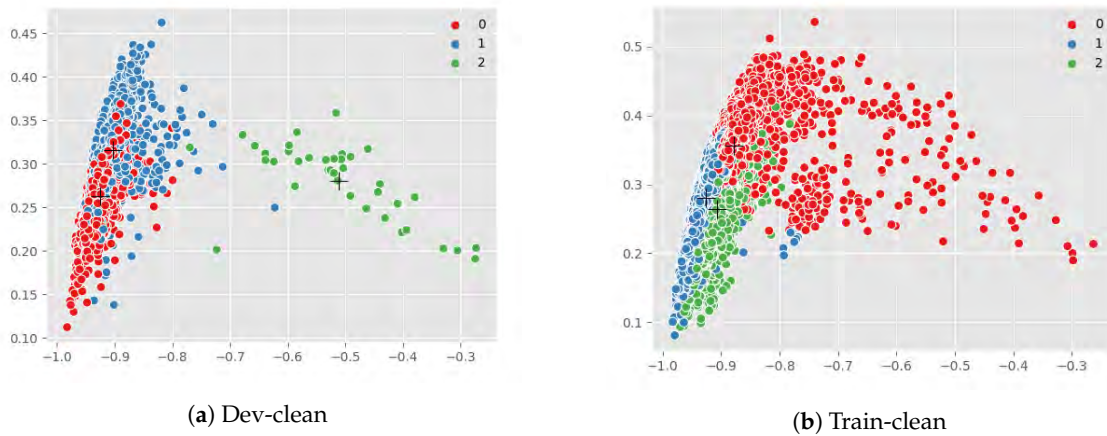

Figure 12. K-means clustering in 2D for audio dataset.

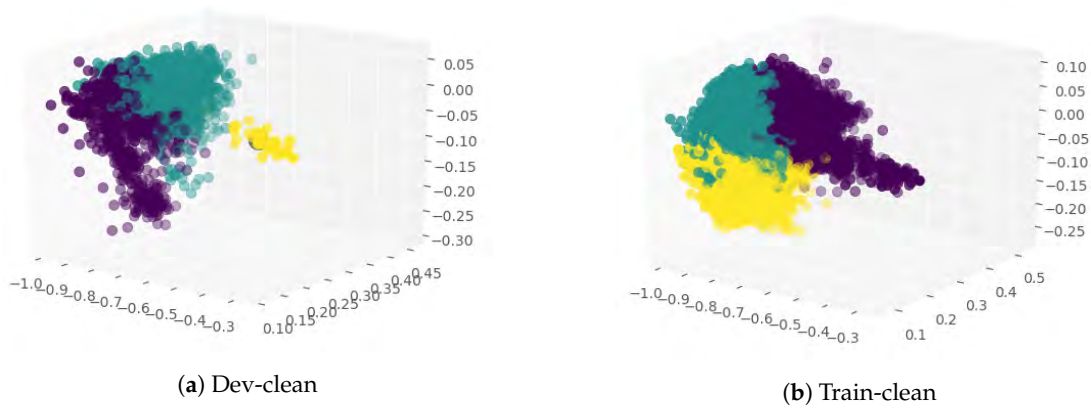

Figure 13. K-means clustering in 3D for audio dataset.

DISTANCE FROM CLUSTER CENTRE

```

[[0.142 0.049 0.065]
 [0.132 0.067 0.092]
 [0.155 0.055 0.083]
 [0.121 0.053 0.074]
 [0.126 0.046 0.061]
 [0.133 0.054 0.057]
 [0.129 0.058 0.042]

```

(a) Audio SVNS

	A	B	C
1	pos	neu	neg
18	0.125	0.835	0.04
19	0.123	0.827	0.05
20	0.047	0.953	0
21	0.1	0.9	0
22	0.116	0.767	0.117
23	0.146	0.854	0
24	0.079	0.921	0
25	0.151	0.786	0.063
26	0.09	0.849	0.061
27	0.078	0.845	0.077

(b) Text SVNS

Figure 14. Sample SVNS values.

5.2. Text Module

The audio to text translations are given in the dataset, a sample from the dataset is given Figure 15.

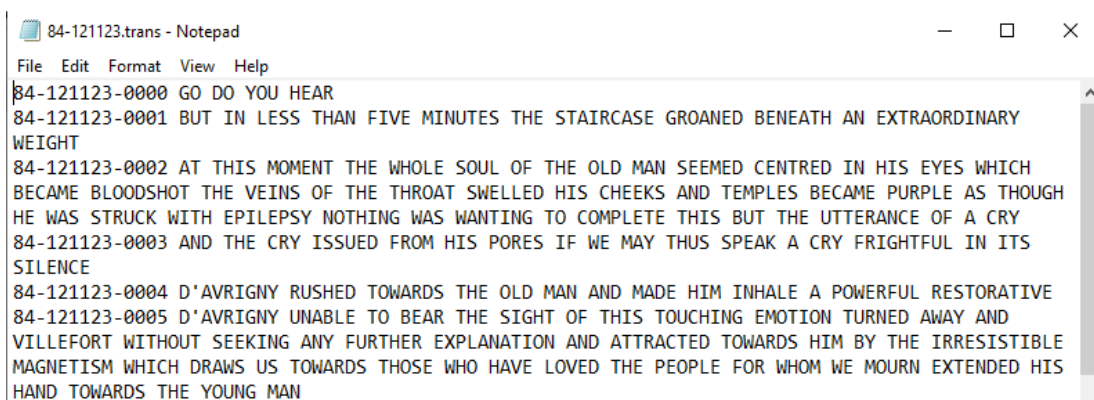

Figure 15. Sample audio to translation.

Now the text file is processed with the VADER tool for analysis, which generates SVNS values in form of $\langle N_T, I_T, P_T \rangle$. For the sake of notational convenience, we created and populated .csv file in the order of $\langle P_T, I_T, N_T \rangle$, where P_T is positive, I_T is the indeterminate membership and N_T is the negative membership. A sample of the .csv file that contains the SVNS values is shown in Figure 14b. VADER also gives a composite score for every line, depending on which the tool also provides a class label, i.e., positive or neutral or negative. Since we were working with unlabelled data, we did not have a method to validate the labels provided by the tool.

In the case of the textual content of a novel, this is a narration, so one cannot get high values for positivity or negativity only, neutrals takes the maximum value when SVNS value is used; which is evident from Figure 14b. The obtained SVNS values are clustered using K-means algorithm and visualized in Figures 16a,b and 17a,b. Figure 16a,b are results of the K-means clustering in 2D on dev-clean and train-clean datasets respectively.

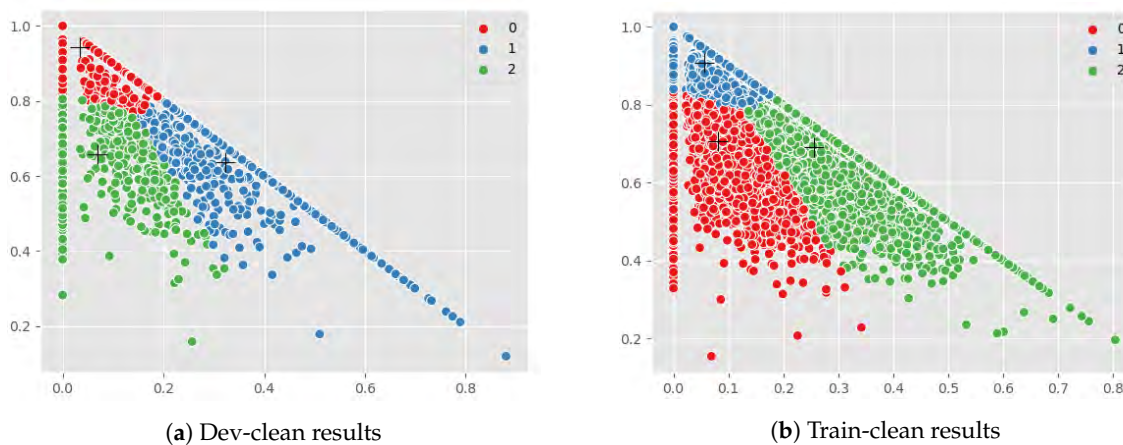

Figure 16. K-means clustering in 2D text SVNS values.

Similarly the clustering results are represented in 3D in Figure 17a,b. Dev-clean folder contains 2703 audio files and train-clean folder contains 28,539 audio files.

The clustering visualisation clearly shows the presence of 3 clusters indicating the existence of neutrality in the data.

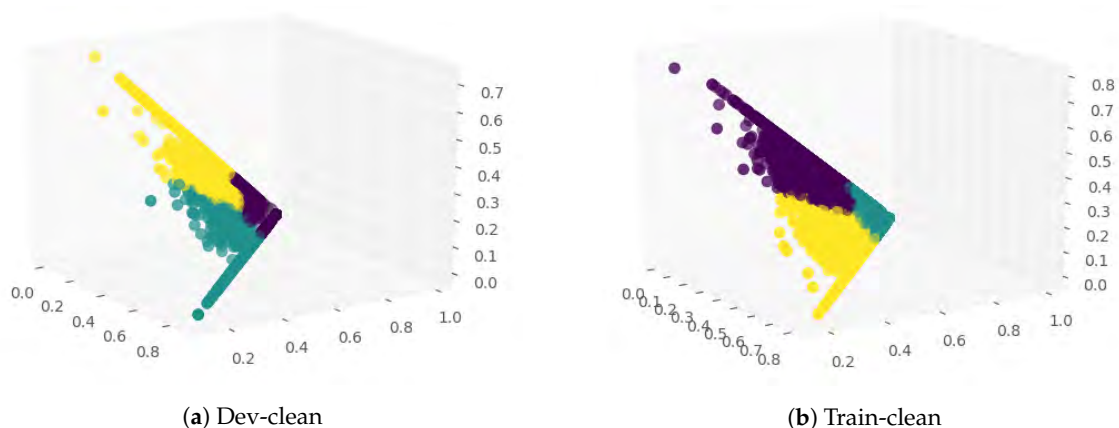

Figure 17. K-means clustering in 3D of text SVNS values.

5.3. Integration Module

The final SVNS are calculated by averaging the audio SVNS and text SVNS. The combined SVNS values are again clustered and visualized for comparison. We visualize the SVNS values using clustering algorithms such as K-means and hierarchical agglomerative clustering given in Algorithm 1. The K-means clustering results of combined SVNS of dev-clean and train-clean are given in Figure 18a,b respectively.

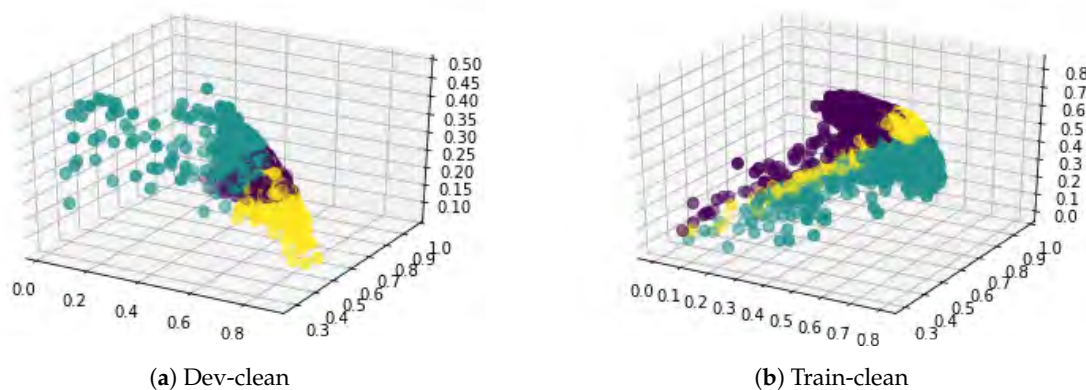

Figure 18. K-means clustering in 3D of combined SVNS values.

The dendrograms generated while clustering the combined SVNS values of dev-clean and train-clean are given in Figure 19 and Figure 20 respectively.

The clustering results of using agglomerative clustering on the combined SVNS values of dev-clean and train-clean datasets are given in Figure 21a,b respectively.

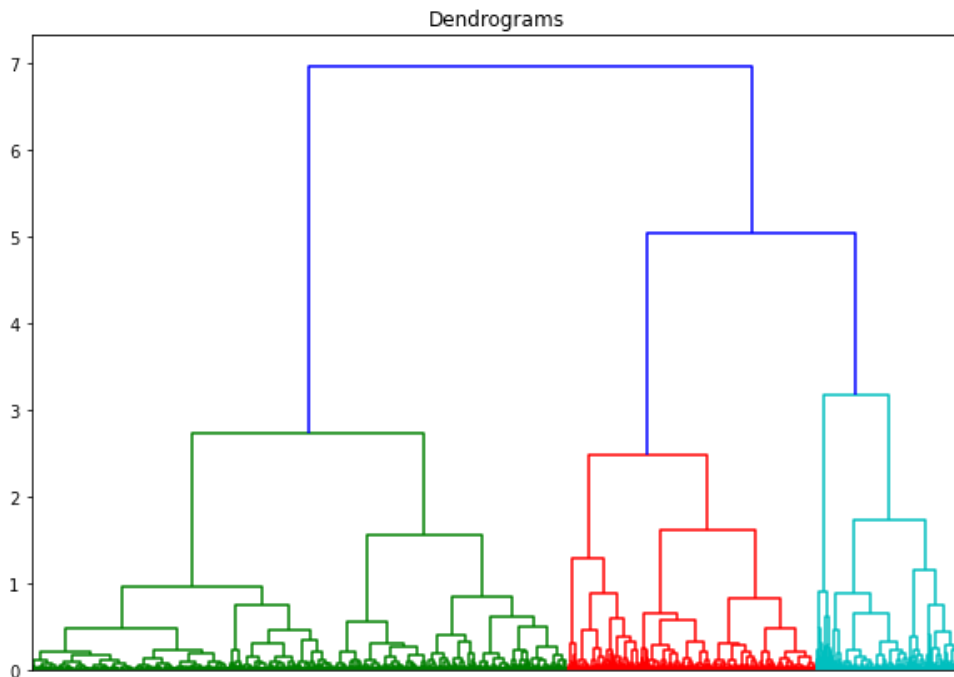

Figure 19. Dendrogram of combined SVNS values of Dev-clean.

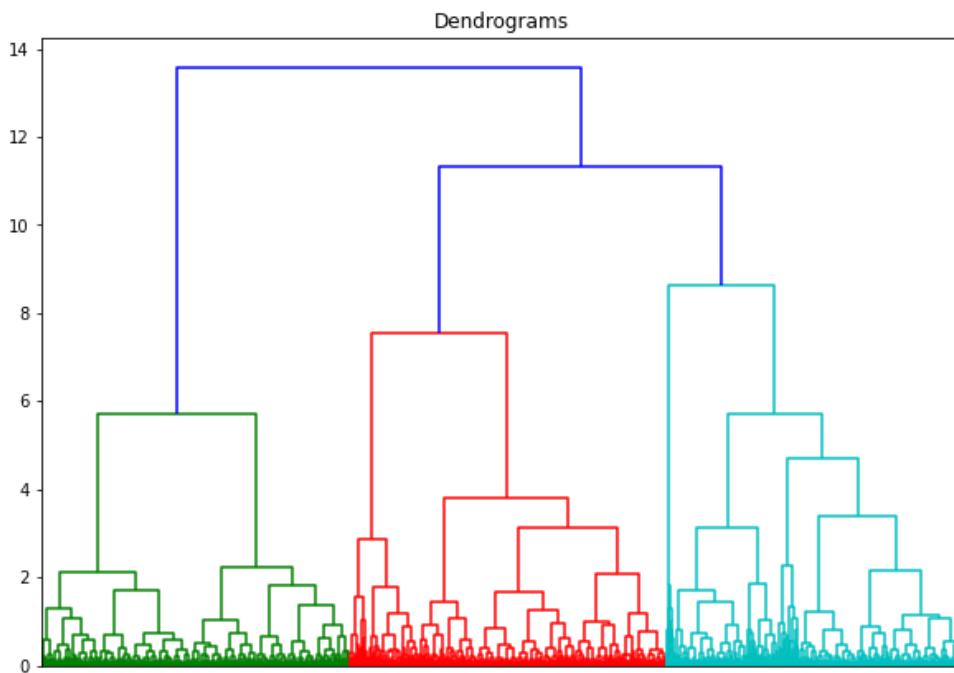

Figure 20. Dendrogram of combined SVNS values of Train-clean.

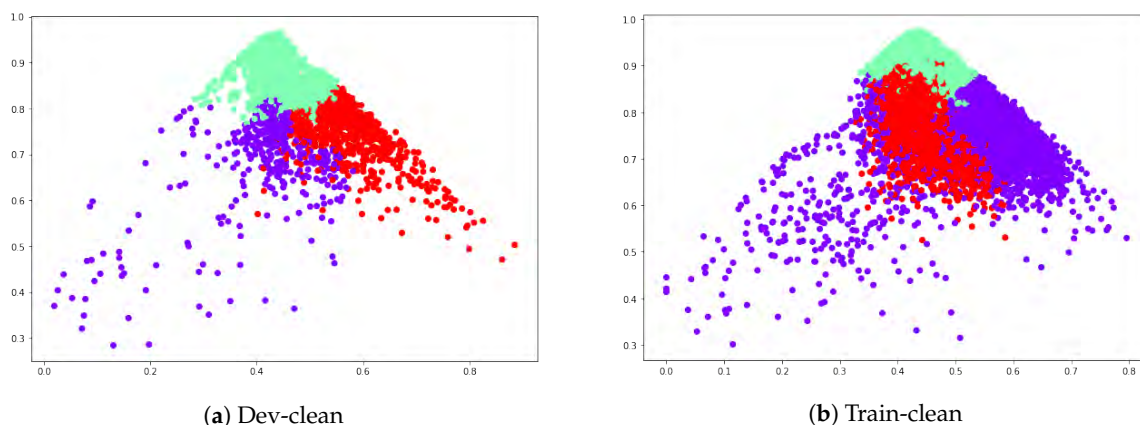

Figure 21. Agglomerative Clustering of combined SVNS values.

6. Result and Discussion

The visualization of clustering results and the dendrogram clearly reveal the presence of neutrality in the data, which is validated by the existence of the third cluster. It is pertinent to note that, in case of sentiment analysis, data cannot be divided into positive and negative alone, the existence of neutrality needs to be acknowledged. After analysing the results of all the clustering algorithms, significant conclusions have been made. The concept of indeterminacy or neutrality has not yet been dealt with in normal or conventional and fuzzy sentiment analysis. SVNS provides a score for neutral sentiment along with positive and negative sentiments. Speech sentiment analysis using neutrosophic sets has not been done to date, whereas it can provide excellent results. The logic behind combining SVNS is to include both features related to the audio files derived from amplitude and frequency and pairing it with the analysis of text for better results. This is a much more wholesome approach than just picking either of the two.

In Table 1, the number of audio classified as cluster 1 (C1), cluster 2 (C2) and cluster 3 (C3) are shown for SVNS from audio features, text SVNS and the combined SVNS for dev-clean LibriSpeech folder which is 337 MB with 2703 audio. There is a considerable overlap in the values that are present in the cluster C1 and C2 and C3, for the three values from speech module, text module and combined module, respectively.

Table 1. Dev-clean clustering results.

SVNS	C1	C2	C3
Audio	1097	1568	38
Text	1431	675	597
Combined	1465	752	486

In Table 2, the number of audio classified as cluster 1 (C1), cluster 2 (C2) and cluster 3 (C3) are shown for SVNS from audio features, text SVNS and the combined SVNS for train-clean-100 LibriSpeech folder which is 6.3 GB with 28539 audio. Since the dataset was unlabelled there was no other choice but to cluster the features, hence the output which was received was clusters without class tags, hence it cannot be identified with these given results which cluster represents positive class, neutral class or negative class. Class tags can be obtained from VADER composite score, but since our aim was to show the presence of neutrality in the data, we did not do the mapping of the clusters to a particular class using the VADER tool provided labels.

Table 2. Train-clean-100 clustering results.

SVNS	C1	C2	C3
Audio	7830	13,234	7475
Text	9332	15,028	4179
Combined	8389	13,174	6976

Instead, if we used the max of the SVNS values present in the cluster to map the cluster to a class tag. Accordingly we obtained C1 cluster was positive class, C2 cluster was neutral and C3 cluster was the negative class. Though it can be inferred from the changing number of data points in the clusters and their ratios to one another that analysis of audio separately and text separately, and then combining the two together with neutrosophic sets is effective to address the indeterminacy and uncertainty of data.

7. Conclusions and Further Work

Work on analyzing sentiment of textual data using neutrosophic sets has been sparse and little, only [13,14] made use of SVNS and refined neutrosophic sets for sentiment analysis. Analysis of audio or speech sentiment analysis using neutrosophy has not been carried out, until now. To date, there has been no way to accommodate the neutrosophy in the sentiment analysis of audio. In the first of a kind, we used the audio features to implement the concept of neutrosophy in speech sentiment analysis. We proposed a novel framework that combines audio features, sentiment analysis, and neutrosophy to generate SVNS values. The initial phase of the work included extracting features from audio, clustering them into three clusters, and generating the SVNS. This was followed by using the VADER tool for text and generating SVNS. Now there were two SVNS for every audio file; one from the audio files and the other from the text file. These two were combined by averaging out the SVNS and the newly obtained SVNS were clustered again for final results. This is an innovative contribution to both sentiment analysis and neutrosophy. For future work, while combining the SVNS weights can be set according to priority or depending on the reliability of the data. For example, if the audio to text translations are bad then weights can be set in the ratio 4:1 for audio SVNS to text SVNS where the resulting SVNS will depend 80% on the audio SVNS and 20% on the text SVNS. Similarly, other similarity measures other than distance measures can be used for generating SVNS values for audio files.

Abbreviations

The following abbreviations are used in this manuscript:

NLP	Natural Language Processing
SVNS	Single-Valued Neutrosophic Sets
MFCC	Mel-Frequency Cepstral Coefficients
RAVDESS	Ryerson Audio-Visual Database of Emotional Speech and Song
VADER	Valence Aware Dictionary and Sentiment Reasoner
SVM	Support Vector Machine
DVNS	Double Valued Neutrosophic Sets
SSE	Sum of Squared Distance

References

1. Smarandache, F. A unifying field in Logics: Neutrosophic Logic. In *Philosophy*; American Research Press: Rehoboth, DE, USA, 1999; pp. 1–141.
2. Panayotov, V.; Chen, G.; Povey, D.; Khudanpur, S. Librispeech: An ASR corpus based on public domain audio books. In Proceedings of the 2015 IEEE International Conference on Acoustics, Speech and Signal Processing (ICASSP), Brisbane, Australia, 19–24 April 2015; pp. 5206–5210. [[CrossRef](#)]
3. Howells, K.; Ertugan, A. Applying fuzzy logic for sentiment analysis of social media network data in marketing. In Proceedings of the 9th International Conference on Theory and Application of Soft Computing, Computing with Words and Perception, ICSCCW 2017, Budapest, Hungary, 24–25 August 2017,
4. Alaei, A.R.; Becken, S.; Stantic, B. Sentiment Analysis in Tourism: Capitalizing on Big Data. *J. Travel Res.* **2019**, *58*, 175–191. [[CrossRef](#)]
5. Ribeiro, F.N.; Araújo, M.; Gonçalves, P.; Gonçalves, M.A.; Benevenuto, F. SentiBench—A benchmark comparison of state-of-the-practice sentiment analysis methods. *EPJ Data Sci.* **2016**, *5*, 1–29. [[CrossRef](#)]
6. Gilbert, C.H.E.; Hutto, E. Vader: A parsimonious rule-based model for sentiment analysis of social media text. In Proceedings of the Eighth International AAAI Conference on Weblogs and Social Media, Ann Arbor, MI, USA, 1–4 June 2014.
7. Ramteke, J.; Shah, S.; Godhia, D.; Shaikh, A. Election result prediction using Twitter sentiment analysis. In Proceedings of the 2016 International Conference on Inventive Computation Technologies (ICICT), Coimbatore, India, 26–27 August 2016; pp. 1–5. [[CrossRef](#)]
8. Smarandache, F.; Teodorescu, M.; Gifu, D. Neutrosophy, a Sentiment Analysis Model. In Proceedings of the RUMOR, Toronto, ON, Canada, 22 June 2017; pp. 38–41.
9. Wang, H.; Smarandache, F.; Zhang, Y.; Sunderraman, R. Single Valued Neutrosophic Sets. *Multispace Multistruct.* **2010**, *4*, 410–413.
10. Smarandache, F. n-Valued Refined Neutrosophic Logic and Its Applications in Physics. *Prog. Phys.* **2013**, *4*, 143–146.
11. Kandasamy, I. Double-valued neutrosophic sets, their minimum spanning trees, and clustering algorithm. *J. Intell. Syst.* **2018**, *27*, 163–182. [[CrossRef](#)]
12. Freen, G.; Kousar, S.; Khalil, S.; Imran, M. Multi-objective non-linear four-valued refined neutrosophic optimization. *Comput. Appl. Math.* **2020**, *39*, 35. [[CrossRef](#)]
13. Kandasamy, I.; Vasantha, W.B.; Mathur, N.; Bisht, M.; Smarandache, F. Sentiment analysis of the # MeToo movement using neutrosophy: Application of single-valued neutrosophic sets. In *Optimization Theory Based on Neutrosophic and Plithogenic Sets*; Academic Press: Cambridge, MA, USA, 2020; pp. 117–135.
14. Kandasamy, I.; Vasantha, W.B.; Obbineni, J.M.; Smarandache, F. Sentiment analysis of tweets using refined neutrosophic sets. *Comput. Ind.* **2020**, *115*, 103180. [[CrossRef](#)]
15. Kandasamy, I.; Kandasamy, W.B.V.; Obbineni, J.M.; Smarandache, F. Indeterminate Likert scale: Feedback based on neutrosophy, its distance measures and clustering algorithm. *Soft Comput.* **2020**, *24*, 7459–7468. [[CrossRef](#)]
16. Pătrașcu, V. Refined neutrosophic information based on truth, falsity, ignorance, contradiction and hesitation. *Neutrosophic Sets Syst.* **2016**, *11*, 57–66.
17. Elaiyaraja, V.; Sundaram, P.M. Audio classification using support vector machines and independent component analysis. *J. Comput. Appl.* **2012**, *5*, 34–38.
18. Huang, A.; Bao, P. Human Vocal Sentiment Analysis. *arXiv* **2019**, arXiv:1905.08632.
19. El Ayadi, M.; Kamel, M.S.; Karray, F. Survey on speech emotion recognition: Features, classification schemes, and databases. *Pattern Recogn.* **2011**, *44*, 572–587. [[CrossRef](#)]
20. Poria, S.; Cambria, E.; Howard, N.; Huang, G.B.; Hussain, A. Fusing Audio, Visual and Textual Clues for Sentiment Analysis from Multimodal Content. *Neurocomputing* **2016**, *174*, 50–59. neucom.2015.01.095. [[CrossRef](#)]
21. Poria, S.; Cambria, E.; Gelbukh, A. Deep convolutional neural network textual features and multiple kernel learning for utterance-level multimodal sentiment analysis. In Proceedings of the 2015 Conference on Empirical Methods in Natural Language Processing, Lisbon, Portugal, 13–17 September 2015; pp. 2539–2544.

(Φ, Ψ) -Weak Contractions in Neutrosophic Cone Metric Spaces via Fixed Point Theorems

Wadei F. Al-Omeri, Saeid Jafari, Florentin Smarandache

Wadei F. Al-Omeri, Saeid Jafari, Florentin Smarandache (2020). (Φ, Ψ) -Weak Contractions in Neutrosophic Cone Metric Spaces via Fixed Point Theorems. *Mathematical Problems in Engineering*, Article ID 9216805, 8; DOI: 10.1155/2020/9216805

In this manuscript, we obtain common fixed point theorems in the neutrosophic cone metric space. Also, notion of (Φ, Ψ) -weak contraction is defined in the neutrosophic cone metric space by using the idea of altering distance function. Finally, we review many examples of cone metric spaces to verify some properties.

1. Introduction

The concept of fuzzy sets was introduced by Zadeh [1]. The study of fuzzy topological spaces was initiated by Chang [2]. The notion of intuitionistic fuzzy sets was introduced by Atanassov [3]. The notion of intuitionistic L -topological spaces was introduced by Atanassov and Stoeva [4] by extending L -topology to intuitionistic L -fuzzy setting. The notion of the intuitionistic fuzzy topological space was introduced by Çoker [5]. The concept of generalized fuzzy closed set was presented by Balasubramanian and Sundaram [6]. Smarandache extended the intuitionistic fuzzy sets to neutrosophic sets [7]. After the introduction of the neutrosophic set concept [8, 9] in 2019 by Smarandache and Shumrani on the nonstandard analysis, the nonstandard neutrosophic topology was developed. In recent years, neutrosophic algebraic structures have been investigated. Neutrosophy has laid the foundation for a whole family of new mathematical theories, generalizing both their classical and fuzzy counterparts, such as a neutrosophic theory in any field, see [10, 11]. Recently, there were introduced neutrosophic mapping and neutrosophic connectedness. The concept of the neutrosophic metric space presented by [12] Al-Omeri et al. is a generalization of the intuitionistic

fuzzy metric space due to Veeramani and George [13]. In 2019 and 2020, Smarandache generalized the classical Algebraic Structures to NeutroAlgebraic Structures (or NeutroAlgebras) whose operations and axioms are partially true, partially indeterminate, and partially false as extensions of Partial Algebra and to AntiAlgebraic Structures (or AntiAlgebras) whose operations and axioms are totally false. And in general, he extended any classical structure, in no matter what field of knowledge, to a NeutroStructure and an AntiStructure, see [14, 15]. In 2007, Huang and Zhang [16] introduced the concept of cone metric space and proved some fixed point theorems for contractive mappings. Recently, Öner et al. [17] introduced the concept of the fuzzy cone metric space that generalized the corresponding notions of the fuzzy metric space by George and Veeramani [13] and proved the fuzzy cone Banach contraction theorem. In 2010, Vetro et al. [18] extended the notion of (Φ, Ψ) -weak contraction to fuzzy metric spaces and proved some common fixed point theorems for four mappings in fuzzy metric spaces by using the idea of an altering distance function. Gupta et al. and Wasfi et al. [19, 20] introduced the notions of E. A and common E. A on the modified intuitionistic generalized fuzzy metric space. They extended the notions of the common limit

range property and E. A property for coupled maps on modified intuitionistic fuzzy metric spaces. This paper is devoted to the study of extending and generalizing the (Φ, Ψ) -weak contraction to the neutrosophic cone metric space and prove some results. In Section 2, we will recall some materials which will be used throughout this paper. In Section 3, we give definitions and present the cone neutrosophic metric space and explain a number of properties. In Section 4, the results obtained from theorems and theoretical application of the neutrosophic fixed point are also presented. The last section contains the conclusions of the paper.

2. Preliminaries

Definition 1 (see [21]). Let Σ be a non-empty fixed set. A neutrosophic set (briefly, NS) R is an object having the form $R = \{\langle t, \xi_R(t), \varrho_R(t), \eta_R(t) \rangle : t \in \Sigma\}$, where $\xi_R(t)$, $\varrho_R(t)$, and $\eta_R(t)$ which represent the degree of membership function (namely, $\xi_R(t)$), the degree of indeterminacy (namely, $\varrho_R(t)$), and the degree of nonmembership (namely, $\eta_R(t)$), respectively, of each element $t \in \Gamma$ to the set R .

A neutrosophic set $H = \{\langle t, \xi_H(t), \varrho_H(t), \eta_H(t) \rangle : t \in \Gamma\}$ can be identified to an ordered triple $\langle \xi_H(t), \varrho_H(t), \eta_H(t) \rangle$ in $[0^-, 1^+]$ on Γ .

Remark 1 (see [21]). By using symbol $H = \{t, \xi_H(t), \varrho_H(t), \eta_H(t)\}$ for the NS, $H = \{\langle t, \xi_H(t), \varrho_H(t), \eta_H(t) \rangle : t \in \Gamma\}$.

Definition 2 (see [13]). Let $H = \langle \xi_H(t), \varrho_H(t), \eta_H(t) \rangle$ be a NS on Γ . The complement of H (briefly, $C(H)$) may be defined as three kinds of complements:

- (1) $C(H) = \{\langle r, 1 - \xi_H(t), 1 - \eta_H(t) \rangle : t \in \Gamma\}$
- (2) $C(H) = \{\langle r, \eta_H(t), 1 - \varrho_H(t), \xi_H(t) \rangle : t \in \Gamma\}$
- (3) $C(H) = \{\langle r, \eta_H(t), \varrho_H(t), \xi_H(t) \rangle : t \in \Gamma\}$

We have the following NSs (see [21]), which will be used in the sequel:

- (1) $1_N = \{\langle t, 1, 0, 0 \rangle : t \in \Gamma\}$ or
- (2) $1_N = \{\langle t, 1, 0, 1 \rangle : t \in \Gamma\}$,
- (3) $1_N = \{\langle t, 1, 1, 0 \rangle : t \in \Gamma\}$,
- (4) $1_N = \{\langle t, 1, 1, 1 \rangle : t \in \Gamma\}$.
- (1) $0_N = \{\langle t, 0, 1, 1 \rangle : t \in \Gamma\}$ or
- (2) $0_N = \{\langle t, 0, 0, 1 \rangle : t \in \Gamma\}$,
- (3) $0_N = \{\langle t, 0, 0, 0 \rangle : t \in \Gamma\}$,
- (4) $0_N = \{\langle t, 0, 1, 0 \rangle : t \in \Gamma\}$.

Definition 3 (see [21]). Let $\{H_j : j \in J\}$ be an arbitrary family of NSs in Γ . Then,

- (1) $\cap H_i$ may be defined as follows:
 - (i) $\cap H_i = \langle t, \bigwedge_{i \in \Lambda} \xi_{Hi}(t), \bigwedge_{i \in \Lambda} \varrho_{Hi}(t), \bigvee_{i \in \Lambda} \eta_{Hi}(t) \rangle$
 - (ii) $\cap H_i = \langle t, \bigwedge_{i \in \Lambda} \xi_{Hi}(t), \bigvee_{i \in \Lambda} \varrho_{Hi}(t), \bigvee_{i \in \Lambda} \eta_{Hi}(t) \rangle$
- (2) $\cup H_i$ may be defined as follows:

- (i) $\cup H_i = \langle t, \bigvee_{i \in \Lambda} \xi_{Hi}(t), \bigvee_{i \in \Lambda} \varrho_{Hi}(t), \bigwedge_{i \in \Lambda} \eta_{Hi}(t) \rangle$
- (ii) $\cup H_i = \langle t, \bigvee_{i \in \Lambda} \xi_{Hi}(t), \bigwedge_{i \in \Lambda} \varrho_{Hi}(t), \bigwedge_{i \in \Lambda} \eta_{Hi}(t) \rangle$

Definition 4 (see [21]). For any $r \neq \emptyset$, let neutrosophic sets R and Γ be in the form $R = \{r, \xi_R(r), \varrho_R(r), \eta_R(r)\}$ and $\Gamma = \{r, \xi_\Gamma(r), \varrho_\Gamma(r), \eta_\Gamma(r)\}$. The two possible definitions of $R \subseteq \Gamma$ are as follows:

- (1) $R \subseteq \Gamma \iff \xi_R(r) \leq \xi_\Gamma(r), \varrho_R(r) \geq \varrho_\Gamma(r), \text{ and } \eta_R(r) \leq \eta_\Gamma(r)$
- (2) $R \subseteq \Gamma \iff \xi_R(r) \leq \xi_\Gamma(r), \varrho_R(r) \geq \varrho_\Gamma(r), \text{ and } \eta_R(r) \geq \eta_\Gamma(r)$

Definition 5 (see [22]). A neutrosophic topology (NT for short) and a nonempty set Γ is a family Ξ of neutrosophic subsets in Γ satisfying the following axioms:

- (1) $0_N, 1_N \in \Xi$
- (2) $B_1 \cap B_2 \in \Xi$ for any $B_1, B_2 \in \Xi$
- (3) $\cup B_i \in \Xi, \forall \{B_i | i \in I\} \subseteq \Xi$

The elements of Ξ are called open neutrosophic sets. The pair (Γ, Ξ) is called a neutrosophic topological space, and any neutrosophic set in Ξ is known as the neutrosophic open set (NOS) in Γ . A neutrosophic set B is closed if its complement is neutrosophic-open, denoted by $C(B)$. Throughout this paper, we suppose that all cone metrics have nonempty interior.

For any NTS R in (Γ, Ξ) [23], we have $Cl(R^c) = [Int(R)]^c$ and $Int(R^c) = [Cl(R)]^c$.

Definition 6. A subset μ of Σ is said to be a cone in the following cases:

- (1) If both $s \in \mu$ and $-s \in \mu$, then $s = \phi$
- (2) If $s, r \in S, s, r \geq 0$, and $u, v \in \mu$, then $su + rv \in \mu$
- (3) μ is closed, nonempty, and $\mu \neq \{\phi\}$

For a given cone, partial ordering (\preceq) on Σ via μ is defined by $u \preceq v$ iff $v - u \in \mu$. $u < v$ will stand for $u \preceq v$ and $u \ll v$, while $u \neq v$ will stand for $v - u \in Int(\mu)$.

If \exists a constant $K > 0$ such that for all $\emptyset \preceq u \preceq v, u, v \in \Sigma$ implies $\|u\| \leq K\|v\|$, and the least positive number K satisfying this property is called the normal constant of P , where P is the normal.

Definition 7. Let Γ be a nonempty set and $s \geq 1$ be a given real number. A function $d: \Gamma \times \Gamma \rightarrow \Sigma$ is said to be a cone metric on Γ if the following conditions hold:

- (1) $d(m_1, m_2) = d(m_2, m_1)$ for all $m_1, m_2 \in \Gamma$
- (2) $0 \preceq d(m_1, m_2)$ for all $m_1, m_2 \in \Gamma$
- (3) $d(m_1, m_3) \preceq s(d(m_1, m_2) + d(m_2, m_3)) \forall m_1, m_2, m_3 \in \Gamma$
- (4) $d(m_1, m_2) = 0$ iff $m_1 = m_2$

The pair (Γ, d) is called a cone metric space (shortly, CMS).

Definition 8. A t -norm is continuous for any binary operation $\ast: [0, 1] \times [0, 1] \rightarrow [0, 1]$ if \ast verifies the following statements:

- (1) \ast is continuous
- (2) \ast is commutative and associative
- (3) $n_1 \ast n_2 \leq n_3 \ast n_4$ whenever $n_1 \leq n_3$ and $n_2 \leq n_4$ for all $n_1, n_2, n_3, n_4 \in [0, 1]$
- (4) $n_1 \ast 1 = n_1$ for all $n_1 \in [0, 1]$

Definition 9. Let (Γ, d) be a CMS. Then, for any $d_1 \gg 0$ and $d_2 \gg 0$, $d_1, d_2 \in \Sigma$, $\exists d \gg 0$, and $d \in \Sigma$ such that $d \ll d_1$ and $d \ll d_2$.

Example 1. $n_1 \ast n_2 = \max\{n_1, n_2\}$ and $n_1 \ast n_2 = n_1 n_2$.

Example 2. $n_1 \diamond n_2 = \max\{n_1, n_2\}$ and $m_1 \diamond n_2 = \min\{n_1 + n_2, 1\}$.

Definition 10. A t -conorm of a binary operation $\diamond: [0, 1] \times [0, 1] \rightarrow [0, 1]$ is continuous if \diamond verifies the following statements:

- (1) \diamond is continuous
- (2) \diamond is associative and commutative
- (3) $q_1 \diamond q_2 \leq q_3 \diamond q_4$ whenever $q_1 \leq q_3$ and $q_2 \leq q_4$ for all $q_1, q_2, q_3, q_4 \in [0, 1]$
- (4) $q_1 \diamond 1 = q_1$ for all $q_1 \in [0, 1]$

Definition 11 (see [12]). $(\Gamma, \psi, \phi, \ast, \diamond)$ is said to be a neutrosophic cone metric space if μ is NCMS of Σ , Γ is an arbitrary set, \diamond is a N-continuous t -conorm, \ast is a N-continuous t -norm, and ψ, ϕ are neutrosophic sets on $\Gamma^3 \times \text{Int}(\mu)$, which satisfy the following statements: $\forall \varepsilon_1, \varepsilon_2, \varepsilon_3 \in \Gamma$ and $n, m \in \text{Int}(\mu)$ (that is, $n \gg 0_\phi$ and $m \gg 0_\phi$):

- (1) $\psi(\varepsilon_1, \varepsilon_2, \varepsilon_3, m) > 0_\phi \forall \varepsilon_1, \varepsilon_2, \varepsilon_3 \in \Gamma$
- (2) $\psi(\varepsilon_1, \varepsilon_2, \varepsilon_3, m) = 1$ iff $\varepsilon_1 = \varepsilon_2 = \varepsilon_3$
- (3) $\psi(\varepsilon_1, \varepsilon_2, \varepsilon_3, m) = \psi(p\{\varepsilon_1, \varepsilon_2, \varepsilon_3\}, m)$, where p is permutation
- (4) $\psi(\varepsilon_1, \varepsilon_2, \varepsilon_3, m) \ast \psi(\varepsilon_2, \varepsilon_3, n) \leq \psi(\varepsilon_1, \varepsilon_3, m + n)$
- (5) $\psi(\varepsilon_1, \varepsilon_2, \varepsilon_3, \cdot): \text{Int}(\mu) \rightarrow]0^-, 1^+[$ is neutrosophic-continuous

Definition 12 (see [12]). Let $(\Gamma, \psi, \phi, \ast, \diamond)$ be a NCMS. For $m \gg 0_\phi$, the open ball $\Gamma(x, s, m)$ with center ε_1 and radius $s \in (0, 1)$ is defined by $(\varepsilon_1, s, m) = \{\varepsilon_2 \in \Gamma: \psi(\varepsilon_1, \varepsilon_2, m) > 1 - m, \phi(\varepsilon_1, \varepsilon_2, m) < s\}$.

Example 3. Let $\Sigma = R^+$. Then, $\mu = \{(p_1, p_2, p_3): p_1, p_2, p_3 \geq 0\} \subseteq \Sigma$ is a normal cone, and $P = 1$ is a normal constant. Let $s \ast t = st$, $\Gamma = R$, and $\psi: \Gamma^3 \times \text{int}(\mu) \rightarrow [0, 1]$, defined by $\psi(\varepsilon_1, \varepsilon_2, \varepsilon_3, t) = (1/e^{(|\varepsilon_1 - \varepsilon_2| + |\varepsilon_2 - \varepsilon_3| + |\varepsilon_3 - \varepsilon_1|/t})) \forall \varepsilon_1, \varepsilon_2, \varepsilon_3 \in \Gamma$ and $t \gg 0$.

Definition 13 (see [12]). An $(\Gamma, \psi, \phi, \ast, \diamond)$ neutrosophic cone metric is called complete neutrosophic if any sequence which is Cauchy in NCMS (Γ, ψ, ϕ) is convergent.

Definition 14 (see [12]). $(\Gamma, \psi, \phi, \ast, \diamond)$ is said to be a neutrosophic CMS if μ is a neutrosophic cone metric (shortly, NCMS) of Σ , where Γ is an arbitrary set, \ast is a neutrosophic continuous t -norm, \diamond is a neutrosophic continuous t -conorm, and ψ, ϕ are neutrosophic sets on $\Gamma^3 \times \text{Int}(\mu)$, which satisfy the following statements: $\forall \varepsilon_1, \varepsilon_2, \varepsilon_3 \in \Gamma$ and $m, n \in \text{Int}(\mu)$ (that is, $n \gg 0_\phi$ and $m \gg 0_\phi$):

- (1) $\psi(\varepsilon_1, \varepsilon_2, \varepsilon_3, m) = 1$ iff $\varepsilon_1 = \varepsilon_2 = \varepsilon_3$
- (2) $\psi(\varepsilon_1, \varepsilon_2, \varepsilon_3, m) \ast \psi(\varepsilon_2, \varepsilon_3, n) \leq \psi(\varepsilon_1, \varepsilon_3, m + n)$
- (3) $\psi(\varepsilon_1, \varepsilon_2, \varepsilon_3, m) = \psi(p\{\varepsilon_1, \varepsilon_2, \varepsilon_3\}, m)$, where p is permutation
- (4) $\psi(\varepsilon_1, \varepsilon_2, \varepsilon_3, m) + \phi(\varepsilon_1, \varepsilon_2, \varepsilon_3) \leq 1_\phi$
- (5) $\psi(\varepsilon_1, \varepsilon_2, \varepsilon_3, \cdot): \text{Int}(\mu) \rightarrow]0^-, 1^+[$ is neutrosophic-continuous
- (6) $\phi(\varepsilon_1, \varepsilon_2, \varepsilon_3, m) \diamond \phi(\varepsilon_2, \varepsilon_3, n) \geq \phi(\varepsilon_1, \varepsilon_3, m + n)$
- (7) $\phi(\varepsilon_1, \varepsilon_2, \varepsilon_3, \cdot): \text{Int}(\mu) \diamond]0^-, 1^+[$ is neutrosophic-continuous
- (8) $\phi(\varepsilon_1, \varepsilon_2, \varepsilon_3, m) < 0_\phi$
- (9) $\phi(\varepsilon_1, \varepsilon_2, \varepsilon_3, m) = 0_\phi$ if and only if $\varepsilon_1 = \varepsilon_2 = \varepsilon_3$
- (10) $\phi(\varepsilon_1, \varepsilon_2, \varepsilon_3, m) > 0_\phi \forall \varepsilon_1, \varepsilon_2, \varepsilon_3 \in \Gamma$
- (11) $\phi(\varepsilon_1, \varepsilon_2, \varepsilon_3, m) = \phi(p\{\varepsilon_1, \varepsilon_2, \varepsilon_3\}, m)$, where p is permutation

Then, (ψ, ϕ) is called a neutrosophic cone metric on Γ .

The functions $\psi(\varepsilon_1, \varepsilon_2, m)$ and $\phi(\varepsilon_1, \varepsilon_2, m)$ are defined by the degree of non-nearness between ε_1 and ε_2 with respect to m , respectively.

Definition 15 (see [12]). Let $(\Gamma, \psi, \phi, \ast, \diamond)$ be a NCMS, $\varepsilon_1 \in \Gamma$, and $\{\varepsilon_{1n}\}$ be a sequence in Γ . Then, $\{\varepsilon_{1n}\}$ is said to be convergent to ε_1 if for all $m \gg 0_\phi$ and all $s \in (0, 1)$, there exists $n_0 \in N$ such that $\psi(\varepsilon_{1n}, \varepsilon_1, m) > 1 - s$, $\phi(\varepsilon_{1n}, \varepsilon_1, m) \leq s$ for any $n \geq n_0$. We defined that $\lim_{n \rightarrow \infty} \varepsilon_{1n} = \varepsilon_1$ or $\varepsilon_{1n} \rightarrow \varepsilon_1$ as $n \rightarrow \infty$.

Definition 16. A function $\Phi: [0, \infty) \rightarrow [0, \infty)$ is an altering distance if $\Phi(n)$ is monotone increasing and continuous, and $\Phi(n) = 0$ iff $n = \emptyset$.

Definition 17. Let (Γ, d) be a metric space and let $\Sigma = R^+$. Defined $\mu_1 \diamond \mu_2 = \min\{\mu_1 + \mu_2, 1\}$ and $\mu_1 \ast \mu_2 = \mu_1 \mu_2$ for any $\mu_1, \mu_2 \in [0, 1]$, and let Γ and ψ be fuzzy sets on $\Gamma^3 \times \text{int}(\mu)$ represented by $\psi(\varepsilon_1, \varepsilon_2, \varepsilon_3, \mu) = (kt^n / kt^n + \mathcal{L}D \ast (\varepsilon_1, \varepsilon_2, \varepsilon_3))$ and $\phi(\varepsilon_1, \varepsilon_2, \varepsilon_3, \mu) = (D \ast (\varepsilon_1, \varepsilon_2, \varepsilon_3) / mt^n + \mathcal{L}D \ast (\varepsilon_1, \varepsilon_2, \varepsilon_3))$.

3. Main Result

Definition 18. Let $(\Gamma, \psi, \phi, \ast, \diamond)$ be a neutrosophic cone metric space (CMS) and $\mathcal{T}, \mathcal{H}: \Gamma \rightarrow \Gamma$ be two mappings. Mapping \mathcal{H} is said to be neutrosophic (Φ, Ψ) -weak contraction if there exists a function $\Psi: [0, \infty) \rightarrow [0, \infty)$ with

$\Psi(s) > 0$ and $\Psi(s) = 0$ for $s > 0$ and an alternating distance function Φ such that

$$\Phi\left(\frac{1}{\psi(\mathcal{H}(\varepsilon_1), \mathcal{H}(\varepsilon_2), \mathcal{H}(\varepsilon_3), m)} - 1_\phi\right) \leq \Phi\left(\frac{1}{\psi(\mathcal{T}(\varepsilon_1), \mathcal{T}(\varepsilon_2), \mathcal{T}(\varepsilon_3), m)} - 1_\phi\right) - \Psi\left(\frac{1}{\psi(\mathcal{T}(\varepsilon_1), \mathcal{T}(\varepsilon_2), \mathcal{T}(\varepsilon_3), m)} - 1_\phi\right),$$

$$\Phi(\phi(\mathcal{H}(\varepsilon_1), \mathcal{H}(\varepsilon_2), \mathcal{H}(\varepsilon_3), m)) \leq \Phi(\phi(\mathcal{T}(\varepsilon_1), \mathcal{T}(\varepsilon_2), \mathcal{T}(\varepsilon_3), m)) - \Psi(\phi(\mathcal{T}(\varepsilon_1), \mathcal{T}(\varepsilon_2), \mathcal{T}(\varepsilon_3), m)). \tag{1}$$

hold for all $\varepsilon_1, \varepsilon_2, \varepsilon_3 \in \psi$ and each $m \gg 0_\phi$. If \mathcal{T} is the identity map, then \mathcal{H} is called a neutrosophic (Φ, Ψ) -weak contraction mapping.

Definition 19. Let $(\Gamma, \psi, \phi, \ast, \diamond)$ be a neutrosophic cone metric space and $\mathcal{T}, \mathcal{H}: \Gamma \rightarrow \Gamma$ be two mappings. Point v is said to be a coincidence point in ψ of \mathcal{T} and \mathcal{H} if $\varepsilon_3 = \mathcal{T}(v) = \mathcal{H}(v)$.

Definition 20. Let $\{\mathcal{T}_i\}$ and $\{\mathcal{H}_i\}$ be two finite families of self-mappings on ψ . They are called pairwise commuting if

- (1) $\mathcal{T}_i \mathcal{T}_j = \mathcal{T}_j \mathcal{T}_i$, where $i, j \in \{1, 2, \dots, n\}$
- (2) $\mathcal{H}_i \mathcal{H}_j = \mathcal{H}_j \mathcal{H}_i$, where $i, j \in \{1, 2, \dots, m\}$
- (3) $\mathcal{T}_i \mathcal{H}_j = \mathcal{H}_j \mathcal{T}_i$, where $i \in \{1, 2, \dots, n\}$ and $j \in \{1, 2, \dots, m\}$

Theorem 1. Let $(\Gamma, \psi, \phi, \ast, \diamond)$ be a neutrosophic cone metric space and $\mathcal{H}: \Gamma \rightarrow \Gamma$ be a neutrosophic (Φ, Ψ) -weak contraction with respect to $\mathcal{T}: \Gamma \rightarrow \Gamma$. If $\mathcal{H}(\psi) \subseteq \mathcal{T}(\psi)$ and $\mathcal{T}(\psi)$ or $\mathcal{H}(\psi)$ is a complete subset of ψ , then \mathcal{T} and \mathcal{H} have a unique common fixed point in ψ provided that Ψ is a continuous function.

Proof. Let $t_0 \in \psi$ be an arbitrary point. Let point $t_1 \in \psi$ such that $\mathcal{H}(t_0) = \mathcal{T}(t_1)$. This can be done since $\mathcal{H}(\psi) \subseteq \mathcal{T}(\psi)$. Continuing this process, we obtain a sequence $\{t_n\} \in \psi$ such that $s_n = \mathcal{H}(t_n) = \mathcal{T}(t_{n+1})$. We assume that $s_n \neq s_{n+1}$ for all $n \in \mathbb{N}$; otherwise, \mathcal{T} and \mathcal{H} have a coincidence point. Now, we get

$$\begin{aligned} \Phi\left(\frac{1}{\psi(s_n, s_n, s_{n+1}, m)} - 1_\phi\right) &= \Phi\left(\frac{1}{\psi(\mathcal{H}(t_n), \mathcal{H}(t_n), \mathcal{H}(t_{n+1}), m)} - 1_\phi\right) \\ &\leq \Phi\left(\frac{1}{\psi(\mathcal{T}(t_n), \mathcal{T}(t_n), \mathcal{T}(t_{n+1}), m)} - 1_\phi\right) \\ &\quad - \Psi\left(\frac{1}{\psi(\mathcal{T}(t_n), \mathcal{T}(t_n), \mathcal{T}(t_{n+1}), m)} - 1_\phi\right) \\ &\leq \Phi\left(\frac{1}{\psi(s_{n-1}, s_{n-1}, s_n, m)} - 1_\phi\right) \\ &\quad - \Psi\left(\frac{1}{\psi(s_{n-1}, s_{n-1}, s_n, m)} - 1_\phi\right) \\ &\leq \Phi\left(\frac{1}{\psi(s_{n-1}, s_{n-1}, s_n, m)} - 1_\phi\right), \end{aligned} \tag{2}$$

which suppose that \mathcal{T} mapping is nondecreasing; hence, $\psi(s_n, s_n, s_{n+1}, m) > \psi(s_{n-1}, s_{n-1}, s_n, m) \forall n \in \mathbb{N}$. Hence, $\psi(s_{n-1}, s_{n-1}, s_n, m)$ is an increasing sequence of positive real numbers in $(0, 1]$. Let $V(m) = \lim_{n \rightarrow \infty} \psi(s_{n-1}, s_{n-1}, s_n, m)$. We prove that $V(m) = 1 \forall m \gg 0_\phi$. If not, there exists $m \gg 0_\phi$ such that $V(m) < 1_\phi$. Then, from the above inequality on taking $n \rightarrow \infty$, we obtain

$$\Phi\left(\frac{1}{V(m)} - 1_\phi\right) \leq \Phi\left(\frac{1}{V(m)} - 1_\phi\right) - \Psi\left(\frac{1}{V(m)} - 1_\phi\right), \tag{3}$$

which is a contradiction. Therefore, $\psi(s_n, s_n, s_{n+1}, m) \rightarrow 1$ as $n \rightarrow \infty$. Now, for each $k \geq 0$, by Definition 18, we get

$$\begin{aligned} \psi(s_n, s_n, s_{n+k}, m) &\geq \psi\left(s_n, s_n, s_{n+1}, \frac{m}{k}\right) * \psi\left(s_{n+1}, s_{n+1}, s_{n+2}, \frac{m}{k}\right) \\ &\quad * \dots * \psi\left(s_{n+k-1}, s_{n+k-1}, s_{n+k}, \frac{m}{k}\right). \end{aligned} \tag{4}$$

It follows that $\lim_{n \rightarrow \infty} \psi(s_n, s_n, s_{n+k}, m) \geq 1 * 1 * \dots * 1 = 1$. At the same time, we have

$$\begin{aligned} \Phi(\phi(s_n, s_n, s_{n+1}, m)) &= \Phi(\phi(\mathcal{H}(t_n), \mathcal{H}(t_n), \mathcal{H}(t_{n+1}), m)) \\ &\leq \Phi(\phi(\mathcal{T}(t_n), \mathcal{T}(t_n), \mathcal{T}(t_{n+1}), m)) \\ &\quad - \Psi(\phi(\mathcal{T}(t_n), \mathcal{T}(t_n), \mathcal{T}(t_{n+1}), m)) \\ &\leq \Phi(\phi(s_{n-1}, s_{n-1}, s_n, m)) \\ &\quad - \Psi(\phi(s_{n-1}, s_{n-1}, s_n, m)) \\ &< \Phi(\phi(s_{n-1}, s_{n-1}, s_n, m)). \end{aligned} \tag{5}$$

in which considering that the \mathcal{T} mapping is nondecreasing, then $\phi(s_n, s_n, s_{n+1}, m) < \phi(s_{n-1}, s_{n-1}, s_n, m) \forall n \in \mathbb{N}$. Thus, $\phi(s_{n-1}, s_{n-1}, s_n, m)$ is a decreasing sequence of positive real numbers in $[0, 1)$. Let $U(m) = \lim_{n \rightarrow \infty} \phi(s_{n-1}, s_{n-1}, s_n, m)$. We show that $U(m) = 0_\phi$ for all $m \gg 0_\phi$. If this is not the case, there exists $m \gg 0_\phi$ such that $U(m) > 0_\phi$. Then, it follows from (5), by taking $n \rightarrow \infty$, that $\Phi(U(m)) \leq \Phi(U(m)) - \Psi(U(m))$, which is a contraction. Therefore, $\phi(s_n, s_n, s_{n+1}, m) \rightarrow 0_\phi$ as $n \rightarrow \infty$. Now, for each $k \geq 0$, by Definition 14 (9), we have

$$\begin{aligned} \psi(s_n, s_n, s_{n+k}, m) + \phi(s_n, s_n, s_{n+k}, m) &\leq 1_\phi, \\ \lim_{n \rightarrow \infty} [\psi(s_n, s_n, s_{n+k}, m) + \phi(s_n, s_n, s_{n+k}, m)] &\leq 1_\phi. \end{aligned} \tag{6}$$

It follows that $\lim_{n \rightarrow \infty} \phi(s_n, s_n, s_{n+k}, m) = 0_\phi$. Hence, s_n is a Cauchy sequence. If $\mathcal{T}(\psi)$ is complete, then there exists $k \in \mathcal{T}(\psi)$ such that $s_n \rightarrow k$ as $n \rightarrow \infty$. The same holds if $\mathcal{H}(\psi)$ is complete with $k \in \mathcal{H}(\psi)$. Let $k \in \psi$ and $\mathcal{T}(k) = p$. Now, we shall show that k is a coincidence point of \mathcal{T} and \mathcal{H} . In fact, we have taken

$$\begin{aligned} \Phi\left(\frac{1}{\psi(\mathcal{H}(k), \mathcal{H}(k), \mathcal{T}(t_{n+1}), m)} - 1_\phi\right) &= \Phi\left(\frac{1}{\psi(\mathcal{H}(k), \mathcal{H}(k), \mathcal{H}(t_n), m)} - 1_\phi\right) \\ &\leq \Phi\left(\frac{1}{\psi(\mathcal{T}(k), \mathcal{T}(k), \mathcal{T}(t_n), m)} - 1_\phi\right) \\ &\quad - \Psi\left(\frac{1}{\psi(\mathcal{T}(k), \mathcal{T}(k), \mathcal{T}(t_n), m)} - 1_\phi\right), \end{aligned} \tag{7}$$

for every $m \gg 0_\phi$, in which by letting $n \rightarrow \infty$,

$$\begin{aligned} \lim_{n \rightarrow \infty} \psi(\mathcal{H}(k), \mathcal{H}(k), \mathcal{T}(t_{n+1}), m) &= \lim_{n \rightarrow \infty} \psi(\mathcal{H}(k), \mathcal{H}(k), \mathcal{H}(t_n), m) \\ &= \psi(\mathcal{H}(k), \mathcal{H}(k), \mathcal{T}(k), m) \\ &= 1. \end{aligned} \tag{8}$$

Therefore, $\mathcal{T}(k) = \mathcal{H}(k) = p$. Now, we shall prove that $\mathcal{T}(p) = p$. If it is not so, then we have

$$\begin{aligned} \Phi\left(\frac{1}{\psi(\mathcal{T}(p), \mathcal{T}(p), \mathcal{T}(p), m)} - 1_\phi\right) &= \Phi\left(\frac{1}{\psi(\mathcal{H}(p), \mathcal{H}(p), \mathcal{H}(k), m)} - 1_\phi\right) \\ &\leq \Phi\left(\frac{1}{\psi(\mathcal{T}(p), \mathcal{T}(p), \mathcal{T}(k), m)} - 1_\phi\right) \\ &\quad - \Psi\left(\frac{1}{\psi(\mathcal{T}(p), \mathcal{T}(p), \mathcal{T}(k), m)} - 1_\phi\right) \\ &\leq \Phi\left(\frac{1}{\psi(\mathcal{T}(p), \mathcal{T}(p), p, m)} - 1_\phi\right) \\ &\quad - \Psi\left(\frac{1}{\psi(\mathcal{T}(p), \mathcal{T}(p), p, m)} - 1_\phi\right), \end{aligned} \tag{9}$$

which is a contradiction. By inequalities (4) and (5) we prove the uniqueness. The desired equality is obtained. \square

Example 4. Let $(\Gamma, \psi, \phi, *, \diamond)$ be a complete neutrosophic cone metric space, $\Gamma = \{(1/n) : n \in \mathbb{N}\} \cup 0_\phi$, \diamond be a maximum norm, and $*$ be a minimum norm. Let ψ, ϕ be defined by

$$\psi(\varepsilon_1, \varepsilon_2, \varepsilon_3, m) = \begin{cases} \frac{m}{m + (|t + s| + |s + r| + |r + t|)}, & \text{if } m > 0_\phi, \\ 0, & \text{if } m = 0_\phi, \end{cases}$$

$$\phi(\varepsilon_1, \varepsilon_2, \varepsilon_3, m) = \begin{cases} \frac{|t + s| + |s + r| + |r + t|}{m + (|t + s| + |s + r| + |r + t|)}, & \text{if } m > 0_\phi, \\ 0, & \text{if } m = 0_\phi. \end{cases} \tag{10}$$

Also, define $(\Phi, \Psi) : [0, \infty) \rightarrow [0, \infty)$ by $\mathcal{T}(t) = (t/2)$, and $\mathcal{H}(t) = (t/4)$. Obviously, $\mathcal{H}(\Gamma) \subseteq \mathcal{T}(\Gamma)$, and Ψ is a continuous function. Then, we have

$$\begin{aligned} & \Phi\left(\frac{1}{\psi(\mathcal{T}(t), \mathcal{T}(s), \mathcal{T}(r), m)} - 1_\phi\right) - \Psi\left(\frac{1}{\psi(\mathcal{T}(t), \mathcal{T}(s), \mathcal{T}(r), m)} - 1_\phi\right) \\ &= \frac{3(|t + s| + |s + r| + |r + t|)}{16m} \\ &\geq \frac{2(|t + s| + |s + r| + |r + t|)}{16m} \\ &= \Phi\left(\frac{1}{\psi(\mathcal{H}(t), \mathcal{H}(s), \mathcal{H}(r), m)} - 1_\phi\right). \end{aligned} \tag{11}$$

From the above inequality and the fact that $\phi = 1_\phi - \psi$, we conclude that the conditions (1) and (2) in Definition 2.18 are satisfied. Thus, \mathcal{H} is a neutrosophic $(\Phi - \Psi)$ -weak contraction with respect to \mathcal{T} .

Corollary 1. Let $(\Gamma, \psi, \phi, *, \diamond)$ be a neutrosophic cone metric space and $\mathcal{H} : \Gamma \rightarrow \Gamma$ be a neutrosophic (Φ, Ψ) -weak contraction. If Ψ is continuous, then \mathcal{H} has a unique fixed point.

Corollary 2. Let $(\Gamma, \psi, \phi, *, \diamond)$ be a neutrosophic cone metric space. Then, $\mathcal{H} : \Gamma \diamond \Gamma$ is a mapping satisfying

$$\Phi\left(\frac{1}{\psi(\mathcal{H}(t), \mathcal{H}(s), \mathcal{H}(r), m)} - 1_\phi\right) \leq p\Phi\left(\frac{1}{\psi(t, s, r, m)} - 1_\phi\right),$$

$$\Phi(\phi(\mathcal{H}(t), \mathcal{H}(s), \mathcal{H}(r), m)) \leq p\Phi(\phi(t, s, r, m)). \tag{12}$$

for each $t, s, r \in \Gamma$, $m \gg 0_\phi$, and $p \in (0, 1)$.

Theorem 2. Let $(\Gamma, \psi, \phi, *, \diamond)$ be a neutrosophic cone metric space and $\mathcal{T}_j, \mathcal{H}_i$ be two finite self-mappings on Γ with $\mathcal{T} = \mathcal{T}_1 \mathcal{T}_2 \dots \mathcal{T}_m$ and $\mathcal{H} = \mathcal{H}_1 \mathcal{H}_2 \dots \mathcal{H}_n$ such that $i \in \{1, 2, \dots, n\}$ and $j \in \{1, 2, \dots, m\}$. Suppose \mathcal{H} be a

generalized neutrosophic (Φ, Ψ) -weak contraction which is given with respect to \mathcal{T} . If $\mathcal{T}(\Gamma)$ and $\mathcal{H}(\Gamma) \subseteq \mathcal{T}(\Gamma)$ or $\mathcal{H}(\Gamma)$ is a complete subset of Γ , then $\mathcal{H}_i, \mathcal{T}_j$ have a common fixed point in which Γ is unique, provided a description of Ψ is a continuous function and the families $\mathcal{T}_j, \mathcal{H}_i$ commute pairwise.

Proof. By Theorem 1, we obtain that \mathcal{T} and \mathcal{H} have a common fixed point that is unique, say p . In order to prove that p remains as a fixed point of all self-mappings, let

$$\begin{aligned} \mathcal{H}\mathcal{H}_j(p) &= (\mathcal{H}_1 \mathcal{H}_2 \dots \mathcal{H}_n) \mathcal{H}_j(p) \\ &= (\mathcal{H}_1 \mathcal{H}_2 \dots \mathcal{H}_{n-1}) \mathcal{H}_n \mathcal{H}_j(p) \\ &= (\mathcal{H}_1 \mathcal{H}_2 \dots \mathcal{H}_{n-1}) \mathcal{H}_j \mathcal{H}_n(p) \\ &= \dots \\ &= \mathcal{H}_1 \mathcal{H}_j (\mathcal{H}_2 \mathcal{H}_3 \dots \mathcal{H}_n)(p) \\ &= \mathcal{H}_j \mathcal{H}_1 (\mathcal{H}_2 \mathcal{H}_3 \dots \mathcal{H}_n)(p) \\ &= \mathcal{H}_j \mathcal{H}(p) \\ &= \mathcal{H}_j(p). \end{aligned} \tag{13}$$

Since the other conditions are similarly proved, we can show that $\mathcal{H}\mathcal{T}_i(p) = \mathcal{T}_i\mathcal{H}(p) = \mathcal{T}_i(p)$, $\mathcal{T}\mathcal{T}_i(p) = \mathcal{T}_i\mathcal{T}(p) = \mathcal{T}_i(p)$, and $\mathcal{T}\mathcal{H}_j(p) = \mathcal{H}_j\mathcal{T}(p) = \mathcal{H}_j(p)$, which imply that $\forall i, j$, $\mathcal{H}_j(p)$, and $\text{Int}_i(p)$ are other fixed points of mapping $\{\mathcal{T}, \mathcal{H}\}$. For the uniqueness of \mathcal{T} and \mathcal{H} of self-mappings, we get $p = \mathcal{H}_j(p) = \mathcal{T}_i(p)$, which shows that p is a common fixed point of \mathcal{T}_j and $\mathcal{H}_i, \forall i, j$. \square

Example 5. Let $(\Gamma, \psi, \phi, \ast, \diamond)$ be a complete neutrosophic cone metric space, $k = \mathbb{R}^+$, and $\Gamma = [0, \infty)$. Define $\Phi = \Psi: [0, \infty) \rightarrow [0, \infty)$ by $\Phi(m) = (m/2), \Psi(m) = (m/4)$, for all $m \gg \phi$ and two families of self mappings \mathcal{T}_j and \mathcal{H}_i where $i, j \in \{1, 2, \dots, n\}$ by

$$\mathcal{T}_j(x) = \begin{cases} 0, & \text{if } m = 0_\phi, \\ \frac{1}{x\sqrt{[n]6}}, & \text{if } m > 0_\phi, \end{cases} \quad (14)$$

$$\mathcal{H}_i(x) = \begin{cases} 0, & \text{if } m > 0_\phi, \\ \frac{1}{x\sqrt{[n]2}}, & \text{if } m = 0_\phi. \end{cases}$$

Then, we have

$$\begin{aligned} & \Phi\left(\frac{1}{\psi(\mathcal{T}(t), \mathcal{T}(s), \mathcal{T}(r), m)} - 1_\phi\right) \\ & - \Psi\left(\frac{1}{\psi(\mathcal{T}(t), \mathcal{T}(s), \mathcal{T}(r), m)} - 1_\phi\right) \\ & = \frac{3(z^6|t^6 + s^6| + t^6|s^6 + r^6| + s^6|r^6 + t^6|)}{2mt^6s^6r^6} \quad (15) \\ & \geq \frac{z^2|t^2 + s^2| + t^2|s^2 + r^2| + s^2|r^2 + t^2|}{2mt^2s^2r^2} \\ & = \Phi\left(\frac{1}{\psi(\mathcal{H}(t), \mathcal{H}(s), \mathcal{H}(r), m)} - 1_\phi\right). \end{aligned}$$

From the above and the idea of $\phi = 1 - \psi$, we get that statements (i) and (ii) hold. All statements of Theorem 2 hold; therefore, \mathcal{T}_j and \mathcal{H}_i have uniqueness.

4. Conclusion

In this paper, the definition of the neutrosophic cone metric space is introduced and studied. Based on this definition, we also stated and proved some fixed point theorems on the neutrosophic CMS. We provided a description of the example and investigated some properties in Section 3. We established and extended the definition of the (Φ, Ψ) -weak contraction in the intuitionistic generalized fuzzy cone metric space.

References

- [1] L. A. Zadeh, "Fuzzy sets," *Information and Control*, vol. 8, no. 3, pp. 338–353, 1965.
- [2] C. L. Chang, "Fuzzy topological spaces," *Journal of Mathematical Analysis and Applications*, vol. 24, no. 1, pp. 182–190, 1968.
- [3] K. Atanassov, "Intuitionistic fuzzy sets," *Fuzzy Sets and Systems*, vol. 20, no. 1, pp. 87–96, 1984.
- [4] K. Atanassov and A. K. Stoeva, "Intuitionistic I-fuzzy," in *Cybernetic and System Research*, R. Trpple, Ed., vol. 2, pp. 539–540, Elsevier, Amsterdam, Netherlands, 1984.
- [5] D. Çoker, "An introduction to intuitionistic fuzzy topological spaces," *Fuzzy Sets and Systems*, vol. 88, no. 1, pp. 81–89, 1997.
- [6] G. Balasubramanian and P. Sundaram, "On some generalizations of fuzzy continuous functions," *Fuzzy Sets and Systems*, vol. 86, no. 1, pp. 93–100, 1997.
- [7] F. Smarandache, "Neutrosophic set is a generalization of intuitionistic fuzzy set, inconsistent intuitionistic fuzzy set (picture fuzzy set, ternary fuzzy set), pythagorean fuzzy set (atanassov's intuitionistic fuzzy set of second type), q-rung orthopair fuzzy set, spherical fuzzy set, and n-hyperspherical fuzzy set, while neutrosophication is a generalization of regret theory, grey system theory, and three-ways decision, arxiv preprint arxiv: 1911.07333," *Journal of New Theory*, vol. 29, pp. 01–35, 2019.
- [8] F. Smarandache, *Neutrosophic Probability, Set, and Logic*, ProQuest Information, Learning, Ann Arbor, MI, USA, 1998.
- [9] M. A. A. Shumrani and F. Smarandache, "Introduction to non-standard neutrosophic topology," *Symmetry*, vol. 11, pp. 1–14, 2019.
- [10] W. F. Al-Omeri and F. Smarandache, *New Neutrosophic Sets via Neutrosophic Topological Spaces*, Pons Publishing House, Brussels, Belgium, 2017.
- [11] W. F. Al-Omeri, "Neutrosophic crisp sets via neutrosophic crisp topological spaces," *Neutrosophic Sets and Systems*, vol. 13, pp. 96–104, 2016.
- [12] W. F. Al-Omeri, S. Jafari, and F. Smarandache, "Neutrosophic fixed point theorems and cone metric spaces," *Neutrosophic Sets and Systems*, vol. 31, no. 1, p. 18, 2020.
- [13] A. George and P. Veeramani, "On some results in fuzzy metric spaces," *Fuzzy Sets and Systems*, vol. 64, no. 3, pp. 395–399, 1994.
- [14] F. Smarandache, "Neutroalgebra is a generalization of partial algebra," *International Journal of Neutrosophic Science (IJNS)*, vol. 2, no. 1, pp. 08–17, 2020.
- [15] F. Smarandache, "Introduction to neutroalgebraic structures and antialgebraic structures," in *Advances of Standard and Nonstandard Neutrosophic Theories Ch. 6 (20220190)*, pp. 240–265, Pons Publishing House, Brussels, Belgium, 2020.
- [16] L.-G. Huang and X. Zhang, "Cone metric spaces and fixed point theorems of contractive mappings," *Journal of Mathematical Analysis and Applications*, vol. 332, no. 2, pp. 1468–1476, 2007.
- [17] T. Öner, M. B. Kandemir, and B. Tanay, "Fuzzy cone metric spaces," *Journal of Nonlinear Sciences and Applications*, vol. 8, no. 5, pp. 610–616, 2015.
- [18] I. Beg, C. Vetro, D. Gopal, and M. Imdad, " (ϕ, ψ) -weak contractions in intuitionistic fuzzy metric spaces," *Journal of Intelligent & Fuzzy Systems*, vol. 26, no. 5, pp. 2497–2504, 2014.

- [19] V. Gupta, R. Saini, and A. Kanwar, "Some coupled fixed point results on modified intuitionistic fuzzy metric spaces and application to integral type contraction," *Iranian Journal of Fuzzy Systems*, vol. 14, no. 5, pp. 123–137, 2017.
- [20] S. Wasfi, G. Vishal, and K. Ashima, "New results on modified intuitionistic generalized fuzzy metric spaces by employing e.a property and common e.a property for coupled maps," *Journal of Intelligent and Fuzzy Systems*, vol. 38, no. 3, pp. 3003–3010, 2020.
- [21] A. A. Salama, S. Broumi, S. Broumi, and S. A. Alblow, "Introduction to neutrosophic topological spatial region, possible application to gis topological rules," *International Journal of Information Engineering and Electronic Business*, vol. 6, no. 6, pp. 15–21, 2014.
- [22] A. A. Salama, F. Smarandache, and V. Kroumov, "Neutrosophic closed set and neutrosophic continuous functions," *Neutrosophic Sets and Systems*, vol. 4, pp. 4–8, 2014.
- [23] W. Al-Omeri and S. Jafari, "On generalized closed sets and generalized pre-closed sets in neutrosophic topological spaces," *Mathematics*, vol. 7, no. 1, pp. 1–12, 2019.

An Introduction to Neutrosophic Minimal Structure Spaces

Muthusamy Karthika, Rishwanth M. Parimala, Florentin Smarandache

Muthusamy Karthika, Rishwanth M. Parimala, Florentin Smarandache (2020). An Introduction to Neutrosophic Minimal Structure Spaces. *Neutrosophic Sets and Systems* 36, 378-388

Abstract. This paper is an introduction of neutrosophic minimal structure space and addresses properties of neutrosophic minimal structure space. Neutrosophic set has plenty of applications. This motivates us to present the concept of neutrosophic minimal structure space. We defined neutrosophic minimal structure space, closure and interior of a set, subspace. Some properties of neutrosophic minimal structure space are also studied. Finally, Decision making problem solved using score function.

Keywords: Neutrosophic minimal structure; N_m -closure; N_m -interior; N_m -connectedness.

1. Introduction

Zadeh's [23] Fuzzy set laid the foundation of many theories such as intuitionistic fuzzy set and neutrosophic set, rough sets etc. Later, researchers developed K. T. Atanassov's [4] intuitionistic fuzzy set theory in many fields such as differential equations, topology, computer science and so on. F. Smarandache [20, 21] found that some objects have indeterminacy or neutral other than membership and non-membership. So he coined the notion of neutrosophy. Researchers [12, 15–18] applied the concept of neutrosophy when object has inconsistent, incomplete information. The universal set X and \emptyset forms a topology (Munkrer [11]). Popa [14] introduced minimal structures and defined separation axioms using minimal structure. M. Alimohammady, M. Roohi [5] introduced fuzzy minimal structure in lowen sense. S.Bhattacharya (Halder) [6] presented the concept of intuitionistic fuzzy minimal space.

1.1. Motivation and Objective

In general topology, the whole set and empty set forms a space with minimal structure. Supra topological space is also a space with neutrosophic minimal structure. These are all the generalization of topological spaces. Our objective is to introduce neutrosophic universal set and neutrosophic null set with neutrosophic minimal structure. It is a generalization of neutrosophic topological space. This paper consisting of basic definitions such as interior, closure, open, closed, subspace with minimal structure and its properties.

1.2. Limitations

Neutrosophic topological space, neutrosophic supra topological space are space with neutrosophic minimal structure. The converse is not true that is space with neutrosophic minimal structure is not a neutrosophic supra topological space or neutrosophic topological space.

In section 1, the basic definitions are presented which are useful for our paper and in section 2, the basic definitions of neutrosophic minimal structure space are presented. In further sections some properties of neutrosophic minimal structure space are also investigated. Finally, we introduced an algorithm to solve some applications of neutrosophic minimal structure space. Note that neutrosophic topological space, neutrosophic supra topological space are neutrosophic minimal structure space but converse is not true.

2. Preliminaries

In this section, we presented the basic definitions developed by [15, 19–21].

Definition 2.1. [20, 21] A neutrosophic set (in short NS) U on a set $X \neq \emptyset$ is defined by

$U = \{ \langle a, T_U(a), I_U(a), F_U(a) \rangle : a \in X \}$ where $T_U : X \rightarrow [0, 1]$, $I_U : X \rightarrow [0, 1]$ and $F_U : X \rightarrow [0, 1]$ denotes the membership of an object, indeterminacy and non-membership of an object, for each $a \in X$ to U , respectively and $0 \leq T_U(a) + I_U(a) + F_U(a) \leq 3$ for each $a \in X$.

Definition 2.2. [19] Let $U = \{ \langle a, T_U(a), I_U(a), F_U(a) \rangle : a \in X \}$ be a neutrosophic set.

- (i) A neutrosophic set U is an empty set i.e., $U = 0_{\sim}$ if 0 is membership of an object and 1 is an indeterminacy and non-membership of an object respectively. i.e., $0_{\sim} = \{ x, (0, 1, 1) : x \in X \}$
- (ii) A neutrosophic set U is a universal set i.e., $U = 1_{\sim}$ if 1 is membership of an object and 0 is an indeterminacy and non-membership of an object respectively. $1_{\sim} = \{ x, (1, 0, 0) : x \in X \}$
- (iii) $U_1 \cup U_2 = \{ a, \max\{T_{U_1}(a), T_{U_2}(a)\}, \min\{I_{U_1}(a), I_{U_2}(a)\}, \min\{F_{U_1}(a), F_{U_2}(a)\} : a \in X \}$

$$(iv) U_1 \cap U_2 = \{a, \min\{T_{U_1}(a), T_{U_2}(a)\}, \max\{I_{U_1}(a), I_{U_2}(a)\}, \max\{F_{U_1}(a), F_{U_2}(a)\} : a \in X\}$$

$$(v) U_1^C = \{a, F_U(a), 1 - I_U(a), T_U(a) : a \in X\}$$

Definition 2.3. [19] A neutrosophic topology (NT) in Salama’s sense on a nonempty set X is a family τ of NSs in X satisfying three axioms:

- (1) Empty set (0_\sim) and universal set(1_\sim) are members of τ .
- (2) $U_1 \cap U_2 \in \tau$ where $U_1, U_2 \in \tau$.
- (3) $\bigcup_{i=1}^\infty U_i \in \tau$ where each $U_i \in \tau$.

Each neutrosophic sets in neutrosophic topological spaces are called neutrosophic open sets. Its complements are called neutrosophic closed sets.

Definition 2.4. [19] Let NS U in NTS X . Then a neutrosophic interior of U and a neutrosophic closure of U are defined by

$$\begin{aligned} n\text{-int}(U) &= \max \{F : F \text{ is an Neutrosophic open set in } X \text{ and } F \leq U\} \text{ and} \\ n\text{-cl}(U) &= \min \{F : F \text{ is an Neutrosophic closed set in } X \text{ and } F \geq U\} \text{ respectively.} \end{aligned}$$

Definition 2.5. [15] A neutrosophic supra topology (in short, NST) on a nonempty set X is a family τ of NSs in X satisfying the following axioms:

- (1) Empty set (0_\sim) and universal set(1_\sim) are members of τ .
- (2) $\bigcup_{i=1}^\infty U_i \in \tau$ where each $U_i \in \tau$.

3. Neutrosophic Minimal Structure Spaces

Neutrosophic minimal structure space is defined and studied its properties in this section.

Definition 3.1. Let the neutrosophic minimal structure space over a universal set X be denoted by N_m . N_m is said to be neutrosophic minimal structure space (in short, NMS) over X if it satisfying following the axiom:

- (1) $0_\sim, 1_\sim \in N_m$.

A family of neutrosophic minimal structure space is denoted by (X, N_{mX})

Note that neutrosophic empty set and neutrosophic universal set can form a topology and it is known as neutrosophic minimal structure space.

Each neutrosophic set in neutrosophic minimal structure space is neutrosophic minimal open set.

The complement of neutrosophic minimal open set is neutrosophic minimal closed set.

Remark 3.2. Each neutrosophic set in neutrosophic minimal structure space is neutrosophic minimal open set.

The complement of neutrosophic minimal open set is neutrosophic minimal closed set.

In this paper, we refer definition 2.2 for basic operations.

Example 3.3. We know that $0_{\sim} = \{x, (0, 1, 1)\}$ & $1_{\sim} = \{x, (1, 0, 0)\}$ are neutrosophic minimal open sets. Lets find out their complements.

$0_{\sim}^C = \{x, (1, 0, 0)\} = 1_{\sim}$ and $1_{\sim}^C = \{x, (0, 1, 1)\} = 0_{\sim}$. This clears that 0_{\sim} and 1_{\sim} are both neutrosophic minimal open and closed set.

Remark 3.4. From Definition 3.1. the following are obvious

- (1) Neutrosophic supra topological spaces are neutrosophic minimal structure space but converse not true.
- (2) Similarly, Neutrosophic topological spaces are neutrosophic minimal structure space but converse is not true.

The following Example 3.5 proves the above Remark 3.4.

Example 3.5. Let $A = \{< 0.6, 0.4, 0.3 >: a\}$, $B = \{< 0.6, 0.5, 0.1 >: a\}$ are neutrosophic sets over the universal set $X = \{a\}$. Then the neutrosophic minimal structure space is $N_m = \{0, 1, A, B\}$. But N_m is not a neutrosophic topological space and not a neutrosophic supra topological space, since arbitrary union and finite intersection doesn't hold in N_m .

Definintion 3.6. A is N_m -closed if and only if $N_m cl(A) = A$.

Similarly, A is a N_m -open if and only if $N_m int(A) = A$.

Definintion 3.7. Let N_m be any neutrosophic minimal structure space and A be any neutrosophic set. Then

- (1) Every $A \in N_m$ is open and its complement is closed.
- (2) N_m -closure of $A = min\{F : F \text{ is a neutrosophic minimal closed set and } F \geq A\}$ and its denoted by $N_m cl(A)$.
- (3) N_m -interior of $A = max\{F : F \text{ is a neutrosophic minimal open set and } F \leq A\}$ and it is denoted by $N_m int(A)$.

In general $N_m int(A)$ is subset of A and A is a subset of $N_m cl(A)$.

Proposition 3.8. Suppose A and B are any neutrosophic set of neutrosophic minimal structure space N_m over X. Then

- i. $N_m^C = \{0, 1, A_i^C\}$ where A_i^C is a complement of neutrosophic set A_i .
- ii. $X - N_m \text{int}(B) = N_m \text{cl}(X - B)$.
- iii. $X - N_m \text{cl}(B) = N_m \text{int}(X - B)$.
- iv. $N_m \text{cl}(A^C) = (N_m \text{cl}(A))^C = N_m \text{int}(A)$.
- v. N_m closure of an empty set is an empty set and N_m closure of a universal set is a universal set. Similarly, N_m interior of an empty set and universal set respectively an empty set and a universal set.
- vi. If B is a subset of A then $N_m \text{cl}(B) \leq N_m \text{cl}(A)$ and $N_m \text{int}(B) \leq N_m \text{int}(A)$.
- vii. $N_m \text{cl}(N_m \text{cl}(A)) = N_m \text{cl}(A)$ and $N_m \text{int}(N_m \text{int}(A)) = N_m \text{int}(A)$.
- viii. $N_m \text{cl}(A \vee B) = N_m \text{cl}(A) \vee N_m \text{cl}(B)$
- ix. $N_m \text{cl}(A \wedge B) = N_m \text{cl}(A) \wedge N_m \text{cl}(B)$

Proof. (i) We know that $A^C = X - A$. Then $N_m \text{cl}(X - A) = N_m \text{cl}(A^C) = (N_m \text{cl}(A))^C = N_m \text{int}(A)$, from (iv).

Similarly for (ii).

(vi) Let $B \leq A$. We know that $B \leq N_m \text{cl}(B)$ and $A \leq N_m \text{cl}(B)$. So $B \leq N_m \text{cl}(B) \leq A \leq N_m \text{cl}(A)$. Therefore $N_m \text{cl}(B) \leq N_m \text{cl}(A)$.

Proof of (vii) is straight forward.

(viii) We know that $A \leq A \vee B$ and $B \leq A \vee B$. $N_m \text{cl}(A) \leq N_m \text{cl}(A \vee B)$ and $N_m \text{cl}(B) \leq N_m \text{cl}(A \vee B)$ this implies $N_m \text{cl}(A) \vee N_m \text{cl}(B) \leq N_m \text{cl}(A \vee B)$. $\rightarrow (*)$

Also $A \leq N_m \text{cl}(A)$ and $B \leq N_m \text{cl}(B) \Rightarrow A \vee B \leq N_m \text{cl}(A) \vee N_m \text{cl}(B)$. $N_m \text{cl}(A \vee B) \leq N_m \text{cl}(N_m \text{cl}(A) \vee N_m \text{cl}(B)) = N_m \text{cl}(A) \vee N_m \text{cl}(B) \rightarrow (**)$.

From (*) and (**), we have $N_m \text{cl}(A \vee B) = N_m \text{cl}(A) \vee N_m \text{cl}(B)$.

Example 3.9. Consider Example 3.5, the complement of N_m is $\{0, 1, A^C, B^C\}$ where $A^C = \{ \langle 1 - 0.6, 1 - 0.4, 1 - 0.3 \rangle / a : a \in X \} = \{ \langle 0.4, 0.6, 0.7 \rangle / a : a \in X \}$ and $B^C = \{ \langle 1 - 0.6, 1 - 0.5, 1 - 0.1 \rangle / a : a \in X \} = \{ \langle 0.4, 0.5, 0.9 \rangle / a : a \in X \}$.

Definintion 3.10. A function $f : (X, N_{mX}) \rightarrow (Y, N_{mY})$ is called neutrosophic minimal continuous function if and only if $f^{-1}(V) \in N_{mX}$ whenever $V \in N_{mY}$.

Definintion 3.11. Boundary of a neutrosophic set A (in short $Bd(A)$) of neutrosophic minimal structure (X, N_{mX}) is the intersection of $N_m \text{closure}$ of the set A and $N_m \text{closure}$ of $X - A$. i.e., $Bd(A) = N_m \text{cl}(A) \cap N_m \text{cl}(X - A)$

Theorem 3.12. If (X, N_{mX}) and (Y, N_{mY}) are neutrosophic minimal structure space. Then

- (1) Identity map from (X, N_{mX}) to (Y, N_{mY}) is a neutrosophic minimal continuous function.
- (2) Any constant function which maps from (X, N_{mX}) to (Y, N_{mY}) is a neutrosophic minimal continuous function.

Proof. The proof is obvious.

Theorem 3.13. Let the map f from neutrosophic minimal structure space (X, N_{mX}) to neutrosophic minimal structure space (Y, N_{mY}) . Then the following are equivalent,

- (1) The map f is a neutrosophic minimal continuous function.
- (2) $f^{-1}(V)$ is a neutrosophic minimal closed set for each neutrosophic minimal closed set $V \in N_{mY}$.
- (3) $N_{mcl}(f^{-1}(V)) \leq f^{-1}(N_{mcl}(V))$, for each $V \in N_{mY}$.
- (4) $N_{mcl}(f(A)) \geq f(N_{mcl}(A))$, for each $A \in N_{mX}$.
- (5) $N_{mint}(f^{-1}(V)) \geq f^{-1}(N_{mint}(V))$, for each $V \in N_{mY}$.

Proof. (1) \Rightarrow (2): Let A be a N_m -closed in Y . Then $f^{-1}(A)^C = f^{-1}(A^C) \in N_{mX}$.

(2) \Rightarrow (3): $N_{mcl}(f^{-1}(A)) = \wedge\{D : f^{-1}(A) \leq D, D^C \in N_{mX}\} \leq \wedge\{f^{-1}(D) : A \leq D, D^C \in N_{mY}\} = f^{-1}(\{D : A \leq D^C \in N_{mY}\}) = f^{-1}(N_{mcl}(A))$.

(3) \Rightarrow (4): Since $A \leq f^{-1}(f(A))$, then $N_{mcl}(A) \leq N_{mcl}f^{-1}(f(A)) \leq f^{-1}(N_{mcl}(f(A)))$.

Therefore $f(N_{mcl}(A)) \leq N_{mcl}(f(A))$.

(4) \Rightarrow (5): $f(N_{mint}(f^{-1}(A)))^C = f(N_{mcl}(f^{-1}(A))^C) = f(N_{mcl}(f(A)^C)) \leq N_{mcl}(f(f^{-1}(A^C))) \leq N_{mcl}(A^C) = (N_{mint}(A))^C$. This implies that $N_{mint}(f^{-1}(B))^C \leq f^{-1}(N_{mint}(A))^C = (f^{-1}(N_{mint}(A)))^C$.

Taking complement on both sides, $f^{-1}(N_{mint}(A)) \leq N_{mint}(f^{-1}(B))$.

Definition 3.14. Let (X, N_{mX}) be neutrosophic minimal structure space.

- i. Arbitrary union of neutrosophic minimal open sets in (X, N_{mX}) is neutrosophic minimal open. (Union Property)
- ii. Finite intersection of neutrosophic minimal open sets in (X, N_{mX}) is neutrosophic minimal open. (intersection Property)

4. Neutrosophic Minimal Subspace

In this section, we introduced the neutrosophic minimal subspace and investigate some properties of subspace.

Definition 4.1. Let A be a neutrosophic set in neutrosophic minimal structure space (X, N_{mX}) . Then Y is said to be neutrosophic minimal subspace if $(Y, N_{mY}) = \{A \cap U : U \in N_{mY}\}$.

Lemma 4.2. If neutrosophic set b in the basis B for neutrosophic minimal structure space X . Then the collection $B_Y = \{b \cap Y : Y \subset X\}$ is a basis for neutrosophic minimal subspace on Y .

Proof. Given a neutrosophic set A in X and C is a neutrosophic set in both A and subset Y of X . Consider a basis element b of B such that C in b and in Y . Then $C \in B \cap Y \subset U \cap Y$. Hence B_Y is a basis for the neutrosophic minimal subspace on the set Y .

Lemma 4.3. Let (Y, N_{mY}) be a subspace of (X, N_{mX}) . If A is a neutrosophic set in Y and $Y \subset X$. Then A is in (X, N_{mX}) .

Proof. Given that neutrosophic set A in (Y, N_{mY}) . $A = Y \cap B$ for some neutrosophic set $B \in X$. Since Y and B in X . Then A is in X .

Proposition 4.4. Suppose (Y, N_{mY}) is a neutrosophic minimal subspace of (X, τ_X) .

- (1) If the neutrosophic minimal structure space (X, N_{mX}) has the union property, then the subspace (Y, N_{mY}) also has union property.
- (2) If the neutrosophic minimal structure space (X, N_{mX}) has the intersection property, then the subspace (Y, N_{mY}) also has union property.

Proof. Suppose the family of open set $\{V_i : i \in Y\}$ in neutrosophic minimal subspace (Y, N_{mY}) then there exist a family of open sets $\{U_j : j \in X\}$ in neutrosophic minimal structure space (X, N_{mX}) such that $V_i = U_j \cap A, \forall i \in Y$ where $A \in N_{mY}$. $\bigcup_{(i \in Y)} V_i = \bigcup_{(j \in X)} (U_j \cap A) = \bigcup_{(i \in Y)} U_j \cap A$. Since (X, N_{mX}) has union property then (Y, N_{mY}) also has union property. The proof of (ii) is similarly to (i).

Definition 4.5. Suppose (B, N_{mB}) and (C, N_{mC}) are neutrosophic minimal subspaces of neutrosophic minimal structure spaces (Y, N_{mY}) and (Z, N_{mZ}) respectively. Also, suppose that f is a mapping from (Y, N_{mY}) to (Z, N_{mZ}) is a mapping. We say that f is a mapping from (B, N_{mB}) into (C, N_{mC}) if the image of B under f is a subset of C .

Definition 4.6. Suppose (A, N_{mA}) and (B, N_{mB}) are neutrosophic minimal subspaces of neutrosophic minimal structure spaces (Y, N_{mY}) and (Z, N_{mZ}) respectively. The mapping f from (A, N_{mA}) into (B, N_{mB}) is called a

- (1) comparative neutrosophic minimal continuous, if $f^1(W) \wedge A \in N_{mA}$ for every neutrosophic minimal structure set W in B ,
- (2) comparative neutrosophic minimal open, if $f(V) \in N_{mB}$ for every fuzzy set $V \in N_{mA}$.

X/E	c_1	c_2	c_3	c_n
a_1	d_{11}	d_{12}	d_{13}	d_{1n}
a_2	d_{21}	d_{22}	d_{23}	d_{2n}
.
a_m	d_{m1}	d_{m2}	d_{m3}	d_{mn}

TABLE 1. Attributes and Alternative

5. Applications

The application of neutrosophic minimal structure space is based on the minimal element and maximal element. In neutrosophic minimal structure space, 0_{\sim} is the minimal element and 1_{\sim} is the maximal element. The application of neutrosophic minimal structure space used in consumer theory where the customer has only two objective. In consumer theory, the customer has either minimize purchase cost and maximize the quantity or maximize the durability.

The following steps are proposed to take better decision.

Step 1.

Input m Attributes and n alternatives (See TABLE 1).

Step 2. Construct the neutrosophic minimal structure from the data. $\tau_k = \{0_{\sim}, 1_{\sim}, U_k\}$ where $U_k = \{d_{1k}, d_{2k} \dots d_{mk}\}$

Step 3. compute the neutrosophic score function (in short, NF) using the following simple formula, $NF(U_k) = \frac{1}{3m} [\sum_{i=1}^m [2 + T_i - I_i - F_i]]$

Step 4. Arrange the score function U_k which we calculated in step 3 in ascending order. Choose the largest score value U_k for better decision.

Lets consider the following example. Let the set of variety of cars be $X = \{C_1, C_2, C_3\}$ and the parameter set $E = \{a = \text{cost of the car}, b = \text{safety}, c = \text{maintenance}\}$. A customer will assign minimum value of 0_{\sim} to bad features, maximum 1_{\sim} to the best feature of the product. Membership, indeterminacy and non-membership values taken from customer’s review rating. Membership referred to cost of the car is worth to the model, safe and low maintenance cost. Non-membership referred to cost of the car is not worth to the model, not safe due to break failure or some other reason and high maintenance cost. Indeterminacy referred to neutrality of cost of the car, safe if drive safe and maintenance is neutral. Let us assume TABLE 2. values are taken from customer review rating for the models C_1, C_2 and C_3 with parameters a, b and c.

Step 2. The neutrosophic minimal structure

$$\tau_1 = \{0_{\sim}, 1_{\sim}, U_1\} \text{ where } U_1 = \{(0.6, 0.2, 0.4), (0.7, 0.3, 0.4), (0.6, 0.3, 0.4)\}$$

$$\text{Similarly, } \tau_2 = \{0_{\sim}, 1_{\sim}, U_2\} \text{ where } U_2 = \{(0.6, 0.3, 0.4), (0.6, 0.3, 0.4), (0.5, 0.2, 0.4)\}$$

X/E	C_1	C_2	C_3
a	(0.6,0.2,0.4)	(0.6,0.3,0.4)	(0.7,0.3,0.4)
b	(0.7,0.3,0.4)	(0.6,0.3,0.4)	(0.8,0.2,0.2)
c	(0.6,0.3,0.4)	(0.5,0.2,0.4)	(0.6,0.2,0.3)

TABLE 2. Input matrix

$\tau_3 = \{0\sim, 1\sim, U_3\}$ where $U_3 = \{(0.7, 0.3, 0.4), (0.8, 0.2, 0.2), (0.6, 0.2, 0.3)\}$

Step 3. Neutrosophic score functions are

$$NS(U_1) = 0.6556$$

$$NS(U_2) = 0.6333$$

$$NS(U_3) = 0.7222$$

Step 4. The neutrosophic score functions are arranged in ascending order as follows $U_2 \leq U_1 \leq U_3$. Based on score function, U_3 is the largest score function. U_3 related to the model C_3 . Hence Model C_3 is best to buy.

Comparison Analysis: The existing and proposed notion of neutrosophic minimal structure space is compared in the below table.

Spaces	Uncertainty	Truth value of parameter	Uncertainty of parameter	False value of parameter.
Minimal structure space	-	-	-	-
Fuzzy minimal structure space	Present	Present	-	-
Intuitionistic Minimal structure space	Present	Present	Present	-
Neutrosophic minimal structure space	Present	Present	Present	present

TABLE 3. Comparison Table

6. Conclusions

In this paper, Neutrosophic minimal structure space is introduced and some of its properties investigated along with this. Neutrosophic minimal continuous and subspace are also investigated with few properties. Finally, application of neutrosophic minimal structure space is discussed. Future work of this paper is to investigate and study various open sets and separation axioms in neutrosophic minimal structure space. Also the application part discussed in this work leads to analyze in weak structure.

References

- [1] Abdel-Basset, M.; Gamal, A.; Son, L.H.; Smarandache, F. A Bipolar Neutrosophic Multi Criteria Decision Making Framework for Professional Selection. *Appl. Sci.*(2020), 10, 1202.
- [2] Abdel-Basset, M.; Mohamed, R.; Zaied, A. E. N. H.; Gamal, A.; & Smarandache, F. Solving the supply chain problem using the best-worst method based on a novel Plithogenic model. In *Optimization Theory Based on Neutrosophic and Plithogenic Sets*,(2020), (pp. 1-19). Academic Press.
- [3] Abdel-Basst, M.; Mohamed, R.; & Elhoseny, M. A novel framework to evaluate innovation value proposition for smart product-service systems. *Environmental Technology & Innovation*, (2020), DOI: 10.1016/j.eti.2020.101036
- [4] Atanassov, K.T. Intuitionistic fuzzy sets. *Fuzzy sets and systems*, (1986), 20, 87-96.
- [5] Alimohammady, M.; Roohi, M. Fixed point in minimal spaces. *Nonlinear Anal.Model. Control*, (2005),10,305-314.
- [6] Battacharya. S(Halder). Some results on IF generalized minimal closed set. *Int. Journal of Math. Analysis*, (2010), 4(32), 1577 - 1589.
- [7] Banu priya, V.; Chandrasekar, S. Neutrosophic α gs Continuity and Neutrosophic α gs Irresolute Maps. *Neutrosophic Sets and Systems*, (2019), 28, 162-170. DOI: 10.5281/zenodo.3382531
- [8] Coker, D. An introduction to fuzzy topological spaces. *Fuzzy sets and systems* (1997), 88, 81-89.
- [9] Dhavaseelan, R.; Narmada Devi, R.; Jafari, S and Qays Hatem Imran. Neutrosophic alpha-m-continuity. *Neutrosophic Sets and Systems*, (2019), 27, 171-179. DOI: 10.5281/zenodo.3275578
- [10] Dhavaseelan, R.; Parimala, M.; Jafari, S.; Smarandache, F. On neutrosophic semi-supra open set and neutrosophic semi-supra continuous functions. *Neutrosophic Sets and Systems*, (2017), 16 ,39-43.
- [11] James Munkres, *Topology*. pearson, (2000).
- [12] Karthika, M.; Parimala, M.; Jafari, S.; Smarandache, F.; Mohammad Alshumrani.; Cenap Ozel and Udhayakumar. R. Neutrosophic complex $\alpha\psi$ connectedness in neutrosophic complex topological spaces. *Neutrosophic sets and systems*, (2019), 29, 158-164.
- [13] Kuratowski. K, *Topology* Vol. II. Academic Press: New York, (1966).
- [14] Popa, V.; Noiri, T. On M-continuous functions. *Anal. Univ. Dunarea de Jos Galati, Ser. Mat. Fiz. Mec. Teor. Fasc. II*, (2000), 18 (23), 31-41.
- [15] Parimala, M.; Karthika, M.; Dhavaseelan, R.; Jafari, S. On neutrosophic supra pre-continuous functions in neutrosophic topological spaces. *New Trends in Neutrosophic Theory and Applications*, (2017), 2, 371-383.
- [16] Parimala, M.; Karthika, M.; Jafari, S.; Smarandache, F.; Udhayakumar, R. Decision-Making via Neutrosophic Support Soft Topological Spaces. *Symmetry*, (2018), 10(6), 217, 1-10.
- [17] Parimala, M.; Karthika,M.; Jafari, S.; Smarandache, F.; El-Atik,A.A. Neutrosophic $\alpha\psi$ -connectedness. *Journal of Intelligent & Fuzzy Systems*, (2020), 38, 853 - 857.

- [18] Parimala, M.; Karthika, M.; Jafari, S.; Smarandache, F. and Udhayakumar, R. Neutrosophic nano ideal topological structures. *Neutrosophic sets and systems*, (2019), 24, 70-77.
- [19] Salama, A.A.; Alblowi, S.A. Neutrosophic Set and Neutrosophic Topological Spaces. *IOSR J. Math.* (2012), 3, 31-35.
- [20] Smarandache, F. Neutrosophy and Neutrosophic Logic. First International Conference on Neutrosophy, Neutrosophic Logic Set, Probability and Statistics, University of New Mexico, Gallup, NM, USA, (2002).
- [21] Smarandache, F. A Unifying Field in Logics: Neutrosophic Logic. Neutrosophy, Neutrosophic Set, Neutrosophic Probability, American Research Press: Rehoboth, NM, USA, (1999).
- [22] Smarandache, F.; Mumtaz Ali. Neutrosophic Triplet Group (revisited). *Neutrosophic Sets and Systems*, 26,(2019), 1-11.
- [23] Zadeh, L.A. Fuzzy Sets. *Information and Control*, (1965), 18, 338-353.

A New Type of Quasi Open Functions in Neutrosophic Topological Environment

Rishwanth Mani Parimala, Cenap Özel, Florentin Smarandache, Muthusamy Karthika

Rishwanth Mani Parimala, Cenap Özel, Florentin Smarandache, Muthusamy Karthika (2020). A New Type of Quasi Open Functions in Neutrosophic Topological Environment, 10

Abstract

Neutrosophic topological space is an generalization of intuitionistic topological space and each neutrosophic set in neutrosophic topological space is triplet set. Intuitionistic topological set deals membership and non-membership values of each variable in open and closed functions and in neutrosophic topology indeterminacy of the same variable has not discussed in the previous work. This motivates us to propose the new type of quasi open and closed functions in neutrosophic topological space. In this paper, we introduce the notion of neutrosophic *quasi $\alpha\psi$ -open* and neutrosophic *quasi $\alpha\psi$ -closed* functions. Also we investigate some of its fundamental properties and its characterizations.

Keywords. neutrosophic *$\alpha\psi$ -closed* set, neutrosophic *$\alpha\psi$ -open* set and neutrosophic *quasi $\alpha\psi$ -function*.

1. Introduction

Atanassov [2] defined the notion of intuitionistic fuzzy sets, which is a generalized form of Zadeh's [19] fuzzy set. Using this concept so many research work are brought in the literature, such as intuitionistic fuzzy semi-generalized closed sets [15]. D. Coker [3] initiated the concept of intuitionistic fuzzy topological spaces. F. Smarandache [17, 18] introduced and studied neutrosophic sets (NS). Later, Salama et al.[13, 14] introduced and studied neutrosophic topology. This approach leads to many investigations in this area.

Since then more research have been identified in the field of neutrosophic topology [7, 10, 11, 12, 13, 14], neutrosophic ideals [6, 8, 9], etc.

Many different terms of open functions have been introduced over the course of years. Various interesting problems arise when one consider openness. Its importance is significant in various areas of Mathematics and related sciences.

The notion of neutrosophic $\alpha\psi$ -closed set was introduced and studied by M. Parimala et al. [7, 11, 12]. In this paper, we will continue the study of related functions by involving neutrosophic $\alpha\psi$ -open sets. We introduce and characterize the concept of neutrosophic *quasi $\alpha\psi$ -functions*.

Through out this paper, spaces means neutrosophic topological spaces on which no separation axioms are assumed unless otherwise mentioned and $f : (X, \tau) \rightarrow (Y, \sigma)$ denotes a neutrosophic function f of a space (X, τ) into a space (Y, σ) . Let A be a subset of a space X . The neutrosophic closure and the neutrosophic interior of A are denoted by $ncl(A)$ and $nint(A)$, respectively.

2. Preliminaries

This sections contains the collection of some existing definition in [1, 3, 6, 7, 10, 11, 12, 13, 14, 17, 18] which are helpful for this work.

Definition 2.1. Let X and I are a non-empty set and the interval $[0, 1]$, respectively. An NS A is defined by

$$A = \{ \langle e, \mu_A(e), \sigma_A(e), \nu_A(e) \rangle : e \in X \}$$

where the mappings of membership μ_A , indeterminacy σ_A and non-membership ν_A respectively defined from non-empty set X to I , $\forall e \in X$ to the set A and with condition that the sum of $\mu_A(e), \sigma_A(e), \nu_A(e)$ should not exceed 3 and greater than zero, $\forall e \in X$.

Definition 2.2. Let the two NSs be of the form $A = \{ \langle e, \mu_A(e), \sigma_A(e), \nu_A(e) \rangle : e \in X \}$ and $B = \{ \langle e, \mu_B(e), \sigma_B(e), \nu_B(e) \rangle : e \in X \}$. Then

- (i) A is a subset of B if and only if membership of A is less than or equal to membership of B , indeterminacy and non-membership of A are respectively, greater than or equal to indeterminacy and non-membership of B .
- (ii) $\bar{A} = \{ \langle e, \nu_A(e), \sigma_A(e), \mu_A(e) \rangle : e \in X \}$;
- (iii) Union of two NS's A and B is set of all maximum of membership of A and B , minimum of indeterminacy and non-membership of A and B , for each $e \in X$.

- (iv) Intersection of two NS's A and B is set of all minimum of membership of A and B , maximum of indeterminacy and non-membership of A and B , for each $e \in X$.

Definition 2.3. A neutrosophic topology (NT) on X is a collection τ of NS's in X holds the following properties

- (i) 0 and 1 are in τ .
- (ii) Union of any NS of τ in τ .
- (iii) Intersection of $A, B \in \tau$ in τ ;

Note: Every NS in τ is a neutrosophic open sets (NOS) and its complements are neutrosophic closed sets (NCS).

Definition 2.4. Let A be an NS in NTS (X, τ) . Then neutrosophic interior of the given NS A is maximum of all NOS contained in A . Neutrosophic closure of the given NS A is minimum of all NOS contains A . Neutrosophic interior of A is denoted by $nint(A)$ and Neutrosophic closure of A is denoted by $ncl(A)$.

Definition 2.5. Let (X, τ) be a neutrosophic topological space and a subset A of (X, τ) is called

1. a neutrosophic pre-open set, if A subset of neutrosophic interior of neutrosophic closure of A and a neutrosophic pre-closed set if the complement is a neutrosophic pre-open set.
2. a neutrosophic semi-open set, if A is a subset of neutrosophic closure of neutrosophic interior of A and a neutrosophic semi-closed set if the complement is a neutrosophic semi-open set.
3. a neutrosophic α -open set, if A is a subset of neutrosophic interior of neutrosophic closure of neutrosophic interior of A and a neutrosophic α -closed set if complement is a neutrosophic α -open set.

Definition 2.6. A subset A of an neutrosophic topological space (X, τ) is called

1. an neutrosophic semi-generalized closed (briefly, nsg -closed) set if intersection of all neutrosophic semi closed sets which contains A is a subset of U whenever A is a subset of U and U is semi-open in (X, τ) .

2. an neutrosophic ψ -closed set if $scl(A) \subseteq U$ whenever $A \subseteq U$ and U is Nsg -open in (X, τ) .
3. an neutrosophic $\alpha\psi$ -closed (briefly, $n\alpha\psi$ -closed) set if $\psi cl(A) \subseteq U$ whenever $A \subseteq U$ and U is $N\alpha$ -open in (X, τ) .

Definition 2.7. Let A be an NS in neutrosophic topological space (X, τ) . Then

1. $n\alpha\psi$ interior of A is the minimum of $n\alpha\psi$ OS in X contained in A and it is denoted by $n\alpha\psi int(A)$.
2. $n\alpha\psi$ -closure of A is the maximum of $n\alpha\psi$ CS in X which contains A . and it is denoted by $n\alpha\psi cl(A)$.

3. On Neutrosophic Quasi $\alpha\psi$ -Open Functions

We introduce the following definition.

Definition 3.1. A neutrosophic function $f : X \rightarrow Y$ is said to be neutrosophic quasi $\alpha\psi$ -open (briefly, $nq\text{-}\alpha\psi\text{-open}$), if the image of every neutrosophic $\alpha\psi$ -open set in X is neutrosophic open in Y .

It is evident that, the the concepts of neutrosophic quasi $\alpha\psi$ -openness and neutrosophic $\alpha\psi$ -continuity coincide if the function is a bijection.

Theorem 3.2. A neutrosophic function $f : X \rightarrow Y$ is $nq\text{-}\alpha\psi\text{-open}$ if and only if for every subset U of X , $f(n\alpha\psi int(U)) \subset nint(f(U))$.

Proof. Let f be a $nq\text{-}\alpha\psi\text{-open}$ function. Now, we have $nint(U) \subset U$ and $n\alpha\psi int(U)$ is a $n\alpha\psi\text{-open}$ set. Hence, we obtain that $f(n\alpha\psi int(U)) \subset f(U)$. As $f(n\alpha\psi int(U))$ is open, $f(n\alpha\psi int(U)) \subset nint(f(U))$.

Conversely, assume that U is a $n\alpha\psi\text{-open}$ set in X . then, $f(U) = f(n\alpha\psi int(U)) \subset nint(f(U))$ but $nint(f(U)) \subset f(U)$. Consequently, $f(U) = nint(f(U))$ and hence f is $nq\text{-}\alpha\psi\text{-open}$.

Theorem 3.3. If a neutrosophic function $f : X \rightarrow Y$ is $nq\text{-}\alpha\psi\text{-open}$, then $n\alpha\psi int(f^{-1}(G)) \subset f^{-1}(nint(G))$ for every subset G of Y .

Proof. Let G be any arbitrary subset of Y . Then, $n\alpha\psi int(f^{-1}(G))$ is a $n\alpha\psi\text{-open}$ set in X and f is $nq\text{-}\alpha\psi\text{-open}$, then $f(n\alpha\psi int(f^{-1}(G))) \subset nint(f(f^{-1}(G))) \subset nint(G)$. Thus, $n\alpha\psi int(f^{-1}(G)) \subset f^{-1}(nint(G))$.

Definition 3.4. A subset A is said to be an $n\alpha\psi$ -neighbourhood of a point x of X if there exists a $n\alpha\psi$ -open set U such that $x \in U \subset A$.

Theorem 3.5. For a neutrosophic function $f : X \rightarrow Y$, the following are equivalent

- (i) f is nq - $\alpha\psi$ -open;
- (ii) for each subset U of X , $f(n\alpha\psi int(U)) \subset nint(f(U))$;
- (iii) for each $x \in X$ and each $n\alpha\psi$ -neighbourhood U of x in X , there exists a neighbourhood V of $f(x)$ in Y such that $V \subset f(U)$.

Proof. (i) \Rightarrow (ii) It follows from Theorem 3.1.

(ii) \Rightarrow (iii) Let $x \in X$ and U be an arbitrary $n\alpha\psi$ -neighbourhood of $x \in X$. Then, there exists a $n\alpha\psi$ -open set V in X such that $x \in V \subset U$. Then by (ii), we have $f(V) = f(n\alpha\psi int(V)) \subset nint(f(V))$ and hence $f(V)$ is open in Y such that $f(x) \in f(V) \subset f(U)$.

(iii) \Rightarrow (i) Let U be an arbitrary $n\alpha\psi$ -open set in X . Then for each $y \in f(U)$, by (iii) there exists a neighbourhood V_y of y in Y such that $V_y \subset f(U)$. As V_y is a neighbourhood of y , there exists an open set W_y in Y such that $y \in W_y \subset V_y$. Thus $f(U) = \bigcup\{W_y : y \in f(U)\}$ which is an open set in Y . This implies that f is nq - $\alpha\psi$ -open function.

Theorem 3.6. A neutrosophic function $f : X \rightarrow Y$ is nq - $\alpha\psi$ -open if and only if for any subset B of Y and for any $n\alpha\psi$ -closed set F of X containing $f^{-1}(B)$, there exists a neutrosophic closed set G of Y containing B such that $f^{-1}(G) \subset F$.

Proof. Suppose f is nq - $\alpha\psi$ -open. Let $B \subset Y$ and F be a $n\alpha\psi$ -closed set of X containing $f^{-1}(B)$. Now, put $G = Y - f(X - F)$. It is clear that $f^{-1}(B) \subset F \Rightarrow B \subset G$. Since f is nq - $\alpha\psi$ -open, we obtain G as a neutrosophic closed set of Y . Moreover, we have $f^{-1}(G) \subset F$.

Conversely, let U be a $n\alpha\psi$ -open set of X and put $B = Y - f(U)$. Then $X - U$ is a $n\alpha\psi$ -closed set in X containing $f^{-1}(B)$. By hypothesis, there exists a neutrosophic closed set F of Y such that $B \subset F$ and $f^{-1}(F) \subset X - U$. Hence, we obtain $f(U) \subset Y - F$. On the other hand, it follows that $B \subset F, Y - F \subset Y - B = f(U)$. Thus we obtain $f(U) = Y - F$ which is neutrosophic open and hence f is a nq - $\alpha\psi$ -open function.

Theorem 3.7 A neutrosophic function $f : X \rightarrow Y$ is nq - $\alpha\psi$ -open if and only

if $f^{-1}(cl(B)) \subset n\alpha\psi cl(f^{-1}(B))$ for every subset B of Y .

Proof. Suppose that f is $nq\text{-}\alpha\psi\text{-open}$. For any subset B of Y , $f^{-1}(B) \subset \alpha\psi\text{-}cl(f^{-1}(B))$. Therefore, by Theorem 3.5 there exists a neutrosophic closed set F in Y such that $B \subset F$ and $(f^{-1}(F)) \subset n\alpha\psi cl(f^{-1}(B))$. Therefore, we obtain $f^{-1}(ncl(B)) \subset (f^{-1}(F)) \subset n\alpha\psi cl(f^{-1}(B))$.

Conversely, let $B \subset Y$ and F be a $n\alpha\psi\text{-closed}$ set of X containing $f^{-1}(B)$. Put $W = ncl_Y(B)$, then we have $B \subset W$ and W is neutrosophic closed and $f^{-1}(W) \subset n\alpha\psi\text{-}cl(f^{-1}(B)) \subset F$. Then by Theorem 3.6., f is $nq\text{-}\alpha\psi\text{-open}$.

Theorem 3.8. Two neutrosophic function $f : X \rightarrow Y$ and $g : Y \rightarrow Z$ and $g \circ f : X \rightarrow Z$ is $nq\text{-}\alpha\psi\text{-open}$. If g is continuous injective function, then f is $nq\text{-}\alpha\psi\text{-open}$.

Proof. Let U be a $n\alpha\psi\text{-open}$ set in X , then $(g \circ f)(U)$ is open in Z , since $g \circ f$ is $nq\text{-}\alpha\psi\text{-open}$. Again g is an injective continuous function, $f(U) = g^{-1}(g \circ f(U))$ is open in Y . This shows that f is $nq\text{-}\alpha\psi\text{-open}$

4. On Neutrosophic Quasi $\alpha\psi\text{-Closed}$ Functions

Definition 4.1. A neutrosophic function $f : X \rightarrow Y$ is said to be neutrosophic quasi $\alpha\psi\text{-closed}$ (briefly, $nq\text{-}\alpha\psi\text{-closed}$), if the image of every neutrosophic $\alpha\psi\text{-closed}$ set in X is neutrosophic closed in Y .

Theorem 4.2. Every $nq\text{-}\alpha\psi\text{-closed}$ function is neutrosophic closed as well as neutrosophic $\alpha\psi\text{-closed}$.

Proof. It is obvious.

The converse of the above theorem need not be true by the following example.

Example 4.3. Let a neutrosophic function $f : X \rightarrow Y$.

Let $X = \{p, q, r\}$ and $\tau_{N1} = \{0, A, B, C, D, 1\}$ ia a neutrosophic topology on X , Where

$$A = \langle x, (\frac{p}{0.4}, \frac{q}{0.3}, \frac{r}{0.2}), (\frac{p}{0.3}, \frac{q}{0.4}, \frac{r}{0.5}), (\frac{p}{0.2}, \frac{q}{0.3}, \frac{r}{0.2}) \rangle,$$

$$B = \langle x, (\frac{p}{0.2}, \frac{q}{0.4}, \frac{r}{0.6}), (\frac{p}{0.3}, \frac{q}{0.2}, \frac{r}{0.1}), (\frac{p}{0.5}, \frac{q}{0.4}, \frac{r}{0.3}) \rangle,$$

$$C = \langle x, (\frac{p}{0.4}, \frac{q}{0.4}, \frac{r}{0.6}), (\frac{p}{0.3}, \frac{q}{0.2}, \frac{r}{0.1}), (\frac{p}{0.2}, \frac{q}{0.3}, \frac{r}{0.2}) \rangle,$$

$$D = \langle x, (\frac{p}{0.2}, \frac{q}{0.3}, \frac{r}{0.2}), (\frac{p}{0.3}, \frac{q}{0.4}, \frac{r}{0.5}), (\frac{p}{0.5}, \frac{q}{0.4}, \frac{r}{0.3}) \rangle \text{ and}$$

Let $Y = \{p, q, r\}$ and $\tau_{N2} = \{0, E, F, G, H, 1\}$ is a neutrosophic topology on Y , Where

$$E = \langle y, (\frac{p}{0.1}, \frac{q}{0.2}, \frac{r}{0.3}), (\frac{p}{0.3}, \frac{q}{0.2}, \frac{r}{0.3}), (\frac{p}{0.5}, \frac{q}{0.6}, \frac{r}{0.4}) \rangle,$$

$$\begin{aligned}
 F &= \langle y, (\frac{p}{0.4}, \frac{q}{0.3}, \frac{r}{0.2}), (\frac{p}{0.3}, \frac{q}{0.4}, \frac{r}{0.5}), (\frac{p}{0.2}, \frac{q}{0.3}, \frac{r}{0.2}) \rangle, \\
 G &= \langle y, (\frac{p}{0.4}, \frac{q}{0.3}, \frac{r}{0.3}), (\frac{p}{0.3}, \frac{q}{0.2}, \frac{r}{0.3}), (\frac{p}{0.2}, \frac{q}{0.3}, \frac{r}{0.2}) \rangle, \\
 H &= \langle y, (\frac{p}{0.1}, \frac{q}{0.2}, \frac{r}{0.2}), (\frac{p}{0.3}, \frac{q}{0.5}, \frac{r}{0.5}), (\frac{p}{0.5}, \frac{q}{0.6}, \frac{r}{0.4}) \rangle.
 \end{aligned}$$

Here $f(p) = p, f(q) = q, f(r) = r$. Then clearly f is $n\alpha\psi$ -closed as well as neutrosophic closed but not $nq\text{-}\alpha\psi$ -closed.

Lemma 4.4. If a neutrosophic function is $nq\text{-}\alpha\psi$ -closed, then $f^{-1}(nint(B)) \subset n\alpha\psi int(f^{-1}(B))$ for every subset B of Y .

Proof. Let B any arbitrary subset of Y . Then, $n\alpha\psi int(f^{-1}(G))$ is a $n\alpha\psi$ -closed set in X and f is $nq\text{-}\alpha\psi$ -closed, then $f(n\alpha\psi\text{-}nint(f^{-1}(B))) \subset nint(f(f^{-1}(B))) \subset nint(B)$. Thus, $f(n\alpha\psi int(f^{-1}(B))) \subset f^{-1}(nint(B))$.

Theorem 4.5. A neutrosophic function $f : X \rightarrow Y$ is $nq\text{-}\alpha\psi$ -closed if and only if for any subset B of Y and for any $n\alpha\psi$ -open set G of X containing $f^{-1}(B)$, there exists an open set U of Y containing B such that $f^{-1}(U) \subset G$.

Proof This proof is similar to that of theorem 3.6.

Definition 4.6. A neutrosophic function $f : X \rightarrow Y$ is called $n\alpha\psi^*$ -closed if the image of every $n\alpha\psi$ -closed subset of X is $n\alpha\psi$ -closed in Y .

Theorem 4.7. If $f : X \rightarrow Y$ and $g : Y \rightarrow Z$ be any $nq\text{-}\alpha\psi$ -closed functions, then $g \circ f : X \rightarrow Z$ is a $nq\text{-}\alpha\psi$ -closed function.

Proof. It is obvious.

Theorem 4.8. Let $f : X \rightarrow Y$ and $g : Y \rightarrow Z$ be any two neutrosophic functions, then

- (i) If f is $n\alpha\psi$ -closed and g is $nq\text{-}\alpha\psi$ -closed, then $g \circ f$ is neutrosophic closed;
- (ii) If f is $nq\text{-}\alpha\psi$ -closed and g is $nq\text{-}\alpha\psi$ -closed, then $g \circ f$ is $n\alpha\psi^*$ -closed;
- (iii) If f is $n\alpha\psi^*$ -closed and g is $nq\text{-}\alpha\psi$ -closed, then $g \circ f$ is $nq\text{-}\alpha\psi$ - closed.

Proof. It is obvious.

Theorem 4.9. Let $f : X \rightarrow Y$ and $g : Y \rightarrow Z$ be any two neutrosophic functions such that $g \circ f : X \rightarrow Z$ is $nq\text{-}\alpha\psi$ -closed.

- (i) If f is $n\alpha\psi$ -irresolute surjective, then g is is neutrosophic closed;

(ii) If g is $n\alpha\psi$ -continuous injective, then f is $n\alpha\psi^*$ -closed.

Proof. (i) Suppose that F is an arbitrary neutrosophic closed set in Y . As f is $n\alpha\psi$ -irresolute, $f^{-1}(F)$ is $n\alpha\psi$ -closed in X . Since $g \circ f$ is nq - $\alpha\psi$ -closed and f is surjective, $(g \circ f)(f^{-1}(F)) = g(F)$, which is closed in Z . This implies that g is a neutrosophic closed function.

(ii) Suppose F is any $n\alpha\psi$ -closed set in X . Since $g \circ f$ is nq - $\alpha\psi$ -closed, $(g \circ f)(F)$ is neutrosophic closed in Z . Again g is a $n\alpha\psi$ -continuous injective function, $g^{-1}(g \circ f(F)) = f(F)$, which is $n\alpha\psi$ -closed in Y . This shows that f is $n\alpha\psi^*$ -closed.

Theorem 4.10. Let X and Y be neutrosophic topological spaces. Then the function $f : X \rightarrow Y$ is a nq - $\alpha\psi$ -closed if and only if $f(X)$ is neutrosophic closed in Y and $f(V) - f(X - V)$ is open in $f(X)$ whenever V is $n\alpha\psi$ -open in X .

Proof. Necessity: Suppose $f : X \rightarrow Y$ is a nq - $\alpha\psi$ -closed function. Since X is $n\alpha\psi$ -closed, $f(X)$ is neutrosophic closed in Y and $f(V) - f(X - V) = f(V) \cap f(X) - f(X - V)$ is neutrosophic open in $f(X)$ when V is $n\alpha\psi$ -open in X .

Sufficiency: Suppose $f(X)$ is neutrosophic closed in Y , $f(V) - f(X - V)$ is neutrosophic open in $f(X)$ when V is $n\alpha\psi$ -open in X and let C be neutrosophic closed in X . Then $f(C) = f(X) - (f(C - X) - f(C))$ is neutrosophic closed in $f(X)$ and hence neutrosophic closed in Y .

Corollary 4.11. Let X and Y be two neutrosophic topological spaces. Then a surjective function $f : X \rightarrow Y$ is nq - $\alpha\psi$ -closed if and only if $f(V) - f(X - V)$ is open in Y whenever U is $n\alpha\psi$ -open in X .

Proof. It is obvious.

Theorem 4.12. Let X and Y be neutrosophic topological spaces and let $f : X \rightarrow Y$ be $n\alpha\psi$ -continuous and nq - $\alpha\psi$ -closed surjective function. Then the topology on Y is $\{f(V) - f(X - V) : V \text{ is } n\alpha\psi\text{-open in } X\}$.

Proof. Let W be open in Y . Let $f^{-1}(W)$ is $n\alpha\psi$ -open in X , and $f(f^{-1}(W)) - f(X - f^{-1}(W)) = W$. Hence all open sets in Y are of the form $f(V) - f(X - V)$, V is $n\alpha\psi$ -open in X . On the other hand, all sets of the form $f(V) - f(X - V)$, V is $n\alpha\psi$ -open in X , are neutrosophic open in Y from corollary 4.11.

Definition 4.13. A neutrosophic topological space (X, τ) is said to be $n\alpha\psi$ -normal if for any pair of disjoint $n\alpha\psi$ -closed subsets F_1 and F_2 of X , there exists

disjoint open sets U and V such that $F_1 \subset U$ and $F_2 \subset V$.

Theorem 4.14. Let X and Y be a neutrosophic topological spaces with X is $n\alpha\psi$ -normal. If $f : X \rightarrow Y$ is $n\alpha\psi$ -continuous and nq - $\alpha\psi$ -closed surjective function. Then Y is normal.

Proof. Let K and M be disjoint neutrosophic closed subsets of Y . Then $f^{-1}(K)$, $f^{-1}(M)$ are disjoint $n\alpha\psi$ -closed subsets of X . Since X is $n\alpha\psi$ -normal, there exists disjoint neutrosophic open sets V and W such that $f^{-1}(K) \subset V$, $f^{-1}(M) \subset W$. Then $K \subset f(V) - f(X - V)$ and $M \subset f(W) - f(X - W)$, further by corollary 4.11, $f(V) - f(X - V)$ and $f(W) - f(X - W)$ are neutrosophic open sets in Y and clearly $(f(V) - f(X - V)) \cap (f(W) - f(X - W)) = n\phi$. This shows that Y is normal.

References

- [1] I. Arokiarani, R. Dhavaseelan, S. Jafari, M. Parimala, On some new notions and functions in neutrosophic topological spaces, *Neutrosophic Sets Syst.*, **16**, (2017), 16-19.
- [2] K. T. Atanassov, Intuitionistic fuzzy sets, *Fuzzy sets and systems*, **20**, (1986), 87-96.
- [3] D. Coker, An introduction to fuzzy topological spaces, *Fuzzy sets and systems*, **88**, (1997), 81-89.
- [4] K. K. Dubey and O. S. Panwar, Some properties of s-connectedness between sets and s-connected mapping, *Indian J. pure Math.*, **154**, (1984), 343-354.
- [5] K. Kuratowski, *Topology Vol. II (transl.)*, Academic Press, New York, (1966).
- [6] M. Parimala, S. Jafari, and S. Murali, Nano Ideal Generalized Closed Sets in Nano Ideal Topological Spaces, *Annales Univ. Sci. Budapest.*, **60**, (2017), 3-11.
- [7] M. Parimala, R. Jeevitha, S. Jafari, F. Smarandache and R. Udhayakumar, Neutrosophic $\alpha\psi$ -Homeomorphism in Neutrosophic Topological Spaces, *Information*, **9**(103)(2018), 1-7.

- [8] M.Parimala, R.Jeevitha and A.Selvakumar, A New Type of Weakly Closed Set in Ideal Topological Spaces, *International Journal of Mathematics and its Applications*, **5**(4-C), (2017), 301-312.
- [9] M. Parimala and R. Perumal, Weaker form of open sets in nano ideal topological spaces, *Global Journal of Pure and Applied Mathematics*, **12**(1), (2016), 302-305.
- [10] M. Parimala, M. Karthika, R. Dhavaseelan, S. Jafari. On neutrosophic supra pre-continuous functions in neutrosophic topological spaces, *New Trends in Neutrosophic Theory and Applications* , **2**, (2018), 371-383.
- [11] M.Parimala, M. Karthika, S. Jafari, F.Smarandache, A.A El-Atik, Neutrosophic $\alpha\psi$ -connectedness, *Journal of Intelligent and Fuzzy Systems*, **38**(1), (2020), 853-857.
- [12] M. Parimala, F. Smarandache, S. Jafari and R. Udhayakumar, On Neutrosophic $\alpha\psi$ -Closed Sets, *Information*, **9**, (2018), 103, 1-7.
- [13] A. A. Salama, S. A. Alblowi, Neutrosophic Set and Neutrosophic Topological Spaces, *IOSR J. Math.*, **3**, (2012), 31-35.
- [14] A. A. Salama, Florentin Smarandache and Valeri Kromov, Neutrosophic Closed Set and Neutrosophic Continuous Functions, *Neutrosophic Sets and Systems*, **4**, (2014),4-8.
- [15] R. Santhi and K. Arun Prakash, On intuitionistic fuzzy Semi-Generalized Closed Sets and its Applications, *Int. J. Contemp. Math. Sciences*, **5**(34), (2010), 1677 - 1688.
- [16] R. Santhi and N. Udhayarani, N_ω closed sets in neutrosophic topological spaces, *Neutrosophic Sets and Systems*, **12**, (2016),114-117.
- [17] F. Smarandache, *Neutrosophy and Neutrosophic Logic*, First International Conference on Neutrosophy, Neutrosophic Logic Set, Probability and Statistics; University of New Mexico, Gallup, NM, USA, (2002).
- [18] F. Smarandache, *A Unifying Field in Logics: Neutrosophic Logic. Neutrosophy, Neutrosophic Set, Neutrosophic Probability*, American Research Press, Rehoboth, NM, USA, (1999).
- [19] L. A. Zadeh, Fuzzy Sets, *Information and Control*, **18**, (1965), 338-353.

Application of Neutrosophic Offsets for Digital Image Processing

Florentin Smarandache, Miguel A. Quiroz-Martínez, Jesús Estupiñan Ricardo,
Noel Batista Hernández, Maikel Y. Leyva Vázquez

Florentin Smarandache, Miguel A. Quiroz-Martínez, Jesús Estupiñan Ricardo, Noel Batista Hernández, Maikel Y. Leyva Vázquez (2020). Application of Neutrosophic Offsets for Digital Image Processing. Revista Investigacion Operacional 41(5), 603-611

ABSTRACT

Neutrosophic offsets are neutrosophic sets whose truth-values lie outside the interval $[0, 1]$. Uninorms are aggregation operators defined in fuzzy logic to generalize t-norms and t-conorms. They satisfy the axioms of symmetry, associativity, monotony and the existence of a neutral element. Fuzzy uninorms have been generalized to intuitionistic fuzzy sets, neutrosophic sets, and neutrosophic offsets, which are called offuninorms in the latter case. This paper aims to demonstrate that offsets and offuninorms can be used in digital image processing, especially for image segmentation and edge detection, moreover algorithms and examples are also provided.

KEYWORDS: neutrosophic set, neutrosophic offset, uninorm, offuninorm, digital image processing.

RESUMEN

Los offsets neutrosóficos son conjuntos neutrosóficos cuyos valores de verdad se encuentran fuera del intervalo $[0, 1]$. Los uninormes son operadores de agregación definidos en lógica difusa para generalizar las t-normas y las t-conormas. Satisfacen los axiomas de simetría, asociatividad, monotonía y la existencia de un elemento neutro. Las uninormas difusas se han generalizado a conjuntos difusos intuicionistas, conjuntos neutrosóficos y offsets neutrosóficos, que en este último caso se denominan offuninormas. Este trabajo pretende demostrar que los offsets y offuninormas pueden ser utilizados en el procesamiento digital de imágenes, especialmente para la segmentación de imágenes y la detección de bordes, además se proporcionan algoritmos y ejemplos.

PALABRAS CLAVE: conjunto neutrosófico, offset neutrosófico, uninorma, offuninorm, procesamiento digital de imágenes

1. INTRODUCTION

According to [19] "Image processing is a science that reveals information about images. Enhancing an image is necessary to perfect the appearance or to highlight some aspect of the information contained in it.

Whenever an image is converted from one form to another, for example, acquired, copied, scanned, digitized, transmitted, displayed, printed or compressed, many types of noise or noise-like degradations may occur. For example, when an analog image is digitized, the resulting digital image contains quantization noise; when an image is half-toned for printing, the resulting binary image contains half-tone noise; when an image is transmitted through a communication channel, the received image contains channel noise; when an image is compressed, the decompressed image contains compression errors. Therefore, an important issue is the development of image enhancement algorithms that eliminate (soften) noise artifacts, while retaining the structure of the image."

In this investigation, operators defined in the neutrosophic theory will be applied for digital image processing. Neutrosophy is the branch of philosophy that studies everything related to neutralities, see [10] [15] [16]. In mathematics, it is a generalization of other theories such as fuzzy logic, fuzzy intuitionist logic, among others. For the first time it includes an indeterminacy membership function, in addition to the membership function and the non-membership function, where any of them can be independent of the rest. Indeterminacy models the contradictions, inconsistencies and ignorance of information or knowledge.

Then the author FlorentinSmarandache himself defines for the first time the neutrosophic offsets, which are neutrosophic sets, whose truth values may lie outside the interval $[0, 1]$. A practical example to explain the usefulness of this theory appears in [17], as set out below.

Assuming we want to study the performance of a group of workers of a certain company, taking into account the number of weekly work hours, then, the set of good workers of the company is defined by the hours worked; then to any worker who fulfills all of his work hours with quality would be assigned a truth-value of 1 of membership to such a group, the worker who did not attend at any time is assigned a truth-value of 0, while the rest is assigned a value in the interval $(0, 1)$, depending on their assistance. However, employees who worked overtime with higher quality than the rest, should have a membership value greater than 1, and those without any assistance and that also caused damage to the company, should have a negative membership value.

This new type of sets has logical operators such as negation, conjunction, disjunction, among others. This leads to the definition of offnegations, offnorms and offconorms.

A very useful aggregation operator is the uninorm, which in fuzzy logic generalizes the idea of t-norm and t-conorm, see [1]. A uninorm is an aggregation operator that satisfies the axioms of symmetry, associativity, monotony and the existence of a neutral element. In the case of t-norms the neutral element is 1, while in t-conorms it is 0.

Uninorms have had great applications in different fields, such as decision-making, as an activation function in artificial neural networks ([18]), among others, including digital image processing, see [4] [7]. They have been generalized to other logics such as Atanassov's fuzzy intuitionist logic ([2]), or the neutrosophic logic ([6]) and the Smarandache's offlogic, in the latter case it was called offuninorm when it includes offsets, see [5].

Offuninorms were defined for the first time in [5], with the objective of having an aggregation operator for the neutrosophic offsets. However, the authors of the article described some approaches to the idea of a fuzzy uninorm where intervals outside $[0, 1]$ were admitted, which means that the association between uninorm and offset is very natural, see [1] [18]. These concepts are also linked to the Prospector operator used in the famous MYCIN medical expert system ([13]). Additionally, it is demonstrated that the calculation with offsets is simpler and equal or more interpretable than the use of fuzzy sets.

The aim of this article is to demonstrate that offsets and offnorms can be used as filters in digital image processing. For this purpose, some filters based on these concepts are proposed and the use of this tool for segmenting images ([8]) and for edge detection ([9] [11]) are illustrated with some examples.

This paper is structured as follows: Section 2 Materials and Methods, contains the main definitions from neutrosophic offsets to neutrosophic offuninorms. Section 3 is dedicated to algorithmization and illustration with examples of the use of neutrosophic offsets and offnorms as filters in digital image processing. The article ends with section 4 conclusions.

2. MATERIALS AND METHODS

This section describes the main concepts required to understand this article, which are formally defined below.

Definition 1.([10]) Let X be a universe of discourse. A *Neutrosophic Set* (NS) is characterized by three membership functions, $u_A(x), r_A(x), v_A(x) : X \rightarrow]^{-}0, 1^{+}[$, which satisfy the condition $^{-}0 \leq \inf u_A(x) + \inf r_A(x) + \inf v_A(x) \leq \sup u_A(x) + \sup r_A(x) + \sup v_A(x) \leq 3^{+}$ for all $x \in X$. $u_A(x), r_A(x)$ and $v_A(x)$ denote the functions of truthfulness, indeterminacy and falseness membership of x in A , respectively, and their images are standard or non-standard subsets of $]^{-}0, 1^{+}[$.

Single-Value- Neutrosophic Sets, which are defined below, were created in order to apply the NS to non-philosophical problems.

Definition 2. ([10]) Let X be a universe of discourse. A *Single-Value-Neutrosophic-Set* (SVNS) A over X is an object defined as follows:

$$A = \{ \langle x, u_A(x), r_A(x), v_A(x) \rangle : x \in X \} \tag{1}$$

Where $u_A, r_A, v_A : X \rightarrow [0,1]$, satisfy the condition $0 \leq u_A(x) + r_A(x) + v_A(x) \leq 3$ for all $x \in X$. $u_A(x), r_A(x)$ and $v_A(x)$ denote the membership functions of truthfulness, indeterminacy and falseness of x in A , respectively. For the sake of convenience, a *Single-Value-Neutrosophic Number* (SVNN) will be represented as $A = (a, b, c)$, where $a, b, c \in [0,1]$ and that satisfies $0 \leq a + b + c \leq 3$.

Definition 3. Let X be a universe of discourse and the neutrosophic set $A_1 \subset X$. Let $T(x), I(x), F(x)$ be the membership, indeterminacy and non-membership functions, respectively, of a generic element $x \in X$, with regard to the neutrosophic set A_1 :

$T, I, F: X \rightarrow [0, \Omega]$, where $\Omega > 1$ is called an *overlimit*, $T(x), I(x), F(x) \in [0, \Omega]$. A *Single-Value-Overset* A_1 is defined as $A_1 = \{(x, \langle T(x), I(x), F(x) \rangle), x \in X\}$, such that there is at least one element in A_1 that contains at least a neutrosophic component greater than 1, and does not contain any element with components less than 0, see [17].

Definition 4. Let X be a universe of discourse and the neutrosophic set $A_2 \subset X$. Let $T(x), I(x), F(x)$ be the membership, indeterminacy and non-membership functions, respectively, of a generic element $x \in X$, with regard to a neutrosophic set A_2 :

$T, I, F: X \rightarrow [\Psi, 1]$, where $\Psi < 0$ is called an *underlimit*, $T(x), I(x), F(x) \in [\Psi, 1]$. A *Single-Value-Underiset* A_2 is defined as: $A_2 = \{(x, \langle T(x), I(x), F(x) \rangle), x \in X\}$, such that there is at least one element in A_2 which contains at least one neutrosophic component that is less than 0, and does not contain any element with components greater than 1, see [17].

Definition 5. Let X be a universe of discourse and the neutrosophic set $A_3 \subset X$. Let $T(x), I(x), F(x)$ be the membership, indeterminacy and non-membership functions, respectively, of a generic element $x \in X$, with regard to a neutrosophic set A_3 :

$T, I, F: X \rightarrow [\Psi, \Omega]$, where $\Psi < 0 < 1 < \Omega$, Ψ is called an *underlimit*, while Ω is called an *overlimit*, $T(x), I(x), F(x) \in [\Psi, \Omega]$. A *Single-Value-Offset* A_3 is defined as: $A_3 = \{(x, \langle T(x), I(x), F(x) \rangle), x \in X\}$, such that there is at least one element in A_3 which contains a neutrosophic component greater than 1, and contains another neutrosophic component that is less than 0, see [17].

Let X be a universe of discourse, $A = \{(x, \langle T_A(x), I_A(x), F_A(x) \rangle), x \in X\}$ and $B = \{(x, \langle T_B(x), I_B(x), F_B(x) \rangle), x \in X\}$ are two single value oversets /undersets / offsets.

$T_A, I_A, F_A, T_B, I_B, F_B: X \rightarrow [\Psi, \Omega]$, where $\Psi \leq 0 < 1 \leq \Omega$, Ψ is an underlimit, while Ω is the overlimit, $T_A(x), I_A(x), F_A(x), T_B(x), I_B(x), F_B(x) \in [\Psi, \Omega]$. Note that in this definition, all three possible cases are taken into account: overset $\Psi = 0$ and $\Omega > 1$, underiset when $\Psi < 0$ and $\Omega = 1$, and offset when $\Psi < 0$ and $\Omega > 1$.

Then, the main operations on these sets are defined as follows:

$A \cup B = \{(x, \langle \max(T_A(x), T_B(x)), \min(I_A(x), I_B(x)), \min(F_A(x), F_B(x)) \rangle), x \in X\}$ is the union.

$A \cap B = \{(x, \langle \min(T_A(x), T_B(x)), \max(I_A(x), I_B(x)), \max(F_A(x), F_B(x)) \rangle), x \in X\}$ is the intersection,

$C(A) = \{(x, \langle F_A(x), \Psi + \Omega - I_A(x), T_A(x) \rangle), x \in X\}$ is the neutrosophic complement of the overset / underiset / offset.

Definition 6. Let c be a neutrosophic component (T_O, I_O o F_O). $c: M_O \rightarrow [\Psi, \Omega]$, where $\Psi \leq 0$ and $\Omega \geq 1$. The *neutrosophic component n-offnorm* $N_O^n: [\Psi, \Omega]^2 \rightarrow [\Psi, \Omega]$ satisfies the following conditions for any elements $x, y, z \in M_O$:

- i. $N_O^n(c(x), \Psi) = \Psi, N_O^n(c(x), \Omega) = c(x)$ (Over-boundary conditions),
- ii. $N_O^n(c(x), c(y)) = N_O^n(c(y), c(x))$ (Commutativity),
- iii. If $c(x) \leq c(y)$ then $N_O^n(c(x), c(z)) \leq N_O^n(c(y), c(z))$ (Monotony),
- iv. $N_O^n(N_O^n(c(x), c(y)), c(z)) = N_O^n(c(x), N_O^n(c(y), c(z)))$ (Associativity).

Definition 7. Let c be a neutrosophic component (T_O, I_O o F_O). $c: M_O \rightarrow [\Psi, \Omega]$, where $\Psi \leq 0$ and $\Omega \geq 1$. The *neutrosophic component n-offconorm* $N_O^{co}: [\Psi, \Omega]^2 \rightarrow [\Psi, \Omega]$ satisfies the following conditions for any elements $x, y, z \in M_O$:

- i. $N_O^{co}(c(x), \Omega) = \Omega, N_O^{co}(c(x), \Psi) = c(x)$ (Over-boundary conditions),
- ii. $N_O^{co}(c(x), c(y)) = N_O^{co}(c(y), c(x))$ (Commutativity),
- iii. If $c(x) \leq c(y)$ then $N_O^{co}(c(x), c(z)) \leq N_O^{co}(c(y), c(z))$ (Monotony),
- iv. $N_O^{co}(N_O^{co}(c(x), c(y)), c(z)) = N_O^{co}(c(x), N_O^{co}(c(y), c(z)))$ (Associativity).

Example 1. An example of offAND/offOR pair is, $c(x) \wedge_{Z0} c(y) = \min(c(x), c(y))$ and $c(x) \vee_{Z0} c(y) = \max(c(x), c(y))$, respectively.

Example 2. An offAND/offOR pair is, $c(x) \wedge_{LO} c(y) = \max(\Psi, c(x) + c(y) - \Omega)$ and $c(x) \vee_{LO} c(y) = \min(\Omega, c(x) + c(y))$, respectively.

Definition 8.([5]) Let c be a neutrosophic component $(T_o, I_o \circ F_o)$. $c: M_o \rightarrow [\Psi, \Omega]$, where $\Psi \leq 0$ and $\Omega \geq 1$. The *neutrosophic component n-offuninorm* $N_o^u: [\Psi, \Omega]^2 \rightarrow [\Psi, \Omega]$ satisfies the following conditions for any elements $x, y, z \in M_o$:

- i. There is a $c(e) \in M_o$, such that $N_o^u(c(x), c(e)) = c(x)$ (Identity),
- ii. $N_o^u(c(x), c(y)) = N_o^u(c(y), c(x))$ (Commutativity),
- iii. If $c(x) \leq c(y)$ then $N_o^u(c(x), c(z)) \leq N_o^u(c(y), c(z))$ (Monotony),
- iv. $N_o^u(N_o^u(c(x), c(y)), c(z)) = N_o^u(c(x), N_o^u(c(y), c(z)))$ (Associativity).

Example 3. Two examples of n-offuninorms components are defined as follows:

$$U_{Zc}(c(x), c(y)) = \begin{cases} \varphi_1^{-1} \left(\varphi_1(c(x)) \overset{\wedge}{Z_0} \varphi_1(c(y)) \right), & \text{if } c(x), c(y) \in [\Psi, c(e)] \\ \varphi_2^{-1} \left(\varphi_2(c(x)) \overset{\vee}{Z_0} \varphi_2(c(y)) \right), & \text{if } c(x), c(y) \in [c(e), \Omega] \\ \min(c(x), c(y)), & \text{otherwise} \end{cases}$$

$$U_{ZD}(c(x), c(y)) = \begin{cases} \varphi_1^{-1} \left(\varphi_1(c(x)) \overset{\wedge}{Z_0} \varphi_1(c(y)) \right), & \text{if } c(x), c(y) \in [\Psi, c(e)] \\ \varphi_2^{-1} \left(\varphi_2(c(x)) \overset{\vee}{Z_0} \varphi_2(c(y)) \right), & \text{if } c(x), c(y) \in [c(e), \Omega] \\ \max(c(x), c(y)), & \text{otherwise} \end{cases}$$

Where $\overset{\wedge}{Z_0}$ and $\overset{\vee}{Z_0}$ were defined in Example 1; $c(e) \in (\Psi, \Omega)$.

For $\varphi_1: [\Psi, c(e)] \rightarrow [\Psi, \Omega]$, $\varphi_1^{-1}: [\Psi, \Omega] \rightarrow [\Psi, c(e)]$, $\varphi_2: [c(e), \Omega] \rightarrow [\Psi, \Omega]$ and $\varphi_2^{-1}: [\Psi, \Omega] \rightarrow [c(e), \Omega]$, defined in Equations 2, 3, 4 and 5, respectively.

$$\varphi_1(c(x)) = \left(\frac{\Omega - \Psi}{c(e) - \Psi} \right) (c(x) - \Psi) + \Psi \tag{2}$$

$$\varphi_1^{-1}(c(x)) = \left(\frac{c(e) - \Psi}{\Omega - \Psi} \right) (c(x) - \Psi) + \Psi \tag{3}$$

$$\varphi_2(c(x)) = \left(\frac{\Omega - \Psi}{\Omega - c(e)} \right) (c(x) - c(e)) + \Psi \tag{4}$$

$$\varphi_2^{-1}(c(x)) = \left(\frac{\Omega - c(e)}{\Omega - \Psi} \right) (c(x) - \Psi) + c(e) \tag{5}$$

In [5] there are more offuninorms examples and ways to obtain them. Since images are studied in this article, which are basically represented through matrixes containing integer values between 0 and 255, then the offuninorm defined from Silvert's fuzzy uninorm will be used, see [14] and Equation 6:

$$u_\lambda(x, y) = \begin{cases} \frac{\lambda xy}{\lambda xy + (1-x)(1-y)}, & \text{if } (x, y) \in [0, 1]^2 \setminus \{(0, 1), (1, 0)\} \\ 0, & \text{in another case} \end{cases} \tag{6}$$

For $\lambda > 0$ and $e_\lambda = \frac{1}{\lambda+1}$.

From Equation 6, the offuninorm is defined as shown in Equation 7:

$$\widehat{N}_o^u(c_o(x), c_o(y)) = \varphi_3^{-1} \left(u_\lambda \left(\varphi_3(c_o(x)), \varphi_3(c_o(y)) \right) \right) \tag{7}$$

Where $\varphi_3: [\Psi, \Omega] \rightarrow [0, 1]$ and its inverse $\varphi_3^{-1}: [0, 1] \rightarrow [\Psi, \Omega]$ are expressed in equations 8 and 9, respectively.

$$\varphi_3(c(x)) = \frac{c(x) - \Psi}{\Omega - \Psi} \tag{8}$$

$$\varphi_3^{-1}(c(x)) = (\Omega - \Psi)c(x) + \Psi \tag{9}$$

While $c_o(x)$ is a neutrosophic component of n-offunorm.

In particular, $\Psi = 0$ and $\Omega = 255$ will be set. The parameter λ will be set taking into account that the neutral element of the offnorm defined in Equation 7, is calculated by $e_o = \varphi_3^{-1}(e_\lambda) = \varphi_3^{-1}\left(\frac{1}{\lambda+1}\right)$. Let us note that in this case it is approached with oversets instead of offsets, however, they will still be called offsets because it is not discarded that in some cases it might be useful to apply truth values less than 0.

3. RESULTS

In this section, the proposed algorithms will be described and the results of the processing performed on several images will be given. To carry out the experiments, the algorithms were coded in Octave 4.2.1, which is a free software for mathematical calculations, similar to MATLAB, see [3].

We will start by describing the neutrosophic offset segmentation:

Neutrosophic offset segmentation algorithm

1. The image is converted to a gray tones image. Therefore, a single matrix of dimension $n \times m$ is obtained, whose elements are integer values from 0 to 255. Each pixel will be denoted by $P(i,j)$ to represent its value in row i , column j of the matrix; $1 \leq i \leq n$ and $1 \leq j \leq m$.
2. Each $P(i, j)$ is taken to the neutrosophic domain containing a triplet of elements corresponding to the truthfulness, indeterminacy and falsehood that is a white pixel. This is denoted by $P_{NS}(i,j) = (T(i,j), I(i,j), F(i,j))$. In order to do so, the following formulas are used:

$$T(i, j) = AM\{P(k, l): \max\{i - 1, 0\} \leq k, l \leq \min\{i + 1, 255\}\} \tag{10}$$

AM denotes the arithmetic mean.

$$I(i, j) = |P(i, j) - T(i, j)| \tag{11}$$

$$F(i, j) = 255 - T(i, j) \tag{12}$$

3. A threshold value U is set, such that the following formula is defined:

$$\bar{T}(i, j) = \begin{cases} T(i, j) & \text{si } I(i, j) < U \\ \bar{T}_p(i, j) & \text{si } I(i, j) \geq U \end{cases} \tag{13}$$

Where $\bar{T}_p(i, j) = AM\{T(k, l): \max\{i - 1, 0\} \leq k, l \leq \min\{i + 1, 255\}\}$.

Thus, a new image with values equal to $\bar{T}(i, j)$ is obtained.

4. k-means algorithm is applied to classify each of the values of the new image with $k= 3$ as it minimum value.
5. Finish.

Next, we apply this algorithm on three original images without noise and on two copies of each one of them, to which two different levels of salt and pepper noise were incorporated, the results can be seen in Figures 1, 2 and 3.

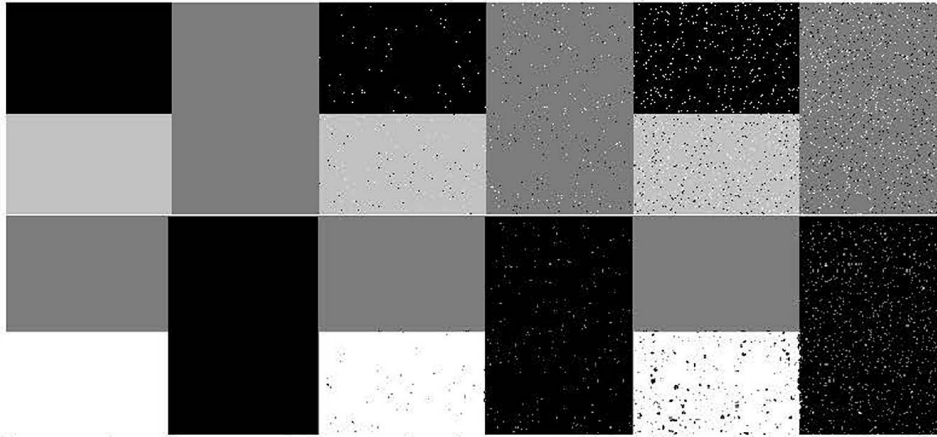

Figure 1. Segmentation of a geometric image using the neutrosophic offset segmentation algorithm. From left to right, at the top, it goes from image without noise to image with most noise. In the lower part the result of the segmentation of the upper images.

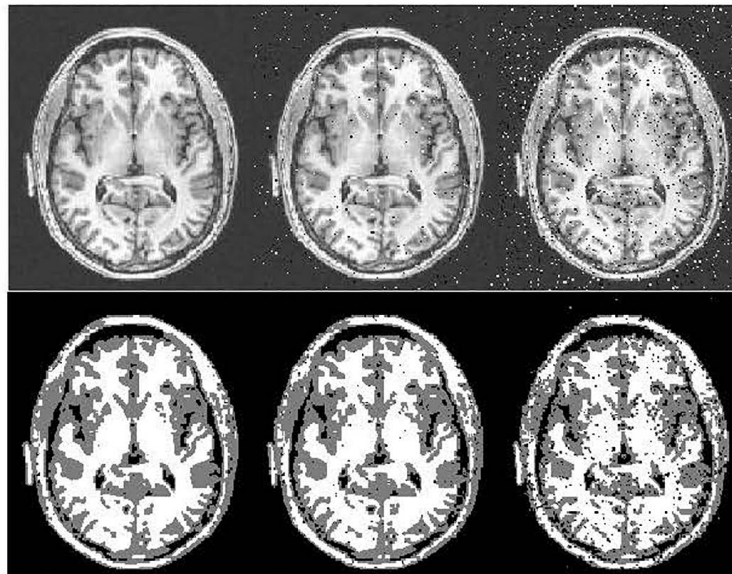

Figure 2. Segmentation of an image of the brain by means of the neutrosophic offset segmentation algorithm. From left to right, at the top, it goes from image without noise to image with most noise. In the lower part the result of the segmentation of the upper images.

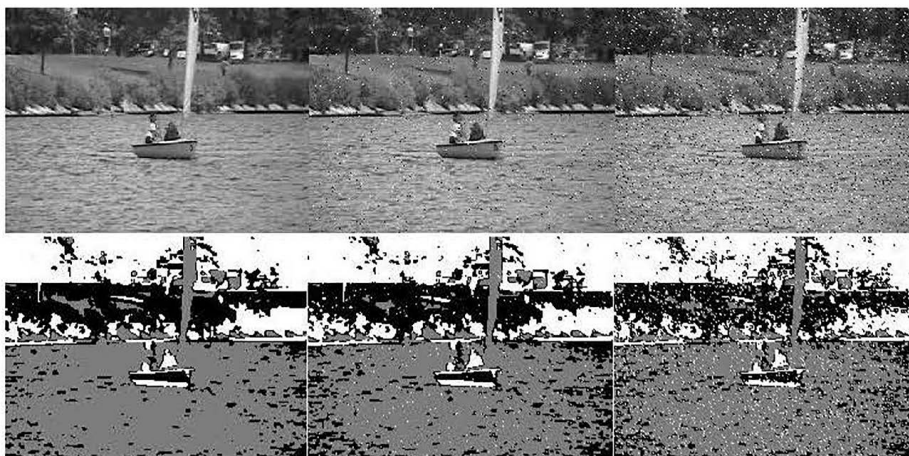

Figure 3. Segmentation of a landscape image using the segmentation neutrosophic offset algorithm. From left

to right, at the top, it goes from image without noise to image with most noise. In the lower part we can see the result of the segmentation of the upper images.

Below is the description for the edges detection algorithm based on offuninorms.

Neutrosophic Offset Edge Detection Algorithm

1. The image is converted to a gray tones image. Therefore, a single matrix of dimension $n \times m$ is obtained, whose elements are integer values from 0 to 255. Each pixel is denoted by $P(i, j)$ to represent its value in row i , column j of the matrix; $1 \leq i \leq n$ and $1 \leq j \leq m$.
2. The image is softened and a method to eliminate noise is applied, see for example [12]. In this article the image is obtained after replacing each $P(i, j)$ with $T(i, j)$ according to formula 10.
3. The values defined by each $P(i, j)$ equal to $V_1 = |P(i-1, j-1) - P(i+1, j-1)|$, $V_2 = |P(i-1, j) - P(i+1, j)|$, $V_3 = |P(i-1, j+1) - P(i+1, j+1)|$, $H_1 = |P(i-1, j-1) - P(i-1, j+1)|$, $H_2 = |P(i, j-1) - P(i, j+1)|$ and $H_3 = |P(i+1, j-1) - P(i+1, j+1)|$ are obtained.
4. A component of the neutrosophic offuninorm is calculated according to Equation 7:

$U_V(i, j) = \hat{N}_O^u(\{V_1, V_2, V_3\})$ and $U_H(i, j) = \hat{N}_O^u(\{H_1, H_2, H_3\})$. In this investigation we set $\Psi = 0$, $\Omega = 255$ and $\lambda = 25$.

$U_T(i, j) = \hat{N}_O^u(U_V(i, j), U_H(i, j))$ is calculated. In this case we set parameter $\lambda = 1$.

5. Two threshold values U_1 and U_2 are set, such that $U_1 < U_2$; and the pixels are classified as follows:
 - 5.1. If $U_T(i, j) < U_1$ then $P(i, j)$ is considered as part of a region.
 - 5.2. If $U_T(i, j) > U_2$ then $P(i, j)$ is considered as part of an edge.
 - 5.3. If $U_1 \leq U_T(i, j) \leq U_2$ then the pixel is considered to be indeterminate. In this case it is classified as an edge if it has at least one neighbor classified as an edge, otherwise it is considered a region.

See [11] for more details on the determination of both thresholds.
6. The obtained image becomes binary, that is, the pixel classified as border is given a black tone and a white tone for region pixels.
7. Edge lines are thinned with algorithms designed for that purpose.
8. Finish.

The previous algorithm was applied to two images, as can be seen in Figure 4.

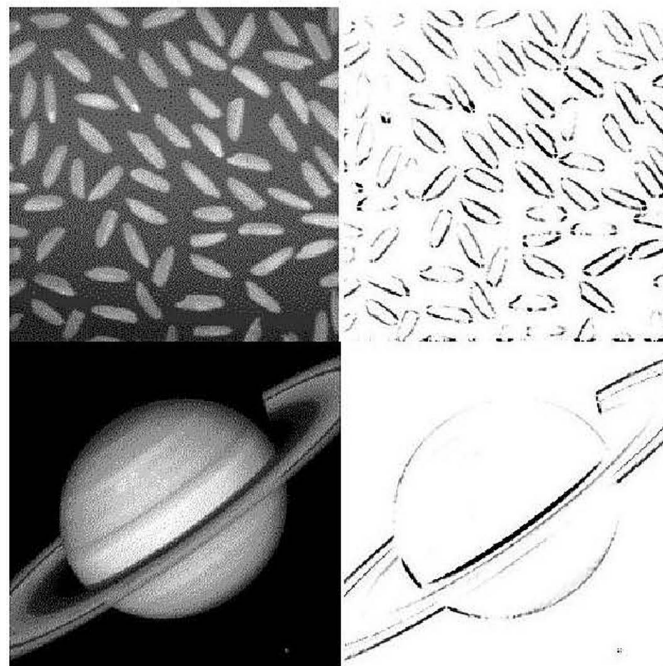

Figure 4. Edge detection with neutrosophic offset edge detection algorithm. On the left the original images appear, on the right we see images of objects with detected edges.

When applying the algorithm, it was not necessary to apply steps 5, 6 and 7, because the images were obtained in binary form and the lines were sufficiently thin.

4. CONCLUSIONS

In this paper, two algorithms based on offsets were proposed. The first one is based on neutrosophic offsets for image segmentation. The second one uses a neutrosophic offuninorms for edge detection. An advantage of both algorithms is the use of offsets, which simplifies the calculations since normalization is not necessary because the interval of definition may exceed the classic $[0, 1]$. Examples of segmentation and edge detection of several images were offered and the results were visually acceptable. In the case of edge detection, in the experiments carried out, the algorithm executes the binarization of the image and the thinning of the edges without the need to use additional algorithms. In both algorithms the noise of salt and pepper artificially introduced by the authors to the original images was reduced.

REFERENCES

- [1] DE BAETS, B. and FODOR, J. (1999): Van Melle's combining function in MYCIN is a representable uninorm: An alternative proof. **Fuzzy Sets and Systems**, 104, 133-136.
- [2] DESCHRIJVER, G. and KERRE, E.E. (2004): Uninorms in L^* -fuzzy set theory. **Fuzzy Sets and Systems**, 148, 243-262.
- [3] EATON, J. W., BATEMAN, D., HAUBERG, S. and WEHBRING, R. (2017): **GNU Octave: A high-level interactive language for numerical computations**, versión 4.2.1. url: <http://www.gnu.org/software/octave/doc/interpreter>.
- [4] FODOR, J., RUDAS, I. J. and BEDE, B. (2006): Uninorms and absorbing norms with applications to Image Processing. In: Proceedings of the 4th **Serbian-Hungarian Joint Symposium on Intelligent Systems, SISY, Subotica, Serbia**, Septiembre 29-30, 59-72.
- [5] GONZÁLEZ, E., SMARANDACHE, F. and LEYVA Vázquez, M. (2019): On Neutrosophic Offuninorms. **Symmetry**, 11, 1136-1160.
- [6] GONZÁLEZ, E., LEYVA, M. and SMARANDACHE, F. On Neutrosophic Uninorms. **Neutrosophic Sets and Systems** (Under review).
- [7] GONZÁLEZ HIDALGO, M., MASSANET, S., MIR, A. and RUIZ AGUILERA, D. (2014): A new edge detector based on uninorms. In: **International Conference on Information Processing and Management of Uncertainty in Knowledge-Based Systems**, 184-193, Springer, Cham.
- [8] GUO, Y. and CHENG, H. D. (2009): New neutrosophic approach to image segmentation. **Pattern Recognition**, 42, 587-595.
- [9] JIN YU, Z., YAN, C. and XIAN XIANG, H. (2009): Edge detection of images based on improved Sobel operator and genetic algorithms. In **2009 International Conference on Image Analysis and Signal Processing**, 31-35, IEEE.
- [10] LEYVA VÁZQUEZ, M. and SMARANDACHE, F. (2018): **Neutrosofía: Nuevos avances en el tratamiento de la incertidumbre**, Pons, Bruselas.
- [11] MEDINA CARNICER, R., CARMONA POYATO, A., MUÑOZ SALINAS, R. and MADRID CUEVAS, F. J. (2009): Determining hysteresis thresholds for edge detection by combining the advantages and disadvantages of thresholding methods. **IEEE transactions on image processing**, 19, 165-173.
- [12] MOHAN, J., CHANDRA, A. T. S., KRISHNAVENI, V. and GUO, Y. (2012): Evaluation of neutrosophic set approach filtering technique for image denoising. **The International Journal of Multimedia & Its Applications**, 4, 73-81.
- [13] SHORTLIFFE, E.H. (1976): **Computer-Based Medical Consultations: MYCIN**, Elsevier: New York, USA.
- [14] SILVERT, W. (1979): Symmetric Summation: A Class of Operations on Fuzzy Sets. **IEEE Transactions, Systems, Man and Cybernetics**, 9, 657-659.
- [15] SMARANDACHE, F. (2002): **Neutrosophy, a new Branch of Philosophy**. Infinite Study.
- [16] SMARANDACHE, F. (2005): **A Unifying Field in Logics: Neutrosophic Logic. Neutrosophy, Neutrosophic Set, Neutrosophic Probability: Neutrosophic Logic. Neutrosophy, Neutrosophic Set,**

- Neutrosophic Probability**, Infinite Study.
- [17] SMARANDACHE, F. (2016): **Neutrosophic Overset, Neutrosophic Underset, and Neutrosophic Offset: Similarly for Neutrosophic Over-/Under-/Off- Logic, Probability, and Statistics**; Pons Editions: Brussels, Belgium.
- [18] TSADIRAS, A.K. and MARGARITIS, K.G. (1998): The MYCIN certainty factor handling function as uninorm operator and its use as a threshold function in artificial neurons. **Fuzzy Sets and Systems**, 93, 263-274.
- [19] WEI, D. and BOVIK, A. C. (2000): **Wavelet Denoising for Image Enhancement**. In: Handbook of Image and Video Processing, Academic Press, San Diego, Estados Unidos.

On Neutro Quadruple Groups

Florentin Smarandache, Akbar Rezaei, Adesina Abdul Akeem Agboola, Young Bae Jun, Rajab Ali Borzooei, Bijan Davvaz, Arsham Borumand Saeid, Mohammad Akram, Mohammad Hamidi, Saeed Mirvakili

Florentin Smarandache, Akbar Rezaei, Adesina Abdul Akeem Agboola, Young Bae Jun, Rajab Ali Borzooei, Bijan Davvaz, Arsham Borumand Saeid, Mohammad Akram, Mohammad Hamidi, Saeed Mirvakili (2021). On Neutro Quadruple Groups. The 51st Annual Iranian Mathematics Conference, University of Kashan, 15-20 February 2021, 1227-1234

ABSTRACT. As generalizations and alternatives of classical algebraic structures there have been introduced in 2019 the Neutro Algebraic Structures (or Neutro Algebras) and Anti Algebraic structures (or Anti Algebras). Unlike the classical algebraic structures, where all operations are well-defined and all axioms are totally true, in Neutro Algebras and Anti Algebras the operations may be partially well-defined and the axioms partially true or respectively totally outer-defined and the axioms totally false. These Neutro Algebras and Anti Algebras form a new field of research, which is inspired from our real world. In this paper, we study neutrosophic quadruple algebraic structures and Neutro Quadruple Algebraic Structures. Neutro Quadruple Group is studied in particular and several examples are provided. It is shown that $(NQ(\mathbb{Z}), \div)$ is a Neutro Quadruple Group. Substructures of Neutro Quadruple Groups are also presented with examples.

Keywords: Neutrosophic quadruple number, Neutro Quadruple Group, Neutro Quadruple Subgroup.

1. Introduction

It was started from Paradoxism, then to Neutrosophy, and afterwards to Neutrosophic Set and Neutrosophic Algebraic Structures. Paradoxism [10] is an international movement in science and culture, founded by Smarandache in 1980s, based on excessive use of antitheses, oxymoron, contradictions, and paradoxes. During the three decades (1980-2020) hundreds of authors from tens of countries around the globe contributed papers to 15 international paradoxist anthologies. In 1995, Smarandache extended the paradoxism (based on opposites) to a new branch of philosophy called neutrosophy (based on opposites and their neutrals), that gave birth to many scientific branches, such as: neutrosophic logic, neutrosophic set, neutrosophic probability and statistics, neutrosophic algebraic structures, and so on with multiple applications in engineering, computer science, administrative work, medical research etc. Neutrosophy is an extension of Yin-Yang Ancient Chinese Philosophy and of course of Dialectics. From Classical Algebraic Structures to Neutro Algebraic Structures and Anti Algebraic Structures. In 2019 Smarandache [8] generalized the classical algebraic structures to Neutro Algebraic Structures (or Neutro Algebras) whose operations and axioms are partially true, partially indeterminate, and partially false as extensions of Partial Algebra, and to Anti Algebraic Structures (or AntiAlgebra) whose operations and axioms are totally false. “Algebra” can be: groupoid, semigroup, monoid, group, commutative group, ring, field, vector space, BCK-Algebra, BCI-Algebra, K-algebra, BE-algebra, etc. (See [1]-[7]).

In the present paper, we study neutrosophic quadruple algebraic structures and Neutro Quadruple Algebraic Structures. Neutro Quadruple Group is studied in particular and several examples are provided. It is shown that $(NQ(\mathbb{Z}), \div)$ is a Neutro Quadruple Group. Substructures of Neutro Quadruple Groups are also presented with examples.

The sets of natural/integer/rational/real/complex numbers are respectively denoted by $\mathbb{N} \subseteq \mathbb{Z} \subseteq \mathbb{Q} \subseteq \mathbb{R} \subseteq \mathbb{C}$.

The Neutrosophic Quadruple Numbers and the Absorbance Law were introduced by Smarandache in 2015 [9]; they have the general form:

$N = a + bT + cI + dF$, where a, b, c, d may be numbers of any type (natural, integer, rational, irrational, real, complex, etc.), where “ a ” is the known part of the neutrosophic quadruple number N , while “ $bT + cI + dF$ ” is the unknown part of the neutrosophic quadruple number N ; then the unknown part is split into three subparts: degree of confidence (T), degree of indeterminacy of confidence (non-confidence) (I), and degree of non-confidence (F). N is a four-dimensional vector that can also be written as: $N = (a, b, c, d)$.

There are transcendental, irrational etc. numbers that are not well known, they are only partially known and partially unknown, they may have infinitely many decimals. Not even the most modern supercomputers can compute more than a few thousands decimals, but the infinitely many left decimals still remain unknown. Therefore, such numbers are very little known (because only a finite number of decimals are known), and infinitely unknown (because an infinite number of decimals are unknown). Take for example: $\sqrt{2} = 1.4142\dots$

2. Arithmetic Operations on the Neutrosophic Set of Quadruple Numbers

DEFINITION 2.1. A neutrosophic set of quadruple numbers denoted by $NQ(X)$ is a set defined by

$$NQ(X) = \{(a, bT, cI, dF) : a, b, c, d \in \mathbb{R} \text{ or } \mathbb{C}\},$$

where T, I, F have their usual neutrosophic logic meanings.

DEFINITION 2.2. A neutrosophic quadruple number is a number of the form $(a, bT, cI, dF) \in NQ(X)$. For any neutrosophic quadruple number (a, bT, cI, dF) representing any entity which may be a number, an idea, an object, etc, a is called the known part and (bT, cI, dF) is called the unknown part. Two neutrosophic quadruple numbers $x = (a, bT, cI, dF)$ and $y = (e, fT, gI, hF)$ are said to be equal written $x = y$ if and only if $a = e, b = f, c = g, d = h$.

Multiplication of two neutrosophic quadruple numbers cannot be carried out like multiplication of two real or complex numbers. In order to multiply two neutrosophic quadruple numbers $a = (a_1, a_2T, a_3I, a_4F), b = (b_1, b_2T, b_3I, b_4F) \in NQ(X)$, the prevalence order of $\{T, I, F\}$ is required.

Two neutrosophic quadruple numbers $m = (a_1, b_1T, c_1I, d_1F)$ and $n = (a_2, b_2T, c_2I, d_2F)$ cannot be divided as we do for real and complex numbers. Since the literal neutrosophic components T, I and F are not invertible, the inversion of a neutrosophic quadruple number or the division of a neutrosophic quadruple number by another neutrosophic quadruple number must be carried out a systematic way. Suppose we are to evaluate m/n . Then we must look for a neutrosophic quadruple number $p = (x, yT, zI, wF)$ equivalent to m/n . In this way, we write

$$\begin{aligned} m/n &= p \\ \Rightarrow \frac{(a_1, b_1T, c_1I, d_1F)}{(a_2, b_2T, c_2I, d_2F)} &= (x, yT, zI, wF) \\ (1) \quad \Leftrightarrow (a_2, b_2T, c_2I, d_2F)(x, yT, zI, wF) &\equiv (a_1, b_1T, c_1I, d_1F). \end{aligned}$$

Assuming the prevalence order $T \succ I \succ F$ and from the equality of two neutrosophic quadruple numbers, we obtain from Eq. (1)

$$\begin{aligned} a_2x &= a_1, \\ b_2x + (a_2 + b_2 + c_2 + d_2)y + b_2z + b_2w &= b_1, \\ c_2x + (a_2 + c_2 + d_2)z + c_2w &= c_1, \\ d_2x + (a_2 + d_2)w &= d_1, \end{aligned}$$

a system of linear equations in unknowns x, y, z and w . By similarly assuming the prevalence order $T \prec I \prec F$, we obtain from Eq. (1)

$$\begin{aligned} a_2x &= a_1, \\ b_2x + (a_2 + b_2)y &= b_1, \\ c_2x + c_2y + (a_2 + b_2 + c_2)z &= c_1, \\ d_2x + d_2y + d_2z + (a_2 + b_2 + c_2 + d_2)w &= d_1, \end{aligned}$$

a system of linear equations in unknowns x, y, z and w .

3. Neutrosophic Quadruple Algebraic Structures, Neutrosophic Quadruple Algebraic Hyper Structures and Neutro Quadruple Algebraic Structures

3.1. Neutrosophic Quadruple Algebraic Structures and Neutrosophic Quadruple Algebraic Hyper Structures. Let $NQ(X)$ be a neutrosophic quadruple set and let $*$: $NQ(X) \times NQ(X) \rightarrow NQ(X)$ be a classical binary operation on $NQ(X)$. The couple $(NQ(X), *)$ is called a neutrosophic quadruple algebraic structure. The structure $(NQ(X), *)$ is named according to the classical laws and axioms satisfied or obeyed by $*$.

If $*$: $NQ(X) \times NQ(X) \rightarrow \mathbb{P}(NQ(X))$ is the classical hyper operation on $NQ(X)$. Then the couple $(NQ(X), *)$ is called a neutrosophic quadruple hyper algebraic structure; and the hyper structure $(NQ(X), *)$ is named according to the classical laws and axioms satisfied by $*$.

3.2. Neutro Quadruple Algebraic Structures. In this section unless otherwise stated, the optimistic prevalence order $T \succ I \succ F$ will be assumed.

DEFINITION 3.1. Let $NQ(G)$ be a nonempty set and let $*$: $NQ(G) \times NQ(G) \rightarrow NQ(G)$ be a binary operation on $NQ(G)$. The couple $(NQ(G), *)$ is called a neutrosophic quadruple group if the following conditions hold:

- (QG1) $x * y \in G \forall x, y \in NQ(G)$ [closure law].
- (QG2) $x * (y * z) = (x * y) * z \forall x, y, z \in G$ [axiom of associativity].
- (QG3) There exists $e \in NQ(G)$ such that $x * e = e * x = x \forall x \in NQ(G)$ [axiom of existence of neutral element].
- (QG4) There exists $y \in NQ(G)$ such that $x * y = y * x = e \forall x \in NQ(G)$ [axiom of existence of inverse element], where e is the neutral element of $NQ(G)$.
If in addition $\forall x, y \in NQ(G)$, we have
- (QG5) $x * y = y * x$, then $(NQ(G), *)$ is called a commutative neutrosophic quadruple group.

DEFINITION 3.2. [Neutro Sophication of the law and axioms of the neutrosophic quadruple]

- (NQ(G)1) There exist some duplets $(x, y), (u, v), (p, q), \in NQ(G)$ such that $x * y \in G$ (inner-defined with degree of truth T) and $[u * v = \text{indeterminate (with degree of indeterminacy I) or } p * q \notin NQ(G) \text{ (outer-defined/falsehood with degree of falsehood F)}]$ [Neutro Closure Law].
- (NQ(G)2) There exist some triplets $(x, y, z), (p, q, r), (u, v, w) \in NQ(G)$ such that $x * (y * z) = (x * y) * z$ (inner-defined with degree of truth T) and $[[p * (q * r)] \text{ or } [(p * q) * r] = \text{indeterminate (with degree of indeterminacy I) or } u * (v * w) \neq (u * v) * w \text{ (outer-defined/falsehood with degree of falsehood F)}]$ [NeutroAxiom of associativity (Neutro Associativity)].
- (NQ(G)3) There exists an element $e \in NQ(G)$ such that $x * e = e * x = x$ (inner-defined with degree of truth T) and $[[x * e] \text{ or } [e * x] = \text{indeterminate (with degree of indeterminacy I) or } x * e \neq x \neq e * x \text{ (outer-defined/falsehood with degree of falsehood F)}]$ for at least one $x \in NQ(G)$ [Neutro Axiom of existence of neutral element (Neutro Neutral Element)].

- (NQ(G)4) There exists an element $u \in NQ(G)$ such that $x * u = u * x = e$ (inner-defined with degree of truth T) and $[[x*u]or[u*x]] = \text{indeterminate}$ (with degree of indeterminacy I) or $x * u \neq e \neq u * x$ (outer-defined/falsehood with degree of falsehood F)] for at least one $x \in G$ [Neutro Axiom of existence of inverse element (Neutro Inverse Element)], where e is a Neutro Neutral Element in $NQ(G)$.
- (NQ(G)5) There exist some duplets $(x, y), (u, v), (p, q) \in NQ(G)$ such that $x * y = y * x$ (inner-defined with degree of truth T) and $[[u * v]or[v * u]] = \text{indeterminate}$ (with degree of indeterminacy I) or $p * q \neq q * p$ (outer-defined/falsehood with degree of falsehood F)] [Neutro Axiom of commutativity (Neutro Commutativity)].

DEFINITION 3.3. A Neutro Quadruple Group $NQ(G)$ is an alternative to the neutrosophic quadruple group $Q(G)$ that has at least one NeutroLaw or at least one of $\{NQ(G)1, NQ(G)2, NQ(G)3, NQ(G)4\}$ with no Anti Law or Anti Axiom.

DEFINITION 3.4. A Neutro Commutative Quadruple Group $NQ(G)$ is an alternative to the commutative neutrosophic quadruple group $Q(G)$ that has at least one Neutro Law or at least one of $\{NQ(G)1, NQ(G)2, NQ(G)3, NQ(G)4\}$ and $NQ(G)5$ with no Anti Law or Anti Axiom.

NeutroClosure of \div over $NQ(\mathbb{Z})$

For the degree of truth, let $a = (0, 0T, I, 0F) \in NQ(\mathbb{Z})$. Then

$$a \div a = \frac{(0, 0T, I, 0F)}{(0, 0T, I, 0F)} = (1 - k_1 - k_2, 0T, k_1I, k_2F) \in NQ(\mathbb{Z}), k_1, k_2 \in \mathbb{Z}.$$

For the degree of indeterminacy, let $a = (4, 5T, -2I, -7F), b = (0, -6T, I, 3F) \in NQ(\mathbb{Z})$. Then

$$a \div b = \frac{(4, 5T, -2I, -7F)}{(0, -6T, I, 3F)} = \left(\frac{4}{0}, ?T, ?I, ?F\right) \notin NQ(\mathbb{Z}).$$

For the degree of falsehood, let $a = (0, 0T, 0I, F), b = (0, 0T, 0I, 2F) \in NQ(\mathbb{Z})$. Then

$$a \div b = \frac{(0, 0T, 0I, F)}{(0, 0T, 0I, 2F)} = \left(\frac{1}{2} - k, 0T, 0I, kF\right) \notin NQ(\mathbb{Z}), k \in \mathbb{Z}.$$

Neutro Associativity of \div over $NQ(\mathbb{Z})$

For the degree of truth, let $a = (6, 6T, 6I, 6F), b = (2, 2T, 2I, 2F), c = (-1, 0T, 0I, 0F) \in NQ(\mathbb{Z})$. Then

$$\begin{aligned} a \div (b \div c) &= (6, 6T, 6I, 6F) \div ((2, 2T, 2I, 2F) \div (-1, 0T, 0I, 0F)) \\ &= (6, 6T, 6I, 6F) \div (-2, 0T, 0I, 0F) \\ &= (-3, 0T, 0I, 0F). \\ (a \div b) \div c &= ((6, 6T, 6I, 6F) \div (2, 2T, 2I, 2F)) \div (-1, 0T, 0I, 0F) \\ &= (3, 0T, 0I, 0F) \div (-1, 0T, 0I, 0F) \\ &= (-3, 0T, 0I, 0F). \end{aligned}$$

For the degree of indeterminacy, let $a = (4, -T, 2I, -7F), b = (0, T, 0I, -8F), c = (0, 0T, 9I, -F) \in NQ(\mathbb{Z})$. Then

$$\begin{aligned} a \div (b \div c) &= (4, -T, 2I, -7F) \div ((0, T, 0I, -8F) \div (0, 0T, 9I, -F)) \\ &= (4, -T, 2I, -7F) \div \left(8 - k, \frac{1}{8}T, -9I, kF\right), k \in \mathbb{Z} \\ &= (? , ?T, ?I, ?F). \\ (a \div b) \div c &= ((4, -T, 2I, -7F) \div (0, T, 0I, -8F)) \div (0, 0T, 9I, -F) \\ &= \left(\frac{4}{0}, ?T, ?I, ?F\right) \div (0, 0T, 9I, -F) \\ &= (? , ?T, ?I, ?F). \end{aligned}$$

For the degree of falsehood, let $a = (0, 5T, 0I, 0F), b = (0, T, 0I, 0F), c = (5, 0T, 0I, 0F) \in NQ(\mathbb{Z})$. Then

$$\begin{aligned} a \div (b \div c) &= (0, 5T, 0I, 0F) \div ((0, T, 0I, 0F) \div (5, 0T, 0I, 0F)) \\ &= (0, 5T, 0I, 0F) \div \left(0, \frac{1}{5}T, 0I, 0F\right) \\ &= (25 - k_1 - k_2 - k_3, k_1T, k_2I, k_3F) \in NQ(\mathbb{Z}), k_1, k_2, k_3 \in \mathbb{Z}. \\ (a \div b) \div c &= ((0, 5T, 0I, 0F) \div (0, T, 0I, 0F)) \div (5, 0T, 0I, 0F) \\ &= (5 - k_1 - k_2 - k_3, k_1T, k_2I, k_3F) \div (5, 0T, 0I, 0F), k_1, k_2, k_3 \in \mathbb{Z} \\ &= \left(\frac{1}{5}(5 - k_1 - k_2 - k_3), \frac{1}{5}k_1T, \frac{1}{5}k_2I, \frac{1}{5}k_3F\right) \notin NQ(\mathbb{Z}). \end{aligned}$$

Existence of Neutro Unitary Element and Neutro Inverse Element in $NQ(\mathbb{Z})$ w.r.t. \div

Let $a = (0, T, 0I, 0F), b = (0, 0T, I, 0F), c = (0, 0T, 0I, F) \in NQ(\mathbb{Z})$. Then

$$\begin{aligned} (2) a \div a &= \frac{(0, T, 0I, 0F)}{(0, T, 0I, 0F)} = (1 - k_1 - k_2 - k_3, k_1T, k_2I, k_3F), k_1, k_2, k_3 \in \mathbb{Z}. \\ (3) b \div b &= \frac{(0, 0T, I, 0F)}{(0, 0T, I, 0F)} = (1 - k_1 - k_2, 0T, k_1I, k_2F), k_1, k_2 \in \mathbb{Z}. \\ (4) c \div c &= \frac{(0, 0T, 0I, F)}{(0, 0T, 0I, F)} = (1 - k, 0T, 0I, kF), k \in \mathbb{Z}. \\ (5) a \div b &= \frac{(0, T, 0I, 0F)}{(0, 0T, I, 0F)} = -(k_1 + k_2), T, k_1I, k_2F, k_1, k_2 \in \mathbb{Z}. \\ (6) b \div a &= \frac{(0, 0T, I, 0F)}{(0, T, 0I, 0F)} = -(k_1 + k_2 + k_3), k_1T, k_2I, k_3F, k_1, k_2, k_3 \in \mathbb{Z}. \end{aligned}$$

For the degree of truth, putting $k_1 = 1, k_2 = k_3 = 0$ in Eq. (2), $k_1 = 1, k_2 = 0$ in Eq. (3) and $k = 1$ in Eq. (4) we will obtain $a \div a = a, b \div b = b$ and $c \div c = c$. These show that a, b, c are respectively Neutro Unitary Elements and Neutro Inverse Elements in $NQ(\mathbb{Z})$.

For the degree of falsehood, putting $k_1 \neq 1, k_2 \neq k_3 \neq 0$ in Eq. (2), $k_1 \neq 1, k_2 \neq 0$ in Eq. (3) and $k \neq 1$ in Eq. (4) we will obtain $a \div a \neq a, b \div b \neq b$ and $c \div c \neq c$. These show that a, b, c are respectively not Neutro Unitary Elements and Neutro Inverse Elements in $NQ(\mathbb{Z})$.

Neutro Commutativity of \div over $NQ(\mathbb{Z})$

For the degree of truth, putting $k_1 = 1, k_2 = k_3 = 0$ in Eq. (2), $k_1 = 1, k_2 = 0$ in Eq. (3) and $k = 1$ in Eq. (4) we will obtain $a \div a = a, b \div b = b$ and $c \div c = c$. These show the commutativity of \div wrt a, b and c $NQ(\mathbb{Z})$.

For the degree of falsehood, putting $k_1 = k_2 = k_3 = 1$ in Eq. (5) and Eq. (6), we will obtain $a \div b = (-2, T, I, F)$ and $b \div a = (-3, T, I, F) \neq a \div b$. Hence, \div is Neutro Commutative in $NQ(\mathbb{Z})$.

DEFINITION 3.5. Let $(NQ(G), *)$ be a neutrosophic quadruple group. A nonempty subset $NQ(H)$ of $NQ(G)$ is called a Neutro Quadruple Subgroup of $NQ(G)$ if $(NQ(H), *)$ is a neutrosophic quadruple group of the same type as $(NQ(G), *)$.

EXAMPLE 3.6.

- i) For $n = 2, 3, 4, \dots$ $(NQ(n\mathbb{Z}), -)$ is a Neutro Quadruple Subgroup of $(NQ(\mathbb{Z}), -)$.
- ii) For $n = 2, 3, 4, \dots$ $(NQ(n\mathbb{Z}), \times)$ is a Neutro Quadruple Subgroup of $(NQ(\mathbb{Z}), \times)$.

EXAMPLE 3.7.

- i) Let $NQ(H) = \{(a, bT, cI, dF) : a, b, c, d \in \{1, 2, 3\}\}$ be a subset of the Neutro Quadruple Group $(NQ(\mathbb{Z}_4), -)$. Then $(NQ(H), -)$ is a Neutro Quadruple Subgroup of $(NQ(\mathbb{Z}_4), -)$.
- ii) Let $NQ(K) = \{(w, xT, yI, zF) : a, b, c, d \in \{1, 3, 5\}\}$ be a subset of the Neutro Quadruple Group $(NQ(\mathbb{Z}_6), \times)$. Then $(NQ(H), \times)$ is a Neutro Quadruple Subgroup of $(NQ(\mathbb{Z}_6), \times)$.

4. Conclusion

We have in this paper studied neutrosophic quadruple algebraic structures and Neutro Quadruple Algebraic Structures. Neutro Quadruple Group was studied in particular and several examples were provided. It was shown that $(NQ(\mathbb{Z}), \div)$ is a Neutro Quadruple Group. Substructures of Neutro Quadruple Groups were also presented with examples.

References

1. A. A. A. Agboola, M. A. Ibrahim and E. O. Adeleke, *Elementary examination of NeutroAlgebras and AntiAlgebras viz-a-viz the classical number systems*, Int. J. Neutrosophic Sci. **4** (1) (2020) 16–19.
2. M. Akram and K. -P. Shum, *A survey on single-valued neutrosophic K-algebras*, J. Math. Res. Appl. **40** (3) (2020). DOI: 10.3770/j.issn:2095-2651.2020.03.000
3. M. Al-Tahan and B. Davvaz, *On some properties of neutrosophic quadruple Hv-rings*, Neutrosophic Sets Sys. **36** (2020) 256–270.
4. R. A. Borzooei, M. Mohseni Takallo, F. Smarandache and Y. B. Jun, *Positive implicative BMBJ-neutrosophic ideals in BCK-algebras*, Neutrosophic Sets Sys. **23** (2018) 126–141.

5. M. Hamidi and F. Smarandache, *Neutro-BCK-Algebra*, Int. J. Neutrosophic Sci. **8** (2020) 110–117.
6. Y. B. Jun, S. Z. Song, F. Smarandache and H. Bordbar, *Neutrosophic Quadruple BCK/BCI-Algebras*, Axioms **7** (41) (2018). DOI:10.3390/axioms7020041.
7. A. Rezaei and F. Smarandache, *On Neutro-BE-Algebras and Anti-BE-Algebras*, Int. J. Neutrosophic Sci. **4** (2020) 8–15.
8. F. Smarandache, *Introduction to NeutroAlgebraic structures and AntiAlgebraic structures, in advances of standard and nonstandard neutrosophic theories*, Pons Publishing House Brussels, Belgium, Chapter 6, pages 240–265, 2019.
9. F. Smarandache, *Neutrosophic quadruple numbers, refined neutrosophic quadruple numbers, absorbance law, and the multiplication of neutrosophic quadruple numbers*, Neutrosophic Sets Sys. **10** (2015) 96–98.
10. UNM, *Paradoxism, the last vanguard of second millennium*, <http://fs.unm.edu/a/paradoxism.htm>.

New Types of Neutrosophic Crisp Closed Sets

Ahmed B. Al-Nafee, Florentin Smarandache, A. A. Salama

Ahmed B. Al-Nafee, Florentin Smarandache, A. A. Salama (2022). New Types of Neutrosophic Crisp Closed Sets. *Neutrosophic Sets and Systems* 36, 175-183

Abstract: The neutrosophic sets were known since 1999, and because of their wide applications and their great flexibility to solve the problems, we used these the concepts to define a new types of neutrosophic crisp closed sets and limit points in neutrosophic crisp topological space, namely [neutrosophic crisp Gem sets and neutrosophic crisp Turig points] respectvely, we stady their properties in details and join it with topological concepts. Finally we used [neutrosophic crisp Gem sets and neutrosophic crisp Turig points] to introduce of topological concepts as : neutrosophic crisp closed (open) sets , neutrosophic crisp closure, neutrosophic crisp interior, neutrosophic crisp extrior and neutrosophic crisp boundary which are fundamental for further reserch on neutrosophic crisp topology and will setrengthen the foundations of theory of neutrosophic topological spaces.

Keywords: Neutrosophic crisp set, Neutrosophic crisp topology, Neutrosophic crisp closed set,

1. Introduction

In 1999, Smarandache firstly proposed the theory of neutrosophic set [1] which is the generalization of the class sets, conventional fuzz set [2] and intuitionistic set fuzzy [3]. After Smarandache, neutrosophic sets have been successfully applied to many fields such as; topology, control theory, databases, medical diagnosis problem, decision making problem and so on, [4-37] .

A.A. Salama, et, al.[38] proposed a new mathematical model called " Neutrosophic crisp sets and Neutrosophic crisp topological spaces " .

The idea of "Gem-Set", which is a characterization of the concept of closure is introduced by AL-Nafee ,Al-Swidi [39] . After AL-Nafee, the idea of "Gem-Set has been successfully using to many topological concepts such as; interior, exterior, boundary ,separation axioms, continuous functions , bitopological spaces, compactness, soft topological spaces, and so on, [40,41,42,43,44,45,46,47,48].

The idea of "controlling soft Gem-Set" and join it with topological concepts in soft topological space is introduced by [49]. The concept of the soft Turing point and used it with separation axioms in soft topological space is introduced by [50,51].

The goal of this research is to combine the concept of "Gem-Set" and Turing point with neutrosophic crisp set to define a new types of neutrosophic crisp closed sets and limit points in neutrosophic crisp topological space, namely [neutrosophic crisp Gem sets and neutrosophic crisp Turig points] respectvely, we stady their properties in details and we also use it to introduce the some of topological concepts as : neutrosophic crisp closed (open) sets , neutrosophic crisp closure, neutrosophic crisp interior, neutrosophic crisp extrior and neutrosophic crisp boundary which are

fundamental for further reserch on neutrosophic crisp topology and will setrenghen the foundations of theory of neutrosophic topological spaces.

The paper is structured as follows; In section 2, we first recall the necessary background on neutrosophic and neutrosophic crisp points [NCP_N for short]. In section 3, a neutrosophic crisp Turing points properties are introduced with their properties. In section 4, the concept of neutrosophic crisp Gem sets are introduced and studied their properties.

Throughout this paper ,NCTS means a neutrosophic crisp topological space , also we write (H) by H (for short),the collection of all neutrosophic crisp sets on H will be denoted by N(H) .

2. Preliminaries

2.1. Definition [52]

Let H be a non-empty fixed set, a neutrosophic crisp set (for short NCS) D is an object having the form $D = \langle D_1, D_2, D_3 \rangle$ where D_1, D_2 and D_3 are subsets of H .

We will exhibit the basic neutrosophic operations defnitions (union, intersection and complement) . Since there are different definitions of neutrosophic operations , we will organize the existing definitions into two types in each type these operations will be consistent and functional . In this work we will use one Type of neutrosophic crisp sets operations .

2.2. Definition [52]

A neutrosophic crisp topology (NCTS) on anon-empty set H is a family T of neutrosophic crisp susets in H satisfying the following conditions ;

$\emptyset_N, H_N \in T.$

$C \cap D \in T, \text{ for } C, D \in T$

The union of any number of set in T belongs to T .

The pair (H,T) is said to be a neutrosophic crisp topological space(NCTS) in H . Moreover the elements in T are said to be neutrosophic crisp open sets. A neutrosophic crisp set F is closed iff its complement (F^c) is an open neutrosophic crisp set .

2.3. Definition [52]

Let NI be a non-null collection of neutrosophic crisp sets over a universe H . Then NI is called neutrosophic crisp ideal on H if ;

- $C \in NI$ and $D \in NI$ then $C \cup D \in NI$.
- $C \in NI$ and $D \subseteq C$ then $D \in NI$.

2.4. Definition [52]

Let (H,) be NCTS ,A be a neutrosophic crisp set then: The intersection of any neutrosophic crisp closed sets contained A is called neutrosophic crisp clusuer of A (for short NC-CL(A)) .

2.5. Definition [52]

((neutrosophic crisp sets operations of Type.I))

Let H be a non-empty set and $C = \langle C_1, C_2, C_3 \rangle, D = \langle D_1, D_2, D_3 \rangle$ be two neutrosophic crisp sets, where D_1, C_1, D_2, C_2 and D_3, C_3 are subsets of H ,such that $(D_1 \cap D_2) = \emptyset, (D_1 \cap D_3) = \emptyset, (D_2 \cap D_3) = \emptyset, (C_1 \cap C_2) = \emptyset, (C_1 \cap C_3) = \emptyset, (C_2 \cap C_3) = \emptyset$ then:

- $\emptyset_N = \langle \emptyset, \emptyset, H \rangle$ (Neutrosophic empty set) .
- $H_N = \langle H, \emptyset, \emptyset \rangle$ (Neutrosophic universal set) .
- $C \cap D = [C_1 \cap D_1], [C_2 \cap D_2]$ and $[C_3 \cup D_3]$.
- $C \cup D = [C_1 \cup D_1], [C_2 \cup D_2]$ and $[C_3 \cap D_3]$.
- $C \subseteq D \Leftrightarrow C_1 \subseteq D_1, C_2 \subseteq D_2$ and $D_3 \subseteq C_3$.

- The complement of a NCS (D) may be defined as: $D^c = \langle D_3, D_2, D_1 \rangle$.
- $C = D \Leftrightarrow C \subseteq D, D \subseteq C$.

2.6. Definition [53]

((neutrosophic crisp sets operations of Type.2))

Let H be a non-empty set and $C = \langle C_1, C_2, C_3 \rangle, D = \langle D_1, D_2, D_3 \rangle$ be two neutrosophic crisp sets, where D_1, C_1, D_2, C_2 and D_3, C_3 are subsets of H then:

- $\emptyset_N = \langle \emptyset, \emptyset, \emptyset \rangle$ (Neutrosophic empty set).
- $H_N = \langle H, H, H \rangle$ (Neutrosophic universal set).
- $C \cap D = \langle C_1 \cap D_1, C_2 \cap D_2, C_3 \cap D_3 \rangle$.
- $C \cup D = \langle C_1 \cup D_1, C_2 \cup D_2, C_3 \cup D_3 \rangle$.
- $C \subseteq D \Leftrightarrow C_1 \subseteq D_1, C_2 \subseteq D_2$ and $C_3 \subseteq D_3$.
- The complement of a NCS (D) may be defined as: $D^c = \langle D_1^c, D_2^c, D_3^c \rangle$.
- $C = D \Leftrightarrow C \subseteq D, D \subseteq C$.

2.7. Definition [53]

For all $a, b, c \in H$. Then the neutrosophic crisp points related to a, b, c are defined as follows ;

- $a_{N_1} = \langle \{a\}, \emptyset, \emptyset \rangle$ on H .
- $b_{N_2} = \langle \emptyset, \{b\}, \emptyset \rangle$ on H .
- $c_{N_3} = \langle \emptyset, \emptyset, \{c\} \rangle$ on H .

(The set of all neutrosophic crisp points $(a_{N_1}, b_{N_2}, c_{N_3})$ is denoted by NCPN) .

3. Neutrosophic crisp turing point

In this work, we will use Type.2 of neutrosophic crisp sets operations , this was necessary to homogeneous suitable results for the upgrade of this research .

3.1. Definition

Let (H, T) be NCTS , $P \in$ NCPN in H, we define a neutrosophic crisp ideal NI with respect to a neutrosophic crisp point P, as follows :

$$NI(P) = \{D \in T : P \in (D)^c\}$$

3.2. Definition

Let (H, T) be NCTS, $P \in$ NCPN in (H, T) , $Y \subseteq H$, we define a neutrosophic crisp ideal ${}^YNI(P)$ respect to subspace (Y, T_Y) , as follows:

$${}^YNI(P) = \{D \in T_Y : P \in (H \setminus D)\}$$

3.3. Remark

Let (H, T) be NCTS, $Y \subseteq H$, for each $D \neq \emptyset_N$ and $P \in$ NCPN in Y , then ;

$${}^YNI(P) = \{D \in T_Y : P \in (H \setminus D)\} = \{D \in T_Y : P \in (Y \setminus D)\}$$

Proof

$${}^YNI(P) = \{D \in T_Y : P \in (H \setminus D)\} = \{D \in T_Y : P \notin D, \text{ for each } P \in Y\} = \{D \in T_Y : P \in (Y \setminus D), \text{ for each } P \in Y\}$$

3.4. Remark

Let (H, T) be NCTS, $Y \subseteq H$, for each $D \neq \emptyset_N$ and $P \in$ NCPN in H, then ;

$${}^YNI(P) = \{D \in T_Y : P \in (H \setminus D)\} = \{D \cap Y : \text{for each } D \neq \emptyset_N \in NI(P)\}$$

3.5. Example

Let (H, T) be NCTS , such that $H = \{1\}$,

$T = \{ \emptyset_N, H_N, A, B, C, D, E, F, G \}$, $P_1 = \langle \emptyset, \{1\}, \emptyset \rangle$, such that;

$A = \langle \{1\}, \emptyset, \emptyset \rangle$, $B = \langle \emptyset, \{1\}, \emptyset \rangle$, $C = \langle \{1\}, \{1\}, \emptyset \rangle$, $D = \langle \{1\}, \emptyset, \{1\} \rangle$,

$E = \langle \emptyset, \{1\}, \{1\} \rangle, F = \langle \emptyset, \emptyset, \{1\} \rangle, G = \langle \{1\}, \{1\}, \{1\} \rangle.$

Then, $NI(P_1) = \{\emptyset_N, A, D, F\}.$

3.6. Definition

Let (H, T) be NCTS, $P \in$ NCPN in H and NI be a neutrosophic crisp ideal on (H, T) , we say that p is a neutrosophiccrisp turing point of NI if $D \in NI$ for each $D \in T_P, T_P$ is collection of all neutrosophic crisp open set of neutrosophic crisp point p .

3.7. Remark

Let (H, T) be NCTS, $P \in$ NCPN in H and $NI(P) = \{D \in T: P \in (D)^c\}$ be a neutrosophiccrisp ideal on (H, T) .

Then, p is a neutrosophic crisp turing point of $NI(P)$.

3.8. Example

Let (H, T) be NCTS, such that $H = \{1\},$

$T = \{\emptyset_N, H_N, A, B, C, D, E, F, G\}, P_1 = \langle \emptyset, \{1\}, \emptyset \rangle, P_2 = \langle \{1\}, \emptyset, \emptyset \rangle,$ such that;

$A = \langle \{1\}, \emptyset, \emptyset \rangle, B = \langle \emptyset, \{1\}, \emptyset \rangle, C = \langle \{1\}, \{1\}, \emptyset \rangle, D = \langle \{1\}, \emptyset, \{1\} \rangle,$

$E = \langle \emptyset, \{1\}, \{1\} \rangle, F = \langle \emptyset, \emptyset, \{1\} \rangle, G = \langle \{1\}, \{1\}, \{1\} \rangle.$

Then, P_1 is a neutrosophiccrisp turing point of neutrosophic crisp ideal $NI(P_1)$, but not P_2 .

3.9. Theorem

Let (H, T) be NCTS, $a_{N_1} \neq b_{N_1} \in$ NCPN in H , then, $\langle \{b\}, \emptyset, \emptyset \rangle$ is a neutrosophic crisp closed set if and only if a_{N_1} is not a neutrosophiccrisp turing point of $NI(b_{N_1})$.

Proof

Let $a_{N_1} \neq b_{N_1} \in$ NCPN in H . Assume that $\langle \{b\}, \emptyset, \emptyset \rangle$ is a neutrosophiccrisp closed set, so that $\langle \{b\}, \emptyset, \emptyset \rangle = cl(\langle \{b\}, \emptyset, \emptyset \rangle)$. But $a_{N_1} \neq b_{N_1}$ get that $a_{N_1} \notin cl(\langle \{b\}, \emptyset, \emptyset \rangle)$. Therefore, there exists a neutrosophic crisp open set U such that, $a_{N_1} \in U, U \cap \langle \{b\}, \emptyset, \emptyset \rangle = \emptyset_N$. So that $a_{N_1} \in U, U^c \notin NI(b_{N_1})$, because if $U^c \in NI(b_{N_1})$, then $\langle \{b\}, \emptyset, \emptyset \rangle \in U$, that means $U \cap \langle \{b\}, \emptyset, \emptyset \rangle \neq \emptyset_N$, this a contradiction!. Hence a_{N_1} is not a neutrosophic crisp turing point of $NI(b_{N_1})$.

Conversely,

Let $a_{N_1} \neq b_{N_1} \in$ NCPN in H . Since a_{N_1} is not a neutrosophiccrisp turing point of $NI(b_{N_1})$, then there exists a neutrosophiccrisp open set U such that, $a_{N_1} \in U, U^c \notin NI(b_{N_1})$, so $\langle \{b\}, \emptyset, \emptyset \rangle \notin U$. Thus $a_{N_1} \in U, U \cap \langle \{b\}, \emptyset, \emptyset \rangle = \emptyset_N$ implies $a_{N_1} \notin cl(\langle \{b\}, \emptyset, \emptyset \rangle)$.

Hence $\langle \{b\}, \emptyset, \emptyset \rangle = cl(\langle \{b\}, \emptyset, \emptyset \rangle)$, thus $\langle \{b\}, \emptyset, \emptyset \rangle$ is a neutrosophiccrisp closed set in H .

Proof by the same proof of 2.10. Theorem.

4. Neutrosophic crisp Gem set

4.1. Definition

Let (H, T) be NCTS, $P \in$ NCPN in H , $NI(P)$ be a neutrosophiccrisp ideal on (H, T) and $D \subseteq (H, T)$, we defined the neutrosophiccrisp set ND^P with respect to space (H, T) as follows:

$ND^P = \{P_1 \in$ NCPN in $H; F \cap D \notin NI(P),$ for each $F \in T_{P_1}, T_{P_1}$ is collection of all neutrosophiccrisp open set of neutrosophiccrisp point P_1 . The neutrosophiccrisp set ND^P is called neutrosophiccrisp Gem-Set.

4.2. Example

Let (H, T) be NCTS, such that $H = \{1, 2, 3\},$

$T = \{\emptyset_N, H_N, A, B, C, D, E, F, G\}, P = \langle \emptyset, \{1\}, \emptyset \rangle, D = \langle \emptyset, \{1, 3\}, \emptyset \rangle,$ such that;

$A = \langle \emptyset, \{1\}, \emptyset \rangle, B = \langle \emptyset, \{2\}, \emptyset \rangle, C = \langle \emptyset, \{3\}, \emptyset \rangle, D = \langle \emptyset, \{1, 2\}, \emptyset \rangle.$

$E = \langle \emptyset, \{1,3\}, \emptyset, \emptyset \rangle, F = \langle \emptyset, \{2,3\}, \emptyset \rangle, G = \langle \emptyset, \{1,2,3\}, \emptyset \rangle.$

Then, $NI(P) = \{\emptyset, N, B, C, F\}$ and $ND^P = \langle \{1\}, \emptyset, \emptyset \rangle.$

4.3. Theorem

Let (H, T) be NCTS, $P \in$ NCPN in H , and let D, C be subsets of (H, T) . Then

1. $\emptyset_N^{*P} = \emptyset_N$
2. $H_N^{*P} = H_N$, whenever $NI(P) = \emptyset_N$.
3. $C \subseteq D \rightarrow NC^{*P} \subseteq ND^P.$
4. For any points $P_1, P_2 \in$ NCPN in H , with $NI(P_2) \supseteq NI(P_1)$ then $ND^{*P_2} \subseteq ND^{*P_1}.$
5. $P \in D$ if and only if $P \in ND^P.$
6. If $P \in D$, then $(ND^P)^{*P} = ND^P.$
7. If $P_1 \in D, P_2 \in C$ with $P_1 \neq P_2, D \cap C = \emptyset_N$, then $ND^{*P_1} \cap NC^{*P_2} = \emptyset_N.$
8. If $a_{N_1}, b_{N_1} \in$ NCPN in H with $a_{N_1} \neq b_{N_1}$, then $b_{N_1} \in (a_{N_1})^c$ implies $a_{N_1} \notin (a_{N_1})^* b_{N_1}$ and $b_{N_1} \notin (b_{N_1})^* a_{N_1}.$

4.4 . Remark

The equality of theorem part (3),(4) does not necessarily hold as shown :

Let (H, T) be NCTS, such that $H = \{1,2\}, D = \langle \emptyset, \{2\}, \emptyset \rangle, C = \langle \emptyset, \{1\}, \emptyset \rangle,$
 $T = \{ \emptyset_N, H_N, A, B, G \}, P_1 = \langle \emptyset, \{2\}, \emptyset \rangle, P_2 = \langle \emptyset, \{1\}, \emptyset \rangle,$
 $A = \langle \emptyset, \{1\}, \emptyset \rangle, B = \langle \emptyset, \{2\}, \emptyset \rangle, G = \langle \emptyset, \{1,2\}, \emptyset \rangle,$
 Then, $NI(P_1) = \{\emptyset_N, A\}, NI(P_2) = \{\emptyset_N, B\}$ and $ND^{*P_1} = \langle \emptyset, \{2\}, \emptyset \rangle, ND^{*P_2} = \emptyset_N, NC^{*P_1} = \emptyset_N$

Note that,

- 1) $ND^{*P_2} \subseteq ND^{*P_1}$, but $NI(P_2) \not\supseteq NI(P_1).$
- 2) $NC^{*P_1} \subseteq ND^{*P_1}$, but $C \not\subseteq D.$

4.5 .Theorem

Let (H, T) be NCTS, $P_1 \in$ NCPN in H and D, C be subsets of (H, T) . Then $ND^{*P_1} \cup NC^{*P_1} = N(D \cup C)^{*P_1}.$

Proof

It is obviously known that $D \subset (D \cup C)$ and $C \subset (D \cup C)$, then from theorem 3.3 part(3) we get, $ND^{*P_1} \subset N(D \cup C)^{*P_1}$ and $NC^{*P_1} \subset N(D \cup C)^{*P_1}$, for any $P_1 \in$ NCPN in H . Hence

$$ND^{*P_1} \cup NC^{*P_1} \subset N(D \cup C)^{*P_1} \text{ ----(1)}$$

For reverse inclusion, let $P_2 \notin ND^{*P_1}$. Then there exists neutrosophic crisp open set U containing p , with $D \cap U \in NI(P_1)$. Similarly, if $P_2 \notin NC^{*P_1}$, then there exists neutrosophic crisp open set V containing p , with $C \cap V \in NI(P_1)$. Then by hereditary property of neutrosophic crisp ideal, we get, $D \cap U \cap V \in NI(P_1)$ and $C \cap U \cap V \in NI(P_1)$. Again by the finite additivity condition of neutrosophic crisp ideal, we get $(D \cup C) \cap U \cap V \in NI(P_1)$. Hence $P_2 \notin N(D \cup C)^{*P_1}$. So,

$$N(D \cup C)^{*P_1} \subset ND^{*P_1} \cup NC^{*P_1} \text{ ----(2)}$$

From (1) and (2) we get, $ND^{*P_1} \cup NC^{*P_1} = N(D \cup C)^{*P_1}.$

4.6 .Theorem

Let (H, T) be NCTS, $P_1 \in$ NCPN in H and D, C be subsets of (H, T) . Then $N(D \cap C)^{*P_1} \subset ND^{*P_1} \cap NC^{*P_1}$.

Proof

It is known that $D \cap C \subset D$ and $D \cap C \subset C$, then from theorem part (3), $N(D \cap C)^{*P_1} \subset ND^{*P_1}$ and $N(D \cap C)^{*P_1} \subset NC^{*P_1}$. Hence $N(D \cap C)^{*P_1} \subset ND^{*P_1} \cap NC^{*P_1}$, for any $P_1 \in$ NCPN in H .

4.7. Theorem

Let (H, T) be NCTS, $a_{N_1} \in$ NCPN in H , for each neutrosophic crisp open set U containing a_{N_1} , then $(a_{N_1})^* a_{N_1} \subseteq U$.

proof

Let $b_{N_1} \notin U$, so $a_{N_1} \neq b_{N_1}$, then we get that $U \cap (b_{N_1}) = \emptyset_N \in NI((a_{N_1}))$. That means $(b_{N_1}) \notin (a_{N_1})^* a_{N_1}$. Thus $(a_{N_1})^* a_{N_1} \subseteq U$.

4.8. Theorem

Let (H, T) be NCTS, $P_1 \in$ NCPN in H and D be subsets of (H, T) . Then

$$D^{*P_1} = \begin{cases} \emptyset_N & \text{if } P_1 \notin D \\ cl(P_1) & \text{if } P_1 \in D \end{cases}$$

Proof

Case(1)

If $P_1 \notin D$, To prove $D^{*P_1} = \emptyset_N$. Let $D^{*P_1} \neq \emptyset_N$, then there exists least one element, say $P_2 \in D^{*P_1}$ (by definition of D^{*P_1}), we have $C_{P_2} \cap D \notin NI(P_1)$. Hence $P_1 \in D \cap C_{P_2}$. So $P_1 \in D$ which contradiction!, then $D^{*P_1} = \emptyset_N$.

Case (2)

If $P_1 \in D$, to prove $D^{*P_1} = cl(P_1)$. Let $P_2 \in D^{*P_1}$ implies $P_1 \in D \cap V_{P_2}$ for each $V_{P_2} \in \tau_{P_2}$ implies that $P_1 \in V_{P_2}$ for each $V_{P_2} \in \tau_{P_2}$ it follows $P_2 \in cl(P_1)$ then $D^{*P_1} \subseteq cl(P_1)$ for each D be subsets of (H, T) . Let $P_2 \in cl(P_1)$ and $P_2 \notin D^{*P_1}$ then there exists neutrosophic crisp open set V_{P_2} containing P_2 such that $D \cap V_{P_2} \in NI(P_1)$, which implies that $P_1 \notin D \cap V_{P_2}$ then $P_1 \notin D$ or $P_1 \notin V_{P_2}$ which means that $P_1 \notin D$ or $P_2 \notin cl(P_1)$ which contradiction! in two case. Hence $P_2 \in D^{*P_1}$ implies that $cl(P_1) \subseteq D^{*P_1}$. Therefore, $D^{*P_1} = cl(P_1)$, if $P_1 \in D$.

4.9. Definition

Let $(H, T), (Y, \delta)$ be NCTS. Then, the mapping $f: (H, T) \rightarrow (Y, \delta)$ is called NI^* -map, if and only if, for every subset D of (H, T) , $P_1 \in$ NCPN in H , $f(D^{*P_1}) = (f(D))^{*f(P_1)}$.

4.10. Example

Let $(H, T), (Y, \delta)$ be NCTS, such that $H = \{1, 2, 3\}, Y = \{a, b, c\}$,

$T = \{ \emptyset_N, H_N, A, B \}, \delta = \{ \emptyset_N, Y_N, G \}$, such that .

$A = \langle \{1\}, \emptyset, \emptyset \rangle, B = \langle \{2, 3\}, \emptyset, \emptyset \rangle, G = \langle \{a\}, \emptyset, \emptyset \rangle$.

Define $f(2) = f(1) = c$ and $f(3) = a$, Put $D = \{3\}$ subset of (H, T) .

Then $D^{*3} = B = \langle \{2, 3\}, \emptyset, \emptyset \rangle$, so $f(D^{*3}) = (f(D))^{*f(3)=a} = (\langle \{a, c\}, \emptyset, \emptyset \rangle)^* a = \langle \{a, b, c\}, \emptyset, \emptyset \rangle$.

4.11. Definition

Let $(H, T), (Y, \delta)$ be NCTS. Then, the mapping $f: (H, T) \rightarrow (Y, \delta)$ is called NI^* -map if and only if, for every subset D of (Y, δ) , $p \in$ NCPN in Y , $f^{-1}(D^{*p}) = (f^{-1}(D))^{*f^{-1}(p)}$.

4.12. Example

Let $(H, T), (Y, \delta)$ be NCTS, such that $H = \{a, b, c\}, Y = \{1, 2, 3\}$

$T = \{ \emptyset_N, H_N, A, B \}, \delta = \{ \emptyset_N, Y_N, G \}$, such that .

$A = \langle \{a\}, \emptyset, \emptyset \rangle$, $B = \langle \{b, c\}, \emptyset, \emptyset \rangle$, $G = \langle \{1\}, \emptyset, \emptyset \rangle$.

Define $f(b)=f(a)=3$ and $f(c)=1$. Put $D=\{3\}$ subset of (Y, δ) .

Then $D^{*1} = B = \langle \{2,3\}, \emptyset, \emptyset \rangle$, so $f^{-1}(D^{*1}) = (f^{-1}(D))^{*c} = (\langle \{b, a\}, \emptyset, \emptyset \rangle)^{*c} = \langle \{b, c\}, \emptyset, \emptyset \rangle$.

Conclusion

We defined a new types of neutrosophic crisp closed sets and limit points in neutrosophic crisp topological space namely [neutrosophic crisp Gem sets and neutrosophic crisp Turig points] respectively , we study their properties in details and we also use it to introduce the some of topological concepts as : neutrosophic crisp closed (open) sets , neutrosophic crisp closure , neutrosophic crisp interior , neutrosophic crisp extrior and neutrosophic crisp boundary which are fundamental for further reserch on neutrosophic crisp topology and will setrengthen the foundations of theory of neutrosophic topological spaces .

We expect, this paper will promote the future study on neutrosophic crisp topological spaces and many other general frameworks .

References

- [1] F. Smarandache. A Unifying Field in Logics: Neutrosophic Logic. Neutrosophy, Neutrosophic Set, Neutrosophic Probability, American Re- search Press, Rehoboth, NM, (1999).
- [2] Zadeh, L.A., *Fuzzy sets*, Information and Control,(1965),8 ,338-353. Accepted: 22.04.2014.
- [3] Atanassov, K., *Intuitionistic Fuzzy Sets*, Fuzzy Sets and Systems, 1986, 20 ,87-96.
- [4] F. Smarandache. An introduction to the Neutrosophy probability applied in Quantum Physics, International Conference on introduction Neutrosophic Physics, Neutrosophic Logic, Set, Probability, and Statistics, University of New Mexico, Gallup, NM 87301, USA2-4 December (2011).
- [5] Aggarwal, S., Biswas, R., Ansari, A.Q., *Neutrosophic Modeling and Control*, Computer and Communication Technology, 2010, 718-723.
- [6] Arora, M., Biswas, R., Pandey, U.S., *Neutrosophic Relational Database Decomposition*, International Journal of Advanced Computer Science and Applications, 2011,2(8), 121-125.
- [7] Arora, M., Biswas, R., *Deployment of Neutrosophic Technology to Re-trieve Answers for Queries Posed in Natural Language*, in 3rd International Conference on Computer Science and Information Technology, 2010,435-439.
- [8] Ansari, Biswas, Aggarwal, *Proposal for Applicability of Neutrosophic Set Theory in Medical AI*, International Journal of Computer Applications, 2011, 27/5 ,5-11.
- [9] Kharal, A., *A Neutrosophic Multicriteria Decision Making Method*, New Mathematics and Natural Computation, Creighton University, USA,2013.
- [10] Lupianez, F.G., *On neutrosophic topology*, Kybernetes, 2008 ,37(6) ,797-800.
- [11] A. A. Salama. Neutrosophic Crisp Points and Neutrosophic Crisp Ideals. Neutrosophic Sets and Systems, 2013, Vol.1, Issue 1, 50-54.
- [12] Salama, A., Florentin Smarandache, and Valeri Kromov. "Neutrosophic Closed Set and Neutrosophic Continuous Functions." Neutrosophic Sets and Systems 4.1 (2014): 2.
- [13] Salama, A. A., Alblowi, S. A., Smarandache, F. "Neutrosophic crisp open set and neutrosophic crisp continuity via neutrosophic crisp ideals". I.J. Information Engineering and Electronic Business vol. 3, pp.1 – 8, 2014.
- [14] Salama, A. A., Elghawalby, H. " *- Neutrosophic Crisp Set & Relations", Neutrosophic Sets and Systems, Vol. 6, pp. 12-17, 2014.
- [15] Salama, A. A., Alblowi, S. A., and Smarandache, F. "The characteristic function of a neutrosophic set", Neutrosophic Sets and Systems vol. 3, pp.14 – 18, 2014.
- [16] Salama, A. A., Smarandache, F. "Neutrosophic Crisp Set Theory", Educational Publisher, Columbus, Ohio,USA., 2015.
- [17] Salama, A. A., Smarandache, F, "Filters via Neutrosophic Crisp Sets", Neutrosophic Sets and Systems, Vol. 1, No. 1, pp. 34-38, 2013 .
- [18] .Salama, A. A., Alblowi, S. "Neutrosophic set and neutrosophic topological spaces", ISOR J.

- Mathematics vol. 3, no. 3, pp.31 – 35, 2012..
- [19] H. E. Khalid, An Original Notion to Find Maximal Solution in the Fuzzy Neutrosophic Relation Equations (FNRE) with Geometric Programming(GP), Neutrosophic Sets and Systems, 2015 vol.7 ,pp.3-7.
- [20] M. Abdel-Basset, M. Saleh, A. Gamal, F.Smarandache An approach of TOPSIS technique for developing supplier selection with group decision making under type-2 neutrosophic number, Applied Soft Computing, April 2019, Volume 77, Pages 438-452.
- [21] M. Abdel-Basset, G. Manogaran, A. Gamal, F. Smarandach, A Group Decision Making Framework Based on Neutrosophic TOPSIS Approach for Smart Medical Device Selection. J. Medical Systems, 2019, 43(2): 38:1-38:13 .
- [22] M. Abdel Basset, V. Chang, A. Gamal, F. Smarandache, An integrated neutrosophic ANP and VIKOR method for achieving sustainable supplier selection: A case study in importing field. Computers in Industry, (2019),106: 94-110 .
- [23] Abdel-Basset, Mohamed, et al. "An integrated plithogenic MCDM approach for financial performance evaluation of manufacturing industries." Risk Management (2020): 1-27.
- [24] Abdel-Basset, M., Mohamed, R., Sallam, K., & Elhoseny, M. (2020). A novel decision-making model for sustainable supply chain finance under uncertainty environment. Journal of Cleaner Production, 122324.
- [25] Abdel-Basst, M., Mohamed, R., & Elhoseny, M. (2020). A novel framework to evaluate innovation value proposition for smart product-service systems. Environmental Technology & Innovation, 101036.
- [26] M. Parimala, M. Karthika, Jafari, F. Smarandache, R. Udhayakumar. Neutrosophic Nano ideal topological structure, Neutrosophic Sets and Systems, 2019, Vol. 24, 70-76.
- [27] R.K. Al-Hamido, "Neutrosophic Crisp Bi-Topological Spaces", Neutrosophic Sets and Systems, 2018. vol. 21, 66-73.
- [28] Giri, B. C., Molla, M. U., and Biswas, P. TOPSIS Method for MADM based on Interval Trapezoidal Neutrosophic Number. *Neutrosophic Sets and Systems*, (2018), 22, 151-167.
- [29] Elhassouny, A., Idbrahim, S., and Smarandache, F. Machine learning in Neutrosophic Environment: A Survey *Neutrosophic Sets and Systems*, (2019) 28, 58-68.
- [30] Gonzalez-Ortega, R., Leyva-Vazquez, M., Sganderla-Figueiredo, J. A., and Guijarro-Rodriguez, A. Sinos river basin social-environmental prospective assessment of water quality management using fuzzy cognitive maps and neutrosophic AHP-TOPSIS. *Neutrosophic Sets and Systems*, (2018), 23, 160-171.
- [31] Wadei F. AL-omeri and Saeid Jafari, Neutrosophic pre continuous multifunction and almost pre continuous multifunctions, Neutrosophic sets and system, 2019, vol 27, 53-69 .
- [32] T. Nandhini and M. Vigneshwaran, $N_{\alpha\gamma\psi}$ -open map, $N_{\alpha\gamma\psi}$ -closed map and $N_{\alpha\gamma\psi}$ -homomorphism in neutrosophic topological spaces. *Neutrosophic Sets and Systems*, (2019), 29, 186-196.
- [33] V. Banupriya and S. Chandrasekar, Neutrosophic $\alpha\gamma\delta$ Continuity and Neutrosophic $\alpha\gamma\delta$ Irresolute Maps. *Neutrosophic Sets and Systems*, (2019), 28, 162-170.11.
- [34] Jayaparthasarathy, G.; Little Flower, V.F.; Arockia Dasan, M. Neutrosophic Supra Topological Applications in Data Mining Process, *Neutrosophic Sets and System*, 2019, Volume 27, pp. 80 – 97.
- [35] Aal, S. I. A.; Ellatif, A.M.A.A.; Hassan, M.M. Two Ranking Methods of Single Valued Triangular Neutrosophic Numbers to Rank and Evaluate Information Systems Quality, *Neutrosophic Sets and Systems*, 2018, Volume 19, pp. 132-141.
- [36] R. Dhavaseelan, R. Narmada Devi, S. Jafari and Qays Hatem Imran, Neutrosophic α_m -continuity. *Neutrosophic Sets and Systems*, (2019) 27, 171-179.10.
- [37] Karaaslan, F. Gaussian single-valued neutrosophic numbers and its application in multi-attribute decision making, *Neutrosophic Sets and Systems*, 2018, Volume 22, pp.101–117.
- [38] Salama, A. A., Florentin Smarandache, and Valeri Kroumov. "Neutrosophic Crisp Sets & Neutrosophic Crisp Topological Spaces." *Neutrosophic Sets and Systems* 2.1 (2014)
- [39] L. AL-Swidi and A. AL-Nafee, "New Separation Axioms Using the idea of "Gem-Set", in *Topological Space*, *Mathematical Theory and modeling*, 2013, vol.3, no.3, pp. 60 - 66.

- [40] L. Al-Swidi and M. A. AL-Ethary " Compactness with "Gem-Set ", *Int. Journal of Math. Analysis*, 2014,vol. 8, no.23, pp. 1105 - 1117.
- [41] L. AL-Swidi. and M. AL-Rubaye, " On Separation Axioms with Respect to Gem set" *International Journal of Engineering Research and Technology*, 2014,vol. 3, pp 2789 – 2792.
- [42] L. AL-Swidi. and M. AL-Rubaye, " New Classes of Separation Axiom via Special Case of Local Function" , *International Journal of Mathematical Analysis*. 2014,vol.8, no.23,pp1119-1131.
- [43] L. Al-Swidi and M. A. AL-Ethary " New Function With "Gem-Set" in Topological Space" , *International Journal of Engineering Research & Technology (IJERT)*, 2014,vol3, no.2, pp.2324 –2327.
- [44] R. Rathinam and C. Elango, " Gem-Separation Axioms in Topological Space" *Annals of Pure and Applied Mathematics*, 2014,vol. 15, pp 133 – 144.
- [45] I. Diaa ." δ - Continuous in Bitopological Space By Gem-set ",*JUBPAS*, 2016,vol.24, no.3, pp. 622 - 629.
- [46] AL-Swidi,L.A. and Al-Nafee,A.B." Separation Axioms Via Turing point of an Ideal in Topological Space" *Archive Des sciences* , 2013,Vol.66, No3,pp510-516.
- [47] L. A. AL-Swidi and Dheargham A. Al-Sada "Turing Point of Proper Ideal" *Archive Des Science* , 2012,Volume 65 No. 7 Jul, 219-220.
- [48] AL-Nafee, A. B.; Hamed, A. H. The Concept of (Gem-Set) in Topology, A Review . *JUBPAS* **2019**, *27*, 213-217.
- [49] AL-Nafee, A. B.; R. D. Ali. On Idea of Controlling Soft Gem-Set in Soft Topological Space, *Jour of Adv Research in Dynamical & Control Systems*, Vol. 10, 13-Special Issue, 2018 , 606-615
<http://jardcs.org/backissues/abstract.php?archiveid=6022>.
- [50] AL-Nafee, A. B. On *Soft Turing Point With Separation Axioms. *JUBPAS* **2018**, *26*, 200 - 209.
- [51] AL-Nafee, A. B.; L.A. Al-Swidi, L.A. "Separation Axioms Using Soft Turing Point of a Soft Ideal in Soft Topological Space". *Journal of New Theory*, 2018, 29-37.
- [52] A. A. Salama, F. Smarandache and Valeri Kroumov. Neutrosophic Crisp Sets and Neutrosophic Crisp Topological Spaces, *Neutrosophic Sets and Systems*, 2014, (2),25-30.
- [53] A. AL-Nafee, R. Al-Hamido and F. Smarandache, " Separation Axioms in Neutrosophic Crisp Topological Spaces", *Neutrosophic Sets and Systems*, 2019, vol. 25 , pp. 25 – 33.

An introduction to single-valued neutrosophic soft topological structure

Yaser Saber, Fahad Alsharari, Florentin Smarandache

Yaser Saber, Fahad Alsharari, Florentin Smarandache (2022). An introduction to single-valued neutrosophic soft topological structure. *Soft Computing*, 16; DOI: 10.1007/s00500-022-07150-4

Abstract

Fuzzy soft set theory presented by Maji et al. (J Fuzzy Math 9(3):589–602, 2001) and soft set theory presented by Molodtsov (Comput Math Appl 37(3):19–31, 1999) are important ideas in decision-making problems. They can be used to model uncertainty and make decisions under uncertainty. A single-valued neutrosophic soft set (svnf-set) is a hybrid model of a single-valued neutrosophic set and fuzzy soft set that is shown in this paper. The novel concept of single-valued neutrosophic soft topology (svnft) is defined to discuss topological structure of (svnf-set). Some fundamental properties of svnft and their related results are studied. It is good to use the proposed models of svnf-sets and svnft to figure out how to deal with uncertainty in real life. Thus, svnft is a generalization of fuzzy soft topology and fuzzy intuitionistic soft topology. Moreover, after giving the definition of a single-valued neutrosophic soft base svnf-base, we also added the concept of svnft. Finally, we set up the concept of single-valued neutrosophic soft closure spaces and show that the initial single-valued neutrosophic soft closure structures are real, which is what we did. From this fact, the category **SVNSC** is considered as a topological category over **SET**.

Keywords Single-valued neutrosophic soft set · Single-valued neutrosophic soft topology · Single-valued neutrosophic soft base · Initial single-valued neutrosophic soft topology · Product single-valued neutrosophic soft topology.

1 Introduction

The majority of extant mathematical tools for formal model-ing, computing, and reasoning are deterministic, exact, and crisp in nature. In reality, however, challenges in economics, biology, social science, environment science, engineering, and engineering, among other fields, do not necessarily entail precise data. The source of these challenges may be the gen-eral insufficiency of the conventional parameterization tool. As a result, Molodtsov (1999) pioneered the idea of soft set theory as a new mathematical technique for dealing with ambiguity and uncertainty that is free of the aforementioned issues. Molodtsov (2001) effectively adapted soft set the-ory to a variety of fields, including function smoothness, measurement theory, Perron integration, Riemann integra-tion and game theory. Maji et al. (2002) demonstrated how soft sets can be used in real-world decision-making issues. Furthermore, Riaz et al. (2019) introduced multi-criteria group decision-making techniques by means of N-soft set and N-soft topology. The main idea of soft multi-rough set is presented as a hybrid model of rough set, multi-set and soft set, which was defined by Riaz et al. (2021). They have familiarized as well the idea of the fuzzy soft set, a more widespread notion that is a mixture of fuzzy set and soft set, and they secured quite a lot of its attributes. The main idea of fuzzy soft mappings was defined by Ahmed and Kharal (2009). Furthermore, Shabir and Naz (2011) introduced soft topological spaces and initiated some ideas contingent on

soft sets. Tanay and Kandemir (2011) originally presented the idea of fuzzy soft topological space (FSTS) by means of fuzzy soft sets and premeditated the basic concepts by next Chang’s fuzzy topology idea Chang (1968). The main idea of fuzzy soft topology in sense of Lowen was defined by Varol and Aygün (2012) and fuzzy soft topology (FST) in Šostak’s sense presented by Aygünoğlu et al. (2014). Şenel G. (2016, 2017) made a wide research on soft sets and its applications in Şenel (2016, 2017). Numerous applications can be found in works of Abbas et al. (2018), Tripathy and Acharjee (2017), Riaz et al. (2019), Riaz et al. (2019), Maji et al. (2001), Zhang et al. (2021), Nawar et al. (2021), Atef et al. 2021, Atef and Nada (2021) and Feng et al. (2010, 2011).

Smarandache (2007) presented the idea of a neutrosophic set as an intuitionistic fuzzy set generalization. Salama and Alblowi (2012) defined the neutrosophic set theory and neutrosophic crisp set. Correspondingly, Salama and Smarandache (2015) introduced neutrosophic topology as they claimed a number of its characteristics. Others as Wang et al. (2010) defined the single-valued neutrosophic set concept. Alsharari et al. (2021), Saber and Abdel-Sattar (2014), Saber and Alsharari (2018), Saber and Alsharari (2020), Saber et al. (2020), Saber et al. (2020) and Saber et al. (2022) introduced and studied the concepts of single-valued neutrosophic ideal, single-valued neutrosophic ideal open local function, connectedness in single-valued neutrosophic topological spaces, and compactness in single-valued neutrosophic ideal topological spaces.

Thus, the single-valued neutrosophic soft set is a power general formal framework, which generalizes the notion of the classic soft set, fuzzy soft set, interval-valued fuzzy soft set, intuitionistic fuzzy soft set, and interval intuitionistic fuzzy soft set from a philosophical point of view. The application aspects of these types of sets can be further noted. Moreover, it can also be applied to control engineering in average consensus in multi-agent systems with uncertain topologies, multiple time-varying delays, and emergence in random noisy environments (see Shang 2014).

In this work, a general introduction together with a complete survey about the topic is given in the first section. The authors initiate the topological construction of single-valued neutrosophic soft set theory in the second section. In the third section, we present the concept of single-valued neutrosophic soft topology $(\tilde{T}^{\tilde{\sigma}}, \tilde{T}^{\tilde{\zeta}}, \tilde{T}^{\tilde{\delta}})$, which is a mapping from \mathcal{E} into $\xi^{\{\mathcal{E}, \mathcal{E}\}}$ that satisfies the three specified conditions. With respect to this concept, the single-valued neutrosophic soft topology $(\tilde{T}^{\tilde{\sigma}}, \tilde{T}^{\tilde{\zeta}}, \tilde{T}^{\tilde{\delta}})$ is a single-valued neutrosophic soft set (svnf) on a family of single-valued neutrosophic soft sets $(\mathcal{E}, \mathcal{E})$. Also, since the value of single-valued neutrosophic soft set f_{ξ} under the maps $\tilde{T}^{\tilde{\sigma}}_{\xi}, \tilde{T}^{\tilde{\zeta}}_{\xi}, \tilde{T}^{\tilde{\delta}}_{\xi}$ gives the degree of openness, the degree of indeterminacy, and the degree of non-

openness, respectively, of the single-valued neutrosophic soft set with respect to the parameter $\tilde{e} \in \mathcal{E}$, $(\tilde{T}^{\tilde{\sigma}}_{\tilde{e}}, \tilde{T}^{\tilde{\zeta}}_{\tilde{e}}, \tilde{T}^{\tilde{\delta}}_{\tilde{e}})$, which could be thought of as a single-valued neutrosophic soft topology in the sense of Šostak. In this way, we present the single-valued neutrosophic soft cotopology and offer the significant relations between single-valued neutrosophic soft topology $(\tilde{T}^{\tilde{\sigma}}, \tilde{T}^{\tilde{\zeta}}, \tilde{T}^{\tilde{\delta}})$ and single-valued neutrosophic soft cotopology $(\tilde{h}^{\tilde{\sigma}}, \tilde{h}^{\tilde{\zeta}}, \tilde{h}^{\tilde{\delta}})$. We also define the single-valued neutrosophic soft base $(\mathcal{L}^{\tilde{\sigma}}, \mathcal{L}^{\tilde{\zeta}}, \mathcal{L}^{\tilde{\delta}})$. Furthermore, we conclude the notion of single-valued neutrosophic soft topology by using the single-valued neutrosophic soft base on the same set. In addition, we demonstrate the notions of single-valued neutrosophic soft closure spaces (svnf-closure space) in the forth section. We show the existence of initial single-valued neutrosophic soft closure structures. Basing on this premise, the category **SVNSC** is a topological category over **SET**. In particular, an initial structure of single-valued neutrosophic soft topological spaces $(\mathcal{L}, \tilde{T}^{\tilde{\sigma}}_{\mathcal{E}}, \tilde{T}^{\tilde{\zeta}}_{\mathcal{E}}, \tilde{T}^{\tilde{\delta}}_{\mathcal{E}})$ could be obtained by the initial structure of svnf-closure space.

Throughout this work, \mathcal{E} denotes an initial universe, $\xi^{\mathcal{E}}$ is the collection of all single-valued neutrosophic sets (simply, svns) on \mathcal{E} (where $\xi = [0, 1]$, $\xi_0 = (0, 1]$ and $\xi_1 = [0, 1)$) and \mathcal{E} is the set of each parameter on \mathcal{E} .

Definition 1 ((Smarandache 2007)) Let \mathcal{E} be a universe set. A neutrosophic set (simply, ns) π of \mathcal{E} was defined as

$$\pi = \{ \langle x, \tilde{\sigma}_{\pi}(x), \tilde{\zeta}_{\pi}(x), \tilde{\delta}_{\pi}(x) \mid x \in \mathcal{E}, \tilde{\sigma}_{\pi}(x), \tilde{\zeta}_{\pi}(x), \tilde{\delta}_{\pi}(x) \in]^{-}0, 1^{+}[\} \},$$

where $\tilde{\sigma}_{\pi}(x)$, $\tilde{\zeta}_{\pi}(x)$ and $\tilde{\delta}_{\pi}(x)$ are the truth, the indeterminacy, and the falsity membership functions, respectively.

Definition 2 [(Wang et al. 2010)] Let \mathcal{E} be a non-null set. The single-valued neutrosophic set (simply, svn-set) π of \mathcal{E} is defined as

$$\pi = \{ \langle x, \tilde{\sigma}_{\pi}(x), \tilde{\zeta}_{\pi}(x), \tilde{\delta}_{\pi}(x) \mid x \in \mathcal{E} \}$$

where $\tilde{\sigma}_{\pi}(x)$, $\tilde{\zeta}_{\pi}(x)$ and $\tilde{\delta}_{\pi}(x) \in [0, 1]$ for every $x \in \mathcal{E}$ and

$$0 \leq \tilde{\sigma}_{\pi}(x) + \tilde{\zeta}_{\pi}(x) + \tilde{\delta}_{\pi}(x) \leq 3$$

Definition 3 The ideas of intersection, union and inclusion have been defined on svn-sets as follows.

Consider π_1, π_2 to be a svn-sets in \mathcal{E} :

- (1) Intersection (Yang et al. 2016) of two sets denoted by π_3 is written as:

$$\pi_3 = \pi_1 \cap \pi_2$$

$$\tilde{\sigma}_{\pi_3}(x) = \min\{\tilde{\sigma}_{\pi_1}(x), \tilde{\sigma}_{\pi_2}(x)\},$$

$$\begin{aligned} \tilde{\zeta}_{\pi_3}(x) &= \min\{\tilde{\zeta}_{\pi_1}(x), \tilde{\zeta}_{\pi_2}(x)\}, \\ \tilde{\delta}_{\pi_3}(x) &= \min\{\tilde{\delta}_{\pi_1}(x), \tilde{\delta}_{\pi_2}(x)\} \end{aligned}$$

(2) Union (Yang et al. 2016) of two sets denoted by π_3 is defined as:

$$\begin{aligned} \pi_3 &= \pi_1 \cup \pi_2 \\ \tilde{\sigma}_{\pi_3}(x) &= \max\{\tilde{\sigma}_{\pi_1}(x), \tilde{\sigma}_{\pi_2}(x)\}, \\ \tilde{\zeta}_{\pi_3}(x) &= \max\{\tilde{\zeta}_{\pi_1}(x), \tilde{\zeta}_{\pi_2}(x)\}, \\ \tilde{\delta}_{\pi_3}(x) &= \max\{\tilde{\delta}_{\pi_1}(x), \tilde{\delta}_{\pi_2}(x)\} \end{aligned}$$

(3) Inclusion (Ye 2014) of two sets ($\pi_1 \subseteq \pi_2$) is defined as:

$$\tilde{\sigma}_{\pi_1}(x) \leq \tilde{\sigma}_{\pi_2}(x), \quad \tilde{\zeta}_{\pi_1}(x) \geq \tilde{\zeta}_{\pi_2}(x), \quad \tilde{\delta}_{\pi_1}(x) \geq \tilde{\delta}_{\pi_2}(x)$$

(4) The complemented (Wang et al. 2010) of the set π denoted by π^c is defined as:

$$\begin{aligned} \tilde{\sigma}_{\pi^c}(x) &= \tilde{\delta}_{\pi}(x), \\ \tilde{\zeta}_{\pi^c}(x) &= 1 - \tilde{\zeta}_{\pi}(x), \\ \tilde{\delta}_{\pi^c}(x) &= \tilde{\sigma}_{\pi}(x). \end{aligned}$$

Definition 4 (Atef and Nada 2021) Let \mathbb{F} be the universal set and \mathcal{E} be a set of attributes. We consider the non-null set $A \subseteq \mathcal{E}$. Assume that $\tilde{P}(\mathbb{F})$ is referred to the set of all fuzzy neutrosophic sets (simply, fn-sets) of \mathbb{F} . Then, the aggregation (f_A) is termed to be the fuzzy neutrosophic soft set (simply, fnf-set) on \mathbb{F} where $(f_A) : A \rightarrow \tilde{P}(\mathbb{F})$

2 Single-valued neutrosophic soft sets

In this part, fundamental concepts and notions are introduced.

f_ℓ is a single-valued neutrosophic soft set (simply, svnfs) on \mathbb{F} where $f : \mathcal{E} \rightarrow \xi^{\mathbb{F}}$, i.e., $f_{\tilde{e}} \triangleq f(\tilde{e})$ is a svns on \mathbb{F} , for all $\tilde{e} \in \ell$ and $f(\tilde{e}) = \langle 0, 1, 1 \rangle$, if $\tilde{e} \notin \ell$.

The svns $f(\tilde{e})$ is termed as an element of the svnfs f_ℓ . Thus, a svnfs $f_\mathcal{E}$ on \mathbb{F} can be defined as:

$$\begin{aligned} (f, \mathcal{E}) &= \left\{ (\tilde{e}, f(\tilde{e})) \mid \tilde{e} \in \mathcal{E}, f(\tilde{e}) \in \xi^{\mathbb{F}} \right\} \\ &= \left\{ (\tilde{e}, (\tilde{\sigma}_f(\tilde{e}), \tilde{\zeta}_f(\tilde{e}), \tilde{\delta}_f(\tilde{e}))) \mid \tilde{e} \in \mathcal{E}, f(\tilde{e}) \in \xi^{\mathbb{F}} \right\}, \end{aligned}$$

where $\tilde{\sigma}_f : \mathcal{E} \rightarrow \xi$ ($\tilde{\sigma}_f$ is termed as a membership function), $\tilde{\zeta}_f : \mathcal{E} \rightarrow \xi$ ($\tilde{\zeta}_f$ is termed as indeterminacy function), and $\tilde{\delta}_f : \mathcal{E} \rightarrow \xi$ ($\tilde{\delta}_f$ is termed as a non-membership function) of svnf set. $(\mathbb{F}, \mathcal{E})$ refers to the collection of all svnfss on \mathbb{F} and is termed svnfs-universe.

A svnfs $f_\mathcal{E}$ on \mathbb{F} is termed as a null svnfs (simply, Φ), if $\tilde{\sigma}_f(\tilde{e}) = 0, \tilde{\zeta}_f(\tilde{e}) = 1$ and $\tilde{\delta}_f(\tilde{e}) = 1$, for any $\tilde{e} \in \mathcal{E}$.

A svnf set $f_\mathcal{E}$ on \mathbb{F} is termed as an absolute svnf set (simply, $\tilde{\mathcal{E}}$), if $\tilde{\sigma}_f(\tilde{e}) = 1, \tilde{\zeta}_f(\tilde{e}) = 0$ and $\tilde{\delta}_f(\tilde{e}) = 0$, for any $\tilde{e} \in \mathcal{E}$.

A svnfs $f_\mathcal{E}$ on \mathbb{F} is termed as a t-absolute svnf set (simply, $\tilde{\mathcal{E}}^t$), if $\tilde{\sigma}_f(\tilde{e}) = t, \tilde{\zeta}_f(\tilde{e}) = 0$ and $\tilde{\delta}_f(\tilde{e}) = 0$, for any $\tilde{e} \in \mathcal{E}$ and $t \in \xi$.

Definition 5 Let f_ℓ, g_j be svnf sets over \mathbb{F} . Then, the union of svnf sets f_ℓ, g_j is a svnf set h_∂ , where $\partial = \ell \cup j$ and for any $\tilde{e} \in \partial$ and $\tilde{\sigma}_h : \mathcal{E} \rightarrow \xi$ ($\tilde{\sigma}_h$ called truth-membership) $\tilde{\zeta}_h : \mathcal{E} \rightarrow \xi$ ($\tilde{\zeta}_h$ called indeterminacy), $\tilde{\delta}_h : \mathcal{E} \rightarrow \xi$ ($\tilde{\delta}_h$ called falsity membership) of h_∂ are as next:

$$\begin{aligned} \tilde{\sigma}_{h(\tilde{e})}(\omega) &= \begin{cases} \tilde{\sigma}_{f(\tilde{e})}(\omega), & \text{if } \tilde{e} \in \ell - j, \\ \tilde{\sigma}_{g(\tilde{e})}(\omega), & \text{if } \tilde{e} \in j - \ell, \\ \tilde{\sigma}_{f(\tilde{e})}(\omega) \cup \tilde{\sigma}_{g(\tilde{e})}(\omega), & \text{if } \tilde{e} \in \ell \cup j. \end{cases} \\ \tilde{\zeta}_{h(\tilde{e})}(\omega) &= \begin{cases} \tilde{\zeta}_{f(\tilde{e})}(\omega), & \text{if } \tilde{e} \in \ell - j, \\ \tilde{\zeta}_{g(\tilde{e})}(\omega), & \text{if } \tilde{e} \in j - \ell, \\ \tilde{\zeta}_{f(\tilde{e})}(\omega) \cap \tilde{\zeta}_{g(\tilde{e})}(\omega), & \text{if } \tilde{e} \in \ell \cap j. \end{cases} \\ \tilde{\delta}_{h(\tilde{e})}(\omega) &= \begin{cases} \tilde{\delta}_{f(\tilde{e})}(\omega), & \text{if } \tilde{e} \in \ell - j, \\ \tilde{\delta}_{g(\tilde{e})}(\omega), & \text{if } \tilde{e} \in j - \ell, \\ \tilde{\delta}_{f(\tilde{e})}(\omega) \cap \tilde{\delta}_{g(\tilde{e})}(\omega), & \text{if } \tilde{e} \in \ell \cap j. \end{cases} \end{aligned}$$

Definition 6 The intersection of svnf sets f_ℓ, g_j is a svnf set h_∂ , where $\partial = \ell \cap j$ and for any $\tilde{e} \in \partial, h_{\tilde{e}} = f_{\tilde{e}} \cap g_{\tilde{e}}$. We write as next:

$$\begin{aligned} \tilde{\sigma}_{h(\tilde{e})}(\omega) &= \begin{cases} \tilde{\sigma}_{f(\tilde{e})}(\omega), & \text{if } \tilde{e} \in \ell - j, \\ \tilde{\sigma}_{g(\tilde{e})}(\omega), & \text{if } \tilde{e} \in j - \ell, \\ \tilde{\sigma}_{f(\tilde{e})}(\omega) \cap \tilde{\sigma}_{g(\tilde{e})}(\omega), & \text{if } \tilde{e} \in \ell \cap j. \end{cases} \\ \tilde{\zeta}_{h(\tilde{e})}(\omega) &= \begin{cases} \tilde{\zeta}_{f(\tilde{e})}(\omega), & \text{if } \tilde{e} \in \ell - j, \\ \tilde{\zeta}_{g(\tilde{e})}(\omega), & \text{if } \tilde{e} \in j - \ell, \\ \tilde{\zeta}_{f(\tilde{e})}(\omega) \cup \tilde{\zeta}_{g(\tilde{e})}(\omega), & \text{if } \tilde{e} \in \ell \cap j. \end{cases} \\ \tilde{\delta}_{h(\tilde{e})}(\omega) &= \begin{cases} \tilde{\delta}_{f(\tilde{e})}(\omega), & \text{if } \tilde{e} \in \ell - j, \\ \tilde{\delta}_{g(\tilde{e})}(\omega), & \text{if } \tilde{e} \in j - \ell, \\ \tilde{\delta}_{f(\tilde{e})}(\omega) \cup \tilde{\delta}_{g(\tilde{e})}(\omega), & \text{if } \tilde{e} \in \ell \cap j. \end{cases} \end{aligned}$$

Definition 7 Consider f_ℓ and g_j to be a svn-sets in \mathbb{F} :

(1) Inclusion of two sets (simply, $f_\ell \subseteq g_j$) defined as:

$$\tilde{\sigma}_f(\tilde{e}) \leq \tilde{\sigma}_g(\tilde{e}), \quad \tilde{\zeta}_f(\tilde{e}) \geq \tilde{\zeta}_g(\tilde{e}), \quad \tilde{\delta}_f(\tilde{e}) \geq \tilde{\delta}_g(\tilde{e}).$$

(2) The complemented of the set f_ℓ denoted by (simply, f_ℓ^c) is defined as:

$$f_\ell^c = \left\{ (\tilde{e}, (\tilde{\delta}_f(\tilde{e}), \tilde{\zeta}_f^c(\tilde{e}), \tilde{\sigma}_f(\tilde{e}))) \mid \tilde{e} \in \mathcal{E} \right\}.$$

Theorem 1 Let $f_\ell, g_j, h_\partial \in (\widetilde{\mathfrak{F}}, \widetilde{\mathcal{E}})$ and $(f_\ell)_j \cong (f_i)_\ell$, $(g_\ell)_j \cong (g_i)_\ell \in (\widetilde{\mathfrak{F}}, \widetilde{\mathcal{E}})$ [$i \in \Delta$, where Δ is termed to be the index set]. Then,

- (1) $f_\ell \widetilde{\cap} g_j = f_\ell \widetilde{\cap} g_j$ and $f_\ell \widetilde{\cup} f_\ell = f_\ell \widetilde{\cup} g_j$.
- (2) $f_\ell \widetilde{\cup} (g_j \widetilde{\cap} h_\partial) = (f_\ell \widetilde{\cup} g_j) \widetilde{\cap} h_\partial$ and $f_\ell \widetilde{\cap} (g_j \widetilde{\cap} h_\partial) = (f_\ell \widetilde{\cap} g_j) \widetilde{\cap} h_\partial$.
- (3) $f_\ell \widetilde{\cup} (\widetilde{\cap}_{i \in \Delta} [g_j]_i) = \widetilde{\cap}_{i \in \Delta} (f_\ell \widetilde{\cup} g_j)$.
- (4) $f_\ell \widetilde{\cap} (\widetilde{\cup}_{i \in \Delta} [g_j]_i) = \widetilde{\cup}_{i \in \Delta} (f_\ell \widetilde{\cap} g_j)$.
- (5) $[f_\ell^c]^c = f_\ell$.
- (6) If $f_\ell \subseteq g_j$, then $f_\ell^c \subseteq g_j^c$.
- (7) $f_\ell \widetilde{\cap} f_\ell = f_\ell$ and $f_\ell \widetilde{\cup} f_\ell = f_\ell$.
- (8) $\Phi \leq f_\ell \subseteq \mathfrak{E}$.
- (9) $(\widetilde{\cup}_{i \in \Delta} [f_\ell]_i)^c = \widetilde{\cap}_{i \in \Delta} [f_\ell^c]_i$

Proof It is clear. □

Definition 8 A map $\vartheta_\varphi : (\widetilde{\mathfrak{F}}, \widetilde{\mathcal{E}}) \rightarrow (\widetilde{\mathfrak{G}}, \widetilde{\mathcal{Y}})$ is termed as a single-valued neutrosophic soft mapping (simply, svnf – map), where $\vartheta : \mathfrak{F} \rightarrow \mathfrak{G}$ and $\varphi : \mathcal{E} \rightarrow \mathcal{Y}$ are mappings, with \mathcal{E}, \mathcal{Y} are parameter sets for $\mathfrak{F}, \mathfrak{G}$, respectively.

Definition 9 Assume that f_ℓ and g_j are two svnf sets on \mathfrak{F} and \mathfrak{G} and $\vartheta_\varphi : (\widetilde{\mathfrak{F}}, \widetilde{\mathcal{E}}) \rightarrow (\widetilde{\mathfrak{G}}, \widetilde{\mathcal{Y}})$ is an svnf – map. Then,

- (1) The image of f_ℓ under the svnf – map ϑ_φ , referred by $\vartheta_\varphi(f_\ell)$, is the svnf set on \mathfrak{G} defined by $\vartheta_\varphi(f_\ell) = \vartheta(f)_{\varphi(\ell)}$, where

$$\vartheta(f)_\pi(\omega) = \begin{cases} \bigvee_{v \in \vartheta^{-1}(\omega)} \left(\bigvee_{\varepsilon \in \varphi^{-1}(\pi) \wedge \ell} f_\varepsilon(v) \right), & \text{if } \vartheta^{-1}(\omega) \\ \neq \phi, \varphi^{-1}(\pi) \wedge \ell \neq \phi, \\ 0, & \text{otherwise,} \end{cases}$$

for all $\pi \in \mathcal{Y}$ and $\omega \in \mathfrak{G}$.

- (2) The pre-image of g_j under the svnf – map ϑ_φ , referred by $\vartheta_\varphi^{-1}(g_j)$, is the svnf set on \mathfrak{F} defined by $\vartheta_\varphi^{-1}(g_j) = \vartheta^{-1}(f)_{\varphi^{-1}(j)}$, where

$$\vartheta^{-1}(g)_\varepsilon(v) = \begin{cases} g_{\vartheta(\varepsilon)}(\varphi(v)), & \text{if } \varphi^{-1}(\varepsilon) \in \\ J \quad \forall \quad \varepsilon \in \mathcal{E} \text{ and } v \in \mathfrak{F}, \\ 0, & \text{otherwise,} \end{cases}$$

Example 1 Assume that, $\mathfrak{F} = \{x_1, x_2, x_3\}$, $\mathfrak{G} = \{y_1, y_2, y_3\}$, $\mathcal{E} = \{\kappa_1, \kappa_2, \kappa_3\}$, $\mathcal{Y} = \{\kappa'_1, \kappa'_2, \kappa'_3\}$ and $(\widetilde{\mathfrak{F}}, \widetilde{\mathcal{E}}), (\widetilde{\mathfrak{G}}, \widetilde{\mathcal{Y}})$ are svnf classes. Define $\varphi : \mathcal{E} \rightarrow \mathcal{Y}$ and $\vartheta : \mathfrak{F} \rightarrow \mathfrak{G}$ as next:

$$\begin{aligned} \vartheta(x_1) &= y_1, & \vartheta(x_2) &= y_3, & \vartheta(x_3) &= y_2, \\ \varphi(\kappa_1) &= \kappa'_2, & \varphi(\kappa_2) &= \kappa'_1, & \varphi(\kappa_3) &= \kappa'_1. \end{aligned}$$

Let f_ℓ and g_j be two svnf sets in $(\widetilde{\mathfrak{F}}, \widetilde{\mathcal{E}})$ and $(\widetilde{\mathfrak{G}}, \widetilde{\mathcal{Y}})$, such that

$$\begin{aligned} f_\ell &= \{\kappa_1, \{(x_1, 0.4, 0.3, 0.6), (x_2, 0.3, 0.6, 0.4), (x_3, 0.3, 0.5, 0.5)\}, \\ &\quad \kappa_3, \{(x_1, 0.3, 0.3, 0.2), (x_2, 0.5, 0.4, 0.4), (x_3, 0.6, 0.4, 0.3)\}, \\ &\quad \kappa_2, \{(x_1, 0.5, 0.6, 0.3), (x_2, 0.5, 0.3, 0.6), (x_3, 0.6, 0.4, 0.7)\}\}, \\ g_j &= \{\kappa'_1, \{(y_1, 0.3, 0.2, 0.1), (y_1, 0.5, 0.6, 0.4), (y_1, 0.3, 0.5, 0.1)\}, \\ &\quad \kappa'_1, \{(y_2, 0.5, 0.7, 0.4), (y_2, 0.5, 0.2, 0.3), (y_2, 0.6, 0.5, 0.1)\}, \\ &\quad \kappa'_2, \{(y_3, 0.3, 0.2, 0.4), (y_3, 0.1, 0.7, 0.5), (y_3, 0.1, 0.4, 0.2)\}\}. \end{aligned}$$

Then, the svnf image of f_ℓ under $\vartheta_\varphi : (\widetilde{\mathfrak{F}}, \widetilde{\mathcal{E}}) \rightarrow (\widetilde{\mathfrak{G}}, \widetilde{\mathcal{Y}})$ is gotten as:

$$\begin{aligned} \vartheta(f)_{\kappa'_1}(y_1) &= \bigvee_{x \in \vartheta^{-1}(y_1)} \left(\bigvee_{\varepsilon \in \varphi^{-1}(\kappa'_1) \wedge \ell} f_\varepsilon(x) \right) \\ &= \bigvee_{x \in \{x_1\}} \left(\bigvee_{\varepsilon \in \{\kappa'_2, \kappa'_3\}} f_\varepsilon(x) \right) \\ &= \langle 0.5, 0.6, 0.3 \rangle \vee \langle 0.3, 0.3, 0.2 \rangle \\ &= \langle 0.5, 0.45, 0.2 \rangle, \\ \vartheta(f)_{\kappa'_1}(y_2) &= \bigvee_{x \in \vartheta^{-1}(y_2)} \left(\bigvee_{\varepsilon \in \varphi^{-1}(\kappa'_1) \wedge \ell} f_\varepsilon(x) \right) \\ &= \bigvee_{x \in \{x_3\}} \left(\bigvee_{\varepsilon \in \{\kappa'_2, \kappa'_3\}} f_\varepsilon(x) \right) \\ &= \langle 0.6, 0.4, 0.7 \rangle \vee \langle 0.6, 0.4, 0.3 \rangle \\ &= \langle 0.6, 0.4, 0.3 \rangle, \\ \vartheta(f)_{\kappa'_1}(y_3) &= \bigvee_{x \in \vartheta^{-1}(y_3)} \left(\bigvee_{\varepsilon \in \varphi^{-1}(\kappa'_1) \wedge \ell} f_\varepsilon(x) \right) \\ &= \bigvee_{x \in \{x_2\}} \left(\bigvee_{\varepsilon \in \{\kappa'_2, \kappa'_3\}} f_\varepsilon(x) \right) \\ &= \langle 0.5, 0.3, 0.6 \rangle \vee \langle 0.5, 0.4, 0.4 \rangle \\ &= \langle 0.5, 0.35, 0.4 \rangle, \end{aligned}$$

By similar calculations, consequently, we get

$$\begin{aligned} \vartheta_\varphi(f_\ell) &= \{\kappa'_1, \{(y_1, 0.5, 0.45, 0.2), \\ &\quad (y_2, 0.6, 0.4, 0.3), (y_3, 0.5, 0.35, 0.4)\}, \\ &\quad \kappa'_2, \{(y_1, 0.4, 0.3, 0.6), (y_2, 0.3, 0.5, 0.5), (y_3, 0.3, 0.6, 0.4)\}, \\ &\quad \kappa'_3, \{(y_1, 0.3, 0.3, 0.2), (y_2, 0.6, 0.4, 0.3), (y_3, 0.5, 0.4, 0.4)\}\}. \end{aligned}$$

By similar calculations, we have

$$\begin{aligned} \vartheta_\varphi(f_\ell) &= \{\kappa'_1, \{(y_1, 0.5, 0.45, 0.2), \\ &\quad (y_2, 0.6, 0.4, 0.3), (y_3, 0.5, 0.35, 0.4)\}, \\ &\quad \kappa'_2, \{(y_1, 0.4, 0.3, 0.6), (y_2, 0.3, 0.5, 0.5), (y_3, 0.3, 0.6, 0.4)\}, \\ &\quad \kappa'_3, \{(y_1, 0.3, 0.3, 0.2), (y_2, 0.6, 0.4, 0.3), (y_3, 0.5, 0.4, 0.4)\}\}. \end{aligned}$$

Definition 10 Let $\vartheta_\varphi : (\widetilde{\mathcal{X}}, \widetilde{\mathcal{E}}) \rightarrow (\widetilde{\mathcal{G}}, \widetilde{\mathcal{Y}})$ be a map, $f_\ell \in (\widetilde{\mathcal{X}}, \widetilde{\mathcal{E}})$ and $f_j \in (\widetilde{\mathcal{G}}, \widetilde{\mathcal{Y}})$. Then, $\forall \pi \in \mathcal{Y}, \omega \in \mathcal{G}$, the svnf union and intersection of svnf – images $\vartheta_\varphi(f_\ell)$ and $\vartheta_\varphi(g_j)$ in $(\widetilde{\mathcal{G}}, \widetilde{\mathcal{Y}})$ are defined as:

$$\begin{aligned} (\vartheta(f \widetilde{\cap} g))_\pi(\omega) &= \vartheta(f)_\pi(\omega) \cap \vartheta(g)_\pi(\omega), \\ (\vartheta(f \widetilde{\cup} g))_\pi(\omega) &= \vartheta(f)_\pi(\omega) \cup \vartheta(g)_\pi(\omega) \end{aligned}$$

Definition 11 Let $\vartheta_\varphi : (\widetilde{\mathcal{X}}, \widetilde{\mathcal{E}}) \rightarrow (\widetilde{\mathcal{G}}, \widetilde{\mathcal{Y}})$ be a map, $f_\ell \in (\widetilde{\mathcal{X}}, \widetilde{\mathcal{E}})$ and $f_j \in (\widetilde{\mathcal{G}}, \widetilde{\mathcal{Y}})$. Then $\forall \varepsilon \in \mathcal{E}, v \in \mathcal{X}$, the svnf union and intersection of svnf – inverse images $\vartheta_\varphi^{-1}(f_\ell)$ and $\vartheta_\varphi^{-1}(g_j)$ in $(\widetilde{\mathcal{X}}, \widetilde{\mathcal{E}})$ are defined as:

$$\begin{aligned} (\vartheta^{-1}(f \widetilde{\cap} g))_\varepsilon(v) &= \vartheta^{-1}(f)_\varepsilon(v) \cap \vartheta^{-1}(g)_\varepsilon(v), \\ (\vartheta^{-1}(f \widetilde{\cup} g))_\varepsilon(v) &= \vartheta^{-1}(f)_\varepsilon(v) \cup \vartheta^{-1}(g)_\varepsilon(v) \end{aligned}$$

Theorem 2 Consider $\vartheta_\varphi : (\widetilde{\mathcal{X}}, \widetilde{\mathcal{E}}) \rightarrow (\widetilde{\mathcal{G}}, \widetilde{\mathcal{Y}}), \vartheta : \mathcal{X} \rightarrow \mathcal{G}$ and $\varphi : \mathcal{E} \rightarrow \mathcal{Y}$ to be a mapping. For svnf sets $f_\ell, g_j \in (\widetilde{\mathcal{X}}, \widetilde{\mathcal{E}})$, we have

- (1) $\vartheta_\varphi(\Phi) = \Phi$.
- (2) $\vartheta_\varphi(\widetilde{\mathcal{E}}) = \widetilde{\mathcal{E}}$.
- (3) $\vartheta_\varphi(f_\ell \widetilde{\cup} g_j) = \vartheta_\varphi(f_\ell) \widetilde{\cup} \vartheta_\varphi(g_j)$.
- (4) $\vartheta_\varphi(f_\ell \widetilde{\cap} g_j) \widetilde{\leq} \vartheta_\varphi(f_\ell) \widetilde{\cap} \vartheta_\varphi(g_j)$.
- (5) If $f_\ell \widetilde{\leq} g_j$, then $\vartheta_\varphi(f_\ell) \widetilde{\leq} \vartheta_\varphi(g_j)$.

Proof We only prove (3)–(5).

(3) We will prove that

$$(\vartheta(f \widetilde{\cup} g))_\pi(\omega) = \vartheta(f)_\pi(\omega) \cup \vartheta(g)_\pi(\omega)$$

for every $\pi \in \mathcal{Y}$ and $\omega \in \mathcal{G}$. Thus for left-hand side, consider $(\vartheta(f \widetilde{\cup} g))_\pi(\omega) = (\vartheta(h))_\pi(\omega)$. Then,

$$(\vartheta(h))_\pi(\omega) = \begin{cases} \bigvee_{v \in \vartheta^{-1}(\omega)} \left(\bigvee_{\tilde{e} \in \varphi^{-1}(\pi) \wedge \partial} h_{\tilde{e}}(v) \right), & \text{if } \vartheta^{-1}(\omega) \\ \neq \phi, \varphi^{-1}(\pi) \wedge \partial \neq \phi, \\ 0, & \text{otherwise,} \end{cases} \tag{1}$$

where $f_{\tilde{e}} \cup g_{\tilde{e}} = h_{\tilde{e}}$ and $\partial = \ell \cup j$ and for any $\tilde{e} \in \partial$. Seeing only the non-trivial case, we get,

$$(\vartheta(h))_\pi(\omega) = \bigvee_{v \in \vartheta^{-1}(\omega)} \left(\bigvee_{\tilde{e} \in \varphi^{-1}(\pi) \wedge (\ell \cup j)} (f_{\tilde{e}} \cup g_{\tilde{e}})(v) \right).$$

on the other hand, by using Definition 6, we get then,

$$\begin{aligned} (\vartheta(f \widetilde{\cup} g))_\pi(\omega) &= \vartheta(f)_\pi(\omega) \cup \vartheta(g)_\pi(\omega) \\ &= \left(\bigvee_{v \in \vartheta^{-1}(\omega)} \left(\bigvee_{\tilde{e} \in \varphi^{-1}(\pi) \wedge \ell} (f_{\tilde{e}})(v) \right) \right) \\ &\cup \left(\bigvee_{v \in \vartheta^{-1}(\omega)} \left(\bigvee_{\tilde{e} \in \varphi^{-1}(\pi) \wedge j} (g_{\tilde{e}})(v) \right) \right) \\ &= \bigvee_{v \in \vartheta^{-1}(\omega)} \left(\bigvee_{\tilde{e} \in \varphi^{-1}(\pi) \wedge (\ell \cup j)} (f_{\tilde{e}} \cup g_{\tilde{e}})(v) \right) \\ &= \bigvee_{v \in \vartheta^{-1}(\omega)} \left(\bigvee_{\tilde{e} \in \varphi^{-1}(\pi) \wedge \partial} (h_{\tilde{e}})(v) \right). \end{aligned}$$

Hence,

$$\vartheta(f)_\pi(\omega) \cup \vartheta(g)_\pi(\omega) = \bigvee_{v \in \vartheta^{-1}(\omega)} \left(\bigvee_{\tilde{e} \in \varphi^{-1}(\pi) \wedge \partial} (h_{\tilde{e}})(v) \right) \tag{2}$$

From Eqs. (1) and (2), we have (3).

(4) For every $\pi \in \mathcal{Y}$ and $\omega \in \mathcal{G}$, and using definition 6, we have ,

$$\begin{aligned} (\vartheta(f \widetilde{\cap} g))_\pi(\omega) &= (\vartheta(h))_\pi(\omega) \\ &= \bigvee_{v \in \vartheta^{-1}(\omega)} \left(\bigvee_{\tilde{e} \in \varphi^{-1}(\pi) \wedge \partial} (h_{\tilde{e}})(v) \right) \\ &= \bigvee_{v \in \vartheta^{-1}(\omega)} \left(\bigvee_{\tilde{e} \in \varphi^{-1}(\pi) \wedge (\ell \cap j)} (f_{\tilde{e}} \cap g_{\tilde{e}})(v) \right) \\ &= \bigvee_{v \in \vartheta^{-1}(\omega)} \left(\bigvee_{\tilde{e} \in \varphi^{-1}(\pi) \wedge (\ell \cap j)} (f_{\tilde{e}}(v)) \right) \\ &\cap \left(\bigvee_{v \in \vartheta^{-1}(\omega)} \left(\bigvee_{\tilde{e} \in \varphi^{-1}(\pi) \wedge (\ell \cap j)} (g_{\tilde{e}}(v)) \right) \right) \\ &\subseteq \left(\bigvee_{v \in \vartheta^{-1}(\omega)} \left(\bigvee_{\tilde{e} \in \varphi^{-1}(\pi) \wedge \ell} (f_{\tilde{e}})(v) \right) \right) \\ &\cap \left(\bigvee_{v \in \vartheta^{-1}(\omega)} \left(\bigvee_{\tilde{e} \in \varphi^{-1}(\pi) \wedge j} (g_{\tilde{e}})(v) \right) \right) \\ &= \vartheta(f)_\pi(\omega) \cap \vartheta(g)_\pi(\omega) = (\vartheta(f) \widetilde{\cap} \vartheta(g))_\pi(\omega). \end{aligned}$$

This proves (4).

(5) Seeing only the non-trivial case, $\forall \pi \in \mathcal{Y}, \omega \in \mathcal{G}$ and let $f_\ell \widetilde{\leq} g_j$, we obtain

$$\begin{aligned} (\vartheta(f))_\pi(\omega) &= \bigvee_{\nu \in \vartheta^{-1}(\omega)} \\ &\left(\bigvee_{\tilde{e} \in \varphi^{-1}(\pi) \wedge \ell} (f_{\tilde{e}}) \right) (\nu) \\ &= \bigvee_{\nu \in \vartheta^{-1}(\omega)} \bigvee_{\tilde{e} \in \varphi^{-1}(\pi) \wedge \ell} (f_{\tilde{e}}) (\nu) \\ &= \bigvee_{\nu \in \vartheta^{-1}(\omega)} \bigvee_{\tilde{e} \in \varphi^{-1}(\pi) \wedge \ell} (g_{\tilde{e}}) (\nu) = (\vartheta(g))_\pi(\omega). \end{aligned}$$

This proves (5). □

Theorem 3 Let $\vartheta_\varphi : (\mathbb{F}, \mathcal{E}) \rightarrow (\mathbb{G}, \mathcal{Y}), \vartheta : \mathbb{F} \rightarrow \mathbb{G}$ and $\varphi : \mathcal{E} \rightarrow \mathcal{Y}$ be mappings. For svnf sets $f_\ell, g_j \in (\mathbb{G}, \mathcal{Y})$, we have

- (1) $\vartheta_\varphi^{-1}(\Phi) = \Phi$.
- (2) $\vartheta_\varphi^{-1}(\tilde{\mathcal{E}}) = \tilde{\mathcal{E}}$.
- (3) $\vartheta_\varphi^{-1}(f_\ell \cup g_j) = \vartheta_\varphi^{-1}(f_\ell) \cup \vartheta_\varphi^{-1}(g_j)$.
- (4) $\vartheta_\varphi^{-1}(f_\ell \widetilde{\cap} g_j) = \vartheta_\varphi^{-1}(f_\ell) \widetilde{\cap} \vartheta_\varphi^{-1}(g_j)$.
- (5) If $f_\ell \widetilde{\leq} g_j$, then $\vartheta_\varphi^{-1}(f_\ell) \widetilde{\leq} \vartheta_\varphi^{-1}(g_j)$.

Proof The proof is straightforward. □

3 Single-valued neutrosophic soft topological structure

To communicate our program and overall notions further exactly, we should recall first the notion of fuzzy topological space presented by Šostak (1985), that is a pair (\mathbb{X}, \mathbb{T}) such that X is a non-empty set and $\mathbb{T} : \xi^{\mathbb{X}} \rightarrow \xi$ is a function (satisfying some axioms) that gives to each fuzzy subset of \mathbb{X} a real number, which then indicates [to what degree] this set is open. Rendering to this notion a fuzzy topology \mathbb{T} is a fuzzy set over $\xi^{\mathbb{X}}$. This methodology has principled us to define the single-valued neutrosophic soft topology (simply, svnft) which is compatible to the single-valued neutrosophic soft theory. By our characterization, an svnft is a svnfs on the set of all single-valued neutrosophic soft sets $(\mathbb{X}, \mathcal{E})$ which refers [to what degree] this set is open according to the parameter set.

Definition 12 Let $(\tilde{\tau}^{\tilde{\sigma}}, \tilde{\tau}^{\tilde{\zeta}}, \tilde{\tau}^{\tilde{\delta}})$ be a collection of svnfs over \mathbb{X} [where $\tilde{\tau}^{\tilde{\sigma}}, \tilde{\tau}^{\tilde{\zeta}}, \tilde{\tau}^{\tilde{\delta}} : \mathcal{E} \rightarrow \xi^{(\mathbb{X}, \mathcal{E})}$], then is termed to be svnft on \mathbb{X} , if it meets the following criteria, for every $\tilde{e} \in \mathcal{E}$:

- (T₁) $\tilde{\tau}_e^{\tilde{\sigma}}(\Phi) = \tilde{\tau}_e^{\tilde{\sigma}}(\tilde{\mathcal{E}}) = 1$ and $\tilde{\tau}_e^{\tilde{\zeta}}(\Phi) = \tilde{\tau}_e^{\tilde{\zeta}}(\tilde{\mathcal{E}}) = \tilde{\tau}_e^{\tilde{\delta}}(\Phi) = \tilde{\tau}_e^{\tilde{\delta}}(\tilde{\mathcal{E}}) = 0$,
 - (T₂) $\tilde{\tau}_e^{\tilde{\sigma}}(f_\ell \widetilde{\cap} g_j) \geq \tilde{\tau}_e^{\tilde{\sigma}}(f_\ell) \cap \tilde{\tau}_e^{\tilde{\sigma}}(g_j), \quad \tilde{\tau}_e^{\tilde{\zeta}}(f_\ell \widetilde{\cap} g_j) \leq \tilde{\tau}_e^{\tilde{\zeta}}(f_\ell) \cup \tilde{\tau}_e^{\tilde{\zeta}}(g_j),$
 $\tilde{\tau}_e^{\tilde{\delta}}(f_\ell \widetilde{\cap} g_j) \leq \tilde{\tau}_e^{\tilde{\delta}}(f_\ell) \cup \tilde{\tau}_e^{\tilde{\delta}}(g_j), \quad \forall f_\ell, g_j \in (\widehat{\mathbb{X}}, \mathcal{E}),$
 - (T₃) $\tilde{\tau}_e^{\tilde{\sigma}}(\bigcup_{i \in \Delta} [f_\ell]_i) \geq \bigcap_{i \in \Delta} \tilde{\tau}_e^{\tilde{\sigma}}([f_\ell]_i), \quad \tilde{\tau}_e^{\tilde{\zeta}}(\bigcup_{i \in \Delta} [f_\ell]_i) \leq \bigcup_{i \in \Delta} \tilde{\tau}_e^{\tilde{\zeta}}([f_\ell]_i),$
 $\tilde{\tau}_e^{\tilde{\delta}}(\bigcup_{i \in \Delta} [f_\ell]_i) \leq \bigcup_{i \in \Delta} \tilde{\tau}_e^{\tilde{\delta}}([f_\ell]_i), \quad \forall f_\ell, f_j \in (\widehat{\mathbb{X}}, \mathcal{E}).$
- The svnft is termed to be stratified if it satisfies the following conditions:
 (T₁^s) $\tilde{\tau}_e^{\tilde{\sigma}}(\tilde{\mathcal{E}}^t) = 1, \tilde{\tau}_e^{\tilde{\zeta}}(\tilde{\mathcal{E}}^t) = 0$ and $\tilde{\tau}_e^{\tilde{\delta}}(\tilde{\mathcal{E}}^t) = 0$.

The quadruple $(\mathbb{X}, \tilde{\tau}_e^{\tilde{\sigma}}, \tilde{\tau}_e^{\tilde{\zeta}}, \tilde{\tau}_e^{\tilde{\delta}})$ is termed as the single-valued neutrosophic soft topological spaces (simply, svnfts), representing the degree of openness ($\tilde{\tau}_e^{\tilde{\sigma}}(f_\ell)$), the degree of indeterminacy ($\tilde{\tau}_e^{\tilde{\zeta}}(f_\ell)$), and the degree of non-openness ($\tilde{\tau}_e^{\tilde{\delta}}(f_\ell)$); of a svnfs f_ℓ with respect to the parameter $\tilde{e} \in \mathcal{E}$, respectively.

Here, we will write $\tilde{\tau}_e^{\tilde{\sigma}\tilde{\zeta}\tilde{\delta}}$ for $(\tilde{\tau}_e^{\tilde{\sigma}}, \tilde{\tau}_e^{\tilde{\zeta}}, \tilde{\tau}_e^{\tilde{\delta}})$, and it will be no ambiguity. Let $\tilde{\tau}_e^{\tilde{\sigma}\tilde{\zeta}\tilde{\delta}}$ and $\tilde{\tau}_e^{*\tilde{\sigma}\tilde{\zeta}\tilde{\delta}}$ be svnfts \mathbb{X} . We say that $\tilde{\tau}_e^{\tilde{\sigma}\tilde{\zeta}\tilde{\delta}}$ is finer than $\tilde{\tau}_e^{*\tilde{\sigma}\tilde{\zeta}\tilde{\delta}}$ ($\tilde{\tau}_e^{*\tilde{\sigma}\tilde{\zeta}\tilde{\delta}}$ is coarser than $\tilde{\tau}_e^{\tilde{\sigma}\tilde{\zeta}\tilde{\delta}}$), denoted by $\tilde{\tau}_e^{\tilde{\sigma}\tilde{\zeta}\tilde{\delta}} \subseteq \tilde{\tau}_e^{*\tilde{\sigma}\tilde{\zeta}\tilde{\delta}}$, if $\tilde{\tau}_e^{*\tilde{\sigma}}(f_\ell) \leq \tilde{\tau}_e^{\tilde{\sigma}}(f_\ell), \tilde{\tau}_e^{*\tilde{\zeta}}(f_\ell) \geq \tilde{\tau}_e^{\tilde{\zeta}}(f_\ell)$ and $\tilde{\tau}_e^{*\tilde{\delta}}(f_\ell) \geq \tilde{\tau}_e^{\tilde{\delta}}(f_\ell) \forall \tilde{e} \in \mathcal{E}; f_\ell \in (\widehat{\mathbb{X}}, \mathcal{E})$.

Example 2 Let $(\tau^{\tilde{\sigma}}, \tau^{\tilde{\zeta}}, \tau^{\tilde{\delta}})$ be a smooth neutrosophic topology on \mathbb{X} presented by Feng et al. (2011), i.e., $\tau^{\tilde{\sigma}} : \xi^{\mathbb{X}} \rightarrow \xi, \tau^{\tilde{\zeta}} : \xi^{\mathbb{X}} \rightarrow \xi$ and $\tau^{\tilde{\delta}} : \xi^{\mathbb{X}} \rightarrow \xi$. Take $\mathcal{E} = \xi$ and define $\tilde{\tau}^{\tilde{\sigma}} : \mathcal{E} \rightarrow \xi^{\mathbb{X}}, \tilde{\tau}^{\tilde{\zeta}} : \mathcal{E} \rightarrow \xi^{\mathbb{X}}, \tilde{\tau}^{\tilde{\delta}} : \mathcal{E} \rightarrow \xi^{\mathbb{X}}$ as $\tilde{\tau}^{\tilde{\sigma}\tilde{\zeta}\tilde{\delta}} = \{\tau^{\tilde{\sigma}}(\mu) \geq e, \tau^{\tilde{\zeta}}(\mu) \leq 1 - e, \tau^{\tilde{\delta}}(\mu) \leq 1 - e\}$, which is fuzzy neutrosophic topology of $(\tau^{\tilde{\sigma}}, \tau^{\tilde{\zeta}}, \tau^{\tilde{\delta}})$ in presented by Salama and Alblowi (2012), for each $e \in \xi$. However, it is well known that each fuzzy topology can be considered as smooth neutrosophic topology by using fuzzifying method. Thus, $\tau^{\tilde{\sigma}\tilde{\zeta}\tilde{\delta}}(e)$ satisfies (T₁), (T₂) and (T₃). According to this concept and by using the decomposition theorem of neutrosophic sets introduced by Smarandache (2007), if we know the resulting single-valued neutrosophic soft topology, then we can find the first fuzzy neutrosophic topology. Hence, we can say that a fuzzy neutrosophic topology can be uniquely represented as a single-valued neutrosophic soft topology.

Definition 13 Let $(\mathbb{X}, \tilde{\tau}^{\tilde{\sigma}\tilde{\zeta}\tilde{\delta}})$ and $(\mathbb{G}, \tilde{\tau}^{*\tilde{\sigma}\tilde{\zeta}\tilde{\delta}})$ be svnfts. A svnf – mapping $\vartheta_\varphi : (\mathbb{X}, \mathcal{E}) \rightarrow (\mathbb{G}, \mathcal{Y})$ is termed a single-valued neutrosophic soft continuous mapping (simply, svnfc – map) if

$$\begin{aligned} \tilde{\tau}_e^{\tilde{\sigma}}(\vartheta_\varphi^{-1}(g_j)) &\geq \tilde{\tau}_{\vartheta(\tilde{e})}^{*\tilde{\sigma}}(g_j), \\ \tilde{\tau}_e^{\tilde{\zeta}}(\vartheta_\varphi^{-1}(g_j)) &\leq \tilde{\tau}_{\vartheta(\tilde{e})}^{*\tilde{\zeta}}(g_j), \quad \tilde{\tau}_e^{\tilde{\delta}}(\vartheta_\varphi^{-1}(g_j)) \end{aligned}$$

$$\leq \tilde{\tau}_{\vartheta(\tilde{e})}^{*\tilde{\delta}}(g_j) \quad \forall \quad g_j \in \widehat{(\mathcal{G}, \mathcal{V})}, \quad \tilde{e} \in \mathcal{E}.$$

Theorem 4 Let $\{\tilde{\tau}_j^{\tilde{\sigma}\tilde{\zeta}\tilde{\delta}}\}_{j \in \Gamma}$ be a group of single-valued neutrosophic soft topologies on \mathfrak{L} . Then,

$$\begin{aligned} \tilde{\tau}^{\tilde{\sigma}} &= \bigcap_{j \in \Gamma} \tilde{\tau}_j^{\tilde{\sigma}}, & \tilde{\tau}^{\tilde{\zeta}} &= \bigcup_{j \in \Gamma} \tilde{\tau}_j^{\tilde{\zeta}}, \\ \tilde{\tau}^{\tilde{\delta}} &= \bigcup_{j \in \Gamma} \tilde{\tau}_j^{\tilde{\delta}}, \end{aligned}$$

is also an svnft on \mathfrak{L} , where

$$\begin{aligned} \tilde{\tau}_e^{\tilde{\sigma}}(f_\ell) &= \bigcap_{j \in \Gamma} (\tilde{\tau}_j^{\tilde{\sigma}})_e(f_\ell), \\ \tilde{\tau}_e^{\tilde{\zeta}}(f_\ell) &= \bigcup_{j \in \Gamma} (\tilde{\tau}_j^{\tilde{\zeta}})_e(f_\ell), \\ \tilde{\tau}_e^{\tilde{\delta}}(f_\ell) &= \bigcup_{j \in \Gamma} (\tilde{\tau}_j^{\tilde{\delta}})_e(f_\ell) \quad \forall \quad f_\ell \in (\mathfrak{L}, \mathcal{E}), \quad \tilde{e} \in \mathcal{E}. \end{aligned}$$

Proof Direct. □

Example 3 Let $\mathfrak{L} = \{x_1, x_2\}$ be a universal set, $\mathcal{E} = \{e_1, e_2, e_3, e_4\}$ be a set of parameters for \mathfrak{L} , $\ell = j = \{e_1, e_2\}$. Let svnf-sets $f_\ell, g_j \in \widehat{(\mathfrak{L}, \mathcal{E})}$ as follows

$$\begin{aligned} f_\ell &= \{(e_1, \{\langle x_1, 0.3, 0.3, 0.3 \rangle, \langle x_2, 0.3, 0.3, 0.3 \rangle\}), \\ &\quad (e_2, \{\langle x_1, 0.5, 0.5, 0.5 \rangle, \langle x_2, 0.5, 0.5, 0.5 \rangle\})\}, \\ g_j &= \{(e_1, \{\langle x_1, 0.4, 0.4, 0.4 \rangle, \\ &\quad \langle x_2, 0.4, 0.4, 0.4 \rangle\}), (e_2, \{\langle x_1, 0.5, 0.5, 0.5 \rangle, \\ &\quad \langle x_2, 0.5, 0.5, 0.5 \rangle\})\}, \end{aligned}$$

Let us consider the next single-valued neutrosophic soft topologies:

$$\begin{aligned} \tilde{\tau}_e^{\tilde{\sigma}}(\Omega) &= \begin{cases} 1, & \text{if } \Omega = \Phi, \\ 1, & \text{if } \Omega = \tilde{\mathcal{E}}, \\ \frac{2}{3}, & \text{if } \Omega = f_\ell, \end{cases} & \tilde{\tau}_e^{*\tilde{\sigma}}(\Omega) &= \begin{cases} 1, & \text{if } \Omega = \Phi, \\ 1, & \text{if } \Omega = \tilde{\mathcal{E}}, \\ \frac{2}{3}, & \text{if } \Omega = f_\ell \text{ or } g_j, \end{cases} \\ \tilde{\tau}_e^{\tilde{\zeta}}(\Omega) &= \begin{cases} 0, & \text{if } \Omega = \Phi, \\ 0, & \text{if } \Omega = \tilde{\mathcal{E}}, \\ \frac{1}{3}, & \text{if } \Omega = f_\ell, \end{cases} & \tilde{\tau}_e^{*\tilde{\zeta}}(\Omega) &= \begin{cases} 0, & \text{if } \Omega = \Phi, \\ 0, & \text{if } \Omega = \tilde{\mathcal{E}}, \\ \frac{1}{3}, & \text{if } \Omega = f_\ell \text{ or } g_j, \end{cases} \\ \tilde{\tau}_e^{\tilde{\delta}}(\Omega) &= \begin{cases} 0, & \text{if } \Omega = \Phi, \\ 0, & \text{if } \Omega = \tilde{\mathcal{E}}, \\ \frac{1}{4}, & \text{if } \Omega = f_\ell, \end{cases} & \tilde{\tau}_e^{*\tilde{\delta}}(\Omega) &= \begin{cases} 0, & \text{if } \Omega = \Phi, \\ 0, & \text{if } \Omega = \tilde{\mathcal{E}}, \\ \frac{1}{4}, & \text{if } \Omega = f_\ell \text{ or } g_j. \end{cases} \end{aligned}$$

The mapping $\vartheta_\varphi : (\mathfrak{L}, \tilde{\tau}_e^{*\tilde{\sigma}\tilde{\zeta}\tilde{\delta}}) \rightarrow (\mathfrak{L}, \tilde{\tau}_e^{\tilde{\sigma}\tilde{\zeta}\tilde{\delta}})$ where $\vartheta : \mathfrak{L} \rightarrow \mathfrak{L}$ and $\varphi : \mathcal{E} \rightarrow \mathcal{E}$ are identity mappings. It's easy to see that ϑ_φ is svnfc - map.

Definition 14 A mapping $\tilde{h}^{\tilde{\sigma}}, \tilde{h}^{\tilde{\zeta}}, \tilde{h}^{\tilde{\delta}} : \mathcal{E} \rightarrow \xi^{\widehat{(\mathfrak{L}, \mathcal{E})}}$ is considered as single-valued neutrosophic soft cotopology on \mathfrak{L} , if it meets the following criteria, for every $\tilde{e} \in \mathcal{E}$

$$(\tilde{h}_1) \tilde{h}_e^{\tilde{\sigma}}(\Phi) = \tilde{h}_e^{\tilde{\sigma}}(\tilde{\mathcal{E}}) = 1 \text{ and } \tilde{h}_e^{\tilde{\zeta}}(\Phi) = \tilde{h}_e^{\tilde{\zeta}}(\tilde{\mathcal{E}}) = \tilde{h}_e^{\tilde{\delta}}(\Phi) = \tilde{h}_e^{\tilde{\delta}}(\tilde{\mathcal{E}}) = 0,$$

$$(\tilde{h}_2) \tilde{h}_e^{\tilde{\sigma}}(f_\ell \tilde{\cup} g_j) \geq \tilde{h}_e^{\tilde{\sigma}}(f_\ell) \cap \tilde{h}_e^{\tilde{\sigma}}(g_j), \quad \tilde{h}_e^{\tilde{\zeta}}(f_\ell \tilde{\cup} g_j) \leq \tilde{h}_e^{\tilde{\zeta}}(f_\ell) \cup \tilde{h}_e^{\tilde{\zeta}}(g_j),$$

$$\tilde{h}_e^{\tilde{\delta}}(f_\ell \tilde{\cup} g_j) \leq \tilde{h}_e^{\tilde{\delta}}(f_\ell) \cup \tilde{h}_e^{\tilde{\delta}}(g_j), \quad \forall f_\ell, g_j \in \widehat{(\mathfrak{L}, \mathcal{E})},$$

$$(\tilde{h}_3) \tilde{h}_e^{\tilde{\sigma}}(\tilde{\bigcap}_{i \in \Delta} [f_\ell]_i) \geq \bigcap_{i \in \Delta} \tilde{h}_e^{\tilde{\sigma}}([f_\ell]_i), \quad \tilde{h}_e^{\tilde{\zeta}}(\tilde{\bigcap}_{i \in \Delta} [f_\ell]_i) \leq \bigcup_{i \in \Delta} \tilde{h}_e^{\tilde{\zeta}}([f_\ell]_i),$$

$$\tilde{h}_e^{\tilde{\delta}}(\tilde{\bigcap}_{i \in \Delta} [f_\ell]_i) \leq \bigcup_{i \in \Delta} \tilde{h}_e^{\tilde{\delta}}([f_\ell]_i), \quad \forall f_\ell, f_j \in \widehat{(\mathfrak{L}, \mathcal{E})}.$$

The quadruple $(\mathfrak{L}, \tilde{h}_e^{\tilde{\sigma}}, \tilde{h}_e^{\tilde{\zeta}}, \tilde{h}_e^{\tilde{\delta}})$ is termed the single-valued neutrosophic soft cotopological space.

Let $\tilde{\tau}^{\tilde{\sigma}\tilde{\zeta}\tilde{\delta}}$ be a svnft on \mathfrak{L} , then the mapping $\tilde{h}^{\tilde{\sigma}}, \tilde{h}^{\tilde{\zeta}}, \tilde{h}^{\tilde{\delta}} : \mathcal{E} \rightarrow \xi^{\widehat{(\mathfrak{L}, \mathcal{E})}}$ defined by

$$\begin{aligned} \tilde{h}_e^{\tilde{\sigma}}(f_\ell) &= \tilde{\tau}_e^{\tilde{\sigma}}(f_\ell^c), & \tilde{h}_e^{\tilde{\zeta}}(f_\ell) &= \tilde{\tau}_e^{\tilde{\zeta}}(f_\ell^c), \\ \tilde{h}_e^{\tilde{\delta}}(f_\ell) &= \tilde{\tau}_e^{\tilde{\delta}}(f_\ell^c), & \forall \quad \tilde{e} \in \mathcal{E}. \end{aligned}$$

is a single-valued neutrosophic soft cotopology on \mathfrak{L} , the mapping $\tilde{h}^{\tilde{\sigma}}, \tilde{h}^{\tilde{\zeta}}, \tilde{h}^{\tilde{\delta}} : \mathcal{E} \rightarrow \xi^{\widehat{(\mathfrak{L}, \mathcal{E})}}$ defined by

$$\begin{aligned} \tilde{\tau}_e^{\tilde{\sigma}}(f_\ell) &= \tilde{h}_e^{\tilde{\sigma}}(f_\ell^c), & \tilde{\tau}_e^{\tilde{\zeta}}(f_\ell) &= \tilde{h}_e^{\tilde{\zeta}}(f_\ell^c), \\ \tilde{\tau}_e^{\tilde{\delta}}(f_\ell) &= \tilde{h}_e^{\tilde{\delta}}(f_\ell^c), & \forall \quad \tilde{e} \in \mathcal{E}, \end{aligned}$$

is an svnft on \mathfrak{L} .

Definition 15 A mapping $\mathfrak{L}^{\tilde{\sigma}}, \mathfrak{L}^{\tilde{\zeta}}, \mathfrak{L}^{\tilde{\delta}} : \mathcal{E} \rightarrow \xi^{\widehat{(\mathfrak{L}, \mathcal{E})}}$ is called a single-valued neutrosophic soft base (simply, svnf-base) on \mathfrak{L} , if it meets the following conditions, $\forall \tilde{e} \in \mathcal{E}$:

$$(\mathfrak{L}_1) \mathfrak{L}_e^{\tilde{\sigma}}(\Phi) = \mathfrak{L}_e^{\tilde{\sigma}}(\tilde{\mathcal{E}}) = 1 \text{ and } \mathfrak{L}_e^{\tilde{\zeta}}(\Phi) = \mathfrak{L}_e^{\tilde{\zeta}}(\tilde{\mathcal{E}}) = \mathfrak{L}_e^{\tilde{\delta}}(\Phi) = \mathfrak{L}_e^{\tilde{\delta}}(\tilde{\mathcal{E}}) = 0,$$

$$(\mathfrak{L}_2) \mathfrak{L}_e^{\tilde{\sigma}}(f_\ell \tilde{\cap} f_j) \geq \mathfrak{L}_e^{\tilde{\sigma}}(f_\ell) \cap \mathfrak{L}_e^{\tilde{\sigma}}(f_j), \quad \mathfrak{L}_e^{\tilde{\zeta}}(f_\ell \tilde{\cap} f_j) \leq \mathfrak{L}_e^{\tilde{\zeta}}(f_\ell) \cup \mathfrak{L}_e^{\tilde{\zeta}}(f_j), \mathfrak{L}_e^{\tilde{\delta}}(f_\ell \tilde{\cap} f_j) \leq \mathfrak{L}_e^{\tilde{\delta}}(f_\ell) \cup \mathfrak{L}_e^{\tilde{\delta}}(f_j), \forall f_\ell, f_j \in \widehat{(\mathfrak{L}, \mathcal{E})}.$$

Theorem 5 Let $(\mathfrak{L}^{\tilde{\sigma}}, \mathfrak{L}^{\tilde{\zeta}}, \mathfrak{L}^{\tilde{\delta}})$ be an svnf-base on \mathfrak{L} . Define a mapping $\tilde{\tau}_\mathfrak{L}^{\tilde{\sigma}}, \tilde{\tau}_\mathfrak{L}^{\tilde{\zeta}}, \tilde{\tau}_\mathfrak{L}^{\tilde{\delta}} : \mathcal{E} \rightarrow \xi^{\widehat{(\mathfrak{L}, \mathcal{E})}}$ as follows:

$$(\tilde{\tau}_\mathfrak{L}^{\tilde{\sigma}})_e(f_\ell) = \bigcup \left\{ \bigcap_{j \in J} \mathfrak{L}_e^{\tilde{\sigma}}(f_\ell)_j \mid f_\ell = \bigcup_{j \in J} (f_\ell)_j \right\}, \quad \forall \quad \tilde{e} \in \mathcal{E},$$

$$(\tilde{\tau}_\mathfrak{L}^{\tilde{\zeta}})_e(f_\ell) = \bigcap \left\{ \bigcup_{j \in J} \mathfrak{L}_e^{\tilde{\zeta}}(f_\ell)_j \mid f_\ell = \bigcup_{j \in J} (f_\ell)_j \right\}, \quad \forall \quad \tilde{e} \in \mathcal{E},$$

$$(\tilde{\tau}_\mathfrak{L}^{\tilde{\delta}})_e(f_\ell) = \bigcap \left\{ \bigcup_{j \in J} \mathfrak{L}_e^{\tilde{\delta}}(f_\ell)_j \mid f_\ell = \bigcup_{j \in J} (f_\ell)_j \right\}, \quad \forall \quad \tilde{e} \in \mathcal{E}.$$

Then, $(\tilde{T}_{\mathcal{L}}^{\tilde{\sigma}}, \tilde{T}_{\mathcal{L}}^{\tilde{\zeta}}, \tilde{T}_{\mathcal{L}}^{\tilde{\delta}})$ is *svnft* on \mathcal{L} for which

$$\begin{aligned} (\tilde{T}_{\mathcal{L}}^{\tilde{\sigma}})_{\tilde{e}}(f_{\ell}) &\geq \mathbf{L}_{\tilde{e}}^{\tilde{\sigma}}(f_{\ell}), & (\tilde{T}_{\mathcal{L}}^{\tilde{\zeta}})_{\tilde{e}}(f_{\ell}) \\ &\leq \mathbf{L}_{\tilde{e}}^{\tilde{\zeta}}(f_{\ell}), & (\tilde{T}_{\mathcal{L}}^{\tilde{\delta}})_{\tilde{e}}(f_{\ell}) \leq \mathbf{L}_{\tilde{e}}^{\tilde{\delta}}(f_{\ell}) \quad \forall f_{\ell} \in \widehat{(\mathcal{L}, \mathcal{E})}, \tilde{e} \in \mathcal{E}. \end{aligned}$$

Proof (T_1) From the definition of $\mathbf{L}^{\tilde{\sigma}}, \mathbf{L}^{\tilde{\zeta}}, \mathbf{L}^{\tilde{\delta}}$ we obtain, $\mathbf{L}_{\tilde{e}}^{\tilde{\sigma}}(\Phi) = \mathbf{L}_{\tilde{e}}^{\tilde{\sigma}}(\mathcal{E}) = 1$ and $\mathbf{L}_{\tilde{e}}^{\tilde{\zeta}}(\Phi) = \mathbf{L}_{\tilde{e}}^{\tilde{\zeta}}(\mathcal{E}) = \mathbf{L}_{\tilde{e}}^{\tilde{\delta}}(\Phi) = \mathbf{L}_{\tilde{e}}^{\tilde{\delta}}(\mathcal{E}) = 0$.

(T_2) Suppose that $\left\{ (f_{\ell})_j \mid f_{\ell} = \bigcup_{j \in J} (f_{\ell})_j \right\}$ and $\left\{ (g_j)_j \mid g_j = \bigcup_{\kappa \in \Gamma} (g_j)_{\kappa} \right\}$, for every $\tilde{e} \in \mathcal{E}$ are families, then there exists $\left\{ (f_{\ell})_j \tilde{\cap} (g_j)_{\kappa} \right\}$ such that

$$\begin{aligned} f_{\ell} \tilde{\cap} g_j &= \left(\bigcup_{j \in J} (f_{\ell})_j \right) \tilde{\cap} \left(\bigcup_{\kappa \in \Gamma} (g_j)_{\kappa} \right) \\ &= \bigcup_{j \in J, \kappa \in \Gamma} (f_{\ell})_j \tilde{\cap} (g_j)_{\kappa}. \end{aligned}$$

It implies that

$$\begin{aligned} (\tilde{T}_{\mathcal{L}}^{\tilde{\sigma}})_{\tilde{e}}(f_{\ell} \tilde{\cap} g_j) &\geq \bigcap_{j \in J, \kappa \in \Gamma} \mathbf{L}_{\tilde{e}}^{\tilde{\sigma}}((f_{\ell})_j \tilde{\cap} (g_j)_{\kappa}) \\ &\geq \bigcap_{j \in J, \kappa \in \Gamma} \left(\mathbf{L}_{\tilde{e}}^{\tilde{\sigma}}((f_{\ell})_j) \cap \mathbf{L}_{\tilde{e}}^{\tilde{\sigma}}((g_j)_{\kappa}) \right) \\ &\geq \left(\bigcap_{j \in J} \mathbf{L}_{\tilde{e}}^{\tilde{\sigma}}((f_{\ell})_j) \right) \cap \left(\bigcap_{\kappa \in \Gamma} \mathbf{L}_{\tilde{e}}^{\tilde{\sigma}}((g_j)_{\kappa}) \right) \\ &\geq (\tilde{T}_{\mathcal{L}}^{\tilde{\sigma}})_{\tilde{e}}(f_{\ell}) \cap (\tilde{T}_{\mathcal{L}}^{\tilde{\sigma}})_{\tilde{e}}(g_j) \\ (\tilde{T}_{\mathcal{L}}^{\tilde{\zeta}})_{\tilde{e}}(f_{\ell} \tilde{\cap} g_j) &\leq \bigcup_{j \in J, \kappa \in \Gamma} \mathbf{L}_{\tilde{e}}^{\tilde{\zeta}}((f_{\ell})_j \tilde{\cap} (g_j)_{\kappa}) \\ &\leq \bigcup_{j \in J, \kappa \in \Gamma} \left(\mathbf{L}_{\tilde{e}}^{\tilde{\zeta}}((f_{\ell})_j) \cap \mathbf{L}_{\tilde{e}}^{\tilde{\zeta}}((g_j)_{\kappa}) \right) \\ &\leq \left(\bigcup_{j \in J} \mathbf{L}_{\tilde{e}}^{\tilde{\zeta}}((f_{\ell})_j) \right) \cap \left(\bigcup_{\kappa \in \Gamma} \mathbf{L}_{\tilde{e}}^{\tilde{\zeta}}((g_j)_{\kappa}) \right) \\ &\leq \left(\bigcup_{j \in J} \mathbf{L}_{\tilde{e}}^{\tilde{\zeta}}((f_{\ell})_j) \right) \cup \left(\bigcup_{\kappa \in \Gamma} \mathbf{L}_{\tilde{e}}^{\tilde{\zeta}}((g_j)_{\kappa}) \right) \\ &\leq (\tilde{T}_{\mathcal{L}}^{\tilde{\zeta}})_{\tilde{e}}(f_{\ell}) \cup (\tilde{T}_{\mathcal{L}}^{\tilde{\zeta}})_{\tilde{e}}(g_j) \\ (\tilde{T}_{\mathcal{L}}^{\tilde{\delta}})_{\tilde{e}}(f_{\ell} \tilde{\cap} g_j) &\leq \bigcup_{j \in J, \kappa \in \Gamma} \mathbf{L}_{\tilde{e}}^{\tilde{\delta}}((f_{\ell})_j \tilde{\cap} (g_j)_{\kappa}) \\ &\leq \bigcup_{j \in J, \kappa \in \Gamma} \left(\mathbf{L}_{\tilde{e}}^{\tilde{\delta}}((f_{\ell})_j) \cap \mathbf{L}_{\tilde{e}}^{\tilde{\delta}}((g_j)_{\kappa}) \right) \end{aligned}$$

$$\begin{aligned} &\leq \left(\bigcup_{j \in J} \mathbf{L}_{\tilde{e}}^{\tilde{\delta}}((f_{\ell})_j) \right) \cap \left(\bigcup_{\kappa \in \Gamma} \mathbf{L}_{\tilde{e}}^{\tilde{\delta}}((g_j)_{\kappa}) \right) \\ &\leq \left(\bigcup_{j \in J} \mathbf{L}_{\tilde{e}}^{\tilde{\delta}}((f_{\ell})_j) \right) \cup \left(\bigcup_{\kappa \in \Gamma} \mathbf{L}_{\tilde{e}}^{\tilde{\delta}}((g_j)_{\kappa}) \right) \\ &\leq (\tilde{T}_{\mathcal{L}}^{\tilde{\delta}})_{\tilde{e}}(f_{\ell}) \cup (\tilde{T}_{\mathcal{L}}^{\tilde{\delta}})_{\tilde{e}}(g_j). \end{aligned}$$

(T_3) Let $\tilde{e} \in \mathcal{E}$ and Υ_i be a family index sets Ω_i such that $\left\{ (f_{\ell})_{i_{\omega}} \in \widehat{(\mathcal{L}, \mathcal{E})} \mid (f_{\ell})_i = \bigcup_{\omega \in \Omega_i} (f_{\ell})_{i_{\omega}} \right\}$ with $f_{\ell} = \bigcup_{i \in \Gamma} (f_{\ell})_i = \bigcup_{i \in \Gamma} \bigcup_{\omega \in \Omega_i} (f_{\ell})_{i_{\omega}}$. for every $i \in \Gamma$ and $\mathfrak{N} \in \mathfrak{B}_{i \in \Gamma \Upsilon_i}$ with $\mathfrak{N}(i) = \Omega_i$, we obtain

$$\begin{aligned} (\tilde{T}_{\mathcal{L}}^{\tilde{\sigma}})_{\tilde{e}}(f_{\ell}) &\geq \bigcap_{i \in \Gamma} \left(\bigcap_{\omega \in \Omega_i} \mathbf{L}_{\tilde{e}}^{\tilde{\sigma}}((f_{\ell})_{i_{\omega}}) \right), \\ (\tilde{T}_{\mathcal{L}}^{\tilde{\zeta}})_{\tilde{e}}(f_{\ell}) &\leq \bigcup_{i \in \Gamma} \left(\bigcup_{\omega \in \Omega_i} \mathbf{L}_{\tilde{e}}^{\tilde{\zeta}}((f_{\ell})_{i_{\omega}}) \right), \\ (\tilde{T}_{\mathcal{L}}^{\tilde{\delta}})_{\tilde{e}}(f_{\ell}) &\leq \bigcup_{i \in \Gamma} \left(\bigcup_{\omega \in \Omega_i} \mathbf{L}_{\tilde{e}}^{\tilde{\delta}}((f_{\ell})_{i_{\omega}}) \right). \end{aligned}$$

Put $\alpha_i, \mathfrak{N}_i = \bigcap_{\omega \in \Omega_i} (\mathbf{L}_{\tilde{e}}^{\tilde{\sigma}, \tilde{\zeta}, \tilde{\delta}}((f_{\ell})_{i_{\omega}}))$. Then,

$$\begin{aligned} (\tilde{T}_{\mathcal{L}}^{\tilde{\sigma}})_{\tilde{e}}(f_{\ell}) &\geq \bigcup_{\mathfrak{N} \in \mathfrak{B}_{i \in \Gamma \Upsilon_i}} \left(\bigcap_{i \in \Gamma} \alpha_i, \mathfrak{N}_i \right) \\ &= \bigcap_{i \in \Gamma} \left(\bigcup_{\eta_i \in \Upsilon_i} \alpha_i, \eta_i \right) \\ &= \bigcap_{i \in \Gamma} \left(\bigcup_{\eta_i \in \Upsilon_i} \left(\bigcap_{\mu \in \eta_i} \mathbf{L}_{\tilde{e}}^{\tilde{\sigma}}(f_{\ell})_{i_{\mu}} \right) \right) = \bigcap_{i \in \Gamma} (\tilde{T}_{\mathcal{L}}^{\tilde{\sigma}})_{\tilde{e}}(f_{\ell})_i. \\ (\tilde{T}_{\mathcal{L}}^{\tilde{\zeta}})_{\tilde{e}}(f_{\ell}) &\leq \bigcap_{\mathfrak{N} \in \mathfrak{B}_{i \in \Gamma \Upsilon_i}} \left(\bigcup_{i \in \Gamma} \alpha_i, \mathfrak{N}_i \right) = \bigcup_{i \in \Gamma} \left(\bigcap_{\eta_i \in \Upsilon_i} \alpha_i, \eta_i \right) \\ &= \bigcup_{i \in \Gamma} \left(\bigcap_{\eta_i \in \Upsilon_i} \left(\bigcup_{\mu \in \eta_i} \mathbf{L}_{\tilde{e}}^{\tilde{\zeta}}(f_{\ell})_{i_{\mu}} \right) \right) = \bigcup_{i \in \Gamma} (\tilde{T}_{\mathcal{L}}^{\tilde{\zeta}})_{\tilde{e}}(f_{\ell})_i. \\ (\tilde{T}_{\mathcal{L}}^{\tilde{\delta}})_{\tilde{e}}(f_{\ell}) &\leq \bigcap_{\mathfrak{N} \in \mathfrak{B}_{i \in \Gamma \Upsilon_i}} \left(\bigcup_{i \in \Gamma} \alpha_i, \mathfrak{N}_i \right) = \bigcup_{i \in \Gamma} \left(\bigcap_{\eta_i \in \Upsilon_i} \alpha_i, \eta_i \right) \\ &= \bigcup_{i \in \Gamma} \left(\bigcap_{\eta_i \in \Upsilon_i} \left(\bigcup_{\mu \in \eta_i} \mathbf{L}_{\tilde{e}}^{\tilde{\delta}}(f_{\ell})_{i_{\mu}} \right) \right) = \bigcup_{i \in \Gamma} (\tilde{T}_{\mathcal{L}}^{\tilde{\delta}})_{\tilde{e}}(f_{\ell})_i. \end{aligned}$$

Thus, $(\tilde{T}_{\mathcal{L}}^{\tilde{\sigma}}, \tilde{T}_{\mathcal{L}}^{\tilde{\zeta}}, \tilde{T}_{\mathcal{L}}^{\tilde{\delta}})$ is *svnft* on \mathcal{L} . □

Theorem 6 Let $(\tilde{T}^{\tilde{\sigma}}, \tilde{T}^{\tilde{\zeta}}, \tilde{T}^{\tilde{\delta}})$ be a *svnft* on \mathcal{L} and $(\mathbf{L}^{\tilde{\sigma}}, \mathbf{L}^{\tilde{\zeta}}, \mathbf{L}^{\tilde{\delta}})$ be a *snvf-base* on \mathcal{G} . Then, the single-valued neutrosophic soft

mapping $\vartheta_\varphi : (\widehat{\mathcal{L}}, \widehat{\mathcal{E}}) \rightarrow (\widehat{\mathcal{G}}, \widehat{\mathcal{Y}})$ is *svnfc* – map if and only if

$$\begin{aligned} \tilde{\tau}_\varphi^{\tilde{\sigma}}(\vartheta_\varphi^{-1}(g_j)) &\geq \mathbf{L}_{\varphi(\tilde{\sigma})}^{\tilde{\sigma}}(g_j), & \tilde{\tau}_\varphi^{\tilde{\zeta}}(\vartheta_\varphi^{-1}(g_j)) &\leq \mathbf{L}_{\varphi(\tilde{\zeta})}^{\tilde{\zeta}}(g_j), \\ \tilde{\tau}_\varphi^{\tilde{\delta}}(\vartheta_\varphi^{-1}(g_j)) &\leq \mathbf{L}_{\varphi(\tilde{\delta})}^{\tilde{\delta}}(g_j), \end{aligned}$$

for each $g_j \in (\widehat{\mathcal{G}}, \widehat{\mathcal{Y}})$ and $\tilde{\sigma} \in \mathcal{E}$.

Proof (\Rightarrow) Let $\vartheta_\varphi : (\mathcal{L}, \tilde{\tau}_\varphi^{\tilde{\sigma}\tilde{\zeta}\tilde{\delta}}) \rightarrow (\mathcal{G}, \tilde{\tau}_\varphi^{\tilde{\sigma}\tilde{\zeta}\tilde{\delta}})$ be a *svnfc*-map and $g_j \in (\widehat{\mathcal{G}}, \widehat{\mathcal{Y}})$. Then,

$$\begin{aligned} \tilde{\tau}_\varphi^{\tilde{\sigma}}(\vartheta_\varphi^{-1}(g_j)) &\geq (\tilde{\tau}_\varphi^{\tilde{\sigma}})_{\varphi(\tilde{\sigma})}(g_j) \geq \mathbf{L}_{\varphi(\tilde{\sigma})}^{\tilde{\sigma}}(g_j), \\ \tilde{\tau}_\varphi^{\tilde{\zeta}}(\vartheta_\varphi^{-1}(g_j)) &\leq (\tilde{\tau}_\varphi^{\tilde{\zeta}})_{\varphi(\tilde{\zeta})}(g_j) \leq \mathbf{L}_{\varphi(\tilde{\zeta})}^{\tilde{\zeta}}(g_j), \\ \tilde{\tau}_\varphi^{\tilde{\delta}}(\vartheta_\varphi^{-1}(g_j)) &\leq (\tilde{\tau}_\varphi^{\tilde{\delta}})_{\varphi(\tilde{\delta})}(g_j) \leq \mathbf{L}_{\varphi(\tilde{\delta})}^{\tilde{\delta}}(g_j), \end{aligned}$$

(\Leftarrow) Let $\tilde{\tau}_\varphi^{\tilde{\sigma}}(\vartheta_\varphi^{-1}(g_j)) \geq \mathbf{L}_{\varphi(\tilde{\sigma})}^{\tilde{\sigma}}(g_j)$, $\tilde{\tau}_\varphi^{\tilde{\zeta}}(\vartheta_\varphi^{-1}(g_j)) \leq \mathbf{L}_{\varphi(\tilde{\zeta})}^{\tilde{\zeta}}(g_j)$ and $\tilde{\tau}_\varphi^{\tilde{\delta}}(\vartheta_\varphi^{-1}(g_j)) \leq \mathbf{L}_{\varphi(\tilde{\delta})}^{\tilde{\delta}}(g_j)$ for each $g_j \in (\widehat{\mathcal{G}}, \widehat{\mathcal{Y}})$ and let $h_\partial \in (\widehat{\mathcal{G}}, \widehat{\mathcal{Y}})$ for any family of $\left\{ (h_\partial)_j \in (\widehat{\mathcal{G}}, \widehat{\mathcal{Y}}) \mid h_\partial = \bigcup_{j \in \Gamma} (h_\partial)_j \right\}$, we obtain

$$\begin{aligned} \tilde{\tau}_\varphi^{\tilde{\sigma}}(\vartheta_\varphi^{-1}(h_\partial)) &= \tilde{\tau}_\varphi^{\tilde{\sigma}}\left(\vartheta_\varphi^{-1}\left(\bigcup_{j \in \Gamma} (h_\partial)_j\right)\right) = \tilde{\tau}_\varphi^{\tilde{\sigma}}\left(\bigcup_{j \in \Gamma} \vartheta_\varphi^{-1}((h_\partial)_j)\right) \\ &\geq \bigcap_{j \in \Gamma} \tilde{\tau}_\varphi^{\tilde{\sigma}}(\vartheta_\varphi^{-1}((h_\partial)_j)) \geq \bigcap_{j \in \Gamma} \mathbf{L}_{\varphi(\tilde{\sigma})}^{\tilde{\sigma}}((h_\partial)_j) \\ \tilde{\tau}_\varphi^{\tilde{\zeta}}(\vartheta_\varphi^{-1}(h_\partial)) &= \tilde{\tau}_\varphi^{\tilde{\zeta}}\left(\vartheta_\varphi^{-1}\left(\bigcup_{j \in \Gamma} (h_\partial)_j\right)\right) \\ &= \tilde{\tau}_\varphi^{\tilde{\zeta}}\left(\bigcap_{j \in \Gamma} \vartheta_\varphi^{-1}((h_\partial)_j)\right) \\ &\leq \bigcup_{j \in \Gamma} \tilde{\tau}_\varphi^{\tilde{\zeta}}(\vartheta_\varphi^{-1}((h_\partial)_j)) \leq \bigcup_{j \in \Gamma} \mathbf{L}_{\varphi(\tilde{\zeta})}^{\tilde{\zeta}}((h_\partial)_j) \\ \tilde{\tau}_\varphi^{\tilde{\delta}}(\vartheta_\varphi^{-1}(h_\partial)) &= \tilde{\tau}_\varphi^{\tilde{\delta}}\left(\vartheta_\varphi^{-1}\left(\bigcup_{j \in \Gamma} (h_\partial)_j\right)\right) = \tilde{\tau}_\varphi^{\tilde{\delta}}\left(\bigcap_{j \in \Gamma} \vartheta_\varphi^{-1}((h_\partial)_j)\right) \\ &\leq \bigcup_{j \in \Gamma} \tilde{\tau}_\varphi^{\tilde{\delta}}(\vartheta_\varphi^{-1}((h_\partial)_j)) \leq \bigcup_{j \in \Gamma} \mathbf{L}_{\varphi(\tilde{\delta})}^{\tilde{\delta}}((h_\partial)_j) \end{aligned}$$

Thus,

$$\begin{aligned} \tilde{\tau}_\varphi^{\tilde{\sigma}}(\vartheta_\varphi^{-1}(h_\partial)) &\geq (\tilde{\tau}_\varphi^{\tilde{\sigma}})_{\varphi(\tilde{\sigma})}(h_\partial), \\ \tilde{\tau}_\varphi^{\tilde{\zeta}}(\vartheta_\varphi^{-1}(h_\partial)) &\leq (\tilde{\tau}_\varphi^{\tilde{\zeta}})_{\varphi(\tilde{\zeta})}(h_\partial), \\ \tilde{\tau}_\varphi^{\tilde{\delta}}(\vartheta_\varphi^{-1}(h_\partial)) &\leq (\tilde{\tau}_\varphi^{\tilde{\delta}})_{\varphi(\tilde{\delta})}(h_\partial). \end{aligned}$$

□

Theorem 7 Let $\{(\mathcal{L}_i, (\tilde{\tau}_i^{\tilde{\sigma}})_{\mathcal{E}_i}), (\mathcal{L}_i, (\tilde{\tau}_i^{\tilde{\zeta}})_{\mathcal{E}_i}), (\mathcal{L}_i, (\tilde{\tau}_i^{\tilde{\delta}})_{\mathcal{E}_i})\}$ be a family of *svnfts*, \mathcal{E} be a parameter set, \mathcal{L} be a non-null set and for

every $i \in \Gamma$, $\vartheta_i : \mathcal{L} \rightarrow \mathcal{L}_i$ and $\varphi_i : \mathcal{E} \rightarrow \mathcal{E}_i$ be a mapping. Define $\mathbf{L}^{\tilde{\sigma}}, \mathbf{L}^{\tilde{\zeta}}, \mathbf{L}^{\tilde{\delta}} : \mathcal{E} \rightarrow \xi^{\widehat{(\mathcal{L}, \mathcal{E})}}$ on \mathcal{L} as follows:

$$\begin{aligned} \mathbf{L}_\varphi^{\tilde{\sigma}}(f_\ell) &= \bigcup \left\{ \bigcap_{j=1}^n (\tilde{\tau}_{\omega_j}^{\tilde{\sigma}})_{\varphi_{\omega_j}(\tilde{\sigma})}((f_\ell)_{\omega_j}) \mid f_\ell = \bigcap_{j=1}^n (\vartheta_{\omega_j})_{\omega_j}^{-1}((f_\ell)_{\omega_j}) \right\} \\ \mathbf{L}_\varphi^{\tilde{\zeta}}(f_\ell) &= \bigcap \left\{ \bigcup_{j=1}^n (\tilde{\tau}_{\omega_j}^{\tilde{\zeta}})_{\varphi_{\omega_j}(\tilde{\zeta})}((f_\ell)_{\omega_j}) \mid f_\ell = \bigcap_{j=1}^n (\vartheta_{\omega_j})_{\omega_j}^{-1}((f_\ell)_{\omega_j}) \right\} \\ \mathbf{L}_\varphi^{\tilde{\delta}}(f_\ell) &= \bigcap \left\{ \bigcup_{j=1}^n (\tilde{\tau}_{\omega_j}^{\tilde{\delta}})_{\varphi_{\omega_j}(\tilde{\delta})}((f_\ell)_{\omega_j}) \mid f_\ell = \bigcap_{j=1}^n (\vartheta_{\omega_j})_{\omega_j}^{-1}((f_\ell)_{\omega_j}) \right\}, \end{aligned}$$

where $\Omega = \{\omega_1, \omega_2, \dots, \omega_n \subseteq \Gamma\}$. Then,

- (1) $(\mathbf{L}^{\tilde{\sigma}}, \mathbf{L}^{\tilde{\zeta}}, \mathbf{L}^{\tilde{\delta}})$ is a *svnfc*-base on \mathcal{L} .
- (2) The *svnft* $(\tilde{\tau}_\varphi^{\tilde{\sigma}}, \tilde{\tau}_\varphi^{\tilde{\zeta}}, \tilde{\tau}_\varphi^{\tilde{\delta}})$ generated by $(\mathbf{L}^{\tilde{\sigma}}, \mathbf{L}^{\tilde{\zeta}}, \mathbf{L}^{\tilde{\delta}})$ is the *svnft* on \mathcal{L} for which every $(\vartheta_\varphi)_i, i \in \Gamma$ are *svnfc*-maps.
- (3) A map $\vartheta_\varphi : (\mathcal{G}, (\tilde{\tau}_\varphi^{\tilde{\sigma}\tilde{\zeta}\tilde{\delta}})_{\mathcal{F}}) \rightarrow (\mathcal{L}, (\tilde{\tau}_\varphi^{\tilde{\sigma}\tilde{\zeta}\tilde{\delta}})_{\mathcal{E}})$ is a *svnfc*-map iff for any $i \in \Gamma$, $(\vartheta_\varphi)_i \circ \vartheta_\varphi : (\mathcal{G}, (\tilde{\tau}_\varphi^{\tilde{\sigma}\tilde{\zeta}\tilde{\delta}})_{\mathcal{F}}) \rightarrow (\mathcal{L}_i, (\tilde{\tau}_i^{\tilde{\sigma}\tilde{\zeta}\tilde{\delta}})_{\mathcal{E}_i})$ is a *svnfc*-map.

Proof (1) (\mathbf{L}_1) Since $f_\ell = (\vartheta_\varphi)_i^{-1}(f_\ell)$ for every $f_\ell = \{\Phi, \tilde{\mathcal{E}}\}$, $\mathbf{L}_\varphi^{\tilde{\sigma}}(\Phi) = \mathbf{L}_\varphi^{\tilde{\sigma}}(\tilde{\mathcal{E}}) = 1$ and $\mathbf{L}_\varphi^{\tilde{\zeta}}(\Phi) = \mathbf{L}_\varphi^{\tilde{\zeta}}(\tilde{\mathcal{E}}) = \mathbf{L}_\varphi^{\tilde{\delta}}(\Phi) = \mathbf{L}_\varphi^{\tilde{\delta}}(\tilde{\mathcal{E}}) = 0, \forall \tilde{\sigma} \in \mathcal{E}$.

(\mathbf{L}_2) For each $J = \{j_1, j_2, \dots, j_m\}$ and $\Omega = \{\omega_1, \omega_2, \dots, \omega_n\}$ of γ such that $f_\ell = \bigcap_{i=1}^n (\vartheta_\varphi)_{\omega_i}^{-1}((f_\ell)_{\omega_i})$ and $g_j = \bigcap_{i=1}^m (\vartheta_\varphi)_{j_i}^{-1}((g_j)_{j_i})$, we have

$$\begin{aligned} f_\ell \tilde{\cap} g_j &= \left\{ \left(\tilde{\sigma} \bigcap_{i=1}^n (\vartheta_\varphi)_{\omega_i}^{-1}((f_\ell)_{\omega_i}) \right)_{\tilde{\sigma}} \cap \left(\tilde{\sigma} \bigcap_{i=1}^m (\vartheta_\varphi)_{j_i}^{-1}((g_j)_{j_i}) \right)_{\tilde{\sigma}} \right\}, \\ &\quad \left(\tilde{\zeta} \bigcap_{i=1}^n (\vartheta_\varphi)_{\omega_i}^{-1}((f_\ell)_{\omega_i}) \right)_{\tilde{\zeta}} \cup \left(\tilde{\zeta} \bigcap_{i=1}^m (\vartheta_\varphi)_{j_i}^{-1}((g_j)_{j_i}) \right)_{\tilde{\zeta}}, \\ &\quad \left(\tilde{\delta} \bigcap_{i=1}^n (\vartheta_\varphi)_{\omega_i}^{-1}((f_\ell)_{\omega_i}) \right)_{\tilde{\delta}} \cup \left(\tilde{\delta} \bigcap_{i=1}^m (\vartheta_\varphi)_{j_i}^{-1}((g_j)_{j_i}) \right)_{\tilde{\delta}} \} \end{aligned}$$

Furthermore, we have for each $\omega \in \Omega \cap J$

$$(\vartheta_\varphi)_\omega^{-1}((f_\ell)_\omega) \cap (\vartheta_\varphi)_\omega^{-1}((g_j)_\omega) = (\vartheta_\varphi)_\omega^{-1}((f_\ell)_\omega \cap (g_j)_\omega).$$

Put $f_\ell \tilde{\cap} g_j = \left\{ \left(\tilde{\sigma} \bigcap_{m_i \in \Omega \cup J} (\vartheta_\varphi)_{m_i}^{-1}(h_\partial)_{(m_i)} \right)_{\tilde{\sigma}} \cup \left(\tilde{\sigma} \bigcup_{m_i \in \Omega \cup J} (\vartheta_\varphi)_{m_i}^{-1}(h_\partial)_{(m_i)} \right)_{\tilde{\sigma}} \right\}$ where

$$\tilde{\sigma}(h_\partial)_{(m_i)}(r) = \begin{cases} \tilde{\sigma}_{f_{(m_i)}}(r), & \text{if } m_i \in \ell - J, \\ \tilde{\sigma}_{g_{(m_i)}}(r), & \text{if } m_i \in J - \ell, \\ \tilde{\sigma}_{f_{(m_i)}}(r) \cap \tilde{\sigma}_{g_{(m_i)}}(r), & \text{if } m_i \in \ell \cap J. \end{cases}$$

$$\tilde{S}_{(h_{\partial})_{(m_i)}}(r) = \begin{cases} \tilde{S}_{f_{(m_i)}}(r), & \text{if } m_i \in \ell - J, \\ \tilde{S}_{g_{(m_i)}}(r), & \text{if } m_i \in J - \ell, \\ \tilde{S}_{f_{(m_i)}}(r) \cup \tilde{S}_{g_{(m_i)}}(r), & \text{if } m_i \in \ell \cap J. \end{cases}$$

$$\tilde{\delta}_{(h_{\partial})_{(m_i)}}(r) = \begin{cases} \tilde{\delta}_{f_{(m_i)}}(r), & \text{if } m_i \in \ell - J, \\ \tilde{\delta}_{g_{(m_i)}}(r), & \text{if } m_i \in J - \ell, \\ \tilde{\delta}_{f_{(m_i)}}(r) \cup \tilde{\delta}_{g_{(m_i)}}(r), & \text{if } m_i \in \ell \cap J. \end{cases}$$

So, we obtain

$$\mathbf{L}_{\tilde{e}}^{\tilde{\sigma}}(f_{\ell} \tilde{\cap} f_J) \geq \bigcap_{j \in \Omega \cup J} (\tilde{T}_j^{\tilde{\sigma}})_{(\varphi_j)(\tilde{e})}(h_{\partial})_j$$

$$\geq \left(\bigcap_{i=1}^n (\tilde{T}_{\omega_i}^{\tilde{\sigma}})_{(\varphi_{\omega_i})(\tilde{e})}((f_{\ell})_{\omega_i}) \right)$$

$$\cap \left(\bigcap_{i=1}^m (\tilde{T}_{j_i}^{\tilde{\sigma}})_{(\varphi_{j_i})(\tilde{e})}((g_J)_{j_i}) \right)$$

If we take the sup over the families $f_{\ell} = \bigcap_{i=1}^{\tilde{n}} (\vartheta_{\varphi})_{\omega_i}^{-1}((f_{\ell})_{\omega_i})$

and $g_J = \bigcap_{i=1}^{\tilde{m}} (\vartheta_{\varphi})_{j_i}^{-1}((g_J)_{j_i})$, then we have

$$\mathbf{L}_{\tilde{e}}^{\tilde{\sigma}}(f_{\ell} \tilde{\cap} f_J) \geq \mathbf{L}_{\tilde{e}}^{\tilde{\sigma}}(f_{\ell}) \cap \mathbf{L}_{\tilde{e}}^{\tilde{\sigma}}(f_J), \quad \forall \tilde{e} \in \mathcal{E}, \tag{3}$$

and on the other hand,

$$\mathbf{L}_{\tilde{e}}^{\tilde{\zeta}}(f_{\ell} \tilde{\cap} f_J) \leq \bigcup_{j \in \Omega \cup J} (\tilde{T}_j^{\tilde{\zeta}})_{(\varphi_j)(\tilde{e})}(h_{\partial})_j$$

$$\leq \left(\bigcup_{i=1}^n (\tilde{T}_{\omega_i}^{\tilde{\zeta}})_{(\varphi_{\omega_i})(\tilde{e})}((f_{\ell})_{\omega_i}) \right)$$

$$\cup \left(\bigcup_{i=1}^m (\tilde{T}_{j_i}^{\tilde{\zeta}})_{(\varphi_{j_i})(\tilde{e})}((g_J)_{j_i}) \right).$$

If we take the sup over the families $f_{\ell} = \bigcup_{i=1}^{\tilde{n}} (\vartheta_{\varphi})_{\omega_i}^{-1}((f_{\ell})_{\omega_i})$

and $g_J = \bigcup_{i=1}^{\tilde{m}} (\vartheta_{\varphi})_{j_i}^{-1}((g_J)_{j_i})$, then we have

$$\mathbf{L}_{\tilde{e}}^{\tilde{\zeta}}(f_{\ell} \tilde{\cap} f_J) \leq \mathbf{L}_{\tilde{e}}^{\tilde{\zeta}}(f_{\ell}) \cup \mathbf{L}_{\tilde{e}}^{\tilde{\zeta}}(f_J), \quad \forall \tilde{e} \in \mathcal{E}. \tag{4}$$

Also,

$$\mathbf{L}_{\tilde{e}}^{\tilde{\delta}}(f_{\ell} \tilde{\cap} f_J) \leq \bigcup_{j \in \Omega \cup J} (\tilde{T}_j^{\tilde{\delta}})_{(\varphi_j)(\tilde{e})}(h_{\partial})_j$$

$$\leq \left(\bigcup_{i=1}^n (\tilde{T}_{\omega_i}^{\tilde{\delta}})_{(\varphi_{\omega_i})(\tilde{e})}((f_{\ell})_{\omega_i}) \right)$$

$$\cup \left(\bigcup_{i=1}^m (\tilde{T}_{j_i}^{\tilde{\delta}})_{(\varphi_{j_i})(\tilde{e})}((g_J)_{j_i}) \right)$$

If we take the sup over the families $f_{\ell} = \bigcup_{i=1}^{\tilde{n}} (\vartheta_{\varphi})_{\omega_i}^{-1}((f_{\ell})_{\omega_i})$

and $g_J = \bigcup_{i=1}^{\tilde{m}} (\vartheta_{\varphi})_{j_i}^{-1}((g_J)_{j_i})$, then we have

$$\mathbf{L}_{\tilde{e}}^{\tilde{\delta}}(f_{\ell} \tilde{\cap} f_J) \leq \mathbf{L}_{\tilde{e}}^{\tilde{\delta}}(f_{\ell}) \cup \mathbf{L}_{\tilde{e}}^{\tilde{\delta}}(f_J), \quad \forall \tilde{e} \in \mathcal{E}. \tag{5}$$

From Eqs. (3), (4) and (5), we have $\mathbf{L}_{\tilde{e}}^{\tilde{\sigma}}(f_{\ell} \tilde{\cap} f_J) \geq \mathbf{L}_{\tilde{e}}^{\tilde{\sigma}}(f_{\ell}) \cap \mathbf{L}_{\tilde{e}}^{\tilde{\sigma}}(f_J)$, $\mathbf{L}_{\tilde{e}}^{\tilde{\zeta}}(f_{\ell} \tilde{\cap} f_J) \leq \mathbf{L}_{\tilde{e}}^{\tilde{\zeta}}(f_{\ell}) \cup \mathbf{L}_{\tilde{e}}^{\tilde{\zeta}}(f_J)$, $\mathbf{L}_{\tilde{e}}^{\tilde{\delta}}(f_{\ell} \tilde{\cap} f_J) \leq \mathbf{L}_{\tilde{e}}^{\tilde{\delta}}(f_{\ell}) \cup \mathbf{L}_{\tilde{e}}^{\tilde{\delta}}(f_J)$, $\forall f_{\ell}, g_J \in \widehat{(\mathcal{F}, \mathcal{E})}$.

(2) For any $(f_{\ell})_i \in \widehat{(\mathcal{F}_i, \mathcal{E})}_i$, one collection $\{(\vartheta_{\varphi})_i^{-1}((f_{\ell})_i)\}$ and $i \in \Gamma$, for each $\tilde{e} \in \mathcal{E}$, we obtain

$$(\tilde{T}_{\tilde{e}}^{\tilde{\sigma}})_{\tilde{e}}(\vartheta_{\varphi})_i^{-1}((f_{\ell})_i) \geq \mathbf{L}_{\tilde{e}}^{\tilde{\sigma}}(\vartheta_{\varphi})_i^{-1}((f_{\ell})_i) \geq (\tilde{T}_i^{\tilde{\sigma}})_{(\varphi_i)(\tilde{e})}((f_{\ell})_i),$$

$$(\tilde{T}_{\tilde{e}}^{\tilde{\zeta}})_{\tilde{e}}(\vartheta_{\varphi})_i^{-1}((f_{\ell})_i) \leq \mathbf{L}_{\tilde{e}}^{\tilde{\zeta}}(\vartheta_{\varphi})_i^{-1}((f_{\ell})_i) \leq (\tilde{T}_i^{\tilde{\zeta}})_{(\varphi_i)(\tilde{e})}((f_{\ell})_i),$$

$$(\tilde{T}_{\tilde{e}}^{\tilde{\delta}})_{\tilde{e}}(\vartheta_{\varphi})_i^{-1}((f_{\ell})_i) \leq \mathbf{L}_{\tilde{e}}^{\tilde{\delta}}(\vartheta_{\varphi})_i^{-1}((f_{\ell})_i) \leq (\tilde{T}_i^{\tilde{\delta}})_{(\varphi_i)(\tilde{e})}((f_{\ell})_i).$$

Therefore, for each $i \in \Gamma$, $(\vartheta_{\varphi})_i : (\mathcal{F}, (\tilde{T}_{\mathcal{L}}^{\tilde{\sigma}\tilde{\zeta}\tilde{\delta}})_{\mathcal{E}}) \rightarrow (\mathcal{F}_i, (\tilde{T}_i^{\tilde{\sigma}\tilde{\zeta}\tilde{\delta}})_{\mathcal{E}_i})$ is a svnfc-map. Let $(\vartheta_{\varphi})_i : (\mathcal{F}, (\tilde{T}_{\mathcal{L}}^{\tilde{\sigma}\tilde{\zeta}\tilde{\delta}})_{\mathcal{E}}) \rightarrow (\mathcal{F}_i, (\tilde{T}_i^{\tilde{\sigma}\tilde{\zeta}\tilde{\delta}})_{\mathcal{E}_i})$ be a svnfc-map and $(f_{\ell})_i \in \widehat{(\mathcal{F}_i, \mathcal{E}_i)}$, $\forall i \in \Gamma$ we have,

$$\tilde{\tau}_{\tilde{e}}^{\tilde{\sigma}}((\vartheta_{\varphi})_i^{-1}((f_{\ell})_i)) \geq (\tilde{T}_i^{\tilde{\sigma}})_{(\varphi_i)(\tilde{e})}((f_{\ell})_i),$$

$$\tilde{\tau}_{\tilde{e}}^{\tilde{\zeta}}((\vartheta_{\varphi})_i^{-1}((f_{\ell})_i)) \leq (\tilde{T}_i^{\tilde{\zeta}})_{(\varphi_i)(\tilde{e})}((f_{\ell})_i),$$

$$\tilde{\tau}_{\tilde{e}}^{\tilde{\delta}}((\vartheta_{\varphi})_i^{-1}((f_{\ell})_i)) \leq (\tilde{T}_i^{\tilde{\delta}})_{(\varphi_i)(\tilde{e})}((f_{\ell})_i),$$

For each $\Omega = \{\omega_1, \omega_2, \dots, \omega_n\}$ of γ such that $f_{\ell} = \bigcap_{i=1}^{\tilde{n}} (\vartheta_{\varphi})_{\omega_i}^{-1}((f_{\ell})_{\omega_i})$ we obtain

$$\tilde{\tau}_{\tilde{e}}^{\tilde{\sigma}}(f_{\ell}) \geq \bigcap_{i=1}^n \tilde{\tau}_{\tilde{e}}^{\tilde{\sigma}}(\vartheta_{\varphi})_{\omega_i}^{-1}((f_{\ell})_{\omega_i}) \geq \bigcap_{i=1}^n (\tilde{T}_{\omega_i}^{\tilde{\sigma}})_{(\varphi_{\omega_i})(\tilde{e})}((f_{\ell})_{\omega_i}),$$

$$\tilde{\tau}_{\tilde{e}}^{\tilde{\zeta}}(f_{\ell}) \leq \bigcup_{i=1}^n \tilde{\tau}_{\tilde{e}}^{\tilde{\zeta}}(\vartheta_{\varphi})_{\omega_i}^{-1}((f_{\ell})_{\omega_i}) \leq \bigcup_{i=1}^n (\tilde{T}_{\omega_i}^{\tilde{\zeta}})_{(\varphi_{\omega_i})(\tilde{e})}((f_{\ell})_{\omega_i}),$$

$$\tilde{\tau}_{\tilde{e}}^{\tilde{\delta}}(f_{\ell}) \leq \bigcup_{i=1}^n \tilde{\tau}_{\tilde{e}}^{\tilde{\delta}}(\vartheta_{\varphi})_{\omega_i}^{-1}((f_{\ell})_{\omega_i}) \leq \bigcup_{i=1}^n (\tilde{T}_{\omega_i}^{\tilde{\delta}})_{(\varphi_{\omega_i})(\tilde{e})}((f_{\ell})_{\omega_i}).$$

It implies for any $\tilde{e} \in \mathcal{E}$

$$\tilde{\tau}_{\tilde{e}}^{\tilde{\sigma}}(f_{\ell}) \geq \mathbf{L}_{\tilde{e}}^{\tilde{\sigma}}(f_{\ell}), \quad \tilde{\tau}_{\tilde{e}}^{\tilde{\zeta}}(f_{\ell}) \leq \mathbf{L}_{\tilde{e}}^{\tilde{\zeta}}(f_{\ell}), \quad \tilde{\tau}_{\tilde{e}}^{\tilde{\delta}}(f_{\ell}) \leq \mathbf{L}_{\tilde{e}}^{\tilde{\delta}}(f_{\ell}).$$

By Theorem 5, $\tilde{\tau}_{\tilde{e}}^{\tilde{\sigma}\tilde{\zeta}\tilde{\delta}} \geq \tilde{T}_{\mathcal{L}}^{\tilde{\sigma}\tilde{\zeta}\tilde{\delta}}$.

(3) \Leftarrow suppose that $\vartheta_\varphi : (\mathcal{G}, (\tilde{\tau}^{\tilde{\sigma}\tilde{\zeta}\tilde{\delta}})_{\mathcal{F}}) \rightarrow (\mathfrak{L}, (\tilde{\mathbb{T}}_{\mathfrak{L}}^{\tilde{\sigma}\tilde{\zeta}\tilde{\delta}})_{\mathcal{E}})$ is an svnfc-map. For each $i \in \Gamma$ and $(f_\ell)_i \in \widehat{(\mathfrak{L}_i, \mathcal{E}_i)}$, we obtain

$$\begin{aligned} & \tilde{\tau}_{\mathcal{F}}^{\tilde{\sigma}}((\varphi_i \circ \varphi)_{\vartheta_i \circ \vartheta}^{-1}((f_\ell)_i)) \\ &= \tilde{\tau}_{\mathcal{F}}^{\tilde{\sigma}}(\vartheta_\varphi^{-1}((\vartheta_\varphi)_i^{-1}((f_\ell)_i))) \geq (\tilde{\mathbb{T}}_{\mathfrak{L}}^{\tilde{\sigma}})_{\varphi(\mathcal{F})}((\vartheta_\varphi)_i^{-1}((f_\ell)_i)) \\ &\geq (\tilde{\mathbb{T}}_i^{\tilde{\sigma}})_{\varphi_i \circ \varphi(\mathcal{F})}((f_\ell)_i), \\ & \tilde{\tau}_{\mathcal{F}}^{\tilde{\zeta}}((\varphi_i \circ \varphi)_{\vartheta_i \circ \vartheta}^{-1}((f_\ell)_i)) \\ &= \tilde{\tau}_{\mathcal{F}}^{\tilde{\zeta}}(\vartheta_\varphi^{-1}((\vartheta_\varphi)_i^{-1}((f_\ell)_i))) \leq (\tilde{\mathbb{T}}_{\mathfrak{L}}^{\tilde{\zeta}})_{\varphi(\mathcal{F})}((\vartheta_\varphi)_i^{-1}((f_\ell)_i)) \\ &\leq (\tilde{\mathbb{T}}_i^{\tilde{\zeta}})_{\varphi_i \circ \varphi(\mathcal{F})}((f_\ell)_i), \\ & \tilde{\tau}_{\mathcal{F}}^{\tilde{\delta}}((\varphi_i \circ \varphi)_{\vartheta_i \circ \vartheta}^{-1}((f_\ell)_i)) \\ &= \tilde{\tau}_{\mathcal{F}}^{\tilde{\delta}}(\vartheta_\varphi^{-1}((\vartheta_\varphi)_i^{-1}((f_\ell)_i))) \leq (\tilde{\mathbb{T}}_{\mathfrak{L}}^{\tilde{\delta}})_{\varphi(\mathcal{F})}((\vartheta_\varphi)_i^{-1}((f_\ell)_i)) \\ &\leq (\tilde{\mathbb{T}}_i^{\tilde{\delta}})_{\varphi_i \circ \varphi(\mathcal{F})}((f_\ell)_i), \end{aligned}$$

Thus, $(\varphi_i \circ \varphi)_{\vartheta_i \circ \vartheta} : (\mathcal{G}, (\tilde{\tau}^{\tilde{\sigma}\tilde{\zeta}\tilde{\delta}})_{\mathcal{F}}) \rightarrow (\mathfrak{L}_i, (\tilde{\mathbb{T}}_i^{\tilde{\sigma}\tilde{\zeta}\tilde{\delta}})_{\mathcal{E}_i})$ is an svnfc-map.

(\Rightarrow) For all finite $\Omega = \{\omega_1, \omega_2, \dots, \omega_n\}$ of Γ such that $f_\ell = \bigcap_{i=1}^n (\vartheta_\varphi)_{\omega_i}^{-1}((f_\ell)_{\omega_i})$ since $(\varphi_i \circ \varphi)_{\vartheta_i \circ \vartheta} : (\mathcal{G}, (\tilde{\tau}^{\tilde{\sigma}\tilde{\zeta}\tilde{\delta}})_{\mathcal{F}}) \rightarrow (\mathfrak{L}_{\omega_i}, (\tilde{\mathbb{T}}_{\omega_i}^{\tilde{\sigma}\tilde{\zeta}\tilde{\delta}})_{\mathcal{E}_{\omega_i}})$ is an svnfc-map, for every $p \in \mathcal{F}$

$$\begin{aligned} & \tilde{\tau}_p^{\tilde{\sigma}}(\vartheta_\varphi^{-1}((\vartheta_\varphi)_{\omega_i}^{-1}((f_\ell)_{\omega_i}))) \geq (\tilde{\mathbb{T}}_{\omega_i}^{\tilde{\sigma}})_{(\varphi_i \circ \varphi)(p)}((f_\ell)_{\omega_i}), \\ & \tilde{\tau}_p^{\tilde{\zeta}}(\vartheta_\varphi^{-1}((\vartheta_\varphi)_{\omega_i}^{-1}((f_\ell)_{\omega_i}))) \leq (\tilde{\mathbb{T}}_{\omega_i}^{\tilde{\zeta}})_{(\varphi_i \circ \varphi)(p)}((f_\ell)_{\omega_i}), \\ & \tilde{\tau}_p^{\tilde{\delta}}(\vartheta_\varphi^{-1}((\vartheta_\varphi)_{\omega_i}^{-1}((f_\ell)_{\omega_i}))) \leq (\tilde{\mathbb{T}}_{\omega_i}^{\tilde{\delta}})_{(\varphi_i \circ \varphi)(p)}((f_\ell)_{\omega_i}). \end{aligned}$$

Hence, we obtain

$$\begin{aligned} \tilde{\tau}_p^{\tilde{\sigma}}(\vartheta_\varphi^{-1}(f_\ell)) &= \tilde{\tau}_p^{\tilde{\sigma}}\left(\bigcap_{i=1}^n (\vartheta_\varphi^{-1}((\vartheta_\varphi)_{\omega_i}^{-1}((f_\ell)_{\omega_i})))\right) \\ &\geq \bigcap_{i=1}^n \tilde{\tau}_p^{\tilde{\sigma}}((\vartheta_\varphi^{-1}((\vartheta_\varphi)_{\omega_i}^{-1}((f_\ell)_{\omega_i})))) \\ &\geq \bigcap_{i=1}^n (\tilde{\mathbb{T}}_{\omega_i}^{\tilde{\sigma}})_{(\varphi_{\omega_i} \circ \varphi)(p)}(f_\ell)_{\omega_i}, \\ \tilde{\tau}_p^{\tilde{\zeta}}(\vartheta_\varphi^{-1}(f_\ell)) &= \tilde{\tau}_p^{\tilde{\zeta}}\left(\bigcap_{i=1}^n (\vartheta_\varphi^{-1}((\vartheta_\varphi)_{\omega_i}^{-1}((f_\ell)_{\omega_i})))\right) \\ &\leq \bigcap_{i=1}^n \tilde{\tau}_p^{\tilde{\zeta}}((\vartheta_\varphi^{-1}((\vartheta_\varphi)_{\omega_i}^{-1}((f_\ell)_{\omega_i})))) \\ &\leq \bigcap_{i=1}^n (\tilde{\mathbb{T}}_{\omega_i}^{\tilde{\zeta}})_{(\varphi_{\omega_i} \circ \varphi)(p)}(f_\ell)_{\omega_i}, \\ \tilde{\tau}_p^{\tilde{\delta}}(\vartheta_\varphi^{-1}(f_\ell)) &= \tilde{\tau}_p^{\tilde{\delta}}\left(\bigcap_{i=1}^n (\vartheta_\varphi^{-1}((\vartheta_\varphi)_{\omega_i}^{-1}((f_\ell)_{\omega_i})))\right) \end{aligned}$$

$$\begin{aligned} & \leq \bigcap_{i=1}^n \tilde{\tau}_p^{\tilde{\delta}}((\vartheta_\varphi^{-1}((\vartheta_\varphi)_{\omega_i}^{-1}((f_\ell)_{\omega_i})))) \\ & \leq \bigcap_{i=1}^n (\tilde{\mathbb{T}}_{\omega_i}^{\tilde{\delta}})_{(\varphi_{\omega_i} \circ \varphi)(p)}(f_\ell)_{\omega_i}. \end{aligned}$$

Therefore,

$$\begin{aligned} \tilde{\tau}_p^{\tilde{\sigma}}(\vartheta_\varphi^{-1}(f_\ell)) &\geq \mathfrak{L}_{\varphi(p)}^{\tilde{\sigma}}(f_\ell), & \tilde{\tau}_p^{\tilde{\zeta}}(\vartheta_\varphi^{-1}(f_\ell)) &\leq \mathfrak{L}_{\varphi(p)}^{\tilde{\zeta}}(f_\ell), \\ \tilde{\tau}_p^{\tilde{\delta}}(\vartheta_\varphi^{-1}(f_\ell)) &\leq \mathfrak{L}_{\varphi(p)}^{\tilde{\delta}}(f_\ell) \quad \forall p \in \mathcal{F} \text{ and } f_\ell \in \widehat{(\mathfrak{L}, \mathcal{E})}. \end{aligned}$$

By Theorem 6, $\vartheta_\varphi : (\mathcal{G}, (\tilde{\tau}^{\tilde{\sigma}\tilde{\zeta}\tilde{\delta}})_{\mathcal{F}}) \rightarrow (\mathfrak{L}, (\tilde{\mathbb{T}}_{\mathfrak{L}}^{\tilde{\sigma}\tilde{\zeta}\tilde{\delta}})_{\mathcal{E}})$ is a svnfc-map.

Let $\{(\mathfrak{L}_i, (\tilde{\mathbb{T}}_i^{\tilde{\sigma}\tilde{\zeta}\tilde{\delta}})_{\mathcal{E}_i})\}_{i \in \Gamma}$ be a collection of svnfts, \mathcal{E} be a parameter set and $\forall i \in \Gamma, \vartheta_i : \mathfrak{L} \rightarrow \mathfrak{L}_i$ and $\varphi_i : \mathcal{E} \rightarrow \mathcal{E}_i$ be a mapping. The initial single-valued neutrosophic soft topology $\tilde{\mathbb{T}}_{\mathfrak{L}}^{\tilde{\sigma}\tilde{\zeta}\tilde{\delta}}$ on \mathfrak{L} is the coarsest svnfts on \mathfrak{L} for which all $(\vartheta_\varphi)_i, i \in \Gamma$ are svnfc-maps. \square

4 Initial single-valued neutrosophic soft closure spaces

In this segment, we launch the ideas of single-valued neutrosophic soft closure spaces (simply, svnf-closure space). In particular, we prove the existence of initial single-valued neutrosophic soft closure structures. From this fact, the category **SVNSC** is a topological category over **SET**.

Definition 16 A map $\mathbf{C} : \mathcal{E} \times \widehat{(\mathfrak{L}, \mathcal{E})} \times \xi_1 \rightarrow \widehat{(\mathfrak{L}, \mathcal{E})}$ is considered single-valued neutrosophic soft closure operator on \mathfrak{L} , if it meets the following conditions for all $\tilde{e} \in \mathcal{E}, f_\ell, g_j \in \widehat{(\mathfrak{L}, \mathcal{E})}, r, s \in \xi_1$:

- (C₁) $\mathbf{C}(\tilde{e}, \Phi, r) = \Phi,$
- (C₂) $\mathbf{C}(\tilde{e}, f_\ell, r) \supseteq f_\ell,$
- (C₃) if $f_\ell \subseteq g_j,$ then $\mathbf{C}(\tilde{e}, f_\ell, r) \subseteq \mathbf{C}(\tilde{e}, g_j, r),$
- (C₄) $\mathbf{C}(\tilde{e}, f_\ell \cup g_j, r) = \mathbf{C}(\tilde{e}, f_\ell, r) \cup \mathbf{C}(\tilde{e}, g_j, r),$
- (C₅) $\mathbf{C}(\tilde{e}, f_\ell, r) \subseteq \mathbf{C}(\tilde{e}, g_j, s)$ if $r \leq s.$

The pair $(\mathfrak{L}, \mathbf{C})$ is termed svnf-closure space.

An svnfc-closure space $(\mathfrak{L}, \mathbf{C})$ is addressed as single-valued neutrosophic topological, provided that $\mathbf{C}(\tilde{e}, \mathbf{C}(\tilde{e}, f_\ell, r), r) = \mathbf{C}(\tilde{e}, f_\ell, r).$

Let $(\mathfrak{L}, (\mathbf{C}_1)_{\mathcal{E}})$ and $(\mathcal{G}, (\mathbf{C}_2)_{\mathcal{F}})$ be svnf-closure spaces. A mapping $\vartheta_\varphi : (\mathfrak{L}, (\mathbf{C}_1)_{\mathcal{E}}) \rightarrow (\mathcal{G}, (\mathbf{C}_2)_{\mathcal{F}})$ is called single-valued neutrosophic soft **C**-map (simply, svnf **C**-map), if for each $f_\ell \in \widehat{(\mathfrak{L}, \mathcal{E})}, r \in \xi_1, \tilde{e} \in \mathcal{E},$

$$\mathbf{C}_2(\vartheta_\varphi \tilde{e}, \vartheta_\varphi(f_\ell), r) \subseteq \vartheta_\varphi(\mathbf{C}_1(\tilde{e}, f_\ell, r)).$$

Suppose that $(\tilde{\tau}^{\tilde{\sigma}\tilde{\zeta}\tilde{\delta}})_{\mathcal{F}}$ and $(\tilde{\tau}^{\tilde{\sigma}\tilde{\zeta}\tilde{\delta}})_{\mathcal{E}}$ are svnfts on \mathbb{X} . We say that $(\tilde{\tau}^{\tilde{\sigma}\tilde{\zeta}\tilde{\delta}})_{\mathcal{F}}$ is finer than $(\tilde{\tau}^{\tilde{\sigma}\tilde{\zeta}\tilde{\delta}})_{\mathcal{E}}$, $[(\tilde{\tau}^{\tilde{\sigma}\tilde{\zeta}\tilde{\delta}})_{\mathcal{E}}$ is coarser than $(\tilde{\tau}^{\tilde{\sigma}\tilde{\zeta}\tilde{\delta}})_{\mathcal{F}}$], denoted by $(\tilde{\tau}^{\tilde{\sigma}\tilde{\zeta}\tilde{\delta}})_{\mathcal{E}} \widehat{\subseteq} (\tilde{\tau}^{\tilde{\sigma}\tilde{\zeta}\tilde{\delta}})_{\mathcal{F}}$, if

$$\begin{aligned} (\tilde{\tau}^{\tilde{\sigma}})_{\tilde{e}}(f_{\ell}) &\leq (\tilde{\tau}^{\tilde{\sigma}})_{\tilde{e}}(f_{\ell}), & (\tilde{\tau}^{\tilde{\zeta}})_{\tilde{e}}(f_{\ell}) &\geq (\tilde{\tau}^{\tilde{\zeta}})_{\tilde{e}}(f_{\ell}), \\ (\tilde{\tau}^{\tilde{\delta}})_{\tilde{e}}(f_{\ell}) &\geq (\tilde{\tau}^{\tilde{\delta}})_{\tilde{e}}(f_{\ell}) \quad \forall \tilde{e} \in \mathcal{E}, \quad f_{\ell} \in \widehat{(\mathbb{X}, \mathcal{E})}, \quad r \in \xi_1. \end{aligned}$$

Theorem 8 Let $(\mathbb{X}, \tilde{\tau}^{\tilde{\sigma}\tilde{\zeta}\tilde{\delta}})$ be svnfts. For all $f_{\ell} \in \widehat{\xi(\mathbb{X}, \mathcal{E})}$, $\tilde{e} \in \mathcal{E}$, $r \in \xi_0$, we define an operator $\mathbf{C}_{\tilde{\tau}^{\tilde{\sigma}\tilde{\zeta}\tilde{\delta}}} : \mathcal{E} \times \widehat{(\mathbb{X}, \mathcal{E})} \times \xi_0 \rightarrow \widehat{(\mathbb{X}, \mathcal{E})}$ as next:

$$\begin{aligned} \mathbf{C}_{\tilde{\tau}^{\tilde{\sigma}\tilde{\zeta}\tilde{\delta}}}(\tilde{e}, f_{\ell}, r) &= \widehat{\cap}\{g_j \in \widehat{(\mathbb{X}, \mathcal{E})} : \\ f_{\ell} \widehat{\subseteq} g_j, \tilde{\tau}^{\tilde{\sigma}}_{\tilde{e}}(g_j^c) &\geq r, \tilde{\tau}^{\tilde{\zeta}}_{\tilde{e}}(g_j^c) \leq 1 - r, \tilde{\tau}^{\tilde{\delta}}_{\tilde{e}}(g_j^c) \leq 1 - r\}. \end{aligned}$$

Then, $(\mathbb{X}, (\mathbf{C}_{\tilde{\tau}^{\tilde{\sigma}\tilde{\zeta}\tilde{\delta}}})_{\mathcal{E}})$ is a svnf-closure space.

Proof $\mathbf{C}_1, \mathbf{C}_2, \mathbf{C}_3$ and \mathbf{C}_5 follows directly from $\mathbf{C}_{\tilde{\tau}^{\tilde{\sigma}\tilde{\zeta}\tilde{\delta}}}$.

\mathbf{C}_4 : Since $f_{\ell} \widehat{\subseteq} f_{\ell} \widehat{\cup} f_{\ell}$ and $g_j \widehat{\subseteq} f_{\ell} \widehat{\cup} f_{\ell}$, we obtain that,

$$\mathbf{C}_{\tilde{\tau}^{\tilde{\sigma}\tilde{\zeta}\tilde{\delta}}}(\tilde{e}, f_{\ell}, r) \widehat{\cup} \mathbf{C}_{\tilde{\tau}^{\tilde{\sigma}\tilde{\zeta}\tilde{\delta}}}(\tilde{e}, g_j, r) \widehat{\subseteq} \mathbf{C}_{\tilde{\tau}^{\tilde{\sigma}\tilde{\zeta}\tilde{\delta}}}(\tilde{e}, f_{\ell} \widehat{\cup} g_j, r).$$

Now we will prove that $\mathbf{C}_{\tilde{\tau}^{\tilde{\sigma}\tilde{\zeta}\tilde{\delta}}}(\tilde{e}, f_{\ell}, r) \widehat{\cup} \mathbf{C}_{\tilde{\tau}^{\tilde{\sigma}\tilde{\zeta}\tilde{\delta}}}(\tilde{e}, g_j, r) \widehat{\subseteq} \mathbf{C}_{\tilde{\tau}^{\tilde{\sigma}\tilde{\zeta}\tilde{\delta}}}(\tilde{e}, f_{\ell} \widehat{\cup} g_j, r)$.

Let $(\mathbb{X}, (\tilde{\tau}^{\tilde{\sigma}\tilde{\zeta}\tilde{\delta}})_{\mathcal{E}})$ be svnfts. From (\mathbf{C}_4) , we obtain that

$$\begin{aligned} f_{\ell} \widehat{\subseteq} \mathbf{C}_{\tilde{\tau}^{\tilde{\sigma}\tilde{\zeta}\tilde{\delta}}}(\tilde{e}, f_{\ell}, r), \tilde{\tau}^{\tilde{\sigma}}_{\tilde{e}}([\mathbf{C}_{\tilde{\tau}^{\tilde{\sigma}\tilde{\zeta}\tilde{\delta}}}(\tilde{e}, f_{\ell}, r)]^c) \\ \geq r, \tilde{\tau}^{\tilde{\zeta}}_{\tilde{e}}([\mathbf{C}_{\tilde{\tau}^{\tilde{\sigma}\tilde{\zeta}\tilde{\delta}}}(\tilde{e}, f_{\ell}, r)]^c) \leq 1 - r, \\ \text{and } \tilde{\tau}^{\tilde{\delta}}_{\tilde{e}}([\mathbf{C}_{\tilde{\tau}^{\tilde{\sigma}\tilde{\zeta}\tilde{\delta}}}(\tilde{e}, f_{\ell}, r)]^c) \leq 1 - r, \\ g_j \widehat{\subseteq} \mathbf{C}_{\tilde{\tau}^{\tilde{\sigma}\tilde{\zeta}\tilde{\delta}}}(\tilde{e}, g_j, r), \tilde{\tau}^{\tilde{\sigma}}_{\tilde{e}}([\mathbf{C}_{\tilde{\tau}^{\tilde{\sigma}\tilde{\zeta}\tilde{\delta}}}(\tilde{e}, g_j, r)]^c) \\ \geq r, \tilde{\tau}^{\tilde{\zeta}}_{\tilde{e}}([\mathbf{C}_{\tilde{\tau}^{\tilde{\sigma}\tilde{\zeta}\tilde{\delta}}}(\tilde{e}, g_j, r)]^c) \leq 1 - r, \\ \text{and } \tilde{\tau}^{\tilde{\delta}}_{\tilde{e}}([\mathbf{C}_{\tilde{\tau}^{\tilde{\sigma}\tilde{\zeta}\tilde{\delta}}}(\tilde{e}, g_j, r)]^c) \leq 1 - r, \end{aligned}$$

It implies that $f_{\ell} \widehat{\cup} g_j \widehat{\subseteq} \mathbf{C}_{\tilde{\tau}^{\tilde{\sigma}\tilde{\zeta}\tilde{\delta}}}(\tilde{e}, f_{\ell}, r) \widehat{\cup} \mathbf{C}_{\tilde{\tau}^{\tilde{\sigma}\tilde{\zeta}\tilde{\delta}}}(\tilde{e}, g_j, r)$,

$$\begin{aligned} \tilde{\tau}^{\tilde{\sigma}}_{\tilde{e}}([\mathbf{C}_{\tilde{\tau}^{\tilde{\sigma}\tilde{\zeta}\tilde{\delta}}}(\tilde{e}, f_{\ell}, r) \cup \mathbf{C}_{\tilde{\tau}^{\tilde{\sigma}\tilde{\zeta}\tilde{\delta}}}(\tilde{e}, g_j, r)]^c) &= \tilde{\tau}^{\tilde{\sigma}}_{\tilde{e}}([\mathbf{C}_{\tilde{\tau}^{\tilde{\sigma}\tilde{\zeta}\tilde{\delta}}}(\tilde{e}, f_{\ell}, r)]^c \\ &\cap [\mathbf{C}_{\tilde{\tau}^{\tilde{\sigma}\tilde{\zeta}\tilde{\delta}}}(\tilde{e}, g_j, r)]^c) \\ &\geq \tilde{\tau}^{\tilde{\sigma}}_{\tilde{e}}([\mathbf{C}_{\tilde{\tau}^{\tilde{\sigma}\tilde{\zeta}\tilde{\delta}}}(\tilde{e}, f_{\ell}, r)]^c) \\ &\cap \tilde{\tau}^{\tilde{\sigma}}_{\tilde{e}}([\mathbf{C}_{\tilde{\tau}^{\tilde{\sigma}\tilde{\zeta}\tilde{\delta}}}(\tilde{e}, g_j, r)]^c) \geq r, \\ \tilde{\tau}^{\tilde{\zeta}}_{\tilde{e}}([\mathbf{C}_{\tilde{\tau}^{\tilde{\sigma}\tilde{\zeta}\tilde{\delta}}}(\tilde{e}, f_{\ell}, r) \\ \cup \mathbf{C}_{\tilde{\tau}^{\tilde{\sigma}\tilde{\zeta}\tilde{\delta}}}(\tilde{e}, g_j, r)]^c) &= \tilde{\tau}^{\tilde{\zeta}}_{\tilde{e}}([\mathbf{C}_{\tilde{\tau}^{\tilde{\sigma}\tilde{\zeta}\tilde{\delta}}}(\tilde{e}, f_{\ell}, r)]^c \\ &\cap [\mathbf{C}_{\tilde{\tau}^{\tilde{\sigma}\tilde{\zeta}\tilde{\delta}}}(\tilde{e}, g_j, r)]^c) \\ &\leq \tilde{\tau}^{\tilde{\zeta}}_{\tilde{e}}([\mathbf{C}_{\tilde{\tau}^{\tilde{\sigma}\tilde{\zeta}\tilde{\delta}}}(\tilde{e}, f_{\ell}, r)]^c) \\ &\cup \tilde{\tau}^{\tilde{\zeta}}_{\tilde{e}}([\mathbf{C}_{\tilde{\tau}^{\tilde{\sigma}\tilde{\zeta}\tilde{\delta}}}(\tilde{e}, g_j, r)]^c) \leq 1 - r, \\ \tilde{\tau}^{\tilde{\delta}}_{\tilde{e}}([\mathbf{C}_{\tilde{\tau}^{\tilde{\sigma}\tilde{\zeta}\tilde{\delta}}}(\tilde{e}, f_{\ell}, r) \cup \mathbf{C}_{\tilde{\tau}^{\tilde{\sigma}\tilde{\zeta}\tilde{\delta}}}(\tilde{e}, g_j, r)]^c) \\ &= \tilde{\tau}^{\tilde{\delta}}_{\tilde{e}}([\mathbf{C}_{\tilde{\tau}^{\tilde{\sigma}\tilde{\zeta}\tilde{\delta}}}(\tilde{e}, f_{\ell}, r)]^c \cap [\mathbf{C}_{\tilde{\tau}^{\tilde{\sigma}\tilde{\zeta}\tilde{\delta}}}(\tilde{e}, g_j, r)]^c) \end{aligned}$$

$$\begin{aligned} &\leq \tilde{\tau}^{\tilde{\delta}}_{\tilde{e}}([\mathbf{C}_{\tilde{\tau}^{\tilde{\sigma}\tilde{\zeta}\tilde{\delta}}}(\tilde{e}, f_{\ell}, r)]^c) \\ &\cup \tilde{\tau}^{\tilde{\delta}}_{\tilde{e}}([\mathbf{C}_{\tilde{\tau}^{\tilde{\sigma}\tilde{\zeta}\tilde{\delta}}}(\tilde{e}, g_j, r)]^c) \leq 1 - r. \end{aligned}$$

Hence, $\mathbf{C}_{\tilde{\tau}^{\tilde{\sigma}\tilde{\zeta}\tilde{\delta}}}(\tilde{e}, f_{\ell}, r) \widehat{\cup} \mathbf{C}_{\tilde{\tau}^{\tilde{\sigma}\tilde{\zeta}\tilde{\delta}}}(\tilde{e}, g_j, r) \widehat{\subseteq} \mathbf{C}_{\tilde{\tau}^{\tilde{\sigma}\tilde{\zeta}\tilde{\delta}}}(\tilde{e}, f_{\ell} \widehat{\cup} g_j, r)$. Thus,

$$\mathbf{C}_{\tilde{\tau}^{\tilde{\sigma}\tilde{\zeta}\tilde{\delta}}}(\tilde{e}, f_{\ell}, r) \widehat{\cup} \mathbf{C}_{\tilde{\tau}^{\tilde{\sigma}\tilde{\zeta}\tilde{\delta}}}(\tilde{e}, g_j, r) = \mathbf{C}_{\tilde{\tau}^{\tilde{\sigma}\tilde{\zeta}\tilde{\delta}}}(\tilde{e}, f_{\ell} \widehat{\cup} g_j, r).$$

□

Theorem 9 Let $(\mathbb{X}, (\mathbf{C})_{\mathcal{E}})$ be a svnf-closure space. Define a mapping $\tilde{\tau}^{\tilde{\sigma}\tilde{\zeta}\tilde{\delta}}_{\mathbf{C}} : \mathcal{E} \rightarrow \widehat{\xi(\mathbb{X}, \mathcal{E})}$ on \mathbb{X} by: For every $\tilde{e} \in \mathcal{E}$,

$$\begin{aligned} (\tilde{\tau}^{\tilde{\sigma}}_{\mathbf{C}})_{\tilde{e}}(f_{\ell}) &= \bigcup\{r \in \xi : \mathbf{C}(\tilde{e}, (f_{\ell})^c, r) = (f_{\ell})^c\}, \\ (\tilde{\tau}^{\tilde{\zeta}}_{\mathbf{C}})_{\tilde{e}}(f_{\ell}) &= \bigcap\{1 - r \in \xi : \mathbf{C}(\tilde{e}, (f_{\ell})^c, r) = (f_{\ell})^c\}, \\ (\tilde{\tau}^{\tilde{\delta}}_{\mathbf{C}})_{\tilde{e}}(f_{\ell}) &= \bigcap\{1 - r \in \xi : \mathbf{C}(\tilde{e}, (f_{\ell})^c, r) = (f_{\ell})^c\}. \end{aligned}$$

Then, $(\tilde{\tau}^{\tilde{\sigma}}_{\mathbf{C}}, \tilde{\tau}^{\tilde{\zeta}}_{\mathbf{C}}, \tilde{\tau}^{\tilde{\delta}}_{\mathbf{C}})$ is a svnfts on \mathbb{X} ,

Proof (\top_1) . Let $(\mathbb{X}, (\mathbf{C})_{\mathcal{E}})$ be an svnf-closure space. Since $\mathbf{C}(\tilde{e}, \Phi, r) = \Phi$ and $\mathbf{C}(\tilde{e}, \mathcal{E}, r) = \mathcal{E}$, for each, $\tilde{e} \in \mathcal{E}$, $r \in \xi_0$ we have (\top_1) .

(\top_2) . Let $(\mathbb{X}, (\mathbf{C})_{\mathcal{E}})$ be an svnf-closure space. Assume that there exists $[f_{\ell}]_1, [f_{\ell}]_2 \in \widehat{\xi(\mathbb{X}, \mathcal{E})}$ such that

$$\begin{aligned} (\tilde{\tau}^{\tilde{\sigma}}_{\mathbf{C}})_{\tilde{e}}([f_{\ell}]_1 \tilde{\cap} [f_{\ell}]_2) &< (\tilde{\tau}^{\tilde{\sigma}}_{\mathbf{C}})_{\tilde{e}}([f_{\ell}]_1) \cap (\tilde{\tau}^{\tilde{\sigma}}_{\mathbf{C}})_{\tilde{e}}([f_{\ell}]_2), \\ (\tilde{\tau}^{\tilde{\zeta}}_{\mathbf{C}})_{\tilde{e}}([f_{\ell}]_1 \tilde{\cap} [f_{\ell}]_2) &> (\tilde{\tau}^{\tilde{\zeta}}_{\mathbf{C}})_{\tilde{e}}([f_{\ell}]_1) \cup (\tilde{\tau}^{\tilde{\zeta}}_{\mathbf{C}})_{\tilde{e}}([f_{\ell}]_2), \\ (\tilde{\tau}^{\tilde{\delta}}_{\mathbf{C}})_{\tilde{e}}([f_{\ell}]_1 \tilde{\cap} [f_{\ell}]_2) &> (\tilde{\tau}^{\tilde{\delta}}_{\mathbf{C}})_{\tilde{e}}([f_{\ell}]_1) \cup (\tilde{\tau}^{\tilde{\delta}}_{\mathbf{C}})_{\tilde{e}}([f_{\ell}]_2). \end{aligned}$$

There exists $r \in \xi_0$ such that

$$\begin{aligned} (\tilde{\tau}^{\tilde{\sigma}}_{\mathbf{C}})_{\tilde{e}}([f_{\ell}]_1 \tilde{\cap} [f_{\ell}]_2) &< r < (\tilde{\tau}^{\tilde{\sigma}}_{\mathbf{C}})_{\tilde{e}}([f_{\ell}]_1) \cap (\tilde{\tau}^{\tilde{\sigma}}_{\mathbf{C}})_{\tilde{e}}([f_{\ell}]_2), \\ (\tilde{\tau}^{\tilde{\zeta}}_{\mathbf{C}})_{\tilde{e}}([f_{\ell}]_1 \tilde{\cap} [f_{\ell}]_2) &> 1 - r > (\tilde{\tau}^{\tilde{\zeta}}_{\mathbf{C}})_{\tilde{e}}([f_{\ell}]_1) \cup (\tilde{\tau}^{\tilde{\zeta}}_{\mathbf{C}})_{\tilde{e}}([f_{\ell}]_2), \\ (\tilde{\tau}^{\tilde{\delta}}_{\mathbf{C}})_{\tilde{e}}([f_{\ell}]_1 \tilde{\cap} [f_{\ell}]_2) &> 1 - r > (\tilde{\tau}^{\tilde{\delta}}_{\mathbf{C}})_{\tilde{e}}([f_{\ell}]_1) \cup (\tilde{\tau}^{\tilde{\delta}}_{\mathbf{C}})_{\tilde{e}}([f_{\ell}]_2). \end{aligned}$$

For each $j \in \{1, 2\}$, there exist $r_i \in \xi_0$ with $\mathbf{C}(\tilde{e}, [f_{\ell}]_i^c, r_i) = [f_{\ell}]_i^c$, such that

$$\begin{aligned} r < r_i \leq (\tilde{\tau}^{\tilde{\sigma}}_{\mathbf{C}})_{\tilde{e}}([f_{\ell}]_i), \quad (\tilde{\tau}^{\tilde{\zeta}}_{\mathbf{C}})_{\tilde{e}}([f_{\ell}]_i) &\leq 1 - r_i < 1 - r, \\ (\tilde{\tau}^{\tilde{\delta}}_{\mathbf{C}})_{\tilde{e}}([f_{\ell}]_i) &\leq 1 - r_i < 1 - r. \end{aligned}$$

On the other hand, since $\mathbf{C}(\tilde{e}, [f_{\ell}]_i^c, r) = [f_{\ell}]_i^c$ from \mathbf{C}_2 and \mathbf{C}_5 in Definition 12, for all $i \in \{1, 2\}$, we have

$$\mathbf{C}(\tilde{e}, [f_{\ell}]_1^c \tilde{\cup} [f_{\ell}]_2^c, r) = [f_{\ell}]_1^c \tilde{\cup} [f_{\ell}]_2^c.$$

It follows that $(\tilde{\tau}^{\tilde{\sigma}}_{\mathbf{C}})_{\tilde{e}}([f_{\ell}]_1 \tilde{\cap} [f_{\ell}]_2) \geq r$, $(\tilde{\tau}^{\tilde{\zeta}}_{\mathbf{C}})_{\tilde{e}}([f_{\ell}]_1 \tilde{\cap} [f_{\ell}]_2) \leq 1 - r$, and $(\tilde{\tau}^{\tilde{\delta}}_{\mathbf{C}})_{\tilde{e}}([f_{\ell}]_1 \tilde{\cap} [f_{\ell}]_2) \leq 1 - r$. It is a contradiction. Hence, for all $f_{\ell}, g_j \in \widehat{\xi(\mathbb{X}, \mathcal{E})}$ we have $(\tilde{\tau}^{\tilde{\sigma}}_{\mathbf{C}})_{\tilde{e}}(f_{\ell} \tilde{\cap} g_j) \geq$

$$(\tilde{T}_{\mathbf{C}}^{\tilde{\sigma}})_{\tilde{e}}(f_{\ell}) \cap (\tilde{T}_{\mathbf{C}}^{\tilde{\sigma}})_{\tilde{e}}(g_j), (\tilde{T}_{\mathbf{C}}^{\tilde{\zeta}})_{\tilde{e}}(f_{\ell} \tilde{\cap} g_j) \leq (\tilde{T}_{\mathbf{C}}^{\tilde{\zeta}})_{\tilde{e}}(f_{\ell}) \cup (\tilde{T}_{\mathbf{C}}^{\tilde{\zeta}})_{\tilde{e}}(g_j), (\tilde{T}_{\mathbf{C}}^{\tilde{\delta}})_{\tilde{e}}(f_{\ell} \tilde{\cap} g_j) \leq (\tilde{T}_{\mathbf{C}}^{\tilde{\delta}})_{\tilde{e}}(f_{\ell}) \cup (\tilde{T}_{\mathbf{C}}^{\tilde{\delta}})_{\tilde{e}}(g_j)$$

(T₃). Assume that there exists $f_{\ell} = \bigcup_{i \in \Gamma} (f_{\ell})_i \in \widehat{\xi}(\mathbb{F}, \mathcal{E})$ such that

$$(\tilde{T}_{\mathbf{C}}^{\tilde{\sigma}})_{\tilde{e}}(f_{\ell}) < \bigcap_{i \in \Gamma} (\tilde{T}_{\mathbf{C}}^{\tilde{\sigma}})_{\tilde{e}}((f_{\ell})_i),$$

$$(\tilde{T}_{\mathbf{C}}^{\tilde{\zeta}})_{\tilde{e}}(f_{\ell}) > \bigcup_{i \in \Gamma} (\tilde{T}_{\mathbf{C}}^{\tilde{\zeta}})_{\tilde{e}}((f_{\ell})_i),$$

$$(\tilde{T}_{\mathbf{C}}^{\tilde{\delta}})_{\tilde{e}}(f_{\ell}) > \bigcup_{i \in \Gamma} (\tilde{T}_{\mathbf{C}}^{\tilde{\delta}})_{\tilde{e}}((f_{\ell})_i).$$

There exists $r_0 \in \xi_0$ such that

$$(\tilde{T}_{\mathbf{C}}^{\tilde{\sigma}})_{\tilde{e}}(f_{\ell}) < r_0 < \bigcap_{i \in \Gamma} (\tilde{T}_{\mathbf{C}}^{\tilde{\sigma}})_{\tilde{e}}((f_{\ell})_i),$$

$$(\tilde{T}_{\mathbf{C}}^{\tilde{\zeta}})_{\tilde{e}}(f_{\ell}) > 1 - r_0 > \bigcup_{i \in \Gamma} (\tilde{T}_{\mathbf{C}}^{\tilde{\zeta}})_{\tilde{e}}((f_{\ell})_i),$$

$$(\tilde{T}_{\mathbf{C}}^{\tilde{\delta}})_{\tilde{e}}(f_{\ell}) > 1 - r_0 > \bigcup_{i \in \Gamma} (\tilde{T}_{\mathbf{C}}^{\tilde{\delta}})_{\tilde{e}}((f_{\ell})_i).$$

$\forall i \in \Gamma$ and $r_i \in \xi_0$ there exists $\mathbf{C}(\tilde{e}, [f_{\ell}]_i^c, r_i) = [f_{\ell}]_i^c$, s.t

$$r_0 < r_i \leq (\tilde{T}_{\mathbf{C}}^{\tilde{\sigma}})_{\tilde{e}}((f_{\ell})_i), \quad 1 - r_0 > 1 - r_i$$

$$\geq (\tilde{T}_{\mathbf{C}}^{\tilde{\zeta}})_{\tilde{e}}((f_{\ell})_i),$$

$$1 - r_i > 1 - r_0 \geq (\tilde{T}_{\mathbf{C}}^{\tilde{\delta}})_{\tilde{e}}((f_{\ell})_i).$$

Moreover, since $\mathbf{C}(\tilde{e}, [f_{\ell}]_i^c, r_0) \leq \mathbf{C}(\tilde{e}, [f_{\ell}]_i^c, r_i) = [f_{\ell}]_i^c$ by \mathbf{C}_2 in Definition 12, we get that $\mathbf{C}(\tilde{e}, [f_{\ell}]_i^c, r_i) = [f_{\ell}]_i^c$. It implies, for all $i \in I$,

$$\mathbf{C}(\tilde{e}, [f_{\ell}]^c, r_0) \leq \mathbf{C}(\tilde{e}, [f_{\ell}]_i^c, r_i) = [f_{\ell}]^c.$$

It follows that $\mathbf{C}(\tilde{e}, [f_{\ell}]^c, r_0) \leq \bigcap_{i \in \Gamma} [f_{\ell}]_i^c = [f_{\ell}]^c$. Hence, $\mathbf{C}(\tilde{e}, [f_{\ell}]^c, r_0) = [f_{\ell}]^c$, that is, $(\tilde{T}_{\mathbf{C}}^{\tilde{\sigma}})_{\tilde{e}}(f_{\ell}) \geq r_0$, $(\tilde{T}_{\mathbf{C}}^{\tilde{\zeta}})_{\tilde{e}}(f_{\ell}) \leq 1 - r_0$ and $(\tilde{T}_{\mathbf{C}}^{\tilde{\delta}})_{\tilde{e}}(f_{\ell}) \leq 1 - r_0$. It is a contradiction. Thus, $(\tilde{T}_{\mathbf{C}}^{\tilde{\sigma}}, \tilde{T}_{\mathbf{C}}^{\tilde{\zeta}}, \tilde{T}_{\mathbf{C}}^{\tilde{\delta}})$ is a swnfts on \mathbb{F} . \square

Theorem 10 Allowing $\{(\mathbb{F}, (\mathbf{C}_i)_{\mathcal{E}_i})\}_{i \in \Gamma}$ to be an aggregation of swnf-closure spaces, let $\vartheta_i : \mathbb{F} \rightarrow \mathbb{F}_i$, $\varphi_i : \mathcal{E} \rightarrow \mathcal{E}_i$ be mappings for all $i \in \Gamma$ and \mathbb{F} be a set. Define a map $\mathbf{C}_{\tilde{\tau}\tilde{\sigma}\tilde{\zeta}\tilde{\delta}}$: $\mathcal{E} \times \widehat{(\mathbb{F}, \mathcal{E})} \times \xi_1 \rightarrow \widehat{(\mathbb{F}, \mathcal{E})}$ over \mathbb{F} as next:

$$\mathbf{C}(\tilde{e}, f_{\ell}, r) = \widehat{\bigg\{ \bigcup_{i=1}^n (\widehat{\bigcap_{i \in \Gamma} (\vartheta_{\varphi_i})^{-1} (\mathbf{C}_i(\varphi_i(\tilde{e}), (\vartheta_{\varphi_i})((f_{\ell})_i), r))) \bigg\}}.$$

For all $\tilde{e} \in \mathcal{E}$, $f_{\ell}, g_j \in \widehat{(\mathbb{F}, \mathcal{E})}$, $r \in \xi_1$ where the first $\widehat{}$ is taken on all finite aggregations $\{(f_{\ell})_i : f_{\ell} = \bigcup_{i=1}^n ((f_{\ell})_i)\}$.

Then

- (1) \mathbf{C} is the coarsest single-valued neutrosophic soft closure operator on \mathbb{F} , for which all $(\vartheta_{\varphi})_i$ are swnfC-maps,
- (2) if $\{(\mathbb{F}, (\mathbf{C}_i)_{\mathcal{E}_i})\}_{i \in \Gamma}$ is a aggregation of swnf-closure spaces, then $(\mathbb{F}, (\mathbf{C})_{\mathcal{E}})$ is a swnfts,
- (3) a map $\vartheta_{\varphi} : (\mathcal{G}, \mathbf{C}_{\mathcal{F}}^*) \rightarrow (\mathbb{F}, \mathbf{C}_{\mathcal{E}})$ is a swnfC-map iff for all $i \in \Gamma$, $(\vartheta_{\varphi})_i \circ \vartheta_{\varphi} : (\mathcal{G}, \mathbf{C}_{\mathcal{F}}^*) \rightarrow (\mathbb{F}, (\mathbf{C}_i)_{\mathcal{E}_i})$ is a swnfC-map.

Proof (1) Firstly, we will prove that \mathbf{C} is a single-valued neutrosophic soft closure operator on \mathbb{F} .

$\mathbf{C}_1, \mathbf{C}_2, \mathbf{C}_3$ and \mathbf{C}_5 follows directly from definition \mathbf{C}

\mathbf{C}_4 : From (\mathbf{C}_3) , we get that $\mathbf{C}(\tilde{e}, f_{\ell}, r) \widehat{\cup} \mathbf{C}(\tilde{e}, g_j, r) \widehat{\subseteq} \mathbf{C}(\tilde{e}, f_{\ell} \widehat{\cup} g_j, r)$.

Now we show that $\mathbf{C}(\tilde{e}, f_{\ell}, r) \widehat{\cup} \mathbf{C}(\tilde{e}, g_j, r) \widehat{\subseteq} \mathbf{C}(\tilde{e}, f_{\ell} \widehat{\cup} g_j, r)$.

For all finite families $\{(f_{\ell})_i : f_{\ell} = \bigcup_{i=1}^m (f_{\ell})_i\}$ and $\{(g_j)_i : g_j = \bigcup_{i=1}^n (g_j)_i\}$, there exists a finite family $\{(f_{\ell})_i, (g_{\ell})_i :$

$f_{\ell} \widehat{\cup} g_j = (\bigcup_{i=1}^m (f_{\ell})_i) \widehat{\cup} (\bigcup_{i=1}^n (g_j)_i)\}$, such that

$$\mathbf{C}(\tilde{e}, f_{\ell} \widehat{\cup} g_j, r) \widehat{\subseteq} \left[\bigcup_{i=1}^m (\widehat{\bigcap_{i \in \Gamma} (\vartheta_{\varphi_i})^{-1} (\mathbf{C}_i(\varphi_i(\tilde{e}), (\vartheta_{\varphi_i})((f_{\ell})_i), r))) \right] \widehat{\cup} \left[\bigcup_{i=1}^n (\widehat{\bigcap_{i \in \Gamma} (\vartheta_{\varphi_i})^{-1} (\mathbf{C}_i(\varphi_i(\tilde{e}), (\vartheta_{\varphi_i})((g_j)_i), r))) \right].$$

Put $h_{\partial} = \bigcup_{i=1}^n (\widehat{\bigcap_{i \in \Gamma} (\vartheta_{\varphi_i})^{-1} (\mathbf{C}_i(\varphi_i(\tilde{e}), (\vartheta_{\varphi_i})((g_j)_i), r)))$. Then,

$$\begin{aligned} \mathbf{C}(\tilde{e}, f_{\ell} \widehat{\cup} g_j, r) &\widehat{\subseteq} \widehat{\bigg[\bigcup_{i=1}^m (\widehat{\bigcap_{i \in \Gamma} (\vartheta_{\varphi_i})^{-1} (\mathbf{C}_i(\varphi_i(\tilde{e}), (\vartheta_{\varphi_i})((f_{\ell})_i), r))) \bigg] \widehat{\cup} h_{\partial}} \\ &= \left[\widehat{\bigg[\bigcup_{i=1}^m (\widehat{\bigcap_{i \in \Gamma} (\vartheta_{\varphi_i})^{-1} (\mathbf{C}_i(\varphi_i(\tilde{e}), (\vartheta_{\varphi_i})((f_{\ell})_i), r))) \bigg] \widehat{\cup} h_{\partial}} \right] \\ &= \mathbf{C}(\tilde{e}, f_{\ell}, r) \widehat{\cup} h_{\partial}, \end{aligned}$$

where $\widehat{\cup}$ is taken on all finite families $\{(f_\ell)_i : f_\ell = \bigcup_{i=1}^m (f_\ell)_i\}$. Also,

$$\begin{aligned} \mathbf{C}(\tilde{e}, f_\ell, r) &\widehat{\subseteq} \widehat{\mathbf{C}}(\tilde{e}, f_\ell, r) \widehat{\cup} h_\partial \\ &= (\mathbf{C}(\tilde{e}, f_\ell, r) \widehat{\cup} \left[\widehat{\mathbf{C}} \left[\bigcup_{i=1}^n (\widehat{\mathbf{C}}_{i \in \Gamma} (\vartheta_\varphi)_i^{-1} (\mathbf{C}_i(\varphi_i(\tilde{e}), \right. \right. \\ &\quad \left. \left. \times (\vartheta_\varphi)_i((g_j)_i), r) \right) \right] \right] \\ &= \mathbf{C}(\tilde{e}, f_\ell, r) \widehat{\cup} \mathbf{C}(\tilde{e}, g_j, r), \end{aligned}$$

where $\widehat{\cup}$ is taken on all finite families $\{(g_j)_i : f_\ell = \bigcup_{i=1}^n (g_j)_i\}$.

Next, from the definition of \mathbf{C}_2 , we have the subsequent regarding the group $\{f_\ell : f_\ell = \bigcup_{i=1}^n (f_\ell)_i\}$,

$$\begin{aligned} \mathbf{C}(\tilde{e}, f_\ell, r) &\widehat{\subseteq} \widehat{\mathbf{C}}_{i \in \Gamma} (\vartheta_\varphi)_i^{-1} (\mathbf{C}_i(\varphi_i(\tilde{e}), (\vartheta_\varphi)_i((f_\ell)_i), r)) \\ &\widehat{\subseteq} (\vartheta_\varphi)_i^{-1} (\mathbf{C}_i(\varphi_i(\tilde{e}), (\vartheta_\varphi)_i((f_\ell)_i), r)), \end{aligned}$$

It implies that

$$\begin{aligned} \vartheta_\varphi(\mathbf{C}(\tilde{e}, f_\ell, r)) &\widehat{\subseteq} (\vartheta_\varphi)_j ((\vartheta_\varphi)_i^{-1} (\mathbf{C}_i(\varphi_i(\tilde{e}), (\vartheta_\varphi)_i((f_\ell)_i), r))) \\ &\widehat{\subseteq} \mathbf{C}_i(\varphi_i(\tilde{e}), (\vartheta_\varphi)_i((f_\ell)_i), r), \end{aligned}$$

Thus for each $i \in \Gamma$, $(\vartheta_\varphi)_i : (\mathfrak{F}, \mathbf{C}_\mathcal{E}) \rightarrow (\mathfrak{F}_i, (\mathbf{C}_i)_{\mathcal{E}_i})$ is a svnf \mathbf{C} -map.

If $(\vartheta_\varphi)_i : (\mathfrak{F}, \mathbf{C}_\mathcal{F}) \rightarrow (\mathfrak{F}_i, (\mathbf{C}_i)_{\mathcal{E}_i})$ is a svnf \mathbf{C} -map, for every $i \in \Gamma$ and $\tilde{e} \in \mathcal{F}$, then we have

$$(\vartheta_\varphi)_i(\mathbf{C}^*(\tilde{e}, f_\ell, r)) \widehat{\subseteq} \mathbf{C}_i(\varphi_i(\tilde{e}), (\vartheta_\varphi)_i((f_\ell)_i), r).$$

It implies that

$$\begin{aligned} \vartheta_\varphi(\mathbf{C}^*(\tilde{e}, f_\ell, r)) &\widehat{\subseteq} (\vartheta_\varphi)_j^{-1} ((\vartheta_\varphi)_i(\mathbf{C}^*(\tilde{e}, f_\ell, r))) \\ &\widehat{\subseteq} (\vartheta_\varphi)_j^{-1} (\mathbf{C}_i(\varphi_i(\tilde{e}), (\vartheta_\varphi)_i((f_\ell)_i), r)). \end{aligned}$$

So we have

$$\vartheta_\varphi(\mathbf{C}^*(\tilde{e}, f_\ell, r)) \widehat{\subseteq} \widehat{\mathbf{C}}(\vartheta_\varphi)_j^{-1} (\mathbf{C}_i(\varphi_i(\tilde{e}), (\vartheta_\varphi)_i((f_\ell)_i), r)).$$

We have the ensuing in respect of every clusters $\{(f_\ell)_i : f_\ell = \bigcup_{i=1}^m (f_\ell)_i\}$

$$f_\ell = \bigcup_{i=1}^m (f_\ell)_i$$

$$\mathbf{C}(\tilde{e}, f_\ell, r) = \widehat{\mathbf{C}} \left[\bigcup_{i=1}^m (\widehat{\mathbf{C}}_{i \in \Gamma} (\vartheta_\varphi)_i^{-1} (\mathbf{C}_i(\varphi_i(\tilde{e}),$$

$$\begin{aligned} &(\vartheta_\varphi)_i((f_\ell)_i), r) \right] \\ &\widehat{\subseteq} \widehat{\mathbf{C}} \left[\bigcup_{i=1}^m \mathbf{C}^*(\tilde{e}, (f_\ell)_i, r) \right] \\ &= \widehat{\mathbf{C}} \left[\mathbf{C}^*(\tilde{e}, \bigcup_{i=1}^m (f_\ell)_i, r) \right] = \mathbf{C}^*(\tilde{e}, f_\ell, r). \end{aligned}$$

Thus, \mathbf{C} is the coarsest single-valued neutrosophic soft closure operator on \mathfrak{F} .

(2) We will show that $\mathbf{C}(\tilde{e}, \mathbf{C}(\tilde{e}, f_\ell, r), r) = \mathbf{C}(\tilde{e}, f_\ell, r)$, for all $\tilde{e} \in \mathcal{E}, f_\ell \in \widehat{(\mathfrak{F}, \mathcal{E})}, r \in \xi_1$.

For all finite families $\{(f_\ell)_i : f_\ell = \bigcup_{i=1}^m (f_\ell)_i\}$, we have

$$\begin{aligned} \mathbf{C}(\tilde{e}, f_\ell, r) &= \widehat{\mathbf{C}} \left[\bigcup_{i=1}^m (\widehat{\mathbf{C}}_{i \in \Gamma} (\vartheta_\varphi)_i^{-1} (\mathbf{C}_i(\varphi_i(\tilde{e}), \right. \\ &\quad \left. (\vartheta_\varphi)_i((f_\ell)_i), r) \right) \\ &= \widehat{\mathbf{C}} \left[\bigcup_{i=1}^m (\widehat{\mathbf{C}}_{i \in \Gamma} (\vartheta_\varphi)_i^{-1} (\mathbf{C}_i(\varphi_i(\tilde{e}), \right. \\ &\quad \left. \mathbf{C}_i(\varphi_i(\tilde{e}), (\vartheta_\varphi)_i((f_\ell)_i), r) \right) \right] \\ &\widehat{\subseteq} \widehat{\mathbf{C}} \left[\bigcup_{i=1}^m (\widehat{\mathbf{C}}_{i \in \Gamma} (\vartheta_\varphi)_i^{-1} (\mathbf{C}_i(\varphi_i(\tilde{e}), \right. \\ &\quad \left. (\vartheta_\varphi)_i(\mathbf{C}_i(\tilde{e}, (f_\ell)_i), r) \right) \right] \\ &\widehat{\subseteq} \mathbf{C}(\tilde{e}, \mathbf{C}(\tilde{e}, f_\ell, r), r). \end{aligned}$$

From (C₂), we have $\mathbf{C}(\tilde{e}, f_\ell, r) = \mathbf{C}(\tilde{e}, \mathbf{C}(\tilde{e}, f_\ell, r), r)$.

(3) Direct. □

The category of svnf-closure spaces and svnf \mathbf{C} -maps is denoted by **SVNSC**.

Definition 17 (Alsharari et al. 2021) A category \mathfrak{C} is termed to be a topological category on **SET** with respect to the usual forgetful functor from \mathfrak{C} to **SET** if it meets the following criteria:

- (C₁) Existence of initial structures: For every \mathfrak{F} , any class Γ , and any aggregation $(\mathfrak{F}_i, \mathfrak{S}_i)_{i \in \Gamma}$ of \mathfrak{C} -object and every aggregation $(f_i : \mathfrak{F} \rightarrow \mathfrak{S}_i)_{i \in \Gamma}$ of mappings, there exists a unique \mathfrak{C} -structure \mathfrak{S} on \mathfrak{F} which is initial with respect to the source $(f_i : \mathfrak{F} \rightarrow (\mathfrak{F}_i, \mathfrak{S}_i)_{i \in \Gamma}$, i.e., for a \mathfrak{C} -object $(\mathcal{G}, \mathfrak{R})$, a mapping $L : (\mathcal{G}, \mathfrak{R}) \rightarrow (\mathfrak{F}, \mathfrak{S})$ is a \mathfrak{C} -morphism iff for any $i \in \Gamma$, $f_i \circ L : (\mathcal{G}, \mathfrak{R}) \rightarrow (\mathfrak{F}_i, \mathfrak{S}_i)$ is a \mathfrak{C} -morphism.

(C₂) Fibre smallness: For every set \mathfrak{L} , the ζ -fibre of \mathfrak{L} , i.e., the class of all ζ -structure over \mathfrak{L} , which we denote $\zeta(\mathfrak{L})$, is a set

Theorem 11 *The forgetful functor $\aleph : \mathbf{SVNSC} \rightarrow \mathbf{SET}$ defined by $\aleph(\mathfrak{L}, \mathbf{C}) = \mathfrak{L}$ and $\aleph(\vartheta_\varphi) = \Phi$ is single-valued neutrosophic topological.*

Proof The proof is straightforward from Theorem 10, and every \aleph -structured source $[(\vartheta_\varphi)_i : \mathfrak{L} \rightarrow \aleph(\mathfrak{L}_i, \mathbf{C}_i)_{i \in \Gamma}]$ has a unique \aleph -initial left $[(\vartheta_\varphi)_i : (\mathfrak{L}, \mathbf{C}) \rightarrow \aleph(\mathfrak{L}_i, \mathbf{C}_i)_{i \in \Gamma}]$, where \mathbf{C} is defined as in Theorem 10. \square

Using Theorems 10 and 11, we obtain the following definition.

Definition 18 Let $\{(\mathfrak{L}_i, (\mathbf{C}_i)_{\mathcal{E}_i})\}_{i \in \Gamma}$ be a family of svnf-closure spaces, for all $i \in \Gamma$, $\mathfrak{L} = \prod_{i \in \Gamma} \mathfrak{L}_i$ and $\mathcal{E} = \prod_{i \in \Gamma} \mathcal{E}_i$. Assume that $P_i : \mathfrak{L} \rightarrow \mathfrak{L}_i$ and $q_i : \mathcal{E} \rightarrow \mathcal{E}_i$ are projection maps for all $i \in \Gamma$. The initial single-valued neutrosophic soft closure operator \mathbf{C} as given in Theorem 10, with respect to the parameter set \mathcal{E} , is the coarsest single-valued neutrosophic soft closure operator on \mathfrak{L} for which all $(P_q)_i, i \in \Gamma$ are svnf \mathbf{C} -maps.

5 Conclusions

We have considered the topological structure of single-valued neutrosophic soft set theory. We also have introduced the concept of single-valued neutrosophic soft topology $(\tilde{\tau}^{\tilde{\sigma}}, \tilde{\tau}^{\tilde{\zeta}}, \tilde{\tau}^{\tilde{\delta}})$ which is a mapping $\tilde{\tau}^{\tilde{\sigma}}, \tilde{\tau}^{\tilde{\zeta}}, \tilde{\tau}^{\tilde{\delta}} : \mathcal{E} \rightarrow \xi(\mathfrak{L}, \mathcal{E})$ [where \mathcal{E} is a parameter set] that meet the three specified conditions. Since the value of a single-valued neutrosophic soft set (svnfs) f_ℓ under the mapping $\tilde{\tau}^{\tilde{\sigma}}, \tilde{\tau}^{\tilde{\zeta}}, \tilde{\tau}^{\tilde{\delta}}$ gives us the degree of openness, the degree of indeterminacy, and the degree of non-openness, respectively, of the svnfs with respect to the parameter $\tilde{e} \in \mathcal{E}$, $(\tilde{\tau}^{\tilde{\sigma}}, \tilde{\tau}^{\tilde{\zeta}}, \tilde{\tau}^{\tilde{\delta}})$, which can be thought of as a single-valued neutrosophic soft topology in the sense of Šostak. In this sense, we have presented single-valued neutrosophic soft cotopology and given the relations among single-valued neutrosophic soft topology and single-valued neutrosophic soft cotopology. Then, we have demarcated single-valued neutrosophic soft base $(\mathfrak{L}^{\tilde{\sigma}}, \mathfrak{L}^{\tilde{\zeta}}, \mathfrak{L}^{\tilde{\delta}})$, and by using a single-valued neutrosophic soft base, we have obtained a single-valued neutrosophic soft topology on the same set. Also, the dual idea of final single-valued neutrosophic soft closure spaces (svnf-closure space) is a typical study and methodically ensured next the same results proved in this paper, and we think that no necessity to improve special study for the final single-valued neutrosophic soft closure structures. Finally, we have showed that the category of single-valued neutrosophic soft topological

spaces **SVNTOP** is a topological category on **SET** with respect to the forgetful functor.

Acknowledgements The authors would like to thank Deanship of Scientific Research at Majmaah University for supporting this work under Project Number No: R-2022-125. The authors would also like to express their sincere thanks to the referees for their useful suggestions and comments.

Funding This research was supported by Majmaah University.

References

- Abbas SE, El-sanowsy E, Atef A (2018) Stratified modeling in soft fuzzy topological structures. *Soft Comput* 22:1603–1613
- Adámek J, Herrlich H, Strecker GE (1990) *Abstract and concrete categories*. Wiley, New York
- Ahmed B, Kharal A (2009) On fuzzy soft sets. *Adv Fuzzy Syst*. <https://doi.org/10.1155/2009/586507>
- Alsharari F, Smarandache F, Saber YM (2021) Compactness on single-valued neutrosophic ideal topological spaces. *Neutrosophic Sets Syst* 41:127–145
- Arockiarani I, Sumathi IR, Jency JM (2013) fuzzy neutrosophic soft topological spaces. *Int J Math Arch* 4(10):225–238
- Atef M, Ali M, Al-shami T (2021) Fuzzy soft covering-based multi-granulation fuzzy rough sets and their applications. *Comput Appl Math* 40(4):1–26
- Atef M, Nada S (2021) On three types of soft fuzzy coverings based rough sets. *Math Comput Simul* 185:452–467
- Aygünoğlu A, Çetkin V, Aygün H (2014) An introduction to fuzzy soft topological spaces. *Hacetatepe J Math Stat* 43(2):193–204
- Chang CL (1968) Fuzzy topological spaces. *J Math Anal Appl* 24(1):182–190
- El-Gayyar MK (2016) Smooth neutrosophic topological spaces. *Neutrosophic Sets Syst* 12:65–72
- Feng F, Li C, Davvaz B, Ali MI (2010) Soft sets combined with fuzzy sets and rough sets: a tentative approach. *Soft Comput* 14:899–911
- Feng F, Liu X, Leoreanu-Fotea V, Jun YB (2011) Soft sets and soft rough sets. *Inf Sci* 181:1125–1137
- Molodtsov D (1999) Soft set theory—first results. *Comput Math Appl* 37(3):19–31
- Molodtsov D (2001) Describing dependences using soft sets. *J Comput Syst Sci Int* 40(3):975–982
- Maji P, Biswas R, Roy A (2001) Fuzzy soft sets. *J Fuzzy Math* 9(3):589–602
- Maji PK, Roy AR, Biswas R (2002) An application of soft sets in a decision making problem. *Comput Math Appl* 44(8):1077–1083
- Nawar AS, Atef M, Khalil AM (2021) Certain types of fuzzy soft β -covering based fuzzy rough sets with application to decision-making. *Intell Fuzzy Syst* 40(6):10825–10836

- Riaz M, Çağman N, Zareef I, Aslam M (2019) N-soft topology and its applications to multi-criteria group decision making. *J Intell Fuzzy Syst* 36(6):6521–6536
- Riaz M, Davvaz B, Firdous A, Fakhar A (2019) Novel concepts of soft rough set topology with applications. *J Intell Fuzzy Syst* 36(4):3579–3590
- Riaz M, Karaaslan F, Nawaz I, Sohail M (2021) Soft multi-rough set topology with applications to multi-criteria decision-making problems. *Soft Comput J Intell Fuzzy Syst* 25(1):799–815
- Riaz M, Samrandache F, Firdous A, Fakhar F (2019) On soft rough topology with multi-attribute group decision making. *Mathematics* 7(1):1–18
- Saber YM, Abdel-Sattar MA (2014) Ideals on fuzzy topological spaces. *Appl Math Sci* 8:1667–1691
- Saber YM, Alsharari F (2018) Generalized fuzzy ideal closed sets on fuzzy topological spaces in Šostak sense. *Int J Fuzzy Logic Intell Syst* 18:161–166
- Saber YM, Alsharari F (2020) $\mathcal{G}\Theta_{\tau_i}^{*r_j}$ -Fuzzy closure operator. *New Math Nat Comput* 16:123–141
- Saber YM, Alsharari F, Smarandache F (2020) On Single-valued neutrosophic ideals in Šostak sense. *Symmetry* 12:194
- Saber YM, Alsharari F, Smarandache F, Abdel-Sattar A (2020) Connectedness and stratification of single-valued neutrosophic topological spaces. *Symmetry* 12:1464
- Saber YM, Alsharari F, Smarandache F, Abdel-Sattar A (2022) On single valued neutrosophic regularity spaces. *Comput Model Eng Sci* 130(3):1625–1648
- Salama AA, Alblowi SA (2012) Neutrosophic set and neutrosophic topological spaces. *IOSR J Math* 3:31–35
- Salama AA, Smarandache F (2015) Neutrosophic crisp set theory. The Educational Publisher Columbus, Columbus
- Şenel G (2016) A new approach to Hausdorff space theory via the soft sets. *Math Probl Eng*. <https://doi.org/10.1155/2016/2196743>
- Şenel G (2017) The parameterization reduction of soft point and its applications with soft matrix. *Int J Comput Appl*. <https://doi.org/10.5120/ijca2017913564>
- Shabir M, Naz M (2011) On soft topological spaces. *Comput Math Appl* 61(7):1786–1799
- Shang Y (2014) Average consensus in multi-agent systems with uncertain topologies and multiple time-varying delays. *Linear Algebra Appl* 459:411–429
- Smarandache, F. A Unifying field in logics: neutrosophic logic. neutrosophy, neutrosophic set, neutrosophic probability and statistics, 6th ed.; InfoLearnQuest: Ann Arbor, MI, USA, 2007. <http://fs.gallup.unm.edu/eBook-neutrosophics6.pdf>. Accessed on 10 February 2019
- Šostak AP (1985) On a fuzzy topological structure. *Rendiconti del Circolo Matematico di Palermo* 1(11):89–103
- Tanay B, Kandemir MB (2011) Topological structure of fuzzy soft sets. *Comput Math Appl* 61(10):2952–2957
- Tripathy BC, Acharjee S (2017) Some results on soft bitopology. *Boletim da Sociedade Paranaense de Matematica* 35(1):269–279
- Varol BP, Aygün H (2012) Fuzzy soft topology. *Hacettepe J Math Stat* 41(3):407–419
- Wang H, Smarandache F, Zhang YQ, Sunderraman R (2010) Single valued neutrosophic sets. *Multispace Multistruct* 4:410–413
- Yang HL, Guo ZL, Liao X (2016) On single valued neutrosophic relations. *J Intell Fuzzy Syst* 30:1045–1056
- Ye JA (2014) multicriteria decision-making method using aggregation operators for simplified neutrosophic sets. *J Intell Fuzzy Syst* 26:2450–2466
- Zhang X, Atef M, Khalil A (2021) On different types of single-valued neutrosophic covering rough set with application in decision-making. *Math Probl Eng*. <https://doi.org/10.1155/2021/7362006>

A Combined Use of Soft and Neutrosophic Sets for Student Assessment with Qualitative Grades

Michael Voskoglou, Said Broumi, Florentin Smarandache

Michael Voskoglou, Said Broumi, Florentin Smarandache (2022). A Combined Use of Soft and Neutrosophic Sets for Student Assessment with Qualitative Grades. *Journal of Neutrosophic and Fuzzy Systems* 4(1), 15-20; DOI: 10.54216/JNFS.040102

Abstract

A hybrid assessment method of a group's overall performance with respect to a certain activity is developed in this paper using soft and neutrosophic sets as tools and it is applied for student assessment. The present method is compared with another method developed in an earlier authors' work, which uses soft sets and grey numbers as tools for the assessment.

Keywords: Fuzzy Set (FS); Neutrosophic Set (NS); Soft Set (SS); Assessment under fuzzy conditions

1. Introduction

The assessment of human or machine activities is a very important process, because it helps to correct mistakes and improve performance. Assessment takes place in two ways, either with the help of numerical or with the help of qualitative grades. The

second way is usually preferred when more elasticity is desirable (as it frequently happens, for example, in case of student assessment), or when no exact numerical data are available.

When numerical grades are used, standard methods are applied for the overall assessment of the skills of a group of objects participating in a certain activity, like the calculation of the mean value of all the individual grades. In earlier works we have developed a series of methods for assessment with qualitative grades (therefore under fuzzy conditions), most of which are reviewed in [1]. Recently we have also develop a hybrid method for assessing analogical reasoning skills that uses soft sets and grey numbers (closed real intervals) as tools [2].

In the present paper we develop a new hybrid assessment method using soft and neutrosophic sets as tools and we apply it to student assessment. Our new method is compared with the previous one [2], to emphasize the different information given to the user in each case. The rest of the paper is organized as follows: Section 2 contains the background information about grey numbers, neutrosophic sets and soft sets needed for the better understanding of the paper. The new hybrid assessment method is developed in Section 3 and is compared to the method developed in [2]. The paper closes with the final conclusions and some hints for future research, which are presented in its last Section 4.

2. Background Information

2.1 Grey Numbers

Deng [3] introduced in 1982 the theory of *grey systems* as a new tool for dealing with the uncertainty created by the use of approximate data. A system is characterized as grey if it lacks information about its structure, operation and/or its behavior. The use of *grey numbers (GNs)* is the tool for performing the necessary calculations in grey systems.

A GN A , is an interval estimate $[x, y]$ of a real number, whose exact value within $[x, y]$ is not known. We write then $A \in [x, y]$. A GN is frequently accompanied by a *whitenization function* $g: [x, y] \rightarrow [0, 1]$, such that, if $a \in [x, y]$, then the closer $g(a)$ to 1, the better a approximates the unknown exact value of the GN. If no whitenization function is defined (then the GN coincides with the *closed real interval* $[x, y]$), it is logical to consider as a crisp approximation of unknown number A the real number

$$V(A) = \frac{x+y}{2} \quad (1)$$

The arithmetic operations on GNs are defined with the help of the known arithmetic of the real intervals [4]. In this work we'll only make use of the addition of GNs and of the scalar product of a GN with a positive number, which are defined as follows:

Let $A \in [x_1, y_1]$, $B \in [x_2, y_2]$ be two GNs and let k be a positive number. Then:

- The sum: $A+B$ is the GN $A+B \in [x_1+y_1, x_2+y_2]$ (2)
- The scalar product kA is the GN $kA \in [kx_1, ky_1]$ (3)

2.2 Neutrosophic Sets

Zadeh defined the concept of *fuzzy set (FS)* in 1965 as follows [5]:

Definition 1: Let U be the universal set of the discourse, then a FS A in U is defined with the help of its *membership function* $m: U \rightarrow [0,1]$ as the set of the ordered pairs

$$A = \{(x, m(x)): x \in U\} \quad (4)$$

The real number $m(x)$ is called the *membership degree* of x in A . The greater $m(x)$, the more x satisfies the characteristic property of A . A crisp subset A of U is a FS on U with membership function taking the values $m(x)=1$ if x belongs to A and 0 otherwise. Whereas probability theory is suitable for tackling the uncertainty due to *randomness* (e.g. games of chance), FSs tackle successfully the uncertainty due to *vagueness*. Vagueness is created when one is unable to clearly differentiate between two classes, such as “a good player” and “a mediocre player”. For general facts on FSs we refer to [6].

Atanassov in 1986 added to Zadeh’s membership degree the *degree of non-membership* and introduced the concept of *intuitionistic fuzzy set (IFS)* as follows [7]:

Definition 2: An IFS A in the universe U is defined with the help of its membership function $m: U \rightarrow [0,1]$ and of its non-membership function $n: U \rightarrow [0,1]$ as the set of the ordered triples

$$A = \{(x, m(x), n(x)): x \in U, 0 \leq m(x) + n(x) \leq 1\} \quad (5)$$

One can write $m(x) + n(x) + h(x) = 1$, where $h(x)$ is called the *hesitation* or *uncertainty degree* of x . When $h(x) = 0$, then the corresponding IFS is reduced to an ordinary FS. An IFS promotes the intuitionistic idea, as it incorporates the degree of hesitation.

For example, if A is the IFS of the diligent students of a class and $(x, 0.7, 0.2) \in A$, then there is a 70% probability for the student x to be diligent, a 20% probability to be not diligent, and a 10% hesitation to be characterized as either diligent or not.

IFSs, simulate successfully the existing *imprecision* in human thinking. For general facts on IFSs we refer to [8]. Smarandache, motivated by the various neutral situations appearing in real life - like <friend, neutral, enemy>, <positive, zero, negative>, <small, medium, high>, <male, transgender, female>, <win, draw, defeat>, etc. - introduced in 1995 the degree of *indeterminacy/neutrality* of the elements of the universal set U in a subset of U and defined the concept of NS as follows [9]:

Definition 3: A *single valued NS (SVNS)* A in U is of the form

$$A = \{(x, T(x), I(x), F(x)): x \in U, T(x), I(x), F(x) \in [0,1], 0 \leq T(x)+I(x)+F(x) \leq 3\} \quad (6)$$

In (6) $T(x)$, $I(x)$, $F(x)$ are the degrees of *truth* (or membership), indeterminacy and *falsity* (or non-membership) of x in A respectively, called the *neutrosophic components* of x . For simplicity, we write $A \langle T, I, F \rangle$.

The term “neutrosophy” comes from the adjective “neutral” and the Greek word “sophia” (wisdom) and means “the knowledge of neutral thought”.

For example, let U be the set of the players of a basketball team and let A be the SVNS of the good players of U . Then each player x of U is characterized by a *neutrosophic triplet* (t, i, f) with respect to A , with t, i, f in $[0, 1]$. For example, $x(0.7, 0.1, 0.4) \in A$ means that there is a 70% probability for x to be a good player, a 10% doubt if x could be characterized as a good player and a 40% probability for x to be a not a good player. In particular, $x(0,1,0) \in A$ means that we do not know absolutely nothing about x 's affiliation with A .

Indeterminacy is understood to be in general everything which is between the opposites of truth and falsity [10]. In an IFS the indeterminacy coincides by default to hesitancy, i.e. we have $I(x)=1- T(x) - F(x)$. Also, in a FS is $I(x)=0$ and $F(x) = 1 - T(x)$, whereas in a crisp set is $T(x)=1$ (or 0) and $F(x)= 0$ (or 1). In other words, crisp sets, FSs and IFSs are special cases of SVNSs.

For general facts on SVNSs new refer to [11]

When the sum $T(x) + I(x) + F(x)$ of the neutrosophic components of $x \in U$ in a SVNS A on U is <1 , then it leaves room for incomplete information about x , when is equal to 1 for complete information and when is greater than 1 for *paraconsistent* (i.e. contradiction tolerant) information about x . A SVNS may contain simultaneously elements leaving room to all the previous types of information.

When $T(x) + I(x) + F(x) < 1, \forall x \in U$, then the corresponding SVNS is usually referred as *picture FS (PiFS)* [12]. In this case $1- T(x)-I(x)-F(x)$ is called the degree of *refusal membership* of x in A . The PiFSs based models are adequate in situations where we face human opinions involving answers of types yes, abstain, no and refusal. Voting is a representative example of such a situation.

The difference between the *general definition of a NS* and the previously given definition of a SVNS is that in the general definition $T(x)$, $I(x)$ and $F(x)$ may take values in the *non-standard unit interval* $] -0, 1+[$ (including values <0 or >1). This could happen in real situations. For example, in a company with full-time work for its

employees 35 hours per week, an employee, with respect to his/her work, belongs by $\frac{35}{35}=1$ to the company

(full-time job) or by $\frac{20}{35} < 1$ (part-time job) or by $\frac{40}{35} > 1$ (over-time job). Assume further that a full-time

employee caused a damage to his/her job's equipment, the cost of which must be taken from his salary. Then, if

the cost is equal to $\frac{40}{35}$ of his/her weekly salary, the employee belongs this week to the company by $-\frac{5}{35} < 0$.

NSs, apart from vagueness, manage as well the cases of uncertainty due to *ambiguity* and *inconsistency*. In the former case the existing information leads to several interpretations by different observers. For example, the statement “Boy no girl” written as “Boy, no girl” means boy, but written as “Boy no, girl” means girl. Inconsistency, on the other hand, appears when two or more pieces of information cannot be true at the same time. As a result the obtainable in this case information is conflicted or undetermined. For example, “the probability for being windy tomorrow is 90%, but this does not mean that the probability for not having strong winds is 10%, because they might be hidden meteorological conditions”.

2.3 Soft Sets

A disadvantage connected to FSs is that there is not any exact rule for defining properly the membership function. The methods used are usually empirical or statistical and the definition of the membership function is not unique depending on the “signals” that each one receives from the environment, which are different from person to person. For example, defining the FS of “young people” one could consider as young all those being less than 30 years old and another one all those being less than 40 years old. As a result the two observers will assign different membership degrees to people with ages below those two upper bounds. The only restriction for the definition of the membership function is to be compatible to common logic; otherwise the resulting FS does not give a reliable description of the corresponding real situation. This could happen for instance, if in the FS of “young people”, people aged over 70 years possess membership degrees ≥ 0.5 .

The same difficulty appears to all generalizations of FSs in which membership functions are involved (e.g. IFSs, NSs, etc.). For this reason, the concept of *interval-valued FS (IVFS)* was introduced in 1975 [13], in which the membership degrees are replaced by sub-intervals of the unit interval $[0, 1]$. Alternative to FSs theories were also proposed, in which the definition of a membership function is either not necessary (grey systems/GNs [3]), or it is overpassed by considering a pair of sets which give the lower and the upper approximation of the original crisp set (*rough sets* [14]).

Molodstov, in order to deal with the uncertainty in a parametric manner, initiated in 1999 the concept of *soft set (SS)* as follows [15]:

Definition 4: Let E be a set of parameters, let A be a subset of E , and let f be a map from A into the power set $P(U)$ of all subsets of the universe U . Then the SS (f, A) in U is defined to be the set of the ordered pairs

$$(f, A) = \{(e, f(e)): e \in A\} \quad (7)$$

The name "soft" was given because the form of (f, A) depends on the parameters of A . For each $e \in A$, its image $f(e)$ is called the *value set* of e in (f, A) , while f is called the *approximation function* of (f, A) .

Example 1: Let $U = \{C_1, C_2, C_3\}$ be a set of cars and let $E = \{e_1, e_2, e_3\}$ be the set of the parameters e_1 =cheap, e_2 =hybrid (petrol and electric power) and e_3 = expensive. Let us further assume that C_1, C_2 are cheap, C_3 is expensive and C_2, C_3 are the hybrid cars. Then, a map $f: E \rightarrow P(U)$ is defined by $f(e_1)=\{C_1, C_2\}$, $f(e_2)=\{C_2, C_3\}$ and $f(e_3)=\{C_3\}$. Therefore, the SS (f, E) in U is the set of the ordered pairs $(f, E) = \{(e_1, \{C_1, C_2\}), (e_2, \{C_2, C_3\}), (e_3, \{C_3\})\}$.

A FS in U with membership function $y = m(x)$ is a SS in U of the form $(f, [0, 1])$, where

$f(\alpha) = \{x \in U: m(x) \geq \alpha\}$ is the corresponding α -cut of the FS, for each α in $[0, 1]$.

As it has been already mentioned, an important advantage of SSs is that, by using the parameters, they pass through the existing difficulty of defining properly membership functions.

For general facts on soft sets we refer to [16].

3. The Hybrid Assessment Method

3.1 Assessment Using Soft Sets and Grey Numbers

We illustrate this method, developed in [2], with the following example:

Example 2: The teacher of mathematics of a high-school class consisting of 20 students evaluated their mathematical skills as follows: The first three of them are excellent students, the next five very good, the next six good, the following four mediocre students and the last two demonstrated a non-satisfactory performance. It is asked:

1. To represent the mathematical performance of the class in a parametric manner.
2. To estimate the mean mathematical level of the class.

Solution: 1. Let $U = \{s_1, s_2, \dots, s_{20}\}$ be the set of the students of the class and let $E = \{A, B, C, D, E\}$ be the set of the qualitative grades (parameters) A =excellent, B =very good, C =good, D =mediocre and F =not satisfactory. Then a function $f: E \rightarrow P(U)$ can be defined by $f(A) = \{s_1, s_2, s_3\}$, $f(B) = \{s_4, s_5, s_6, s_7, s_8\}$, $f(C) = \{s_9, s_{10}, s_{11}, s_{12}, s_{13}, s_{14}\}$, $f(D) = \{s_{15}, s_{16}, s_{17}, s_{18}\}$ and $f(F) = \{s_{19}, s_{20}\}$. A parametric representation of the performance of the class in mathematics is given, therefore, by the SS in U

$(f, E) = \{(A, f(A)), (B, f(B)), (C, f(C)), (D, f(D)), (F, f(F))\}$.

2. Translating the qualitative grades of E in the numerical scale 0-100 we assign to each qualitative grade a closed real interval (GN), denoted for simplicity by the same letter, as follows: $A=[85, 100]$, $B=[75, 84]$, $C=[60, 74]$, $D=[50, 59]$ and $F=[49, 0]$. Obviously, although it was performed according to generally accepted standards, this assignment is not unique, depending on the user's personal goals (more strict or more elastic assessment).

It is logical now to consider as a representative of the student mean performance the real interval $M = \frac{1}{20} (3A +$

$5B + 6C + 4D + 2F)$. Using equations (2) and (3) it is straightforward to check that $M = \frac{1}{20} [1190, 1498] = [59.5,$

$74.9]$. Therefore, by equation (1) one finds that $V(M)=67.2$, which shows that the mean mathematical level of the class is good (C).

Remark 1: Case 2 of Example 2 could be also solved by using *triangular fuzzy numbers (TFNs)* instead of GNs. It can be shown that these two methods are equivalent to each other ([1], Sections 5, 6 and Remark 3:(1)).

3.2 Summation and Scalar Product with Neutrosophic Triplets (in the Sense of Grey Numbers)

Summation of neutrosophic triplets is equivalent to neutrosophic union of sets. That is why the neutrosophic summation and implicitly its extension to neutrosophic scalar multiplication can be defined in many ways, equivalently to the known in the literature neutrosophic union operators [17].

Here, writing the elements of a SVN A in the form of neutrosophic triplets we define addition and scalar product in A (in the sense of GNs) as follows:

Let $(t_1, i_1, f_1), (t_2, i_2, f_2)$ be in A and let k be appositve number. Then;

- The sum $(t_1, i_1, f_1) + (t_2, i_2, f_2) = (t_1 + t_2, i_1 + i_2, f_1 + f_2)$ (8)

- The scalar product $k(t_1, i_1, f_1) = (kt_1, k i_1, kf_1)$ (9)

3.3 Assessment Using Soft Sets and Neutrosophic Sets

We illustrate our new hybrid assessment method with the following example:

Example 3: Reconsider Example 2 and assume that the teacher is not sure about the individual assessment of the student mathematical skills. He/she decides, therefore, to characterize the set of excellent students using neutrosophic triplets as follows: $s_1(1, 0, 0)$, $s_2(0.9, 0.1, 0.1)$, $s_3(0.8, 0.2, 0.1)$, $s_4(0.4, 0.5, 0.8)$, $s_5(0.4, 0.5, 0.8)$, $s_6(0.3, 0.7, 0.8)$, $s_7(0.3, 0.7, 0.8)$, $s_8(0.2, 0.8, 0.9)$, $s_9(0.1, 0.9, 0.9)$, $s_{10}(0.1, 0.9, 0.9)$ and all the other students by $(0, 0, 1)$. This means that the teacher is absolutely sure that s_1 is an excellent student, 90% sure that s_2 is an excellent student too, but he/she has a 10% doubt about it and there is also a 10% probability to be not an excellent student, etc. For the last 10 students the teacher is absolutely sure that they cannot be characterized as excellent.

1. It is asked to represent the mathematical performance of the class in a parametric manner.
2. What should be the teacher’s conclusion about the class’s mean mathematical level in this case?

Solution: 1. Work as in case 1 of Example 2.

2. It is logical to accept in this case that the class’s mean mathematical level can be estimated by the

neutrosophic triplet $\frac{1}{20} [(1, 0, 0)+(0.9, 0.1, 0.1)+(0.8, 0.2, 0.1)+2(0.4, 0.5, 0.8)+2(0.3, 0.7, 0.8)+(0.2, 0.8,$

$0.9)+2(0.1, 0.9, 0.9)+10(0, 0, 1)]$, which by equations (8) and (9) is equal to $\frac{1}{20} (4.5, 5.3, 16.3) = (0.225, 0.265,$

$0.815)$. This means that a random student of the class has a 22.5 % probability to be an excellent student, however, there exist also a 26.5% doubt about it and an 81.5% probability to be not an excellent student. Obviously this conclusion is characterized by inconsistency.

Remark 2: The teacher could work in the same way by considering the NSs of the very good, good, mediocre and weak students and get analogous results.

3.4 Comparison of the Assessment Methods

The use of SS enables in both cases a parametric/qualitative assessment of the class’s performance. The use of GNs is appropriate when the teacher is absolutely sure for the assessment of the individual performance of each student and gives a creditable approximation of the class’s mean performance. The use of NSs, on the contrary, is appropriate when the teacher has doubts about the student individual assessment. In this case, the information obtained depends on the choice of the corresponding NS (e.g. excellent students, good students, etc.) and it is possible to be characterized by inconsistency (e.g. in Example 3 a random student of the class has a 22.5 % probability to be an excellent student, but at the same timer a 81.5% probability to be not an excellent student).

4. Conclusions and Hints for Future Research

In the present paper two hybrid assessment methods under fuzzy conditions (with qualitative grades) were studied. The discussion performed leads to the following three important conclusions:

- The use of SSs enables a parametric/qualitative assessment of the class’s overall performance.
- The use of closed real intervals (GNs) is suitable when the teacher is absolutely sure for the assessment of the individual performance of each student and gives a creditable approximation of the class’s mean performance. Obviously, this approach is very useful when the performance of two or more classes must be compared.
- The use of NSs is suitable when the teacher has doubts about the student individual assessment. In this case, the information obtained depends on the choice of the corresponding NS (e.g. excellent students, good students, etc.) and it is possible to be characterized by inconsistency.

The results obtained in this and in older authors’ papers (e.g. [2, 18], etc.) show that frequently a combination of two or more of the theories developed for dealing with the existing in real world fuzziness (e.g. see [19]) gives better results, not only in assessment cases, but also in decision making, for tackling the uncertainty, and possibly in many other human or machine activities. This is, therefore, a promising area for future research.

References

- [1] Voskoglou, M.Gr., Methods for Assessing Human-Machine Performance under Fuzzy Conditions. *Mathematics*, 7, article 230, 2019.
- [2] Voskoglou, M.Gr. and Broumi, S., A Hybrid Method for the Assessment of Analogical Reasoning Skills, *Journal of Fuzzy Extension and Applications*, 3(2), 152-157, 2022.
- [3] Deng, J., Control Problems of Grey Systems, *Systems and Control Letters*, 288-294, 1982.
- [4] Moore, R.A., Kearfort, R.B., Cloud, M.G., *Introduction to Interval Analysis*, 2nd ed., SIAM, Philadelphia, PA, USA, 1995.
- [5] Zadeh, L.A. Fuzzy Sets. *Inf. Control*, 8, 338–353, 1965.
- [6] Klir, G.J. and Folger, T.A., *Fuzzy sets, Uncertainty and Information*, Prentice-Hall, London, 1988
- [7] Atanassov, K.T., Intuitionistic Fuzzy Sets, *Fuzzy Sets and Systems*, 20(1), 87- 96, 1986.
- [8] Atanassov, K.T., *Intuitionistic Fuzzy Sets*, Physica-Verlag, Heidelberg, N.Y., 1999.
- [9] Smarandache, F., *Neutrosophy / Neutrosophic Probability, Set, and Logic*, Proquest, Michigan, USA, 1998
- [10] Smarandache, F., Indeterminacy in Neutrosophic Theories and their Applications, *International Journal of Neutrosophic Science*, 15(2), 89-97, 2021,.
- [11] Wang, H., Smarandache, F., Zhang, Y. and Sunderraman, R., Single Valued Neutrosophic Sets, *Review of the Air Force Academy (Brasov)*, 1(16), 10-14, 2010.
- [12] Cuong, B.C., Picture Fuzzy Sets, *Journal of Computer Science and Cybernetics*, 30(4), 409-420, 2014.
- [13] Dubois, D. and Prade, H., Interval-Valued Fuzzy Sets, *Possibility Theory and Imprecise Probability, Proceedings EUSFLAT-LFA*, 314-319, 2005.
- [14] Pawlak, Z., *Rough Sets: Aspects of Reasoning about Data*, Kluwer Academic Publishers, Dordrecht, 1991.
- [15] Molodtsov, D., Soft set theory – first results, *Computers and Mathematics with Applications*, 37(4-5), 19-31, 1999.
- [16] Maji, P.K., Biswas, R., & Roy, A.R., *Soft Set Theory*, *Computers and Mathematics with Applications*, 45, 555-562, 2003.
- [17] Smarandache, F., Subtraction and Division of Neutrosophic Numbers, *Critical Review*, Vol. XIII, 103-110, 2016.
- [18] Voskoglou, M.Gr., A Combined Use of Softs Sets and Grey Numbers in Decision Making, *Journal of Computational and Cognitive Engineering*, 2022, DOI: [10.47852/bonviewJCCE2202237](https://doi.org/10.47852/bonviewJCCE2202237) (in press).
- [19] Voskoglou, M.Gr., Generalizations of Fuzzy Sets and Related Theories, in M. Voskoglou (Ed.), *An Essential Guide to Fuzzy Systems*, Nova Science Publishers, NY, 345-352, 2019.

Improved Definition of NonStandard Neutrosophic Logic and Introduction to Neutrosophic Hyperreals (Fifth version)

Florentin Smarandache

Florentin Smarandache (2022). Improved Definition of NonStandard Neutrosophic Logic and Introduction to Neutrosophic Hyperreals (Fifth version). *Neutrosophic Sets and Systems* 51, 26-46.

Abstract: In the fifth version of our response-paper [26] to Imamura's criticism, we recall that NonStandard Neutrosophic Logic was never used by neutrosophic community in no application, that the quarter of century old neutrosophic operators (1995-1998) criticized by Imamura were never utilized since they were improved shortly after but he omits to tell their development, and that in real world applications we need to convert/approximate the NonStandard Analysis hyperreals, monads and binads to tiny intervals with the desired accuracy – otherwise they would be inapplicable.

We point out several errors and false statements by Imamura [21] with respect to the inf/sup of nonstandard subsets, also Imamura's "rigorous definition of neutrosophic logic" is wrong and the same for his definition of nonstandard unit interval, and we prove that there is not a total order on the set of hyperreals (because of the newly introduced Neutrosophic Hyperreals that are indeterminate), whence the Transfer Principle from R to R^* is questionable.

After his criticism, several response publications on theoretical nonstandard neutrosophics followed in the period 2018-2022. As such, I extended the NonStandard Analysis by adding the *left monad closed to the right*, *right monad closed to the left*, *pierced binad* (we introduced in 1998), and *unpierced binad* - all these in order to close the newly extended nonstandard space (R^*) under nonstandard addition, nonstandard subtraction, nonstandard multiplication, nonstandard division, and nonstandard power operations [23, 24].

Improved definitions of NonStandard Unit Interval and NonStandard Neutrosophic Logic, together with NonStandard Neutrosophic Operators are presented.

Keywords: Neutrosophic Logic; NonStandard Analysis; NonStandard Neutrosophic Logic; Neutrosophic Operators; Neutrosophic Hyperreals

1. Introduction

I recall my first two answers to Imamura's 7th Nov. 2018 critics [1] about the NonStandard Neutrosophic Logic [20] on 24 Nov. 2018 (version 1) and 13 Feb. 2019 (version 2), and I update them after Imamura has published a third version [21] on a journal without even citing my previous response papers, nor making any comments or critics to them, although the paper was uploaded to arXiv shortly after him and also online at my UNM [20]. I find it as dishonest.

Surely, he can recall over and over again the first neutrosophic connectives, but he has to tell the whole story: they were never used in no application, and they were improved several times starting with the American researcher Ashbacher’s neutrosophic connectives in 2002, Riviaccio in 2008, and Wang, Smarandache, Zhang, and Sunderraman in 2010. Version

The only reason I have added the nonstandard form to neutrosophic logic (and similarly to neutrosophic set and probability) was in order to make a distinction between *Relative Truth* (which is truth in some Worlds, according to Leibniz) and *Absolute Truth* (which is truth in all possible Words, according to Leibniz as well) that occur in philosophy.

Another possible reason may be when the neutrosophic degrees of truth, indeterminacy, or falsehood are infinitesimally determined, for example: the right monad (0.8⁺) means a value strictly bigger than 0.8 but infinitely closer to 0.8. And similarly, the left monad (-0.8) means a value strictly smaller than 0.8 but infinitely closer to 0.8. While the binad (-0.8⁺) means a value different from 0.8 but infinitely closer (from the right-hand side, or left-hand side) to 0.8. But they do not exist in our real world (the real set R), only in the hyperreal set R*, so we need to *convert / approximate* these hyperreal sets by tiny real intervals with the desired accuracy (ε), such as: $(0.8, 0.8 + \varepsilon)$, $(0.8 - \varepsilon, 0.8)$, or $(0.8 - \varepsilon, 0.8) \cup (0.8, 0.8 + \varepsilon)$ respectively [24].

Since the beginning of the neutrosophic field, many things have been developed and evolved, where better definitions, operators, descriptions, and applications of the neutrosophic logic have been defined. The same way happens in any scientific field: starting from some initial definitions and operations the community improves them little by little. The reader should check the last development of the neutrosophics - there are thousands of papers, books, and conference presentations online, check for example: <http://fs.unm.edu/neutrosophy.htm>. It is not fear to keep recalling the old definitions and operators since they have been improved in the meantime. The last development of the field should be revealed, not omitted.

The general definition of the neutrosophic set used in the last years.

Let U be a universe and a set S included in U . Then each element $x \in S$, denoted as $x(T(x), I(x), F(x))$, has a degree of membership/truth $T(x)$ with respect to S , degree of indeterminate-membership $I(x)$, and degree of nonmembership $F(x)$, where

$T(x), I(x), F(x)$ are real subsets of $[0, 1]$.

I was more prudent when I presented the sum of single valued standard neutrosophic components, saying:

Let T, I, F be single valued numbers, $T, I, F \in [0, 1]$, such that $0 \leq T + I + F \leq 3$.

A friend alerted me: “If T, I, F are numbers in $[0, 1]$, of course their sum is between 0 and 3.” “Yes, I responded, I afford this tautology, because if I did not mention that the sum is up to 3, readers would take for granted that the sum $T + I + F$ is bounded by 1, since that is in all logics and in probability!”

Similarly, for the Neutrosophic Logic, but instead of elements we have propositions (in the propositional logic).

2. Errors in Imamura’s paper [21]:

2.1 Imamura’s assertion, referring to the Neutrosophic components T, I, F as subsets, that:

“Subsets of $]0, 1[$ may have neither infima nor suprema” is false.

Counter-Examples of subsets that have both infima and suprema:

Let denote the nonstandard unit interval $U =]0, 1[$.

Let $M =]0.2^+, .0.3]$, which is a subset of U , then

$inf(M) = 0.2, sup(M) = 0.3$.

In general, for any real numbers a and b , such that $0 \leq a < b \leq 1$, one has the corresponding nonstandard subset $S =]a^+, .b]$ included in U , that has both: $inf(S) = a, sup(S) = b$.

As a particular and interesting case, one has: $]0^+, .1[\subset]0, 1[$.

Even more general, for any finite real numbers $a, b \in R, a < b$, the nonstandard subset $S =]a^+, .b]$ included in R^* , has both: $inf(S) = a, sup(S) = b$.

2.2 Imamura’s “rigorous definition of neutrosophic logic” is wrong.

Let K be a nonarchimedean ordered field. The ordered field K is called nonarchimedean if it has nonzero infinitesimals.

He defined, for $x, y \in K$, x and y are said to be infinitely close (denoted by $x \approx y$) if $x-y$ is infinitesimal. Then x is roughly smaller than y (denoted as $x \lesssim y$) if $x < y$ or $x \approx y$.

This is wrong. See the below Counter-Examples.

Let $\varepsilon > 0$ be a positive infinitesimal, also $x = 5 + \varepsilon$ and $y = 5 - \varepsilon$ be hyperreals.

Of course, $x \in (5^+)$, right monad of 5, and $y \in ({}^-5)$, left monad of 5.

$5 + \varepsilon$ is infinitely closer to 5, but above (strictly greater than) 5;

while $5 - \varepsilon$ is infinitely closer to 5, but below (strictly smaller than) 5.

Then $x - y = 2\varepsilon$, which is infinitesimal, and, because x is *infinitely close to* y ($x \approx y$), one has that x is roughly smaller than y (or $x \lesssim y$), according to Imamura’s definition.

But this is false, since for $\varepsilon > 0$ clearly $5 + \varepsilon > 5 > 5 - \varepsilon$, whence $x > y$.

Therefore, x is not roughly smaller than y , but the opposite.

General Contra-Examples:

Let $\varepsilon > 0$ be a positive infinitesimal, and the real number $a \in R$.

Then for $x = a + \varepsilon$ and $y = a - \varepsilon$ we get the same wrong result $x < y$, according to Imamura.

Further on, for $x = a + \varepsilon$ and $y = a$, one gets the wrong result $x < y$.

And similarly, for $x = a$ and $y = a - \varepsilon$, one gets the wrong result $x < y$.

2.3 There exists no order between a and ${}^-a^+$ in R^* .

Let $a \in R$ be a real number, and ε be a positive or negative (we do not know exactly) infinitesimal.

Then $y = {}^-a^+$ is a hyperreal number of the form $y = a + \varepsilon$, where ε may be positive or negative infinitesimal.

Let $({}^-a^+)$ be the left-right binad [5] of a , defined as:

$$({}^-a^+) = \{a \pm \varepsilon, \text{ where } \varepsilon \text{ is a positive infinitesimal}\}.$$

Of course, ${}^-a^+ \in ({}^-a^+)$.

The transfer principle [21] states that R^* has the same first order properties as R .

But R^* has only a partial order, since there is no order between a and ${}^-a^+$ in R^* ,

while R has a total order.

On has $a \leq_N^{} a \leq_N^{} a$, then $a \leq_N^{} a \leq_N^{} a$, whence $a \leq_N^{} a$.

But, similar problems of non-order relationships are between a , a respectively and ${}^-a^+$.

Hence, the Transfer Principle from R to R^* is questionable...

3. Uselessness of Nonstandard Analysis in Neutrosophic Logic, Set, Probability. Statistics, et al.

Imamura’s discussion [1] on the definition of neutrosophic logic is welcome, but it is useless, since from all neutrosophic papers and books published, from all conference presentations, and from all MSc and PhD theses defended around the world, etc. (more than two thousands) in the last two decades since the first neutrosophic research started (1998-2022), and from thousands of neutrosophic researchers, not even a single one ever used the nonstandard form of neutrosophic logic, set, or probability and statistics in no occasion (extended researches or applications).

All researchers, with no exception, have used the *Standard Neutrosophic Set and Logic* [so no stance whatsoever of *Nonstandard Neutrosophic Set and Logic*], where the neutrosophic components T, I, F are real subsets of the standard unit interval $[0, 1]$.

People don't even write "standard" since it is understood, because nonstandard was never used in no applications - it is unusable in real applications.

Even more, for simplifying the calculations, the majority of researchers have utilized the *Single-Valued Neutrosophic Set and Logic* {when T, I, F are single real numbers from $[0, 1]$ }, on the second place was *Interval-Valued Neutrosophic Set and Logic* {when T, I, F are intervals included in $[0, 1]$ }, and on the third one the *Hesitant Neutrosophic Set and Logic* {when T, I, F were discrete finite subsets included in $[0, 1]$ }.

In this direction, there have been published papers on single-valued "neutrosophic standard sets" [12, 13, 14], where the neutrosophic components are just *standard real numbers*, considering the particular case when $0 \leq T + I + F \leq 1$ (in the most general case $0 \leq T + I + F \leq 3$).

Actually, Imamura himself acknowledges on his paper [1], page 4, that:

"neutrosophic logic does not depend on transfer, so the use of non-standard analysis is not essential for this logic, and can be eliminated from its definition".

Entire neutrosophic community has found out about this result and has ignored the nonstandard analysis from the beginning in the studies and applications of neutrosophic logic for two decades.

4. Applicability of Neutrosophic Logic et al. vs. Theoretical NonStandard Analysis

He wrote:

"we do not discuss the theoretical significance or the applications of neutrosophic logic"

Why doesn't he discuss of the applications of neutrosophic logic? Because it has too many that brough its popularity among researchers [2], unlike the NonStandard Analysis that is a non-physical (idealistic, imaginary) object and it is hard to apply it in the real world.

Neutrosophic logic, set, measure, probability, statistics and so on were designed with the primordial goal of being applied in practical fields, such as:

Artificial Intelligence, Information Systems, Computer Science, Cybernetics, Theory Methods, Mathematical Algebraic Structures, Applied Mathematics, Automation, Control Systems, Big Data, Engineering, Electrical, Electronic, Philosophy, Social Science, Psychology, Biology, Biomedical, Engineering, Medical Informatics, Operational Research, Management Science, Imaging Science, Photographic Technology, Instruments, Instrumentation, Physics, Optics, Economics, Mechanics, Neurosciences, Radiology Nuclear, Medicine, Medical Imaging, Interdisciplinary Applications, Multidisciplinary Sciences etc. [2], while nonstandard analysis is mostly a pure mathematics.

Since 1990, when I emigrated from a political refugee camp in Turkey to America, working as a software engineer for Honeywell Inc., in Phoenix, Arizona State, I was advised by American coworkers to do theories that have *practical applications*, not pure-theories and abstractizations as "*art pour art*".

5. Theoretical Reason for the Nonstandard Form of Neutrosophic Logic

The only reason I have added the nonstandard form to neutrosophic logic (and similarly to neutrosophic set and probability) was in order to make a distinction between *Relative Truth* (which is truth in some Worlds, according to Leibniz) and *Absolute Truth* (which is truth in all possible Words, according to Leibniz as well) that occur in philosophy.

Another possible reason may be when the neutrosophic degrees of truth, indeterminacy, or falsehood are infinitesimally determined, for example a value infinitesimally bigger than 0.8 (or 0.8^+), or infinitesimally smaller than 0.8 (or 0.8^-). But these can easily be overcome by roughly using interval

neutrosophic values and depending on the desired accuracy, for example (0.80, 0.81) and (0.79, 0.80) respectively.

I wanted to get the neutrosophic logic as general as possible [6], extending all previous logics (Boolean, fuzzy, intuitionistic fuzzy logic, intuitionistic logic, paraconsistent logic, dialethism), and to have it able to deal with all kinds of logical propositions (including paradoxes, nonsensical propositions, etc.).

That's why in 2013 I extended the Neutrosophic Logic to Refined Neutrosophic Logic [from generalizations of 2-valued Boolean logic to fuzzy logic, also from the Kleene's and Lukasiewicz's and Bochvar's 3-symbol valued logics or Belnap's 4-symbol valued logic to the most general n-symbol or n-numerical valued refined neutrosophic logic, for any integer $n \geq 1$], the largest ever so far, when some or all neutrosophic components T, I, F were respectively split/refined into neutrosophic subcomponents: $T_1, T_2, \dots; I_1, I_2, \dots; F_1, F_2, \dots;$ which were deduced from our everyday life [3].

6. From Paradoxism movement to Neutrosophy – generalization of Dialectics

I started first from *Paradoxism* (that I founded in 1980's as a movement based on antitheses, antinomies, paradoxes, contradictions in literature, arts, and sciences), then I introduced the *Neutrosophy* (as generalization of Dialectics (studied by Hegel and Marx) and of Yin Yang (Ancient Chinese Philosophy), neutrosophy is a branch of philosophy studying the dynamics of triads, inspired from our everyday life, triads that have the form:

$$\langle A \rangle, \text{ its opposite } \langle antiA \rangle, \text{ and their neutrals } \langle neutA \rangle,$$

where $\langle A \rangle$ is any item or entity [4].

(Of course, we take into consideration only those triads that make sense in our real and scientific world.)

The Relative Truth neutrosophic value was marked as 1 , while the Absolute Truth neutrosophic value was marked as 1^+ (a tinny bigger than the Relative Truth's value):

$$1^+ >_N 1, \text{ where } >_N \text{ is a nonstandard inequality, meaning } 1^+ \text{ is nonstandardly bigger than } 1.$$

Similarly for Relative Falsehood / Indeterminacy (which falsehood / indeterminacy in some Worlds), and Absolute Falsehood / Indeterminacy (which is falsehood / indeterminacy in all possible worlds).

7. Introduction to Nonstandard Analysis [15, 16]

An *infinitesimal number* is a number ϵ such that its absolute value $|\epsilon| < 1/n$, for any non-null positive integer n . An infinitesimal is close to zero, and so small that it cannot be measured.

The infinitesimal is a number smaller, in absolute value, than anything positive nonzero.

Infinitesimals are used in calculus, but interpreted as tiny real numbers.

An *infinite number* (ω) is a number greater than anything:

$$1 + 1 + 1 + \dots + 1 \text{ (for any finite number terms)}$$

The infinites are reciprocals of infinitesimals.

The set of *hyperreals* (*non-standard reals*), denoted as R^* , is the extension of set of the real numbers, denoted as R , and it comprises the infinitesimals and the infinites, that may be represented on the *hyperreal number line*

$$1/\epsilon = \omega/1.$$

The set of hyperreals satisfies the *transfer principle*, which states that the statements of first order in R are valid in R^* as well [according to the classical NonStandard Analysis]:

" 'Anything provable about a given superstructure V by passing to a nonstandard enlargement $*V$ of V is also provable without doing so, and vice versa.' It is a result of Łoś' theorem and the completeness theorem for first-order predicate logic." [16]

A monad (halo) of an element $a \in R^*$, denoted by $\mu(a)$, is a subset of numbers infinitesimally close to a .

Let's denote by R_+^* the set of positive nonzero hyperreal numbers.

7.1. First Extension of NonStandard Analysis

We consider the left monad and right monad; afterwards we recall the *pierced binad* (Smarandache [5]) introduced in 1998:

Left Monad {that we denote, for simplicity, by (^-a) } is defined as:

$$\mu(^-a) = \{a - x, x \in R_+^* \mid x \text{ is infinitesimal}\}.$$

Right Monad {that we denote, for simplicity, by (^+a) } is defined as:

$$\mu(^+a) = \{a + x, x \in R_+^* \mid x \text{ is infinitesimal}\}.$$

The *Pierced Binad* {that we denote, for simplicity, by $(^-a^+)$ } is defined as:

$$\begin{aligned} \mu(^-a^+) &= \{a - x, x \in R_+^* \mid x \text{ is infinitesimal}\} \cup \{a + x, x \in R_+^* \mid x \text{ is infinitesimal}\} \\ &= \{a - x, x \in R^* \mid x \text{ is positive or negative infinitesimal}\}. \end{aligned}$$

7.1. Second Extension of Nonstandard Analysis [23]

For necessity of doing calculations that will be used in nonstandard neutrosophic logic in order to calculate the nonstandard neutrosophic logic operators (conjunction, disjunction, negation, implication, equivalence) and in order to have the Nonstandard Real MoBiNad Set closed under arithmetic operations, we extend now for the time: the left monad to the Left Monad Closed to the Right, the right monad to the Right Monad Closed to the Left; and the Pierced Binad to the Unpierced Binad, defined as follows (Smarandache, 2018-2019):

- Left Monad Closed to the Right

$$\mu\left(\overset{-0}{a}\right) = \left(\overset{-0}{a}\right) = \{a - x \mid x = 0, \text{ or } x \in R_+^* \text{ and } x \text{ is infinitesimal}\} = \mu(^-a) \cup \{a\}.$$

And by $x = \overset{-0}{a}$ we understand the **hyperreal** $x = a - \varepsilon$, or $x = a$, where ε is a positive infinitesimal. So, x is not clearly known, $x \in \{a - \varepsilon, a\}$.

- Right Monad Closed to the Left

$$\mu\left(\overset{0+}{a}\right) = \left(\overset{0+}{a}\right) = \{a + x \mid x = 0, \text{ or } x \in R_+^* \text{ and } x \text{ is infinitesimal}\} = \mu(^+a) \cup \{a\}.$$

And by $x = \overset{0+}{a}$ we understand the **hyperreal** $x = a + \varepsilon$, or $x = a$, where ε is a positive infinitesimal. So, x is not clearly known, $x \in \{a + \varepsilon, a\}$.

- Unpierced Binad

$$\begin{aligned} \mu\left(\overset{-0+}{a}\right) &= \left(\overset{-0+}{a}\right) = \{a + x \mid x = 0, \text{ or } x \in R^* \text{ where } x \text{ is a positive or negative infinitesimal}\} = \\ &= \mu(^-a) \cup \mu(^+a) \cup \{a\} = (^-a) \cup (^+a) \cup \{a\}. \end{aligned}$$

And by $x = \overset{-0+}{a}$ we understand the **hyperreal** $x = a - \varepsilon$, or $x = a$, or $x = a + \varepsilon$, where ε is a positive infinitesimal. So, x is not clearly known, $x \in \{a - \varepsilon, a, a + \varepsilon\}$.

The left monad, left monad closed to the right, right monad, right monad closed to the left, the pierced binad, and the unpierced binad are subsets of R^* , while the above hyperreals are numbers from R^* .

Let's define a partial order on R^* .

8. Neutrosophic Strict Inequalities

We recall the neutrosophic strict inequality which is needed for the inequalities of nonstandard numbers.

Let α, β be elements in a partially ordered set M .

We have defined the neutrosophic strict inequality

$$\alpha \succ_N \beta$$

and read as

" α is neutrosophically greater than β "

if

α in general is greater than β ,

or α is approximately greater than β ,

or subject to some indeterminacy (unknown or unclear ordering relationship between α and β) or subject to some contradiction (situation when α is smaller than or equal to β) α is greater than β .

It means that in most of the cases, on the set M , α is greater than β .

And similarly for the opposite neutrosophic strict inequality $\alpha \prec_N \beta$.

9. Neutrosophic Equality

We have defined the neutrosophic inequality

$$\alpha \simeq_N \beta$$

and read as

" α is neutrosophically equal to β "

if

α in general is equal to β ,

or α is approximately equal to β ,

or subject to some indeterminacy (unknown or unclear ordering relationship between α and β) or subject to some contradiction (situation when α is not equal to β) α is equal to β .

It means that in most of the cases, on the set M , α is equal to β .

10. Neutrosophic (Non-Strict) Inequalities

Combining the neutrosophic strict inequalities with neutrosophic equality, we get the \geq_N and \leq_N neutrosophic inequalities.

Let α, β be elements in a partially ordered set M .

The neutrosophic (non-strict) inequality

$$\alpha \geq_N \beta$$

and read as

" α is neutrosophically greater than or equal to β "

if

α in general is greater than or equal to β ,

or α is approximately greater than or equal to β ,

or subject to some indeterminacy (unknown or unclear ordering relationship between α and β) or subject to some contradiction (situation when α is smaller than β) α is greater than or equal to β .

It means that in most of the cases, on the set M , α is greater than or equal to β .

And similarly for the opposite neutrosophic (non-strict) inequality $\alpha \leq_N \beta$.

11. Neutrosophically Ordered Set

Let M be a set. $(M, <_N)$ is called a neutrosophically ordered set if:
 $\forall \alpha, \beta \in M$, one has: either $\alpha <_N \beta$, or $\alpha =_N \beta$, or $\alpha >_N \beta$.

12. Definition of Standard Part and Infinitesimal Part of a HyperReal Number

For each hyperreal (number) $h \in R^*$ one defines its standard part $st(h)$ be the real (standard) part of h , $st(h) \in R$, and its infinitesimal part, that may be positive $(+\varepsilon)$, or zero (0) , or negative $(-\varepsilon)$, and any combination of two or three of them in the case of Neutrosophic Hyperreals that have alternative (indeterminate) values as seen below, denoted as $in(h) \in R^*$.

Then $h = st(h) + in(h)$.

Two hyperreal numbers h_1 and h_2 are equal, if:
 $st(h_1) = st(h_2)$ and $in(h_1) = in(h_2)$.

- Examples

Let ε be a positive infinitesimal, and the hyperreal numbers:

$$h_1 = 4 - \varepsilon \in ({}^-4)$$

$$h_2 = 4 + 0 \stackrel{def}{=} 4 \in R$$

$$h_3 = 4 + \varepsilon \in (4^+)$$

$$h_4 = 4 - \{\varepsilon, \text{ or } 0\} = \{4 - \varepsilon, \text{ or } 4 - 0\} = \{4 - \varepsilon, \text{ or } 4\} \in \binom{-0}{4}$$

$$h_5 = 4 + \{0, \text{ or } \varepsilon\} = \{4 + 0, \text{ or } 4 + \varepsilon\} = \{4, \text{ or } 4 + \varepsilon\} \in \binom{0+}{4}$$

$$h_6 = 4 + \{-\varepsilon, \text{ or } \varepsilon\} = \{4 - \varepsilon, \text{ or } 4 + \varepsilon\} \in \binom{-+}{4}$$

$$h_7 = 4 + \{-\varepsilon, \text{ or } 0, \text{ or } \varepsilon\} = \{4 - \varepsilon, \text{ or } 4 + 0, \text{ or } 4 + \varepsilon\} = \{4 - \varepsilon, \text{ or } 4, \text{ or } 4 + \varepsilon\} \in \binom{-0+}{4}$$

Then, their standard parts are all the same:

$$st(h_1) = st(h_2) = \dots = st(h_7) = 4$$

While their infinitesimal parts are different:

$$in(h_1) = -\varepsilon$$

$$in(h_2) = 0$$

$$in(h_3) = \varepsilon$$

13. Neutrosophic Hyperreal Numbers

The below cases are indeterminate, as in neutrosophy, that's why they are called *Neutrosophic Hyperreals*, introduced now for the first time:

$in(h_4) = \{-\varepsilon, \text{ or } 0\}$; one can also write that $in(h_4) \in \{-\varepsilon, 0\}$, because we are not sure if

$$in(h_4) = -\varepsilon, \text{ or } in(h_4) = 0.$$

$in(h_5) = \{\varepsilon, \text{ or } 0\}$; one can also write that $in(h_5) \in \{\varepsilon, 0\}$.

$$in(h_6) = \{-\varepsilon, \text{ or } \varepsilon\}, \text{ or } in(h_6) \in \{-\varepsilon, \varepsilon\}.$$

$$in(h_7) = \{-\varepsilon, \text{ or } 0, \text{ or } \varepsilon\}, \text{ or } in(h_6) \in \{-\varepsilon, 0, \varepsilon\}.$$

14. Nonstandard Partial Order of Hyperreals

Let h_1 and h_2 be hyperreal numbers. Then $h_1 <_N h_2$ if:
 either $st(h_1) < st(h_2)$, or $st(h_1) = st(h_2)$ and $in(h_1) <_N in(h_2)$.

By $in(h_1)$ we understand all possible infinitesimals of h_1 , and similarly for $in(h_2)$.

This makes a partial order on the set of hyperreals R^* , because of the Neutrosophic Hyperreals that have indeterminate infinitesimal parts and cannot always be ordered.

15. Appurtenance of a Hyperreal number to a Nonstandard Set

We define for the first time the appurtenance of a hyperreal number (h) to a subset S of R^* , denoted as \in_N , or an approximate appurtenance (from a Neutrosophic point of view).

As seeing above, a hyperreal number may have one, two, or three infinitesimal parts - depending on its form.

Let's denote the standard part of h by $st(h)$, and its infinitesimal part(s) be $in(h) = in(h)_1, in(h)_2$, and $in(h)_3$. We construct three corresponding hyperreal numbers:

$$h_1 = st(h) + in(h)_1$$

$$h_2 = st(h) + in(h)_2$$

$$h_3 = st(h) + in(h)_3$$

If all three $h_1, h_2, h_3 \in_N S$, then $h \in_N S$. If at least one does not belong to S , then $h \notin_N S$.

(In the case when h has only one or two possible infinitesimals, of course we take only them.)

The appurtenance of a hyperreal number to a nonstandard set may be later extended if new forms of Neutrosophic Hyperreals are constructed in the meantime.

16. Notations and Approximations

Approximation is required with a desired accuracy, since the hyperreals, monads and binads do not exist in our real world. They are only very abstract concepts built in some imaginary math space.

That's why they must be approximated by real tiny sets.

As an example, let's assume that the truth-value (T) of a proposition (P), in the propositional logic, is the hyperreal $T(P) = 0.7^+$ that means, in nonstandard analysis, according to Imamura [22]:

- "The interpretation of $T(P) = 0.7^+$ (right monad of 0.7 in your terminology):*
- 1. the truth value of P is strictly greater than and infinitely close to 0.7 (but its precise value is unknown);*
 - 2. the truth value of P can be strictly greater than and infinitely close to 0.7;*
 - 3. the truth value of P takes all hyperreals strictly greater than and infinitely close to 0.7 simultaneously."*

We prove by reductio ad absurdum that such a number does not exist in our real world. Let assume that $0.7^+ = w$. Then $w > 0.7$, but on the set of continuous real numbers, in the interval $(0.7, w]$ there exists a number v such that $0.7 < v < w$, therefore v is closer to 0.7 than w , and thus w is not infinitely close to 0.7. Contradiction. Even Imamura acknowledges about 0.7^+ that "its value is unknown".

And because they do not exist in our real world, we need to approximate/convert them with a given accuracy to the real world, therefore, instead of 0.7^+ we may take for example the tiony interval $(0.7, 0.7001)$ with four decimals, or $(0.7, 0.7000001)$, etc.

In the same way one can prove that, for any real number $a \in R$, its left monad, left monad closed to the right, right monad, right monad closed to the left, pierced binad, and unpierced binad do not exist in our real world. They are just abstract concepts available in abstract/imaginary math spaces.

17. Nonstandard Unit Interval

Imamura cites my work:

*“by “-a” one signifies a monad, i.e., a set of hyper-real numbers in non-standard analysis:
 $(-a) = \{ a - x \in R_- \mid x \text{ is infinitesimal} \}$, and similarly “b+” is a hyper monad:
 $(b+) = \{ b + x \in R_+ \mid x \text{ is infinitesimal} \}$. ([5] p. 141; [6] p. 9)”*

But these are inaccurate, because my exact definitions of monads, since my 1998 first world neutrosophic publication [see [5], page 9; and [6], pages 385 - 386], were:

“(a) = { a - x: x ∈ R+ | x is infinitesimal }, and similarly “b+” is a hyper monad:
 $(b+) = \{ b + x: x \in R_{+}^* \mid x \text{ is infinitesimal} \}$ ”*

Imamura says that:

*“The correct definitions are the following:
 $(-a) = \{ a - x \in R_- \mid x \text{ is positive infinitesimal} \}$,
 $(b+) = \{ b + x \in R_+ \mid x \text{ is positive infinitesimal} \}$.”*

I did not have a chance to see how my article was printed in *Proceedings of the 3rd Conference of the European Society for Fuzzy Logic and Technology* [7], that Imamura talks about, maybe there were some typos, but Imamura can check the *Multiple Valued Logic / An International Journal* [6], published in England in 2002 (ahead of the European Conference from 2003, that Imamura cites) by the prestigious Taylor & Francis Group Publishers, and clearly one sees that it is: R_{+}^* (so, x is a positive infinitesimal into the above formulas), therefore there is no error.

Then Imamura continues:

*“Ambiguity of the definition of the nonstandard unit interval. Smarandache did not give any explicit definition of the notation]-0, 1+[in [5] (or the notation #-0, 1+ -# in [6]). He only said:
 Then, we call]-0, 1+[a non-standard unit interval. Obviously, 0 and 1, and analogously non-standard numbers infinitely small but less than 0 or infinitely small but greater than 1, belong to the non-standard unit interval. ([5] p. 141; [6] p. 9).”*

Concerning the notations I used for the nonstandard intervals, such as #- #| or] [, it was imperative to employ notations that are different from the classical [] or () intervals, since the extremes of the nonstandard unit interval were unclear, vague with respect to the real set.

I thought it was easily understood that:

$$]-0, 1+[= (-0) \cup [0, 1] \cup (1+).$$

Or, using the previous neutrosophic inequalities, we may write:

$$]-0, 1+[= \{x \in R^*, -0 \leq_N x \leq_N 1+\}.$$

Imamura says that:

*“Here -0 and 1+ are particular real numbers defined in the previous paragraph:
 $-0 = 0 - \epsilon$ and $1+ = 1 + \epsilon$, where ϵ is a fixed non-negative infinitesimal.”*

This is untrue, I never said that “ ϵ is a fixed non-negative infinitesimal”, ϵ was not fixed, I said that for any real numbers a and b [see again [5], page 9; and [6], pages 385 - 386]:

“(a) = { a - x: x ∈ R+ | x is infinitesimal }, (b+) = { b + x: x ∈ R+* | x is infinitesimal }”.*

Therefore, once we replace $a = 0$ and $b = 1$, we get:

$$\begin{aligned} (-0) &= \{ 0 - x: x \in R_{+}^* \mid x \text{ is infinitesimal} \}, \\ (1+) &= \{ 1 + x: x \in R_{+}^* \mid x \text{ is infinitesimal} \}. \end{aligned}$$

Thinking out of box, inspired from the real world, was the first intent, i.e. allowing neutrosophic components (truth / indeterminacy / falsehood) values be outside of the classical (standard) unit real

interval $[0, 1]$ used in all previous (Boolean, multi-valued etc.) logics if needed in applications, so neutrosophic component values < 0 and > 1 had to occur due to the Relative / Absolute stuff, with:

$$-0 <_N 0 \quad \text{and} \quad 1^+ >_N 1.$$

Later on, in 2007, I found plenty of cases and real applications in Standard Neutrosophic Logic and Set (therefore, not using the Nonstandard Neutrosophic Logic and Set), and it was thus possible the extension of the neutrosophic set to *Neutrosophic Overset* (when some neutrosophic component is > 1), and to *Neutrosophic Underset* (when some neutrosophic component is < 0), and to *Neutrosophic Offset* (when some neutrosophic components are off the interval $[0, 1]$, i.e. some neutrosophic component > 1 and some neutrosophic component < 0). Then, similar extensions to respectively *Neutrosophic Over/Under/Off Logic, Measure, Probability, Statistics etc.* [8, 17, 18, 19], extending the unit interval $[0, 1]$ to

$$[\Psi, \Omega], \text{ with } \Psi \leq 0 < 1 \leq \Omega,$$

where Ψ, Ω are standard real numbers.

Imamura says, regarding the definition of neutrosophic logic that:

“In this logic, each proposition takes a value of the form (T, I, F) , where T, I, F are subsets of the nonstandard unit interval $] -0, 1^+[$ and represent all possible values of Truthness, Indeterminacy and Falsity of the proposition, respectively.”

Unfortunately, this is not exactly how I defined it.

In my first book {see [5], p. 12; or [6] pp. 386 – 387} it is stated:

“Let T, I, F be real standard or non-standard subsets of $] -0, 1^+[$ ”

meaning that T, I, F may also be “real standard” not only real non-standard.

In *The Free Online Dictionary of Computing*, 1999-07-29, edited by Denis Howe from England, it is written:

Neutrosophic Logic:

<logic> (Or “Smarandache logic”) A generalization of fuzzy logic based on Neutrosophy. A proposition is t true, i indeterminate, and f false, where $t, i,$ and f are real values from the ranges $T, I, F,$ with no restriction on $T, I, F,$ or the sum

$$n = t + i + f.$$

Neutrosophic logic thus generalizes:

- *intuitionistic logic, which supports incomplete theories (for $0 < n < 100,$ $0 \leq t, i, f \leq 100$);*
- *fuzzy logic (for $n = 100$ and $i = 0,$ and $0 \leq t, i, f \leq 100$);*
- *Boolean logic (for $n=100$ and $i = 0,$ with t, f either 0 or 100);*
- *multi-valued logic (for $0 \leq t, i, f \leq 100$);*
- *paraconsistent logic (for $n > 100,$ with both $t, f < 100$);*
- *dialetheism, which says that some contradictions are true (for $t = f = 100$ and $i = 0$; some paradoxes can be denoted this way).*

Compared with all other logics, neutrosophic logic introduces a percentage of “indeterminacy” - due to unexpected parameters hidden in some propositions. It also allows each component t, i, f to “boil over” 100 or “freeze” under 0 . For example, in some tautologies $t > 100,$ called “overtrue”.

[“Neutrosophy / Neutrosophic probability, set, and logic”, F. Smarandache, American Research Press, 1998].

As Denis Howe said in 1999, the neutrosophic components t, i, f are “real values from the ranges T, I, F ”, not nonstandard values or nonstandard intervals. And this was because nonstandard ones were not important for the neutrosophic logic (the Relative/Absolute played no role in technological and scientific applications and future theories).

18. Formal Notations

In my first version of the paper, I used informal notations. Let's see them improved. Hyperreal Numbers are represented without parentheses () around them:

$$\begin{aligned} \bar{a} &= a = a - \varepsilon \\ a &= a + 0, \text{ which coincides with the real number } a. \\ a^+ &= a = a + \varepsilon \end{aligned}$$

Neutrosophic Hyperreal Numbers (that are indeterminate, alternative) are represented without braces, or with braces { } around them for discrete sets that may have one, two, or three elements:

$$\begin{aligned} a &= a - \varepsilon, \text{ or } a + 0 = \{a - \varepsilon, \text{ or } a + 0\} \\ a &= a + \varepsilon, \text{ or } a + 0 = \{a + \varepsilon, \text{ or } a + 0\} \\ a &= a - \varepsilon, \text{ or } a + \varepsilon = \{a - \varepsilon, \text{ or } a + \varepsilon\} \\ a &= a - \varepsilon, \text{ or } a + 0, \text{ or } a + \varepsilon = \{a - \varepsilon, \text{ or } a + 0, \text{ or } a + \varepsilon\} \end{aligned}$$

For the monads and binads one just adds the parentheses around them:

$$\begin{aligned} \text{Monad Sets: } a &= \binom{0}{a}, (\bar{a}) = \binom{-}{a}, (a^+) = \binom{+}{a} \\ \text{Binad Sets: } \binom{-0}{a}, \binom{0+}{a}, \binom{-+}{a}, \binom{-0+}{a} \end{aligned}$$

19. Improved Definition of NonStandard Unit Interval

- **Formula of NonStandard Unit Interval**

$$]^-0, 1^+ [\equiv]\bar{0}, 1[= \{a \in R^*, 0 \leq st(a) \leq 1\} = \{a, a, a, a, a, a, a, a, a \in [0, 1]\}$$

Proof of the above formula

For $0 < st(a) < 1$ it does not matter what $in(a)$ is, because $st(a) + in(a) \in_N]\bar{0}, 1[$, this being a nonstandard interval.

It is not necessarily to set any restriction on $in(a)$ in this case, since \bar{a} is the smallest hyperreal, while a^+ is the greatest hyperreal in the set of seven types of hyperreals listed above.

Let ε be a positive infinitesimal, $\varepsilon \in R^*$.

Let $a = 0$, and $\bar{0}$ be any possible hyperreal number associated to 0.

For $st(\bar{0}) = 0$, the smallest $in(\bar{0})$ may be $-\varepsilon$, whence $0 - \varepsilon = \bar{0} \in_N]\bar{0}, 1^+ [$;

and if $in(\bar{0})$ is bigger (i.e. 0, or $+\varepsilon$), of course $0 + 0 = \bar{0} \in_N]\bar{0}, 1^+ [$ and $0 + \varepsilon = \bar{0} \in_N]\bar{0}, 1^+ [$.

Then also any other nonstandard version of the number 0, such as: $\bar{0}, \bar{0}, \bar{0}, \bar{0} \in_N]\bar{0}, 1^+ [$.

Let $a = 1$, and $\bar{1}$ be any possible hyperreal number associate to 1.

For $st(1) = 1$, the greatest $in(1)$ may be $+\varepsilon$, whence $1 + \varepsilon = 1 \in_N]0, 1[$,
 and if $in(1)$ is smaller (i.e. 0, or $-\varepsilon$), of course $1 + 0 = 1 \in_N]0, 1[$ and $1 - \varepsilon = 1 \in_N]0, 1[$.
 Then also any other nonstandard version of the number 1, such as: $1, 1, 1, 1 \in_N]0, 1[$.

Remark:

This formula has to be updated if new types of hyperreals / monads / binads will be introduced

- Example of Inclusion of Nonstandard Sets

$$]0, 1[\subset]0, 1[$$

- Partial Ordering on the Set of Hyperreals

Let $a \in R$ be a real number. Then there is no order between a and a , nor between a and a .
 Some nonstandard inequalities involving hyperreals:

$$a <_N a <_N a$$

$$a \leq_N a \leq_N a \leq_N a$$

$$a \leq_N a \leq_N a \leq_N a$$

$$a \leq_N a \leq_N a$$

- Examples of Nonstandard Intervals

$$]a, a[= \{a, a, a\}$$

$$]a, a[= \{a, a, a, a, a, a, a\}$$

20. Improved Definition of NonStandard Neutrosophic Logic

In the nonstandard propositional calculus, a proposition P has degrees of truth (T), indeterminacy (I), and falsehood (F), such that T, I, F are nonstandard subsets of the nonstandard unit interval $]0, 1+[$, or $T, I, F \subseteq_N]0, 1+[$.

As a particular case one has when T, I, F are hyperreal or neutrosophic hyperreal numbers of the nonstandard unit interval $]0, 1+[$, or $T, I, F \in_N]0, 1+[$.

21. NonStandard Neutrosophic Operators

Since the Hyprreal Set R^* does not have a total order, in general we cannot use connectives (nonstandard conjunction, nonstandard disjunction, nonstandard negation, nonstandard implication, nonstandard equivalence, etc.) involving the operations of min/max or inf/sup, but we may use connectives involving addition, subtraction, scalar multiplication, multiplication, power, and division operations dealing with nonstandard subsets or hyperreals from the nonstandard unit interval $]0, 1+[$. See below operations with hyperreals, monads and binads.

For any nonstandard subsets or hyperreal numbers, $T_1, I_1, F_1, T_2, I_2, F_2$, from the nonstandard unit interval $]^{-}0, 1^{+}[$ one has:

- NonStandard Neutrosophic Conjunction
 $(T_1, I_1, F_1) \wedge_N (T_2, I_2, F_2) = (T_1 \wedge_F T_2, I_1 \vee_F I_2, F_1 \vee_F F_2)$
- NonStandard Neutrosophic Disjunction
 $(T_1, I_1, F_1) \vee_N (T_2, I_2, F_2) = (T_1 \vee_F T_2, I_1 \wedge_F I_2, F_1 \wedge_F F_2)$
- NonStandard Neutrosophic Negation
 $\neg^N (T_1, I_1, F_1) = (F_1, 1^+ - I_1, T_1)$
- NonStandard Neutrosophic Implication
 $(T_1, I_1, F_1) \rightarrow_N (T_2, I_2, F_2) = (F_1, 1^+ - I_1, T_1) \vee_N (T_2, I_2, F_2) = (F_1 \vee_F T_2, (1^+ - I_1) \wedge_F I_2, T_1 \wedge_F F_2)$
- NonStandard Neutrosophic Equivalence
 $(T_1, I_1, F_1) \leftrightarrow_N (T_2, I_2, F_2)$ means $(T_1, I_1, F_1) \rightarrow_N (T_2, I_2, F_2)$ and $(T_2, I_2, F_2) \rightarrow_N (T_1, I_1, F_1)$

Example of Fuzzy Conjunction:

$$A \wedge_F B = AB$$

Example of Fuzzy Disjunction:

$$A \vee_F B = A + B - AB$$

More explanations about them follow.

22. Approximations of the NonStandard Logical Operators/Connectives $\wedge, \vee, \neg, \rightarrow, \leftrightarrow$

Imamura’s critics of my first definition of the neutrosophic operators is history for over a quarter of century ago. He is attacking my paper with "errors... errors... paradoxes" etc., however my first operators were not kind of errors, but less accurate approximations of the aggregation with respect to the falsity component (F), but not with respect to the truth (T) and indeterminacy (I) ones that were correct.

The representations of sets of monads and binads by tiny intervals were also approximations (\cong) with a desired accuracy ($\varepsilon > 0$), from a classical (real) point of view, for the real number $a \in \mathbb{R}$:

$$\left(\begin{smallmatrix} - \\ a \end{smallmatrix} \right) = \left(\begin{smallmatrix} - \\ a \end{smallmatrix} \right) \cong (a - \varepsilon, a)$$

$$\left(\begin{smallmatrix} + \\ a \end{smallmatrix} \right) = \left(\begin{smallmatrix} + \\ a \end{smallmatrix} \right) \cong (a, a + \varepsilon)$$

$$\left(\begin{smallmatrix} - \\ a^+ \end{smallmatrix} \right) = \left(\begin{smallmatrix} -+ \\ a \end{smallmatrix} \right) \cong (a - \varepsilon, a + \varepsilon)$$

$$\left(\begin{smallmatrix} -0 \\ a \end{smallmatrix} \right) \cong (a - \varepsilon, a]$$

$$\left(\begin{smallmatrix} 0+ \\ a \end{smallmatrix} \right) \cong [a, a + \varepsilon)$$

$$\left(\begin{matrix} -0+ \\ a \end{matrix} \right) \cong (a - \varepsilon, a + \varepsilon)$$

And by language abuse one denotes:

$$\left(\begin{matrix} 0 \\ a \end{matrix} \right) = a = [a, a]$$

The representations of hyperreal numbers ($h = st(h) + in(h)$) by tiny numbers closed to their standard part ($st(h)$) were also approximations (\cong) with a desired accuracy ($\varepsilon > 0$), from a classical (real) point of view:

$$\begin{aligned} - \\ a &\cong a - \varepsilon \\ + \\ a &\cong a + \varepsilon \\ -+ \\ a &\cong a - \varepsilon, \text{ or } a + \varepsilon \\ -0 \\ a &\cong a - \varepsilon, \text{ or } 0 \\ 0+ \\ a &\cong 0, \text{ or } a + \varepsilon \\ -0+ \\ a &\cong a - \varepsilon, \text{ or } 0, \text{ or } a + \varepsilon \\ 0 \\ a &= a \end{aligned}$$

All aggregations in fuzzy and fuzzy-extensions (that includes neutrosophic) logics and sets are *approximations* (not exact, as in classical logic), and they depend on each specific application and on the experts. Some experts/authors prefer ones, others prefer different operators.

It is NOT A UNIQUE operator of fuzzy/neutrosophic conjunction, as it is in classical logic, but a class of many neutrosophic operators, which is called neutrosophic t-norm; similarly for fuzzy/neutrosophic disjunction, called neutrosophic t-conorm, fuzzy/neutrosophic negation, fuzzy/neutrosophic implication, fuzzy/neutrosophic equivalence, etc.

All fuzzy, intuitionistic fuzzy, neutrosophic (and other fuzzy-extension) logic operators are *inferential approximations*, not written in stone. They are improved from application to application.

23. Operations with monads, binads, and hyperreals

In order to operate on them, it is easier to consider their real approximations to tiny intervals for the monads and binads, or to real numbers closed to the standard form of the hyperreal numbers, as in above section.

For **monads and binads**:

$$\left(\begin{matrix} m_1, m_2, m_3 \\ a \end{matrix} \right) \circ \left(\begin{matrix} m_1, m_2, m_3 \\ b \end{matrix} \right) = \left(\begin{matrix} x_1, x_2, x_3 \\ a \circ b \end{matrix} \right), \text{ where } \circ \text{ is any of the well-defined arithmetic operation}$$

(addition, subtraction, multiplication, scalar multiplication, power, root, division).

Where $m_1, m_2, m_3 \in \{-, 0, +\}$, but there are cases when some or all of the infinitesimal parts m_1, m_2, m_3 may be discarded for a or for b or for both, if one has only monads, or closed monads, or pierced binads. If such m_i is discarded, we consider it as $m_i = \phi$, for $i \in \{1, 2, 3\}$.

Always we do the classical operation $a \circ b$, but the problem is: what are the infinitesimals corresponding to the result $\left(\begin{matrix} x_1, x_2, x_3 \\ a \circ b \end{matrix} \right)$, i.e. what are $x_1, x_2, x_3 = ?$

Of course the infinitesimals $x_1, x_2, x_3 \in \{-, 0, +\}$, that represent respectively the left monad of $a \circ b$, just the real number $a \circ b$, or the right monad of $a \circ b$. To find them, we need to move from R^* to R using tiny approximations.

One gets the similar result for **hyperreal numbers** as for monads and binads:

$${}^{m_1, m_2, m_3} a \circ {}^{m_1, m_2, m_3} b = {}^{x_1, x_2, x_3} a \circ b$$

- A Monad-Binad Example

Let $\varepsilon_1, \varepsilon_2 > 0$ be tiny real numbers.

Let's prove that:

$$\left(\overset{-}{a} \right) + \left(\overset{+}{b} \right) = \left(\overset{-0+}{a+b} \right)$$

We approximate the above monads by:

$$(a - \varepsilon_1, a) + (b, b + \varepsilon_2) = (a + b - \varepsilon_1, a + b + \varepsilon_2) \cong \left(\overset{-0+}{a+b} \right)$$

because, in the real interval $(a + b - \varepsilon_1, a + b + \varepsilon_2)$, one gets values smaller than $a+b$ (whence the $-$ on the top, standing for 'left monad of $a+b$ '), equal to $a+b$ (whence the 0 on the top, standing just for 'the real number $a+b$ '), and greater than $a+b$ (whence the $+$ on the top, standing for 'right monad of $a+b$ ').

- Numerical example

$$\left(\overset{-}{2} \right) + \left(\overset{+}{3} \right) = \left(\overset{-0+}{2+3} \right) = \left(\overset{-0+}{5} \right)$$

because $\left(\overset{-}{2} \right) + \left(\overset{+}{3} \right) \cong (2 - 0.1, 2) + (3, 3 + 0.2) = (5 - 0.1, 5 + 0.2)$, and this interval is a little below 5,

a little above 5, and also includes 5.

For hyperreal numbers the result is similar:

$$\overset{-}{a} + \overset{+}{b} = \overset{-0+}{a+b} \text{ because}$$

$$\overset{-}{a} + \overset{+}{b} \cong a - \varepsilon_1 + b + \varepsilon_2 = a + b - \varepsilon_1 + \varepsilon_2, \text{ where } \varepsilon_1, \varepsilon_2 \text{ are any tiny positive numbers,}$$

hence $a + b - \varepsilon_1 + \varepsilon_2$ can be less than $a+b$, equal to $a+b$, or greater than $a+b$ by conveniently choosing the tiny positive numbers ε_1 and ε_2 , as: $\varepsilon_1 > \varepsilon_2$, or $\varepsilon_1 = \varepsilon_2$, or $\varepsilon_1 < \varepsilon_2$ respectively.

- More Examples of NonStandard Operations

$$\left(\overset{-}{a} \right) + b = \left(\overset{-}{a+b} \right)$$

$$a + \left(\overset{+}{b} \right) = \left(\overset{+}{a+b} \right)$$

$$\left(\overset{-}{a} \right) + \left(\overset{-}{b} \right) = \left(\overset{-}{a+b} \right)$$

$$\left(\overset{+}{a} \right) + \left(\overset{+}{b} \right) = \left(\overset{+}{a+b} \right)$$

$$a + \left(\overset{-+}{b} \right) + b = \left(\overset{-+}{a+b} \right)$$

$$\left(\overset{-+}{a} \right) + \left(\overset{-+}{b} \right) = \left(\overset{-0+}{a+b} \right)$$

$$\begin{aligned} \left(\bar{a}\right) + \left(\bar{b}\right) &= \left(a^{+0} + b\right) \\ 8 \div \left(\bar{2}\right) &= \left(\bar{4}\right) \\ 8 \div \left(\bar{2}\right) &= \left(4\right) \\ 8 \div \left(\bar{2}^{+0}\right) &= \left(\bar{4}\right) \\ \sqrt{\left(\bar{9}\right)} &= \left(\bar{3}\right) \\ \left(\bar{11}\right)^2 &= \left(\bar{121}\right) \\ \left(\bar{6}\right) \times \left(7\right) &= \left(\bar{42}\right) \\ \left(\bar{10}\right) - \left(4\right) &= \left(\bar{6}\right) \\ \left(10\right) - \left(\bar{4}\right) &= \left(6\right) \\ \text{Etc.} \end{aligned}$$

24. NonStandard Neutrosophic Operators (revisited)

Let's denote:

$\Lambda_F, \Lambda_N, \Lambda_P$ representing respectively the fuzzy conjunction, neutrosophic conjunction, and plithogenic conjunction; similarly

\vee_F, \vee_N, \vee_P representing respectively the fuzzy disjunction, neutrosophic disjunction, and plithogenic disjunction,

\neg_F, \neg_N, \neg_P representing respectively the fuzzy negation, neutrosophic negation, and plithogenic negation,

$\rightarrow_F, \rightarrow_N, \rightarrow_P$ representing respectively the fuzzy implication, neutrosophic implication, and plithogenic implication; and

$\leftrightarrow_F, \leftrightarrow_N, \leftrightarrow_P$ representing respectively the fuzzy equivalence, neutrosophic equivalence, and plithogenic equivalence.

I agree that my beginning neutrosophic operators (when I applied the same *fuzzy t-norm*, or the same *fuzzy t-conorm*, to all neutrosophic components T, I, F) were less accurate than others developed later by the neutrosophic community researchers. This was pointed out since 2002 partially corrected by Ashbacher [9] and confirmed in 2008 by Riviuccio [10] and fixed in 2010 by Wang, Smarandache, Zhang, and Sunderraman [25], much ahead of Imamura [1] in 2018. They observed that if on T_1 and T_2 one applies a *fuzzy t-norm*, on their opposites F_1 and F_2 one needs to apply the *fuzzy t-conorm* (the opposite of fuzzy t-norm), and reciprocally.

About inferring I_1 and I_2 , some researchers combined them in the same directions as T_1 and T_2 .

Then:

$$(T_1, I_1, F_1) \wedge_N (T_2, I_2, F_2) = (T_1 \wedge_F T_2, I_1 \wedge_F I_2, F_1 \vee_F F_2),$$

$$(T_1, I_1, F_1) \vee_N (T_2, I_2, F_2) = (T_1 \vee_F T_2, I_1 \vee_F I_2, F_1 \wedge_F F_2),$$

$$(T_1, I_1, F_1) \rightarrow_N (T_2, I_2, F_2) = (F_1, I_1, T_1) \vee_N (T_2, I_2, F_2) = (F_1 \vee_F T_2, I_1 \vee_F I_2, T_1 \wedge_F F_2);$$

others combined I_1 and I_2 in the same direction as F_1 and F_2 (since both I and F are negatively qualitative neutrosophic components), the most used one:

$$(T_1, I_1, F_1) \wedge_N (T_2, I_2, F_2) = (T_1 \wedge_F T_2, I_1 \vee_F I_2, F_1 \vee_F F_2),$$

$$(T_1, I_1, F_1) \vee_N (T_2, I_2, F_2) = (T_1 \vee_F T_2, I_1 \wedge_F I_2, F_1 \wedge_F F_2),$$

$$(T_1, I_1, F_1) \rightarrow_N (T_2, I_2, F_2) = (F_1, I_1, T_1) \vee_N (T_2, I_2, F_2) = (F_1 \vee_F T_2, I_1 \wedge_F I_2, T_1 \wedge_F F_2).$$

Now, applying the neutrosophic conjunction suggested by Imamura:

“This causes some counterintuitive phenomena. Let A be a (true) proposition with value $(\{ 1 \}, \{ 0 \}, \{ 0 \})$ and let B be a (false) proposition with value $(\{ 0 \}, \{ 0 \}, \{ 1 \})$.

Usually we expect that the falsity of the conjunction $A \wedge B$ is $\{ 1 \}$. However, its actual falsity is $\{ 0 \}$.”

we get:

$$(1, 0, 0) \wedge_N (0, 0, 1) = (0, 0, 1), \tag{50}$$

which is correct (so the falsity is 1).

Even more, recently, in an extension of neutrosophic set to *plithogenic set* [11] (which is a set whose each element is characterized by many attribute values), the *degrees of contradiction* $c(,)$ between the neutrosophic components T, I, F have been defined (in order to facilitate the design of the aggregation operators), as follows: $c(T, F) = 1$ (or 100%, because they are totally opposite), $c(T, I) = c(F, I) = 0.5$ (or 50%, because they are only half opposite), then:

$$(T_1, I_1, F_1) \wedge_P (T_2, I_2, F_2) = (T_1 \wedge_F T_2, 0.5(I_1 \wedge_F I_2) + 0.5(I_1 \vee_F I_2), F_1 \vee_F F_2),$$

$$(T_1, I_1, F_1) \vee_P (T_2, I_2, F_2) = (T_1 \vee_F T_2, 0.5(I_1 \vee_F I_2) + 0.5(I_1 \wedge_F I_2), F_1 \wedge_F F_2).$$

$$(T_1, I_1, F_1) \rightarrow_N (T_2, I_2, F_2) = \neg_N (T_1, I_1, F_1) \vee_N (T_2, I_2, F_2) = (F_1, I_1, T_1) \vee_N (T_2, I_2, F_2) \\ = (F_1 \vee_F T_2, 0.5(I_1 \vee_F I_2) + 0.5(I_1 \wedge_F I_2), T_1 \wedge_F F_2).$$

For NonStandard Neutrosophic Logic, one replace all the above neutrosophic components $T_1, I_1, F_1, T_2, I_2, F_2$ by hyperreal numbers, monads or binads from the nonstandard unit interval $]0, 1[$ and use the previous nonstandard operations.

25. Application of NonStandard Neutrosophic Logic

Assume two sources s_1 and s_2 provide information about the nonstandard truth value of a given proposition P :

$$s_1(P) = (T_1(P), I_1(P), F_1(P)) = \left(\overset{+}{1}, \overset{-+}{0.4}, \overset{-}{0.2} \right)$$

$$s_2(P) = (T_2(P), I_2(P), F_2(P)) = \left(\overset{0}{0.8}, \overset{+}{0.6}, \overset{-0}{0.3} \right)$$

Let's use the below *Fuzzy Conjunction*:

$$A \wedge_F B = A \cdot B$$

and *Fuzzy Disjunction*:

$$A \vee_F B = A + B - A \cdot B$$

We fusion the two sources (using the nonstandard neutrosophic conjunction):

$$s_1(P) \wedge_N s_2(P) = (T_1(P) \wedge_F T_2(P), I_1(P) \vee_F I_2(P), F_1(P) \vee_F F_2(P)) \\ = (1 \wedge_F 0.8, 0.4 \vee_F 0.6, 0.2 \vee_F 0.3) = (1 \times 0.8, 0.4 + 0.6 - 0.4 \times 0.6, 0.2 + 0.3 - 0.2 \times 0.3) \\ = (0.8, 1 - 0.24, 0.5 - 0.06) = (0.8, 1 - 0.24, 0.5 - 0.06) = (0.80, 0.76, 0.44),$$

which means that with respect to the two fused sources, the nonstandard neutrosophic degree of truth of the proposition P is tinnily above 0.8, its nonstandard neutrosophic degree of indeterminacy is tinnily below or above or equal to 0.76, and similarly its nonstandard neutrosophic degree of falsity is tinnily below or above or equal to 0.44.

Converting/approximating from hyperreal numbers to real numbers, with an accuracy $\varepsilon = 0.001$, one gets:

$$s_1(P) \wedge_N s_2(P) \cong ((0.8, 0.8 + 0.001), (0.76 - 0.001, 0.76 + 0.001), (0.44 - 0.001, 0.44 + 0.001)) \\ = ((0.800, 0.801), (0.759, 0.761), (0.439, 0.441))$$

26. Open Statement

In general, the Transfer Principle, from a non-neutrosophic field to a corresponding neutrosophic field, does not work. This conjecture is motivated by the fact that each neutrosophic field may have various types of indeterminacies.

27. Conclusion

We thank very much Dr. Takura Imamura for his interest and critics of *Nonstandard Neutrosophic Logic*, which eventually helped in improving it. {In the history of mathematics, critics on nonstandard analysis, in general, have been made by Paul Halmos, Errett Bishop, Alain Connes and others.} We hope we'll have more dialogues on the subject in the future.

We introduced in this paper for the first time the Neutrosophic Hyperreals (that have an indeterminate form), and we improved the definitions of NonStandard Unit Interval and of NonStandard Neutrosophic Logic.

We pointed out several errors and false statements by Imamura [21] with respect to the inf/sup of nonstandard subsets, also Imamura's "rigorous definition of neutrosophic logic" is wrong and the same for his definition of nonstandard unit interval, and we proved that there is not a total order on the set of hyperreals (because of the newly introduced Neutrosophic Hyperreals that are indeterminate) therefore the transfer principle is questionable. We conjectured that: In general, the Transfer Principle, from a non-neutrosophic field to a corresponding neutrosophic field, does not work.

References

1. Takura Imamura, *Note on the Definition of Neutrosophic Logic*, arxiv.org, 7 Nov. 2018.
2. Xindong Peng and Jingguo Dai, *A bibliometric analysis of neutrosophic set: two decades review from 1998 to 2017*, Artificial Intelligence Review, Springer, 18 August 2018; <http://fs.unm.edu/BibliometricNeutrosophy.pdf>
3. Florentin Smarandache, *n-Valued Refined Neutrosophic Logic and Its Applications in Physics*, Progress in Physics, 143-146, Vol. 4, 2013; <http://fs.unm.edu/n-ValuedNeutrosophicLogic-PiP.pdf>
4. F. Smarandache, *Neutrosophy, A New Branch of Philosophy*, <Multiple Valued Logic / An International Journal>, USA, ISSN 1023-6627, Vol. 8, No. 3, pp. 297-384, 2002.
5. Florentin Smarandache, *Neutrosophy. / Neutrosophic Probability, Set, and Logic*, ProQuest Information & Learning, Ann Arbor, Michigan, USA, 105 p., 1998; <http://fs.unm.edu/eBook-Neutrosophics6.pdf>.
6. F. Smarandache, *A Unifying Field in Logics: Neutrosophic Logic*, <Multiple Valued Logic / An International Journal>, USA, ISSN 1023-6627, Vol. 8, No. 3, pp. 385-438, 2002. {The whole issue of this journal is dedicated to Neutrosophy and Neutrosophic Logic.}
7. Florentin Smarandache, *Definition of neutrosophic logic — a generalization of the intuitionistic fuzzy logic*, Proceedings of the 3rd Conference of the European Society for Fuzzy Logic and Technology, 2003, pp. 141–146.
8. Florentin Smarandache, *Neutrosophic Overset, Neutrosophic Underset, and Neutrosophic Offset. Similarly for Neutrosophic Over-/Under-/Off- Logic, Probability, and Statistics*, 168 p., Pons Editions, Bruxelles, Belgique, 2016; <https://arxiv.org/ftp/arxiv/papers/1607/1607.00234.pdf>

9. Charles Ashbacher, Section: Logical Connectives in Neutrosophic Logic, pages 59-72 in his book Introduction to Neutrosophic Logic, ProQuest Information & Learning, Ann Arbor, 2002, <http://fs.unm.edu/IntrodNeutLogic.pdf>.
10. Umberto Rivieccio, Neutrosophic logics: Prospects and problems, Fuzzy Sets and Systems, v. 159, issue 14, 1860–1868, 2008.
11. F. Smarandache, Plithogeny, Plithogenic Set, Logic, Probability, and Statistics, Pons Publishing House, Brussels, Belgium, 141 p., 2017; arXiv.org (Cornell University), Computer Science - Artificial Intelligence, 03Bxx: <https://arxiv.org/ftp/arxiv/papers/1808/1808.03948.pdf>
12. Nguyen Xuan Thao, Florentin Smarandache, *(I, T)-Standard neutrosophic rough set and its topologies properties*, Neutrosophic Sets and Systems, Vol. 14, 2016, pp. 65-70; doi.org/10.5281/zenodo.570892 <http://fs.unm.edu/NSS/RoughStandardNeutrosophicSets.pdf>
13. Nguyen Xuan Thao, Bui Cong Cuong, Florentin Smarandache, *Rough Standard Neutrosophic Sets: An Application on Standard Neutrosophic Information Systems*, Neutrosophic Sets and Systems, Vol. 14, 2016, pp. 80-92; doi.org/10.5281/zenodo.570890 <http://fs.unm.edu/NSS/RoughStandardNeutrosophicSets.pdf>
14. Bui Cong Cuong, Pham Hong Phong, Florentin Smarandache, *Standard Neutrosophic Soft Theory - Some First Results*, Neutrosophic Sets and Systems, Vol. 12, 2016, pp. 80-91; doi.org/10.5281/zenodo.571149 <http://fs.unm.edu/NSS/StandardNeutrosophicSoftTheory.pdf>
15. Insall, Matt and Weisstein, Eric W. "Nonstandard Analysis." From *MathWorld*--A Wolfram Web Resource. <http://mathworld.wolfram.com/NonstandardAnalysis.html>
16. Insall, Matt. "Transfer Principle." From *MathWorld*--A Wolfram Web Resource, created by Eric W. Weisstein. <http://mathworld.wolfram.com/TransferPrinciple.html>
17. F. Smarandache, Applications of Neutrosophic Sets in Image Identification, Medical
18. Diagnosis, Fingerprints and Face Recognition and Neutrosophic Overset/Underset/Offset, COMSATS Institute of Information Technology, Abbottabad, Pakistan, December 26th, 2017; [18] F. Smarandache, Interval-Valued Neutrosophic Oversets, Neutrosophic Understes, and Neutrosophic Offsets, International Journal of Science and Engineering Investigations, Vol. 5, Issue 54, 1-4, July 2016.
19. F. Smarandache, *Operators on Single-Valued Neutrosophic Oversets, Neutrosophic Undersets, and Neutrosophic Offsets*, Journal of Mathematics and Informatics, Vol. 5, 63-67, 2016.
20. Florentin Smarandache, About Nonstandard Neutrosophic Logic (Answers to Imamura 'Note on the Definition of Neutrosophic Logic'), pp. 1-16, Cornell University, New York City, USA, {Submitted on 24 Nov 2018 (version 1), last revised 13 Feb 2019 (version 2)}
Abstract: <https://arxiv.org/abs/1812.02534v2>
Full paper: <https://arxiv.org/ftp/arxiv/papers/1812/1812.02534.pdf>
UNM Website: <http://fs.unm.edu/neut/AboutNonstandardNeutrosophicLogic.pdf>
21. T. Imamura, On the Definition of Neutrosophic Logic, Journal of Japan Society for Fuzzy Theory and Intelligent Informatics, Vol. 34, No. 3, pp. 669-672, 2022.
22. T. Imamura, Emails to the Author, August 2022
23. F. Smarandache, Extended Nonstandard Neutrosophic Logic, Set, and Probability based on Extended Nonstandard Analysis, Symmetry 2019, 11, 515; doi:10.3390/sym11040515, <http://doi.org/10.5281/zenodo.2838678>; arXiv.org, Cornell University, <https://arxiv.org/ftp/arxiv/papers/1903/1903.04558.pdf>
24. F. Smarandache, *Advances of Standard and Nonstandard Neutrosophic Theories*, Pons Publishing House Brussels, Belgium, 307 p., 2019, <http://fs.unm.edu/AdvancesOfStandardAndNonstandard.pdf>
25. Haibin Wang, Florentin Smarandache, Yanqing Zhang, Rajshekhar Sunderraman, Single Valued Neutrosophic Sets, in Multispace & Multistructure. Neutrosophic Transdisciplinarity, Vol. IV, pp. 410-413, North-European Scientific Publishers, Hanko, Finland, 2010, <http://fs.unm.edu/MultispaceMultistructure.pdf>
26. Florentin Smarandache, Improved Definition of NonStandard Neutrosophic Logic and Introduction to Neutrosophic Hyperreals (version 3), arXiv.org, 13 Sep 2022, <http://arxiv.org/abs/1812.02534>

Neutrosafia, generalizare a Dialecticii. Noțiuni fundamentale

Florentin Smarandache

Abstract

În acest articol este prezentată o nouă ramură a filosofiei, denumită *neutrosafie* [1995], care studiază originea, natura și sfera neutralităților, precum și interacțiunile acestora cu diferite spectre ideationale. Neutrosafia este o generalizare a dialecticii. În timp ce dialectica studiaza doar dinamica contrariilor, neutrosafia studiaza dinamica atat a contrariilor cat si a neutralelor dintre ele in orice domeniu: filozofic, literar, stiintific, artistic, social etc.

Un exemplu elementar: doua tari care bat la razboi constituie domeniile $\langle A \rangle$ si $\langle \text{Anti}A \rangle$, dar unele tari neutre $\langle \text{Neut}A \rangle$ intervin de o parte sau de alta.

Teza fundamentală: Orice idee $\langle A \rangle$ este $T\%$ adevărată, $I\%$ nedeterminată și $F\%$ falsă, unde T, I, F sunt submulțimi standard sau non-standard incluse în $\| -0, 1^+ \|$. Tema fundamentală: Fiecare idee $\langle A \rangle$ tinde să fie neutralizată, diminuată, echilibrată de idei $\langle \text{Non}A \rangle$ {nu numai $\langle \text{Anti}A \rangle$, precum in dialectica (lui Hegel si Marx)} - ca o stare de echilibru.

$\langle \text{Non}A \rangle$ este format din idei neutre $\langle \text{Neut}A \rangle$ si opuse $\langle \text{Anti}A \rangle$ lui $\langle A \rangle$.

Neutrosafia este baza logicii neutrosafice, o logică cu valori multiple care generalizează logica fuzzy si intuitionistice fuzzy, a mulțimii neutrosafice care generalizează mulțimea fuzzy si intuitionistica fuzzy, și a probabilității neutrosafice și a statisticii neutrosafice, care generalizează probabilitatea imprecisa și, respectiv, statistica clasică.

Cuvinte cheie: analiză non-standard, număr hiper-real, infinitezimal, monadă, binadă, interval unitar real non-standard, operații cu numere standard și non-standard

Notă: Acest articol a apărut și în limba engleză: Florentin Smarandache, "Neutrosophy, A New Branch of Philosophy". *Multiple-Valued Logic (MVL)*. An International Journal, Taylor & Francis Group, United Kingdom and United States, ISSN 1023-6627, Vol. 8, No. 3, pp. 297-384, June 2002

Neutrosophic theory: fundamentals

Abstract

This article presents a new branch of philosophy, called *neutrosophy* [1995], which studies the origin, nature, and scope of neutralities, as well as their interactions with different ideational spectrums. Neutrosophy is a generalization of Dialectics. While dialectics only studies the dynamics of opposites, neutrosophy studies the dynamics of both opposites and neutrals between them in any field: philosophical, literary, scientific, artistic, social, etc.

An elementary example: two countries at war constitute the domains $\langle A \rangle$ and $\langle \text{Anti}A \rangle$, but some neutral countries $\langle \text{Neut}A \rangle$ intervene on one side or the other.

Fundamental theme: Any idea $\langle A \rangle$ is T% true, I% indeterminate, and F% false, where T, I, F are standard or non-standard subsets included in $\mathbb{I}^0, \mathbb{I}^+$. Fundamental theory: Every $\langle A \rangle$ idea tends to be neutralized, diminished, balanced by $\langle \text{Non}A \rangle$ ideas {not only $\langle \text{Anti}A \rangle$, as the dialectics (by Hegel and Marx)} - as a state of equilibrium.

$\langle \text{Non}A \rangle$ is composed from neutral $\langle \text{Neut}A \rangle$ and opposed $\langle \text{Anti}A \rangle$ ideas to $\langle A \rangle$.

Neutrosophy is the basis of neutrosophic logic, a multiple-valued logic that generalizes fuzzy logic, neutrosophic set generalizing fuzzy set, and neutrosophic probability and neutrosophic statistics, which generalizes the classical and imprecise probability and the classical statistics, respectively.

Keywords: non-standard analysis, hyper-real number, infinitesimal, monad, binad, non-standard real unit interval, operations with standard and non-standard numbers

Note: This article also appeared in English: Florentin Smarandache, "Neutrosophy, A New Branch of Philosophy". Multiple-Valued Logic (MVL). An International Journal, Taylor & Francis Group, United Kingdom and United States, ISSN 1023-6627, Vol. 8, No. 3, pp. 297-384, June 2002

A. Etimologie

Neutro-sofie [\langle fr. *neutre* \langle lat. *neuter*, neutru + gr. *sophia*, calificare / înțelepciune] înseamnă **cunoaștere a gândirii neutre.**

B. Definiție

Neutrosopia este o nouă ramură a filosofiei, generalizare a dialecticii, care studiază originea, natura și domeniul de aplicare a neutralităților, precum și interacțiunile acestora cu diferite spectre ideationale.

C. Caracteristici

Acest mod de gândire:

- propune noi teze, principii, legi, metode, formule, mișcări filosofice;
- arată că lumea este plină de nedeterminare;
- interpretează neinterpretabilul;

- tratează din unghiuri diferite concepte și sisteme vechi, arătând că o idee care este adevărată într-un sistem de referință dat poate fi falsă în altul — și invers;
- încearcă să atenueze războiul de idei și să se războiască cu ideile pașnice;
- măsoară stabilitatea sistemelor instabile, și instabilitatea sistemelor stabile.

D. Metode de studiu neutrosific

Matematizare (logica neutrosifică, probabilitatea neutrosifică și statisticile neutrosifice, dualitate), generalizare, complementaritate, contradicție, paradox, tautologie, analogie, reinterpretare, asociere, interferență, aforistic, lingvistic, transdisciplinaritate.

E. Formalizarea

Să notăm cu $\langle A \rangle$ o idee, sau o propoziție, o teorie, un eveniment, un concept, o entitate; cu $\langle \rangle$ ceea ce nu este $\langle A \rangle$ și cu $\langle \text{Anti}A \rangle$ opusul lui $\langle A \rangle$. De asemenea, $\langle \text{Neut}A \rangle$ simbolizează ceea ce nu este nici $\langle A \rangle$ nici $\langle \text{Anti}A \rangle$, și anume neutralitatea dintre cele două extreme. Iar $\langle A' \rangle$ este o versiune a lui $\langle A \rangle$. Să notăm că $\langle \rangle$ este diferit de $\langle \text{Anti}A \rangle$.

De exemplu:

Dacă $\langle A \rangle = \text{alb}$, atunci $\langle \text{Anti}A \rangle = \text{negru}$ (antonim),

— dar $\langle \text{Non}A \rangle = \text{verde, roșu, albastru, galben, negru etc.}$ (orice culoare, mai puțin albul),

— în timp ce $\langle \text{Neut}A \rangle = \text{verde, roșu, albastru, galben etc.}$ (orice culoare, cu excepția albului și negrului),

— iar $\langle A' \rangle = \text{alb închis, alb lucios etc.}$ (orice nuanță de alb).

Într-un mod clasic:

$$\langle \text{Neut}A \rangle \equiv \langle \text{Neut}(\text{Anti}A) \rangle,$$

adică neutralitățile lui $\langle A \rangle$ sunt identice cu neutralitățile lui $\langle \text{Anti}A \rangle$.

$$\langle \text{Non}A \rangle \supset \langle \text{Anti}A \rangle \text{ și } \langle \text{Non}A \rangle \supset \langle \text{Neut}A \rangle,$$

precum și $\langle A \rangle \cap \langle \text{Anti}A \rangle = \emptyset$,

$$\langle A \rangle \cap \langle \text{Non}A \rangle = \emptyset,$$

ori $\langle A \rangle$, $\langle \text{Neut}A \rangle$ și $\langle \text{Anti}A \rangle$ sunt disjuncte două câte două.

$\langle \text{Non}A \rangle$ este completarea lui $\langle A \rangle$ cu privire la mulțimea universală.

Dar, pentru că în multe cazuri frontierele dintre noțiuni sunt vagi, imprecise, este posibil ca $\langle A \rangle$, $\langle \text{Neut}A \rangle$, $\langle \text{Anti}A \rangle$ (și bineînțeles $\langle \text{Non}A \rangle$) să aibă părți comune, două câte două.

F. Principiul fundamental

Între o idee $\langle A \rangle$ și opusul ei $\langle \text{Anti}A \rangle$ există un spectru continuu de putere a neutralităților $\langle \text{Neut}A \rangle$.

G. Teza fundamentală

Orice idee $\langle A \rangle$ este $T\%$ adevărată, $I\%$ nedeterminată și $F\%$ falsă, unde $T, I, F \subset \llbracket -0, 1^+ \rrbracket$.

H. Legi principale

Să considerăm un atribut $\langle \alpha \rangle$ și $T, I, F \subset \llbracket -0, 1^+ \rrbracket^3$. Atunci:

— Există o propoziție $\langle P \rangle$ și un sistem de referință $\{R\}$, astfel ca $\langle P \rangle$ să fie $T\%$ $\langle \alpha \rangle$, $I\%$ nedeterminat sau $\langle \text{Neut-}\alpha \rangle$ și $F\%$ $\langle \text{Anti-}\alpha \rangle$.

— Pentru orice propoziție $\langle P \rangle$ există un sistem de referință $\{R\}$, astfel ca $\langle P \rangle$ să fie $T\%$ $\langle \alpha \rangle$, $I\%$ nedeterminat sau $\langle \text{Neut-}\alpha \rangle$ și $F\%$ $\langle \text{Anti-}\alpha \rangle$.

— $\langle \alpha \rangle$ este într-un anumit grad $\langle \text{Anti-}\alpha \rangle$, în timp $\langle \text{Anti-}\alpha \rangle$ este într-un anumit grad $\langle \alpha \rangle$.

Prin urmare:

— Pentru fiecare propoziție $\langle P \rangle$ există sisteme de referință $\{R_1\}, \{R_2\}, \dots$, astfel că $\langle P \rangle$ arată diferit în fiecare dintre ele — obținând toate gradele posibile de la $\langle P \rangle$, la $\langle \text{Non}P \rangle$, până la $\langle \text{Anti}P \rangle$.

— Și, ca o consecință, pentru oricare două propoziții $\langle M \rangle$ și $\langle N \rangle$ există două sisteme de referință $\{R_M\}$ și respectiv $\{R_N\}$, astfel că $\langle M \rangle$ și $\langle N \rangle$ arată la fel. Sistemele de referință sunt oglinzi de curburi diferite care reflectă propozițiile.

I. Motto-uri

TOTUL ESTE POSIBIL, CHIAR ȘI IMPOSIBILUL!

NIMIC NU ESTE PERFECT, NICI CHIAR PERFECȚIUNEA!

J. Teoria fundamentală

Orice idee $\langle A \rangle$ tinde să fie neutralizată, diminuată, echilibrată de idei $\langle \text{Non}A \rangle$ (nu numai $\langle \text{Anti}A \rangle$, cum a susținut Hegel) - ca o stare de echilibru. Între $\langle A \rangle$ și $\langle \text{Anti}A \rangle$ există infinit de multe idei $\langle \text{Neut}A \rangle$, care pot echilibra $\langle A \rangle$ fără a fi necesare versiuni $\langle \text{Anti}A \rangle$.

Pentru a neutraliza o idee, trebuiesc descoperite toate cele trei laturi ale sale: de sens (adevărul), de nonsens (falsitate) și de imprecizie (nedeterminare) – apoi trebuie inversate / combinate. Ulterior, ideea va fi clasificată ca neutralitate.

K. Delimitarea de alte concepte și teorii filosofice

1. Neutrosafia se bazează nu numai pe analiza de propoziții opuse, așa cum face *dialectica*, ci de asemenea pe *analiza neutralităților* dintre ele.

2. În timp ce *epistemologia* studiază limitele cunoașterii și ale raționamentului, neutrosfia trece de aceste limite și ia sub lupă nu numai caracteristicile defnitorii și condițiile de fond ale unei entități <E> – dar și tot spectrul <E'> în legătură cu <NeutE> .

Epistemologia studiază contrariile filosofice, de exemplu <E> versus <AntiE>; neutrosfia studiază <NeutE> versus <E> și versus <AntiE>, ceea ce înseamnă logică bazată pe neutralități.

3-4. *Monismul neutru* afirmă că realitatea ultimă nu este nici fizică, nici mentală.

Neutrosfia constă într-un punct de vedere pluralist: o infinitudine de nuanțe separate și ultime conturează lumea.

5. *Hermeneutica* este arta sau știința interpretării, în timp ce neutrosfia creează idei noi și analizează o gamă largă de câmp ideatic prin echilibrarea sistemelor instabile și dezechilibrarea sistemelor stabile.

6. *Philosophia Perennis* spune adevărul comun al punctelor de vedere contradictorii, neutrosfia combină neutraliile cu adevărul.

7. *Falibilismul* atribuie incertitudine fiecărei clase de convingeri sau propoziții, în timp ce neutrosfia acceptă afirmații 100% adevărate precum și afirmații 100% false, iar, în plus, verifică în care sisteme de referință procentajul incertitudinii se apropie de zero sau de 100.

L. Limitele filosofiei

Întreaga filosofie este un tautologism: adevăr în virtutea formei, pentru că orice idee lansată pentru prima oară este dovedită ca adevărată de către inițiatorul(ii) său(i). Prin urmare, filosofia este goală sau dezinformativă, și reprezintă a priori cunoașterea.

Se poate afirma: TOTUL ESTE ADEVĂRAT, CHIAR ȘI FALSUL!

Și totuși, întreaga filosofie este un *nihilism*: pentru că orice idee, odată dovedită adevărată, este mai târziu dovedită ca falsă de către urmași. Este o contradicție: fals în virtutea formei. Prin urmare, filosofia este supra-informativă și o cunoaștere a posteriori.

Astfel, se poate afirma: TOTUL ESTE FALS, CHIAR ȘI ADEVĂRUL!

Toate ideile filosofice care nu au fost încă contrazise vor fi mai devreme sau mai târziu contrazise deoarece fiecare filosof încearcă să găsească o breșă în sistemele vechi. Chiar și această nouă teorie (care sunt sigur că nu este sigură!) va fi inversată. Iar mai târziu alții o vor reconsidera din nou...

Prin urmare, filosofia este **logic necesară** și **logic imposibilă**. Agostino Steuco (alias Agostinus Steuchus sau Eugubinus) a avut dreptate, *diferențele dintre filosofi sunt de nediferențiat*.

Expresia lui Leibniz <adevărat în orice lume posibilă> este de prisos, peiorativă, întrucât mintea noastră poate construi de asemenea o lume imposibilă, care devine posibilă în imaginația noastră.

— ÎN ACEASTĂ TEORIE NU SE POATE DOVEDI NIMIC!

— ÎN ACEASTĂ TEORIE NU SE POATE NEGA NIMIC!

(F. Smarandache, "Sisteme de axiome inconsistente", 1995.)

A filosofa = tautologism + nihilism.

M. Clasificarea ideilor

- a) acceptate cu ușurință, uitate repede;
- b) acceptate cu ușurință, uitate greu;
- c) acceptate greu, uitate repede;
- d) acceptate greu, uitate greu.

Și versiuni diferite între orice două categorii.

N. Evoluția unui idei

Evoluția unui idei <A> în lume nu este ciclică (dupa cum a afirmat Marx), ci discontinuă, înnodată, fără margini:

- <Neut-A> = fond ideatic existent, înainte de apariția lui <A>;
- <Pre-A> = o pre-idee, un precursor al lui <A>;
- <Pre-A'> = Spectru de versiuni <PreA>;
- <A> = Ideea în sine, care dă naștere implicit la:
- <NonA> = ceea ce este în afara lui <A>;
- <A'> = Spectru de versiuni <A> după interpretări / înțelegeri (greșite) de către persoane, școli, culturi diferite;
- <A/NeutA> = Spectru de derivate /deviații <A>, deoarece <A> se amestecă parțial mai întâi cu idei neutre;
- <AntiA> = Opusul direct al <A>, dezvoltat în interiorul lui <NonA>;
- <AntiA'> = Spectru de versiuni <AntiA> după interpretări / înțelegeri (greșite) de către persoane, școli, culturi diferite;
- <AntiA/NeutA> = Spectru de derivate /deviații <AntiA>, ceea ce înseamnă <AntiA> și <NeutA> parțial combinate în procentaje diferite;
- <A'/Anti-A'> = Spectru de derivate /deviații după amestecarea spectrelor <A'> și <AntiA'>;
- <PostA> = După <A>, o post-idee, o concluzie;
- <PostA'> = Spectru de versiuni <PostA>;

- $\langle \text{NeoA} \rangle = \langle \text{A} \rangle$ reluat într-un mod nou, la un alt nivel, în condiții noi, ca într-o curbă iregulară cu puncte de inflexiune, în perioade evolutive și involutive, într-un mod recurent; viața lui $\langle \text{A} \rangle$ re-începe.

"Spirala" evoluției, a lui Marx, este înlocuită cu o curbă diferențială complexă, cu urcușurile și coborâșurile sale, cu noduri - pentru că evoluția înseamnă și cicluri de involuție.

Aceasta este *dina-filosofia* = studiul drumului infinit al unei idei.

$\langle \text{NeoA} \rangle$ are o sferă mai largă (incluzând, în afară de părți vechi ale lui $\langle \text{A} \rangle$ și părți ale lui $\langle \text{NeutA} \rangle$ rezultate din combinații anterioare), are mai multe caracteristici, este mai eterogen (după combinații cu diferite idei $\langle \text{NonA} \rangle$). Dar, $\langle \text{NeoA} \rangle$, ca un întreg în sine, are tendința de a-și omogeniza conținutul și apoi de a dez-omogeniza prin alăturarea cu alte idei.

Și așa mai departe, până când $\langle \text{A} \rangle$ -ul anterior ajunge la un punct în care încorporează în mod paradoxal întregul $\langle \text{NonA} \rangle$, fiind nedeslușit de ansamblu. Și acesta este punctul în care ideea moare, nu poate fi distinctă de altele.

Întregul se destramă, pentru că mișcarea îi este caracteristică într-o pluralitate de idei noi (unele dintre ele conținând părți din originalul $\langle \text{A} \rangle$), care își încep viața lor într-un mod similar. Ca un imperiu multinațional.

Nu este posibil să se treacă de la o idee la opusul său, fără a trece peste un spectru de versiuni ale ideii, de abateri sau de idei neutre între cele două.

Astfel, în timp, $\langle \text{A} \rangle$ ajunge să se amestece cu $\langle \text{NeutA} \rangle$ și $\langle \text{AntiA} \rangle$.

Nu am spune că "opusele se atrag", ci $\langle \text{A} \rangle$ și $\langle \text{NonA} \rangle$ (adică interiorul, exteriorul și neutrul ideii).

Prin urmare, teoria lui Hegel este incompletă: o teză este înlocuită de alta, numită anti-teză; contradicția dintre teză și anti-teză este depășită și astfel rezolvată printr-o sin-teză.

Deci Socrate la început, sau Marx și Engels (materialismul dialectic).

Nu este un sistem triadic:

— teză, antiteză, sinteză (hegelieni);

sau:

— afirmație, negație, negație a negației (marxiști);

ci un *sistem piramidal pluradic*, așa cum se vede mai sus.

Antiteza $\langle \text{AntiT} \rangle$ a lui Hegel și Marx nu rezultă pur și simplu din teza $\langle \text{T} \rangle$. $\langle \text{T} \rangle$ apare pe un fond de idei preexistente și se amestecă cu ele în evoluția sa. $\langle \text{Anti-T} \rangle$ este construit pe un fond ideatic similar, nu pe un câmp gol, și folosește, în construcția sa, nu numai elemente opuse $\langle \text{T} \rangle$, dar și elementele de $\langle \text{NeutT} \rangle$, precum și elemente de $\langle \text{T} \rangle$.

Căci o teză <T> este înlocuită nu numai de către o antiteză <AntiT>, dar și de diferite versiuni ale neutralităților <NeutT>.

Am putea rezuma astfel: **teză-neutră** (fond ideatic înainte de teză), **pre-teză, teză, pro-teză, non-teză** (diferită, dar nu opusă), **anti-teză, post-teză, neo-teză**.

Sistemul lui Hegel a fost purist, teoretic, idealist. De aceea, a fost necesară generalizarea acestui sistem. De la *simplism* la *organicism*.

N. Formule filosofice

De ce există atât de multe școli filosofice distincte (chiar contrare)?

De ce, concomitent cu introducerea unei noțiuni <A>, rezultă și inversul ei, <NonA>?

În cele ce urmează, sunt prezentate câteva formule filosofice, pentru că în domeniul spiritual este foarte dificil să obții formule (exacte).

a. Legea echilibrului

Cu cât <A> crește mai mult, cu atât scade <AntiA>. Relația este următoarea:

$$\langle A \rangle \cdot \langle \text{Anti}A \rangle = k \cdot \langle \text{Neut}A \rangle,$$

unde k este o constantă care depinde de <A>, iar <NeutA> este un punct de sprijin pentru echilibrarea celor două extreme.

În cazul în care punctul de sprijin este centrul de greutate al neutralităților, atunci formula de mai sus este simplificată:

$$\langle A \rangle \cdot \langle \text{Anti}A \rangle = k,$$

unde k este o constantă care depinde de <A>.

Cazuri particulare interesante:

Industrializare \times Spiritualizare = constant, pentru orice societate.

Cu cât o societate este mai industrializată, cu atât scade nivelul spiritual al cetățenilor săi.

- Știința \times Religie = constant.
- Alb \times Negru = constant.
- Plus \times Minus = constant.

Împingând limitele, în alte cuvinte, calculând în spațiul absolut, se obține:

Total \times Nimic = universal constant sau $\infty \times 0 (= 0 \times \infty) =$ universal constant.

Ne îndreptăm către o matematizare a filosofiei, dar nu în sens platonician.

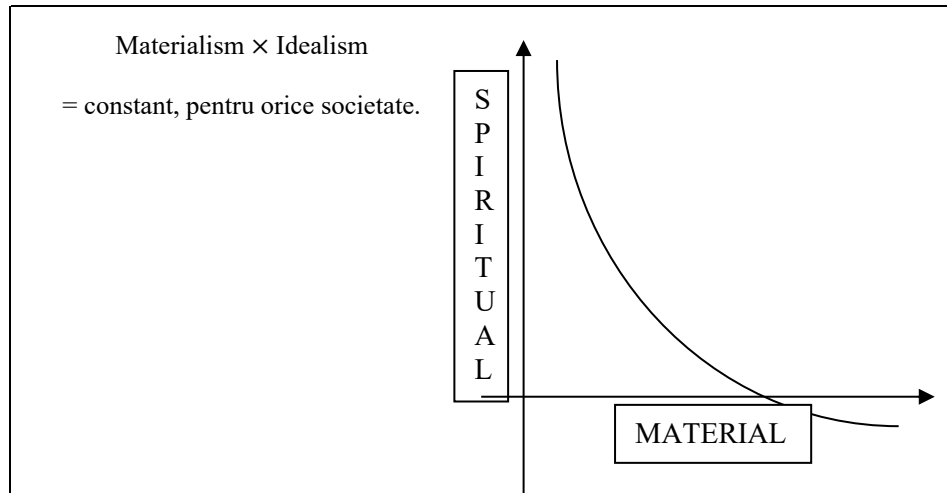

Axele carteziene verticale și orizontale sunt asimptote pentru curba $M \cdot I = k$.

b. Legea anti-reflexivitate

$\langle A \rangle$ în oglindă cu $\langle A \rangle$ dispare treptat. Sau $\langle A \rangle$ -ul lui $\langle A \rangle$ se poate transforma într-un $\langle A \rangle$ distorsionat.

Exemple:

- Căsătoria între rude dă naștere la descendenți anoști (de multe ori cu handicap).
- De aceea, amestecând specii de plante (și uneori, rase de animale și oameni), obținem hibridi cu calități și / sau cantități mai bune (Teoria biologică a amestecării speciilor).
- De aceea, emigrarea este benignă întrucat aduce sânge proaspăt într-o populație statică.
- Nihilismul, înțeles ca negare absolută, propovăduit după romanul "Părinți și copii" de Turgheniev în 1862, neagă totul, prin urmare, se neagă pe sine!
- Dadaismul dadaismului face să dispară fundamentele dadaismului.

c. Legea complementarității

$\langle A \rangle$ simte nevoia să se completeze prin $\langle \text{Non}A \rangle$ cu scopul de a forma un întreg.

Exemple:

- Persoanele diferite simt nevoia să se completeze reciproc și să se asocieze (bărbatul cu femeia.)
- Culorile complementare (care, combinate la intensitățile potrivite, produc albul).

d. Legea efectului invers

Atunci când se încerceacă convertirea cuiva la o idee, credință, sau religie prin repetiții plictisitoare sau prin forță, acea persoana ajunge să urască ceea ce îi este impus.

Exemple:

- Cu cât rogi pe cineva să facă ceva, cu atât persoana vrea mai puțin să o facă.
- Dublând regula, ajungi la înjumătățire.
- Ce e mult, nu e bine ... (invers proporțional).
- Când ești sigur, nu fii!

Atunci când forțăm pe cineva să facă ceva, persoana va avea o reacție diferită (nu necesar opusă, precum afirmă axioma legii a treia a mișcării a lui Newton):

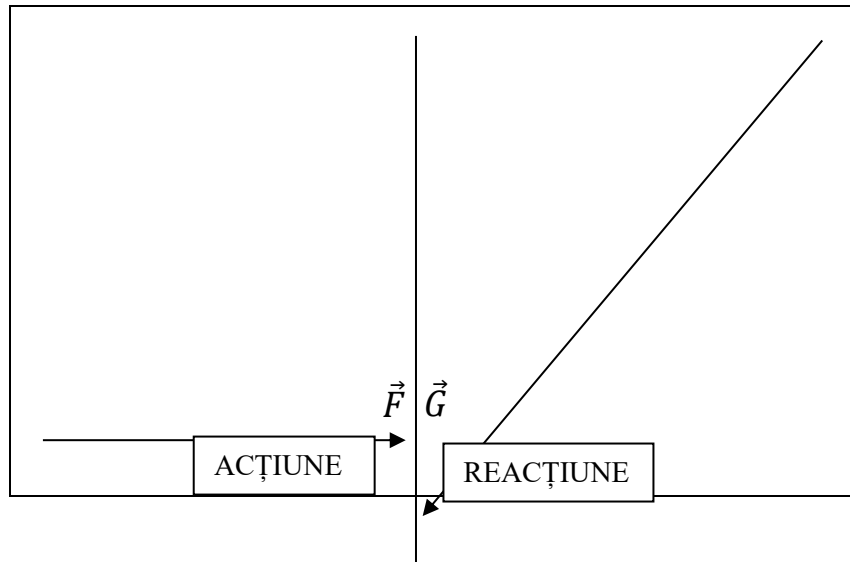

e. Legea identificării întoarse

<NonA> este un <A> mai bun decât <A>.

Exemplu:

- Poezia este mai filosofică decât filosofia.

f. Legea întreruperii conectate

<A> și <NonA> au elemente în comun.

Exemple:

- Există o distincție vagă între "bine" și "rău".

- Raționalul și iraționalul funcționează împreună inseparabil.
- În mod similar, conștiința și inconștiința.
- Finitul este infinit [vezi microinfinitatea].

"Vino, sufletul mi-a spus, haide să scriem poezii pentru corpul meu, căci suntem Unul" (Walt Whitman).

g. Legea întreruperii de identități

Lupta permanentă între <A> și <A'> (unde <A'> sunt diferite nuanțe de <A>).

Exemple:

- Lupta permanentă între adevărul absolut și adevărul relativ.
- Distincția dintre falsul clar și falsul neutrosific (cea de doua noțiuni reprezintă o combinație de grade de falsitate, nedeterminare și adevăr).

h. Legea compensației

Dacă acum <A>, atunci mai târziu <NonA>.

Exemple:

- Orice pierdere are un câștig [ceea ce înseamnă că mai târziu va fi mai bine, pentru că ai învățat ceva din pagubă].
- Nu există niciun succes fără eșec [aveți răbdare!].

i. Legea condiției prescrise

Nu pot fi depășite limitele proprii. (Ne învârtim în cercul propriu.)

j. Legea gravitației particular-ideaționale

Fiecare idee <A> atrage și respinge altă idee cu o forță direct proporțională cu produsul măsurilor lor neutrosifice și exponențialul distanței lor.

(În opoziție cu reafirmarea modernă a Legii lui Newton cu privire la gravitația particulelor de materie, distanța influențează direct proporțional - nu indirect: cu cât sunt ideile mai opuse / distanțate, cu atât se atrag mai puternic.)

k. Legea gravitației universal-ideaționale

<A> tinde către <NonA> (nu către <AntiA> cum a afirmat Hegel), și reciproc.

Există forțe care acționează asupra lui <A>, orientând-o către <NonA>, până când un punct critic este atins, iar apoi <A> se întoarce.

<A> și <NonA> sunt în continuă mișcare, iar limitele lor se schimbă în consecință.

Exemple:

Perfecțiunea duce la imperfecțiune.

Ignoranța este mulțumitoare.

Caz particular:

Fiecare persoană tinde să se apropie de nivelul său de... incompetență!

Aceasta nu este o glumă, ci purul adevăr:

Să spunem că X obține un loc de muncă la nivelul N_1 ;

— dacă este bun, este promovat la nivelul N_2 ;

— dacă este bun în noua sa poziție, este promovat mai departe la N_3 ;

— și așa mai departe ... până când el nu mai este bun și prin urmare, nu mai este promovat;

— astfel, el a ajuns la nivelul său de incompetență.

$\langle A \rangle$ tinde către $\langle \text{Non}A \rangle$.

Prin urmare, idealul fiecăruia este de a tinde către ceea ce nu poate face.

Dar mișcarea este neliniară.

$\langle \text{Non}-A \rangle$ dispune de o gamă largă (continuum de putere), de versiuni care "nu sunt $\langle A \rangle$ " ($\langle A \rangle$ exterior); să le indexăm în mulțimea $\{\langle \text{Non}A \rangle_i\}_i$.

(Toate versiunile $\{\langle \text{Anti}A \rangle_i\}_i$ sunt incluse în $\langle \text{Non}A \rangle$.)

Prin urmare, infinit de multe versiuni $\langle \text{Non}-A \rangle_i$ gravitează, precum planetele în jurul unui astru, pe orbitele lui $\langle A \rangle$. Și între fiecare versiune $\langle \text{Non}A \rangle_i$ și centrul de greutate al "astrului" $\langle A \rangle$, există forțe de atracție și de respingere. Se apropie una de alta până când se ajunge la anumite limite critice minime: $P_{m(i)}$ pentru $\langle A \rangle$ și $Q_{m(i)}$ pentru $\langle \text{Non}A \rangle_i$ și apoi se depărtează una de cealaltă până la atingerea anumitor limite maxime: $P_{M(i)}$ pentru $\langle A \rangle$ și $Q_{M(i)}$ pentru $\langle \text{Non}A \rangle_i$.

Prin ecuații diferențiale putem calcula distanțele minime și maxime (spirituale) dintre $\langle A \rangle$ și $\langle \text{Non}A \rangle_i$, coordonatele carteziane ale punctelor critice și status quo-ul fiecărei versiuni.

Am putea spune că $\langle A \rangle$ și o versiune $\langle \text{Anti}A \rangle_i$ se întâlnesc într-un punct absolut / infinit.

Când toate versiunile $\langle \text{Anti}A \rangle_i$ cad sub categoria $\langle A \rangle$... avem o catastrofă!

Concluzie

Pentru că lumea este plină de nedeterminare, este necesară o imprecizie mai precisă. De aceea, în acest articol este introdus un nou punct de vedere în filosofie, care ajută la generalizarea 'teoriei

probabilităților', 'mulțimii fuzzy', și 'logicii fuzzy' la < probabilitate neutrosofică>, <mulțime neutrosofică>, și respectiv <logică neutrosofică>. Acestea sunt utile în domeniul inteligenței artificiale, rețelelor neuronale, programării evoluționare, sistemelor neutrosofice dinamice, mecanicii cuantice ș.a.

Acesta este un articol introductiv fundamental al FILOSOFIEI NEUTROSOFICE; un întreg colectiv de cercetători ar trebui să treacă prin toate școlile/mișcările/tezele/ideile filosofice și să le extragă trăsăturile pozitive, negative și neutre. Filosofia este supusă interpretării. Aceasta este o propedeutică, o primă încercare a unui astfel de tratat. O filosofie neutrosofică exhaustivă - dacă este posibilă - ar trebui să fie o sinteză a filosofiilor din toate timpurile în interiorul unui sistem neutrosofic.

Referințe

- [1] Albee, Ernest, "History of English Utilitarianism", Collier Books, Crowell-Collier Publ. Co., N.Y., 1962.
- [2] Ayer, A.J., "Logical Positivism", The Free Press of Glencoe, New York, 1958.
- [3] Bailey, Cyril, "The Greek Atomists and Epicurus", Russell & Russell, Inc., New York, 1964.
- [4] Berlin, Isaiah (ed.), "The Empiricists: John Locke, George Berkeley, David Hume", Dolphin Books, Doubleday & Company, Inc., Garden City, N.Y., 1961.
- [5] Bouvier, Alain, George, Michel, "Dictionnaire des Mathématiques", sous la direction de François Le Lionnais, Presses Universitaire de France, Paris, 1979.
- [6] Bouwsma, W.J., "The Culture of Renaissance Humanism", American Historical Association, Washington, 1973.
- [7] Burnet, John, "Greek Philosophy: Thales to Plato", St. Martin's Press, Inc., New York, 1962.
- [8] Carr., M.H., "Realists and Nominalists", Oxford University Press, Fair Lawn, NJ, 1946.
- [9] Copleston, Frederick, "Arthur Schopenhauer, Philosopher of Pessimism", Barnes and Noble Books, New York, 1975.
- [10] Hassing, Richard F., "Final Causality in Nature and Human Affairs", The Catholic University of America Press, Baltimore, 282 p., 1997.
- [11] Hegel, G.W.F., "The Phenomenology of Spirit", trans., A.V. Miller, Clarendon Press, Oxford, 1977.
- [12] Hobbes, Thomas, "Body, Man and Citizen", Collier Books, Crowell-Collier Publishing Co., New York, 1962.
- [13] Iorga, Nicolae, "Cugetări", edited by Elisabeta Jurca-Pod, The Yellow Bird Publ., Chicago, 1991.
- [14] Jaspers, K., "Nietzsche: An Introduction to the Understanding of His Philosophical Activity", University of Arizona Press, Tucson, 1965.
- [15] Jaspers, Karl, "General Psychopathology", translated by J. Hoenig and Marian W. Hamilton, Introduction by Paul McHugh, The John Hopkins University Press, Baltimore, Vol. I and II.
- [16] Kant, Immanuel, "Critique of Pure Reason", St. Martin's Press, New York, 1965.
- [17] Kenny, A., "Aquinas", Hill and Wang, Inc., New York, 1980.
- [18] Kockelmans, J.L., "Phenomenology: The Philosophy of Edmund Husserl and Its Interpretation", Doubleday and Company, Inc., Garden City, N.Y., 1967.
- [19] Le, C., "The Smarandache Class of Paradoxes", in <Journal of Indian Academy of Mathematics>, Bombay, India, No. 18, 53-55, 1996.
- [20] Leff, Gordon, "Medieval Thought from St. Augustine to Ockham", Penguin Books, Inc., Baltimore, 1962.

- [21] Loeb, Peter A.(ed.); Wolff, Manfred (ed.). Nonstandard analysis for the working mathematician. [B] Mathematics and its Applications (Dordrecht). 510. Dordrecht: Kluwer Academic Publishers. xiv, 311 p., 2000.
- [22] Marcel, Gabriel, "Man against Mass Society", Henry Regnery Co., Chicago, 1962.
- [23] Marcuse, Herbert, "Reason and Revolution: Hegel and the Rise of Social Theory", Beacon Press, Boston, 1960.
- [24] McKeon, Richard P., "An Introduction to Aristotle", Random House, Inc., New York, 1947.
- [25] McNeil, Martin, F., Thro, Ellen, "Fuzzy Logic / A Practical Approach", Foreword by Ronald R. Yager, Academic Press, 1994.
- [26] Mehta, J.L., "Martin Heidegger: The Way and the Vision", University of Hawaii Press, Honolulu, 1976.
- [27] Munshi, K.M., Diwakar, R.R. (gen. eds.), "Introduction to Vedanta", by P. Nagaraja Rao, Bhavan's Book University, Chowpatty, Bombay, India, 1966.
- [28] Peirce, C.S., "Essays in the Philosophy of Science", The Liberal Arts Press, Inc., New York, 1957.
- [29] Popa, Constantin M., "The Paradoxist Literary Movement", Xiquan Publ., Hse., Phoenix, 1992.
- [30] Popescu, Titu, "Estetica paradoxismului", Tempus Publ. Hse., Bucharest, 1995.
- [31] Reynolds, Barbara E., Hagelgans, Nancy L., Schwingendorf, Keith E., Vidakovic, Draga, Dubinsky, Ed, Shahin, Mazen, Wimbish, G. Joseph, Jr., "A Practical Guide to Cooperative Learning in Collegiate Mathematics", Mathematical Association of America, Washington, D.C., 1995.
- [32] Rousseau, Jean-Jacques, "On the Social Contract", trans. Judith R. Masters, St. Martin's Press, Inc., New York, 1978.
- [33] Russell, Bertrand, "Introduction to Mathematical Philosophy", Dover Publications, Inc., New York, 1993.
- [34] Ryle, Gilbert, "The Concept of Mind", Barnes and Noble, Inc., New York, 1950.
- [35] Sartre, Jean-Paul, "Existentialism and Human Emotions", Philosophical Library, Inc., New York, 1957.
- [36] Scruton, Roger, "A Short History of Modern Philosophy / From Descartes to Wittgenstein", Routledge, London, 1992.
- [37] Smarandache, Florentin, "Collected Papers", Vol. II, University of Kishinev Press, Kishinev, 1997.
- [38] Smarandache, Florentin. "Collected Papers", Vol. III, Abaddaba, Oradea, 160 p., 2000.
- [39] Smarandache, Florentin, "Distihuri paradoxiste", Dorul, Nþrresundby, 1998. [39] Smarandache, Florentin, "Linguistic Paradoxists and Tautologies", Libertas Mathematica, University of Texas at Arlington, Vol. XIX, 143-154, 1999.
- [40] Soare, Ion, "Un Scriitor al Paradoxurilor: Florentin Smarandache", Almarom, Rm. Vâlcea, 1994.
- [41] Soare, Ion, "Paradoxism și Postmodernism", Almarom, Rm. Vâlcea, 2000.
- [42] Stephens, J., "Francis Bacon and the Style of Science", University of Chicago Press, Chicago, 1975.
- [43] TeSelle, E., "Augustine the Theologian", Herder & Herder, Inc., 1970.
- [44] Vasiliu, Florin, "Paradoxism's Main Roots", Ed. Haiku, Bucharest, 1994.
- [45] Veatch, H.B., "A Contemporary Appreciation", Indiana University Press, Bloomington, 1974.

[46] Vlastos, Gregory, "The Philosophy of Socrates", Anchor Books, Garden City, New York, 1971.

[47] Webster's New World Dictionary of American English>, Third College Edition, Cleveland & New York, Simon & Schuster Inc., Editori: Victoria Neufeldt, David B. Guralnik, p. 1133, 1988.)

[48] Wittgenstein, L., "Tractatus Logico-Philosophicus", Humanitas Press, New York, 1961.

Circuite și fluxuri neutrosofice

Florentin Smarandache

Determinism paradoxist: Lipsa cauzei este, totuși, o cauză.

*

Aceasta este o *judecată definitivă*: nu există o judecată definitivă.

*

Le Roi le veut.

Să-i cităm pe maeștri: Platon: *panta chorei* (totul se mișcă);

Diogene Laertius: *rhein ta hola* (totul trece);

Aristotel: *panta rhei, ouden menei* (totul trece, nimic nu mai rămâne). Prin urmare, o propoziție afirmativă de astăzi va fi infirmată mâine.

*

Am decis să nu mai decid nimic.

*

Lumea se schimbă continuu și ideile la fel. Dar, după un timp, aceasta ajunge în aceeași poziție.

*

Putem trece cu ușurință de la o extremă la alta.

*

Paradoxul este imanent conștiinței (Schuppe), așadar teoria neutrosofică este o filosofie imanentă (pentru că paradoxul este o parte a neutrosofiei).

*

Lotze a studiat distincția dintre realitate, adevăr, valoare.

El a inițiat axiologia, filosofia culturii, filosofia antropologică. Să introducem în mod analog:

- NEUTROSOLOGIA (semnificația filosofică a neutralității *lato sensu*),
- NEUTROSOLOGIA CULTURII,
- ANTROPOLOGIA NEUTROSOFICĂ.

Și așa mai departe: neutrosologia valorilor, istoriei, științei, artelor.

*

Filosofia reflectă existentul din inexistent.

*

Heraclit a găsit un consens de tendințe și tensiuni opuse, cum ar fi cel al arcului și al lirei. Oamenii nu-și pot imagina cât de în-armonie-cu-sine este discordia!

*

Îi mulțumesc lui Dumnezeu că mi-a spus că nu există.

Acesta este *Te Deum laudatum* al meu!

*

Nu s-ar putea pune în calendar o sărbătoare religioasă pentru atei?

*

Ar trebui să ne dăm seama că uneori frumusețea este urâtenie, iar urâtenia este frumusețe – parafrazând-o pe Gertrude Stein.

*

Există o unitate între limbajele științifice și cele artistice, iar aceasta nu este *fizicismul* lui Neurath, ci o acomodare a variabilității.

*

Doar pentru că omul este muritor, el vrea să devină nemuritor (prin creația sa în arte, știință, istorie).
Ce s-ar întâmpla dacă toți oamenii ar fi nemuritori?

*

Fiecare om poartă în interior un supra-om (energie pozitivă), un infra-om (energie negativă) și un om-nul (fără energie):

*el însuși proiectat în afara lui,
el însuși proiectat în interiorul său.*

Componentele sunt activate aleatoriu.

*

Neurologiei este caracteristică mișcarea interioară spre (și întru) sine.

*

“Omul este o ascensiune spre nu-e-posibil” (Ion Ornescu, <Poezii din închisori>).

*

Cauzele și efectele sunt antagonice.
Nu există dinamică fără antagonisme.

*

Behaviorismul inițiat de J. Watson nu poate fi liniar. Există, de asemenea, un behaviorism interior al ființei (*esse*), într-un dezechilibru continuu cu imaginea exterioară a ființei (F. C. Tolman și, în special, G. H. Mead, prin conceptul său de *social behaviorism* – comportamentism social).

Unind noțiunile anterioare în interior și în exterior cu noțiunile neutre, putem fundamenta un *comportamentism neutrosolic*.

*

Comportamentul uman funcționează pe legile ecuațiilor diferențiale cu derivate parțiale în raport cu parametrii mai mult sau mai puțin adverși unul față de celălalt. Prin urmare: neliniar.

Esența naturii, începând cu atomul, constă în lupta și acordul componentelor sale. Convergența lor trece prin divergență.

*

“Începutul și sfârșitul se găsesc în același cerc” (Heraclit).

Cât de infinit de mare poate fi infinitul?

Ne-am putea imagina în mintea noastră cum ar arăta infinitul în viața de zi cu zi ? O întrebare care m-a fascinat...

A merge, a merge și a nu ajunge niciodată la final? Sau, dacă găsești vreodată un sfârșit, cum este? Perete înalt de o sută de kilometri... și gros? O prăpastie, un abis? Sau universul este circular și ne tot învărtim la infinit? Universul, ca sferă sau suprafață închisă, nu are început, nici sfârșit.

Nici infinitul mic, nici infinitul mare pe care îl percepem altfel decât într-un mod teoretic abstract.

*

Teoria infinității transcendente a lui Cantor conține frumusețea paradoxului. Două mulțimi inegale pot avea, totuși, aceeași corespondență unu-la-unu între punctele lor. Aceasta a fost marea surpriză care l-a deranjat pe rivalul său matematician Kronecker.

Dar nimeni nu poate scoate farmecul și inefabilul din lumea științei (și din noile adevăruri care, ca parte a vechilor sisteme de referință, neagă afirmațiile clasicizate).

*

Dictatura: chiar dacă nu vrei, trebuie!

*

Putem construi o filosofie non-filosofică?

Orice pozitiv are efectele sale secundare negative și nule.

Ritmul minții nu există.

Războiul sistemelor macină și renaște neuronii noștri.

Cum să contești un subiect incontestabil!

Formarea este doar tensiunea dintre contrarii. Se recurge la un fel de lege catastrofală, la o luptă (*polemos*) (Radu Enescu, <Eminescu, Universul himeric>).

*

John Dewey consideră inteligența însăși ca un obicei prin care omul își ajustează relația cu mediul. Un circuit permanent:

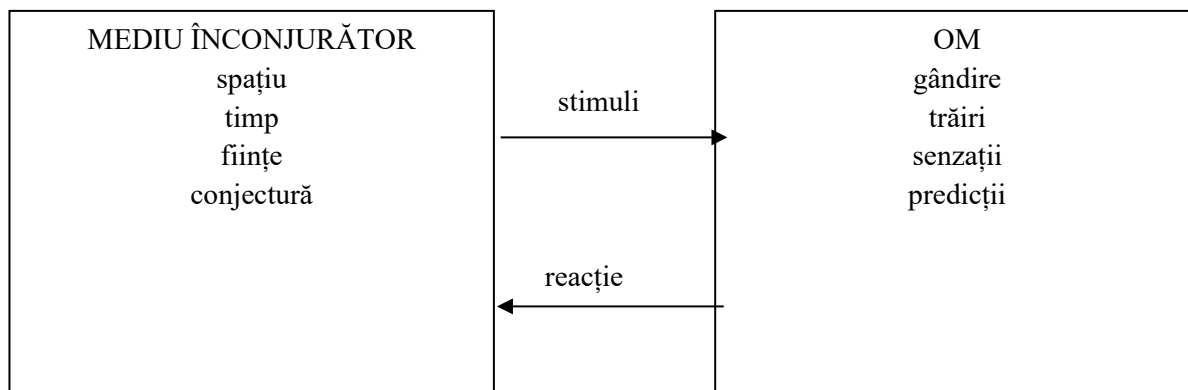

care se oprește când omul moare (sau chiar mult după aceea).

*

“Marx a protestat adesea spunând că nu era marxist”, scrie Samuel Enoch Stumpf în <Socrate către Sartre>, *History of philosophy*, 1988.

*

Neutralitatea cunoaște un proces de autodezvoltare nelimitată către un spirit absolut (hegelian).

După Marx și Engels, totul (și inclusiv neutralitatea) “este într-o stare neîncetată de mișcare și schimbare”.

*

Filosoful nu este capabil să descopere o formă unică de informație (Wittgenstein).

*

Neutrosfia nu se folosește abuziv pentru a “trage concluzii false, sau a pune întrebări false, sau a face presupuneri fără sens” (A. J. Ayer, referindu-se în special la filosofia analitică).

*

Neutrosafia nu este doar “unitară și luptă a contradicțiilor” (V. I. Lenin), ci transcendența lor în viața noastră de fiecare zi; *spațiu neutrosofic, timp, existență*.

Aceasta este o generalizare și o relativizare a ambiguităților, precum și a controverselor filosofice.

*

Omul trebuie să fie pregătit să se adapteze și să facă față situațiilor controversate.

Omul ar trebui să fie suficient de puternic pentru a-și permite ceea ce nu este accesibil.

“Este mult mai bine ca oamenii să nu fi realizat tot ce își doresc; boala este cea care dă sens și valoare sănătății; răul binelui; înfometarea de saturație; oboseala din timpul liber” (Heraclit).

*

Non-filosofia face filosofie.

Cele mai multe probleme filosofice apar din nedumerire (L. Wittgenstein, Gilbert Ryle).

*

Plăcerea și suferința, luate împreună, au fost studiate de Heidegger și Sartre.

*

Uneori, o metodă analitică poate fi sintetică, în timp ce o metodă sintetică poate fi analitică. W. V. O. Quine a afirmat că “pur și simplu nu a fost trasată o graniță între afirmațiile analitice și cele sintetice”.

*

Fiecare noțiune are forma unei *sfere neutrosofice*: $t\%$ din puncte/elemente sunt sigur în (înăuntru), $f\%$ dintre puncte sunt sigur în afară (în exterior) și $i\%$ din puncte sunt nedeterminate (neutre), unde:

$$t + i + f \leq 300^+.$$

*

Paradoxul are multe funcții, pe lângă trăsătura sa <clasică>, *para* (împotriva) + *doxa* (opinie) (gr.).

Există o multitudine de opugnații în interiorul ei.

Dar nu lăsa paradoxul să te vrăjească!

*

Heraclit: Totul se schimbă. Parmenide: Nimic nu se schimbă.

Cine are dreptate?

Heraclit: Individul este esențial. Parmenide: Universul este esențial.

Cine are dreptate?

Heraclit: pluralist. Parmenide: monist.

Cine are dreptate?

(Amândoi în fiecare caz! Și, simultan, amândoi greșesc.)

Fiecare sistem de referință reflectă o propoziție într-o lumină diferită.

*

Orice dogmă dă naștere unei antidogme.

<A nu avea deloc vreo dogmă> este și un fel de dogmă, nu-i așa? Antidogma revine din nou ca o dogmă însăși.

*

Corpul și mintea sunt reunite (și studiate de Gilbert Ryle).

*

Existențialism neutrosofic: Viața este, acum, mașinizată. Mașina este, acum, umanizată de îmbunătățirile senzoriale ale științei.

Aceasta este o existență inexistențială.

Omul este dezumanizat! Care este alienarea lui?

*

Anti-tautologie: Existența este, așadar, ceea ce nu există...

*

Ideile banale ale unor *băieți șmecheri* sunt considerate mai importante decât ideile inteligente ale unor *indivizi anonimi*. Fiecare este judecat după locul lui în societate. Oamenii au etichete lipite pe frunte (etichetism).

Ideile mari ale oamenilor săraci sau din țările sărace sunt ignorate în mod intenționat. Greșelile *băieților șmecheri* sunt reduse la tăcere. Nu opera spirituală contează cel mai mult, ci poziția autorului (să absolvi o universitate “renumită”, să-ți publici lucrările la o editură sau revistă “importantă”, să ai o rețea de legături, ca o mafie științifică sau artistică, cu aranjamente, premii pentru... sforăit; trafic de influență!).

Mulțimea este manipulată de mass-media, care a devenit cea mai puternică forță din societate. Conștiința oamenilor este furată.

*

Omul este liber în societate, dar guvernat de legile ei. Prin urmare, omul nu este liber, ci limitat. Nu există libertate absolută.

*

"Omenirea nu poate trăi doar prin logică. Are nevoie și de poezie." (M. Gandhi)

*

Epistemologie: Cum să știm tot ceea ce știm?

*

Patologie spirituală: Filosofia este boala vieții mele.

*

Materie imaterială? Este aceasta o absurditate?

Hobbes a scris despre substanțele imateriale ca fiind ceva fără sens.

*

Noi nu suntem noi; trăim prin elementele prieteniei, ale profesiei, ale limbii și ale epocii. (C. Noica, <Cartea Înțelepciunii>)

*

Cercetătorii în teoria haosului sunt în curs de a descoperi ordinea în interiorul haosului ecuațiilor diferențiale neliniare.

*

Existența nu are sens și totuși are un sens.

*

Voința și non-voința, țelul și non-țelul, sensul și non-sensul acționează toate împreună, noi fiind conștienți și inconștienți de ele.

*

Empedocle explică modul în care *Filia* și *Neikos* (Dragostea și Ura, atracția și oroarea) funcționează împreună.

*

Protagoras a fost primul care a spus că în toate lucrurile există rațiuni contrare.

*

Definiția retoricii a lui Gorgias: “arta de a transforma cea mai proastă teză în cea mai bună teză” (*Ton eto logon kreito poeiein*).

*

Efemerul este doar etern.

*

În virtutea unor principii contrare, lucrurile se fac ele însele remarcate (Anaxagoras): lumina prin întuneric, întunericul prin lumină etc.

Totul este necesitate și se întâmplă în același timp. Atitudinile omului în prezența răului sau a suferinței sunt:

- pasivitate primitivă: suportă, îndură;
- reacție magică: face ritualuri magice pentru alungarea spiritelor rele ascunse în obiecte și ființe;
- resemnare: rămâne pesimist, pentru că răul este ireparabil;
- utilizarea suferinței: transformă suferința în bucurie, pentru că suferința este necesară și nu poate fi eliminată din viața noastră;
- soluție activistă: acceptă suferința și condamnă răul (Tudor Vianu); (Müller-Lyer, <Soziologie der Leiden>).

Dar care sunt atitudinile omului în prezența binelui sau a bucuriei?

- extaz;
- aroganță;
- indolență;
- declin.

Acesta este circuitul închis al atitudinilor omului în prezența lui "-", "0", și "+".

*

Schopenhauer afirmă că “lumea este reprezentarea mea”, reprezentare distorsionată de pluralitatea diferitelor imaginații.

Reprezentări contradictorii și similare la indivizi diferiți.

Contrar idealismului transcendent al lui Fichte (care, la rândul său, a contrazis determinismul metafizic al lui Kant), Schopenhauer concluzionează că dincolo de vălul lumii există o realitate absolută.

*

Un text pe un monument funerar chinezesc:

“Ocol de ne-limită, declarație de non-declarare, așezarea celor care nu se pot așeza au fost chinurile noastre”.

*

Eliade dezvăluie un “Dumnezeu irecognoscibil”, care este prezent fără a se face cunoscut, un ecou al paradoxului budist al prezenței-absență întemeiat de Nāgārjuna. În timp ce Hegel (după H. Küng) vorbește despre un “Dumnezeu care se sacrifică”.

*

Kant: omul trebuie privit mai întâi ca scop, apoi ca mijloc. În timp ce alții spuneau că scopul scuză mijloacele!

*

Cel care spune că nu a mințit niciodată în viața lui este un mincinos.

Există o neutralitate în fiecare neutralitate

Florentin Smarandache

Lumea este compusă din contradicții. Anti-lumea este compusă din contradicții.
Contradicțiile sunt compuse din contradicții.

*

Lumea este simultan de natură materială și psihică.

Acestea nu pot fi despărțite, așa cum au încercat să facă filosofii materialști și idealști; afirmația că psihicul este rezultatul superior al materialului este adevărată, dar și propoziția reciprocă este adevărată.

*

Determinismul are cauze paradoxiste.

*

Adevărul este relativ (V. Conta), falsul este și el relativ. Ambele sunt corelate intrinsec de un sistem parametric (timp, spațiu, mișcare).

*

Criza impune un progres. Progresul, la rândul său, duce fără îndoială la criză.

Progresul se produce dacă și numai dacă se produce criza (un fel de drum răsturnat: *Via Negativa* a Sfântului Toma de Aquino).

Dezvoltarea are urcușuri și coborîșuri.

*

Entitățile sunt legate de diferențele lor.

*

Paradoxul este infinit. Acesta este un fel de Dumnezeu pentru om. Îl putem parafraza pe Hegel: ceea ce este rațional este antagonic și ceea ce este antagonic este rațional; și, mai departe: ceea ce este irațional este și antagonic.

Putem spune că $1+1=2$ este rațional, dar nu antagonic.

Totuși, $1+1$ poate fi egal cu 3 într-un alt sistem logic.

*

Nimic nu va exista și nu va dura în afara neutrosofiei.

Neutrosopia nu este trebuie asociată cu idealismul german al lui Fichte și Schelling. De exemplu, în absolut, categorii precum: cauză și efect, existență și negație, pot fi inversate și amestecate.

EXISTĂ O NEUTRALITATE ÎN FIECARE NEUTRALITATE.

*

Celebra formulă panteistă a lui Spinoza, împrumutată de la Giordano Bruno: *Deus, sive Natura* (adică "Dumnezeu, sau Natura", identificarea lui Dumnezeu cu Natura), este generalizată la $\langle A \rangle$, sau $\langle \text{Non-A} \rangle$, asemănarea (până la confuzie) între atributul $\langle A \rangle$ și contrastul său $\langle \text{Non-A} \rangle$.

*

Sinonimul antonimelor, antonimul sinonimelor.

*

Gândesc, deci sunt neutrososof (parafrazând formula existenței a lui Descartes: *Cogito ergo sum*).

*

Aserțiunea lui Schopenhauer: “nimic nu există fără cauză”, se disjunge la existența mai multor cauze – nu numai una –, iar cel puțin două dintre ele sunt contradictorii între ele.

*

Lumea ca paradox

Schopenhauer a afirmat că “Lumea este ideea mea” folosind *vorstellung* (germ.) pentru *idee*, prin urmare materialul este imaterial (pentru că “ideea” este “imaterială”).

*

Unii clericaliști sunt ateii pentru că transformă biserica într-o afacere și religia într-o propagandă politică.

*

“A fi contradictoriu este o componentă a personalității individului” (E. Simion). “Antitezele sunt viața” (M. Eminescu).

Oamenii sunt la fel, dar fiecare este diferit.

*

“Dacă aș fi putut vreodată să scriu un sfert din ceea ce am văzut și simțit, cu ce claritate ar fi trebuit să scot la iveală toate contradicțiile sistemului nostru social!” (J. J. Rousseau).

*

Un argument paradoxist: “Omul este prin fire bun și numai instituțiile noastre l-au făcut să devină rău” (J. J. Rousseau).

*

În structura materiei există întotdeauna o uniune între continuu și discontinuu.

*

Nimic nu este non-contradictoriu. Totul este “+”, “-” și “0”.

Chiar și matematica exactă.

Aceasta este o DHARMA pentru neutrosomie.

*

Arta este un Dumnezeu pentru sufletul nostru.

*

“Bărbații vor fi întotdeauna ceea ce femeile au ales să facă din ei” (J. J. Rousseau). În consecință, bărbații vor fi ceea ce poate nu vor să fie!

*

Învățând, devenim cel mai răi (*paradoxul civilizației*): mai departe de noi înșine.

*

Rousseau a atacat artele, literatura din cauza coruperii eticii și a înlocuirii religiei. După moda modernă, nu ne diferențiem unul de celălalt, ci ne conformăm în vorbire, haine și atitudini; și apărem drept ceea ce nu suntem! Oamenii sunt la fel, dar... diferit.

Ironia sa împotriva politicianilor: “politicienii lumii antice vorbeau mereu despre morală și virtute, ai noștri nu vorbesc decât despre comerț și bani”.

Atacul său împotriva luxului: “acei artiști și muzicieni care urmăresc luxul își coboară geniul la nivelul mediocru al vremurilor lor”.

Prin urmare, orice progres în arte, literatură și științe duce la decadența societății. “Omul se naște liber și oriunde se află în lanțuri” (J. J. Rousseau, <Contractul social>).

*

Existența ființei umane în societate este nefirească: aceasta acționează așa cum trebuie să acționeze (nu cum simte), vorbește cum trebuie să vorbească. Personalitatea acesteia este distrusă; ființa umană devine anonimă. Existența-i este inexistentă. Se simte străină (Heidegger).

*

Heidegger a respins știința.

*

NU SUNT IGNORANT CĂ SUNT IGNORANT, parodiindu-l pe Socrate. NU MĂ ÎNDOIESC CĂ MĂ ÎNDOIESC.

*

Autoritatea mea este să nu am deloc autoritate, pentru că nu sunt un dictator.

Nimic din ceea ce ne aparține nu ne aparține cu adevărat.

Știm că nu știm totul.

*

Eternitatea nu există. Este o poezie.

Eternitatea trece...

Eternitatea este o amăgire a spiritului însetat de absolut.

*

Nici măcar absolutul, în sine sau prin sine, nu există, dar a fost inventat de omenire ca scop spre care nu poate fi atins. Pentru a-l judeca pe cel înflăcărat.

Nimic nu este perfect, nimic nu este permanent.

Orice noțiune este murdărită de elemente opuse, în ea se întipărește umbrirea contrariului. Un obiect este luminat de umbra lui.

*

Filosofia este o știință zadarnică, inutilă. Hrănește cântecul albastru al idealistilor. Fiecare filosof este un idealist, la fel și materialistii.

*

Cine ține ambii ochi larg deschiși la noțiuni și concepte p-u-r-e? Convenționalismul științei este uneori exagerat.

*

Filosofia este o taciturnitate... și o ascundere...

*

Omenirea progresează împotriva umanității, până la distrugerea ei. Nu ne îndreptăm doar spre o ruină materială, dar oamenii sunt transformați în roboți din carne.

*

Cum se face că se pune mai mult accent cultural de mase în țările subdezvoltate decât în cele bogat industrializate?

Doar o brumă de cultură încă mai subzistă, de exemplu, în mass-media academică americană (Dana Gioia).

*

Cu cât tehnologia se extinde mai mult, cu atât cultura înfloarește mai puțin. Un nou eveniment în cultură nu diferă mult de precedentul – cultura chiar se repetă, comparativ cu creșterea exponențială a științei.

Relația $\frac{\text{Cultură}}{\text{Știință}} \xrightarrow{t \rightarrow \infty} \zeta$, unde ζ este o constantă și t reprezintă timpul.

*

Din fericire, știința influențează și cultura (vezi futurism, cubism, abstractism etc.).

*

Există o confuzie între cultură și civilizație.

Alfred Weber a analizat relația dintre dezvoltarea cunoașterii (știință, tehnologie) și cultură (suflet).

*

O întrebare: există o limită în înaintarea civilizației dincolo de care nu se poate trece?

*

Știința s-a extins asupra culturii, a sugrumat-o, și-a ocupat locul în societate.

*

De meditat la:

- particularitatea generalului sau generalitatea particularului;
- complexitatea simplității sau simplitatea complexității;
- partea negativă a pozitivului și reciproc.

• *

Viața este neutrosifică: plângi azi, râzi mâine, nici nu plângi, nici nu râzi poimâine...

Râsul și plânsul au devenit sentimente/reacții atât de apropiate, încât viața a devenit mai neutrosifică, iar neutrosafia mai vie.

*

Oamenii au comportamente neutrosifice: prieteni care se transformă în dușmani sau se uită reciproc... bogați care cad în sărăcie sau în clasa de mijloc...

*

Ideile sunt neutrosifice.

*

O propoziție poate fi adevărată:

- *a priori* (indiferent în ce condiții),
- sau *a posteriori* (în funcție de anumite condiții).

De asemenea, aceeași propoziție poate fi adevărată la momentul T_1 , ignorată la momentul T_2 și falsă la momentul T_3 , sau poate fi adevărată în spațiul S_1 , ignorată în spațiul S_2 și falsă în spațiul S_3 și așa mai departe...

De asemenea, aceeași propoziție poate fi adevărată la un anumit moment de timp, ignorată la un anumit moment de timp și falsă la un anumit moment de timp, sau poate fi adevărată într-un anumit spațiu, ignorată într-un anumit spațiu și falsă într-un anumit spațiu; și așa mai departe...

*

Există o distincție între Filosofia Neutrosifică și Filosofia Neutralităților.

Prima studiază contradicțiile și neutralitățile diverselor sisteme, metode, școli filosofice. A doua caută neutralitățile și implicațiile lor în viață.

*

Paradoxul a invadat toate domeniile de activitate, toate disciplinele științifice și artistice. Nu mai este un fenomen marginal, ci se plasează în inima actului și gândirii umane. În afara paradoxului nu suntem capabili să înțelegem lumea. Trebuie să învățăm să identificăm paradoxul în stadiile sale de o diversitate extraordinară, să-i descoperim mecanismele funcționale pentru a-l limita și controla, eventual a-l manipula tocmai pentru a nu fi manipulați noi înșine de acesta. Dacă până nu demult, paradoxul era considerat un

simptom al unei stări patologice, în ultimele decenii este mai frecventă o fațetă opusă a paradoxului: cea a unei stări sănătoase, normale (Solomon Marcus) Anti-structura nu înseamnă haos.

*

Logica falsului sau Anti-Matematică?

*

Există Energia YIN (feminină) - canalul stâng și Energia YANG (masculină) - canalul drept, pentru puterea psihică sau spirituală.

Prima este a dorințelor. A doua este a proiectelor. Ambele sunt de natură biologică.

În anumite forme de yoga, șapte chakre coexistă în corpul uman, dar ele nu pot fi urmărite prin mijloace fizice, chimice, anatomice.

Energia Kundalini (de natură divină) este proiecția energiei universale în noi.

Athman (interiorul individual) se îmbină cu Brahman (interiorul colectiv) în filosofia indiană.

Meditația yoghină constă în purificarea chakrelor și atingerea unui statut de ne-gândire, ducând la creșterea Energiei Kundalini.

*

Concretețea abstracției

O noțiune abstractă este definită de elemente concrete, și reciproc.

Obiectele concrete au calitățile lor abstracte.

Laromiguière a numit simțurile noastre: mașini de a face abstracții.

*

Filosofie mecanică?

Dispozitive de producere a presupuzițiilor asupra curelei de rulare (programare pe computer) - filosofie inutilă.

*

Gândirea a priori à la Kant este încrustată doar în imaginație, un fel de trecere la limita spre infinit.

În spațiul kantian gândul îmbracă forma purității, depărtându-se de realitate, idealizându-se și autoidealizându-se.

*

Esența naturii nu are un aspect omogen și nici pur - sau se bazează pe acceptanța termenilor.

*

Matematica funcționează și cu aproximări. Dar *aproximări exacte*.

*

Perfecțiunea este o noțiune inventată de om: un efort, o țintă care nu poate fi atinsă niciodată.

Ne dorim mereu ceea ce nu avem. Odată ce avem, interesul nostru pentru acel ceva se pierde. Dar ne dezvoltăm tendința spre alt-ceva.

*

Omul este într-o DORINȚĂ continuă, CĂUTARE continuă, NESATISFACTIE continuă. Și acestea sunt bune, pentru că aduc progresul. Deci, omul este stresat, conectat la priză.

(În competiția sportivă, un aforism spune că este mai ușor să cucerești un record mondial decât să-l păstrezi.)

*

O cauză a declinului tuturor imperiilor (niciunul dintre ele nu a durat și nu va dura niciodată la infinit) este mulțumirea de sine a rolului lor principal în lume, încetinind astfel motoarele lor creative și de vigilență.

*

Într-un univers există mai multe universuri (concentrice sau nu); într-un spațiu: mai multe spații; într-un timp: mai mult timp; într-o mișcare: mai multe mișcări.

Întâlnim, ca atare, alte sisteme în cadrul unui sistem; și așa mai departe:

sub-univers sub-spațiu sub-timp sub-mișcare sub-sistem

Și aceste concentrații trec în sus și în jos la nivelurile (macro și micro) infinite.

*

Nietzsche: “Totul este haos”, dar haosul este organizat, coafat pe bigudiurile unui cap nepieptănat.

*

Adevărul este ascuns și în neadevăr.

*

Teoria Întâmplărilor și Teoria NeÎntâmplărilor fenomenelor se corelează. Conștiința inconștienței.

*

Nu că susținem teoria contrariilor, vehiculată de dualiști, ba chiar o generalizăm astfel:

Există doar contrarii: niciun fenomen nu are loc fără *non*-ul său (nu neapărat *anti*), fără negația și neutralitățile sale. Adică: un eveniment și non-evenimentul său se nasc în același timp.

Filosofia este neutrosifică sau nu este deloc

Florentin Smarandache

Filosofia este inutilă. Este o durere de cap pentru indivizii fără cap. Filosofii sunt oameni de știință inutilă.

*

Nu sunt un filosof. Sunt util? Dacă filosofia este ineficientă, să facem filosofie!

*

Cea mai bună filosofie este lipsa totală a filosofiei? Pentru că non-filosofia este în sine o filosofie. Dar pseudo-filosofia?

*

Nici măcar nu am vrut să devin filosof în această societate mercantilă (căci aş muri de foame). De aceea filosofez... Încerc să nu găsesc un sistem.

Oamenii de azi sunt foarte pragmatici, nu dau un ban nici pe argumentele mele neutrosifice, nici pe cele anti-neutrosifice ale altora!

Numai de bani le pasă...

*

Numărul umaniștilor, și mai ales procentul lor în populație, scade dramatic.

*

La ce folosește o teorie inutilă?

*

Și totuși, fața profundă a lumii, mișcarea ei interioară, presiunea și de-presiunea ei sunt ascunse simțurilor noastre.

Și de aceea lumea este uneori ceea ce nu este.

Asta este criza crizei omului modern!

*

Natura neutrosifică învăluie totul.

*

Este ușor să *scrii* filosofie. Dar filosofia nu ar trebui să fie un joc în cerc.

Este mai greu să *descoperi* filosofia — ne referim la a găsi legi aplicabile categoriilor mari. Filosofia impecabilă ar cuprinde în esență metabolismul ideatic al sferei infinite - pentru a absorbi raza arhetipurilor nemărginite.

*

Ideologia lui Jacques Derrida: moartea tuturor ideologiilor!

*

Filosofia nu este o reprezentare teoretică generalizată unitară a lumii (doar pentru a intersecta pozitivismul lui A. Comte cu conceptele noastre).

*

“Propozițiile metafizice nu sunt nici adevărate, nici false, pentru că nu afirmă nimic, nu conțin conștiință și nici erori” (Rudolf Carnap).

*

Omul este infinit. Ne opunem finitudinii umane a lui Jaspers. Spiritul este granița lui nemărginită.

*

Legea experimentală a lui Murphy: constantele nu există, variabilele nu vor.

*

Încercați să salvați ceea ce nu poate fi salvat!

*

Este ușor să uiți ceva important, dar este mai greu să uiți ceva care nu este important!

*

Imaginarul este mai real decât realitatea. Totul este ură, chiar și iubire.

*

“Cunoașterea este putere” (Francis Bacon), dar cunoașterea aduce și slăbiciune (de exemplu un bolnav de cancer care știe că este bolnav).

Cunoașterea este putere în știință, cercetare, dar poate fi frică, suferință, chiar sinucidere — ca în cazul pacientului anterior, de exemplu. Puterea într-o direcție înseamnă slăbiciune în altă direcție și mediocritate într-o a treia direcție. Cred că puterea, slăbiciunea și mediocritatea se îmbină.

*

Când te întreb: *De ce exist? Care este misiunea mea în această lume stupidă?* — gândești pesimist ca un Kierkegaard sau un Schopenhauer, ori inima ta vibrează de acordurile pianului care îngână un Chopin?

*

Neutralitatea este unitatea de măsură a tuturor lucrurilor, parafrazând celebrul adagiul al lui Protagoras: *Pántōn chrémátōn ánthrōpos métron* (Gr.) (Omul este măsura tuturor lucrurilor).

De ce? Pentru că neutralitatea și contradicția sunt esențele naturii. Exemple în acest sens putem găsi oriunde.

*

Un sistem filosofic este o dogmă (Francis Bacon). De aceea pledez pentru un sistem filosofic fără sistem.

Nu chiar filosofie analitică!

*

Felicitări pentru eșecul tău!

*

Dacă ești învins, ripostează. Dacă câștigi, ripostează și mai tare.

Există o strategie mai bună?

*

Ah, dacă aș avea forța să schimb ceea ce este de neschimbat!

*

Ne îndreptăm permanent spre o omogenizare a eterogenului, cum ar spune Stefan Lupasco.

*

Fixă este doar transformarea.

*

Logos este pătruns de *NonLogos*.

*

Încercând să se elibereze prin arte, omul se înrobește creației.

*

Homo homini lupus (lat., omul este lup pentru om), de aceea există un *bellum omnium contra omnes* (lat., războiul tuturor împotriva tuturor), ca *statut natural* (Hobbes, din Plaut).

În sens opus, Spinoza, cu *homo homini deus* (lat., omul este Dumnezeu pentru om), în timp ce Feuerbach a absolutizat la: *Dumnezeul omului este însuși om / este uman*.

Omul este un *om uman*?

*

Personalismul lui Schleiermacher propune ca toate problemele sociale să fie rezolvate prin evazionism, prin intercomunicare cu Dumnezeu sau prin retragere în propriile *dimensiuni* personale.

Așadar, un fel de *uitare*, de rezolvare a unei probleme prin neglijarea în mod corespunzător a acesteia (ignoranță).

*

Nu cred că există un început absolut al lucrurilor, nici un sfârșit absolut.

Nu există un fenomen perfect, care să tindă către un scop în mișcare ca în analiza matematică parametrială.

Nimic perpetuu.

*

Orice noțiune este murdarită de noțiuni netangente.

*

Este imposibil să pătrunzi infinitul în sine. Este vorba de aproximări psihice și chiar filosofice.

*

De multe ori ne simțim străini față de noi înșine, acționând împotriva gândurilor sau simțurilor noastre - ca oamenii pe care i-am dezaproba.

Ființa umană este haos organizat, înzestrată cu rațiune abisală, simțuri limitate și iraționalism nemărginit. Totul este de câmp continuu și transcendențial. Nici măcar fenomenele nu sunt total derivate din altele și există efect fără cauză pentru că iraționalul își are propriul imperiu de acțiune.

*

Teoria mulțimilor a lui Cantor a rezolvat infinitatea finitului și, în mod surprinzător, echipotența mulțimilor inegale, în felul în care una era finită (segment de dreapta) și alta infinită (toată linia) = alegerea paradoxului!

*

Lumea reală este dezordonată. Multe probleme sunt prost puse. În practică, există matematică urâtă. Curățați datele groaznice pentru a vedea frumusețea teoremelor!

*

Cei care nu sunt matematicieni se împotmolesc în probleme.

*

În filosofia artei și literaturii:

- rețea de frumos, bine, adevăr este înlocuită de voluptatea pentru urât, rău, fals;
- mizeria vieții la Zola, pofta de scabros, mucegăios, putregăcios (Baudelaire, Arghezi), nedreptatea oamenilor puternici împotriva celor neputincioși;
- răul promulgat sub fațada dreptății;
- și, în general, <Non-A> îmbrăcat în haine de <A>.

*

Nu vorbim despre politică, pentru că “în politică nu trebuie să spunem adevărul” (Metternich), nici despre istorie, care este “prostituata politicii” (Nicolae Iorga), ci despre naționalismul celor care se prefac a fi cosmopoliți.

*

Existența unor contradicții fugare, deci a unei continue instabilități în esența mișcătoare a lucrurilor și fenomenelor.

*

Viziunea lui Heraclit despre armonie și stabilitate se alătură cumva cu valorile absolute, perfecte, infinite supuse unui ideal teoretic.

Desigur, putem găsi o armonie în contradicții și o stabilitate în mijlocul unei instabilități – legate dialectic.

Precum și:

- un absolut în absolut,
- perfecțiune în perfecțiune,
- infinitate în infinit.

• *

“Intrăm în aceleași valuri și nu intrăm. Suntem și nu suntem” (Heraclit).

“Murim și nu murim; omul este un amestec de animal și zeu” (Petre Țuțea).

*

Decodificarea paradoxului ascuns în miezul problemelor.

*

Stilul înseamnă *unitate în diversitate*.

*

Viața ia forma unui echilibru instabil, cu o imprecizie precisă.

*

Filosofia nu are nevoie de filosofi, ci de gânditori. Gânditorii nu au nevoie de filosofie. Prin urmare, filosofia nu are nevoie de filosofie!

Este aceasta o anarhie?

*

În timp ce Platon, prin dialogurile sale, înțelege că nu rezolvă nimic, Kant crede că rezolvă totul.

Niciuna dintre variante nu este corectă.

*

Un cerc vicios

Vasile Pârvan: etnicul este punctul de plecare, iar universalul este punctul de sosire.

Terminus a quo și terminus ad quem.

Și iarăși ne întoarcem la Petre Țuțea: națiunea este punctul ultim al evoluției universale. [Noi, personal, nu credem!]

*

Heidegger: a trăi absolut murind în fiecare zi (pentru a ieși din anonim).

*

Paradoxul produce anxietate, amețeli (gânduri sumbre care se rotesc), ceartă în cerc, răsucindu-ți mintea!

*

Un paradox rezolvat își pierde misterul și nu mai este un paradox.

*

Cum putem interpreta expresia: *Vrăjește-mă, Doamne, ca să fiu liber (Imitatio Christi)?*

*

Libertatea este un demon nestăpânit din spirit; iar nemulțumirea duce la revolta libertății, până se ajunge la un echilibru.

În timp ce Țuța are o altă părere: “Libertatea omului este partea divină a lui”. *Divina particula aerae*.

*

Echilibrul este într-un echilibru permanent instabil.

Și dezechilibru are înclinație spre echilibru.

*

Spune proverbul: Doamne, dă omului ceea ce nu are! Ai nevoie cu râvnă de ceva și, când îl primești, se ofilește în mâna ta.

*

Plus tinde spre minus. Minusul tinde spre plus. Se aleargă unul pe altul, ca într-un cerc vicios care trece prin zero.

Negativ și pozitiv.

*

Eterogenitatea este omogenizată. Omogenitatea nu este pură.

*

Există puncte optime către care fenomenele sociale converg și acționează ca niște curbe cu asimptote. Mai exact, ecuațiile diferențiale ar putea simula sufletul.

*

Extremele se ating unele pe altele, spunea Marx. Fără extreme, echilibrul nu ar exista.

*

Nu se vehicula în Evul Mediu o teorie asupra dublului adevăr (interpretat după credință: *secundum fidem*, respectiv asupra rațiunii: *secundum rationem*)?

*

Fiecare om este propriul său sclav și stăpân.

*

Mama natura este reversibilă și ireversibilă.

*

După Țuța: Hristos este umanul divinizat și divinul umanizat.

*

Țuța îl caracterizează pe Nae Ionescu astfel: “meditația metafizică mutată la nivel cotidian, sau ridicarea cotidianului la nivel filosofic”!

Filosofie cultivată și ideologie în cultură!

*

Există într-adevăr fenomene fără istorie, lucruri fără istorie?

*

Nu, această noțiune de <istorie> este încorporată în esența esențelor. Chiar și lucrurile fără istorie au istoria lor.

*

Învățarea te învață și ce să nu înveți.

*

Inteligența are prejudecăți, prejudecățile au și un sâmbure de inteligență.

*

Imitația are un caracter original. Și, la rândul său, originalitatea este adesea imitativă.

“Dumnezeu este creator, omul este imitator” (Țuțea), și nu numai, pentru că omul l-a creat pe Dumnezeu în mintea lui (imaginație).

*

“Funcția idiotului este pozitivă, căci fără el nu am înțelege nici genialitatea, nici normalitatea” (Țuțea).

*

Neutrosafia a devenit o religie, un mit contemporan.

Trans-spiritual. Trans-senzorial.

Legi, factori, principii, funcții contradictorii și neutre.

*

Rezultatele fantastice din partea realului, ca o excrescență. Urmează apoi ciclul invers: când realul (concepția științifică/tehnică) este inspirat din imaginar.

*

Nicolae Iorga considera că factorii ideali i-au influențat pe materialisti în înțelegerea evoluției societății umane.

Și invers este corect.

*

“Am crezut că adevărul este universal, continuu, etern” (Mircea Eliade, <Oceanografie>). Desigur, nu este.

*

“Cum se poate mângâia omul care suferă din cauza fericirii” (M. Eliade, <Oceanografie>).

Și cineva poate mângâia un om care se bucură de neazuri?

*

Esența unui lucru nu poate fi niciodată atinsă. Este un simbol, o noțiune pură și abstractă și absolută.

*

O acțiune poate fi considerată B% bună (sau corectă) și R% rea (sau greșită), unde $B, R \subset \ll -0, 1^+ \ll$, restul fiind nedeterminare, nu numai <bun> sau numai <rău>, cu rare excepții, ca de exemplu atunci când consecința sa este B% fericire (plăcere).

În acest caz, acțiunea este B%-utilă (în mod semi-utilitar). Utilitarismul nu ar trebui să funcționeze doar cu valori absolute!

Verificarea are un pluri-sens deoarece trebuie să demonstrăm sau să dovedim că ceva este T% adevărat și F% fals, unde $T, F \subset \ll -0, 1^+ \ll$ și $n_{\text{sup}} \leq 2^+$, nu numai $T = \{0\}$ sau $\{1\}$ – care apare în rare/absolute excepții, prin intermediul regulilor formale de raționament ale filosofiei neutrosifice.

*

Structura gândirii logice este discordantă.

*

Scientismul și empirismul sunt strâns legate. Unul nu funcționează fără celălalt, pentru că unul există pentru a-l completa pe celălalt și pentru a îl diferenția de oponentul său.

*

Faptele există izolat de alte fapte (= filosofia analitică) și în conexiune între ele (= concepțiile lui Whitehead și Bergson).

Filosofia neutrosifică unifică ideile contradictorii și necontradictorii în orice domeniu uman.

Modus neutrosophicus

Florentin Smarandache

Omul trebuie să trăiască în conformitate cu lumea naturală din jurul lui (filosofia Pueblo Indian).
În timp ce geniul nu ar trebui!

*

Credo quia absurdum (lat., Cred fiindcă este absurd; Tertulian e creditat cu această afirmație).
Prin urmare, cred pentru că este de necrezut!

*

Ideea alternativei eterne a lui Kierkegaard: de unde reiese imposibilitatea omului de a selecta sau de a mijloci între contrarii.

O dialectică a stărilor neutrosofice ale conștiinței etice.

*

Normal că drepturile omului sunt apărate de cei care nu le respectă – după principiul că, făcând zgomot, încălcările lor trec neobservate.

*

PHANTASÍA KATALEPTIKÉ (Gr., reprezentare cuprinzătoare) funcționează numai prin legea contradicției unităților componente.

*

Philosophia perennis & paradoxae (lat.)

*

Mai te gândești la mine când nu te gândești la mine?

*

Realitatea filosofiei este nereală. Și realitatea non-realului, de asemenea.

*

Ca parte a teoriei generale a acțiunii eficiente (praxiologia lui Kotarbitisky) trebuie cauzate rolurile intermediarilor și extremelor.

*

Filosofia arată formarea spiritului uman.

*

“Deoarece un filosof scrie cu cunoștințe despre ceea ce au gândit predecesorii săi, propria sa opera este în același timp o critică a gândirii anterioare și o contribuție creativă la marginea crescândă a filosofiei” (Samuel Enoch Stumpf, <A History of Philosophy>).

*

“Sunt constrâns să mărturisesc că nu există nimic din ceea ce credeam înainte că este adevărat de care să nu mă îndoiesc cumva acum” (Descartes).

*

Teologul Toma d'Aquino a fost de acord că universalul se găsește în anumite lucruri (*in re*) și, conform experienței noastre, este extras din anumite lucruri (*post rem*).

*

Dumnezeu este natura supremă. El este neutrosorul suprem al tuturor timpurilor. El este absolutul, neantul, neființa, <A>, <Neut-A> și <Anti-A> simultan.

*

Adevărul dublu al lui Ockham: un fel de adevăr este produsul rațiunii umane, celălalt este o chestiune de credință.

*

Seneca: “Oamenii își iubesc și își urăsc viciile în același timp”.

*

Să ne iubim dușmanii, să ne urâm prietenii? Cât de imprevizibili suntem!

Ce curioși!

Ne comportăm straniu și bizar.

*

Platon a spus că sufletul se luptă între rațiune și pasiune.

*

Personajele tragediei clasice a lui Pierre Corneille se zbat între idealul și pasiunea lor (<Le Cid>), dar idealul lor învinge.

În timp ce personajele lui Jean Racine sunt distruse de pasiunile lor (<Iphigénie>, <Phèdre>).

*

În ființa noastră există un *eu* și un *non-eu* care își dispută prioritatea. Este acea disecție interioară care ne împarte existența în două părți duble.

*

“Filosofia științifică nu există” (Nae Ionescu).

*

Filosofia este drumul spre neutralitate, exercițiul la granița dintre ființă și neființă, o reacție ideatică a contradicției esențiale în confruntarea DA cu NU, cu mii de poziții intermediare între ele.

*

Nae Ionescu spune că opera de artă încadrată într-un moment istoric nu corespunde într-un alt moment istoric.

*

Investițiile guvernamentale nu intră în faliment, chiar dacă falimentează [pentru că guvernul le refinanță din impozitele oamenilor!].

*

Nu-mi permit să nu-mi permit să gândesc.

*

Filosofia mea este să contrazic filosofia. Și, astfel, să livrez o anti-filosofie care, după un timp, devine filosofie.

*

Studiez opiniile celorlalți pentru că le contrazic.

*

Ideologia mea înseamnă moartea altor ideologii. Îl studiez pe Kant pentru a nu-l urma (pentru că, dacă nu-l studiez și nu știu nimic despre <Critica rațiunii pure> a lui, s-ar putea să-i redescopăr din greșeală teoria, dar aș vrea să nu imit pe nimeni).

*

Neutralitatea constituie nota dominantă a existenței, precum *misterul* în centrul sistemului filosofic speculativ și metaforic al lui Lucian Blaga.

Tensiunea sa interioară o dilată.

A dezvălui acest lucru înseamnă a forma stimuli de creștere viitoare.

O privim ca pe un iraționalism al raționalismului.

*

Paradoxismul studiază paradoxurile și utilizarea lor în diferite domenii.

Un sistem axiomatic al paradoxismului nu putea fi altfel decât... contradictoriu.

Teoria sensului și a nonsensului.

Forma in-formului. — Vezi și Logica Paraconsistentă (Newton C. Da Costa, în jurnalul <Modern Logic>).

Paradoxul este perceput metafizic, inconștient, ocult... și seamănă cu iadul!

Absolutul, abisul, perfectul sunt doar câteva noțiuni care nu sunt atinse decât de sensurile paradoxiste.

Sunt izomorfe.

*

Pentru orice fel de opinie există o contra-opinie și o neutră-opinie; pentru Kant există un contra-Kant și un neutru-Kant, pentru Moses ben Maimonides un contra- și un neutru-Maimonides, pentru filosofia lui Augustin o filosofie contra-și neutru-Augustin.

*

EXISTENȚA — CONTRA-EXISTENȚA — NEUTRU-EXISTENȚA.

*

De când s-a născut filosofia - datorită mozaicului său de idei contrapuse, sisteme care se ciocnesc, Școli rivale -, și neutrosafia a luat viață. Dar oamenii nu și-au dat seama. Neutrosafia există în istoria fiecărui domeniu al cogniției.

*

Deplasarea către neutralitate - acesta este motto-ul evoluției. Cunoașterea se ridică de la neutralitate spre neutralitate.

*

Politica este dictată de interese meschine (Machiavelli).

*

Filosoful arab Ibn-Haldun definește istoria ca o repetare într-un mod regulat și alternant a ciclurilor de urcare și declin al civilizațiilor.

*

Nu trebuie să fii filosof pentru a deveni filosof.

*

Doctrina religioasă dualistă maniheistă a luptei eterne între bine și rău (sau a luminii și obscurității), propusă de profetul persan Mani (Manichaeus) în secolul al III-lea d.Hr., combinând elemente zoroastriene + gnostice și alte elemente, este printre primele expresii de pre-neutralitate.

*

“Devii ceea ce ești în contextul a ceea ce alții au făcut din tine” (Sartre).

Prin urmare, ești ceea ce nu ești.

*

O metodă “de a face/produce filosofie”:

- Se trece o idee de bază <A> prin toate sistemele filosofice cunoscute și școlile de gândire și o compară cu opiniile și conceptele lor;
- Se extrag propozițiile <PRO-A>, <CONTRA-A> și <NEUTRU-A>, se comentează și se contestă.

Totul pus sub formă de scurte secțiuni (filosofie analitică), sistematic concatenate pe teme, noțiuni, categorii. Și, bineînțeles, folosind un meta-limbaj adecvat.

*

Mă întreb dacă forma poate exista în afara materiei?

Aristotel a negat această posibilitate.

Dar gândurile, ideile... au vreo formă?

*

Sunt filosofi care se contrazic pe ei înșiși: ca mine, de exemplu. Numai că eu nu sunt filosof (!).

*

Fiecare acțiune a noastră, oricât de pozitivă, are părți negative.

Și, oricât de negativă (rea), are părți pozitive (bune).

Pentru a câștiga, trebuie mai întâi să pierdem.

*

Oamenii ar trebui să vorbească filosofie.

Vorbesc deja filosofie, dar nu-și dau seama!

Oamenii mănâncă filosofie, oamenii beau filosofie în fiecare zi.

*

Filosofia ar trebui să fie un vis al cetățeanului contemporan.

Cu toate acestea, filosofia lor este să nu facă deloc filosofie. Gândul lor nu este să gândească.

*

Dintr-o poezie celebră a lui Tennyson:

“Theirs not to make reply,

Theirs not to reason why,

Theirs but to do and die.”

(Nu-i pentru ei să vorbească,

Nu-i pentru ei să întrebe,

Pentru ei e doar să muncească și să moară.)

*

Criminalii sunt transformați în eroi.

Păcătoșii în sfinți. Aceasta este lumea contemporană!

În timp ce inocenții și ascultătorii devin victime ale societății (cei mai săraci)...

*

Lumea exterioară este reală, dar depinde de conștiința noastră cum o percepem, deci nu este reală!

*

Lipsa existenței non-existențialismului. Lipsa de absurd a absurdismului.

A fost pragmatismul american (Charles S. Peirce, William James, John Dewey) un alt fel de te(r)orism?

La Peirce vedem gândire [= teorie] și acțiune [= practică], apoi un aliaj.

Orice idee este testată prin efectele sale neutrosofice.

*

Filosofia este o speculație, pornind de la o idee simplă, care devine mai îndrăzneță, extinsă și aplicată sistemelor disponibile...

Ca un schelet acoperit cu o piele estetică, care formează un corp.

Și așa, filosofia nu mai este o speculație.

Filosofia este încă și nu este.

*

Spiritul este transcendent. Spiritul este și material.

*

Dacă un filosof <F> a afirmat într-o zi o idee <A>, în viitor un alt filosof <G> îl va neutraliza susținând/motivând ideea <Non-A>.

Acesta este un mod de a face filosofie sau chiar carieră filosofică pentru unii.

*

Ca atacator, nu există nicio îndoială că trebuie să-ți aperi atacul de rezistența adversarilor.

Ca apărător, nu este îndoială că trebuie să ataci atacatorii?

Cea mai bună apărare este atacul – spune un proverb.

*

Mai mult îți plac poeziile mele când le critici.

*

Tratamentul este mai rău decât problema pe care presupune că o va trata.

*

Simone de Beauvoir există chiar și atunci când nu există [prin opera ei literară].

*

Cultura occidentală progresează într-o direcție greșită, spre criza omului european (Husserl, <Fenomenologie>).

*

Wittgenstein: “rezultatele filosofiei sunt descoperirea câte unui nonsens”.

Interpretarea unei interpretări greșite?

*

Omul ajunge să se identifice cu Dumnezeu, pe calea eliberării sufletului și a detașării de lume (*abgeschlidenheit*) [Meister Eckhart, <Die Deutsche Werke>].

Dar omul ajunge să se identifice și cu Diavolul, dezvăluind mizeria sufletului și a vieții private.

*

Esența este Dumnezeu (*essential est Deus*), și esența este Diavolul (*essential est Diabolus*).

Ambii, Dumnezeu și Diavolul, sunt necesari pentru a menține un echilibru.

Dumnezeu și Diavolul se identifică pentru că sunt noțiuni abstracte, simbolice, infinite, neclare chiar neutrosifice. Și, mai ales, pentru că nu există o acțiune pură “pozitivă” sau “negativă”. Fiecare acțiune este o combinație de atribute “+”, “-” și “0”. Dumnezeu, de asemenea, comite erori (Biblia este plină de crime, incest și păcate). Diavolul, la rândul său, face o muncă benefică (pentru că acesta este ca un vaccin, care ne ajută mintea să producă imunitate la “boala” de comportament rău, provocând formarea de “anticorpi” spirituali, pe care i-am numi “*antispirite*”, produse de creierul nostru). Din viciu ne ridicăm din nou, pe o scară lungă, la virtute. De la virtute regresăm înapoi la viciu (extremele se atrag) - trecând prin neutru, pentru că monotonia este împotriva ritmului nostru biologic. Și ciclul este repetat la nesfârșit.

Nu există nici Dumnezeu, nici Diavol, ci un amestec între ei – ei se neutralizează într-o oarecare măsură: un “zeu diavolesc” și un “diavol evlavios”, l-aș numi *DiaDum*.

*

La majoritatea întrebărilor:

- nu există un răspuns corect exact,
- nu există un răspuns exact greșit,

sau

- fiecare răspuns este corect,
- fiecare răspuns este greșit,

deoarece este o interpolare a acestora.

*

Un sistem formal, suficient de interesant pentru a-și formula propria consistență, își poate dovedi propria consistență dacă și numai dacă sistemul este inconsecvent (a doua teoremă de incompletitudine a lui Godel).

Evenimentele culturale au loc “sincronic” în multe țări, dar și “protocronic”. Primul adverb include o cantitate de universal, al doilea o cantitate de particular.

Cum putem combina abstractismul cu concretețea?

Neutrosofie maieutică

Florentin Smarandache

Miguel de Unamuno: Când doi oameni, Juan și Pedro vorbesc, există șase oameni care vorbesc de fapt:

- adevăratul Juan, cu adevăratul Pedro;
- imaginea lui Juan văzută de Pedro, cu imaginea lui Pedro văzută de Juan;
- imaginea lui Juan văzută de el însuși, cu imaginea lui Pedro văzută de el însuși.

De fapt, sunt mai multe:

- Imaginile lui Juan văzute de diverși oameni din jur, cu imaginile lui Pedro văzute de diverși oameni din jur.

Câte dialoguri au loc?

Dar într-un grup de n oameni, când toată lumea vorbește?

*

Știm fără să știm.

*

În biologie, care dintre ele, teoria fixistă sau teoria evoluționistă este adevărată?

*

În diplomația modernă “economisirea de timp și energie nu este posibilă fără înlocuirea comunicării reale cu un cod, prin formalizare. (...) În rest, codul rămâne atotputernic. Ești <important> și nul în același timp.” Mai mult decât ești tu, ești insigna ta (Andrei Pleșu, <Câteva nevroze orientale>).

*

Dacă vorbești serios, râzi de mine.

Dacă nu vorbești cu adevărat serios, râzi și mai mult de mine!

*

Să construiești o filosofie fără niciun suport filosofic (de la zero)?

Ar fi o *filosofie* “naivă”?

Filosofie fără filosofie?

Parafrazându-l pe Husserl: a judeca numai prin comparație cu antinomiile, și nu după alte fenomene banale.

*

O fenomenologie neutrosofică se bazează pe conștiința intenționată orientată către suișurile și coborâșurile vieții și evenimentele liniare. Aceasta este o ramură a *epoché*-ei fenomenologice a lui Husserl.

*

Putem trece cu ușurință de la o extremă la alta, dar uneori cu greu între două stări apropiate.

*

Frica de noi înșine... Nu știm cine și de ce suntem...

*

“Fiecare DA trebuie să se sprijine pe un NU (altfel pe ce s-ar sprijini pârgia lui Arhimede?)” (Ion Rotaru).

*

O idee naște o non-idee (nu neapărat o anti-idee), altfel precedentă ar deveni o îndoctrinare.

*

Spiritul nou se construiește pe spiritul vechi, distrugându-l.

O altă logică convențională înlocuiește logica perimată.

*

Orice aserțiune este o limitare, de aceea o non-afirmație izvodește în mod regulat: pentru depășirea limitelor.

*

Probleme neutrosifice de morală contemporană: există argumente pro, neutre și contra avort, eutanasiu, homosexualitate, pornografie, discriminare inversă, pedeapsa cu moartea, etica în afaceri, egalitatea sexuală, consumul legal de droguri, justiția economică.

*

Paradoxul este un mister!

Întrebarea umană specială *Ce sunt eu?* a lui Gabriel Marcel are două răspunsuri complementare în cadrul paradoxismului:

- Sunt ceea ce nu sunt; și:

- Nu sunt ceea ce sunt.

Credem că acestea spun totul. Perioadă! Uneori:

- Este posibil să captezi imposibilul; și:

- Este imposibil să captezi posibilul.

*

- Dacă faci ceva, este greșit.

- Dacă nu faci, tot este greșit.

În concluzie:

- Ce ar trebui să faci? și/sau

- Ce nu ar trebui să faci?

*

Omul este infinit în interiorul său și finit în exteriorul său.

Cum este posibil ca o entitate finită să includă una infinită?

Binefacerile neutrosofiei emerg din filosofia ei de viață și scris: e normal să ai parte și de rău, și de bine în viață, este chiar mai bine decât să ai parte numai de rău sau numai bine (ceea ce înseamnă monotonicitate, de unde moartea minții și acțiunii).

*

Fericirea ta este în interiorul tău (din budism). Astfel, Dumnezeu este în interiorul omului.

De asemenea, tristețea ta.

Dar omul este și în interiorul lui Dumnezeu.

Și totuși omul și Dumnezeu nu coincid.

*

Filosofia trebuia să guverneze statul în democrația ateniană (Karl Popper), în timp ce în "democrația" modernă de inspirație hegeliană filosofia a devenit sclava demagogilor.

*

"Totul este o metamorfoză continuă și, prin urmare, așa este contrariul" (Chuang Tzu, în taoismul său).

*

Există un <A> dincolo de <A>.

Exemplu: Există o realitate dincolo de realitate; care? Realitatea din imaginația noastră.

Neutrosofia nu consimte în niciun fel la dominarea unor doctrine spirituale – deși, la rândul ei, aceasta devine intrinsec stabilită ca o altă doctrină(!)... *pentru* și, în același timp, *împotriva* tuturor doctrinelor, dar păstrând o parte neutră.

De unde, neutrosafia va acționa mai târziu față de neutrosografie, dând naștere *post-neutrosografie*.

*

O persoană este guvernată de simțurile sale neutrosografice. E surprinzător că oamenii nu percep asta! Toți evită acest adevăr, suferind de orbire nocturnă. Fără variații de opinii nu ar exista evoluție.

*

Există multe moduri neutrosografice, desigur. La fel ca în fenomenologia lui Husserl, trebuie oarecum să ieșim din tărâmul neutrosografiilor experimentate (într-un act de detașare) pentru a înțelege și a permite să stăpânim adversarii și neutralitățile vieții noastre.

*

Acesta este un sistem filosofic fără sistem, sau bazat pe un non-sistem.

*

Dipă Kierkegaard, anxietatea implică o simpatie antipatică și o antipatie simpatcă.

Bucuria fizică poate duce la o amărăciune psihică.

Victoria spirituală este cucerită prin daune corporale.

*

Existența umană (*Dasein*-ul lui Heidegger), prin nonsensul și absurditatea ei, duce la Non-Existență? (Cumva: autodistrugere?)

Orice evoluție se încheie prin închiderea ciclului (decesul)!

În general, punctul de maxim extrem de pe curba de evoluție a oricărui fenomen este identic cu un punct anterior originii fenomenului. Infinitul circular coincide cu zero.

Existențialul, în fierberea sa spre apogeu, trece la non-existent. <E> este transformat în <Non-E> (nu neapărat <Anti-A>), care este transformat în <F>, care este transformat în <Non-F>...

*

Victima își iubește călăul. Învinsul îl îndrăgește pe învingător.

Sclavul își adoră stăpânul.

Câinele linge biciul care îl bate.

Cum ne putem pune de acord cu dezacordul altcuiva?

Cum ar fi să studiem formalității informali sau a informalității formali?

*

“Un filosof, când se preface a fi filosof, nu este un filosof. Ideile filosofice apar în mod normal spontan, altfel dacă încerci să le colorezi - arată strident.” (O. Paler, <Cele zece comandamente ale înțelepciunii>)

*

Asimilați ceea ce este prea puțin (raritatea este prețioasă),

Dez-asimilați ceea ce este prea mult (un proverb românesc spune: ce este mult, nu merită).

*

Definirea negativă: introducem elevilor un concept <C> explicându-le ce nu este <C>.

Astfel, învățând ceea ce este <Anti-C>, opusul lui <C>, suntem pe cale să-i facem să înțeleagă ceea ce este <C>.

Această metodă este comună în știință atunci când <Anti-C> este mai ușor de definit sau mai bine cunoscut.

În mod similar, putem introduce un concept <C> care îi învață pe elevi ce este <Non-C>.

*

Analizarea, sintetizarea și evaluarea subiectului opus și neutru duce la neutrosomie.

Inter-(trans-)disciplinaritatea se bazează mai mult pe integrarea teoriilor din discipline aparent intangibile.

Un astfel de *Centre Internationale de Recherches et Etudes Transdisciplinaires* a fost înființat la Paris, prezidat de Basarab Nicolescu.

*

În ceea ce privește teoria dezvoltării cognitive a lui J. Piaget & B. Inhelder conform căreia indivizii construiesc cunoștințe interacționând cu mediul lor, susținem ideea că intelectul unei persoane este influențat de fenomene, fapte, evenimente contradictorii pe un fundal de neutralii. Cu cât sunt mai diferiți, cu atât experiența de viață și creșterea mentală este mai bună.

Interacțiunea socială întâlnește pro-acțiunea și anti-acțiunea și neutru-acțiunea. [<La Psychologie de l'Enfant>].

*

Forța explicativă a lipsei-motivului-acțiunii sau a motivului non-acțiunii?

*

Teoriile sunt elaborate din fapte, dar și faptele emerg din teorie.

Dacă varianta universitară a relativismului este afirmația că nu există un criteriu obiectiv pentru a decide între adevărat și fals, bine și rău, varianta informală susține că “totul este un joc de putere” (H.R. Patapievici, <Relativismul și Politica>).

*

“Mă trezesc călătorind spre destinul meu în pânțele unui paradox” (Thomas Merton).

*

Se trece de la un lucru obișnuit la unul bizar, apoi de la o curiozitate înapoi la normal.

*

Valoarea absolută (Platon, Aristotel) este înlocuită de o *valoare relativă*.

Ideile pure sunt în general impure.

*

În textul sacru hindus *Bhagavad-Gita*, ce se regăsește în *Mahabharata*, una dintre vechile epopei sanscrite, Krishna oferă elevului său Arjuna cunoașterea completă a vieții: Cel care în acțiune vede inacțiune și în inacțiune vede acțiune este înțelept între oameni.

*

Cetățeanul zilnic, după iluministul Rousseau, poartă <maskă>. Datorită tehnologiei sofisticate, nu poate privi înăuntrul său, înoată prin lume, trecând în afara lui.

Numai omul spiritual este suficient de curajos pentru recuperarea sa interioară (La Rochefoucault), îndurând acea “umilință de lux”.

Omul tehnologizat nu spune ceea ce simte, ce gândește sau ce este adevărat; dar spune ce e bine să spună (pentru a-și păstra poziția/locul de muncă sau pentru a fi promovat, sau în previziunea recompenselor). E robotizat. E dezumanizat. E fals...

Individul este depășit de universal.

*

De la psihologia experimentală la *filosofia experimentală*.

*

“Geometria este exagerare, filosofia este exagerare, și poezia este exagerare. Tot ceea ce are sens este exagerare.

(...) Ontologic, răul și idealizarea, ca necesitate spirituală, sunt exagerări.

(...) <măsura> grecilor a fost excesivă ca și *hybrid-ul* care a rupt-o. Serenitatea lor era un echilibru volubil, de excese contrare.

Fără o doză de exagerare nu există cunoaștere, nici acțiune. Nici știință, nici dreptate. Și nici măcar bunul simț.” (Alexandru Paleologu, <Bunul simț ca paradox>)

*

Platon: esența precede existența, care este ușor de explicat pentru obiecte. Mai întâi crezi că ai nevoie de un aparat - și ce caracteristici să aibă -, iar în al doilea rând îl construiești. După Platon, ceea ce există acum a fost necesar (produs de legile naturale).

Întrebare antropologică: Astfel, ființa umană ar putea fi prezisă de la originea sistemului solar?

Sartre: existența precede esența, care este disponibilă pentru ființe. Să spunem: calul, mai întâi există, apoi îi studiem caracteristicile, care sunt generale pentru toți indivizii aceluiași exemplar.

Cine are dreptate? (Amândoi!)

Cine greșește? (Tot amândoi!)

Apoi, care a fost primul, oul sau găina (?) Există un ciclu: existență → esență → existență → ... În opinia noastră, niciunul dintre “existență” sau “esență” nu este primul.

*

"Orice poate merge bine, nu va merge!"

*

Nietzsche: *Dumnezeu a murit.*

Dostoievski: *Dacă Dumnezeu nu ar exista, totul ar fi permis.*

*

Conexiuni și adversități între *ego*, *supra-ego* și *sub-ego*.

*

Daimon-ul este o formă de a ilustra extragerea mobilității din imobilitate (Gabriel Liiceanu).

Hobby-uri.

Oamenii de rând au devenit sclavii obiectelor (mașină de lux, casă), ai pasiunilor (sex, călătorie). Stăpâni: sclavii ideilor.

*

Când vrei să faci conexiuni, legi chiar și cazuri opuse; iar când nu vrei, separi chiar și lucruri identice.

*

Cele mai mari lecții de morală sunt gândite de imoraliști (pentru că au ajuns în necaz și sunt experimentați).

*

Hermeneutica lui Foucault, hermeneutica hermeneuticii anterioare, până la anti-hermeneutică...

Dacă vrei să susții prea mult, ai putea nega! De la *homo religios* la *homo neutrosophus*.

*

O *pluri-filosofie* înseamnă idei opuse și similare încrucișate în întreaga cunoaștere.

*

Nu există nici un sfârșit definit, nici un scop ultim.
Teologii ignoră rolul întâmplării, și vitaliștii la fel.

*

Fii adaptabil la inadaptabilitate. Schimbă schimbarea.

*

Fericirea artistului persistă în nefericirea lui.

*

Ordinea supremă înseamnă haos.

Neutrosafia, o teorie a teoriilor

Florentin Smarandache

PLUS nu funcționează fără MINUS și ambele sunt susținute de ZERO. Toate sunt încrucișate uneori până la confuzie.

*

Neînțelesul este de înțeles.

*

Dacă viciile nu ar exista, virtuțile nu s-ar vedea (T. Mușatescu).

*

Orice teorie nou creată (noțiune, termen, eveniment, fenomen) își generează automat non-teoria - nu neapărat o anti-(noțiune, termen, eveniment, fenomen). În general, pentru orice <A> un <Non-A> (nu neapărat un <Anti-A>) va exista pentru compensare.

*

Neutrosafia este o teorie a teoriilor, deoarece în orice moment apar idei și concepții noi și implicit le sunt evidențiate sensurile negative și neutre.

Conexiuni și interconexiuni...

Neimportant este important, pentru că primul este umbra celui de-al doilea, care îi face valoarea să crească.

Lucrurile importante nu ar fi așa importante fără comparația cu lucruri neimportante.

*

Filosofia neutrosafică acceptă *a priori* & *a posteriori* orice idee filosofică, dar o asociază cu cele adverse și neutre ei, ca un *summum*.

Asta înseamnă să fii neutrosafic fără a fi! Schemele neutrosafice sunt legate de neutralitatea a tot și a toate.

*

Organicismul lui Spencer, care afirmă că evoluția socială este de la simplu la complex și de la omogen la eterogen, poate fi actualizat la o mișcare ciclică:

- de la simplu la complex și înapoi la simplu - deoarece orice lucru complex după un timp devine simplu (dar la un nivel superior),
- și iar la complex (dar și la un nivel superior celui precedent); prin urmare: de la nivelul 1 la nivelul 2 și așa mai departe...

Idem de la omogen la eterogen (nivelul 1) și înapoi la omogen (nivelul 2), iar din nou la eterogen (nivelul 3)... [un *evoluționism neutrosafic*, nici ca al lui H. Spencer, nici ca al lui V. Conta].

*

Neutrosafia creează o anti-filosofie.

Și, la rândul său, anti-filosofia creează filosofie. UN CERC VICIOS.

Așa se face istoria (?).

*

O noțiune/idee/eveniment/fenomen <A> se transformă în <Non-A> și invers. Filosofia este o știință poetică și o poezie științifică.

*

Există trei tipuri principale de oameni: <supra-omul> lui Nietzsche, cu voința lui de putere, <mijloc-omul>, cu voința sa de mediocritate (da, oamenii cărora le place să trăiască anonim în fiecare zi, plictisitor, monoton) și <sub-omul>, cu voința lui de slăbiciune (săraci, oameni fără adăpost, vagabonzi, puturoși, criminali).

În interiorul fiecărui om există un <supra-om>, un <mijloc-om> și un <sub-om>, variind în termeni de moment, spațiu, context.

De aceea, în general, fiecare om este: $O\%$ supra-om, $M\%$ mijloc-om și $U\%$ sub-om, unde $O, M, U \subset \ll -0, 1^+ \ll$.

În timp ce Spencer a susținut mecanic un evoluționism linear, S. Alexander, C. L. Morgan și mai târziu W. P. Montague s-au concentrat pe evoluția emergentă: noile calități apar în mod spontan și incalculabil.

Există totuși o linearitate în spontaneitate.

*

“Dialectica lucrurilor” creează “dialectica ideilor”, dar nu reciproc (Lenin); și totuși, funcționează și invers.

Aceeași dinamică înainte-înapoi pentru *tri-alectică* (cu atributele neutrilor), *plur-alectică*, *trans-alectică*.

*

Dacă înveți mai bine o disciplină, vei învăța “mai puțin” alta (căci nu ai timp să o aprofundezi pe cea de-a doua).

Și, dacă înveți mai bine o disciplină, vei învăța “mai bine” alta (pentru că cu cât ai mai multe cunoștințe, cu atât vei înțelege mai mult o altă disciplină). *N'est-ce pas?*

*

Când șomajul $U(t)$ crește, crește și abuzul asupra copiilor $CA(t)$:

$$CA(t) = k \log U(t),$$

unde t este variabila de timp, k este o constantă în funcție de rata șomajului și procentul de copii din populație.

*

Filosofia este un puzzle ideational și, la fel ca geometria, circumscrie și înscrie o idee într-o clasă de lucruri.

*

A gândi înseamnă a fi neobișnuit și intrigant și este inconfortabil pentru ceilalți.

Dacă X spune <A>, să examinăm toate versiunile sale, <A_i>; ce este <Neut-A>?; apoi să ne concentrăm pe <Anti-A>; și să nu uităm de toate derivatele lor. Să punem la îndoială orice. Să fim sceptici față de orice “mare” gânditor.

Mergeți înainte și căutați conflictul în orice teorie - grăunțele de înțelepciune și creativitate.

*

Văd ideile. Sunt roșii și albastre și albe, rotunde și ascuțite, mici și mari și mijlocii.

Mă uit prin obiecte și văd esența.

*

Ce ar putea fi o algebră filosofică? Dar un spațiu vectorial filosofic? Și cum ar trebui să introducem o normă filosofică asupra acestuia?

*

Structura logică a limbii a lui Wittgenstein riscă să iasă din peisaj atunci când trece de la o limbă L_1 la o limbă L_2 foarte diferite din punct de vedere gramatical.

*

Nici interdisciplinaritatea, nici multidisciplinaritatea, ci noțiunea extinsă la *infinitdisciplinaritate* (sau *total-disciplinaritate*), pentru a forma o disciplină globală, apărută din înglobarea fiecărei discipline individuale pentru a forma o teorie atotcuprinzătoare aplicabilă elementelor au născut-o.

*

Paradigma lui Thomas Kuhn se bazează la fel de mult și pe credințe științifice, și pe credințe metafizice.

*

Schopenhauer era tratat ca un radical pesimist; cum ar fi un filosof care râde? Ar trece drept un filosof glumeț?

*

Teoria deterministă afirmă că fiecare fapt sau eveniment din univers este determinat sau cauzat de fapte sau evenimente anterioare.

În regulă, dar cum rămâne cu *primul* fapt / eveniment? Cine l-a cauzat?

Dacă ești religios, poți răspunde: Dumnezeu. Atunci, cine l-a cauzat pe Dumnezeu?

Este Ființa Supremă creată de Ea însăși?

Sau, poate, nu a existat un *prim* fapt sau eveniment? Atunci, cum a fost posibil să ajungem la un moment dat să avem fapte sau evenimente în spațiu și timp fără un început?

De-terminismul flirtează cu *sub-terminismul* într-o anumită măsură.

*

Orice fapt sau eveniment din univers este $d(F)\%$ determinat sau cauzat de fapte sau evenimente anterioare, $0 \leq d(F) \leq 100$, iar procentul depinde de fiecare fapt sau eveniment individual F . Determinismul funcționează parțial în neutrosofie.

Proverbul: *cel care s-a născut pentru a fi spânzurat nu va fi niciodată înecat*, nu se aplică în întregime. Destinul este deviat și de omul însuși.

*

Mintea noastră nu poate reflecta adevărul cu acuratețe (Francis Bacon).

Din păcate nici știința.

Poate artele? (Nu, sunt prea subiective!)

*

“Adevărul este subiectivitate” (Jaspers).

Da, în majoritatea cazurilor, dar conform definiției anterioare, adevărul poate fi și obiectiv (ca limită dreaptă a subiectivității, când aceasta se îndepărtează de sine ca $x \rightarrow 1$). Variabila independentă x variază între 0 și 1.

Subiectiv = 0, obiectiv = 1 și orice altceva este un amestec de subiectiv și obiectiv. Dacă procentul de subiectivitate dintr-un adevăr este $s\%$, atunci procentul său de obiectivitate nu este neapărat $\leq (100 - s)\%$.

Adevărul nu este o proprietate stagnantă a ideilor, spunea William James, ideile devin adevărate pentru că sunt făcute de evenimente. Există tot atâtea adevăruri câte acțiuni concrete de succes.

*

Subiectivul este, la rândul său, *obiectiv*.

Obiectivul este și *subiectiv*.

*

Nicio afirmație nu este imună la revizuire (W. V. O. Quine).

*

Extindem *solipsismul*, teoria conform căreia sursa tuturor cunoașterilor existenței este doar sinele, la *pluripsism*, o teorie care să susțină că sursa tuturor cunoașterilor sunt toate ființele, pentru că suntem influențați de credințele, speranțele, dorințele, fricile altora. Este imposibil să trăiești izolat, nici măcar pustnicii sau călugării nu stau singuri, ci măcar interferează cu natura. Și trebuie să facă asta - pentru a supraviețui.

S-ar putea să nu înțelegem niciodată în mod adecvat experiența colegilor noștri (solipsismul empatic al lui Thomas Nagel) sau atribuirea stărilor psihologice (solipsismul psihologic al lui Wittgenstein), și totuși un mic procent din ea înțelegem, chiar dacă înțelegem greșit, dar ne încărcăm inconștientul cu fragmente din ele gândurilor lor — și mai târziu s-ar putea să acționăm parțial în felul lor, fără măcar să știm!

Ne comportăm într-un anumit fel nu numai din cauza a ceea ce se întâmplă în interiorul creierului nostru (așa cum afirmă solipsismul mitologic), ci și din cauza evenimentelor externe.

*

Se impune o matematizare a cunoașterii filosofice (și nu numai).

*

Uneori oamenii nici nu știu de ce au reacționat așa cum au făcut-o. Ceva care venea din adâncurile lor cele mai interioare, ceva inconștient, de care nu aveau habar — îi determină să reacționeze într-un fel sau altul.

*

"Impossible de penser que <penser> soit une activite serieuse" (Emile Cioran). [E imposibil să crezi că <a gândi> este o activitate serioasă].

*

Un înțelept: Nu există filosofie, există doar filosofi. Prin urmare, filosofi fără filosofie!

Dar reciproc: există o filosofie fără filosofi?

*

“Orice mare filosofie sfârșește într-o banalitate” (Constantin Noica).

*

Valoarea unei acțiuni este determinată de conformitatea acesteia cu regulile obligatorii date (deontologice) și în egală măsură de consecințele sale.

*

Aceeași propoziție este adevărată într-un sistem de referință și falsă în altul. De exemplu: “Plouă” poate fi adevărat *azi*, dar fals *mâine*; sau poate fi adevărat *aici*, dar fals *dincolo*, aiurea.

Mai mult, propoziția este și nedeterminată: nu știm dacă peste zece ani de azi înainte va ploua sau nu.

*

Pentru că orice încercare de schimbare a puterii politice sfârșește prin îmbarcarea unei alte puteri, “revoluția este imposibilă” (Bernard-Henry Lévy, André Glucksmann, Jean-Marie Benoist, Philippe Némó).

*

Puterea monarhului derivă din neputința poporului său (Juan de Mariana, sec. XVI-XVII). Pentru că, dacă ar avea vreo putere, poziția monarhului ar fi în pericol.

*

“Se pare că marile sisteme au început să-și piardă influența, pentru că plutesc în zadar peste univers” (Țuțea).

*

Pluralitatea cauzelor unui singur efect (J. S. Mill) este extinsă la pluralitatea de cauze întrețesute ale unei pluralități de efecte întrețesute. Este imposibil să separăm cauzele,

$$C_1, C_2, \dots, C_n, \text{ unde } 0 \leq C_i \leq 1 \text{ pentru fiecare indice } i \text{ și } \sum_{i=1}^n C_i = 1,$$

acționează ca un întreg, deci efectele,

$$E_1, E_2, \dots, E_m, \text{ unde } 0 \leq E_j \leq 1 \text{ pentru fiecare indice } j \text{ și } \sum_{j=1}^m E_j = 1,$$

chiar mai mult: ambele, cauzele și efectele, au puterea de continuum.

*

O analiză și o sinteză a întregii filosofii făcute de neutrosomie ar ajunge din urmă cu o auto-analiză și o auto-sinteză (reflexivitate), deoarece mișcarea neutrosomică este ea însăși o parte a filosofiei. Cum ar trebui, prin urmare, să arate neutrosomia neutrosomiei?

*

În *învățarea prin cooperare*, grupurile de elevi ar trebui să fie eterogene (nu omogene) în ceea ce privește genul, abilitățile și mediul etnic sau cultural, pentru a învăța unii de la alții și a interacționa mai bine.

Interdependența joacă un rol neimportant, deoarece un elev ar putea fi nevoit să coopereze cu altul de care ar putea să nu-i placă.

*

Cu cât lucrurile se schimbă mai mult, cu atât rămân la fel.

Toate obiectele matematice sunt multiple (nu funcții, așa cum a afirmat Alonzo Church).

Școala Eleatică susține că <totul este unul> și nu acceptă schimbarea și pluralitatea.

Spunem că <unul este totul>, dar lipsa de schimbare și singularitizarea nu funcționează în viața reală.

*

Nu există *-ism* real, pentru că *-ism*-ul reduce totul la o conceptualizare, la lucrul-în-sine, la o varietate de aparențe – în timp ce totul este amestecat și interdependent.

*

Timpul este fluid, vizibil și material. Ca un organism, o ființă. Facem parte din ea.

*

Epoca fenomenologică a lui Husserl trece nu numai de la credințele naturale la o reflecție intelectuală, ci și înapoi. Trece printr-un punct de mijloc de neutralitate zero de la o extremă la alta, pe lângă multi-punctele intermediare.

*

În interiorul atomului co-abitează protoni+electroni+neutroni.

*

Teologii au definit *trinitarismul* ca: Tată, Fiu și Duh Sfânt.

Dar Diavolul? Prin urmare, un *tetranitarism*?

Dar îngerii? Deci *plurinitarism*?

*

Este necesar să se introducă o măsurătoare pentru domeniul ideilor.

Să notăm prin IDON [lat. < *idoneus*, (cap)abil de] cea mai mică unitate de măsură a unei idei. Măsurarea idonică este direct proporțională cu următoarele caracteristici ale unei idei:

- noutate
- calitate
- originalitate
- densitate
- continuitate
- limpezime
- cantitate
- analiză
- sinteză
- valoare de adevăr,

și invers proporțională cu următoarele caracteristici:

- imprecizie
- discontinuitate
- trivialitate
- falsitate.

*

“De la eroare la paradox nu este, de multe ori, mai mult decât un pas, dar acest pas este definitiv, deoarece, contrazicând chiar și caracterul apodictic al afirmațiilor matematice, poate deveni un fluviu de cunoștințe al matematicii viitoare”. (Al. Froda, *Eroare și paradox în matematică*).

Prin urmare, matematica nu este suficientă pentru a explica totul. Știința este de fapt limitată.

*

Aceasta este *ideea definitivă*: NU EXISTĂ O IDEE DEFINITIVĂ!

*

Atomismul lui Leucip, elaborat de Democrit, afirmând că atomii și vidul sunt realități ultime, este el însuși anulat, golit de conținut!

*

Orice sistem sau substanță are un grad de dezordine (măsurat prin entropie), un grad de ordine și un grad de ordine și dezordine în același timp.

*

Ce înseamnă sentimentul golului (Gabriel Marcel), dar al întregului? Sunt opuse, dar în mintea mea ambele arată ca niște sfere perfecte. Chiar și întregul este golit de sens. În formă pură, acestea nu există.

*

Putem trata diverse teme, în consecință am putea afirma că neutrosfia nu este o filosofie specializată.

Cu toate acestea, neutrosfia este specializată prin metoda sa de cercetare și prin sistemul său. Această modalitate de gândire se inspiră direct din viața reală. Se aplică, de asemenea, și în literatură, arte, teatru și știință.

*

Uneori ne iubim poezia când nu o iubim!

*

Universul se extinde, neutralitatea se extinde – pentru echilibrare.

*

Paradoxul dă frumusețe și mister unui eveniment.

*

Pentru fiecare obiect există un anti-obiect și un non-obiect.

Diferența dintre $\langle A \rangle$ și $\langle \text{Anti-}A \rangle$ este uneori mai concisă: femeie-mascul, minus-plus etc. sau mai diluată... dar asta e altă poveste.

*

Fac filosofie doar pentru că nu sunt filosof și nu mă interesează filosofia. Pierd ceva timp citind și răsfoind tratatele de gândire.

Neutrosafia ca matrice universală

Florentin Smarandache

Neutrosafia:

- are scopul de a unifica domeniul umanist (cum a încercat să facă Einstein în știință);
- explorează diferențele dintre gânditori, școli filosofice, mișcări, teorii, principii și dovedește că sunt minime;
- arată că nicio școală de gândire nu este mai bună decât alta și niciun filosof nu este mai mare decât altul;
- este o încercare de a reconcilia punctele de vedere divergente;
- susține că adevărul nu poate fi separat de fals.

Dacă filosoful X a enunțat o propoziție P , neutrosafia studiază și contrariul acelei propoziții, $\langle \text{Anti-}P \rangle$, iar apoi compară cu $\langle \text{Neut-}P \rangle$.

*

Orice idee nouă provoacă reacții pro și contra, dar și neutre (indiferență, neutralitate). $\langle \text{Dialectica} \rangle$ lui Hegel [gr. *dialektike* < *dia* “cu, împreună cu”, *legein* “a vorbi, a afirma”] nu funcționează, în consecință trebuie extinsă la un termen oarecum impropriu, *trialectică*, și cu atât mai mult la o *pluralectică*, pentru că există diferite grade de pozitiv, și de negativ, precum și de indiferență - toate întrepătrunse; continuând spre o *transalectică* de putere continuă (∞ -*alectică*).

“+” nu cere numai “-” pentru echilibru, așa cum afirma Hegel, ci și un “0”, ca un punct de sprijin pentru pârghia gândirii.

Dezvoltarea hegeliană a unei idei $\langle A \rangle$ nu este determinată doar de contrariile sale interne, ci trebuie legată și de neutralitățile sale - pentru că și acestea intervin în proces. Dezvoltarea unei idei este determinată și de factori externi (pro, contra, neutri) — *filosofie comparată*, ca literatură comparată.

Între particular și universal există $P\%$ lucruri particulare, $I\%$ nedeterminate (neutre) și $U\%$ universale, cu $P, I, U \subset \parallel -0, 1^+ \parallel$

*

Structura atomului se menține în istoria oricărei idei. Raționamentul se bazează pe analiza propozițiilor pozitive, negative și neutre.

Aceasta ar trebui să se numească *Filosofie cuantică*.

În fiziunea nucleară, un neutron liber interacționează puternic cu nucleele și este absorbit, apoi se descompune într-un proton, un electron și un “neutrin” (Enrico Fermi).

*

Neutrosafia încastrează în egală măsură un punct de vedere filosofic, dar și un mod de reflecție, un concept, o metodă în sine, o acțiune, o mișcare, o teorie generală, un proces de raționament.

Această abordare diferă de *neutrosofism*, care este un punct de vedere conform căruia neutrosafia este o știință fundamentală pentru a studia lumea din această perspectivă.

Neutrosafia studiază nu numai condițiile de posibilitate a unei idei, ci și de imposibilitate a acesteia, concentrându-se pe dezvoltarea istorică (interpretarea trecutului și prezentului - prin utilizarea analizei clasice și interpretarea viitoare - prin utilizarea probabilității și statisticii neutrosofice).

*

În economie, Keynes a ales conceptul de “echilibru instabil”, în timp ce Anghel M. Rugină a trecut la cel de “dezechilibru stabil” (<Adevărul în abstract (analitic) vs. Adevărul în concret (empiric) >).

În fiecare sistem funcționează un mecanism de auto-reglare și auto-dereglare, trecând de la echilibru la dezechilibru și invers.

O stabilitate instabilă și o instabilitate stabilă. Sau echilibru în dezechilibru și dezechilibru în echilibru.

Ne referim la un sistem foarte dinamic prin mici modificări rapide, caracterizat printr-o derivată. Sistemul static este mort.

Leon Walras avea dreptate: monopolurile reduc concurența, și astfel progresul.

*

Părerea mea este că unii filosofi bâjbâie, se poticnesc. Ei nu au idei sau sisteme clare, sau chiar direcții precise pe un subiect. *Paroles, paroles...*

Ceea ce unul afirmă astăzi, altul va nega mâine.

De multe ori vorbesc prea mult pentru a nu spune nimic. Unii au puncte contrare experienței și dovezilor, alții au o rațiune inadecvată.

De aceea ar fi necesară o matematizare (cu atât mai mult, o axiomatizare, dar nu *stricto sensu*) a tuturor domeniilor de cunoaștere, mai ales în filosofie (ca și Tabelul Elementelor Chimice al lui Mendeleev).

*

Filosofia este semi-științifică și semi-empirică. Este mai puțin științifică decât psihologia, dar mai științifică decât poezia.

*

Omul este dependent și independent în același timp. Înțeleg spiritul drept calitate și materialul drept cantitate.

Desigur, acestea se topesc unul în celălalt.

Văd adevărul ca un corp, un obiect cu o formă.

Văd materialul ca un spirit dens/condensat, o idee vâscoasă.

Structura ideilor reflectă structura obiectelor.

Și reciproc.

*

În problema minte-corp: Fenomenul mental este de natură fizică, iar fenomenul fizic este de asemenea mental.

*

“(...) se simte uneori că economia a fost propulsată pe principiul simetriei, care cere ca fiecare nouă teorie să fie întotdeauna exact inversul celei vechi” [Mark Blaug, <Teoria economiei în retrospectivă>].

*

Neohegelienii: Reconcilierea contrariilor (Bradley) sau neconcilierea contrariilor (Wahl)? Amândouă!

*

Țările care concentrează *centrul de putere* ignoră în mod deliberat artele, literatura, știința, cultura, tradițiile țărilor din lumea a treia. Mai mult, ei chiar boicotează, disprețuiesc ce vine din acele țări...

Creatorii și inventatorii din țările din lumea a treia sunt, de asemenea, marginalizați din cauza limbii, condițiilor precare de viață, au la dispoziție mai puțină tehnologie pentru cercetare.

În istoriile artelor, literaturii, științei nu vezi decât occidentali; rare sunt excepțiile personalităților ne-occidentale, care se află acolo să confirme regula!

Un poet minor, de exemplu, care a scris în engleză sau franceză sau germană este mai cunoscut decât un geniu ca Eminescu care a scris într-o limbă ne-internațională.

*

Negativitatea (Heraclit, Spinoza, Kant, Hegel) trece prin diverse faze: de la afirmare la un spectru de negativitate parțială și, eventual, la un grad mai mare de negativitate.

*

Nu *com*-plementaritatea (folosită de Bohr și Heisenberg în filosofia fizicii), ci *tri*-plementaritatea (negativitatea, pozitivitatea și neutralitatea - corespunzând la 0, 1 și, respectiv, 1/2), chiar și *n*-plementaritatea (care înseamnă: *n* elemente disjuncte formând împreună un întreg); sau generalizate la ∞ -plementaritate (cu putere de *continuum*), deoarece există versiuni complexe, mixte ale acestora.

*

Dincolo de multe stări la infinit între 0 și 1, punctul de mijloc $\frac{1}{2}$ nu reprezintă nici negativ, nici pozitiv - sau le reprezintă pe ambele (care se anulează reciproc).

*

Hermeneutica hermeneuticii filosofice: dacă prejudecățile nu pot fi eliminate în judecăți, de ce avem nevoie de știința interpretării?

În contradicție cu Plehanov (dezvoltarea istorică nu se conduce după voință), se poate spune că dezvoltarea istorică este într-o anumită măsură condusă și într-o altă anumită măsură nu este condusă de voință.

Conceptualismul lui Abelard, care afirmă că *universalia post rem* (generalul este *dincolo de lucruri*), adică generalul nu este *în lucruri*, este parțial adevărat, deoarece generalul persistă în fiecare individ, de aceea este posibil să se formeze clase de indivizi cu caracteristici particulare similare.

*

Filosofia filosofiei:

- de ce avem nevoie de filosofie astăzi?
- de ce nu avem nevoie de filosofie astăzi?
- în ce direcție merge filosofia?
- în ce direcție nu merge filosofia?

Unii spun că filosofia este pentru oameni care nu au altceva mai bun de făcut, cum ar fi puzzle-uri sau rebus!

*

Neutrosafia înseamnă/cuprinde:

- filosofia văzută de un matematician și un poet;
- studiul Istoriei Filosofiei;
- teme controversate ale filosofiei (pentru a explora ofensivitatea și inofensivitatea);
- evoluția unei idei de la $\langle A \rangle$ la $\langle \text{Non-}A \rangle$ și apoi la $\langle \text{Anti-}A \rangle$;
- detectarea unor tipare acolo unde nu pare să existe;
- găsirea unor caracteristici comune atributelor “+”, “-” și “0”;
- cum emerge o idee din puncte diferite de vedere sau din toate punctele de vedere;
- identificarea punctului de fugă al tuturor ideilor filosofice.

*

Neutrosafia poate fi văzută și ca:

- nouă abordare a filosofiei;
- filosofie a filosofiilor;
- nonfilosofie;
- superfilosofie;
- neofilosofie;
- Dumnezeu și Diavolul filosofiei;
- metafilosofie;
- macrofilosofie;
- Noua Ordine Mondială în filosofie;
- paradoxul filosofiei și filosofia paradoxului;
- gândul gândului;
- perfecțiunea și imperfecțiunea filosofiei;
- paradox în/din paradox;
- enigma lumii;
- esența naturii;
- filosofie algebrică, fizică și chimică.

*

Orice substanță are în cele din urmă un atribut neutrosific.
 Intuiția paradoxistă înseamnă un nivel ridicat de conștientizare.
 Neutrosafia este consecventă cu inconsecvența sa.

*

Transcendentalismul (Emerson în special, dar și Kant, Hegel, Fichte), care își propune să descopere natura realității prin investigarea procesului gândirii, este combinat cu pragmatismul (Williams James), care mai întâi încearcă să interpreteze fiecare noțiune sau teorie urmărindu-i consecințele practice.

Cunoașterea realității prin gândire și a gândirii prin realitate.

*

În India secolelor VIII-IX s-a propagat ideea de Non-Dualitate (*Advaita*) prin nediferențierea dintre Ființa Individuală (*Atman*) și Ființa Supremă (*Brahman*). Filosoful Sankaracharya (782-814) a fost considerat atunci salvatorul hinduismului, tocmai în momentul în care budismul și jainismul se aflau într-o frământare puternică, iar India era într-o criză spirituală.

Non-dualitatea înseamnă eliminarea ego-ului, pentru a te îmbina cu Ființa Supremă (pentru a ajunge la fericire).

Ridicarea la Suprem s-a realizat prin Rugăciune (*Bhakti*) sau Cunoaștere (*Jnana*). Originalitatea interpretării și sintetizării *Sursei cunoașterii* (*Vede*, secolul al IV-lea î.Hr.), a *Epozeilor* (cu multe povești) și a *Upanishad*-urilor (principiile filosofiei hinduse) este o parte din meritul imens al lui Sankaracharya (*charya* înseamnă profesor), concluzionând în Non-Dualitate.

Urmează apoi Dualitatea Specială (*Visishta Advaita*), care afirmă că Ființa Individuală și Ființa Supremă sunt diferite la început, dar ajung să se îmbine (Ramanujacharya, secolul al XI-lea).

Și, mai târziu, pentru a vedea că schema neutrosifică funcționează perfect, rezultă Dualitatea (*Dvaita*), prin care s-a diferențiat Ființa Individuală de Ființa Supremă (Madhvacharya, secolele XIII - XIV).

Astfel: Non-Dualitatea s-a îndreptat către Dualitate.

<Non-A> converge spre <A>.

*

Cunoaște-te pe tine însuși pentru a-i cunoaște pe ceilalți. Studiază-i pe ceilalți pentru a te înțelege pe tine însuși.

*

În consecință, vreau să fiu ceea ce nu vreau să fiu: un Filosof.

De aceea nu sunt.

(Ori de aceea, poate, sunt?)

*

Controlează ce poți, lasă restul în seama norocului.

Controlează ceea ce nu poți, lipsește-te de ceea ce controlezi.

*

Am încercat să de-formalizăm formalizarea geometriei lui Hilbert: prin construirea unui anti-model, care nu respectă niciuna dintre cele 20 de axiome ale sale! (F. Smarandache, <Matematica paradoxistă>)

Pentru că, prin axiomatizare, o teorie își pierde transcendentalul, mitul, frumusețea și devine prea aritmetică, tehnică, mecanică.

Or, dacă un sistem de axiome este definit într-o teorie, acesta ar trebui să fie de cardinalitate infinită (și, chiar mai bine, de aleph-cardinalitate).

*

Logicism: Axiomele lui Frege pentru teoria mulțimilor, pentru a deriva întreaga aritmetică, erau inconsistente (vezi Paradoxul lui Bertrand Russell).

*

Sisteme inconsistente de axiome: Fie $(a_1), (a_2), \dots, (a_n), (b)$ și $n+1$ axiome independente, cu $n \geq 1$; fie (b') o altă axiomă contradictorie lui (b) . Construim un sistem de axiome $n+2$:

[I] $(a_1), (a_2), \dots, (a_n), (b), (b')$, care este inconsistent.

Dar acest sistem poate fi împărțit în două sisteme consistente de axiome independente:

[C] $(a_1), (a_2), \dots, (a_n), (b)$,

și

[C'] $(a_1), (a_2), \dots, (a_n), (b')$.

Luăm în considerare și sistemul parțial de axiome independente [P]: (a₁),
(a₂), ..., (a_n).

Dezvoltând [P], găsim multe propoziții (teoreme, leme etc.)

$(p_1), (p_2), \dots, (p_m)$, prin combinații logice ale axiomelor sale.

Dezvoltând [C], găsim toate propozițiile lui [P]

$(p_1), (p_2), \dots, (p_m)$,

rezultate prin combinații logice de $(a_1), (a_2), \dots, (a_n)$, în plus alte propoziții

$(r_1), (r_2), \dots, (r_r)$,

rezultat prin combinații logice ale lui (b) cu oricare dintre

$(a_1), (a_2), \dots, (a_n)$.

Similar pentru [C'], găsim propozițiile lui [P]

$(p_1), (p_2), \dots, (p_m)$,

în plus alte propoziții

$(r_1'), (r_2'), \dots, (r_r')$,

rezultat prin combinații logice ale lui (b') cu oricare dintre

$(a_1), (a_2), \dots, (a_n)$,

cu (r_1') fiind o axiom contradictorie cu (r_1) , și așa mai departe.

Acum, dezvoltând [I], vom găsi toate propozițiile rezultate anterioare:

$(p_1), (p_2), \dots, (p_m),$

$(r_1), (r_2), \dots, (r_t),$

$(r_1'), (r_2'), \dots, (r_t').$

Prin urmare, [I] este echivalent cu [C] reunit cu [C'].

Dintr-o pereche de propoziții la început contradictorii $\{(b), (b')\}$, [I] adaugă mai multe astfel de perechi t , unde $t \geq 1$,

$\{(r_1), (r_1')\}, \dots, \{(r_t), (r_t')\}$, după un pas complet.

Cu cât mergem mai departe, cu atât mai multe perechi de propoziții contradictorii se acumulează în [I].

*

Știați că... Uneori e bine să greșești?

De ce oamenii evită să se gândească la o teorie contradictorie?

După cum știm, natura nu este perfectă: fenomene opuse apar împreună, iar ideile opuse sunt concomitent afirmate și, în mod ironic, dovedit că ambele sunt adevărate! Cum este posibil? ...

O afirmație poate fi adevărată într-un sistem referențial, dar falsă în altul. Adevărul este subiectiv. Dovada este relativă.

(În filosofie există o teorie, denumită relativitatea cunoașterii: "cunoașterea este legată de minte, căci lucrurile pot fi cunoscute numai prin efectele lor asupra minții și, în consecință, nu poate exista cunoaștere a realității așa cum este ea în sine", <Webster's New World Dictionary of American English>.)

Așadar... Uneori e bine să greșești!

Cum se reduce la absurd metoda *reductio ad absurdum*?

Ipoteza continuum-ului (cardinalitatea *continuum-ului* este cel mai mic cardinal nenumărabil) s-a dovedit a fi indecidabilă, prin aceea că atât ea, cât și negația sa sunt în concordanță cu axiomele standard ale teoriei mulțimilor.

Spre deosebire de relativism, care afirmă că nu există cunoaștere absolută, în neutrosofie este posibil să se obțină în știința pură și prin convenție adevărul absolut, $t = 100$, și totuși ca un fapt rar.

Spirit și materie în neutrosofie

Florentin Smarandache

Spiritul este o emanație a materiei, spuneau materialişti.

Materia este o emanație a spiritului, spuneau idealişti.

Adevărul este undeva la mijloc. Este neutru.

Este spiritul material, iar materia spirituală?

Ambele, spiritul și materia, au caracteristici ambi-(chiar pluri-)valente.

*

Efortul omului spre imposibil, infinit, absolut trece prin posibil, finit, relativ.

*

Se explică <A> prin <Non-A>. Ceea ce înseamnă: <A> este ceea ce nu este.

*

Principiul goethe-ian al bipolarității: *idol* și *diavol*, puteri interioare ale ființei umane aflate într-o permanentă dispută. *Mefistofel* și *Faust*.

Pledăm pentru existența unei pluripolarități a diferitelor combinații de idol și diavol în sufletul și mintea noastră.

*

Concepte filosofice pure nu se găsesc. Aceasta este o dialectică a metafizicii și, în mod similar, o metafizică a dialecticii.

*

Există o necesitate de a se întâmpla și o întâmplare a necesității? Adică: un determinism al in-determinismului și un in-determinism al determinismului.

Există un termen intern al esenței lucrurilor care implică apariția unui termen extern pentru ele?

[Necesitate = termen intern; întâmplare = termen extern.]

*

O discontinuitate continuă și o continuitate discontinuă în procesul de evoluție.

Totuși, setul de puncte izolate este de măsură nulă.

*

Nimic nu ne aparține pe lumea asta. Doar ideile noastre originale (dacă există!), transmise posterității, pot avea amprentele minții noastre:

- idei spirituale (cum ar fi teorii, teoreme, formule, concepte);
- idei materiale (încorporate în artă, sculpturi, arhitecturi, mașini, unelte).

Creativitatea și inventivitatea ne aparțin.

*

Este normal când un filosof afirmă ceva ca un altul să îl combată (pentru a se distanța, pentru a fi diferit, pentru a fi vizibil), altfel al doilea ar fi un simplu imitator, un epigon.

Și nu numai în filosofie. Prin urmare, iată cum au fost propuse două idei/concepte/sisteme opuse! Cât de ușor este să dezvoltăm paradoxul!

Astfel, este normal să fii anormal! (Eugène Ionesco)

*

Moartea filosofiei neutrosofice ar însemna moartea întregii filosofii și a omenirii. (Filosofia filosofiei o va arăta.) Cum ar fi ca toți oamenii să gândească în cor, la unison, în întreaga lume? Nu ar fi un totalitarism?

*

Geniul filosofiei arată că totalitarismul poate să nu fie absolut, perfect, finit.

Există două tipuri de totalitarism:

A. necondiționat — din propria voință; de exemplu, oamenii din lumea a treia care imită/urmează ideologia, politica, cultura, comportamentul occidentale.

b. condiționată — de forțe militare, ideologice, economice impuse (în dictaturi, de exemplu vezi Arthur Koesler, <Le zéro et l'infini>).

Întotdeauna în lume va fi un totalitarism într-o anumită măsură.

*

Individul merge cu mulțimea, fără măcar să-și dea seama (totalitarismul societal împotriva individului) — ca o oaie cu capul aplecat în turmă.

*

De asemenea, există o opresiune ideatică a clasicilor care plutesc în aer și revolta permanentă a contemporanului.

*

Există totalitarism și la niveluri transversale: lingvistic (dominanță, așa-zisele limbi “internaționale”), politic (solidaritate cu cei mai puternici), economic, ideologic, cultural, chiar științific.

*

Gabriel Marcel a scris “Les hommes contre l'humain”, vorbind despre spălarea creierului (în franceză: *le lavage du cerveau*) și despre *tabula rasa*.

Mass-media face parțial acest lucru.

*

Boala socială, creată de manipularea politică a mass-media: dați cetățenilor impresia/iluzia că sunt liberi și vor simți că sunt — chiar dacă nu sunt.

Dați-le cetățenilor impresia că trăiesc într-o societate democratică, ei ar crede asta — chiar dacă nu e fals.

*

O societate liberă absolută nu poate să existe. Țările diferă prin gradul lor de nedemocrație.

*

Rămâi cu lumea ta reală — care există, dar eu rămân cu lumea mea ideală — care nu există. Căci în aceasta exist mai bine.

*

La început a fost sfârșitul. Un țărâm trece. Un țărâm vine. Și, la sfârșit, începe începutul.

*

Să prezentăm fenomenele reale așa cum nu sunt.

*

Nereprezentabilul reprezintă ceva.

*

Să definim umanul printr-o non-definire.

*

Ființa rațională este plină de elemente iraționale.

*

Omul este un animal filosofic (dar degradat, spunea Rousseau). (Să notăm degradarea.)

*

Dante era florentin (dar nu Smarandache)!

*

Sunt un model de artist nemodelat. Un anti-Goethe și non-Faust. Un păcătos sacerdotal, un sfânt rău.

*

Eroii ascund secrete lașe. Poltronii au fațete eroice.

*

Filosofia este un cimitir viu de idei moarte.

*

Sufletul este un fel de anti-corp/anti-organism/non-corp care se izocronizează cu corpul printr-o unitate de contrarii și neutralități. Sufletul este o parte a corpului, trupul este o formă a sufletului. Sufletul este Eu și non-Eu.

*

Dumnezeu este nemuritor.

Dar “Dumnezeu a murit”, a spus Nietzsche.

De aceea cred în Dumnezeu.

*

Perfecțiunea este imperfectă.

Aceasta este o noțiune numai teoretică, nu este atinsă în practică.

*

“Paradoxul este limita până unde poate merge mintea noastră, după care se arată neantul” (Țuțea).

*

Viața este o sursă de bucurie și furie (completează Nietzsche, poetul). Viața este utilă morții. Viața este inutilă. Moartea este și ea inutilă. Atunci ce?

*

De studiat slăbiciunea supraomului nietzschian, voința lui de neputincios.

*

Fericirea este sediul nefericirii viitoare.

Păcatul este sediul onestității ulterioare.

Ordinea este sediul dezordinei.

*

Pasiunea luptă împotriva pasiunii.

*

Gust și dezgust... sa tai nodul gordian.

*

Filosofia a început când nici măcar nu a început și se va sfârși când nu se va termina.

O treabă care s-a făcut când nu s-a făcut și nu s-a făcut când s-a făcut cu adevărat.

*

Unde merge un drum care nu merge nicăieri?

(Paul Claudel: “Unde merge un drum care nu duce la biserică?”)

*

Paradoxul este o metodă terapeutică în știință. Nu mai vorbim de arte și poezie, care îl vânează (vezi, de exemplu, Mișcarea literară paradoxistă înființată în anii 1980).

Cu toate acestea, știința uită de asta!

*

James F. Peterman a considerat întreaga filosofie ca pe o terapie.

*

“Unde sunt cei care nu mai sunt?” (Nichifor Crainic). Ce eram când nu eram? Ce am fost înainte de a fi?

*

Viața mea personală a devenit publică (prin tipărirea jurnalului), viața mea privată nu mai este privată.

*

“Operele poezilor pot sta una lângă alta, ale filosofilor — nu” (Schopenhauer).

*

Absurdul este natural, deci și nenaturalul este natural.

[Vezi lipsa de sens a sensului.]

*

Scriu filosofie ca să o denunț sau să dovedesc boala filosofiei (?).

*

Cum vor arăta universul și omenirea după un milion de ani?

(Aceasta nu este o întrebare *science-fiction*/fantastică, ci o problemă strict științifică.) În ce direcție vor converge?

*

Scopul meu este infirmitatea scopului!

*

Scopul interior nu este un scop. Nici scopul exterior nu este un scop.

*

Orice crez oferă un anti-crez.

<A nu avea niciun crez> este, de asemenea, un crez, nu-i așa?

*

Cum să eliberezi durerea de durere? Dar sufletul din suflet, iar trupul din trup?

*

Vreau să fiu un măsurator al adevărului, să renunț la renunțare și să mă inspir din farmecul miturilor.

*

Filosofie-poezie: o non-inspirație inspirată, o involuntaritate voluntară.

*

Trebuie să exprimăm artistic inexprimabilul. Să prindem non-artistul într-o formă artistică!

*

Rolul ateismului în dezvoltarea credinței.

*

Schleiermacher nominalizează prin *Dumnezeu* existența la care ne raportăm, mergând spre o religie fără un Dumnezeu personal.

*

Infinit interior de obiecte finite.

*

Dincolo de filosofie există o filosofie. Dincolo de arte există arte. Dincolo de religie există o religie.

*

Materia este de esență neutrosifică.

*

Sărăcia filosofică: “Trăim împreună, dar murim singuri” (Țuțea).

*

Omul este înflorirea neutrosofiei naturii.

*

Teologia și știința se contopesc în filosofie.

*

De la psihologia animală la filosofia animală.

*

Întotdeauna facem lucruri făcute de alții înainte.

*

Societatea de azi creează suboameni, nu supraoameni (*übermensch*-ul lui Nietzsche), pentru că omul este pierdut, mic, lipsit de importanță, uitat în imensul amalgam de informații, știri la fiecare secundă, forțe științifice și culturale... El nu poate înfrunța această dinamică accelerată.

*

Cele mai complicate lucruri sunt cele mai simple. Cele mai neobișnuite sunt cele comune.

Dar nu le vedem pentru că suntem superficiali și nu avem timp să gândim mai profund (prăbușiți de ziua agresivă).

*

Totul se bazează și se ridică pe/din contradicții și neutralități.

*

Lumea este unitară în variațiile și diferențierile sale (Lossky, "Lumea ca întreg organic").

*

Ca și în epopoea Ramayana, neutrosafia adoptă o atitudine sceptică respingând și contrazicând în același timp celebrele teze filosofice. Cu alte cuvinte: un LOKAYATA între contemporani, sau un CARVAKA.

Și nu dezacord în numele dezacordului, ci pentru generalizare. Nu a spus Voltaire: "Legile în artă sunt făcute pentru a fi încălcate"?

*

Când ființa umană va înțelege ceea ce nu este de înțeles?

*

Cine l-a făcut pe Dumnezeu? Nu El, într-adevăr, comite greșeli? Nu are El propriul Său Dumnezeu care să-L considere responsabil pentru creația Sa? Sau este un dictator?!

*

"Leagă două păsări împreună. Nu vor putea zbura, deși acum au patru aripi." (Jalaludin Rumi)
[<Calea sufi>, de Idries Shah]

*

Întotdeauna ceea ce nu ai este formidabil, în timp ce ceea ce ai te plictisește.

*

X scrie pe o bucată de hârtie și o pune într-un plic adresat lui Y: "azi nu-ți mai scriu nicio scrisoare".
Este asta o antiteză?

*

Din păcate, puzzle-urile de cuvinte sunt substitute ale filosofiei, mai ales în filosofia limbajului.
Un astfel de gânditor ar trebui să fie numit teoretician al cuvintelor sau terorist (al cuvintelor)?
Și, totuși, îl iubesc pe Frege.

*

Conținutul nu este o formă a formei, dar tinde să devină o formă. Și invers.

*

Spiritul nu ar putea respira fără opoziție și neutralități, s-ar ofili ca o plantă...

Transdisciplinaritate neutrosifică

Florentin Smarandache

Transdisciplinaritatea neutrosifică înseamnă a găsi trăsături comune unor entități ne-comune: de exemplu, pentru o entitate vagă, imprecisă, cu granițe neclare $\langle A \rangle$, avem $\langle A \rangle \cap \langle \text{Non-}A \rangle \neq \emptyset$, sau chiar mai mult, $\langle A \rangle \cap \langle \text{Anti-}A \rangle \neq \emptyset$.

Multi-Structuri și Multi-Spații

Structuri multi-concentrice

Fie S_1 și S_2 două structuri distincte, induse de ansamblul legilor L , care verifică ansamblurile axiomelor A_1 și respectiv A_2 , astfel încât A_1 să fie strict inclus în A_2 .

Se dă mulțimea M , dotată cu proprietățile:

- M are o structură S_1 ;
- există o submulțime propriu-zisă P (diferită de mulțimea vidă \emptyset , de elementul unitar, de elementul idempotent dacă există față de S_2 și de întreaga mulțime M) a mulțimii inițiale M , care are o structură S_2 ;
- M nu are o structură S_2 ; se numește structură 2-concentrică.

O putem generaliza la o structură n -concentrică, pentru $n \geq 2$ (chiar structură-infinit-concentrică).

(În mod implicit, structură 1-concentrică pe o mulțime M înseamnă o singură structură pe M și pe submulțimile sale adecvate.)

O **structură n -concentrică** pe o mulțime S înseamnă o structură slabă $\{w(0)\}$ pe S astfel încât să existe un lanț de submulțimi proprii

$$P(n-1) < P(n-2) < \dots < P(2) < P(1) < S,$$

unde ' $<$ ' înseamnă 'inclus în',

ale căror structuri corespunzătoare verifică lanțul invers

$$\{w(n-1)\} > \{w(n-2)\} > \dots > \{w(2)\} > \{w(1)\} > \{w(0)\},$$

unde ' $>$ ' semnifică 'strict mai puternic' (i.e., structura satisface mai multe axiome).

De exemplu:

Avem un grupoid D , care conține o submulțime propriu-zisă S care este un semigrup, care la rândul său conține o submulțime propriu-zisă M care este un monoid, care conține o submulțime propriu-zisă NG care este un grup necomutativ, care conține o submulțime propriu-zisă CG care este un grup comutativ, unde D include S , care include M , care include NG , care include CG .

[Aceasta este o structură 5-concentrică.]

Multi-Spațiu

Fie S_1, S_2, \dots, S_n distincte două câte două structuri pe, respectiv, mulțimile M_1, M_2, \dots, M_k , unde $n \geq 2$ (n poate fi chiar infinit).

Structurile $S_i, i = 1, 2, \dots, n$ pot să nu fie neapărat distincte două câte două; fiecare structură S_i poate fi, de asemenea, n_i -concentrică, $n_i \geq 1$.

Și mulțimile $M_i, i = 1, 2, \dots, n$ pot să nu fie neapărat disjunctive, de asemenea, unele mulțimi M_i pot fi egale sau incluse în alte mulțimi $M_j, j = 1, 2, \dots, n$. Definim Multi-Spațiul M ca o unire a mulțimilor anterioare:

$$M = M_1 \cup M_2 \cup \dots \cup M_n,$$

deci avem n structuri (diferite) pe M . Un multi-spațiu este un spațiu cu multe structuri care se pot suprapune, sau unele structuri includ altele, sau structurile pot interacționa și se pot influența reciproc ca în viața noastră de zi cu zi.

De exemplu, putem construi un multi-spațiu geometric format prin unirea a trei subspații distincte: un spațiu euclidian, unul hiperbolic și unul eliptic.

Cazuri particulare se pot construi când toate seturile M_i au același tip de structură; putem defini Multi-Grup-uri (sau un n -grup; de exemplu, bi-grup, tri-grup etc., când toate seturile M_i sunt grupuri), Multi-Inele (sau un n -inel, de exemplu bi-inel, tri-inel etc. când toate seturile M_i sunt inele), Multi-Câmpuri (n -câmp), Multi-Latice (n -latice), Multi-Algebre (n -algebra), Multi-Module (n -modul), și așa mai departe - care pot fi generalizate la Infinit-Structură-Spațiu (când toate mulțimile au același tip de structură), etc. (F. Smarandache, "Mixed Non-Euclidean Geometries", 1969).

Să introducem câțiva termeni noi.

Psihomatematică

O disciplină care studiază procesele psihologice în conexiune cu matematica.

Modelarea matematică a proceselor psihologice

Îmbunătățirea legilor lui Weber și Fechner referitoare la senzația și stimulii

Conform teoriei neutrosifice, între o <idee> (=spirituală) și un <obiect> (=material) există infinit de multe stări. Atunci, cum putem amesteca o <idee> cu un <obiect> și să obținem ceva între ele: $s\%$ spiritual și $m\%$ material? [ca un fel de aliaj chimic].

Sau, după cum a îndemnat Boethius, un întemeietor al scolasticii, să "unească credința cu rațiunea" pentru a concilia judecata creștină cu judecata rațională.

De exemplu, <mintea> și <corp> coexistă. Gustav Theodor Fechner, cel care a inaugurat psihologia experimentală, obsedat de această problemă, a avansat teoria că fiecare obiect este atât mental, cât și fizic (psihofizica).

Legea lui Fechner, $S = k \cdot \log R$, cu S senzația, R stimulul și constanta k , care este derivată din Legea lui Weber, $\Delta R / R = k$, cu ΔR creșterea stimulului doar detectabil, ar trebui îmbunătățite, deoarece funcția $\log R$ crește la nesfârșit ca $R \rightarrow \infty$, la $S(R) = k \cdot \ln R / \ln R_M$, pentru $R \in [R_m, R_M]$ și $S(R) = 0$, pentru $R \in [0, R_m) \cup (R_M, \infty)$, unde k este o constantă pozitivă în funcție de trei parametri: ființa individuală, tipul de senzație și felul de stimul, iar R_m, R_M reprezintă magnitudinea stimulului minim și respectiv maxim perceptibil de subiect, al doilea provocând moartea senzației.

"Relația funcțională" a lui Fechner, precum și legea puterii $R = k \cdot S^n$, cu n în funcție de tipul de stimul, au fost nelimitate superior, în timp ce ființele sunt cu siguranță limitate în percepție.

$S: [0, \infty) \rightarrow \{0\} \cup [S_m, S_M]$, cu S_m, S_M senzația perceptibilă minimă și respectiv maximă.

Desigur, $R_m > 1$, $S(R_m) = S_m$, și $S(R_M) = S_M = k$.

\ln , crescând mai rapid, înlocuiește \log deoarece senzația crește mai rapid la început, iar mai târziu continuă mult mai lent.

La $R = R_M$, S atinge maximul său, dincolo de care devine din nou plat, coborând la zero. Ființele au un prag scăzut și, respectiv, înalt, un interval în care pot simți o senzație.

Graficul îmbunătățit al legii lui Fechner:

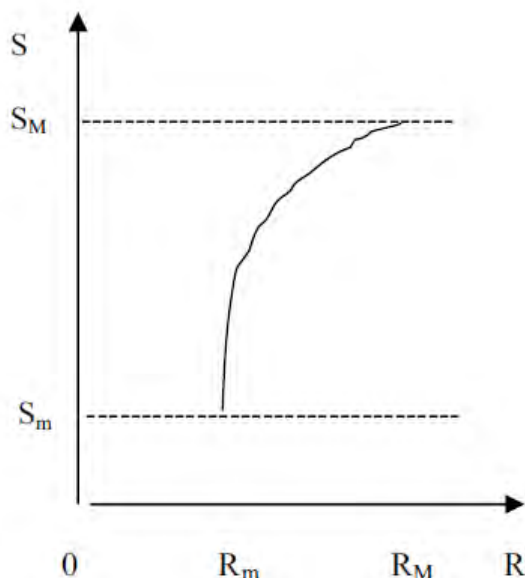

De exemplu, în acustică: un sunet nu se aude la început și, dacă continuă să-și mărească intensitatea, la un moment dat îl auzim, iar pentru o vreme zgomotul lui crește în urechile noastre, până când numărul de decibeli - din ce în ce mai mare decât posibilitatea noastră de a auzi - ne rupe timpanele. N-am mai auzi nimic.

Acum, dacă la un moment dat t_0 stimulul R rămâne constant egal cu R_0 (între limitele conștiente ale ființei, pentru o perioadă lungă de timp t), și senzația $S(R_0) = c$, atunci obținem următoarele formule :

În cazul în care stimulul nu dăunează, fizic sau fiziologic, individului:

$S_{dec}(t) = c \cdot \log \frac{1}{e} \left(t + \frac{1}{e} \right) = c \cdot \ln \left(t + \frac{1}{e} \right)$, pentru $0 \leq t \leq \exp \left(\frac{-S_m}{c} \right) - \frac{1}{e}$, iar 0 în caz contrar; care este o funcție descrescătoare.

În cazul în care stimulul face rău individului:

$S_{inc}(t) = c \cdot \ln(t + e)$, pentru $0 \leq t \leq \exp \left(\frac{S_M}{c} \right) - e$, iar 0 în caz contrar; care este o funcție crescătoare până când senzația își atinge limita superioară; unde c , constantă, depinde de ființa individuală, tipul de senzație și tipul de stimul.

Exemple:

- i) Dacă un deținut simte un miros constant în camera sa închisă zile și zile, izolat de exterior, și nu iese afară să schimbe mediul, începe să-l simtă din ce în ce mai puțin și după un moment critic el se obișnuiește cu mirosul și nu-l mai simte - astfel senzația dispare sub limita inferioară perceptibilă.
- ii) Dacă o picătură de apă se prelinge constant, la același interval de timp, cu aceeași intensitate, pe capul unui deținut legat de un stâlp, prizonierul după un timp va simți

picătura de apă din ce în ce mai grea, se va îmbolnăvi psihic și poate chiar va muri; prin urmare, din nou, senzația dispare, dar peste limita superioară. Iată cum se poate ucide cineva cu o... picătură de apă!

- iii) Dacă se cântă în permanență același cântec zile și zile unei persoane închise într-o cameră fără niciun alt zgomot din exterior, acea persoană va înnebuni, sau chiar va muri.

Legea lui Weber poate fi îmbunătățită la $\Delta R/\ln R = k$, cu R definit pe $[R_m, R_M]$, unde k este o constantă în funcție de ființa individuală, tipul de senzație și tipul de stimul, datorită faptului că pragul relativ ΔR crește mai lent în raport cu R .

Test de sinonimitate

Să propunem un *test de sinonimitate*, similar cu și o extensie a testului antonim în psihologie; ar fi un test verbal în care subiectul trebuie să furnizeze cât mai multe sinonime ale unui anumit cuvânt într-o perioadă cât mai scurtă de timp. Cum se măsoară? Spectrul sinonimelor furnizate (s), în perioada de timp măsurată (t), arată nivelul de neutrosocie lingvistică al subiectului: $\frac{s}{t}$.

O iluzie

Să presupunem că voiajezi într-o țară din lumea a treia, de exemplu România. Ajungi în capitala țării, București, noaptea târziu, și vrei să schimbi o bancnotă de 100 de dolari în moneda țării, care se numește "lei". Toate casele de schimb valutar sunt închise. Un cetățean se apropie și îți propune să te ajute să-ți schimbi banii. El este un hoț.

Îi dai bancnota de 100 de dolari, el îți dă echivalentul în moneda țării, să zicem 25.000 de lei. Dar legile țării nu permit schimbul pe stradă și amândoi știți asta.

Hoțul strigă: "poliția!" și îți dă dolarii înapoi cu o mână, în timp ce cu cealaltă mână ia înapoi leii și fuge, dispărând în spatele unei clădiri.

Hoțul te-a înșelat.

Luat prin surprindere, nu-ți dai seama ce s-a întâmplat și, uitându-te la ce ții în mână, așteptând să vezi o bancnotă de 100 de dolari, de fapt vezi o bancnotă de 1 dolar... În mintea ta, în primele secunde, apare iluzia că cei 100 de dolari s-au preschimbato, sub ochii tăi, într-o bancnotă de 1 dolar!

Psihoneutrosocie

Psihologia gândirii, acțiunii, comportamentului, senzației, percepției etc. neutre. Acesta este un domeniu hibrid care derivă din psihologie, filosofie, economie, teologie etc.

De exemplu, pentru a găsi cauzele și efectele psihologice ale indivizilor care susțin ideologii neutre (nici capitaliști, nici comuniști) sau au opțiuni politice neutre (nu în stânga, nu în dreapta) etc.

Socioneutrosocie

Sociologia neutralităților. De exemplu, fenomenele și motivele sociologice care determină o țară sau un grup de oameni sau o clasă să rămână neutră într-o dispută militară, politică, ideologică, culturală, artistică, științifică, economică etc., internă sau internațională.

Econoneutrosafia

Economia organizațiilor nonprofit, a grupurilor, cum ar fi: biserici, asociații filantropice, organizații de caritate, fundații pentru emigranți, societăți artistice sau științifice etc. Cum funcționează, cum supraviețuiesc, cine beneficiază și cine pierde, de ce sunt necesare, cum pot să îmbunătățească modul în care interacționează cu companiile comerciale.

Noi tipuri de filosofii

Filosofia obiectului

O clădire, prin arhitectura ei, o floare, o pasăre care zboară (generic, orice obiect) sunt toate idei, sau inspiră idei - care nu trebuie neapărat notate pe hârtie pentru că și-ar pierde naturalețea, și-ar denatura esența. Prin urmare, filosofia ar trebui să aibă un limbaj universal, nu să se agațe de un limbaj specific (cum se traduce, de exemplu, *dasein*-ul lui Heidegger; de ce să se încurce într-o noțiune, sintagmă sau cuvânt?!).

Filosofie concretă

Un desen, un tablou, o pânză, orice imagine bidimensională sunt toate idei și inspiră idei.

Filosofia sonoră

O melodie simfonică, muzica de jazz, un sunet, orice zgomot sunt toate idei sau inspiră idei - pentru că lucrează direct cu inconștientul nostru..

Filosofia fuzzy

Există o graniță neclară (*fuzzy*) între <A> și <Non-A> și, în consecință, există elemente care aparțin (cu o anumită probabilitate) ambelor.

Ca norii de pe cer.

Un element *e* aparține 70% lui <A> și 30% lui <Non-A>.

Sau, mai organic, *e* aparține 70% la <A>, 20% la <Neut-A> și 10% la <Anti-A>, de exemplu.

Dihotomia dintre <A> și <Non-A> poate fi înlocuită cu o tri-hotomie (<A>, <Neut-A>, <Anti-A>), și, prin generalizare, cu o pluri-hotomie, înainte de trans-hotomie [i-hotomie] (nuanțe de putere continuă între <A>, <Neut-A> și <Anti-A>).

Și, când este implicată probabilitatea, fuzzy-hotomie, sau mai mult: neutro-hotomie.

Filosofie aplicată

Cunoștințe filosofice (cum ar fi: proverbe, aforisme, maxime, fabule, povești) folosite în viața noastră de zi cu zi.

Filosofie experimentală

Verificarea filosofică și studiul ideilor stranii, bizare.

Filosofie futuristă

Idei create de mașini, roboți, computere folosind inteligența artificială; aceasta este filosofia zilei de mâine.

Non-Filosofie

Să faci filosofie nefăcând deloc filosofie!

Ca un mutism.

Totul poate însemna filosofie: un graffiti (fără cuvinte, fără litere), orice semn științific sau expresie afișată pe pagină...

O poezie este un sistem filosofic. O lege a fizicii, o formulă chimică, și o ecuație matematică.

De exemplu, o pagină goală înseamnă și o idee, și un fenomen natural. Datorita faptului ca toate te fac să reflectezi, să meditezi, să gândești.

Această non-filosofie devine, în mod paradoxal, un nou tip de filosofie!

Noi tipuri de mișcări filosofice

Revizionism

Revizuirea tuturor sistemelor, ideilor, fenomenelor, școlilor filosofice și rescrierea filosofiei ca un cumul de *summum bonum*.

Inspiraționism

Căutarea indiciilor la antecesori și inspirație la contemporani pentru a obține propriile metode de cercetare și a crea un sistem original.

Recurentism

Orice idee provine dintr-o idee anterioară și determină o altă idee, ca o succesiune recurentă infinită.

Sofisticalism

Cu cât mai ininteligibil, ambiguu, alambicat, abstract, general... cu atât mai bine!

[Acesta este stilul unora...]

Rejectivism

O voință subconștientă (și, într-o oarecare măsură, amestecându-se cu conștientul) de a respinge aprioric sistemul altcuiva și de a îl înlocui total sau parțial cu al tău.

Paradoxism

Orice idee filosofică este adevărată și falsă în același timp. Legea paradoxismului: Nimic nu este non-contradictoriu. Esența naturii este antonimică.

Modelarea logică și combinatorie în literatura experimentală

O mișcare literară de avangardă, Paradoxismul (care folosește paradoxuri matematice în creațiile artistice)

Studiul paradoxurilor ca disciplină aparte și utilizarea lor în alte domenii.

Teza de bază a paradoxismului: totul are un sens și un non-sens într-o armonie unul cu celălalt.

Esența paradoxismului: sensul are un non-sens și reciproc non-sensul are un sens.

Delimitarea de alte avangarde:

- paradoxismul are o semnificație, în timp ce dadaismul, letrismul, mișcarea absurdă nu o au;
- paradoxismul dezvăluie mai ales contradicțiile, antinomiile, antitezele, antifrazele, antagonismul, nonconformismul, cu alte cuvinte paradoxurile oricărui lucru (în literatură, artă, știință), în timp ce futurismul, cubismul, abstractismul, pe când toate celelalte avangarde nu se concentrează asupra lor.

Indicații pentru paradoxism:

- să utilizeze metode științifice (în special algoritmi) pentru generarea (și, de asemenea, studierea) lucrărilor literare și artistice contradictorii;
- să creeze lucrări literare și artistice contradictorii în spații științifice (folosind simboluri, meta-limbaj, matrice, teoreme, leme științifice).

Noi tipuri de poezie “matematică” cu formă fixă (folosind paradoxuri și tautologii)

- *Distih paradoxist* = o poezie în două versuri, astfel încât al doilea îl contrazice pe primul, dar împreună formează un sens unitar care definește (sau face legătura cu) titlul.
- *Distih tautologic* = un poem în două versuri, aparent redundant, dar împreună versurile redundante dau un sens mai profund întregului poem definind (sau făcând legătura cu) titlul.
- *Distih dualist*
- *Terțină paradoxistă*
- *Terțină tautologică*
- *Catren paradoxist*
- *Catren tautologic*
- *Poem Fractal*

Noi tipuri de povestiri

- *Nuvelă silogistică*
- *Nuvelă circulară* (F. Smarandache, “Povestea infinită”, 1997)

Noi tipuri de dramă

- *Dramă neutrosofică*
- *Dramă sofistică*
- *Dramă combinată* = o dramă ale cărei scene sunt permutate și combinate în cât mai multe moduri producând peste un miliard de miliarde de drame diferite! (F. Smarandache, “Lumea cu susul în jos”, 1993)

Definiții similare pentru alte tipuri de poezii, de nuvele și de drame.

FUZZY SETS
INTUITIONISTIC FUZZY SETS
PICTURE FUZZY SETS

New Operations over Interval Valued Intuitionistic Hesitant Fuzzy Set

Said Broumi, Florentin Smarandache

Abstract Hesitancy is the most common problem in decision making, for which hesitant fuzzy set can be considered as a useful tool allowing several possible degrees of membership of an element to a set. Recently, another suitable means were defined by Zhiming Zhang [1], called interval valued intuitionistic hesitant fuzzy sets, dealing with uncertainty and vagueness, and which is more powerful than the hesitant fuzzy sets. In this paper, four new operations are introduced on interval-valued intuitionistic hesitant fuzzy sets and several important properties are also studied.

Keywords Fuzzy Sets, Intuitionistic Fuzzy Set, Hesitant Fuzzy Sets, Interval-Valued Intuitionistic Hesitant Fuzzy Set, Interval Valued Intuitionistic Fuzzy Sets

1. Introduction

In recent decades, several types of sets, such as fuzzy sets [2], interval-valued fuzzy sets [3], intuitionistic fuzzy sets [4, 5], interval-valued intuitionistic fuzzy sets [6], type 2 fuzzy sets [7, 8], type n fuzzy sets [7], and hesitant fuzzy sets [9], neutrosophic sets, have been introduced and investigated widely. The concept of intuitionistic fuzzy sets, was introduced by Atanassov [4, 5]; it is interesting and useful in modeling several real life problems.

An intuitionistic fuzzy set (IFS for short) has three associated defining functions, namely the membership function, the non-membership function and the hesitancy function. Later, Atanassov and Gargov provided in [6] what they called interval-valued intuitionistic fuzzy sets theory (IVIFS for short), which is a generalization of both interval valued fuzzy sets and intuitionistic fuzzy sets. Their concept is characterized by a membership function and a non-membership function whose values are intervals rather than real number. IVIFS is more powerful in dealing with vagueness and uncertainty than IFS.

Recently, Torra and Narukawa [9] and Torra [10] proposed the concept of hesitant fuzzy sets, a new

generalization of fuzzy sets, which allows the membership of an element of a set to be represented by several possible values. They also discussed relationships among hesitant fuzzy sets and other generalizations of fuzzy sets such as intuitionistic fuzzy sets, type-2 fuzzy sets, and fuzzy multisets. Some set theoretic operations such as union, intersection and complement on hesitant fuzzy sets have also been proposed by Torra [9]. Hesitant fuzzy sets can be used as an efficient mathematical tool for modeling people's hesitancy in daily life than the other classical extensions of fuzzy sets. We'll further study the interval valued intuitionistic hesitant fuzzy sets. Xia and Xu [11] made an intensive study of hesitant fuzzy information aggregation techniques and their applications in decision making. They also defined some new operations on hesitant fuzzy sets based on the interconnection between hesitant fuzzy sets and the interval valued intuitionistic fuzzy sets. To aggregate the hesitant fuzzy information under confidence levels, Xia et al. [12] developed a series of confidence induced hesitant fuzzy aggregations operators. Further, Xia and Xu [13, 14] gave a detailed study on distance, similarity and correlation measures for hesitant fuzzy sets and hesitant fuzzy elements respectively. Xu et al. [15] developed several series of aggregation operators for interval valued intuitionistic hesitant fuzzy information such as: the interval valued intuitionistic fuzzy weighted arithmetic aggregation (IIFWA), the interval valued intuitionistic fuzzy ordered weighted aggregation (IIFOWA) and the interval valued intuitionistic fuzzy hybrid aggregation (IIFHA) operator. Wei and Wang [16], Xu et al. [17] introduced the interval valued intuitionistic fuzzy weighted geometric (IIFWG) operator, the interval valued intuitionistic fuzzy ordered weighted geometric (IIFOWG) operator and the interval valued intuitionistic fuzzy hybrid geometric (IIFHG) operator. Recently, Zhiming Zhang [1] have proposed the concept of interval valued intuitionistic hesitant fuzzy set , study their some basic properties and developed several series of aggregation operators for interval valued intuitionistic hesitant fuzzy environment and have applied them to solve multi-attribute group decision making

problems.

In this paper, our aim is to propose four new operations on interval valued intuitionistic hesitant fuzzy sets and study their properties.

Therefore, the rest of the paper is set out as follows. In Section 2, some basic definitions related to intuitionistic fuzzy sets, hesitant fuzzy sets and interval valued intuitionistic hesitant fuzzy set are briefly discussed. In Section 3, four new operations on interval valued intuitionistic hesitant fuzzy sets have been proposed and some properties of these operations are proved. In section 4, we conclude the paper.

2. Preliminaries

In this section, we give below some definitions related to intuitionistic fuzzy sets, interval valued intuitionistic fuzzy sets, hesitant fuzzy set and interval valued hesitant fuzzy sets.

Definition 2.1. [4, 5] (Set operations on IFS)

Let IFS(X) denote the family of all intuitionistic fuzzy sets defined on the universe X, and let $\alpha, \beta \in IFS(X)$ be given as

$$\alpha = (\mu_\alpha, \nu_\alpha), \quad \beta = (\mu_\beta, \nu_\beta).$$

Then nine set operations are defined as follows:

- (i) $\alpha^c = (\nu_\alpha, \mu_\alpha)$;
- (ii) $\alpha \cup \beta = (\max(\mu_\alpha, \mu_\beta), \min(\nu_\alpha, \nu_\beta))$;
- (iii) $\alpha \cap \beta = (\min(\mu_\alpha, \mu_\beta), \max(\nu_\alpha, \nu_\beta))$;
- (iv) $\alpha \oplus \beta = (\mu_\alpha + \mu_\beta - \mu_\alpha \mu_\beta, \nu_\alpha \nu_\beta)$;
- (v) $\alpha \otimes \beta = (\mu_\alpha \mu_\beta, \nu_\alpha + \nu_\beta - \nu_\alpha \nu_\beta)$;
- (vi) $\alpha @ \beta = (\frac{\mu_\alpha + \mu_\beta}{2}, \frac{\nu_\alpha + \nu_\beta}{2})$;
- (vii) $\alpha \$ \beta = (\sqrt{\mu_\alpha \mu_\beta}, \sqrt{\nu_\alpha \nu_\beta})$;
- (viii) $\alpha \# \beta = (\frac{2\mu_\alpha \mu_\beta}{\mu_\alpha + \mu_\beta}, \frac{2\nu_\alpha \nu_\beta}{\nu_\alpha + \nu_\beta})$;
- (ix) $\alpha * \beta = (\frac{\mu_\alpha + \mu_\beta}{2(\mu_\alpha \mu_\beta + 1)}, \frac{\nu_\alpha + \nu_\beta}{2(\nu_\alpha \nu_\beta + 1)})$;

In the following, we introduce some basic concepts related to IVIFS.

Definition 2.2. [6] (Interval valued intuitionistic fuzzy sets)

An Interval valued intuitionistic fuzzy sets (IVIFS) α in the finite universe X is expressed by the form

$\alpha = \{ \langle x, \mu_\alpha(x), \nu_\alpha(x) \rangle \mid x \in X \}$, where $\mu_\alpha(x) = [\mu_\alpha^-(x), \mu_\alpha^+(x)] \in [I]$ is called membership interval of element to IVIFS α , while $[\nu_\alpha^-(x), \nu_\alpha^+(x)] \in [I]$ is the non-membership interval of that element to the set α , with the condition $0 \leq \mu_\alpha^+(x) + \nu_\alpha^+(x) \leq 1$ must hold for any $x \in X$.

For convenience, the lower and upper bounds of $\mu_\alpha(x)$ and $\nu_\alpha(x)$ are denoted by $\mu_\alpha^-, \mu_\alpha^+, \nu_\alpha^-, \nu_\alpha^+$, respectively. Thus, the IVIFS α may be concisely expressed as

$$\alpha = (\mu_\alpha, \nu_\alpha) = \{ \langle x, [\mu_\alpha^-, \mu_\alpha^+], [\nu_\alpha^-, \nu_\alpha^+] \rangle \mid x \in X \} \quad (1)$$

Where $0 \leq \mu_\alpha^+ + \nu_\alpha^+ \leq 1$

Definition 2.3 [9, 11]

Let X be a fixed set. A hesitant fuzzy set (HFS) on X is in terms of a function that when applied to X returns a subset of $[0, 1]$ the HFS is expressed by a mathematical symbol

$$E = \{ \langle x, h_E(x) \rangle \mid x \in X \} \quad (2)$$

where $h_E(x)$ is a set of some values in $[0, 1]$, denoting the possible membership degree of the element $x \in X$ to the set E. For convenience, Xia and Xu [11] called $h = h_E(x)$ a hesitant fuzzy element (HFE) and H be the set of all HFEs.

Given three HFEs represented by $h, h_1, \text{and } h_2$, Torra [9] defined some operations on them, which can be described as:

- 1) $h^c = \{ 1 - \gamma \mid \gamma \in h \}$
- 2) $h_1 \cup h_2 = \{ \max(\gamma_1, \gamma_2) \mid \gamma_1 \in h_1, \gamma_2 \in h_2 \}$
- 3) $h_1 \cap h_2 = \{ \min(\gamma_1, \gamma_2) \mid \gamma_1 \in h_1, \gamma_2 \in h_2 \}$

Furthermore, in order to aggregate hesitant fuzzy information, Xia and Xu [11] defined some new operations on the HFEs $h, h_1, \text{and } h_2$:

- 1) $h_1 \oplus h_2 = \{ \gamma_1 + \gamma_2 - \gamma_1 \gamma_2 \mid \gamma_1 \in h_1, \gamma_2 \in h_2 \}$
- 2) $h_1 \otimes h_2 = \{ \gamma_1 \gamma_2 \mid \gamma_1 \in h_1, \gamma_2 \in h_2 \}$
- 3) $h^\lambda = \{ \gamma^\lambda \mid \gamma \in h \}$
- 4) $\lambda h = \{ 1 - (1 - \gamma)^\lambda \mid \gamma \in h \}$

Definition 2.4 [1] (Interval valued intuitionistic hesitant fuzzy sets)

Let X be a fixed set, an interval-valued intuitionistic hesitant fuzzy set (IVIHFS) on X is given in terms of a function that when applied to X returns a subset of Ω . The IVIHFS is expressed by a mathematical symbol

$$\tilde{E} = \{ \langle x, h_{\tilde{E}}(x) \rangle \mid x \in X \} \quad (3)$$

where $h_{\tilde{E}}(x)$ is a set of some IVIFNs in X, denoting the possible membership degree intervals and non-membership degree intervals of the element $x \in X$ to the set \tilde{E} .

For convenience, an interval-valued intuitionistic hesitant fuzzy element (IVIHFE) is denoted by $\tilde{h} = h_{\tilde{E}}(x)$ and \tilde{h} be the set of all IVIHFEs. If $\alpha \in \tilde{h}$, then an IVIFN can be denoted by $\alpha = (\mu_\alpha, \nu_\alpha) = ([\mu_\alpha^-, \mu_\alpha^+], [\nu_\alpha^-, \nu_\alpha^+])$.

For any $\alpha \in \tilde{h}$, if α is a real number in $[0, 1]$, then \tilde{h} reduces to a hesitant fuzzy element (HFE) [9]; if α is a closed subinterval of the unit interval, then \tilde{h} reduces to an interval-valued hesitant fuzzy element (IVHFE)[1]; if α is an intuitionistic fuzzy number (IFN), then \tilde{h} reduces to an intuitionistic hesitant fuzzy element (IHFE). Therefore, HFEs, IVHFEs, and IHFEs are special cases of IVIHFEs.

Definition 2.5. [1, 9]

Given three IVIHFEs represented by $\tilde{h}, \tilde{h}_1, \text{and } \tilde{h}_2$, one defines some operations on them, which can be described as:

$$\tilde{h}^c = \{ \alpha^c \mid \alpha \in \tilde{h} \} = \{ ([\nu_\alpha^-, \nu_\alpha^+], [\mu_\alpha^-, \mu_\alpha^+]) \mid \alpha \in \tilde{h} \},$$

$$\tilde{h}_1 \cup \tilde{h}_2 = \{ \max(\alpha_1, \alpha_2) \mid \alpha_1 \in \tilde{h}_1, \alpha_2 \in \tilde{h}_2 \}$$

$$\begin{aligned}
 &= \{([\max(\mu_{\alpha_1}^-, \mu_{\alpha_2}^-), \max(\mu_{\alpha_1}^+, \mu_{\alpha_2}^+)], [\min(v_{\alpha_1}^-, v_{\alpha_2}^-), \min(v_{\alpha_1}^+, v_{\alpha_2}^+)]) \mid \alpha_1 \in \tilde{h}_1, \alpha_2 \in \tilde{h}_2\}, \\
 \tilde{h}_1 \cap \tilde{h}_2 &= \{\min(\alpha_1, \alpha_2) \mid \alpha_1 \in \tilde{h}_1, \alpha_2 \in \tilde{h}_2\} \\
 &= \{([\min(\mu_{\alpha_1}^-, \mu_{\alpha_2}^-), \min(\mu_{\alpha_1}^+, \mu_{\alpha_2}^+)], [\max(v_{\alpha_1}^-, v_{\alpha_2}^-), \max(v_{\alpha_1}^+, v_{\alpha_2}^+)]) \mid \alpha \in \tilde{h}_1, \alpha_2 \in \tilde{h}_2\}, \\
 \tilde{h}_1 \oplus \tilde{h}_2 &= \left\{ \left([\mu_{\alpha_1}^- + \mu_{\alpha_2}^- - \mu_{\alpha_1}^- \mu_{\alpha_2}^-, \mu_{\alpha_1}^+ + \mu_{\alpha_2}^+ - \mu_{\alpha_1}^+ \mu_{\alpha_2}^+], [\nu_{\alpha_1}^- \nu_{\alpha_2}^-, \nu_{\alpha_1}^+ \nu_{\alpha_2}^+] \mid \alpha_1 \in \tilde{h}_1, \alpha_2 \in \tilde{h}_2 \right) \right\} \\
 \tilde{h}_1 \otimes \tilde{h}_2 &= \{([\mu_{\alpha_1}^- \mu_{\alpha_2}^-, \mu_{\alpha_1}^+ \mu_{\alpha_2}^+], [\nu_{\alpha_1}^- + \nu_{\alpha_2}^-, \nu_{\alpha_1}^+ + \nu_{\alpha_2}^+ - \nu_{\alpha_1}^+ \nu_{\alpha_2}^+]) \mid \alpha_1 \in \tilde{h}_1, \alpha_2 \in \tilde{h}_2\} \\
 \lambda \tilde{h} &= \left\{ \left(\left[1 - (1 - \mu_{\alpha}^-)^\lambda, 1 - (1 - \mu_{\alpha}^+)^\lambda \right], \left[(\nu_{\alpha}^-)^\lambda, (\nu_{\alpha}^+)^\lambda \right] \mid \alpha \in \tilde{h} \right) \right\}
 \end{aligned}$$

3. Four New Operations on IVIHFEs

Definition 3.1

Let \tilde{h}_1 and $\tilde{h}_2 \in$ IVIHFE (X), we propose the following operations on IVIHFEs as follows:

- 1) $\tilde{h}_1 @ \tilde{h}_2 = \{([\frac{\mu_{\alpha_1}^- + \mu_{\alpha_2}^-}{2}, \frac{\mu_{\alpha_1}^+ + \mu_{\alpha_2}^+}{2}], [\frac{\nu_{\alpha_1}^- + \nu_{\alpha_2}^-}{2}, \frac{\nu_{\alpha_1}^+ + \nu_{\alpha_2}^+}{2}]) \mid \alpha_1 \in \tilde{h}_1, \alpha_2 \in \tilde{h}_2\}$
- 2) $\tilde{h}_1 \$ \tilde{h}_2 = \{([\sqrt{\mu_{\alpha_1}^- \mu_{\alpha_2}^-}, \sqrt{\mu_{\alpha_1}^+ \mu_{\alpha_2}^+}], [\sqrt{\nu_{\alpha_1}^- \nu_{\alpha_2}^-}, \sqrt{\nu_{\alpha_1}^+ \nu_{\alpha_2}^+}]) \mid \alpha_1 \in \tilde{h}_1, \alpha_2 \in \tilde{h}_2\}$
- 3) $\tilde{h}_1 \# \tilde{h}_2 = \{([\frac{2\mu_{\alpha_1}^- \mu_{\alpha_2}^-}{\mu_{\alpha_1}^- + \mu_{\alpha_2}^-}, \frac{2\mu_{\alpha_1}^+ \mu_{\alpha_2}^+}{\mu_{\alpha_1}^+ + \mu_{\alpha_2}^+}], [\frac{2\nu_{\alpha_1}^- \nu_{\alpha_2}^-}{\nu_{\alpha_1}^- + \nu_{\alpha_2}^-}, \frac{2\nu_{\alpha_1}^+ \nu_{\alpha_2}^+}{\nu_{\alpha_1}^+ + \nu_{\alpha_2}^+}]) \mid \alpha_1 \in \tilde{h}_1, \alpha_2 \in \tilde{h}_2\}$
- 4) $\tilde{h}_1 * \tilde{h}_2 = \{([\frac{\mu_{\alpha_1}^- + \mu_{\alpha_2}^-}{2(\mu_{\alpha_1}^- \mu_{\alpha_2}^- + 1)}, \frac{\mu_{\alpha_1}^+ + \mu_{\alpha_2}^+}{2(\mu_{\alpha_1}^+ \mu_{\alpha_2}^+ + 1)}], [\frac{\nu_{\alpha_1}^- + \nu_{\alpha_2}^-}{2(\nu_{\alpha_1}^- \nu_{\alpha_2}^- + 1)}, \frac{\nu_{\alpha_1}^+ + \nu_{\alpha_2}^+}{2(\nu_{\alpha_1}^+ \nu_{\alpha_2}^+ + 1)}]) \mid \alpha_1 \in \tilde{h}_1, \alpha_2 \in \tilde{h}_2\}$

Obviously, for every two IVIHFEs \tilde{h}_1 and \tilde{h}_2 , ($\tilde{h}_1 @ \tilde{h}_2$), ($\tilde{h}_1 \$ \tilde{h}_2$), ($\tilde{h}_1 \# \tilde{h}_2$) and ($\tilde{h}_1 * \tilde{h}_2$) are also IVIHFEs.

Example 3.2

Let $\tilde{h}_1(x) = \{([0.2, 0.3], [0.5, 0.6]), ([0.5, 0.8], [0.1, 0.2])\}$ and $\tilde{h}_2(x) = \{([0.4, 0.6], [0.3, 0.4]), ([0.3, 0.5], [0.1, 0.2])\}$ be two interval valued intuitionistic hesitant fuzzy elements. Then we have

$$\begin{aligned}
 (\tilde{h}_1 @ \tilde{h}_2) &= \{([0.3, 0.45], [0.4, 0.5]), ([0.4, 0.65], [0.1, 0.2])\} \\
 (\tilde{h}_1 \$ \tilde{h}_2) &= \{([0.28, 0.42], [0.38, 0.48]), ([0.38, 0.63], [0.1, 0.2])\} \\
 (\tilde{h}_1 \# \tilde{h}_2) &= \{([0.26, 0.4], [0.37, 0.48]), ([0.37, 0.61], [0.1, 0.2])\} \\
 (\tilde{h}_1 * \tilde{h}_2) &= \{([0.27, 0.38], [0.34, 0.40]), ([0.34, 0.46], [0.09, 0.19])\}
 \end{aligned}$$

With these operations, several results follow.

Theorem 3.3

For every $\tilde{h} \in$ IVIHFE(X), the following are true,

- (i) $\tilde{h} @ \tilde{h} = \tilde{h}$;
- (ii) $\tilde{h} \$ \tilde{h} = \tilde{h}$;
- (iii) $\tilde{h} \# \tilde{h} = \tilde{h}$;

Proof. we prove only (i) (ii) .

(i) Let $\tilde{h} \in$ IVIHFEs

$$\begin{aligned}
 \tilde{h} @ \tilde{h} &= \{([\frac{\mu_{\alpha}^- + \mu_{\alpha}^-}{2}, \frac{\mu_{\alpha}^+ + \mu_{\alpha}^+}{2}], [\frac{\nu_{\alpha}^- + \nu_{\alpha}^-}{2}, \frac{\nu_{\alpha}^+ + \nu_{\alpha}^+}{2}]) \mid \alpha \in \tilde{h}\} \\
 &= [\mu_{\alpha}^-, \mu_{\alpha}^+], [\nu_{\alpha}^-, \nu_{\alpha}^+]
 \end{aligned}$$

Then, $\tilde{h} @ \tilde{h} = \tilde{h}$

(ii) Let $\tilde{h} \in$ IVIHFEs

$$\begin{aligned}
 \tilde{h} \$ \tilde{h} &= \{([\sqrt{\mu_{\alpha}^- \mu_{\alpha}^-}, \sqrt{\mu_{\alpha}^+ \mu_{\alpha}^+}], [\sqrt{\nu_{\alpha}^- \nu_{\alpha}^-}, \sqrt{\nu_{\alpha}^+ \nu_{\alpha}^+}]) \mid \alpha \in \tilde{h}\} \\
 &= [\mu_{\alpha}^-, \mu_{\alpha}^+], [\nu_{\alpha}^-, \nu_{\alpha}^+]
 \end{aligned}$$

Then, $\tilde{h} \$ \tilde{h} = \tilde{h}$

Theorem 3.4

For $\tilde{h}_1, \tilde{h}_2 \in$ IVIHFEs,

- (i) $\tilde{h}_1 @ \tilde{h}_2 = \tilde{h}_2 @ \tilde{h}_1$;

- (ii) $\tilde{h}_1 \$ \tilde{h}_2 = \tilde{h}_2 \$ \tilde{h}_1$;
- (iii) $\tilde{h}_1 \# \tilde{h}_2 = \tilde{h}_2 \# \tilde{h}_1$;
- (iv) $\tilde{h}_1 * \tilde{h}_2 = \tilde{h}_2 * \tilde{h}_1$;

Proof. These also follow from definitions.

Theorem 3.5

For $\tilde{h}_1, \tilde{h}_2 \in \text{IVIHFE}(X)$,

$$(\tilde{h}_1^c @ \tilde{h}_2^c)^c = \tilde{h}_1 @ \tilde{h}_2$$

Proof. In the following, we prove (i), (ii) and (iii), results (iv), (v) and (vi) can be proved analogously.

$$\begin{aligned} (\tilde{h}_1^c @ \tilde{h}_2^c)^c &= \{ [v_{\alpha_1}^-, v_{\alpha_1}^+], [\mu_{\alpha_1}^-, \mu_{\alpha_1}^+] | \alpha_1 \in \tilde{h}_1 \} @ \{ [v_{\alpha_2}^-, v_{\alpha_2}^+], [\mu_{\alpha_2}^-, \mu_{\alpha_2}^+] | \alpha_2 \in \tilde{h}_2 \} \\ (\tilde{h}_1^c @ \tilde{h}_2^c)^c &= \left(\{ [v_{\alpha_1}^-, v_{\alpha_1}^+], [\mu_{\alpha_1}^-, \mu_{\alpha_1}^+] | \alpha_1 \in \tilde{h}_1 \} @ \{ [v_{\alpha_2}^-, v_{\alpha_2}^+], [\mu_{\alpha_2}^-, \mu_{\alpha_2}^+] | \alpha_2 \in \tilde{h}_2 \} \right)^c \\ &= \left(\left\{ \left[\frac{v_{\alpha_1}^- + v_{\alpha_2}^-}{2}, \frac{v_{\alpha_1}^+ + v_{\alpha_2}^+}{2} \right], \left[\frac{\mu_{\alpha_1}^- + \mu_{\alpha_2}^-}{2}, \frac{\mu_{\alpha_1}^+ + \mu_{\alpha_2}^+}{2} \right] | \alpha_1 \in \tilde{h}_1, \alpha_2 \in \tilde{h}_2 \right\} \right)^c \\ &= \left(\left\{ \left[\frac{\mu_{\alpha_1}^- + \mu_{\alpha_2}^-}{2}, \frac{\mu_{\alpha_1}^+ + \mu_{\alpha_2}^+}{2} \right], \left[\frac{v_{\alpha_1}^- + v_{\alpha_2}^-}{2}, \frac{v_{\alpha_1}^+ + v_{\alpha_2}^+}{2} \right] | \alpha_1 \in \tilde{h}_1, \alpha_2 \in \tilde{h}_2 \right\} \right)^c \\ &= \tilde{h}_1 @ \tilde{h}_2 \end{aligned}$$

This proves the theorem.

Note 1: One can easily verify that

1. $(\tilde{h}_1^c \$ \tilde{h}_2^c)^c \neq \tilde{h}_1 \$ \tilde{h}_2$
2. $(\tilde{h}_1^c \# \tilde{h}_2^c)^c \neq \tilde{h}_1 \# \tilde{h}_2$
3. $(\tilde{h}_1^c * \tilde{h}_2^c)^c \neq \tilde{h}_1 * \tilde{h}_2$

Theorem 3.6

For \tilde{h}_1, \tilde{h}_2 and $\tilde{h}_3 \in \text{IVIHFE}(X)$, we have the following identities:

- (i) $(\tilde{h}_1 \cup \tilde{h}_2) @ \tilde{h}_3 = (\tilde{h}_1 @ \tilde{h}_3) \cup (\tilde{h}_2 @ \tilde{h}_3)$;
- (ii) $(\tilde{h}_1 \cap \tilde{h}_2) @ \tilde{h}_3 = (\tilde{h}_1 @ \tilde{h}_3) \cap (\tilde{h}_2 @ \tilde{h}_3)$
- (iii) $(\tilde{h}_1 \cup \tilde{h}_2) \$ \tilde{h}_3 = (\tilde{h}_1 \$ \tilde{h}_3) \cup (\tilde{h}_2 \$ \tilde{h}_3)$;
- (iv) $(\tilde{h}_1 \cap \tilde{h}_2) \$ \tilde{h}_3 = (\tilde{h}_1 \$ \tilde{h}_3) \cap (\tilde{h}_2 \$ \tilde{h}_3)$;
- (v) $((\tilde{h}_1 \cup \tilde{h}_2)) \# \tilde{h}_3 = (\tilde{h}_1 \# \tilde{h}_3) \cup (\tilde{h}_2 \# \tilde{h}_3)$;
- (vi) $(\tilde{h}_1 \cap \tilde{h}_2) \# \tilde{h}_3 = (\tilde{h}_1 \# \tilde{h}_3) \cap (\tilde{h}_2 \# \tilde{h}_3)$;
- (vii) $(\tilde{h}_1 \cup \tilde{h}_2) * \tilde{h}_3 = (\tilde{h}_1 * \tilde{h}_3) \cup (\tilde{h}_2 * \tilde{h}_3)$;
- (viii) $(\tilde{h}_1 \cap \tilde{h}_2) * \tilde{h}_3 = (\tilde{h}_1 * \tilde{h}_3) \cap (\tilde{h}_2 * \tilde{h}_3)$;
- (ix) $(\tilde{h}_1 @ \tilde{h}_2) \oplus \tilde{h}_3 = (\tilde{h}_1 \oplus \tilde{h}_3) @ (\tilde{h}_2 \oplus \tilde{h}_3)$;
- (x) $(\tilde{h}_1 @ \tilde{h}_2) \otimes \tilde{h}_3 = (\tilde{h}_1 \otimes \tilde{h}_3) @ (\tilde{h}_2 \otimes \tilde{h}_3)$

Proof. We prove (i), (iii), (v), (vii) and (ix), results (ii), (iv), (vi), (viii) and (x) can be proved analogously

Using definitions in 2.3 and 3.1, we have

$$\begin{aligned} (\tilde{h}_1 \cup \tilde{h}_2) @ \tilde{h}_3 &= \{ [\max(\mu_{\alpha_1}^-, \mu_{\alpha_2}^-), \max(\mu_{\alpha_1}^+, \mu_{\alpha_2}^+)], [\min(v_{\alpha_1}^-, v_{\alpha_2}^-), \min(v_{\alpha_1}^+, v_{\alpha_2}^+)] | \alpha_1 \in \tilde{h}_1, \alpha_2 \in \tilde{h}_2 \} @ \{ [\mu_{\alpha_3}^-, \mu_{\alpha_3}^+], [v_{\alpha_3}^-, v_{\alpha_3}^+] | \alpha_3 \in \tilde{h}_3 \} \\ &= \left\{ \left[\frac{\max(\mu_{\alpha_1}^-, \mu_{\alpha_2}^-) + \mu_{\alpha_3}^-}{2}, \frac{\max(\mu_{\alpha_1}^+, \mu_{\alpha_2}^+) + \mu_{\alpha_3}^+}{2} \right], \left[\frac{\min(v_{\alpha_1}^-, v_{\alpha_2}^-) + v_{\alpha_3}^-}{2}, \frac{\min(v_{\alpha_1}^+, v_{\alpha_2}^+) + v_{\alpha_3}^+}{2} \right] | \alpha_1 \in \tilde{h}_1, \alpha_2 \in \tilde{h}_2, \alpha_3 \in \tilde{h}_3 \right\} \\ &= \left\{ \left[\max\left(\frac{\mu_{\alpha_1}^- + \mu_{\alpha_3}^-}{2}, \frac{\mu_{\alpha_2}^- + \mu_{\alpha_3}^-}{2} \right), \max\left(\frac{\mu_{\alpha_1}^+ + \mu_{\alpha_3}^+}{2}, \frac{\mu_{\alpha_2}^+ + \mu_{\alpha_3}^+}{2} \right) \right], \left[\min\left(\frac{v_{\alpha_1}^- + v_{\alpha_3}^-}{2}, \frac{v_{\alpha_2}^- + v_{\alpha_3}^-}{2} \right), \min\left(\frac{v_{\alpha_1}^+ + v_{\alpha_3}^+}{2}, \frac{v_{\alpha_2}^+ + v_{\alpha_3}^+}{2} \right) \right] | \alpha_1 \in \tilde{h}_1, \alpha_2 \in \tilde{h}_2, \alpha_3 \in \tilde{h}_3 \right\} \\ &= (\tilde{h}_1 @ \tilde{h}_3) \cup (\tilde{h}_2 @ \tilde{h}_3) \end{aligned}$$

This proves (i)

(iii) From definitions in 2.3 and 3.1, we have

$$(\tilde{h}_1 \cup \tilde{h}_2) \$ \tilde{h}_3 = \{ [\max(\mu_{\alpha_1}^-, \mu_{\alpha_2}^-), \max(\mu_{\alpha_1}^+, \mu_{\alpha_2}^+)], [\min(v_{\alpha_1}^-, v_{\alpha_2}^-), \min(v_{\alpha_1}^+, v_{\alpha_2}^+)] | \alpha_1 \in \tilde{h}_1, \alpha_2 \in \tilde{h}_2 \} \$ \{ [\mu_{\alpha_3}^-, \mu_{\alpha_3}^+], [v_{\alpha_3}^-, v_{\alpha_3}^+] | \alpha_3 \in \tilde{h}_3 \}$$

$$\begin{aligned}
 &= \{ [\sqrt{\max(\mu_{\alpha_1}^-, \mu_{\alpha_2}^-) \mu_{\alpha_3}^-}, \sqrt{\max(\mu_{\alpha_1}^+, \mu_{\alpha_2}^+) \mu_{\alpha_3}^+}], [\sqrt{\min(v_{\alpha_1}^-, v_{\alpha_2}^-) v_{\alpha_3}^-}, \sqrt{\min(v_{\alpha_1}^+, v_{\alpha_2}^+) v_{\alpha_3}^+}] | \alpha_1 \in \tilde{h}_1, \alpha_2 \in \tilde{h}_2, \alpha_3 \in \tilde{h}_3 \} \\
 &= \{ [\max(\sqrt{\mu_{\alpha_1}^- \mu_{\alpha_3}^-}, \sqrt{\mu_{\alpha_2}^- \mu_{\alpha_3}^-}), \max(\sqrt{\mu_{\alpha_1}^+ \mu_{\alpha_3}^+}, \sqrt{\mu_{\alpha_2}^+ \mu_{\alpha_3}^+})], [\min(\sqrt{v_{\alpha_1}^- v_{\alpha_3}^-}, \sqrt{v_{\alpha_2}^- v_{\alpha_3}^-}), \min(\sqrt{v_{\alpha_1}^+ v_{\alpha_3}^+}, \sqrt{v_{\alpha_2}^+ v_{\alpha_3}^+})] | \alpha_1 \in \tilde{h}_1, \alpha_2 \in \tilde{h}_2, \alpha_3 \in \tilde{h}_3 \} \\
 &=(\tilde{h}_1 \# \tilde{h}_3) \cup (\tilde{h}_2 \# \tilde{h}_3);
 \end{aligned}$$

This proves (iii).

(v) Using definitions 2.3 and 3.1, we have

$$\begin{aligned}
 ((\tilde{h}_1 \cup \tilde{h}_2) \# \tilde{h}_3) &= \{ [\max(\mu_{\alpha_1}^-, \mu_{\alpha_2}^-), \max(\mu_{\alpha_1}^+, \mu_{\alpha_2}^+)], [\min(v_{\alpha_1}^-, v_{\alpha_2}^-), \min(v_{\alpha_1}^+, v_{\alpha_2}^+)] | \alpha_1 \in \tilde{h}_1, \alpha_2 \in \tilde{h}_2 \} \# \{ [\mu_{\alpha_3}^-, \mu_{\alpha_3}^+], [v_{\alpha_3}^-, v_{\alpha_3}^+] | \alpha_3 \in \tilde{h}_3 \} \\
 &= \{ [\frac{2 \max(\mu_{\alpha_1}^-, \mu_{\alpha_2}^-) \mu_{\alpha_3}^-}{\max(\mu_{\alpha_1}^-, \mu_{\alpha_2}^-) + \mu_{\alpha_3}^-}, \frac{2 \max(\mu_{\alpha_1}^+, \mu_{\alpha_2}^+) \mu_{\alpha_3}^+}{\max(\mu_{\alpha_1}^+, \mu_{\alpha_2}^+) + \mu_{\alpha_3}^+}], [\frac{2 \min(v_{\alpha_1}^-, v_{\alpha_2}^-) v_{\alpha_3}^-}{\min(v_{\alpha_1}^-, v_{\alpha_2}^-) + v_{\alpha_3}^-}, \frac{2 \min(v_{\alpha_1}^+, v_{\alpha_2}^+) v_{\alpha_3}^+}{\min(v_{\alpha_1}^+, v_{\alpha_2}^+) + v_{\alpha_3}^+}] | \alpha_1 \in \tilde{h}_1, \alpha_2 \in \tilde{h}_2, \alpha_3 \in \tilde{h}_3 \} \\
 &= \{ [\max(\frac{2 \mu_{\alpha_1}^- \mu_{\alpha_3}^-}{\mu_{\alpha_1}^- + \mu_{\alpha_3}^-}, \frac{2 \mu_{\alpha_2}^- \mu_{\alpha_3}^-}{\mu_{\alpha_2}^- + \mu_{\alpha_3}^-}), \max(\frac{2 \mu_{\alpha_1}^+ \mu_{\alpha_3}^+}{\mu_{\alpha_1}^+ + \mu_{\alpha_3}^+}, \frac{2 \mu_{\alpha_2}^+ \mu_{\alpha_3}^+}{\mu_{\alpha_2}^+ + \mu_{\alpha_3}^+})], [\min(\frac{2 v_{\alpha_1}^- v_{\alpha_3}^-}{v_{\alpha_1}^- + v_{\alpha_3}^-}, \frac{2 v_{\alpha_2}^- v_{\alpha_3}^-}{v_{\alpha_2}^- + v_{\alpha_3}^-}), \min(\frac{2 v_{\alpha_1}^+ v_{\alpha_3}^+}{v_{\alpha_1}^+ + v_{\alpha_3}^+}, \frac{2 v_{\alpha_2}^+ v_{\alpha_3}^+}{v_{\alpha_2}^+ + v_{\alpha_3}^+})] | \alpha_1 \in \tilde{h}_1, \alpha_2 \in \tilde{h}_2, \alpha_3 \in \tilde{h}_3 \} \\
 &=(\tilde{h}_1 \# \tilde{h}_3) \cup (\tilde{h}_2 \# \tilde{h}_3)
 \end{aligned}$$

This proves (v)

(vii) From definitions 2.3 and 3.1, we have

$$\begin{aligned}
 (\tilde{h}_1 \cup \tilde{h}_2) * \tilde{h}_3 &= (\tilde{h}_1 * \tilde{h}_3) \cup (\tilde{h}_2 * \tilde{h}_3) \\
 &= \{ [\max(\mu_{\alpha_1}^-, \mu_{\alpha_2}^-), \max(\mu_{\alpha_1}^+, \mu_{\alpha_2}^+)], [\min(v_{\alpha_1}^-, v_{\alpha_2}^-), \min(v_{\alpha_1}^+, v_{\alpha_2}^+)] | \alpha_1 \in \tilde{h}_1, \alpha_2 \in \tilde{h}_2 \} * \{ [\mu_{\alpha_3}^-, \mu_{\alpha_3}^+], [v_{\alpha_3}^-, v_{\alpha_3}^+] | \alpha_3 \in \tilde{h}_3 \} \\
 &= \{ [\frac{\max(\mu_{\alpha_1}^-, \mu_{\alpha_2}^-) + \mu_{\alpha_3}^-}{2(\max(\mu_{\alpha_1}^-, \mu_{\alpha_2}^-) \mu_{\alpha_3}^- + 1)}, \frac{\max(\mu_{\alpha_1}^+, \mu_{\alpha_2}^+) + \mu_{\alpha_3}^+}{2(\max(\mu_{\alpha_1}^+, \mu_{\alpha_2}^+) \mu_{\alpha_3}^+ + 1)}], [\frac{\min(v_{\alpha_1}^-, v_{\alpha_2}^-) + v_{\alpha_3}^-}{2(\min(v_{\alpha_1}^-, v_{\alpha_2}^-) v_{\alpha_3}^- + 1)}, \frac{\min(v_{\alpha_1}^+, v_{\alpha_2}^+) + v_{\alpha_3}^+}{2(\min(v_{\alpha_1}^+, v_{\alpha_2}^+) v_{\alpha_3}^+ + 1)}] | \alpha_1 \in \tilde{h}_1, \alpha_2 \in \tilde{h}_2, \alpha_3 \in \tilde{h}_3 \} \\
 &= \{ [\max(\frac{\mu_{\alpha_1}^- + \mu_{\alpha_3}^-}{2(\mu_{\alpha_1}^- \mu_{\alpha_3}^- + 1)}, \frac{\mu_{\alpha_2}^- + \mu_{\alpha_3}^-}{2(\mu_{\alpha_2}^- \mu_{\alpha_3}^- + 1)}), \max(\frac{\mu_{\alpha_1}^+ + \mu_{\alpha_3}^+}{2(\mu_{\alpha_1}^+ \mu_{\alpha_3}^+ + 1)}, \frac{\mu_{\alpha_2}^+ + \mu_{\alpha_3}^+}{2(\mu_{\alpha_2}^+ \mu_{\alpha_3}^+ + 1)})], [\min(\frac{v_{\alpha_1}^- + v_{\alpha_3}^-}{2(v_{\alpha_1}^- v_{\alpha_3}^- + 1)}, \frac{v_{\alpha_2}^- + v_{\alpha_3}^-}{2(v_{\alpha_2}^- v_{\alpha_3}^- + 1)}), \min(\frac{v_{\alpha_1}^+ + v_{\alpha_3}^+}{2(v_{\alpha_1}^+ v_{\alpha_3}^+ + 1)}, \frac{v_{\alpha_2}^+ + v_{\alpha_3}^+}{2(v_{\alpha_2}^+ v_{\alpha_3}^+ + 1)})] | \alpha_1 \in \tilde{h}_1, \alpha_2 \in \tilde{h}_2, \alpha_3 \in \tilde{h}_3 \} \\
 &= (\tilde{h}_1 * \tilde{h}_3) \cup (\tilde{h}_2 * \tilde{h}_3)
 \end{aligned}$$

This proves (vii).

(ix) Using definitions 2.3 and 3.1, we have

$$\begin{aligned}
 (\tilde{h}_1 @ \tilde{h}_2) \oplus \tilde{h}_3 &= (\tilde{h}_1 \oplus \tilde{h}_3) @ (\tilde{h}_2 \oplus \tilde{h}_3); \\
 &= \{ [\frac{\mu_{\alpha_1}^- + \mu_{\alpha_2}^-}{2}, \frac{\mu_{\alpha_1}^+ + \mu_{\alpha_2}^+}{2}], [\frac{v_{\alpha_1}^- + v_{\alpha_2}^-}{2}, \frac{v_{\alpha_1}^+ + v_{\alpha_2}^+}{2}] | \alpha_1 \in \tilde{h}_1, \alpha_2 \in \tilde{h}_2 \} \oplus \{ [\mu_{\alpha_3}^-, \mu_{\alpha_3}^+], [v_{\alpha_3}^-, v_{\alpha_3}^+] | \alpha_3 \in \tilde{h}_3 \} \\
 &= \{ [\frac{\mu_{\alpha_1}^- + \mu_{\alpha_2}^-}{2} + \mu_{\alpha_3}^- - \frac{\mu_{\alpha_1}^- + \mu_{\alpha_2}^-}{2} \mu_{\alpha_3}^-, \frac{\mu_{\alpha_1}^+ + \mu_{\alpha_2}^+}{2} + \mu_{\alpha_3}^+ - \frac{\mu_{\alpha_1}^+ + \mu_{\alpha_2}^+}{2} \mu_{\alpha_3}^+], [\frac{v_{\alpha_1}^- + v_{\alpha_2}^-}{2} + v_{\alpha_3}^- - \frac{v_{\alpha_1}^- + v_{\alpha_2}^-}{2} v_{\alpha_3}^-, \frac{v_{\alpha_1}^+ + v_{\alpha_2}^+}{2} + v_{\alpha_3}^+ - \frac{v_{\alpha_1}^+ + v_{\alpha_2}^+}{2} v_{\alpha_3}^+] | \alpha_1 \in \tilde{h}_1, \alpha_2 \in \tilde{h}_2, \alpha_3 \in \tilde{h}_3 \} \\
 &= \{ [\frac{(\mu_{\alpha_1}^- + \mu_{\alpha_3}^- - \mu_{\alpha_1}^- \mu_{\alpha_3}^-) + (\mu_{\alpha_2}^- + \mu_{\alpha_3}^- - \mu_{\alpha_2}^- \mu_{\alpha_3}^-)}{2}, \frac{(\mu_{\alpha_1}^+ + \mu_{\alpha_3}^+ - \mu_{\alpha_1}^+ \mu_{\alpha_3}^+) + (\mu_{\alpha_2}^+ + \mu_{\alpha_3}^+ - \mu_{\alpha_2}^+ \mu_{\alpha_3}^+)}{2}], [\frac{(v_{\alpha_1}^- + v_{\alpha_3}^- - v_{\alpha_1}^- v_{\alpha_3}^-) + (v_{\alpha_2}^- + v_{\alpha_3}^- - v_{\alpha_2}^- v_{\alpha_3}^-)}{2}, \frac{(v_{\alpha_1}^+ + v_{\alpha_3}^+ - v_{\alpha_1}^+ v_{\alpha_3}^+) + (v_{\alpha_2}^+ + v_{\alpha_3}^+ - v_{\alpha_2}^+ v_{\alpha_3}^+)}{2}] | \alpha_1 \in \tilde{h}_1, \alpha_2 \in \tilde{h}_2, \alpha_3 \in \tilde{h}_3 \} \\
 &= (\tilde{h}_1 \oplus \tilde{h}_3) @ (\tilde{h}_2 \oplus \tilde{h}_3)
 \end{aligned}$$

This proves (ix)

Theorem 3.7

For \tilde{h}_1 and $\tilde{h}_2 \in$ IVIHFS (X), we have the following identities:

(i) $(\tilde{h}_1 \oplus \tilde{h}_2) \cap (\tilde{h}_1 \otimes \tilde{h}_2) = \tilde{h}_1 \otimes \tilde{h}_2;$

- (ii) $(\tilde{h}_1 \oplus \tilde{h}_2) \cup (\tilde{h}_1 \otimes \tilde{h}_2) = \tilde{h}_1 \oplus \tilde{h}_2;$
- (iii) $(\tilde{h}_1 \oplus \tilde{h}_2) \cap (\tilde{h}_1 @ \tilde{h}_2) = \tilde{h}_1 @ \tilde{h}_2;$
- (iv) $(\tilde{h}_1 \oplus \tilde{h}_2) \cup (\tilde{h}_1 @ \tilde{h}_2) = \tilde{h}_1 \oplus \tilde{h}_2;$
- (v) $(\tilde{h}_1 \otimes \tilde{h}_2) \cap (\tilde{h}_1 @ \tilde{h}_2) = \tilde{h}_1 \otimes \tilde{h}_2;$
- (vi) $(\tilde{h}_1 \otimes \tilde{h}_2) \cup (\tilde{h}_1 @ \tilde{h}_2) = \tilde{h}_1 @ \tilde{h}_2;$
- (vii) $(\tilde{h}_1 \oplus \tilde{h}_2) \cap (\tilde{h}_1 \$ \tilde{h}_2) = \tilde{h}_1 \$ \tilde{h}_2;$
- (viii) $(\tilde{h}_1 \oplus \tilde{h}_2) \cup (\tilde{h}_1 \$ \tilde{h}_2) = \tilde{h}_1 \oplus \tilde{h}_2;$
- (ix) $(\tilde{h}_1 \otimes \tilde{h}_2) \cap (\tilde{h}_1 \$ \tilde{h}_2) = \tilde{h}_1 \otimes \tilde{h}_2;$
- (x) $(\tilde{h}_1 \otimes \tilde{h}_2) \cup (\tilde{h}_1 \$ \tilde{h}_2) = \tilde{h}_1 \$ \tilde{h}_2;$
- (xi) $(\tilde{h}_1 \oplus \tilde{h}_2) \cap (\tilde{h}_1 \# \tilde{h}_2) = \tilde{h}_1 \# \tilde{h}_2;$
- (xii) $(\tilde{h}_1 \oplus \tilde{h}_2) \cup (\tilde{h}_1 \# \tilde{h}_2) = \tilde{h}_1 \oplus \tilde{h}_2;$
- (xiii) $(\tilde{h}_1 \otimes \tilde{h}_2) \cap (\tilde{h}_1 \# \tilde{h}_2) = \tilde{h}_1 \otimes \tilde{h}_2;$
- (xiv) $(\tilde{h}_1 \otimes \tilde{h}_2) \cup (\tilde{h}_1 \# \tilde{h}_2) = \tilde{h}_1 \# \tilde{h}_2$

Proof. We prove (i), (iii), (v), (vii), (ix), (xi) and (xii), other results can be proved analogously.

From definitions 2.3, 2.5 and 3.1, we have

$$\begin{aligned}
 &(\tilde{h}_1 \oplus \tilde{h}_2) \cap (\tilde{h}_1 \otimes \tilde{h}_2) \\
 &= ([\mu_{\alpha_2}^- + \mu_{\alpha_1}^- - \mu_{\alpha_2}^- \mu_{\alpha_1}^-, \mu_{\alpha_2}^+ + \mu_{\alpha_1}^+ - \mu_{\alpha_2}^+ \mu_{\alpha_1}^+], [v_{\alpha_2}^- v_{\alpha_1}^-, v_{\alpha_2}^+ v_{\alpha_1}^+]) \cap \{[\mu_{\alpha_1}^- \mu_{\alpha_2}^-, \mu_{\alpha_1}^+ \mu_{\alpha_2}^+], [v_{\alpha_1}^- + v_{\alpha_2}^- - v_{\alpha_1}^- v_{\alpha_2}^-, v_{\alpha_1}^+ + v_{\alpha_2}^+ - v_{\alpha_1}^+ v_{\alpha_2}^+]\} \\
 &= \{[\min(\mu_{\alpha_2}^- + \mu_{\alpha_1}^- - \mu_{\alpha_2}^- \mu_{\alpha_1}^-, \mu_{\alpha_1}^- \mu_{\alpha_2}^-), \min(\mu_{\alpha_2}^+ + \mu_{\alpha_1}^+ - \mu_{\alpha_2}^+ \mu_{\alpha_1}^+, \mu_{\alpha_1}^+ \mu_{\alpha_2}^+)], \\
 &[\max(v_{\alpha_2}^- v_{\alpha_1}^-, v_{\alpha_1}^- + v_{\alpha_2}^- - v_{\alpha_1}^- v_{\alpha_2}^-), \max(v_{\alpha_2}^+ v_{\alpha_1}^+, v_{\alpha_1}^+ + v_{\alpha_2}^+ - v_{\alpha_1}^+ v_{\alpha_2}^+)] | \alpha_1 \in \tilde{h}_1, \alpha_2 \in \tilde{h}_2\} \\
 &= [\mu_{\alpha_1}^- \mu_{\alpha_2}^-, \mu_{\alpha_1}^+ \mu_{\alpha_2}^+], [v_{\alpha_1}^- + v_{\alpha_2}^- - v_{\alpha_1}^- v_{\alpha_2}^-, v_{\alpha_1}^+ + v_{\alpha_2}^+ - v_{\alpha_1}^+ v_{\alpha_2}^+] | \alpha_1 \in \tilde{h}_1, \alpha_2 \in \tilde{h}_2\} \\
 &= \tilde{h}_1 \otimes \tilde{h}_2
 \end{aligned}$$

This proves (i)

iii) Using definitions 2.3, 2.5 and 3.1, we have

$$\begin{aligned}
 &(\tilde{h}_1 \oplus \tilde{h}_2) \cap (\tilde{h}_1 @ \tilde{h}_2) = \tilde{h}_1 @ \tilde{h}_2; \\
 &= \{([\mu_{\alpha_2}^- + \mu_{\alpha_1}^- - \mu_{\alpha_2}^- \mu_{\alpha_1}^-, \mu_{\alpha_2}^+ + \mu_{\alpha_1}^+ - \mu_{\alpha_2}^+ \mu_{\alpha_1}^+], [v_{\alpha_2}^- v_{\alpha_1}^-, v_{\alpha_2}^+ v_{\alpha_1}^+]) | \alpha_1 \in \tilde{h}_1, \alpha_2 \in \tilde{h}_2\} \cap \{[\frac{\mu_{\alpha_1}^- + \mu_{\alpha_2}^-}{2}, \frac{\mu_{\alpha_1}^+ + \mu_{\alpha_2}^+}{2}], [\frac{v_{\alpha_1}^- + v_{\alpha_2}^-}{2}, \frac{v_{\alpha_1}^+ + v_{\alpha_2}^+}{2}]\} | \alpha_1 \in \tilde{h}_1, \alpha_2 \in \tilde{h}_2\} \\
 &= \{[\min(\mu_{\alpha_2}^- + \mu_{\alpha_1}^- - \mu_{\alpha_2}^- \mu_{\alpha_1}^-, \frac{\mu_{\alpha_1}^- + \mu_{\alpha_2}^-}{2}), \min(\mu_{\alpha_2}^+ + \mu_{\alpha_1}^+ - \mu_{\alpha_2}^+ \mu_{\alpha_1}^+, \frac{\mu_{\alpha_1}^+ + \mu_{\alpha_2}^+}{2})], \\
 &[\max(v_{\alpha_2}^- v_{\alpha_1}^-, \frac{v_{\alpha_1}^- + v_{\alpha_2}^-}{2}), \max(v_{\alpha_2}^+ v_{\alpha_1}^+, \frac{v_{\alpha_1}^+ + v_{\alpha_2}^+}{2})] | \alpha_1 \in \tilde{h}_1, \alpha_2 \in \tilde{h}_2\} \\
 &= \{[\frac{\mu_{\alpha_1}^- + \mu_{\alpha_2}^-}{2}, \frac{\mu_{\alpha_1}^+ + \mu_{\alpha_2}^+}{2}], [\frac{v_{\alpha_1}^- + v_{\alpha_2}^-}{2}, \frac{v_{\alpha_1}^+ + v_{\alpha_2}^+}{2}] | \alpha_1 \in \tilde{h}_1, \alpha_2 \in \tilde{h}_2\} = \tilde{h}_1 @ \tilde{h}_2
 \end{aligned}$$

This proves (iii).

(v) From definitions 2.3, 2.5 and 3.1, we have

$$\begin{aligned}
 &(\tilde{h}_1 \otimes \tilde{h}_2) \cap (\tilde{h}_1 @ \tilde{h}_2) = \tilde{h}_1 \otimes \tilde{h}_2; \\
 &= \{[\mu_{\alpha_1}^- \mu_{\alpha_2}^-, \mu_{\alpha_1}^+ \mu_{\alpha_2}^+], [v_{\alpha_1}^- + v_{\alpha_2}^- - v_{\alpha_1}^- v_{\alpha_2}^-, v_{\alpha_1}^+ + v_{\alpha_2}^+ - v_{\alpha_1}^+ v_{\alpha_2}^+]] | \alpha_1 \in \tilde{h}_1, \alpha_2 \in \tilde{h}_2\} \cap \{[\frac{\mu_{\alpha_1}^- + \mu_{\alpha_2}^-}{2}, \frac{\mu_{\alpha_1}^+ + \mu_{\alpha_2}^+}{2}], [\frac{v_{\alpha_1}^- + v_{\alpha_2}^-}{2}, \frac{v_{\alpha_1}^+ + v_{\alpha_2}^+}{2}] | \alpha_1 \in \tilde{h}_1, \alpha_2 \in \tilde{h}_2\} \\
 &= \{[\min(\mu_{\alpha_1}^- \mu_{\alpha_2}^-, \frac{\mu_{\alpha_1}^- + \mu_{\alpha_2}^-}{2}), \min(\mu_{\alpha_1}^+ \mu_{\alpha_2}^+, \frac{\mu_{\alpha_1}^+ + \mu_{\alpha_2}^+}{2})], \\
 &[\max(v_{\alpha_1}^- + v_{\alpha_2}^- - v_{\alpha_1}^- v_{\alpha_2}^-, \frac{v_{\alpha_1}^- + v_{\alpha_2}^-}{2}), \max(v_{\alpha_1}^+ + v_{\alpha_2}^+ - v_{\alpha_1}^+ v_{\alpha_2}^+, \frac{v_{\alpha_1}^+ + v_{\alpha_2}^+}{2})] | \alpha_1 \in \tilde{h}_1, \alpha_2 \in \tilde{h}_2\} \\
 &= \{[\mu_{\alpha_1}^- \mu_{\alpha_2}^-, \mu_{\alpha_1}^+ \mu_{\alpha_2}^+], [v_{\alpha_1}^- + v_{\alpha_2}^- - v_{\alpha_1}^- v_{\alpha_2}^-, v_{\alpha_1}^+ + v_{\alpha_2}^+ - v_{\alpha_1}^+ v_{\alpha_2}^+]] | \alpha_1 \in \tilde{h}_1, \alpha_2 \in \tilde{h}_2\} = \tilde{h}_1 \otimes \tilde{h}_2
 \end{aligned}$$

This proves (v)

(vii) Using definitions 2.3, 2.5 and 3.1, we have

$$(\tilde{h}_1 \oplus \tilde{h}_2) \cap (\tilde{h}_1 \$ \tilde{h}_2) = \tilde{h}_1 \$ \tilde{h}_2$$

$$\begin{aligned}
 &= ([\mu_{\alpha_2}^- + \mu_{\alpha_1}^- - \mu_{\alpha_2}^- \mu_{\alpha_1}^-, \mu_{\alpha_2}^+ + \mu_{\alpha_1}^+ - \mu_{\alpha_2}^+ \mu_{\alpha_1}^+], [v_{\alpha_2}^- v_{\alpha_1}^-, v_{\alpha_2}^+ v_{\alpha_1}^+]) \cap \{[\sqrt{\mu_{\alpha_1}^- \mu_{\alpha_2}^-}, \sqrt{\mu_{\alpha_1}^+ \mu_{\alpha_2}^+}], [\sqrt{v_{\alpha_1}^- v_{\alpha_2}^-}], \sqrt{v_{\alpha_1}^+ v_{\alpha_2}^+}]\} | \alpha_1 \in \tilde{h}_1, \alpha_2 \in \tilde{h}_2 \} \\
 &= \{[\min(\mu_{\alpha_2}^- + \mu_{\alpha_1}^- - \mu_{\alpha_2}^- \mu_{\alpha_1}^-, \sqrt{\mu_{\alpha_1}^- \mu_{\alpha_2}^-}), \min(\mu_{\alpha_2}^+ + \mu_{\alpha_1}^+ - \mu_{\alpha_2}^+ \mu_{\alpha_1}^+, \sqrt{\mu_{\alpha_1}^+ \mu_{\alpha_2}^+})], [\max(v_{\alpha_2}^- v_{\alpha_1}^-, \sqrt{v_{\alpha_1}^- v_{\alpha_2}^-}), \max(v_{\alpha_2}^+ v_{\alpha_1}^+, \sqrt{v_{\alpha_1}^+ v_{\alpha_2}^+})]\} | \alpha_1 \in \tilde{h}_1, \alpha_2 \in \tilde{h}_2 \} \\
 &= \{[\sqrt{\mu_{\alpha_1}^- \mu_{\alpha_2}^-}, \sqrt{\mu_{\alpha_1}^+ \mu_{\alpha_2}^+}], [\sqrt{v_{\alpha_1}^- v_{\alpha_2}^-}, \sqrt{v_{\alpha_1}^+ v_{\alpha_2}^+}]\} | \alpha_1 \in \tilde{h}_1, \alpha_2 \in \tilde{h}_2 \} = \tilde{h}_1 \$ \tilde{h}_2
 \end{aligned}$$

This proves (vii)

(ix) From definitions 2.3, 2.5 and 3.1, we have

$$(\tilde{h}_1 \otimes \tilde{h}_2) \cap (\tilde{h}_1 \$ \tilde{h}_2) = \tilde{h}_1 \otimes \tilde{h}_2;$$

$$\begin{aligned}
 &= \{([\mu_{\alpha_1}^- \mu_{\alpha_2}^-, \mu_{\alpha_1}^+ \mu_{\alpha_2}^+], [v_{\alpha_1}^- + v_{\alpha_2}^- - v_{\alpha_1}^- v_{\alpha_2}^-, v_{\alpha_1}^+ + v_{\alpha_2}^+ - v_{\alpha_1}^+ v_{\alpha_2}^+]) | \alpha_1 \in \tilde{h}_1, \alpha_2 \in \tilde{h}_2 \} \cap \{[\sqrt{\mu_{\alpha_1}^- \mu_{\alpha_2}^-}, \sqrt{\mu_{\alpha_1}^+ \mu_{\alpha_2}^+}], [\sqrt{v_{\alpha_1}^- v_{\alpha_2}^-}, \sqrt{v_{\alpha_1}^+ v_{\alpha_2}^+}]\} | \alpha_1 \in \tilde{h}_1, \alpha_2 \in \tilde{h}_2 \} \\
 &= \{[\min(\mu_{\alpha_1}^- \mu_{\alpha_2}^-, \sqrt{\mu_{\alpha_1}^- \mu_{\alpha_2}^-}), \min(\mu_{\alpha_1}^+ \mu_{\alpha_2}^+, \sqrt{\mu_{\alpha_1}^+ \mu_{\alpha_2}^+})], [\max(v_{\alpha_1}^- + v_{\alpha_2}^- - v_{\alpha_1}^- v_{\alpha_2}^-, \sqrt{v_{\alpha_1}^- v_{\alpha_2}^-}), \max(v_{\alpha_1}^+ + v_{\alpha_2}^+ - v_{\alpha_1}^+ v_{\alpha_2}^+, \sqrt{v_{\alpha_1}^+ v_{\alpha_2}^+})]\} | \alpha_1 \in \tilde{h}_1, \alpha_2 \in \tilde{h}_2 \}
 \end{aligned}$$

$$= \{[\mu_{\alpha_1}^- \mu_{\alpha_2}^-, \mu_{\alpha_1}^+ \mu_{\alpha_2}^+], [v_{\alpha_1}^- + v_{\alpha_2}^- - v_{\alpha_1}^- v_{\alpha_2}^-, v_{\alpha_1}^+ + v_{\alpha_2}^+ - v_{\alpha_1}^+ v_{\alpha_2}^+]\} | \alpha_1 \in \tilde{h}_1, \alpha_2 \in \tilde{h}_2 \} = \tilde{h}_1 \otimes \tilde{h}_2$$

This proves (ix)

(xiii) From definitions 2.3, 2.5 and 3.1, we have

$$(\tilde{h}_1 \otimes \tilde{h}_2) \cap (\tilde{h}_1 \# \tilde{h}_2) = \tilde{h}_1 \otimes \tilde{h}_2;$$

$$\begin{aligned}
 &= \{[\mu_{\alpha_1}^- \mu_{\alpha_2}^-, \mu_{\alpha_1}^+ \mu_{\alpha_2}^+], [v_{\alpha_1}^- + v_{\alpha_2}^- - v_{\alpha_1}^- v_{\alpha_2}^-, v_{\alpha_1}^+ + v_{\alpha_2}^+ - v_{\alpha_1}^+ v_{\alpha_2}^+]\} | \alpha_1 \in \tilde{h}_1, \alpha_2 \in \tilde{h}_2 \} \cap \{[\frac{2\mu_{\alpha_1}^- \mu_{\alpha_2}^-}{\mu_{\alpha_1}^- + \mu_{\alpha_2}^-}, \frac{2\mu_{\alpha_1}^+ \mu_{\alpha_2}^+}{\mu_{\alpha_1}^+ + \mu_{\alpha_2}^+}], [\frac{2v_{\alpha_1}^- v_{\alpha_2}^-}{v_{\alpha_1}^- + v_{\alpha_2}^-}, \frac{2v_{\alpha_1}^+ v_{\alpha_2}^+}{v_{\alpha_1}^+ + v_{\alpha_2}^+}]\} | \alpha_1 \in \tilde{h}_1, \alpha_2 \in \tilde{h}_2 \} \\
 &= \{[\min(\mu_{\alpha_1}^- \mu_{\alpha_2}^-, \frac{2\mu_{\alpha_1}^- \mu_{\alpha_2}^-}{\mu_{\alpha_1}^- + \mu_{\alpha_2}^-}), \min(\mu_{\alpha_1}^+ \mu_{\alpha_2}^+, \frac{2\mu_{\alpha_1}^+ \mu_{\alpha_2}^+}{\mu_{\alpha_1}^+ + \mu_{\alpha_2}^+})], [\max(v_{\alpha_1}^- + v_{\alpha_2}^- - v_{\alpha_1}^- v_{\alpha_2}^-, \frac{2v_{\alpha_1}^- v_{\alpha_2}^-}{v_{\alpha_1}^- + v_{\alpha_2}^-}), \max(v_{\alpha_1}^+ + v_{\alpha_2}^+ - v_{\alpha_1}^+ v_{\alpha_2}^+, \frac{2v_{\alpha_1}^+ v_{\alpha_2}^+}{v_{\alpha_1}^+ + v_{\alpha_2}^+})]\} | \alpha_1 \in \tilde{h}_1, \alpha_2 \in \tilde{h}_2 \} \\
 &= \{[\mu_{\alpha_1}^- \mu_{\alpha_2}^-, \mu_{\alpha_1}^+ \mu_{\alpha_2}^+], [v_{\alpha_1}^- + v_{\alpha_2}^- - v_{\alpha_1}^- v_{\alpha_2}^-, v_{\alpha_1}^+ + v_{\alpha_2}^+ - v_{\alpha_1}^+ v_{\alpha_2}^+]\} | \alpha_1 \in \tilde{h}_1, \alpha_2 \in \tilde{h}_2 \} = \tilde{h}_1 \otimes \tilde{h}_2
 \end{aligned}$$

This proves (xiii).

Theorem 3.8

For \tilde{h}_1 and $\tilde{h}_2 \in$ IVIHFE(X), then following relations are valid:

- (i) $(\tilde{h}_1 \# \tilde{h}_2) \$ (\tilde{h}_1 \# \tilde{h}_2) = \tilde{h}_1 \# \tilde{h}_2;$
- (ii) $(\tilde{h}_1 * \tilde{h}_2) \$ (\tilde{h}_1 * \tilde{h}_2) = \tilde{h}_1 * \tilde{h}_2;$
- (iii) $(\tilde{h}_1 \oplus \tilde{h}_2) \$ (\tilde{h}_1 \oplus \tilde{h}_2) = \tilde{h}_1 \oplus \tilde{h}_2;$
- (iv) $(\tilde{h}_1 \otimes \tilde{h}_2) \$ (\tilde{h}_1 \otimes \tilde{h}_2) = \tilde{h}_1 \otimes \tilde{h}_2;$
- (v) $(\tilde{h}_1 @ \tilde{h}_2) \$ (\tilde{h}_1 @ \tilde{h}_2) = \tilde{h}_1 @ \tilde{h}_2;$
- (vi) $(\tilde{h}_1 \# \tilde{h}_2) @ (\tilde{h}_1 \# \tilde{h}_2) = \tilde{h}_1 \# \tilde{h}_2;$
- (vii) $(\tilde{h}_1 * \tilde{h}_2) @ (\tilde{h}_1 * \tilde{h}_2) = \tilde{h}_1 * \tilde{h}_2;$
- (viii) $(\tilde{h}_1 \oplus \tilde{h}_2) @ (\tilde{h}_1 \otimes \tilde{h}_2) = \tilde{h}_1 @ \tilde{h}_2;$
- (ix) $(\tilde{h}_1 \cup \tilde{h}_2) @ (\tilde{h}_1 \cap \tilde{h}_2) = \tilde{h}_1 @ \tilde{h}_2;$
- (x) $(\tilde{h}_1 \cup \tilde{h}_2) \$ (\tilde{h}_1 \cap \tilde{h}_2) = \tilde{h}_1 \$ \tilde{h}_2;$
- (xi) $(\tilde{h}_1 \cup \tilde{h}_2) \# (\tilde{h}_1 \cap \tilde{h}_2) = \tilde{h}_1 \# \tilde{h}_2;$
- (xii) $(\tilde{h}_1 \cup \tilde{h}_2) * (\tilde{h}_1 \cap \tilde{h}_2) = \tilde{h}_1 * \tilde{h}_2;$
- (xiii) $(\tilde{h}_1 * \tilde{h}_2) @ (\tilde{h}_1 * \tilde{h}_2) = \tilde{h}_1 * \tilde{h}_2;$
- (xiv) $(\tilde{h}_1 * \tilde{h}_2) \$ (\tilde{h}_1 * \tilde{h}_2) = \tilde{h}_1 * \tilde{h}_2.$

Proof, The proofs of these results are the same as in the above proof

Theorem 3.9.

For every two \tilde{h}_1 and $\tilde{h}_2 \in$ IVIHFE (X), we have:

- (i) $((\tilde{h}_1 \cup \tilde{h}_2) \oplus (\tilde{h}_1 \cap \tilde{h}_2)) @ ((\tilde{h}_1 \cup \tilde{h}_2) \otimes (\tilde{h}_1 \cap \tilde{h}_2)) = \tilde{h}_1 @ \tilde{h}_2;$
- (ii) $((\tilde{h}_1 \cup \tilde{h}_2) \# (\tilde{h}_1 \cap \tilde{h}_2)) \$ ((\tilde{h}_1 \cup \tilde{h}_2) @ (\tilde{h}_1 \cap \tilde{h}_2)) = \tilde{h}_1 \$ \tilde{h}_2$
- (iii) $((\tilde{h}_1 \oplus \tilde{h}_2) \cup (\tilde{h}_1 \otimes \tilde{h}_2)) @ ((\tilde{h}_1 \oplus \tilde{h}_2) \cap (\tilde{h}_1 \otimes \tilde{h}_2)) = \tilde{h}_1 @ \tilde{h}_2;$
- (iv) $((\tilde{h}_1 \oplus \tilde{h}_2) \cup (\tilde{h}_1 @ \tilde{h}_2)) @ ((\tilde{h}_1 \otimes \tilde{h}_2) \cap (\tilde{h}_1 @ \tilde{h}_2)) = \tilde{h}_1 @ \tilde{h}_2;$
- (v) $((\tilde{h}_1 \oplus \tilde{h}_2) \cup (\tilde{h}_1 \# \tilde{h}_2)) @ ((\tilde{h}_1 \otimes \tilde{h}_2) \cap (\tilde{h}_1 \# \tilde{h}_2)) = \tilde{h}_1 @ \tilde{h}_2;$
- (vi) $((\tilde{h}_1 \oplus \tilde{h}_2) \cup (\tilde{h}_1 \$ \tilde{h}_2)) @ ((\tilde{h}_1 \otimes \tilde{h}_2) \cap (\tilde{h}_1 \$ \tilde{h}_2)) = \tilde{h}_1 @ \tilde{h}_2;$
- (vii) $((\tilde{h}_1 \oplus \tilde{h}_2) \cup (\tilde{h}_1 @ \tilde{h}_2)) @ ((\tilde{h}_1 \oplus \tilde{h}_2) \cap (\tilde{h}_1 \# \tilde{h}_2)) = \tilde{h}_1 \$ \tilde{h}_2.$

Proof. In the following, we prove (i) and (iii), other results can be proved analogously.

(i) From definitions 2.3 and 3.1, we have

$$\begin{aligned}
 & ((\tilde{h}_1 \cup \tilde{h}_2) \oplus (\tilde{h}_1 \cap \tilde{h}_2)) @ ((\tilde{h}_1 \cup \tilde{h}_2) \otimes (\tilde{h}_1 \cap \tilde{h}_2)) = \\
 & ((\tilde{h}_1 \cup \tilde{h}_2) \oplus (\tilde{h}_1 \cap \tilde{h}_2)) = \\
 & \{[\max(\mu_{\alpha_1}^-, \mu_{\alpha_2}^-), \max(\mu_{\alpha_1}^+, \mu_{\alpha_2}^+)], [\min(\nu_{\alpha_1}^-, \nu_{\alpha_2}^-), \min(\nu_{\alpha_1}^+, \nu_{\alpha_2}^+)] | \alpha_1 \in \tilde{h}_1, \alpha_2 \in \tilde{h}_2\} \oplus \{[\min(\mu_{\alpha_1}^-, \mu_{\alpha_2}^-), \min(\mu_{\alpha_1}^+, \mu_{\alpha_2}^+)], [\max(\nu_{\alpha_1}^-, \nu_{\alpha_2}^-), \max(\nu_{\alpha_1}^+, \nu_{\alpha_2}^+)] | \alpha_1 \in \tilde{h}_1, \alpha_2 \in \tilde{h}_2\} \\
 & = \{[\max(\mu_{\alpha_1}^-, \mu_{\alpha_2}^-) + \min(\mu_{\alpha_1}^-, \mu_{\alpha_2}^-) - \max(\mu_{\alpha_1}^-, \mu_{\alpha_2}^-) \min(\mu_{\alpha_1}^+, \mu_{\alpha_2}^+), \max(\mu_{\alpha_1}^+, \mu_{\alpha_2}^+) + \min(\mu_{\alpha_1}^+, \mu_{\alpha_2}^+) - \max(\mu_{\alpha_1}^+, \mu_{\alpha_2}^+) \min(\mu_{\alpha_1}^-, \mu_{\alpha_2}^-) + \min(\mu_{\alpha_1}^+, \mu_{\alpha_2}^+)], [\min(\nu_{\alpha_1}^-, \nu_{\alpha_2}^-) \max(\nu_{\alpha_1}^-, \nu_{\alpha_2}^-), \min(\nu_{\alpha_1}^+, \nu_{\alpha_2}^+) \max(\nu_{\alpha_1}^+, \nu_{\alpha_2}^+)] | \alpha_1 \in \tilde{h}_1, \alpha_2 \in \tilde{h}_2\} \\
 & ((\tilde{h}_1 \cup \tilde{h}_2) \otimes (\tilde{h}_1 \cap \tilde{h}_2)) = \\
 & \{[\max(\mu_{\alpha_1}^-, \mu_{\alpha_2}^-), \max(\mu_{\alpha_1}^+, \mu_{\alpha_2}^+)], [\min(\nu_{\alpha_1}^-, \nu_{\alpha_2}^-), \min(\nu_{\alpha_1}^+, \nu_{\alpha_2}^+)] | \alpha_1 \in \tilde{h}_1, \alpha_2 \in \tilde{h}_2\} \otimes \{[\min(\mu_{\alpha_1}^-, \mu_{\alpha_2}^-), \min(\mu_{\alpha_1}^+, \mu_{\alpha_2}^+)], [\max(\nu_{\alpha_1}^-, \nu_{\alpha_2}^-), \max(\nu_{\alpha_1}^+, \nu_{\alpha_2}^+)] | \alpha_1 \in \tilde{h}_1, \alpha_2 \in \tilde{h}_2\} \\
 & = \{[\max(\mu_{\alpha_1}^-, \mu_{\alpha_2}^-) \min(\mu_{\alpha_1}^-, \mu_{\alpha_2}^-), \max(\mu_{\alpha_1}^+, \mu_{\alpha_2}^+) \min(\mu_{\alpha_1}^+, \mu_{\alpha_2}^+)], [\min(\nu_{\alpha_1}^-, \nu_{\alpha_2}^-) \max(\nu_{\alpha_1}^-, \nu_{\alpha_2}^-) + \max(\nu_{\alpha_1}^+, \nu_{\alpha_2}^+) \min(\nu_{\alpha_1}^+, \nu_{\alpha_2}^+) - \min(\nu_{\alpha_1}^-, \nu_{\alpha_2}^-) \max(\nu_{\alpha_1}^+, \nu_{\alpha_2}^+) - \max(\nu_{\alpha_1}^-, \nu_{\alpha_2}^-) \min(\nu_{\alpha_1}^+, \nu_{\alpha_2}^+)] | \alpha_1 \in \tilde{h}_1, \alpha_2 \in \tilde{h}_2\} \\
 & ((\tilde{h}_1 \cup \tilde{h}_2) \oplus (\tilde{h}_1 \cap \tilde{h}_2)) @ ((\tilde{h}_1 \cup \tilde{h}_2) \otimes (\tilde{h}_1 \cap \tilde{h}_2)) = \\
 & \left\{ \left[\frac{\{\max(\mu_{\alpha_1}^-, \mu_{\alpha_2}^-) + \min(\mu_{\alpha_1}^-, \mu_{\alpha_2}^-) - \max(\mu_{\alpha_1}^-, \mu_{\alpha_2}^-) \min(\mu_{\alpha_1}^-, \mu_{\alpha_2}^-)\} + \max(\mu_{\alpha_1}^-, \mu_{\alpha_2}^-) \min(\mu_{\alpha_1}^-, \mu_{\alpha_2}^-)}{2}, \right. \right. \\
 & \left. \left. \frac{\{\max(\mu_{\alpha_1}^+, \mu_{\alpha_2}^+) + \min(\mu_{\alpha_1}^+, \mu_{\alpha_2}^+) - \max(\mu_{\alpha_1}^+, \mu_{\alpha_2}^+) \min(\mu_{\alpha_1}^+, \mu_{\alpha_2}^+)\} + \max(\mu_{\alpha_1}^+, \mu_{\alpha_2}^+) \min(\mu_{\alpha_1}^+, \mu_{\alpha_2}^+)}{2} \right], \right. \\
 & \left. \left[\frac{\min(\nu_{\alpha_1}^-, \nu_{\alpha_2}^-) \max(\nu_{\alpha_1}^-, \nu_{\alpha_2}^-) + \min(\nu_{\alpha_1}^-, \nu_{\alpha_2}^-) \max(\nu_{\alpha_1}^+, \nu_{\alpha_2}^+) + \max(\nu_{\alpha_1}^-, \nu_{\alpha_2}^-) - \min(\nu_{\alpha_1}^-, \nu_{\alpha_2}^-) \max(\nu_{\alpha_1}^-, \nu_{\alpha_2}^-)}{2}, \right. \right. \\
 & \left. \left. \frac{\min(\nu_{\alpha_1}^+, \nu_{\alpha_2}^+) \max(\nu_{\alpha_1}^+, \nu_{\alpha_2}^+) + \min(\nu_{\alpha_1}^+, \nu_{\alpha_2}^+) \max(\nu_{\alpha_1}^-, \nu_{\alpha_2}^-) + \max(\nu_{\alpha_1}^+, \nu_{\alpha_2}^+) - \min(\nu_{\alpha_1}^+, \nu_{\alpha_2}^+) \max(\nu_{\alpha_1}^+, \nu_{\alpha_2}^+)}{2} \right] \right. \\
 & \left. = \left[\frac{\{\max(\mu_{\alpha_1}^-, \mu_{\alpha_2}^-) + \min(\mu_{\alpha_1}^-, \mu_{\alpha_2}^-)\}}{2}, \frac{\{\max(\mu_{\alpha_1}^+, \mu_{\alpha_2}^+) + \min(\mu_{\alpha_1}^+, \mu_{\alpha_2}^+)\}}{2} \right], \right. \\
 & \left. \left[\frac{\min(\nu_{\alpha_1}^-, \nu_{\alpha_2}^-) \max(\nu_{\alpha_1}^-, \nu_{\alpha_2}^-) + \min(\nu_{\alpha_1}^-, \nu_{\alpha_2}^-) \max(\nu_{\alpha_1}^+, \nu_{\alpha_2}^+) + \max(\nu_{\alpha_1}^-, \nu_{\alpha_2}^-) - \min(\nu_{\alpha_1}^-, \nu_{\alpha_2}^-) \max(\nu_{\alpha_1}^-, \nu_{\alpha_2}^-)}{2}, \right. \right. \\
 & \left. \left. \frac{\min(\nu_{\alpha_1}^+, \nu_{\alpha_2}^+) \max(\nu_{\alpha_1}^+, \nu_{\alpha_2}^+) + \min(\nu_{\alpha_1}^+, \nu_{\alpha_2}^+) \max(\nu_{\alpha_1}^-, \nu_{\alpha_2}^-) + \max(\nu_{\alpha_1}^+, \nu_{\alpha_2}^+) - \min(\nu_{\alpha_1}^+, \nu_{\alpha_2}^+) \max(\nu_{\alpha_1}^+, \nu_{\alpha_2}^+)}{2} \right] \right. | \alpha_1 \in \tilde{h}_1, \alpha_2 \in \tilde{h}_2 \} \\
 & = \left\{ \left[\frac{\mu_{\alpha_1}^- + \mu_{\alpha_2}^-}{2}, \frac{\mu_{\alpha_1}^+ + \mu_{\alpha_2}^+}{2} \right], \left[\frac{\min(\nu_{\alpha_1}^-, \nu_{\alpha_2}^-) + \max(\nu_{\alpha_1}^-, \nu_{\alpha_2}^-)}{2}, \frac{\min(\nu_{\alpha_1}^+, \nu_{\alpha_2}^+) + \max(\nu_{\alpha_1}^+, \nu_{\alpha_2}^+)}{2} \right] \right. | \alpha_1 \in \tilde{h}_1, \alpha_2 \in \tilde{h}_2 \} \\
 & = \left\{ \left[\frac{\mu_{\alpha_1}^- + \mu_{\alpha_2}^-}{2}, \frac{\mu_{\alpha_1}^+ + \mu_{\alpha_2}^+}{2} \right], \left[\frac{\nu_{\alpha_1}^- + \nu_{\alpha_2}^-}{2}, \frac{\nu_{\alpha_1}^+ + \nu_{\alpha_2}^+}{2} \right] \right. | \alpha_1 \in \tilde{h}_1, \alpha_2 \in \tilde{h}_2 \} \\
 & = \tilde{h}_1 @ \tilde{h}_2
 \end{aligned}$$

This proves (i).

(ii) From definitions 2.3 and 3.1, we have

$$\begin{aligned}
 & ((\tilde{h}_1 \oplus \tilde{h}_2) \cup (\tilde{h}_1 \otimes \tilde{h}_2)) @ ((\tilde{h}_1 \oplus \tilde{h}_2) \cap (\tilde{h}_1 \otimes \tilde{h}_2)) = \tilde{h}_1 @ \tilde{h}_2; \\
 & ((\tilde{h}_1 \oplus \tilde{h}_2) \cap (\tilde{h}_1 \otimes \tilde{h}_2)) = \{[\mu_{\alpha_1}^-, \mu_{\alpha_2}^- - \mu_{\alpha_2}^- \mu_{\alpha_1}^-, \mu_{\alpha_1}^+ + \mu_{\alpha_2}^+ - \mu_{\alpha_2}^+ \mu_{\alpha_1}^+], [\nu_{\alpha_2}^- \nu_{\alpha_1}^-, \nu_{\alpha_2}^+ \nu_{\alpha_1}^+]] | \alpha_1 \in \tilde{h}_1, \alpha_2 \in \tilde{h}_2\} \cup \\
 & \{[\mu_{\alpha_1}^-, \mu_{\alpha_2}^-], [\nu_{\alpha_1}^- + \nu_{\alpha_2}^- - \nu_{\alpha_1}^- \nu_{\alpha_2}^-, \nu_{\alpha_1}^+ + \nu_{\alpha_2}^+ - \nu_{\alpha_1}^+ \nu_{\alpha_2}^+]] | \alpha_1 \in \tilde{h}_1, \alpha_2 \in \tilde{h}_2\}
 \end{aligned}$$

$$\begin{aligned}
 &= \{ [\min (\mu_{\alpha_1}^- + \mu_{\alpha_2}^- - \mu_{\alpha_2}^- \mu_{\alpha_1}^- , \mu_{\alpha_1}^- \mu_{\alpha_2}^-) , \min (\mu_{\alpha_1}^+ + \mu_{\alpha_2}^+ - \mu_{\alpha_2}^+ \mu_{\alpha_1}^+ , \mu_{\alpha_1}^+ \mu_{\alpha_2}^+)], \\
 &[\max (v_{\alpha_2}^- v_{\alpha_1}^- , v_{\alpha_1}^- + v_{\alpha_2}^- - v_{\alpha_1}^- v_{\alpha_2}^-) , \max (v_{\alpha_2}^+ v_{\alpha_1}^+ , v_{\alpha_1}^+ + v_{\alpha_2}^+ - v_{\alpha_1}^+ v_{\alpha_2}^+)] | \alpha_1 \in \tilde{h}_1 , \alpha_2 \in \tilde{h}_2 \} \\
 &= \{ [\mu_{\alpha_1}^- \mu_{\alpha_2}^- , \mu_{\alpha_1}^+ \mu_{\alpha_2}^+], [v_{\alpha_1}^- + v_{\alpha_2}^- - v_{\alpha_1}^- v_{\alpha_2}^- , v_{\alpha_1}^+ + v_{\alpha_2}^+ - v_{\alpha_1}^+ v_{\alpha_2}^+] | \alpha_1 \in \tilde{h}_1 , \alpha_2 \in \tilde{h}_2 \} \\
 &(\tilde{h}_1 \oplus \tilde{h}_2) \cup (\tilde{h}_1 \otimes \tilde{h}_2) = \{ [\mu_{\alpha_1}^- + \mu_{\alpha_2}^- - \mu_{\alpha_2}^- \mu_{\alpha_1}^- , \mu_{\alpha_1}^+ + \mu_{\alpha_2}^+ - \mu_{\alpha_2}^+ \mu_{\alpha_1}^+], [v_{\alpha_2}^- v_{\alpha_1}^- , v_{\alpha_2}^+ v_{\alpha_1}^+] | \alpha_1 \in \tilde{h}_1 , \alpha_2 \in \tilde{h}_2 \} \cup \\
 &\{ [\mu_{\alpha_1}^- \mu_{\alpha_2}^- , \mu_{\alpha_1}^+ \mu_{\alpha_2}^+], [v_{\alpha_1}^- + v_{\alpha_2}^- - v_{\alpha_1}^- v_{\alpha_2}^- , v_{\alpha_1}^+ + v_{\alpha_2}^+ - v_{\alpha_1}^+ v_{\alpha_2}^+] | \alpha_1 \in \tilde{h}_1 , \alpha_2 \in \tilde{h}_2 \} \\
 &= \{ [\max (\mu_{\alpha_1}^- + \mu_{\alpha_2}^- - \mu_{\alpha_2}^- \mu_{\alpha_1}^- , \mu_{\alpha_1}^- \mu_{\alpha_2}^-) , \max (\mu_{\alpha_1}^+ + \mu_{\alpha_2}^+ - \mu_{\alpha_2}^+ \mu_{\alpha_1}^+ , \mu_{\alpha_1}^+ \mu_{\alpha_2}^+)], \\
 &[\min (v_{\alpha_2}^- v_{\alpha_1}^- , v_{\alpha_1}^- + v_{\alpha_2}^- - v_{\alpha_1}^- v_{\alpha_2}^-) , \min (v_{\alpha_2}^+ v_{\alpha_1}^+ , v_{\alpha_1}^+ + v_{\alpha_2}^+ - v_{\alpha_1}^+ v_{\alpha_2}^+)] | \alpha_1 \in \tilde{h}_1 , \alpha_2 \in \tilde{h}_2 \} \\
 &= \{ [\mu_{\alpha_1}^- + \mu_{\alpha_2}^- - \mu_{\alpha_2}^- \mu_{\alpha_1}^- , \mu_{\alpha_1}^+ + \mu_{\alpha_2}^+ - \mu_{\alpha_2}^+ \mu_{\alpha_1}^+], [v_{\alpha_2}^- v_{\alpha_1}^- , v_{\alpha_2}^+ v_{\alpha_1}^+] | \alpha_1 \in \tilde{h}_1 , \alpha_2 \in \tilde{h}_2 \} \\
 &((\tilde{h}_1 \oplus \tilde{h}_2) \cup (\tilde{h}_1 \otimes \tilde{h}_2)) @ ((\tilde{h}_1 \oplus \tilde{h}_2) \cap (\tilde{h}_1 \otimes \tilde{h}_2)) = \{ [\frac{\mu_{\alpha_1}^- \mu_{\alpha_2}^- + \mu_{\alpha_1}^- + \mu_{\alpha_2}^- - \mu_{\alpha_2}^- \mu_{\alpha_1}^-}{2} , \frac{\mu_{\alpha_1}^+ \mu_{\alpha_2}^+ + \mu_{\alpha_1}^+ + \mu_{\alpha_2}^+ - \mu_{\alpha_2}^+ \mu_{\alpha_1}^+}{2}], \\
 &[\frac{v_{\alpha_1}^- + v_{\alpha_2}^- - v_{\alpha_1}^- v_{\alpha_2}^- + v_{\alpha_2}^- v_{\alpha_1}^-}{2} , \frac{v_{\alpha_1}^+ + v_{\alpha_2}^+ - v_{\alpha_1}^+ v_{\alpha_2}^+ + v_{\alpha_2}^+ v_{\alpha_1}^+}{2}] | \alpha_1 \in \tilde{h}_1 , \alpha_2 \in \tilde{h}_2 \} \\
 &= \{ [\frac{\mu_{\alpha_1}^- + \mu_{\alpha_2}^-}{2} , \frac{\mu_{\alpha_1}^+ + \mu_{\alpha_2}^+}{2}], [\frac{v_{\alpha_1}^- + v_{\alpha_2}^-}{2} , \frac{v_{\alpha_1}^+ + v_{\alpha_2}^+}{2}] | \alpha_1 \in \tilde{h}_1 , \alpha_2 \in \tilde{h}_2 \}
 \end{aligned}$$

Hence, $((\tilde{h}_1 \oplus \tilde{h}_2) \cup (\tilde{h}_1 \otimes \tilde{h}_2)) @ ((\tilde{h}_1 \oplus \tilde{h}_2) \cap (\tilde{h}_1 \otimes \tilde{h}_2)) = \tilde{h}_1 @ \tilde{h}_2$
 This proves (ii).

4. Conclusion

In this paper, we have defined four new operations on interval valued intuitionistic hesitant fuzzy sets which involve different defining functions. Some related results have been proved and the characteristics of the interval valued intuitionistic hesitant fuzzy sets have been brought out..

REFERENCES

[1] Zhiming Zhang ,” Interval-Valued Intuitionistic Hesitant Fuzzy Aggregation Operators and Their Application in Group Decision-Making”, Journal of Applied Mathematics Volume 2013 (2013), Article ID 670285, 33 p.

[2] Zadeh .L A , Fuzzy sets. Information and Control 8(3) ,1965,pp.338-353.

[3] Zadeh L A ,The concept of a linguistic variable and its application to approximate reasoning-I.Information Sciences 8(3),1975, pp.199-249.

[4] Atanassov K T , Intuitionistic fuzzy sets. Fuzzy Sets and Systems 20(1),1986, pp.87-96.

[5] Atanassov K T , Intuitionistic fuzzy sets. Springer Physica-Verlag, Heidelberg,1999.

[6] K. T. Atanassov and G. Gargov, Interval valued intuitionistic fuzzy sets, Fuzzy Sets and Systems, Vol. 31, Issue 3, 1989, pp. 343 – 349.

[7] Dubois D, Prade H , Fuzzy sets and systems: theory and applications. Academic Press, NewYork,1980.

[8] Karnik N N, Mendel J M , Operations on type-2 fuzzy sets. Fuzzy Sets and Systems 122(2),2001,pp.327-348.

[9] Torra V, Narukawa Y ,On hesitant fuzzy sets and decision. The 18th IEEE international Conference on Fuzzy Systems, Jeju Island, Korea,2009, pp.1378-1382.

[10] Torra V ,Hesitant fuzzy sets. International Journal of Intelligent Systems 25(6),2010, pp.529-539.

[11] Xia M, Xu Z S Hesitant fuzzy information aggregation in decision making. International Journal of Approximate Reasoning 52(3),2011, pp.395-407.

[12] Xia M M, Xu Z S, Chen N, Induced aggregation under confidence levels. International Journal of Uncertainty, Fuzziness and Knowledge-Based Systems 19(2),2011, pp.201-227

[13] Xu Z S, Xia M M ,Distance and similarity measures on hesitant fuzzy sets. Information Sciences 181(11),2011, pp.2128-2138.

[14] Xu Z S, Xia M M , On distance and correlation measures of hesitant fuzzy information. Inter-national Journal of Intelligent Systems 26(5),2011,pp. 410-425.

[15] Xu ZS ,Methods for aggregating interval-valued intuitionistic fuzzy information and their application to decision making. Control Decis,22(2) ,2007 , pp.215-219.

[16] Wei GW, Wang XR ,Some geometric aggregation operators based on interval-valued intuitionistic fuzzy sets and their application to group decision making, In Proceedings of the international conference on computational intelligence and security. Washington, DC, USA: IEEE Computer Society Press, 2007, pp. 495-499.

[17] Xu ZS, Chen J , On geometric aggregation over interval-valued intuitionistic fuzzy information., In Proceedings of the fourth international conference on fuzzy systems and knowledge discovery. Washington, DC, USA: IEEE Computer Society Press,,2007,pp. 466-471.

A new multi-criteria decision making algorithm for medical diagnosis and classification problems using divergence measure of picture fuzzy sets

Nguyen Xuan Thao, Mumtaz Ali, Le Thi Nhung, Hemant Kumar Gianey, Florentin Smarandache

Nguyen Xuan Thao, Mumtaz Ali, Le Thi Nhung, Hemant Kumar Gianey, Florentin Smarandache (2019). A new multi-criteria decision making algorithm for medical diagnosis and classification problems using divergence measure of picture fuzzy sets. *Journal of Intelligent & Fuzzy Systems* 37(6), 7785-7796; DOI: 10.3233/JIFS-182697

Abstract. A divergence measure plays an important part in distinguishing two probability distributions and drawing conclusions based on that discrimination. In this paper, we proposed the concept of divergence measure of picture fuzzy sets. We also built some formulas of the proposed divergence measure of picture fuzzy sets and discussed some basic properties of this measure. Based on the proposed measure, we developed a multi-criteria decision-making algorithm. Finally, we applied the proposed multi-criteria decision-making algorithm in the medical diagnosis problem and the classification problem.

Keywords: Picture fuzzy set, picture fuzzy divergence measure, medical diagnosis, classification problem

1. Introduction

The multi-criteria decision-making model has been applied to many practical problems. Approaches to building a decision-making model are also diverse and rich. The decision making depends on the information collected and the subjectivity of the decision maker. Information may be vague, inaccurate and uncertain. The subjectivity of decision makers can also be influenced by many factors such as information, psychology. Therefore, decision making in an uncertain environment has been of interest

to many researchers, especially decision-making models in fuzzy environments [13–20, 24, 42, 51–55]. The ranking of objects is very important in the decision-making process. The ranking of objects can be done based on the aggregation operators [2, 14–19, 42], or cross-entropy operators [51]. The ranking can be based on measures such as the similarity measures, the distance measures or dissimilarity measures [13, 24, 42]. In addition, the decision-making based on the divergence measures of fuzzy sets and the intuitionistic fuzzy sets are also interested and developed by many researchers [9, 10, 12, 21–23, 25, 26, 32, 43, 44].

The picture fuzzy set [3] was first introduced by Cuong as an extension of the intuitionistic fuzzy set [1] and fuzzy set [50]. It is a useful mathematical tool

for dealing with ambiguous and inaccurate problems. So far, many theoretical and applied results have been exploited on picture fuzzy sets [3–5, 7, 8, 11, 13, 24, 27, 29–31, 33, 34, 42, 45–47]. Cuong et al. continued to study the operators on picture fuzzy sets [4, 5]. Dinh et al. [7] studied the dissimilarity and distance measures of picture fuzzy sets and applied them in classification problems. The class of fuzzy clustering problems was illustrated by the authors Kumar et al. [11], Son et al. [29–31] and Thong et al. [38–40]. The aggregation operators of the picture fuzzy sets were also investigated and applied in multi-criterion decision-making problems as Garg [8], Wang et al. [45], and Wei et al. [46]. Wei et al. [47] studied the picture fuzzy cross-entropy for multiple attribute decision-making problems. Thao and Dinh [34] established the concept of rough picture fuzzy sets and studied the properties of them together picture fuzzy topologies on rough picture fuzzy sets. Dinh et al. studied the fuzzy picture database and applied it to searching for criminals [41]. Another operator of picture fuzzy sets is the correlation coefficient which was also published by Singh [27] and used in some classes of decision, clustering and classification problems with picture fuzzy information.

In the area of research on applications of fuzzy set theory, researchers are often very interested in measurements between fuzzy sets. Measures are often used to measure the degree of similarity or dissimilarity between objects. One of the dissimilarity measures of fuzzy sets/intuitionistic fuzzy sets was recently investigated by investigators as a measure of the divergence of fuzzy sets [22, 23, 25]. Divergence measures also have many applications in practical problem classes and give us interesting results. Some authors applied divergence measure to determine the relationship between the patient and the treatment regimen based on symptoms, thereby selecting the most appropriate treatment regimen for each patient [26]. Divergence measure was also used in multi-criteria decision problems [21, 32, 41]. The picture fuzzy set is considered an extension of the fuzzy set and the intuitionistic fuzzy set. Therefore, following the results of research on the measures on the fuzzy sets, the intuitionistic fuzzy sets for the picture fuzzy sets is also natural and necessary. That is the driving force for us to study the divergence measure of the picture fuzzy sets both in theory and its application.

In this paper, we introduce the concept of the divergence measure of picture fuzzy sets, called picture fuzzy divergence measure, a kind of dissimilarity measure. This is a new concept that has never been

mentioned before. We also give some expressions that define the picture fuzzy divergence measure and investigate the properties of them. After that, we develop a multi-criteria decision-making algorithm, apply it in the medical diagnosis problem and the classification problem and compare the obtained results to the calculated results by the other measures. The results show that our measure is really robust and effective.

The article is organized as follows: In Section 2, we recall the knowledge related to picture fuzzy sets. In Section 3, we introduce the concept of picture fuzzy divergence measure and investigate their properties. We show some applications of picture fuzzy divergence measures in Section 4. Section 5, we give conclusion on picture fuzzy divergence measures and some development direction of them.

2. Preliminary

Definition 1. Picture fuzzy set (PFS):

$$A = \{(x, \mu_A(x), \eta_A(x), \gamma_A(x)) | x \in U\} \quad (1)$$

where $\mu_A(x) \in [0, 1]$ is a membership function, $\eta_A(x) \in [0, 1]$ is neutral membership function, $\gamma_A(x) \in [0, 1]$ is a non-membership function of A and $\mu_A(x) + \eta_A(x) + \gamma_A(x) \leq 1$ for all $u \in S$.

We denote $PFS(U)$ is a collection of picture fuzzy set on U . In which $U = \{(u, 1, 0, 0) | u \in U\}$ and $\emptyset = \{(u, 0, 0, 1) | u \in U\}$.

The picture fuzzy set is a particular case of the neutrosophic set [28], where $\mu_A(x) + \eta_A(x) + \gamma_A(x) \leq 3$ for all $u \in S$.

For two sets $A, B \in PFS(U)$ we have:

– Union of A and B :

$$A \cup B = \left\{ (x, \max(\mu_A(x), \mu_B(x)), \min(\eta_A(x), \eta_B(x)), \min(\gamma_A(x), \gamma_B(x))) | x \in U \right\}$$

– Intersection of A and B :

$$A \cap B = \left\{ (x, \min(\mu_A(x), \mu_B(x)), \min(\eta_A(x), \eta_B(x)), \max(\gamma_A(x), \gamma_B(x))) | x \in U \right\}$$

– Subset: $A \subseteq B$ iff $\mu_A(x) \leq \mu_B(x), \eta_A(x) \leq \eta_B(x)$

– Complement of A : $A^C = \{(x, \gamma_A(x), \eta_A(x), \mu_A(x)) | x \in U\}$

Now, we define an operator called difference between picture fuzzy sets.

3. Divergence measure of picture fuzzy sets

Definition 2. Let A and B be two picture fuzzy sets on U . A function $D : PFS(U) \times PFS(U) \rightarrow R$ (R is the real number set) is a divergence measure of picture fuzzy sets if it satisfies the following conditions:

- Div1. $D(A, B) = D(B, A)$,
- Div2. $D(A, A) = 0$,
- Div3. $D(A \cap C, B \cap C) \leq D(A, B)$ for all $C \in PFS(U)$,
- Div4. $D(A \cup C, B \cup C) \leq D(A, B)$ for all $C \in PFS(U)$.

We call the divergence measure in definition 2 is the picture fuzzy divergence measure.

We can easily see that a picture fuzzy divergence measure is not negative. Because, if we choose $C = \emptyset$ then from conditions Div2 and Div3 in definition 2 we have $D(A, B) \geq D(A \cap C, B \cap C) = D(\emptyset, \emptyset) = 0$.

Now we give some divergence measures of picture fuzzy sets and their properties.

Definition 3. Let A and B be two picture fuzzy sets on $U = \{u_1, u_2, \dots, u_n\}$. A function $D : PFS(U) \times PFS(U) \rightarrow R$ is defined as follows:

$$D(A, B) = \frac{1}{n} \sum_{i=1}^n [D_{\mu}^i(A, B) + D_{\eta}^i(A, B) + D_{\gamma}^i(A, B)] \tag{2}$$

where

$$D_{\mu}^i(A, B) = \mu_A(u_i) \ln \frac{2\mu_A(u_i)}{\mu_A(u_i) + \mu_B(u_i)} + \mu_B(u_i) \ln \frac{2\mu_B(u_i)}{\mu_A(u_i) + \mu_B(u_i)} \tag{3}$$

$$D_{\eta}^i(A, B) = \eta_A(u_i) \ln \frac{2\eta_A(u_i)}{\eta_A(u_i) + \eta_B(u_i)} + \eta_B(u_i) \ln \frac{2\eta_B(u_i)}{\eta_A(u_i) + \eta_B(u_i)} \tag{4}$$

and

$$D_{\gamma}^i(A, B) = \gamma_A(u_i) \ln \frac{2\gamma_A(u_i)}{\gamma_A(u_i) + \gamma_B(u_i)} + \gamma_B(x_i) \ln \frac{2\gamma_B(u_i)}{\gamma_A(u_i) + \gamma_B(u_i)} \tag{5}$$

Example 1. Assume that there are two patterns denoted by picture fuzzy sets on $U = \{u_1, u_2, u_3\}$ as follows

$$A = \{(u_1, 0.2, 0.2, 0.2), (u_2, 0.3, 0.4, 0.1), (u_3, 0.2, 0.1, 0.6)\},$$

$$B = \{(u_1, 0.6, 0.1, 0.3), (u_2, 0.2, 0.1, 0.6), (u_3, 0.1, 0.2, 0.7)\}$$

By using Equations (2)–(5) in Definition 3, we have

$$D_{\mu}^1(A, B) = 0.10465, D_{\mu}^2(A, B) = 0.01007,$$

$$D_{\mu}^3(A, B) = 0.01699, D_{\eta}^1(A, B) = 0.01699,$$

$$D_{\eta}^2(A, B) = 0.09637, D_{\eta}^3(A, B) = 0.01699,$$

$$D_{\gamma}^1(A, B) = 0.01007, D_{\gamma}^2(A, B) = 0.19812,$$

$$D_{\gamma}^3(A, B) = 0.00385$$

and $D(A, B) = 0.15803$.

To proof that $D(A, B)$ is a divergence measure of picture fuzzy sets we need some following lemmas.

Lemma 1. Given $a \in (0, 1]$. For all $z \in [0, 1 - a]$ then:

$$f(z) = a \ln \frac{2a}{2a+z} + (a+z) \ln \frac{2a+2z}{2a+z} \tag{6}$$

is a non-decreasing function and $f(z) \geq 0$.

Proof. We obtain $\frac{\partial f(z)}{\partial z} = \ln \frac{2a+2z}{2a+z} \geq 0$ for all $z \in [0, 1 - a]$.

Lemma 2. Given $b \in (0, 1]$. For all $z \in (0, b]$ then

$$f(z) = b \ln \frac{2b}{b+z} + z \ln \frac{2z}{b+z} \tag{7}$$

is a non-decreasing function and $f(z) \geq 0$.

Proof. We have $\frac{\partial f(z)}{\partial z} = \ln \frac{2z}{b+z} \leq 0$ for all $z \in (0, b]$.

Lemma 3. Given $a \in (0, 1]$. For all $z \in [a, 1]$ then

$$f(z) = a \ln \frac{2a}{a+z} + z \ln \frac{2z}{a+z} \tag{8}$$

is a non-decreasing function and $f(z) \geq 0$.

Proof. We have $\frac{\partial f(z)}{\partial z} = \ln \frac{2z}{a+z} \leq 0$ for all $z \in [a, 1]$.

Theorem 1. The function $D(A, B)$ defined by Equations (2)–(5) (in definition 3) is a divergence measure of two picture fuzzy sets.

Proof. We check the conditions of the definition. For two picture fuzzy sets A and B on U , we have:

- Div1: $D(A, B) = D(B, A)$,
- Div2: If $B \equiv A$ we have $D_\mu^i(A, B) = D_\eta^i(A, B) = D_\gamma^i(A, B) = 0$. So that $D(A, B) = 0$.
- Div3. For all $C \in PFS(U)$ and for all $u_i \in U, (i = 1, 2, \dots, n)$. Because of the symmetry, we can consider the following cases we have:

– With positive degree, we have:

+If $\mu_A(u_i) \leq \mu_B(u_i) \leq \mu_C(u_i)$ then $\mu_{A \cap C}(u_i) = \mu_A(u_i)$ and $\mu_{B \cap C}(u_i) = \mu_B(u_i)$ so that

$$\begin{aligned} & D_\mu^i(A \cap C, B \cap C) \\ &= \mu_{A \cap C}(u_i) \ln \frac{2\mu_{A \cap C}(u_i)}{\mu_{A \cap C}(u_i) + \mu_{B \cap C}(u_i)} \\ &+ \mu_{B \cap C}(u_i) \ln \frac{2\mu_{B \cap C}(u_i)}{\mu_{A \cap C}(u_i) + \mu_{B \cap C}(u_i)} \\ &= \mu_A(u_i) \ln \frac{2\mu_A(u_i)}{\mu_A(u_i) + \mu_B(u_i)} \\ &+ \mu_B(u_i) \ln \frac{2\mu_B(u_i)}{\mu_A(u_i) + \mu_B(u_i)} \\ &= D_\mu^i(A, B) \end{aligned}$$

+ If $\mu_A(u_i) \leq \mu_C(u_i) \leq \mu_B(u_i)$ then $\mu_{A \cup C}(u_i) = \mu_C(u_i)$ and $\mu_{B \cup C}(u_i) = \mu_B(u_i)$. So that, according the lemma 3 with $a = \mu_A(u_i)$ we have:

$$\begin{aligned} & D_\mu^i(A \cap C, B \cap C) \\ &= \mu_A(u_i) \ln \frac{2\mu_A(u_i)}{\mu_A(u_i) + \mu_C(u_i)} + \mu_C(u_i) \ln \frac{2\mu_C(u_i)}{\mu_A(u_i) + \mu_C(u_i)} \\ &\leq \mu_A(u_i) \ln \frac{2\mu_A(u_i)}{\mu_A(u_i) + \mu_B(u_i)} + \mu_C(u_i) \ln \frac{2\mu_B(u_i)}{\mu_A(u_i) + \mu_B(u_i)} \\ &= D_\mu^i(A, B) \end{aligned}$$

+If $\mu_C(u_i) \leq \mu_A(u_i) \leq \mu_B(u_i)$ then $\mu_{A \cap C}(u_i) = \mu_{B \cap C}(u_i) = \mu_C(u_i)$ and $\mu_B(u_i) = \mu_C(u_i) + z$ with $z \in [0, 1 - \mu_A(u_i)]$ so that according the lemma 1 we have:

$$\begin{aligned} & D_\mu^i(A \cap C, B \cap C) \\ &= \mu_C(u_i) \ln \frac{2\mu_C(u_i)}{\mu_C(u_i) + \mu_C(u_i)} + \mu_C(u_i) \ln \frac{2\mu_C(u_i)}{\mu_C(u_i) + \mu_C(u_i)} = 0 \\ &\leq \mu_A(u_i) \ln \frac{2\mu_A(u_i)}{2\mu_A(u_i) + z} + \mu_B(u_i) \ln \frac{2\mu_A(u_i) + 2z}{2\mu_A(u_i) + z} \\ &= \mu_A(u_i) \ln \frac{2\mu_A(u_i)}{\mu_A(u_i) + \mu_B(u_i)} + \mu_B(u_i) \ln \frac{2\mu_B(u_i)}{\mu_A(u_i) + \mu_B(u_i)} \\ &= D_\mu^i(A, B). \end{aligned}$$

- With neutral degree: We do the same with the case of positive degree.
- With negative degree, we have:

+If $\gamma_A(u_i) \leq \gamma_B(u_i) \leq \gamma_C(u_i)$ then $\gamma_{A \cap C}(u_i) = \gamma_C(u_i)$ and $\gamma_{B \cap C}(u_i) = \gamma_C(u_i)$ so that according lemma 1 we have:

$$\begin{aligned} & D_\gamma^i(A \cap C, B \cap C) \\ &= \gamma_{A \cap C}(u_i) \ln \frac{2\gamma_{A \cap C}(u_i)}{\gamma_{A \cap C}(u_i) + \gamma_{B \cap C}(u_i)} \\ &+ \gamma_{B \cap C}(u_i) \ln \frac{2\gamma_{B \cap C}(u_i)}{\gamma_{A \cap C}(u_i) + \gamma_{B \cap C}(u_i)} \\ &= \gamma_C(u_i) \ln \frac{2\gamma_C(u_i)}{\gamma_C(u_i) + \gamma_C(u_i)} + \gamma_C(u_i) \ln \frac{2\gamma_C(u_i)}{\gamma_C(u_i) + \gamma_C(u_i)} = 0 \\ &\leq \gamma_A(u_i) \ln \frac{2\gamma_A(u_i)}{\gamma_A(u_i) + \gamma_B(u_i)} + \gamma_B(u_i) \ln \frac{2\gamma_B(u_i)}{\gamma_A(u_i) + \gamma_B(u_i)} \\ &= D_\gamma^i(A, B) \end{aligned}$$

+If $\gamma_A(u_i) \leq \gamma_C(u_i) \leq \gamma_B(u_i)$ then $\gamma_{A \cup C}(u_i) = \gamma_C(u_i)$ and $\gamma_{B \cup C}(u_i) = \gamma_B(u_i)$. So that, according the lemma 2 with $b = \gamma_B(u_i)$ we have:

$$\begin{aligned} & D_\gamma^i(A \cap C, B \cap C) \\ &= \gamma_C(u_i) \ln \frac{2\gamma_C(u_i)}{\gamma_C(u_i) + \gamma_B(u_i)} + \gamma_B(u_i) \ln \frac{2\gamma_B(u_i)}{\gamma_C(u_i) + \gamma_B(u_i)} \\ &\leq \gamma_A(u_i) \ln \frac{2\gamma_A(u_i)}{\gamma_A(u_i) + \gamma_B(u_i)} + \gamma_B(u_i) \ln \frac{2\gamma_B(u_i)}{\gamma_A(u_i) + \gamma_B(u_i)} \\ &= D_\gamma^i(A, B) \end{aligned}$$

+If $\gamma_C(u_i) \leq \gamma_A(u_i) \leq \gamma_B(u_i)$ then according the lemma 1 we have:

$$\begin{aligned} & D_\gamma^i(A \cap C, B \cap C) \\ &= \gamma_A(u_i) \ln \frac{2\gamma_A(u_i)}{\gamma_A(u_i) + \gamma_B(u_i)} + \gamma_B(u_i) \ln \frac{2\gamma_B(u_i)}{\gamma_A(u_i) + \gamma_B(u_i)} \\ &= D_\gamma^i(A, B). \end{aligned}$$

Now, we add that with respect to the respective components we have:

$$\begin{aligned} & D(A \cap C, B \cap C) \\ &= \frac{1}{n} \sum_{i=1}^n [D_\mu^i(A \cap C, B \cap C) + D_\eta^i(A \cap C, B \cap C) \\ &+ D_\gamma^i(A \cap C, B \cap C)] \\ &\leq \frac{1}{n} \sum_{i=1}^n [D_\mu^i(A, B) + D_\eta^i(A, B) + D_\gamma^i(A, B)] \\ &= D(A, B) \end{aligned}$$

- Div4. We perform as Div3.

Some properties of divergence measure defined by definition 3.

Theorem 2. For all picture fuzzy sets $A, B \in PFS(U)$, we have:

- (D1) $D(A^C, B^C) = D(A, B)$,
- (D2) $D(A^C, B) = D(A, B^C)$,
- (D3) For all $A \subseteq B$, or $B \subseteq A$ we have $D(A \cap B, B) = D(A, A \cup B) \leq D(A, B)$,
- (D4) $D(A \cap B, A \cup B) = D(A, B)$,
- (D5) For all $A \subseteq B \subseteq C$ we have $D(A, B) \leq D(A, C)$,
- (D6) For all $A \subseteq B \subseteq C$ we have $D(B, C) \leq D(A, C)$.

Proof. (D1). We have:

$$\begin{aligned} D_{\mu}^i(A^C, B^C) &= \mu_{A^C}(u_i) \ln \frac{2\mu_{A^C}(u_i)}{\mu_{A^C}(u_i) + \mu_{B^C}(u_i)} \\ &\quad + \mu_{B^C}(u_i) \ln \frac{2\mu_{B^C}(u_i)}{\mu_{A^C}(u_i) + \mu_{B^C}(u_i)} \\ &= \gamma_A(u_i) \ln \frac{2\gamma_A(u_i)}{\gamma_A(u_i) + \gamma_B(u_i)} \\ &\quad + \gamma_B(u_i) \ln \frac{2\gamma_B(u_i)}{\gamma_A(u_i) + \gamma_B(u_i)} \\ &= D_{\gamma}^i(A, B), D_{\eta}^i(A^C, B^C) \\ &= D_{\eta}^i(A, B), D_{\gamma}^i(A^C, B^C) \\ &= D_{\mu}^i(A, B). \end{aligned}$$

(D2). We have:

$$\begin{aligned} D_{\mu}^i(A^C, B) &= \mu_{A^C}(u_i) \ln \frac{2\mu_{A^C}(u_i)}{\mu_{A^C}(u_i) + \mu_B(u_i)} \\ &\quad + \mu_B(u_i) \ln \frac{2\mu_B(u_i)}{\mu_{A^C}(u_i) + \mu_B(u_i)} \\ &= \gamma_A(u_i) \ln \frac{2\gamma_A(u_i)}{\gamma_A(u_i) + \mu_B(u_i)} \\ &\quad + \mu_B(u_i) \ln \frac{2\mu_B(u_i)}{\gamma_A(u_i) + \mu_B(u_i)} \\ &= D_{\gamma}^i(A, B^C), D_{\eta}^i(A^C, B) \\ &= D_{\eta}^i(A, B^C), D_{\gamma}^i(A^C, B) \\ &= D_{\mu}^i(A, B^C) \end{aligned}$$

So that

$$D(A^C, B) = \frac{1}{n} \sum_{i=1}^n [D_{\mu}^i(A^C, B) + D_{\eta}^i(A^C, B) + D_{\gamma}^i(A^C, B)]$$

$$\begin{aligned} &= \frac{1}{n} \sum_{i=1}^n [D_{\gamma}^i(A, B^C) + D_{\eta}^i(A, B^C) + D_{\mu}^i(A, B^C)] \\ &= D(A, B^C). \end{aligned}$$

(D3). If $A \subseteq B$ then $D(A \cap B, B) = D(A, B)$, and $D(A, A \cup B) = D(A, B)$.

If $B \subseteq A$ then $D(A \cap B, B) = D(B, B) = 0$, and $D(A, A \cup B) = D(A, A) = 0$.

It means that if $A \subseteq B$, or $B \subseteq A$ we have $D(A \cap B, B) = D(A, A \cup B) \leq D(A, B)$.

(D4). Because of the symmetry of the divergence measure, we consider the cases:

– If $\mu_A(u_i) \leq \mu_B(u_i)$ then we have:

$$\begin{aligned} D_{\mu}^i(A \cup B, A \cap B) &= \mu_B(u_i) \ln \frac{2\mu_B(u_i)}{\mu_A(u_i) + \mu_B(u_i)} \\ &\quad + \mu_A(u_i) \ln \frac{2\mu_A(u_i)}{\mu_A(u_i) + \mu_B(u_i)} \\ &= D(A, B). \end{aligned}$$

– If $\mu_B(u_i) \leq \mu_A(u_i)$ then we have:

$$\begin{aligned} D_{\mu}^i(A \cup B, A \cap B) &= \mu_A(u_i) \ln \frac{2\mu_A(u_i)}{\mu_A(u_i) + \mu_B(u_i)} \\ &\quad + \mu_B(u_i) \ln \frac{2\mu_B(u_i)}{\mu_A(u_i) + \mu_B(u_i)} \\ &= D(A, B). \end{aligned}$$

By the same consideration for the neutral degree and negative degree, we obtain

$$D(A \cap B, A \cup B) = D(A, B).$$

(D5). For all $A \subseteq B \subseteq C$ and for all $u_i \in U$ we have:

– With the positive degree:

From condition $\mu_A(u_i) \leq \mu_B(u_i) \leq \mu_C(u_i)$ and lemma 2 we have:

$$\begin{aligned} D_{\mu}^i(A, B) &= \mu_A(u_i) \ln \frac{2\mu_A(u_i)}{\mu_A(u_i) + \mu_B(u_i)} + \mu_B(u_i) \ln \frac{2\mu_B(u_i)}{\mu_A(u_i) + \mu_B(u_i)} \\ &= \mu_A(u_i) \ln \frac{2\mu_A(u_i)}{\mu_A(u_i) + \mu_C(u_i)} + \mu_C(u_i) \ln \frac{2\mu_C(u_i)}{\mu_C(u_i) + \mu_A(u_i)} \\ &= D_{\mu}^i(A, C). \end{aligned}$$

– With the neutral degree:

By the same way as the positive we have $D_{\eta}^i(A, B) \leq D_{\eta}^i(A, C)$.

– With the negative degree:

From condition $\gamma_A(u_i) \geq \gamma_B(u_i) \geq \gamma_C(u_i)$ and lemma 3 we have:

$$\begin{aligned} D_{\gamma}^i(A, B) &= \gamma_A(u_i) \ln \frac{2\gamma_A(u_i)}{\gamma_A(u_i) + \gamma_B(u_i)} \\ &\quad + \gamma_B(u_i) \ln \frac{2\gamma_B(u_i)}{\gamma_A(u_i) + \gamma_B(u_i)} \\ &\leq \gamma_A(u_i) \ln \frac{2\gamma_A(u_i)}{\gamma_A(u_i) + \gamma_C(u_i)} \\ &\quad + \gamma_C(u_i) \ln \frac{2\gamma_C(u_i)}{\gamma_A(u_i) + \gamma_C(u_i)} \\ &= D_{\gamma}^i(A, C). \end{aligned}$$

So that, we obtain the result $D(A, B) \leq D(A, C)$.

(D6). By the same way as (D5) using lemma 1, lemma 2 and lemma 3, it is easy to derive these results when considering specific cases.

Definition 4. Let A and B be two picture fuzzy sets on $U = \{u_1, u_2, \dots, u_n\}$. A function $D : PFS(U) \times PFS(U) \rightarrow R$ is defined as follows

$$\bar{D}(A, B) = \frac{1}{n} \sum_{i=1}^n [\bar{D}_{\mu}^i(A, B) + \bar{D}_{\eta}^i(A, B) + \bar{D}_{\gamma}^i(A, B)] \tag{9}$$

where

$$\bar{D}_{\mu}^i(A, B) = \mu_A(u_i) \ln \frac{\mu_A(u_i)}{\mu_B(u_i)} + \mu_B(u_i) \ln \frac{\mu_B(u_i)}{\mu_A(u_i)} \tag{10}$$

$$\bar{D}_{\eta}^i(A, B) = \eta_A(u_i) \ln \frac{\eta_A(u_i)}{\eta_B(u_i)} + \eta_B(u_i) \ln \frac{\eta_B(u_i)}{\eta_A(u_i)} \tag{11}$$

and

$$\bar{D}_{\gamma}^i(A, B) = \gamma_A(u_i) \ln \frac{\gamma_A(u_i)}{\gamma_B(u_i)} + \gamma_B(u_i) \ln \frac{\gamma_B(u_i)}{\gamma_A(u_i)} \tag{12}$$

for all $u_i \in U$.

Example 2. With two picture fuzzy sets A and B in Example 1, using Equations (9)–(12) in Definition 4, we have

$$\bar{D}_{\mu}^1(A, B) = 0.43944, \bar{D}_{\mu}^2(A, B) = 0.04055,$$

$$\bar{D}_{\mu}^3(A, B) = 0.06931,$$

$$\bar{D}_{\eta}^1(A, B) = 0.06931, \bar{D}_{\eta}^2(A, B) = 0.41589,$$

$$\bar{D}_{\eta}^3(A, B) = 0.06931,$$

$$\bar{D}_{\gamma}^1(A, B) = 0.04055, \bar{D}_{\gamma}^2(A, B) = 0.89588,$$

$$\bar{D}_{\gamma}^3(A, B) = 0.01542$$

and $\bar{D}(A, B) = 0.68522$.

To proof that $D(A, B)$ is a divergence measure of picture fuzzy sets we need some following lemmas.

Now we consider the function:

$$f(x, y) = x \ln \frac{x}{y} + y \ln \frac{y}{x}, \forall x, y \in (0, 1] \tag{13}$$

Transforms the expression of function $f(x, y)$ we have $f(x, y) = (x - y)(\ln x - \ln y) \geq 0, \forall x, y \in (0, 1]$.

Besides, we also have:

$\frac{\partial f}{\partial x}(x, y) = \frac{y-x}{y} + \ln y - \ln x \geq 0$ for all $y \geq x$, and

$\frac{\partial f}{\partial y}(x, y) = \frac{x-y}{y} + \ln x - \ln y \leq 0$ for all $x \leq y$.

So that, we have result that is stated in lemma 4.

Lemma 4. Function $f(x, y) = x \ln \frac{x}{y} + y \ln \frac{y}{x}$ is

- $f(x, y), \forall x, y \in (0, 1]$.
- Increasing with variable x such that $y \geq x$,
- Decreasing with variable y such that $x \leq y$.

Theorem 3. The function $D(A, B)$ defined by using Equations (9)–(12) (in definition 4) is a divergence measure of two picture fuzzy sets.

Proof. We consider divergence measure conditions for function $\bar{D}(A, B)$ defined by Equation (9).

Div1: $\bar{D}(A, B) = \bar{D}(B, A)$ is obvious.

Div2: If $A = B$ then $\mu_A(u_i) = \mu_B(u_i), \eta_A(u_i) = \eta_B(u_i), \gamma_A(u_i) = \gamma_B(u_i)$. So that, when we replace them into the Equations (10, 11, 12) we obtain $\bar{D}(A, B) = 0$.

Div3: $\bar{D}(A \cap C, B \cap C) \leq \bar{D}(A, B)^{\frac{1}{2}}$ for all $C \in PFS(U)$. Indeed, we consider the cases for each degree of picture fuzzy sets:

– With the positive degree:

+If $\mu_A(u_i) \leq \mu_B(u_i) \leq \mu_C(u_i)$ then $\mu_{A \cap C}(u_i) = \mu_A(u_i)$ and $\mu_{B \cap C}(u_i) = \mu_B(u_i)$ so that

$$\begin{aligned} \bar{D}_{\mu}^i(A \cap C, B \cap C) &= \mu_{A \cap C}(u_i) \ln \frac{\mu_{A \cap C}(u_i)}{\mu_{B \cap C}(u_i)} + \mu_{B \cap C}(u_i) \ln \frac{\mu_{B \cap C}(u_i)}{\mu_{A \cap C}(u_i)} \\ &= \mu_A(u_i) \ln \frac{\mu_A(u_i)}{\mu_B(u_i)} + \mu_B(u_i) \ln \frac{\mu_B(u_i)}{\mu_A(u_i)} \\ &= \bar{D}_{\mu}^i(A, B). \end{aligned}$$

+If $\mu_A(u_i) \leq \mu_C(u_i) \leq \mu_B(u_i)$ then $\mu_{A \cup C}(u_i) = \mu_C(u_i)$ and $\mu_{B \cup C}(u_i) = \mu_B(u_i)$. So that, according the lemma 4.b with $x = \mu_A(u_i)$ we have:

$$\begin{aligned} & \bar{D}_\mu^i(A \cap C, B \cap C) \\ &= \mu_A(u_i) \ln \frac{\mu_A(u_i)}{\mu_C(u_i)} + \mu_C(u_i) \ln \frac{\mu_C(u_i)}{\mu_A(u_i)} \\ &\leq \mu_A(u_i) \ln \frac{\mu_A(u_i)}{\mu_B(u_i)} + \mu_C(u_i) \ln \frac{\mu_B(u_i)}{\mu_A(u_i)} \\ &= \bar{D}_\mu^i(A, B). \end{aligned}$$

+If $\mu_C(u_i) \leq \mu_A(u_i) \leq \mu_B(u_i)$ then $\mu_{A \cap C}(u_i) = \mu_{B \cap C}(u_i) = \mu_C(u_i)$ so that according the lemma 4.a we have:

$$\begin{aligned} & \bar{D}_\mu^i(A \cap C, B \cap C) \\ &= \mu_C(u_i) \ln \frac{\mu_C(u_i)}{\mu_C(u_i)} + \mu_C(u_i) \ln \frac{\mu_C(u_i)}{\mu_C(u_i)} = 0 \\ &\leq \mu_A(u_i) \ln \frac{\mu_A(u_i)}{\mu_B(u_i)} + \mu_B(u_i) \ln \frac{\mu_B(u_i)}{\mu_A(u_i)} \\ &= \bar{D}_\mu^i(A, B). \end{aligned}$$

with neutral degree, we do the same with the case of positive degree.

– With negative degree, we have:

+If $\gamma_A(u_i) \leq \gamma_B(u_i) \leq \gamma_C(u_i)$ then $\gamma_{A \cap C}(u_i) = \gamma_C(u_i)$ and $\gamma_{B \cap C}(u_i) = \gamma_C(u_i)$ so that according lemma 1 we have:

$$\begin{aligned} & \bar{D}_\gamma^i(A \cap C, B \cap C) \\ &= \gamma_{A \cap C}(u_i) \ln \frac{\gamma_{A \cap C}(u_i)}{\gamma_{B \cap C}(u_i)} + \gamma_{B \cap C}(u_i) \ln \frac{\gamma_{B \cap C}(u_i)}{\gamma_{A \cap C}(u_i)} \\ &= \gamma_C(u_i) \ln \frac{\gamma_C(u_i)}{\gamma_C(u_i)} + \gamma_C(u_i) \ln \frac{\gamma_C(u_i)}{\gamma_C(u_i)} = 0 \\ &\leq \gamma_A(u_i) \ln \frac{\gamma_A(u_i)}{\gamma_B(u_i)} + \gamma_B(u_i) \ln \frac{\gamma_B(u_i)}{\gamma_A(u_i)} \\ &= \bar{D}_\gamma^i(A, B). \end{aligned}$$

+If $\gamma_A(u_i) \leq \gamma_C(u_i) \leq \gamma_B(u_i)$ then $\gamma_{A \cup C}(u_i) = \gamma_C(u_i)$ and $\gamma_{B \cup C}(u_i) = \gamma_B(u_i)$. So that, according the lemma 4.c with $y = \gamma_B(u_i)$ we have:

$$\begin{aligned} & \bar{D}_\gamma^i(A \cap C, B \cap C) \\ &= \gamma_C(u_i) \ln \frac{\mu_C(u_i)}{\mu_B(u_i)} + \gamma_B(u_i) \ln \frac{\mu_B(u_i)}{\mu_C(u_i)} \end{aligned}$$

$$\begin{aligned} & \leq \gamma_A(u_i) \ln \frac{\gamma_A(u_i)}{\gamma_B(u_i)} + \gamma_B(u_i) \ln \frac{\gamma_B(u_i)}{\gamma_A(u_i)} \\ &= \bar{D}_\gamma^i(A, B). \end{aligned}$$

+If $\gamma_C(u_i) \leq \gamma_A(u_i) \leq \gamma_B(u_i)$ then according the lemma 4.a we have:

$$\begin{aligned} & \bar{D}_\gamma^i(A \cap C, B \cap C) \\ &= \gamma_A(u_i) \ln \frac{\gamma_A(u_i)}{\gamma_B(u_i)} + \gamma_B(u_i) \ln \frac{\gamma_B(u_i)}{\gamma_A(u_i)} \\ &= \bar{D}_\gamma^i(A, B). \end{aligned}$$

Now, we add that with respect to the respective components we have:

$$\begin{aligned} & \bar{D}(A \cap C, B \cap C) \\ &= \frac{1}{n} \sum_{i=1}^n [\bar{D}_\mu^i(A \cap C, B \cap C) + \bar{D}_\eta^i(A \cap C, B \cap C) \\ & \quad + \bar{D}_\gamma^i(A \cap C, B \cap C)] \\ &\leq \frac{1}{n} \sum_{i=1}^n [\bar{D}_\mu^i(A, B) + \bar{D}_\eta^i(A, B) + \bar{D}_\gamma^i(A, B)] \\ &= \bar{D}(A, B). \end{aligned}$$

Div4. We perform as Div3.

Some properties of divergence measure can be defined by theorem 4.

Theorem 4. For all picture fuzzy set $A, B \in PFS(U)$.

- (D1) $\bar{D}(A^C, B^C) = \bar{D}(A, B)$,
- (D2) $\bar{D}(A^C, B) = \bar{D}(A, B^C)$,
- (D3) For all $A \subseteq B$, or $B \subseteq A$ we have $\bar{D}(A \cap B, B) = \bar{D}(A, A \cup B) \leq \bar{D}(A, B)$,
- (D4) $\bar{D}(A \cap B, A \cup B) = \bar{D}(A, B)$,
- (D5) For all $A \subseteq B \subseteq C$, or we have $\bar{D}(A, B) \leq \bar{D}(A, C)$,
- (D6) For all $A \subseteq B \subseteq C$, or we have $\bar{D}(B, C) \leq \bar{D}(A, C)$
- (D7) $\bar{D}(A, A^C) = 0$ if only if $\mu_A(u_i) = \gamma_A(u_i)$, and $\eta_A(u_i) \in [0, 1 - 2\mu_A(u_i)]$.

Proof. The results (D1), (D2), (D3), (D4), (D5), (D6) are proved similar to theorem 2 by using lemma 4.

(D7). We have:

$$\begin{aligned} & \bar{D}_\eta^i(A, A^C) \\ &= \eta_A(u_i) \ln \frac{\eta_A(u_i)}{\eta_{A^C}(u_i)} + \eta_{A^C}(u_i) \ln \frac{\eta_{A^C}(u_i)}{\eta_A(u_i)} \\ &= \eta_A(u_i) \ln \frac{\eta_A(u_i)}{\eta_A(u_i)} + \eta_A(u_i) \ln \frac{\eta_A(u_i)}{\eta_A(u_i)} = 0. \end{aligned}$$

- Let $\bar{D}(A, A^C) = 0$. Because $\bar{D}(A, A^C) \geq 0$ and we must have $\bar{D}_\mu^i(A, A^C) = 0, \bar{D}_\gamma^i(A, A^C) = 0$. We consider:

$$\begin{aligned} &\bar{D}_\mu^i(A, A^C) \\ &= \mu_A(u_i) \ln \frac{\mu_A(u_i)}{\mu_{A^C}(u_i)} + \mu_{A^C}(u_i) \ln \frac{\mu_{A^C}(u_i)}{\mu_A(u_i)} \\ &= (\mu_A(u_i) - \mu_{A^C}(u_i))(\ln \mu_A(u_i) - \ln \mu_{A^C}(u_i)) = 0. \end{aligned}$$

This implies that $\mu_A(u_i) - \mu_{A^C}(u_i) = 0$. It means $\mu_A(u_i) = \mu_{A^C}(u_i) = \gamma_A(u_i)$.

- In contrast, assume that $\mu_A(u_i) = \gamma_A(u_i)$, we have:

$$\begin{aligned} &\bar{D}_\mu^i(A, A^C) \\ &= \mu_A(u_i) \ln \frac{\mu_A(u_i)}{\mu_{A^C}(u_i)} + \mu_{A^C}(u_i) \ln \frac{\mu_{A^C}(u_i)}{\mu_A(u_i)} \\ &= (\mu_A(u_i) - \mu_{A^C}(u_i))(\ln \mu_A(u_i) - \ln \mu_{A^C}(u_i)) \\ &= (\mu_A(u_i) - \gamma_A(u_i))(\ln \mu_A(u_i) - \ln \gamma_A(u_i)) = 0. \end{aligned}$$

and

$$\begin{aligned} &\bar{D}_\gamma^i(A, A^C) \\ &= \gamma_A(u_i) \ln \frac{\gamma_A(u_i)}{\gamma_{A^C}(u_i)} + \gamma_{A^C}(u_i) \ln \frac{\gamma_{A^C}(u_i)}{\gamma_A(u_i)} \\ &= \gamma_A(u_i) \ln \frac{\gamma_A(u_i)}{\mu_A(u_i)} + \mu_A(u_i) \ln \frac{\mu_A(u_i)}{\gamma_A(u_i)} = 0. \end{aligned}$$

So that $\bar{D}(A, A^C) = \frac{1}{n} \sum_{i=1}^n \{\bar{D}_\mu^i(A, A^C) + \bar{D}_\gamma^i(A, A^C)\} = 0$.

4. Applications of divergence measure of picture fuzzy set.

In this section, we apply the picture fuzzy divergence measures in the medical diagnosis and classification problems.

4.1. In the medical diagnosis

Input:

- Diagnosis, in which each Diagnosis is a picture fuzzy set on a universal set of symptoms characteristics.
- Patients in which each pattern is a picture fuzzy set on a universal set of symptoms characteristics.

Output: What diagnosis is best for each patient?

Algorithm:

- **Step 1.** We compute the divergence measure of each patient for all diagnosis by using Equations (2) or (9).
- **Step 2.** For each patient, we choose the smallest value of the divergence measure in Step 1. This will give us the best diagnosis for each patient.

Now, we applied the picture fuzzy divergence measure for obtaining a proper diagnosis for the data given in Tables 1 and 2. This data was modified from the data introduced in [6]. When using the divergence measure we compute all the divergence measure between each patient and each diagnosis. After that, we chose the smallest value of them. This will be give us the best diagnosis for each patient (Tables 3 and 4). The results show that the optimization will be Al (Typhoid), Bob (Stomach Problem), Joe (Viral fever), and Ted (Typhoid).

- Compare with using other measures

+Using the dissimilarity measure of picture fuzzy sets of Le et al., in [13].

$$DM_1(A, B) = \frac{1}{n} \sum_{i=1}^n DM_1^i(A, B) \quad (14)$$

where

$$DM_1^i(A, B) = (|(\mu_A(u_i) - \gamma_A(u_i)) - ((\mu_B(u_i) - \gamma_B(u_i))| + |(\eta_A(u_i) - \gamma_A(u_i)) - ((\eta_B(u_i) - \gamma_B(u_i))|) \text{ for all } u_i \in U \text{ and } i = 1, 2, \dots, n.$$

When using the dissimilarity measure, we compute all the dissimilarity measures between each patient and each diagnosis. After that, we choose the smallest value of them. This measure also gives us the best diagnosis for each patient (Table 5). The results also show that the optimization will be Al (Typhoid), Bob (Stomach Problem), Joe (Viral fever), and Ted (Typhoid).

+Using the dissimilarity measure of picture fuzzy sets of Thao in [24].

$$DM_T(A, B) = \frac{1}{n} \sum_{i=1}^n DM_T^i(A, B) \quad (15)$$

where

$$DM_T^i(A, B) = (|(\mu_A(u_i) + \eta_A(u_i) - \gamma_A(u_i)) - (\mu_B(u_i) + \eta_B(u_i) - \gamma_B(u_i))| + |(\eta_A(u_i) - \gamma_A(u_i)) - (\eta_B(u_i) - \gamma_B(u_i))|) \text{ for all } u_i \in U \text{ and } i = 1, 2, \dots, n.$$

Table 1
Symptoms characteristics for the diagnosis

	Viral fever (V)	Malaria (M)	Typhoid (T)	Stomach problem (S)	Chest problem (C)
Temperature	(0.4,0.5,0.1)	(0.7,0.2,0.1)	(0.3,0.4,0.2)	(0.1,0.2,0.7)	(0.1,0.1,0.8)
Headache	(0.3,0.2,0.4)	(0.2,0.2,0.5)	(0.6,0.1,0.2)	(0.2,0.4,0.3)	(0.05,0.2,0.7)
Stomach pain	(0.8,0.1,0.1)	(0.01,0.9,0.05)	(0.2,0.1,0.5)	(0.7,0.2,0.1)	(0.2,0.1,0.6)
Cough	(0.45,0.3,0.1)	(0.7,0.2,0.1)	(0.2,0.2,0.5)	(0.2,0.1,0.65)	(0.2,0.1,0.6)
Chest pain	(0.1,0.6,0.2)	(0.1,0.1,0.8)	(0.1,0.05,0.8)	(0.2,0.1,0.6)	(0.8,0.1,0.1)

Table 2
Symptoms characteristics for the patients

	Temperature	Headache	Stomach pain	Cough	Chest pain
Al	(0.7,0.1,0.15)	(0.6,0.3,0.05)	(0.25,0.45,0.25)	(0.2,0.25,0.5)	(0.1,0.2,0.6)
Bob	(0.2,0.3,0.45)	(0.05,0.5,0.4)	(0.6,0.15,0.25)	(0.25,0.4,0.35)	(0.02,0.25,0.65)
Joe	(0.75,0.05,0.05)	(0.02,0.85,0.1)	(0.3,0.2,0.4)	(0.7,0.25,0.05)	(0.25,0.4,0.4)
Ted	(0.4,0.2,0.3)	(0.7,0.2,0.1)	(0.2,0.2,0.5)	(0.2,0.1,0.65)	(0.1,0.5,0.25)

Table 3
Diagnosis results for the divergence measure using Equation (2)

	Viral fever	Malaria	Typhoid	Stomach Problem	Chest Problem
Al	0.223922	0.206541	0.102753	0.188912	0.282006
Bob	0.147244	0.315669	0.166453	0.115887	0.255222
Joe	0.224068	0.260287	0.310353	0.365106	0.380268
Ted	0.197407	0.350241	0.099601	0.282984	0.165600

Table 5
Diagnosis results for the dissimilarity measure using Equation (14)

	Viral fever	Malaria	Typhoid	Stomach problem	Chest problem
Al	0.2500	0.2110	0.1350	0.1875	0.3750
Bob	0.2015	0.2320	0.1785	0.1340	0.3090
Joe	0.1810	0.2010	0.2590	0.2885	0.3785
Ted	0.2375	0.3545	0.1375	0.2050	0.2250

Table 4
Diagnosis results for the divergence measure using Equation (9)

	Viral fever	Malaria	Typhoid	Stomach Problem	Chest Problem
Al	0.3231	0.3159	0.1456	0.2746	0.3387
Bob	0.1858	0.5115	0.1998	0.1312	0.1806
Joe	0.3337	0.4017	0.4980	0.5257	0.3938
Ted	0.2850	0.5302	0.1477	0.2871	0.1990

Table 6
Diagnosis results for the dissimilarity measure using Equation (15)

	Viral fever	Malaria	Typhoid	Stomach problem	Chest problem
Al	0.2550	0.2420	0.1575	0.1675	0.4025
Bob	0.2065	0.2080	0.1816	0.1440	0.3490
Joe	0.2085	0.2705	0.2510	0.3210	0.4160
Ted	0.2675	0.4145	0.1850	0.2150	0.2450

Table 7
Diagnosis results for the similarity measure using Equation (16)

	Viral fever	Malaria	Typhoid	Stomach problem	Chest problem
Al	0.6736	0.7876	0.8627	0.7384	0.5212
Bob	0.8052	0.6482	0.7648	0.9162	0.6792
Joe	0.7875	0.7725	0.6257	0.6322	0.6193
Ted	0.8088	0.6379	0.8693	0.7029	0.8559

When using the dissimilarity measure we compute all the dissimilarity measure between each patient and each diagnosis. After that, we choose the smallest value of them. This measure also gives us the best diagnosis for each patient (Table 6). The results also show that the optimization will be Al (Typhoid), Bob (Stomach Problem), Joe (Viral fever), and Ted (Typhoid).

+Using the similarity measure of picture fuzzy sets of Weiin [45].

$$C(A, B) = \frac{1}{n} \sum_{i=1}^n C^i(A, B) \tag{16}$$

where

$$C^i(A, B) = \frac{(\mu_A(u_i)\mu_B(u_i) + \eta_A(u_i)\eta_B(u_i) + \gamma_A(u_i)\gamma_B(u_i))}{\text{sqrt}(\mu_A^2(u_i) + \eta_A^2(u_i) + \gamma_A^2(u_i)) \times \text{sqrt}(\mu_B^2(u_i) + \eta_B^2(u_i) + \gamma_B^2(u_i))}$$

for all $u_i \in U$ and $i = 1, 2, \dots, n$.

When using the similarity measure, we compute all the similarity measures between each patient and each diagnosis. After that, we choose the largest value of them. This measure also gives us the best

Table 8
The most suitable relationship between patients and diagnosis when using some other measures (T: Typhoid, S: Stomach Problem, V: Viral fever)

	Proposed method in Equation (2)	Proposed method in Equation (9)	Method in [13]	Method in [24]	Method in [48]
Al	T	T	T	T	T
Bob	S	S	S	S	S
Joe	V	V	V	V	V
Ted	T	T	T	T	T

diagnosis for each patient (Table 7). The results also show that the optimization will be Al (Typhoid), Bob (Stomach Problem), Joe (Viral fever), and Ted (Typhoid).

The combined results of using different methods for solving the above problem are shown in Table 8. It gives us the most relevant results of the relationship between the patient and the diagnosis when using different measures. From Table 8, we find that the results of using the proposed method are also consistent with the results when using other existing measures on the picture fuzzy sets.

4.2. In the classification problem

Assume that, we have m pattern $\{A_1, A_2, \dots, A_m\}$, in which each pattern is a picture fuzzy set on universal set $U = \{u_1, u_2, \dots, u_n\}$. Suppose that, we have a sample B with the given feature information. Our goal is to classify sample B into which sample. To solve this, we calculate the divergence measure of B with each pattern $A_i (i = 1, 2, \dots, m)$. Then we choose the smallest value. It gives us the class that B belongs to.

Input:

- m pattern $\{A_1, A_2, \dots, A_m\}$, in which each pattern is a picture fuzzy set on universal set $U = \{u_1, u_2, \dots, u_n\}$.
- Sample B is a picture fuzzy set on universal set $U = \{u_1, u_2, \dots, u_n\}$.

Output: What classification is B belong to?

Algorithm:

- **Step 1.** We compute the divergence measures $D(A_i, B), i = 1, 2, \dots, m$ by using Equations (2) or (9).
- **Step 2.** Put B belongs to the class of A_{i^*} in which $D(A_{i^*}, B) = \min\{D(A_i, B)|i = 1, 2, \dots, m\}$.

Example 3. Assume that there are three picture fuzzy patterns in $U = \{u_1, u_2, u_3\}$ as following

$$A_1 = \{(u_1, 0.4, 0.4, 0.1), (u_2, 0.7, 0.15, 0.1), (u_3, 0.3, 0.3, 0.2)\}$$

$$A_2 = \{(u_1, 0.5, 0.3, 0.1), (u_2, 0.7, 0.2, 0.05), (u_3, 0.5, 0.3, 0.1)\}$$

$$A_3 = \{(u_1, 0.4, 0.5, 0.1), (u_2, 0.7, 0.1, 0.1), (u_3, 0.4, 0.3, 0.2)\}$$

Assume that a sample

$$B = \{(u_1, 0.1, 0.1, 0.4), (u_2, 0.8, 0.05, 0.05), (u_3, 0.05, 0.8, 0.05)\}$$

Using the divergence measure in Equation (2) we have $D(A_1, B) = 0.11845, D(A_2, B) = 0.13717, D(A_3, B) = 0.13593$. So that we can classifies that B belongs to the class of A_1 .

If using the divergence measure in Equation (9) then we have $\bar{D}(A_1, B) = 0.51037, \bar{D}(A_2, B) = 0.61238, \bar{D}(A_3, B) = 0.59688$. So that we can also classifies that B belongs to the class of A_1 .

- Compare with using other measures

+Using the dissimilarity measure of picture fuzzy sets in [13] or [24].

Step 1. We compute the dissimilarity measures $DM(A_i, B), i = 1, 2, \dots, m$ by using Equations (14) or (15).

Step 2. Put B belongs to the class of A_{i^*} in which $DM(A_{i^*}, B) = \min\{DM(A_i, B)|i = 1, 2, \dots, m\}$.

Using the dissimilarity measure in Equation (14) we have $DM_1(A_1, B) = 0.1792, DM_2(A_2, B) = 0.2, DM_1(A_3, B) = 0.1917$. So that we can classifies that B belongs to the class of A_1 .

If using the dissimilarity measure in Equation (15) then we have $DM_T(A_1, B) = 0.2208, DM_T(A_2, B) = 0.2375, DM_T(A_3, B) = 0.2360$. So

that we can also classify that B belongs to the class of A_1 .

+Using the similarity measure of picture fuzzy sets in [48].

Step 1. We compute the similarity measures $C(A_i, B)$, $i = 1, 2, \dots, m$ by using Equation (16).

Step 2. Put B belongs to the class of A_{i^*} in which $C(A_{i^*}, B) = \max\{C(A_i, B) | i = 1, 2, \dots, m\}$.

If using the dissimilarity measure in Equation (16) then we have $C(A_1, B) = 0.7273$, $C(A_2, B) = 0.6744$, $C(A_3, B) = 0.6970$. So that we can also classify that B belongs to the class of A_1 .

We find that, when using the new measures, the classification results also give the same results as the previous measures.

5. Conclusions

There are many theoretical and applied results on picture fuzzy sets that are built and developed. In this paper, we study the divergence measure of picture fuzzy sets. Along with that, we offer some divergence formulas on picture fuzzy sets and give some properties of these measures. Finally, we apply the proposed measures in some cases. We also compared the results using the proposed new measure with other measures. The results obtained using the proposed new measure also yield the same results with some of the measures proposed on the picture fuzzy set. A divergence measure plays an important part in distinguishing two probability distributions and making conclusions based on that discrimination. This idea should also be generalized to the picture fuzzy sets to distinguish two picture fuzzy sets and to draw conclusions based on that discrimination. In the future, we will continue to study this measure and offer some of their applications in other areas such as image segmentation, clustering, the multi-criteria decision making problems or studying the relationship of this measure with other types of measures, such as [31, 35–37, 49], on the picture fuzzy sets and apply to the practical problems.

References

- [1] K.T. Atanassov, Intuitionistic Fuzzy Sets, *Fuzzy set and systems* **20** (1986), 87–96.
- [2] T.A.K. Chaira, Ray, A new measure using intuitionistic fuzzy set theory and its application to edge detection, *Applied Soft Computing* **8**(2) (2007), 919–927.
- [3] B.C. Cuong and V. Kreinovich, Picture Fuzzy Sets—a new concept for computational intelligence problems, In: *3rd World Congress on Information and Communication Technologies (WICT)*, Hanoi, Vietnam, IEEE CS, 2013, pp.1–6.
- [4] B.C. Cuong and P. Hai *Some fuzzy logic operators for picture fuzzy sets*, In: *7th Knowledge and Systems Engineering (KSE)*, Hochiminh, Vietnam, 2015, pp. 132–137.
- [5] B.C. Cuong, R.T. Ngan and B.D. Hai, An involutive picture fuzzy negator on picture fuzzy sets and some De Morgan triples, In: *7th Knowledge and Systems Engineering (KSE)*, Hochiminh, Vietnam, 2015, pp. 126–131
- [6] S.K. De, R. Biswas and A.R. Roy, An application of intuitionistic fuzzy sets in medical diagnosis, *Fuzzy sets and Systems* **117**(2) (2001), 209–213.
- [7] N.V. Dinh, N.X. Thao and N.M. Chau, Distance and dissimilarity measure of picture fuzzy sets, In: *10th Fundamental and Applied IT Research (FAIR 2017)*, Danang, Vietnam, 2017, pp. 104–109.
- [8] H. Garg, Some Picture Fuzzy Aggregation Operators and Their Applications to Multicriteria Decision-Making, *Arabian Journal for Science and Engineering* **42**(12) (2017), 5275–5290.
- [9] W.L. Hung and M.S. Yang, On the J-divergence of intuitionistic fuzzy sets with its application to pattern recognition, *Information sciences* **178**(6) (2007), 1641–1650.
- [10] V. Kobza, V. Janiš and S. Montes, Divergence measures on hesitant fuzzy sets, *Journal of Intelligent & Fuzzy Systems* **33**(3) (2017), 1589–1601.
- [11] S.V.A. Kumar, B.S. Harish and V.M. Aradhya, A picture fuzzy clustering approach for brain tumor segmentation, In: *2nd Cognitive Computing and Information Processing (CCIP)*, Mysore, India, 2016, pp. 1–6.
- [12] K.C. Jain and P. Chhabra, New information inequalities on new generalized f-divergence and applications, *Le Matematiche* **70**(2) (2015), 271–281.
- [13] N.T. Le, D. Van Nguyen, C.M. Ngoc and T.X. Nguyen, New dissimilarity measures on picture fuzzy sets and applications, *Journal of Computer Science and Cybernetics* **34**(3) (2018), 219–231.
- [14] P. Liu and H. Li, Interval-valued intuitionistic fuzzy power Bonferroni aggregation operators and their application to group decision making, *Cognitive Computation* **9**(4) (2017), 494–512.
- [15] P. Liu, J. Liu and J.M. Merigó, Partitioned Heronian means based on linguistic intuitionistic fuzzy numbers for dealing with multi-attribute group decision making, *Applied Soft Computing* **62** (2018), 395–422.
- [16] P. Liu, Multiple attribute group decision making method based on interval-valued intuitionistic fuzzy power Heronian aggregation operators, *Computers & Industrial Engineering* **108** (2017), 199–212.
- [17] P. Liu and P. Wang, Some q-Rung Orthopair Fuzzy Aggregation Operators and Their Applications to Multiple-Attribute Decision Making, *International Journal of Intelligent Systems* **33**(2) (2018), 259–280.
- [18] P. Liu and S.M. Chen, Group decision making based on Heronian aggregation operators of intuitionistic fuzzy numbers, *IEEE Transactions on Cybernetics* **47**(9) (2017), 2514–2530.
- [19] P. Liu, S.M. Chen and J. Liu, Multiple attribute group decision making based on intuitionistic fuzzy interaction

- partitioned Bonferroni mean operators, *Information Sciences* **411** (2017), 98–121.
- [20] P. Liu and S.M. Chen, Multiattribute Group Decision Making Based on Intuitionistic 2-Tuple Linguistic Information, *Information Sciences* **430-431** (2018), 599–619.
- [21] A.R. Mishra, R. Kumari and D.K. Sharma, Intuitionistic fuzzy divergence measure-based multi-criteria decision-making method, *Neural Computing and Applications* (2017), 1–16.
- [22] S. Montes, N.R. Pal and V. Janiš, Divergence measures for intuitionistic fuzzy sets, *IEEE Transactions on Fuzzy Systems* **23**(2) (2015), 444–456.
- [23] S. Montes, I. Couso, P. Gil and C. Bertoluzza, Divergence measure between fuzzy sets, *International Journal of Approximate Reasoning* **30**(2) (2002), 91–105.
- [24] X.T. Nguyen, Evaluating Water Reuse Applications under Uncertainty: A Novel Picture Fuzzy Multi Criteria Decision Making Method, *International Journal of Information Engineering and Electronic Business* **10**(6) (2018), 32–39.
- [25] Ohlan, A new generalized fuzzy divergence measure and applications, *Fuzzy Information and Engineering* **7**(4) (2015), 507–523.
- [26] O. Parkash and R. Kumar, Modified fuzzy divergence measure and its applications to medical diagnosis and MCDM, *Risk and Decision Analysis* **6**(3) (2017), 231–237.
- [27] P. Singh, Correlation coefficients for picture fuzzy sets, *Journal of Intelligent & Fuzzy Systems* **28**(2) (2015), 591–604.
- [28] F. Smarandache, Neutrosophy. Neutrosophic Probability, Set, and Logic, ProQuest Information & Learning, Ann Arbor, Michigan, USA, 105 p., 1998; <http://fs.unm.edu/eBook-Neutrosophics6.pdf> (edition online).
- [29] L.H. Son, DPFCM: A novel distributed picture fuzzy clustering method on picture fuzzy sets, *Expert Systems with Applications* **42**(1) (2015), 51–66.
- [30] L.H. Son, Generalized picture distance measure and applications to picture fuzzy clustering, *Applied Soft Computing* **46**(C) (2016), 284–295.
- [31] L.H. Son, Measuring analogousness in picture fuzzy sets: from picture distance measures to picture association measures, *Fuzzy Optimization and Decision Making* **16**(3) (2017), 359–378.
- [32] Srivastava, S. Maheshwari, Decision making in medical investigations using new divergence measures for intuitionistic fuzzy sets, *Iranian Journal of Fuzzy Systems* **13**(1) (2016), 25–44.
- [33] N.X. Thao, B.C. Cuong, M. Ali, and L.H. Lan, Fuzzy equivalence on standard and rough neutrosophic sets and applications to clustering analysis, In: *Information Systems Design and Intelligent Applications*, Springer-Singapore, 2018, pp. 834–842.
- [34] N.X. Thao and N.V. Dinh, Rough picture fuzzy set and picture fuzzy topologies, *Journal of Computer Science and Cybernetics* **31**(3) (2015), 245–253.
- [35] N.X. Thao and F.A. Smarandache, A new fuzzy entropy on pythagorean fuzzy sets, *Journal of Intelligent & Fuzzy Systems* **37**(1) (2019), 1065–1074.
- [36] N.X. Thao and T.T.T. Duong, Selecting target market by similar measures in interval intuitionistic fuzzy set, *Technological and Economic Development of Economy* (2019), 1–17 (accepted).
- [37] N.X. Thao, M. Ali and F. Smarandache, An intuitionistic fuzzy clustering algorithm based on a new correlation coefficient with application in medical diagnosis, *Journal of Intelligent & Fuzzy Systems* **36**(1) (2019), 189–198.
- [38] P.H. Thong, A novel automatic picture fuzzy clustering method based on particle swarm optimization and picture composite cardinality, *Knowledge-Based Systems* **109** (2016), 48–60.
- [39] P.H. Thong and L.H. Son, Picture fuzzy clustering for complex data, *Engineering Applications of Artificial Intelligence* **56** (2016), 121–130.
- [40] P.H. Thong, Picture fuzzy clustering: a new computational intelligence method, *Soft computing* **20**(9) (2016), 3549–3562.
- [41] N. Van Dinh, N.X. Thao and N.M. Chau, On the picture fuzzy database: theories and application, *J Sci & Devel* **13**(6) (2015), 1028–1035.
- [42] N. Van Dinh and N.X. Thao, Some measures of picture fuzzy sets and their application, *Journal of Science and Technology: Issue on Information and Communications Technology* **3**(2) (2017), 35–40.
- [43] R. Verma and B.D. Sharma, On generalized intuitionistic fuzzy divergence (relative information) and their properties, *Journal of Uncertain Systems* **6**(4) (2012), 308–320.
- [44] R. Verma and S. Maheshwari, A new measure of divergence with its application to multi-criteria decision making under fuzzy environment, *Neural Computing and Applications* **28**(8) (2017), 2335–2350.
- [45] C.Y. Wang, X.Q. Zhou, H.N. Tu and S.D. Tao, Some geometric aggregation operators based on picture fuzzy sets and their application in multiple attribute decision making, *Ital. J. Pure Appl. Math* **37** (2017), 477–492.
- [46] G. Wei, Picture fuzzy aggregation operators and their application to multiple attribute decision making, *Journal of Intelligent & Fuzzy Systems* **33**(2) (2017), 713–724.
- [47] G. Wei, Picture fuzzy cross-entropy for multiple attribute decision making problems, *Journal of Business Economics and Management* **17**(4) (2016), 491–502.
- [48] G. Wei, Some similarity measures for picture fuzzy sets and their applications, *Iranian Journal of Fuzzy Systems* **15**(1) (2018), 77–89.
- [49] N. Xuan Thao, A new correlation coefficient of the intuitionistic fuzzy sets and its application, *Journal of Intelligent & Fuzzy Systems* **35**(2), (2018), 1959-1968.
- [50] L.A. Zadeh, Fuzzy sets, *Information and control* **8**(3) (1965), 338–353.
- [51] J. Zhan and J.C.R. Alcantud, A novel type of soft rough covering and its application to multi criteria group decision making, *Artificial Intelligence Review* (2018), 1–30.
- [52] J. Zhan and J.C.R. Alcantud, A survey of parameter reduction of soft sets and corresponding algorithms, *Artificial Intelligence Review* (2018), 1–34.
- [53] Zhan, B. Sun, J.C.R. Alcantud, Covering based multi-granulation (I, T)-fuzzy rough set models and applications in multi-attribute group decision-making, *Information Sciences* **476** (2019), 290–318.
- [54] J. Zhang and Z.X. Zhan, Xu, Covering-based generalized IF rough sets with applications to multi-attribute decision-making, *Information Sciences* **478** (2019), 275–302.
- [55] Zhang, J. Zhan, W.Z. Wu and J.C.R. Alcantud, Fuzzy β -covering based (I, T)-fuzzy rough set models and applications to multi-attribute decision-making, *Computers & Industrial Engineering* **128** (2019), 605–621.

The picture fuzzy distance measure in controlling network power consumption

Ngan Thi Roan, Salvador Coll, Marina Alonso, Juan Miguel Martínez Rubio, Pedro López, Fran Andujar, Son Hoang Le, Manh Van Vu, Florentin Smarandache

Ngan Thi Roan, Salvador Coll, Marina Alonso, Juan Miguel Martínez Rubio, Pedro López, Fran Andujar, Son Hoang Le, Manh Van Vu, Florentin Smarandache (2020). The picture fuzzy distance measure in controlling network power consumption. *Journal of Fuzzy Extension and Applications* 1(3), 139-158; DOI: 10.22105/jfea.2020.249183.1009

A B S T R A C T

Keywords:

Neutrosophic Set.
Picture Fuzzy Set.
Distance Measure.
Decision Making.
Interconnection Network
Power Consumption.

In order to solve the complex decision-making problems, there are many approaches and systems based on the fuzzy theory were proposed. In 1998, Smarandache [10] introduced the concept of single-valued neutrosophic set as a complete development of fuzzy theory. In this paper, we research on the distance measure between single-valued neutrosophic sets based on the H-max measure of Ngan et al. [8]. The proposed measure is also a distance measure between picture fuzzy sets which was introduced by Cuong in 2013 [15]. Based on the proposed measure, an Adaptive Neuro Picture Fuzzy Inference System (ANPFIS) is built and applied to the decision making for the link states in interconnection networks. In experimental evaluation on the real datasets taken from the UPV (Universitat Politècnica de València) university, the performance of the proposed model is better than that of the related fuzzy methods.

1. Introduction

The fuzzy theory was introduced the first time in 1965 by Zadeh [1]. A fuzzy set is determined by a membership function limited to $[0, 1]$. Until now, there is a giant research construction of fuzzy theory as well as its application. The fuzzy set is used in pattern recognition, artificial intelligent, decision making, or

data mining [2, 3], and so on. Besides that, the expansion of fuzzy theory is also an interesting topic. The interval-valued fuzzy set [4], the type-2 fuzzy set [5], and the intuitionistic fuzzy set [6] are all developed from the fuzzy set. They replaced the value type or added the other evaluation to the fuzzy set in order to overcome the inadequate simple approach of this traditional fuzzy set. Such as in 1986, the intuitionistic fuzzy set of Atanassov [6] builds up the concept of the non-membership degree. This supplement gives more accurate results in pattern recognition, medical diagnosis and decision making [7-9], and so on. In 1998, Smarandache [10] introduced neutrosophic set to generalize intuitionistic fuzzy set by three independent components. Until today, many subclasses of neutrosophic sets were studied such as complex neutrosophic sets [11, 12]. As a particular case of standard neutrosophic sets [13, 14], the picture fuzzy set introduced in 2013 by Cuong [15], considered as a complete development of the fuzzy theory, allows an element to belong to it with three corresponding degrees where all of these degrees and their sum are limited to $[0, 1]$. Concerning extended fuzzy set, some recent publications may be mentioned here as in [16-20].

As one of the important pieces of set theory, distance measure between the sets is a tool for evaluating different or similar levels between them. Some literature on the application of intuitionistic fuzzy measure from 2012 to present can be found in [7, 21-23]. In 2018, Wei introduced the generalized Dice similarity measures for picture fuzzy sets [17]. However, the definition of Wei is without considering the condition related to order relation on picture fuzzy sets. In a decision-making model, a distance measure can be used to compare the similarities between the sets of attributes of the samples and that of the input, such as in predicting dental diseases from images [24]. In this paper, we define the concept of the single-valued neutrosophic distance measure, picture fuzzy distance measure, and represent the specific measure formula. We prove the characteristics of this formula as well as the relation among it and some of the other operators of picture fuzzy sets. The proposed distance measure is inspired by the H-max distance measure of intuitionistic fuzzy sets [8]. Hence, it inherits the advantage of the cross-evaluation in the H-max and moreover it has the completeness of picture fuzzy environment.

The decision-making problems appear in most areas aiming to provide the optimal solution. Saving interconnection network power is always interested, researched and becoming more and more urgent in the current technological era. In 2010, Alonso et al. introduced the power saving mechanism in regular interconnection network [25]. This decision-making model dynamically increases or reduces the number of links based on a thresholds policy. In 2015, they continue to study power consumption control in fat-tree interconnection networks based on the static and dynamic thresholds policies [26]. In general, these threshold policies are rough and hard because they are without any fuzzy approaches, parameter learning and optimizing processes. In 2017, Phan et al. [27] proposed a new method in power consumption estimation of network-on-chip based on fuzzy logic. However, this fuzzy logic system based on Sugeno model [27] is too rudimentary and the parameters here are chosen according to the authors' quantification.

In this paper, aiming to replace the above threshold policy, an Adaptive Neuro Picture Fuzzy Inference System (ANPFIS) based on picture fuzzy distance measure is proposed to make the decisions for the link states in interconnection networks. ANPFIS is a modification and combination between Adaptive Neuro Fuzzy Inference System (ANFIS) [28-30], picture fuzzy set, and picture fuzzy distance measure. Hence, ANPFIS operates based on the picture fuzzification and defuzzification processes, the picture fuzzy operators [18] and distance measure, and the learning capability for automatic picture fuzzy rule generation and

parameter optimization. In order to evaluate performance, we tested the ANPFIS method on the real datasets of the network traffic history taken from the UPV (Universitat Politècnica de València) university with related methods. The result is that ANPFIS is the most effective algorithm.

The rest of the paper is organized as follows. Section 2 provides some fundamental concepts of the fuzzy, intuitionistic fuzzy, single-valued neutrosophic, and picture fuzzy theories. Section 3 proposes the distance measure of single-valued neutrosophic sets and points out its important properties. Section 4 shows the new decision-making method named Adaptive Neuro Picture Fuzzy Inference System (ANPFIS) and an application of ANPFIS to controlling network power consumption. Section 5 shows the experimental results of ANPFIS and the related methods on real-world datasets. Finally, conclusion is given in Section 6.

2. Preliminary

In this part, some concepts of the theories of fuzzy sets, intuitionistic fuzzy sets, single-valued neutrosophic sets, and picture fuzzy sets are showed.

Let X be a space of points.

Definition 1. [1]. A fuzzy set (FS) A in X ,

$$A = \{ (x : \mu_A(x)) \mid x \in X \}, \tag{1}$$

is characterized by a membership function, μ_A , with a range in $[0,1]$.

Definition 2. [6]. A intuitionistic fuzzy set (IFS) A in X ,

$$A = \{ (x : \mu_A(x), \nu_A(x)) \mid x \in X \}, \tag{2}$$

is characterized by a membership function μ_A and a non-membership function ν_A with a range in $[0,1]$ such that $0 \leq \mu_A + \nu_A \leq 1$.

Definition 3. [31]. A Single-Valued Neutrosophic Set (SVNS) A in X ,

$$A = \{ (x : T_A(x), I_A(x), F_A(x)) \mid x \in X \}, \tag{3}$$

is characterized by a truth-membership function T_A , an indeterminacy-membership function I_A , and a false-nonmembership function F_A with a range in $[0,1]$ such that $0 \leq T_A + I_A + F_A \leq 3$.

Definition 4. [15]. A Picture Fuzzy Set (PFS) A in X ,

$$A = \{ (x : \mu_A(x), \eta_A(x), \nu_A(x)) \mid x \in X \}, \tag{4}$$

is characterized by a positive membership function μ_A , a neutral function η_A , and a negative membership function ν_A with a range in $[0,1]$ such that $0 \leq \mu_A + \eta_A + \nu_A \leq 1$.

We denote that $SVNS(X)$ is the set of all SVNSs in X and $PFS(X)$ is the set of all PFSs in X . We consider the sets N^* and P^* defined by

$$N^* = \{x = (x_1, x_2, x_3) \mid 0 \leq x_1, x_2, x_3 \leq 1\}, \tag{5}$$

$$P^* = \{x = (x_1, x_2, x_3) \mid 0 \leq x_1, x_2, x_3, x_1 + x_2 + x_3 \leq 1\}. \tag{6}$$

Definition 5. The orders on N^* and P^* are defined as follows

- $x \leq y \Leftrightarrow (x_1 < y_1, x_3 \geq y_3) \vee (x_1 = y_1, x_3 > y_3) \vee (x_1 = y_1, x_3 = y_3, x_2 \leq y_2), \forall x, y \in P^*, [19].$
- $x \ll y \Leftrightarrow x_1 \leq y_1, x_2 \leq y_2, x_3 \geq y_3, \forall x, y \in N^*.$

Clearly, on P^* , if $x \ll y$ then $x \leq y$.

Remark 1. The lattice (P^*, \leq) is a complete lattice [19] but (P^*, \ll) is not. For example, let $x = (0.2, 0.3, 0.5)$ and $y = (0.3, 0, 0.7)$, then there is not any supremum value of x and y on (P^*, \ll) .

Otherwise, we have $sup(x, y) = (0.3, 0, 0.5)$ on the lattice (P^*, \leq) . We denote the units of (P^*, \leq) as follows $0_{P^*} = (0, 0, 1)$ and $1_{P^*} = (1, 0, 0)$ [19]. It is easy to see that 0_{P^*} and 1_{P^*} are also the units on (P^*, \ll) . Now, some logic operators on $PFS(X)$ are presented.

Definition 6. [19]. A picture fuzzy negation N is a function satisfying

$$N : P^* \rightarrow P^*, N(0_{P^*}) = 1_{P^*}, N(1_{P^*}) = 0_{P^*}, \text{ and } N(x) \geq N(y) \Leftrightarrow x \leq y.$$

Example 1. For every $x \in P^*$, then $N_0(x) = (x_3, 0, x_1)$ and $N_s(x) = (x_3, x_4, x_1)$ are picture fuzzy negations, where $x_4 = 1 - x_1 - x_2 - x_3$.

Remark 2. The operator N_0 also satisfies $N_0(x) \gg N_0(y) \Leftrightarrow x \ll y, \forall x, y \in P^*.$

Now, let $x, y, z \in P^*$ and $I(x) = \{y \in P^* : y = (x_1, y_2, x_3), 0 \leq y_2 \leq x_2\}.$

Definition 7. [19] A picture fuzzy t-norm T is a function satisfying

$$T : P^* \times P^* \rightarrow P^*, T(x, y) = T(y, x), T(T(x, y), z) = T(x, T(y, z)),$$

$$T(1_{P^*}, x) \in I(x), \text{ and } T(x, y) \leq T(x, z), \forall y \leq z.$$

Definition 8. [19] A picture fuzzy t-conorm S is a function satisfying

$$S : P^* \times P^* \rightarrow P^*, S(x, y) = S(y, x), S(S(x, y), z) = S(x, S(y, z)),$$

$$S(0_{P^*}, x) \in I(x), \text{ and } S(x, y) \leq S(x, z), \forall y \leq z.$$

Example 2. For all $x, y \in P^*$, the following operators are the picture fuzzy t-norms:

- $T_0(x, y) = (\min(x_1, y_1), \min(x_2, y_2), \max(x_3, y_3)).$
- $T_1(x, y) = (x_1 y_1, x_2 y_2, x_3 + y_3 - x_3 y_3).$
- $T_2(x, y) = (\max(0, x_1 + y_1 - 1), \max(0, x_2 + y_2 - 1), \min(1, x_3 + y_3)).$
- $T_3(x, y) = (\max(0, x_1 + y_1 - 1), \max(0, x_2 + y_2 - 1), x_3 + y_3 - x_3 y_3).$
- $T_4(x, y) = (x_1 y_1, \max(0, x_2 + y_2 - 1), x_3 + y_3 - x_3 y_3).$
- $T_5(x, y) = (\max(0, x_1 + y_1 - 1), x_2 y_2, x_3 + y_3 - x_3 y_3).$

Example 3. For all $x, y \in P^*$, the following operators are the picture fuzzy t-conorms:

- $S_0(x, y) = (\max(x_1, y_1), \max(0, x_2 + y_2 - 1), \min(x_3, y_3)).$
- $S_1(x, y) = (x_1 + y_1 - x_1 y_1, x_2 y_2, x_3 y_3).$
- $S_2(x, y) = (\min(1, x_1 + y_1), \max(0, x_2 + y_2 - 1), \max(0, x_3 + y_3 - 1)).$
- $S_3(x, y) = (x_1 + y_1 - x_1 y_1, \max(0, x_2 + y_2 - 1), \max(0, x_3 + y_3 - 1)).$
- $S_4(x, y) = (x_1 + y_1 - x_1 y_1, \max(0, x_2 + y_2 - 1), x_3 y_3).$
- $S_5(x, y) = (x_1 + y_1 - x_1 y_1, x_2 y_2, \max(0, x_3 + y_3 - 1)).$

Remark 3. For all $x, y, z \in P^*$ and $y \ll z$, the operators $T_{i(i=0, \dots, 5)}$ also satisfy the condition $T(x, y) \ll T(x, z)$.

Similarly, $S_{i(i=0, \dots, 5)}$ also satisfy $S(x, y) \ll S(x, z)$.

The logic operators N, T and S on P^* are corresponding to the basic set-theory operators on PFS(X) as follows.

Definition 9. Let N, T and S be the picture fuzzy negation, t-norm and t-conorm, respectively, and $A, B \in \text{PFS}(X)$. Then, the complement of A w.r.t N is defined as follows:

$$\overline{A}^N = \left\{ \left(x : N \left(\left(\mu_A(x), \eta_A(x), \nu_A(x) \right) \right) \right) \mid x \in X \right\}, \tag{7}$$

the intersection of A and B w.r.t T is defined as follows:

$$A \cap_T B = \left\{ \left(x : T \left(\left(\mu_A(x), \eta_A(x), \nu_A(x) \right), \left(\mu_B(x), \eta_B(x), \nu_B(x) \right) \right) \right) \mid x \in X \right\}, \tag{8}$$

and the union of A and B w.r.t T is defined as follows:

$$A \cup_S B = \left\{ \left(x : S \left(\left(\mu_A(x), \eta_A(x), \nu_A(x) \right), \left(\mu_B(x), \eta_B(x), \nu_B(x) \right) \right) \right) \mid x \in X \right\}. \tag{9}$$

3. The Single-valued Neutrosophic Distance Measure and the Picture Fuzzy Distance Measure

Recently, Wei has introduced the generalized Dice similarity measures for picture fuzzy sets [17]. However, the definition of Wei is without considering the condition related to order relation on picture fuzzy sets. The new distance measure on picture fuzzy sets is proposed in this section. It is developed from intuitionistic distance measure of Wang et al. [32] and Ngan et al. [8].

Definition 10. A single-valued neutrosophic distance measure d is a function satisfying

- $d : N^* \times N^* \rightarrow [0, +\infty)$,
- $d(x, y) = d(y, x)$,
- $d(x, y) = 0 \Leftrightarrow x = y$,
- If $x \ll y \ll z$ then $d(x, y) \leq d(x, z)$ and $d(y, z) \leq d(x, z)$.

Definition 11. A picture fuzzy distance measure d is a single-valued neutrosophic distance measure and $d(x, y) \in [0, I], \forall x, y \in P^*$.

Definition 12. The measure D_0 is defined as follows

$$D_0(x, y) = \frac{1}{3} \left(|x_1 - y_1| + |x_2 - y_2| + |x_3 - y_3| + \left| \max\{x_1, y_3\} - \max\{x_3, y_1\} \right| \right), \forall x, y \in P^*. \tag{10}$$

Proposition 1. The measure D_0 is a picture fuzzy distance measure.

Proof. Firstly, we have $\left| \max\{x_1, y_3\} - \max\{x_3, y_1\} \right| \in [0, I]$ and

$$|x_1 - y_1| + |x_2 - y_2| + |x_3 - y_3| \leq (|x_1| + |y_1|) + (|x_2| + |y_2|) + (|x_3| + |y_3|) \leq (x_1 + x_2 + x_3) + (y_1 + y_2 + y_3) \leq 2.$$

Therefore, $0 \leq \frac{1}{3} \left(|x_1 - y_1| + |x_2 - y_2| + |x_3 - y_3| + \left| \max\{x_1, y_3\} - \max\{x_3, y_1\} \right| \right) \leq 1$.

Secondly, we obtain that $D_0(x, y) = D_0(y, x)$ since D_0 has the symmetry property between the arguments.

Thirdly, $D_0(x, y) = 0 \Leftrightarrow |x_1 - y_1| = |x_2 - y_2| = |x_3 - y_3| = \left| \max\{x_1, y_3\} - \max\{x_3, y_1\} \right| = 0 \Leftrightarrow x = y$.

Finally, let $x \ll y \ll z$, then $x_1 \leq y_1 \leq z_1, x_2 \leq y_2 \leq z_2, x_3 \geq y_3 \geq z_3$. We obtain that

$$|x_1 - y_1| \leq |x_1 - z_1|, |x_2 - y_2| \leq |x_2 - z_2|, |x_3 - y_3| \leq |x_3 - z_3|.$$

Moreover, $\max\{z_1, x_3\} \geq \max\{y_1, x_3\} \geq \max\{x_1, y_3\} \geq \max\{x_1, z_3\}$. Hence,

$|\max\{x_1, y_3\} - \max\{x_3, y_1\}| \leq |\max\{x_1, z_3\} - \max\{x_3, z_1\}|$. $\lim_{x \rightarrow \infty}$. Thus, $D_0(x, y) \leq D_0(x, z)$. Similarly, we also have $D_0(y, z) \leq D_0(x, z)$.

Remark 4. If d is a picture fuzzy distance measure, then d is a single-valued neutrosophic distance measure. The opposite is not necessarily true. Some picture fuzzy operations were introduced by the group of authors of this paper [18, 19]. Hence, this research is seen as a complete link to the authors' previous work on picture fuzzy inference systems. An inference system of neutrosophic theory will be developed in another paper as a future work.

Proposition 2. Let $x, y \in P^*$. The measure D_0 satisfies the following properties:

- $D_0(N_0(x), N_S(x)) = \frac{1}{3}x_4$.
- If $x_2 \geq x_4$, then $|D_0(x, N_0(x)) - D_0(x, N_S(x))| = \frac{1}{3}x_4$.
- $|D_0(x, N_0(y)) - D_0(N_0(x), y)| = \frac{1}{3}|x_2 - y_2|$.
- $|D_0(x, y) - D_0(N_0(x), N_0(y))| = \frac{1}{3}|x_2 - y_2|$.
- If $x_1 + x_3 = y_1 + y_3$, then $D_0(x, y) = D_0(N_S(x), N_S(y))$.
- If $x_1 + x_3 = y_1 + y_3$, then $D_0(x, N_S(y)) = D_0(N_S(x), y)$.
- $D_0(x, N_0(x)) = |x_1 - x_3| + \frac{1}{3}x_2$.
- $D_0(x, N_S(x)) = |x_1 - x_3| + \frac{1}{3}|x_2 - x_4|$.
- $D_0(x, I_{P^*}) = \frac{1}{3}(2 - 2x_1 + x_2 + x_3)$.
- $D_0(x, O_{P^*}) = \frac{1}{3}(2 - 2x_3 + x_1 + x_2)$.
- $D_0(O_{P^*}, I_{P^*}) = 1$.
- $D_0(x, N_0(x)) = 1$ if and only if $x \in \{O_{P^*}, I_{P^*}\}$.
- $D_0(x, N_S(x)) = 1$ if and only if $x \in \{O_{P^*}, I_{P^*}\}$.
- $D_0(x, N_0(x)) = 0$ if and only if $x_1 = x_3, x_2 = 0$.
- $D_0(x, N_S(x)) = 0$ if and only if $x_1 = x_3, x_2 = x_4$.
- $D_0((0, 0, 0), (0, a, 0)) < D_0((0, 0, 0), (a, 0, 0)) = D_0((0, 0, 0), (0, 0, a))$
 $< D_0((a, 0, 0), (0, 0, a)) = D_0((a, 0, 0), (0, a, 0)) = D_0((0, 0, a), (0, a, 0)), \forall a \in (0, 1]$.

Proof. These properties are proved as follows:

– We have $D_0(N_0(x), N_S(x)) = D_0((x_3, 0, x_1), (x_3, x_4, x_1))$

$$= \frac{1}{3}(|x_3 - x_3| + |0 - x_4| + |x_1 - x_1| + |\max\{x_3, x_1\} - \max\{x_3, x_1\}|) = \frac{1}{3}x_4.$$

– We have

$$\begin{aligned} |D_0(x, N_0(x)) - D_0(x, N_S(x))| &= |D_0((x_1, x_2, x_3), (x_3, 0, x_1)) - D_0((x_1, x_2, x_3), (x_3, x_4, x_1))| \\ &= \left| \frac{1}{3}(|x_1 - x_3| + |x_2 - 0| + |x_3 - x_1| + |\max\{x_1, x_1\} - \max\{x_3, x_3\}|) \right. \\ &\quad \left. - \frac{1}{3}(|x_1 - x_3| + |x_2 - x_4| + |x_3 - x_1| + |\max\{x_1, x_1\} - \max\{x_3, x_3\}|) \right| \\ &= \frac{1}{3}|x_2 - |x_2 - x_4|| = \frac{1}{3}x_4. \end{aligned}$$

– We have

$$\begin{aligned} |D_0(x, N_0(y)) - D_0(N_0(x), y)| &= |D_0((x_1, x_2, x_3), (y_3, 0, y_1)) - D_0((x_3, 0, x_1), (y_1, y_2, y_3))| \\ &= \left| \frac{1}{3}(|x_1 - y_3| + |x_2 - 0| + |x_3 - y_1| + |\max\{x_1, y_1\} - \max\{y_3, x_3\}|) \right. \\ &\quad \left. - \frac{1}{3}(|x_3 - y_1| + |0 - y_2| + |x_1 - y_3| + |\max\{x_3, y_3\} - \max\{y_1, x_1\}|) \right| = \frac{1}{3}|x_2 - y_2|. \end{aligned}$$

– We have

$$\begin{aligned} |D_0(x, y) - D_0(N_0(x), N_0(y))| &= |D_0((x_1, x_2, x_3), (y_1, y_2, y_3)) - D_0((x_3, 0, x_1), (y_3, 0, y_1))| \\ &= \left| \frac{1}{3}(|x_1 - y_1| + |x_2 - y_2| + |x_3 - y_3| + |\max\{x_1, y_3\} - \max\{x_3, y_1\}|) \right. \\ &\quad \left. - \frac{1}{3}(|x_3 - y_3| + |0 - 0| + |x_1 - y_1| + |\max\{x_3, y_1\} - \max\{y_3, x_1\}|) \right| = \frac{1}{3}|x_2 - y_2|. \end{aligned}$$

– We have $D_0(N_S(x), N_S(y)) = D_0((x_3, x_4, x_1), (y_3, y_4, y_1))$

$$= \frac{1}{3}(|x_3 - y_3| + |x_4 - y_4| + |x_1 - y_1| + |\max\{x_3, y_1\} - \max\{y_3, x_1\}|). \text{ Further,}$$

$$|x_4 - y_4| = |(I - x_1 - x_2 - x_3) - (I - y_1 - y_2 - y_3)| = |x_2 - y_2|. \text{ Thus, } D_0(N_S(x), N_S(y)) = D_0(x, y).$$

– We have $D_0(x, N_S(y)) = D_0((x_1, x_2, x_3), (y_3, y_4, y_1))$

$$= \frac{I}{3}(|x_1 - y_3| + |x_2 - y_4| + |x_3 - y_1| + |\max\{x_1, y_1\} - \max\{y_3, x_3\}|).$$

In other hand,

$$D_0(N_S(x), y) = D_0((x_3, x_4, x_1), (y_1, y_2, y_3))$$

$$= \frac{I}{3}(|x_3 - y_1| + |x_4 - y_2| + |x_1 - y_3| + |\max\{x_3, y_3\} - \max\{y_1, x_1\}|).$$

Further,

$$|x_2 - y_4| = |x_2 - I + y_1 + y_2 + y_3| = |x_2 - I + x_1 + y_2 + x_3| = |y_2 - x_4|.$$

Thus,

$$D_0(x, N_S(y)) = D_0(N_S(x), y). \lim_{x \rightarrow \infty}$$

– We have $D_0(x, N_0(x)) = D_0((x_1, x_2, x_3), (x_3, 0, x_1))$

$$= \frac{I}{3}(|x_1 - x_3| + |x_2 - 0| + |x_3 - x_1| + |\max\{x_1, x_1\} - \max\{x_3, x_3\}|) = |x_1 - x_3| + \frac{I}{3}x_2.$$

– We have

$$D_0(x, N_S(x)) = D_0((x_1, x_2, x_3), (x_3, x_4, x_1))$$

$$= \frac{I}{3}(|x_1 - x_3| + |x_2 - x_4| + |x_3 - x_1| + |\max\{x_1, x_1\} - \max\{x_3, x_3\}|) = |x_1 - x_3| + \frac{I}{3}|x_2 - x_4|.$$

– We have $D_0(x, I_{p'}) = D_0((x_1, x_2, x_3), (I, 0, 0))$

$$= \frac{I}{3}(|x_1 - I| + |x_2 - 0| + |x_3 - 0| + |\max\{x_1, 0\} - \max\{x_3, I\}|) = \frac{I}{3}(2 - 2x_1 + x_2 + x_3).$$

– We have $D_0(x, 0_{p'}) = D_0((x_1, x_2, x_3), (0, 0, I))$

$$= \frac{I}{3}(|x_1 - 0| + |x_2 - 0| + |x_3 - I| + |\max\{x_1, I\} - \max\{x_3, 0\}|) = \frac{I}{3}(2 - 2x_3 + x_1 + x_2).$$

– We have $D_0(0_{p'}, I_{p'}) = D_0((I, 0, 0), (0, 0, I)) = I.$

Assume that $D_0(x, N_0(x)) = I$, we have $|x_1 - x_3| + \frac{I}{3}x_2 = I$. Since $|x_1 - x_3| + \frac{I}{3}x_2 \leq (x_1 + x_3) + x_2 \leq I$.

Therefore, $|x_1 - x_3| + \frac{I}{3}x_2 = (x_1 + x_3) + x_2 = I$. We obtain that $x_2 = 0$ and $|x_1 - x_3| = I$. Thus,

$x \in \{0_{p'}, I_{p'}\}$. Assume that $D_0(x, N_S(x)) = I$, we have $|x_1 - x_3| + \frac{I}{3}|x_2 - x_4| = I$. Since

$|x_1 - x_3| + \frac{I}{3}|x_2 - x_4| \leq (x_1 + x_3) + (x_2 + x_4) = I$. We obtain that $x_2 = x_4 = 0$ and $|x_1 - x_3| = I$. Thus,

$x \in \{0_{P'}, I_{P'}\}$. Assume that $D_0(x, N_0(x)) = 0$, we have $|x_1 - x_3| + \frac{1}{3}x_2 = 0$. Hence, $x_2 = 0$ and $x_1 = x_3$.

Assume that $D_0(x, N_S(x)) = 0$, we have $|x_1 - x_3| + \frac{1}{3}|x_2 - x_4| = 0$. Hence, $x_2 = x_4$ and $x_1 = x_3$.

– We have $D_0((0,0,0),(0,a,0)) = \frac{a}{3}$,

$$D_0((0,0,0),(a,0,0)) = D_0((0,0,0),(0,0,a)) = \frac{2a}{3}, \text{ and}$$

$$D_0((a,0,0),(0,0,a)) = D_0((a,0,0),(0,a,0)) = D_0((0,0,a),(0,a,0)) = a.$$

Remark 5. The order “ \ll ” on P^* corresponds to the following order on $PFS(X)$:

$$A \subseteq B \Leftrightarrow \mu_A(x) \leq \mu_B(x), \eta_A(x) \leq \eta_B(x), \nu_A(x) \geq \nu_B(x), \forall x \in X. \tag{11}$$

Remark 6. The picture fuzzy distance measure on P^* corresponds to the picture fuzzy distance measure on $PFS(X)$, i.e., for all $A, B \in PFS(X = \{x_1, x_2, \dots, x_m\})$, we have the picture fuzzy distance measure D_0 between A and B as follows:

$$D_0(A, B) = \frac{1}{3m} \sum_{i=1}^m (|\mu_A(x_i) - \mu_B(x_i)| + |\eta_A(x_i) - \eta_B(x_i)| + |\nu_A(x_i) - \nu_B(x_i)| + |\max\{\mu_A(x_i), \nu_B(x_i)\} - \max\{\nu_A(x_i), \mu_B(x_i)\}|). \tag{12}$$

Proposition 3. Consider the picture fuzzy distance measure D_0 in Eq. (10), the picture fuzzy t-norms $T_{i(i=0,\dots,5)}$ in Example 2, the picture fuzzy t-conorms $S_{i(i=0,\dots,5)}$ in Example 3, and the picture fuzzy negation N_0 in Example 1. Let A and B be two picture fuzzy sets on the universe $X = \{x_1, x_2, \dots, x_m\}$. Then, we have the following properties:

– $D_0(A \cap_{T_2} B, B) \geq \max\{D_0(A \cap_{T_i} B, A \cap_{T_j} B), D_0(A \cap_{T_k} B, B)\}$,

$$D_0(A \cap_{T_2} B, A) \geq \max\{D_0(A \cap_{T_i} B, A \cap_{T_j} B), D_0(A \cap_{T_k} B, A)\},$$

$$D_0(\overline{A \cap_{T_2} B}^{N_0}, \overline{A}^{N_0}) \geq \max\{D_0(\overline{A \cap_{T_i} B}^{N_0}, \overline{A \cap_{T_j} B}^{N_0}), D_0(\overline{A \cap_{T_k} B}^{N_0}, \overline{A}^{N_0})\},$$

$$D_0(\overline{A \cap_{T_2} B}^{N_0}, \overline{B}^{N_0}) \geq \max\{D_0(\overline{A \cap_{T_i} B}^{N_0}, \overline{A \cap_{T_j} B}^{N_0}), D_0(\overline{A \cap_{T_k} B}^{N_0}, \overline{B}^{N_0})\},$$

$$\forall (i, j) \in \{(x, y) \mid x, y = 0, \dots, 5\} \setminus \{(4, 5)\} \text{ and } k = 0, 1, 3, 4, 5.$$

$$\begin{aligned}
 - \quad & D_0(A \cup_{S_5} B, A) \geq \max\{D_0(A \cup_{S_5} B, A \cup_{S_j} B), D_0(A \cup_{S_k} B, A)\}, \\
 & D_0(A \cup_{S_5} B, B) \geq \max\{D_0(A \cup_{S_5} B, A \cup_{S_j} B), D_0(A \cup_{S_k} B, B)\}, \\
 & D_0(\overline{A \cup_{S_5} B}^{N_0}, \overline{A}^{N_0}) \geq \max\{D_0(\overline{A \cup_{S_5} B}^{N_0}, \overline{A \cup_{S_j} B}^{N_0}), D_0(\overline{A \cup_{S_k} B}^{N_0}, \overline{A}^{N_0})\}, \\
 & D_0(\overline{A \cup_{S_5} B}^{N_0}, \overline{B}^{N_0}) \geq \max\{D_0(\overline{A \cup_{S_5} B}^{N_0}, \overline{A \cup_{S_j} B}^{N_0}), D_0(\overline{A \cup_{S_k} B}^{N_0}, \overline{B}^{N_0})\},
 \end{aligned}$$

$\forall (i, j) \in \{(x, y) \mid x, y = 0, 1, 3, 4, 5\} \setminus \{(1, 3)\}$ and $k = 0, 1, 3, 4$.

$$\begin{aligned}
 - \quad & D_0(A \cup_{S_2} B, A) \geq \max\{D_0(A \cup_{S_2} B, A \cup_{S_j} B), D_0(A \cup_{S_k} B, A)\}, \\
 & D_0(A \cup_{S_2} B, B) \geq \max\{D_0(A \cup_{S_2} B, A \cup_{S_j} B), D_0(A \cup_{S_k} B, B)\}, \\
 & D_0(\overline{A \cup_{S_2} B}^{N_0}, \overline{A}^{N_0}) \geq \max\{D_0(\overline{A \cup_{S_2} B}^{N_0}, \overline{A \cup_{S_j} B}^{N_0}), D_0(\overline{A \cup_{S_k} B}^{N_0}, \overline{A}^{N_0})\}, \\
 & D_0(\overline{A \cup_{S_2} B}^{N_0}, \overline{B}^{N_0}) \geq \max\{D_0(\overline{A \cup_{S_2} B}^{N_0}, \overline{A \cup_{S_j} B}^{N_0}), D_0(\overline{A \cup_{S_k} B}^{N_0}, \overline{B}^{N_0})\},
 \end{aligned}$$

$\forall i, j = 0, 2, 3, 4$, and $k = 0, 3, 4$.

$$\begin{aligned}
 - \quad & D_0(A \cap_{T_i} B, A \cup_{S_j} B) \geq D_0(A \cap_{T_0} B, A \cup_{S_0} B) \text{ and} \\
 & D_0(\overline{A \cap_{T_i} B}^{N_0}, \overline{A \cup_{S_j} B}^{N_0}) \geq D_0(\overline{A \cap_{T_0} B}^{N_0}, \overline{A \cup_{S_0} B}^{N_0}), \forall i, j = 0, \dots, 5.
 \end{aligned}$$

Proof. These properties are proved as follows. Firstly, we see that for all $x, y \in [0, 1]$,

$$\max(0, x + y - 1) \leq xy \leq \min(x, y) \quad \text{and} \quad \min(1, x + y) \geq x + y - xy \geq \max(0, x + y - 1). \text{ Hence,}$$

$$(\max(0, x_1 + y_1 - 1), \max(0, x_2 + y_2 - 1), \min(1, x_3 + y_3)) \ll (x_1 y_1, x_2 y_2, x_3 + y_3 - x_3 y_3). \text{ This means } T_2 \ll T_1.$$

Similarly, we obtain that $T_2 \ll T_3 \ll T_4 \ll T_1 \ll T_0$ and $T_2 \ll T_3 \ll T_5 \ll T_1 \ll T_0$. Hence,

$$A \cap_{T_2} B \subseteq^* A \cap_{T_3} B \subseteq^* A \cap_{T_4} B \subseteq^* A \cap_{T_1} B \subseteq^* A \cap_{T_0} B \subseteq^* A,$$

$$A \cap_{T_2} B \subseteq^* A \cap_{T_3} B \subseteq^* A \cap_{T_5} B \subseteq^* A \cap_{T_1} B \subseteq^* A \cap_{T_0} B \subseteq^* A,$$

$$A \cap_{T_2} B \subseteq^* A \cap_{T_3} B \subseteq^* A \cap_{T_4} B \subseteq^* A \cap_{T_1} B \subseteq^* A \cap_{T_0} B \subseteq^* B, \text{ and}$$

$$A \cap_{T_2} B \subseteq^* A \cap_{T_3} B \subseteq^* A \cap_{T_5} B \subseteq^* A \cap_{T_1} B \subseteq^* A \cap_{T_0} B \subseteq^* B.$$

Since D_0 is the picture fuzzy distance measure, thus

$$D_0(A \cap_{T_2} B, A) \geq \max\{D_0(A \cap_{T_i} B, A \cap_{T_j} B), D_0(A \cap_{T_k} B, A)\} \text{ and}$$

$$D_0(A \cap_{T_2} B, B) \geq \max\{D_0(A \cap_{T_i} B, A \cap_{T_j} B), D_0(A \cap_{T_k} B, B)\},$$

$\forall (i, j) \in \{(x, y) \mid x, y = 0, \dots, 5\} \setminus \{(4, 5)\}$ and $k = 0, 1, 3, 4, 5$. Furthermore, we have

$$\bar{A}^{N_0} = \{(x : N_0((\mu_A(x), \eta_A(x), \nu_A(x)))) \mid x \in X\} = \{(x : (\nu_A(x), 0, \mu_A(x))) \mid x \in X\}, \otimes.$$

It is easy to prove the following lemma: If $A \subseteq B$, then $\bar{B}^{N_0} \subseteq \bar{A}^{N_0}$. Thus,

$$D_0(\overline{A \cap_{T_2} B}^{N_0}, \bar{A}^{N_0}) \geq \max\{D_0(\overline{A \cap_{T_i} B}^{N_0}, \overline{A \cap_{T_j} B}^{N_0}), D_0(\overline{A \cap_{T_k} B}^{N_0}, \bar{A}^{N_0})\} \text{ and}$$

$$D_0(\overline{A \cap_{T_2} B}^{N_0}, \bar{B}^{N_0}) \geq \max\{D_0(\overline{A \cap_{T_i} B}^{N_0}, \overline{A \cap_{T_j} B}^{N_0}), D_0(\overline{A \cap_{T_k} B}^{N_0}, \bar{B}^{N_0})\},$$

$\forall (i, j) \in \{(x, y) \mid x, y = 0, \dots, 5\} \setminus \{(4, 5)\}$ and $k = 0, 1, 3, 4, 5$.

Secondly, we have $S_0 \ll S_4 \ll S_3 \ll S_5$, $S_0 \ll S_4 \ll S_3 \ll S_2$, and $S_0 \ll S_4 \ll S_1 \ll S_5$. Hence,

$$A \subseteq A \cup_{S_0} B \subseteq A \cup_{S_4} B \subseteq A \cup_{S_3} B \subseteq A \cup_{S_5} B,$$

$$B \subseteq A \cup_{S_0} B \subseteq A \cup_{S_4} B \subseteq A \cup_{S_3} B \subseteq A \cup_{S_5} B,$$

$$A \subseteq A \cup_{S_0} B \subseteq A \cup_{S_4} B \subseteq A \cup_{S_1} B \subseteq A \cup_{S_5} B, \text{ and}$$

$$B \subseteq A \cup_{S_0} B \subseteq A \cup_{S_4} B \subseteq A \cup_{S_1} B \subseteq A \cup_{S_5} B.$$

Therefore $D_0(A \cup_{S_5} B, A) \geq \max\{D_0(A \cup_{S_i} B, A \cup_{S_j} B), D_0(A \cup_{S_k} B, A)\}$,

$$D_0(A \cup_{S_5} B, B) \geq \max\{D_0(A \cup_{S_i} B, A \cup_{S_j} B), D_0(A \cup_{S_k} B, B)\},$$

$$D_0(\overline{A \cup_{S_5} B}^{N_0}, \bar{A}^{N_0}) \geq \max\{D_0(\overline{A \cup_{S_i} B}^{N_0}, \overline{A \cup_{S_j} B}^{N_0}), D_0(\overline{A \cup_{S_k} B}^{N_0}, \bar{A}^{N_0})\}, \text{ and}$$

$$D_0(\overline{A \cup_{S_5} B}^{N_0}, \bar{B}^{N_0}) \geq \max\{D_0(\overline{A \cup_{S_i} B}^{N_0}, \overline{A \cup_{S_j} B}^{N_0}), D_0(\overline{A \cup_{S_k} B}^{N_0}, \bar{B}^{N_0})\},$$

$\forall (i, j) \in \{(x, y) \mid x, y = 0, 1, 3, 4, 5\} \setminus \{(1, 3)\}$ and $k = 0, 1, 3, 4$.

Now, we have $A \subseteq A \cup_{S_0} B \subseteq A \cup_{S_4} B \subseteq A \cup_{S_3} B \subseteq A \cup_{S_2} B$ and

$$B \subseteq_* A \cup_{S_0} B \subseteq_* A \cup_{S_1} B \subseteq_* A \cup_{S_2} B \subseteq_* A \cup_{S_3} B \subseteq_* A \cup_{S_4} B.$$

Thus, for all $i, j = 0, 2, 3, 4$, and $k = 0, 3, 4$, we have

$$D_0(A \cup_{S_2} B, A) \geq \max\{D_0(A \cup_{S_i} B, A \cup_{S_j} B), D_0(A \cup_{S_k} B, A)\},$$

$$D_0(A \cup_{S_2} B, B) \geq \max\{D_0(A \cup_{S_i} B, A \cup_{S_j} B), D_0(A \cup_{S_k} B, B)\},$$

$$D_0(\overline{A \cup_{S_2} B}^{N_0}, \overline{A}^{N_0}) \geq \max\{D_0(\overline{A \cup_{S_i} B}^{N_0}, \overline{A \cup_{S_j} B}^{N_0}), D_0(\overline{A \cup_{S_k} B}^{N_0}, \overline{A}^{N_0})\}, \text{ and}$$

$$D_0(\overline{A \cup_{S_2} B}^{N_0}, \overline{B}^{N_0}) \geq \max\{D_0(\overline{A \cup_{S_i} B}^{N_0}, \overline{A \cup_{S_j} B}^{N_0}), D_0(\overline{A \cup_{S_k} B}^{N_0}, \overline{B}^{N_0})\}.$$

Finally, we see that $A \cap_{T_2} B \subseteq_* A \cap_{T_0} B \subseteq_* A \subseteq_* A \cup_{S_0} B \subseteq_* A \cup_{S_5} B$.

Thus, we obtain that $D_0(A \cap_{T_2} B, A \cup_{S_5} B) \geq D_0(A \cap_{T_0} B, A \cup_{S_0} B)$ and the remaining inequalities of

Proposition 3.

4. An Application of the Picture Fuzzy Distance Measure for Controlling Network Power Consumption

4.1. Figures and Tables

The interconnection network is important in the parallel computer systems. Saving interconnection network power is always interested, researched and becoming more and more urgent in the current technological era. In order to achieve high performance, the architectural design of the interconnection network requires an effective power saving mechanism. The aim of this mechanism is to reduce the network latency (the average latency of a message) and the percentages between the number of links that are kept switched on by the saving mechanism and the total number of links [25]. As a simplified way of understanding, this is a matter of optimizing the number of links opened in a networking system. This is a decision-making problem for the trunk link state.

In 2010, Alonso et al. introduced the power saving mechanism in regular interconnection network [25]. This model dynamically increases or reduces the number of links that compose a trunk link. This is done by measuring network traffic and dynamically turning these individual links on or off based on a u_{on} / u_{off} threshold policy with keeping at least one operational link (see *Fig. 1* and *Fig. 2*).

The two parameters u_{on} and u_{off} are designed based on different requirements of mechanism aggressiveness (controlled by the value $u_{avg} = (u_{on} + u_{off}) / 2$) and mechanism responsiveness (controlled by the difference $u_{on} - u_{off}$).

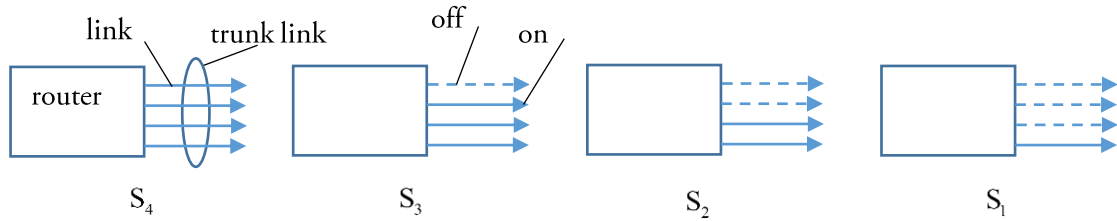

Fig. 1. Four trunk link states.

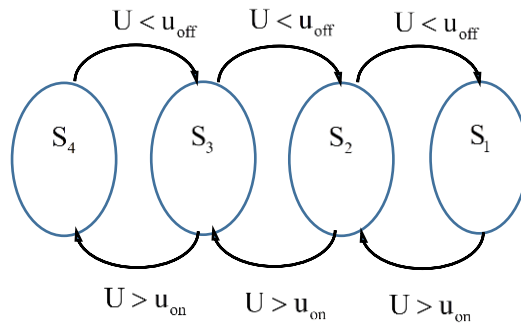

Fig. 2. The operational mechanism of switches.

In order to avoid the possibility of cyclic state transitions that makes the system become unstable, the following restrictions hold in the selection u_{on} and u_{off} :

$$0 < u_{off} \leq \frac{u_{on}}{2} \leq \frac{U_{max}}{2}. \tag{13}$$

Thus, the different values of u_{off} and u_{on} that satisfy Eq. (13) are stifferly chosen in order to achieve different goals of responsiveness and aggressiveness for the power saving mechanism. In 2015, they continue to study and modify power consumption control in fat-tree interconnection networks based on the static and dynamic thresholds policies [26]. In general, this threshold policy is hard because it is without any fuzzy approaches, parameter learning and optimizing processes.

In 2017, Phan et al. [27] proposed a new method in power consumption estimation of network-on-chip based on fuzzy logic [27]. However, this fuzzy logic system based on Sugeno model is too rudimentary and the parameters here are chosen according to the authors' quantification. In this paper, aiming to replace the above threshold policy in decision making problem for the trunk link state, we propose a higher-level fuzzy system based on the proposed single-valued neutrosophic distance measure in Section 3.

4.2. The Adaptive Neuro Picture Fuzzy Inference System (ANPFIS)

In this subsection, an ANPFIS based on picture fuzzy distance measure is introduced to decision making problems. ANPFIS is a modification and combination between ANFIS [28], picture fuzzy set, and picture fuzzy distance measure. Hence, ANPFIS operates based on the picture fuzzification and defuzzification

processes, the picture fuzzy operators and distance measure, and the learning capability for automatic picture fuzzy rule generation and parameter optimization. The model is showed as in the *Fig. 3*.

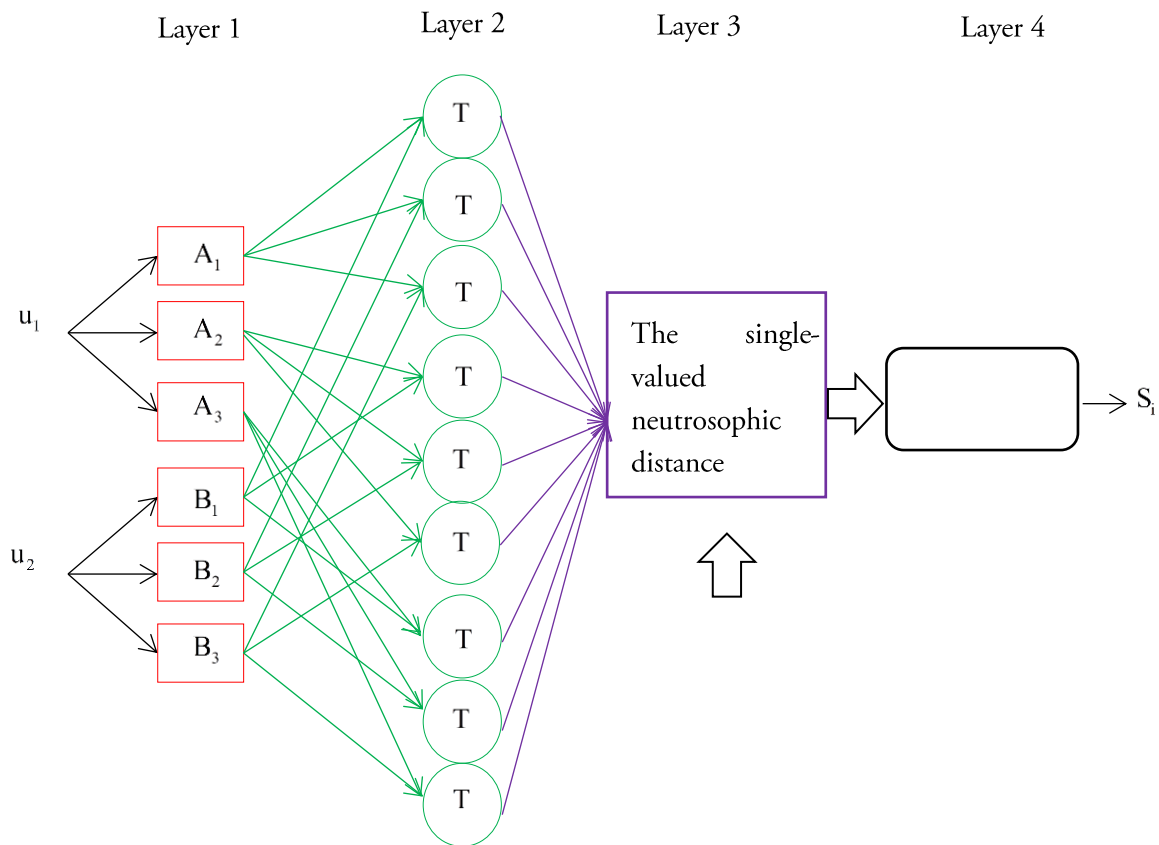

Fig. 3. The proposed ANPFIS decision making model.

The model has the inputs are number values and the output $S_i, i \in \{1, \dots, n\}$ is the chosen solution. ANPFIS includes four layers as follows:

Layer 1-Picture Fuzzification. Each input value is connected to three neuros O_i^j , in other words is fuzzified by three corresponding picture fuzzy sets named “High”, “Medium”, and “Low”. We use the Picture Fuzzy Gaussian Function (PFGF): the PFGF is specified by two parameters. The Gaussian function is defined by a central value m and width $k > 0$. The smaller the k , the narrower the curve is. Picture fuzzy Gaussian positive membership, neutral, and negative membership functions are defined as follows

$$\mu(x) = \exp\left(-\frac{(x-m)^2}{2k^2}\right),$$

$$v(x) = c_1(1 - \mu(x)), \quad (c_1 \in [0, 1]), \text{ and}$$

$$\eta(x) = c_2(1 - \mu(x) - v(x)), \quad (c_2 \in [0, 1]), \text{ where the parameters } m \otimes \text{ and } k \triangleright \text{ are trained.}$$

Layer 2-Automatic Picture Fuzzy Rules. The picture fuzzy t-norm T (see. *Definition 7* and *Example 2*) is used in this step in order to establish the IF-THEN picture fuzzy rules, i.e., the links between the neuros O_i^1 of Layer 1 and the neuros O_k^2 of Layer 2 as follows

“If O_i^1 is x and O_j^1 is y then O_k^2 is $T(x, y)$.”

For examples $T(x, y) = T_1^\lambda(x, y)$, where [18]

$$T_1^\lambda(x, y) = \left(\frac{x_1 y_1}{\lambda_1 + (1 - \lambda_1)(x_1 + y_1 - x_1 y_1)}, \frac{x_2 y_2}{\lambda_2 + (1 - \lambda_2)(x_2 + y_2 - x_2 y_2)}, \left(x_3^{\lambda_3} + y_3^{\lambda_3} - x_3^{\lambda_3} y_3^{\lambda_3} \right)^{\frac{1}{\lambda_3}} \right), \text{ here } x, y \in P^*,$$

and the parameters $\lambda_1, \lambda_2, \lambda_3 \in [1, +\infty)$ are trained.

Layer 3 – Calculate the difference to the samples. The difference between the input I and the sample K is calculated by the proposed picture fuzzy distance measure D_0 in *Eq. (10)* as follows

$$D_0(I, K) = \frac{1}{3m} \sum_{i=1}^m \omega_i \cdot \left\{ |\mu_1(x_i) - \mu_2(x_i)| + |\eta_1(x_i) - \eta_2(x_i)| + |v_1(x_i) - v_2(x_i)| \right. \\ \left. + \left| \max\{\mu_1(x_i), v_2(x_i)\} - \max\{\mu_2(x_i), v_1(x_i)\} \right| \right\},$$

where, m is the number of attribute neuro values and $\omega_{(i=1, \dots, m)}$ are the trained weights.

Layer 4-Picture Defuzzification. In this final step, we point out the minimum difference value in all values received from Layer 3,

$$\text{Min } D_0(I, K) = D_0(I, K_i).$$

Then, the output value of the ANPFIS is the solution S_i which is corresponding to the sample K_i .

4.3. Application of the ANPFIS algorithm in Controlling Network Power Consumption

In this part, we present the installation of ANPFIS algorithm in the trunk link state Controller of interconnection network.

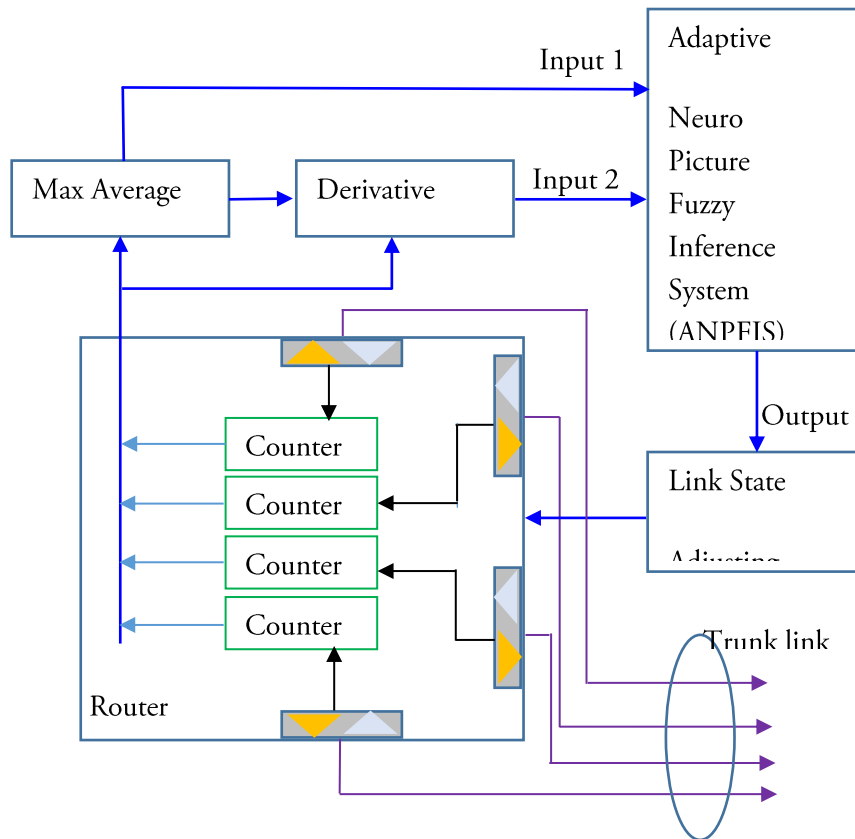

Fig. 4. The architecture of the trunk link state controller based on ANPFIS.

Fig. 4 describes the architecture of the trunk link state Controller based on ANPFIS. This Controller is developed from the previous architecture which is proposed by Phan et al. in 2017 for network-on-chip [27]. For details, each router input port will be equipped with a traffic counter. These counters count the data flits passing through the router in certain clock cycles based on the corresponding response signals from the router. The flits through the router is counted in a slot of time. When the counting finish, the traffic through the corresponding port will be calculated [27]. Each port of the router is connected with a Counter, then there are four average values of the traffic.

- The Max Average (MA) block receives the values of traffic from the counters which are connected with the routers ports. It compares these values and chose the maximum value for Input 1 of the ANPFIS.
- The Derivative (DER) block calculates the derivative of traffics obtained from the counters. This value is defined as an absolute value of the traffics change in a unit of time. This value is determined according to the maximum traffic value decided by MA block. After that, the DER gives it to the Input 2 of the ANPFIS for further processes.

The value domain of Input 1 and Input 2 is from 0 to the maximum bandwidth value. They are normed into [0, 1] by Min Max normalization.

- Through the ANPFIS block, the received Output is the trunk link state $S, i \in \{1, 2, 3, 4\}$. The received new state are adjusted by the Link State Adjusting block.

5. Experiments on Real-World Datasets

5.1. Experimental Environments

In order to evaluate performance, we test the ANPFIS method on the real datasets of the network traffic history taken from the UPV (Universitat Politècnica de València) university with related methods. The descriptions of the experimental dataset are presented in *Table 1*.

Table 1. The descriptions of the experimental dataset.

No. elements (checking-cycles)	16.571	
No. attributes	2 (MA, DER)	
The normalized value domain of attributes	MA	DER
	[0,1]	[-1,1]
No. classes (No. link states)	4	

We compare the ANPFIS method against the methods of Hung (M2012) [21], Junjun et al. (M2013) [22], Maheshwari et al. (M2016) [23], Ngan et al. (H-max) [8], and ANFIS [28] in the Matlab 2015a programming language. The Mean Squared Error (MSE) degrees of these methods are given out to compare their performance.

5.2. The Quality

The MSE degree of the ANPFIS method are less than those of other methods. The specific values are expressed in *Table 2*.

Table 2. The performance of the methods.

Method	M2012 [21]	M2013 [22]	M2016 [23]	H-max [8]	ANFIS [28]	ANPFIS
MSE	0.2009	0.2606	0.2768	0.1259	0.2006	0.0089

Fig. 5 clearly show the difference between the performance values of six considered algorithms. In *Fig. 5*, the blue columns illustrate the MSE values of the methods. It can be seen that the columns of the other methods are higher than that of the ANPFIS method. That means the accuracy of the proposed method is better than that of the related methods on the considered dataset.

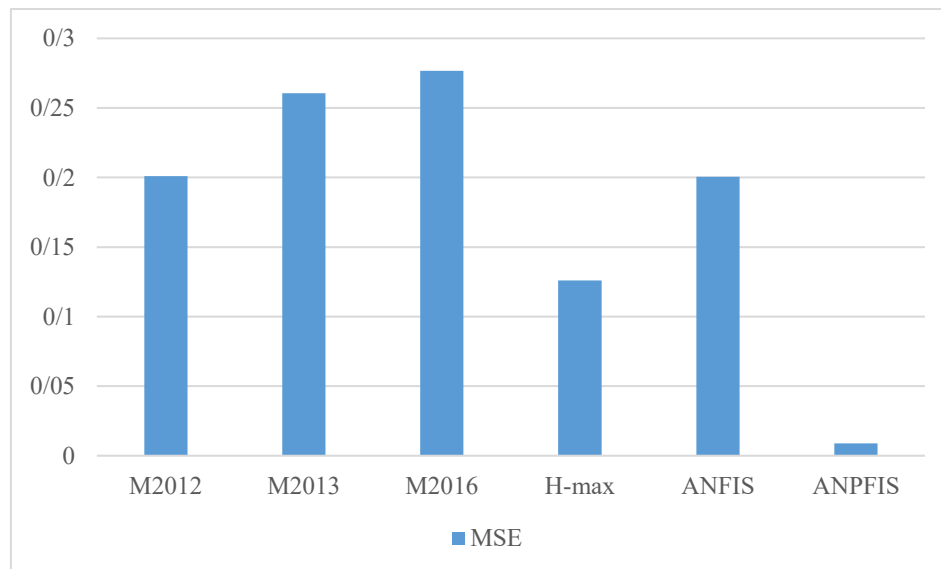

Fig. 5. The MSE values of 6 methods.

6. Conclusion

The neutrosophic theory increasingly attracts researchers and is applied in many fields. In this paper, a new single-valued neutrosophic distance measure is proposed. It is also a distance measure between picture fuzzy sets and is a development of the H-max measure which was introduced by Ngan et al. [8]. Further, an Adaptive NPFIS based on the proposed measure is shown and applied to the decision making for the link states in interconnection networks. The proposed model is tested on the real datasets taken from the UPV university. The MSE value of the proposed methods is less than that of other methods.

Appendix

Source code and datasets of this paper can be found at this link, <https://sourceforge.net/projects/pfdm-datasets-code/>.

References

- [1] Zadeh, L. A. (1965). Fuzzy sets. *Information and control*, 8(3), 338-353.
- [2] Khorshidi, H. A., & Nikfalazar, S. (2017). An improved similarity measure for generalized fuzzy numbers and its application to fuzzy risk analysis. *Applied soft computing*, 52, 478-486.
- [3] Liang, D., & Xu, Z. (2017). The new extension of TOPSIS method for multiple criteria decision making with hesitant Pythagorean fuzzy sets. *Applied soft computing*, 60, 167-179.
- [4] Zadeh, L. A. (1975). The concept of a linguistic variable and its application to approximate reasoning—I. *Information sciences*, 8(3), 199-249.
- [5] Coupland, S., & John, R. (2008). New geometric inference techniques for type-2 fuzzy sets. *International journal of approximate reasoning*, 49(1), 198-211.
- [6] Atanassov, K. T. (1986). Intuitionistic fuzzy sets. *Fuzzy sets Syst.*, 20(1), 87-96.
- [7] Chen, S. M., Cheng, S. H., & Lan, T. C. (2016). A novel similarity measure between intuitionistic fuzzy sets based on the centroid points of transformed fuzzy numbers with applications to pattern recognition. *Information sciences*, 343-344, 15-40. doi: 10.1016/j.ins.2016.01.040

- [8] Ngan, R. T., Cuong, B. C., & Ali, M. (2018). H-max distance measure of intuitionistic fuzzy sets in decision making. *Applied soft computing*, 69, 393-425.
- [9] Chen, S. M., & Li, T. S. (2013). Evaluating students' answerscripts based on interval-valued intuitionistic fuzzy sets. *Information sciences*, 235, 308-322. doi: 10.1016/j.ins.2012.12.031
- [10] Smarandache, F. (1999). *A unifying field in logics. Neutrosophy: Neutrosophic probability, set and logic, reboth.* American Research Press, Rehoboth.
- [11] Ali, M., & Smarandache, F. (2017). Complex neutrosophic set. *Neural computing and applications*, 28(7), 1817-1834.
- [12] Dat, L. Q., Thong, N. T., Ali, M., Smarandache, F., Abdel-Basset, M., & Long, H. V. (2019). Linguistic approaches to interval complex neutrosophic sets in decision making. *IEEE access*, 7, 38902-38917.
- [13] Smarandache, F. (2016). *Degree of dependence and independence of the (sub) components of fuzzy set and neutrosophic set.* Infinite Study.
- [14] Smarandache, F. (2019). *Neutrosophic set is a generalization of intuitionistic fuzzy set, inconsistent intuitionistic fuzzy set (picture fuzzy set, ternary fuzzy set), pythagorean fuzzy set (atanassov's intuitionistic fuzzy set of second type), q-rung orthopair fuzzy set, spherical fuzzy set, and n-hyperspherical fuzzy set, while neutrosophication is a generalization of regret theory, grey system theory, and three-ways decision (revisited).* Infinite Study.
- [15] Cuong, B. C., & Kreinovich, V. (2013, December). Picture fuzzy sets-a new concept for computational intelligence problems. *2013 third world congress on information and communication technologies (WICT 2013)* (pp. 1-6). IEEE.
- [16] Thong, P. H. (2015). A new approach to multi-variable fuzzy forecasting using picture fuzzy clustering and picture fuzzy rule interpolation method. In *Knowledge and systems engineering* (pp. 679-690). Springer, Cham. doi:10.1007/978-3-319-11680-8_54
- [17] Wei, G., & Gao, H. (2018). The generalized Dice similarity measures for picture fuzzy sets and their applications. *Informatica*, 29(1), 107-124.
- [18] Cong, C. B., Ngan, R. T., & Long, L. B. (2017). Some new de morgan picture operator triples in picture fuzzy logic. *Journal of computer science and cybernetics*, 33(2), 143-164.
- [19] Cuong, B. C., Kreinovich, V., & Ngan, R. T. (2016, October). A classification of representable t-norm operators for picture fuzzy sets. *2016 eighth international conference on knowledge and systems engineering (KSE)* (pp. 19-24). IEEE.
- [20] Khalil, A. M., Li, S. G., Garg, H., Li, H., & Ma, S. (2019). New operations on interval-valued picture fuzzy set, interval-valued picture fuzzy soft set and their applications. *IEEE access*, 7, 51236-51253.
- [21] Hung, K. C. (2012). Medical pattern recognition: applying an improved intuitionistic fuzzy cross-entropy approach. *Advances in fuzzy systems*, 863549. 1-6. doi: 10.1155/2012/863549
- [22] Mao, J., Yao, D., & Wang, C. (2013). A novel cross-entropy and entropy measures of IFSs and their applications. *Knowledge-based systems*, 48, 37-45.
- [23] Maheshwari, S., & Srivastava, A. (2016). Study on divergence measures for intuitionistic fuzzy sets and its application in medical diagnosis. *Journal of applied analysis and computation*, 6(3), 772-789.
- [24] Ngan, R. T., Cuong, B. C., & Tuan, T. M. (2018, August). Medical diagnosis from images with intuitionistic fuzzy distance measures. *International joint conference on rough sets* (pp. 479-490). Springer, Cham.
- [25] Alonso, M., Coll, S., Martínez, J. M., Santonja, V., López, P., & Duato, J. (2010). Power saving in regular interconnection networks. *Parallel computing*, 36(12), 696-712.
- [26] Alonso, M., Coll, S., Martínez, J. M., Santonja, V., & López, P. (2015). Power consumption management in fat-tree interconnection networks. *Parallel computing*, 48, 59-80.
- [27] Phan, H. P., Tran, X. T., & Yoneda, T. (2017, May). Power consumption estimation using VNOC2.0 simulator for a fuzzy-logic based low power Network-on-Chip. *2017 IEEE international conference on IC design and technology (ICICDT)* (pp. 1-4). IEEE.
- [28] Çaydaş, U., Hasçalık, A., & Ekici, S. (2009). An adaptive neuro-fuzzy inference system (ANFIS) model for wire-EDM. *Expert systems with applications*, 36(3), 6135-6139.
- [29] Ali, M., Deo, R. C., Downs, N. J., & Maraseni, T. (2018). An ensemble-ANFIS based uncertainty assessment model for forecasting multi-scalar standardized precipitation index. *Atmospheric research*, 207, 155-180.
- [30] Karaboga, D., & Kaya, E. (2019). Adaptive network based fuzzy inference system (ANFIS) training approaches: a comprehensive survey. *Artificial intelligence review*, 52(4), 2263-2293.
- [31] Ali, M., Deo, R. C., Downs, N. J., & Maraseni, T. (2018). An ensemble-ANFIS based uncertainty assessment model for forecasting multi-scalar standardized precipitation index. *Atmospheric research*, 207, 155-180.
- [32] Wang, W., & Xin, X. (2005). Distance measure between intuitionistic fuzzy sets. *Pattern recognition letters*, 26(13), 2063-2069.

TOPSIS Approach for MCGDM based on Intuitionistic Fuzzy Rough Dombi Aggregation Operations

Azmat Hussain, Tahir Mahmood, Florentin Smarandache, Shahzaib Ashraf

Azmat Hussain, Tahir Mahmood, Florentin Smarandache, Shahzaib Ashraf (2022). TOPSIS Approach for MCGDM based on Intuitionistic Fuzzy Rough Dombi Aggregation Operations. SSRN Electronic Journal, 23; DOI: 10.2139/ssrn.4203412

Abstract: Atanassov presented the dominant notion of intuitionistic fuzzy sets (IFS) which brought revolution in different fields of science since their inception. The aim of this manuscript is to propose IF rough TOPSIS method based on Dombi operations. For this, first we proposed some new operational laws based on Dombi operations to aggregate averaging and geometric aggregation operators. On the proposed concept, we presented IF rough Dombi weighted averaging (IFRDWA), IF rough Dombi ordered weighted averaging (IFRDOWA) and IF rough Dombi hybrid averaging (IFRDHA) operators. Moreover, on the developed concept we presented IF rough Dombi weighted geometric (IFRDWG), IF rough Dombi ordered weighted geometric (IFRDOWG) and IF rough Dombi hybrid geometric (IFRDHG) operators. The basic related properties of the developed operators are presented in detailed. Then the algorithm for MCGDM based on TOPSIS method for IF rough Dombi averaging and geometric operators is presented. By applying accumulated geometric operator, the IF rough numbers are converted into the IF numbers. The massive outbreak of the pandemic COVID-19 promoted the challenging scenario for the world organizations including scientists, laboratories and researchers to conduct special clinical treatment strategies to prevent the people from COVID-19 pandemic. Additionally, an illustrative example is proposed to solve MCGDM problem to diagnose the most severe patient of COVID-19 by applying TOPSIS. Finally, a comparative analysis of the developed model is presented with some existing methods which shows the applicability and superiority of the developed model.

Key words: IFS, Rough sets, Dombi Operations, averaging and geometric aggregation operators, TOPSIS, MCGDM

1. Introduction

The multi criteria group decision making (MCGDM) the most significant and prominent methodology, in which a team of professional specialist evaluate alternatives for the selection of best optimal object based on multiple criteria. Group decision making (DM) has the ability and capability to improve the assessment process by evaluating multiple conflicting criteria based on the performance of alternatives from independent aspects. In DM it's hard to avoid the uncertainty due to the imprecise judgement by the professional specialist. The process of DM has engaged the attention of scholars in diverse directions around the world and gained the fruitful results by applying different approaches [1, 2]. To cope with vague and uncertain data Zadeh [3] originated the prominent concept of fuzzy sets (FS) and this concept has strong description of ambiguous information in MCGDM problems. After the inception of FS, researchers carried out different methods by applying the concept of FS in diverse directions [4, 5]. Atanassov [6] initiated the dominant notion of intuitionistic fuzzy set [IFS], having the property which is incorporated by the membership degree (MeD) and nonmembership degree (NonMeD) such that their sum belongs to $[0, 1]$, which enables better description of the imperfect and imprecise date in DM problems. Thao and Nguyen [7] put forwarded the concept of correlation coefficient and proposed for the same concept to determine the variance and covariance in sense of IFS. Chen et al. [8] presented new fuzzy DM methods based on evidential reasoning strategy. Chen and Chun [9] put forwarded the technique for TOPSIS method similarity measure based on IF date. In DM one of the most serious issue is to aggregate the preferences reports presented by the several professional experts to get a unique result. In this situation aggregation operators (AO) play significant role to aggregate the collective information presented from the different sources. Xu [10], Yager and Xu [11] developed the dominant concepts of IFWA and IFWG aggregation operators and discussed their fundamental properties. Garg [12] built up some improvement in averaging operators and proposed a series IF interactive weighted averaging operators. Li [13] originated idea of the generalized OWAO to aggregate the decision maker's assessment by applying IF information and solved MADM problems on the proposed concept. Wei [14] investigated the concept of IFOWGA operators and interval-valued IFOWGA operators and presented an illustrated example on the proposed model. The concept of Einstein operators was proposed by Wang and Liu [15] by applying IF information. Huang [16] originated the idea of some new Hamacher operators by applying

the idea of IFS and then applied the developed concept in DM. Hwang and Yoon [17] initiated the dominant and top most method technique for order preference by similarity to ideal solution (TOPSIS). This model measures the shortest and farthest distance from PIS and NIS. Garg and Kumar [18] initiated the idea of exponential distance measure by applying the technique of TOPSIS method under interval-valued IFS and solve its application in DM. The concept of new distance measure was proposed by Shen et al. [19] and by applying TOPSIS technique under IF environment and studied its desirable properties. Zeng and Xiao [20] originated TOPSIS technique based on averaging distance and initiated its desirable characteristics. Zeng et al. [21] developed a new score function and used VIKOR and TOPSIS for ranking IF numbers. Zulqarnain et al. [22] proposed the model for TOPSIS approach by using interval-valued IF soft set based on correlation coefficient to aggregate the expert's decision by applying soft aggregation operators. By applying the idea of cosine function Ye [23] discussed concept of two similarity measure. Garg and Kumar [24] proposed similarity measure by using set pair analysis theory. By using the concept of direct operation, Song et al. [25] put forward the notion of similarity measure under IF environment. The geometrical interpretation of entropy measure under IFS was proposed by Szmidi and Kacprzyk [26]. A novel approach of entropy and similarity measure was proposed by Meng and Chen [27] which is based on fuzzy measure. Lin and Ren [28] proposed a new approach for entropy measure based on the weight determination. Garg [29] made some improvement in cosine similarity measure. Yager [30] address the shortcoming in IFS and originated the concept of Pythagorean fuzzy sets (PFS) which become a hot research area for scholars. The notions of averaging and geometric operators was proposed by Yager [31]. Peng et al. [32] put forward some result in PFS. Hussain et al. [33, 34] introduced the algebraic structure of PFS in semigroup and further presented its combined studied with soft and rough sets. Zhang [35] proposed TOPSIS for PSF and described its application in DM. In spite of these, the concept of q-rung orthopair fuzzy sets (qROFS) was delivered by Yager [36]. Ali [37] initiated the ideas of orbits and L-fuzzy sets in qROFS. Hussain et al. [38, 39, 40, 41] proposed the combined study of qROFS with rough and soft sets. Ashraf et al. [42] investigated Einstein averaging and geometric operations for qROF rough sets through EDAS method.

In 1982 Dombi [43] investigated Dombi t-norm and Dombi t-conorm based on Dombi operational parameter. The concept of IFWA and IFWG operators based on Dombi operations was proposed by Seikh et al [44]. The idea of Bonferroni mean operations was proposed by Lui et al. [45] to aggregate the multi attributes based on IF aggregation operators and proposed its application in DM. Later, Chen and Ye [46] made an effort to proposed the Dombi operation in neutrosophic information and constructed its application in DM. We and We [47] initiated the hybrid study of Dombi operation with prioritized aggregation operators. Jana et al. [48] put forward the idea of arithmetic and geometric operations based on bipolar fuzzy Dombi operations.

Pawlak [49] initiated the prominent concept of rough set (RS) and this novel concept generalized the crisp set theory. The developed notion of RS theory handles the uncertainty and vagueness in more accurate way than classical set theory. From the inception, RS theory has been presented in different directions and proposed its applications in both practical and theoretical aspect as well. Dubois and Prade [50] put forward the idea of fuzzy RS based on fuzzy relation. Cornelis et al. [51] developed the combined structure of RS and IFS to get the dominant concept of IF rough set (IFRS). The constrictive and axiomatic study of rough set was presented by Zhou and Wu [52] by utilizing IF rough aggregation operators. Zhou and Wu [53] developed the idea of rough IFS and IFRS by applying crisp and fuzzy relation. Bustince and Burillo [54] developed the notion of IF relation. By applying the generalized IF relation Zhang et al. [55] proposed IFRS instead of IF relation. Moreover, the combine study of RS, soft set and IFS was investigated by Zhang et al. [56] to obtained the novel concepts of soft rough IFS and IF soft RS based on crisp and fuzzy approximation spaces. By applying the IF soft relation, Zhang et al. [57] developed concept of generalized IF soft RS. Chinram et al. [58] presented the concept of IF rough aggregation operators to aggregate the multi assessment of experts to get a unique optimal option based on IFRWA, IFRWG, IFROWA, IFROWG, IFRHA and IFRHG operators and by applying EDAS method to illustrate the DM application. Later on, Yhya [59] developed the IFR frank aggregation operators and discussed its basic properties. From the above analysis and discussion, it is clear that Dombi operations has natural resilience and flexibility to demonstrate the datum and questionable real life issues more effectively. Furthermore, the behavior of general operational parameter β in Dombi operations has more importance

to express the decision maker’s attitude. Therefore, motivated from the existing literature, in the current work we introduced the combine study of IFR averaging and geometric aggregation operators based on Dombi operations to get the novel concepts of IFRDWA and IFRDWG aggregation operators. Moreover, we developed IFRDOWA, IFRDHA, IFRDOWG and IFRDHG operators and investigated their desirable properties with details. The remaining portion of the manuscript is managed as.

In Section 2, of the manuscript some basic concepts are given which will be helpful for onward sections. Section 3, consists of Dombi operations and proposed some new operational laws based on Dombi operations to aggregate averaging operators and geometric operators. In Section 4, we investigated the notion of IFRDWA, IFRDOWA and IFRDHA operators. Moreover, in Section 5, we developed the concept of IFRDWG, IFRDOWG and IFRDHA operators. The fundamental related characteristics of the developed operators are presented in detailed. Section 6, we developed a step algorithm of TOPSIS method for MCGDM based on for IF rough Dombi averaging and geometric operators. In Section 7, an illustrative example is proposed to solve MCGDM problem to diagnose the most severe patient of COVID-19 by applying TOPSIS technique. Finally, a comparative analysis of the developed model is presented with different previous models in literature which presents that the investigated concepts are more resilience and flexible than the developed models.

2. Preliminaries

This section, includes the review of some elementary definitions, operations and their score values, which associate the existing literature with the developed concepts.

Definition 1 [6]. Consider K be a universal set, and IFS \mathfrak{G} on the set K is given as;

$$\mathfrak{G} = \{ \langle g, \mu_{\mathfrak{G}}(g), \nu_{\mathfrak{G}}(g) \rangle | g \in K \},$$

where $\mu_{\mathfrak{G}}, \nu_{\mathfrak{G}}: K \rightarrow [0, 1]$, represent the MeD and NonMeD of an object $g \in K$, to the set \mathfrak{G} with $0 \leq \mu_{\mathfrak{G}}(g) + \nu_{\mathfrak{G}}(g) \leq 1$. Moreover, $\pi_{\mathfrak{G}}(g) = 1 - (\mu_{\mathfrak{G}}(g) + \nu_{\mathfrak{G}}(g))$ denotes the hesitancy degree of an alternative $g \in K$. For simplicity $\mathfrak{G} = \langle g, \mu_{\mathfrak{G}}(g), \nu_{\mathfrak{G}}(g) \rangle$ is denoted by $\mathfrak{G} = (\mu_{\mathfrak{G}}, \nu_{\mathfrak{G}})$ and is known as IF number (IFN) for $g \in K$.

Assume to IFNs $\mathfrak{G} = (\mu_{\mathfrak{G}}, \nu_{\mathfrak{G}})$ and $\mathfrak{G}_1 = (\mu_{\mathfrak{G}_1}, \nu_{\mathfrak{G}_1})$, then some fundamental operations on them are defined as:

- (i) $\mathfrak{G} \cup \mathfrak{G}_1 = (\max(\mu_{\mathfrak{G}}(g), \mu_{\mathfrak{G}_1}(g)), \min(\nu_{\mathfrak{G}}(g), \nu_{\mathfrak{G}_1}(g)))$;
- (ii) $\mathfrak{G} \cap \mathfrak{G}_1 = (\min(\mu_{\mathfrak{G}}(g), \mu_{\mathfrak{G}_1}(g)), \max(\nu_{\mathfrak{G}}(g), \nu_{\mathfrak{G}_1}(g)))$;
- (iii) $\mathfrak{G} \oplus \mathfrak{G}_1 = (\mu_{\mathfrak{G}} + \mu_{\mathfrak{G}_1} - \mu_{\mathfrak{G}}\mu_{\mathfrak{G}_1}, \nu_{\mathfrak{G}}\nu_{\mathfrak{G}_1})$;
- (iv) $\mathfrak{G} \otimes \mathfrak{G}_1 = (\mu_{\mathfrak{G}}\mu_{\mathfrak{G}_1}, \nu_{\mathfrak{G}} + \nu_{\mathfrak{G}_1} - \nu_{\mathfrak{G}}\nu_{\mathfrak{G}_1})$;
- (v) $\mathfrak{G} \leq \mathfrak{G}_1$ if $\mu_{\mathfrak{G}}(g) \leq \mu_{\mathfrak{G}_1}(g), \nu_{\mathfrak{G}}(g) \geq \nu_{\mathfrak{G}_1}(g)$ for all $g \in K$;
- (vi) $\mathfrak{G}^c = (\nu_{\mathfrak{G}}, \mu_{\mathfrak{G}})$ where \mathfrak{G}^c represents the complement of \mathfrak{G} ;
- (vii) $\alpha \mathfrak{G} = (1 - (1 - \mu_{\mathfrak{G}})^\alpha, \nu_{\mathfrak{G}}^\alpha)$ for $\alpha \geq 1$;
- (viii) $\mathfrak{G}^\alpha = (\mu_{\mathfrak{G}}^\alpha, 1 - (1 - \nu_{\mathfrak{G}})^\alpha)$ for $\alpha \geq 1$.

Definition 2 [60]. Consider the score function for IFN $\mathfrak{G} = (\mu_{\mathfrak{G}}, \nu_{\mathfrak{G}})$, is denoted and defined as;

$$\bar{S}(\mathfrak{G}) = \mu_{\mathfrak{G}} - \nu_{\mathfrak{G}} \text{ for } \bar{S}(\mathfrak{G}) \in [-1, 1].$$

Greater the score batter the IFN is.

Definition 3 [61]. The accuracy function for IFN $\mathfrak{G} = (\mu_{\mathfrak{G}}, \nu_{\mathfrak{G}})$, is denoted and defined as;

$$\bar{A}(\mathfrak{G}) = \mu_{\mathfrak{G}} + \nu_{\mathfrak{G}} \text{ for } \bar{A}(\mathfrak{G}) \in [0, 1].$$

Definition 4 [52]. Assume a fixed set K and crisp IF relation $\psi \in IFS(K \times K)$. Then

- (i) For all $g \in K$, the relation ψ is reflexive, if $k_\psi(g,g) = 1$ and $\delta_\psi(g,g) = 0$.
- (ii) For all $(g,c) \in K \times K$, the relation ψ is symmetric, if $k_\psi(g,c) = k_\psi(c,g)$ and $\delta_\psi(g,c) = \delta_\psi(c,g)$.
- (iii) For all $(g,d) \in K \times K$, the relation ψ is transitive, if $k_\psi(g,d) \geq \bigvee_{c \in K} \{k_\psi(g,c) \vee k_\psi(c,d)\}$ and $\delta_\psi(g,d) \geq \bigwedge_{c \in K} \{\delta_\psi(g,c) \wedge \delta_\psi(c,d)\}$.

Definition 5 [58]. Consider K as a universal of discourse such that ψ be IF relation over K i.e. $\psi \in IFS(K \times K)$. Then the order pair (K,ψ) is known to be IF approximation space. Now any normal decision object $\mathfrak{B} \subseteq IFS(K)$, the lower and upper approximation of \mathfrak{B} w.r.t IF approximation space (K,ψ) are represented by $\underline{\psi}(\mathfrak{B})$ and $\overline{\psi}(\mathfrak{B})$ which is defined as:

$$\underline{\psi}(\mathfrak{B}) = \{ \langle g, k_{\underline{\psi}(\mathfrak{B})}(g), \delta_{\underline{\psi}(\mathfrak{B})}(g) \rangle \mid g \in K \}$$

$$\overline{\psi}(\mathfrak{B}) = \{ \langle g, k_{\overline{\psi}(\mathfrak{B})}(g), \delta_{\overline{\psi}(\mathfrak{B})}(g) \rangle \mid g \in K \}$$

where

$$k_{\underline{\psi}(\mathfrak{B})}(g) = \bigwedge_{c \in K} \{ k_\psi(g,c) \wedge k_{\mathfrak{B}}(c) \}, \quad \delta_{\underline{\psi}(\mathfrak{B})}(g) = \bigvee_{c \in K} \{ \delta_\psi(g,c) \vee \delta_{\mathfrak{B}}(c) \}$$

$$k_{\overline{\psi}(\mathfrak{B})}(g) = \bigvee_{c \in K} \{ k_\psi(g,c) \vee k_{\mathfrak{B}}(c) \}, \quad \delta_{\overline{\psi}(\mathfrak{B})}(g) = \bigwedge_{c \in K} \{ \delta_\psi(g,c) \wedge \delta_{\mathfrak{B}}(c) \}$$

with $0 \leq k_{\underline{\psi}(\mathfrak{B})}(g) + \delta_{\underline{\psi}(\mathfrak{B})}(g) \leq 1$ and $0 \leq k_{\overline{\psi}(\mathfrak{B})}(g) + \delta_{\overline{\psi}(\mathfrak{B})}(g) \leq 1$. As $\underline{\psi}(\mathfrak{B})$ and $\overline{\psi}(\mathfrak{B})$ are IFS, so $\underline{\psi}(\mathfrak{B}), \overline{\psi}(\mathfrak{B}) : IFS(K) \rightarrow IFS(K)$ are lower and upper approximation operators. Therefore, the pair $\psi(\mathfrak{B}) = (\underline{\psi}(\mathfrak{B}), \overline{\psi}(\mathfrak{B})) = \{ \langle g, \langle k_{\underline{\psi}(\mathfrak{B})}(g), \delta_{\underline{\psi}(\mathfrak{B})}(g) \rangle, \langle k_{\overline{\psi}(\mathfrak{B})}(g), \delta_{\overline{\psi}(\mathfrak{B})}(g) \rangle \rangle \mid g \in K \}$ is called IF rough set (IFRS). For simplicity $\psi(\mathfrak{B}) = (\underline{\psi}(\mathfrak{B}), \overline{\psi}(\mathfrak{B})) = (\langle \underline{k}, \underline{\delta} \rangle, \langle \overline{k}, \overline{\delta} \rangle)$ denotes the IF rough number (IFRN).

Definition 6 [58]. Consider the score function for IFRN $\psi(\mathfrak{B}) = (\underline{\psi}(\mathfrak{B}), \overline{\psi}(\mathfrak{B})) = (\langle \underline{k}, \underline{\delta} \rangle, \langle \overline{k}, \overline{\delta} \rangle)$, is denoted and defined as;

$$\overline{S}(\mathfrak{B}) = \frac{1}{4}(2 + \underline{k} + \overline{k} - \underline{\delta} - \overline{\delta}) \quad \text{for } \overline{S}(\mathfrak{B}) \in [0,1].$$

Greater the score batter the IFRN is.

Definition 7 [59]. The accuracy function for IFRN $\psi(\mathfrak{B}) = (\underline{\psi}(\mathfrak{B}), \overline{\psi}(\mathfrak{B})) = (\langle \underline{k}, \underline{\delta} \rangle, \langle \overline{k}, \overline{\delta} \rangle)$, is denoted and defined as;

$$\overline{A}(\mathfrak{B}) = \frac{1}{4}(\underline{k} + \overline{k} + \underline{\delta} + \overline{\delta}) \quad \text{for } \overline{A}(\mathfrak{B}) \in [0,1].$$

3. Dombi Operations

Dombi presented the pioneer concept Dombi operations known as Dombi product and Dombi sum, which are the special form of t-norms and t-conorms given in the following definition.

Definition 8 [43]. Consider that ξ and ν belong to real numbers with $\beta \geq 1$. Then Dombi operations are elaborated as:

$$T_D(\xi, \nu) = \frac{1}{1 + \left\{ \left(\frac{1-\xi}{\xi} \right)^\beta + \left(\frac{1-\nu}{\nu} \right)^\beta \right\}^{\frac{1}{\beta}}}$$

$$T_D(\xi, \nu) = 1 - \frac{1}{1 + \left\{ \left(\frac{\xi}{1-\xi} \right)^\beta + \left(\frac{\nu}{1-\nu} \right)^\beta \right\}^{\frac{1}{\beta}}}$$

Definition 9. Let $\psi(\mathfrak{B}_1) = (\underline{\psi}(\mathfrak{B}_1), \overline{\psi}(\mathfrak{B}_1)) = ((\underline{\kappa}_1, \underline{\delta}_1), (\overline{\kappa}_1, \overline{\delta}_1))$ and $\psi(\mathfrak{B}_2) = (\underline{\psi}(\mathfrak{B}_2), \overline{\psi}(\mathfrak{B}_2)) = ((\underline{\kappa}_2, \underline{\delta}_2), (\overline{\kappa}_2, \overline{\delta}_2))$ be two IFRNs and $\alpha > 0$. Then some basic operation based on Dombi t-norms and t-conorms operations are give as:

- (i) $\psi(\mathfrak{B}_1) \oplus \psi(\mathfrak{B}_2) = \left\langle \left(1 - \frac{1}{1 + \left\{ \left(\frac{\underline{\kappa}_1}{1-\underline{\kappa}_1} \right)^\beta + \left(\frac{\underline{\kappa}_2}{1-\underline{\kappa}_2} \right)^\beta \right\}^{\frac{1}{\beta}}}, \frac{1}{1 + \left\{ \left(\frac{1-\underline{\delta}_1}{\underline{\delta}_1} \right)^\beta + \left(\frac{1-\underline{\delta}_2}{\underline{\delta}_2} \right)^\beta \right\}^{\frac{1}{\beta}}} \right), \left(1 - \frac{1}{1 + \left\{ \left(\frac{\overline{\kappa}_1}{1-\overline{\kappa}_1} \right)^\beta + \left(\frac{\overline{\kappa}_2}{1-\overline{\kappa}_2} \right)^\beta \right\}^{\frac{1}{\beta}}}, \frac{1}{1 + \left\{ \left(\frac{1-\overline{\delta}_1}{\overline{\delta}_1} \right)^\beta + \left(\frac{1-\overline{\delta}_2}{\overline{\delta}_2} \right)^\beta \right\}^{\frac{1}{\beta}}} \right) \right\rangle$
- (ii) $\psi(\mathfrak{B}_1) \otimes \psi(\mathfrak{B}_2) = \left\langle \left(\frac{1}{1 + \left\{ \left(\frac{1-\underline{\kappa}_1}{\underline{\kappa}_1} \right)^\beta + \left(\frac{1-\underline{\kappa}_2}{\underline{\kappa}_2} \right)^\beta \right\}^{\frac{1}{\beta}}}, 1 - \frac{1}{1 + \left\{ \left(\frac{\underline{\delta}_1}{1-\underline{\delta}_1} \right)^\beta + \left(\frac{\underline{\delta}_2}{1-\underline{\delta}_2} \right)^\beta \right\}^{\frac{1}{\beta}}} \right), \left(\frac{1}{1 + \left\{ \left(\frac{1-\overline{\kappa}_1}{\overline{\kappa}_1} \right)^\beta + \left(\frac{1-\overline{\kappa}_2}{\overline{\kappa}_2} \right)^\beta \right\}^{\frac{1}{\beta}}}, 1 - \frac{1}{1 + \left\{ \left(\frac{\overline{\delta}_1}{1-\overline{\delta}_1} \right)^\beta + \left(\frac{\overline{\delta}_2}{1-\overline{\delta}_2} \right)^\beta \right\}^{\frac{1}{\beta}}} \right) \right\rangle$
- (iii) $\alpha\psi(\mathfrak{B}_1) = \left\langle \left(1 - \frac{1}{1 + \left\{ \alpha \left(\frac{\underline{\kappa}_1}{1-\underline{\kappa}_1} \right)^\beta \right\}^{\frac{1}{\beta}}}, \frac{1}{1 + \left\{ \alpha \left(\frac{1-\underline{\delta}_1}{\underline{\delta}_1} \right)^\beta \right\}^{\frac{1}{\beta}}} \right), \left(1 - \frac{1}{1 + \left\{ \alpha \left(\frac{\overline{\kappa}_1}{1-\overline{\kappa}_1} \right)^\beta \right\}^{\frac{1}{\beta}}}, \frac{1}{1 + \left\{ \alpha \left(\frac{1-\overline{\delta}_1}{\overline{\delta}_1} \right)^\beta \right\}^{\frac{1}{\beta}}} \right) \right\rangle$
- (iv) $(\psi(\mathfrak{B}_1))^\alpha = \left\langle \left(\frac{1}{1 + \left\{ \alpha \left(\frac{1-\underline{\kappa}_1}{\underline{\kappa}_1} \right)^\beta \right\}^{\frac{1}{\beta}}}, 1 - \frac{1}{1 + \left\{ \alpha \left(\frac{\underline{\delta}_1}{1-\underline{\delta}_1} \right)^\beta \right\}^{\frac{1}{\beta}}} \right), \left(\frac{1}{1 + \left\{ \alpha \left(\frac{1-\overline{\kappa}_1}{\overline{\kappa}_1} \right)^\beta \right\}^{\frac{1}{\beta}}}, 1 - \frac{1}{1 + \left\{ \alpha \left(\frac{\overline{\delta}_1}{1-\overline{\delta}_1} \right)^\beta \right\}^{\frac{1}{\beta}}} \right) \right\rangle$

Theorem 1. Let $\psi(\mathfrak{B}_1) = (\underline{\psi}(\mathfrak{B}_1), \overline{\psi}(\mathfrak{B}_1))$ and $\psi(\mathfrak{B}_2) = (\underline{\psi}(\mathfrak{B}_2), \overline{\psi}(\mathfrak{B}_2))$ be two IFRNs and $\alpha_1, \alpha_2 > 0$. Then the following results are hold:

- (i) $\psi(\mathfrak{B}_1) \oplus \psi(\mathfrak{B}_2) = \psi(\mathfrak{B}_2) \oplus \psi(\mathfrak{B}_1)$,
- (ii) $\psi(\mathfrak{B}_1) \otimes \psi(\mathfrak{B}_2) = \psi(\mathfrak{B}_2) \otimes \psi(\mathfrak{B}_1)$,
- (iii) $\alpha_1(\psi(\mathfrak{B}_1) \oplus \psi(\mathfrak{B}_2)) = \alpha_1\psi(\mathfrak{B}_1) \oplus \alpha_1\psi(\mathfrak{B}_2)$,
- (iv) $(\alpha_1 + \alpha_2)\psi(\mathfrak{B}_1) = \alpha_1\psi(\mathfrak{B}_1) \oplus \alpha_2\psi(\mathfrak{B}_1)$,
- (v) $(\psi(\mathfrak{B}_1) \otimes \psi(\mathfrak{B}_2))^{\alpha_1} = (\psi(\mathfrak{B}_1))^{\alpha_1} \otimes (\psi(\mathfrak{B}_2))^{\alpha_1}$,
- (vi) $(\psi(\mathfrak{B}_1))^{\alpha_1} \otimes (\psi(\mathfrak{B}_1))^{\alpha_2} = (\psi(\mathfrak{B}_1))^{\alpha_1 + \alpha_2}$.

4. Average Aggregation Operators

The process of aggregation plays a key role to in DM to aggregate the multiple input information of different specialists into a single value. Here we will address the concept of IFRDWA, IFRDOWA and IFRDHA aggregation operators and presented the important properties of these operators.

4.1. IF rough Dombi weighted averaging operators

Definition 10. Assume that $\psi(\mathfrak{B}_i) = (\underline{\psi}(\mathfrak{B}_i), \overline{\psi}(\mathfrak{B}_i))$ be the family of IFRNs. Let $\varepsilon = (\varepsilon_1, \varepsilon_2, \varepsilon_3, \dots, \varepsilon_n)^T$ be the weight vector (WV) such that $\sum_{i=1}^n \varepsilon_i = 1$ and $\varepsilon_i \in [0, 1]$. Then the IFRDWA operator is a mapping $(\psi(\mathfrak{B}))^n \rightarrow \psi(\mathfrak{B})$, which is given as:

$$IFRDWA(\psi(\mathfrak{B}_1), \psi(\mathfrak{B}_2), \psi(\mathfrak{B}_3), \dots, \psi(\mathfrak{B}_n)) = (\oplus_{i=1}^n \varepsilon_i \underline{\psi}(\mathfrak{B}_i), \oplus_{i=1}^n \varepsilon_i \overline{\psi}(\mathfrak{B}_i)).$$

Theorem 2. Let $\psi(\mathfrak{B}_i) = (\underline{\psi}(\mathfrak{B}_i), \overline{\psi}(\mathfrak{B}_i))$ be the family of IFRNs and $\varepsilon = (\varepsilon_1, \varepsilon_2, \varepsilon_3, \dots, \varepsilon_n)^T$ be the WV such that $\sum_{i=1}^n \varepsilon_i = 1$ and $\varepsilon_i \in [0, 1]$. Then by using IFRDWA operator, the aggregated result is described as:

$$IFRDWA(\psi(\mathfrak{B}_1), \psi(\mathfrak{B}_2), \psi(\mathfrak{B}_3), \dots, \psi(\mathfrak{B}_n)) = (\oplus_{i=1}^n \varepsilon_i \underline{\psi}(\mathfrak{B}_i), \oplus_{i=1}^n \varepsilon_i \overline{\psi}(\mathfrak{B}_i)) \\ = \left(\left(1 - \frac{1}{1 + \left\{ \sum_{i=1}^n \varepsilon_i \left(\frac{\underline{\kappa}_i}{1 - \underline{\kappa}_i} \right)^{\beta} \right\}^{\frac{1}{\beta}}} \right)^{\frac{1}{\beta}}, \left(1 - \frac{1}{1 + \left\{ \sum_{i=1}^n \varepsilon_i \left(\frac{1 - \delta_i}{\delta_i} \right)^{\beta} \right\}^{\frac{1}{\beta}}} \right)^{\frac{1}{\beta}} \right).$$

Proof. By applying induction method to prove the required result.

Let $n = 2$, and now using the Dombi operational laws, we get

$$IFRDWA(\psi(\mathfrak{B}_1), \psi(\mathfrak{B}_2)) = (\oplus_{i=1}^2 \varepsilon_i \underline{\psi}(\mathfrak{B}_i), \oplus_{i=1}^2 \varepsilon_i \overline{\psi}(\mathfrak{B}_i)) \\ = \left(1 - \frac{1}{1 + \left\{ \varepsilon_1 \left(\frac{\underline{\kappa}_1}{1 - \underline{\kappa}_1} \right)^{\beta} + \varepsilon_2 \left(\frac{\underline{\kappa}_2}{1 - \underline{\kappa}_2} \right)^{\beta} \right\}^{\frac{1}{\beta}}}, 1 - \frac{1}{1 + \left\{ \varepsilon_1 \left(\frac{1 - \delta_1}{\delta_1} \right)^{\beta} + \varepsilon_2 \left(\frac{1 - \delta_2}{\delta_2} \right)^{\beta} \right\}^{\frac{1}{\beta}}} \right) \\ \left(1 - \frac{1}{1 + \left\{ \varepsilon_1 \left(\frac{\overline{\kappa}_1}{1 - \overline{\kappa}_1} \right)^{\beta} + \varepsilon_2 \left(\frac{\overline{\kappa}_2}{1 - \overline{\kappa}_2} \right)^{\beta} \right\}^{\frac{1}{\beta}}}, 1 - \frac{1}{1 + \left\{ \varepsilon_1 \left(\frac{1 - \delta_1}{\delta_1} \right)^{\beta} + \varepsilon_2 \left(\frac{1 - \delta_2}{\delta_2} \right)^{\beta} \right\}^{\frac{1}{\beta}}} \right) \\ = \left(\left(1 - \frac{1}{1 + \left\{ \sum_{i=1}^2 \varepsilon_i \left(\frac{\underline{\kappa}_i}{1 - \underline{\kappa}_i} \right)^{\beta} \right\}^{\frac{1}{\beta}}} \right)^{\frac{1}{\beta}}, \left(1 - \frac{1}{1 + \left\{ \sum_{i=1}^2 \varepsilon_i \left(\frac{1 - \delta_i}{\delta_i} \right)^{\beta} \right\}^{\frac{1}{\beta}}} \right)^{\frac{1}{\beta}} \right).$$

The result is true for $n = 2$.

Assume that the required result holds for $n = k$, so we have

$$IFRDWA(\psi(\mathfrak{B}_1), \psi(\mathfrak{B}_2), \dots, \psi(\mathfrak{B}_k)) = (\oplus_{i=1}^k \varepsilon_i \underline{\psi}(\mathfrak{B}_i), \oplus_{i=1}^k \varepsilon_i \overline{\psi}(\mathfrak{B}_i)) \\ = \left(\left(1 - \frac{1}{1 + \left\{ \sum_{i=1}^k \varepsilon_i \left(\frac{\underline{\kappa}_i}{1 - \underline{\kappa}_i} \right)^{\beta} \right\}^{\frac{1}{\beta}}} \right)^{\frac{1}{\beta}}, \left(1 - \frac{1}{1 + \left\{ \sum_{i=1}^k \varepsilon_i \left(\frac{1 - \delta_i}{\delta_i} \right)^{\beta} \right\}^{\frac{1}{\beta}}} \right)^{\frac{1}{\beta}} \right).$$

Further, to prove for $n = k + 1$, so we have

$$IFRDWA\{(\psi(\mathfrak{B}_1), \psi(\mathfrak{B}_2), \dots, \psi(\mathfrak{B}_k)), \psi(\mathfrak{B}_{k+1})\} \\ = (\oplus_{i=1}^k \varepsilon_i \underline{\psi}(\mathfrak{B}_i), \oplus_{i=1}^k \varepsilon_i \overline{\psi}(\mathfrak{B}_i)) \oplus (\varepsilon_{k+1} \underline{\psi}(\mathfrak{B}_{k+1}), \varepsilon_{k+1} \overline{\psi}(\mathfrak{B}_{k+1}))$$

$$\begin{aligned}
 &= \left\{ \left(1 - \frac{1}{1 + \left\{ \sum_{i=1}^k \varepsilon_i \left(\frac{\bar{\kappa}_i}{1 - \bar{\kappa}_i} \right)^{\beta/\bar{\beta}} \right\}^{1/\bar{\beta}}}, \frac{1}{1 + \left\{ \sum_{i=1}^k \varepsilon_i \left(\frac{1 - \delta_i}{\delta_i} \right)^{\beta/\bar{\beta}} \right\}^{1/\bar{\beta}}} \right), \left(1 - \frac{1}{1 + \left\{ \sum_{i=1}^k \varepsilon_i \left(\frac{\bar{\kappa}_i}{1 - \bar{\kappa}_i} \right)^{\beta/\bar{\beta}} \right\}^{1/\bar{\beta}}}, \frac{1}{1 + \left\{ \sum_{i=1}^k \varepsilon_i \left(\frac{1 - \delta_i}{\delta_i} \right)^{\beta/\bar{\beta}} \right\}^{1/\bar{\beta}}} \right) \right\} \oplus \\
 &\left\{ \left(1 - \frac{1}{1 + \left\{ \varepsilon_{k+1} \left(\frac{\bar{\kappa}_{k+1}}{1 - \bar{\kappa}_{k+1}} \right)^{\beta/\bar{\beta}} \right\}^{1/\bar{\beta}}}, \frac{1}{1 + \left\{ \varepsilon_{k+1} \left(\frac{1 - \delta_{k+1}}{\delta_{k+1}} \right)^{\beta/\bar{\beta}} \right\}^{1/\bar{\beta}}} \right), \left(1 - \frac{1}{1 + \left\{ \varepsilon_{k+1} \left(\frac{\bar{\kappa}_{k+1}}{1 - \bar{\kappa}_{k+1}} \right)^{\beta/\bar{\beta}} \right\}^{1/\bar{\beta}}}, \frac{1}{1 + \left\{ \varepsilon_{k+1} \left(\frac{1 - \delta_{k+1}}{\delta_{k+1}} \right)^{\beta/\bar{\beta}} \right\}^{1/\bar{\beta}}} \right) \right\} \\
 &= \left\{ \left(1 - \frac{1}{1 + \left\{ \sum_{i=1}^{k+1} \varepsilon_i \left(\frac{\bar{\kappa}_i}{1 - \bar{\kappa}_i} \right)^{\beta/\bar{\beta}} \right\}^{1/\bar{\beta}}}, \frac{1}{1 + \left\{ \sum_{i=1}^{k+1} \varepsilon_i \left(\frac{1 - \delta_i}{\delta_i} \right)^{\beta/\bar{\beta}} \right\}^{1/\bar{\beta}}} \right), \left(1 - \frac{1}{1 + \left\{ \sum_{i=1}^{k+1} \varepsilon_i \left(\frac{\bar{\kappa}_i}{1 - \bar{\kappa}_i} \right)^{\beta/\bar{\beta}} \right\}^{1/\bar{\beta}}}, \frac{1}{1 + \left\{ \sum_{i=1}^{k+1} \varepsilon_i \left(\frac{1 - \delta_i}{\delta_i} \right)^{\beta/\bar{\beta}} \right\}^{1/\bar{\beta}}} \right) \right\}.
 \end{aligned}$$

Hence the condition is true for $n \geq k + 1$. Therefore, by induction principle the result holds $\forall n \geq 1$.

As $\underline{\psi}(\mathfrak{B})$ and $\bar{\psi}(\mathfrak{B})$ are IFRNs, this implies $\bigoplus_{i=1}^n \varepsilon_i \underline{\psi}(\mathfrak{B}_i)$ and $\bigoplus_{i=1}^n \varepsilon_i \bar{\psi}(\mathfrak{B}_i)$ is also IFRNs. Therefore, from the above analysis $IFRDWA(\underline{\psi}(\mathfrak{B}_1), \underline{\psi}(\mathfrak{B}_2), \dots, \underline{\psi}(\mathfrak{B}_n))$ also represents an IFRN based on IFR approximation space (K, ψ) .

Theorem 3. Let $\psi(\mathfrak{B}_i) = (\underline{\psi}(\mathfrak{B}_i), \bar{\psi}(\mathfrak{B}_i))$ be the family of IFRNs and $\varepsilon = (\varepsilon_1, \varepsilon_2, \varepsilon_3, \dots, \varepsilon_n)^T$ be the WV such that $\sum_{i=1}^n \varepsilon_i = 1$ and $\varepsilon_i \in [0, 1]$. Then some elementary properties are satisfied for IFRDWA operator.

(i) **Idempotency.** Let $\psi(\mathfrak{B}_i) = E(\mathfrak{B}) \quad \forall i = 1, 2, \dots, n$ with $E(\mathfrak{B}) = (\underline{E}(\mathfrak{B}), \bar{E}(\mathfrak{B})) = (\langle \bar{\kappa}, \delta \rangle, \langle \bar{\kappa}, \bar{\delta} \rangle)$. Then $IFRDWA(\psi(\mathfrak{B}_1), \psi(\mathfrak{B}_2), \dots, \psi(\mathfrak{B}_n)) = E(\mathfrak{B})$.

(ii) **Boundedness.**

Let $(\psi(\mathfrak{B}_i))^- = (\min_i \underline{\psi}(\mathfrak{B}_i), \min_i \bar{\psi}(\mathfrak{B}_i))$ and $(\psi(\mathfrak{B}_i))^+ = (\max_i \underline{\psi}(\mathfrak{B}_i), \max_i \bar{\psi}(\mathfrak{B}_i))$. Then

$$(\psi(\mathfrak{B}_i))^- \leq IFRDWA(\psi(\mathfrak{B}_1), \psi(\mathfrak{B}_2), \dots, \psi(\mathfrak{B}_n)) \leq (\psi(\mathfrak{B}_i))^+.$$

(iii) **Monotonicity.** Consider the another family $\psi(\mathfrak{B}'_i) = (\underline{\psi}(\mathfrak{B}'_i), \bar{\psi}(\mathfrak{B}'_i))$ of IFRNs, such that $\underline{\psi}(\mathfrak{B}'_i) \leq \underline{\psi}(\mathfrak{B}_i)$ and $\bar{\psi}(\mathfrak{B}'_i) \leq \bar{\psi}(\mathfrak{B}_i)$. Then

$$IFRDWA(\psi(\mathfrak{B}'_1), \psi(\mathfrak{B}'_2), \dots, \psi(\mathfrak{B}'_n)) \leq IFRDWA(\psi(\mathfrak{B}_1), \psi(\mathfrak{B}_2), \dots, \psi(\mathfrak{B}_n)).$$

(iv) **Shift Invariance.** Assume that $E(\mathfrak{B}') = (\underline{E}(\mathfrak{B}'), \bar{E}(\mathfrak{B}')) = (\langle \bar{\kappa}', \delta' \rangle, \langle \bar{\kappa}', \bar{\delta}' \rangle)$ be another IFRN. Then

$$IFRDWA(\psi(\mathfrak{B}_1) \oplus E(\mathfrak{B}'), \psi(\mathfrak{B}_2) \oplus E(\mathfrak{B}'), \dots, \psi(\mathfrak{B}_n) \oplus E(\mathfrak{B}')) = IFRDWA(\psi(\mathfrak{B}_1), \psi(\mathfrak{B}_2), \dots, \psi(\mathfrak{B}_n)) \oplus E(\mathfrak{B}').$$

(v) **Homogeneity.** For a real number $\alpha > 0$,

$$IFRDWA(\alpha \psi(\mathfrak{B}_1), \alpha \psi(\mathfrak{B}_2), \dots, \alpha \psi(\mathfrak{B}_n)) = \alpha IFRDWA(\psi(\mathfrak{B}_1), \psi(\mathfrak{B}_2), \dots, \psi(\mathfrak{B}_n)).$$

Proof. (i) **Idempotency.** Since $\psi(\mathfrak{B}_i) = E(\mathfrak{B}) \quad \forall i = 1, 2, \dots, n$ where $E(\mathfrak{B}) = (\underline{E}(\mathfrak{B}), \bar{E}(\mathfrak{B})) = (\langle \bar{\kappa}, \delta \rangle, \langle \bar{\kappa}, \bar{\delta} \rangle)$. Then by applying Theorem 2, we have

$$IFRDWA(\psi(\mathfrak{B}_1), \psi(\mathfrak{B}_2), \psi(\mathfrak{B}_3), \dots, \psi(\mathfrak{B}_n)) = (\bigoplus_{i=1}^n \varepsilon_i \underline{\psi}(\mathfrak{B}_i), \bigoplus_{i=1}^n \varepsilon_i \bar{\psi}(\mathfrak{B}_i))$$

$$\begin{aligned}
 &= \left(\left(1 - \frac{1}{1 + \left\{ \sum_{i=1}^n \varepsilon_i \left(\frac{\underline{\kappa}_i}{1 - \underline{\kappa}_i} \right)^{\beta/\bar{\beta}} \right\}^{\frac{1}{\beta}}} \right)^{1'} \cdot \left(1 - \frac{1}{1 + \left\{ \sum_{i=1}^n \varepsilon_i \left(\frac{1 - \underline{\delta}_i}{\underline{\delta}_i} \right)^{\beta/\bar{\beta}} \right\}^{\frac{1}{\beta}}} \right)^{\frac{1}{\beta}} \right) \\
 &\quad \left(1 - \frac{1}{1 + \left\{ \sum_{i=1}^n \varepsilon_i \left(\frac{\bar{\kappa}_i}{1 - \bar{\kappa}_i} \right)^{\beta/\bar{\beta}} \right\}^{\frac{1}{\beta}}} \right)^{1'} \cdot \left(1 - \frac{1}{1 + \left\{ \sum_{i=1}^n \varepsilon_i \left(\frac{1 - \bar{\delta}_i}{\bar{\delta}_i} \right)^{\beta/\bar{\beta}} \right\}^{\frac{1}{\beta}}} \right)^{\frac{1}{\beta}} \right) \\
 &= \left(\left(1 - \frac{1}{1 + \left\{ \left(\frac{\underline{\kappa}}{1 - \underline{\kappa}} \right)^{\beta/\bar{\beta}} \right\}^{\frac{1}{\beta}} \right)^{1'} \cdot \left(1 - \frac{1}{1 + \left\{ \left(\frac{1 - \underline{\delta}}{\underline{\delta}} \right)^{\beta/\bar{\beta}} \right\}^{\frac{1}{\beta}}} \right)^{\frac{1}{\beta}} \right) \right. \\
 &\quad \left. \left(1 - \frac{1}{1 + \left\{ \left(\frac{\bar{\kappa}}{1 - \bar{\kappa}} \right)^{\beta/\bar{\beta}} \right\}^{\frac{1}{\beta}} \right)^{1'} \cdot \left(1 - \frac{1}{1 + \left\{ \left(\frac{1 - \bar{\delta}}{\bar{\delta}} \right)^{\beta/\bar{\beta}} \right\}^{\frac{1}{\beta}}} \right)^{\frac{1}{\beta}} \right) \right) \\
 &= (E(\mathfrak{B}), \bar{E}(\mathfrak{B})) \\
 &= E(\mathfrak{B})
 \end{aligned}$$

(ii) **Boundedness.** As $(\psi(\mathfrak{B}_i))^- = ((\underline{\psi}(\mathfrak{B}_i))^- , (\bar{\psi}(\mathfrak{B}_i))^-) = \left[\left(\min_i \{ \underline{\kappa}_i \}, \max_i \{ \underline{\delta}_i \} \right), \left(\min_i \{ \bar{\kappa}_i \}, \max_i \{ \bar{\delta}_i \} \right) \right]$

and $(\psi(\mathfrak{B}_i))^+ = ((\underline{\psi}(\mathfrak{B}_i))^+ , (\bar{\psi}(\mathfrak{B}_i))^+) = \left[\left(\max_i \{ \underline{\kappa}_i \}, \min_i \{ \underline{\delta}_i \} \right), \left(\max_i \{ \bar{\kappa}_i \}, \min_i \{ \bar{\delta}_i \} \right) \right]$

and $\psi(\mathfrak{B}_i) = [(\underline{\kappa}_i, \underline{\delta}_i), (\bar{\kappa}_i, \bar{\delta}_i)]$. To verify that

$$(\psi(\mathfrak{B}_i))^- \leq IFRDWA(\psi(\mathfrak{B}_1), \psi(\mathfrak{B}_2), \dots, \psi(\mathfrak{B}_n)) \leq (\psi(\mathfrak{B}_i))^+$$

Since for each $i = 1, 2, \dots, n$, we have

$$\begin{aligned}
 \min_i \underline{\kappa}_i \leq \underline{\kappa}_i \leq \max_i \underline{\kappa}_i &\Rightarrow \frac{\min_i \underline{\kappa}_i}{1 - \min_i \underline{\kappa}_i} \leq \frac{\underline{\kappa}_i}{1 - \underline{\kappa}_i} \leq \frac{\max_i \underline{\kappa}_i}{1 - \max_i \underline{\kappa}_i} \\
 \Rightarrow 1 + \frac{\min_i \underline{\kappa}_i}{1 - \min_i \underline{\kappa}_i} &\leq 1 + \frac{\underline{\kappa}_i}{1 - \underline{\kappa}_i} \leq 1 + \frac{\max_i \underline{\kappa}_i}{1 - \max_i \underline{\kappa}_i} \Rightarrow \frac{1}{1 + \frac{\max_i \underline{\kappa}_i}{1 - \max_i \underline{\kappa}_i}} \leq \frac{1}{1 + \frac{\underline{\kappa}_i}{1 - \underline{\kappa}_i}} \leq \frac{1}{1 + \frac{\min_i \underline{\kappa}_i}{1 - \min_i \underline{\kappa}_i}} \\
 \Rightarrow 1 - \frac{1}{1 + \left(\sum_{i=1}^n \varepsilon_i \left(\frac{\min_i \underline{\kappa}_i}{1 - \min_i \underline{\kappa}_i} \right)^{\beta/\bar{\beta}} \right)^{\frac{1}{\beta}}} &\leq 1 - \frac{1}{1 + \left(\sum_{i=1}^n \varepsilon_i \left(\frac{\underline{\kappa}_i}{1 - \underline{\kappa}_i} \right)^{\beta/\bar{\beta}} \right)^{\frac{1}{\beta}}} \leq 1 - \frac{1}{1 + \left(\sum_{i=1}^n \varepsilon_i \left(\frac{\max_i \underline{\kappa}_i}{1 - \max_i \underline{\kappa}_i} \right)^{\beta/\bar{\beta}} \right)^{\frac{1}{\beta}}}
 \end{aligned}$$

$$\Rightarrow 1 - \frac{1}{1 + \frac{1}{1 - \min_i \underline{k}_i}} \leq 1 - \frac{1}{1 + \left(\sum_{i=1}^n \varepsilon_i \left(\frac{\underline{k}_i}{1 - \underline{k}_i} \right)^\beta \right)^{\frac{1}{\beta}}} \leq 1 - \frac{1}{1 + \frac{1}{1 - \max_i \underline{k}_i}}$$

$$\Rightarrow \min_i \underline{k}_i \leq 1 - \frac{1}{1 + \left(\sum_{i=1}^n \varepsilon_i \left(\frac{\underline{k}_i}{1 - \underline{k}_i} \right)^\beta \right)^{\frac{1}{\beta}}} \leq \max_i \underline{k}_i$$

Next consider for every $i = 1, 2, \dots, n$, consider that

$$\max_i \{\underline{\delta}_i\} \geq \underline{\delta}_i \geq \min_i \{\underline{\delta}_i\} \Rightarrow 1 - \min_i \{\underline{\delta}_i\} \geq 1 - \underline{\delta}_i \geq 1 - \max_i \{\underline{\delta}_i\}$$

$$\Rightarrow 1 + \frac{1 - \min_i \{\underline{\delta}_i\}}{\min_i \{\underline{\delta}_i\}} \geq 1 + \frac{1 - \underline{\delta}_i}{\underline{\delta}_i} \geq 1 + \frac{1 - \max_i \{\underline{\delta}_i\}}{\max_i \{\underline{\delta}_i\}}$$

$$\Rightarrow 1 + \left(\sum_{i=1}^n \varepsilon_i \left(\frac{1 - \min_i \{\underline{\delta}_i\}}{\min_i \{\underline{\delta}_i\}} \right)^\beta \right)^{\frac{1}{\beta}} \geq 1 + \left(\sum_{i=1}^n \varepsilon_i \left(\frac{1 - \underline{\delta}_i}{\underline{\delta}_i} \right)^\beta \right)^{\frac{1}{\beta}} \geq 1 + \left(\sum_{i=1}^n \varepsilon_i \left(\frac{1 - \max_i \{\underline{\delta}_i\}}{\max_i \{\underline{\delta}_i\}} \right)^\beta \right)^{\frac{1}{\beta}}$$

$$\Rightarrow \frac{1}{1 + \left(\sum_{i=1}^n \varepsilon_i \left(\frac{1 - \max_i \{\underline{\delta}_i\}}{\max_i \{\underline{\delta}_i\}} \right)^\beta \right)^{\frac{1}{\beta}}} \geq \frac{1}{1 + \left(\sum_{i=1}^n \varepsilon_i \left(\frac{1 - \underline{\delta}_i}{\underline{\delta}_i} \right)^\beta \right)^{\frac{1}{\beta}}} \geq \frac{1}{1 + \left(\sum_{i=1}^n \varepsilon_i \left(\frac{1 - \min_i \{\underline{\delta}_i\}}{\min_i \{\underline{\delta}_i\}} \right)^\beta \right)^{\frac{1}{\beta}}}$$

$$\Rightarrow \frac{1}{1 + \frac{1 - \max_i \{\underline{\delta}_i\}}{\max_i \{\underline{\delta}_i\}}} \geq \frac{1}{1 + \left(\sum_{i=1}^n \varepsilon_i \left(\frac{1 - \underline{\delta}_i}{\underline{\delta}_i} \right)^\beta \right)^{\frac{1}{\beta}}} \geq \frac{1}{1 + \frac{1 - \min_i \{\underline{\delta}_i\}}{\min_i \{\underline{\delta}_i\}}}$$

$$\Rightarrow \max_i \{\underline{\delta}_i\} \geq \frac{1}{1 + \left(\sum_{i=1}^n \varepsilon_i \left(\frac{1 - \underline{\delta}_i}{\underline{\delta}_i} \right)^\beta \right)^{\frac{1}{\beta}}} \geq \min_i \{\underline{\delta}_i\}$$

In the same way, we can prove that

$$\Rightarrow \min_i \overline{k}_i \leq 1 - \frac{1}{1 + \left(\sum_{i=1}^n \varepsilon_i \left(\frac{\overline{k}_i}{1 - \overline{k}_i} \right)^\beta \right)^{\frac{1}{\beta}}} \leq \max_i \overline{k}_i$$

and

$$\max_i \{ \bar{\delta}_i \} \geq \frac{1}{1 + \left(\sum_{i=1}^n \varepsilon_i \left(\frac{1 - \bar{\delta}_i}{\bar{\delta}_i} \right)^\beta \right)^{\frac{1}{\beta}}} \geq \min_i \{ \bar{\delta}_i \}$$

Thus from the above analysis, we have

$$(\psi(\mathfrak{B}_i))^- \leq IFRDWA(\psi(\mathfrak{B}_1), \psi(\mathfrak{B}_2), \dots, \psi(\mathfrak{B}_n)) \leq (\psi(\mathfrak{B}_i))^+$$

The proofs of (iii), (iv) and (v) can be follows from (i) and (ii).

4.2. IF rough Dombi ordered weighted averaging operators

Definition 11. Assume that $\psi(\mathfrak{B}_i) = (\underline{\psi}(\mathfrak{B}_i), \bar{\psi}(\mathfrak{B}_i))$ be the family of IFRNs. Let $\varepsilon = (\varepsilon_1, \varepsilon_2, \varepsilon_3, \dots, \varepsilon_n)^T$ be the WV such that $\sum_{i=1}^n \varepsilon_i = 1$ and $\varepsilon_i \in [0, 1]$. Then the aggregated result for IFRDOWA operator is a mapping $(\psi(\mathfrak{B}))^n \rightarrow \psi(\mathfrak{B})$, which is given as:

$$IFRDOWA(\psi(\mathfrak{B}_1), \psi(\mathfrak{B}_2), \psi(\mathfrak{B}_3), \dots, \psi(\mathfrak{B}_n)) = (\oplus_{i=1}^n \varepsilon_i \underline{\psi}(\mathfrak{B}_{\sigma(i)}), \oplus_{i=1}^n \varepsilon_i \bar{\psi}(\mathfrak{B}_{\sigma(i)})).$$

Theorem 4. Let $\psi(\mathfrak{B}_i) = (\underline{\psi}(\mathfrak{B}_i), \bar{\psi}(\mathfrak{B}_i))$ be the family of IFRNs and $\varepsilon = (\varepsilon_1, \varepsilon_2, \varepsilon_3, \dots, \varepsilon_n)^T$ be the WV such that $\sum_{i=1}^n \varepsilon_i = 1$ and $\varepsilon_i \in [0, 1]$. Then by using IFRDOWA operator, the aggregated result is described as:

$$IFRDOWA(\psi(\mathfrak{B}_1), \psi(\mathfrak{B}_2), \psi(\mathfrak{B}_3), \dots, \psi(\mathfrak{B}_n)) = (\oplus_{i=1}^n \varepsilon_i \underline{\psi}(\mathfrak{B}_{\sigma(i)}), \oplus_{i=1}^n \varepsilon_i \bar{\psi}(\mathfrak{B}_{\sigma(i)})) \\ = \left(\left(1 - \frac{1}{1 + \left\{ \sum_{i=1}^n \varepsilon_i \left(\frac{\underline{k}_{\sigma(i)}}{1 - \underline{k}_{\sigma(i)}} \right)^\beta \right\}^{\frac{1}{\beta}}} \right)^{\frac{1}{\beta}}, \left(1 - \frac{1}{1 + \left\{ \sum_{i=1}^n \varepsilon_i \left(\frac{\bar{k}_{\sigma(i)}}{1 - \bar{k}_{\sigma(i)}} \right)^\beta \right\}^{\frac{1}{\beta}}} \right)^{\frac{1}{\beta}} \right)$$

where the IFRN $\psi(\mathfrak{B}_{\sigma(i)}) = (\underline{\psi}(\mathfrak{B}_{\sigma(i)}), \bar{\psi}(\mathfrak{B}_{\sigma(i)}))$ represent the largest permutation of the collection $\psi(\mathfrak{B}_i)$.

Theorem 5. Let $\psi(\mathfrak{B}_i) = (\underline{\psi}(\mathfrak{B}_i), \bar{\psi}(\mathfrak{B}_i))$ be the family of IFRNs and $\varepsilon = (\varepsilon_1, \varepsilon_2, \varepsilon_3, \dots, \varepsilon_n)^T$ be the WV such that $\sum_{i=1}^n \varepsilon_i = 1$ and $\varepsilon_i \in [0, 1]$. Then some rudimentary axioms are discussed for IFRDOWA operator.

(i) **Idempotency.** Let $\psi(\mathfrak{B}_i) = E(\mathfrak{B}) \forall i = 1, 2, \dots, n$ such that $E(\mathfrak{B}) = (\underline{E}(\mathfrak{B}), \bar{E}(\mathfrak{B})) = ((\underline{k}, \underline{\delta}), (\bar{k}, \bar{\delta}))$. Then $IFRDOWA(\psi(\mathfrak{B}_1), \psi(\mathfrak{B}_2), \dots, \psi(\mathfrak{B}_n)) = E(\mathfrak{B})$.

(ii) **Boundedness.**

Let $(\psi(\mathfrak{B}_i))^- = (\min_i \underline{\psi}(\mathfrak{B}_i), \min_i \bar{\psi}(\mathfrak{B}_i))$ and $(\psi(\mathfrak{B}_i))^+ = (\max_i \underline{\psi}(\mathfrak{B}_i), \max_i \bar{\psi}(\mathfrak{B}_i))$. Then

$$(\psi(\mathfrak{B}_i))^- \leq IFRDOWA(\psi(\mathfrak{B}_1), \psi(\mathfrak{B}_2), \dots, \psi(\mathfrak{B}_n)) \leq (\psi(\mathfrak{B}_i))^+.$$

(iii) **Monotonicity.** Consider the another family $\psi(\mathfrak{B}'_i) = (\underline{\psi}(\mathfrak{B}'_i), \bar{\psi}(\mathfrak{B}'_i))$ of IFRNs, such that $\underline{\psi}(\mathfrak{B}'_i) \leq \underline{\psi}(\mathfrak{B}_i)$ and $\bar{\psi}(\mathfrak{B}'_i) \leq \bar{\psi}(\mathfrak{B}_i)$. Then

$$IFRDOWA(\psi(\mathfrak{B}'_1), \psi(\mathfrak{B}'_2), \dots, \psi(\mathfrak{B}'_n)) \leq IFRDOWA(\psi(\mathfrak{B}_1), \psi(\mathfrak{B}_2), \dots, \psi(\mathfrak{B}_n)).$$

(iv) **Shift Invariance.** Assume that $E(\mathfrak{B}') = (\underline{E}(\mathfrak{B}'), \bar{E}(\mathfrak{B}')) = ((\underline{k}', \underline{\delta}'), (\bar{k}', \bar{\delta}'))$ be another IFRN. Then

$$IFRDOWA(\psi(\mathfrak{B}_1) \oplus E(\mathfrak{B}'), \psi(\mathfrak{B}_2) \oplus E(\mathfrak{B}'), \dots, \psi(\mathfrak{B}_n) \oplus E(\mathfrak{B}')) = IFRDOWA(\psi(\mathfrak{B}_1), \psi(\mathfrak{B}_2), \dots, \psi(\mathfrak{B}_n)) \oplus E(\mathfrak{B}').$$

(v) **Homogeneity.** For a real number $\alpha > 0$,

$$IFRDOWA(\alpha \psi(\mathfrak{B}_1), \alpha \psi(\mathfrak{B}_2), \dots, \alpha \psi(\mathfrak{B}_n)) = \alpha IFRDOWA(\psi(\mathfrak{B}_1), \psi(\mathfrak{B}_2), \dots, \psi(\mathfrak{B}_n)).$$

4.3. IF rough Dombi hybrid averaging operators

In this portion of the manuscript, to examine relation of the hybrid aggregation operators with IFRDWA and IFRDOWA operators which weight both the ordered position and the arguments value itself, that is IFRDHA

generalized both the operations. This subsection consists of the study of IFRDHA operator and discuss its rudimentary properties.

Definition 12. Assume that $\psi(\mathfrak{B}_i) = (\underline{\psi}(\mathfrak{B}_i), \overline{\psi}(\mathfrak{B}_i))$ be the family of IFRNs such that $\rho = (\rho_1, \rho_2, \dots, \rho_n)^T$ be the WV such that $\sum_{i=1}^n \rho_i = 1$ and $\rho_i \in [0, 1]$. Let $\varepsilon = (\varepsilon_1, \varepsilon_2, \varepsilon_3, \dots, \varepsilon_n)^T$ be the associated WV such that $\sum_{i=1}^n \varepsilon_i = 1$ and $\varepsilon_i \in [0, 1]$. Then the aggregated result for IFRDHA operator is a mapping $(\psi(\mathfrak{B}))^n \rightarrow \psi(\mathfrak{B})$, which is given as:

$$IFRDHA(\psi(\mathfrak{B}_1), \psi(\mathfrak{B}_2), \psi(\mathfrak{B}_3), \dots, \psi(\mathfrak{B}_n)) = (\oplus_{i=1}^n \varepsilon_i \underline{\psi}(\mathfrak{B}_{\sigma_i}), \oplus_{i=1}^n \varepsilon_i \overline{\psi}(\mathfrak{B}_{\sigma_i})).$$

Theorem 6. Let $\psi(\mathfrak{B}_i) = (\underline{\psi}(\mathfrak{B}_i), \overline{\psi}(\mathfrak{B}_i))$ be the family of IFRNs such that $\rho = (\rho_1, \rho_2, \dots, \rho_n)^T$ be the WV such that $\sum_{i=1}^n \rho_i = 1$ and $\rho_i \in [0, 1]$. Let $\varepsilon = (\varepsilon_1, \varepsilon_2, \varepsilon_3, \dots, \varepsilon_n)^T$ be the associated WV such that $\sum_{i=1}^n \varepsilon_i = 1$ and $\varepsilon_i \in [0, 1]$. Then by using IFRDHA operator, the aggregated result is described as:

$$IFRDHA(\psi(\mathfrak{B}_1), \psi(\mathfrak{B}_2), \psi(\mathfrak{B}_3), \dots, \psi(\mathfrak{B}_n)) = (\oplus_{i=1}^n \varepsilon_i \underline{\psi}(\mathfrak{B}_{\sigma_i}), \oplus_{i=1}^n \varepsilon_i \overline{\psi}(\mathfrak{B}_{\sigma_i}))$$

$$= \left(\left(1 - \frac{1}{1 + \left\{ \sum_{i=1}^n \varepsilon_i \left(\frac{\underline{k}_{\sigma_i}}{1 - \underline{k}_{\sigma_i}} \right)^{\beta} \right\}^{\frac{1}{\beta}}} \right)^{\beta}, \left(1 - \frac{1}{1 + \left\{ \sum_{i=1}^n \varepsilon_i \left(\frac{1 - \overline{\delta}_{\sigma_i}}{\overline{\delta}_{\sigma_i}} \right)^{\beta} \right\}^{\frac{1}{\beta}}} \right)^{\beta} \right)$$

where the IFRN $\psi(\mathfrak{B}_{\sigma_i}) = n\rho_i \psi(\mathfrak{B}_i) = n\rho_i (\underline{\psi}(\mathfrak{B}_i), \overline{\psi}(\mathfrak{B}_i))$ represent the largest permutation of the collection $\psi(\mathfrak{B}_i)$.

Theorem 7. Let $\psi(\mathfrak{B}_i) = (\underline{\psi}(\mathfrak{B}_i), \overline{\psi}(\mathfrak{B}_i))$ be the family of IFRNs and $\varepsilon = (\varepsilon_1, \varepsilon_2, \varepsilon_3, \dots, \varepsilon_n)^T$ be the WV such that $\sum_{i=1}^n \varepsilon_i = 1$ and $\varepsilon_i \in [0, 1]$. Then some rudimentary characteristics are discussed for IFRDHA operator.

(i) **Idempotency.** Let $\psi(\mathfrak{B}_i) = E(\mathfrak{B}) \forall i = 1, 2, \dots, n$ such that $E(\mathfrak{B}) = (\underline{E}(\mathfrak{B}), \overline{E}(\mathfrak{B})) = (\langle \underline{k}, \underline{\delta} \rangle, \langle \overline{k}, \overline{\delta} \rangle)$. Then $IFRDHA(\psi(\mathfrak{B}_1), \psi(\mathfrak{B}_2), \dots, \psi(\mathfrak{B}_n)) = E(\mathfrak{B})$.

(ii) **Boundedness.**

Let $(\psi(\mathfrak{B}_i))^- = (\min_i \underline{\psi}(\mathfrak{B}_i), \min_i \overline{\psi}(\mathfrak{B}_i))$ and $(\psi(\mathfrak{B}_i))^+ = (\max_i \underline{\psi}(\mathfrak{B}_i), \max_i \overline{\psi}(\mathfrak{B}_i))$. Then

$$(\psi(\mathfrak{B}_i))^- \leq IFRDHA(\psi(\mathfrak{B}_1), \psi(\mathfrak{B}_2), \dots, \psi(\mathfrak{B}_n)) \leq (\psi(\mathfrak{B}_i))^+.$$

(iii) **Monotonicity.** Consider the another family $\psi(\mathfrak{B}'_i) = (\underline{\psi}(\mathfrak{B}'_i), \overline{\psi}(\mathfrak{B}'_i))$ of IFRNs, such that $\underline{\psi}(\mathfrak{B}'_i) \leq \underline{\psi}(\mathfrak{B}_i)$ and $\overline{\psi}(\mathfrak{B}'_i) \leq \overline{\psi}(\mathfrak{B}_i)$. Then

$$IFRDHA(\psi(\mathfrak{B}'_1), \psi(\mathfrak{B}'_2), \dots, \psi(\mathfrak{B}'_n)) \leq IFRDHA(\psi(\mathfrak{B}_1), \psi(\mathfrak{B}_2), \dots, \psi(\mathfrak{B}_n)).$$

(iv) **Shift Invariance.** Assume that $E(\mathfrak{B}') = (\underline{E}(\mathfrak{B}'), \overline{E}(\mathfrak{B}')) = (\langle \underline{k}', \underline{\delta}' \rangle, \langle \overline{k}', \overline{\delta}' \rangle)$ be another IFRN. Then

$$IFRDHA(\psi(\mathfrak{B}_1) \oplus E(\mathfrak{B}'), \psi(\mathfrak{B}_2) \oplus E(\mathfrak{B}'), \dots, \psi(\mathfrak{B}_n) \oplus E(\mathfrak{B}')) = IFRHWA(\psi(\mathfrak{B}_1), \psi(\mathfrak{B}_2), \dots, \psi(\mathfrak{B}_n)) \oplus E(\mathfrak{B}').$$

(v) **Homogeneity.** For a real number $\alpha > 0$,

$$IFRDHA(\alpha \psi(\mathfrak{B}_1), \alpha \psi(\mathfrak{B}_2), \dots, \alpha \psi(\mathfrak{B}_n)) = \alpha IFRDHA(\psi(\mathfrak{B}_1), \psi(\mathfrak{B}_2), \dots, \psi(\mathfrak{B}_n)).$$

5. Geometric Aggregation Operators

Here we will originate the novel notion of IFRDWG, IFRDOWG and IFRDHG aggregation operators and presented the important properties of these operators.

5.1. IF rough Dombi weighted geometric operators

Definition 13. Assume that $\psi(\mathfrak{B}_i) = (\underline{\psi}(\mathfrak{B}_i), \overline{\psi}(\mathfrak{B}_i))$ be the family of IFRNs. Let $\varepsilon = (\varepsilon_1, \varepsilon_2, \varepsilon_3, \dots, \varepsilon_n)^T$ be the WV such that $\sum_{i=1}^n \varepsilon_i = 1$ and $\varepsilon_i \in [0, 1]$. Then the aggregated result for IFRDWG operator is a mapping $(\psi(\mathfrak{B}))^n \rightarrow \psi(\mathfrak{B})$, which is given as:

$$IFRDWG(\psi(\mathfrak{B}_1), \psi(\mathfrak{B}_2), \psi(\mathfrak{B}_3), \dots, \psi(\mathfrak{B}_n)) = (\otimes_{i=1}^n (\underline{\psi}(\mathfrak{B}_i))^{\varepsilon_i}, \otimes_{i=1}^n (\overline{\psi}(\mathfrak{B}_i))^{\varepsilon_i}).$$

Theorem 8. Let $\psi(\mathfrak{B}_i) = (\underline{\psi}(\mathfrak{B}_i), \overline{\psi}(\mathfrak{B}_i))$ be the family of IFRNs and $\varepsilon = (\varepsilon_1, \varepsilon_2, \varepsilon_3, \dots, \varepsilon_n)^T$ be the WV such that $\sum_{i=1}^n \varepsilon_i = 1$ and $\varepsilon_i \in [0, 1]$. Then by using IFRDWG operator, the aggregated result is described as:

$$IFRDWG(\psi(\mathfrak{B}_1), \psi(\mathfrak{B}_2), \psi(\mathfrak{B}_3), \dots, \psi(\mathfrak{B}_n)) = \left(\otimes_{i=1}^n (\underline{\psi}(\mathfrak{B}_i))^{\varepsilon_i}, \otimes_{i=1}^n (\overline{\psi}(\mathfrak{B}_i))^{\varepsilon_i} \right)$$

$$= \left(\left(\frac{1}{1 + \left\{ \sum_{i=1}^n \varepsilon_i \left(\frac{1 - \underline{\kappa}_i}{\underline{\kappa}_i} \right)^{\beta} \right\}^{\frac{1}{\beta}}}, 1 - \frac{1}{1 + \left\{ \sum_{i=1}^n \varepsilon_i \left(\frac{\delta_i}{1 - \delta_i} \right)^{\beta} \right\}^{\frac{1}{\beta}}} \right), \left(\frac{1}{1 + \left\{ \sum_{i=1}^n \varepsilon_i \left(\frac{1 - \overline{\kappa}_i}{\overline{\kappa}_i} \right)^{\beta} \right\}^{\frac{1}{\beta}}}, 1 - \frac{1}{1 + \left\{ \sum_{i=1}^n \varepsilon_i \left(\frac{\overline{\delta}_i}{1 - \overline{\delta}_i} \right)^{\beta} \right\}^{\frac{1}{\beta}}} \right) \right)$$

Proof. Proof followed from Theorem 2.

Theorem 9. Let $\psi(\mathfrak{B}_i) = (\underline{\psi}(\mathfrak{B}_i), \overline{\psi}(\mathfrak{B}_i))$ be the family of IFRNs and $\varepsilon = (\varepsilon_1, \varepsilon_2, \varepsilon_3, \dots, \varepsilon_n)^T$ be the WV such that $\sum_{i=1}^n \varepsilon_i = 1$ and $\varepsilon_i \in [0, 1]$. Then the elementary result for IFRDWG operator are given as.

(i) **Idempotency.** Let $\psi(\mathfrak{B}_i) = E(\mathfrak{B}) \ \forall i = 1, 2, \dots, n$ such that $E(\mathfrak{B}) = (E(\mathfrak{B}), \overline{E}(\mathfrak{B})) = (\langle \underline{\kappa}, \underline{\delta} \rangle, \langle \overline{\kappa}, \overline{\delta} \rangle)$. Then $IFRDWG(\psi(\mathfrak{B}_1), \psi(\mathfrak{B}_2), \dots, \psi(\mathfrak{B}_n)) = E(\mathfrak{B})$.

(ii) **Boundedness.**

Let $(\psi(\mathfrak{B}_i))^- = \left(\min_i \underline{\psi}(\mathfrak{B}_i), \min_i \overline{\psi}(\mathfrak{B}_i) \right)$ and $(\psi(\mathfrak{B}_i))^+ = \left(\max_i \underline{\psi}(\mathfrak{B}_i), \max_i \overline{\psi}(\mathfrak{B}_i) \right)$. Then

$$(\psi(\mathfrak{B}_i))^- \leq IFRDWG(\psi(\mathfrak{B}_1), \psi(\mathfrak{B}_2), \dots, \psi(\mathfrak{B}_n)) \leq (\psi(\mathfrak{B}_i))^+$$

(iii) **Monotonicity.** Consider the another family $\psi(\mathfrak{B}'_i) = (\underline{\psi}(\mathfrak{B}'_i), \overline{\psi}(\mathfrak{B}'_i))$ of IFRNs, such that $\underline{\psi}(\mathfrak{B}'_i) \leq \underline{\psi}(\mathfrak{B}_i)$ and $\overline{\psi}(\mathfrak{B}'_i) \leq \overline{\psi}(\mathfrak{B}_i)$. Then

$$IFRDWG(\psi(\mathfrak{B}'_1), \psi(\mathfrak{B}'_2), \dots, \psi(\mathfrak{B}'_n)) \leq IFRDWG(\psi(\mathfrak{B}_1), \psi(\mathfrak{B}_2), \dots, \psi(\mathfrak{B}_n)).$$

(iv) **Shift Invariance.** Assume that $E(\mathfrak{B}') = (E(\mathfrak{B}'), \overline{E}(\mathfrak{B}')) = (\langle \underline{\kappa}', \underline{\delta}' \rangle, \langle \overline{\kappa}', \overline{\delta}' \rangle)$ be another IFRN. Then

$$IFRDWG(\psi(\mathfrak{B}_1) \oplus E(\mathfrak{B}'), \psi(\mathfrak{B}_2) \oplus E(\mathfrak{B}'), \dots, \psi(\mathfrak{B}_n) \oplus E(\mathfrak{B}')) = IFRDWG(\psi(\mathfrak{B}_1), \psi(\mathfrak{B}_2), \dots, \psi(\mathfrak{B}_n)) \oplus E(\mathfrak{B}').$$

(v) **Homogeneity.** For a real number $\alpha > 0$,

$$IFRDWG(\alpha \psi(\mathfrak{B}_1), \alpha \psi(\mathfrak{B}_2), \dots, \alpha \psi(\mathfrak{B}_n)) = \alpha IFRDWG(\psi(\mathfrak{B}_1), \psi(\mathfrak{B}_2), \dots, \psi(\mathfrak{B}_n)).$$

Proof. Proofs are e easy and straightforward.

5.2. IF rough Dombi ordered weighted geometric operators

Definition 14. Assume that $\psi(\mathfrak{B}_i) = (\underline{\psi}(\mathfrak{B}_i), \overline{\psi}(\mathfrak{B}_i))$ be the family of IFRNs. Let $\varepsilon = (\varepsilon_1, \varepsilon_2, \varepsilon_3, \dots, \varepsilon_n)^T$ be the WV such that $\sum_{i=1}^n \varepsilon_i = 1$ and $\varepsilon_i \in [0, 1]$. Then the aggregated result for IFRDOWG operator is a mapping $(\psi(\mathfrak{B}))^n \rightarrow \psi(\mathfrak{B})$, which is given as:

$$IFRDOWG(\psi(\mathfrak{B}_1), \psi(\mathfrak{B}_2), \psi(\mathfrak{B}_3), \dots, \psi(\mathfrak{B}_n)) = \left(\otimes_{i=1}^n (\underline{\psi}(\mathfrak{B}_{\sigma_i}))^{\varepsilon_i}, \otimes_{i=1}^n (\overline{\psi}(\mathfrak{B}_{\sigma_i}))^{\varepsilon_i} \right).$$

Theorem 10. Let $\psi(\mathfrak{B}_i) = (\underline{\psi}(\mathfrak{B}_i), \overline{\psi}(\mathfrak{B}_i))$ be the family of IFRNs and $\varepsilon = (\varepsilon_1, \varepsilon_2, \varepsilon_3, \dots, \varepsilon_n)^T$ be the WV such that $\sum_{i=1}^n \varepsilon_i = 1$ and $\varepsilon_i \in [0, 1]$. Then by using IFRDOWG operator, the aggregated result is described as:

$$IFRDOWG(\psi(\mathfrak{B}_1), \psi(\mathfrak{B}_2), \dots, \psi(\mathfrak{B}_n)) = \left(\otimes_{i=1}^n (\underline{\psi}(\mathfrak{B}_{\sigma_i}))^{\varepsilon_i}, \otimes_{i=1}^n (\overline{\psi}(\mathfrak{B}_{\sigma_i}))^{\varepsilon_i} \right)$$

$$= \left(\left(\frac{1}{1 + \left\{ \sum_{i=1}^n \varepsilon_i \left(\frac{1 - \underline{\kappa}_{\sigma_i}}{\underline{\kappa}_{\sigma_i}} \right)^{\beta} \right\}^{\frac{1}{\beta}}}, 1 - \frac{1}{1 + \left\{ \sum_{i=1}^n \varepsilon_i \left(\frac{\delta_{\sigma_i}}{1 - \delta_{\sigma_i}} \right)^{\beta} \right\}^{\frac{1}{\beta}}} \right), \left(\frac{1}{1 + \left\{ \sum_{i=1}^n \varepsilon_i \left(\frac{1 - \overline{\kappa}_{\sigma_i}}{\overline{\kappa}_{\sigma_i}} \right)^{\beta} \right\}^{\frac{1}{\beta}}}, 1 - \frac{1}{1 + \left\{ \sum_{i=1}^n \varepsilon_i \left(\frac{\overline{\delta}_{\sigma_i}}{1 - \overline{\delta}_{\sigma_i}} \right)^{\beta} \right\}^{\frac{1}{\beta}}} \right) \right)$$

where the IFRN $\psi(\mathfrak{B}_{\sigma_i}) = (\underline{\psi}(\mathfrak{B}_{\sigma_i}), \overline{\psi}(\mathfrak{B}_{\sigma_i}))$ represent the largest permutation of the collection $\psi(\mathfrak{B}_i)$.

Theorem 11. Let $\psi(\mathfrak{B}_i) = (\underline{\psi}(\mathfrak{B}_i), \overline{\psi}(\mathfrak{B}_i))$ be the family of IFRNs and $\varepsilon = (\varepsilon_1, \varepsilon_2, \varepsilon_3, \dots, \varepsilon_n)^T$ be the WV such that $\sum_{i=1}^n \varepsilon_i = 1$ and $\varepsilon_i \in [0, 1]$. Then some basic results are satisfied for the collection $\psi(\mathfrak{B}_i)$ by applying IFRDOWA operator.

(i) **Idempotency.** Let $\psi(\mathfrak{B}_i) = E(\mathfrak{B}) \forall i = 1, 2, \dots, n$ such that $E(\mathfrak{B}) = (E(\mathfrak{B}), \overline{E}(\mathfrak{B})) = (\langle \underline{k}, \underline{\delta} \rangle, \langle \overline{k}, \overline{\delta} \rangle)$. Then $IFRDOWG(\psi(\mathfrak{B}_1), \psi(\mathfrak{B}_2), \dots, \psi(\mathfrak{B}_n)) = E(\mathfrak{B})$.

(ii) **Boundedness.** Let $(\psi(\mathfrak{B}_i))^- = (\min_i \underline{\psi}(\mathfrak{B}_i), \min_i \overline{\psi}(\mathfrak{B}_i))$ and $(\psi(\mathfrak{B}_i))^+ = (\max_i \underline{\psi}(\mathfrak{B}_i), \max_i \overline{\psi}(\mathfrak{B}_i))$. Then $(\psi(\mathfrak{B}_i))^- \leq IFRDOWG(\psi(\mathfrak{B}_1), \psi(\mathfrak{B}_2), \dots, \psi(\mathfrak{B}_n)) \leq (\psi(\mathfrak{B}_i))^+$.

(iii) **Monotonicity.** Consider the another family $\psi(\mathfrak{B}'_i) = (\underline{\psi}(\mathfrak{B}'_i), \overline{\psi}(\mathfrak{B}'_i))$ of IFRNs, such that $\underline{\psi}(\mathfrak{B}'_i) \leq \underline{\psi}(\mathfrak{B}_i)$ and $\overline{\psi}(\mathfrak{B}'_i) \leq \overline{\psi}(\mathfrak{B}_i)$. Then

$$IFRDOWG(\psi(\mathfrak{B}'_1), \psi(\mathfrak{B}'_2), \dots, \psi(\mathfrak{B}'_n)) \leq IFRDOWG(\psi(\mathfrak{B}_1), \psi(\mathfrak{B}_2), \dots, \psi(\mathfrak{B}_n)).$$

(iv) **Shift Invariance.** Assume that $E(\mathfrak{B}') = (E(\mathfrak{B}'), \overline{E}(\mathfrak{B}')) = (\langle \underline{k}', \underline{\delta}' \rangle, \langle \overline{k}', \overline{\delta}' \rangle)$ be another IFRN. Then $IFRDOWG(\psi(\mathfrak{B}_1) \oplus E(\mathfrak{B}'), \psi(\mathfrak{B}_2) \oplus E(\mathfrak{B}'), \dots, \psi(\mathfrak{B}_n) \oplus E(\mathfrak{B}')) = IFRDOWG(\psi(\mathfrak{B}_1), \psi(\mathfrak{B}_2), \dots, \psi(\mathfrak{B}_n)) \oplus E(\mathfrak{B}')$.

(v) **Homogeneity.** For a real number $\alpha > 0$, $IFRDOWG(\alpha\psi(\mathfrak{B}_1), \alpha\psi(\mathfrak{B}_2), \dots, \alpha\psi(\mathfrak{B}_n)) = \alpha IFRDOWG(\psi(\mathfrak{B}_1), \psi(\mathfrak{B}_2), \dots, \psi(\mathfrak{B}_n))$.

5.3. IF rough Dombi hybrid geometric operators

In this portion of the manuscript, to examine relation of the hybrid geometric operators with IFRDWG and IFRDOWG operators which weight both the ordered position and the arguments value itself, that is IFRDHG generalized both the operations. This subsection consists of the study of IFRDHG operator and discuss its rudimentary properties.

Definition 15. Assume that $\psi(\mathfrak{B}_i) = (\underline{\psi}(\mathfrak{B}_i), \overline{\psi}(\mathfrak{B}_i))$ be the family of IFRNs such that $\rho = (\rho_1, \rho_2, \dots, \rho_n)^T$ be the WV such that $\sum_{i=1}^n \rho_i = 1$ and $\rho_i \in [0, 1]$. Let $\varepsilon = (\varepsilon_1, \varepsilon_2, \varepsilon_3, \dots, \varepsilon_n)^T$ be the associated WV such that $\sum_{i=1}^n \varepsilon_i = 1$ and $\varepsilon_i \in [0, 1]$. Then the IFRDHG operator is a mapping $(\psi(\mathfrak{B}))^n \rightarrow \psi(\mathfrak{B})$, which is given as:

$$IFRDHG(\psi(\mathfrak{B}_1), \psi(\mathfrak{B}_2), \psi(\mathfrak{B}_3), \dots, \psi(\mathfrak{B}_n)) = (\otimes_{i=1}^n (\underline{\psi}(\mathfrak{B}_{\sigma_i}))^{\varepsilon_i}, \otimes_{i=1}^n (\overline{\psi}(\mathfrak{B}_{\sigma_i}))^{\varepsilon_i}).$$

Theorem 12. Let $\psi(\mathfrak{B}_i) = (\underline{\psi}(\mathfrak{B}_i), \overline{\psi}(\mathfrak{B}_i))$ be the family of IFRNs such that $\rho = (\rho_1, \rho_2, \dots, \rho_n)^T$ be the WV such that $\sum_{i=1}^n \rho_i = 1$ and $\rho_i \in [0, 1]$. Let $\varepsilon = (\varepsilon_1, \varepsilon_2, \varepsilon_3, \dots, \varepsilon_n)^T$ be the associated WV such that $\sum_{i=1}^n \varepsilon_i = 1$ and $\varepsilon_i \in [0, 1]$. Then by using IFRDHG operator, the aggregated result is described as:

$$IFRDHG(\psi(\mathfrak{B}_1), \psi(\mathfrak{B}_2), \psi(\mathfrak{B}_3), \dots, \psi(\mathfrak{B}_n)) = (\otimes_{i=1}^n (\underline{\psi}(\mathfrak{B}_{\sigma_i}))^{\varepsilon_i}, \otimes_{i=1}^n (\overline{\psi}(\mathfrak{B}_{\sigma_i}))^{\varepsilon_i})$$

$$= \left(\left(\frac{1}{1 + \left\{ \sum_{i=1}^n \varepsilon_i \left(\frac{1 - \underline{k}_{\sigma_i}}{\underline{k}_{\sigma_i}} \right)^\beta \right\}^{\frac{1}{\beta}}}, 1 - \frac{1}{1 + \left\{ \sum_{i=1}^n \varepsilon_i \left(\frac{\delta_{\sigma_i}}{1 - \delta_{\sigma_i}} \right)^\beta \right\}^{\frac{1}{\beta}}} \right), \left(\frac{1}{1 + \left\{ \sum_{i=1}^n \varepsilon_i \left(\frac{1 - \overline{k}_{\sigma_i}}{\overline{k}_{\sigma_i}} \right)^\beta \right\}^{\frac{1}{\beta}}}, 1 - \frac{1}{1 + \left\{ \sum_{i=1}^n \varepsilon_i \left(\frac{\overline{\delta}_{\sigma_i}}{1 - \overline{\delta}_{\sigma_i}} \right)^\beta \right\}^{\frac{1}{\beta}}} \right) \right)$$

where the IFRN $\psi(\mathfrak{B}_{\sigma_i}) = n\rho_i\psi(\mathfrak{B}_i) = n\rho_i(\underline{\psi}(\mathfrak{B}_i), \overline{\psi}(\mathfrak{B}_i))$ represent the largest permutation of the collection $\psi(\mathfrak{B}_i)$.

Theorem 13. Let $\psi(\mathfrak{B}_i) = (\underline{\psi}(\mathfrak{B}_i), \overline{\psi}(\mathfrak{B}_i))$ be the family of IFRNs and $\varepsilon = (\varepsilon_1, \varepsilon_2, \varepsilon_3, \dots, \varepsilon_n)^T$ be the WV such that $\sum_{i=1}^n \varepsilon_i = 1$ and $\varepsilon_i \in [0, 1]$. Then some basic results are satisfied for the collection $\psi(\mathfrak{B}_i)$ by applying IFRDOWG operator.

(i) **Idempotency.** Let $\psi(\mathfrak{B}_i) = E(\mathfrak{B}) \forall i = 1, 2, \dots, n$ such that $E(\mathfrak{B}) = (E(\mathfrak{B}), \overline{E}(\mathfrak{B})) = (\langle \underline{k}, \underline{\delta} \rangle, \langle \overline{k}, \overline{\delta} \rangle)$. Then $IFRDHG(\psi(\mathfrak{B}_1), \psi(\mathfrak{B}_2), \dots, \psi(\mathfrak{B}_n)) = E(\mathfrak{B})$.

(ii) **Boundedness.**

Let $(\psi(\mathfrak{B}_i))^- = (\min_i \underline{\psi}(\mathfrak{B}_i), \min_i \bar{\psi}(\mathfrak{B}_i))$ and $(\psi(\mathfrak{B}_i))^+ = (\max_i \underline{\psi}(\mathfrak{B}_i), \max_i \bar{\psi}(\mathfrak{B}_i))$. Then

$$(\psi(\mathfrak{B}_i))^- \leq IFRDHG(\psi(\mathfrak{B}_1), \psi(\mathfrak{B}_2), \dots, \psi(\mathfrak{B}_n)) \leq (\psi(\mathfrak{B}_i))^+.$$

(iii) **Monotonicity.** Consider the another family $\psi(\mathfrak{B}'_i) = (\underline{\psi}(\mathfrak{B}'_i), \bar{\psi}(\mathfrak{B}'_i))$ of IFNRNs, such that $\underline{\psi}(\mathfrak{B}'_i) \leq \underline{\psi}(\mathfrak{B}_i)$ and $\bar{\psi}(\mathfrak{B}'_i) \leq \bar{\psi}(\mathfrak{B}_i)$. Then

$$IFRDHG(\psi(\mathfrak{B}'_1), \psi(\mathfrak{B}'_2), \dots, \psi(\mathfrak{B}'_n)) \leq IFRDHG(\psi(\mathfrak{B}_1), \psi(\mathfrak{B}_2), \dots, \psi(\mathfrak{B}_n)).$$

(iv) **Shift Invariance.** Assume that $E(\mathfrak{B}) = (\underline{E}(\mathfrak{B}), \bar{E}(\mathfrak{B})) = ((\underline{\kappa}, \underline{\delta}), (\bar{\kappa}, \bar{\delta}))$ be another IFRN. Then $IFRDHG(\psi(\mathfrak{B}_1) \oplus E(\mathfrak{B}), \psi(\mathfrak{B}_2) \oplus E(\mathfrak{B}), \dots, \psi(\mathfrak{B}_n) \oplus E(\mathfrak{B})) = IFRHWG(\psi(\mathfrak{B}_1), \psi(\mathfrak{B}_2), \dots, \psi(\mathfrak{B}_n)) \oplus E(\mathfrak{B})$.

(v) **Homogeneity.** For a real number $\alpha > 0$,

$$IFRDHG(\alpha\psi(\mathfrak{B}_1), \alpha\psi(\mathfrak{B}_2), \dots, \alpha\psi(\mathfrak{B}_n)) = \alpha IFRDHG(\psi(\mathfrak{B}_1), \psi(\mathfrak{B}_2), \dots, \psi(\mathfrak{B}_n)).$$

6. TOPSIS approach to MCGDM based of IFR Dombi aggregation operators

In this portion of the manuscript, we will present the general structure of the TOPSIS and step wise algorithm for TOPSIS technique based of MCGDM.

In real life group DM is one of the most significant process, in which the professional experts of different genre present their input evaluations for every alternative against all criteria to get the most desirable solution. Assume that the set $K = \{g_1, g_2, \dots, g_n\}$ of n objects and let $\tilde{C} = \{\tilde{C}_1, \tilde{C}_2, \dots, \tilde{C}_m\}$ be the set corresponding criteria with WV $\varepsilon = (\varepsilon_1, \varepsilon_2, \dots, \varepsilon_m)^T$ such that $\sum_{j=1}^m \varepsilon_j$ with $\varepsilon_j \in [0, 1]$. Let $G = \{G_1, G_2, \dots, G_t\}$ be a set of professional specialist who assign their personal views for each alternatives with respect to corresponding criteria with WV $v = (v_1, v_2, \dots, v_t)^T$ such that $\sum_{l=1}^t v_l$ with $v_l \in [0, 1]$. The decision experts present their evaluation in the form of IFNRNs and collectively represented in the form of decision matrix $\mathcal{M} = [\psi(\mathfrak{B}_{ij})]_{m \times n}$. Then defined the accumulated geometric operator to transform the IFNRNs into IFNs which is defined by:

Definition 16. Assume an IFRN of the form $\psi(\mathfrak{B}) = (\underline{\psi}(\mathfrak{B}), \bar{\psi}(\mathfrak{B})) = ((\underline{\kappa}, \underline{\delta}), (\bar{\kappa}, \bar{\delta}))$. Then transform the IFRN into IFN by applying accumulated geometric operator (AGO), which is defined as:

$$\mathfrak{G} = (\underline{\kappa}_{\mathfrak{G}}, \underline{\delta}_{\mathfrak{G}}) = (\underline{\psi}(\mathfrak{B}), \bar{\psi}(\mathfrak{B}))^{0.5} = ((\underline{\kappa}\bar{\kappa})^{0.5}, (\underline{\delta}\bar{\delta})^{0.5})$$

The combined opinions of decision experts are expressed in the form of IF rough decision matrix $\mathcal{M} = [\psi(\mathfrak{B}_{ij})]_{m \times n}$ is transformed into an IF decision matrix $\mathcal{M} = [\mathfrak{G}(\underline{\kappa}_{\mathfrak{G}ij}, \underline{\delta}_{\mathfrak{G}ij})]_{m \times n}$ by applying AGO.

Furthermore, by applying the technique of TOPSIS method to calculate the IF-PIS \mathcal{P}^+ and IF-NIS \mathcal{P}^- of the transformed decision matrix via the score function which is defined as:

$$\begin{aligned} \mathcal{P}^+ &= \{ \{ \tilde{C}_j, \max\{\bar{S}(\tilde{C}_j(g_i))\} \} | i = 1, \dots, n, j = 1, \dots, m \} \\ &= \{ \{ \tilde{C}_1, (\underline{\kappa}_1^+, \underline{\delta}_1^+) \}, \{ \tilde{C}_2, (\underline{\kappa}_2^+, \underline{\delta}_2^+) \}, \dots, \{ \tilde{C}_m, (\underline{\kappa}_m^+, \underline{\delta}_m^+) \} \} \\ \mathcal{P}^- &= \{ \{ \tilde{C}_j, \min\{\bar{S}(\tilde{C}_j(g_i))\} \} | i = 1, \dots, n, j = 1, \dots, m \} \\ &= \{ \{ \tilde{C}_1, (\underline{\kappa}_1^-, \underline{\delta}_1^-) \}, \{ \tilde{C}_2, (\underline{\kappa}_2^-, \underline{\delta}_2^-) \}, \dots, \{ \tilde{C}_m, (\underline{\kappa}_m^-, \underline{\delta}_m^-) \} \} \end{aligned}$$

Calculate the shortest distance D^+ and farthest distance D^- between the each object g_i and the IF-PIS and IF-NIS

$$\begin{aligned} D^+(g_i, \mathcal{P}^+) &= \sum_{j=1}^n \varepsilon_j d(\tilde{C}_j(g_i), \tilde{C}_j(\mathcal{P}^+)) \\ &= \frac{1}{2} \sum_{j=1}^n \varepsilon_j (|\underline{\kappa}_{ij} - \underline{\kappa}_j^+| + |\underline{\delta}_{ij} - \underline{\delta}_j^+| + |\pi_{ij} - \pi_j^+|) \text{ for } p > 1 \end{aligned}$$

$$D^-(g_i, \mathcal{P}^-) = \sum_{j=1}^n \varepsilon_j d(\tilde{C}_j(g_i), \tilde{C}_j(\mathcal{P}^-))$$

$$= \frac{1}{2} \sum_{j=1}^n \varepsilon_j (|\kappa_{ij} - \kappa^-_j| + |\delta_{ij} - \delta^-_j| + |\pi_{ij} - \pi^-_j|) \text{ for } p > 1$$

Generally the objects having smaller the value of shortest distance $D^+(g_i, \mathcal{P}^+)$ is better the one and bigger the value of farthest distance $D^-(g_i, \mathcal{P}^-)$ better that alternative is.

$$D_{min}^+(g_i, \mathcal{P}^+) = \min_{1 \leq i \leq n} D^+(g_i, \mathcal{P}^+), D_{max}^-(g_i, \mathcal{P}^-) = \max_{1 \leq i \leq n} D^-(g_i, \mathcal{P}^-)$$

Finally, from the above analysis calculate the ranking of all alternatives according to the corresponding criteria and arranged them in a specific ordered to get the optimum value.

$$\xi(g_i) = \frac{D^-(g_i, \mathcal{P}^-)}{D_{max}^-(g_i, \mathcal{P}^-)} - \frac{D^+(g_i, \mathcal{P}^+)}{D_{min}^+(g_i, \mathcal{P}^+)}$$

Table 1, IFR evaluation information D_1

	\tilde{C}_1	\tilde{C}_2	\tilde{C}_3	\tilde{C}_4	\tilde{C}_5
g1	((0.7,0.1),(0.4,0.2))	((0.7,0.2),(0.6,0.4))	((0.5,0.2),(0.8,0.2))	((0.8,0.1),(0.7,0.2))	((0.4,0.2),(0.5,0.3))
g2	((0.6,0.2),(0.9,0.1))	((0.5,0.3),(0.9,0.1))	((0.9,0.1),(0.6,0.3))	((0.4,0.1),(0.5,0.1))	((0.8,0.1),(0.6,0.2))
g3	((0.8,0.2),(0.7,0.2))	((0.4,0.1),(0.3,0.2))	((0.4,0.2),(0.7,0.1))	((0.9,0.1),(0.6,0.2))	((0.6,0.3),(0.7,0.2))
g4	((0.4,0.1),(0.6,0.3))	((0.8,0.1),(0.7,0.3))	((0.9,0.1),(0.6,0.2))	((0.5,0.2),(0.8,0.1))	((0.7,0.1),(0.9,0.1))

Table 2, IFR evaluation information D_2

	\tilde{C}_1	\tilde{C}_2	\tilde{C}_3	\tilde{C}_4	\tilde{C}_5
g1	((0.4,0.1),(0.3,0.3))	((0.9,0.1),(0.5,0.2))	((0.8,0.1),(0.7,0.2))	((0.9,0.1),(0.4,0.1))	((0.6,0.1),(0.8,0.2))
g2	((0.5,0.3),(0.8,0.2))	((0.7,0.1),(0.9,0.1))	((0.7,0.2),(0.5,0.2))	((0.4,0.3),(0.3,0.2))	((0.5,0.2),(0.9,0.1))
g3	((0.7,0.3),(0.6,0.1))	((0.6,0.2),(0.7,0.3))	((0.8,0.1),(0.6,0.3))	((0.8,0.2),(0.9,0.1))	((0.4,0.1),(0.3,0.2))
g4	((0.2,0.1),(0.5,0.2))	((0.9,0.1),(0.6,0.2))	((0.3,0.1),(0.4,0.3))	((0.5,0.4),(0.7,0.3))	((0.6,0.2),(0.8,0.1))

6.1. Algorithm

From the above analysis, the step wise decision algorithm for the developed approach consists of the following steps:

Step 1. The decision experts present their evaluation in the form of IFRNs and collectively expressed in the form of IFR decision matrix given by:

$$\mathcal{M} = [\psi(\mathfrak{B}_{ij})]_{m \times n}$$

Step 2. Aggregate the expressed combine decision assessment of the professional experts by applying the developed approach to get a single decision matrix in the form of IFR decision matrix.

Step 3. The collective aggregated evaluation information of decision experts in the form of IF rough decision matrix $\mathcal{M} = [\psi(\mathfrak{B}_{ij})]_{m \times n}$ is transformed into an IF decision matrix $\mathcal{M} = [\mathfrak{G}(\mathfrak{k}_{\mathfrak{G}_{ij}}, \delta_{\mathfrak{G}_{ij}})]_{m \times n}$ by applying AGO.

Step 4. Calculate the IF-PIS \mathcal{P}^+ and IF-NIS \mathcal{P}^- of the transformed decision matrix via the score function.

Step 5. Calculate the shortest distance D^+ and farthest distance D^- between the alternative g_i and the IF-PIS and IF-NIS.

Step 6. Finally, by applying the ranking function $\xi(g_i)$ and arrange the ranking information in a specific ordered get the optimum object.

7. Illustrative Example

The massive outbreak of the pandemic COVID-19 promoted the challenging scenario for the world organizations including scientists, laboratories and researchers to conduct special clinical treatment strategies to prevent the people from COVID-19 pandemic. Globally, COVID-19 pandemic affected the human race and hit hard on them in term of health and economy. The most severe symptoms, which need medical attention are, low level of oxygen in the body, pneumonia, sometime failure of vital organs such as kidneys, heart, and liver. Studies also reported loss of taste and smell. The common symptoms reported by CDC is mentioned somewhere in this article, but we here studied the symptoms with sever disease that are associated to most distinctive comorbidities SARS-CoV-2 infection. The severeness of disease with symptoms we linked via illustrative analysis.

Assume that a team of experts doctors including D_1, D_2 and D_3 are called to diagnose the most severe illness of COVID-19 patient with WV $\varepsilon = (0.326, 0.352, 0.322)^T$ such that $\sum_{j=1}^m \varepsilon_j$ with $\varepsilon_j \in [0, 1]$. The experts examined four patients g_1, g_2, g_3 and g_4 . According to the recent study by the collaboration of different organizations a majority exhibited clinical criteria such as $\tilde{C}_1 =$ fever, $\tilde{C}_2 =$ dry cough, $\tilde{C}_3 =$ fatigue, $\tilde{C}_4 =$ diarrhea and $\tilde{C}_5 =$ shortness of breath, with WV $\vartheta = (0.215, 0.218, 0.212, 0.231, 0.124)^T$. Further the decision maker presented their evaluation report in the form of IFRNs for each patient g_i with respect to their corresponding criteria. Now by applying the step wise algorithm for the developed approach to diagnose the most severe ill patient by taking the operational parameter $\beta = 2$.

Table 3, IFR evaluation information D_3

	\tilde{C}_1	\tilde{C}_2	\tilde{C}_3	\tilde{C}_4	\tilde{C}_5
g_1	$((0.6, 0.3), (0.8, 0.1))$	$((0.6, 0.2), (0.9, 0.1))$	$((0.7, 0.3), (0.9, 0.1))$	$((0.5, 0.3), (0.9, 0.1))$	$((0.8, 0.1), (0.4, 0.3))$
g_2	$((0.7, 0.1), (0.4, 0.2))$	$((0.8, 0.1), (0.7, 0.2))$	$((0.4, 0.2), (0.7, 0.2))$	$((0.3, 0.2), (0.8, 0.2))$	$((0.7, 0.3), (0.5, 0.1))$
g_3	$((0.5, 0.3), (0.8, 0.2))$	$((0.3, 0.2), (0.5, 0.3))$	$((0.8, 0.1), (0.4, 0.3))$	$((0.7, 0.2), (0.5, 0.3))$	$((0.9, 0.1), (0.2, 0.3))$
g_4	$((0.7, 0.2), (0.6, 0.4))$	$((0.2, 0.1), (0.4, 0.1))$	$((0.6, 0.4), (0.5, 0.2))$	$((0.6, 0.1), (0.9, 0.1))$	$((0.7, 0.2), (0.8, 0.1))$

Table 4, aggregated result by applying IFRWA operator

	\tilde{C}_1	\tilde{C}_2	\tilde{C}_3
g_1	$((0.6197, 0.1173), (0.6984, 0.1479))$	$((0.8478, 0.1382), (0.8390, 0.1493))$	$((0.7352, 0.1438), (0.8521, 0.1413))$

g ₂	((0.6275,0.1479),(0.8501,0.1409))	((0.7311,0.1175),(0.8827,0.1143))	((0.8422,0.1409),(0.6275,0.2201))
g ₃	((0.7319,0.2512),(0.7353,0.1382))	((0.4995,0.1409),(0.6026,0.2512))	((0.7678,0.1145),(0.6221,0.1542))
g ₄	((0.5808,0.1143),(0.5736,0.2596))	((0.8531,0.1),(0.6221,0.1473))	((0.8391,0.1182),(0.5240,0.2220))
	\tilde{C}_4	\tilde{C}_5	
g ₁	((0.8537,0.1173),(0.8411,0.1145))	((0.7116,0.1145),(0.7118,0.2484))	
g ₂	((0.3752,0.1474),(0.7019,0.1409))	((0.7302,0.1468),(0.8447,0.1145))	
g ₃	((0.8532,0.1409),(0.8447,0.1438))	((0.8385,0.1175),(0.5769,0.2198))	
g ₄	((0.5822,0.1501),(0.8521,0.1194))	((0.6752,0.1409),(0.8591,0.1))	

For IFRDWA/ IFRDWG operator

Step 1. The decision experts expressed their judgement in the form of IFRNs and collectively represented in the form of IFR decision matrix given in Tables 1-3.

Step 2. Aggregate the collective decision information of the professional experts given in Tables 1-3, by applying the IFRDWA/IFRDWG operator to get a single decision matrix in the form of IFR decision matrix which is given in Table 4.

Step 3. The collective aggregated evaluation information of decision experts in the form of IF rough decision matrix $\mathcal{M} = [\psi(\mathfrak{B}_{ij})]_{m \times n}$ is transformed into an IF decision matrix $\mathcal{M} = [\mathfrak{G}(\underline{k}_{\mathfrak{G}_{ij}}, \delta_{\mathfrak{G}_{ij}})]_{m \times n}$ by applying AGO, which is defined as:

$$\mathfrak{G} = (\underline{k}_{\mathfrak{G}}, \delta_{\mathfrak{G}}) = (\underline{\psi}(\mathfrak{B}), \overline{\psi}(\mathfrak{B}))^{0.5} = ((\underline{k}\overline{k})^{0.5}, (\delta\overline{\delta})^{0.5}).$$

The collective evaluation information of decision experts in the form of IF decision matrix by applying AGO is given in Table 5.

Step 4. Determine the IF-PIS \mathcal{P}^+ and IF-NIS \mathcal{P}^- of the transformed decision matrix given in Table 5, by applying the score function given in Definition 6.

$$\mathcal{P}^+ = \{(0.7304,0.1443),(0.8434,0.1437),(0.7915,0.1425),(0.8474,0.1159),(0.7853,0.1296)\}$$

$$\mathcal{P}^- = \{(0.5772,0.1723),(0.5486,0.1881),(0.6631,0.1620),(0.5131,0.1441),(0.6955,0.1607)\}$$

Step 5. Calculate the shortest distance $D^+(g_i, \mathcal{P}^+)$ and farthest distance $D^-(g_i, \mathcal{P}^-)$ between the alternative g_i and the IF-PIS and IF-NIS, which is given in Table 6.

Step 6. Finally, by applying the ranking function $\xi(g_i)$ and arrange the ranking information in a specific ordered to get the optimum object, which is illustrated in Table 7.

Table 5, IF decision matrix after the use of AGO

	\tilde{C}_1	\tilde{C}_2	\tilde{C}_3	\tilde{C}_4	\tilde{C}_5
g ₁	(0.6579,0.1317)	(0.8434,0.1437)	(0.7915,0.1425)	(0.8474,0.1159)	(0.7117,0.1686)
g ₂	(0.7304,0.1443)	(0.8034,0.1159)	(0.7270,0.1761)	(0.5131,0.1441)	(0.7853,0.1296)

g_3	(0.7336,0.1863)	(0.5486,0.1881)	(0.6911,0.1329)	(0.8489,0.1423)	(0.6955,0.1607)
g_4	(0.5772,0.1723)	(0.7285,0.1214)	(0.6631,0.1620)	(0.6797,0.1338)	(0.7616,0.1187)

Table 7, Ranking ordered of function $\xi(g_i)$ for optimum object,

Proposed method	Score Values $\xi(g_i)$				Ranking
	g_1	g_2	g_3	g_4	
IFRDWA proposed	0	- 3.2327	- 3.5469	- 4.3899	$g_1 \geq g_2 \geq g_3 \geq g_4$
IFRDWG proposed	0.0000,	- 0.3131,	- 0.4616,	- 0.8582	$g_1 \geq g_2 \geq g_4 \geq g_3$

Table 6, result obtained for IFRDWA operator by applying IFR TOPSIS method

	$D^+(g_i, \mathcal{P}^+)$	$D^-(g_i, \mathcal{P}^-)$	$\xi(g_i)$	Ranking
g_1	0.0275	0.1891	0	1
g_2	0.1057	0.1162	- 3.2327	2
g_3	0.1149	0.1204	- 3.5469	3
g_4	0.1331	0.0859	- 4.3899	4

Table 7, result obtained for IFRDWG operator by applying IFR TOPSIS method

	$D^+(g_i, \mathcal{P}^+)$	$D^-(g_i, \mathcal{P}^-)$	$\xi(g_i)$	Ranking
g_1	0.0785	0.1760	0	1
g_2	0.1351	0.1514	- 0.8600	2
g_3	0.1858	0.1397	- 1.5732	3
g_4	0.1496	0.1317	- 1.1570	4

Table 8, Comparative study of the proposed model with some existing approaches

Methods	$\xi(g_i)$				Ranking
IFWA [11]	0.6523,	0.5781,	0.5646,	0.5361	$g_1 \geq g_2 \geq g_3 \geq g_4$
IF TOPSIS [62]	0.8041,	0.4434,	0.5694,	0.4631	$g_1 \geq g_3 \geq g_4 \geq g_2$
IFRFWA based on EDAS [59]	0.8966,	0.6654,	0.247,	0.3567	$g_1 \geq g_2 \geq g_4 \geq g_3$
IFRWA based on EDAS [58]	0.8584,	0.5703,	0.2734,	0.2234	$g_1 \geq g_2 \geq g_3 \geq g_4$

IFDWA [44]	0.6747,	0.6081,	0.6113,	0.5530	$g_1 \geq g_3 \geq g_2 \geq g_4$
IFWG [12]	0.6356,	0.5507,	0.5362,	0.5253	$g_1 \geq g_2 \geq g_3 \geq g_4$
IFDWG [44]	0.6136,	0.5064,	0.5022,	0.5107	$g_1 \geq g_4 \geq g_3 \geq g_2$
IFRWG based on EDAS [58]	0.7789,	0.6357,	0.3677,	0.2043	$g_1 \geq g_2 \geq g_3 \geq g_4$
IFRDWA proposed	0.0000,	- 3.2327,	- 3.5469,	- 4.3899	$g_1 \geq g_2 \geq g_3 \geq g_4$
IFRDWG proposed	0.0000,	- 0.1313,	- 0.4616,	- 0.8582	$g_1 \geq g_2 \geq g_3 \geq g_4$

Table 9, Ranking result based on different parameter β , for IFRWA and IFRWG operators

β	The IFRDWA Operator		The IFRDWG Operator	
	Score value for $\xi(g_i)$	Ranking Result	Score value for $\xi(g_i)$	Ranking Result
$\beta = 2$	0, - 3.2327, - 3.5469, - 4.3899	$g_1 \geq g_2 \geq g_3 \geq g_4$	0, - 0.3131, - 0.4616, - 0.8582	$g_1 \geq g_2 \geq g_3 \geq g_4$
$\beta = 3$	0, - 4.4821, - 4.6355, - 5.7402	$g_1 \geq g_2 \geq g_3 \geq g_4$	0, - 0.3943, - 0.4598, - 0.8727	$g_1 \geq g_2 \geq g_3 \geq g_4$
$\beta = 5$	0, - 4.7495, - 4.6601, - 6.2513	$g_1 \geq g_3 \geq g_2 \geq g_4$	0, - 0.3291, - 0.4541, - 0.7768	$g_1 \geq g_2 \geq g_3 \geq g_4$
$\beta = 8$	0, - 5.1842, - 4.9268, - 6.7728	$g_1 \geq g_3 \geq g_2 \geq g_4$	0, - 0.3397, - 0.4569, - 0.7674	$g_1 \geq g_2 \geq g_3 \geq g_4$
$\beta = 10$	0, - 5.3057, - 4.9896, - 6.9064	$g_1 \geq g_3 \geq g_2 \geq g_4$	0, - 0.3446, - 0.4592, - 0.7674	$g_1 \geq g_2 \geq g_3 \geq g_4$

7.1. Comparative study for the effectiveness of the proposed approaches

The TOPSIS method is one of the most significant technique to cope MCDM problems, in which the target is to get the optimal object having highest score vale known as PIS and the object with the least score value is known as NIF. To present the ability and resilience of proposed approach by applying IF rough aggregation operators based on Dombi t-norms and t-conorms hybrid with TOPSIS method, we made a comparison of the investigated concept with several previous models in literature such as IFWA operator by Xu [10], IFWG operator by Xu and Yager [11], IF TOPSIS method by Yinghui and Wenlu [62], IFRWA operator by Yahya et al. [59], IFRWA and IFRWG operators based on EDAS method by chinram et al. [58], IFDWA and IFDWG operators by Seikh and Mandal [44]. If we consider the Tables 1 – 4, then the aggregation operators presented in [10, 11, 44, 62] are not capable to aggregate the illustrative example presented in Section 7. However, the aggregation operators investigated by chinram et al. [58] work but these operators are the special cases of the investigated operators. Furthermore, the influence of operational parameter β provides additional space to the decision makers to use their skill and expertise. Dombi operators has general capability and provides additional space in evaluation process to the decision makers. Some of the existing models such as [10, 11, 44, 58, 62] have lake of this operational parameter. The collectively aggregated ranking result of the existing and developed approaches are given in Table 8. The influence of operational parameter β plays significant role in DM. Different values are used for the operational parameter β to judge the ranking result of proposed approaches IFRDWA and IFRDWG operators. The raking result based on different values of operational parameter β in the range of $2 \leq \beta \leq 10$, for both IFRWA and IFRWG operators are shown in Table 9. From Table 9, it is clear that the ranking results

and best optimal object is same that is g_1 . From the analysis of existing models and proposed approaches it is clear that the investigated approach provides extra flexibility and capability than the previous methods.

7.2. Conclusion

The MCGDM is one of the prominent methodology, in which a team of professional experts evaluate alternatives for the selection of best optimal object based on multiple criteria. Group DM has the ability and capability to improve the assessment process by evaluating multiple conflicting criteria based on the performance of each objects from independent aspect. In DM it's hard to avoid the uncertainty due to the imprecise judgement by the decision makers. For this shortcoming, Atanassov presented the dominant notion of intuitionistic fuzzy sets (IFS) which brought revolution in different field of science scene their inception. The aim of this manuscript is proposed IF rough TOPSIS method based on Dombi operations. For this, first we proposed some new operational laws based on Dombi operations to aggregate averaging and geometric aggregation operators. On the proposed concept, we presented IFRDWA, IFRDOWA and IFRDHA operators. Moreover, on the developed concept we presented IFRDWG, IFRDOWG and IFRDHG operators. The basic related properties of the developed operators are presented in detailed. Then the algorithm for MCGDM based on TOPSIS method for IF rough Dombi averaging and geometric operators is presented. By applying accumulated geometric operator, the IF rough numbers are converted into the IF numbers. The massive outbreak of the pandemic COVID-19 promoted the challenging scenario for the world organizations including scientists, laboratories and researchers to conduct special clinical treatment strategies to prevent the people from COVID-19 pandemic. In addition, an illustrative example is proposed to solve MCGDM problem to diagnose the most severe patient of COVID-19 by applying TOPSIS. Finally, a comparative analysis of the developed model is presented with some existing approaches which shows the applicability and preeminence of the investigated model.

References

- [1] Ishizaka A, Nemery P. Multi-Criteria Decision Analysis: Methods and Software. West Sussex, UK: Wiley. 2013.
- [2] Xu ZS. Uncertain Multi-Attribute Decision Making. Beijing, China: Tsinghua University Press. 2004.
- [3] Zadeh LA. Fuzzy sets. *Inf Control*. 1965; 8:338-353.
- [4] Biswas A, Modak N. A fuzzy goal programming technique for multi objective chance constrained programming with normally distributed fuzzy random variables and fuzzy numbers. *Int J Math Oper Res*. 2013; 5:551-570.
- [5] Debnath J, Majumder D, Biswas A. Air quality assessment using interval type-2 weighted fuzzy inference system. *Ecol Inf*. 2018; 46:133-146.
- [6] Atanassov KT. Intuitionistic fuzzy sets. *Fuzzy Set Syst*. 1986; 20:87-96.
- [7] Thao X, Nguyen. A new correlation co-efficient of intuitionistic fuzzy sets and its application. *J Intell Fuzzy Syst*. 2018; 35(2): 1959–1968.
- [8] Chen SM, Cheng SH, C hiou CH. Fuzzy multiattribute group decision making based on intuitionistic fuzzy sets and evidential reasoning methodology. *Inf Fusion*. 2016; 27:215–227.
- [9] Chen SM, Chun TL. Multicriteria decision making based on the TOPSIS method and similarity measures between intuitionistic fuzzy values. *Inf Sci*. 2016; 367:279–295.
- [10] Xu ZS. Intuitionistic fuzzy aggregation operators. *IEEE Trans. Fuzzy Syst*. 2007; 15:1179–1187.
- [11] Xu ZS, Yager RR. Some geometric aggregation operators based on intuitionistic fuzzy sets. *Int J Gen Syst*. 2006; 35:417–433.
- [12] Garg H. Some series of intuitionistic fuzzy interactive averaging aggregation operators. *Springer Plus*. 2016; 5(1):999.
- [13] Li DF. Multi-attribute decision-making method based on generalized OWA operator with intuitionistic fuzzy sets. *Expert Syst Appl*. 2010; 37(12):8673–8678.

- [14] Wei G. Some induced geometric aggregation operators with intuitionistic fuzzy information and their application to group decision making. *Appl Soft Comput.* 2010; 10(2):423–431.
- [15] Wang W, Liu X. Intuitionistic fuzzy information aggregation using Einstein operations. *IEEE Trans Fuzzy Syst.* 2012; 20(5):923–938.
- [16] Huang JY. Intuitionistic fuzzy Hamacher aggregation operators and their application to multiple attribute decision making. *J Intell Fuzzy syst.* 2014; 27(1):505–513.
- [17] Hwang CL, Yoon K. *Multiple attribute decision making: methods and applications.* Springer, New York (1981).
- [18] Garg H, Kumar K. A novel exponential distance and its based TOPSIS method for interval-valued intuitionistic fuzzy sets using connection number of SPA theory. *Artif Intell Rev.* 2018:1-30.
- [19] Shen F, Ma X, Li Z, Xu ZS, Cai D. An extended intuitionistic fuzzy TOPSIS method based on a new distance measure with an application to credit risk evaluation. *Inf Sci.* 2018; 428:105-119.
- [20] Zeng S, Xiao Y. TOPSIS method for intuitionistic fuzzy multiple criteria decision making and its application to investment selection. *Kybernetes.* 2016; 45(2):282–296.
- [21] Zeng S, Chen SM, Kuo LW. Multiattribute decision making based on novel score function of intuitionistic fuzzy values and modified VIKOR method. *Inf. Sci.* 2019; 488:76–92.
- [22] Zulqarnain, RM, Xin XL, Saqlain, M, Khan WA. TOPSIS method based on the correlation coefficient of interval-valued intuitionistic fuzzy soft sets and aggregation operators with their application in decision-making. *J Math.* 2021.
- [23] Ye J. Similarity measures of intuitionistic fuzzy sets based on cosine function for the decision making of mechanical design schemes. *J Intell Fuzzy Syst.* 2016; 30:151-158.
- [24] Garg H, Kumar K. An advanced study on the similarity measures of intuitionistic fuzzy sets based on the set pair analysis theory and their application in decision making. *Soft Comput.* 2018; 22(15):4959-4970.
- [25] Song Y, Wang X, Quan W, Huang W. A new approach to construct similarity measure for intuitionistic fuzzy sets. *Soft Comput.* 2017; 23(6):1985-1998.
- [26] Szmidt E, Kacprzyk J. Entropy for intuitionistic fuzzy sets. *Fuzzy Sets Syst.* 2001; 118(3):467-477.
- [27] Meng F, Chen X. Entropy and similarity measure of Atanassov intuitionistic fuzzy sets and their application to pattern recognition based on fuzzy measures. *Pattern Anal Appl.* 2016; 19:11-20.
- [28] Liu M, Ren H. A new intuitionistic fuzzy entropy and application in multi-attribute decision making. *Information.* 2014; 5(4): 587-601.
- [29] Garg H. An improved cosine similarity measure for intuitionistic fuzzy sets and their applications to decision-making process. *Hacetatepe J Math Stat.* 2018; 47(6):1585-1601.
- [30] Yager RR. Pythagorean fuzzy subsets. *Proceedings of the Joint IFSA World Congress and NAFIPS Annual Meeting Edmonton Canada.* 2013; 57-61.
- [31] Yager RR. Pythagorean membership grades in multicriteria decision-making. *IEEE Trans. Fuzzy Syst.* 2014; 22:958–965.
- [32] Peng X, Yang Y. Some results for Pythagorean fuzzy sets. *Int J Intell Syst.* 2015; 30:1133–1160.
- [33] Hussain A, Ali MI, Mahmood T. Pythagorean fuzzy soft rough sets and their applications in decision-making. *J Tabah Uni Sci.* 2020; 14(1), 101-113.
- [34] Hussain A, Mahmood T, Ali MI. Rough Pythagorean fuzzy ideals in semigroups. *Comput Appl Math.* 2019; 38 (2):67.
- [35] Zhang X, Xu Z. Extension of TOPSIS to Multiple Criteria Decision-Making with Pythagorean Fuzzy Sets. *Int. J. Intell. Syst.* 2014; 29:1061–1078.

- [36] Yager RR. Generalized Orthopair Fuzzy Sets. *IEEE Trans Fuzzy Syst.* 2016.
- [37] Ali MI. Another view on q-rung orthopair fuzzy sets. *Int J Intell Syst.* 2019; 33:2139-2153.
- [38] Hussain A, Ali MI, Mahmood T. Covering based q-rung orthopair fuzzy rough set model hybrid with TOPSIS for multi-attribute decision making. *J Intell Fuzzy Syst.* 2019; 1-13.
- [39] Hussain A, Ali MI, Mahmood T. Hesitant q-rung orthopair fuzzy aggregation operators with their applications in multi-criteria decision making. *Iran J Fuzzy Syst.* 2019; 1903-5074.
- [40] Hussain A, Ali MI, Mahmood T, Munir M. Q- Rung orthopair fuzzy soft average aggregation operators and their application in multicriteria decision making. *Int J Intell Syst.* 2020; 35 (4):571-599.
- [41] Wang Y, Hussain A, Mahmood T, Ali MI, Wu H, Jin Y. Decision making based on q-rung orthopair fuzzy soft rough sets. *Math Prob Engr.* 2020; 2020:1-21.
- [42] Shahzaib A, Rehman N, Hussain A, AlSalman H, Gumaei AH. q-Rung Orthopair Fuzzy Rough Einstein Aggregation Information-Based EDAS Method: Applications in Robotic Agrifarming. *Comput Intell Neurosci.* 2021; (2021).
- [43] Dombi J. A general class of fuzzy operators, the De Morgan class of fuzzy operators and fuzziness measures induced by fuzzy operators. *Fuzzy Sets Syst.* 1982; 8(2):149-163.
- [44] Seikh MR, Mandal U. Intuitionistic fuzzy Dombi aggregation operators and their application to multiple attribute decision-making. *Gran Comp.* 2021;6(3), 473-488.
- [45] Liu P, Liu J, Chen SM. Some intuitionistic fuzzy Dombi Bonferonni operators and their application to multi-attribute group decision-making. *J Oper Res Soc.* 2018;69(1):1–24.
- [46] Chen J, Ye J. Some single-valued neutrosophic Dombi weighted aggregation operators for multi attribute decision making. *Symmetry.* 2017; 9(82):1–11.
- [47] Wei G, Wei Y. Some single-valued neutrosophic Dombi prioritized weighted aggregation operators in multiple attributes decision-making. *J Intell Fuzzy Syst.* 2018; 35(2):2001–2013.
- [48] Jana C, Pal M, Wang JQ. Bipolar fuzzy Dombi aggregation operators and its application in multiple-attribute decision making process. *J Amb Intel Hum Comp.* 2018; 10(9):3533–3549
- [49] Pawlak Z. Rough sets. *Int J Comput Inf. Sci.* 1982; 11(5):341–356.
- [50] Dubois D, Prade H. Rough fuzzy sets and fuzzy rough sets. *Int. J. General Syst.*, 1990; 17(2–3):191–209.
- [51] Cornelis C, De Cock M, Kerre EE. Intuitionistic fuzzy rough sets: At the crossroads of imperfect knowledge. *Expert Syst.* 2003; 20(5):260–269.
- [52] Zhou L, Wu WZ. On generalized intuitionistic fuzzy rough approximation operators. *Inform Sci.* 2008; 178:2448-2465.
- [53] Zhou L, Wu WZ. Characterization of rough set approximations in Atanassov intuitionistic fuzzy set theory. *Comput. Math. Appl.* 2011; 62(1): 282–296.
- [54] Bustince H, Burillo P. Structures on intuitionistic fuzzy relations. *Fuzzy Sets Syst.* 1996; 78(3):293–303.
- [55] Zhang X, Zhou B, Li P. A general frame for intuitionistic fuzzy rough sets. *Inf. Sci.* 2012; 216:34–49.
- [56] Zhang H, Shu L, Liao S. Intuitionistic fuzzy soft rough set and its application in decision making. *Abstract Appl. Anal.*, 2014; 2014:287314.
- [57] Zhang Z. Generalized intuitionistic fuzzy rough sets based on intuitionistic fuzzy coverings. *Inf. Sci.* 2012; 198:186–206.
- [58] Chinram R, Hussain A, Mahmood T, Ali MI. EDAS method for multi criteria decision group decision making based on intuitionistic fuzzy rough aggregation operators. *IEEE Access.* 2021; 9:10199-10216.

- [59] Yahya M, Naeem M, Abdullah S, Qiyas M, Aamir M. A Novel Approach on the Intuitionistic Fuzzy Rough Frank Aggregation Operator-Based EDAS Method for Multicriteria Group Decision-Making. *Complexity*. 2021.
- [60] Chen SM, Tan JM. Handling multicriteria fuzzy decision making problem based on vague set theory. *Fuzzy Sets Syst* 1994; 67(2):163–172.
- [61] Hong DH, Choi CH. Multi-criteria fuzzy decision-making problem based on vague set theory. *Fuzzy Sets Syst*. 2000; 114(1):103–113
- [62] Yinghui W, Wenlu L. The application of intuitionistic fuzzy set TOPSIS method in employee performance appraisal. *Int J u- and e-Service, Sci Tech*. 2015; 8(3):329-344.

MATHEMATICS

A Group-Permutation Algorithm to Solve the Generalized SUDOKU

Florentin Smarandache

Florentin Smarandache (2011). A Group-Permutation Algorithm to Solve the Generalized SUDOKU. *Recreații matematice*, Anul XIII, Nr. 1, 20-22

Abstract. Sudoku can be generalized to squares whose dimensions are $n^2 \times n^2$, where $n \geq 2$, using various symbols (numbers, letters, mathematical symbols, etc.), written just one time on each row and on each column; and the large square is divided into n^2 small squares with the side $n \times n$ and each will contain all n^2 symbols written only once. In this paper we present an elementary solution for the generalized sudoku based on a group-permutation algorithm.

Keywords: permoutation, group, sudoku.

MSC 2000: 00A08, 97A20.

Sudoku is a game with numbers, formed by a square with the side of 9, and on each row and column are placed the digits 1, 2, 3, 4, 5, 6, 7, 8, 9, written only one time; the square is subdivided in 9 smaller squares with the side of 3×3 , which, also, must satisfy the same condition, i.e. each square to contain all digits from 1 to 9 written only once.

The Japanese company Nikoli has popularized this game in 1986 under the name of *sudoku*, meaning "single number".

Sudoku can be generalized to squares whose dimensions are $n^2 \times n^2$, where $n \geq 2$, using various symbols (numbers, letters, mathematical symbols, etc.), written just one time on each row and on each column; and the large square is divided into n^2 small squares with the side $n \times n$ and each will contain all n^2 symbols written only once.

An *elementary solution* of one of these *generalized Sudokus*, with elements (symbols) from the set

$$S = \{s_1, s_2, \dots, s_n, s_{n+1}, \dots, s_{2n}, \dots, s_{n^2}\}$$

(supposing that their placement represents the relation of total order on the set of elements S), is:

Row 1: all elements in ascending order

$$s_1, s_2, \dots, s_n, s_{n+1}, \dots, s_{2n}, \dots, s_{n^2}$$

On the next rows we will use circular permutations, considering groups of n elements from the first row as follows:

Row 2:

$$s_{n+1}, s_{n+2}, \dots, s_{2n}; s_{2n+1}, \dots, s_{3n}; \dots, s_{n^2}; s_1, s_2, \dots, s_n$$

Row 3:

$$s_{2n+1}, \dots, s_{3n}; \dots, s_{n^2}; s_1, s_2, \dots, s_n; s_{n+1}, s_{n+2}, \dots, s_{2n},$$

.....
Row n :

$$s_{n^2-n+1}, \dots, s_{n^2}; s_1, \dots, s_n; s_{n+1}, s_{n+2}, \dots, s_{2n}; \dots, s_{3n}; \dots, s_{n^2-n}.$$

Now we start permutations of the elements of row $n + 1$ considering again groups of n elements.

Row $n + 1$:

$$s_2, \dots, s_n, s_{n+1}; s_{n+2}, \dots, s_{2n}, s_{2n+1}; \dots; s_{n^2-n+2}, \dots, s_{n^2}, s_1$$

Row $n + 2$:

$$s_{n+2}, \dots, s_{2n}, s_{2n+1}; \dots; s_{n^2-n+2}, \dots, s_{n^2}, s_1; s_2, \dots, s_n, s_{n+1}$$

.....
Row $2n$:

$$s_{n^2-n+2}, \dots, s_{n^2}, s_1; s_2, \dots, s_n, s_{n+1}; s_{n+2}, \dots, s_{2n}, s_{2n+1}; \dots$$

Row $2n + 1$:

$$s_3, \dots, s_{n+2}; s_{n+3}, \dots, s_{2n+2}; \dots; s_{n^2+3}, \dots, s_{n^2}, s_1, s_2$$

and so on.

Replacing the set S by any *permutation* of its symbols, which we'll note by S' , and applying the same procedure as above, we will obtain a new solution.

The *classical Sudoku* is obtained for $n = 3$.

Below is an example of this group-permutation algorithm for the classical case:

1	2	3	4	5	6	7	8	9
4	5	6	7	8	9	1	2	3
7	8	9	1	2	3	4	5	6
2	3	4	5	6	7	8	9	1
5	6	7	8	9	1	2	3	4
8	9	1	2	3	4	5	6	7
3	4	5	6	7	8	9	1	2
6	7	8	9	1	2	3	4	5
9	1	2	3	4	5	6	7	8

For a $4^2 \times 4^2$ square we use the following 16 symbols:

$$\{A, B, C, D, E, F, G, H, I, J, K, L, M, N, O, P\}$$

and use the same group-permutation algorithm to solve this Sudoku.

From one solution to the generalized Sudoku we can get *more solutions* by simply doing permutations of columns or/and of rows of the first solution.

A	B	C	D	E	F	G	H	I	J	K	L	M	N	O	P
E	F	G	H	I	J	K	L	M	N	O	P	A	B	C	D
I	J	K	L	M	N	O	P	A	B	C	D	E	F	G	H
M	N	O	P	A	B	C	D	E	F	G	H	I	J	K	L
B	C	D	E	F	G	H	I	J	K	L	M	N	O	P	A
F	G	H	I	J	K	L	M	N	O	P	A	B	C	D	E
J	K	L	M	N	O	P	A	B	C	D	E	F	G	H	I
N	O	P	A	B	C	D	E	F	G	H	I	J	K	L	M
C	D	E	F	G	H	I	J	K	L	M	N	O	P	A	B
G	H	I	J	K	L	M	N	O	P	A	B	C	D	E	F
K	L	M	N	O	P	A	B	C	D	E	F	G	H	I	J
O	P	A	B	C	D	E	F	G	H	I	J	K	L	M	N
D	E	F	G	H	I	J	K	L	M	N	O	P	A	B	C
H	I	J	K	L	M	N	O	P	A	B	C	D	E	F	G
L	M	N	O	P	A	B	C	D	E	F	G	H	I	J	K
P	A	B	C	D	E	F	G	H	I	J	K	L	M	N	O

Bibliografie

1. **Z. Pitkow** – *Sudoku: Medium to Hard*, Chronicle Books, 2006.
2. **F. Longo** – *Absolutely Nasty Sudoku Level 4* (Mensa), Puzzlewright, 2007.
3. **P. Gordon, F. Longo** – *Mensa Guide to Solving Sudoku: Hundreds of Puzzles Plus Technique to Help You Crack Them All*, Sterling, 2006.

Two Triangles With The Same Orthocenter and A Vectorial Proof of Stevanovic's Theorem

Ion Pătrașcu, Florentin Smarandache

Ion Pătrașcu, Florentin Smarandache (2011). Two Triangles With The Same Orthocenter and A Vectorial Proof Of Stevanovic's Theorem. In: Marcelina Mocanu, Cornel Berceanu, Catalin Barbu (coordinators), Simpozionul National de Geometrie "Gheorghe Titeica": editia II, Bacau, Romania, 24-27 martie 2011

Abstract. In this article we'll emphasize on two triangles and provide a vectorial proof of the fact that these triangles have the same orthocenter. This proof will, further allow us to develop a vectorial proof of the Stevanovic's theorem relative to the orthocenter of the Fuhrmann's triangle.

Lemma 1. Let ABC an acute angle triangle, H its orthocenter, and A',B',C' the symmetrical points of H in rapport to the sides BC,CA,AB . We denote by X,Y,Z the symmetrical points of A,B,C in rapport to $B'C',C'A',A'B'$. The orthocenter of the triangle XYZ is H .

Proof. We will prove that $XH \perp YZ$, by showing that $\vec{XH} \cdot \vec{YZ} = 0$. We have (see Figure1) $\vec{VH} = \vec{AH} - \vec{AX}$, $\vec{BC} = \vec{BY} + \vec{YZ} + \vec{ZC}$, from here $\vec{YZ} = \vec{BC} - \vec{BY} - \vec{ZC}$.

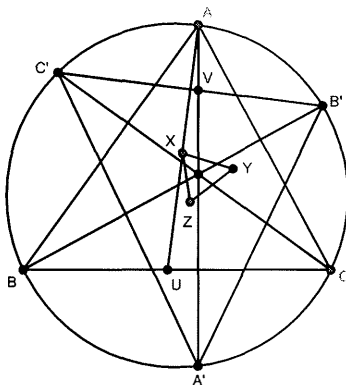

Figure 1

Because Y is the symmetric of B in rapport to $A'C'$ and Z is the symmetric of C in rapport to $A'B'$, the parallelogram's rule gives us that: $\overrightarrow{BY} = \overrightarrow{BC'} + \overrightarrow{BA'}$, $\overrightarrow{CZ} = \overrightarrow{CB'} + \overrightarrow{CA'}$. Therefore

$$\overrightarrow{YZ} = \overrightarrow{BC} - (\overrightarrow{BC'} + \overrightarrow{BA'}) + \overrightarrow{B'C} + \overrightarrow{A'C}$$

But, $\overrightarrow{BC'} = \overrightarrow{BH} + \overrightarrow{HC'}$, $\overrightarrow{BA'} = \overrightarrow{BH} + \overrightarrow{HA'}$, $\overrightarrow{CB'} = \overrightarrow{CH} + \overrightarrow{HB'}$, $\overrightarrow{CA'} = \overrightarrow{CH} + \overrightarrow{HA'}$. By substituting these relations in the \overrightarrow{YZ} , we find:

$$\overrightarrow{YZ} = \overrightarrow{BC} + \overrightarrow{C'B'}$$

We compute

$$\begin{aligned} \overrightarrow{XH} \cdot \overrightarrow{YZ} &= (\overrightarrow{AH} - \overrightarrow{AX}) \cdot (\overrightarrow{BC} + \overrightarrow{C'B'}) = \\ &= \overrightarrow{AX} \cdot \overrightarrow{BC} + \overrightarrow{AH} \cdot \overrightarrow{C'B'} - \overrightarrow{AX} \cdot \overrightarrow{BC} - \overrightarrow{AX} \cdot \overrightarrow{C'B'} \end{aligned}$$

Because $AH \perp BC$ we have $\overrightarrow{AH} \cdot \overrightarrow{BC} = 0$, also $AX \perp B'C'$ and therefore $\overrightarrow{AX} \cdot \overrightarrow{B'C'} = 0$. We need to prove also that $\overrightarrow{XH} \cdot \overrightarrow{YZ} = \overrightarrow{AH} \cdot \overrightarrow{C'B'} - \overrightarrow{AX} \cdot \overrightarrow{BC}$. We note: $\{U\} = AX \cap BC$ and $\{V\} = AH \cap B'C'$. Then

$$\begin{aligned} \overrightarrow{AX} \cdot \overrightarrow{BC} &= AX \cdot BC \cdot \cos(\sphericalangle AUC) \\ \overrightarrow{AH} \cdot \overrightarrow{C'B'} &= AH \cdot C'A' \cdot \cos(\sphericalangle AVC') \end{aligned}$$

We observe that $\sphericalangle AUC \equiv \sphericalangle AVC'$ (angles with the sides respectively perpendicular). The point B' is the symmetric of H in rapport to AC , consequently $\sphericalangle HAC \equiv \sphericalangle CAB'$, also the point C' is the symmetric of the point H in rapport to AB , and therefore $\sphericalangle HAB \equiv \sphericalangle BAC'$.

From these last two relations we find that $\sphericalangle B'AC' = 2\sphericalangle A$. The sinus theorem applied in the triangles $AB'C'$ and ABC gives:

$$B'C' = 2R \cdot \sin 2A$$

$$BC = 2R \sin A$$

We'll show that

$$AX \cdot BC = AH \cdot C'B',$$

and from here

$$AX \cdot 2R \sin A = AH \cdot 2R \cdot \sin 2A$$

which is equivalent to

$$AX = 2AH \cos A$$

We noticed that $\sphericalangle B'AC' = 2A$. Because $AX \perp B'C'$, it results that $\sphericalangle TAB \equiv \sphericalangle A$, we noted $\{T\} = AX \cap B'C'$. On the other side $AC' = AH$, $AT = \frac{1}{2}AY$, and $AT = AC' \cos A = AH \cos A$, therefore $\overrightarrow{XH} \cdot \overrightarrow{YZ} = 0$.

Similarly, we prove that $YH \perp XZ$, and therefore H is the orthocenter of triangle XYZ .

Lemma 2. Let ABC a triangle inscribed in a circle, I the intersection of its bisector lines, and A',B',C' the intersections of the circumscribed circle with the bisectors AI, BI, CI respectively. The orthocenter of the triangle $A'B'C'$ is I .

Proof.

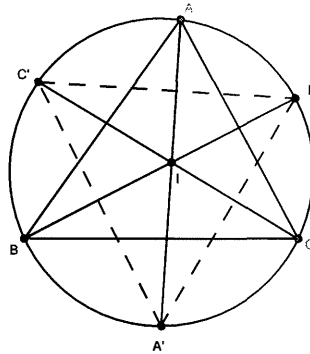

Figure 2

We'll prove that $A'I \perp B'C'$ (see Figure 2). Let $\alpha = m(\widehat{A'C}) = m(\widehat{A'B})$, $\beta = m(\widehat{B'C}) = m(\widehat{B'A})$, $\gamma = m(\widehat{C'A}) = m(\widehat{C'B})$. Then $m(\sphericalangle A'IC') = \frac{1}{2}(\alpha + \beta + \gamma)$. Because $2(\alpha + \beta + \gamma) = 360^\circ$ it results $m(\sphericalangle A'IC') = 90^\circ$, therefore $A'I \perp B'C'$.

Similarly, we prove that $B'I \perp A'C'$, and consequently the orthocenter of the triangle $A'B'C'$ is I .

Definition. Let ABC a triangle inscribed in a circle with the center in O and A', B', C' the middle of the arcs \widehat{BC} , \widehat{CA} , \widehat{AB} respectively. The triangle XYZ formed by the symmetric of the points A', B', C' respectively in rapport to BC, CA, AB is called the *Fuhrmann triangle* of the triangle ABC .

Note. In 2002 the mathematician Milorad Stevanovic proved the following theorem:

Theorem (M. Stevanovic). *In an acute angle triangle the orthocenter of the Fuhrmann's triangle coincides with the center of the circle inscribed in the given triangle.*

Proof. We note $A'B'C'$ the given triangle and let A, B, C respectively the middle of the arcs $\widehat{B'C'}$, $\widehat{C'A'}$, $\widehat{A'B'}$ (see Figure 1). The lines AA', BB', CC' being bisectors in the triangle $A'B'C'$ are concurrent in the center of the circle inscribed in this triangle, which will note H , and which, in conformity with Lemma 2 is the orthocenter of the triangle ABC . Let XYZ the Fuhrmann triangle of the triangle $A'B'C'$, in conformity with Lemma 1, the orthocenter of XYZ coincides with H the orthocenter of ABC , therefore with the center of the inscribed circle in the given triangle $A'B'C'$.

References

- [1] Fuhrmann W., **Synthetische Beweise Planimetrischer Satze**, Berlin (1890).
- [2] Stevanovic M., **Orthocentrer of Fuhrmann triangle**, Message Hyacinthos # du 20/09/2002.
- [3] Barbu Cătălin, **Teoreme fundamentale din geometria triunghiului**, Editura Unique, Bacău, Romania, 2008.

A Note on Testing of Hypothesis

Rajesh Singh, Jayant Singh, Florentin Smarandache

Rajesh Singh, Jayant Singh, Florentin Smarandache (2011). A Note on Testing of Hypothesis. *Italian Journal of Pure and Applied Mathematics* 28, 161-164

Abstract. In this paper problem of testing of hypothesis is discussed when the samples have been drawn from normal distribution. The study of hypothesis testing is also extended to Bayes set up.

Keywords: hypothesis, level of significance, Bayes rule.

Let the random variable (r.v.) X have a normal distribution $N(\theta, \sigma_2)$, where σ_2 is assumed to be known.

The hypothesis $H_0: \theta = \theta_0$ against $H_1: \theta = \theta_1, \theta_1 > \theta_0$ is to be tested.

Let X_1, X_2, \dots, X_n be a random sample from $N(\theta, \sigma^2)$ population.

Let $\bar{X} \left(= \frac{1}{n} \sum_{i=1}^n X_i \right)$ be the sample mean.

By Neyman–Pearson lemma, the most powerful test rejects H_0 at α % level of significance,

if $\frac{\sqrt{n} (\bar{X} - \theta_0)}{\sigma} \geq d_\alpha$, where d_α is such that

$$\int_{d_\alpha}^{\infty} \frac{1}{\sqrt{2\pi}} e^{-\frac{Z^2}{2}} dZ = \alpha.$$

If the sample is such that H_0 is rejected, then will it imply that H_1 will be accepted?

In general, this will not be true for all values of θ_1 , but will be true for some specific value of θ_1 , i.e., when θ_1 is at a specific distance from θ_0 .

H_0 is rejected

$$(1) \quad \text{if } \frac{\sqrt{n} (\bar{X} - \theta_0)}{\sigma} \geq d_\alpha, \text{ i.e., } \bar{X} \geq \theta_0 + d_\alpha \frac{\sigma}{\sqrt{n}}.$$

Similarly, the Most Powerful Test will accept H_1 against H_0

$$(2) \quad \text{if } \frac{\sqrt{n} (\bar{X} - \theta_0)}{\sigma} \geq d_\alpha, \text{ i.e., } \bar{X} \geq \theta_1 - d_\alpha \frac{\sigma}{\sqrt{n}}.$$

Rejecting H_0 will mean accepting H_1

if (1) \implies (2)

$$(3) \quad \text{i.e., } \bar{X} \geq \theta_0 + d_\alpha \frac{\sigma}{\sqrt{n}} \implies \bar{X} \geq \theta_1 - d_\alpha \frac{\sigma}{\sqrt{n}}$$

$$\text{i.e., } \theta_1 - d_\alpha \frac{\sigma}{\sqrt{n}} \leq \theta_0 + d_\alpha \frac{\sigma}{\sqrt{n}}.$$

Similarly, accepting H_1 will mean rejecting H_0

if (2) \implies (1)

$$(4) \quad \text{i.e., } \theta_0 + d_\alpha \frac{\sigma}{\sqrt{n}} \leq \theta_1 - d_\alpha \frac{\sigma}{\sqrt{n}}.$$

From (3) and (4) we have

$$(5) \quad \theta_0 + d_\alpha \frac{\sigma}{\sqrt{n}} = \theta_1 - d_\alpha \frac{\sigma}{\sqrt{n}} \text{ i.e., } \theta_1 - \theta_0 = 2d_\alpha \frac{\sigma}{\sqrt{n}}.$$

Thus,

$$d_\alpha \frac{\sigma}{\sqrt{n}} = \frac{\theta_1 - \theta_0}{2} \quad \text{and} \quad \theta_1 = \theta_0 + 2d_\alpha \frac{\sigma}{\sqrt{n}}.$$

From (1),

$$\text{Reject } H_0 \text{ if } \bar{X} > \theta_0 + \frac{\theta_1 - \theta_0}{2} = \frac{\theta_0 + \theta_1}{2}$$

and from (2),

$$\text{Accept } H_1 \text{ if } \bar{X} > \theta_1 - \frac{\theta_1 - \theta_0}{2} = \frac{\theta_0 + \theta_1}{2}.$$

Thus, rejecting H_0 will mean accepting H_1 when

$$\bar{X} > \frac{\theta_0 + \theta_1}{2}.$$

From (5), this will be true only when

$$\theta_1 = \theta_0 + 2d_\alpha \frac{\sigma}{\sqrt{n}}.$$

For other values of $\theta_1 \neq \theta_0 + 2d_\alpha \frac{\sigma}{\sqrt{n}}$ rejecting H_0 will not mean accepting H_1 .

Therefore, it is recommended that, instead of testing $H_0 : \theta = \theta_0$ against $H_1 : \theta = \theta_1, \theta_1 > \theta_0$, it is more appropriate to test $H_0 : \theta = \theta_0$ against $H_1 : \theta = \theta_0$.

In this situation, rejecting H_0 will mean $\theta > \theta_0$ and is not equal to some given value $= \theta_1$.

But in Baye's setup, rejecting H_0 means accepting H_1 whatever may be H_0 and H_1 .

In this set up, the level of significance is not a preassigned constant, but depends on H_0, H_1, σ_2 and n .

Consider $(0, 1)$ loss function and equal prior probabilities $1/2$ for θ_0 and θ_1 . The Baye's test rejects H_0 (accept H_1)

$$\text{if } \bar{X} > \frac{\theta_0 + \theta_1}{2}$$

and accepts H_0 (rejects H_1)

$$\text{if } \bar{X} < \frac{\theta_0 + \theta_1}{2}.$$

[See Rohatagi, p.463, Example 2].

The level of significance is given by

$$P_{H_0} \left[\bar{X} > \frac{\theta_0 + \theta_1}{2} \right] = P_{H_0} \left[\frac{(\bar{X} - \theta_0)\sqrt{n}}{\sigma} > \frac{(\theta_1 - \theta_0)\sqrt{n}}{2\sigma} \right] = 2 - \Phi \left(\frac{\sqrt{n}(\theta_1 - \theta_0)}{2\sigma} \right),$$

where

$$\Phi(t) = \int_{-\infty}^t \frac{1}{\sqrt{2\pi}} e^{-\frac{z^2}{2}} dZ.$$

Thus, the level of significance depends on $\theta_0, \theta_1, \sigma^2$ and n .

Acknowledgement. Author's are thankful to Prof. Jokhan Singh for suggesting this problem.

References

- [1] LEHMANN, E.L., *Testing Statistical Hypotheses*, Wiley Eastern Ltd., New Delhi, 1976.
- [2] ROHATAGI, V.K., *An introduction to probability theory and mathematical statistics*, Wiley Eastern Ltd., New Delhi, 1985.

Cercurile Apollonius de rangul -1

Ion Pătrașcu, Florentin Smarandache

Ion Pătrașcu, Florentin Smarandache (2017). Cercurile Apollonius de rangul -1. *Recreații matematice*, Anul XIX, Nr. 2, 114-115

Abstract. In this Note, the authors present some properties of Apollonius circles of rank -1 associated to a triangle.

Keywords: Apollonius circle of rank -1, symmedian, harmonic quadrilateral.

În acest articol, evidențiem câteva proprietăți ale *cercurilor Apollonius de rangul -1* asociate unui triunghi. Articolul este în strânsă legătură cu [1], în care autorii s-au ocupat cu cercurilor Apollonius de rangul k . Să reamintim câteva noțiuni.

Definiția 1. Se numește *ceviană de rangul k* în triunghiul ABC o ceviană AD cu $D \in BC$ și $\frac{BD}{DC} = \left(\frac{AB}{AC}\right)^k$, $k \in \mathbb{R}$.

Mediana este ceviană de rangul 0, iar bisectoarea este ceviană de rangul 1.

Definiția 2. Ceviana de rang -1 se numește *antibisectoare*, iar ceviana exterioară de rang -1 se numește *antibisectoare exterioară*.

Antibisectoarea este izotomica bisectoarei.

Definiția 3. Cercul construit pe segmentul determinat de picioarele antibisectoarei din A și antibisectoarei exterioare din A ca diametru se numește cerc A - *Apollonius de rangul -1* asociat triunghiului ABC .

Unui triunghi îi corespund trei cercuri Apollonius de rangul -1 .

Teorema 1. *Cercul A -Apollonius de rangul -1 asociat triunghiului ABC este locul geometric al punctelor M din planul triunghiului cu proprietatea $\frac{MB}{MC} = \frac{AC}{AB}$.*

Pentru demonstrația acestei teoreme, vezi [1].

Teorema 2. *Cercurile Apollonius de rangul -1 asociate triunghiului ABC trec prin două puncte fixe (fac parte dintr-un fascicol de genul al doilea).*

Teorema 3. *Cercul A -Apollonius de rangul -1 al triunghiului ABC intersectează cercul circumscris acestuia în două puncte ce aparțin respectiv medianei din A a triunghiului și paralelei dusă prin A la latura BC .*

Demonstrație. Fie Q intersecția paralelei dusă prin A la BC cu cercul circumscris triunghiului ABC . Patrulaterul $QACB$ este trapez isoscel, deci $QC = AB$ și $QB = AC$. Deoarece $\frac{QB}{QC} = \frac{AC}{AB}$, rezultă că punctul Q aparține cercului A -Apollonius de rangul -1 .

Notăm cu P intersecția medianei AM a triunghiului ABC cu cercul circumscris acestuia. Deoarece mediana împarte triunghiul în două triunghiuri echivalente, avem că aria $\triangle ABM$ este egală cu aria $\triangle ACM$ și aria $\triangle PBM$ este egală cu aria $\triangle PCM$. Prin adunare, rezultă că aria $\triangle ABP$ este egală cu aria $\triangle ACP$.

Dar aria $\triangle ABP$ este $\frac{1}{2} AB \cdot PB \cdot \sin \widehat{ABP}$,
 iar aria $\triangle ACP$ este $\frac{1}{2} AC \cdot PC \cdot \sin \widehat{ACP}$.
 Cum unghiurile \widehat{ACP} și \widehat{ABP} sunt suplementare, obținem că $AB \cdot PB = AC \cdot PC$,
 care se scrie $\frac{PB}{PC} = \frac{AC}{AB}$ și rezultă că
 punctul P aparține cercului A-Apollonius
 de rangul -1 .

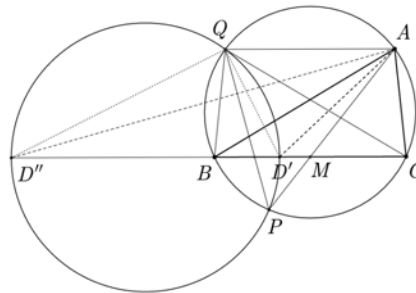

Teorema 4. *Cercul A-Apollonius de rang -1 al triunghiului ABC este cerc Apollonius pentru triunghiul QBC , unde Q este intersecția cu cercul circumscris triunghiului ABC cu paralela dusă prin A la BC .*

Demonstrație. Patrulaterul $AQBC$ este trapez isoscel, rezultă că $\widehat{BAC} \equiv \widehat{QBC}$, deci QD' va fi bisectoare în BQC (D' este simetricul față de M , mijlocul laturii BC , al piciorului bisectoarei dusă din A a triunghiului ABC). Deoarece $D''Q \perp D'Q$ avem că $D''Q$ este bisectoare exterioară pentru \widehat{BQC} și, în consecință, cercul A-Apollonius de rangul -1 este cercul Apollonius al triunghiului QBC .

Observații. 1) Din teorema precedentă, rezultă că QP este simediană în triunghiul QBC , deci patrulaterul $QBPC$ este patrulater armonic (a se vedea [2]).

2) Patrulaterul $QBPC$ fiind armonic, PQ este simediană în triunghiul PBC .

3) Cercurile Brocard ale triunghiurilor ABC și QBC sunt congruente. Într-adevăr, dacă O este centrul cercului circumscris triunghiului ABC și M mijlocul laturii BC , avem că triunghiurile ABC și QBC sunt simetrice față de dreapta OM . În consecință, simetricul lui K – centrul simedian al lui ABC față de OM va fi K' centrul simedian al lui QBC . Cercurile Brocard având diametrele OK , respectiv OK' , din $OK = OK'$ rezultă că acestea sunt congruente (ele sunt simetrice față de OM).

Bibliografie

1. **I. Pătrașcu, F. Smarandache** – *Cercurile Apollonius de rangul k* , *Recreații matematice*, XVIII (2016), nr. 1, pp. 20–23.
2. **I. Pătrașcu, F. Smarandache** – *Some Properties of the Harmonic Quadrilateral*, *Recreații matematice*, XVI (2014), nr. 2, pp. 99-104.
3. **I. Pătrașcu, F. Smarandache** – *Complements to ClassicTopics of Circles Geometry*, Pons Editions, Brussels, 2016.

Două probleme de minimum geometric

Ion Pătrașcu, Florentin Smarandache

Ion Pătrașcu, Florentin Smarandache (2018). Două probleme de minimum geometric. *Recreații matematice*, Anul XX, nr. 1, 16-18

Abstract. In this Note two problems of geometric minima are solved. The first is: given a proper angle xAy and a fixed point P in its interior, construct a straight line BC through P with $B \in (Ax$ and $C \in (Ay$ such that the perimeter of the triangle ABC to be minimal. The second one is related to the first: Let xAy be a proper angle and $C(J)$ be a circle tangent to its sides. Construct a tangent BC to this circle for $B \in (Ax$ and $C \in (Ay$ such that the circle to be inscribed in the triangle ABC and the perimeter of the triangle ABC to be minimal.

Keywords: angle, triangle, circle, minimal perimeter

MSC 2010: 51M04.

În acest articol rezolvăm două probleme de minim geometric; prima este din [1], iar pe a doua am formulat-o în legătură cu prima.

Enunțul primei probleme este următorul:

Problema 1. Se dă un unghi propriu xAy și P un punct fixat în interiorul său. Construieți prin P o secantă BC , cu $B \in (Ax$ și $C \in (Ay$, astfel ca triunghiul ABC să aibă perimetrul minim.

Pentru rezolvarea problemei, folosim următoarea:

Lemă. Dacă xAy este un unghi propriu și $C(J)$ este un cerc tangent laturilor $(Ax$ și $(Ay$, fixat, iar BC este o tangentă la acest cerc astfel încât cercul să fie A -exînscriș triunghiului ABC , atunci perimetrul triunghiului ABC este constant.

Demonstrația Lemei. Fie D și E punctele de tangentă cu $(Ax$ respectiv $(Ay$ ale cercului $C(J)$ și fie BC o tangentă oarecare la acest cerc în condițiile enunțului (vezi Fig. 1). Notăm cu T contactul tangentei BC cu cercul. Cu ajutorul teoremei tangentelor duse dintr-un punct exterior la un cerc, avem că: $BD = BT$, $CT = CE$ și $AD = AE$. Cum perimetrul triunghiului ABC este $AB + BC + AC = AB + BT + TC + AC$, avem că $AB + BC + AC = AB + AC + BD + CE = AD + AE = 2AD = \text{constant}$.

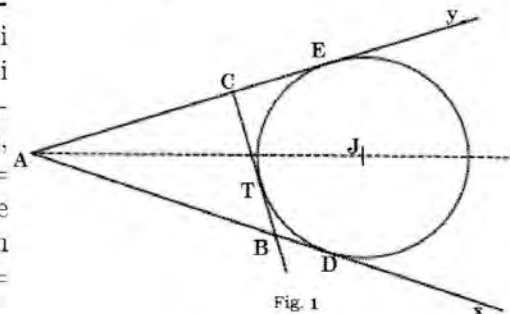

Fig. 1

Rezolvarea problemei

Afirmăm că triunghiul ABC de perimetru minim pentru care BC trece prin P este acela în care BC este tangent în P cercului ce trece prin P și este tangent laturilor $(Ax$ și $(Ay$ ale unghiului dat.

Din Lemă, am văzut că perimetrul triunghiului ABC (orice triunghi cu BC tangentă cercului) este constant și egal cu $2AD$. Să arătăm că orice triunghi $AB'C'$ cu $B'C'$ secantă ce trece prin P este mai mare decât perimetrul triunghiului ABC .

Putem construi o secantă $B''C'' \parallel B'C'$ care să fie tangentă cercului $C(J)$

și acesta din urmă să fie A -exînscriș triunghiului $AB''C''$. Perimetrul triunghiului $AB''C''$ este egal cu cel al triunghiului ABC (conform lemei), deci cu $2AD$. Evident că perimetrul triunghiului $AB'C'$ este mai mare decât perimetrul triunghiului $AB''C''$ (vezi Fig. 2), în consecință triunghiul ABC are perimetrul minim.

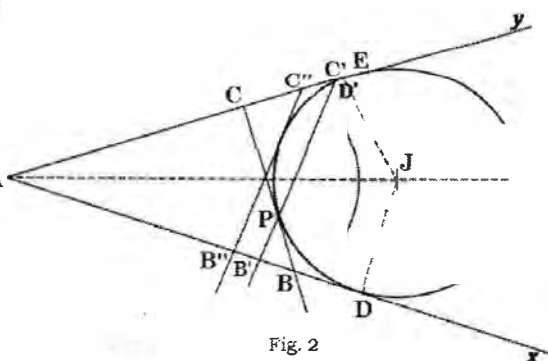

Fig. 2

Deoarece problema propusă cere construcția secantei BC , deci implicit a cercului ce trece prin P și este tangent laturilor (Ax și Ay ale unghiului, prezentăm două metode de a realiza construcția cercului.

Prima construcție

Presupunem problema rezolvată, fie deci C (J) tangent laturilor (Ax și Ay ce va trece prin P .

Centrul J al cercului este situat pe bisectoarea (Az a unghiului xAy , deci cercul va trece și prin punctul Q simetricul lui P față de Az . Notăm $\{R\} = PQ \cap (Ax$. Puterea punctului R față de cercul C (J, JP) furnizează $RP \cdot RQ = RD^2$ (D punctul de tangentă cu $(Ax$ al cercului, vezi Fig. 3).

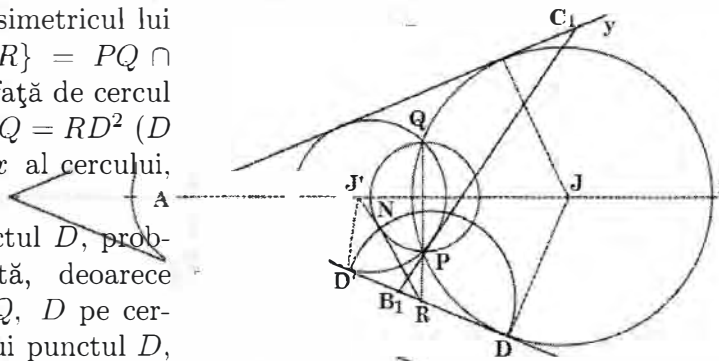

Fig. 3

Dacă vom construi punctul D , problema este practic rezolvată, deoarece cunoaștem trei puncte P, Q, D pe cercul căutat. Pentru a construi punctul D , putem proceda astfel: Construim un cerc arbitrar care trece prin P și Q ; construim tangenta RN din R la acest cerc și construim cercul $C(R, RN)$; acesta va intersecta $(Ax$ în două puncte D și D' .

Problema are două soluții: cercul circumscris triunghiului DPQ și cercul circumscris triunghiului $D'PQ$. Tangenta în P la cel din urmă cerc notată în figură, B_1C_1 , formează cu A un triunghi în care cercul $D'PQ$ este înscris.

Putem arăta ca mai înainte că perimetrul acestui triunghi este mai mare decât al triunghiului ABC în care BC este tangenta în P la cercul DPQ .

A doua construcție

Construim un cerc tangent laturilor (Ax și Ay . Fie J_1 centrul său. Notăm M_1M_2 intersecțiile acestui cerc cu (AP) . Construim $PJ \parallel J_1M_1, J \in (Az$ și $PJ' \parallel J_1M_2, J' \in (Az$ (vezi Fig. 4).

Cercurile $C(J', J'P)$, fiind omotetice cercului $C(J_1, M_1)$ prin omotetiile corespunzătoare, sunt cele căutate.

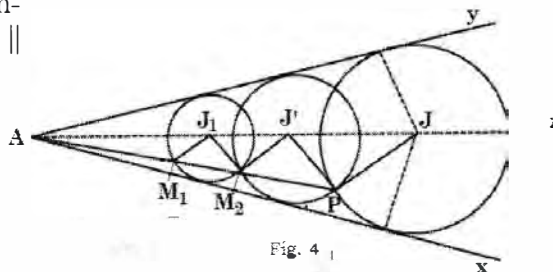

Fig. 4

Observație. Lema și Problema analizate ne-au condus la următoarea problemă de minim:

Problema 2. Fie $\angle xAy$ un unghi propriu dat și fie $\mathcal{C}(J)$ un cerc tangent laturilor (Ax) și (Ay) fixat. Construiți o tangentă BC la cerc, $B \in (Ax), C \in (Ay)$ astfel ca cercul dat să fie cerc înscris al triunghiului ABC , iar ABC să aibă perimetrul minim.

Rezolvarea problemei. Să considerăm o tangentă $B'C'$ la cercul $\mathcal{C}(J)$ și cercul A -exînscriș triunghiului $AB'C'$ de centru J' . Dacă D și D' sunt contactele cercurilor $\mathcal{C}(J)$ și $\mathcal{C}(J')$ cu (Ax) , avem că: Perimetrul triunghiului $AB'C'$ este egal cu $2AD + 2B'C'$ și tot el este egal cu $2AD'$ (vezi Fig. 5). Pentru ca perimetrul triunghiului $AB'C'$ să fie minim, este necesar ca $B'C'$ să fie minimă, și cum $B'C' = AD' - AD$, iar AD este constantă, este necesar ca AD' să fie minimă. Dacă vom nota $J'D' = x, JD = r$ și $\widehat{mAy} = 2\varphi$, avem: $\sin \varphi = \frac{x-r}{JJ'}$, deci

$$JJ' = \frac{x-r}{\sin \varphi}. \text{ Deoarece}$$

$$DD' = \sqrt{JJ'^2 + (x-r)^2} = (x-r) \sqrt{1 + \frac{1}{\sin^2 \varphi}}$$

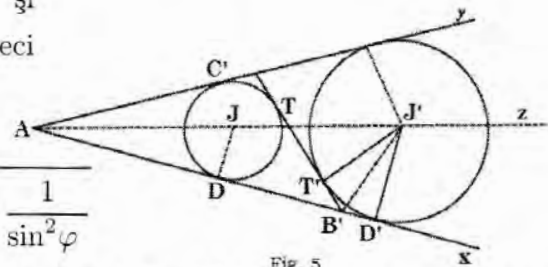

Fig. 5

găsim că minimum lui DD' se atinge odată cu minimum lui $x = J'D'$. Aceasta se întâmplă când cercul de centru J' este tangent cercului de centru J . În acest caz, BC este tangentă comună acestor cercuri și este perpendiculară pe (Az) , bisectoarea $\angle xAy$.

Bibliografie

1. F. G.-M., *Exercices de Géométrie*, huitième édition, Librairie générale de l'enseignement libre, 77 Ruse de Vaugirard. Paris (6).

Câteva probleme privind calculul unor măsuri de unghiuri într-un triunghi isoscel

Ion Pătrașcu, Florentin Smarandache

Ion Pătrașcu, Florentin Smarandache (2018). Câteva probleme privind calculul unor măsuri de unghiuri într-un triunghi isoscel. *Revista de Matematică din Timișoara*, Anul XXIII (Seria a IV-a), Nr. 4, 3-5

În acest articol, rezolvăm cu ajutorul unei leme o categorie de probleme privind calculul măsurilor unor unghiuri determinate de anumite ceviane într-un triunghi isoscel.

Lemă

Dacă $ABCD$ este un patrulater convex cu proprietățile:

(i) $DA = DC$ și

(ii) $m(\widehat{ADC}) + 2m(\widehat{ABC}) = 360^\circ$,

atunci punctul D este centrul cercului circumscris triunghiului ABC .

Demonstrație:

Construim pe semidreapta $(BD$ punctul E astfel încât D este între B și E , iar $DE = DA$ (vezi *Fig. 1*). Notăm $m(\widehat{AED}) = \alpha$ și $m(\widehat{CED}) = \beta$. Avem: $m(\widehat{ADB}) = 2\alpha$, $m(\widehat{BDC}) = 2\beta$.

Relația (ii) devine $2m(\widehat{ABC}) + 2(\alpha + \beta) = 360^\circ$. Ea se rescrie $m(\widehat{ABC}) + m(\widehat{AEC}) = 180^\circ$, ceea ce arată că patrulaterul $ABCE$ este inscripabil. Această concluzie și faptul că D este centrul cercului circumscris triunghiului ACE conduc la demonstrarea afirmației că D este centrul cercului circumscris triunghiului ABC .



Figura 1

APLICAȚII

Problema 1.

Fie ABC un triunghi dreptunghic isoscel, cu $m(\widehat{A}) = 90^\circ$. Se consideră punctul M în semiplanul determinat de BC și care nu conține vârful A , astfel încât $m(\widehat{MBC}) = 15^\circ$ și $m(\widehat{MCB}) = 30^\circ$. Calculați $m(\widehat{MAC})$.

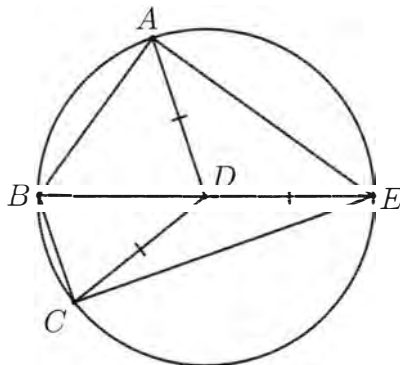
Ion Pătrașcu

Soluție:

Deoarece $AB = AC$, $m(\widehat{A}) = 90^\circ$ și $m(\widehat{BMC}) = 135^\circ$, sunt verificate condițiile din ipoteza **Lemei**. Aplicând **Lema**, rezultă $AM = AB = AC$. În triunghiul $\triangle AMC$, avem $m(\widehat{ACM}) = 75^\circ$, apoi găsim $m(\widehat{MAC}) = 30^\circ$.

Problema 2.

Fie ABC un triunghi isoscel cu $m(\widehat{ABC}) = 150^\circ$. Se consideră punctul M astfel încât $m(\widehat{MAC}) = 30^\circ$, $m(\widehat{MCA}) = 45^\circ$, iar dreapta AC separă punctele B și M . Demonstrați că $MB \perp AB$.

Ion Pătrașcu

Soluție:

Găsim $m(\widehat{AMC}) = 105^\circ$; avem: $m(\widehat{ABC}) + 2m(\widehat{AMC}) = 150^\circ + 210^\circ = 360^\circ$. De asemenea, $BA = BC$, prin urmare patrulaterul convex $BAMC$ satisface condițiile de aplicabilitate ale **Lemei**. Rezultă că $BM = BC = BA$. În triunghiul $\triangle BMA$, avem $m(\widehat{BAM}) = 15^\circ + 30^\circ = 45^\circ$, deci acest triunghi este dreptunghic isoscel. În consecință, $MB \perp AB$.

Problema 3.

Fie ABC un triunghi cu $AB = AC$ și $m(\widehat{A}) = 80^\circ$. Considerăm un punct în interiorul triunghiului astfel încât $m(\widehat{MBC}) = 30^\circ$ și $m(\widehat{MCB}) = 10^\circ$. Calculați $m(\widehat{AMC})$.

I. F. Sharygin [1]

Soluție:

Notăm cu D mijlocul lui $[BC]$ și cu N simetricul lui M față de D (vezi Fig. 2). În patrulaterul convex $ABNC$ avem: $AB = AC$, $m(\widehat{BNC}) = 140^\circ$. Deoarece $m(\widehat{BAC}) + 2m(\widehat{BNC}) = 360^\circ$, se poate aplica **Lema** în acest patrulater și obține $AN = AC$.

Patrulaterul $BMCN$ este paralelogram, deci $BN = MC$ și $m(\widehat{MBN}) = m(\widehat{MCN}) = 40^\circ$. Deoarece $m(\widehat{BCA}) = 50^\circ$, găsim că $m(\widehat{ACN}) = 80^\circ$. Însă $m(\widehat{BNC}) = 140^\circ$, deci $m(\widehat{BNA}) = 140^\circ - 80^\circ = 60^\circ$. Triunghiul isoscel ABN , având $m(\widehat{ANB}) = 60^\circ$,

este echilateral, prin urmare $BN = AN$. Triunghiul CMA este isoscel, $CM = CA$, având $m(\widehat{MCA}) = 40^\circ$, deci $m(\widehat{CMA}) = 70^\circ$.



Figura 2

Problema 4.

Fie ABC un triunghi cu $AB = AC$ și $m(\widehat{BAC})$

Considerăm punctul M

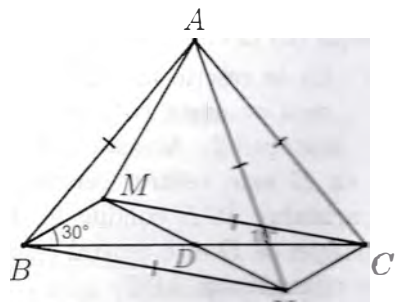
în interiorul triunghiului astfel încât $m(\widehat{MBA}) = 7^\circ$ și $m(\widehat{MCB}) = 23^\circ$. Calculați $m(\widehat{AMC})$.

Ion Pătrașcu

Soluție:

Notăm cu D mijlocul laturii BC și cu N simetricul lui M față de D . Patrulaterul $BMCN$ este paralelogram, $m(\widehat{MBN}) = m(\widehat{MBC}) + m(\widehat{CBN}) = 30^\circ + 23^\circ = 53^\circ$, deci $m(\widehat{BMC}) = m(\widehat{BNC}) = 127^\circ$. Având $AB = AC$ și $m(\widehat{BAC}) + 2m(\widehat{BNC}) = 106^\circ + 2 \cdot 127^\circ = 360^\circ$ în patrulaterul convex $ABNC$, putem aplica **Lema**. În consecință, $AN = AB$. Triunghiul isoscel ABN are $m(\widehat{ABN}) = 7^\circ + 53^\circ = 60^\circ$, prin urmare este echilateral. Deoarece $BN = CM = AC$, obținem că triunghiul CAM este isoscel și găsim $m(\widehat{AMC}) = 83^\circ$.

Problema 5. (generalizarea problemelor 3 și 4)

Fie ABC un triunghi cu $AB = AC$ și $m(\widehat{BAC}) = \alpha$, $60^\circ < \alpha < 120^\circ$. Considerăm punctul M în interiorul triunghiului ABC astfel încât $m(\widehat{MBC}) = 30^\circ$ și $m(\widehat{MCB}) = \beta$, unde $2\beta + 60^\circ = \alpha$. Calculați $m(\widehat{AMC})$.

Ion Pătrașcu

Soluție:

Notăm cu D mijlocul laturii BC și cu N simetricul lui M față de D . Patrulaterul $BMCN$ este paralelogram, $m(\widehat{MBN}) = 30^\circ + \beta$, $m(\widehat{BNC}) = 150^\circ - \beta$. Având $AB = AC$ și $m(\widehat{BAC}) + 2m(\widehat{BNC}) = \alpha + 300^\circ - 2\beta = 300^\circ + (\alpha - 2\beta) = 360^\circ$, se poate aplica **Lema** în patrulaterul $ABNC$. Astfel obținem că $AB = AN = AC$. Avem $m(\widehat{ABN}) = m(\widehat{ACN}) + m(\widehat{MCB}) = \frac{1}{2}(180^\circ - \alpha) + \beta = \frac{180^\circ - (\alpha - 2\beta)}{2} = 60^\circ$, deci BAN , fiind isoscel cu un unghi de 60° , este echilateral; în consecință, $BN = AN = AC$. Cum $BN = CM$ (laturi opuse în paralelogram), obținem că triunghiul CAM este isoscel, cu $CM = CA$. Deoarece $m(\widehat{MCA}) = m(\widehat{ACB}) - m(\widehat{MCB})$, găsim $m(\widehat{MCA}) = \frac{180^\circ - \alpha}{2} - \beta$, însă cum $\beta = \frac{1}{2}(\alpha - 60^\circ)$, rezultă că $m(\widehat{MCA}) = 120^\circ - \alpha$. În final, obținem $m(\widehat{AMC}) = 30^\circ + \frac{\alpha}{2}$.

Observație:

Problema 3 se obține din *Problema 5* pentru $\alpha = 80^\circ$ și $\beta = 10^\circ$, iar *Problema 4* se obține pentru $\alpha = 106^\circ$ și $\beta = 23^\circ$.

BIBLIOGRAFIE

- [1] I. F. Izaak – *Ne salvează cercul circumscris*, revista KVANT, nr. 2 (1987)
- [2] I. F. Sharygin – *Problemas de geometria. Planimetria*, Ed. Mir, Moscova, 1989
- [3] I. Pătrașcu – *Probleme de geometrie plană*, Editura Cardinal, Craiova, 1996

Continuum Hypothesis Revisited: From Cantor, to Godel, then to Discrete Cellular Space model

Victor Christianto, Florentin Smarandache

Victor Christianto, Florentin Smarandache (2021). Continuum Hypothesis Revisited: From Cantor, to Godel, then to Discrete Cellular Space model. *Asia Matematika* 5(2), 11 – 12

Abstract: This article is a follow-up to our previous article (cf. Octagon Mathematical Magazine, 2018). As we know, Continuum Hypothesis is one unresolved problem in mathematics, and it is likely to affect physics theories too, once a reasonable solution has been achieved. The Continuum Hypothesis can be stated as follows: if you are given a line with an infinite set of points marked out on it, then just two things can happen: either the set is countable, or it has as many elements as the whole line. There is no third infinity between the two (cf. Juliette Kennedy's article, IAS, 2011, <https://www.ias.edu/ideas/2011/kennedy-continuum-hypothesis>). Here we review CH from Godel view etc, then we also review Smarandache's partially denying of axioms, and then we will review our proposed Discrete Cellular Space.

Key words: Continuum Hypothesis, Discrete Cellular Space, Godel's view on Continuum Hypothesis, quasicrystalline

1. Introduction

The word 'geometry' comes from the Greek words 'geo', which means the 'earth', and 'metrein', signifying 'to gauge'. Math seems to have started from issues that emerged for estimating land. This part of math was contemplated in different structures in each old civilisation, be it in Egypt, Babylonia, China, India, Greece, the Incas, and so forth. Individuals of those ancient civilisations dealt with a few useful issues which required the improvement of math in different ways. Euclidean Geometry is the investigation of Geometry dependent on definitions, vague terms (such as points, line and plane) and the presumptions of the mathematician Euclid (330 BC). As historians of mathematics told us, it was in 1900 at the Paris conference that Hilbert presented his list of unsolved mathematical problems; as number one on that list, which was entitled *Mathematische Probleme*, stands the continuum problem, already conjectured by Cantor.[1] The famous Poincaré's remark to be mentioned in Russell's classic book, *The Principles of Mathematics* (Russell 1937, p.347), and it can be paraphrased as follows: "The continuum consequently considered is only an assortment of people organized in a specific request, endless in number, it is valid, yet outside to one another. This isn't the customary idea, where there should be, between the components of the continuum, a kind of personal bond which makes an entire of them, in which the point isn't preceding the line, yet the line direct." [3] In Godel's article, he once wrote, that "Cantor's continuum problem is simply the question: How many points are there in a straight line in Euclidean space?" [2] According to Koellner (2011): "The Continuum Hypothesis is one of the most central open problems in set theory, one that is significant for both numerical and philosophical reasons. The issue really emerged with the introduction of set hypothesis; for sure, in many regards it animated the introduction of

set hypothesis. In 1874 Cantor had shown that there is a balanced correspondence between the regular numbers and the mathematical numbers. All the more shockingly, he showed that there is nobody to-one correspondence between the regular numbers and the genuine numbers. Taking the presence of a coordinated correspondence as a measure for when two sets have a similar size (something he unquestionably did by 1878), this outcome shows that there is more than one degree of limitlessness and subsequently brought forth the higher endless in science.”[6] As we see that this is unsolved problem in mathematics, and even according to Hamkins (2015), a dream solution to this problem is unattainable. See also Cohen (1953), Feferman (2011). Why does this problem matter to physics sciences? Because as we know, theoretical physics have become so abstract but yet many more problems are unresolved, as Sabine Hossenfelder wrote in her book, *Lost in Math* (2019). As an education expert puts it: "it is such that we are as confused as ever, only at a much higher level." Therefore one of things needed to review, is to check if there is problem in the very corner stone of geometry itself, i.e. Euclid axioms. In the following section, let us discuss a possible path to find out if this CH problem is still within our reach. First of all, let us review Euclid's five axioms and other related definitions.

2. Euclid's five axioms and several definitions

The followings are the axioms of standard Euclidean Geometry. They show up toward the beginning of Book I of *The Elements* by Euclid. Propose 1: A straight line fragment can be drawn joining any two focuses. Hypothesize 2: Any straight line fragment can be stretched out endlessly to shape a straight line. Propose 3: Given any line portion, a circle can be drawn involving the fragment as the range with one endpoint as the middle. Hypothesize 4: All right points are consistent. Propose 5: If a straight line falling on two straight lines make the inside points on a similar side under two right points, the two straight lines, whenever delivered endlessly, meet on that side on which are the points not exactly the two right points. Then, let us audit a portion of Euclid's Book 1 Definitions. (1). A point is what has no part. This can be perceived to imply that a point is something that can't be partitioned into anything more modest. (2). A line is breadthless length. A line is a develop that has no thickness. It very well may be considered as a constant progression of focuses. (3). A straight line is a line which lies equally with the focuses on itself. (4). A plane point is the tendency to each other of two lines in a plane which meet each other and don't lie in an orderly fashion.

3. Motivation of this study

Quite some time ago, these writers began a small book dedicated to discretization and quantization in astrophysics. It becomes clear, that discretization of space requires deeper understanding. Later on, we put forth some ideas which appeared later in *Octogon Mathematical Magazine* (2018). Around a year later, we got involved in another book project, which several contributing physicist fellows. Among some of us, and also with other contributors, discussion arises on several unsolved problems in mathematics, including continuum problem, and whether theoretical physicists have concern on that issue [44]. It is clear, that once this problem in underpinning of mathematics has been solved, then the implications will be profound to many diverse area of physics fields. One hint to find the solution to this Continuum Hypothesis problem is : The basic idea is NOT to get number correct, BUT to get the ideas correct. Mathematics is not solving equations! It is understanding.

4. Previous efforts to solve Continuum Hypothesis

In this section, let us review five existing attempts to solve CH problem. For an introduction, see for example [47], Let us discuss one by one, as follows: (a) Cantor's set theory. In 1874, Georg Cantor, then, at that

point, a youthful teacher at Halle University, distributed a four-page note in Crelle's Journal, showing that the arrangement of mathematical numbers is countable, and the arrangement of genuine numbers uncountable. Cantor, in his attempt to build Cardinal chain reached the first continuum Cardinal. The first continuum Cardinal was at the limit of the chain of finite Cardinals. As he kept going up constructing Cardinal chain, he reached the largest Cardinal C . Then a shock wave hit him. He discovered that $C+1$ is a Cardinal such that:

$$C \leq C + 1. \quad (1)$$

When Cantor announced this shocking result which proved that his set theory is inconsistent, Russell who badly needed Cantor's set theory for his Principia Mathematica was in shock. His life time project was demolished. In his desperate attempt to save Cantor's set theory, Russell ended up with a simplest proof for the inconsistency of Cantor's set theory, aka Russell's paradox. As a desperate patch up solution to this shocking problem, ZF and von Neumann developed an axiomatic set theory. Though we still have not found an inconsistency proof for this new set theory, and most of us have already given up on this, all attempts to show that this formal set theory is consistent failed. To make the matter even more discouraging, Paul Cohen showed in his PhD, that the Continuum hypothesis which is the formal version of Cantor's first continuum set is independent upon the ZF. Disappointed by his own discovery, Cohen left set theory and moved to mathematical analysis. Under this discouraging situation, the only bright light was the result which showed that ZF minus (what ever) one axiom is always consistent. Practically minded mathematicians say this is enough. Conclusion: Cantor set theory is inconsistent. Cantor himself proved it. He was the first. Then Russell presented the simple most proof which goes as follows: Let $R = \{x : x \text{ not in } x\}$. If $R \in R$, then $R \text{ not in } R$. If $R \text{ not in } R$ then $R \in R$. Cantor's original proof used an infinite chain of cardinals. Russell's proof is simple most. But they say the same thing: Set theory of Cantor is inconsistent. So, on mathematics side, things are not in good shape and we are seriously concerned about the implication of this to theoretical physics. See also Rede [41]. (b) Dedekind cut theorem. From 1872 onwards, Cantor compared with Richard Dedekind (1831- 1916), who was 14 years his senior and had quite recently advanced the meaning of Dedekind cuts of genuine numbers. Before that, Dedekind proposed an answer, called Dedekind cut. A Dedekind cut is a fragment of the plan of normal numbers into two subsets A_n and B , so much that any part of A_n isn't precisely any part of B ; Dedekind displayed that the plan of cuts acts unequivocally as one would guess that the arrangement of genuine numbers ought to act, with the cut (A,B) tending to the novel veritable number between A moreover B . Dedekind slice would in this manner have the option to be used to foster authentic numbers.[37] Dedekind looked to draw motivation from specific properties of the line, when we mean to place in correspondence and arrange the arrangement of genuine numbers on it. The property of coherence of the straight line introduces itself as a mathematical, perceptual and subjective person that Dedekind tried to foster a conventional treatment.[40] Crosby concludes Dedekind method with remark, which can be paraphrased as follows: "On Richard Dedekind's independent endeavor to exhibit the progression of the genuine numbers utilizing just arithmetical thinking. It is worth taking note of that his meaning of progression didn't go unchallenged by other numerical personalities of his time. The most noticeable elective perspective cases that a continuum can't be compositional in nature. That is, as Dedekind's genuine numbers are made out of discrete components, they can't be persistent. Paul du Bois-Reymond, a German mathematician who was alive at the point when "Progression and Irrational Numbers" was distributed, called the decrease of a continuum to discrete components "a program whose philosophical cogency, and surprisingly legitimate consistency, had been tested many occasions throughout the long term" [39]. Such a remark can be viewed as early indication that the solution of CH problem shall be found in redefining what is "discreteness." (c) Godel's restatement of the problem. Godel gave a restatement of CH problem, which can

be paraphrased as follows: "This shortage of results, even with regards to the most key inquiries in this field, might be because of some degree to simply numerical troubles. ... This negative mentality towards Cantor's set hypothesis, nonetheless, is in no way, shape or form a fundamental result of a nearer assessment of its establishments, yet at the same just the after effect of s pecific philosophical or iginations of the idea of math, which concede numerical items just to the degree wherein they are interpretable as acts and developments of our own brain." [38] (d) Woodin's recent result. A review of Woodin's result has been given by Dehornoy, including his conjecture: "Conjecture 1 (Woodin, 1999). Every set theory that is compatible with the existence of large cardinals and makes the properties of sets with hereditary cardinalityunder forcing implies that the Continuum Hypothesis be false." [42] (e) Lakoff Nunez's cognitive function approach. In our interpretation, Lakoff Nunez's approach is the closest to Godel's remark: "wherein they are (or alternately are accepted to be) interpretable as acts and developments of our own brain." Therefore, let us see where the problem began. Firstly, let us quote from Robinson, which can be paraphrased as follows: "Concerning the establishment of science, my position (assessment) depends on the accompanying two fundamental standards: (1) No matter what an importance of words is utilized, endless sets don't exist. (They do not exist by and by or in principle). All the more explicitly, any assertion on endless sets is just inane. (2) However, we should in any case direct numerical works and exercises not surprisingly. In other words, when we work, we should in any case regard endless sets as though they really existed." [43] Such a conclusion shall be startling, indicating that the very notion of infinite sets etc. do not exist at all, except in the human mind. Lakoff Nunez make it more clear in preface in their book, which can be paraphrased as follows: "How would we see such fundamental ideas as endlessness, zero, lines, focuses, and sets utilizing our ordinary theoretical device? How are we to figure out numerical thoughts that, to the fledgling, are paradoxical—thoughts like space-filling bends, little numbers, the point at in-limit, and non-very much established sets (i.e., sets that "contain themselves" as individuals)?" [23]. It becomes more clear that such an alteration from daily experience with "line segment" began with Descartes. Lakoff Nunez wrote in chapter 12 in their book: "Euclid characterized a surface as "that which has length and broadness just," a line as "breadthless length," and a point as "that which has no part." Euclid utilized the customary idea of a come up short on: A surface needs thickness, a line needs expansiveness also thickness, and a point (which is comprised of no skillet) comes up short on these." [23, p. 265]. Moreover, they conclude: "Space has been conceptualized in two altogether different ways in the historical backdrop of math. Before the mid-nineteenth century, space was conceptualized as the vast majority ordinarily consider it-in particular, as normally consistent. Here is how we as a whole contemplate space in daily existence. ... Descartes' creation of logical calculation changed science for eternity. His focal similitude, Numbers Are Points on a Line (see Case Study 1), permitted one to conceptualize number juggling and polynomial math in mathematical terms and to envision capacities and logarithmic conditions in spatial terms. The reasonable mix of the source and target areas of this illustration allows us to move to and fro conceptually among numbers and focuses on a line." [23, p. 260] So we know, why for most mathematicians, they assign real number line to define finite line segment, which actually do not exist in reality. The aforementioned discussions can be found helpful in order to see where we get lost.

5. On theorem of partially denying of axioms and known attempts to solve Continuum Hypothesis

Quite some time ago, Smarandache when he was young, introduced partial denial of axiom, especially considering Euclid's fifth axiom. Smarandache (b. 1954) partially negated Euclid's V postulate: "There exist straight lines and exterior points to them such that from those exterior points one can construct to the given straight lines: 1.

only one parallel – in a certain zone of the geometric space [therefore, here functions the Euclidean geometry]; 2. more parallels, but in a finite number – in another space zone; 3. an infinite number of parallels, but numerable. [7] We can make the following remark on partial denying of axioms, which can be paraphrased as follows: "While the Non-Euclidean Geometries came about because of the complete invalidation of only one explicit maxim (Euclid's Fifth Postulate), the AntiGeometry results from the all out nullification of any adage and even of additional sayings from any mathematical proverbial framework (Euclid's, Hilbert's, and so on), and the NeutroAxiom results from the halfway refutation of at least one aphorisms [and no all out nullification of no axiom] from any mathematical aphoristic framework." [46] Now, we can say that among existing attempts to solve Continuum Hypothesis include: Dedekind cuts, algorithm approach etc., of which none has achieved to solve CH problem. In our view, the deep root cause why this problem has not been solved until today is: to remind you the aforementioned remark by Godel, i.e. the simplest formulation of the problem can be restated as follows: "How many points are there in a straight line in Euclidean space?" That is, according to principle of parsimony, we don't have to complicate the arguments beyond what is necessary, such as what Cantor did (while surely we appreciate his inventive transfinite sets etc.). In other words, we shall consider continuum hypothesis as it is from a more realistic perspective, not to do with real numbers or infinite numbers. To assert a finite length of line segment with real numbers only lead us to complicated arguments.

6. Discrete Cellular Space and its implications

In this section, allow us to review in a more accessible way, our arguments as we presented in Octogon Mathematical Magazine (2018). From previous section, we can recall that Definition of a point is as follows: (1). A point is that which has no part. In other words, that can cause serious contradiction. Let us start that we assume that a line segment is composed of infinite number of points, but a point is defined as "circle with zero diameter." By definition, a circle is the arrangement of all places in a plane that are equidistant from a given point called the focal point of the circle. We utilize the image to address a circle. The line section from the focal point of the circle to any point on the circle is a sweep of the circle. Furthermore, by meaning of a circle, all radii have a similar length. We likewise utilize the term span to mean the length of a sweep of the circle. That would imply:

$$"o + o + o + ...adinfinitum = finitelengthoflinesegment." \tag{2}$$

Of course, that is confusing and contradictory, because by definition, a series of infinite number of zeroes never become a finite length. In our perspective, that is nothing to do with real numbers, but it is required to revisit our definition of what a point is. A more realistic definition can be given as follows: a point is defined as "a circle with small but non-zero diameter cell, let say we call it, z." From that starting point, we can arrive to a more palatable argument, i.e.:

$$"z + z + z + ...adinfinitum = finitelengthoflinesegment." \tag{3}$$

Therefore we arrive to a plausible solution to continuum hypothesis, that space is composed of Discrete Cells; that is why we call it Discrete Cellular Space hypothesis. While for some mathematician readers, that proposed solution may be found too pragmatics, we suppose that for many physics sciences, astrophysics etc., that solution shall be sufficient "for all practical purposes" – provided we are allowed to use that popular phrase for physicists. QED. With regards to Smarandache's aforementioned theorem, the proposed DCS model do not really make use of such a partial denial of axiom, except just a redefinition and clarification of the first

axiom of Euclid. (Postscript note: In Sm. Hybrid Geometries, an axiom may be denied 100 percent but in different ways (see a book-chapter by E. Gonzalez), for example: the 5-th postulate of Euclid is denied as: a) there are lines and exterior points such that there is no parallel to the lines; b) there are lines and points such that there are many parallels to the points. For further reading on Smarandache geometries, see: <http://fs.unm.edu/Geometries.htm>). Nonetheless, his theorem of partially deny an axiom can be viewed as a guide, i.e. we can find out what happens if we relax Euclidean axioms one by one. Implications may be found in cosmology model, as we know there is Lindquist-Wheeler model, or Conrad Ranzan's cellular universe [10], and also foam-like model of the Universe [11]. What's more interesting here is that recently one of these authors communicated with Prof. E. Panarella, from Physics Essays journal, where we discuss a paper on discretization [12]. We suggest that it may be possible to extend further our DCS model to be more linked to on-going research in quantum gravity. See for instance Friedel-Livine, who stated which can be paraphrased as follows: "... Refining our depiction of the 3d calculation, we supporter to consider each 3d cells as air pockets, implying that we will portray the 3d math of every cells as the condition of the 2d calculation of its limit. Then, at that point, the 3d cells are stuck along shared limit surfaces and consistency conditions transform into matching imperatives between the two portrayals of the math of the limit according to the viewpoint of the two 3d cells sharing it. This image prompts 3d calculation as an organizations of air pockets." [13] This seems very interesting as well as workable approach, to find connection between DCS hypothesis and such network bubble, related to 3D cellular structure. Moreover, such a model of network bubble can be connected also to Wheeler's foam gravity model, which is composed of crystals, as David T. Crouse remarks: "John Wheeler's quantum foam such that the foam becomes a gravity crystal permeating all space and producing measurable inertial anomalies of astronomical bodies." [13] Nonetheless, allow us to remind fellow physicists to keep working in the above 3D cells, as they lead to direct connection with 3D crystalline structure as we will discuss as follows.

7. Discussion A: Remark on philosophical aspects

In this section, we will discuss several aspects which may be asked by readers. First of all, it is common to assert a finite length of line segment with real numbers only lead us to complicated arguments; it is called "real number line." (see for instance Scott [27]). But as we all know, that is only perceived by human cognition, in particular in a mathematician's cognitive process. As Lakoff and Nunez put it in preface of their book: "We discovered that it did: What is called the real-number line is not a line as most people understand it. What is called the continuum is not continuous in the ordinary sense of the term." [23] Nunez also wrote on definition of point, which can be paraphrased as follows: "... a point, which is the most straightforward substance in Euclidean math can't be really seen. A point, as characterized by Euclid is a dimensionless element, a substance that has just area however no expansion. No super-magnifying instrument can at any point permit us to see a point in fact. A point, with its accuracy and clear character, is a romanticized conceptual element." [24][25] Therefore, the aforementioned arguments are essentially to alter the notion of "real number line" into a natural meaning of a line segment, composed of circles with small but finite cells. Now, let us discuss on method, we use a direct method by redefining the meaning of point, because that approach has nearest correspondence with our daily experience, as we argue in [28]. That particular direct approach may be favorable to physicists. While we do not wish to compare with others, we can mention difference between Landau and de Gennes, which can be paraphrased as follows: "The style of Landau was to go to the core of the issue, make not many yet significant suppositions, and infer apparently by wizardry a few vigorous outcomes. de Gennes' methodology bore in excess of a passing likeness to that of Landau." [29] And one more note, we can mention that there are

other quite similar hypothesis with ours, for instance by Y. Breck, who argue for several postulates: "Postulate 1. (Discreteness): Space is discrete and composed of the underlying elementary units. The resulting discrete structure can be geometrically represented as a graph, network, or lattice (see Figure 1). The graph does not exist in space; rather, the graph itself is space." See Breck [30]. While it seems to correspond with our DCS, Breck does not consider the cellular structure of 3D space itself.

8. Discussion B: Remark on a few mathematical aspects

A German mathematician/Physicist Riemann in the mid 19th century managed to articulate the concept of limit using what is now called "- method" and manage to articulate the concept of $\lim_{x \rightarrow a} f(x)$ as :

$$\lim_{x \rightarrow a} f(x) = b \text{ (} > 0 \text{)} \text{ (} > 0 \text{)} [|x - a| < |f(x) - b| <] \tag{4}$$

With this limit concept Riemann obtained the instantaneous change of rate of a function $f(x)$ as follows:

$$f'(x) = \lim_{h \rightarrow 0} ((f(x+h) - f(x))/h) \tag{5}$$

In physics, we represent a motion as a function $f(t)$ from time t to locations. Then clearly by $f(t)$ we mean the instantaneous speed at t . We can define the acceleration of $f(t)$ at t as $f''(t)$. This well understood definition of the speed of $f(x)$ at time x as $f'(x)$ has been rather thoughtlessly accepted. Mathematics and physics are very different disciplines and we can not just adopt mathematics to describe physical reality. This is to say there is a little more going on in physics than in mathematics which is philosophically obvious because mathematics is a generalization of physics. Lack of philosophical understanding everywhere in physics has been slowing down the development of physics in many places. We know that "time" never reverses, it is an autonomous process which advances "without" any interferes, we must have very different mathematics for physics. Mathematics can not handle physics. Mathematics and physics are based upon totally different philosophies despite apparent similarity. Few physicists understand this difference. This is how mathematics was wrongly used in physics creating serious problems. Many mathematicians rightly think that as mathematics is more general than physics, we must be more careful when we use mathematics to describe physics. It is unfortunate that the pride of the King of Science is so high that there is little hope in communicating with physicists on these serious issues. Let us be more specific on this issue. the - definition of $f'(x)$ has nothing to do with physics. This definition came from Cauchy-Riemann. Neither of them are philosophers nor physicists. They are just bloody articulate mathematicians who did not understand real world. For physicists,

$$f'(x) = \lim_{h \rightarrow 0} ((f(x+h) - f(x))/h) \tag{6}$$

does not mean

$$\lim_{x \rightarrow a} f(x) = b \text{ (} > 0 \text{)} \text{ (} > 0 \text{)} [|x - a| < |f(x) - b| <] \tag{7}$$

at all. For physicists $\lim_{x \rightarrow a}$ is a physical process of x approaching a on a real line where x and a are geometric points. It was the grandeur complex of grand mathematicians like Cauchy and Riemann that they "improved" (or "articulate") the limit concept of $\lim_{x \rightarrow a} f(x)$. Certainly it was "improved" conceptually up in the air and we still have no idea how this abstract concept of $\lim_{x \rightarrow a}$ has anything to do with physics. All of this conflict created a troubled dichotomy of pure mathematics and mathematics for real world. Certainly this abstract mathematics produced many fancy "deep results" most of which were never ever used in real

life. This grandeur-complex driven abstract mathematics in the end reached the grandest set theory of Cantor, which Cantor himself proved inconsistent. Recently a book was published entitled "Lost in Mathematics" [45]. This book was the complain on the role pure mathematics played in the modern development of physics. Starting with Maxwell's EM field theory, Einstein's relativity theory and Heisenberg- Schrödinger's quantum mechanics which produced the grandest fallacy of the "Ultimate Physics, most empirically verified theory in, namely Quantum Mechanics". It is unfortunate that the author (i.e. S. Hossenfelder) was not aware of the fatal errors of these legendary ultimate theories of physics which dominated physics world for almost 1.5 centuries. She was just complaining about the oppressive usage of these "advanced mathematics" in theoretical physics. As we said just above the situation is much worse. Basically none of these figures of fame of the last 1.5 century of theoretical physics understood the mathematics they used. All of it turned out to be just embarrassing mathematical jokes. Contrary and almost amusingly, none of these pure mathematicians who promoted this irrelevant mathematization of physics understood physics at all. So the comedy and the tragedy is that physicists did not understand mathematics they use and mathematicians who promote their highly questionable mathematical theories did not understand physics at all. Going back to mathematics and science: The problem we mentioned just above about, the concept of limit, mathematical v.s. physical, has a lot to do with what happened to pure mathematics at the turn of the 20th century where Cantorian set theory destroying the grand hope by many prominent mathematicians such as Russell, Frege etc. motivated some determined mathematicians to abandon the over generality of set theory and pure mathematics in general which is based upon the fake empire of set theory. In one end, determined constructivism mathematicians such as Kronecker and Barwise concluded that only under the restriction on mathematical constructions to comply with the Principle of Constructivity, rejecting any fancy abstract metaphysical constructions, we can build trustable consistent mathematical theories. This idea was purified in the form of what we mathematicians call Recursion Theory and its generalization in the form of "Numeration Theory" which was started and developed by Soviet Mathematicians such as Malcev and Ershov at The Academy of Science Novosibirsk. In the limited context of theoretical computer science, this theory was discussed among constructivism mathematicians. It is our current view that the only mathematics which is solidly grounded and trust worthy is this theory. The rest are rather up in the air fantasy dreaming world. We are proposing that a restriction similar to this is badly needed in theoretical physics too. The situation this field was in up until recently was as seriously confused as the pure mathematics of the late 19th century, if not more. The only difference is that thanks to the academic honesty of mathematicians, in mathematics these issues were openly discussed without any suppression.

9. Application 1. What is space? A new hypothesis of super-crystalline vacua

In this section, allow us to extend ideas in the aforementioned section on possibility that the space consists of discrete cells, to become cells composed of superconductor quasi-crystalline. We discuss some features of this model. It is known that continuum problem is a fundamental question in pure mathematics and also theoretical physics field: whether the space is discrete or continuous. As we argued before how plausible it is discrete cellular space (DCS) to solve CH problem. Now, we can extend further by assuming that the 3D space is composed of network of dense-packed cells. That way the space system looks both as graph network as well as discrete cellular pattern. In this section, allow us to put forth a new hypothesis that the discrete cellular structure of space consists of cells of superconductor quasi-cristallyne. That proposition can be viewed as an alternative to Finkelstein's old hypothesis of hypercrystalline vacua [15]. There are furthermore (cautiously aperiodic) quasiperiodic jewels for which a depiction in regards to a change of a central design or a course of action of no less than two establishments is either inappropriate or unfathomable. We fight that one should insinuate

all such valuable stones as quasicrystals, paying little brain to their point-pack equity. The most notable model for such jewels is a quasiperiodic tiling, for instance, the prestigious Penrose tiling. One consumes space with "unit cells" or "tiles" such that keeps up long-range demand without periodicity, and produces an essentially discrete diffraction diagram. Unquestionably, quasiperiodic diamonds having balances that are unlawful for discontinuous jewels, for instance, the watched icosahedral, octagonal, decagonal, and dodecagonal valuable stones—can't be outlined by changing a secret periodic design with a comparable equilibrium, and are along these lines all quasicrystals. Quasiperiodic pearls with no-no equilibriums can be formed as a difference in a discontinuous design, yet that need not be what is going on.[16] Ongoing discovery proposes that semi translucent has superconductive stage in exceptionally low temperature.[17] Consider the possibility that the quasicrystalline model isn't in semiconductor solid...but a superconductor quasicrystalline. Maybe, we might refer to it as: "super-glasslike vacua speculation." Quasi-translucent strong is additionally great since it gets multiple aspects, which might be exceptionally important. This likewise would bring into an amicable view among Finkelstein and Penrose and some of Frank Tony Smith's examinations. The following thing to consider is a super-semi crystalline strong (SQC). In view of its "fractal properties," we can expect that the Superconductor Quasi-Crystalline (SQC) can stretch out down to the construction of room, like what Finkelstein visualized. The semi precious stone design of room might be made out of strong matter or delicate matter, of which its overall elements has been illustrated by Fan et al. [18] See also several discussions on new findings of natural quasicrystals in Nature [19-22]. It is worth to remark here, that the proposed super-crystalline model of 3D space resembles the dense-packed spheron model of the late Prof. Linus Pauling. Such a dense-packed spheres have been discussed by many mathematicians. Australian mathematician, Mahler, also once wrote on dense-packed sphere. The difference here is, the dense-packed crystalline model now to be hypothesised to form the 3D space itself.

It is also possible to consider 'crystalline symmetry' within those real-space; see for instance Song et al. [31-32]. While this extended hypothesis of super-quasi-crystal structure of 3D space seems rather weird, we are sure that this is one of the most plausible direction toward description of what the space is made of. More research is of course recommended.

10. Application 2: Direct Discrete Formulation of Field Laws

There are other applications on such discrete cell model, for instance Finite Cell Method has been suggested by Parvizian et al. [33]. But it seems the most promising application is the so-called "The Cell method for Direct Discrete Formulation of Field Laws" [34-35]. See also a recent publication describing application of the Cell method in finite formulation of parallel computation. As Tonti wrote, which can be para-phrased as follows: "The quintessence of the technique is to straightforwardly give a discrete formulation of field laws, without utilizing and requiring a differential detailing. It is demonstrated that, for direct interjection, the firmness grid so got coincides with the one of the Finite Element Method" [34]. Moreover, Tonti describes: "On managing differential definitions, it is very regular to utilize coordinate frameworks. Despite what might be expected, a direct discrete definition manages worldwide factors, that are normally associated with limited sizes of spaces, and limited time spans, for example volumes, surfaces, lines, time spans just as focuses what's more moments. We will signify them as spatial and transient elements. Following the act of arithmetical geography, a branch of geography that utilizes cell buildings, the vertices, edges, faces what's more cells are considered as "cells" of aspect zero, one, two and three individually. In short they are signified as 0-cells, 1-cells, 2-cells and 3-cells. Likewise a cell complex isn't imagined as a bunch of little volumes yet as an assortment of cells of different

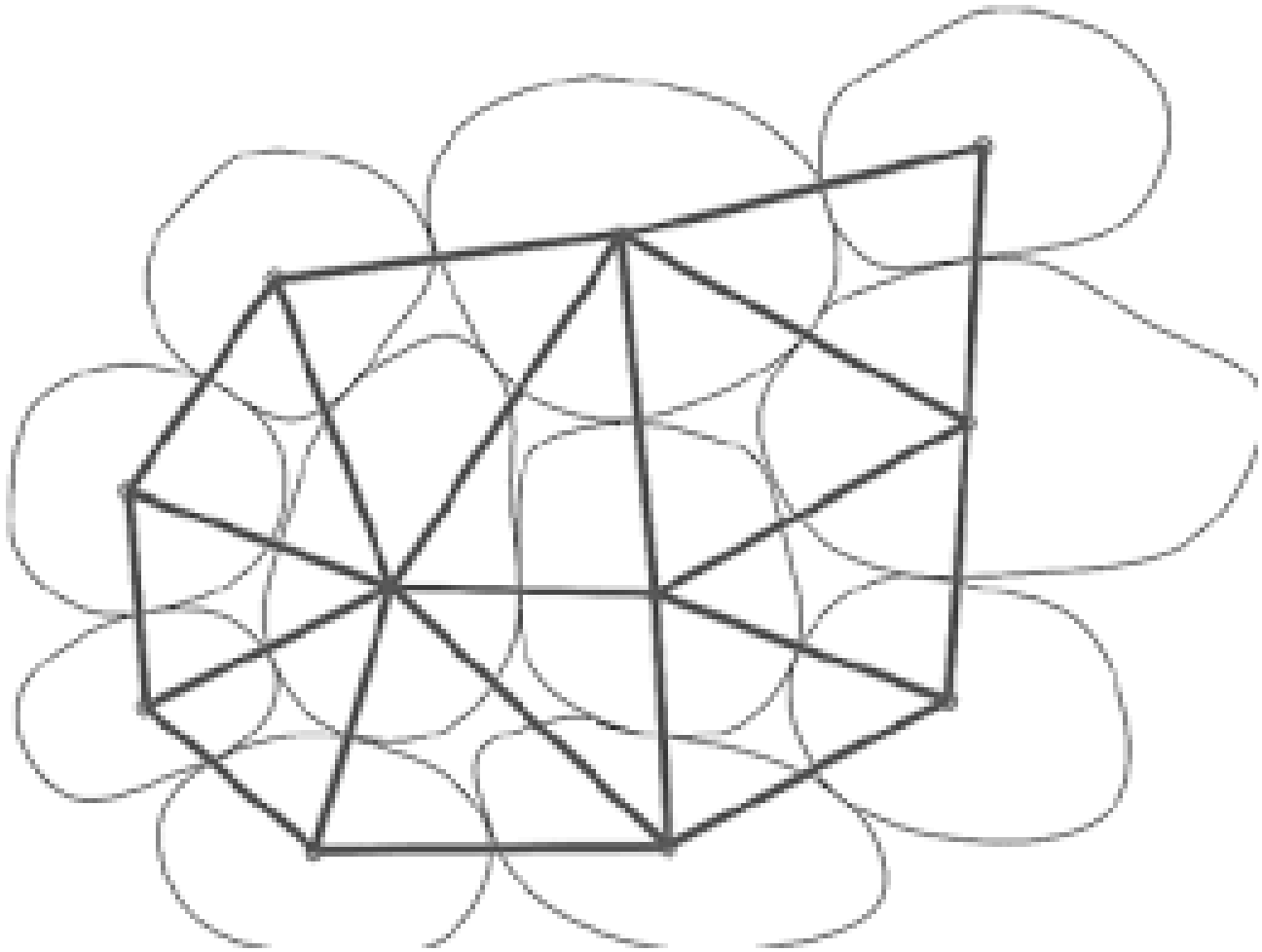

Figure 1. Discrete cellular model of 3D space

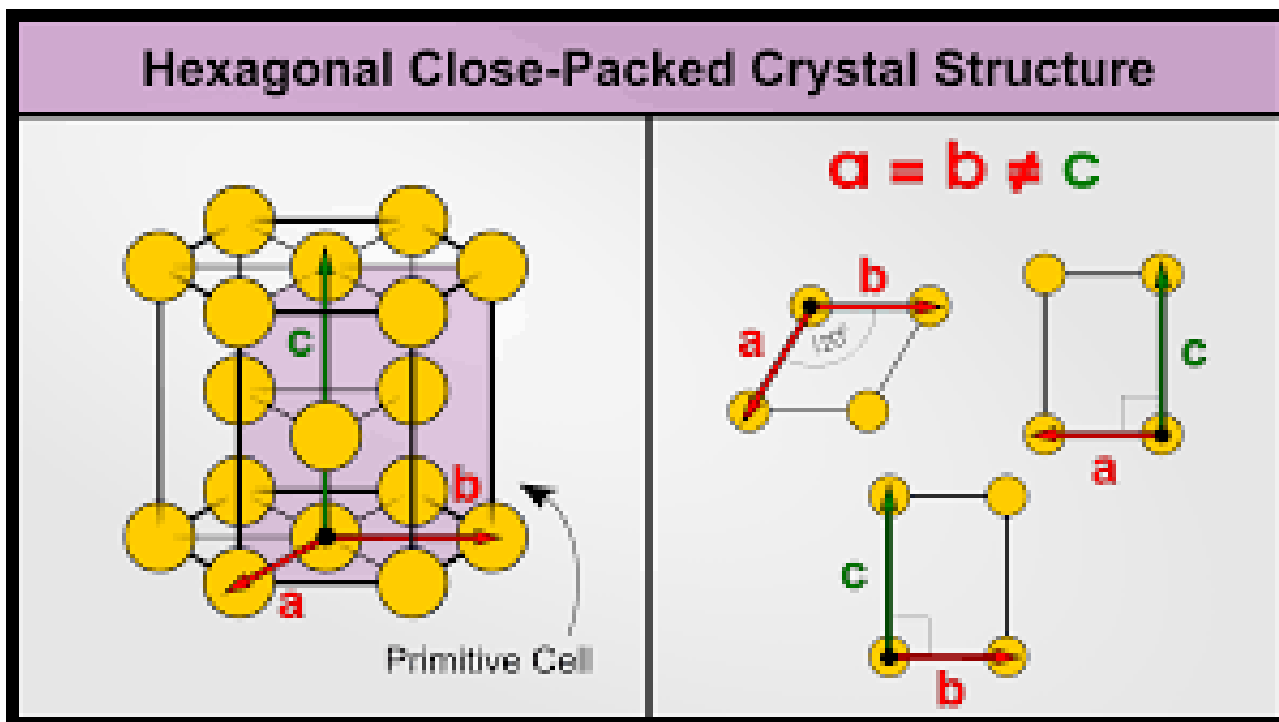

Figure 2. Hexagonal cellular close-packed crystal structure.

aspects.”[33] It can be expected that the Cell Method can be applied to various problems in sciences, given more availability of fast computers.

11. Concluding remarks

In this review article, we revisit our previous hypothesis called Discrete Cellular Space (Octogon, 2018), in order to answer the known unsolved problem, called Continuum Hypothesis. We believe that a tenable solution to this problem shall be found in close connection with empirical science, i.e. the notion of discrete cellular space, which can be attributed more to discrete mathematics, such as cellular automata modeling. In the last section, we gave an outline of extension of DCS hypothesis toward super-quasi-crystalline model of 3D space. While this extended hypothesis of super-quasi-crystal structure of 3D space seems rather weird, we are sure that this is one of the most plausible direction toward description of what the space is made of. All in all, allow us to close this article with a quote from Karl Popper: "For me, both philosophy and science lose all their attraction when they give up that pursuit [of knowledge and understanding of the world] – when they become specialisms and cease to see, and to wonder at, the riddles of our world. Specialization maybe a great temptation for the scientist. For the philosopher it is the mortal sin." (cf. Karl Popper, "The World of Parmenides.")

12. Acknowledgment

These authors wish to extend sincere gratitude to Prof. Akira Kanda, Robert Neil Boyd PhD. and Prof The Houw Liong PhD., for many insightful discussions. One of these authors (VC) found this old book by E. Kamke, particularly useful and recommended as an introduction to set theory, see E. Kamke, Theory of Sets, Dover

References

- [1] D. Hilbert (1900) *Mathematische Probleme, Presented at the Paris conference of 1900*, and published in Nachrichten der Königl. Gesellschaft der Wissenschaften zu Göttingen, Mathematische-physikalische Klasse, 3 (1900); see also [Hilbert 1932], vol. III, page 29.
- [2] S. Feferman et al. 1995 *K. Gödel, collected works. Vol. II* New York, Oxford University Press.
- [3] H. Zhu (2013) *A solution for the differences in the continuity of continuum* arXiv: 1302.0464.
- [4] P. Koellner (2011) *The continuum hypothesis* Mathematics. url: <https://www.semanticscholar.org/paper/The-Continuum-Hypothesis-Koellner/ec8e552f56103a278283553de674c27542a1b6cc>
- [5] J.D. Hamkins (2015) *Is the Dream Solution of the Continuum Hypothesis Attainable?* Notre Dame Journal of Formal Logic, Volume 56, Number 1, 2015.
- [6] F. Smarandache (1969) *“Paradoxist Mathematics” in Collected Papers – Vol. II*. State University of Moldova Press, Kishinev, pp. 5-28, 1997.
- [7] S. Feferman (2011) *Is the Continuum Hypothesis a definite mathematical problem?* Exploring the Frontiers of Incompleteness (EFI) Project, Harvard 2011-2012.
- [8] P.J. Cohen (1953) *THE INDEPENDENCE OF THE CONTINUUM HYPOTHESIS* Mathematics, Vol. 50, 1963.
- [9] V. Christianto F. Smarandache (2018) *How many points are there in a line segment?* Octagon Mathematical Magazine Vol. 26, no. 2, p. 604-615.
- [10] C. Ranzan (2014) *American Journal of Astronomy and Astrophysics*, vol. 2(5), 47-60.
- [11] A.A. Kirillov D. Turaev (2007) *Foam-like structure of the Universe* Phys. Lett. B 656. p. 1-9.
- [12] E. Panarella (2021) *Private communication*, Physics Essays, Dec. 2021.
- [13] L. Friedel E.R. Livine (2018) *Bubble Networks: Framed Discrete Geometry for Quantum Gravity* General Relativity and Gravitation (2018), also in arXiv: arXiv:1810.09364v2 [gr-qc]
- [14] D.T. Crouse (2016) *The nature of discrete space-time: The atomic theory of space-time and its effects on Pythagoras’s theorem, time versus duration, inertial anomalies of astronomical bodies, and special relativity at the Planck scale*, submitted to Elsevier (2016). arXiv:1608.08506v2.
- [15] D. R. Finkelstein et al. (1996) *Hypercrystalline vacua*. <https://arxiv.org/abs/quant-ph/9608024>
- [16] R. Lifshitz (2000) *The definition of quasicrystals*. arXiv: 0008152
- [17] K. Kamiya et al. (2018) *Discovery of superconductivity in quasicrystal* NATURE COMMUNICATIONS, 9:154, DOI: 10.1038/s41467-017-02667-x, www.nature.com/naturecommunications
- [18] T-Y. Fan, et al. (2019) *Review on Generalized Dynamics of Soft-Matter Quasicrystals and Its Applications*. arXiv: 1909.10676
- [19] C.R. Iacovella, et al. (2011) *Self-assembly of soft-matter quasicrystals and their approximants* PNAS, December 27, 2011, Vol. 108, No. 52, 20935–20940.
- [20] Paul J. Steinhardt Luca Bindi (2012) *In search of natural quasicrystals*. Rep. Prog. Phys. 75 (2012) 092601 (11p). <https://dx.doi.org/10.1088/0034-4885/75/9/092601>
- [21] Glenn J. MacPherson et al. (2013) *Khatyrka, a new CV3 find from the Koryak Mountains, Eastern Russia*. Meteoritics Planetary Science 48, Nr 8, 1499–1514 (2013)
- [22] Luca Bindi (2020) *Natural quasicrystals: The Solar System’s hidden secrets*. Switzerland: Springer Nature, 2020. ISSN 2524-8596.

- [23] G. Lakoff r. Nunez (2000) *Preface in "Where Mathematics Comes From"* New York: Basic Books, 2000. url: <https://cogsci.ucsd.edu/nunez/web/FM.PDF>
- [24] R. Nunez () *Do Real numbers really move? The embodied cognitive foundations of mathematics* in 18 Unconventional Essays on the Nature of Mathematics pp 160-181. url: https://link.springer.com/chapter/10.1007/0-387-29831-2_9
- [25] M. Schiralli N. Sinclair (2003) *A CONSTRUCTIVE RESPONSE TO 'WHERE MATHEMATICS COMES FROM'* Educational Studies in Mathematics 52: 79–91, 2003.
- [26] Lam Kai Shun (2021) *An Algorithmic Approach to Solve Continuum Hypothesis* Academic Journal of Applied Mathematical Sciences Vol. 7, Issue. 1, pp: 36-49, 2021. ISSN(e): 2415-2188, ISSN(p): 2415-5225.
- [27] D. Scott (1967) *A Proof of the Independence of the Continuum Hypothesis* Mathematical systems theory, vol. 1 (1967), pp. 89–111. url: <https://www2.karlin.mff.cuni.cz/krajicek/scott67.pdf>
- [28] V. Christianto F. Smarandache (2019) *A Review of Seven Applications of Neutrosophic Logic: In Cultural Psychology, Economics Theorizing, Conflict Resolution, Philosophy of Science, etc.* J, 2, 128–137; doi:10.3390/j2020010
- [29] T.J. Sluckin (2009) *APPRECIATION Pierre-Gilles de Gennes (1932–2007)* Liquid Crystals Vol. 36, Nos. 10–11, October–November 2009, 1019–1022.
- [30] Y. Breck (2020) *Geometric Discrete Unified Theory Framework* Nvidia, Santa Clara, USA. url: <https://users.math.cas.cz/hbilkova/css2020/breck.pdf>
- [31] Z. Song et al. (2018) {Topological states from topological crystals rXiv:1810.02330v2 [cond-mat.mes-hall]
- [32] Z. Song et al. (2020) *Real-space recipes for general topological crystalline states* arXiv:1810.11013v2 [cond-mat.str-el]
- [33] Jamshid Parvizian et al. () *Finite Cell Method* submitted to Computational Mechanics.
- [34] E. Tonti 2001 *A Direct Discrete Formulation of Field Laws: The Cell Method* CMES, vol.1, no.1
- [35] E. Tonti (2014) *Why starting from differential equations for computational physics?* urnal of Computational Physics 257 (2014) 1260–1290
- [36] A. de P. Sanchez et al. (2017) *Finite Formulation in Parallel Computation. Application to Electromagnetic Field in 3-D* url: https://accedacris.ulpgc.es/bitstream/10553/77433/4/TFM_AdriandePabloSanchezResumen.pdf
- [37] P. Dehornoy (2009) *Cantor's infinities* Based on the lecture “Un texte, un mathématicien”, delivered by the author at the Bibliothèque Nationale de France on 18 March 2009.
- [38] K. Gödel (1991) *What is Cantor's continuum problem* chapter in Philosophy of mathematics, edited by P. Benacerraf H. Putnam, Cambridge University Press.
- [39] C. Crosby (2016) *An Examination of Richard Dedekind's "Continuity and Irrational Numbers"Numbers"* Rose-Hulman Undergraduate Mathematics Journal: Vol. 17 : Iss. 1 , Article 9. Available at: <https://scholar.rose-hulman.edu/rhumj/vol17/iss1/9>
- [40] Francisco Regis Vieira Alves, Marlene Alves Dias (2018) *An historical investigation about the Dedekind s cuts: some implications for the Teaching of Mathematics in Brazil* . Acta Didactica Napocensia, 11(3-4), 1-12, DOI: 10.24193/adn.11.3-4.2.
- [41] S. Rede () *Disproof of the Continuum Hypothesis and Determination of the Cardinality of Continuum by Approximations of Sets* available online.
- [42] P. Dehornoy () *RECENT PROGRESS ON THE CONTINUUM HYPOTHESIS (AFTER WOODIN)* updated version of P. Dehornoy, La d etermination projective d'après Martin, Steel et Woodin, S eminaire Bourbaki, Ast erisque 177–178(1989)261-276.
- [43] Jeffrey Yi-Lin Forrest (2013) *A Systemic Perspective on Cognition and Mathematics* Quote from Robinson in Chapter 9. Boca Raton: CRC Press.
- [44] V. Krasnoholovets, V. Christianto, F. Smarandache (2019) *Old Problems and New Horizons in World Physics* Canada: Nova Science Publ., 2019. ISBN: 978-1-53615-430-6. url: <https://novapublishers.com/shop/old-problems-and-new-horizons-in-world-physics/>

- [45] S. Hossenfelder (2020) *Lost in Math* New York: Basic Books, 2020. ISBN-13: 9781541646766. url: <https://www.basicbooks.com/titles/sabine-hossenfelder/lost-in-math/9781541646766/>
- [46] F. Smarandache *NeutroGeometry AntiGeometry are alternatives and generalizations of the Non-Euclidean Geometries* Neutrosophic Sets and Systems, vol. 46, 2021, pp. 456-477. DOI: 10.5281/zenodo.5553552 <http://fs.unm.edu/NSS/NeutroGeometryAntiGeometry31.pdf>
- [47] A. Muntean *Continuum Modeling: An Approach Through Practical Examples* New York: Springer, 2015. ISSN 2191-5318

INFORMATION FUSION

New Distance and Similarity Measures of Interval Neutrosophic Sets

Said Broumi, Florentin Smarandache

Said Broumi, Florentin Smarandache (2014). New Distance and Similarity Measures of Interval Neutrosophic Sets. 17th International Conference on Information Fusion, 13-19

Abstract: In this paper we proposed a new distance and several similarity measures between interval neutrosophic sets.

Keywords: Neutrosophic set, Interval neutrosophic set, Similarity measure.

I. INTRODUCTION

The neutrosophic set, founded by F.Smarandache [1], has capability to deal with uncertainty, imprecise, incomplete and inconsistent information which exist in the real world. Neutrosophic set theory is a powerful tool in the formal framework, which generalizes the concepts of the classic set, fuzzy set [2], interval-valued fuzzy set [3], intuitionistic fuzzy set [4], interval-valued intuitionistic fuzzy set [5], and so on.

After the pioneering work of Smarandache, in 2005 Wang [6] introduced the notion of interval neutrosophic set (INS for short) which is a particular case of the neutrosophic set. INS can be described by a membership interval, a non-membership interval, and the indeterminate interval. Thus the interval value neutrosophic set has the virtue of being more flexible and practical than single value neutrosophic set. And the Interval Neutrosophic Set provides a more reasonable mathematical framework to deal with indeterminate and inconsistent information.

Many papers about neutrosophic set theory have been done by various researchers [7, 8, 9, 10, 11, 12, 13, 14, 15, 16, 17, 18, 19, 20].

A similarity measure for neutrosophic set (NS) is used for estimating the degree of similarity between two neutrosophic sets. Several researchers proposed some similarity measures between NSs, such as S. Broumi and F. Smarandache [26], Jun Ye [11, 12], P. Majumdar and S.K.Smanta [23].

In the literature, there are few researchers who studied the distance and similarity measure of IVNS.

In 2013, Jun Ye [12] proposed similarity measures between interval neutrosophic set based on the Hamming and Euclidean distance, and developed a multicriteria decision-making method based on the similarity degree. S. Broumi and F.

Smarandache [10] proposed a new similarity measure, called “cosine similarity measure of interval valued neutrosophic sets”. On the basis of numerical computations, S. Broumi and F. Smarandache found out that their similarity measures are stronger and more robust than Ye’s measures.

We all know that there are various distance measures in mathematics. So, in this paper, we will extend the generalized distance of single valued neutrosophic set proposed by Ye [12] to the case of interval neutrosophic set and we’ll study some new similarity measures.

This paper is organized as follows. In section 2, we review some notions of neutrosophic set and interval valued neutrosophic set. In section 3, some new similarity measures of interval valued neutrosophic sets and their proofs are introduced. Finally, the conclusions are stated in section 4.

II. PRELIMIAIRIES

This section gives a brief overview of the concepts of neutrosophic set, and interval valued neutrosophic set.

A. Neutrosophic Sets

1) Definition [1]

Let X be a universe of discourse, with a generic element in X denoted by x, then a neutrosophic set A is an object having the form:

$A = \{ \langle x: T_A(x), I_A(x), F_A(x) \rangle, x \in X \}$, where the functions $T, I, F : X \rightarrow]0, 1^+[$ define respectively the degree of membership (or Truth), the degree of indeterminacy, and the degree of non-membership (or Falsehood) of the element $x \in X$ to the set A with the condition:

$$0 \leq T_A(x) + I_A(x) + F_A(x) \leq 3^+ \tag{1}$$

From philosophical point of view, the neutrosophic set takes the value from real standard or non-standard subsets of $]0, 1^+[$. Therefore, instead of $]0, 1^+[$ we need to take the interval $[0, 1]$ for technical applications, because $]0, 1^+[$ will

be difficult to apply in the real applications such as in scientific and engineering problems.

For two NSs, $A_{NS} = \{ \langle x, T_A(x), I_A(x), F_A(x) \rangle \mid x \in X \}$ (2)

and $B_{NS} = \{ \langle x, T_B(x), I_B(x), F_B(x) \rangle \mid x \in X \}$ the two relations are defined as follows:

(1) $A_{NS} \subseteq B_{NS}$ if and only if $T_A(x) \leq T_B(x), I_A(x) \geq I_B(x), F_A(x) \geq F_B(x)$.

(2) $A_{NS} = B_{NS}$ if and only if, $T_A(x) = T_B(x), I_A(x) = I_B(x), F_A(x) = F_B(x)$.

B. Interval Valued Neutrosophic Sets

In actual applications, sometimes, it is not easy to express the truth-membership, indeterminacy-membership and falsity-membership by crisp value, and they may be easier to be expressed by interval numbers. Wang et al. [6] further defined interval neutrosophic sets (INS) shows as follows:

1) Definition [6]

Let X be a universe of discourse, with generic element in X denoted by x . An interval valued neutrosophic set (for short IVNS) A in X is characterized by truth-membership function $T_A(x)$, indeterminacy-membership function $I_A(x)$, and falsity-membership function $F_A(x)$. For each point x in X , we have that $T_A(x), I_A(x), F_A(x) \in [0, 1]$.

For two IVNS, $A_{IVNS} = \{ \langle x, [T_A^L(x), T_A^U(x)], [I_A^L(x), I_A^U(x)], [F_A^L(x), F_A^U(x)] \rangle \mid x \in X \}$ (3)

and $B_{IVNS} = \{ \langle x, [T_B^L(x), T_B^U(x)], [I_B^L(x), I_B^U(x)], [F_B^L(x), F_B^U(x)] \rangle \mid x \in X \}$ the two relations are defined as follows:

$$d_\lambda(A, B) = \left\{ \frac{1}{6} \sum_{i=1}^n w_i [|T_A^L(x_i) - T_B^L(x_i)|^\lambda + |T_A^U(x_i) - T_B^U(x_i)|^\lambda + |I_A^L(x_i) - I_B^L(x_i)|^\lambda + |I_A^U(x_i) - I_B^U(x_i)|^\lambda + |F_A^L(x_i) - F_B^L(x_i)|^\lambda + |F_A^U(x_i) - F_B^U(x_i)|^\lambda] \right\}^{\frac{1}{\lambda}} \tag{5}$$

The normalized generalized interval neutrosophic distance is

$$d_\lambda(A, B) = \left\{ \frac{1}{6n} \sum_{i=1}^n w_i [|T_A^L(x_i) - T_B^L(x_i)|^\lambda + |T_A^U(x_i) - T_B^U(x_i)|^\lambda + |I_A^L(x_i) - I_B^L(x_i)|^\lambda + |I_A^U(x_i) - I_B^U(x_i)|^\lambda + |F_A^L(x_i) - F_B^L(x_i)|^\lambda + |F_A^U(x_i) - F_B^U(x_i)|^\lambda] \right\}^{\frac{1}{\lambda}} \tag{6}$$

If $w = \{ \frac{1}{n}, \frac{1}{n}, \dots, \frac{1}{n} \}$, the distance (6) is reduced to the following distances:

$$d_\lambda(A, B) = \left\{ \frac{1}{6} \sum_{i=1}^n [|T_A^L(x_i) - T_B^L(x_i)|^\lambda + |T_A^U(x_i) - T_B^U(x_i)|^\lambda + |I_A^L(x_i) - I_B^L(x_i)|^\lambda + |I_A^U(x_i) - I_B^U(x_i)|^\lambda + |F_A^L(x_i) - F_B^L(x_i)|^\lambda + |F_A^U(x_i) - F_B^U(x_i)|^\lambda] \right\}^{\frac{1}{\lambda}} \tag{7}$$

$$d_\lambda(A, B) = \left\{ \frac{1}{6n} \sum_{i=1}^n [|T_A^L(x_i) - T_B^L(x_i)|^\lambda + |T_A^U(x_i) - T_B^U(x_i)|^\lambda + |I_A^L(x_i) - I_B^L(x_i)|^\lambda + |I_A^U(x_i) - I_B^U(x_i)|^\lambda + |F_A^L(x_i) - F_B^L(x_i)|^\lambda + |F_A^U(x_i) - F_B^U(x_i)|^\lambda] \right\}^{\frac{1}{\lambda}} \tag{8}$$

Particular case.

(1) $A_{IVNS} \subseteq B_{IVNS}$ if and only if $T_A^L(x) \leq T_B^L(x), T_A^U(x) \leq T_B^U(x), I_A^L(x) \geq I_B^L(x), I_A^U(x) \geq I_B^U(x), F_A^L(x) \geq F_B^L(x), F_A^U(x) \geq F_B^U(x)$.

(2) $A_{IVNS} = B_{IVNS}$ if and only if $T_A^L(x_i) = T_B^L(x_i), T_A^U(x_i) = T_B^U(x_i), I_A^L(x_i) = I_B^L(x_i), I_A^U(x_i) = I_B^U(x_i), F_A^L(x_i) = F_B^L(x_i)$ and $F_A^U(x_i) = F_B^U(x_i)$ for any $x \in X$.

C. Definition

Let A and B be two interval valued neutrosophic sets, then

- i. $0 \leq S(A, B) \leq 1$.
- ii. $S(A, B) = S(B, A)$.
- iii. $S(A, B) = 1$ if $A = B$, i.e

$$T_A^L(x_i) = T_B^L(x_i), T_A^U(x_i) = T_B^U(x_i), I_A^L(x_i) = I_B^L(x_i), I_A^U(x_i) = I_B^U(x_i) \text{ and } F_A^L(x_i) = F_B^L(x_i), F_A^U(x_i) = F_B^U(x_i), \text{ for } i = 1, 2, \dots, n.$$

iv. $A \subset B \subset C \Rightarrow S(A, B) \leq \min(S(A, C), S(B, C))$.

III. NEW DISTANCE MEASURE OF INTERVAL VALUED NEUTROSOPHIC SETS

Let A and B be two single neutrosophic sets, then J. Ye [11] proposed a generalized single valued neutrosophic weighted distance measure between A and B as follows:

$$d_\lambda(A, B) = \left\{ \frac{1}{3} \sum_{i=1}^n w_i [|T_A(x_i) - T_B(x_i)|^\lambda + |I_A(x_i) - I_B(x_i)|^\lambda + |F_A(x_i) - F_B(x_i)|^\lambda] \right\}^{\frac{1}{\lambda}} \tag{4}$$

where

$\lambda > 0$ and $T_A(x_i), I_A(x_i), F_A(x_i), T_B(x_i), I_B(x_i), F_B(x_i) \in [0, 1]$.

Based on the geometrical distance model and using the interval neutrosophic sets, we extended the distance (4) as follows:

(i) If $\lambda = 1$ then the distances (7) and (8) are reduced to the following Hamming distance and respectively normalized Hamming distance defined by Ye Jun [11]:

$$d_H(A, B) = \left\{ \frac{1}{6} \sum_{i=1}^n [|T_A^L(x_i) - T_B^L(x_i)| + |T_A^U(x_i) - T_B^U(x_i)| + |I_A^L(x_i) - I_B^L(x_i)| + |I_A^U(x_i) - I_B^U(x_i)| + |F_A^L(x_i) - F_B^L(x_i)| + |F_A^U(x_i) - F_B^U(x_i)|] \right\}, \tag{9}$$

$$d_{NH}(A, B) = \left\{ \frac{1}{6n} \sum_{i=1}^n [|T_A^L(x_i) - T_B^L(x_i)| + |T_A^U(x_i) - T_B^U(x_i)| + |I_A^L(x_i) - I_B^L(x_i)| + |I_A^U(x_i) - I_B^U(x_i)| + |F_A^L(x_i) - F_B^L(x_i)| + |F_A^U(x_i) - F_B^U(x_i)|] \right\}. \tag{10}$$

(ii) If $\lambda = 2$ then the distances (7) and (8) are reduced to the following Euclidean distance and respectively normalized Euclidean distance defined by Ye Jun [12]:

$$d_E(A, B) = \left\{ \frac{1}{6} \sum_{i=1}^n [|T_A^L(x_i) - T_B^L(x_i)|^2 + |T_A^U(x_i) - T_B^U(x_i)|^2 + |I_A^L(x_i) - I_B^L(x_i)|^2 + |I_A^U(x_i) - I_B^U(x_i)|^2 + |F_A^L(x_i) - F_B^L(x_i)|^2 + |F_A^U(x_i) - F_B^U(x_i)|^2] \right\}^{\frac{1}{2}}, \tag{11}$$

$$d_{NE}(A, B) = \left\{ \frac{1}{6n} \sum_{i=1}^n [|T_A^L(x_i) - T_B^L(x_i)|^2 + |T_A^U(x_i) - T_B^U(x_i)|^2 + |I_A^L(x_i) - I_B^L(x_i)|^2 + |I_A^U(x_i) - I_B^U(x_i)|^2 + |F_A^L(x_i) - F_B^L(x_i)|^2 + |F_A^U(x_i) - F_B^U(x_i)|^2] \right\}^{\frac{1}{2}}. \tag{12}$$

IV. NEW SIMILARITY MEASURES OF INTERVAL VALUED NEUTROSOPHIC SET

A. Similarity measure based on the geometric distance model

Based on distance (4), we define the similarity measure between the interval valued neutrosophic sets A and B as follows:

$$S_{DM}(A, B) = 1 - \left\{ \frac{1}{6n} \sum_{i=1}^n \left[|T_A^L(x_i) - T_B^L(x_i)|^\lambda + |T_A^U(x_i) - T_B^U(x_i)|^\lambda + |I_A^L(x_i) - I_B^L(x_i)|^\lambda + |I_A^U(x_i) - I_B^U(x_i)|^\lambda + |F_A^L(x_i) - F_B^L(x_i)|^\lambda + |F_A^U(x_i) - F_B^U(x_i)|^\lambda \right] \right\}^{\frac{1}{\lambda}}, \tag{13}$$

where $\lambda > 0$ and $S_{DM}(A, B)$ is the degree of similarity of A and B .

If we take the weight of each element $x_i \in X$ into account, then

$$S_{DM}^w(A, B) = 1 - \left\{ \frac{1}{6} \sum_{i=1}^n w_i \left[|T_A^L(x_i) - T_B^L(x_i)|^\lambda + |T_A^U(x_i) - T_B^U(x_i)|^\lambda + |I_A^L(x_i) - I_B^L(x_i)|^\lambda + |I_A^U(x_i) - I_B^U(x_i)|^\lambda + |F_A^L(x_i) - F_B^L(x_i)|^\lambda + |F_A^U(x_i) - F_B^U(x_i)|^\lambda \right] \right\}^{\frac{1}{\lambda}}. \tag{14}$$

If each elements has the same importance, i.e. $w = \left\{ \frac{1}{n}, \frac{1}{n}, \dots, \frac{1}{n} \right\}$, then similarity (14) reduces to (13).

By (definition C) it can easily be known that $S_{DM}(A, B)$ satisfies all the properties of the definition..

Similarly, we define another similarity measure of A and B, as:

$$S(A, B) = 1 - \left[\frac{\sum_{i=1}^n (|T_A^L(x_i) - T_B^L(x_i)|^\lambda + |T_A^U(x_i) - T_B^U(x_i)|^\lambda + |I_A^L(x_i) - I_B^L(x_i)|^\lambda + |I_A^U(x_i) - I_B^U(x_i)|^\lambda + |F_A^L(x_i) - F_B^L(x_i)|^\lambda + |F_A^U(x_i) - F_B^U(x_i)|^\lambda)}{\sum_{i=1}^n (|T_A^L(x_i) + T_B^L(x_i)|^\lambda + |T_A^U(x_i) + T_B^U(x_i)|^\lambda + |I_A^L(x_i) + I_B^L(x_i)|^\lambda + |I_A^U(x_i) + I_B^U(x_i)|^\lambda + |F_A^L(x_i) + F_B^L(x_i)|^\lambda + |F_A^U(x_i) + F_B^U(x_i)|^\lambda)} \right]^{\frac{1}{\lambda}}. \tag{15}$$

If we take the weight of each element $x_i \in X$ into account, then

$$S(A, B) = 1 - \left[\frac{\sum_{i=1}^n w_i (|T_A^L(x_i) - T_B^L(x_i)|^\lambda + |T_A^U(x_i) - T_B^U(x_i)|^\lambda + |I_A^L(x_i) - I_B^L(x_i)|^\lambda + |I_A^U(x_i) - I_B^U(x_i)|^\lambda + |F_A^L(x_i) - F_B^L(x_i)|^\lambda + |F_A^U(x_i) - F_B^U(x_i)|^\lambda)}{\sum_{i=1}^n w_i (|T_A^L(x_i) + T_B^L(x_i)|^\lambda + |T_A^U(x_i) + T_B^U(x_i)|^\lambda + |I_A^L(x_i) + I_B^L(x_i)|^\lambda + |I_A^U(x_i) + I_B^U(x_i)|^\lambda + |F_A^L(x_i) + F_B^L(x_i)|^\lambda + |F_A^U(x_i) + F_B^U(x_i)|^\lambda)} \right]^{\frac{1}{\lambda}}. \tag{16}$$

It also has been proved that all conditions of the definition are satisfied. If each elements has the same importance, and then the similarity (16) reduces to (15).

B. Similarity measure based on the interval valued neutrosophic theoretic approach:

In this section, following the similarity measure between two neutrosophic sets defined by P. Majumdar in [24], we extend Majumdar's definition to interval valued neutrosophic sets.

Let A and B be two interval valued neutrosophic sets, then we define a similarity measure between A and B as follows:

$$S_{TA}(A, B) = \frac{\sum_{i=1}^n (\min\{T_A^L(x_i), T_B^L(x_i)\} + \min\{T_A^U(x_i), T_B^U(x_i)\} + \min\{I_A^L(x_i), I_B^L(x_i)\} + \min\{I_A^U(x_i), I_B^U(x_i)\} + \min\{F_A^L(x_i), F_B^L(x_i)\} + \min\{F_A^U(x_i), F_B^U(x_i)\})}{\sum_{i=1}^n (\max\{T_A^L(x_i), T_B^L(x_i)\} + \max\{T_A^U(x_i), T_B^U(x_i)\} + \max\{I_A^L(x_i), I_B^L(x_i)\} + \max\{I_A^U(x_i), I_B^U(x_i)\} + \max\{F_A^L(x_i), F_B^L(x_i)\} + \max\{F_A^U(x_i), F_B^U(x_i)\})} \quad (17)$$

1) Proposition

Let A and B be two interval valued neutrosophic sets, then

iv. $0 \leq S_{TA}(A, B) \leq 1$.

v. $S_{TA}(A, B) = S_{TA}(B, A)$.

vi. $S(A, B) = 1$ if $A = B$ i.e.

$T_A^L(x_i) = T_B^L(x_i), T_A^U(x_i) = T_B^U(x_i), I_A^L(x_i) = I_B^L(x_i), I_A^U(x_i) = I_B^U(x_i)$ and $F_A^L(x_i) = F_B^L(x_i), F_A^U(x_i) = F_B^U(x_i)$ for $i = 1, 2, \dots, n$.

iv. $A \subset B \subset C \Rightarrow S_{TA}(A, B) \leq \min(S_{TA}(A, B), S_{TA}(B, C))$.

Proof. Properties (i) and (ii) follow from the definition.

(iii) It is clearly that if $A = B \Rightarrow S_{TA}(A, B) = 1$

$$\begin{aligned} &\Rightarrow \sum_{i=1}^n \{ \min\{T_A^L(x_i), T_B^L(x_i)\} + \min\{T_A^U(x_i), T_B^U(x_i)\} + \min\{I_A^L(x_i), I_B^L(x_i)\} + \min\{I_A^U(x_i), I_B^U(x_i)\} + \min\{F_A^L(x_i), F_B^L(x_i)\} + \min\{F_A^U(x_i), F_B^U(x_i)\} \\ &= \sum_{i=1}^n \{ \max\{T_A^L(x_i), T_B^L(x_i)\} + \max\{T_A^U(x_i), T_B^U(x_i)\} + \max\{I_A^L(x_i), I_B^L(x_i)\} + \max\{I_A^U(x_i), I_B^U(x_i)\} + \max\{F_A^L(x_i), F_B^L(x_i)\} + \max\{F_A^U(x_i), F_B^U(x_i)\} \\ &\Rightarrow \sum_{i=1}^n \{ [\min\{T_A^L(x_i), T_B^L(x_i)\} - \max\{T_A^L(x_i), T_B^L(x_i)\}] + [\min\{T_A^U(x_i), T_B^U(x_i)\} - \max\{T_A^U(x_i), T_B^U(x_i)\}] + [\min\{I_A^L(x_i), I_B^L(x_i)\} - \max\{I_A^L(x_i), I_B^L(x_i)\}] \\ &+ [\min\{I_A^U(x_i), I_B^U(x_i)\} - \max\{I_A^U(x_i), I_B^U(x_i)\}] + [\min\{F_A^L(x_i), F_B^L(x_i)\} - \max\{F_A^L(x_i), F_B^L(x_i)\}] + [\min\{F_A^U(x_i), F_B^U(x_i)\} - \max\{F_A^U(x_i), F_B^U(x_i)\}] \} = 0. \end{aligned}$$

Thus for each x, one has that

$$\begin{aligned} [\min\{T_A^L(x_i), T_B^L(x_i)\} - \max\{T_A^L(x_i), T_B^L(x_i)\}] &= 0 \\ [\min\{T_A^U(x_i), T_B^U(x_i)\} - \max\{T_A^U(x_i), T_B^U(x_i)\}] &= 0 \\ [\min\{I_A^L(x_i), I_B^L(x_i)\} - \max\{I_A^L(x_i), I_B^L(x_i)\}] &= 0 \\ [\min\{I_A^U(x_i), I_B^U(x_i)\} - \max\{I_A^U(x_i), I_B^U(x_i)\}] &= 0 \\ [\min\{F_A^L(x_i), F_B^L(x_i)\} - \max\{F_A^L(x_i), F_B^L(x_i)\}] &= 0 \\ [\min\{F_A^U(x_i), F_B^U(x_i)\} - \max\{F_A^U(x_i), F_B^U(x_i)\}] &= 0 \end{aligned}$$

hold.

Thus $T_A^L(x_i) = T_B^L(x_i), T_A^U(x_i) = T_B^U(x_i), I_A^L(x_i) = I_B^L(x_i), I_A^U(x_i) = I_B^U(x_i), F_A^L(x_i) = F_B^L(x_i)$ and $F_A^U(x_i) = F_B^U(x_i) \Rightarrow A=B$

(iv) Now we prove the last result.

Let $A \subset B \subset C$, then we have

$$T_A^L(x) \leq T_B^L(x) \leq T_C^L(x), T_A^U(x) \leq T_B^U(x) \leq T_C^U(x), I_A^L(x) \geq I_B^L(x) \geq I_C^L(x), I_A^U(x) \geq I_B^U(x) \geq I_C^U(x), F_A^L(x) \geq F_B^L(x) \geq F_C^L(x), F_A^U(x) \geq F_B^U(x) \geq F_C^U(x) \text{ for all } x \in X.$$

Now

$$T_A^L(x) + T_A^U(x) + I_A^L(x) + I_A^U(x) + F_B^L(x) + F_B^U(x) \geq T_A^L(x) + T_A^U(x) + I_A^L(x) + I_A^U(x) + F_C^L(x) + F_C^U(x)$$

and

$$T_B^L(x) + T_B^U(x) + I_B^L(x) + I_B^U(x) + F_A^L(x) + F_A^U(x) \geq T_C^L(x) + T_C^U(x) + I_C^L(x) + I_C^U(x) + F_A^L(x) + F_A^U(x).$$

$$S(A, B) = \frac{T_A^L(x) + T_A^U(x) + I_A^L(x) + I_A^U(x) + F_B^L(x) + F_B^U(x)}{T_B^L(x) + T_B^U(x) + I_B^L(x) + I_B^U(x) + F_A^L(x) + F_A^U(x)} \geq \frac{T_A^L(x) + T_A^U(x) + I_A^L(x) + I_A^U(x) + F_C^L(x) + F_C^U(x)}{T_C^L(x) + T_C^U(x) + I_C^L(x) + I_C^U(x) + F_A^L(x) + F_A^U(x)} = S(A, C).$$

Again, similarly we have

$$\begin{aligned} T_B^L(x) + T_B^U(x) + I_B^L(x) + I_B^U(x) + F_C^L(x) + F_C^U(x) &\geq T_A^L(x) + T_A^U(x) + I_A^L(x) + I_A^U(x) + F_C^L(x) + F_C^U(x) \\ T_C^L(x) + T_C^U(x) + I_C^L(x) + I_C^U(x) + F_A^L(x) + F_A^U(x) &\geq T_C^L(x) + T_C^U(x) + I_C^L(x) + I_C^U(x) + F_B^L(x) + F_B^U(x) \\ S(B, C) = \frac{T_B^L(x) + T_B^U(x) + I_B^L(x) + I_B^U(x) + F_C^L(x) + F_C^U(x)}{T_C^L(x) + T_C^U(x) + I_C^L(x) + I_C^U(x) + F_B^L(x) + F_B^U(x)} &\geq \frac{T_A^L(x) + T_A^U(x) + I_A^L(x) + I_A^U(x) + F_C^L(x) + F_C^U(x)}{T_C^L(x) + T_C^U(x) + I_C^L(x) + I_C^U(x) + F_A^L(x) + F_A^U(x)} = S(A, C) \end{aligned}$$

$$\Rightarrow S_{TA}(A, B) \leq \min(S_{TA}(A, B), S_{TA}(B, C)).$$

Hence the proof of this proposition.

If we take the weight of each element $x_i \in X$ into account, then

$$S(A, B) = \frac{\sum_{i=1}^n w_i \{\min\{T_A^L(x_i), T_B^L(x_i)\} + \min\{T_A^U(x_i), T_B^U(x_i)\} + \min\{I_A^L(x_i), I_B^L(x_i)\} + \min\{I_A^U(x_i), I_B^U(x_i)\} + \min\{F_A^L(x_i), F_B^L(x_i)\} + \min\{F_A^U(x_i), F_B^U(x_i)\}\}}{\sum_{i=1}^n w_i \{\max\{T_A^L(x_i), T_B^L(x_i)\} + \max\{T_A^U(x_i), T_B^U(x_i)\} + \max\{I_A^L(x_i), I_B^L(x_i)\} + \max\{I_A^U(x_i), I_B^U(x_i)\} + \max\{F_A^L(x_i), F_B^L(x_i)\} + \max\{F_A^U(x_i), F_B^U(x_i)\}\}} \tag{18}$$

Particularly, if each element has the same importance, then (18) is reduced to (17), clearly this also satisfies all the properties of the definition.

C. Similarity measure based on matching function by using interval neutrosophic sets:

Chen [24] and Chen et al. [25] introduced a matching function to calculate the degree of similarity between fuzzy

$$S_{MF}(A, B) = \frac{\sum_{i=1}^n \left((T_A^L(x_i) \cdot T_B^L(x_i)) + (T_A^U(x_i) \cdot T_B^U(x_i)) + (I_A^L(x_i) \cdot I_B^L(x_i)) + (I_A^U(x_i) \cdot I_B^U(x_i)) + (F_A^L(x_i) \cdot F_B^L(x_i)) + (F_A^U(x_i) \cdot F_B^U(x_i)) \right)}{\max(\sum_{i=1}^n (T_A^L(x_i)^2 + T_A^U(x_i)^2 + I_A^L(x_i)^2 + I_A^U(x_i)^2 + F_A^L(x_i)^2 + F_A^U(x_i)^2), \sum_{i=1}^n (T_B^L(x_i)^2 + T_B^U(x_i)^2 + I_B^L(x_i)^2 + I_B^U(x_i)^2 + F_B^L(x_i)^2 + F_B^U(x_i)^2))} \tag{19}$$

Proof.

i. $0 \leq S_{MF}(A, B) \leq 1$.

The inequality $S_{MF}(A, B) \geq 0$ is obvious. Thus, we only prove the inequality $S(A, B) \leq 1$.

$$S_{MF}(A, B) = \sum_{i=1}^n \left((T_A^L(x_i) \cdot T_B^L(x_i)) + (T_A^U(x_i) \cdot T_B^U(x_i)) + (I_A^L(x_i) \cdot I_B^L(x_i)) + (I_A^U(x_i) \cdot I_B^U(x_i)) + (F_A^L(x_i) \cdot F_B^L(x_i)) + (F_A^U(x_i) \cdot F_B^U(x_i)) \right) \\ = T_A^L(x_1) \cdot T_B^L(x_1) + T_A^L(x_2) \cdot T_B^L(x_2) + \dots + T_A^L(x_n) \cdot T_B^L(x_n) + T_A^U(x_1) \cdot T_B^U(x_1) + T_A^U(x_2) \cdot T_B^U(x_2) + \dots + T_A^U(x_n) \cdot T_B^U(x_n) + \\ I_A^L(x_1) \cdot I_B^L(x_1) + I_A^L(x_2) \cdot I_B^L(x_2) + \dots + I_A^L(x_n) \cdot I_B^L(x_n) + I_A^U(x_1) \cdot I_B^U(x_1) + I_A^U(x_2) \cdot I_B^U(x_2) + \dots + I_A^U(x_n) \cdot I_B^U(x_n) + \\ F_A^L(x_1) \cdot F_B^L(x_1) + F_A^L(x_2) \cdot F_B^L(x_2) + \dots + F_A^L(x_n) \cdot F_B^L(x_n) + F_A^U(x_1) \cdot F_B^U(x_1) + F_A^U(x_2) \cdot F_B^U(x_2) + \dots + F_A^U(x_n) \cdot F_B^U(x_n).$$

According to the Cauchy–Schwarz inequality:

$$(x_1 \cdot y_1 + x_2 \cdot y_2 + \dots + x_n \cdot y_n)^2 \leq (x_1^2 + x_2^2 + \dots + x_n^2) \cdot (y_1^2 + y_2^2 + \dots + y_n^2)$$

where $(x_1, x_2, \dots, x_n) \in R^n$ and $(y_1, y_2, \dots, y_n) \in R^n$

we can obtain

$$[S_{MF}(A, B)]^2 \leq \sum_{i=1}^n (T_A^L(x_i)^2 + T_A^U(x_i)^2 + I_A^L(x_i)^2 + I_A^U(x_i)^2 + F_A^L(x_i)^2 + F_A^U(x_i)^2) \cdot \sum_{i=1}^n (T_B^L(x_i)^2 + T_B^U(x_i)^2 + I_B^L(x_i)^2 + I_B^U(x_i)^2 + F_B^L(x_i)^2 + F_B^U(x_i)^2) = S(A, A) \cdot S(B, B)$$

Thus $S_{MF}(A, B) \leq [S(A, A)]^{\frac{1}{2}} \cdot [S(B, B)]^{\frac{1}{2}}$.

Then $S_{MF}(A, B) \leq \max\{S(A, A), S(B, B)\}$.

Therefore $S_{MF}(A, B) \leq 1$.

If we take the weight of each element $x_i \in X$ into account, then

$$S_{MF}^w(A, B) = \frac{\sum_{i=1}^n w_i \left((T_A^L(x_i) \cdot T_B^L(x_i)) + (T_A^U(x_i) \cdot T_B^U(x_i)) + (I_A^L(x_i) \cdot I_B^L(x_i)) + (I_A^U(x_i) \cdot I_B^U(x_i)) + (F_A^L(x_i) \cdot F_B^L(x_i)) + (F_A^U(x_i) \cdot F_B^U(x_i)) \right)}{\max(\sum_{i=1}^n w_i (T_A^L(x_i)^2 + T_A^U(x_i)^2 + I_A^L(x_i)^2 + I_A^U(x_i)^2 + F_A^L(x_i)^2 + F_A^U(x_i)^2), \sum_{i=1}^n w_i (T_B^L(x_i)^2 + T_B^U(x_i)^2 + I_B^L(x_i)^2 + I_B^U(x_i)^2 + F_B^L(x_i)^2 + F_B^U(x_i)^2))} \tag{20}$$

Particularly, if each element has the same importance, then the similarity (20) is reduced to (19). Clearly this also satisfies all the properties of definition.

The larger the value of $S(A, B)$, the more the similarity between A and B.

V. COMPARISON OF NEW SIMILARITY MEASURE OF IVNS WITH THE EXISTING MEASURES.

Let A and B be two interval valued neutrosophic sets in the universe of discourse $X = \{x_1, x_2, \dots, x_n\}$. The new similarity $S_{TA}(A, B)$ of IVNS and the existing similarity measures of

sets. In the following, we extend the matching function to deal with the similarity measure of interval valued neutrosophic sets.

Let A and B be two interval valued neutrosophic sets, then we define a similarity measure between A and B as follows:

interval valued neutrosophic sets (examples 1 and 2) introduced in [10, 12, 23] are listed as follows:

Pinaki similarity I:

this similarity measure was proposed as concept of association coefficient of the neutrosophic sets as follows

$$S_{PI} = \frac{\sum_{i=1}^n \{\min\{T_A(x_i), T_B(x_i)\} + \min\{I_A(x_i), I_B(x_i)\} + \min\{F_A(x_i), F_B(x_i)\}\}}{\sum_{i=1}^n \{\max\{T_A(x_i), T_B(x_i)\} + \max\{I_A(x_i), I_B(x_i)\} + \max\{F_A(x_i), F_B(x_i)\}\}} \tag{21}$$

Broumi and Smarandache cosine similarity:

$$C_N(A, B) = \frac{1}{n} \sum_{i=1}^n \frac{(T_A^L(x_i) + T_A^U(x_i))(T_B^L(x_i) + T_B^U(x_i)) + (I_A^L(x_i) + I_A^U(x_i))(I_B^L(x_i) + I_B^U(x_i)) + (F_A^L(x_i) + F_A^U(x_i))(F_B^L(x_i) + F_B^U(x_i))}{\sqrt{(T_A^L(x_i) + T_A^U(x_i))^2 + (I_A^L(x_i) + I_A^U(x_i))^2 + (F_A^L(x_i) + F_A^U(x_i))^2} \sqrt{(T_B^L(x_i) + T_B^U(x_i))^2 + (I_B^L(x_i) + I_B^U(x_i))^2 + (F_B^L(x_i) + F_B^U(x_i))^2}} \tag{22}$$

Ye similarity

$$S_{ye}(A, B) = 1 - \frac{1}{6} \sum_{i=1}^n [|\inf T_A(x_i) - \inf T_B(x_i)| + |\sup T_A(x_i) - \sup T_B(x_i)| + |\inf I_A(x_i) - \inf I_B(x_i)| + |\sup I_A(x_i) - \sup I_B(x_i)| + |\inf F_A(x_i) - \inf F_B(x_i)| + |\sup F_A(x_i) - \sup F_B(x_i)|] \tag{23}$$

Example 1

Let $A = \{ \langle x, (a, 0.2, 0.6, 0.6), (b, 0.5, 0.3, 0.3), (c, 0.6, 0.9, 0.5) \rangle \}$

and $B = \{ \langle x, (a, 0.5, 0.3, 0.8), (b, 0.6, 0.2, 0.5), (c, 0.6, 0.4, 0.4) \rangle \}$.

Pinaki similarity $I = 0.6$.

$S_{ye}(A, B) = 0.38$ (With $w_i = 1$).

Cosine similarity $C_N(A, B) = 0.95$.

$S_{TA}(A, B) = 0.8$.

Example 2:

Let $A = \{ \langle x, (a, [0.2, 0.3], [0.2, 0.6], [0.6, 0.8]), (b, [0.5, 0.7], [0.3, 0.5], [0.3, 0.6]), (c, [0.6, 0.9], [0.3, 0.9], [0.3, 0.5]) \rangle \}$ and

$B = \{ \langle x, (a, [0.5, 0.3], [0.3, 0.6], [0.6, 0.8]), (b, [0.6, 0.8], [0.2, 0.4], [0.5, 0.6]), (c, [0.6, 0.9], [0.3, 0.4], [0.4, 0.6]) \rangle \}$.

Pinaki similarity $I = NA$.

$S_{ye}(A, B) = 0.7$ (With $w_i = 1$).

Cosine similarity $C_N(A, B) = 0.92$.

$S_{TA}(A, B) = 0.9$.

On the basis of computational study Jun Ye [12] has shown that their measure is more effective and reasonable. A similar kind of study with the help of the proposed new measure based on theoretic approach, it has been done and it is found that the obtained results are more refined and accurate. It may be observed from the above examples that the values of similarity measures are closer to 1 with $S_{TA}(A, B)$ which is this proposed similarity measure.

VI. CONCLUSIONS

Few distance and similarity measures have been proposed in literature for measuring the distance and the degree of similarity between interval neutrosophic sets. In this paper, we proposed a new method for distance and similarity measure for measuring the degree of similarity between two weighted interval valued neutrosophic sets, and we have extended the work of Pinaki, Majumdar and S. K. Samant and Chen. The results of the proposed similarity measure and existing

similarity measure are compared.

In the future, we will use the similarity measures which are proposed in this paper in group decision making

VII. ACKNOWLEDGMENT

The authors are very grateful to the anonymous referees for their insightful and constructive comments and suggestions, which have been very helpful in improving the paper.

VIII. REFERENCES

- [1] F. Smarandache, "A Unifying Field in Logics. Neutrosophy: Neutrosophic Probability, Set and Logic". Rehoboth: American Research Press, (1998).
- [2] L. A. Zadeh, "Fuzzy Sets". Information and Control, 8, (1965), pp. 338-353.
- [3] Turksen, "Interval valued fuzzy sets based on normal forms". Fuzzy Sets and Systems, 20, (1968), pp.191-210.
- [4] Atanassov, K. "Intuitionistic fuzzy sets". Fuzzy Sets and Systems, 20, (1986), pp. 87-96.
- [5] Atanassov, K., & Gargov, G "Interval valued intuitionistic fuzzy sets". Fuzzy Sets and Systems. International Journal of General Systems 393, 31,(1998), pp. 343-349
- [6] Wang, H., Smarandache, F., Zhang, Y.-Q. and Sunderraman, R., "Interval Neutrosophic Sets and Logic: Theory and Applications in Computing", Hexis, Phoenix, AZ, (2005).
- [7] A. Kharal, "A Neutrosophic Multicriteria Decision Making Method", New Mathematics & Natural Computation, to appear in Nov. 2013.
- [8] S. Broumi and F. Smarandache, "Intuitionistic Neutrosophic Soft Set", Journal of Information and Computing Science, England, UK, ISSN 1746-7659, Vol. 8, No. 2, (2013), pp. 130-140.
- [9] S.Broumi, "Generalized Neutrosophic Soft Set", International Journal of Computer Science, Engineering and Information Technology (IJCEIT), ISSN: 2231-3605, E-ISSN: 2231-3117, Vol.3, No.2, (2013), pp. 17-30.
- [10] S. Broumi and F. Smarandache, "Cosine similarity measure of interval valued neutrosophic sets", 2014 (submitted).
- [11] J. Ye. "Single valued neutrosophic minimum spanning tree and its clustering method" De Gruyter journal of intelligent system, (2013), pp. 1-24.

- [12] J. Ye, "Similarity measures between interval neutrosophic sets and their multicriteria decision-making method "Journal of Intelligent & Fuzzy Systems, DOI: 10.3233/IFS-120724 ,(2013), pp.587–595.
- [13] M. Arora, R. Biswas, U. S. Pandey, "Neutrosophic Relational Database Decomposition", International Journal of Advanced Computer Science and Applications, Vol. 2, No. 8, (2011) 121-125.
- [14] M. Arora and R. Biswas, "Deployment of Neutrosophic technology to retrieve answers for queries posed in natural language", in 3rd International Conference on Computer Science and Information Technology ICCSIT, IEEE catalog Number CFP1057E-art, Vol.3, ISBN: 978-1-4244-5540-9,(2010) 435-439.
- [15] Ansari, Biswas, Aggarwal, "Proposal for Applicability of Neutrosophic Set Theory in Medical AI", International Journal of Computer Applications (0975 – 8887), Vol. 27–No.5, (2011) 5-11.
- [16] F. G. Lupiáñez, "On neutrosophic topology", Kybernetes, Vol. 37, Iss: 6, (2008), pp. 797 - 800, Doi: 10.1108/03684920810876990.
- [17] S. Aggarwal, R. Biswas, A. Q. Ansari, "Neutrosophic Modeling and Control", 978-1-4244-9034-/10 IEEE, (2010), pp. 718-723.
- [18] H. D. Cheng, & Y. Guo. "A new neutrosophic approach to image thresholding". New Mathematics and Natural Computation, 4(3), (2008), pp.291–308.
- [19] Y. Guo, & H. D. Cheng "New neutrosophic approach to image segmentation". Pattern Recognition, 42, (2009), pp.1510-1517.
- [20] M. Zhang, L. Zhang, and H. D. Cheng. "A neutrosophic approach to image segmentation based on watershed method". Signal Processing 5, 90, (2010), pp. 410–413.
- [21] Wang, H., Smarandache, F., Zhang, Y. Q., Sunderraman, R, "Single valued neutrosophic sets". Multispace and Multistructure, 4 (2010), pp. 410–413.
- [22] S. Broumi, F. Smarandache, "Correlation Coefficient of Interval Neutrosophic set", Periodical of Applied Mechanics and Materials, Vol. 436, 2013, with the title Engineering Decisions and Scientific Research in Aerospace, Robotics, Biomechanics, Mechanical Engineering and Manufacturing; Proceedings of the International Conference ICMERA, Bucharest, October 2013.
- [23] P. Majumdar, S.K. Samant, "On similarity and entropy of neutrosophic sets", Journal of Intelligent and Fuzzy Systems, 1064-1246(Print)-1875-8967(Online), (2013), DOI:10.3233/IFS-130810, IOS Press.
- [24] S.M. Chen, S. M. Yeh and P.H. Hsiao, "A comparison of similarity measure of fuzzy values" Fuzzy sets and systems, 72, 1995. 79-89.
- [25] S.M. Chen, "A new approach to handling fuzzy decision making problem", IEEE transactions on Systems, man and cybernetics, 18, 1988. , pp. 1012-1016.
- [26] Said Broumi, and Florentin Smarandache, "Several Similarity Measures of Neutrosophic Sets", Neutrosophic Sets and Systems, Vol. 1 (2013), pp. 54-62.

Reliability and Importance Discounting of Neutrosophic Masses

Florentin Smarandache

Florentin Smarandache (2014). Reliability and Importance Discounting of Neutrosophic Masses. *Critical Review IX*, 33-43

Abstract. In this paper, we introduce for the first time the discounting of a neutrosophic mass in terms of reliability and respectively the importance of the source.

We show that reliability and importance discounts commute when dealing with classical masses.

1. Introduction. Let $\Phi = \{\Phi_1, \Phi_2, \dots, \Phi_n\}$ be the frame of discernment, where $n \geq 2$, and the set of **focal elements**:

$$F = \{A_1, A_2, \dots, A_m\}, \text{ for } m \geq 1, F \subset G^\Phi. \quad (1)$$

Let $G^\Phi = (\Phi, \cup, \cap, \mathcal{C})$ be the **fusion space**.

A **neutrosophic mass** is defined as follows:

$$m_n: G \rightarrow [0, 1]^3$$

for any $x \in G, m_n(x) = (t(x), i(x), f(x)), \quad (2)$

where $t(x)$ = believe that x will occur (truth);
 $i(x)$ = indeterminacy about occurrence;
 and $f(x)$ = believe that x will not occur (falsity).

Simply, we say in neutrosophic logic:

$t(x)$ = believe in x ;
 $i(x)$ = believe in neut(x)
 [the neutral of x , i.e. neither x nor anti(x)];
 and $f(x)$ = believe in anti(x) [the opposite of x].

Of course, $t(x), i(x), f(x) \in [0, 1]$, and

$$\sum_{x \in G} [t(x) + i(x) + f(x)] = 1, (3)$$

while

$$m_n(\phi) = (0, 0, 0). (4)$$

It is possible that according to some parameters (or data) a source is able to predict the believe in a hypothesis x to occur, while according to other parameters (or other data) the same source may be able to find the believe in x not occuring, and upon a third category of parameters (or data) the source may find some indeterminacy (ambiguity) about hypothesis occurrence.

An element $x \in G$ is called **focal** if

$$n_m(x) \neq (0, 0, 0), (5)$$

i.e. $t(x) > 0$ or $i(x) > 0$ or $f(x) > 0$.

Any **classical mass**:

$$m : G^\phi \rightarrow [0, 1] (6)$$

can be simply written as a neutrosophic mass as:

$$m(A) = (m(A), 0, 0). (7)$$

2. Discounting a Neutrosophic Mass due to Reliability of the Source.

Let $\alpha = (\alpha_1, \alpha_2, \alpha_3)$ be the reliability coefficient of the source, $\alpha \in [0,1]^3$.

Then, for any $x \in G^\theta \setminus \{\theta, I_t\}$,

where θ = the empty set

and I_t = total ignorance,

$$m_n(x)_\alpha = (\alpha_1 t(x), \alpha_2 i(x), \alpha_3 f(x)), (8)$$

and

$$m_n(I_t)_\alpha = \left(t(I_t) + (1 - \alpha_1) \sum_{x \in G^\theta \setminus \{\phi, I_t\}} t(x), \right. \\ \left. i(I_t) + (1 - \alpha_2) \sum_{x \in G^\theta \setminus \{\phi, I_t\}} i(x), f(I_t) + (1 - \alpha_3) \sum_{x \in G^\theta \setminus \{\phi, I_t\}} f(x) \right) \tag{9}$$

and, of course,

$$m_n(\phi)_\alpha = (0, 0, 0).$$

The missing mass of each element x , for $x \neq \phi, x \neq I_t$, is transferred to the mass of the total ignorance in the following way:

$$t(x) - \alpha_1 t(x) = (1 - \alpha_1) \cdot t(x) \text{ is transferred to } t(I_t), \tag{10}$$

$$i(x) - \alpha_2 i(x) = (1 - \alpha_2) \cdot i(x) \text{ is transferred to } i(I_t), \tag{11}$$

$$\text{and } f(x) - \alpha_3 f(x) = (1 - \alpha_3) \cdot f(x) \text{ is transferred to } f(I_t). \tag{12}$$

3. Discounting a Neutrosophic Mass due to the Importance of the Source.

Let $\beta \in [0, 1]$ be the importance coefficient of the source. This discounting can be done in several ways.

a. For any $x \in G^\theta \setminus \{\phi\}$,

$$m_n(x)_{\beta_1} = (\beta \cdot t(x), i(x), f(x) + (1 - \beta) \cdot t(x)), \tag{13}$$

which means that $t(x)$, the believe in x , is diminished to $\beta \cdot t(x)$, and the missing mass, $t(x) - \beta \cdot t(x) = (1 - \beta) \cdot t(x)$, is transferred to the believe in *anti*(x).

b. Another way:

For any $x \in G^\theta \setminus \{\phi\}$,

$$m_n(x)_{\beta_2} = (\beta \cdot t(x), i(x) + (1 - \beta) \cdot t(x), f(x)), \tag{14}$$

which means that $t(x)$, the believe in x , is similarly diminished to $\beta \cdot t(x)$, and the missing mass $(1 - \beta) \cdot t(x)$ is now transferred to the believe in *neut*(x).

c. The third way is the most general, putting together the first and second ways.

For any $x \in G^\theta \setminus \{\phi\}$,

$$m_n(x)_{\beta_3} = (\beta \cdot t(x), i(x) + (1 - \beta) \cdot t(x) \cdot \gamma, f(x) + (1 - \beta) \cdot t(x) \cdot (1 - \gamma)), \quad (15)$$

where $\gamma \in [0, 1]$ is a parameter that splits the missing mass $(1 - \beta) \cdot t(x)$ a part to $i(x)$ and the other part to $f(x)$.

For $\gamma = 0$, one gets the first way of distribution, and when $\gamma = 1$, one gets the second way of distribution.

4. Discounting of Reliability and Importance of Sources in General Do Not Commute.

a. Reliability first, Importance second.

For any $x \in G^\theta \setminus \{\phi, I_t\}$, one has after reliability α discounting, where

$$\alpha = (\alpha_1, \alpha_2, \alpha_3):$$

$$m_n(x)_\alpha = (\alpha_1 \cdot t(x), \alpha_2 \cdot t(x), \alpha_3 \cdot f(x)), \quad (16)$$

and

$$m_n(I_t)_\alpha = \left(t(I_t) + (1 - \alpha_1) \cdot \sum_{x \in G^\theta \setminus \{\phi, I_t\}} t(x), i(I_t) + (1 - \alpha_2) \cdot \sum_{x \in G^\theta \setminus \{\phi, I_t\}} i(x), f(I_t) + (1 - \alpha_3) \cdot \sum_{x \in G^\theta \setminus \{\phi, I_t\}} f(x) \right) \stackrel{\text{def}}{=} (T_{I_t}, I_{I_t}, F_{I_t}). \quad (17)$$

Now we do the importance β discounting method, the third importance discounting way which is the most general:

$$m_n(x)_{\alpha\beta_3} = (\beta\alpha_1 t(x), \alpha_2 i(x) + (1 - \beta)\alpha_1 t(x)\gamma, \alpha_3 f(x) + (1 - \beta)\alpha_1 t(x)(1 - \gamma)) \quad (18)$$

and

$$m_n(I_t)_{\alpha\beta_3} = (\beta \cdot T_{I_t}, I_{I_t} + (1 - \beta)T_{I_t} \cdot \gamma, F_{I_t} + (1 - \beta)T_{I_t}(1 - \gamma)). \quad (19)$$

b. Importance first, Reliability second.

For any $x \in G^\theta \setminus \{\phi, I_t\}$, one has after importance β discounting (third way):

$$m_n(x)_{\beta_3} = (\beta \cdot t(x), i(x) + (1 - \beta)t(x)\gamma, f(x) + (1 - \beta)t(x)(1 - \gamma)) \quad (20)$$

and

$$m_n(I_t)_{\beta_3} = (\beta \cdot t(I_t), i(I_t) + (1 - \beta)t(I_t)\gamma, f(I_t) + (1 - \beta)t(I_t)(1 - \gamma)). \quad (21)$$

Now we do the reliability $\alpha = (\alpha_1, \alpha_2, \alpha_3)$ discounting, and one gets:

$$m_n(x)_{\beta_3\alpha} = (\alpha_1 \cdot \beta \cdot t(x), \alpha_2 \cdot i(x) + \alpha_2(1 - \beta)t(x)\gamma, \alpha_3 \cdot f(x) + \alpha_3 \cdot (1 - \beta)t(x)(1 - \gamma)) \quad (22)$$

and

$$m_n(I_t)_{\beta_3\alpha} = (\alpha_1 \cdot \beta \cdot t(I_t), \alpha_2 \cdot i(I_t) + \alpha_2(1 - \beta)t(I_t)\gamma, \alpha_3 \cdot f(I_t) + \alpha_3(1 - \beta)t(I_t)(1 - \gamma)). \quad (23)$$

Remark.

We see that (a) and (b) are in general different, so reliability of sources does not commute with the importance of sources.

5. Particular Case when Reliability and Importance Discounting of Masses Commute.

Let's consider a classical mass

$$m: G^\theta \rightarrow [0, 1] \quad (24)$$

and the focal set $F \subset G^\theta$,

$$F = \{A_1, A_2, \dots, A_m\}, m \geq 1, \quad (25)$$

and of course $m(A_i) > 0$, for $1 \leq i \leq m$.

Suppose $m(A_i) = a_i \in (0,1]$. (26)

a. Reliability first, Importance second.

Let $\alpha \in [0, 1]$ be the reliability coefficient of $m(\cdot)$.

For $x \in G^\theta \setminus \{\phi, I_t\}$, one has

$$m(x)_\alpha = \alpha \cdot m(x), \tag{27}$$

$$\text{and } m(I_t) = \alpha \cdot m(I_t) + 1 - \alpha. \tag{28}$$

Let $\beta \in [0, 1]$ be the importance coefficient of $m(\cdot)$.

Then, for $x \in G^\theta \setminus \{\phi, I_t\}$,

$$m(x)_{\alpha\beta} = (\beta\alpha m(x), \alpha m(x) - \beta\alpha m(x)) = \alpha \cdot m(x) \cdot (\beta, 1 - \beta), \tag{29}$$

considering only two components: believe that x occurs and, respectively, believe that x does not occur.

Further on,

$$m(I_t)_{\alpha\beta} = (\beta\alpha m(I_t) + \beta - \beta\alpha, \alpha m(I_t) + 1 - \alpha - \beta\alpha m(I_t) - \beta + \beta\alpha) = [\alpha m(I_t) + 1 - \alpha] \cdot (\beta, 1 - \beta). \tag{30}$$

b. Importance first, Reliability second.

For $x \in G^\theta \setminus \{\phi, I_t\}$, one has

$$m(x)_\beta = (\beta \cdot m(x), m(x) - \beta \cdot m(x)) = m(x) \cdot (\beta, 1 - \beta), \tag{31}$$

$$\text{and } m(I_t)_\beta = (\beta m(I_t), m(I_t) - \beta m(I_t)) = m(I_t) \cdot (\beta, 1 - \beta). \tag{32}$$

Then, for the reliability discounting scalar α one has:

$$m(x)_{\beta\alpha} = \alpha m(x)(\beta, 1 - \beta) = (\alpha m(x)\beta, \alpha m(x) - \alpha\beta m(x)) \tag{33}$$

$$\text{and } m(I_t)_{\beta\alpha} = \alpha \cdot m(I_t)(\beta, 1 - \beta) + (1 - \alpha)(\beta, 1 - \beta) = [\alpha m(I_t) + 1 - \alpha] \cdot (\beta, 1 - \beta) = (\alpha m(I_t)\beta, \alpha m(I_t) - \alpha m(I_t)\beta) + (\beta - \alpha\beta, 1 - \alpha - \beta + \alpha\beta) = (\alpha\beta m(I_t) + \beta - \alpha\beta, \alpha m(I_t) - \alpha\beta m(I_t) + 1 - \alpha - \beta - \alpha\beta). \tag{34}$$

Hence (a) and (b) are equal in this case.

6. Examples.

1. Classical mass.

The following classical is given on $\theta = \{A, B\}$:

m	A	B	AUB
	0.4	0.5	0.1

(35)

Let $\alpha = 0.8$ be the reliability coefficient and $\beta = 0.7$ be the importance coefficient.

a. Reliability first, Importance second.

m_α	A	B	AUB
	0.32	0.40	0.28
$m_{\alpha\beta}$	(0.224, 0.096)	(0.280, 0.120)	(0.196, 0.084)

(36)

We have computed in the following way:

$$m_\alpha(A) = 0.8m(A) = 0.8(0.4) = 0.32, \quad (37)$$

$$m_\alpha(B) = 0.8m(B) = 0.8(0.5) = 0.40, \quad (38)$$

$$m_\alpha(AUB) = 0.8(AUB) + 1 - 0.8 = 0.8(0.1) + 0.2 = 0.28, \quad (39)$$

and

$$m_{\alpha\beta}(A) = (0.7m_\alpha(A), m_\alpha(A) - 0.7m_\alpha(A)) = (0.7(0.32), 0.32 - 0.7(0.32)) = (0.224, 0.096), \quad (40)$$

$$m_{\alpha\beta}(B) = (0.7m_\alpha(B), m_\alpha(B) - 0.7m_\alpha(B)) = (0.7(0.40), 0.40 - 0.7(0.40)) = (0.280, 0.120), \quad (41)$$

$$m_{\alpha\beta}(AUB) = (0.7m_{\alpha}(AUB), m_{\alpha}(AUB) - 0.7m_{\alpha}(AUB)) = (0.7(0.28), 0.28 - 0.7(0.28)) = (0.196, 0.084). \quad (42)$$

b. Importance first, Reliability second.

	A	B	AUB
m	0.4	0.5	0.1
m_{β}	(0.28, 0.12)	(0.35, 0.15)	(0.07, 0.03)
$m_{\beta\alpha}$	(0.224, 0.096)	(0.280, 0.120)	(0.196, 0.084)

(43)

We computed in the following way:

$$m_{\beta}(A) = (\beta m(A), (1 - \beta)m(A)) = (0.7(0.4), (1 - 0.7)(0.4)) = (0.280, 0.120), \quad (44)$$

$$m_{\beta}(B) = (\beta m(B), (1 - \beta)m(B)) = (0.7(0.5), (1 - 0.7)(0.5)) = (0.35, 0.15), \quad (45)$$

$$m_{\beta}(AUB) = (\beta m(AUB), (1 - \beta)m(AUB)) = (0.7(0.1), (1 - 0.1)(0.1)) = (0.07, 0.03), \quad (46)$$

and $m_{\beta\alpha}(A) = \alpha m_{\beta}(A) = 0.8(0.28, 0.12) = (0.8(0.28), 0.8(0.12)) = (0.224, 0.096), \quad (47)$

$$m_{\beta\alpha}(B) = \alpha m_{\beta}(B) = 0.8(0.35, 0.15) = (0.8(0.35), 0.8(0.15)) = (0.280, 0.120), \quad (48)$$

$$m_{\beta\alpha}(AUB) = \alpha m(AUB)(\beta, 1 - \beta) + (1 - \alpha)(\beta, 1 - \beta) = 0.8(0.1)(0.7, 1 - 0.7) + (1 - 0.8)(0.7, 1 - 0.7) = 0.08(0.7, 0.3) + 0.2(0.7, 0.3) = (0.056, 0.024) + (0.140, 0.060) = (0.056 + 0.140, 0.024 + 0.060) = (0.196, 0.084). \quad (49)$$

Therefore reliability discount commutes with importance discount of sources when one has classical masses.

The result is interpreted this way: believe in A is 0.224 and believe in $nonA$ is 0.096, believe in B is 0.280 and believe in $nonB$ is 0.120, and believe in total ignorance AUB is 0.196, and believe in non-ignorance is 0.084.

7. Same Example with Different Redistribution of Masses Related to Importance of Sources.

Let's consider the third way of redistribution of masses related to importance coefficient of sources. $\beta = 0.7$, but $\gamma = 0.4$, which means that 40% of β is redistributed to $i(x)$ and 60% of β is redistributed to $f(x)$ for each $x \in G^\theta \setminus \{\phi\}$; and $\alpha = 0.8$.

a. Reliability first, Importance second.

	A	B	AUB
m	0.4	0.5	0.1
m_α	0.32	0.40	0.28
$m_{\alpha\beta}$	(0.2240, 0.0384, 0.0576)	(0.2800, 0.0480, 0.0720)	(0.1960, 0.0336, 0.0504).

(50)

We computed m_α in the same way.

But:

$$m_{\alpha\beta}(A) = (\beta \cdot m_\alpha(A), i_\alpha(A) + (1 - \beta)m_\alpha(A) \cdot \gamma, f_\alpha(A) + (1 - \beta)m_\alpha(A)(1 - \gamma)) = (0.7(0.32), 0 + (1 - 0.7)(0.32)(0.4), 0 + (1 - 0.7)(0.32)(1 - 0.4)) = (0.2240, 0.0384, 0.0576). \quad (51)$$

Similarly for $m_{\alpha\beta}(B)$ and $m_{\alpha\beta}(AUB)$.

b. Importance first, Reliability second.

	A	B	AUB
m	0.4	0.5	0.1
m_β	(0.280, 0.048, 0.072)	(0.350, 0.060, 0.090)	(0.070, 0.012, 0.018)
$m_{\beta\alpha}$	(0.2240, 0.0384, 0.0576)	(0.2800, 0.0480, 0.0720)	(0.1960, 0.0336, 0.0504).

(52)

We computed $m_\beta(\cdot)$ in the following way:

$$m_\beta(A) = (\beta \cdot t(A), i(A) + (1 - \beta)t(A) \cdot \gamma, f(A) + (1 - \beta)t(A)(1 - \gamma)) = (0.7(0.4), 0 + (1 - 0.7)(0.4)(0.4), 0 + (1 - 0.7)0.4(1 - 0.4)) = (0.280, 0.048, 0.072). \quad (53)$$

Similarly for $m_\beta(B)$ and $m_\beta(AUB)$.

To compute $m_{\beta\alpha}(\cdot)$, we take $\alpha_1 = \alpha_2 = \alpha_3 = 0.8$, (54)

in formulas (8) and (9).

$$\begin{aligned} m_{\beta\alpha}(A) &= \alpha \cdot m_\beta(A) = 0.8(0.280, 0.048, 0.072) \\ &= (0.8(0.280), 0.8(0.048), 0.8(0.072)) \\ &= (0.2240, 0.0384, 0.0576). \end{aligned} \quad (55)$$

Similarly

$$m_{\beta\alpha}(B) = 0.8(0.350, 0.060, 0.090) = (0.2800, 0.0480, 0.0720). \quad (56)$$

For $m_{\beta\alpha}(AUB)$ we use formula (9):

$$\begin{aligned} m_{\beta\alpha}(AUB) &= (t_\beta(AUB) + (1 - \alpha)[t_\beta(A) + t_\beta(B)], i_\beta(AUB) \\ &\quad + (1 - \alpha)[i_\beta(A) + i_\beta(B)], \\ &\quad f_\beta(AUB) + (1 - \alpha)[f_\beta(A) + f_\beta(B)]) \\ &= (0.070 + (1 - 0.8)[0.280 + 0.350], 0.012 \\ &\quad + (1 - 0.8)[0.048 + 0.060], 0.018 + (1 - 0.8)[0.072 + 0.090]) \\ &= (0.1960, 0.0336, 0.0504). \end{aligned}$$

Again, the reliability discount and importance discount commute.

8. Conclusion.

In this paper we have defined a new way of discounting a classical and neutrosophic mass with respect to its importance. We have also defined the discounting of a neutrosophic source with respect to its reliability.

In general, the reliability discount and importance discount do not commute. But if one uses classical masses, they commute (as in Examples 1 and 2).

Acknowledgement.

The author would like to thank Dr. Jean Dezert for his opinions about this paper.

References.

1. F. Smarandache, J. Dezert, J.-M. Tacnet, *Fusion of Sources of Evidence with Different Importances and Reliabilities*, Fusion 2010 International Conference, Edinburgh, Scotland, 26-29 July, 2010.
2. Florentin Smarandache, *Neutrosophic Masses & Indeterminate Models. Applications to Information Fusion*, Proceedings of the International Conference on Advanced Mechatronic Systems [ICAMechS 2012], Tokyo, Japan, 18-21 September 2012.

A DSMT Based System for Writer-Independent Handwritten Signature Verification

Nassim Abbas, Youcef Chibani, Bilal Hadjadji, Zayen Azzouz Omar, Florentin Smarandache

Nassim Abbas, Youcef Chibani, Bilal Hadjadji, Zayen Azzouz Omar, Florentin Smarandache (2016). A DSMT Based System for Writer-Independent Handwritten Signature Verification, 8

Abstract—We propose in this paper a new writer-independent off-line handwritten signature verification (HSV) system using only genuine signatures. This system is based on a combination of two off-line individual HSV systems through the plausible and paradoxical reasoning theory of Dezert-Smarandache (DSMT). Firstly, we propose to evaluate the performances of both off-line HSV systems through using one-class SVM classifiers (OC-SVM) that operate independently of each other, which are associated to DCT and Curvelet transform based descriptors. To improve system performance, the outputs of both individual HSV systems are combined in DSMT framework, where a new decision making criterion is proposed. Experimental results conducted on the well known CEDAR database show the effective use of the proposed DSMT based combination for improving the verification accuracy comparatively to individual systems.

Keywords—Conflict management; Dezert-Smarandache theory; Writer-independent off-line signature verification; One-class SVM.

I. INTRODUCTION

The handwritten signature is one of the oldest behavioral biometric modalities employed for authentication of an individual or a document. Despite technological advances in the modern digital era, signature remains one of the popular means for the authentication of official documents like bank checks, credit card transactions, certificates, contracts and bonds. Hence, its use is more relevant for the verification on a system. The main objective of a handwritten signature verification (HSV) system is to verify the identity of an individual based on the analysis of signature employing the unique personal characteristics of his or her writing [1], [2], [3]. Indeed, signatures are a special case of handwriting in which special characters and flourishes occur and therefore most of the time they can be unreadable. Furthermore, intrapersonal variations and interpersonal differences make it necessary to analyze them as complete images (or subsequent sampled trajectory points including the signature's shape and the dynamic information issued from the ballistic movements of the signer) and not as letters and words put together [4], [3].

Depending on the mode of signature acquisition, such a HSV problem can be categorized into on-line and off-line [3], [4]. In general, on-line HSV systems achieve better performance since they deal with dynamic features like time,

speed, pressure and order of strokes, which can be easily generated from a signature acquired through the on-line devices [2]. Off-line HSV systems, on the other hand, rely only on static features generated from signature images [1]. Although an efficient off-line HSV system is comparatively difficult to design, as many desirable dynamic features are not available, its wide application in the area of forensics and biometrics has made it an intense research field.

Signature verification methods fall into two broad categories: *writer-dependent* versus *writer-independent* methods [5]. The *writer-dependent* methods are the commonly used for HSV, where a specific model is build for each writer [6], [4], [7]. These methods therefore require selecting at each time the parameters of the model, when a new writer should be included in the system [8], [9]. The *writer-independent* HSV methods go for a generic and more economic system which can be tested on any writer. A set of writers, producing a minimal amount of handwriting signatures, is necessary for generating a unique model in order to mitigate the effect of large inter-class variability. In the testing phase, one or more reference signatures of any arbitrary writer can be used, comparing with which the system would conclude whether a questioned signature belongs to this particular writer or not. Our approach falls in this latter category. From the application point of view, the notable advantage is that classifier parameters remain the same whenever a new writer is added to the system.

In order to improve writer-independent off-line HSV performances, we propose an effective combination scheme of OC-SVM classifiers in DSMT framework [10], [11], [12], [13]. Indeed, few works have been recently focused on the classifier combination for dealing with the writer-independent off-line HSV. For instance, Oliveira *et al.* [8] take into account the framework initially proposed by Santos *et al.* [14] for improving the performance of a writer-independent off-line HSV system. Two contributions have been proposed in this work for designing the system. Firstly, authors analyze the impacts of choosing different fusion strategies to combine the partial decisions provided by the SVM classifiers. Hence, they have found that the Max rule is more effective than the original Voting proposed in [14]. Then Receiver Operating Characteristic (ROC) curves produced by different classifiers are combined using maximum likelihood analysis, producing

an ROC combined classifier. Bertolini *et al.* [9] resume work in depth investigation of writer-independent off-line HSV problem, which has already been studied in [8], by reducing forgeries through ensemble of classifiers. In [15], an hybrid generative-discriminative ensembles of classifiers (EoCs) approach is investigated for addressing the challenge of designing off-line HSV systems form a limited amount of genuine signature samples, where the classifier selection process is performed dynamically. Later, two different learning approaches, namely global and writer-dependent SVMs, are proposed in [16] for performing the verification. The global SVM classifiers, which are writer-independent classifiers, are combined at score level with writer-dependent SVM classifiers through weighted sum rule, for improving overall verification accuracy. However, the problem of designing a robust writer-independent off-line HSV system, through an effective classifier combination approach, using only few genuine signatures, is research challenge that still need to be addressed.

The contribution of this paper is twofold. First, we introduce a new intelligent learning technique which allows us to build a unique model, while reducing the pattern recognition problem to a two-class problem, by introducing the concept of (dis) similarity representation [17] using only genuine signatures. Therefore, makes it possible to build robust individual HSV systems even when few signatures per writer are available. In this vein, we propose firstly to evaluate the performances of two writer-independent off-line HSV systems through using OC-SVM classifiers that operate independently of each other, which are associated to DCT and Curvelet transform based descriptors, respectively.

Second, for a given test signature during verification, both OC-SVM classifiers are considered using a static selection strategy, where a single ensemble of OC-SVM classifiers is selected before operations, and applied to all input samples, and then all the corresponding outputs of this ensemble provide the degrees of imprecision for the verification task. We then transform these ones in generalized basic belief assignments (gbba) using an inspired version of Appriou's model. To improve the performance of the proposed system, the gbba issued from both OC-SVM classifiers are combined through an effective combination scheme within DSMT framework, where a new decision making criterion has been implemented, while managing significantly the conflict provided from the corresponding individual HSV systems.

The paper is organized as follows. We give in Section II a review of Proportional Conflict Redistribution (PCR5) rule based on DSMT. Section III describes the proposed verification system. The dataset of the off-line handwritten signatures and experimental protocol used for validation are described in Section IV. The experimental and statistical results are summarized in Section V.

II. REVIEW OF PCR5 COMBINATION RULE

Let $\Theta = \{\theta_1, \theta_2\}$ the *discernment space* of the two-class classification problem under consideration having 2 *exhaustive elementary* hypotheses θ_i , which are not necessarily mutually *exclusive* in DSMT. Hence, the

combination of two individual systems, namely information sources S_1 and S_2 , respectively, is performed through the PCR5 combination rule based on the DSMT [18]. The main concept of the DSMT is to distribute unitary mass of certainty over all the composite propositions built from elements of with (Union) and (Intersection) operators instead of making this distribution over the elementary hypothesis only. Therefore, the hyper-powerset D^Θ is defined as $D^\Theta = \{\emptyset, \theta_1, \theta_2, \theta_1 \cup \theta_2, \theta_1 \cap \theta_2\}$. The DSMT uses the generalized basic belief mass, also known as the generalized basic belief assignment (gbba) computed on hyper-powerset of Θ and defined by a map $m(\cdot): D^\Theta \rightarrow [0,1]$ associated to a given source of evidence, which can support paradoxical information, as follows: $m(\emptyset) = 0$ and $m(\theta_1) + m(\theta_2) + m(\theta_1 \cup \theta_2) + m(\theta_1 \cap \theta_2) = 1$. The combined masses m_{PCR5} obtained from $m_1(\cdot)$ and $m_2(\cdot)$ by means of the PCR5 rule [18] is defined as:

$$m_{PCR5}(A) = \begin{cases} 0 & \text{if } A \in \Phi \\ m_{DSmC}(A) + m_{A \cap X}(A) & \text{otherwise} \end{cases}$$

Where

$$m_{A \cap X}(A) = \sum_{\substack{X \in D^\Theta \setminus \{A\} \\ c(A \cap X) = \emptyset}} \left[\frac{\{m_1(A)\}^2 m_2(X)}{m_1(A) + m_2(X)} + \frac{\{m_2(A)\}^2 m_1(X)}{m_2(A) + m_1(X)} \right]$$

and $\Phi = \{\Phi_M, \emptyset\}$ is the set of all relatively and absolutely empty elements, Φ_M is the set of all elements of D^Θ which have been forced to be empty in the Shafer's model M defined by the exhaustive and exclusive constraints, \emptyset is the empty set, and $c(A \cap X)$ is the canonical form (conjunctive normal) of $A \cap X$ and where all denominators are different to zero. If a denominator is zero, that fraction is discarded. Thus, the term $m_{DSmC}(A)$ represents a conjunctive consensus, also called DSMT Classic (DSmC) combination rule, which is defined as [10], [10]:

$$m_{DSmC}(A) = \begin{cases} 0 & \text{if } A = \emptyset \\ \sum_{(X, Y \in D^\Theta, X \cap Y = A)} m_1(X) m_2(Y) & \text{otherwise} \end{cases}$$

III. SYSTEM DESCRIPTION

The structure of the combined system for writer-independent HSV is depicted in Fig. 1, which is composed of two individual off-line HSV systems and a DSMT based

combination module. Each individual HSV system is generally composed of three modules: pre-processing, feature generation for constructing descriptors and classification.

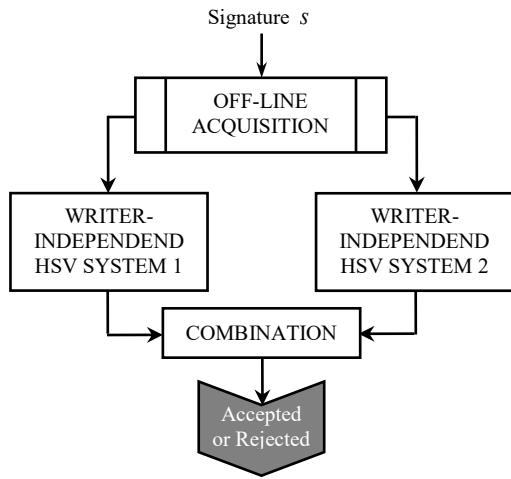

Fig. 1. Structure of the global system for writer-independent HSV.

A. Pre-processing

Any image-processing application suffers from noise like touching line segments, isolated pixels and smeared images. Hence, pre-processing is one of the crucial stages for solving any document analysis problem. In our case, the pre-processing will be only performed on signature images for which we have applied the descriptor issued from the feature generation method, namely Curvelet transform (CT), except the signature images which are to be submissive to DCT based feature generation method. A normalization of size is performed on scanned signature images, which are available in the form of grey-level images, as required by CT-based descriptor. This normalization is performed by adding zeros around these images to make them in a square matrix of dimensions $[R \times R]$, such that $R = 2^l$ and l is an integer, without distorting the signature image.

B. Features Used for Training Individual Classifiers

To evaluate the verification performance of the global system, we use two kinds of features generated from a signature image using two suitable methods whose each one of them allows constructing a descriptor: (1) Discrete Cosine Transform (DCT)-based descriptor and (2) Curvelet Transform (CT)-based descriptor. In this section, we briefly describe descriptors used for training both individual classifiers, respectively.

1) *Discrete Cosine Transform*: In the 2D-DCT based descriptor, the input signature image is transformed into frequency domain. Hence, we obtain a matrix of size $[R \times R]$ which includes DCT coefficients. Thus, the most significant information of the original signature image will be concentrated on the upper left part of the DCT matrix (energy compaction property). Due to this property, the input data will

be reduced in a few significant coefficients using the zig-zag algorithm [19].

2) *Curvelet Transform*: The CT based method is well adapted for analyzing local line or curve singularities contained in an image [20]. In this work, we only use the energy of the curvelet coefficient computed from the whole of the signature image. More specifically, to generate a feature vector, the CT is applied on the image via the wrapping technique at different scales and different orientations in order to generate curvelet coefficients. For more details, the interested reader is referred to [7].

C. Similarity Learning Based OC-SVM Classifier

The OC-SVM is an unsupervised learning algorithm proposed by Schölkopf *et al.* [21], which consists to estimate a function $f_{OC}(x)$ that encloses the most of learning data into a hyper sphere $R_x = \{x \in \mathbb{R}^d, f_{OC}(x) > 0\}$ with a minimum volume where d is the size of feature vector [21]. Hence, the decision function $f_{OC}(x)$ is given as [21]:

$$f_{OC}(x) = \sum_{k=1}^{S_v} \alpha_k K(x, x_k) - \rho \tag{1}$$

where S_v is the number of support vectors x_k from the training dataset, α_k are Lagrange multipliers, such that $0 \leq \alpha_k \leq \frac{1}{\nu m}$, m is the cardinal of training dataset, ν is the percentage of data considered as outliers, ρ defines the distance of the hyper sphere from the origin, and $K(.,.)$ defines the OC-SVM kernel that allows projecting data from the original space to the feature space.

1) *Writer-Independent Verification Scheme*: As part of this work, the writer-independent verification scheme of each OC-SVM classifier is proposed by incorporating an intelligent learning technique according to the following steps.

a) *Learning Phase*: In this step the classifier is only trained with samples belonging to the genuine class of signatures in order to generate the corresponding OC-SVM model. This one will be served for computing an optimal decision threshold, which is determined by using the criterion of equal error rate (EER) during an intermediate step, called *validation phase*.

b) *Verification Phase*: This step consists to assess the robustness of the classifier using the generated model and the selected optimal threshold during the validation phase for a decision making.

2) *Generating Vectors of (Dis) Similarity Measures*: The main idea behind the proposed verification scheme employed for designing the individual HSV systems, is based on the use of dissimilarity representation presented in [17], while using a set of prototype genuine signatures (called *representation set*

\mathfrak{R}) for generating a unique OC-SVM model. Hence, a distance metric $h(.,.)$ is used for generating the vectors of (dis) similarity measures $H(x, \mathfrak{R}) = [h(x, p_1), h(x, p_2), \dots, h(x, p_n)]$ between the feature vector x representing a given signature and the elements $p_i \in \mathfrak{R}$. Thus, the obtained vectors through this operation will be considered as the inputs of OC-SVM classifiers.

It should be noted that the key point of this work is to propose an intelligent learning technique, where training data for each OC-SVM classifier will be established from only the generated vectors of similarity measures between the feature vectors associated to genuine signatures, which are selected for learning.

Let N_{wr} be the number of writers for the learning phase and N_s be the number of genuine signatures per writer selected during this step. The number of vectors of similarity measures generated during learning is denoted N_{sim} and will be computed according the following formula:

$$N_{sim} = \frac{N_s \times (N_s - 1)}{2} \times N_{wr} \quad (2)$$

Moreover, the testing and validation data will be represented by the vectors of (dis) similarity measures which are generated between the feature vector representing the input signature and those associated to reference signatures. Thus, for each signature image belonging to the testing or validation dataset, the vectors of (dis) similarity measures will be then sent to the input of OC-SVM classifier with a number equals to those of reference signatures.

3) *Decision Rule in OC-SVM Framework:* Generally, the decision making in OC-SVM classifier framework is performed through a function, denoted here f_{OC} , which takes positive values in some region of the representation space and negative values somewhere else. The value of this one for a given vector of (dis) similarity measures is defined by equation (1). In other words, if we note θ_{gen} and θ_{imp} as the classes associated respectively to genuine and impostor, then the decision rule is given as follows:

$$x \in \begin{cases} \theta_{gen} & \text{if } f_{OC}(x) > 0 \\ \theta_{imp} & \text{otherwise} \end{cases} \quad (3)$$

In this work, the decision on learning data will be performed according to (3). In contrast, the majority voting rule is applied to validation and testing data as follows:

$$x \in \begin{cases} \theta_{gen} & \text{if } N_{gen} \geq N_{imp} \\ \theta_{imp} & \text{otherwise} \end{cases} \quad (4)$$

where N_{gen} and N_{imp} are the number of the responses, i.e. $f_{OC_j}(x)$ generated in relation to the reference signatures associated to the sample x such that $0 \leq j \leq N_{scores}$, provided by the i -th OC-SVM classifier under constraints $f_{OC_j}(x) \geq t_{opt}$ and $f_{OC_j}(x) < t_{opt}$, respectively. The index i stands here for the information source corresponding to the used descriptor, N_{scores} is the number of vectors of (dis) similarity measures generated for each signature of testing or validation, t_{opt} is the optimal threshold associated with i -th OC-SVM classifier and determined during the validation phase.

D. Combining Individual HSV Systems in DSMT Framework

The proposed combination module consists of three steps: i) transform the OC-SVM outputs into belief assignments using an estimation technique, ii) combine masses through a DSMT based combination rule and iii) implementing a new decision criterion for accepting or rejecting a signature.

1) *Estimation of Masses:* We propose in this paper an inspired version of Appriou's model, which is initially defined for two classes [22], for estimating the mass function within DSMT framework. Thus, the estimation of masses is performed into two steps: i) mapping the uncalibrated outputs provided by each OC-SVM classifier to posterior probabilities, ii) estimation of masses of the two simple classes and their classes representing the ignorance and paradox, respectively.

a) *Calibration of the OC-SVM Outputs:* Each OC-SVM classifier provides an uncalibrated output that allows representing the distance between the data to classify and the hyperplane of separating. However this one can be converted to posterior probability measure. Hence, we first exploit the logarithmic function in order to redistribute the decision outputs on large range. The reassigned OC-SVM output using logarithmic function is given as follows [23]:

$$g_i(x) = -\log \left[\sum_{j=1}^{Sv_i} \alpha_j K(x, x_j) \right] + \log(\rho_i) \quad (5)$$

where Sv_i and ρ_i are the number of support vectors and the distance of the hyper sphere from the origin for each i -th OC-SVM which is trained with samples of the genuine class θ_{gen} provided by the source of information S_i , $i=1,2$ (i.e. the i -th descriptor), respectively. However, this logarithmic function will only concern the chosen responses by a selection rule in order to find a single response among the N_{scores} responses for each tested signature. Hence, the selection rule is defined according the following criterion:

$$g_i^*(x) = \max \{ f_{OC_j}(x), 0 \leq j \leq q \} \quad (6)$$

$g_i^*(x)$ is the output of i -th OC-SVM classifier selected from N_{scores} responses and q is the number of majority responses, representing the scores of similarity measures issued from the same classifier, with respect to an optimal decision threshold. Then, we use a sigmoid transformation for mapping the reassigned OC-SVM outputs, obtained by applying Equation (5), to probabilities in the range of $[0,1]$ as follows [23]:

$$P_i(\theta_i) = \frac{1}{1 + \exp(-g_i(x))} \quad (7)$$

where θ_i defines the class of features issued from the first descriptor ($i=1$) and the second descriptor ($i=2$), respectively.

b) Assignment of the Masses within DSMT Framework: In this paper, the frame of discernment, namely Θ , is composed of two distinct elements as: $\Theta = \{\theta_1, \theta_2\}$. Thus, we consider the outputs issued from information sources S_1 (First classifier) and S_2 (Second classifier) using features of *target* class θ_1 and *complementary* class θ_2 , respectively. Hence, the set of focal elements F generated within DSMT framework for each source is given as: $F = \{\theta_1, \theta_2, \theta_1 \cup \theta_2, \theta_1 \cap \theta_2\}$. Then, we assign a mass to each element in F using an inspired version of Appriou's model defined as follows [23]:

$$m_i(\theta_i) = \frac{(1-\beta)P_i(\theta_i/x)}{P_i(\theta_i/x)(1+\varepsilon)} \quad (8)$$

$$m_i(\bar{\theta}_i) = \frac{(1-\beta)}{P_i(\theta_i/x)(1+\varepsilon)} \quad (9)$$

$$m_i(\theta_i \cup \bar{\theta}_i) = \frac{\varepsilon}{(1+\varepsilon)} \quad (10)$$

$$m_i(\theta_i \cap \bar{\theta}_i) = \frac{\beta}{(1+\varepsilon)} \quad (11)$$

where $\varepsilon \geq 0$ is a tuning parameter, and β is the sum of false accepted rates (FAR) made by both sources of information (i.e. OC-SVM classifiers) during the validation phase. Furthermore, $\beta/(1+\varepsilon)$ is used to quantify the belief for conflicting region, and $\varepsilon/(1+\varepsilon)$ is used to quantify the belief that the pattern x belong to the subset of ignorance $\theta_i \cup \bar{\theta}_i, i=1,2$. Therefore, the value of ε is fixed here to 0.001.

2) Combination of Masses: In order to manage the conflict generated from the two information sources S_1 and S_2 (i.e. both OC-SVM classifiers), the belief assignments ($m_i(\cdot), i=1,2$) are combined as follows:

$$m_c = m_1 \oplus_F m_2 \quad (12)$$

where m_c is the combined mass calculated for any element in F and \oplus defines the combination operator of fifth version of Proportional Conflict Redistribution (PCR5) rule [18] (see Section II).

3) Decision Criterion: To take a decision whether the signature is accepted or rejected, we propose here a new decision criterion which consists to determine an optimal decision threshold expressed in terms of mass according the following steps:

- Perform a combination between the two belief assignments $m_1(\cdot)$ and $m_2(\cdot)$ computed according to equations (8), (9), (10) and (11), in DSMT framework and associated to the posterior probabilities of the two decision thresholds determined for both information sources S_1 and S_2 through using the EER criterion during the validation phase.

- Compute the threshold t_1 according the following formula:

$$t_1 = \min \{m_c(\theta_1), m_c(\theta_2)\}$$

where $m_c(\theta_1)$ and $m_c(\theta_2)$ are the combined masses of θ_1 and θ_2 using PCR5 rule, respectively.

- Perform a second combination between the two belief assignments $m_1(\cdot)$ and $m_2(\cdot)$ computed according to equations (8), (9), (10) and (11), in DSMT framework and associated to the posterior probabilities of both learning and validation responses resulting from the corresponding OC-SVM classifiers.

- Compute the threshold t_2 according the following formula:

$$t_2 = \min \{ \min (m_{learn}(\theta_1)), \min (m_{learn}(\theta_2)) \}$$

where $m_{learn}(\theta_1)$ and $m_{learn}(\theta_2)$ are the combined masses of θ_1 and θ_2 using PCR5 rule for a given learning sample, respectively.

- Determine the optimal decision threshold t_{opt}^{new} expressed in terms of mass through computing the mean between t_1 and t_2 , i.e:

$$t_{opt}^{new} = \frac{t_1 + t_2}{2} \quad (13)$$

Once the threshold has reached a predetermined value, a decision rule is applied to the combined masses generated from belief assignments associated to posterior probabilities corresponding to test data. Each test sample is accepted or rejected according to the following rule:

$$\text{Decision} = \begin{cases} \text{Accepted} & \text{if } \min \{m_{test}(\theta_1), m_{test}(\theta_2)\} \geq t_{opt}^{new} \\ \text{Rejected} & \text{otherwise} \end{cases} \quad (14)$$

where $m_{test}(\theta_1)$ and $m_{test}(\theta_2)$ are the combined masses of θ_1 and θ_2 using PCR5 rule for a given test sample, respectively.

IV. DATASET AND EXPERIMENTAL PROTOCOL USED FOR VALIDATION

A. Dataset

The Center of Excellence for Document Analysis and Recognition (CEDAR) signature dataset [24] is used for evaluating the verification performance of the proposed combined writer-independent off-line HSV system in DSMT framework. The CEDAR dataset consists of 55 signature users, each one provided 24 genuine and 24 forgery samples, respectively.

B. Experimental Protocol

In this work, we took the 2640 preprocessed signature images spread over 55 writers (i.e. 48 images for each one), and then we assigned them to two datasets, whose the first one will only contain 600 genuine signatures of the first 25 writers (i.e. 24 images for each one), that will be used for both learning and validation of the OC-SVM models and the second will contain the 1440 signatures of the remaining 30 writers (i.e. 48 images for each one) for the testing phase whose 5 genuine signatures serve as the references for each writer. The 24 genuine signature images per writer selected for the first dataset have been partitioned into three subsets whose the first one will contain 5 signatures to be used for the learning phase, the second one will include 5 other signatures that will be considered as signature references and used for generating test scores and the last one will contain the remaining 14 signatures to be served for both validation phase and computing the optimal thresholds. For each individual classifier, a decision optimal threshold is established during the validation phase according the EER criterion which corresponds to operating point resulting from the intersection between both FAR and FRR curves. By reason of the adapted protocol where the signature images associated to the validation phase are genuine, the generation of the forged signatures for each writer represents the genuine signatures of the other writers, known as fictitious signatures.

V. EXPERIMENTAL RESULTS

The following sections present details of the experiments and are followed by the discussion of obtained results. Furthermore, we choose to evaluate the performance of each individual OC-SVM classifier using only five signatures per writer during the learning phase.

A. Validation of Individual OC-SVM Models

In order to train and validate both individual OC-SVM models, the choice of the optimal hyper parameters, namely the percentage of outliers ν and RBF kernel parameter γ , for each OC-SVM model is performed according to the maximization criterion of the number of support vectors S_V representing the learning data: higher the number of support vectors is, the better the information is representative for each class. Table I shows the optimal parameters of both individual OC-SVM models associated to DCT and CT based descriptors using validation data, respectively. We notice that not only

there is an increased ranges of variation of ν and γ but also the number of support vectors that allows a better representation of genuine class of signatures.

TABLE I. OPTIMAL PARAMETERS OF INDIVIDUAL OC-SVM MODELS DURING VALIDATION PHASE

Parameter of the OC-SVM Model	Descriptor	
	DCT	CT
ν	9.50	0.20
γ	8.02	65.1
S_V	238	220

B. Parameters in Relation with both Descriptors During the Validation Phase

In what follows, we shall describe how the optimal number of DCT coefficients, optimal decomposition level of CT and the corresponding decision thresholds for each OC-SVM classifiers are determined during the validation phase, respectively.

1) *Selecting the Optimal Number of DCT Coefficients and the Corresponding Decision Threshold:* In order to set the optimal number of the significant DCT coefficients, we have studied the influence of the number of DCT coefficients on the different error rates computed from the validation samples. Indeed, we have chosen to set in the DCT based feature vector the number of significant coefficients to 24 in accordance with best global error rate AER (23.2857%) obtained for this value. Thus, this optimal number of coefficients will be retained for the next experiments. Fig. 2 shows the FRR and FAR computed for different values of the decision threshold, which allows determining the optimal threshold ($\cong -0.06071$) for the OC-SVM classifier associated to DCT based descriptor during the validation phase. Hence, the same optimal value of threshold will be used for evaluating the performance of the OC-SVM classifier associated to DCT based descriptor during the testing phase.

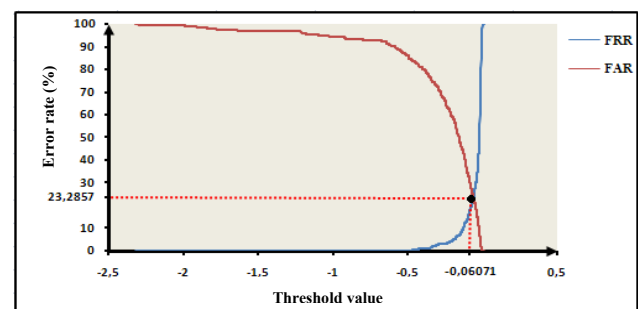

Fig. 2. Error rates of the OC-SVM classifier associated to DCT based descriptor using different values of the decision threshold during validation phase.

2) *Selecting the Optimal Decomposition Level of CT and the Corresponding Decision Threshold:* In following, we try to investigate the use of CT based descriptor in order to train the

second individual OC-SVM classifier. The determination of the optimal decomposition level j_{opt} has been established by varying the decomposition level between 4 and 7, where the value 7 defines here the maximal decomposition level due to the size of the normalization of signature images associated to the CT, which has been fixed to $[1024 \times 1024]$ using CEDAR dataset. Fig. 3 shows the FRR and FAR computed for different values of the decision threshold, which allows determining the optimal threshold for the OC-SVM classifier associated to CT based descriptor during the validation phase for an optimal decomposition level j_{opt} equal to 4.

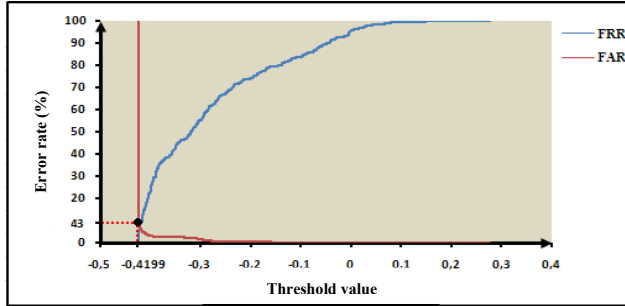

Fig. 3. Error rates of the OC-SVM classifier associated to CT based descriptor using different values of the decision threshold during validation phase.

According to the above figure, we notice that the optimal decision threshold of the OC-SVM classifier associated to CT based descriptor during the validation phase corresponds to -0.4199 for which the AER is minimal with a value of 7.7143%. Hence, the same optimal value of threshold will be used for evaluating the performance of the OC-SVM classifier associated to CT based descriptor during the testing phase.

C. Performance Evaluation and Discussion

The effectiveness of the proposed writer-independent HSV system based on DS_mT is demonstrated experimentally by computing the verification performance of the two individual writer-independent off-line HSV systems, which will be tested on testing signatures of the CEDAR dataset. In these experiments, we compare the performance of the proposed DS_m theory-based combination algorithm with learning-based individual OC-SVM classifiers, statistical match score combination algorithms, and DS theory-based combination algorithm. Table II shows the FRR, FAR and AER based verification error rates computed for the corresponding optimal values of decision threshold of both individual OC-SVM classifiers and the proposed combination frameworks with Max, Sum, Min, Dempster-Shafer (DS) and PCR5 rules. Here OC-SVM classifier 1 represents the individual writer-independent off-line HSV system using OC-SVM classifier associated to DCT based descriptor that yields an AER of 37.2868% corresponding to the optimal value of threshold $t = -0.060712$; while OC-SVM classifier 2 represents the individual writer-independent off-line HSV system using OC-SVM classifier associated to CT based descriptor that yields an AER of 4.2636% corresponding to the optimal value of threshold $t = -0.41988$. The Max and Sum based combination

algorithms decrease the AER of OC-SVM classifier 1 to 32.3256% and 27.5969% for the corresponding optimal values of threshold $t = -0.06071$ and $t = -0.48059$, respectively. While Min based combination algorithm provides a similar result, which is obtained when using the OC-SVM classifier 2 (i.e. an AER of 4.2636%) with the same corresponding optimal value of threshold $t = -0.41988$. Indeed, the Max, Sum and Min based combination algorithms failed to improve the verification performance of the proposed combination system since it couldn't handle managing correctly the conflict generated from the two individual writer-independent off-line HSV systems. Hence, the proposed statistical match score combination algorithms are not appropriate to solve our problem for writer-independent off-line HSV.

TABLE II. EXPERIMENTAL RESULTS OF PROPOSED ALGORITHMS

Algorithm	Optimal Threshold	Verification Error Rates (%)		
		FRR	FAR	AER
Classifier 1 (DCT)	-0.060712	28.7719	44.0278	37.2868
Classifier 2 (CT)	-0.419880	9.6491	0.0000	4.2636
Max rule	-0.060710	17.5439	44.0278	32.3256
Sum rule	-0.480590	6.8421	44.0278	27.5969
Min rule	-0.419880	9.6491	0.0000	4.2636
DS rule	0.334200	0.0000	6.3158	2.7907
PCR5 rule	0.267100	0.0000	6.1404	2.7132

In the following, DS theory (DST) and DS_mT are based on different approaches for modelling respectively the notion of ignorance and paradox which seem to be an excellent choice for managing the conflicting outputs provided by both individual writer-independent off-line HSV systems, where statistical match score algorithms of combination fail to improve the performance attained through using OC-SVM learning algorithm associated to CT based descriptor. In this vein, we consider only the DS and PCR5 combination algorithms which are the more appropriate combination rules developed within DST and DS_mT frameworks, respectively. For each combination rule, a decision making has been performed about whether the signature is genuine or forgery by using a decision threshold expressed in terms of mass according to (13), which will be applied on the combined masses (see equation (14)). In order to appreciate the advantage of combining two sources of information through both DS and PCR5 combination rules, we present in Fig. 4 the conflict measured during testing phase between the two OC-SVM classifiers associated to DCT and CT-based descriptors. By analyzing the different values of conflict, we first notice that the minimal value of conflict for all testing genuine and forged signatures is respectively the same and equals to 0.4999. Moreover, this representation is very attractive because of the constant value of the conflict ($K_c = 0.4999$) for all testing forged signatures due to the values of the posterior probabilities related to DCT based descriptor, which are negligible compared to those provided through using the CT based descriptor. Furthermore, the proposed combination module (see Fig. 4) is even more interesting in terms of discriminating values of conflict of the forged and genuine signatures, which allows defining an optimal threshold for the decision making. We can see that the two sources of information are very conflicting since the value of conflict for

any testing signature is greater than or equal to 0.4999. Hence, the task of the proposed combination module is to manage the conflicts generated from both individual writer-independent off-line HSV systems for each testing signature.

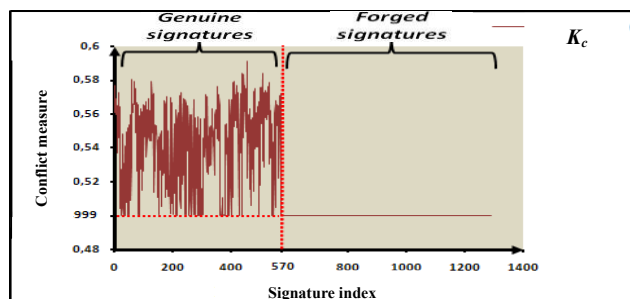

Fig. 4. Conflict between both OC-SVM classifiers using DCT and CT-based descriptors for testing signatures.

The proposed combination scheme using the DS combination algorithm yields an AER of 2.7907% corresponding to the optimal value of threshold $t = 0.3342$; while PCR5 combination algorithm yields the best AER of 2.7132% corresponding to the optimal value of threshold $t = 0.2671$. Indeed, the use of DS rule in the combination module allows efficiently redistributing the beliefs through a simple normalization by $(1-K_c)$ in the combination process of masses and combining the normalized outputs of both individual writer-independent off-line HSV systems which are not highly conflicting. However, when outputs are highly conflicting, they do not provide reliable decision. Further, an improvement of 0.0775% in the verification performance is obtained through using PCR5 combination algorithm. This is due to the efficient redistribution of the partial conflicting mass only to the elements involved in the partial conflict.

VI. CONCLUSION

This paper proposed and presented an effective combination scheme of two writer-independent off-line HSV systems in a general belief function framework. The OC-SVM classifiers associated respectively to DCT and CT features can be incorporated as an intelligent learning technique using only genuine signatures. The combination framework is performed through belief function theories using the estimation technique based on an inspired version of Appriou's model, DST and DSMT based combination algorithms. A new decision criterion has been implemented in DST and DSMT frameworks for a decision making whether the signature is accepted or rejected. Experimental results show that the proposed combination scheme with PCR5 rule yields the best verification accuracy compared to the statistical match score combination algorithms and DS theory-based combination algorithm even when the individual writer-independent off-line HSV systems provide conflicting outputs.

REFERENCES

- [1] D. Impedovo and G. Pirlo, "Automatic Signature Verification: The State of the Art," *IEEE Transactions on Systems, Man, and Cybernetics-C*, vol. 38, no. 5, pp. 609–335, 2008.
- [2] V. S. Nalwa, "Automatic on-line signature verification," in *Proc. IEEE*, vol. 85, issue. 2, pp. 215–239, 1997.
- [3] R. Plamondon and S. N. Srihari, "On-line and off-line handwriting recognition: A comprehensive survey," *IEEE Transactions on Pattern Analysis and Machine Intelligence*, vol. 22, no. 1, pp. 63–84, 2000.
- [4] N. Abbas and Y. Chibani, "SVM-DSMT combination for the simultaneous verification of off-line and on-line handwritten signatures," *International Journal of Computational Intelligence and Applications (IJCIA)*, vol. 11, no. 3, 2012.
- [5] S. Srihari, A. Xu, and M. Kalera, "Learning strategies and classification methods for offline signature verification," in *Proc. 9th International Workshop on Frontiers in Handwriting Recognition (IWFHR)*, pp. 161–166, 2004.
- [6] R. Kumar, J. D. Sharma, and B. Chanda, "Writer-independent off-line signature verification using surroundedness feature," *Pattern Recognition Letters*, vol. 33, no. 3, pp. 301–308, 2012.
- [7] Y. Guerbai, Y. Chibani and B. Hadjadj, "The effective use of the one-class SVM classifier for handwritten signature verification based on writer-independent parameters," *Pattern Recognition*, vol. 48, pp. 103–103, 2015.
- [8] L. S. Oliveira, E. Justino, and R. Sabourin, "Off-line signature verification using writer-independent approach," in *Proc. International Joint Conference on Neural Networks (IJCNN)*, Orlando, Florida, USA, pp. 2539–2544, August 12–17, 2007.
- [9] D. Bortoloni, L. S. Oliveira, E. Justino, and R. Sabourin, "Reducing forgeries in writer-independent off-line signature verification through ensemble of classifiers," *Pattern Recognition*, vol. 43, no. 1, pp. 387–396, 2010.
- [10] F. Smarandache and J. Dezert, *Advances and Applications of DSMT for Information Fusion*. Rehoboth, NM: Amer. Res. Press, 2004.
- [11] F. Smarandache and J. Dezert, *Advances and Applications of DSMT for Information Fusion*. Rehoboth, NM: Amer. Res. Press, 2006.
- [12] F. Smarandache and J. Dezert, *Advances and Applications of DSMT for Information Fusion*. Rehoboth, NM: Amer. Res. Press, 2009.
- [13] F. Smarandache and J. Dezert, *Advances and Applications of DSMT for Information Fusion*. Rehoboth, NM: Amer. Res. Press, 2015.
- [14] C. Santos, E. J. R. Justino, F. Bortolozzi, and R. Sabourin, "An offline signature verification method based on document questioned expert's approach and a neural network classifier," in *Proc. 9th International Workshop on Frontiers in Handwriting Recognition (IWFHR)*, pp. 498–502, 2004.
- [15] L. Batista, E. Granger, and R. Sabourin, "Dynamic selection of generative-discriminative ensembles for off-line signature verification," *Pattern Recognition*, vol. 45, no.4, pp.1326–1340, 2012.
- [16] M. Berkay Yilmaz, and B. Yanikoglu, "Score Level Fusion of Classifiers in Off-line Signature Veification," in *Press, Information Fusion*.
- [17] E. Pekalska and R. P. W. Duin, "Dissimilarity representations allow for building good classifiers," *Pattern Recognition Letters*, vol. 23, pp. 943–956, 2002.
- [18] F. Smarandache, J. Dezert, "Information Fusion Based on New Proportional Conflict Redistribution Rules," in *Proc. of the 8th International Conference on Information Fusion (ICIF)*, Philadelphia, USA, 25–29 July, 2005.
- [19] W. Chen, C. H. Smith, and S. C. Fralick, "A fast computational algorithm for the discrete cosine transform." *IEEE Trans. Commun.*, vol. COM-25, pp. 1004–1009, Sep. 1977.
- [20] E. J. Candès and D. Donoho, "Curvelets—A surprisingly effective nonadaptive representation for objects with edges, in *Curves and Surface Fitting: Saint-Malo 1999*, A. Cohen, C. Rabut and L. Schumaker, Eds. Nashville: Vanderbilt Univ. Press, pp. 105–120, 2000.
- [21] B. Schölkopf, J. Platt, J. Shawe-Taylor, A. Smola, and R. Williamson, "Estimating the support of a high dimensional distribution," *Neural Competition*, vol. 13, no. 7, pp. 1443–1472, 2001.
- [22] A. Appriou, "Probabilités et incertitude en fusion de données multisenseurs," *Revue Scientifique et Technique de la Défense*, vol. 11, pp. 27–40, 1991.
- [23] N. Abbas, Y. Chibani, Z. Belhadi, and M. Hedir, "A DSMT Based Combination Scheme for Multi-Class Classification," in *Proc. 16th International Conference on Information Fusion (ICIF)*, Istanbul, Turkey, pp. 1950–1957, 9–12 July, 2013.
- [24] M. Kalera, B. Zhang, and S. Srihari, "Offline Signature Verification and Identification Using Distance Statistics," *International Journal of Pattern Recognition and Artificial Intelligence*, vol. 18, no. 7, pp. 1339–1360, 2004.

An Evidence Fusion Method with Importance Discounting Factors based on Neutrosophic Probability Analysis in DS_mT Framework

Qiang Guo, Haipeng Wang, You He, Yong Deng, Florentin Smarandache

Qiang Guo, Haipeng Wang, You He, Yong Deng, Florentin Smarandache (2017). An Evidence Fusion Method with Importance Discounting Factors based on Neutrosophic Probability Analysis in DS_mT Framework. *Neutrosophic Sets and Systems* 17, 64-73

Abstract:

To obtain effective fusion results of multi source evidences with different importance, an evidence fusion method with importance discounting factors based on neutrosophic probability analysis in DS_mT framework is proposed. First, the reasonable evidence sources are selected out based on the statistical analysis of the pignistic probability functions of single focal elements. Secondly, the neutrosophic probability analysis is conducted based on the similarities of the pignistic probability functions from the prior evidence knowledge of the reasonable evidence sources. Thirdly, the importance discounting factors of the reasonable evidence sources are obtained based on the neutrosophic probability analysis and the reliability

discounting factors of the real-time evidences are calculated based on probabilistic-based distances. Fourthly, the real-time evidences are discounted by the importance discounting factors and then the evidences with the mass assignments of neutrosophic empty sets are discounted by the reliability discounting factors. Finally, DS_mT+PCR5 of importance discounted evidences is applied. Experimental examples show that the decision results based on the proposed fusion method are different from the results based on the existed fusion methods. Simulation experiments of recognition fusion are performed and the superiority of proposed method is testified well by the simulation results.

Keywords: Information fusion; Belief function; Dezert-Smarandache Theory; Neutrosophic probability; Importance discounting factors.

1. Introduction

As a high-level and commonly applicable key technology, information fusion can integrate partial information from multisource, and decrease potential redundant and incompatible information between different sources, thus reducing uncertainties and improving the quick and correct decision ability of high intelligence systems. It has drawn wide attention attention by scholars and has found many successful applications in the military and economy fields in recent years [1-9]. With the increment of information environmental complexity, effective highly conflict evidence reasoning has huge demands on information fusion. Belief function also called evidence theory which includes Dempster-Shafer theory (DST) and Dezert-Smarandache theory (DS_mT) has made great efforts and contributions to solve this problem. Dempster-Shafer theory (DST) [10,11] has been commonly applied in information fusion field since it can represent uncertainty and full ignorance effectively and includes Bayesian theory

as a special case. Although very attractive, DST has some limitations, especially in dealing with highly conflict evidences fusion [9]. DS_mT, jointly proposed by Dezert and Smarandache, can be considered as an extension of DST. DS_mT can solve the complex fusion problems beyond the exclusive limit of the DST discernment framework and it can get more reasonable fusion results when multisource evidences are highly conflicting and the refinement of the discernment framework is unavailable. Recently, DS_mT has many successful applications in many areas, such as, Map Reconstruction of Robot [12,13], Clustering [14,15], Target Type Tracking [16,17], Image Processing [18], Data Classification [19-21], Decision Making Support [22], Sonar Imagery [23], and so on. Recently the research on the discounting factors based on DST or DS_mT have been done by many scholars [24,25]. Smarandache and et al [24] put forward that discounting factors in the procedure of evidence fusion should conclude

importance discounting factors and reliability discounting factors, and they also proved that effective fusion could not be carried out by Dempster combination rules when the importance discounting factors were considered. However, the method for calculating the importance discounting factors was not mentioned. A method for calculating importance or reliability discounting factors was proposed in article [25]. However, the importance and reliability discounting factors could not be distinguished and the focal element of empty set or full ignorance was processed based on DST. As the exhaustive limit of DST, it could not process empty set effectively. So, the fusion results based on importance and reliability

discounting factors are the same in [25], which is not consist with real situation. In this paper, an evidence fusion method with importance discounting factors based on neutrosophic probability analysis in DSMT framework is proposed. In Section 2, basic theories including DST, DSMT and the dissimilarity measure of evidences are introduced briefly. In Section 3, the contents and procedure of the proposed fusion method are given. In Section 4, simulation experiments in the application background of recognition fusion are also performed for testifying the superiority of proposed method. In Section 5, the conclusions are given.

2. Basic Theories

2.1. DST

Let $\Theta = \{\theta_1, \theta_2, L, \theta_n\}$ be the discernment frame having n exhaustive and exclusive hypotheses $\theta_i, i = 1, 2, L, n$. The exhaustive and exclusive limits of DST assume that the refinement of the fusion problem is accessible and the hypotheses are

$$2^\Theta = \{\emptyset, \{\theta_1\}, \{\theta_2\}, L, \{\theta_n\}, \{\theta_1, \theta_2\}, L, \{\theta_1, \theta_2, L, \theta_n\}\}. \tag{1}$$

In Shafer’s model, a basic belief assignment (bba) $m(\cdot): 2^\Theta \rightarrow [0,1]$ which consists evidences is defined by $m_k(\emptyset) = 0$ and $\sum_{A \in 2^\Theta} m(A) = 1$. (2)

The DST rule of combination (also called the Dempster combination rule) can be considered as a conjunctive normalized rule on the power set 2^Θ . The fusion results based on the Dempster combination rule are obtained by the bba’s products

$$(m_1 \oplus m_2)(C) = \frac{1}{1-K} \sum_{A \cap B = C} m_1(A)m_2(B), \forall C \subseteq \Theta \tag{3}$$

$$K = \sum_{\substack{A, B \subseteq \Theta \\ A \cap B = \emptyset}} m_1(A)m_2(B) \tag{4}$$

In some applications of multisource evidences fusion, some evidences influenced by the noise or some other conditions are highly conflicting with the other evidences. The reliability of an evidence can represent its accuracy degree of describing the given problem. The reliability discounting factor α in $[0, 1]$ is considered as the quantization of the reliability of an evidence. The reliability discounting method of

of the focal elements from different evidences which intersect to get the focal elements of the results. DST also assumes that the evidences are independent. The i^{th} evidence source’s bba is denoted m_i . The Dempster combination rule is given by [10,11]:

DST (also called the Shafer’s discounting method) is widely accepted and applied. The method consists of two steps. First, the mass assignments of focal elements are multiplied by the reliability discounting factor α . Second, all discounted mass assignments of the evidence are transferred to the focal element of full ignorance Θ . The Shafer’s discounting method can be mathematically defined as follows [10,11]

$$\begin{cases} m_\alpha(X) = \alpha \cdot m(X), \text{ for } X \neq \Theta \\ m_\alpha(X) = \alpha \cdot m(\Theta) + (1 - \alpha) \end{cases} \tag{5}$$

where the reliability discounting factor is denoted by α and $0 \leq \alpha \leq 1, X$ denotes the focal element which is not the empty set, $m(\cdot)$ denotes the original bba of evidence, $m_\alpha(\cdot)$ denotes the bba after importance discounting.

2.2. DSMT

For many complex fusion problems, the elements can not be separated precisely and the refinement of discernment frame is inaccessible. For dealing with this situation, DSMT [9] which overcomes the exclusive limit of DST, is jointly proposed by Dezert and Smarandache. The hyper-power set in DSMT framework denoted by D^Θ consists of the unions and intersections elements in

Θ . Assume that $\Theta = \{\theta_1, \theta_2\}$, the hyper-power set of Θ can be defined as $D^\Theta = \{\emptyset, \theta_1, \theta_2, \theta_3, \theta_1 \cup \theta_2, \theta_1 \cap \theta_2\}$. The bba which consists the body of the evidence in DSMT framework is defined on the hyper-power set as $m(\cdot): D^\Theta \rightarrow [0,1]$.

Dezert Smarandache Hybrid (DSmH) combination rule transfers partial conflicting beliefs to the union of the corresponding elements in conflicts which can be considered as partial ignorance or uncertainty. However, the way of transferring the conflicts in DSmH increases the uncertainty of fusion results and it is not convenient for decision-making based on the fusion results. The

$$m_{1\oplus 2}(X_i) = \sum_{\substack{Y, Z \in G^\Theta \text{ and } Y, Z \neq \emptyset \\ Y \cap Z = X_i}} m_1(Y) \cdot m_2(Z) \tag{6}$$

$$m_{PCR5}(X_i) = \begin{cases} m_{1\oplus 2} + \sum_{\substack{X_j \in G^\Theta \text{ and } i \neq j \\ X_i \cap X_j = \emptyset}} \left[\frac{m_1(X_i)^2 \cdot m_2(X_j)}{m_1(X_i) + m_2(X_j)} + \frac{m_2(X_i)^2 \cdot m_1(X_j)}{m_2(X_i) + m_1(X_j)} \right] & X_i \in G^\Theta \text{ and } X_i \neq \emptyset \\ 0 & X_i = \emptyset \end{cases}$$

where all denominators are more than zero, otherwise the fraction is discarded, and where G^Θ can be regarded as a general power set which is equivalent to the power set 2^Θ , the hyper-power set D^Θ and the super-power set S^Θ , if discernment of the fusion problem satisfies the Shafer's model, the hybrid DSm model, and the minimal refinement Θ^{ref} of Θ respectively [9,26,27].

Although PCR5 rule can get more reasonable fusion results than the combination rule of DST, it still has two disadvantages, first, it is not associative which means that the fusion sequence of multiple (more than 2) sources of evidences can influence the fusion results, second, with the increment of the focal element number in discernment frame, the computational complexity increases exponentially.

It is pointed out in [24] that importances and reliabilities of multisources in evidence fusion are different. The reliability of a source in DSMT framework represents the ability of describing the given problem by its real-time evidence which is the same as the notion in DST framework. The

$$\begin{cases} m_\beta(X) = \beta \cdot m(X), \text{ for } X \neq \emptyset \\ m_\beta(\emptyset) = \beta(\emptyset) + (1 - \beta) \end{cases} \tag{7}$$

where the importance discounting factor is denoted by β and $0 \leq \beta \leq 1$, X denotes the focal element which is not the empty set, $m(\cdot)$ denotes the original bba of evidence, $m_\beta(\cdot)$ denotes the bba after importance discounting. The empty set \emptyset of Equation (7) is particular in DSMT discounted framework which is not the representation of unknown elements under the open-world assumption

Proportional Conflict Redistribution (PCR) 1-6 rules overcome the weakness of DSmH and gives a better way of transferring the conflicts in multisource evidence fusion. PCR 1-6 rules proportionally transfer conflicting mass beliefs to the involved elements in the conflicts [9,26,27]. Each PCR rule has its own and different way of proportional redistribution of conflicts and PCR5 rule is considered as the most accurate rule among these PCR rules [9,26,27]. The combination of two independent evidences by PCR5 rule is given as follows [9,26,27]:

importances of sources in DSMT framework represent the weight that the fusion system designer assigns to the sources. Since the notions of importances and reliabilities of sources make no difference in DST framework, Shafer's discounting method can not be applied to evidence fusion of multisources with unequal importances.

The importance of a source in DSMT framework [24] can be characterized by an importance discounting factor, denoted β in $[0,1]$. The importance discounting factor β is not related with the reliability discounting factor α which is defined the same as DST framework. β can be any value in $[0,1]$ chosen by the fusion system designer for his or her experience. The main difference of importance discounting method and reliability discounting method lies in the importance discounted mass beliefs of evidences are transferred to the empty set rather than the total ignorance Θ . The importance discounting method in DSMT framework can be mathematically defined as

$$m_{PCR5_\beta}(A) = \sum_{\substack{X_1, X_2 \in G^\Theta \\ X_1 \cap X_2 = A}} m_1(X_1) m_2(X_2) + \sum_{\substack{X \in G^\Theta \\ X \cap A = \emptyset}} \left[\frac{m_1(A)^2 \cdot m_2(X)}{m_1(A) + m_2(X)} + \frac{m_2(A)^2 \cdot m_1(X)}{m_2(A) + m_1(X)} \right] \tag{8}$$

The fusion rules with importance discounting factors considered as the extension of PCR6 and the

fusion rule for multisources ($s > 2$) as the extension of PCR5 can be seen referred in [24].

3. An Evidence Fusion Method with Importance Discounting Factors Based on Neutrosophic Probability Analysis in DSMT Framework

An evidence fusion method with importance discounting factors based on neutrosophic probability analysis in DSMT framework is proposed in this section. First, the reasonable evidence sources are selected out based on the statistical analysis of the pignistic probability functions of single focal elements. Secondly, the neutrosophic probability analysis is conducted based on the similarities of the pignistic probability functions from the prior evidence knowledge of the reasonable evidence sources. Thirdly, the importance discounting factors

of the reasonable evidence sources are obtained based on the neutrosophic probability analysis and the reliability discounting factors of the real-time evidences are calculated based on probabilistic-based distances. Fourthly, the real-time evidences are discounted by the importance discounting factors and then the evidences with the mass assignments of neutrosophic empty sets are discounted by the reliability discounting factors. Finally, DSMT+PCR5 of importance discounted evidences is applied.

3.1. The reasonable evidence sources are selected out

Definition 1: Extraction function for extracting focal elements from the the pignistic probability functions of single focal elements.

$$\chi(P(a_i)) = a_i, a_i \in \{a_1, a_2, L, a_z\} \quad (11)$$

Definition 2: Reasonable sources.

The evidence sources are defined as reasonable sources if and only if the focal element which has the maximum mean value of the pignistic probability functions of all single focal elements is the element a_j which is known in prior knowledge, denoted by

$$\chi(P(\theta)) = \max(\overline{P(a)}) = a_j, 1 \leq i \leq z \quad (12)$$

where θ represents that the focal element which has the maximum mean value of the pignistic probability functions of all single focal elements.

Based on *Definition 2* and the prior evidence knowledge, reasonable sources are selected out. The unreasonable sources are not suggested to be considered in the following procedure for they are imprecise and unbelievable.

3.2. The neutrosophic probability analysis of the sources and the importance discounting factors in DSMT framework

The neutrosophic probability theory is proposed by Smarandache [30]. In this section, the neutrosophic probability analysis is conducted based

on the similarities of the pignistic probability functions from the prior evidence knowledge of the reasonable evidence sources.

Definition 3: Similarity measure of the pignistic probability functions (SMPPF).

Assume that the distribution characteristics of pignistic probability functions of the focal elements $P(a_i): \{\overline{P(a_i)}, \sigma(a_i)\}, P(a_k): \{\overline{P(a_k)}, \sigma(a_k)\}$.

$a_i, 1 \leq i \leq z$ and $a_k, k \neq i, 1 \leq k \leq z$ are denoted by:

The similarity measure of the pignistic probability functions(SMPPF) is the function satisfying the following conditions:

(1) Symmetry:

$$\forall a_i, a_k \in \Theta, Sim(P(a_i), P(a_k)) = Sim(P(a_k), P(a_i));$$

(2) Consistency:

$$\forall a_i \in \Theta, Sim(P(a_i), P(a_i)) = Sim(P(a_i), P(a_i)) = 1;$$

(3) Nonnegativity:

$$\forall a_i, a_k \in \Theta, Sim(P(a_i), P(a_k)) > 0.$$

We will say that $P(a_i)$ is more similar to $P(a_k)$ than $P(a_g)$ if and only if:

$$Sim(P(a_i), P(a_k)) > Sim(P(a_i), P(a_g)).$$

The similarity measure of the pignistic probability functions based on the distribution

$$similarity(a_i, a_k) = \exp \left\{ -\frac{|P(a_i) - P(a_k)|}{2[\sigma(a_i) + \sigma(a_k)]} \right\} \quad (13)$$

Assume that a_j is known in prior knowledge, the diagram for the similarity of the pignistic probability functions of focal elements a_j and a_k which has the largest SMPPF to a_j is shown in Fig. 1. $P(a_j)$ is mapped to a circle in which $\overline{P(a_j)}$ is the center and $\sigma(a_j)$ is the radius. Similarly, $P(a_k)$ is mapped to a circle in which $\overline{P(a_k)}$ is the center and $\sigma(a_k)$ is the radius. All the evidences in the prior knowledge from the reasonable source are mapped to the drops in any circle which means that the mapping from drops in the circle of $P(a_j)$ to the prior evidences is one-to-one mapping and similarly the mapping from drops in the circle of $P(a_k)$ to the prior evidences is also one-to-one mapping. If $P(a_j)$ is very similar to $P(a_k)$, the shadow accounts for a

characteristics of the pignistic probability functions is defined as follows:

large proportion of $P(a_j)$ or $P(a_k)$. If $P(a_j)$ or $P(a_k)$ has the random values in the shadow of the diagram, the evidences of the reasonable source can not totally and correctly support decision-making for there are two possibilities which are $P(a_j) > P(a_k)$ and $P(a_j) \leq P(a_k)$. If $P(a_j) \leq P(a_k)$ in the evidences, the decisions are wrong. However, if $P(a_j)$ or $P(a_k)$ has the random values in the blank of the diagram, there is only one possibility which is $P(a_j) > P(a_k)$ for the sources are reasonable and the decisions by these evidences are totally correct. So, we define the neutrosophic probability and the absolutely right probability of the reasonable evidence source as probability of $P(a_j)$ in the shadow and blank of the diagram.

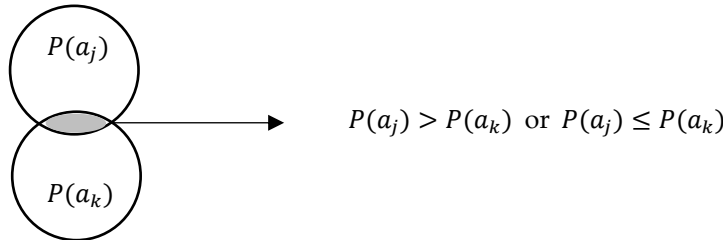

Figure 1. The diagram for the similarity.

Based on the above analysis, the neutrosophic probability and the absolutely right probability of the reasonable evidence source can be obtained by the similarity from the prior evidences for the mapping of the SMPPF of $P(a_j)$ and $P(a_k)$ to the probability of $P(a_j)$ in the shadow is one-to-one mapping.

As $\forall a_i, a_k \in \Theta, 0 < similarity(P(a_i) P(a_k)) \leq 1$, iff $a_i = P(S_k \text{ is neutral} | a_i) = \max_{1 < j < n, j \neq i} [similarity(P(a_i) P(a_k))]$ (14)

Then, the absolutely right probability of the reasonable evidence source in the prior condition that a_j is known can be calculated as follows:

$$(S_k \text{ is absolutely right} | a_i) = 1 - P(S_k \text{ is neutral} | a_i) = 1 - \max_{1 < j < n, j \neq i} [similarity(P(a_i) P(a_k))] \quad (15)$$

So, if the prior probability of each focal element can be obtained accurately, the absolutely right $P(S_k \text{ is absolutely right}) = \sum_{a_i \in \Theta, i=1,2,L,n} P(S_k \text{ is absolutely right} | a_i) g P(a_i)$. (16)

If the prior probability of each focal element can not be obtained accurately and any focal element has no advantage in the prior knowledge, denoted by

$$P(S_k \text{ is absolutely right}) = \frac{\sum_{a_i \in \Theta, i=1,2,L,n} P(S_k \text{ is absolutely right} | a_i)}{n} \quad (17)$$

We define the discounting factors of importances in DSMT framework $\alpha_{SIG}(S_k)$ as the normalization of the absolutely right probabilities of

$a_k, similarity(P(a_i))$, we define that the probability of $P(a_j)$ in the shadow is the same as $similarity(P(a_i) P(a_k))$.

Assume there are reasonable evidence sources for evidence fusion, denoted by $S_k, k = 1, 2, L, h$. So, the neutrosophic probability of the the reasonable evidence source in the prior condition that a_j is known can be calculated as follows:

probability of the reasonable evidence source can be calculated by the equation

$P(a_1) = P(a_2) = L = P(a_n)$, the absolutely right probability of the reasonable evidence source can be calculated as follows:

the the reasonable evidence sources $P(S_k \text{ is right}), k = 1, 2, L, h$, denoted by

$$\alpha_{SIG}(S_k) = \frac{P(S_k \text{ is absolutely right})}{\max_{k=1,2,L,h} [P(S_k \text{ is absolutely right})]} \quad (18)$$

3.3. The reliability discounting factors based on probabilistic-based distances

The Classical Pignistic Transformation(CPT) [9,10,11] is introduced briefly as follows:

$$P(A) = \sum_{X \in 2^\Theta} \frac{|X \cap A|}{|X|} m(X) \tag{19}$$

Based on CPT, if the mass assignments of the single focal elements which consist of the union set of single focal elements are equal divisions of the mass assignment of the union set of single focal elements in two evidences, the pignistic probability of two evidences are equal and the decisions of the two evidences based on CPT are also the same. From the view of decision, it is a good way to measure the similarity of the real-time evidences based on pignistic probability of evidences. Probabilistic distance based on Minkowski's distance [25] is applied in this paper to measure the similarity of real-time evidences. The method for calculating the

reliability discounting factors based on Minkowski's distance [25] ($t = 1$) is given as follows.

Assume that there are h evidence sources, denoted by $S_k, k = 1, 2, L, h$, the real-time 2 evidences from S_i and $S_j, i \neq j$ are denoted by $\mathbf{m}_i, \mathbf{m}_j$ the discernment framework of the sources is $\{\theta_1, \theta_2, L, \theta_n\}$, the pignistic probabilities of single focal elements from S_i are denoted by $P_{S_i}(\theta_w), 1 < w < n$ and the pignistic probabilities of single focal elements from S_j are denoted by $P_{S_j}(\theta_w), 1 < w < n$.

1) Minkowski's distance ($t = 1$) between two real-time evidences is calculated as follows:

$$DistP(\mathbf{m}_i, \mathbf{m}_j) = \frac{1}{2} \sum_{\substack{\theta_w \in \Theta \\ |\theta_w|=1}} |P_{S_i}(\theta_w) - P_{S_j}(\theta_w)|. \tag{20}$$

2) The similarity of the real-time evidences is obtained by

$$similarity(\mathbf{m}_i, \mathbf{m}_j) = 1 - DistP(\mathbf{m}_i, \mathbf{m}_j). \tag{21}$$

3) The similarity matrix of the real-time evidences from $S_k, k = 1, 2, L, h$ is given

$$S = \begin{bmatrix} 1 & similarity(\mathbf{m}_1, \mathbf{m}_2) & L & similarity(\mathbf{m}_1, \mathbf{m}_h) \\ similarity(\mathbf{m}_2, \mathbf{m}_1) & 1 & L & similarity(\mathbf{m}_2, \mathbf{m}_h) \\ M & M & M & M \\ similarity(\mathbf{m}_h, \mathbf{m}_1) & similarity(\mathbf{m}_h, \mathbf{m}_2) & L & 1 \end{bmatrix} \tag{22}$$

The average similarity of the real-time evidences from $S_k, k = 1, 2, L, h$ is given

$$\overline{similarity(S_k)} = \frac{\sum_{i=1,2,L,h, i \neq k} similarity(\mathbf{m}_i, \mathbf{m}_k)}{h-1} \tag{23}$$

4) The reliability discounting factors of the real-time evidences from $S_k, k = 1, 2, L, h$ is given

$$\alpha_{REL}(S_k) = \frac{\overline{similarity(S_k)}}{\max_{k=1,2,L,h} [\overline{similarity(S_k)}]} \tag{24}$$

3.4. The discounting method with both importance and reliability discounting factors in DSMT framework

1) Discounting evidences based on the discounting factors of importance.

Assume that the real-time evidence from the reasonable evidence source s_k is denoted by:

$$\mathbf{m}_k = \{m(A), A \subseteq D^\Theta\}, G^\Theta = \{a_1 L, a_2, a_1 I L I a_2, a_1 UL U a_2\}.$$

Based on the discounting factors of importances \mathbf{m}_k^{SIG} after importance-discounting by $\alpha_{SIG}(s_k)$ can be calculated by:

$$\mathbf{m}_k^{SIG} = \begin{cases} m^{SIG}(A) = \alpha_{SIG}(S_k)g(m(A)), A \subseteq G^\Theta \\ m^{SIG}(\emptyset) = 1 - \alpha_{SIG}(S_k) \end{cases} \tag{25}$$

where $m^{SIG}(A)$ are the mass assignments to all focal elements of the original evidence and $m^{SIG}(\emptyset)$ is the neutrosophic probability of the

source, which represents the mass assignment of paradox.

2) Discounting the real-time evidences based on reliability discounting factors after importance discounting.

As the property of the neutrosophic probability of the source, the pignistic probabilities of single focal elements are not changed after importance-discounting the real-time evidences in DSMT framework and the mass assignments of neutrosophic empty focal element \emptyset which represent the importances degree of sources is added to the new

evidences. If some real-time evidence has larger conflict with the other real-time evidences, the evidence should be not reliable and the mass assignments of the focal elements of the evidence should be discounted based on the discounting factors of reliabilities. As one focal element of the new evidence, the mass assignment of neutrosophic

empty focal element \emptyset of the unreliable evidence should also be discounted. So the new discounting method based on the discounting factors of

reliabilities after discounting by the discounting factors of importances is given as follows

$$m_K^{SIG} = \begin{cases} m^{\alpha SIG}(A) = \alpha_{REL}(S_k)g\alpha_{SIG}(S_k)g(m(A)), A \subseteq G^\Theta \\ m^{\alpha SIG}(\emptyset) = \alpha_{REL}(S_k)g[1 - \alpha_{SIG}(S_k)] \\ m^{\alpha SIG}(\Theta) = 1 - \alpha_{REL}(S_k) \end{cases} \quad (26)$$

3.5. The fusion method of PCR5 \emptyset in DSMT framework is applied

After applying the new discounting method to the real-time evidences, the new evidences with the mass assignments of both the neutrosophic empty focal element \emptyset and the total ignorance focal elements Θ are obtained. The classic Dempster

fusion rules can not be sufficient to process these evidences in DSMT framework and PCR5 \emptyset for 2 sources in DSMT framework is applied as our fusion method as follows:

$$m_{PCR5\emptyset}(A) = \sum_{\substack{X_1, X_2 \in G^\Theta \\ X_1 \cap X_2 = A}} m_1(X_1)m_2(X_2) + \sum_{\substack{X \in G^\Theta \\ X \cap A = \emptyset}} \left[\frac{m_1(A)^2 \cdot m_2(X)}{m_1(A) + m_2(X)} + \frac{m_2(A)^2 \cdot m_1(X)}{m_2(A) + m_1(X)} \right], A \in G^\Theta \text{ or } \emptyset \quad (27)$$

The mass assignment of the neutrosophic empty focal element \emptyset is included in the fusion results, which is not meaningful to decision. According to the

principle of proportion, $m_{PCR5\emptyset}(\emptyset)$ in the fusion result is redistributed to the other focal elements of the fusion result as follows:

$$m'_{PCR5\emptyset}(A) = m_{PCR5\emptyset}(A) + \frac{m_{PCR5\emptyset}(A)}{\sum_{A \in G^\Theta} m_{PCR5\emptyset}(A)} \cdot m_{PCR5\emptyset}(\emptyset), A \in G^\Theta$$

$$m'_{PCR5\emptyset}(\emptyset) = 0 \quad (28)$$

where $m'_{PCR5\emptyset}(A), A \in G^\Theta$ is the final fusion results of our method.

4. Simulation Experiments

The Monto Carlo simulation experiments of recognition fusion are carried out. Through the simulation experiment results comparison of the proposed method and the existed methods, included PCR5 fusion method, the method in [25] and PCR5 fusion method with the reliability discounting factors, the superiority of the proposed method is testified. (In this paper, all the simulation experiments are implemented by Matlab simulation in the hardware condition of Pentimu(R) Dual-Core CPU E5300 2.6GHz 2.59GHz, memory 1.99GB. Abscissas of the figures represent that the ratio of the the standard deviation of Gauss White noise to the

maximum standard deviation of the pignistic probabilities of focal elements in prior knowledge of the evidence sources, denoted by ‘the ratio of the standard deviation of GWN to the pignistic probabilities of focal elements’.)

Assume that the prior knowledge of the evidence sources is counted as the random distributions of the pignistic probability when different focal element occurs. The prior knowledge is shown in *Table 3* and the characteristics of random distributions are denoted by $P(\cdot)$: (mean value, variance).

Table 3. Prior knowledge of evidence sources.

Evidence sources	Prior knowledge when a occurs	Prior knowledge when b occurs
S1	$P_1(a) \sim (0.6, 0.3)$	$P_1(a) \sim (0.46, 0.3)$
	$P_1(b) \sim (0.4, 0.3)$	$P_1(b) \sim (0.54, 0.3)$
S2	$P_2(a) \sim (0.6, 0.3)$	$P_2(a) \sim (0.4, 0.3)$
	$P_2(b) \sim (0.4, 0.3)$	$P_2(b) \sim (0.6, 0.3)$
S3	$P_3(a) \sim (0.8, 0.05)$	$P_3(a) \sim (0.2, 0.05)$
	$P_3(b) \sim (0.2, 0.05)$	$P_3(b) \sim (0.8, 0.05)$

5.1.1 Simulation experiments in the condition that importance discounting factors of most evidence sources are low

Assume that there are 3 evidence sources, denoted by s_1, s_2, s_3 , and the discernment framework

of the sources is 2 types of targets, denoted by $\{a, b\}$. The prior knowledge is shown in *Table 3*. Assume

that the pignistic probabilities of the focal elements are normally distributed. The real-time evidences of 3 sources are random selected out 1000 times based on the prior knowledge in *Table 3* in the condition that *a* occurs and *b* occurs respectively. The Moto-carlo simulation experiments of recognition fusion based on the proposed method and the existed methods are carried out. With the increment of the standard deviation of Gauss White noise in the mass assignments of evidences, the fusion results comparisons in different conditions are shown in *Fig. 3* and *Fig. 4*, and the mean value of the correct recognition rates and computation time are show in *Table 11* and *Table 12*.

The fusion results comparisons in the condition that importance discounting factors of most evidence sources are low show that:

1) The method proposed in this paper has the highest correct recognition rates among the existed methods. PCR5 fusion method has the secondly highest correct recognition rates, PCR5 fusion method with reliability discounting factors has the thirdly highest correct recognition rates, the method in [25] has the lowest correct recognition rates.

2) The method proposed in this paper has the largest computation time among the existed methods. the method in [25] has the secondly largest computation time, PCR5 fusion method with reliability discounting factors has the thirdly largest computation time, PCR5 fusion method has the lowest computation time.

Table 11. The mean value of correct recognition rates.

Prior conditions	The proposed method	PCR5 fusion method	The method in [25]	PCR5 fusion method with realibility-discounting factors
<i>a</i>	98.9%	88.6%	80.5%	84.3%
<i>b</i>	98.9%	87.6%	79.0%	82.9%

Table 12. The mean value of computation time.

Prior conditions	The proposed method	PCR5 fusion method	The method in [25]	PCR5 fusion method with realibility-discounting factors
<i>a</i>	1.47×10^{-4}	0.48×10^{-4}	0.88×10^{-4}	0.67×10^{-4}
<i>b</i>	1.46×10^{-4}	0.47×10^{-4}	0.89×10^{-4}	0.66×10^{-4}

Table 13. Prior knowledge of evidence sources.

Evidence sources	Prior knowledge when <i>a</i> occurs	Prior knowledge when <i>b</i> occurs
<i>s</i> ₁	$P_1(a) \sim (0.6,0.3)$	$P_1(a) \sim (0.46,0.3)$
	$P_1(b) \sim (0.4,0.3)$	$P_1(b) \sim (0.54,0.3)$
<i>s</i> ₂	$P_2(a) \sim (0.8,0.05)$	$P_2(a) \sim (0.2,0.05)$
	$P_2(b) \sim (0.2,0.05)$	$P_2(b) \sim (0.8,0.05)$
<i>s</i> ₃	$P_3(a) \sim (0.8,0.05)$	$P_3(a) \sim (0.2,0.05)$
	$P_3(b) \sim (0.2,0.05)$	$P_3(b) \sim (0.8,0.05)$

5.1.2 Simulation experiments in the condition that importance discounting factors of most evidence sources are high

Assume that there are 3 evidence sources, denoted by *s*₁, *s*₂, *s*₃, and the discernment framework of the sources is 2 types of targets, denoted by {*a*,*b*}. The prior knowledge is shown in *Table 13*. Assume

that the pignistic probabilities of the focal elements are normally distributed. The Moto-carlo simulation experiments are carried out similarly to the *Section 4.3.1*. With the increment of the standard deviation

of Gauss White noise in the mass assignments of evidences, the fusion results comparisons in different conditions are shown in Fig. 5 and Fig. 6, and the mean value of the correct recognition rates and

computation time are show in Table 14 and Table 15. The importance factors of the evidences are calculated by Equation (18). The importance factor of s_1 is 0.19, the importance factor of s_2 and s_3 is 1.

Table 14. The mean value of correct recognition rates.

Prior conditions	The proposed method	PCR5 fusion method	The method in [25]	PCR5 fusion method with reliability-discounting factors
<i>a</i>	99.0%	98.8%	99.0%	99.0%
<i>b</i>	99.0%	98.8%	99.0%	99.0%

Table 15. The mean value of computation time.

Prior conditions	The proposed method	PCR5 fusion method	The method in [25]	PCR5 fusion method with reliability-discounting factors
<i>a</i>	1.45×10^{-4}	0.47×10^{-4}	0.86×10^{-4}	0.67×10^{-4}
<i>b</i>	1.46×10^{-4}	0.47×10^{-4}	0.87×10^{-4}	0.65×10^{-4}

The fusion results comparisons in the condition that importance discounting factors of most evidence sources are high show that:

1) The correct recognition rates of four methods are similarly closed, PCR5 fusion method has the lowest correct recognition rates among four methods.

5. Conclusions

Based on the experiments results, we suggest that the fusion methods should be chosen based on the following conditions:

1) Judge whether the evidences are simple.

2) The method proposed in this paper has the largest computation time among the existed methods. the method in [25] has the secondly largest computation time, PCR5 fusion method with reliability discounting factors has the thirdly largest computation time, PCR5 fusion method has the lowest computation time.

2) The importance discounting factors of most evidences are low or not high, the method in this paper is chosen.

The importance discounting factors of most evidences are high, PCR5 fusion method with reliability discounting factors is chosen

References

- Alan J. Terry, Munir Zaman, John Illingworth. Sensor fusion by a novel algorithm for time delay estimation. *Digital Signal Processing*, **2012**, 22(3), 439-452.
- Yilmaz Kalkan, Buyurman Baykal. Multiple target localization & data association for frequency-only widely separated MIMO radar, *Digital Signal Processing*, **2014**, 25, 51-61.
- Donka Angelova, Lyudmila Mihaylova. Joint target tracking and classification with particle filtering and mixture Kalman filtering using kinematic radar information, *Digital Signal Processing*, **2006**, 16(2), 180-204.
- Lauro Snidaro, Ingrid Visentini, Karna Bryan. Fusing uncertain knowledge and evidence for maritime situational awareness via Markov Logic Networks, *Information Fusion*. 21 (**2015**) 159-172.
- Yi Yang, Deqiang Han, Chongzhao Han. Discounted combination of unreliable evidence using degree of disagreement, *International Journal of Approximate Reasoning*. 54(8) (**2013**) 1197-1216.
- Ammar Cherchar, Messaoud Thameri, Adel Belouchrani. Performance improvement of direction finding algorithms in non-homogeneous environment through data fusion, *Digital Signal Processing*. 41 (**2015**) 41-47.

7. X. Li, J. Dezert, F. Smarandache, X. Dai. Combination of qualitative information based on 2-Tuple modelings in DSMT, *Journal of Computer Science and Technology*. 24(4) (2009) 786-798.
8. X. Li, J. Dezert, F. Smarandache. Fusion of imprecise qualitative information, *Applied Intelligence*. 33(3) (2010) 340-351.
9. F. Smarandache, J. Dezert. *Advances and Applications of DSMT for Information Fusion*, American Research Press, Rehoboth, USA, Vol. 1, Vol. 2, Vol.3, 2004/2006/2009.
10. G. Shafer. *A Mathematical Theory of Evidence*, Princeton Univ. Press, Princeton, NJ, 1976.
11. G. Shafer, Perspectives on the Theory and Practice of Belief Functions, *International Journal of Approximate Reasoning*. 4 (1990) 323-362.
12. R. Singh, M. Vatsa, A. Noore. Integrated multilevel image fusion and match score fusion of visible and infrared face images for robust face recognition, *Pattern Recognition*. 41(3) (2008) 880-893.
13. X. Li, X. Huang, X. Dai, Z. Meng. Study on environment perception of mobile robots using DSMT-based fusion machine, *Journal of Huazhong University of Science and Technology*. 12(37) (2009) 64-67 [Chinese].
14. Z. Liu, Q. Pan, J. Dezert, G. Mercier. Credal c-means clustering method based on belief functions, *Knowledge Based Syst*. 74 (2015) 119-132.
15. T. Denoeux. Maximum likelihood estimation from Uncertain Data in the Belief Function Framework, *IEEE Transactions on Knowledge and Data Engineering*, 25(1) (2013) 119-130.
16. T. Denoeux, N. El Zoghby, V. Cherfaoui, A. Jouglet. Optimal object association in the Dempster-Shafer framework, *IEEE Transactions on Cybernetics*. 44(22) (2014) 2521-2531.
17. F. Faux, F. Luthon, Theory of evidence for face detection and tracking, *International Journal of Approximate Reasoning*. 53(5) (2012) 728-746.
18. Z. Liu, J. Dezert, G. Mercier, Q. Pan. Dynamic Evidential Reasoning for Change Detection in Remote Sensing Images, *IEEE T. Geoscience and Remote Sensing*. 50(5) (2012) 1955-1967.
19. Z. Liu, Q. Pan, J. Dezert, G. Mercier. Credal classification rule for uncertain data based on belief functions, *Pattern Recognition*. 47(7) (2014) 2532-2541.
20. Z. Liu, Q. Pan, G. Mercier, J. Dezert. A New Incomplete Pattern Classification Method Based on Evidential Reasoning, *IEEE T. Cybernetics*. 45(4) (2015) 635-646.
21. C. Lian, S. Ruan, T. Denoeux. An evidential classifier based on feature selection and two-step classification strategy, *Pattern Recognition*. 48 (2015) 2318-2327.
22. Z. Liu, J. Dezert, Q. Pan, Grégoire Mercier. Combination of sources of evidence with different discounting factors based on a new dissimilarity measure, *Decision Support Systems*. 52(1) (2011) 133-141.
23. X. Li, X. Huang, J. Dezert, et al. A successful application of DSMT in sonar grid map building and comparison with DST-based approach, *International Journal of Innovative Computing, Information and Control*. 3(3) (2007) 539-551.
24. Smarandache F, Dezert J, Tacnet J.-M. Fusion of sources of evidence with different importances and reliabilities[C], in Proceedings of Fusion 2010 Conference, Edinburgh, UK, July 2010.
25. Liu Zhun-ga, Dezert J, Pan Quan. Mercier Gregoire. Combination of sources of evidence with different discounting factors based on a new dissimilarity measure, *Decision Support System* 52 (2011), 133-141.
26. J. Dezert, F. Smarandache. DSMT: A new paradigm shift for information fusion, Cogis06 International Conference, Paris, France, 2006, pp. 15-17.
27. F. Smarandache, J. Dezert. Information Fusion Based on New Proportional Conflict Redistribution Rules, in: Proceedings of Fusion 2005 Conference, Philadelphia, July 26-29, 2005, pp. 907-914.
28. M.C. Florea, E. Bosse, A.L. Jousselme. Metrics, distances and dissimilarity measures within Dempster-Shafer theory to characterize sources' reliability, Proceeding of Cognitive Systems with Interactive Sensors Conference (COGIS '09), 2009.
29. Anne-Laure Jousselme et al. A new distance between two bodies of evidence, *Information Fusion*. 2(2) (2001) 91-101.
30. Florentin Smarandache. *A Unifying Field in Logics. Neutrosophy: Neutrosophic Probability, Set, and Logic*, American Research Press, Rehoboth, 1999.
31. F. Smarandache, *Neutrosophic Perspectives: Triplets, Duplets, Multisets, Hybrid Operators, Modal Logic, Hedge Algebras. And Applications*. Pons Editions, Bruxelles, 325 p., 2017.
32. Topal, S. and Öner, T. Contrastings on Textual Entailmentness and Algorithms of Syllogistic Logics, *Journal of Mathematical Sciences*, Volume 2, Number 4, April 2015, pp 185-189.
33. Topal S. An Object- Oriented Approach to Counter-Model Constructions in A Fragment of Natural Language, *BEU Journal of Science*, 4(2), 103-111, 2015.

ROBOTICS

Some mathematical aspects on walking robots stable evolution

Marcel Migdalovici, Luige Vlădăreanu, Gabriela Vlădeanu, Daniela Baran, Said Broumi,
Florentin Smarandache, Hongbo Wang, Yonfei Feng

Marcel Migdalovici, Luige Vlădăreanu, Gabriela Vlădeanu, Daniela Baran, Said Broumi, Florentin Smarandache, Hongbo Wang, Yonfei Feng (2016). Some mathematical aspects on walking robots stable evolution. 10th International Conference on Software, Knowledge, Information Management & Applications (SKIMA), 199-204

Abstract: A survey of some author's concepts on the dynamic systems stability regions, in the general case of dynamic systems that depend on parameters is related in the paper. The property of separation of stable regions in the free parameters domain is assumed in the paper as an important property of the environment that is carry out and in the specified case of walking robot analyzed in the paper. The matrix that defines the linear dynamic system has the components of the matrix, assumed to be with real values, and the matrices that intervene in the exposure of the method are also, with real values of the components. We assumed that the matrices from the exposure have the complex values such that the real values are also taken into account as particular case of the complex values. This hypothesis assures a new method of analysis, in the complex domain, on the dynamic systems stability. Our theory on the stability control of the dynamic systems is applied here for specified walking robot model that depend on parameters. The critical position of the walking robot evolution is defined and analyzed on some cases of the walking robot leg, and possible application for robot walking up stairs is exposed. The further way of research is emphasized.

Keywords: *dynamic system; stable region; walking robots; critical position; walking up stair; kinematics analyze*

I. INTRODUCTION

Any dynamic system can be considered as dynamic system in terms of its defining parameters without fixing their values as physical parameters (in particular mechanical parameters), geometrical parameters, possible economical, biological parameters or other.

An important idea is that many concrete dynamic systems from the literature that depend on parameters have the proper-

-ty of separation between the stable and unstable regions in a specified domain of free parameters. The stable and unstable regions are separated in the domain of free parameters by a boundary. The property of separation can be defined by the fact that the stable and unstable regions are open sets, excepting the points on boundary. This separation aspect creates the freedom of stability control on a neighborhood of any stable point in the open stable region of the dynamic system. We discovered mathematical conditions of the stability regions existence for the dynamic systems using various results from applied mathematics domain.

The property of separation of stability regions is an important property of the environment that can contribute to mathematical modelling of it.

In this paper we analyze some aspects on the conditions of separation between stable and unstable regions in the free parameters domain of the linear or nonlinear dynamical systems, calling the QR algorithm applied on the real matrix that defines the linear dynamic system or on the "first approximation" of the nonlinear dynamic system, using operations in the complex domain by the matrix "shift of origin". The dependence of this matrix eigenvalues on the matrix components properties intervene in justification of separation property. The components of the real matrix A that define the linear dynamic system depending on parameters are assumed to be piecewise continuous in the free parameters.

II. ON TRANSPOSITION OF THE REAL SYSTEM IN COMPLEX ONE

The linear dynamic system or the "first approximation" of the nonlinear dynamic system depending on some parameters

is defined by one real matrix for the cases from the literature. The components of such real matrix are assumed to be piecewise continuous functions of the system parameters.

The properties of the stability for the dynamic system with parameters are described by the properties of eigenvalues functions for the system matrix. The eigenvalues of the system matrix are the same as for the matrix in Hessenberg corresponding form. The Hessenberg form is defined by the condition $a_{ij} \cong 0$ for $2 \leq i \leq n, j \geq i + 1$. The dynamic system can be substituted by the dynamic system with the system matrix in Hessenberg form for the stability analysis of the system [28], [29].

The system matrix in Hessenberg form is denoted by A . The matrix $A - oI$, where o is real or complex value, is also a matrix in Hessenberg form. The value o is named "shift of origin" of the matrix. The shift of origin for the matrix is important because allow the transposition of the real matrix that define the dynamic system in the complex one for analysis of the dynamic system stability.

The QR algorithm for matrix A , using "shift of origin", is defined by the relations [29]:

$$Q_s(A_s - oI) \cong R_s, A_{s+1} \cong R_s Q_s^T \cdot k_s I \cong Q_s A_s Q_s^T, s \leq N \quad (1)$$

In the above relations by A_1 is denoted initial matrix of the system in the Hessenberg form, k_s is "shift of origin", Q_s is orthogonal matrix, R_s is upper triangular matrix, $A_s, s \geq 2$ is also in Hessenberg form and N is natural numbers set.

The shift of origin, with the initial value o sufficient close to one initial matrix eigenvalue, real or complex, impose acceleration of the QR algorithm convergence to respective eigenvalue on the similar diagonal form of the matrix. This is an important property of QR algorithm with shift of origin.

In conclusion, the real matrix A with distinct eigenvalues is similar with the matrix in Hessenberg form and QR algorithm with "shift of origin" can facilitate the convergence of the initial matrix to similar diagonal form of the matrix with real or complex eigenvalues on the diagonal.

This study is performed in the hypothesis that all eigenvalues of the real matrix are distinct. For extension of the results in the case of real matrix multiple eigenvalues, we called to the study of Hirsch, Smale and Devaney that have demonstrated that the set of matrices with distinct eigenvalues from linear normed space $L(R^n)$ is opened and dense set in this space [1].

The above remark gives the possibilities to motivate the transmission of some properties from the real matrices with distinct eigenvalues to the real matrices with multiple eigenvalues that can intervene in evolution analysis of the linear dynamic system.

III. ON SEPARATION OF THE DYNAMIC SYSTEM STABLE REGIONS

Firstly we analyze the transmissibility of the piecewise continuity of the dynamic system matrix components depending of the system parameters to the eigenvalues of the

matrix. This analysis is simplified in the case of the system real matrix substituted by the close matrix in the complex domain using "shift of origin".

Theorem 1. If the components of the matrix A are piecewise continuous of the system parameters and the sequence of Hessenberg form matrices $A_s, s \cong 1, 2, \dots$ from QR algorithm that started with the matrix A is uniform convergent in the complex domain to the diagonal form of the matrix A then the eigenvalues of the matrix A are piecewise continuous.

This theorem is verified using the property that the uniform convergence of the continuous functions imposes the continuity on the function limit. In the case in which the eigenvalue is on the boundary between stable and unstable regions in the free parameters domain this eigenvalue has null real part and the character of the point (stable or unstable) is unknown. Above theorem is capitalized here using the following property formulated for the continuous functions of one variable.

Theorem 2. Let the function $f : E \rightarrow C, E \in R$ where R and C are real respective complex domain, be a continuous function in the point $x_0 \in E$ and the function value $f(x_0)$ with its module $|f(x_0)|$ so that the inequalities $\delta \leq |f(x_0)| \leq \varepsilon; \delta, \varepsilon \in R$ are satisfied. Then there is a neighborhood of the point $x_0 \in E$ where the function values carry out the same inequalities.

Remark: Theorem 2 assures that the function f , continuous in the point $x_0 \in E$ preserve, in the neighborhood of x_0 , the function module sign from x_0 .

The mathematical conditions that assure the separation between stable and unstable regions for the linear dynamic system are described using and the following property:

Theorem 3. Let the linear dynamic system be defined by the differential equation of the form $dy/dt \cong Ay(t)$, $y(t) \cong (y_1(t), \dots, y_n(t))^T, A \cong (a_{ij}), i \cong 1, \dots, n; j \cong 1, \dots, n$,

where the symbol T signifies the transposition of the matrix and the values a_{ij} are assumed constants. If the real part of all eigenvalues of the matrix A is strict negative then the solution of the differential equation is asymptotic stable in origin. If the real part of at least one eigenvalue of the matrix A is strict positive then the solution of the differential equation is unstable in origin.

If the real parts of the matrix A eigenvalues are strict negative with exception of at least one eigenvalue that has null real part then the stability of the dynamic system in origin is unknown (possible stable or unstable).

In the case of distinct eigenvalues of the real matrix A , attached to the linear dynamic system, a theorem on separation between stable and unstable regions in the free parameters domain of linear dynamic system, using the QR algorithm

with the shift of origin in complex domain is formulated below. This theorem is deduced calling the theorems 1- 3.

Theorem 4 (Separation theorem). If the linear dynamic system defined by the real matrix A , in the Hessenberg form, has the piecewise continuous components of the matrix as functions of the dynamic system free parameters and the QR algorithm with the shift of origin in complex domain is convergent to the similar diagonal form corresponding to the matrix A and assures that the real part of the eigenvalue functions from the similar diagonal form are also piecewise continuous, then these conditions determine the separation between stable and unstable regions of the dynamic system in the free parameters domain.

Remark: We comment on the possibility to substitute in practice the infinite QR algorithm by finite one and such that the conditions of the theorem 4 applications will be simplified.

In the following we analyze some problems of walking robot evolution by synchronization of their leg evolution in kinetics hypothesis. Extension to dynamic evolution of walking robot, on particular case, appealing to above theory is intuitive possible and is very attractive to study.

IV. MULTI-LEGGED WALKING ROBOT MODELLING

The physical and mathematical walking robot model, with physical model consists from a platform and four similar legs that have a joined extremity attached to the robot platform and a synchronized evolution in the vertical plane (fig.1).

Each of the leg is assumed to be compounded from two segments articulated between them and with this articulation, named and knee joint, traversing a circle arc route in a cyclic evolution of the leg and where the base extremity of the leg traverse an imposed continuous route on the ellipse arc (fig.2). The leg base point in their evolution is assumed with constant speed component on horizontal direction, hypothesis that defines the leg evolution of the robot in our case studied. This physical model and corresponding mathematical model of the robot leg create the possibility to remark the possible appearance of the critical position, defined by the authors, on the circle arc of the knee joint assumed to have a trajectory on the circle arc in cyclic evolution of the walking robot leg. The points that specify the extremities of the continuous domain on

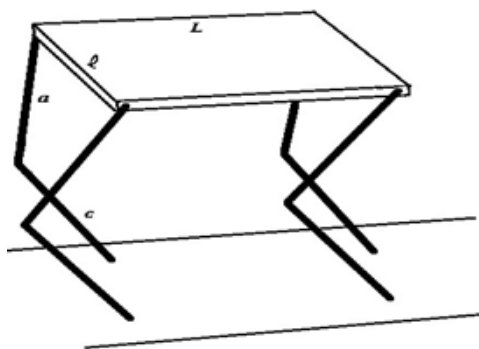

Fig.1 Walking robot physical model.

circle arc where the knee joint is moving are defined in positions where the inferior segment of the leg is normally on the ellipse arc. The possibility to apply the identified critical positions of the walking robot evolution to climbing by stairs is mentioned in the paper.

Physical model of the walking robot leg is described in fig.2.

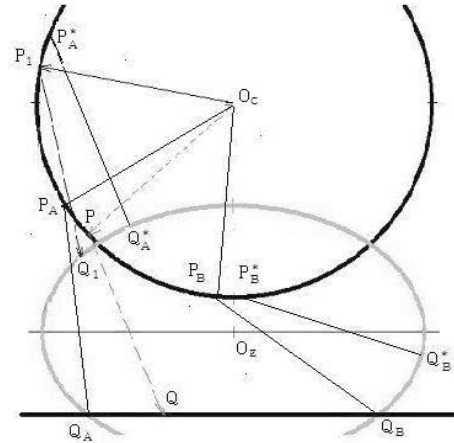

Fig. 2. Physical model of walking robot leg.

Articulated extremity of the leg to robot platform is denoted by O_C and the components of the robot leg are segments denoted $O_C P$ and PQ of the length a respectively c , and where the point P is the knee joint of the leg with the point Q the leg base point.

The knee joint P describe, in cyclic movement of robot leg, a trajectory on circle arc, and a base point Q of the leg an imposed elliptic trajectory on the superior ellipse arc $Q_B Q_A$.

The circular trajectory is considered with the radius a and centre O_C while the elliptic trajectory is assumed with the semiaxes a, b and centre O_E . The elliptic and respectively circular trajectories are transverse involving impose constant speed component of the leg base point, on horizontal direction. The critical point of the robot leg evolution is the point P_C on the circular arc and corresponding Q_C point on the elliptic arc with the change of the movement direction of the “knee joint”.

The orthogonal system of coordinates for the physical model from fig.2 is identified by the following values of coordinates associated to the figure points:

$$O_C(a, h), O_E(a, b_1), P(x_p, y_p), \\ Q(x_Q, y_Q), Q_A(x_A, 0), Q_B(x_B, 0).$$

Some conditions are imposed on the model parameters:

$$a \geq b, b_1 \geq 0; a \leq c \leq h$$

In critical position of leg “knee joint” evolution and in corresponding leg “base point” position is necessary null speed, important property that will be used in concrete robot leg mathematical modelled evolution.

The points P_A^* and P_B^* define extremities of the maximal domain on the circular arc where the point P can be moved because in this position the segments $P_A^*Q_A^*$ and $P_B^*Q_B^*$ are normally on the ellipse arc.

The mathematical model of the robot leg deduced from the physical model defined in fig.2 is described by the implicit functions from (1):

$$\begin{aligned} (x_0 a)^2 \cdot (y_p - h)^2 - a^2 &\cong 0; \\ (x_0 a)^2 / a^2 \cdot (y_Q - b_1)^2 / b^2 &\cong 1. \end{aligned} \tag{1}$$

A covering domain for the variables from (1) is defined below:

$$x \in [0, 2a], y_p \in [h - a, h + a], y_Q \in [0, b - b_1]. \tag{2}$$

The explicit functions deduced from (1) have the form:

$$\begin{aligned} y_p &\cong h \mp (2ax - x^2)^{1/2}; \\ y_Q &\cong \pm b/a (2ax - x^2)^{1/2} - b_1 \end{aligned} \tag{3}$$

Let $P(x_p, y_p)$ and $Q(x_Q, y_Q)$ be points on the circle arc respectively on the ellipse arc that correspond for one position of the robot leg evolution. The condition $(x_p - x_Q)^2 \cdot (y_p - y_Q)^2 - c^2 \cong 0$ is imposed.

In the triangle $O_C P Q$, the segment $O_C Q$ can be expressed as function of τ , measure of angle $(O_C P Q)$:

$$(O_C Q)^2 \cong (O_C P)^2 \cdot (P Q)^2 - 2(O_C P)(P Q) \cos \tau \tag{4}$$

The following analytical relation is true, where the variable x_Q is considered an independent variable and is denoted by x :

$$\begin{aligned} (a - x)^2 \cdot [h - b_1 \mp (b/a)(2ax - x^2)^{1/2}]^2 &\cong \\ &\cong a^2 \cdot c^2 - 2ac \cos \tau \end{aligned} \tag{5}$$

The relation (5) can be used to evaluate the measure of the angle $(O_C P Q)$ as function of variable x , for $x \in [0, 2a]$. The $Q_A(x_A, 0)$ and $Q_B(x_B, 0)$ points have abscises $x_A \cong a - a(1 - (b_1/b)^2)^{1/2}$ and $x_B \cong a + a(1 - (b_1/b)^2)^{1/2}$, where x_A, x_B are strictly between 0 and $2a$.

The uniform linear evolution of the variable x between 0 and $2a$ is assumed as below, where the selected constant speed ζ and initial condition x_0 are considered:

$$x(t) \cong \zeta t + x_0 \tag{6}$$

An evolution cycle of the robot leg can start from the point Q_B , moving on the superior ellipse arc up to point Q_A , using an evolution law on horizontal axe defined by (6), excepting a neighborhood of critical points.

The covering domain of variables is mentioned below.

$$x \in [0, 2a], y_p \in [h - a, h + a], y_Q \in [0, b - b_1] \tag{7}$$

The explicit functions selected for the physical models from figs. 3 and 4, are as:

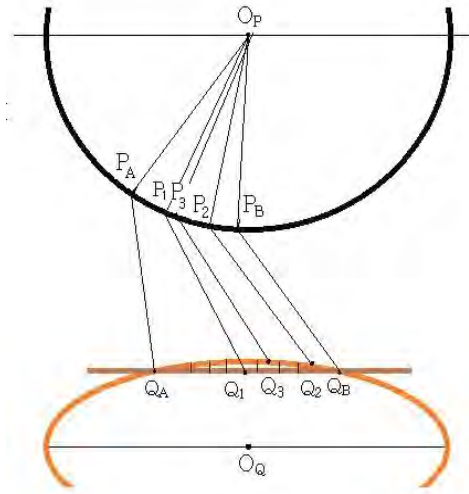

Fig.3. One physical model for walking robot leg.

$$\begin{aligned} y_p &\cong h - (2ax - x^2)^{1/2} \\ y_Q &\cong b/a (2ax - x^2)^{1/2} - b_1 \end{aligned} \tag{8}$$

In first concrete case of walking robot leg physical model is assured the below relation, where $x \in [x_{QA}, x_{QB}]$:

$$\begin{aligned} (a - x)^2 \cdot [(b/a)(2ax - x^2)^{1/2} - b_1 - \\ - (b_1 - h)]^2 &\cong a^2 \cdot c^2 - 2ac \cos \tau \end{aligned} \tag{9}$$

Because the knee joint speed is natural of zero value in critical positions where the sense of motion is changed, using also Cauchy conditions of continuity is necessary in neighborhood of critical points to assure continue values of displacement and speed as functions of time.

In the following we describe particular cases of walking robot legs using physical models from the figs. 3 and 4. The walking robot's physical model is defined with the help of the corresponding robot leg definition.

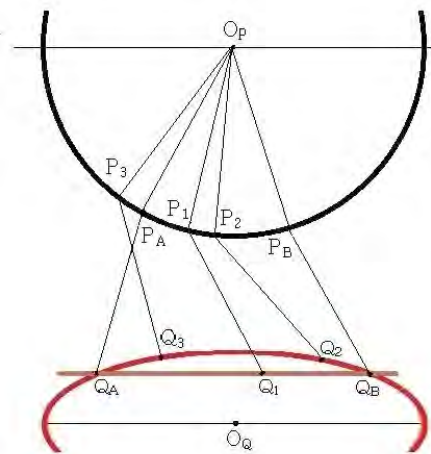

Fig.4. Other physical model of walking robot leg.

For the physical robot leg model from fig. 3 the pivot point of leg O_P , the mobile joint P of the leg that describes a circle arc in the leg's evolution on cycle and the point Q of the robot leg base are positioned in our case on an ellipse arc of centre O_Q and semi axes length a and b . The orthogonal system of coordinate axes is analogue as for fig.2.

Let $O_P(a, h)$, $O_Q(a, 0b_1)$, $Q_A(x_A, 0)$, $Q_B(x_B, 0)$ be points from figs. 3 and 4.

An evolution cycle of the leg base point from fig.3 is defined by the succession Q_A, Q_1, Q_B , on the horizontal axis followed by the succession Q_2, Q_3, Q_A on the superior ellipse arc. The critical points are not on the physical model from fig. 3 but exist on the physical model from fig.4.

These two models are different through the value of parameter h , in the first case the value h_1 and in the second case the value h_2 Ah_1 that imply the corresponding modification of the parameter b_1 .

The conditions $a \leq Ab_1 \leq A0$; $a \leq Ah$ are assumed, where the length of the inferior component of the robot leg is c . For the physical model from fig.3 is assumed $c \leq Aa$.

Our critical position definition in the robot leg evolution, reminded here by us, is the position where the point P_c on the circular arc and corresponding Q_c point on the elliptic arc have the property of changing the movement direction of the "knee joint".

In the critical position of leg "knee joint" evolution and in corresponding leg "base point" evolution we remark the necessary null speed of leg "knee joint" and we mention again that this is an important property used in assurance of concrete evolution of the robot leg.

The critical points P_c and Q_c , in our concrete case, define extremities of one maximal domain on the circular arc where the point P can be moved and in this position the segment P_cQ_c is normally on the ellipse arc. The sense of movement is changed on the circle arc in the extremities of the continuous domain of evolution for "knee joint". In our opinion this notion on critical position can be generalized in the case more general of walking robot movement where the ellipse arc can be substituted by another continuous curve.

The analytical method for identification of critical points on the circle arc and implicit the critical points on the ellipse arc, for concrete physical model from fig.4, is deduced by solving the equation that depend on x_Q imposed by the orthogonally condition.

The ellipse arc trajectory of walking robot leg base point is recommended by us for walking up stairs in kinematics or possible dynamics of walking robot evolution (see fig.5). The stair is configured in vertical plane, by broken line $ABCD$.

The walking robot can be imagined as in fig.1. The trajectory of one leg, in cyclic climbing by stairs of the walking robot is assured ellipse arc EF , where the points E, F are selected critical points of the leg movement.

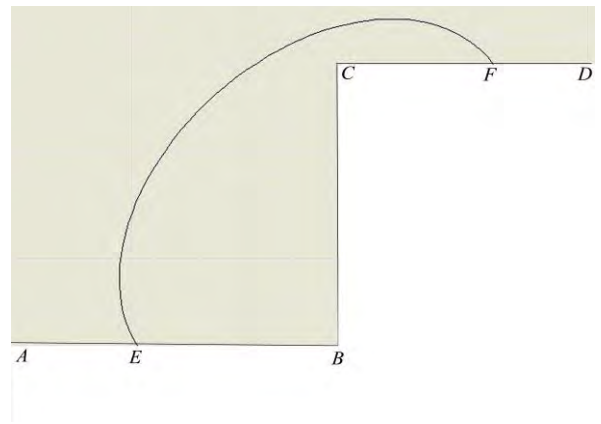

Fig. 5. Recommended trajectories of leg base point for walking up stairs

In the critical points E, F , is necessary to be assured zero value of leg base point speed. The synchronized evolution of the legs is searched so that the stability (existence) of the walking robot to be assured.

We remark that the property of walking robot stability (existence) position is also maintained in a neighborhood for one such position.

V. CONCLUSIONS

A mathematical study on the walking robots dynamic system stability control possibilities, the walking robot being considered as particular case of a dynamic (kinematics) system that depends on parameters, is performed. The mathematical conditions on the separation between stable and unstable regions, in the domain of the dynamic system free parameters, discovered by us, are emphasized, calling the algebraic operations in complex domain that permit new results in the stability theory.

The property of separation described in the paper, encountered also in many other dynamic systems from the literature, without mathematical justification, is very important because it creates the possibility of the stability control of a dynamic system by optimization of the system evolution using the compatible criterion in the stability regions of the free parameters domain. The study for the dynamic systems can be performed, with conservation of the fundamental idea, and for kinematics of the walking robots. A defined walking robot having the property of separation in stable and unstable regions is analyzed. The property of stable region separation is described in our case of walking robot leg with the possibility to be extended on other cases. The critical position on the particular case of the walking robot is defined in the paper and a mathematical method of its identification is performed. The possibilities of our study application in control of walking robot evolution can be as example for walking up stairs that is underlined in the paper. We remark that our study has not exhausted the problem of dynamical systems stability control or for kinematics stability control and that however an interesting domain of walking robot stable evolution control has been opened.

ACKNOWLEDGMENT

This work was developed with the support of MEN-UEFISCDI, PN-II-PT-PCCA-2013-4, VIPRO project No.009/2014, Romanian Academy and “Joint Laboratory of Intelligent Rehabilitation Robot” collaborative research agreement between Romanian Academy by IMSAR and Yanshan University, China, project KY201501009, 2015.

REFERENCES

- [1] Hirsch, M. W., Smale, S., and Devaney, R. L. *Differential Equations, Dynamical Systems, and an Introduction to Chaos*, Academic Press, Amsterdam, Boston, Heidelberg, London, New York, Oxford, Paris, San Diego, San Francisco, Singapore, Sydney, Tokyo (2004).
- [2] Halanay, A., and Rasvan, V. *Applications of Liapunov Methods in Stability*, Kluwer Academic Publishers, Dordrecht, Boston, London, (1993).
- [3] Hayashi, C. *Nonlinear Oscillations in Physical Systems*, Ed. McGraw - Hill Book Company, New York, San Francisco, Toronto, London, (1964).
- [4] Voinea R.P. and Stroe I.V. *Introduction in the Theory of Dynamical Systems* (in Romanian) Academy Printing House, Bucharest (2000).
- [5] Zeveleanu C. and Bratu P. *Nonlinear Vibrations* (in Romanian), Impuls Printing House, Bucharest (2001).
- [6] Teodorescu P.P., Stanescu N.D., Pandrea N., *Numerical analysis with applications in mechanics and engineering*, John Wiley & Sons, Hoboken, USA, (2013).
- [7] Stanescu N.D., Munteanu L., Chiroiu V. and Pandrea N. *Dynamical Systems. Theory and Applications* (in Romanian), Romanian Academy Printing House, Bucharest, Vol.I (2007), Vol.II (2011).
- [8] Lazăr, D. *Analytical Mechanics Principles* (in Romanian), Technical Printing House, Bucharest, (1976).
- [9] Hacker, T. *Stability and command in flight theory* (in Romanian), Academy Printing House, Bucharest, (1968).
- [10] Jung-Yup Kim, Ill-Woo Park, Jun-Ho Oh, Walking Control Algorithm of Biped Humanoid Robot on Uneven and Inclined Floor, Springer Science, *J. Intell Robot Syst* ; 48:457–484, DOI 10.1007/s10846-006-9107-829 – 65, (2007).
- [11] Vladareanu, L., Tont, G., Ion, I., Munteanu, M. S., Mitroi, D., Walking Robots Dynamic Control Systems on an Uneven Terrain, *Advances in Electrical and Computer Engineering*, **10**(2), 146-153, (2010).
- [12] Migdalovici, M., Baran, D., Vlădeanu G., *Dynamical systems stability. Theory and applications* (in Romanian), Self-Publishing Printing House, Bucharest, (2013).
- [13] Migdalovici, M., Baran, D., On a method of vibration analysis for dynamical systems, Topics in Applied Mechanics, Eds. Chiroiu V. and Sireteanu T., Romanian Academy Printing House, Bucharest, **I**, Cap.9, 248-266, (2003),
- [14] Migdalovici, M. and Baran, D. About the stability of motion for two sprung superposed masses in contact with a wire, Proceedings ICSV10, Stockholm, 2147-2154, (2003).
- [15] Migdalovici, M. and Baran, D. On a stability analysis method of dynamical systems with numerical tests, Proceedings of the Int. Conf. of diff. geom. and dynamical systems (DGDS-2008), Mangalia, Romania, Geometry Balkan Press, 99-107, (2009).
- [16] Chung, Y. I. and Genin, J. Stability of a vehicle on a multispan simply supported guideway, *J. of Dynamic Systems, Measurements and Control*, **100**, 326-331, (1978).
- [17] Poetsch, G. and all. Pantograph / catenary dynamics and control, *Vehicle system dynamics*, **28**, 159-195, (1997).
- [18] Migdalovici, M., Baran, D., Vlădeanu, G. On the separation conditions of the stability zones of the dynamical systems that depend of parameters, ICSV20, Bangkok, Proceedings on CD, (2013).
- [19] Migdalovici, M., Baran, D., Vlădeanu, G. Mathematical aspects on the stability of nonlinear dynamical systems, ICSV21, Beijing, Proceedings on CD, (2014).
- [20] Lupu M. and Isaia F. The study of some nonlinear dynamical systems modelled by a more general Rayleigh-Van Der Pol equation, *Creative Math. & Inf.*, **16**, 81-90, (2007).
- [21] Kumaniecka, A. and Grzyb, A., On dynamics of catenary - pantograph modelled as discrete continuous system, *Machine dynamics problems*, **24**, 105-119, (2000).
- [22] Staretu I., Itu A.M. and Moldovan C.C. Software Modules for Command and Control of the Anthropomorphic Gripper for Robots, *Applied Mechanics and Materials*, **332**, 229-234, (2013).
- [23] Migdalovici M., Sireteanu T, and Videa E.M. Control of Vibration of Transmission Lines, *International Journal of Acoustics and Vibration*, **15**(2), 65-71, (2010).
- [24] Wilkinson, J. H. Convergence of the LR, QR and related algorithms, *Computer J.* **8**, 77-84, (1965).
- [25] Rutishauser, H., Solution of eigenvalue problems with the LR transformation, *Appl. Math Ser., Nat. Bur. Stand.*, **49**, 47-81, (1958).
- [26] Rutishauser, H. and Bauer, F. L. Determination des vecteurs propres d'une matrice par une methode iterative avec convergence quadratique, *C.R. Acad. Sci., Paris*, 240, 1680, (1955)
- [27] Francis, J. G. F., QR transformation, *The Computer Journal*, **4**, First part, 265-271, (1961), Second part, 332-345, (1962).
- [28] Parlet, B.N. Global convergence of the basic QR algorithm on Hessenberg matrices, *Math. of Computation*, **22**, 803–817, (1968).
- [29] Martin R.S., Peters G. and Wilkinson J.H. The QR Algorithm for Real Hessenberg Matrices, *Numer. Math.* **14**, 219-231, (1970).

Simulation Environment for Mobile Robots Testing Using ROS and Gazebo

Kenta Takaya, Toshinori Asai, Valeri Kroumov, Florentin Smarandache

Kenta Takaya, Toshinori Asai, Valeri Kroumov, Florentin Smarandache (2016). Simulation Environment for Mobile Robots Testing Using ROS and Gazebo. 20th International Conference on System Theory, Control and Computing (ICSTCC), Sinaia, Romania, 6

Abstract—In the process of development a control strategy for mobile robots, simulation is important for testing the software components, robot behavior and control algorithms in different surrounding environments. In this paper we introduce a simulation environment for mobile robots based on ROS and Gazebo. We show that after properly creating the robot models under Gazebo, the code developed for the simulation process can be directly implemented in the real robot without modifications. In this paper autonomous navigation tasks and 3D-mapping simulation using control programs under ROS are presented. Both the simulation and experimental results agree very well and show the usability of the developed environment.

Index Terms—Mobile robot simulation, 3D mapping, ROS, Gazebo.

I. INTRODUCTION

Today's robot system is a complex hardware device equipped with a numerous sensors and computers which are often controlled by complex distributed software. Robots must navigate and perform successfully specific tasks in various environments and under changing conditions. However, it is costly and time consuming to build different test fields and to examine the robot behaviour under multiple conditions. Using a well-developed simulation environment allows safe and cost-effective testing of the robotic system under development. The simulation decreases the development cycle and can be versatily applied for different environments.

Even though there exist several software platforms (cf. Section II) for simulation and robot control, as far as the authors are concerned, ROS (Robot Operation System)[1] allows building of reliable robot control and navigation software and Gazebo[2] simulation together with ROS's RViz library helps to create simulation, which results can be directly deployed to the real robot hardware.

In this paper we describe the design and implementation of an environment for development and simulation of mobile robots using ROS and Gazebo software. Accurate models of the simulated robots and their working environment are designed. Simulation and experiments for mapping and control

are presented as well. The contribution of this paper is: (a) the content of the paper can be used as a tutorial for building 2D and 3D environment simulation models under Gazebo and simulation of robot models in those environments; (b) an effective method for creating precise 3D maps by suitable combination of the ROS packages is presented. The software used during simulations is successfully used in the control of real robots without any modifications.

The final goal of this research is a development of reliable guiding robot for elderly or disabled people for indoor and outdoor environments. At present, differential drive robots are considered because they can move and turn in narrow places and are enough manoeuvrable compared to other types wheeled robots.

This paper is organized as follows. The next section describes related work. Section III describes briefly Gazebo and the ROS software. The robot and the working environment models are introduced there, too. Section IV and Section V detail the 2D and 3D simulation and experimental results, respectively. In Section VI the simulation and experimental results are analyzed and compared to other work and plans for further developments are presented. Section VII concludes the paper.

II. RELATED WORK

There are several commercial and open source simulation environments for robotic field. Some common examples of such software are briefly listed here.

WEBOTS[3] supports C/C++, Java, Python, URBI and MATLAB and has TCP/IP interface to communicate to other software products. It has many components which can be connected to create complex construction easily. Visual Components[4] is a simulation suite for production lines and can even simulate entire factory. Robot Virtual Worlds[5] was primarily designed for educational purpose but it seems that it can be used for some advanced applications. LabVIEW[6] is a complex software system suited for data acquisition, analysis, control, and automation. It has numerous libraries

for simulation of hardware components and supports most of the standard interfaces.

On other hand there exist a great number of open source simulators and many of them have very advanced features.

USARSim (Unified System for Automation and Robot Simulation)[7] is commonly used in RoboCup rescue virtual robot competition as well as a research platform. It is based on the Unreal Tournament Game Engine[8]. Initially, the Unreal Engine was proprietary, but starting from 2015, it is available for free.

The OpenHRP3[9] (Open-architecture Human-centered Robotics Platform version 3) is compatible with OpenRTM-aist[10]—a robotic technology middleware. However, the OpenHRP is designed to develop and simulate mainly humanoid robots. There are some attempts[11] to develop a software supporting the OpenRTM-aist for simulation of other types of robots, as well.

OpenRAVE[12] is a tool for testing, development, and simulation for robotics systems. It uses high level scripting such as MATLAB and Octave. The OpenRAVE focuses mainly on humanoid robots and robot manipulators. However, it has ROS plugins that create Nodes (executables) for controllers and sensors data simulation. A comparison between several open source simulation environments for mobile robots can be found in [13], [14] and the references there.

There are many publications about robot simulation covering variety of robots: manipulators, legged robots, underwater vehicles, and unmanned aerial vehicles (UAV). Many of those developments are based on ROS and Gazebo software packages which proves their reliability and great usability. The Virtual Robotics Challenge[15] hosted by Defense Advanced Research Projects Agency (DARPA) as a part of the DARPA Robotics Challenge led to development and improvement of simulation software to run nearly identically to the real robotic hardware[16]. Simulation of manipulation tasks including grasp and place motions are presented in [17]. The advantages and disadvantages of simulators for testing the robot behaviours are compared in [18]. Results in UAV simulation and experimental challenges are covered in other publications[19], [20].

III. ROBOT SIMULATION UNDER ROS AND GAZEBO

A. Gazebo

Gazebo is a part of the Player Project[21] and allows simulation of robotic and sensors applications in three-dimensional indoor and outdoor environments. It has a *Client/Server* architecture and has a topic-based *Publish/Subscribe* model of interprocess communication.

Gazebo has a standard Player interface and additionally has an native interface. The Gazebo clients can access its data through a shared memory. Each simulation object in Gazebo can be associated with one or more *controllers* that process commands for controlling the object and generate the state of that object. The data generated by the *controllers* are published into the shared memory using Gazebo interfaces (*Ifaces*). The *Ifaces* of other processes can read the data from the shared

memory, thus allowing interprocess communication between the robot controlling software and Gazebo, independently of the programming language or the computer hardware platform.

In the process of dynamic simulation Gazebo can access the high-performance physics engines like Open Dynamics Engine (ODE)[22], Bullet[23], Simbody[24] and Dynamic Animation and Robotics Toolkit (DART)[25] which are used for rigid body physical simulation. Object-Oriented Graphics Rendering Engine (OGRE)[26] provides the 3D graphics rendering of environments of Gazebo.

The *Client* sends control data, simulated objects' coordinates to the *Server* which performs the real-time control of the simulated robot. It is possible to realize a distributed simulation by placing the *Client* and the *Server* on different machines. Deploying ROS Plugin for Gazebo helps to implement a direct communication interface to ROS, thus controlling the simulated and the real robots using the same software. This provides an effective simulation tool for testing and development of real robotic systems.

B. ROS

ROS[1] is a collection of libraries, drivers, and tools for effective development and building of a robot systems. It has a Linux-like command tool, interprocess communication system, and numerous application-related packages. The ROS executable process is called *Node* and interprocess communication has a *Publish/Subscribe* model. The communication data is called *Topic*. The Publisher process may publish one or more Topics and processes which subscribe to certain *Topic* can receive its content. The interprocess communication library allows easily to add user developed libraries and ROS executables. Moreover, the ROS-based software is language and platform-independent—it is implemented in C++, Python, and LISP. Furthermore, it has experimental libraries in Java and Lua[1].

The process name resolving and execution is scheduled by the *Master Server*. The ROS packages include many sensor drivers, navigation tools, environment mapping, path planning, interprocess communication visualization tool, as well as a 3D environment visualization tool and many others. ROS allows effective development of new robotic systems and when used together with a simulation middleware like Gazebo the time for development a reliable and high performance robotic control software can be dramatically decreased.

C. Robot and Environment Modeling

In representing the robot and environment models in ROS, the URDF (Universal Robotic Description Format) is used. The URDF is an XML file format used and standardized in ROS for description of all elements (sensors, joints, links etc.) of a robot model. Because URDF can only specify the kinematic and dynamic properties of a single robot in isolation, to make the URDF file work properly in Gazebo, additional simulation-specific tags concerning the robot pose, frictions, inertial elements and other properties were added[27]. The addition of these properties makes the original URDF file

```
<gazebo>
  <plugin name="differential_drive_controller" \
    filename="libdiffdrive_plugin.so">
    ... plugin parameters ...
  </plugin>
</gazebo>
```

(a) The URDF file

```
<model name="P3DX_robot_model">
  <plugin name="differential_drive_controller" \
    filename="libdiffdrive_plugin.so">
    ... plugin parameters ...
  </plugin>
</model>
```

(b) The SDF file

Fig. 1. Using *gazebo_plugins*.

compatible with the native SDF (Simulation Description Format) Gazebo’s model description format. The SDF can fully describe the simulated world together with the complete robot model.

The process of conversion from URDF to SDF can be easily done by adding the so called *gazebo_plugins* into URDF file. The *gazebo_plugins* can attach into ROS messages and service calls the sensor outputs and driving motor inputs[28], i.e. the *gazebo_plugins* create a complete interface (*Topic*) between ROS and Gazebo. The control process intercommunication under ROS is achieved by performing a *Publish/Subscribe* to that *Topic*. There are several plugins available in *gazebo_plugins*[28]: Camera (ROS interface for simulating cameras), Multicamera (synchronizes multiple camera shutters to publish their images together—typically stereo cameras), GPU Laser, F3D (for external forces on a body), Inertial Measurement Unit (IMU), Bumper, Differential Drive, Skid Steering Drive, Planar Move Plugin and many others. Fig. 1

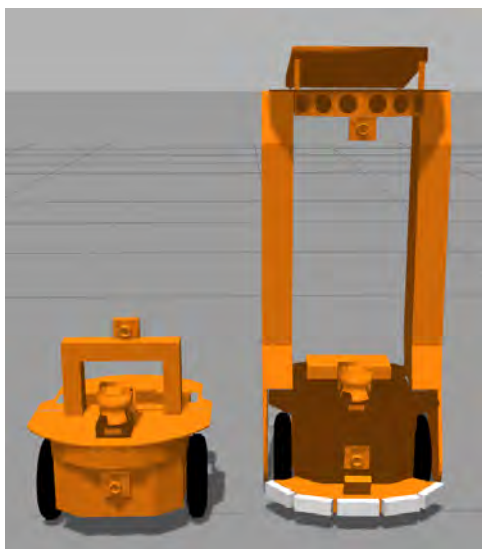

Fig. 2. Pioneer3-DX (left) and PeopleBot (right) models in Gazebo.

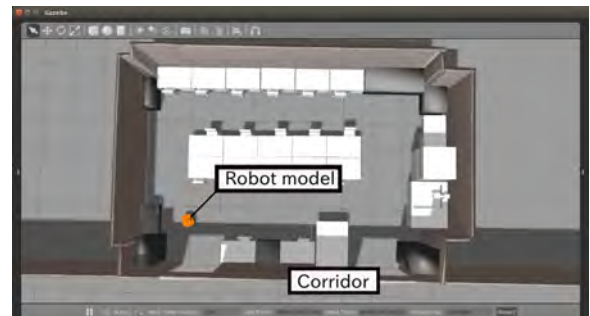

Fig. 3. P3-DX and lab models in Gazebo

shows the result of conversion of an URDF to SDF format.

For the purpose of this study we have created models of PeopleBot and Pioneer 3-DX robots. The model of P3-DX is distributed together with Gazebo, but its dimensions and properties differ from the real robot. Because of this a new much more precise model of P3-DX including the models of several sensors was created. Part of P3-DX model was adopted in the process of designing the PeopleBot model. The models of 2D (Hokuyo UTM-30LX LIDAR) and 3D (Hokuyo YVT-X002 LIDAR) laser finders, sonars, odometry, camera, IR sensors, and bumpers were also added. Additionally, the robots masses and frictions were properly defined. The created models of both robots are shown in Fig. 2. In the process of simulation we are using the already distributed Willow Garage model and the model of one of our laboratories as shown in Fig. 3.

IV. 2D SIMULATION AND EXPERIMENTAL RESULTS

This section describes the simulation results using ROS and Gazebo. The robot model and the real robot are equipped with 2D laser finder (Hokuyo UTM-30LX LIDAR), 2 Web cameras (Logicool c615), sonars (16pcs for P3-DX robot and 24psc for PeopleBot), odometry system and a laptop computer for controlling the robot. The sonars are used by the obstacle avoidance Node. Because there is no a plugin for sonars

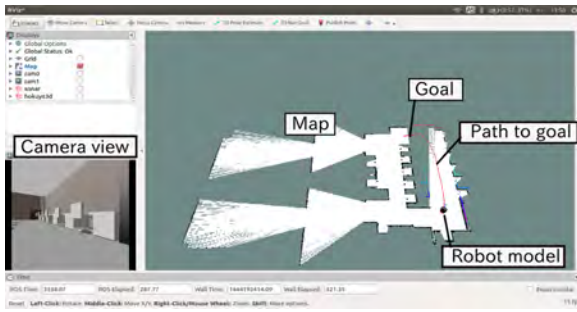

Fig. 4. Map generation using Hector mapping in Rviz

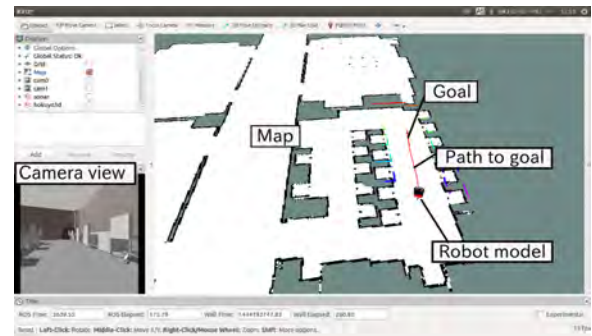

Fig. 5. Navigation using AMCL in RViz

in the *gazebo_plugins*, we adopted the Laser plugin (*ray, libgazebo_ros_laser.so*) making it work approximately like a sonar sensor. Additionally, we have designed an obstacle avoidance Node: a standard Britenberg vehicle type node.

The first camera is used for environment monitoring and the second one transfers the floor area directly in front of the robot which increases the reliability during remote control operations. The robot and the environment models are created using Gazebo and simulation is performed under the ROS control. As depicted in Fig. 4 and Fig. 5 the simulation results are visualized using the RViz package. By using the Camera plugin the simulated environment is displayed in RViz (left side in the figures). The goal position of the robot is set by pointing and clicking at it with the computer mouse.

The simulation results from map generation of unknown environment and robot navigation using the generated map are presented in the next subsections. For path generation we are using the ROS Navigation Stack[29] package which extensively uses costmap[30] to store information about the obstacles situated in the robot working space and builds occupancy grid of the data. The Navigation Stack uses one costmap for global planning and another one for local planning and obstacle avoidance. The global planning is based on the Dijkstra’s Algorithm[31] and in the local coordinates the path is additionally corrected using Dynamic Window Approach (DWA)[32].

A. Unknown Environment Mapping Simulation

A simulation example of map generation of unknown environment is shown in Fig. 4. To perform map generation the *hector_mapping*[33] package was used. *hector_mapping* realizes the SLAM (Simultaneous Localization and Mapping) algorithm and provides robot pose estimates at the scan rate of the laser scanner (40Hz for the UTM-30LX LIDAR). Generally, the package does not need odometry if the robot platform does not perform yaw motion. Because during the simulations our obstacle avoidance algorithm causes some yaw motions, we are using the odometry data to properly estimate the robot pose.

One way to perform the map generation is by simultaneously setting goal positions until the whole working space is covered by the robot. Another approach is to make the robot to “explore” the environment until the complete map

is constructed. The problem with the latter is that a special care must be taken in the exploration algorithm to make the robot not to perform unnecessary turns and “reexplore” already covered areas. Otherwise, the map generation process may take very long time. In our simulations we are using the first approach: setting simultaneously goals as depicted in Fig. 4. Fig. 5 shows the completed map which is further used in the navigation simulation.

B. Navigation Simulation

After performing the map generation using the *hector_mapping* package, we used the *amcl*[34] (Adaptive Monte Carlo Localization) package for navigation inside the generated map. To properly estimate the robot position inside the environment, this package uses the laser scan and odometry readings data as well a laser-based map. Most of the algorithms used by *amcl* package are described in [35]. One simulation result in known environment is shown in Fig. 5.

C. Experimental Results

Using the simulation control software we performed experiments of control of real robots under ROS. During the experiments there was no difference in robots behaviour compared to the simulations. However, due to differences in the interprocess communication speed and calculation speeds there was need to tune some parameter of the Navigation stack node.

V. 3D MAPPING SIMULATION AND EXPERIMENTAL RESULTS

To perform the 3D mapping we use the Octomap package[36] and the Hokuyo YVT-X002 LIDAR model. The Octomap Package does not possess a SLAM algorithm and relies on odometry measurements, which introduce a bias in the position estimation of the robot and consequently uncertainties in the map as shown in Fig. 6.

In order to solve the above problem we have combined the Octomap and the Hector Mapping as follows. Instead to use the 3D laser Topic for the YVT-X002, we changed it with 2D Topic to create a map using the Hector Mapping Package (SLAM algorithm). While using the robot position from the 2D SLAM we create the 3D map by Octomap, and combining

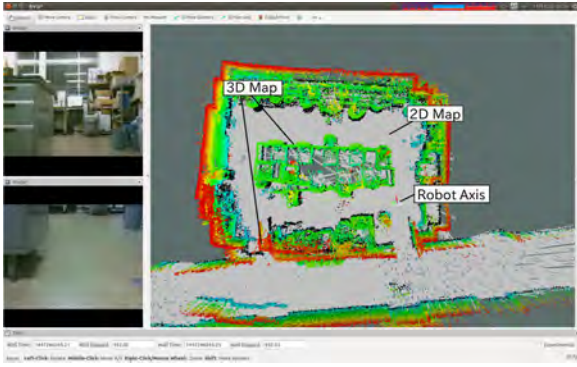

Fig. 6. 3D Mapping Using Only the Octomap Package

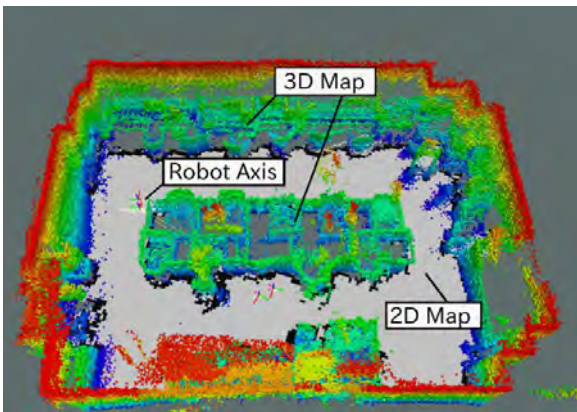

Fig. 7. 3D Mapping Using Octomap and Hector Mapping

the 2D and 3D maps we performed the visualization under RViz tool. These tasks are performed in parallel without doing additional scans of the environment. The result is generation of quite precise 3D map as shown in Fig. 7 and 8.

Fig. 7 depicts an experimental result under ROS control and Fig. 8 shows the simulation using Gazebo. From the figures it can be confirmed that the maps are precise enough. The map created during the experiment has some noise which successfully can be neglected.

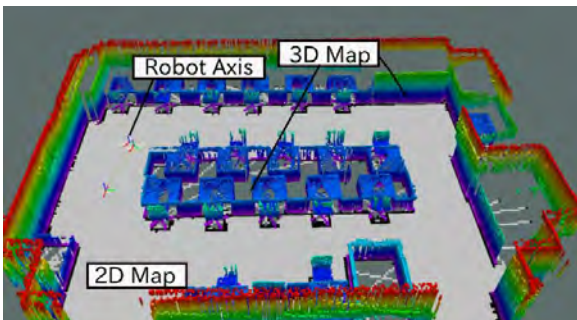

Fig. 8. 3D Map Generation Using Gazebo in RViz (simulation)

VI. DISCUSSION

2D and 3D real-time mapping and simulations cause very high load on the CPUs. The laptop computers used in the course of the experiments were Intel® Core™i5-4200@1.6GHz equipped with 8GB RAM. During the experiments the robot speed was set to 0.4 [m/s] and the whole map building and navigation run smoothly, while due to the extensive calculations during the simulation, the robot speed had to be decreased to about 0.2 [m/s]. The ROS and Gazebo software run under 64-bit Ubuntu 15.04 OS. Even though there exist several software platforms (cf. Section II) for simulation and robot control, as far as the authors are concerned, ROS allows building of reliable robot control and navigation software and Gazebo simulation together with ROS’s RViz library helps to create simulation, which results can be directly deployed to the real robot hardware.

During the robot navigation it is very much important to perform precise localization and position correction of the mobile robot. The authors have already proposed a method for localization and position correction using artificial landmarks(see [37] and the references there) based on vSLAM®[38] algorithm. That method has very good performance for indoor environments but the map building based on vSLAM does not work well for outdoor applications and it is almost impossible to render realistic 3D maps[39]. In this work, to perform reliable outdoor and indoor navigation, a map building using laser sensors and dead reckoning was adopted.

VII. CONCLUSION

The purpose of this study is to develop a reliable environment for simulation and control of mobile robots using the ROS and Gazebo software.

It was shown that after designing properly the models of the robot platforms and their working environments the software used in the simulations can be directly used to control the real robots. Simulations and experimental results in 2D and 3D mapped environments prove the usability of the models. The main contribution of this paper is that the well done combination of ROS packages allowed real-time generation of precise map in 3D space.

The paper describes in details which software packages were employed and we hope that the results reported here will be useful at least for part of the roboticists community.

The final goal of this research is a design of reliable guiding robot for elderly for indoor and outdoor environments. We are in process of deploying a voice recognition and voice synthesis for Japanese and after adding a face recognition functions we will be able to realize the next stage of the project.

ACKNOWLEDGMENT

The authors would like to thank Mr. Hirona Kato for his valuable support during the experiments. This work was partially supported by the Japanese Ministry of Education, Culture, Sports and Technology (MEXT): Strategic Research on QOL Innovation 2012–2016.

REFERENCES

- [1] Open Source Robotic Foundation. (2016) ROS/Introduction. [Online]. Available: <http://wiki.ros.org/ROS/Introduction>
- [2] (2016) Robot simulation made easy. [Online]. Available: <http://gazebosim.org/>
- [3] (2016) Webots. [Online]. Available: <https://www.cyberbotics.com>
- [4] (2016) Visual Components. [Online]. Available: <http://www.visualcomponents.com/products/>
- [5] (2016) Robot Virtual Worlds. [Online]. Available: <http://www.robotvirtualworlds.com/>
- [6] National Instruments. (2016) What Can You Do With LabVIEW? [Online]. Available: <http://www.ni.com/labview/why/>
- [7] S. Carpin, M. Lewis, J. Wang, S. Balakirski, and C. Scrapper, "US-ARSim: a robot simulator for research and education," in *Proc. 2007 IEEE International Conference on Robotics and Automation*, Roma, Italy, April 2007, pp. 1400–1405.
- [8] Epic Games. (2016) Unreal Engine 4. [Online]. Available: <https://www.epicgames.com/>
- [9] OpenHRP3 Official Site (2016) About OpenHRP3. [Online]. Available: <http://fkanehiro.github.io/openhrp3-doc/en/about.html>
- [10] Japan's National Institute of Advanced Industrial Science and Technology. (2016) OpenRTM-aist. [Online]. Available: <http://www.openrtm.org/openrtm/en/node/629>
- [11] I. Chen, B. MacDonald, B. Wunsche, G. Biggs, and T. Kotoku, "A Simulation Environment for OpenRTM-aist," in *Proc. SII 2009. IEEE/SICE International Symposium on System Integration*, Tokyo, Japan, Nov. 2009, pp.113–117.
- [12] R. Diankov and J. Kuffner, "Openrave: A planning architecture for autonomous robotics," Robotics Institute, Pittsburgh, PA, Tech. Rep. CMU-RI-TR-08-34, July 2008.
- [13] P. Castillo-Pizarro, T.V. Arredondo, and M. Torres-Torriti, "Introductory Survey to Open-Source Mobile Robot Simulation Software," in *Proc. 2010 Latin American Robotics Symposium and Intelligent Robotics Meeting (LARS)*, 2010, pp. 150–155.
- [14] D. Cook, A. Vardy, and R. Lewis, "A survey of AUV and robot simulators for multi-vehicle operations," in *Proc. 2014 IEEE/OES Autonomous Underwater Vehicles (AUV)*, Ocford, Mississippi, Oct. 2014, pp. 1–8.
- [15] Defense Advanced Research Projects Agency (DARPA). (2016) DARPA Robotics Challenge. [Online]. Available: <http://theroboticschallenge.org/>
- [16] C. E. Aguero, N. Koenig, I. Chen, H. Boyer, S. Peters, J. Hsu, B. Gerkey, S. Paepcke, J. L. Rivero, J. Manzo, E. Krotkov, and G. Pratt, "Inside the Virtual Robotics Challenge: Simulating Real-Time Robotic Disaster Response," *IEEE Trans. Autom. Sci. Eng.*, vol. 12, no. 2, pp. 494–506, Apr. 2015.
- [17] W. Qian, Z. Xia, J. Xiong, Y. Gan, Y. Guo, S. Weng, H. Deng, Y. Hu, J. Zhang, "Manipulation Task Simulation using ROS and Gazebo," in *Proc. 2014 IEEE Int. Conf. on Robotics and Biomimetics*, Dec. 2014, Bali, Indonesia, pp. 2594–2598.
- [18] F. R. Lera, F. C. Garcia, G. Esteban, and V. Matellan, "Mobile Robot Performance in Robotics Challenges: Analyzing a Simulated Indoor Scenario and its Translation to Real-World," in *Proc. 2014 Second International Conference on Artificial Intelligence, Modelling and Simulation*, pp. 149–154.
- [19] Q. Bu, F. Wan, Z. Xie, Q. Ren, J. Zhang, and S. Liu, "General Simulation Platform for Vision Based UAV Testing," in *Proc. 2015 IEEE Int. Conf. Information and Automation*, Lijiang, China, Aug. 2015, pp.2512–2516.
- [20] M. Zhang, H. Qin, M. Lan., J. Lin., S. Wang, K. Liu, F. Lin, and B. M. Chen, "A High Fidelity Simulator for a Quadrotor UAV using ROS and Gazebo," *IECON2015-Yokohama*, Nov. 2015, pp. 2846–2851.
- [21] Player/Stage project. (2016) The Player Project. [Online]. Available: <http://playerstage.sourceforge.net/>
- [22] Russell L. Smith. (2016) Open Dynamics Engine. [Online]. Available: <https://bitbucket.org/odedevs/ode/>
- [23] Real-Time Physics Simulation. (2016) BULLET Physics Library. [Online]. Available: <http://bulletphysics.org/wordpress/>
- [24] (2016) Simbody: Multibody Physics API. [Online]. Available: <https://simtk.org/home/simbody/>
- [25] Georgia Tech Graphics Lab and Humanoid Robotics Lab. (2016) DART (Dynamic Animation and Robotics Toolkit). [Online]. Available: <http://dartsim.github.io/>
- [26] OGRE3D. (2016) Object-Oriented Graphics Rendering Engine. [Online]. Available: <http://www.ogre3d.org/>
- [27] URDF in Gazebo. (2016) Tutorial: Using a URDF in Gazebo. [Online]. Available: http://gazebosim.org/tutorials/?tut=ros_urdf
- [28] Gazebo plugins in ROS. (2016) Tutorial: Using Gazebo plugins with ROS. [Online]. Available: http://gazebosim.org/tutorials/?tut=ros_gzplugins
- [29] ROS Navigation Stack. (2016) navigation. [Online]. Available: <http://wiki.ros.org/navigation>
- [30] (2016) costmap_2d Package. [Online]. Available: http://wiki.ros.org/costmap_2d
- [31] J. C. Latombe, *Robot Motion Planning*, Kluwer Academic Publishers, pp. 604–608, 1998.
- [32] R. Segward and I. R. Nourbakhsh, *Introduction to Autonomous Mobile Robots*, The MIT Press, pp.282–284, 2004.
- [33] S. Kohlbrecher. (2016) hector_mapping. [Online]. Available: http://wiki.ros.org/hector_mapping
- [34] B. P. Gerkey. (2016) amcl. [Online]. Available: <http://wiki.ros.org/amcl>
- [35] S. Turn, W. Burgard and D. Fox, *Probabilistic Robotics*, The MIT Press, 2006.
- [36] (2016) Octomap—A probabilistic, flexible, and compact 3D mapping library for robotic systems. [Online]. Available: http://octomap.github.io/octomap/doc/md_README.html
- [37] V. Kroumov and K. Okuyama, "Localization and Position Correction for Mobile Robot Using Artificial Visual Landmarks", *Int. J. Advanced Mechatronic Systems*, pp. 112–119, vol. 4, no. 2, 2012.
- [38] N. Karlsson, E. Di Bernardo, J. Ostrowski, L. Goncalves, P. Pirjanian, and M. E. Munich, "The vSLAM algorithm for robust localization and mapping", in *Proc. Int. Conf. Robotics and Automation (ICRA)*, Barcelona, Spain, 2005, pp.24–29.
- [39] X. Li, N. Aouf and A. Nemra, "3D Mapping based VSLAM for UAVs," in *Proc. 2012 20th Mediterranean Conference on Control & Automation (MED)*, Barcelona, Spain, July 2012, pp. 348–352.

Robot Advanced Intellectual Control developed through Flexible Intelligent Portable Platform

Luige Vlădăreanu, Victor Vlădăreanu, Hongnian Yu, Hongbo Wang, Florentin Smarandache

Luige Vlădăreanu, Victor Vlădăreanu, Hongnian Yu, Hongbo Wang, Florentin Smarandache (2019). Robot Advanced Intellectual Control developed through Flexible Intelligent Portable Platform. *International Journal of Advanced Trends in Computer Science and Engineering* 8(1.1), 202-208; DOI: 10.30534/ijatcse/2019/3881.12019

ABSTRACT

This paper offers an intelligent, flexible, portable robot platform VIPRo, involving the development of intelligent control interfaces through the application of advanced control techniques which are modified to the robot environment. These include Robot Haptic Control (RHC), Robot Extenics Control (eHFPC), Robot Neutrosophic Control (RNC), human adaptive mechatronics, applied by high speed processing IT&C techniques, and real time communications for processing large volumes of data. An original virtual projection methodology is used to SMOOTH firefighting robots by representing mobile intelligent robots in a three-dimensional virtual environment using VIP-F²Ro with a robotic strong simulator, an open architecture system, and flexible networks over the classic robot control system.

Key words: VIPRO platform, robot simulation, graphical user interface, reference generation.

1. INTRODUCTION

Mobile robots have caught the attention of the research community and the manufacturing industry as well, leading to a great hardware and software developing. Some applications of great interest for researchers are human behaviour in fires and the simulation of the movement of individuals in such hazardous environment [1-3]. Simultaneously, the real time robot control with remote network control having human operators' ability play an important part in hazardous and challenging environments of human life exposed to great dangers such as support and repair in nuclear contaminated area, fire, earthquake or any other disaster area in case of an accident or a terrorist attack involving CBRN materials. [2-3]. A big amount of researches led to the development of different robots with sensing abilities, transport and manipulation of different applications [4-7].

This calls further developing of the mobile and remote control self-ruling robots which can help individuals to perform seeking and sparing activities, speaking to a priority and a complex task.

Generally, the total impact cost of larger episodes is extremely high and is higher than that of the countermeasures. For a biological threat, indirect economic impacts are evaluated so they are in the range of billions, to tens of billions, of US dollars. The countermeasure cost range is lower, and ranges from hundreds of millions to approximately 10 billion USD. The bio-defense program is a few hundred thousand to tens of millions spent by European countries in a particular year, whilst the USA invests about 200 million Euros.

Intelligent heterogeneous robot networks, controlled remotely by humans, have a vital role in challenging and hazardous environments, where lives might be at risk [8-10]. This is a challenge for developing autonomous systems perceptive to human requirements which can continuously learn, adapt and improve in "real world" complex environments to give support in natural disasters, fires, etc. [14-17].

The paper offers a VIPRo versatile, intelligent robot platform, which develops intelligent control interfaces through the application of advanced control techniques which are adapted to the robot environment, such as Robot Haptic Control (RHC), Robot Extenics Control (eHFPC), Robot Neutrosophic Control (RNC), human adaptive mechatronics, etc. An original virtual projection methodology is applied to SMOOTH firefighting robots, via development of the VIP-F²Ro Platform, allowing a representation of intelligent mobile robots in a 3D virtual environment using a strong robotic simulator, an open architecture system and adaptive networks over the classical robot control system.

The VIP-F²Ro Virtual Intelligent Portable platform, is the one designed to acquire the data received from unmanned ground vehicles (UGV), to process and analyse them, to provide feedback. The VIP-F²Ro brings the virtual robots to the real world, wanting to create an innovative robot platform, which will allow developing mechatronic systems of mobile robots in virtual environments and communicating with real robot systems through a high speed interface.

The obtained results lead to the conclusion that the advanced intelligent robot control methods using *neutrosophic control*, *extended control* (Extencis), *human adaptive mechatronics*, developed through versatile intelligent portable platform, allow a correct evaluation of robot behaviours in hazardous or challenging environments and improving the robot performances at the interaction with the environment.

2. VERSATILE INTELLIGENT PORTABLE PLATFORM

The VIP-F²Ro Virtual Intelligent Portable Platform for firefighting robots has been developed by an e-learning and remote-control platform which enables communities interested in the topic and long-term plans for the additional development of innovation and research. This is the tool which ensures the ability to continuously learn, adapt and improve in “real world” complex environments, modeling in real time information collected by advanced technologies to provide support in “big data” management and international cluster development which can process the information in a unifying vision.

This way, networking activities will be in good balance with scientific and technical activities contributing equally to advance the project and to achieve the specific objectives mentioned above [18, 20].

For the development of new features for the unmanned ground robotic mobile vehicle, such as motion on uneven ground, or motion by bypassing or overcoming obstacles, high level intelligent algorithms need to be developed. This is because the motion mechanism is a complicated process, and because it is a repetitive process of tilting and unstable movements which can occur on a bumpy road, it will cause the robot to tip over.

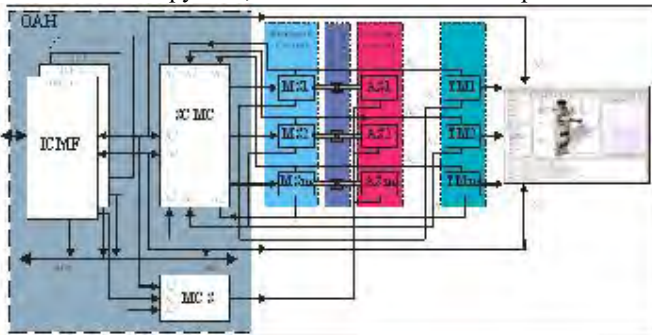

Figure 1: Virtual projection method by Vladareanu-Munteanu applied to VIP-CBRN Platform

The virtual projection method [19-20] (Figure 1) is used to test the performance of dynamic position-force control through integrating dynamic control loops using a Bayesian interface for the neutrosophic interface and sensor network for decision making [9-11]. The CMC classical mechatronic control directly controls servomotors MS1, MS_m, where m is the number of the robot’s degrees of freedom. The signals are sent to a virtual control interface (VCI), this processes them and creates the necessary signals for 3D graphical representation on a graphical terminal CGD. Developing an open architecture control system by integrating *n* control functions as well as to those supplied by the CMC mechatronic control system. With this assistance new control methods can be introduced, such as: control of the center of gravity, motion control schemes, contour tracking functions, orientation control through image processing, decision making by neutrosophic logic control, and Bayesian interface for sensor networks [11,12]. Real time control, priority control, and information exchange management between the *n* interfaces is controlled by the multifunctional control interface MCI, connected via a high speed databus.

The optimization of intelligent control methods allows the Unmanned Ground robotic mobile Vehicle (UGV) to adapt to environmental scene of in case of the fire investigation, hazardous chemicals detection, fire and rescue threat the firefighter’s safety and life, through real time control, without losing its stability during the mission.

To model through adaptive mechatronic methods of the robot implemented by the intelligent, versatile, and portable robot, the VIPRO platform presents three intelligent control interfaces (ICs). Human adaptive mechatronics are intelligent mechanical-electrical systems which can adapt to human skills in different environments and provide assistance to improve the skill and overall operation of the combined human machine system to improve performance. The VIPRO platform architecture, in correlation with the virtual projection method (Figure 1) is developed in Figure 2

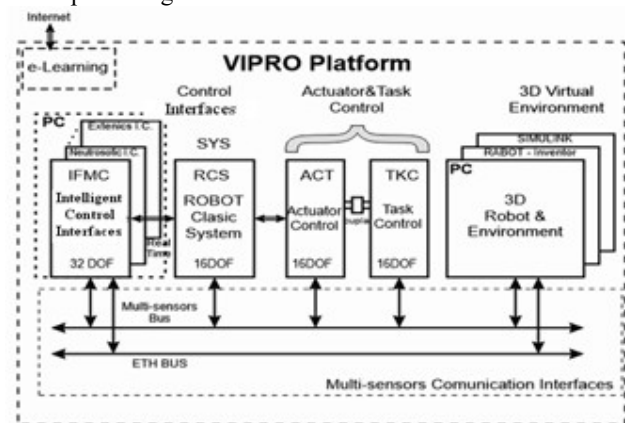

Figure 2 Integration of the VIP-F²Ro Platform in the VIPRO Platform architecture

The results of simulation investigation and identifying the features and parameters of the virtual intelligent platform VIP-F²Ro are obtaining by simulation studies. These will be used to establish the UGV optimal parameters for intelligent interfaces development. VIP Platform allows intensive simulation studies for damping motion, motion compensation, UGV swing amplitude, UGV rotation/advance, motion timing, motion orientation, UGV tilt over, landing position.

The VIP-F²Ro platform technical solution contains the intelligence control interface module, which utilizes advanced control strategies which are adapted to the robot environment, such as extended control – extenics, neutrosophic control human adaptive mechatronics, etc., used via various IT&C techniques, with real time communication and fast processing. This module mainly contains the interface for intelligent neutrosophic control through integration of the RNC (Robot Neutrosophic Control) method [12], known as Vladareanu-Smarandache method, Extended Control Interface through Extenics (ICEx) [10, 13] and Haptic Robot Control Interface (CRH) [9-11].

The control system is comprised of proposed intelligent control interfaces: neutrosophic control interface (ICN) integrating neutrosophic robot control (RNC), extended control interface (ICEx) which is integrated through an extended hybrid force- position control (eHFPC) and the multifunctional control interface (ICM). Additionally, the haptic robot control interface (CRH) is used for movement and navigation in uncertain environments and on uneven terrain.

3. ADVANCED INTELLIGENT CONTROL OF THE SMOOTH ROBOT, THROUGH VIP PLATFORM

The new virtual intelligent portable platform of firefighting robots, VIP- F²Ro, is the one designed to acquire the data received from unmanned robotic vehicles, to process and analyse them, to provide feedback. The , VIP- F²Ro brings the virtual robots to the real world, wanting to create aninnovative robot platform, which will allow to develop mechatronic systems of mobile robots in virtual environments and communicate with real robot systems through a high speed interface

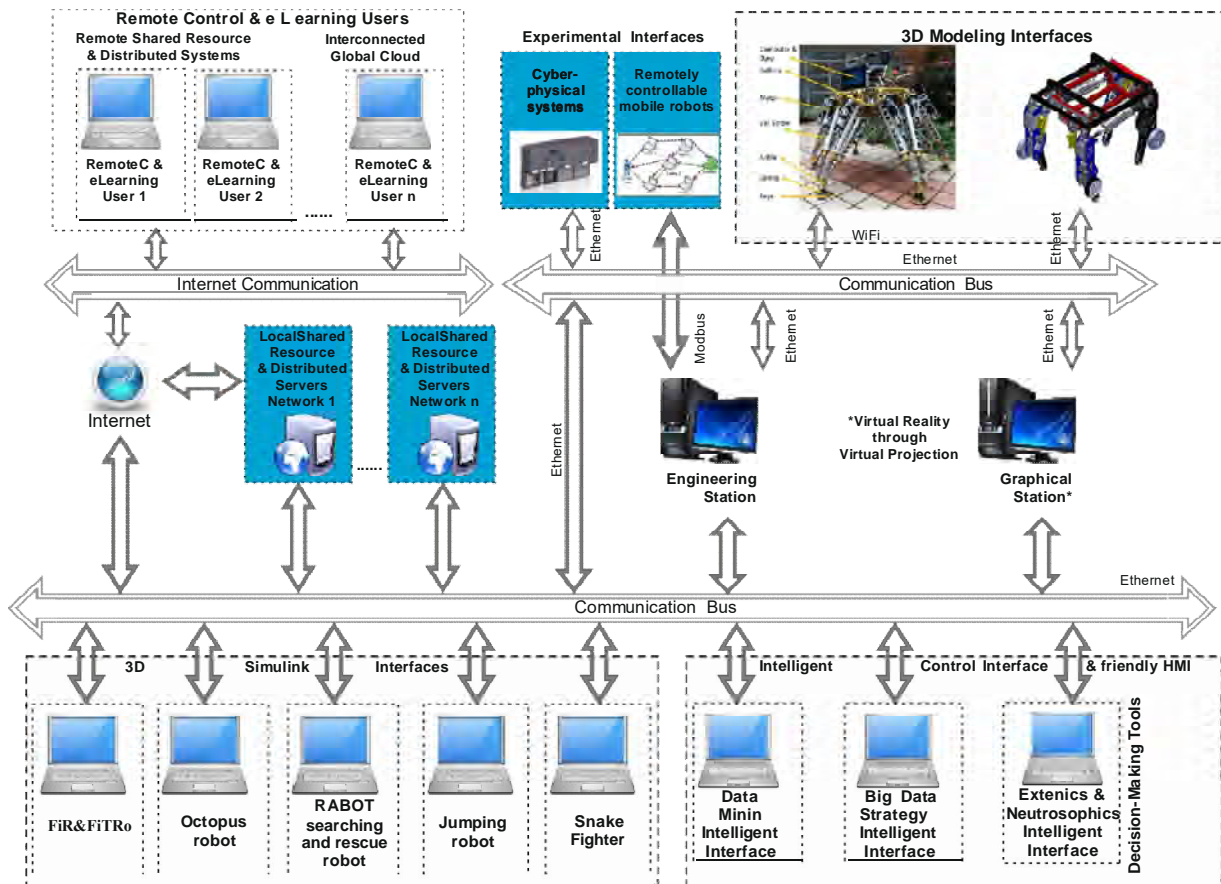

Figure 3: The VIP- F²Ro - Virtual Intelligent Portable Platform of the SMOOTH firefighting robot

The predictions and outputs from the generated models may be used innumerous ways Often, in circumstances such as fire growth , the results may be directly sent to personnel at

the fire ground or to other community services. If the model predicted that the fire may spread into a section of the building where toxic compounds are stored, the model may integrate

with a smoke- generation model and weather model for predicting any potential impact on surrounding communities.

The information is then directly sent to law enforcement agencies, disaster management departments, and local hospital stone able potential evacuation planning and treatment of victims. Usually, predictions and model outputs would drive real-time 3D visualization of the fire ground, personnel, and equipment. The ICs then display the evolution of the fire incident to analyze the possible impact of actions and decisions before issuing commands to personnel. The visualization is then recorded for future analysis, training, and lessons learned.

The computational platform VIP-F²Ro designed in this project will be based on the virtual projection method. VIP-F²Ro is extendable for integration, testing and experimenting of firefighting environments through building an open architecture system and adaptive networks, combining the expertise of a team of specialists in fire engineering, electronics, mathematics, computer sciences with the expertise of a diverse group of researchers in different fire specialties.

The innovative platform VIP- F²Ro (Figure 3), has been developed as an open architecture system and adaptive network which integrates Future Internet Systems vision enabling: intelligent network control systems, cyber-physical systems by adaptive networks, big data, data mining, human in the loop principles, network quality of service, intelligent control interfaces, shared resources, and distributed server network - remote control and e-learning users by interconnected global clouds. Thus, the challenges and expected progress of VIP- F²Ro are its ability to be competitive, interactive, and integrated with advanced scientific research concepts.

The idea is that the robotics mobile unit will go to the safe proximity of the firefighting emergency area, in particular fire and rescue operations such as aircraft/airport rescue, wilderness fire suppression, and search and rescue, including emergency medical services. It can do that as it is equipped with innovative devices that determine the direction and the identification of dangerous clouds and the toxic environment created by combustible materials, their moving direction, nature of agents that contaminate, oxygen deficiency, elevated temperatures, and poisonous atmospheres, provided in safe condition for personnel protection. After the safe stop of robotics mobile unit, there are the correlated actions of unmanned ground and aerial vehicles (VIP- F²Ro and UAV), all of these coordinated by the virtual intelligent platform, as follows next.

The requirement for managing every interaction and behavior is solved through the development of a new interface for intelligent control based on advanced control strategies, such as extended control (Extenics), human adaptive mechatronics, neutrosophic control, implemented by high speed processing IT&C techniques in real time communication for a high volumes of data processing, including a remote control & e-learning component and an adaptive networked control.

This permits the development of new methodologies, test platforms, evaluation metrics, experiment reproducibility, novel approaches to academia-industry co-operation, of the products and process innovation and a fire engineering network for modeling and researching complex data for firefighting quick actions, and management of fire and emergency services.

Robotic control is fundamental in the development of control and perception algorithms for robotics applications. A 3D simulator for mobile robots needs to be able to correctly control the robot dynamics and objects in the environment. Additionally, real- time control is vital to correctly model interactions amongst and between robots and the environment, therefore it is frequently necessarily to approximate to obtain real-time performance.

The innovative firefighting robotic mobile ground vehicle, is sent for support to people, physical evaluation, examination and collection of material / evidence. Some “plus (+)” aspects of this innovative firefighting robot are: high stability and ease of remote control (manoeuvrability) in severe ground topography and / or narrow spaces like pipes; modular structure with, relatively, low costs specific components; ability to work in natural disasters and emergency incidents threatening life and property.

The networked real- time control will be distributed and decentralized using multi-processor devices for fusion control, data reception from transducers mounted on the robot, peripheral devices connected through a wireless LAN for off-line communications and CAN, MODBUS, PROFIBUS or ETHERNET fast communication network for real time control. The VIP- F²Ro system was designed in a distributed and decentralized structure to enable development of new applications easily and to add new modules for new hardware or software control functions. Moreover, the short time execution will ensure a faster feedback, allowing other programs to be performed in real time as well, like the apprehension force control, objects recognition, making it possible that the control system have a human flexible and friendly interface.

The VIP-F²Ro Platform develop the intelligent interfaces using Robot Neutrosophic Control (RNC), Robot Extenics Control Interface (eHFPC) and Robot Haptic Control (RHC) Interface for Unmanned Ground robotic mobile Vehicle (UGV) which acts in correlation and interaction with Unmanned Aerial Vehicle (UAV) through implementation of the network mobile robot system over Mobile Ad-hoc Network. The target robot is equipped with a robotic arm to execute various tasks. The relay / observer robot can route network packets between the controller and the target robot. It also produces visual feedback of the target robot to the user at the controlling end.

4. HAPTIC INTELLIGENT CONTROL INTERFACES

Recently haptic interfaces have become a reliable solution for solving problems which arise when humans interact with the environment. In research areas of haptic interaction between humans and the environment there is important research, an innovative approach for interactions between the robot and the environment using haptic interfaces and virtual projection method is present adhere. To control this interaction, we used the Virtual Projection Method where haptic control interfaces of impedance and admittance will be embedded.

For moving of the firefighting robots in uncertain environments, allowing actuation in crisis situations or natural disaster, in which human life is in danger, SMOOTH will develop haptic interfaces that provides the robot spatial orientation and navigation based on that the robot feels the land on which it moves by changing the stiffness of the robot paw joints and of the segments robot joints, using the stiffness associated of the paw joints position X_C on the robot environment map if uneven ground is detected [9-11].

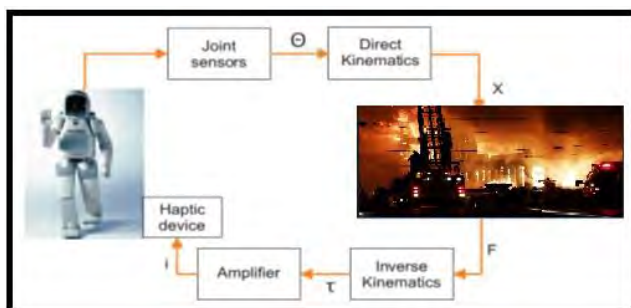

Figure 4: Haptic interfaces for firefighting robots using VIP-F²Ro Platform

This leads to successively change the robot movement scheme and change the position control loop to the force control. Thus, the human operator can remotely control the robot's movement through two parameters, first visual and the second haptic (Figure 4). Respectively, the human operator sees the robot environment map and simultaneously feels damping of the robot leg movement at actuation of the haptic device lever, with the possibility of generating the haptic Cartesian positions X_{CH} for adapting the robot movement, on uneven and unstructured terrain.

Haptic interfaces are intended to reproduce or include the sense of touch through manipulation or, perception of real environments using computer control and mechatronic devices. They consist of a haptic device and a computer, which incorporates software that associates input data with haptic information rendering. Figure 4 shows how haptic interfaces work and the ways in which it will be implemented for controlling fire fighting robots using the VIP-F²Ro Platform.

The innovative solution developed and patented for haptic robot control allows the robot to “feel” the terrain on which the

mobile autonomous robot moves by the **modification in rigidity** of the joints and of the joints segment when detecting unevenness depending on the rigidity K_{Xc} associated to the joint position of the robot X_C on the robot environment map. Modifications in rigidity are realized from the time the joint touches the terrain until complete contact of the joint segment. **The human operator** has the possibility to remotely control the robot movement, through two parameters, one visual and the second haptic, respectively seeing the robot environment map and simultaneously to feel remotely the dampening of the robot joint movement when using the haptic device stick. Depending on the type of manipulation of the haptic device, the human operator generates the haptic Cartesian positions X_{CH} to ensure the robot motion is adapted to the uneven and unstructured terrain in crisis situations or natural disasters where human lives may be at risk.

To generate the robot environment map, a CCD camera is used to process the images, stabilized for various robot motion directions. This is achieved by processing the signals received from a 3D gravitational transducer (TGR3D) and a magnetic compass (TBM), which results in an interface of the 3D robot environment map with a stable image to the robot movement. Each of the points in the robot environment map are associated with the rigidity of the robot joint position X_C , named the associated rigidity K_{Xc} . **Movement damping** at contact between the robot joint and uneven terrain is obtained by switching from the position control to the force control when the tip or joint posterior touches the terrain, depending on the robot motion scheme, until total contact of the joint segment is achieved.

Haptic control of the robot movement by the human operator occurs via a haptic device permitting the human operator to feel the robot joint movement damping and generates the Cartesian reference positions of the robot movement, called haptic Cartesian positions X_{CH}^H , for adaptation of robot movement to an unstructured and uneven terrain. **The telemetry module (TL)** permits measurement of the distance to the joint segment through the use of an optical scanning device.

The novelty VIP-F²Ro Virtual Intelligent Portable platform for firefighting robots, is competitive with other similar virtual simulation platforms with applications in robotics, called virtual instrumentation, CDA, CAM, CAE, Solid Works, etc., very powerful in modeling but only in a virtual environment, or the MatLab, Simulink, COMSOL, Lab View platforms, which allow extensions for real time data acquisition and signal processing. In addition to these, VIP-F²Ro allow the experimental validation of intelligent control methods by integrating the classical robot real time control system in modelling, design, simulation and testing of the robot motion and stability.

5. CONCLUSION

Development of 3D dynamic perception and visualization, and human-robot interaction software systems are formidably challenging and accordingly the activities to support software

developments and project management processes are of vital importance to this piece of research. Attribute selected techniques can be categorised on the basis of a number of criteria. Dynamic data come from environmental and wearable sensors, mobile robots and radio communications. SMOOTH will therefore develop software systems for real-time data analytics to assess situational awareness, assess risk and improve decision-making by firefighters and ICs. New computational software tools and virtual reality engines are being developed to support both risk and the decisions. The VIP-F²Ro Platform also develop adequate metrics and testing tools to determine the effectiveness and validity.

This is part of a larger effort to completely define a virtual environment for the simulation and testing of mechatronic systems on a remote virtual platform, encompassing all the usual and innovative aspects in the field of Robotics research, from low-level actuator control and mechanism design to intelligent operational strategies and environment configuration modelling. It has the advantage of allowing virtually all manner of testing to be made remotely, with little or no extra configuration cost, while reducing the risk of equipment damage and maintaining the realism and end-result application value that can only come with actual hardware testing. This approach combines the best features of both scientific lines of enquiry, software simulation and direct hardware implementation.

Major outcome of this work is development of an Integrated Safe Smart Robotics Mobile Unit & Virtual Intelligent Platform for Remotely - Controlled Technologies in the fire investigation, hazardous chemicals detection, fire and rescue threat the firefighter's safety and life in emergency situations. Its innovation potential comes from the fact that it integrates, through VIP-F²Ro Platform, both UGV (with innovative robotic arm module) and UAV (with innovative sensors and miniature sensors). This is how it enables intervention in various ground condition (uneven terrain, narrow spaces) where examination by humans may not be possible, or could be severely restricted. It allows searching and rescuing in smart firefighting control, safe operating in highly contaminated radioactive and chemical environments, and to facilitate the decision making with higher efficiency and collecting evidence / data which are further automated processed and generated reports are transmitted to decision centre. Also, prediction and local prognoses on highly contaminated areas are available.

ACKNOWLEDGMENT

This work was developed with the support of MEN-UEFISCDI, PN-II-PT-PCCA-2013-4, VIPRO project No.009/2014-2017, Romanian Academy, "Joint Laboratory of Intelligent Rehabilitation Robot" collaborative research agreement between Romanian Academy by IMSAR, RO and Yanshan University, CN, project KY201501009/2016-2018 and H2020-MSCA-RISE-2016/H2020-MSCA-RISE-2016, SMOOTH project, GA no. 734875, 2016-2020.

REFERENCES

- [1] Murphy, Robin R. "Human-robot interaction in rescue robotics." *IEEE Transactions on Systems, Man, and Cybernetics, Part C (Applications and Reviews)* 34.2 (2004): 138-153.
<https://doi.org/10.1109/TSMCC.2004.826267>
- [2] Hongnian Yu (UK), L. Vladareanu (RO), H. Wang (CN), Z.G. Hou (CN), F. Gao (CN), FP7-PEOPLE-2012-IRSES RABOT project no. 318902, 2012-2016
- [3] Hongnian Yu (UK), L. Vladareanu (RO), H. Wang (CN), Z.G. Hou (CN), F. Gao (CN), V. Somoghi (RO), R. Lopez (SP), F. Claeysen (FR), H2020-MSCA-RISE-2016/H2020-MSCA-RISE-2016, SMOOTH project, GA no. 734875, 2016-2020
- [4] Yang Liu, Hongnian Yu, Luige Vladareanu, Shuang Cang, and T. C. Yang, "Trajectory Optimization of a Pendulum-Driven Underactuated Cart", *SISOM 2011 and Session of the Commission of Acoustics*, pp 287- 299, Bucharest 25-26 May, 2011
- [5] O. Formsma, N. Dijkshoorn, S. van Noort and A. Visser (2011), "Realistic Simulation of Laser Range Finder Behavior in a Smoky Environment", in "RoboCup 2010: Robot Soccer World Cup XIV", *Lecture Notes on Artificial Intelligence series*, volume 6556, p. 336-349, Springer, Heidelberg, March 2011.
https://doi.org/10.1007/978-3-642-20217-9_29
- [6] Vladareanu L., A. Curaj, R.I. Munteanu, *Complex Walking Robot Kinematics Analysis And PLC Multi-Tasking Control*, *Revue Roumaine des Sciences Techniques – Série Électrotechnique et Énergétique*, 2011, Volume: 57 Issue: 1 Pages: 90-99 Published: JAN-MAR 2012, WOS:000303096800010, ISSN 0035-4066.
- [7] Yi Dong, Hongnian Yu, Feng Gao, Design, Modelling and control of a light touch Mechanism, *International Conference on Advanced Mechatronic Systems*, Zhengzhou, China, 11-13 August 2011.
- [8] R. R. Murphy, "Human-Robot Interaction in Rescue Robotics", *IEEE Trans on Systems, Man, Cybernetics, Part C*, vol.34, no. 2, pp.138-158.
- [9] Victor Vladareanu, Radu I. Munteanu, Ali Mumtaz, Florentin Smarandache and Luige Vladareanu, "The optimization of intelligent control interfaces using Versatile Intelligent Portable Robot Platform", *Procedia Computer Science* 65 (2015): 225 – 232, ELSEVIER, www.sciencedirect.com, doi:10.1016/j.procs.2015.09.115.
<https://doi.org/10.1016/j.procs.2015.09.115>
- [10] Luige Vladareanu, et. al, "Versatile Intelligent Portable Robot Platform using Adaptive Networked Control Systems of Rescue Robots", *VIPRO Platform*, project no. 009/2014, PN-II-PT-PCCA-2013-4, MEN-UEFISCDI, RO, 2014-2017
- [11] Victor Vladareanu, Ovidiu Ilie Sandru, Luige Vladareanu, Hongnian Yu, "Extension Dynamical Stability Control Strategy for the Walking Robots", *International Journal of Technology Management, SKIMA 2012*, Inderscience Publisher, 2013, ISSN online: 1741-5276, ISSN print: 0267-5730,
<http://www.inderscience.com/jhome.php?jcode=ijtm>
- [12] Smarandache F., Vladareanu L., "Applications of Neutrosophic Logic to Robotics - An Introduction", *The 2011 IEEE International Conference on Granular Computing Kaohsiung, Taiwan*, Nov. 8-10, 2011, pp. 607-612, ISBN 978-1-4577-0370-6
<https://doi.org/10.1109/GRC.2011.6122666>
- [13] Sandru Ovidiu Ilie, Luige Vladareanu, Paul Şchiopu, Victor Vlădareanu, Alexandra Şandru, "Multidimensional Extensics Theory", *U.P.B. Sci. Bull., Series A*, Vol. 75, Iss. 1, 2013, pg.3-12, ISSN 1223-7027
- [14] Marina Shitikova, Luige Vladareanu, Claudio Guarnaccia, "Recent advances in mechanical engineering", *WSEAS Press*, 2014, pg.207-2014, ISBN: 978-960-474-402-2

- [15] S.B. Balakirsky and Z. Kootbally, "USARSim/ROS: A Combined Framework for Robotic Control and Simulation", Proceedings of the ASME 2012 International Symposium on Flexible Automation (ISFA 2012), St. Louis, June 18-20, 2012
<https://doi.org/10.1115/ISFA2012-7179>
- [16] Cononovici, Sergiu Boris, and Adrian Curaj. "An approach to walking robots planning and control." Proceedings of the Romanian Academy (2010): 75-82.
- [17] Y.F. Feng, H.B. Wang, T.T. Lu, et al. "Teaching training method of a lower limb rehabilitation robot." Int J Adv Robot Syst, vol. 13, pp. 1-11, February 2016.
<https://doi.org/10.5772/62058>
- [18] Cononovici, S.B., Vlădăreanu, V., et al. "Control Strategies for Synchronous Generation of Resistive Loads Correlated to the Robot Motion Environment", 5th International Workshop on Cyber Physical Systems (IWoCPS-2016), Romanian Academy, Bucharest.
- [19] Vladareanu Luige, et all, Method and device for the real-time control of robots by virtual, projection, EPO: A 200800232.
- [20] Yang Liu, Hongnian Yu and Luige Vladareanu, An Iterative Learning Control Scheme for the Capsbot, UKACC International Conference on Control 2008, University of Manchester, UK, 2-4 September 2008.

STATISTICS

Ratio estimators in simple random sampling using information on auxiliary attribute

Rajesh Singh, Pankaj Chauhan, Nirmala Sawan, Florentin Smarandache

Rajesh Singh, Pankaj Chauhan, Nirmala Sawan, Florentin Smarandache (2008). Ratio estimators in simple random sampling using information on auxiliary attribute. *Pakistan Journal of Statistics and Operation Research* 4(1),47-53

Abstract

Some ratio estimators for estimating the population mean of the variable under study, which make use of information regarding the population proportion possessing certain attribute, are proposed. Under simple random sampling without replacement (SRSWOR) scheme, the expressions of bias and mean-squared error (MSE) up to the first order of approximation are derived. The results obtained have been illustrated numerically by taking some empirical population considered in the literature.

Key words: Proportion, bias, MSE, ratio estimator.

1. Introduction

The use of auxiliary information can increase the precision of an estimator when study variable y is highly correlated with auxiliary variable x . There exist situations when information is available in the form of attribute ϕ , which is highly correlated with y . For example

- a) Sex and height of the persons,
 - b) Amount of milk produced and a particular breed of the cow,
 - c) Amount of yield of wheat crop and a particular variety of wheat etc.
- (see Jhajj et. al. [1]).

Consider a sample of size n drawn by SRSWOR from a population of size N . Let y_i and ϕ_i denote the observations on variable y and ϕ respectively for i^{th} unit ($i = 1, 2, \dots, N$). Suppose there is a complete dichotomy in the population with respect to the presence or absence of an attribute, say ϕ , and it is assumed that attribute ϕ takes only the two values 0 and 1 according as

$$\begin{aligned} \phi_i &= 1, \text{ if } i^{\text{th}} \text{ unit of the population possesses attribute } \phi \\ &= 0, \text{ otherwise.} \end{aligned}$$

Let $A = \sum_{i=1}^N \phi_i$ and $a = \sum_{i=1}^n \phi_i$ denote the total number of units in the population and sample respectively possessing attribute ϕ . Let $P = \frac{A}{N}$ and $p = \frac{a}{n}$ denote the proportion of units in the population and sample respectively possessing attribute ϕ .

Taking into consideration the point biserial correlation between a variable and an attribute, Naik and Gupta [2] defined ratio estimator of population mean when the prior information of population proportion of units, possessing the same attribute is available, as follows:

$$t_{NG} = \bar{y} \left(\frac{P}{p} \right) \tag{1.1}$$

Here \bar{y} is the sample mean of variable of interest. The MSE of t_{NG} up to the first order of approximation is –

$$MSE(t_{NG}) = \left(\frac{1-f}{n} \right) [S_y^2 + R_1^2 S_\phi^2 - 2R_1 S_{y\phi}] \tag{1.2}$$

Where $f = \frac{n}{N}$, $R_1 = \frac{\bar{Y}}{P}$, $S_y^2 = \frac{1}{N-1} \sum_{i=1}^N (y_i - \bar{Y})^2$, $S_\phi^2 = \frac{1}{N-1} \sum_{i=1}^N (\phi_i - P)^2$,

$$S_{y\phi} = \frac{1}{N-1} \sum_{i=1}^N (\phi_i - P)(y_i - \bar{Y}).$$

In the present paper, some ratio estimators for estimating the population mean of the variable under study, which make use of information regarding the population proportion possessing certain attribute, are proposed. The expressions of bias and MSE have been obtained. The numerical illustrations have also been done by taking some empirical populations considered in the literature.

2. The suggested estimator

Following Ray and Singh [3], we propose the following estimator –

$$t_1 = \frac{\bar{y} + b_\phi (P - p)}{p} P = R^* P \tag{2.1}$$

Where $b_\phi = \frac{s_{y\phi}}{s_\phi^2}$, $R^* = \frac{\bar{y} + b_\phi (P - p)}{p}$, $s_\phi^2 = \left(\frac{1}{n-1} \right) \sum_{i=1}^n (\phi_i - p)^2$ and

$$s_{y\phi} = \left(\frac{1}{n-1} \right) \sum_{i=1}^n (\phi_i - p)(y_i - \bar{Y}).$$

Remark 1: When we put $b_\phi = 0$ in (2.1) the proposed estimator turns to the Naik and Gupta [2] ratio estimator t_{NG} given in (1.1).

MSE of this estimator can be found by using Taylor series expansion given by –

$$f(p, \bar{y}) \cong f(P, \bar{Y}) + \frac{\partial f(c, d)}{\partial c} \Big|_{p, \bar{y}} (p - P) + \frac{\partial f(c, d)}{\partial c} \Big|_{p, \bar{y}} (\bar{y} - \bar{Y}) \tag{2.2}$$

Where $f(p, \bar{y}) = R^*$ and $f(P, \bar{Y}) = R_1$.

Expression (2.2) can be applied to the proposed estimator in order to obtain MSE equation as follows:

$$\begin{aligned} R^* - R_1 &\cong \frac{\partial((\bar{y} + b_\phi(P - p)))/p}{\partial p} \Big|_{p, \bar{y}} (p - P) + \frac{\partial((\bar{y} + b_\phi(P - p)))/p}{\partial \bar{y}} \Big|_{p, \bar{y}} (\bar{y} - \bar{Y}) \\ &\cong -\left(\frac{\bar{y}}{p^2} + \frac{b_\phi P}{p^2}\right) \Big|_{p, \bar{y}} (p - P) + \frac{1}{p} \Big|_{p, \bar{y}} (\bar{y} - \bar{Y}) \\ E(R^* - R_1)^2 &\cong \frac{(\bar{Y} + B_\phi P)^2}{p^4} V(p) - \frac{2(\bar{Y} + B_\phi P)}{p^3} \text{Cov}(p, \bar{y}) + \frac{1}{p^2} V(\bar{y}) \\ &\cong \frac{1}{p^2} \left\{ \frac{(\bar{Y} + B_\phi P)^2}{p^2} V(p) - \frac{2(\bar{Y} + B_\phi P)}{p} \text{Cov}(p, \bar{y}) + V(\bar{y}) \right\} \end{aligned} \tag{2.3}$$

Where $B_\phi = \frac{S_{\phi y}}{S_\phi^2} = \frac{\rho_{pb} S_y}{S_\phi}$.

$\rho_{pb} = \frac{S_{y\phi}}{S_y S_\phi}$, is the point biserial correlation coefficient.

Now,

$$\begin{aligned} \text{MSE}(t_1) &= P^2 E(R_1 - R_\phi)^2 \\ &\cong \frac{(\bar{Y} + B_\phi P)^2}{p^2} V(p) - \frac{2(\bar{Y} + B_\phi P)}{p} \text{Cov}(p, \bar{y}) + V(\bar{y}) \end{aligned} \tag{2.4}$$

Simplifying (2.4), we get MSE of t_1 as

$$\text{MSE}(t_1) \cong \left(\frac{1-f}{n}\right) [R_1^2 S_\phi^2 + S_y^2 (1 - \rho_{pb}^2)] \tag{2.5}$$

Several authors have used prior value of certain population parameters (s) to find more precise estimates. Searls (1964) used Coefficient of Variation (CV) of study character at estimation stage. In practice this CV is seldom known. Motivated by Searls (1964) work, Sen (1978), Sisodiya and Dwivedi (1981), and Upadhyaya and Singh (1984) used the known CV of the auxiliary character for estimating population mean of a study character in ratio method of estimation. The use of prior value of Coefficient of Kurtosis in estimating the population variance of study character y was first made by Singh et. al. (1973). Later, used by and Searls and Intarapanich (1990), Upadhyaya and Singh (1999), Singh (2003) and Singh et. al. (2004) in the estimation of population mean of study character. Recently Singh and Tailor (2003) proposed a modified ratio estimator by using the known value of correlation coefficient.

In next section, we propose some ratio estimators for estimating the population mean of the variable under study using known parameters of the attribute ϕ such as coefficient of variation C_p , Kurtosis $(\beta_2(\phi))$ and point biserial correlation coefficient ρ_{pb} .

3. Suggested Estimators

We suggest following estimator –

$$t = \frac{\bar{y} + b_\phi(P - p)}{(m_1p + m_2)}(m_1P + m_2) \tag{3.1}$$

Where $m_1(\neq 0)$, m_2 are either real number or the functions of the known parameters of the attribute such as C_p , $(\beta_2(\phi))$ and ρ_{pb} .

The following scheme presents some of the important estimators of the population mean, which can be obtained by suitable choice of constants m_1 and m_2 :

Estimator	Values of	
	m_1	m_2
$t_1 = \frac{\bar{y} + b_\phi(P - p)}{p}P$	1	1
$t_2 = \frac{\bar{y} + b_\phi(P - p)}{(p + \beta_2(\phi))} [P + \beta_2(\phi)]$	1	$\beta_2(\phi)$
$t_3 = \frac{\bar{y} + b_\phi(P - p)}{(p + C_p)} [P + C_p]$	1	C_p
$t_4 = \frac{\bar{y} + b_\phi(P - p)}{(p + \rho_{pb})} [P + \rho_{pb}]$	1	ρ_{pb}
$t_5 = \frac{\bar{y} + b_\phi(P - p)}{(p\beta_2(\phi) + C_p)} [P\beta_2(\phi) + C_p]$	$\beta_2(\phi)$	C_p
$t_6 = \frac{\bar{y} + b_\phi(P - p)}{(pC_p + \beta_2(\phi))} [PC_p + \beta_2(\phi)]$	C_p	$\beta_2(\phi)$
$t_7 = \frac{\bar{y} + b_\phi(P - p)}{(pC_p + \rho_{pb})} [PC_p + \rho_{pb}]$	C_p	ρ_{pb}
$t_8 = \frac{\bar{y} + b_\phi(P - p)}{(p\rho_{pb} + C_p)} [P\rho_{pb} + C_p]$	ρ_{pb}	C_p
$t_9 = \frac{\bar{y} + b_\phi(P - p)}{(p\beta_2(\phi) + \rho_{pb})} [P\beta_2(\phi) + \rho_{pb}]$	$\beta_2(\phi)$	ρ_{pb}
$t_{10} = \frac{\bar{y} + b_\phi(P - p)}{(p\rho_{pb} + \beta_2(\phi))} [P\rho_{pb} + \beta_2(\phi)]$	ρ_{pb}	$\beta_2(\phi)$

Following the approach of section 2, we obtain the MSE expression for these proposed estimators as –

$$MSE(t_i) \cong \left(\frac{1-f}{n}\right) [R_i S_\phi^2 + S_y^2 (1 - \rho_{pb}^2)], \quad (i = 1, 2, 3, \dots, 10) \tag{3.2}$$

Where $R_1 = \frac{\bar{Y}}{P}$, $R_2 = \frac{\bar{Y}}{P + \beta_2(\phi)}$, $R_3 = \frac{\bar{Y}}{P + C_p}$, $R_4 = \frac{\bar{Y}}{P + \rho_{pb}}$,

$$R_5 = \frac{\bar{Y}\beta_2(\phi)}{P\beta_2(\phi) + C_p}, \quad R_6 = \frac{\bar{Y}C_p}{PC_p + \beta_2(\phi)}, \quad R_7 = \frac{\bar{Y}C_p}{PC_p + \rho_{pb}}, \quad R_8 = \frac{\bar{Y}\rho_{pb}}{P\rho_{pb} + C_p},$$

$$R_9 = \frac{\bar{Y}\beta_2(\phi)}{P\beta_2(\phi) + \rho_{pb}}, \quad R_{10} = \frac{\bar{Y}\rho_{pb}}{P\rho_{pb} + \beta_2(\phi)}.$$

4. Efficiency comparisons

It is well known that under simple random sampling without replacement (SRSWOR) the variance of the sample mean is

$$V(\bar{y}) = \left(\frac{1-f}{n}\right) S_y^2 \tag{4.1}$$

From (4.1) and (3.2), we have

$$V(\bar{y}) - MSE(t_i) \geq 0, \quad i = 1, 2, \dots, 10$$

$$\Rightarrow \rho_{pb}^2 > \frac{S_\phi^2}{S_y^2} R_i^2 \tag{4.2}$$

When this condition is satisfied, proposed estimators are more efficient than the sample mean.

Now, we compare the MSE of the proposed estimators with the MSE of Naik and Gupta (1996) estimator t_{NG} . From (3.2) and (1.1) we have

$$MSE(t_{NG}) - MSE(t_i) \geq 0, \quad (i = 1, 2, \dots, 10)$$

$$\Rightarrow \rho_{pb}^2 \geq \frac{S_\phi^2}{S_y^2} [R_i^2 - R_\phi^2 + 2R_\phi K_{yp}] \tag{4.3}$$

where $K_{yp} = \rho_{yp} \frac{C_y}{C_p}$.

5. Empirical Study

The data for the empirical study is taken from natural population data set considered by Sukhatme and Sukhatme (1970):

- y = Number of villages in the circles and
- ϕ = A circle consisting more than five villages

$N = 89, \bar{Y} = 3.36, P = 0.1236, \rho_{pb} = 0.766, C_y = 0.604, C_p = 2.19, \beta_2(\phi) = 6.23181.$

In table 5.1 percent relative efficiencies (PRE) of various estimators are computed with respect to \bar{y} .

Table 5.1: PRE of different estimators of \bar{Y} with respect to \bar{y}

Estimator	PRE ($., \bar{y}$)
\bar{y}	100
t_{NG}	11.61
t_1	7.36
t_2	236.55
t_3	227.69
t_4	208.09
t_5	185.42
t_6	230.72
t_7	185.27
t_8	230.77
t_9	152.37
t_{10}	237.81

From table 5.1, we observe that the proposed estimators $t_i (i = 2, \dots, 10)$ which uses some known values of population proportion performs better than the usual sample mean \bar{y} and Naik and Gupta (1996) estimator t_{NG} .

Conclusion

We have suggested some ratio estimators for estimating \bar{Y} which uses some known value of population proportion. For practical purposes the choice of the estimator depends upon the availability of the population parameters.

References

1. Jhaji, H. S., Sharma, M. K. and Grover, L. K. (2006): A family of estimators of population mean using information on auxiliary attribute. Pak. J. Statist., 22 (1), 43-50.

2. Naik, V.D. and Gupta, P.C. (1996): A note on estimation of mean with known population proportion of an auxiliary character. *Jour. Ind. Soc. Agr. Stat.*, 48 (2), 151-158.
3. Ray, S. K. and Singh, R. K. (1981): Difference-cum-ratio type estimators. *J. Ind. Statist. Assoc.*, 19, 147-151.
4. Searls, D.T. (1964): The utilization of known coefficient of variation in the estimation procedure. *Journal of American Statistical Association*, 59, 1125-1126.
5. Searls, D.T. and Intarapanich, P. (1990): A note on an estimator for the variance that utilizes the kurtosis. *The American Statistician*, 44, 4, 295-296.
6. Sen, A.R. (1978): Estimation of the population mean when the coefficient of variation is known. *Commun. Statist., Theory – Meth. A* (7), 657-672.
7. Singh, G.N. (2003): On the improvement of product method of estimation in sample surveys. *Jour. Ind. Soc. Agri. Statistics*, 56(3), 267-275.
8. Singh H.P. And Tailor, R. (2003): Use of known correlation coefficient in estimating the finite population mean. *Statistics in Transition*, 6, 4, 555-560.
9. Singh H.P., Tailor, R., Tailor, R. and Kakran, M.S. (2004): An improved estimator of population mean using power transformation. *Jour. Ind. Soc. Agr. Stat.*, 58 (2), 223-230.
10. Singh, J. Pandey, B.N. and Hirano, K. (1973): On the utilization of a known coefficient of kurtosis in the estimation procedure of variance. *Ann. Inst. Stat. Math.*, 25, 51-55.
11. Sisodia, B.V.S. And Dwivedi, V.K. (1981): A modified ratio estimator using coefficient of variation of auxiliary variable. *Jour.Ind.Soc.Agril. Statist.*, 33, 2, 13-18.
12. Sukhatme, P.V. and Sukhatme, B.V. (1970): *Sampling theory of surveys with applications*. Iowa State University Press, Ames, U.S.A.
13. Upadhyaya, L.N. and Singh, H.P. (1984): On the estimation of the population mean with known coefficient of variation. *Biom. Jour.*, 26 (8), 915-922.
14. Upadhyaya, L.N. and Singh, H.P. (1999): Use of transformed auxiliary variable in estimating the finite population mean. *Biometrical Journal*, 41, 5, 627-636.

Optimum Statistical Test Procedure

Rajesh Singh, Jayant Singh, Florentin Smarandache

Rajesh Singh, Jayant Singh, Florentin Smarandache (2009). Optimum Statistical Test Procedure. *Italian Journal of Pure and Applied Mathematics* 26, 219-228

Abstract. In this paper we search for the optimum tests that minimize the sum of two error probabilities.

Keywords and Phrases: Testing hypotheses, Neyman-Pearson lemma, optimality, normal distribution, chi-square distribution with n degrees of freedom, exponential dis-tribution, optimum test, critical region, variance.

1. Introduction

Let X be a random variable having probability distribution $P(X/\theta)$, $\theta \in \Theta$. It is desired to test $H_0: \theta \in \Theta$ against $H_1: \theta \in \Theta_1 = \Theta - \Theta_0$. Let S denote the sample space of outcomes of an experiment and $\underline{x} = (x_1, x_2, \dots, x_n)$ denote an arbitrary element of S . A test procedure consists in dividing the sample space into two regions W and $S - W$ and deciding to reject H_0 if the observed $\underline{x} \in W$. The region W is called the critical region. The function $\gamma(\theta) = P_\theta(x \in W) = P_\theta(W)$, say, is called the power function of the test.

We consider first the case where Θ_0 consists of a single element, θ_0 and its complement Θ_1 also has a single element θ_1 . We want to test the simple hypothesis $H_0: \theta = \theta_0$ against the simple alternative hypothesis $H_1: \theta = \theta_1$.

Let $L_0 = L(X/H_0)$ and $L_1 = L(X/H_1)$ be the likelihood functions under H_0 and H_1 respectively. In the Neyman-Pearson set up the problem is to determine a critical region W such that

$$(1) \quad \gamma(\theta_0) = P_{\theta_0}(W) = \int_W L_0 dx = \alpha, \text{ an assigned value, and}$$

$$(2) \quad \gamma(\theta_1) = P_{\theta_1}(W) = \int_W L_1 dx \text{ is maximum}$$

compared to all other critical regions satisfying (1). If such a critical region exists it is called the most powerful critical region of level α .

By the Neyman-Pearson lemma, the most powerful critical region W_0 for testing $H_0 : \theta = \theta_0$ against $H_1 : \theta = \theta_1$ is given by

$$W_0 = \{x : L_1 \geq kL_0\}$$

provided there exists a k such that (1) is satisfied.

For this test $\gamma(\theta_0) = \alpha$ and $\gamma(\theta_1) \rightarrow 1$ as $n \rightarrow \infty$.

But for any good test we must have $\gamma(\theta_0) \rightarrow 0$ and $\gamma(\theta_1) \rightarrow 1$ as $n \rightarrow \infty$ because complete discrimination between the hypotheses H_0 and H_1 should be possible as the sample size becomes indefinitely large.

Thus, for a good test it is required that the two error probabilities α and β should depend on the sample size n and both should tend to zero as $n \rightarrow \infty$.

We describe below test procedures which are optimum in the sense that they minimize the sum of the two error probabilities as compared to any other test. Note that minimizing $(\alpha + \beta)$ is equivalent to maximising

$$1 - (\alpha + \beta) = (1 - \beta) - \alpha = \text{Power-Size.}$$

Thus, an optimum test maximises the difference of power and size as compared to any other test.

Definition 1. A critical region W_0 will be called *optimum* if

$$(3) \quad \int_{W_0} L_1 dx - \int_{W_0} L_0 dx \geq \int_W L_1 dx - \int_W L_0 dx,$$

for every other critical region W .

Lemma 1. For testing $H_0 : \theta = \theta_0$ against $H_1 : \theta = \theta_1$ the region

$$W_0 = \{x : L_1 \geq L_0\} \text{ is optimum.}$$

Proof. W_0 is such that inside W_0 , $L_1 \geq L_0$ and outside W_0 , $L_1 < L_0$. Let W be any other critical region

$$\int_{W_0} (L_1 - L_0) dx - \int_W (L_1 - L_0) dx = \int_{W_0 \cap W^c} (L_1 - L_0) dx - \int_{W \cap W_0^c} (L_1 - L_0) dx,$$

$$\begin{aligned} &\text{by subtracting the integrals over the common region } W_0 \cap W \\ &\geq 0 \end{aligned}$$

since the integrand of first integral is positive and the integrand under second integral is negative. Hence (3) is satisfied and W_0 is an optimum critical region.

Example 1. Consider a normal population $N(\theta, \sigma^2)$, where σ^2 is known. It is desired to test $H_0 : \theta = \theta_0$ against $H_1 : \theta = \theta_1, \theta_1 > \theta_0$.

$$L(x/\theta) = \left(\frac{1}{\sigma\sqrt{2\pi}} \right)^n e^{-\sum_{i=1}^n \frac{(x_i - \theta)^2}{2\sigma^2}}$$

$$\frac{L_1}{L_0} = \frac{e^{-\frac{\sum(x_i - \theta_1)^2}{2\sigma^2}}}{e^{-\frac{\sum(x_i - \theta_0)^2}{2\sigma^2}}}$$

The optimum test rejects H_0 if $\frac{L_1}{L_0} \geq 1$,

i.e., if $\log \frac{L_1}{L_0} \geq 0$,

i.e., if $-\frac{\sum(x_i - \theta_1)^2}{2\sigma^2} + \frac{\sum(x_i - \theta_0)^2}{2\sigma^2} \geq 0$,

i.e., if $2\theta_1 \sum x_i - n\theta_1^2 - 2\theta_0 \sum x_i + n\theta_0^2 \geq 0$,

i.e., if $(2\theta_1 - 2\theta_0) \sum x_i \geq n(\theta_1^2 - \theta_0^2)$,

i.e., if $\frac{\sum x_i}{n} \geq \frac{\theta_1 + \theta_0}{2}$,

i.e., if $\bar{x} \geq \frac{\theta_1 + \theta_0}{2}$.

Thus the optimum test rejects H_0 if $\bar{x} \geq \frac{\theta_1 + \theta_0}{2}$.

We have $\alpha = P_{H_0} \left[\bar{x} \geq \frac{\theta_1 + \theta_0}{2} \right] = P_{H_0} \left[\frac{\bar{x} - \theta_0}{\sigma/\sqrt{n}} \geq \frac{\sqrt{n}(\theta_1 - \theta_0)}{2\sigma} \right]$.

Under H_0 , $\frac{\bar{x} - \theta_0}{(\sigma/\sqrt{n})}$ follows $N(0, 1)$ distribution.

$$\therefore \alpha = 1 - \Phi \left(\frac{\sqrt{n}(\theta_1 - \theta_0)}{2\sigma} \right),$$

where Φ is the c.d.f. of an $N(0, 1)$ distribution

$$\beta = P_{H_1} \left[\bar{x} < \frac{\theta_1 + \theta_0}{2} \right] = P_{H_1} \left[\frac{\bar{x} - \theta_1}{\sigma/\sqrt{n}} < \frac{\sqrt{n}(\theta_1 - \theta_0)}{2\sigma} \right].$$

Under H_1 , $\frac{\bar{x} - \theta_1}{(\sigma/\sqrt{n})}$ follows $N(0, 1)$ distribution

$$\beta = 1 - \Phi\left(\frac{\sqrt{n}(\theta_1 - \theta_0)}{2\sigma}\right).$$

Here $\alpha = \beta$. It can be seen that $a = \beta \rightarrow 0$ as $n \rightarrow \infty$.

Example 2. For testing $H_0 : \theta = \theta_0$ against $H_1 : \theta = \theta_1, \theta_1 < \theta_0$, the optimum test rejects H_0 when $\bar{x} \leq \frac{\theta_1 + \theta_0}{2}$.

Example 3. Consider a normal distribution $N(\theta, \sigma^2)$, θ known. It is desired to test $H_0 : \sigma^2 = \sigma_0^2$ against $H_1 : \sigma^2 = \sigma_1^2, \sigma_1^2 > \sigma_0^2$. We have

$$\begin{aligned} L(x/\sigma^2) &= \left(\frac{1}{2\pi\sigma^2}\right)^{\frac{n}{2}} e^{-\sum \frac{(x_i - \theta)^2}{2\sigma^2}} \\ \frac{L_1}{L_0} &= \frac{\left(\frac{\sigma_0^2}{\sigma_1^2}\right)^{\frac{n}{2}} e^{-\frac{\sum (x_i - \theta)^2}{2\sigma_1^2}}}{e^{-\frac{\sum (x_i - \theta)^2}{2\sigma_0^2}}} \\ \log \frac{L_1}{L_0} &= -\frac{n}{2} (\log \sigma_1^2 - \log \sigma_0^2) - \frac{\sum (x_i - \theta)^2}{2\sigma_1^2} + \frac{\sum (x_i - \theta)^2}{2\sigma_0^2} \\ &= -\frac{n}{2} (\log \sigma_1^2 - \log \sigma_0^2) - \frac{\sum (x_i - \theta)^2}{2} \frac{\sigma_1^2 - \sigma_0^2}{\sigma_1^2 \sigma_0^2} \end{aligned}$$

The optimum test rejects H_0 if $\frac{L_1}{L_0} \geq 1$

i.e., if $\frac{\sigma_1^2 - \sigma_0^2}{2\sigma_1^2 \sigma_0^2} \sum (x_i - \theta)^2 \geq \frac{n}{2} (\log \sigma_1^2 - \log \sigma_0^2)$

i.e., if $\frac{\sum (x_i - \theta)^2}{\sigma_0^2} \geq \frac{n\sigma_1^2}{\sigma_1^2 - \sigma_0^2} (\log \sigma_1^2 - \log \sigma_0^2)$

i.e., if $\sum \left(\frac{x_i - \theta}{\sigma_0}\right)^2 \geq nc$,

where $c = \frac{\sigma_1^2}{\sigma_1^2 - \sigma_0^2} (\log \sigma_1^2 - \log \sigma_0^2)$.

Thus the optimum test rejects H_0 if $\sum \left(\frac{x_i - \theta}{\sigma_0}\right)^2 \geq nc$.

Note that under $H_0 : \frac{x_i - \theta}{\sigma_0}$ follows $N(0, 1)$ distribution. Hence $\sum \left(\frac{x_i - \theta}{\sigma_0}\right)^2$ follows under H_0 , a chi-square distribution with n degrees of freedom (d.f.). Here

$$\alpha = P_{H_0} \left[\sum \left(\frac{x_i - \theta_0}{\sigma_0}\right)^2 \geq nc \right] = P \left[\chi_{(n)}^2 \geq nc \right]$$

and

$$\begin{aligned} 1 - \beta &= P_{H_1} \left[\sum \left(\frac{x_i - \theta}{\sigma_0}\right)^2 \geq nc \right] \\ &= P_{H_1} \left[\left(\frac{x_i - \theta}{\sigma_0}\right)^2 \geq \frac{nc\sigma_0^2}{\sigma_1^2} \right] \\ &= P_{H_1} \left[\chi_{(n)}^2 \geq \frac{nc\sigma_0^2}{\sigma_1^2} \right]. \end{aligned}$$

Note that under H_1 , $\sum \left(\frac{x_i - \sigma}{\sigma_1}\right)^2$ follows a chi-square distribution with n d.f. It can be seen that $\alpha \rightarrow 0$ and $\beta \rightarrow 0$ as $n \rightarrow \infty$.

Example 4. Let X follow the exponential family distributions

$$f(x/\theta) = c(\theta)e^{Q(\theta)T(x)h(x)}.$$

It is desired to test $H_0 : \theta = \theta_0$ against $H_1 : \theta = \theta_1$

$$L(x/\theta) = [c(\theta)]^n e^{Q(\theta)T(x_i)} \prod_i h(x_i)$$

The optimum test rejects H_0 when $\log \frac{L_1}{L_0} \geq 0$

i.e., when $[Q(\theta_1) - q(\theta_0)] \sum t(x_i) \geq n \log \frac{c(\theta_0)}{c(\theta_1)}$

i.e., when $\sum T(x_i) \geq \frac{n \log \frac{c(\theta_0)}{c(\theta_1)}}{[Q(\theta_1) - Q(\theta_0)]}$ if $Q(\theta_1) - Q(\theta_0) > 0$

and rejects H_0 , when $\sum T(x_i) \leq \frac{c(\theta_0)}{c(\theta_1)} [Q(\theta_1) - Q(\theta_0)]$ if $Q(\theta_1) - Q(\theta_0) < 0$.

Locally Optimum Tests

Let the random variable X have the probability distribution $P(x/\theta)$. We are interested in testing $H_0 : \theta = \theta_0$ against $H_1 : \theta > \theta_0$. If W is any critical region, then the power of the test as a function of θ is

$$\gamma(\theta) = P_\theta(W) = \int_W L(x/\theta) dx.$$

We want to determine a region W for which

$$\gamma(\theta) - \gamma(\theta_0) = \int_W L(x/\theta)dx - \int_W L(x/\theta_0)$$

is a maximum.

When a uniformly optimum region does not exist, there is not a single region which is best for all alternatives. We may, however, find regions which are best for alternatives close to the null hypothesis and hope that such regions will also do well for distant alternatives. We shall call such regions locally optimum regions.

Let $\gamma(\theta)$ admit Taylor expansion about the point $\theta = \theta_0$. Then

$$\begin{aligned} \gamma(\theta) &= \gamma(\theta_0) + (\theta - \theta_0)\gamma'(\theta_0) + \delta \quad \text{where } \delta \rightarrow 0 \text{ as } \theta \rightarrow \theta_0 \\ \therefore \gamma(\theta) - \gamma(\theta_0) &= (\theta - \theta_0)\gamma'(\theta_0) + \delta. \end{aligned}$$

If $|\theta - \theta_0|$ is small, $\gamma(\theta) - \gamma(\theta_0)$ is maximized when $\gamma'(\theta_0)$ is maximized.

Definition 2. A region W_0 will be called a *locally optimum critical region* if

$$(4) \quad \int_{W_0} L'(x/\theta_0)dx \geq \int_W L'(x/\theta_0)dx$$

for every other critical region W .

Lemma 2. Let W_0 be the region $\{x : L'(x/\theta_0) \geq L(x/\theta_0)\}$. Then W_0 is locally optimum.

Proof. Let W_0 be the region such that inside it $L'(x/\theta_0) \geq L(x/\theta_0)$ and outside if $L'(x/\theta_0) < L(x/\theta_0)$. Let W be any other region.

$$\begin{aligned} & \int_{W_0} L'(x/\theta_0)dx - \int_W L'(x/\theta_0)dx \\ &= \int_{W_0 \cap W^c} L'(x/\theta_0)dx - \int_{W_0^c \cap W} L'(x/\theta_0)dx \\ (*) \quad &= \int_{W_0 \cap W^c} L'(x/\theta_0)dx + \int_{W_0^c \cup W} L'(x/\theta_0)dx \\ &\geq \int_{W_0 \cap W^c} L(x/\theta_0)dx + \int_{W_0^c \cup W} L(x/\theta_0)dx \\ &\quad \text{since } L'(x/\theta_0)dx \geq L(x/\theta_0) \text{ inside both the regions of the integrals.} \\ &\geq 0, \text{ since } L(x/\theta_0) \geq 0 \text{ in all the regions.} \end{aligned}$$

Hence $\int_{W_0} L'(x/\theta_0)dx \geq \int_W L'(x/\theta_0)dx$ for every other region W .

To prove (*) we have $\int_R L(x/\theta_0)dx + \int_{R^c} L(x/\theta_0)dx = 1$ for every region R . Differentiating, we have

$$\begin{aligned} \int_R L'(x/\theta_0)dx + \int_{R^c} L'(x/\theta_0)dx &= 0 \\ \int_R L'(x/\theta_0)dx &= - \int_{R^c} L'(x/\theta_0)dx = 0. \end{aligned}$$

In (*), take $R^c = W_0^c \cap W$ and the relation is proved.

Similarly, if the alternatives are $H_1 : \theta < \theta_0$, the locally optimum critical region is

$$\{\underline{x} : L'(x/\theta_0) \leq L(x/\theta_0)\}.$$

Example 5. Consider $N(\theta, \sigma^2)$ distribution, σ^2 known. It is desired to test $H_0 : \theta = \theta_0$ against $H_1 : \theta > \theta_0$

$$\begin{aligned} L(x/\theta) &= \left(\frac{1}{\sigma\sqrt{2\pi}}\right)^n e^{-\frac{\sum(x_i-\theta)^2}{2\sigma^2}} \\ \log L(x/\theta) &= n \log\left(\frac{1}{\sigma\sqrt{2\pi}}\right) - \frac{\sum(x_i-\theta)^2}{2\sigma^2} \\ \frac{L'(x/\theta)}{L(x/\theta)} &= \frac{\delta \log L(x/\theta)}{\delta \theta} = \frac{\sum(x_i-\theta)}{\sigma^2} = \frac{n(\bar{x}-\theta)}{\sigma^2} \\ \therefore \frac{L'(x/\theta_0)}{L(x/\theta_0)} &= \frac{n(\bar{x}-\theta_0)}{\sigma^2}. \end{aligned}$$

The locally optimum test rejects H_0 , if

$$\frac{n(\bar{x}-\theta_0)}{\sigma^2} \geq 1 \quad \text{i.e.} \quad \bar{x} \geq \theta_0 + \frac{\sigma^2}{n}.$$

Now,

$$\begin{aligned} \alpha &= P_{H_0} \left[\bar{x} \geq \theta_0 + \frac{\sigma^2}{n} \right] \\ &= P_{H_0} \left[\frac{\bar{x}-\theta_0}{\sigma/\sqrt{n}} \geq \sigma/\sqrt{n} \right] \\ &= 1 - \Phi(\sigma/\sqrt{n}), \text{ since under } H_0, \frac{\bar{x}-\theta_0}{\sigma/\sqrt{n}} \text{ follows } N(0, 1) \text{ distribution.} \end{aligned}$$

$$\begin{aligned} 1 - \beta &= P_{H_1} [\bar{x} \geq \theta_0 + \sigma^2/n] \\ &= P_{H_1} \left[\frac{\bar{x}-\theta_1}{\sigma/\sqrt{n}} \geq -\frac{\theta_1-\theta_0}{\sigma/\sqrt{n}} + \frac{\sigma}{\sqrt{n}} \right] \\ &= 1 - \Phi \left[\frac{-(\theta_1-\theta_0\sqrt{n})}{\sigma} + \frac{\sigma}{\sqrt{n}} \right] \end{aligned}$$

since under H_1 , $\frac{\bar{x}-\theta_1}{\sigma/\sqrt{n}}$ follows $N(0, 1)$ distribution.

Exercise. If $\theta_0 = 10$, $\theta_1 = 11$, $\sigma = 2$, $n = 16$, then $\alpha = 0.3085$, $1 - \beta = 0.9337$, Power-Size = 0.6252.

If we reject H_0 when $\frac{\bar{x} - \theta_0}{\sigma/\sqrt{n}} > 1.64$, then $\alpha = 0.05$, $1 - \beta = 0.6406$, Power-Size = 0.5906. Hence Power-Size of locally optimum test is greater than Power-size of the usual test.

Locally Optimum Unbiased Test

Let the random variable X follows the probability distribution $P(x/\theta)$. Suppose it is desired to test $H_0 : \theta = \theta_0$ against $H_1 : \theta \neq \theta_0$. We impose the unbiasedness restriction

$$\gamma(\theta) \geq \gamma(\theta_0), \theta \neq \theta_0$$

and $\gamma(\theta) - \gamma(\theta_0)$ is a maximum as compared to all other regions. If such a region does not exist, we impose the unbiasedness restriction $\gamma'(\theta_0) = 0$.

Let $\gamma(\theta)$ admit Taylor expansion about the point $\theta = \theta_0$. Then

$$\gamma(\theta) = \gamma(\theta_0) + (\theta - \theta_0)\gamma'(\theta_0) + \frac{(\theta - \theta_0)^2}{2} \gamma''(\theta_0) + \eta$$

where $\eta \rightarrow 0$ as $\theta \rightarrow 0$.

$$\therefore \gamma(\theta) - \gamma(\theta_0) = (\theta - \theta_0)\gamma'(\theta_0) + \frac{(\theta - \theta_0)^2}{2} \gamma''(\theta_0) + \eta$$

Under the unbiasedness restriction $\gamma'(\theta_0) = 0$, if $|\theta - \theta_0|$ is small $\gamma(\theta) - \gamma(\theta_0)$ is maximized when $\gamma''(\theta_0)$ is maximized.

Definition 3. A region W_0 will be called a locally optimum unbiased region if

$$(5) \quad \gamma'(\theta_0) = \int_{W_0} L'(x/\theta_0)dx = 0$$

and

$$(6) \quad \gamma''(\theta_0) = \int_{W_0} L''(X/\theta_0)dx \geq \int_W L''(X/\theta_0)dx$$

for all other regions W satisfying (5).

Lemma 3. Let W_0 be the region

$$\{\underline{x} : L''(x/\theta_0) \geq L(x/\theta_0)\}.$$

Then W_0 is locally optimum unbiased.

Proof. Let W be any other region

$$\begin{aligned} & \int_{W_0} L''(x/\theta_0)dx - \int_W L''(x/\theta_0)dx \\ &= \int_{W_0 \cap W^c} L''(x/\theta_0)dx + \int_{W_0 \cap W} L''(x/\theta_0)dx \\ & \quad \text{by subtracting the common area of } W \text{ and } W_0. \\ &= \int_{W_0 \cap W^c} L''(x/\theta_0)dx + \int_{W_0 \cap W^c} L''(x/\theta_0)dx, \\ & \quad \text{since } L''(x/\theta_0) \geq L(x/\theta) \text{ inside } W_0 \text{ and outside } W. \\ & \geq 0 \text{ since } L(x/\theta) \geq 0. \end{aligned}$$

Example 6. Consider $N(\theta, \sigma^2)$ distribution, σ^2 known.

$$H_0 : \theta = \theta_0, \quad H_1 = \theta \neq \theta_0$$

$$L = \left(\frac{1}{\sigma\sqrt{2\pi}} \right)^n e^{-\frac{\sum(x_i - \theta)^2}{2\sigma^2}}$$

$$\frac{L''(x/\theta)}{L(x/\theta)} = \frac{n^2(\bar{x} - \theta)^2}{\sigma^4} - \frac{n}{\sigma^2}.$$

Locally optimum unbiased test rejects H_0

$$\text{if } \frac{n^2(\bar{x} - \theta_0)^2}{\sigma^4} - \frac{n}{\sigma^2} \geq 1 \text{ i.e., } \frac{n(\bar{x} - \theta_0)^2}{\sigma^2} \geq 1 + \frac{\sigma^2}{n}$$

Under H_0 , $\frac{n(\bar{x} - \theta_0)^2}{\sigma^2}$ follows $\chi^2_{(1)}$ distribution.

Testing Mean of a normal population when variance is unknown

Consider $N(\theta, \sigma^2)$ distribution, σ^2 known. For testing $H_0 : \theta = \theta_0$ against $H_1 : \theta = \theta_1$, the critical function of the optimum test is given by

$$\phi_m(x) = \begin{cases} 1 & \text{if } L(x/\theta_1) \geq L(x/\theta_0) \\ 0 & \text{otherwise.} \end{cases}$$

On simplification, we get

$$\phi_m(x) = \begin{cases} 1 & \text{if } \bar{x} \geq \frac{\theta_0 + \theta_1}{2} \text{ if } \mu_1 > \mu_0 \\ 0 & \text{otherwise.} \end{cases}$$

$$\phi_m(x) = \begin{cases} 1 & \text{if } \bar{x} \geq \frac{\theta_0 + \theta_1}{2} \text{ if } \mu_1 < \mu_0 \\ 0 & \text{otherwise.} \end{cases}$$

Consider the case when σ^2 is unknown.

For this case we propose a test which rejects H_0 when

$$\frac{\widehat{L}(x/\theta_1)}{\widehat{L}(x/\theta_0)} \geq 1$$

where $\widehat{L}(x/\theta_i)$, ($i = 0, 1$), is the maximum of the likelihood under H_i obtained from $L(x/\theta_i)$ by replacing σ^2 by its maximum likelihood estimate

$$\widehat{\sigma}_i^2 = \frac{1}{n} \sum_{j=1}^n (x_j - \theta_i)^2; \quad i = 0, 1.$$

Let $\phi_p(x)$ denote the critical function of the proposed test, then

$$\phi_p(x) = \begin{cases} 1 & \text{if } \widehat{L}(x/\theta_1) \geq \widehat{L}(x/\theta_0) \\ 0 & \text{otherwise} \end{cases}$$

On simplification, we get

$$\phi_p(x) = \begin{cases} 1 & \text{if } \bar{x} \geq \frac{\theta_0 + \theta_1}{2} \text{ if } \mu_1 > \mu_0 \\ 0 & \text{otherwise.} \end{cases}$$

$$\phi_p(x) = \begin{cases} 1 & \text{if } \bar{x} \geq \frac{\theta_0 + \theta_1}{2} \text{ if } \mu_1 < \mu_0 \\ 0 & \text{otherwise.} \end{cases}$$

Thus, the proposed test $\phi_p(x)$ is equivalent to $\phi_m(x)$, which is the optimum test that minimizes the sum of two error probabilities ($\alpha + \beta$). Thus, we see that one gets the same test which minimizes the sum of the two error probabilities irrespective of whether σ^2 is known or unknown.

Acknowledgement. Authors are thankful to Prof. Jokhan Singh for his guidance in writing this article.

References

- [1] PANDEY, M. and SINGH, J., *A note on testing mean of a normal population when variance is unknown*, J.I.S.A., 16 (1978), 145-146.
- [2] PRADHAN, M., *On testing a simple hypothesis against a simple alternative making the sum of the probabilities of two errors minimum*, J.I.S.A., 6 (1968), 149-159.
- [3] RAO, C.R., *Linear Statistical Inference and its Applications*, John Wiley and Sons, 1973.
- [4] SINGH, J., *Optimum Statistical Test Procedures*, Vikram Mathematical Journal, vol. V (1985), 53-56.

Improved Exponential Estimator for Population Variance Using Two Auxiliary Variables

Rajesh Singh, Pankaj Chauhan, Nirmala Sawan, Florentin Smarandache

Rajesh Singh, Pankaj Chauhan, Nirmala Sawan, Florentin Smarandache (2011). Improved Exponential Estimator for Population Variance Using Two Auxiliary Variables. *Italian Journal of Pure and Applied Mathematics* 28, 101-108

Abstract. In this paper, exponential ratio and exponential product type estimators using two auxiliary variables are proposed for estimating unknown population variance S_y^2 . Problem is extended to the case of two-phase sampling. Theoretical results are supported by an empirical study.

Keywords: auxiliary information, exponential estimator, mean squared error.

1. Introduction

It is common practice to use the auxiliary variable for improving the precision of the estimate of a parameter. Out of many ratio and product methods of estimation are good examples in this context. When the correlation between the study variate and the auxiliary variate is positive (high) ratio method of estimation is quite effective. On the other hand, when this correlation is negative (high) product

method of estimation can be employed effectively. Let y and (x, z) denote the study variate and auxiliary variates taking the values y_i and (x_i, z_i) respectively, on the unit U_i ($i = 1, 2, \dots, N$), where x is positively correlated with y and z is negatively correlated with y . To estimate $S_y^2 = \frac{1}{(N-1)} \sum_{i=1}^N (y_i - \bar{y})^2$, it is assumed that $S_x^2 = \frac{1}{(N-1)} \sum_{i=1}^N (x_i - \bar{X})^2$ and $S_z^2 = \frac{1}{(N-1)} \sum_{i=1}^N (z_i - \bar{Z})^2$ are known. Assume that population size N is large so that the finite population correction terms are ignored.

Assume that a simple random sample of size n is drawn without replacement (SRSWOR) from U . The usual unbiased estimator of S_y^2 is

$$(1.1) \quad s_y^2 = \frac{1}{(N-1)} \sum_n^{i=1} (y_i - \bar{y})^2,$$

where $\bar{y} = \frac{1}{n} \sum_n^{i=1} y_i$ is the sample mean of y .

When the population variance $S_x^2 = \frac{1}{(N-1)} \sum_n^{i=1} (x_i - \bar{X})^2$ is known, Isaki (1983) proposed a ratio estimator for S_y^2 as

$$(1.2) \quad t_k = s_y^2 \frac{S_x^2}{s_x^2},$$

where $s_x^2 = \frac{1}{(n-1)} \sum_n^{i=1} (x_i - \bar{X})^2$ is an unbiased estimator of S_x^2 .

Upto the first order of approximation, the variance of S_y^2 and MSE of t_k (ignoring the finite population correction (fpc) term) are respectively given by

$$(1.3) \quad \text{var}(s_y^2) = \left(\frac{S_y^4}{n} \right) [\partial_{400} - 1]$$

$$(1.4) \quad \text{MSE}(t_k) = \left(\frac{S_y^4}{n} \right) [\partial_{400} + \partial_{040} - 2\partial_{220}]$$

where

$$\delta_{pqr} = \frac{\mu_{pqr}}{(\mu_{200}^{p/2} \mu_{020}^{q/2} \mu_{002}^{r/2})},$$

$$\mu_{pqr} = \frac{1}{N} \sum_{i=1}^N (y_i - \bar{Y})^p (x_i - \bar{X})^q (z_i - \bar{Z})^r; \quad p, q, r \text{ being the non-negative integers.}$$

Following Bahl and Tuteja (1991), we propose exponential ratio type and exponential product type estimators for estimating population variance S_y^2 as

$$(1.5) \quad t_1 = s_y^2 \exp \left[\frac{S_x^2 - s_x^2}{S_x^2 + s_x^2} \right]$$

$$(1.6) \quad t_2 = s_y^2 \exp \left[\frac{s_z^2 - S_z^2}{s_z^2 + S_z^2} \right]$$

2. Bias and MSE of proposed estimators

To obtain the bias and MSE of t_1 , we write

$$s_y^2 = S_y^2(1 + e_0), \quad s_x^2 = S_x^2(1 + e_1),$$

such that

$$E(e_0) = E(e_1) = 0$$

and

$$E(e_0^2) = \frac{1}{n} (\partial_{400} - 1), \quad E(e_1^2) = \frac{1}{n} (\partial_{040} - 1), \quad E(e_0 e_1) = \frac{1}{n} (\partial_{220} - 1).$$

After simplification, we get the bias and MSE of t_1 as

$$(2.1) \quad B(t_1) \cong \frac{S_y^2}{n} \left[\frac{\partial_{040}}{8} - \frac{\partial_{220}}{2} + \frac{3}{8} \right],$$

$$(2.2) \quad \text{MSE}(t_1) \cong \frac{S_y^4}{n} \left[\partial_{400} + \frac{\partial_{040}}{4} - \partial_{220} + \frac{1}{4} \right].$$

To obtain the bias and MSE of t_2 , we write

$$s_y^2 = S_y^2(1 + e_0), \quad s_z^2 = S_z^2(1 + e_2),$$

such that

$$E(e_0) = E(e_2) = 0, \quad E(e_2^2) = \frac{1}{n} (\partial_{004} - 1), \quad E(e_0 e_2) = \frac{1}{n} (\partial_{202} - 1).$$

After simplification, we get the bias and MSE of t_2 as

$$(2.3) \quad B(t_2) \cong \frac{S_y^4}{n} \left[\frac{\partial_{040}}{8} - \frac{\partial_{220}}{2} + \frac{3}{8} \right],$$

$$(2.4) \quad \text{MSE}(t_2) \cong \frac{S_y^2}{n} \left[\partial_{400} + \frac{\partial_{040}}{4} - \partial_{220} + \frac{1}{4} \right].$$

3. Improved estimator

Following Kadilar and Cingi (2006) and Singh et.al. (2007), we propose an improved estimator for estimating population variance S_y^2 as

$$(3.1) \quad t = s_y^2 \left[\alpha \exp \left\{ \frac{S_x^2 - s_x^2}{S_x^2 + s_x^2} \right\} + (1 - \alpha) \exp \left\{ \frac{s_z^2 - S_z^2}{s_z^2 + S_z^2} \right\} \right],$$

where α is a real constant to be determined such that the MSE of t is minimum.

Expressing t in terms of e 's, we have

$$(3.2) \quad t = S_y^2(1 + e_0) \left[\alpha \exp \left\{ -\frac{e_1}{2} \left(1 + \frac{e_1}{2} \right)^{-1} \right\} + (1 - \alpha) \exp \left\{ \frac{e_2}{2} \left(1 + \frac{e_2}{2} \right)^{-1} \right\} \right].$$

Expanding the right hand side of (3.2) and retaining terms up to second power of e 's, we have

$$(3.3) \quad t \cong S_y^2 \left[1 + e_0 + \frac{e_2}{2} + \frac{e_2^2}{8} + \frac{e_0 e_2}{2} + \alpha \left(e \frac{e_1}{2} + \frac{e_1^2}{8} \right) - \alpha \left(\frac{e_2}{2} + \frac{e_2^2}{8} \right) + e_0 \alpha \left(-\frac{e_1}{2} + \frac{e_1^2}{8} \right) \alpha e_0 \left(\frac{e_2}{2} + \frac{e_2^2}{8} \right) \right].$$

Taking expectations of both sides of (3.3) and then subtracting S_y^2 from both sides, we get the bias of the estimator t , up to the first order of approximation, as

$$(3.4) \quad B(t) = \frac{S_y^2}{n} \left[\frac{\alpha}{8} (\partial_{040} - 1) + \frac{(1 - \alpha)}{8} (\partial_{004} - 1) + \frac{(1 - \alpha)}{2} (\partial_{202} - 1) - \frac{\alpha}{2} (\partial_{220} - 1) \right].$$

From (3.3), we have

$$(3.5) \quad (t - S_y^2) \cong S_y^2 \left[e_0 - \frac{\alpha e_1}{2} + \frac{(1 - \alpha)}{2} e_2 \right].$$

Squaring both the sides of (3.5) and then taking expectation, we get MSE of the estimator t , up to the first order of approximation, as

$$(3.6) \quad \text{MSE}(t) \cong \frac{S_y^4}{n} \left[(\partial_{400} - 1) + \frac{\alpha^2}{4} (\partial_{040} - 1) + \frac{(1 - \alpha^2)}{4} (\partial_{004} - 1) + \alpha(\partial_{220} - 1) + (1 - \alpha)(\partial_{202} - 1) - \frac{\alpha(1 - \alpha)}{2} (\partial_{022} - 1) \right].$$

Minimization of (3.6) with respect to α yields its optimum value as

$$(3.7) \quad \alpha = \frac{\{\partial_{004} + 2(\partial_{220} + \partial_{202}) + \partial_{022} - 6\}}{(\partial_{040} + \partial_{004} + 2\partial_{022} - 4)} = \alpha_0(\text{say}).$$

Substitution of α_0 from (3.7) into (3.6) gives minimum value of MSE of t .

4. Proposed estimators in two-phase sampling

In certain practical situations when S_x^2 is not known a priori, the technique of two-phase or double sampling is used. This scheme requires collection of information on x and z the first phase sample s of size n ($n < N$) and on y for the second phase sample s of size n ($n < n$) from the first phase sample.

The estimators t_1, t_2 and t in two-phase sampling will take the following form, respectively

$$(4.1) \quad t_{1d} = s_y^2 \exp \left[\frac{s_x'^2 - s_x^2}{s_x'^2 + s_x^2} \right]$$

$$(4.2) \quad t_{2d} = s_z^2 \exp \left[\frac{s_z'^2 - s_z^2}{s_z'^2 + s_z^2} \right]$$

$$(4.3) \quad t_d = s_y^2 \left[k \exp \left\{ \frac{s_x'^2 - s_x^2}{s_x'^2 + s_x^2} \right\} + (1 - k) \exp \left\{ \frac{s_z'^2 - s_z^2}{s_z'^2 + s_z^2} \right\} \right]$$

To obtain the bias and MSE of t_{1d}, t_{2d} and t_d , we write

$$s_y^2 = S_y^2(1 + e_0), \quad s_x^2 = S_x^2(1 + e_1), \quad s_x'^2 = S_x^2(1 + e_1'),$$

$$s_z^2 = S_z^2(1 + e_2), \quad s_z'^2 = S_z^2(1 + e_2'),$$

where

$$s_x'^2 = \frac{1}{(n' - 1)} \sum_{i=1}^{n'} (x_i - \bar{x}')^2, \quad s_z'^2 = \frac{1}{(n' - 1)} \sum_{i=1}^{n'} (z_i - \bar{z}')^2,$$

$$\bar{x}' = \frac{1}{n'} \sum_{i=1}^{n'} x_i, \quad \bar{z}' = \frac{1}{n'} \sum_{i=1}^{n'} z_i.$$

Also,

$$E(e_1') = E(e_2') = 0,$$

$$E(e_1'^2) = \frac{1}{n'} (\partial_{040} - 1),$$

$$E(e_2'^2) = \frac{1}{n'} (\partial_{004} - 1),$$

$$E(e_1' e_2') = \frac{1}{n'} (\partial_{220} - 1).$$

Expressing t_{1d}, t_{2d} and t_d in terms of e s and following the procedure explained in Sections 2 and 3, we get the MSE of these estimators, respectively as

$$(4.4) \quad \text{MSE}(t_{1d}) \cong S_y^4 \left[\frac{1}{n} (\partial_{400} - 1) + \frac{1}{4} \left(\frac{1}{n} - \frac{1}{n'} \right) (\partial_{040} - 1) + \left(\frac{1}{n'} - \frac{1}{n} \right) (\partial_{220} - 1) \right].$$

$$(4.5) \quad \text{MSE}(t_{2d}) \cong S_y^4 \left[\frac{1}{n} (\partial_{400} - 1) + \frac{1}{4} \left(\frac{1}{n} - \frac{1}{n'} \right) (\partial_{040} - 1) - \left(\frac{1}{n'} - \frac{1}{n} \right) (\partial_{220} - 1) \right].$$

$$(4.6) \quad \text{MSE}(t_d) \cong S_y^4 \left[\frac{1}{n} (\partial_{400} - 1) + \frac{k^2}{4} \left(\frac{1}{n} - \frac{1}{n'} \right) (\partial_{040} - 1) + \frac{(k^2 - 1)}{4} \left(\frac{1}{n} - \frac{1}{n'} \right) (\partial_{004} - 1) + k \left(\frac{1}{n} - \frac{1}{n'} \right) (\partial_{220} - 1) + (k - 1) \left(\frac{1}{n'} - \frac{1}{n} \right) (\partial_{202} - 1) - \frac{k(k - 1)}{2} \left(\frac{1}{n'} - \frac{1}{n} \right) (\partial_{022} - 1) \right].$$

Minimization of (4.6) with respect to k yields its optimum value as

$$(4.7) \quad k = \frac{\{\partial_{004} + 2(\partial_{220} - 1) + \partial_{022} - 6\}}{(\partial_{040} + \partial_{004} + 2\partial_{022} - 4)} = k_0(\text{say}).$$

Substitution of k_0 from (4.7) to (4.6) gives minimum value of MSE of t_d .

5. Empirical study

To illustrate the performance of various estimators of S_y^2 , we consider the data given in Murthy (1967, p. 226). The variates are:

y : output, x : number of workers, z : fixed capital,

$$N = 80, n' = 25, n = 10.$$

$$\partial_{400} = 2.2667, \quad \partial_{040} = 3.65, \quad \partial_{004} = 2.8664,$$

$$\partial_{220} = 2.3377, \quad \partial_{202} = 2.2208, \quad \partial_{400} = 3.14.$$

The percent relative efficiency (PRE) of various estimators of S_y^2 with respect to conventional estimator s_y^2 has been computed and displayed in Table 5.1.

Table 5.1. PRE of s_y^2, t_1, t_2 and $\min .MSE(t)$ with respect to s_y^2

Estimator	PRE(\cdot, s_y^2)
s_y^2	100
t_1	214.35
t_2	42.90
t	215.47

In Table 5.2, PRE of various estimators of s_y^2 in two-phase sampling with respect to S_y^2 are displayed.

Table 5.2. PRE of s_y^2, t_{1d}, t_{2d} and $\min .MSE(t_d)$ with respect to s_y^2

Estimator	PRE(\cdot, s_y^2)
s_y^2	100
t_{1d}	1470.76
t_{2d}	513.86
t	513.86

6. Conclusion

From Tables 5.1 and 5.2, we infer that the proposed estimators t perform better than a conventional estimator s_y^2 and other mentioned estimators.

References

- [1.] ISAKI, C.T., *Variance estimation using auxiliary information*, Journal of American Statistical Association, 1983.
- [2.] BAHL, S. and TUTEJA, R.K., *Ratio and Product type exponential estimator*, Information and Optimization sciences, vol. XII, I (1991), 159-163.
- [3.] KADILAR, C. and CINGI, H., *Improvement in estimating the population mean in simple random sampling*, Applied Mathematics Letters, 19 (2006), 7579.

- [4.] SINGH, R. CHAUHAN, P. SAWAN, N. and SMARANDACHE, F., *Auxiliary information and a priori values in construction of improved estimators*, Renaissance high press, USA, 2007.
- [5.] MURTHY, M.N., *Sampling Theory and Methods*, Statistical Publishing Society, Calcutta, India, 1967.

Improvement in Estimating Population Mean Using Two Auxiliary Variables in Two-Phase Sampling

Rajesh Singh, Pankaj Chauhan, Nirmala Sawan, Florentin Smarandache

Rajesh Singh, Pankaj Chauhan, Nirmala Sawan, Florentin Smarandache (2011). Improvement in Estimating Population Mean Using Two Auxiliary Variables in Two-Phase Sampling. Italian Journal of Pure and Applied Mathematics 28, 135-142

Abstract. This study proposes improved chain-ratio type estimator for estimating population mean using some known values of population parameter(s) of the second auxiliary character. The proposed estimators have been compared with two-phase ratio estimator and some other chain type estimators. The performances of the proposed estimators have been supposed with a numerical illustration.

Keywords: auxiliary variables, chain ratio-type estimator, bias, mean squared error.

1. Introduction

The ratio method of estimation is generally used when the study variable Y is positively correlated with an auxiliary variable X whose population mean is known in advance. In the absence of the knowledge on the population mean of the auxiliary character we go for two-phase (double) sampling. The two-phase sampling

happens to be a powerful and cost effective (economical) procedure for finding the reliable estimate in first phase sample for the unknown parameters of the auxiliary variable x and hence has eminent role to play in survey sampling, for instance, see Hidiroglou and Sarndal (1998). Consider a finite population $U = (U_1, U_2, \dots, U_N)$. Let y and x be the study and auxiliary variable, taking values y_i and x_i , respectively, for the i th unit U_i . Allowing SRSWOR (Simple Random Sampling without Replacement) design in each phase, the two-phase sampling scheme is as follows:

- (i) the first phase sample $s_{n'}$ ($s_{n'} \subset U$) of a fixed size n' is drawn to measure only x in order to formulate a good estimate of a population mean \bar{X} ,
- (ii) given $s_{n'}$, the second phase sample s_n ($s_n \subset s_{n'}$) of a fixed size n is drawn to measure y only.

Let

$$\bar{x} = \frac{1}{n} \sum_{i \in s_n} x_i, \quad \bar{y} = \frac{1}{n} \sum_{i \in s_n} y_i, \quad \bar{x}' = \frac{1}{n'} \sum_{i \in s_{n'}} x_i,$$

The classical ratio estimator for \bar{Y} is defined as

$$(1.1) \quad \bar{y}_r = \frac{\bar{y}}{\bar{x}} \bar{X}.$$

If \bar{X} is not known, we estimate \bar{Y} by the two-phase ratio estimator

$$(1.2) \quad \bar{y}_{rd} = \frac{\bar{y}}{\bar{x}} \bar{x}'.$$

Sometimes, even if \bar{X} is not known, information on a cheaply ascertainable variable z , closely related to x but compared to x remotely related to y , is available on all units of the population. For instance, while estimating the total yield of wheat in a village, the yield and area under the crop are likely to be unknown, but the total area of each farm may be known from village records or may be obtained at a low cost. Then y , x and z are respectively yield, area under wheat and area under cultivation see Singh et.al. (2004). Assuming that the population mean \bar{Z} of the variable z is known, Chand (1975) proposed a chain type ratio estimator as

$$(1.3) \quad t_1 = \frac{\bar{y}}{\bar{x}} \left(\frac{\bar{x}'}{\bar{z}'} \right) \bar{Z}.$$

Several authors have used prior value of certain population parameter(s) to find more precise estimates. Singh and Upadhyaya (1995) used coefficient of variation of z for defining modified chain type ratio estimator. In many situation the value of the auxiliary variable may be available for each unit in the population, for instance, see Das and Tripathi (1981). In such situations knowledge on \bar{Z} , C_z , $\beta_1(z)$ (coefficient of skewness), $\beta_2(z)$ (coefficient of kurtosis) and possibly on some other parameters may be utilized. Regarding the availability of information on C_z , $\beta_1(z)$ and $\beta_2(z)$, the researchers may be referred to Searls (1964), Sen (1978), Singh et.al. (1973), Searls and Intarapanich (1990) and Singh et.al. (2007). Using

the known coefficient of variation C_z and known coefficient of kurtosis $\beta_2(z)$ of the second auxiliary character z Upadhyaya and Singh (2001) proposed some estimators for Y .

If the population mean and coefficient of variation of the second auxiliary character is known, the standard deviation σ_z is automatically known and it is more meaningful to use the σ_z in addition to C_z , see Srivastava and Jhajj (1980). Further, C_z , $\beta_1(z)$ and $\beta_2(z)$ are the unit free constants, their use in additive form is not much justified. Motivated with the above justifications and utilizing the known values of σ_z , $\beta_1(z)$ and $\beta_2(z)$, Singh (2001) suggested some modified estimators for Y .

In this paper, under simple random sampling without replacement (SRSWOR), we have suggested improved chain ratio type estimator for estimating population mean using some known values of population parameter(s).

2. The suggested estimator

The work of authors discussed in Section 1 can be summarized by using following estimator

$$(2.1) \quad t = \bar{y} \left(\frac{\bar{x}'}{\bar{x}} \right) \left(\frac{a\bar{Z} + b}{a\bar{z}' + b} \right),$$

where $a (\neq 0)$, b are either real numbers or the functions of the known parameters of the second auxiliary variable z such as standard deviation (σ_z), coefficient of variation (C_z), skewness ($\beta_1(z)$) and kurtosis ($\beta_2(z)$).

The following scheme presents some of the important known estimators of the population mean which can be obtained by suitable choice of constants a and b .

Estimator	Values of	
	a	b
$t_1 = \bar{y} \left(\frac{\bar{x}'}{\bar{x}} \right) \left(\frac{\bar{Z}}{\bar{z}'} \right)$ Chand (1975) chain ratio type estimator	1	0
$t_2 = \bar{y} \left(\frac{\bar{x}'}{\bar{x}} \right) \left(\frac{\bar{Z} + C_z}{\bar{z}' + C_z} \right)$ Singh and Upadhyaya (1995) estimator	1	C_z
$t_3 = \bar{y} \left(\frac{\bar{x}'}{\bar{x}} \right) \left(\frac{\beta_2(z)\bar{Z} + C_z}{\beta_2(z)\bar{z}' + C_z} \right)$ Upadhyaya and Singh (2001) estimator	$\beta_2(z)$	C_z
$t_4 = \bar{y} \left(\frac{C_z\bar{Z} + \beta_2(z)}{C_z\bar{x}' + \beta_2(z)} \right) \left(\frac{\beta_2(z)\bar{Z} + C_z}{\beta_2(z)\bar{z}' + C_z} \right)$ Upadhyaya and Singh (2001) estimator	C_z	$\beta_2(z)$

$t_5 = \bar{y} \left(\frac{\bar{x}'}{\bar{x}} \right) \left(\frac{\bar{Z} + \sigma_z}{\beta_1(z)\bar{z}' + \sigma_z} \right)$ Singh (2001) estimator	1	σ_z
$t_6 = \bar{y} \left(\frac{\bar{x}'}{\bar{x}} \right) \left(\frac{\beta_1(z)\bar{Z} + \sigma_z}{\beta_1(z)\bar{z}' + \sigma_z} \right)$ Singh (2001) estimator	$\beta_1(z)$	σ_z
$t_7 = \bar{y} \left(\frac{\bar{x}'}{\bar{x}} \right) \left(\frac{\beta_2(z)\bar{Z} + \sigma_z}{\beta_2(z)\bar{z}' + \sigma_z} \right)$	$\beta_2(z)$	σ_z

In addition to these estimators, a large number of estimators can also be generated from the estimator t at (2.1) by putting suitable values of a and b .

Following Kadilar and Cingi (2006), we propose modified estimator combining t_1 and t_i ($i = 2, 3, \dots, 7$) as follows

$$(2.2) \quad t_i^* = \alpha t_1 + (1 - \alpha)t_i, \quad (i = 2, 3, \dots, 7),$$

where α is a real constant to be determined such that MSE of t_i^* is minimum and t_i ($i = 2, 3, \dots, 7$) are estimators listed above.

To obtain the bias and MSE of t_i^* , we write

$$\bar{y} = \bar{Y}(1 + e_0), \quad \bar{x} = \bar{X}(1 + e_1), \quad \bar{x}' = \bar{X}(1 + e'_1), \quad \bar{z}' = \bar{Z}(1 + e'_2)$$

such that

$$E(e_0) = E(e_1) = E(e'_1) = E(e'_2) = 0$$

and

$$\begin{aligned} E(e_0^2) &= f_1 C_y^2, & E(e_1^2) &= f_1 C_x^2, & E(e'_1{}^2) &= f_2 C_x^2, \\ E(e_2'^2) &= f_2 C_z^2, & E(e_0 e_1) &= f_1 \rho_{xy} C_x C_y, & E(e_0 e'_1) &= f_2 \rho_{xy} C_x C_y, \\ E(e_0 e'_2) &= f_2 \rho_{yz} C_y C_z, & E(e_1 e'_1) &= f_2 C_x^2, & E(e_1 e'_2) &= f_2 \rho_{xz} C_x C_z, \\ E(e'_1 e'_2) &= f_2 \rho_{xz} C_x C_z, \end{aligned}$$

where

$$\begin{aligned} f_1 &= \left(\frac{1}{n} - \frac{1}{N} \right), & f_2 &= \left(\frac{1}{n'} - \frac{1}{N} \right), \\ C_y^2 &= \frac{S_y^2}{\bar{Y}^2}, & C_x^2 &= \frac{S_x^2}{\bar{X}^2}, & C_z^2 &= \frac{S_z^2}{\bar{Z}^2}, \\ \rho_{xy} &= \frac{S_{xy}}{S_x S_y}, & \rho_{xz} &= \frac{S_{xz}}{S_x S_z}, & \rho_{yz} &= \frac{S_{yz}}{S_y S_z}, \end{aligned}$$

$$S_y^2 = \frac{1}{(N-1)} \sum_{i \in U} (y_i - \bar{Y})^2, \quad S_x^2 = \frac{1}{(N-1)} \sum_{i \in U} (x_i - \bar{X})^2,$$

$$S_z^2 = \frac{1}{(N-1)} \sum_{i \in U} (z_i - \bar{Z})^2, \quad S_{xy}^2 = \frac{1}{(N-1)} \sum_{i \in U} (x_i - \bar{X})(y_i - \bar{Y}),$$

$$S_{xz}^2 = \frac{1}{(N-1)} \sum_{i \in U} (x_i - \bar{X})(z_i - \bar{Z}), \quad S_{yz}^2 = \frac{1}{(N-1)} \sum_{i \in U} (y_i - \bar{Y})(z_i - \bar{Z}),$$

Expressing t_i^* in terms of e 's, we have

$$(2.3) \quad t_i^* = \bar{Y}(1 + e_0)[\alpha(1 + e'_1)(1 + e_1)^{-1}(1 + e'_2)^{-1} + (1 - \alpha)(1 + e'_1)(1 + e_1)^{-1}(1 + \theta e'_2)^{-1}]$$

where

$$(2.4) \quad \theta = \frac{a\bar{Z}}{a\bar{Z} + b}.$$

Expanding the right hand side of (2.3) and retaining terms up to second power of e 's, we have

$$(2.5) \quad t_i^* \cong \bar{Y}[1 + e_0 - e_1 + e'_1 - e'_2(\alpha + \theta - \alpha\theta)]$$

or

$$(2.6) \quad t_i^* - \bar{Y} \cong \bar{Y}[e_0 - e_1 + e'_1 - e'_2(\alpha + \theta - \alpha\theta)].$$

Squaring both sides of (2.6) and then taking expectation, we get the MSE of the estimator t_i^* , up to the first order of approximation, as

$$(2.7) \quad \text{MSE}(t_i^*) = \bar{Y}^2[f_1 C_y^2 + f_3 C_x^2 + (\alpha + \alpha\theta)^2 f_2 C_z^2],$$

where

$$f_3 = \left(\frac{1}{n} - \frac{1}{n'} \right).$$

Minimization of (2.7) with respect to α yield its optimum value as

$$(2.8) \quad \alpha_{\text{opt}} = \frac{K_{yz} - \theta}{1 - \theta},$$

where

$$K_{yz} = \rho_{yz} \frac{C_y}{C_z}.$$

Substitution of (2.8) in (2.7) yields the minimum value of $\text{MSE}(t_i^*)$ as

$$(2.9) \quad \min .\text{MSE}(t_i^*) = M_0 = \bar{Y}^2[f_1 C_y^2 + f_3(C_x^2 - 2\rho_{yx} C_y C_x) - f_2 \rho_{yz}^2 C_y^2].$$

3. Efficiency comparisons

In this section, the conditions for which the proposed estimator is better than t_i ($i = 1, 2, \dots, 7$) have been obtained. The MSE's of these estimators up to the order $o(n) - 1$ are derived as

$$(3.1) \quad \text{MSE}(\bar{y}_{rd}) = \bar{Y}^2 [f_1 C_y^2 + f_3 (C_x^2 - 2\rho_{yx} C_y C_x)]$$

$$(3.2) \quad \text{MSE}(t_1) = \bar{Y}^2 [f_1 C_y^2 + f_2 (C_z^2 - 2\rho_{yz} C_y C_z) + f_3 (C_x^2 - 2\rho_{yx} C_y C_x)]$$

$$(3.3) \quad \text{MSE}(t_2) = \bar{Y}^2 [f_1 C_y^2 + f_2 (\theta_2^2 C_z^2 - 2\theta_2 \rho_{yz} C_y C_z) + f_3 (C_x^2 - 2\rho_{yx} C_y C_x)]$$

$$(3.4) \quad \text{MSE}(t_3) = \bar{Y}^2 [f_1 C_y^2 + f_2 (\theta_3^2 C_z^2 - 2\theta_3 \rho_{yz} C_y C_z) + f_3 (C_x^2 - 2\rho_{yx} C_y C_x)]$$

$$(3.5) \quad \text{MSE}(t_4) = \bar{Y}^2 [f_1 C_y^2 + f_2 (\theta_4^2 C_z^2 - 2\theta_4 \rho_{yz} C_y C_z) + f_3 (C_x^2 - 2\rho_{yx} C_y C_x)]$$

$$(3.6) \quad \text{MSE}(t_5) = \bar{Y}^2 [f_1 C_y^2 + f_2 (\theta_5^2 C_z^2 - 2\theta_5 \rho_{yz} C_y C_z) + f_3 (C_x^2 - 2\rho_{yx} C_y C_x)]$$

$$(3.7) \quad \text{MSE}(t_6) = \bar{Y}^2 [f_1 C_y^2 + f_2 (\theta_6^2 C_z^2 - 2\theta_6 \rho_{yz} C_y C_z) + f_3 (C_x^2 - 2\rho_{yx} C_y C_x)]$$

and

$$(3.8) \quad \text{MSE}(t_7) = \bar{Y}^2 [f_1 C_y^2 + f_2 (\theta_7^2 C_z^2 - 2\theta_7 \rho_{yz} C_y C_z) + f_3 (C_x^2 - 2\rho_{yx} C_y C_x)]$$

where

$$\theta_2 = \frac{\bar{Z}}{\bar{Z} + C_z}, \quad \theta_3 = \frac{\beta_2(z)\bar{Z}}{\beta_2(z)\bar{Z} + C_z}, \quad \theta_4 = \frac{C_z \bar{Z}}{C_z \bar{Z} + \beta_2(z)},$$

$$\theta_5 = \frac{\bar{Z}}{\bar{Z} + \sigma_z}, \quad \theta_6 = \frac{\beta_1(z)\bar{Z}}{\beta_1(z)\bar{Z} + \sigma_z}, \quad \theta_7 = \frac{\beta_2(z)\bar{Z}}{\beta_2(z)\bar{Z} + (s)_z}.$$

From (2.9) and (3.1), we have

$$(3.9) \quad \text{MSE}(\bar{y}_{rd}) - M_0 = f_2 \rho_{yz}^2 C_y^2 \geq 0.$$

Also from (2.9) and (3.2)-(3.8), we have

$$(3.10) \quad \text{MSE}(t_i) - M_0 = f_2 (\theta_i C_z - \rho_{yz} C_y)^2 \geq 0, \quad (i = 2, 3, \dots, 7).$$

Thus, it follows from (3.9) and (3.10) that the suggested estimator under optimum condition is always better than the estimator t_i ($i = 1, 2, \dots, 7$).

4. Empirical study

To illustrate the performance of various estimators of \bar{Y} , we consider the data used by Anderson (1958). The variates are

- y : Head length of second son,
- x : Head length of first son,
- z : Head breadth of first son,

$$N = 25, \bar{Y} = 183.84, \bar{X} = 185.72, \bar{Z} = 151.12, \sigma_z = 7.224,$$

$$C_y = 0.0546, C_x = 0.0526, C_z = 0.0488,$$

$$\rho_{yx} = 0.7108, \rho_{yz} = 0.6932, \rho_{xz} = 0.7346, \beta_1(z) = 0.002, \beta_2(z) = 2.6519.$$

Consider $n' = 10$ and $n = 7$. We have computed the percent relative efficiency (PRE) of different estimators of \bar{Y} with respect to usual estimator \bar{y} and compiled in the Table 4.1.

Table 4.1. PRE of different estimators of \bar{Y} with respect to \bar{y}

Estimator	PRE
\bar{y}	100
\bar{y}_{rd}	122.5393
t_1	178.8189
t_2	178.8405
t_3	178.8277
t_4	186.3912
t_5	181.6025
t_6	122.5473
t_7	179.9636
t_i^*	186.6515

5. Conclusion

We have suggested modified estimators t_i^* ($i = 2, 3, \dots, 7$). From Table 4.1, we conclude that the proposed estimators are better than usual two-phase ratio estimator \bar{y}_{rd} , Chand (1975) chain type ratio estimator t_1 , estimator t_2 proposed by Singh and Upadhyaya (1995), estimators t_i ($i = 3, 4$) and than that of Singh (2001) estimators t_i ($i = 5, 6, 7$). For practical purposes, the choice of the estimator depends upon the availability of the population parameter(s).

References

[1] ANDERSON, T.W., *An Introduction to Multivariate Statistical Analysis*, John Wiley & Sons, Inc., New York, 1958.

[2] CHAND, L., *Some ratio type estimators based on two or more auxiliary variables*, Unpublished Ph.D. thesis, Iowa State University, Ames, Iowa (USA), 1975.

- [3] DAS, A.K. and TRIPATHI, T.P., *A class of sampling strategies for population mean using information on mean and variance of an auxiliary character*, Proc. of the Indian Statistical Institute Golden Jubilee International Conference on Statistics. Applications and New Directions, Calcutta, 16-19, December 1981, 174-181.
- [4] HIDIROGLOU, M.A. and SARNDAL, C.E., *Use of auxiliary information for two-phase sampling*, Survey Methodology, 24 (1) (1998), 11-20.
- [5] SEARLS, D.T., *The utilization of known coefficient of variation in the estimation procedure*, Journal of American Statistical Association, 59 (1964), 1125-1126.
- [6] SEARLS, D.T. and INTARAPANICH, R., *A note on an estimator for variance that utilizes the kurtosis*, Amer. Stat., 44 (4) (1990), 295-296.
- [7] SEN, A.R., *Estimation of the population mean when the coefficient of variation is known*, Comm. Stat.-Theory Methods, A7 (1978), 657-672.
- [8] SINGH, G.N., *On the use of transformed auxiliary variable in the estimation of population mean in two-phase sampling*, Statistics in Transition, 5 (3) (2001), 405- 416.
- [9] SINGH, G.N. and UPADHYAYA, L.N., *A class of modified chain type estimators using two auxiliary variables in two-phase sampling*, Metron, LIII, (1995), 117-125.
- [10] SINGH, H.P, UPADHYAYA, L.N. and CHANDRA, P., *A general family of estimators for estimating population mean using two auxiliary variables in two-phase sampling*, Statistics in transition, 6 (7) (2004), 1055-1077.
- [11] SINGH, J., PANDEY, B.N. and HIRANO, K., *On the utilization of a known coefficient of kurtosis in the estimation procedure of variance*, Ann. Inst. Statist. Math., 25 (1973), 51-55.
- [12] SINGH, R. CHAUHAN, P. SAWAN, N. and SMARANDACHE, F., *Auxiliary information and a priori values in construction of improved estimators*, Renaissance High Press, USA, 2007.
- [13] SRIVASTAVA, S.K. and JHAJJ, H.S., *A class of estimators using auxiliary information for estimating finite population variance*, Sankhya, C, 42 (1980), 87-96.
- [14] UPADHYAYA, L.N. and SINGH, G.N., *Chain type estimators using transformed auxiliary variable in two-phase sampling*, Advances in Modeling and Analysis, 38, (1-2) (2001), 1-10.

Neutrosophic statistical evaluation of migration with particular reference to Jaipur

Deepesh Kunwar, Jayant Singh, Florentin Smarandache

Deepesh Kunwar, Jayant Singh, Florentin Smarandache (2018). Neutrosophic statistical evaluation of migration with particular reference to Jaipur. *Octogon Mathematical Magazine* 26(2), 560-568

ABSTRACT. This paper is principally focused on the basic characteristics and various factors affecting the migration in Jaipur. By graphical representation we have tried to explain the main reason of migration. We tried to explain the independence between satisfaction level of migration & marital status of migrated persons using SPSS software also to test the independence between satisfaction level of migration and reason of migration using SPSS software. We use neutrosophic statistics, which is statistics with indeterminate data.

INTRODUCTION

Migration is the movement of people across a specified boundary for the purpose of establishing a new or semi-permanent residence. Migration from one area to another in search of important livelihood is a key feature of human history. Numerous studies show that the process of migration is influenced by social, cultural and economic factors and outcome can be vastly different for men and women, for different groups and different regions. The migrants respond primarily to economic incentives. People move from poorer area to wealthier area to improve their economic condition. Fewer studies have used neutrosophic statistics in their research, so we are among the first.

CAUSES OF MIGRATION

Push factors. are those that compel a person, due to different reasons, to leave that place or go to some other place for instance, low productivity, unemployment and underdevelopment.

Exhaustion of natural resources and natural calamities may compel people to leave the native place in search of better economic opportunities.

. **Pull factors.** refer to those factors which attract the migrants to the area, such as, opportunities for better employment, higher wages, facilities, better working conditions and amenities etc. There is generally city ward migration, when rapid growth of industry, commerce and business takes place, migration from the country side to bears a close functional relation to the process of industrialization, technological advancement and other cultural changes which characterize the evaluation of modern society in almost all parts of world.

Objectives of the Survey.

- To Study the main reason & impact of migration in Jaipur city.
- To study the distance graph between native place & current place and well test the following Hypotheses:
- The independency between satisfaction level of migration and marital status of migrated persons.T
- The independency between satisfaction level of migration and male female ratio.

Data collection technique. We collect primary neutrosophic data with the help of questionnaire method that includes indeterminacy which is filled by the respondent itself. Questionnaire consists of 18 questions to collect the information from the migrated persons in different areas of Jaipur city. (A neutrosophic questionnaire with (t,i,f)-answers will be used in a future study.) We used multistage neutrosophic sampling to collect the data, based on migration. In this survey our universe (population) is Jaipur city. Firstly, we found the total wards in Jaipur i.e. 77. Now, at the first stage we used purposive neutrosophic sampling and classified our population into two groups, first group consists of zero migration or negligible migration & second group consists of those areas from the population which fulfill our objective of migration. By the prior information we get 39 wards in first group and 38 wards in second group. Now, keeping in view the objective of the survey we had selected the second group. Now, at the second stage we applied simple random sampling without replacement for selecting 4 wards out of 38 wards, and for the selection of 4 wards we used Lottery method. The wards are Sanganer, Malviya Nagar, Murlipura, Bapu Nagar. Now, at third stage we used acceptance sampling. We collected neutrosophic data of

size 135 from each area. Thus, we got a sample of size 540.

Graphical Representation of Data.

1. Male Female Ratio:

Total Male	Total Female
322	210

Migrate Male Female Ratio

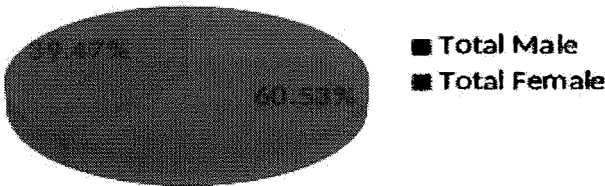

2. Single Married Ratio:

Total Single	Total Married
422	118

Migrate Single Married Ratio

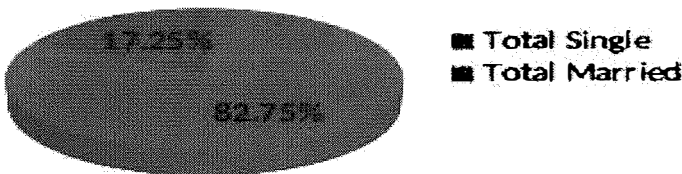

3. Graph between native place and current place:

Distance group	No of persons
Below 100	90
100-200	203
200-300	110
300-400	75
400 above	62
Total	540

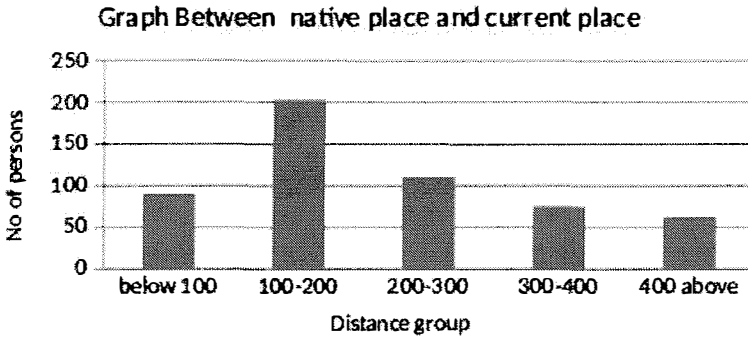

Statistical test for association of migration neutrosophic degree of satisfaction/indeterminacy/nonsatisfaction with different demographic variables, we used (X^2_{test}) Chi-square test, whether two attributes are independent or dependent to each other. This is one of the very important applications of Chi-square distribution. To apply this test, first we arranged frequencies in a contingency table. Test statistic is:

$$X^2 = \sum \frac{(O_i - E_i)^2}{E_i}$$

Where, O_i is observed frequency; E_i is expected frequency. We extend the Chi-square distribution to neutrosophic Chi-square distribution by taking the observed and expected frequencies as neutrosophic numbers of the form $N = a + bI$, where a is the determinate part of N , while bI is the indeterminate part of N .

1). To test the independence between neutrosophic degree of satisfaction/indeterminacy/nonsatisfaction of migration and marital status of migrated persons

Null hypothesis, H_0 : The satisfaction level of migration is independent to marital status of migrated persons V_s .

Alternative Hypothesis, H_1 : The satisfaction level of migration is dependent to marital status of migrated person.

Now, from our data we get a 2*2 contingency table as follow:

Marital status	Satisfied	Not satisfied	Total
Single	310	81-82	391-392
Married	50	38	88
Total	360	120	479-480

By applying the SPSS, we got the following results:

Case Processing Summary						
	Cases					
	Valid		Missing		Total	
	N	Percent	N	Percent	N	Percent
MARITAL STATUS * Satisfaction level for migration	479-480	99-100.0 %	0	0.0%	479-480	99-100.0 %

MARITAL STATUS * Neurosophic degree of satisfaction/indeterminacy/nonsatisfaction for migration Cross tabulation					
		Neurosophic degree of satisfaction/indeterminacy/nonsatisfaction for migration			Total
		0	1		
MARITAL STATUS	0	Count	82	310	392
		Expected Count	98.0	294.0	392.0
	1	Count	38	50	88
		Expected Count	22.0	66.0	88.0
Total		Count	120	360	479-480

	Expected Count	120.0	360.0	480.0	
Chi-Square Tests					
	Value	df	Asymp. Sig. (2- sided)	Exact Sig. (2-sided)	Exact Sig. (1-sided)
Pearson Chi-Square	18.998 ^a	1	.000		
Neutrosophic Chi-square	18.9-19	1	.000		

2). To test the independence between Neutrosophic degree of satisfaction/indeterminacy/nonsatisfaction of migration and reason of migration.

Null hypothesis, H_0 : The Neutrosophic degree of satisfaction/indeterminacy/nonsatisfaction of migration are independent to reason of migration.

Alternative Hypothesis, H_1 : The satisfaction level of migration are dependent to reason of migration.

Now, from our data we get a 3*2 contingency table as follow:

Reason	Satisfied	Not satisfied	Total
Study	235	76-77	311-312
Study & job	88	8	96
Service	37	35	72
Total	360	120	479-480

By apply the SPSS Statistics, we get the following results

Case Processing Summary						
	Cases					
	Valid		Missing		Total	
	N	Percent	N	Percent	N	Percent
REASON * Satisfaction level for migration	479-480	99-100.0%	0	0.0%	479-480	99-100.0%

REASON * Neutrosophic degree of satisfaction/indeterminacy/nonsatisfaction for migration Cross tabulation			
	Satisfaction level for migration		Total
	0	1	

REASON	N	Count	77	235	312
		0	Expected Count	78.0	234.0
1	Count	8	88	96	
	Expected Count	24.0	72.0	96.0	
2	Count	34-35	37	71-72	
	Expected Count	18.0	54.0	72.0	
Total		Count	120	360	479.0-480
		Expected Count	120.0	360.0	479.0-480.0

Chi-Square Tests			
	Value	Df	Asymp.Sig.(2-sided)
Pearson Chi-Square	35.647 ^a	2	.000
Neutrosophic Chi-Square	34.997-35.779 ^a	1.92-2.02	.000-.020

Conclusion. From the above approximate graphical representation we have the following conclusion about data:

- According to neutrosophic data (i.e. data with unclear, vague or incomplete information) we conclude that the number of migrated male persons are greater than the number of migrate female persons in Jaipur city, because in Rajasthan, there is a considerable gap between male and female literacy rates. In most of the families, boys at home are given priority in terms of education, but girls are not treated in the same way. Right from the

beginning, parents do not consider the girls as earning members of their family, as after marriage they have to leave their parents home. So, their education is just considered as wastage of money as well as time. For this reason, parents prefer to send the boys to schools, but not girls.

- According to the neutrosophic data we conclude that the numbers of single migrated persons are greater than the number of married migrated persons in Jaipur city, because after marriage people want a stable life, so they do not move frequently.
- According to the neutrosophic chart (i.e. not exact) we conclude that maximum number of migrated persons in Jaipur is from 100 to 200 km from their native place, so it is very convenient for them to move.
- According to our neutrosophic survey we conclude that the neutrosophic degree of satisfaction/indeterminacy/nonsatisfaction is dependent to marital status of migrated persons, which shows that marital status affects their satisfaction level. Because, in regard to female candidates, marriage makes the migration convenient, but jobs and services are more difficult.

REFERENCES

- [1] Das, P. 1989 Job Research & Internal Migration, the Indian Economic Journal 37(2). Sinha, S.K. 1961-1981. New Delhi. 1986 Internal migration in India 1961-1981. New Delhi Office of the Registrar, Ministry of Home Affairs.
- [2] De Haan, A. 1999. 'Livelihoods and Poverty: The Role of Migration - A Critical Review of the Migration Literature', Journal of Development Studies, Vol. 36, No. 2.
- [3] Gazdar, H. 2003. 'A Review of Migration Issues in Pakistan', Refugee and Migratory Movements Research Unit, Bangladesh, DFID.
- [4] King, R., Lulle, A., Conti, F., Mueller, S. and Scotto, G. (2014) The Lure of London: A Comparative Study of Recent Graduate Migration from Germany, Italy and Latvia. Brighton: University of Sussex, Sussex Centre for Migration Research Working Paper 75.
- [5] Kofman, E. (2004) Family-related migration: a critical review of European studies, Journal of Ethnic and Migration Studies, 30(2): 243-262.
- [6] Kraler, A., Kofman, E., Kohli, M. and Schmoll, C. (eds) (2011) Gender, Generations and the Family in International Migration. Amsterdam: Amsterdam University Press.
- [7] Kulu, H. and Milewski, N. Research 17k, 567-590 (2006) , *Introduction. Demographic Migration in Bhattacharya*, P. 1998 The informal sector and Weekly, 33(21).

- [8] Skeldon, Ronald, (1986), *On migration patterns in India during the 1970s*, Population and Development Review, Vol.12 No.4.
- [9] Smarandache, Florentin, (2014). *Introduction to Neutrosophic Statistics*, Sitech and Education Publisher, Craiova, 123 pages.

Neutrosophic statistical techniques to find migration pattern in Jaipur

Deepesh Kunwar, Jayant Singh, Florentin Smarandache

Deepesh Kunwar, Jayant Singh, Florentin Smarandache (2018). Neutrosophic statistical techniques to find migration pattern in Jaipur. *Octagon Mathematical Magazine* 26(2), 583-592

ABSTRACT This paper is principally focused on the factors and effect of migration in Jaipur city. With the help of neutrosophical graphical and diagrammatic representation we study the main reason of migration.

INTRODUCTION

Migration is the movement of people across a specified boundary for the purpose of establishing a new or semi-permanent residence. On the basis of its nature, migration is sub-divided into internal migration and international migration. Internal migration is much more powerful as compared to the international migration. However, the international external migration is where residence changes between a residential unit in the country and one outside it, and internal migration is where residence changes from one residential unit to another in the same country.

Neutrosophic Statistics means statistical analysis of population or sample that has indeterminate (imprecise, ambiguous, vague, incomplete, unknown) data. For example, the population or sample size might not be exactly determinate because of some individuals that partially belong to the population or sample, and partially they do not belong, or individuals whose appurtenance is completely unknown. Also, there are population or sample individuals whose data could be indeterminate. It is possible to define the neutrosophic statistics in many ways, because there are various types of indeterminacies, depending on the problem to solve. [Smarandache, 1995]

OBJECTIVES

- To Study the main reason of migration and to study the migrated peoples neutrosophic degree of satisfaction/indeterminacy/nonsatisfaction with the help of graphical representation.
- To test the independency between the neutrosophic degree of satisfaction/indeterminacy/nonsatisfaction of migration and the occupation of migrated people.

Neutrosophic Data Source. For neutrosophic data collection, primary data collection technique was used and questionnaire method was applied. In this study, multistage sampling is used for data collection on migration. By applying neutrosophic sampling technique, we selected a sample which is approximately representing our population and fulfilling the objectives of the study. A neutrosophic sample is a sample whose size is not known exactly, or its individuals do not 100% belong to the sample; for example an individual may belong to the sample in a degree (t,i,f) , where t = degree of appurtenance, i = degree of indeterminate-appurtenance, and f = degree of non-appurtenance with t,i,f in $[0, 1]$. In this survey the population is from Jaipur city. Total number of wards in Jaipur city is 77.

Now, at the first stage, purposive sampling was used and we classified the population in two groups. First group has zero migration or negligible migration and second group covers those areas from the population which fulfill our objective of migration. By the prior information we got 39 wards in first group in which zero and negligible migration and 38 wards in second group. Now, keeping in view the objective of the survey we selected second group because this group fulfill our object of the survey. Now, at the second stage we applied simple random neutrosophic sampling without replacement for selecting 4 wards out of 38 wards. For selection of 4 wards, we used lottery method and the wards are - Sanganer, University area, Mansarover area and Vidhyadhar Nagar. Now, at third stage we used acceptance sampling and we decided on same day and same time for doing survey. We collected the data of about 120 from each area. Thus, we got the sample of 479-480.

GRAPHICAL REPRESENTATION

1. No. of persons in different age groups (Figure 1)

Age Group	No of persons
17-21	31-32
21-25	273-276
25-29	124
29-33	24
33 and above	24
Total	476-480

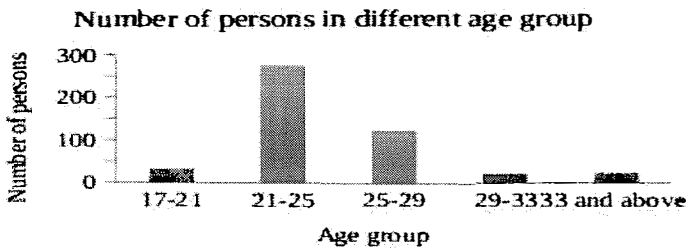

2. Reason of Migration (Figure 2)

Reason	No of person
Study	311-312
Service	72
Study & job	94-96
Total	477-80

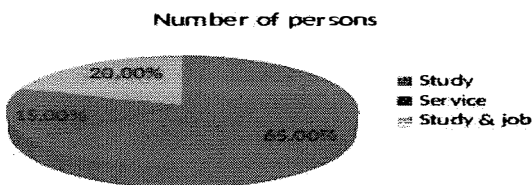

3. Respondents helped their family after migration: (Figure 3)

Response	No of persons
Completely	160
No	30-32
As possible	244
Partial	43-44
Total	47-80

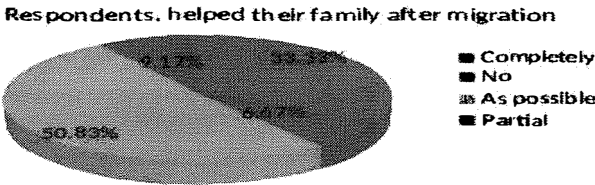

4. Satisfaction level of job among migrated persons (Figure 4)

Satisfaction level	No of persons
Extremely	28
Less	40
Partial	40
Not	7-8
Total	115-116

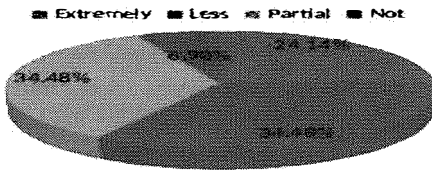

Neutrosophic Statistical test for the association of neutrosophic degree of migration satisfaction/indeterminacy/nonsatisfaction with different demographic variables.

Chi-square is a test formula for exact sampling distribution. To test two attributes which are independent or dependent to each other, we used chi-square test. This is one of the very important applications of Chi-square distribution.

To apply this test, first we arranged frequencies in a contingency table. Test statistic is

$$X^2 = \sum \frac{(O_i - E_i)^2}{E_i}$$

Where O_i is observed frequency; E_i is expected frequency. In a previous paper (2017), when dealing with indeterminate numbers, this has been

extended to neutrosophic Chi-square distribution.

1). To test the independency between the neutrosophic degree of satisfaction/indeterminacy/nonsatisfaction level of migration and male female ratio of migrated persons.

Null Hypothesis, HO: The neutrosophic degree of satisfaction/indeterminacy/nonsatisfaction of migration is independent from the sex of migrated person. Vs

Alternative Hypothesis, H1: The satisfaction level of migration is dependent to sex of migrated person.

Now, from our data we get a 2*2 contingency table as follow:

Sex	Satisfied	Not Satisfied	Total
Male	212	80	291-292
Female	148	40	187-188
Total	360	120	478-480

By apply the SPSS Statistics, we get the following results:

Case Processing Summary						
	Cases					
	Valid		Missing		Total	
	N	Percent	N	Percent	N	Percent
SEX * Satisfaction level for migration	478-480	98-100.0%	0	0.0-2.0%	478-480	98-100.0%

SEX * Satisfaction level for migration Cross tabulation							
Chi-Square Tests				Satisfaction level for migration			
	Value	Df	Asymp. Sig. (2-sided)	Exact Sig. (2-sided)	Exact Sig. (1-sided)	Total	
SEX		0	Count	40	148	188	
Pearson Chi-Square	2.285 ^a	1	Expected Count	47.0	141.0	188.0	
	2.2-2.3 ^a	1	Count	80	211-212	291-207	
			Expected Count	73.0	219.0	292.0	
Total			Count	120	360	479-480	
			Expected Count	120.0	359-360.0	479-480.0	

2). To test the independence between neutrosophic degree of satisfaction/indeterminacy/nonsatisfaction of migration and reason of migration.

Null hypothesis, H_0 : The neutrosophic degree of satisfaction/indeterminacy/nonsatisfaction of migration is independent from the reason of migration. Vs

Alternative Hypothesis, H_1 : The neutrosophic degree of satisfaction/indeterminacy/nonsatisfaction of migration is dependent to the reason of migration.

Now, from our data we get a 3*2 contingency table as follow:

Reason	Satisfied	Not satisfied	Total
Study	235	77	312
Study & job	88	7-8	95-96
Service	36-37	35	71-72
Total	360	120	478-480

By applying the SPSS Statistics, results are

REASON * Neutrosophic Degree of Satisfaction/Indeterminacy/Nonsatisfaction for migration Cross tabulation					
			Satisfaction level for migration		Total
			0	1	
REA SON	0	Count	77	235	312
		Expected Count	78.0	234.0	312.0
	1	Count	7-8	88	95-96
		Expected Count	24.0	72.0	96.0
	2	Count	35	36-37	71-72
		Expected Count	18.0	54.0	72.0
Total		Count	120	360	480
		Expected Count	1119.0-120.0	359.0-360.0	478.0-480.0

Chi-Square Tests			
	Value	df	Asymp. Sig. (2-sided)
Pearson Chi-Square	35.647 ^a	2	.000
Neutrosophic Chi-Square	34.997-35.779 ^a	1.92-2.02	.000-.020

3). To test the independence between the neutrosophic degree of satisfaction/indeterminacy/nonsatisfaction of migration and occupation of migrated person.

Null hypothesis, H_0 : The neutrosophic degree of satisfaction/indeterminacy/nonsatisfaction of migration are independent to occupation of migrated person. Vs

Alternative Hypothesis, H_1 : The neutrosophic degree of satisfaction/indeterminacy/nonsatisfaction of migration are dependent to occupation of migrated person. Now, from our data we get a 2*2 contingency table as follow:

Occupation	Satisfied	Not satisfied	Total
Student	287	80-81	367-368
Service class	71-73	39	110-112
Total	358-360	119-120	477-480

By apply the SPSS Statistics, we get the following results:

Case Processing Summary						
	Cases					
	Valid		Missing		Total	
	N	Percent	N	Percent	N	Percent
OCCUPATION * Neutrosophic degree of satisfaction/indeterminacy/nonsatisfaction for migration	480	100.0 %	0	0.0%	480	100.0 %

OCCUPATION * Neutrosophic degree of satisfaction/indeterminacy/nonsatisfaction for migration Cross tabulation

		Neutrosophic degree of satisfaction/indeterminacy/nonsatisfaction for migration		Total	
		0	1		
OCCUPATION	0	Count	81	287	368
		Expected Count	91.0-92.0	276.0	367.0-368.0
	1	Count	39	73	112
		Expected Count	28.0	84.0	112.0
Total	Count	119-120	360	478-480	
	Expected Count	119.0-120.0	360.0	478.0-480.0	

Chi-Square Tests					
	Value	Df	Asymp. Sig. (2-sided)	Exact Sig. (2-sided)	Exact Sig. (1-sided)
Pearson Chi-Square	7.516 ^a	1	.006		
Neutrosophic Chi-Square	7.426-7.632 ^a	1-2	.005-.007		

CONCLUSION

- According to the survey three reasons are found for migration in Jaipur city. First is study, second is service, and the third one is study & job both. According to our survey, highest proportion of migrants (65-66%) was engaged in the study group. Thus, we concluded that the main reason of human migration in Jaipur city is study.
- 51-53% Migrated persons told that they helped their family after their migration.
- According to our survey, we found that 45-48% migrated persons are extremely satisfied, 27% migrated persons are partial satisfied, 12-17% migrated persons are unsatisfied and 8% migrated persons are very unsatisfied from their migration. So, on the basis of this study we can say that migrants who come from less developed area near to Jaipur for study, are satisfied from their migration.
- According to Figure 1, we conclude that the maximum migrated persons belong to the age group between 21 to 25.

By testing the hypothesis we got the following result

- According to our study we conclude that the neutrosophic degree of satisfaction/indeterminacy/nonsatisfaction is independent from the sex or gender of migrated persons, which shows that sex of migrated person, does not affect their neutrosophic satisfaction degree at any level.
- Occupation has its impact on the neutrosophic degree of satisfaction/indeterminacy/nonsatisfaction of migrated person.

REFERENCES

- [1] De Haan, A. 1999. 'Livelihoods and Poverty: The Role of Migration - A Critical Review of the Migration Literature', *Journal of Development Studies*, Vol. 36, No. 2.
- [2] King, R., Lulle, A., Conti, F., Mueller, S. and Scotto, G. (2014) *The Lure of London: A Comparative Study of Recent Graduate Migration from Germany, Italy and Latvia*. Brighton: University of Sussex, Sussex Centre for Migration Research Working Paper 75.
- [3] Kofman, E. (2004) Family-related migration: a critical review of European studies, *Journal of Ethnic and Migration Studies*, 30(2): 243-262.
- [4] Kraler, A., Kofman, E., Kohli, M. and Schmoll, C. (eds) (2011) *Gender, Generations and the Family in International Migration*. Amsterdam: Amsterdam University Press.

- [5] Kulu, H. and Milewski, N. Research17k, 567-590 (2006) ,Introduction. Demographic Migration in Bhattacharya, P. 1998 The informal sector and Weekly, 33(21).
- [6] Smarandache, Florentin, (2014). Introduction to Neutrosophic Statistics, Sitech and Education Publisher, Craiova, 123 pages.
- [7] Deepesh Kunwar, Jayant Singh, Florentin Smarandache. (2017) Neutrosophic Statistical Evaluation of Migration with particular Reference to Jaipur, submitted mss.

Neutrosophic Statistics is an extension of Interval Statistics, while Plithogenic Statistics is the most general form of statistics (third version)

Florentin Smarandache

Abstract: In this paper we prove that Neutrosophic Statistics is an extension of the Interval Statistics, since it may deal with all types of indeterminacies (with respect to the data, inferential procedures, probability distributions, graphical representations, etc.), it allows the reduction of indeterminacy, and it uses the neutrosophic probability that is more general than imprecise and classical probabilities, and has more detailed corresponding probability density functions.

While Interval Statistics *only* deals with indeterminacy that can be represented by intervals. And we respond to the arguments by Woodall et al. [1].

We show that not all indeterminacies (uncertainties) may be represented by intervals. Also, in some applications, we should better use hesitant sets (that have less indeterminacy) instead of intervals.

We redirect the authors to the Plithogenic Probability and Plithogenic Statistics that are the most general forms of MultiVariate Probability and MultiVariate Statistics respectively (including, of course, the Imprecise Probability and Interval Statistics as subclasses).

1. Introduction

First, we present the distinctions between Neutrosophic Statistics and Interval Statistics and give conclusive examples of neutrosophic algebra that provide more accuracy than the interval algebra.

Afterwards we respond to the critics presented by Woodall et al.

Neutrosophic Statistics was first defined (book [1]) in 1998, developed (Book [3]) in 2014, related with Neutrosophic Probability (Book [9]), connected and extended to other fields (Books [2, 4-8]), a PhD Thesis on Neutrosophic Statistics in 2019 (PhD Thesis [1]), and several international seminars [S1-S5], that resulted in an explosion of articles about its applications (Articles [1 – 122]) to many fields such as: medicine, biology, economics, administration, computer science, engineering etc., regarding the decision making, rock joint roughness coefficient, repetitive sampling, indeterminate similarity

coefficient, indeterminate sample/population size, individuals that only partially belong to a sample/population, indeterminate mean/variance/standard deviation, control charts, probability distributions of indeterminate or thick functions, measurement errors, tests or hypotheses under uncertainty/indeterminacy etc.

2. Neutrosophic Statistics vs. Interval Statistics

In this paper we make a comparison between Neutrosophic Statistics (NS) and Interval Statistics (IS). We show that they are different and in many cases the NS is more general than IS.

NS is not reduced to only using neutrosophic numbers in statistical applications, as Woodall et al. assert, but it is much broader. NS deals with all types of indeterminacy, while IS deals only with indeterminacy that may be represented by intervals.

Below we present several advantages of applying NS over IS:

- Neutrosophic Statistics is based on Set Analysis, while Interval Statistics on Interval Analysis, therefore the Interval Statistics is a particular case of the Neutrosophic Statistics (that uses all types of sets, not only intervals).
- The numerical neutrosophic numbers permit the reduction of indeterminacy through operations, while the intervals increase the indeterminacy (see examples below).
- Not all uncertain (indeterminate) data can be represented by intervals as in IS, while NS deals with all types of indeterminacy.
- NS deals with sample or population whose size is not well-known.
- NS deals with sample or population which contain individuals that only partially belong to the sample/population and others whose appurtenance is unknown.
- NS deals with sample or population individuals whose degree of appurtenance to the sample or population may be outside of the interval $[0, 1]$, as in neutrosophic overset (degree > 1), underset (degree < 0), and in general neutrosophic offset (both appurtenance degrees, > 1 and < 0 , for various individuals)
- Neutrosophic (or Indeterminate) Data is a vague, unclear, incomplete, partially unknown, conflicting indeterminate data.
- NS also deals with refined neutrosophic data used in the Big Data.
- Partially indeterminate curves.
- Neutrosophic Random Variable, which may not be represented as an interval sequence.
- NS also uses Thick Functions (as intersections of curves, that may not be represented by intervals) as probability distributions.
- Neutrosophic Probability Distribution (NPD) of an event (x) to occur is represented by three curves: $NPD(x) = (T(x), I(x), F(x))$, where $T(x)$ represent the chance that the event x occurs, $I(x)$ the indeterminate-chance that the event x occurs or not, and $F(x)$ the chance that the event x does not occur. With $T(x)$, $I(x)$, $F(x)$ being classical or neutrosophic (unclear, approximate, thick) functions – depending on each application, and $0 \leq T(x) + I(x) + F(x) \leq 3$ for all x in the given neutrosophic probability space.

NPD is better than the classical or imprecise probability distributions, since it is a MultiVariate Probability Distribution that and presents more details about the event.

- Diagrams, histograms, pictographs, line/bar/cylinder graphs, plots with neutrosophic data (not represented by intervals).
- Not well-known (or completely unknown): the mean, variance, standard deviation, probability distribution function, and other statistic
- For example, it is no need to increase the uncertainty by extending the set of possible values, for example, $\{0.2, 3.7, 45.9\}$ to the interval $[0.2, 45.9]$ in order to be able to use the interval statistics. NS simply employs the hesitant discrete finite set $\{0.2, 3.7, 45.9\}$.
- The Qualitative Data is represented by a finite discrete neutrosophic label set, instead of a label interval.
- You cannot use Interval Statistics or Interval (Imprecise) Probability to compute the probability of a die on a cracked surface, or coin on a crack surface, or a defect die or coin. We deal with indeterminacy with respect to the probability or statistics space (either the surface, or the die, or the coin), indeterminacy with respect to the observer that evaluates the event, indeterminacy with respect to the event [4].
You cannot approximate the indeterminacy from these examples by using some interval, so you need neutrosophic probability and statistics that deal with all types of indeterminacies.
- In conclusion: we cannot represent all types of indeterminacies by intervals.

For the sake of the truth, we'll respond below to the critics [1].

2.1. **Woodall at al. [1]** on their section of Neutrosophic Mathematics:

- The basic rules for arithmetic given by Smarandache [42, pp. 31-33] do not match the rules given by Zhang et al. [37].
Smarandache [42] expressed neutrosophic numbers in the form $a + bI$, where a and b are real numbers, and I represents the indeterminacy interval such that $I^2 = I$ and $0 \cdot I = 0$.

Response:

This is false, since although the book [reference 2 in this paper] contains the literal neutrosophic numbers, they were never used in the applications of neutrosophic statistics. Instead, all the times there were used the numerical neutrosophic numbers.

The authors should learn that there are two types of neutrosophic numbers of the form $a + bI$, where a, b are real (or complex) numbers, while " I " = indeterminacy.

- (i) Literal Neutrosophic Numbers, when " I " is just a letter, where $I^2 = I$ (because: $indeterminacy \times indeterminacy = indeterminacy$) and $0 \cdot I = 0$, that are used in the neutrosophic algebraic structures, but not in no paper on applications of the neutrosophic statistics - upon the best of my knowledge

The literal neutrosophic numbers were introduced and developed by Kandasamy and Smarandache starting from 2003; see several books using literal neutrosophic numbers in neutrosophic algebraic structures:

W.B.V. Kandasamy, F.Smarandache, Fuzzy Cognitive Maps and Neutrosophic Cognitive Maps, Xiquan, Phoenix, 2003, <http://fs.unm.edu/NCMs.pdf>

W.B.V. Kandasamy, F.Smarandache, Neutrosophic Rings, ProQuest Information & Learning, Ann Arbor, MI, USA, 2006, <http://fs.unm.edu/NeutrosophicRings.pdf>

Etc.

- (ii) Numerical Neutrosophic Numbers, where the indeterminacy “I” is a real subset, in order to approximate the imprecise data. This is more general than the interval, since “I” may be any subset.

For example, $N = 3 + 2I$, where “I” is in the discrete hesitant subset $\{0.3, 0.9, 6.4, 45.6\}$ of only four elements, which is not part of interval analysis (statistics). On the interval statistics, you take the interval $[0.3, 45.6]$ in order to include the above numbers, but this this increases very much the uncertainty.

Of course, there are particular cases when the “I” is an interval $I = [I_1, I_2]$,

with $I_1 \leq I_2$, then $N = a + bI$ coincides with the interval $N = [a + b \cdot I_1, a + b \cdot I_2]$.

1.2. Woodall et al. [1]:

- Using the approach of Zhang et al. [37] and interval arithmetic, however, the interval for the average would be $[3, 5]$. We consider the interval arithmetic approach to lead to the much more useful and realistic results.

Response:

Woodall et al. made a confusion, since Zhang et al. [reference 3, in this paper] paper deals with the Interval Neutrosophic Set (not within the frame of Neutrosophic Statistics), where an element

$x(T, I, F)$, from a given neutrosophic set A , has degrees of membership / indeterminacy / nonmembership (T, I, F) respectively expressed under the form of an interval each of them; for example

$x([0.7, 0.8], [0.2, 0.3], [0.5, 0.6])$.

Therefore, the comparison with Zhang et al. interval arithmetic is irrelevant with respect to the neutrosophic statistics, since Zhang et al. only used their arithmetic on the neutrosophic sets.

Zhang et al. presented the classical operations with intervals because they need them when dealing with operations of neutrosophic triplets. For example, the addition of neutrosophic triplets

$(T_1, I_1, F_1) + (T_2, I_2, F_2) = (T_1 + T_2 - T_1T_2, I_1I_2, F_1F_2)$, where all neutrosophic components are intervals, so additions, subtractions and multiplications of intervals were needed.

See the Neutrosophic Set operations herein [127].

1.3. Wood et al. [1]

- Thus the interval neutrosophic number [4, 6] could be represented as $4 + 2I$. Smarandache [42] calculated the average of two neutrosophic numbers, say $a + bI$ and $c + dI$, as $(a + c)/2 + [(b + d)/2]I$.

As an example, consider the two neutrosophic numbers [4, 6] and [2, 4] represented as $4+2I$ and $4-2I$, respectively.

Then using the approach of Smarandache [42], the average of these two neutrosophic numbers would be $4 + 0I$, or simply the precise value 4. This result does not seem reasonable.

Response:

This just shows the advantage of the numerical neutrosophic numbers over the intervals, since they allow for the reduction of indeterminacy, while using intervals the indeterminacy increases.

For example:

$N_1 = 4 + 2I$, where $I \in [0, 1]$, shows that $2I$ is the indeterminate part of the number N_1 , similarly for $N_2 = 4 - 2I$. If we add them, the indeterminacies of N_1 and N_2 cancel out, and for the average is:

$$\frac{1}{2}(N_1 + N_2) = \frac{1}{2}(4 + 2I + 4 - 2I) = \frac{1}{2}(8) = 4, \text{ with no indeterminacy;}$$

while, using intervals, $N_1 = [4, 6], N_2 = [2, 4]$,

$$\frac{1}{2}(N_1 + N_2) = \frac{1}{2}[6, 10] = [3, 5], \text{ therefore the indeterminacy is between } [0, 2].$$

1.4. Woodall et al.

- We note that Smarandache [42] and others do not refer to interval statistical methods despite their very strong similarities with neutrosophic statistical methods.

Response

At the beginning, in the book [2], page 5, there is no reference to the interval analysis/statistics, but it is to the **set analysis/statistics** that is more general than the interval analysis/statistics:

“In most of the classical statistics equations and formulas, one simply replaces several numbers by sets. And consequently, instead of operations with numbers, one uses operations with sets. One normally replaces the parameters that are indeterminate (imprecise, unsure, and even completely unknown).”

Later on, more citations and comparisons have been presented between neutrosophic statistics vs. classical and interval statistics, watch this: <http://fs.unm.edu/NS/NeutrosophicStatistics.htm>

“The Neutrosophic Statistics is also a generalization of Interval Statistics, because of, among others, while Interval Statistics is based on Interval Analysis, Neutrosophic Statistics is based on Set Analysis (meaning all kinds of sets, not only intervals, for example finite discrete sets).

Also, when computing the mean, variance, standard deviation, probability distributions, and other statistics concepts in classical and interval statistics it is automatically assumed that all individuals belong 100% to the respective sample or population, but in our world, one often meet individuals that only partially belong, partially do not belong, and partially their belongness is indeterminate. The neutrosophic statistics results are more accurate/real than the classical and interval statistics, since the individuals who only partially belong do not have to be considered at the same level as those that fully belong.

The Neutrosophic Probability Distributions may be represented by three curves: one representing the chance of the event to occur, other the chance of the event not to occur, and a third one the indeterminate chance of the event to occur or not.” They provide more details than classical and interval statistics.

“Neutrosophic Statistics is the analysis of events described by the Neutrosophic Probability.

Neutrosophic Probability is a generalization of the classical probability and imprecise probability in which the chance that an event A occurs is t% true - where t varies in the subset T, i% indeterminate - where i varies in the subset I, and f% false - where f varies in the subset F. In classical probability the sum of all space probabilities is equal to 1, while in Neutrosophic Probability it is equal to 3.

In Imprecise Probability: the probability of an event is a subset T in [0, 1], not a number p in [0, 1], what's left is supposed to be the opposite, subset F (also from the unit interval [0, 1]); there is no indeterminate subset I in imprecise probability [see B9].

The function that models the Neutrosophic Probability of a random variable x is called *Neutrosophic distribution*: $NP(x) = (T(x), I(x), F(x))$, where T(x) represents the probability that value x occurs, F(x) represents the probability that value x does not occur, and I(x) represents the indeterminate / unknown probability of value x [see B3].”

Therefore, a more detailed characterization of a neutrosophic random variable, not done in classical and interval statistics.

See this book:

F. Smarandache, Introduction to Neutrosophic Measure, Neutrosophic Integral, and Neutrosophic Probability, Sitech Publishing House, Craiova, 2013,
<http://fs.unm.edu/NeutrosophicMeasureIntegralProbability.pdf>

1.5. Woodall et al.

- The examples involving imprecise sample sizes given in Smarandache [42] all involve attribute data without carefully expressed operational definitions. It seems impossible to have a sample of variables data without knowing the sample size. (p. 4)

Response:

We disagree. There are many frequent examples of populations and samples from our everyday life: such as school of fish in a river, flock of migratory birds, trees in a forest, plants on a given field, herd of cattle, etc. More examples below:

Indeterminate Sample Size

“A statistician wants to analyze the reaction of the spectators to a handball match, where team A plays against team B. Suppose that about 4,000 tickets have been sold. Spectators who attend the match form a sample, whose size cannot be exactly determined, because there are also spectators who entered without tickets (as guests, or illegally), while others who had bought tickets could not come for various reasons.

Therefore, the sample size could be estimated, for example, between for example between 3,900 and 4,200.”

“To estimate how many people watched the game on TV is even more vague. Electronically one finds out that about 3 million people have watched it. But this is ambiguous as well, since many people could have been watched on the same TV set, while some TVs would have been left on without anyone watching because the owners would have been busy with other things. Sample size was estimated, for example, between 2.9 – 3.2 million.” [F.Smarandache, Nidus idearum. Scilogs, II: de rerum consecratione (second edition) Brussels, pages 108-109, 2016, <http://fs.unm.edu/NidusIdearum2-ed2.pdf>]

Comment by Woodall et al. [127]:

There is no reason to treat the sample sizes as indeterminate.

Answer:

A set of individuals may be considered a population with respect to a reference, but a sample with respect to larger reference.

A simple example when a population's size is indeterminate, but that population becomes a sample with respect to a super-population.

So, there are many cases when the sample size may not be well known.

Let's consider the population P of trees, whose size is indeterminate (between 100-120 trees), in a given park of a city. But, with respect to the trees in all 10 parks of the city, the population P is a sample (of indeterminate size: {100, 101, ..., 120}).

Notice that the sample's size is not an interval, but a discrete finite set.

Therefore, most times in the real world it is not possible to exactly estimate a sample or population size.

Woodall et al.

By the way, we spent several years studying fuzzy logic methods, finding no advantages over the use of probability and statistics.

Answer:

You have used or tried to use the fuzzy logic in statistics, I understand.

But the main distinction between fuzzy and neutrosophic logics is that

in neutrosophic logic has been introduced the indeterminacy as independent component.

Woodall et al.:

The repetitive sampling approach provides for the possibility of more than n observations to be collected at any sampling time.

Answer:

This one better falls under the Plithogenic Probability and Statistics that consider MultiVariate Analysis of events and their statistics.

If you are interested, just see:

<http://fs.unm.edu/NSS/PlithogenicProbabilityStatistics20.pdf>

1.6. Mean of a Sample with partially belonging individuals

Let $S = \{a, b, c, d\}$ be a sample set of four elements, such that $a = 2$, $b = 8$, $c = 5$, and $d = 11$.

In the classical statistics it is assumed that all elements belong 100% to the sample, therefore

$$S = \{a(1), b(1), c(1), d(1)\}.$$

Whence the classical mean:

$$CA = \frac{2 \cdot 1 + 8 \cdot 1 + 5 \cdot 1 + 11 \cdot 1}{1+1+1+1} = \frac{26}{4} = 6.5.$$

But, in the real world, not all elements may totally (100%) belong to the sample, for example, let's assume the neutrosophic sample be:

$NS = \{a(1.1), b(0.4), c(0.6), d(0.3)\}$, which means that:

the element a belongs 110% (someone who works overtime, for example, as in the neutrosophic overset (see [B4]), b belongs only 40% to the sample, c belongs 60%, and d belongs 30%.

Whence the neutrosophic mean (NM) is:

$$NM = \frac{2 \cdot (1.1) + 8 \cdot (0.4) + 5 \cdot (0.6) + 11(0.3)}{1.1 + 0.4 + 0.6 + 0.3} = \frac{11.7}{2.4} = 4.875$$

Clearly, the classical mean and the neutrosophic mean are different,

$$CM = 6.5 \neq 4.875 = NM.$$

And consequently: the variance, standard deviation, probability distribution function and other statistics depending on them will be different as well.

But, the *neutrosophic mean* is more accurate since it reflects the real (not idealistic) mean, because it takes into account the degree of membership of each element with respect to the set." [5] And consequently the other statistics depending on them are more accurate.

1.7. The Thick Function (Distribution), from the neutrosophic statistics, is defined as:

$$f : R \rightarrow P(R), f(x) = [f_1(x), f_2(x)]$$

The thick curve as the graph of a thick function [2] was introduced in 2014, and it is different from the interval functions, because we may have a probability distribution in between two curves, of the form $f(x) = [f_1(x), f_2(x)]$.

For example, let $f_1(x) = (x-1)^3 + 2$, $f_2(x) = 1.5x^3$,
then $f(x) = [(x-1)^3 + 2, 1.5x^3]$
which is a thick function, i.e. the zone between two below curves.

So, it is different from Interval Statistics.

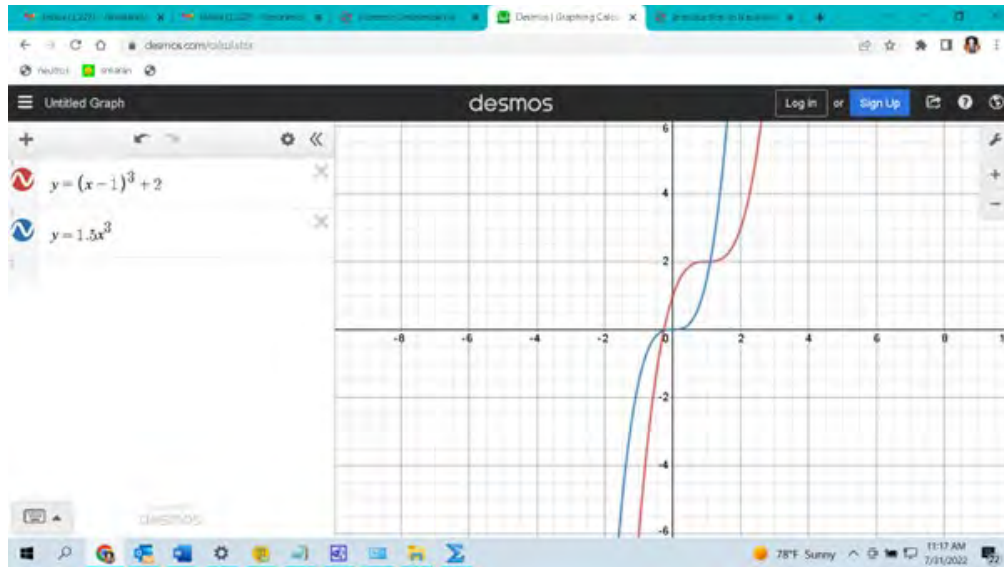

Table 1. A Thick Function used in Neutrosophic Statistics

1.7.Interval-Valued Variable vs. Neutrosophic-Number Variable

The Interval Statistics uses variables [7] of the form:
 $aX + b$, where a and b are constants, and X is a set of varying intervals.
 For example, $a = 2$, $b = 3$, and $X = [0.1, 0.3], [4, 5], [7, 9], \dots$
 give
 $aX + b = 2[0.1, 0.3] + 3, 2[4, 5] + 3, 2[7, 9] + 3, \dots$
 $= [3.2, 3.6], [11, 13], [17, 21], \dots$

While the Neutrosophic Numbers have the form:
 $N = a + bI$,
 where " a " is the determinant (known) part of N , and " bI " is the indeterminate (unclear) part of N ;
 I is a fixed real subset, while a and b are varying real numbers.

Example:
 Let $I = [0.1, 0.2]$ be a fixed subset (we take it as an interval, although it can be any type of subset), and the initial $a = 2$ and $b = 3$, then $a = 4$ and $b = 6$, $a = 5.5$ and $b = 6.2$ etc.
 The $a + bI = 2 + 3[0.1, 0.2], 4 + 6[0.1, 0.2], 7 + 3[0.1, 0.2], \dots$
 $= [2.3, 2.6], [4.6, 5.2], [7.3, 7.6], \dots$

So, clearly the two approaching are different, i.e. the interval-valued variable from interval statistics is different from the neutrosophic number variable from neutrosophic statistics.

1.8. Hesitant Set vs. Interval

In neutrosophic statistics we may use all types of set, for instance the hesitant sets, that have a finite discrete number of elements. In various examples it would be advantageous to use a hesitant set instead of an interval.

Suppose the temperature, in Celsius degrees, is above 10°C , on extreme low/high fluctuation, 18°C low and 40°C or 45°C high.

In neutrosophic statistics the random variable t is modelled as $t = 10 + I$, where $I \in \{5, 30, 35\}$, where the indeterminate part of t is a hesitant discrete finite set of only three elements: 5, 30, and 35.

In interval statistics, the random variable t is modelled as an interval $t = [15, 45]$, whose uncertainty is much higher than that in neutrosophic statistics, and it propagates with each new calculation.

This is another example showing the preference of using neutrosophic statistics over interval statistics.

1.9. Comparisons between interval algebra and neutrosophic algebra

a) Addition

Interval Statistics (IS)

We take the example presented by Woodall et al.

For $I \in [0, 1]$,

$$N_1 = 4 + 2I = [4, 6]$$

$$N_2 = 4 - 2I = [2, 4]$$

$$N_1 + N_2 = [4 + 2, 6 + 4] = [6, 10]$$

By adding $N_1 + N_2$ in interval statistics, the indeterminate part $[0, 2]$ of each number add up, increasing the addition's uncertainty to $[0, 2] + [0, 2] = [0, 4]$.

Neutrosophic Statistics (NS)

$$N_1 = 4 + 2I$$

$$N_2 = 4 - 2I$$

$$N_1 + N_2 = 4 + 2I + 4 - 2I = 8$$

The indeterminate part of N_1 is $2I = [0, 2]$ and the indeterminate part of N_2 is $-2I = [0, -2]$.

By adding $N_1 + N_2$ in the neutrosophic statistics, the indeterminate parts cancel out, $2I - 2I = 0$, and we get a determinate answer: 8.

The result [6, 10] got in interval statistics is much vaguer than 8 obtained in neutrosophic statistics. It shows the advantage of NS over IS.

While in some cases the results of the operations with neutrosophic numbers coincide with those obtained by operations with intervals, in many other cases the results are different.

Clearly, the interval statistics is different from the neutrosophic statistics.

Unlike the interval statistics that accumulates the uncertainty from an operation to another, the neutrosophic statistics diminishes or even cancels the uncertainty.

Question by Woodall et al. [127]:

I have one question about neutrosophic arithmetic. Suppose one has, as in your example, $4+2I$ and $4-2I$. You give the sum as the constant 8. Suppose one writes the numbers equivalently as $4+2I$ and $2+2I$, then the sum is $6+4I$. why should the sum depend on how the numbers are expressed?

Answer:

The numerical neutrosophic numbers (N) are chosen by the researcher upon the parts which are considered determinate (a) and indeterminate (bI), so $N = a+bI$.

Therefore, they depend on what is the indeterminate/vague part of the number.

$N_1 = 2+2I$ means that the determinate part of N_1 is 2, the other is indeterminate, while $N_2 = 4-2I$ has its determinate part be 4.

N_1 is different from N_2 in neutrosophic statistics, but they mean the same thing in interval statistics: $[0, 4]$ when $I = [0, 1]$.

This is another point to show that the Neutrosophic Statistics and Interval Statistics are different from each other.

b) Multiplication

$$N_1 = 4 + 2I, I \in [0, 1]$$

$$N_2 = 4 - 2I$$

IS

$$\begin{aligned} N_1 \cdot N_2 &= (4 + 2I) \cdot (4 - 2I) = (4 + 2 \cdot [0, 1]) \cdot (4 - 2 \cdot [0, 1]) \\ &= (4 + [2 \cdot 0, 2 \cdot 1]) \cdot (4 - [2 \cdot 0, 2 \cdot 1]) \end{aligned}$$

$$\begin{aligned}
 &= (4 + [0, 2]) \cdot (4 - [0, 2]) \\
 &= [4, 6] \cdot [2, 4] = [4 \cdot 2, 6 \cdot 4] = [8, 24],
 \end{aligned}$$

the length of uncertainty is $24 - 8 = 16$.

NS

$$\begin{aligned}
 N_1 \cdot N_2 &= (4 + 2I) \cdot (4 - 2I) = 4^2 - (2I)^2 \\
 &= 16 - 4I^2 = 16 - 4 \cdot [0^2, 1^2] \\
 &= 16 - 4 \cdot [0, 1] \\
 &= 16 - 4 \cdot [0, 4] \\
 &= [16 - 4, 16 - 0] \\
 &= [12, 16],
 \end{aligned}$$

length of uncertainty is $16 - 12 = 4 < 16$, therefore more accurate result from NS.

c) Subtraction

IS

$$\begin{aligned}
 N_1 - N_2 &= (4 + 2I) - (4 - 2I) \\
 &= [4, 6] - [2, 4] \\
 &= [4 - 4, 6 - 2] = [0, 4]
 \end{aligned}$$

NS

$$\begin{aligned}
 N_1 - N_2 &= (4 + 2I) - (4 - 2I) \\
 &= 4 + 2I - 4 + 2I \\
 &= 4I = 4 \cdot [0, 1] = [0, 4], \text{ the same.}
 \end{aligned}$$

But let's take other neutrosophic numbers:

$$M_1 = 5 + 4I, I \in [2, 3]$$

$$M_2 = 6 + 3I$$

IS

$$M_1 = 5 + 4I, I \in [2, 3], \text{ hence } M_1 = 5 + [4 \cdot 2, 4 \cdot 3] = [13, 17];$$

$$M_2 = 6 + 3I = 6 + 3 \cdot [2, 3] = [12, 15].$$

$$M_1 - M_2 = [13, 17] - [12, 15]$$

$$= [13 - 15, 17 - 12] = [-2, 5], \text{ interval of uncertainty length } 5 - (-2) = 7.$$

NS

$$M_1 - M_2 = (5 + 4I) - (6 + 3I) = 5 + 4I - 6 - 3I$$

$$= -1 + I = -1 + [2, 3] = [-1 + 2, -1 + 3]$$

$$= [1, 2], \text{ interval of uncertainty length } 2 - 1 = 1.$$

But $1 < 7$, so better accuracy by using the NS.

d) Division

IS

$$\frac{4 + 2I}{2 + I} = \frac{4 + 2[0, 1]}{2 + [0, 1]} = \frac{4 + [0, 2]}{[2 + 0, 2 + 1]} = \frac{[4 + 0, 4 + 2]}{[2, 3]}$$

$$= \frac{[4, 6]}{[2, 3]} = \left[\frac{4}{3}, \frac{6}{2} \right] = [1.3, 3], \text{ interval of uncertainty } 3 - 1.3 = 1.7.$$

NS

$$\frac{4+2I}{2+I} = \frac{2(2+I)}{2+I} = 2, \text{ uncertainty} = 0,$$

which is a more accurate result, since the neutrosophic statistics permitted the simplification of the uncertainty I .

1.10. Refined Neutrosophic Statistics used in the Big Data

In this Big Data world, we are facing this kind of situation with more uncertainties resulted from multiple variables, leading to Refined Neutrosophy.

Thus, we may use the Refined Neutrosophic Statistics, i.e. when the indeterminacy " I " is split into many types of uncertainties I_1, I_2, \dots, I_s , where $s \geq 2$, as many as needed into the application.

Refined Neutrosophic Statistics followed in the steps of the Refined Neutrosophic Set (Smarandache, 2013). Therefore, an element from a Big Data that belongs to a refined neutrosophic set, $x \in M$, may have refined neutrosophic coordinates, for example $x(T, I_1, I_2, I_3, F)$ if there are only 3 types of uncertainties. We may have as many types of uncertainties as needed into the problem.

Check first the Refined Neutrosophic Set, where T, I, F can be refined/split respectively as:

$$T_1, T_2, \dots, T_p,$$

$$I_1, I_2, \dots, I_r,$$

$$\text{and } F_1, F_2, \dots, F_s,$$

where p, r, s are integers ≥ 0 , and at least one of p, r, s is ≥ 2 (to ensure the existence of refinement of at least one of the three neutrosophic components T, I , and F).

When p, r , or s is equal to 0, that component is discarded. For example, T_0 means that T is discarded, and similarly for I_0 and F_0 .

This leave room for defining the Refined Fuzzy Set, under the form T_1, T_2, \dots, T_p , where p is an integer ≥ 2 , and I_0 and F_0 are discarded.

And for Refined Intuitionistic Fuzzy Set, under the form T_1, T_2, \dots, T_p , and F_1, F_2, \dots, F_s , for integers $p, s \geq 1$, and at least one of p or s is ≥ 2 (in order to assure the refinement of a least one component T or F).

Similarly for other Refined Fuzzy-Extension Sets / Logics / Probabilities / Statistics.

1.10. Plithogenic Probability & Plithogenic Statistics that are generalizations of MultiVariate Probability & Statistics

The **Plithogenic Variate Analysis (PVA)** is an extension of of the classical MultiVariate Analysis, where indeterminate data or procedures, that are called neutrosophic data and respectively neutrosophic procedures, are allowed. Therefore PVA deals with neutrosophic/indeterminate variables, neutrosophic/indeterminate subsystems, and neutrosophic/indeterminate system-of-systems as a whole.

Therefore the Plithogenic Variate Analysis studies a neutrosophic/indeterminate system as a whole, characterized by many neutrosophic/indeterminate variables (i.e. neutrosophic/indeterminate sub-systems), and many neutrosophic/indeterminate relationships. Hence many neutrosophic measurements and observations are needed.

The **Plithogenic Probability** of an event to occur is composed from the chances that the event occurs with respect to all random variables (parameters) that determine it. The Plithogenic Probability, based on Plithogenic Variate Analysis, is a multi-dimensional probability (“plitho” means “many”, synonym with “multi”). We may say that it is a probability of sub-probabilities, where each sub-probability describes the behavior of one variable. We assume that the event we study is produced by one or more variables. Each variable is represented by a Probability Distribution (Density) Function (PDF).

Plithogenic Statistics (PS) encompasses the analysis and observations of the events studied by the Plithogenic Probability. Plithogenic Statistics is a generalization of classical MultiVariate Statistics, and it is a simultaneous analysis of many outcome neutrosophic/indeterminate variables, and it as well is a multi-indeterminate statistics.

Subclasses of Plithogenic Statistics are:

- Interval Statistics
- Neutrosophic Statistics
- MultiVariate Statistics

- Plithogenic Neutrosophic Statistics
- Plithogenic Indeterminate Statistics
- Plithogenic Intuitionistic Fuzzy Statistics
- Plithogenic Picture Fuzzy Statistics - Plithogenic Spherical Fuzzy Statistics
- and in general: Plithogenic (fuzzy-extension) Statistics - and Plithogenic Hybrid Statistics.

Plithogenic Refined Statistics are, similarly, the most general form of statistics that studies the analysis and observations of the events described by the Plithogenic Refined Probability.

See more development, extension of Interval Statistics and Neutrosophic Statistics to Plithogenic Probability & Plithogenic Statistics that are generalizations of MultiVariate Probability & Statistics: [6].

Conclusion

In this paper we made a comparison between Neutrosophic Statistics (NS) and Interval Statistics (IS). We showed that they are different and in many cases the NS is more general than IS.

NS is not reduced to only using neutrosophic numbers in statistical applications, as Woodall et al. assert, but it is much broader. NS deals with all types of indeterminacy, while IS deals only with indeterminacy that may be represented by intervals.

And we responded to the arguments by Woodall et al. [1].

We redirected the authors to the Plithogenic Probability and Plithogenic Statistics that are the most general forms of MultiVariate Probability and MultiVariate Statistics respectively (including, of course, the Interval Statistics as a subclass).

References

[1] William H. Woodall, Anne R. Driscoll, and Douglas C. Montgomery, A Review and Perspective on Neutrosophic Statistical Process Monitoring Methods, preprint, ResearchGate, June 2022.

[2] Florentin Smarandache, Introduction to Neutrosophic Statistics, Sitech & Education Publishing, Craiova, 2014, 124 p. <http://fs.unm.edu/NeutrosophicStatistics.pdf>.

The website of Neutrosophic Statistics where you're cited as well: <http://fs.unm.edu/NeutrosophicStatistics.htm>

[3] H. Zhang, J. Wang, and X. Chen, Interval neutrosophic sets and their application in multicriteria decision making problems, Scientific World Journal Volume 2014, Article ID 645953, 15 pages, <http://dx.doi.org/10.1155/2014/645953>.

[4] F. Smarandache, Introduction to Neutrosophic Measure, Neutrosophic Integral, and Neutrosophic Probability, Sitech Publishing House, Craiova, 2013, <http://fs.unm.edu/NeutrosophicMeasureIntegralProbability.pdf>

[5] F.Smarandache, Nidus idearum. Scilogs, II: de rerum consecratione (second edition) Brussels, pages 109-110, 2016, <http://fs.unm.edu/NidusIdearum2-ed2.pdf>

[6] F. Smarandache, Plithogenic Probability & Statistics are generalizations of MultiVariate Probability & Statistics, Neutrosophic Sets and Systems, Vol. 43, 280-289, 2021, <http://fs.unm.edu/NSS/PlithogenicProbabilityStatistics20.pdf>

[7] Frederica Gioia, Carlo N. Lauro, Basic Statistical Methods for Interval Data, Statistica Applicata, Vol. 17, no. 1, pp. 1-29, 2005.

Books

B1. Florentin Smarandache: A Unifying Field in Logics: Neutrosophic Logic. Neutrosophy, Neutrosophic Set, Neutrosophic Probability and Statistics (sixth edition). InfoLearnQuest, 1998 - 2007, 156 p. <http://fs.unm.edu/eBook-Neutrosophics6.pdf>

B2. W. B. Vasantha Kandasamy, Florentin Smarandache, *Fuzzy Cognitive Maps and Neutrosophic Cognitive Maps*, Xiquan, Phoenix, 211 p., 2003, <http://fs.unm.edu/NCMs.pdf>

B3. Florentin Smarandache: Introduction to Neutrosophic Statistics. Sitech & Education Publishing, 2014, 124 p. <http://fs.unm.edu/NeutrosophicStatistics.pdf>

B4. Florentin Smarandache: Neutrosophic Overset, Neutrosophic Underset, and Neutrosophic Offset. Similarly for Neutrosophic Over-/Under-/Off- Logic, Probability, and Statistics. Pons Editions, Brussels, 2016, 168 p. <http://fs.unm.edu/NeutrosophicOversetUndersetOffset.pdf>

B5. Maikel Leyva Vázquez, Florentin Smarandache: Neutrosofía: Nuevos avances en el tratamiento de la incertidumbre. Pons Editions, Bruselas, 2018, 74 p. <http://fs.unm.edu/NeutrosofiaNuevosAvances.pdf>

B6. Tatiana Veronica Gutierrez Quinonez, Fabian Andres Espinoza, Ingrid Kathyuska Giraldo, Angel Steven Asanza, Mauricio Daniel Montenegro: Estadística y Probabilidades: Una Vision Neutrosofica desde el Aprendizaje Basado en Problemas en la Construcción del Conocimiento. Pons Editions, Bruselas, 2020, 131 p. <http://fs.unm.edu/EstadisticaYProbabilidadNeutrosofica.pdf>

B7. F. Smarandache, Neutrosophic Statistics vs. Classical Statistics, section in *Nidus Idearum / Superluminal Physics*, Vol. 7, third edition, p. 117, 2019, <http://fs.unm.edu/NidusIdearum7-ed3.pdf>.

B8. F. Smarandache, *Nidus Idearum de Neutrosophia* (Book Series), Editions Pons, Brussels, Belgium, Vols. 1-7, 2016-2019; <http://fs.unm.edu/ScienceLibrary.htm>

B9. F. Smarandache, *Introduction to Neutrosophic Measure, Neutrosophic Integral, and Neutrosophic Probability*, Sitech Publishing House, Craiova, 2013, <http://fs.unm.edu/NeutrosophicMeasureIntegralProbability.pdf>

PhD Thesis

PhD1. Rafif Alhabib: Formulation of the classical probability and some probability distributions due to neutrosophic logic and its impact on Decision Making. PhD Thesis in Arabic, held under the supervision of Dr. M. M. Ranna, Dr. H. Farah, Dr. A. A. Salama, Faculty of Science, Department of Mathematical Statistics, University of Aleppo, Syrian Arab Republic, 2019. <http://fs.unm.edu/NS/FormulationOfTheClassicalProbability-PhDThesis.pdf>

Articles

1. Florentin Smarandache: Operators on Single-Valued Neutrosophic Oversets, Neutrosophic Undersets, and Neutrosophic Offsets. *Journal of Mathematics and Informatics*, Vol. 5, 2016, 63-67.

2. Florentin Smarandache: Interval-Valued Neutrosophic Oversets, Neutrosophic Undersets, and Neutrosophic Offsets. *International Journal of Science and Engineering Investigations*, Vol. 5, issue 54, 2016, Paper ID: 55416-01, 4 p.

3. Nouran M. Radwan, M. Badr Senousy, Alaa El Din M. Riad: Approaches for Managing Uncertainty in Learning Management Systems. *Egyptian Computer Science Journal*, vol. 40, no. 2, May 2016, 10 p.

4. Muhammad Aslam: A Variable Acceptance Sampling Plan under Neutrosophic Statistical Interval Method. *Symmetry* 2019, 11, 114, DOI: 10.3390/sym11010114.

5. Soumyadip Dhar, Malay K. Kundu: Accurate segmentation of complex document image using digital shearlet transform with neutrosophic set as uncertainty handling tool. *Applied Soft Computing*, vol. 61, 2017, 412–426.

6. B. Kavitha, S. Karthikeyan, P. Sheeba Maybell: An ensemble design of intrusion system for handling uncertainty using Neutrosophic Logic Classifier. *Knowledge-Based Systems*, vol. 28, 2012, 88-96.

7. Muhammad Aslam: A new attribute sampling plan using neutrosophic statistical interval method. *Complex & Intelligent Systems*, 6 p. DOI: 10.1007/s40747-018-0088-6
8. Muhammad Aslam, Nasrullah Khan, Mohammed Albassam: Control Chart for Failure-Censored Reliability Tests under Uncertainty Environment. *Symmetry* 2018, 10, 690, DOI: 10.3390/sym10120690.
9. Muhammad Aslam, Nasrullah Khan, Ali Hussein AL-Marshadi: Design of Variable Sampling Plan for Pareto Distribution Using Neutrosophic Statistical Interval Method. *Symmetry* 2019, 11, 80, DOI: 10.3390/sym11010080.
10. Jun Ye, Jiqian Chen, Rui Yong, Shigui Du: Expression and Analysis of Joint Roughness Coefficient Using Neutrosophic Number Functions. *Information*, Volume 8, 2017, 13 pages.
11. Jiqian Chen, Jun Ye, Shigui Du, Rui Yong: Expressions of Rock Joint Roughness Coefficient Using Neutrosophic Interval Statistical Numbers. *Symmetry*, Volume 9, 2017, 7 pages.
12. Adrian Rubio-Solis, George Panoutsos: Fuzzy Uncertainty Assessment in RBF Neural Networks using neutrosophic sets for Multiclass Classification. Presented at 2014 IEEE International Conference on Fuzzy Systems (FUZZ-IEEE) July 6-11, 2014, Beijing, China, 8 pages.
13. Pierpaolo D'Urso: Informational Paradigm, management of uncertainty and theoretical formalisms in the clustering framework: A review. *Information Sciences*, 400–401 (2017), pp. 30-62, 33 pages.
14. Muhammad Aslam, Mohammed Albassam: Inspection Plan Based on the Process Capability Index Using the Neutrosophic Statistical Method. *Mathematics* 2019, 7, 631, DOI: 10.3390/math7070631.
15. Mirela Teodorescu, Florentin Smarandache, Daniela Gifu: Maintenance Operating System Uncertainties Approached through Neutrosophic Theory. 8 p.
16. Muhammad Aslam, Rashad A. R. Bantan, Nasrullah Khan: Monitoring the Process Based on Belief Statistic for Neutrosophic Gamma Distributed Product. *Processes* 2019, 7, 209, DOI: 10.3390/pr7040209.
17. Rafael Rojas-Gualdrón, Florentin Smarandache, Carlos Diaz-Bohorquez: Application of The Neutrosophical Theory to Deal with Uncertainty in Supply Chain Risk Management. *AGLALA* 2019; 10 (2): 1-19.
18. Florentin Smarandache, Gheorghe Savoiu: Neutrosophic Index Numbers: Neutrosophic Logic Applied In The Statistical Indicators Theory. *Critical Review*, Vol. XI, 2015, pp. 67-100.
19. Murat Kirisci, Necip Simsek: Neutrosophic normed spaces and statistical convergence. *Journal of Analysis*, 11 April 2020, DOI: 10.1007/s41478-020-00234-0.

20. S.K. Patro: The Neutrosophic Statistical Distribution: More Problems, More Solutions. 17 p.
21. Deepesh Kunwar, Jayant Singh, Florentin Smarandache: Neutrosophic statistical evaluation of migration with particular reference to Jaipur. *Octogon Mathematical Magazine*, vol. 26, no. 2, October 2018, 560-568.
22. Deepesh Kunwar, Jayant Singh, Florentin Smarandache: Neutrosophic statistical techniques to find migration pattern in Jaipur. *Octogon Mathematical Magazine*, vol. 26, no. 2, October 2018, 583-592.
23. Muhammad Aslam, Osama H. Arif, Rehan Ahmad Khan Sherwani: New Diagnosis Test under the Neutrosophic Statistics: An Application to Diabetic Patients. Hindawi, BioMed Research International, Volume 2020, Article ID 2086185, 7 pages; DOI: 10.1155/2020/2086185.
24. Jose L. Salmeron, Florentin Smarandache: Processing Uncertainty and Indeterminacy in Information Systems success mapping. 13 p., arXiv:cs/0512047v2.
25. Wenzhong Jiang, Jun Ye, Wenhua Cui: Scale Effect and Anisotropic Analysis of Rock Joint Roughness Coefficient Neutrosophic Interval Statistical Numbers Based on Neutrosophic Statistics. *Journal of Soft Computing in Civil Engineering*, 2-4 / 2018, 62-71; DOI: 10.5281/zenodo.3130240.
26. Muhammad Aslam, P. Jeyadurga, Saminathan Balamurali, Ali Hussein Al-Marshadi: Time-Truncated Group Plan under a Weibull Distribution based on Neutrosophic Statistics. *Mathematics* 2019, 7, 905; DOI: 10.3390/math7100905
27. A.A. Salama, M. Elsayed Wahed, Eman Yousif: A Multi-objective Transportation Data Problems and their Based on Fuzzy Random Variables. *Neutrosophic Knowledge*, vol. 1, 2020, 41-53; DOI: 10.5281/zenodo.4269558.
28. Philippe Schweizer: Uncertainty: two probabilities for the three states of neutrosophy. *International Journal of Neutrosophic Science (IJNS)*, Volume 2, Issue 1, 2020, 18-26; DOI: 10.5281/zenodo.3989350.
29. Carlos N. Bouza-Herrera, Mir Subzar: Estimating the Ratio of a Crisp Variable and a Neutrosophic Variable. *International Journal of Neutrosophic Science (IJNS)*, Volume 11, Issue 1, 2020, 9-21; DOI: 10.5281/zenodo.4275712
30. Angel Carlos Yumar Carralero, Darvin Manuel Ramirez Guerra, Giorver Perez Iribar: Analisis estadístico neutrosófico en la aplicación de ejercicios físicos en la rehabilitación del adulto mayor con gonartrosis. *Neutrosophic Computing and Machine Learning*, Vol. 13, 1-9, 2020; DOI: <https://zenodo.org/record/3901770>.
31. Alexandra Dolores Molina Manzo, Rosa Leonor Maldonado Manzano, Blanca Esmeralda Brito Herrera, Johanna Irene Escobar Jara: Analisis estadístico neutrosófico de la incidencia del

voto facultativo de los jovenes entre 16 y 18 anos en el proceso electoral del Ecuador. *Neutrosophic Computing and Machine Learning*, Vol. 11, 9-14, 2020; DOI: <https://zenodo.org/record/3474439>.

32. Johana Cristina Sierra Morán, Jenny Fernanda Enríquez Chuga, Wilmer Medardo Arias Collaguazo And Carlos Wilman Maldonado Gudiño: Neutrosophic statistics applied to the analysis of socially responsible participation in the community , *Neutrosophic Sets and Systems*, vol. 26, 2019, pp. 19 -28. DOI: 10.5281/zenodo.3244232

33. Paúl Alejandro Centeno Maldonado, Yusmany Puertas Martinez, Gabriela Stephanie Escobar Valverde, and Juan Danilo Inca Erazo: Neutrosophic statistics methods applied to demonstrate the extra-contractual liability of the state from the Administrative Organic Code, *Neutrosophic Sets and Systems*, vol. 26, 2019, pp. 29-34. DOI: 10.5281/zenodo.3244262

34. S. K. Patro, F. Smarandache: The Neutrosophic Statistical Distribution - More Problems, More Solutions, *Neutrosophic Sets and Systems*, vol. 12, 2016, pp. 73-79. doi.org/10.5281/zenodo.571153

35. Lilia Esther Valencia Cruzaty, Mariela Reyes Tomalá, Carlos Manuel Castillo Gallo and Florentin Smarandache, A Neutrosophic Statistic Method to Predict Tax Time Series in Ecuador, *Neutrosophic Sets and Systems*, vol. 34, 2020, pp. 33-39. DOI: 10.5281/zenodo.3843289; <http://fs.unm.edu/NSS/NeutrosophicStatisticMethod.pdf>

36. Somen Debnath: Neutrosophication of statistical data in a study to assess the knowledge, attitude and symptoms on reproductive tract infection among women. *Journal of Fuzzy Extension & Applications (JFEA)*, Volume 2, Issue 1, Winter 2021, 33-40; DOI: 10.22105/JFEA.2021.272508.1073.

37. Muhammad Aslam, Rashad A.R. Bantan, Nasrullah Khan: Design of tests for mean and variance under complexity-an application to rock measurement data. Elsevier: *Measurement*, Volume 177, June 2021, 109312; DOI: 10.1016/j.measurement.2021.109312.

38. O.H. Arif, Muhammad Aslam: A new sudden death chart for the Weibull distribution under complexity. Springer: *Complex & Intelligent Systems* (2021); DOI: 10.1007/s40747-021-00316-x.

39. Nasrullah Khan, Muhammad Aslam, Asma Arshad, Ambreen Shafqat: Tracking Temperature Under Uncertainty Using EWMA-MA Control Chart. Springer: *Journal of Metrology Society of India* (2021); DOI: 10.1007/s12647-021-00436-2.

40. Muhammad Aslam: Analyzing wind power data using analysis of means under neutrosophic statistics. Springer: *Soft Computing* (2021); DOI: 10.1007/s00500-021-05661-0.

41. Muhammad Aslam: On Testing Autocorrelation in Metrology Data Under Indeterminacy. Springer: *Journal of Metrology Society of India* (2021); DOI: 10.1007/s12647-021-00429-1.
42. Muhammad Aslam, Nasrullah Khan: Normality Test of Temperature in Jeddah City Using Cochran's Test Under Indeterminacy. Springer: *Journal of Metrology Society of India* (2021); DOI: 10.1007/s12647-020-00428-8.
43. Muhammad Aslam, Gadde Srinivasa Rao, Nasrullah Khan, Liaquat Ahmad: Two-stage sampling plan using process loss index under neutrosophic statistics. Taylor&Francis: *Communications in Statistics - Theory and Methods* (2020); DOI: 10.1080/03610918.2019.1702212.
44. Ali Hussein Al-Marshadi, Ambreen Shafqat, Muhammad Aslam, Abdullah Alharbey: Performance of a New Time-Truncated Control Chart for Weibull Distribution Under Uncertainty. Atlantis Press: *International Journal of Computational Intelligence Systems*, Volume 14, Issue 1, 2021, 1256 - 1262; DOI: 10.2991/ijcis.d.210331.001.
45. Muhammad Aslam: Testing average wind speed using sampling plan for Weibull distribution under indeterminacy. Nature: *Scientific Reports*, 11, Article number: 7532 (2021); DOI: 10.1038/s41598-021-87136-8.
46. Muhammad Aslam, G. Srinivasa Rao, Nasrullah Khan: Single-stage and two-stage total failure-based group-sampling plans for the Weibull distribution under neutrosophic statistics. Springer: *Complex & Intelligent Systems*, 7, 891–900 (2021); DOI: 10.1007/s40747-020-00253-1.
47. Muhammad Aslam, G. Srinivasa Rao, Ambreen Shafqat, Liaquat Ahmad, Rehan Ahmad Khan Sherwani: Monitoring circuit boards products in the presence of indeterminacy. Elsevier: *Measurement*, Volume 168, 15 January 2021, 108404; DOI: 10.1016/j.measurement.2020.108404.
48. Mohammed Albassam, Nasrullah Khan, Muhammad Aslam: Neutrosophic D'Agostino Test of Normality: An Application to Water Data. Hindawi: *Journal of Mathematics - Theory, Algorithms, and Applications within Neutrosophic Modelling and Optimisation*, 2021, Article ID 5582102, 5 pages; DOI: 10.1155/2021/5582102.
49. Mohammed Albassam: Radar data analysis in the presence of uncertainty. Taylor&Francis: *European Journal of Remote Sensing*, 54:1, 140-144, 2021; DOI: 10.1080/22797254.2021.1886597.
50. Muhammad Aslam: A new goodness of fit test in the presence of uncertain parameters. Springer: *Complex & Intelligent Systems*, 7, 359–365, 2021; DOI: 10.1007/s40747-020-00214-8.

51. Abdullah M. Almarashi, Muhammad Aslam: Process Monitoring for Gamma Distributed Product under Neutrosophic Statistics Using Resampling Scheme. Hindawi: *Journal of Mathematics: Soft Computing Algorithms Based on Fuzzy Extensions*, Volume 2021, Article ID 6635846, 12 pages; DOI: 10.1155/2021/6635846.
52. Muhammad Aslam: A study on skewness and kurtosis estimators of wind speed distribution under indeterminacy. Springer: *Theoretical and Applied Climatology*, 143, 1227–1234, 2021; DOI: 10.1007/s00704-020-03509-5.
53. Muhammad Aslam, Ali Algarni: Analyzing the Solar Energy Data Using a New Anderson-Darling Test under Indeterminacy. Hindawi: *International Journal of Photoenergy*, Volume 2020, Article ID 6662389, 6 pages; DOI: 10.1155/2020/6662389.
54. Muhammad Aslam: Forecasting of the wind speed under uncertainty. Nature: *Sc. Rep.*, Volume 10 (2020).
55. Azhar Ali Janjua, Muhammad Aslam, Naheed Sultana: Evaluating the relationship between climate variability and agricultural crops under indeterminacy. Springer: *Theoretical and Applied Climatology*, Volume 142, pages 1641–1648 (2020); DOI: 10.1007/s00704-020-03398-8.
56. Rehan Ahmad Khan Sherwan, Mishal Naeem, Muhammad Aslam, Muhammad Ali Raza, Muhammad Abid, Shumaila Abbas: Neutrosophic Beta Distribution with Properties and Applications. University of New Mexico: *Neutrosophic Sets and Systems*, Vol. 41, 209-214, 2021; DOI: 10.5281/zenodo.4625715.
57. Muhammad Aslam, Ambreen Shafqat, Mohammed Albassam, Jean-Claude Malela-Majika, Sandile C. Shongwe: A new CUSUM control chart under uncertainty with applications in petroleum and meteorology. PLoS ONE 16(2): e0246185, 2021; DOI: 10.1371/journal.pone.0246185.
58. Muhammad Aslam: Monitoring the road traffic crashes using NEWMA chart and repetitive sampling. Taylor&Francis: *International Journal of Injury Control and Safety Promotion*, Volume 28, 2021 - Issue 1, 39-45; DOI: 10.1080/17457300.2020.1835990.
59. Muhammad Aslam: Analysing Gray Cast Iron Data using a New Shapiro-Wilks test for Normality under Indeterminacy. Taylor&Francis: *International Journal of Cast Metals Research*, Volume 34, 2021 - Issue 1, 1-5; DOI: 10.1080/13640461.2020.1846959.
60. Ishmal Shahzadi, Muhammad Aslam, Hussain Aslam: Neutrosophic Statistical Analysis of Income of YouTube Channels. University of New Mexico: *Neutrosophic Sets and Systems*, Vol. 39, 101-106, 2020.
61. Nasrullah Khan, Muhammad Aslam, P. Jeyadurga, S. Balamurali: Monitoring of production of blood components by attribute control chart under indeterminacy. Nature: *Sc. Rep.*, volume 11 (2021).

62. Muhammad Aslam, Rashad A.R. Bantan: A study on measurement system analysis in the presence of indeterminacy. Elsevier: *Measurement*, Volume 166, December 2020, 108201; DOI: 10.1016/j.measurement.2020.108201.
63. Muhammad Aslam, Rashad A. R. Bantan, Nasrullah Khan: Design of NEWMA np control chart for monitoring neutrosophic nonconforming items. Springer: *Soft Computing*, Volume 24, 16617–16626 (2020); DOI: 10.1007/s00500-020-04964-y.
64. M. Albassam, Muhammad Aslam: Monitoring Non-Conforming Products Using Multiple Dependent State Sampling Under Indeterminacy-An Application to Juice Industry. IEEE Access, vol. 8, pp. 172379-172386, 2020; DOI: 10.1109/ACCESS.2020.3024569.
65. Ahmed Ibrahim Shawky , Muhammad Aslam, Khushnoor Khan: Multiple Dependent State Sampling-Based Chart Using Belief Statistic under Neutrosophic Statistics. Hindawi: *Journal of Mathematics*, Volume 2020, Article ID 7680286, 14 pages; DOI: 10.1155/2020/7680286.
66. Muhammad Aslam: Introducing Grubbs's test for detecting outliers under neutrosophic statistics - An application to medical datas. Science Direct: *Journal of King Saud University - Science*, Volume 32, Issue 6, September 2020, 2696-2700; DOI: 10.1016/j.jksus.2020.06.003.
67. Muhammad Aslam: A New Sampling Plan Using Neutrosophic Process Loss Consideration. MDPI: *Symmetry*, 2018, 10 (5), 132; DOI: 10.3390/sym10050132.
68. Muhammad Aslam, Osama H. Arif: Testing of Grouped Product for the Weibull Distribution Using Neutrosophic Statistics. MDPI: *Symmetry*, 2018, 10 (9), 403; DOI: 10.3390/sym10090403.
69. Muhammad Aslam, Nasrullah Khan, Muhammad Zahir Khan: Monitoring the Variability in the Process Using Neutrosophic Statistical Interval Method. MDPI: *Symmetry*, 2018, 10 (11), 562; DOI: 10.3390/sym10110562.
70. Muhammad Zahir Khan, Muhammad Farid Khan, Muhammad Aslam, Abdur Razzaque Mughal: Design of Fuzzy Sampling Plan Using the Birnbaum-Saunders Distribution. MDPI: *Mathematics*, 2019, 7 (1), 9; DOI: 10.3390/math7010009.
71. Muhammad Aslam, Ali Hussein Al-Marshadi: Design of Sampling Plan Using Regression Estimator under Indeterminacy. MDPI: *Symmetry*, 2018, 10 (12), 754; DOI: 10.3390/sym10120754.
72. Muhammad Zahir Khan, Muhammad Farid Khan, Muhammad Aslam, Seyed Taghi Akhavan Niaki, Abdur Razzaque Mughal: A Fuzzy EWMA Attribute Control Chart to Monitor Process Mean. MDPI: *Information*, 2018, 9 (12), 312; DOI: 10.3390/info9120312.
73. Muhammad Aslam, Nasrullah Khan, Mohammed Albassam: Control Chart for Failure-Censored Reliability Tests under Uncertainty Environment. MDPI: *Symmetry*, 2018, 10 (12), 690; DOI: 10.3390/sym10120690.

74. Muhammad Aslam, Mohammed Albassam: Application of Neutrosophic Logic to Evaluate Correlation between Prostate Cancer Mortality and Dietary Fat Assumption. MDPI: *Symmetry*, 2019, 11 (3), 330; DOI: 10.3390/sym11030330.
75. Muhammad Aslam, Mansour Sattam Aldosari: Inspection Strategy under Indeterminacy Based on Neutrosophic Coefficient of Variation. MDPI: *Symmetry*, 2019, 11 (2), 193; DOI: 10.3390/sym11020193.
76. Muhammad Aslam: A Variable Acceptance Sampling Plan under Neutrosophic Statistical Interval Method. MDPI: *Symmetry*, 2019, 11 (1), 114; DOI: 10.3390/sym11010114.
77. Muhammad Aslam, Nasrullah Khan, Ali Hussein Al-Marshadi: Design of Variable Sampling Plan for Pareto Distribution Using Neutrosophic Statistical Interval Method. MDPI: *Symmetry*, 2019, 11 (1), 80; DOI: 10.3390/sym11010080.
78. Muhammad Aslam, Rashad A. R. Bantan, Nasrullah Khan: Design of S₂N—NEWMA Control Chart for Monitoring Process having Indeterminate Production Data. MDPI: *Processes*, 2019, 7 (10), 742; DOI: 10.3390/pr7100742.
79. Muhammad Aslam, Ali Hussein Al-Marshadi, Nasrullah Khan: A New X-Bar Control Chart for Using Neutrosophic Exponentially Weighted Moving Average. MDPI: *Mathematics*, 2019, 7 (10), 957; DOI: 10.3390/math7100957.
80. Muhammad Aslam, P. Jeyadurga, Saminathan Balamurali, Ali Hussein Al-Marshadi: Time-Truncated Group Plan under a Weibull Distribution based on Neutrosophic Statistics. MDPI: *Mathematics*, 2019, 7 (10), 905; DOI: 10.3390/math710090557.
81. Muhammad Aslam, Osama Hasan Arif: Classification of the State of Manufacturing Process under Indeterminacy. MDPI: *Mathematics*, 2019, 7 (9), 870; DOI: 10.3390/math7090870.
82. Muhammad Aslam, Mohammed Albassam: Inspection Plan Based on the Process Capability Index Using the Neutrosophic Statistical Method. MDPI: *Mathematics*, 2019, 7 (7), 631; DOI: 10.3390/math7070631.
83. Muhammad Aslam, Rashad A. R. Bantan, Nasrullah Khan: Monitoring the Process Based on Belief Statistic for Neutrosophic Gamma Distributed Product. MDPI: *Processes*, 2019, 7 (4), 209; DOI: 10.3390/pr7040209.
84. Muhammad Aslam: Product Acceptance Determination with Measurement Error Using the Neutrosophic Statistics. Hindawi: *Advances in Fuzzy Systems*, Volume 2019, Article ID 8953051, 8 pages; DOI: 10.1155/2019/8953051.
85. Muhammad Aslam, Rashad A. R. Bantan, Nasrullah Khan: Design of a New Attribute Control Chart Under Neutrosophic Statistics. Springer: *International Journal of Fuzzy Systems*, Volume 21, 433–440 (2019); DOI: 10.1007/s40815-018-0577-1.

86. Muhammad Aslam, Osama H. Arif: Test of Association in the Presence of Complex Environment. Hindawi: *Complexity*, Volume 2020, Article ID 2935435, 6 pages; DOI: 10.1155/2020/2935435.
87. Mohammed Albassam, Nasrullah Khan, Muhammad Aslam: The W/S Test for Data Having Neutrosophic Numbers: An Application to USA Village Population. Hindawi: *Complexity*, Volume 2020, Article ID 3690879, 8 pages; DOI: 10.1155/2020/3690879.
88. Muhammad Aslam, Osama H. Arif, Rehan Ahmad Khan Sherwani: New Diagnosis Test under the Neutrosophic Statistics: An Application to Diabetic Patients. Hindawi: *BioMed Research International*, Volume 2020, Article ID 2086185, 7 pages; DOI: 10.1155/2020/2086185.
89. Muhammad Aslam, Ali Hussein Al-Marshadi: Design of a Control Chart Based on COM-Poisson Distribution for the Uncertainty Environment. Hindawi: *Complexity*, Volume 2019, Article ID 8178067, 7 pages; DOI: 10.1155/2019/8178067.
90. Muhammad Aslam, Osama H. Arif: Multivariate Analysis under Indeterminacy: An Application to Chemical Content Data. Hindawi: *Journal of Analytical Methods in Chemistry*, Volume 2020, Article ID 1406028, 6 pages; DOI: 10.1155/2020/1406028.
91. Muhammad Aslam, Abdulmohsen Al-Shareef, Khushnoor Khan: Monitoring the temperature through moving average control under uncertainty environment. Nature: *Sc. Rep.*, Volume 10, Article number: 12182 (2020).
912. Muhammad Aslam: Design of Sampling Plan for Exponential Distribution Under Neutrosophic Statistical Interval Method. IEEE Access, vol. 6, pp. 64153-64158, 2018; DOI: 10.1109/ACCESS.2018.2877923.
93. Muhammad Aslam: Control Chart for Variance Using Repetitive Sampling Under Neutrosophic Statistical Interval System. IEEE Access, vol. 7, pp. 25253-25262, 2019; DOI: 10.1109/ACCESS.2019.2899020.
94. Muhammad Aslam, M. Azam, M. Albassam: Sampling Plan Using Process Loss Index Using Multiple Dependent State Sampling Under Neutrosophic Statistics. IEEE Access, vol. 7, pp. 38568-38576, 2019; DOI: 10.1109/ACCESS.2019.2906408.
95. Naeem Jan, Muhammad Aslam, Kifayat Ullah, Tahir Mahmood, Jun Wang: An approach towards decision making and shortest path problems using the concepts of interval-valued Pythagorean fuzzy information. Wiley: *International Journal of Intelligent Systems*, Volume 34, Issue 10, October 2019, 2403-2428.
96. Muhammad Aslam: Attribute Control Chart Using the Repetitive Sampling Under Neutrosophic System. IEEE Access, vol. 7, 2019, 2163-3536; DOI: 10.1109/ACCESS.2019.2895162.

97. Muhammad Aslam, R. A. R. Bantan, N. Khan: Design of a Control Chart for Gamma Distributed Variables Under the Indeterminate Environment. *IEEE Access*, vol. 7, pp. 8858-8864, 2019; DOI: 10.1109/ACCESS.2019.2891005.
98. Muhammad Aslam, Muhammad Ali Raza: Design of New Sampling Plans for Multiple Manufacturing Lines Under Uncertainty. Springer: *International Journal of Fuzzy Systems*, volume 21, 978–992 (2019); DOI: 10.1007/s40815-018-0560-x.
99. Muhammad Aslam: A New Failure-Censored Reliability Test Using Neutrosophic Statistical Interval Method. Springer: *International Journal of Fuzzy Systems*, volume 21, 1214–1220 (2019); DOI: 10.1007/s40815-018-0588-y.
100. Muhammad Aslam: Neutrosophic analysis of variance: application to university students. Springer: *Complex & Intelligent Systems*, volume 5, 403–407 (2019); DOI: 10.1007/s40815-018-0588-y.
101. Muhammad Aslam, Mohammed Albassam: Presenting post hoc multiple comparison tests under neutrosophic statistics. Elsevier: *Journal of King Saud University - Science*, Volume 32, Issue 6, September 2020, 2728-2732; DOI: 10.1016/j.jksus.2020.06.008.
102. Muhammad Aslam, Mansour Sattam Aldosari: Analyzing alloy melting points data using a new Mann-Whitney test under indeterminacy. Elsevier: *Journal of King Saud University - Science*, Volume 32, Issue 6, September 2020, 2831-2834; DOI: 10.1016/j.jksus.2020.07.005.
103. Muhammad Aslam: On detecting outliers in complex data using Dixon's test under neutrosophic statistics. Elsevier: *Journal of King Saud University - Science*, Volume 32, Issue 3, April 2020, 2005-2008; DOI: 10.1016/j.jksus.2020.02.003.
104. Muhammad Aslam: A new attribute sampling plan using neutrosophic statistical interval method. Springer: *Complex & Intelligent Systems*, 5, 365–370 (2019); DOI: 10.1007/s40747-018-0088-6.
105. Muhammad Aslam, Saminathan Balamurali, Jeyadurga Periyasamyandian, Ali Hussein Al-Marshadi: Plan for Food Inspection for Inflated-Pareto Data Under Uncertainty Environment. *IEEE Access*, vol. 7, 164186-164193, 2019; DOI: 10.1109/ACCESS.2019.2951019.
106. Muhammad Aslam, R. A. R. Bantan, N. Khan: Design of X-Bar Control Chart Using Multiple Dependent State Sampling Under Indeterminacy Environment. *IEEE Access*, vol. 7, pp. 152233-152242, 2019; DOI: 10.1109/ACCESS.2019.2947598.
107. Muhammad Aslam: Introducing Kolmogorov-Smirnov Tests under Uncertainty: An Application to Radioactive Data. American Chemical Society: *ACS Omega* 2020, 5, 1, 914-917; DOI: 10.1021/acsomega.9b03940.

108. Muhammad Aslam: Design of the Bartlett and Hartley tests for homogeneity of variances under indeterminacy environment. Taylor&Francis: *Journal of Taibah University for Science*, Volume 14, 2020, Issue 1; DOI: 10.1080/16583655.2019.1700675.
109. Muhammad Aslam, Muhammad Ali Raza, Liaquat Ahmad: Acceptance sampling plans for two-stage process for multiple manufacturing lines under neutrosophic statistics. IOS Press: *Journal of Intelligent & Fuzzy Systems*, vol. 37, no. 6, pp. 7839-7850, 2019; DOI: 10.3233/JIFS-182849.
110. Muhammad Kashif, Hafiza Nida, Muhammad Imran Khan, Muhammad Aslam: Decomposition of Matrix under Neutrosophic Environment. University of New Mexico: *Neutrosophic Sets and Systems*, vol. 30, 143-148, 2019.
111. Muhammad Aslam, Nasrullah Khan: A new variable control chart using neutrosophic interval method-an application to automobile industry. University of New Mexico: *Journal of Intelligent & Fuzzy Systems*, vol. 36, no. 3, pp. 2615-2623, 2019; DOI: 10.3233/JIFS-181767.
112. N Khan, L Ahmad, M Azam, M Aslam, F Smarandache, *Control Chart for Monitoring Variation Using Multiple Dependent State Sampling Under Neutrosophic Statistics*, in the book *Neutrosophic Operational Research* (eds. F. Smarandache, M. Abdel-Basset), *Springer*, pp 55-70, 10 September 2021, https://link.springer.com/chapter/10.1007/978-3-030-57197-9_4.
113. Rehan Ahmad Khan Sherwani, Muhammad Aslam, Muhammad Ali, Raza Muhammad, Farooq Muhammad, Abid Muhammad Tahir, Neutrosophic Normal Probability Distribution—A Spine of Parametric Neutrosophic Statistical Tests: Properties and Applications, in the book *Neutrosophic Operational Research* (eds. F. Smarandache, M. Abdel-Basset), *Springer*, pp 153-169, 10 September 2021, https://link.springer.com/chapter/10.1007/978-3-030-57197-9_8.
114. Rehan Ahmad Khan Sherwani, Muhammad Aslam, Huma Shakeel, Kamran Abbas, Farrukh Jamal, Neutrosophic Statistics for Grouped Data: Theory and Applications, in the book *Neutrosophic Operational Research* (eds. F. Smarandache, M. Abdel-Basset), *Springer*, pp 263-289, 10 September 2021, https://link.springer.com/chapter/10.1007/978-3-030-57197-9_14.
115. Arif, O.H., Aslam, M. A new sudden death chart for the Weibull distribution under complexity. *Complex Intell. Syst.* 7, 2093–2101 (2021), *Springer*, <https://doi.org/10.1007/s40747-021-00316-x>, <https://link.springer.com/article/10.1007/s40747-021-00316-x>
116. Wen-Qi Duan, Zahid Khan, Muhammad Gulistan, Adnan Khurshid, Neutrosophic Exponential Distribution: Modeling and Applications for Complex Data Analysis, *Complexity*, vol. 2021, Article ID 5970613, 8 pages, 2021. <https://doi.org/10.1155/2021/5970613>
117. Akber Abbasi, S., Abid, M., Riaz, M., & Nazir, H. Z. (2020). Performance evaluation of moving average-based EWMA chart for exponentially distributed process. *Journal of the Chinese Institute of Engineers*, 1-8.

118. Areepong, Y. (2012). Explicit formulas of average run length for a moving average control chart for monitoring the number of defective products. *International Journal of Pure and Applied Mathematics*, 80(3), 331-343.
119. Aslam, M. (2021). An insight into control charts using EWMA. *Communications in Statistics-Theory and Methods*, 1-5.
119. Aslam, M., Khan, N., & Jun, C.-H. (2015). A new S 2 control chart using repetitive sampling. *Journal of Applied Statistics*, 42(11), 2485-2496.
120. Aslam, M., Saghir, A., & Ahmad, L. (2020). *Introduction to statistical process control*: John Wiley & Sons.
121. Chen, J., Ye, J., & Du, S. (2017). Scale effect and anisotropy analyzed for neutrosophic numbers of rock joint roughness coefficient based on neutrosophic statistics. *Symmetry*, 9(10), 208.
122. Chen, J., Ye, J., Du, S., & Yong, R. (2017). Expressions of rock joint roughness coefficient using neutrosophic interval statistical numbers. *Symmetry*, 9(7), 123.
123. Hunter, J. S. (1986). The exponentially weighted moving average. *Journal of Quality Technology*, 18(4), 203-210.
124. Montgomery, D. C. (2007). *Introduction to statistical quality control*: John Wiley & Sons.
125. Woodall, W. H. (2022). Book review: Introduction to statistical process control: Introduction to statistical process control by Muhammad Aslam, Aamir Saghir and Liaquat Ahmad, John Wiley & sons, Hoboken, NJ, 2020. 304 pp. \$120.00 hardcover, ISBN 978-1-119-52845-6: Taylor & Francis.
126. Florentin Smarandache: Subtraction and Division of Neutrosophic Numbers, Critical Review, Vol. XIII, 2016, pp. 103-110, <http://fs.unm.edu/CR/SubtractionAndDivision.pdf>.
127. Woodall, W. H. (2022), Messages to F. Smarandache, M. Aslam and others, ResearchGate.net, September 2022.

Seminars on Neutrosophic Statistics

- S1. F. Smarandache, *History of Neutrosophic Set, Logic, Probability and Statistics and their Applications*, Mathematics and Statistics Departments, King Abdulaziz University, Jeddah, Saudi Arabia, 19 December 2019.
- S2. F. Smarandache, *Neutrosophic Set and Logic / Interval Neutrosophic Set and Logic / Neutrosophic Probability and Neutrosophic Statistics / Neutrosophic Precalculus and Calculus / Symbolic Neutrosophic Theory / Open Challenges of Neutrosophic Set*, lecture series, Nguyen Tat Thanh University, Ho Chi Minh City, Vietnam, 31st May - 3th June 2016.

- S3. F. Smarandache, *Neutrosophic Set and Logic / Interval Neutrosophic Set and Logic / Neutrosophic Probability and Neutrosophic Statistics / Neutrosophic Precalculus and Calculus / Symbolic Neutrosophic Theory / Open Challenges of Neutrosophic Set*, Ho Chi Minh City University of Technology (HUTECH), Ho Chi Minh City, Vietnam, 30th May 2016.
- S4. F. Smarandache, *Neutrosophic Set and Logic / Interval Neutrosophic Set and Logic / Neutrosophic Probability and Neutrosophic Statistics / Neutrosophic Precalculus and Calculus / Symbolic Neutrosophic Theory / Open Challenges of Neutrosophic Set*, lecture series, Vietnam national University, Vietnam Institute for Advanced Study in Mathematics, Hanoi, Vietnam, lecture series, 14th May – 26th May 2016.
- S5. F. Smarandache, *Foundations of Neutrosophic Logic, Set, Probability and Statistics and their Applications in Science. n-Valued Refined Neutrosophic Set, Logic, Probability and Statistics*, Universidad Complutense de Madrid, Facultad de Ciencia Matematicas, Departamento de Geometria y Topologia, Instituto Matematico Interdisciplinar (IMI), Madrid, Spain, 9th July 2014.

MISCELLANEA

Applications of Extenics to 2D-Space and 3D-Space

Florentin Smarandache, Victor Vlădăreanu

Florentin Smarandache, Victor Vlădăreanu (2012). Applications of Extenics to 2D-Space and 3D-Space. SKIMA, Chengdu, China, Track 7: Intelligent & Informed, 4

Abstract. In this article one proposes several numerical examples for applying the extension set to 2D- and 3D-spaces. While rectangular and prism geometrical figures can easily be decomposed from 2D and 3D into 1D linear problems, similarly for the circle and the sphere, it is not possible in general to do the same for other geometrical figures.

Key words. Extenics, extension engineering, contradictory problems, computational and artificial intelligence

I. INTRODUCTION

EXTENICS has been used since 1983 by Cai Wen and many other Chinese scholars in solving contradictory problems.

The distance between a number and a set, and the degree of dependence of a point with respect to a set were defined for the one-dimensional space, and later for higher dimensional spaces. We present below several examples in 2D and 3D spaces.

2. APPLICATION 1.

We have a factory piece whose desired 2D-dimensions should be 20 cm × 30 cm, and acceptable 2D-dimensions 22 cm × 34 cm. We define the extension 2D-distance, and then we compute the extension 2D-dependent function. Let's do an extension diagram:

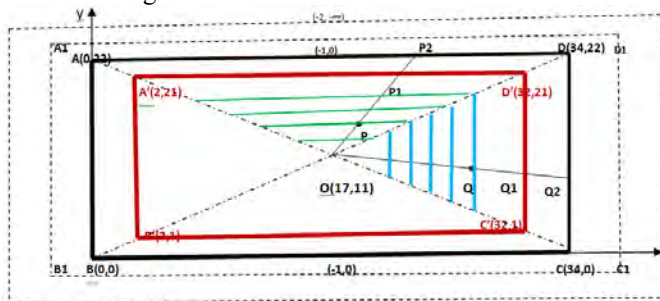

Diagram 1.

We have a desirable factory piece A'B'C'D' and an acceptable factory piece ABCD. The optimal point for both of them is O(17,11).

a) The region determined by the rays OA and OD.

The extension 2D-distance ρ between a point P and a set is the \pm distance from P to the closest frontier of the set, distance measured on the line OP. Whence

$$\rho(P, A'B'C'D') = -|PP_1| \quad (1)$$

and

$$\rho(P, ABCD) = -|PP_2|. \quad (2)$$

The extension 2D-dependent function k of a point P which represents the dependent of the point of the nest of the two sets is:

$$k(P) = \pm \frac{\rho(P, \text{bigger_set})}{\rho(P, \text{bigger_set}) - \rho(P, \text{smaller_set})} = \pm \frac{\rho(P, ABCD)}{\rho(P, ABCD) - \rho(P, A'B'C')} = \pm \frac{|PP_2|}{|PP_2| - |PP_1|} = \pm \frac{|PP_2|}{|P_1P_2|} \quad (3)$$

In other words, the extension 2D-dependent function k of a point P is the 2D-extension distance between the point and the closest frontier of the larger set, divided by the 2D-extension distance between the frontiers of the two nested sets; all these 2D-extension distances are taken along the line OP.

In our application one has:

$$k(P) = + \frac{|PP_2|}{|P_1P_2|} \quad (4)$$

since P is inside of the larger set. If P was outside of the larger set, then k(P) would be negative.

Let's consider the coordinates of P(x₀, y₀), where P is between the rays OA and OD in order to make sure OP intersects the line segments AD and A'D' which are closest frontiers of the rectangles ABCD and respectively A'B'C'D'. {The problem would be similar if P was in between the rays OB and OC.} Hence y₀ ∈ (11, ∞] but such y₀ that remains in between the rays OA and OD.

Let's find the coordinates of P₁.

In analytical geometry the equation of line OP passing through two points, O(17,11) and P(x₀, y₀), is:

$$y - 11 = \frac{y_0 - 11}{x_0 - 17} (x - 17). \quad (5)$$

Since the y-coordinate of P₁ is 21, we replace y = 21 in the above equation and we get the x-coordinate of P₁.

Whence one has

$$P_1\left(\frac{10x_0 + 17y_0 - 357}{y_0 - 11}, 21\right).$$

Let's find the coordinates of P_2 . The y-coordinate of P_2 is 22. Replace $y = 22$ in equation (2) and solve for the x-coordinate of P_2 .

One gets

$$P_2\left(\frac{11x_0 + 17y_0 - 374}{y_0 - 11}, 22\right).$$

The classical distance in 2D-space between two points $M(m_1, m_2)$, $N(n_1, n_2)$ is

$$d(M, N) = \sqrt{(m_1 - n_1)^2 + (m_2 - n_2)^2}. \quad (6)$$

We compute the classical 2D-distances $d(P, P_2)$ and $d(P_1, P_2)$.

$$\begin{aligned} k(P) &= \pm \frac{|PP_2|}{|P_1P_2|} = \pm \frac{\sqrt{\left(\frac{11x_0 + 17y_0 - 374}{y_0 - 11} - x_0\right)^2 + (22 - y_0)^2}}{\sqrt{\left(\frac{11x_0 + 17y_0 - 374}{y_0 - 11} - \frac{10x_0 + 17y_0 - 357}{y_0 - 11}\right)^2 + (22 - 21)^2}} \\ &= \pm \frac{\sqrt{\left(\frac{22x_0 + 17y_0 - x_0y_0 - 374}{y_0 - 11}\right)^2 + (y_0 - 22)^2}}{\sqrt{\left(\frac{x_0 - 17}{y_0 - 11}\right)^2 + 1}} = \pm \frac{\sqrt{\frac{(x_0 - 17)^2(y_0 - 22)^2}{(y_0 - 11)^2} + (y_0 - 22)^2}}{\sqrt{\frac{(x_0 - 17)^2}{(y_0 - 11)^2} + 1}} \\ &= \pm |y_0 - 22| = \begin{cases} 22 - y_0, & y_0 \in (11, 22] \\ 22 - y_0, & y_0 > 22 \end{cases} = 22 - y_0, y_0 > 11 \end{aligned} \quad (7)$$

and P in between the rays OA and OD .

Since the extension 2D-dependent function $k(x_0, y_0) = 22 - y_0$, for $y_0 > 11$, does not depend on x_0 for the region between rays OA and OD , one has classes of points lying on horizontal lines parallel to $A'D'$ (see the green line segments on *Diagram 1*) whose extension 2D-dependent function value is the same. For example, the green horizontal line segment passing through P is the class of points having the same extension 2D-dependent function value as point P .

- b) The region determined by the rays OC and OD .
 {Similar result would obtain if one gets the opposite region determined by the rays OA and OB .}

If one takes another region determined by the rays OC and OD and a point $Q(x_1, y_1)$ in between one gets

$$k(Q) = k(x_1, y_1) = \pm \frac{|QQ_2|}{|Q_1Q_2|} \quad (8)$$

By a similar method we find the Cartesian coordinates of the points Q_1 and Q_2 .

In analytical geometry the equation of line OQ passing through two points, $O(17, 11)$ and $Q(x_1, y_1)$, is:

$$y - 11 = \frac{y_1 - 11}{x_1 - 17}(x - 17). \quad (9)$$

Since the x-coordinate of Q_1 is 32, we replace $x = 32$ in the above equation and we get the y-coordinate of P_1 .

Whence one has $Q_1\left(32, \frac{11x_1 + 15y_1 - 352}{x_1 - 17}\right)$ (10)

Let's find the coordinates of Q_2 .

The x-coordinate of P_2 is 34. Replace $x=22$ in equation (3) and solve for the y-coordinate of Q_2 . One gets

$$Q_2\left(34, \frac{11x_1 + 17y_1 - 374}{x_1 - 17}\right). \quad (11)$$

We compute the classical 2D-distances $d(Q, Q_2)$ and $d(Q_1, Q_2)$.

$$\begin{aligned} k(P) &= \pm \frac{|QQ_2|}{|Q_1Q_2|} = \pm \frac{\sqrt{(34 - x_1)^2 + \left(\frac{11x_1 + 17y_1 - 374}{x_1 - 17} - y_1\right)^2}}{\sqrt{(34 - 32)^2 + \left(\frac{11x_1 + 17y_1 - 374}{x_1 - 17} - \frac{11x_1 + 15y_1 - 352}{x_1 - 17}\right)^2}} \\ &= \pm \frac{\sqrt{(x_1 - 34)^2 + \frac{(x_1 - 34)^2(y_1 - 11)^2}{(x_1 - 17)^2}}}{\sqrt{4 + \frac{4(y_1 - 11)^2}{(x_1 - 17)^2}}} = \pm \frac{|x_1 - 34|}{2} = \frac{34 - x_1}{2}, x_1 > 17 \end{aligned} \quad (12)$$

and Q in between the rays OC and OD .

Since the extension 2D-dependent function $k(x_1, y_1) = \frac{34 - x_1}{2}$, for $x_1 > 17$, does not depend on y_1 for the region

between rays OC and OD , one has classes of points lying on vertical lines parallel to $C'D'$ (see the red line segments on *Diagram 1*) whose extension 2D-dependent function value is the same. For example, the blue vertical line segment passing through Q is the class of points having the same extension 2D-dependent function value as point Q .

2. SPLITTING AN EXTENSION 2D-PROBLEM INTO TWO 1D-PROBLEMS.

Remarkably, for rectangular shapes one can decompose a 2D-problem into two 1D-problems. Yet, for other geometrical figures it is not possible. The more irregular geometrical figure, the less chance to decompose a 2D-problem into 1D-problems.

In our case, we separately consider the factory piece's width and length.

- 1) The width of a factory piece is desirable to be 20 cm and acceptable up to 22 cm.
- 2) And the length of a factory piece is desirable to be 30 cm and acceptable up to 34 cm.

In the first 1D-problem one makes the diagram:

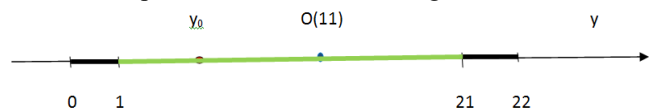

Diagram 2.

One computes, using Prof. Cai Wen's extension 1D-dependent function:

$$k(y_0) = \frac{|y_0-11| - \frac{22-0}{2}}{|y_0-11| - \frac{22-0}{2} - (|y_0-11| - \frac{21-1}{2})} = \frac{|y_0-11|-11}{-11+10} = 11 - |y_0-11| \tag{13}$$

If $y_0 > 11$ as in our 2D-space problem, then $k(y_0) = 22 - y_0$ which is consistent with what we got in the 2D case. In the second 1D-problem one makes the diagram:

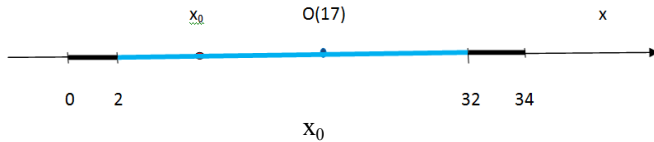

Diagram 3.

One computes, using Prof. Cai Wen's extension 1D-dependent function:

$$k(x_0) = \frac{|x_0-17| - \frac{34-0}{2}}{|x_0-17| - \frac{34-0}{2} - (|x_0-17| - \frac{32-2}{2})} = \frac{|x_0-17|-17}{-17+15} = \frac{|x_0-17|-17}{-2} = \frac{17-|x_0-17|}{2} \tag{14}$$

If $x_0 > 17$ as in our 2D-space problem, then

$$k(x_0) = \frac{34 - x_0}{2}, \text{ which is consistent with what we got in the 2D-case.}$$

Therefore, a 2D-extension problem involving rectangles is equivalent with two 1D-extension problems. Certainly this equivalence is not valid any longer if instead of rectangles we have more irregular geometrical figures representing factory pieces. Similarly will be possible for splitting a 3D-application for prisms into three 1D-applications, or into one 2D-application and one 1D-application.

3. REGION CRITICAL ZONE.

Critical Zone is the region of points where the degree of dependence of a point P with respect to a nest of two intervals $k(P) \in (-1, 0)$.

In the above figure, it is all area between the rectangles ABCD and $A_1B_1C_1D_1$.

$A_1B_1C_1D_1$ was constructed by drawing parallels to the sides of the rectangle ABCD, such that:

- The distance between the parallel lines $A'D'$ and AD, be the same with the distance between the parallel lines AD and A_1D_1 ;
- The distance between the parallel lines $A'B'$ and AB, be the same with the distance between the parallel lines AB and A_1B_1 ;
- The distance between the parallel lines $B'C'$ and BC, be the same with the distance between the parallel lines BC and B_1C_1 ;
- The distance between the parallel lines $C'D'$ and CD,

be the same with the distance between the parallel lines CD and C_1D_1 .

One then extend the construction of a net of included rectangles $A_iB_iC_iD_i \subset A_{i+1}B_{i+1}C_{i+1}D_{i+1}$ and for the points P_{i+1} lying on surface in between the rectangles $A_iB_iC_iD_i$ and $A_{i+1}B_{i+1}C_{i+1}D_{i+1}$ the dependent function $k(P_{i+1}) \in (-i-1, -i)$.

4. APPLICATION IN THE 3D-SPACE.

A factory piece has the desirable dimensions 20x30x7 but the acceptable factory piece can be 22x34x10 (in centimeters). The red prism is the desirable form, and the green prism is the acceptable form.

We consider a Cartesian system XYZ and the vertexes of these two prisms are:

$A(0,22,0)$, $B(0,0,0)$, $C(34,0,0)$, $D(34,22,0)$, $E(0,22,10)$, $F(0,0,10)$, $G(34,0,10)$, $H(34,22,10)$;

$A'(2,21,3)$, $B'(2,1,3)$, $C'(32,1,3)$, $D'(32,21,3)$, $E'(2,21,7)$, $F'(2,1,7)$, $G'(32,1,7)$, $H'(32,21,7)$.

$O(17,11,5)$; $P(x_0, y_0, z_0)$, $P'(x_1, y_1, 7)$, $P''(x_2, y_2, 10)$;

$Q(17,11,z_0)$, $Q'(17,11,7)$, $Q''(17,11,10)$. (15)

The following triangles are similar: $\triangle QOP$, $\triangle Q'OP'$, $\triangle Q''OP''$.

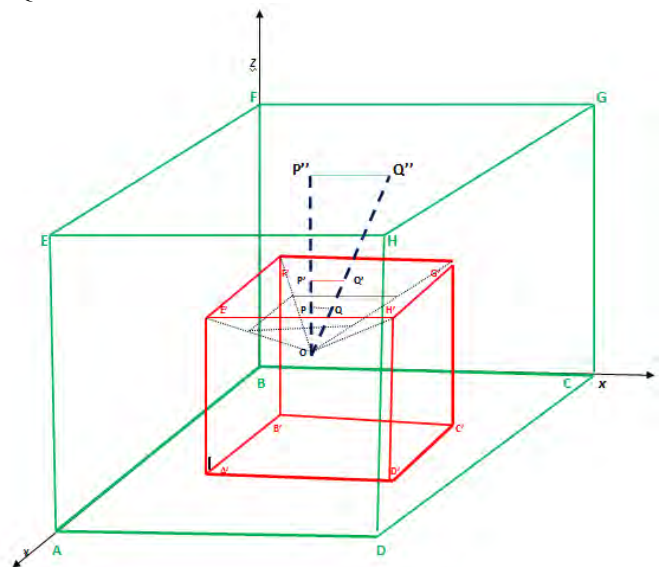

Diagram 4.

Using similarity of triangles, Thales Theorem, and proportionalizations we get that:

$$\frac{|PP''|}{|P'P''|} = \frac{|QQ''|}{|Q'Q''|}$$

which is equivalent to the equality of dependent function values

$$\text{of } k(P) = k(Q),$$

since

$$k(P) = \pm \frac{\rho(P, ABCDEFGH)}{\rho(P, ABCDEFGH) - \rho(P, A'B'C'D'E'F'G'H')} = \pm \frac{|PP''|}{|PP''| - |PP''|} = \pm \frac{|PP''|}{|P'P''|} \tag{16}$$

and similarly:

$$k(Q) = \pm \frac{\rho(Q, ABCDEFGH)}{\rho(Q, ABCDEFGH) - \rho(Q, A'B'C'D'E'F'G'H')} = \pm \frac{|QQ''|}{|QQ''| - |QQ''|} = \pm \frac{|QQ''|}{|Q'Q''|} \tag{17}$$

Therefore, the plane which passes through the point P and is parallel with the planes $EFHG$ and $E'F'G'H'$ (limited by the lines OE' , OF' , OG' , OH') is the locus of points having the same dependent function value.

$k(P) = \frac{z_0 - 10}{3}$ for $z_0 > 5$ and point P inside the reversed pyramid $OEFGH$.

5. CRITICAL ZONE.

The Critical Zone, whose dependent function of each point in this zone belongs to $(-1, 0)$, will be a larger prism $A_1B_1C_1D_1E_1F_1G_1H_1$ which envelopes the prism $ABCDEFGH$ at the same distance from each face as it was between the prisms $A'B'C'D'E'F'G'H'$ and $ABCDEFGH$. Therefore, the distance between faces $A'B'C'D'$ and $ABCD$ is the same as the distance between faces $ABCD$ and $A_1B_1C_1D_1$; and the faces $A'B'C'D'$ and $ABCD$ and $A_1B_1C_1D_1$ are parallel. Similarly for all six faces of the prism $A_1B_1C_1D_1E_1F_1G_1H_1$: the distance between faces $A'E'H'D'$ and $AEHD$ is the same as the distance between faces $AEHD$ and $A_1E_1H_1D_1$; and the faces $A'E'H'D'$ and $AEHD$ and $A_1E_1H_1D_1$ are parallel, etc.

One can construct a net of such prisms: $A_{i+1}B_{i+1}C_{i+1}D_{i+1}E_{i+1}F_{i+1}G_{i+1}H_{i+1} \supset A_iB_iC_iD_iE_iF_iG_iH_i$ where the value of the dependent function for the points which belong to $Int(A_{i+1}B_{i+1}C_{i+1}D_{i+1}E_{i+1}F_{i+1}G_{i+1}H_{i+1} - A_iB_iC_iD_iE_iF_iG_iH_i)$ is in the interval $(-i-1, -i)$, while for the points lying on the $Fr(A_{i+1}B_{i+1}C_{i+1}D_{i+1}E_{i+1}F_{i+1}G_{i+1}H_{i+1})$ the dependent function is $-i-1$. One considers $ABCDEFGH$ as $A_0B_0C_0D_0E_0F_0G_0H_0$, and $A'B'C'D'E'F'G'H'$ as $A_1B_1C_1D_1E_1F_1G_1H_1$ for the rule to work for all included prisms.

6. SPLITTING A 3D-PROBLEM INTO THREE 1D-PROBLEM.

Similarly to the previous 2D-problem, we separately consider the factory piece's width, length, and height.

- 1) The width of a factory piece is desirable to be 20 cm and acceptable up to 22 cm.
- 2) And the length of a factory piece is desirable to be 30 cm and acceptable up to 34 cm.
- 3) And the height of a piece factory is desirable to be 7

cm and acceptable 10 cm.

In the first 1D-problem one makes the diagram:

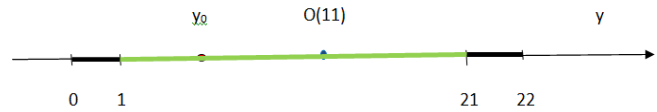

Diagram 5.

One computes, using Prof. Cai Wen's extension 1D-dependent function:

$$k(y_0) = 11 - |y_0 - 11| \tag{18}$$

In the second 1D-problem one makes the diagram:

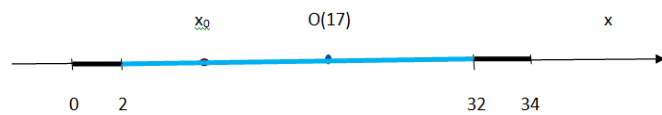

Diagram 6.

In the third 1D-problem one makes the diagram:

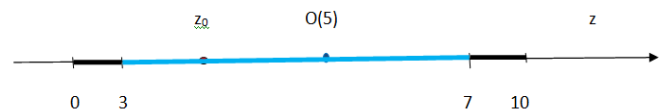

Diagram 7.

One computes, using Prof. Cai Wen's extension 1D-dependent function:

$$k(z_0) = \frac{z_0 - 10}{3} \tag{19}$$

7. SPLITTING A 3D-PROBLEM INTO A 2D-PROBLEM AND A 1D-PROBLEM.

Similarly to the previous 2D-problem, we separately consider the factory piece's width, length, and height.

- 1) The factory 2D-piece is desirable to be 20x30 cm and acceptable up to 22x34 cm.
- 2) And the height of a piece factory is desirable to be 7 cm and acceptable 10 cm.

8. A 2D-PROBLEM WHICH IS SPLIT INTO ONLY ONE 1D-PROBLEM.

Assume the desirable circular factory piece radius is 6 cm and acceptable is 8 cm.

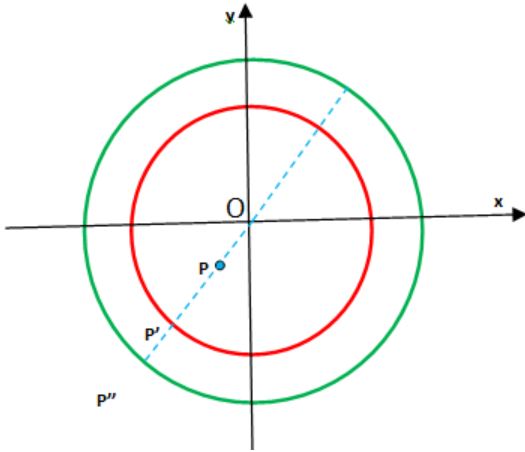

Diagram 8.

It is equivalent to a 1D-problem which has the diagram:



Diagram 9.

One computes, using Prof. Cai Wen’s extension 1D-dependent function:

$$k(x_0) = \frac{x_0}{2} \quad (20)$$

9. A 2D-PROBLEM WHICH CANNOT BE SPLIT INTO 1D-PROBLEMS.

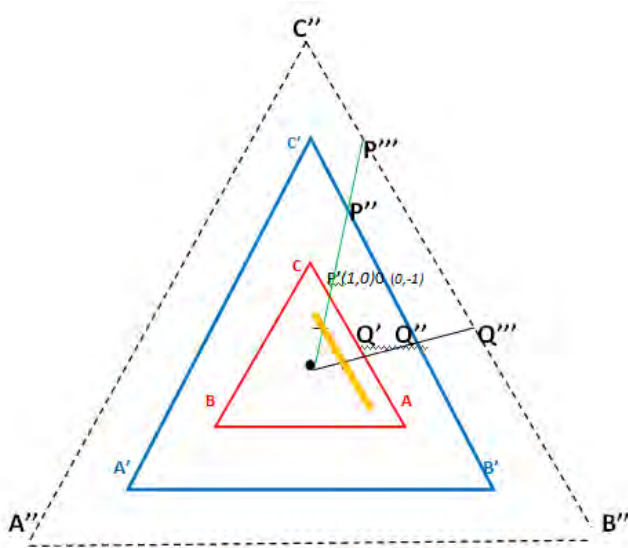

Diagram 10.

1. The **Critical Zone** is between the blue triangle $A'B'C'$ and the black dotted triangle $A''B''C''$. Points lying on lines parallel to the red triangle’s sides have the same dependence function value (for example the points lying on the orange line segment).

References:

[1] Cai Wen. Extension Set and Non-Compatible Problems [J]. Journal of Scientific Exploration, 1983, (1): 83-97.
 [2] Yang Chunyan, Cai Wen. Extension Engineering [M]. Beijing: Public Library of Science, 2007.
 [3] F. Smarandache, Generalizations of the Distance and Dependent Function in Extenics to 2D, 3D, and n-D. vixra.org, <http://vixra.org/abs/1206.0014> and <http://vixra.org/pdf/1206.0014v1.pdf>, 2012.

On Global corporate control and Federal Reserve between 2007-2010

Victor Christianto, Florentin Smarandache

Victor Christianto, Florentin Smarandache (2015). On Global corporate control, Federal Reserve, and the Great Theft 2007-2010. *Journal of Research in Economics and International Finance* 4(2), 6; DOI: 10.14303/jrief.2015.109

ABSTRACT

A common intuition among scholars and in the media sees the global economy as being dominated by a handful of powerful transnational corporations (TNCs). However, such an assumption has not been confirmed by numerical data until recently, in a report by Vitali, Glattfelder, and Battiston [1]. They gave a list of 50 most elite TNCs, which were called “super-entity”, along with other 97 TNCs which were not mentioned in their list. This super-entity is supposed to be more powerful than the core, consisting of 1,318 corporations. In this paper we expose for the first time that Vitali et al.’s finding on these super-entity TNCs apparently does not match exactly with recipients of secret funds given by the Federal Reserve Bank of USA (the Fed) during 2007-2010. Therefore, it seems that more investigations are needed on the nature of the financial corporate which received secret funds from the Fed, because those recipients of fund from Fed appear to be more powerful than the 147 super-entity TNCs. Although we give references on several papers which outlined the implications of this finding to global economy, in this paper we give no prescription on how to improve the global economy architecture. We reserve this issue for a future paper.

Keywords: Global economy, Numerical data, Financial corporate, TNC

INTRODUCTION

In a series of papers based on network analysis, Vitali, Glattfelder and Battiston [1][2] described their findings of the network of global corporate that controls about 80% of the world profits. Vitali, Glattfelder, and Battiston gave a list of 50 most elite TNCs, which were called „super-entity”, along with other 97 TNCs which were not mentioned in their list. This super-entity is supposed to be more powerful than the „core”, consisting of 1,318 corporations.

In this paper we expose for the first time that Vitali et al.’s finding on these super-entity TNCs apparently does not match exactly with recipients of secret fund which was given by the Federal Reserve Bank (Fed) during 2007-2010. Therefore, it seems that more investigations are needed on the nature of the financial corporate which received secret fund from the Fed, because those recipients of funds from the Fed appear to be more powerful than the 147 super-entity TNCs discovered by

Vitali et al. [1].

Although we give references on several papers which outlined the implications of such a finding from network analysis to global economy [5][6], in this paper we give no prescription concerning how to improve the global economy architecture. We reserve that issue for a future paper.

The Network of Global Corporate control

Vitali et al., 2011 begin their paper with a remark as follows: [1]

“We present the first investigation of the architecture of the international ownership network, along with the computation of the control held by each global player. We find that transnational corporations form a giant bow-tie structure and that a large portion of control flows to a small tightly-knit core of financial institutions. This core

can be seen as an economic “super-entity” that raises new important issues both for researchers and policy makers.”

Then they conclude their paper as follows: [1, p.6]

“In contrast, we find that only 737 top holders accumulate 80% of the control over the value of all TNCs (see also the list of the top 50 holders in Tbl. S1 of SI Appendix, Sec. 8.3). This means that network control is much more unequally distributed than wealth. In particular, the top ranked actors hold a control ten times bigger than what could be expected based on their wealth.”

Previously, Glattfelder and Battiston remarked in a separate paper [2, p.20], as follows:

“However, in contrast to such intuition, our main finding is that a local dispersion of control is associated with a global concentration of control and value. This means that only a small elite of shareholders controls a large fraction of the stock market, without ever having been previously systematically reported on. Some authors have suggested such a result by observing that a few big US mutual funds managing personal pension plans have become the biggest owners of corporate America since the 1990s.”

David Wilcock [3] summarizes Vitali et al’s finding about the network of Global Corporate control as follows:

“To review, 80 percent of the world’s profits are being earned by a „core“ group of 1,318 corporations. As we look even deeper, we find this „core“ is mostly run by a “super-entity” of 147 companies that are totally interlocked. 75 percent of them are financial institutions. The top 20 companies in the “super-entity” include Barclays Bank, JP Morgan Chase and Co., Merrill Lynch, UBS, Bank of New York, Deutsche Bank and Goldman Sachs. The 147-part “super-entity” has controlling interest in the 1318-part “core”, which in turn has controlling interest in 80 percent of the world’s wealth.”

Therefore it appears that 80% of the world’s profit are being earned by a core group of 1,318 TNCs, which in turn these core TNCs are run by a super-entity of 147 companies. The Table S1 of S1 Appendix Sec. 8.3. in Vitali et al’s paper consists of 50 top TNCs which are mostly financial corporate, as follows [1, p.33]:

- 1 BARCLAYS PLC GB 6512 SCC 4.05
- 2 CAPITAL GROUP COMPANIES INC, THE US 6713 IN 6.66
- 3 FMR CORP US 6713 IN 8.94
- 4 AXA FR 6712 SCC 11.21
- 5 STATE STREET CORPORATION US 6713 SCC 13.02
- 6 JPMORGAN CHASE and CO. US 6512 SCC 14.55
- 7 LEGAL and GENERAL GROUP PLC GB 6603 SCC

- 16.02
- 8 VANGUARD GROUP, INC., THE US 7415 IN 17.25
- 9 UBS AG CH 6512 SCC 18.46
- 10 MERRILL LYNCH and CO., INC. US 6712 SCC 19.45
- 11 WELLINGTON MANAGEMENT CO. L.L.P. US 6713 IN 20.33
- 12 DEUTSCHE BANK AG DE 6512 SCC 21.17
- 13 FRANKLIN RESOURCES, INC. US 6512 SCC 21.99
- 14 CREDIT SUISSE GROUP CH 6512 SCC 22.81
- 15 WALTON ENTERPRISES LLC US 2923 TandT 23.56
- 16 BANK OF NEW YORK MELLON CORP. US 6512 IN 24.28
- 17 NATIXIS FR 6512 SCC 24.98
- 18 GOLDMAN SACHS GROUP, INC., THE US 6712 SCC 25.64
- 19 T. ROWE PRICE GROUP, INC. US 6713 SCC 26.29
- 20 LEGG MASON, INC. US 6712 SCC 26.92
- 21 MORGAN STANLEY US 6712 SCC 27.56
- 22 MITSUBISHI UFJ FINANCIAL GROUP, INC. JP 6512 SCC 28.16
- 23 NORTHERN TRUST CORPORATION US 6512 SCC 28.72
- 24 SOCIÉTÉ GÉNÉRALE FR 6512 SCC 29.26
- 25 BANK OF AMERICA CORPORATION US 6512 SCC 29.79
- 26 LLOYDS TSB GROUP PLC GB 6512 SCC 30.30
- 27 INVESCO PLC GB 6523 SCC 30.82
- 28 ALLIANZ SE DE 7415 SCC 31.32
- 29 TIAA US 6601 IN 32.24
- 30 OLD MUTUAL PUBLIC LIMITED COMPANY GB 6601 SCC 32.69
- 31 AVIVA PLC GB 6601 SCC 33.14
- 32 SCHRODERS PLC GB 6712 SCC 33.57
- 33 DODGE and COX US 7415 IN 34.00
- 34 LEHMAN BROTHERS HOLDINGS, INC. US 6712 SCC 34.43
- 35 SUN LIFE FINANCIAL, INC. CA 6601 SCC 34.82
- 36 STANDARD LIFE PLC GB 6601 SCC 35.2
- 37 CNCE FR 6512 SCC 35.57
- 38 NOMURA HOLDINGS, INC. JP 6512 SCC 35.92
- 39 THE DEPOSITORY TRUST COMPANY US 6512 IN 36.28
- 40 MASSACHUSETTS MUTUAL LIFE INSUR. US 6601 IN 36.63
- 41 ING GROEP N.V. NL 6603 SCC 36.96
- 42 BRANDES INVESTMENT PARTNERS, L.P. US 6713 IN 37.29
- 43 UNICREDITO ITALIANO SPA IT 6512 SCC 37.61
- 44 DEPOSIT INSURANCE CORPORATION OF JP JP 6511 IN 37.93
- 45 VERENIGING AEGON NL 6512 IN 38.25
- 46 BNP PARIBAS FR 6512 SCC 38.56

- 47 AFFILIATED MANAGERS GROUP, INC. US 6713
SCC 38.88
48 RESONA HOLDINGS, INC. JP 6512 SCC 39.18
49 CAPITAL GROUP INTERNATIONAL, INC. US 7414
IN 39.48
50 CHINA PETROCHEMICAL GROUP CO. CN 6511
TandT 39.78

Next we will see whether there is connection between the above 50 top TNCs and the recipients of the Fed's secret funds during 2007-2010.

The Great Theft by the Fed between 2007 - 2010

It is discovered after being audited by GAO, that the Fed secretly gave fund to a very short list of financial corporate both inside USA and from foreign countries, in a spectacular amount, i.e. about \$16,000,000,000,000 (sixteen trillions of US dollar). We propose to call that event as the Great Theft, because it is basically a massive theft of US tax payers' wealth during the financial crisis, when many middle-income families suffered.

According to O'Leary [4, p.13]

"A partial audit of a limited period of time - the first audit of any kind in its near 100 year history - took place in July 2011 when, as part of the Dodd-Frank reform legislation, the Fed was forced to reveal whom it had lent money to during the financial debacle beginning in late 2007. The audit was carried out by the General Accounting Office (GAO) and is available on-line. To say that its shocking findings have been under-reported by the media is a gross understatement."

"During the period December 1, 2007 through July 21, 2010 the Fed created sixteen trillion (\$16,000,000,000,000) dollars" worth of credit (loans) to US banks and corporations and (notwithstanding its supposed jurisdiction as an agency of the United States) to foreign banks. These were secret bailouts engineered to prevent the borrowers from insolvency or bankruptcy; the money was loaned at nearly zero percent (.01%) interest."

The recipients of the Fed's secret loan during 2007-2010 are as follows [4, p.14]:

- Citigroup, Inc (Citibank): \$2.5 trillion
*Morgan Stanley: \$2.04 trillion
*Merrill Lynch and Co.: \$1.949 trillion
*Bank of America Corporation: \$1.344 trillion
*Barclays PLC (United Kingdom): \$868 billion
Bear Stearns Companies, Inc.: \$853 billion
*Goldman Sachs Group, Inc.: \$814 billion

Royal Bank of Scotland PLC (UK): 541 billion

*JPMorgan Chase: \$391 billion

*Deutsche Bank AG (Germany): \$354 billion
United Bank of Switzerland AG: \$287 billion
Credit Suisse Group AG (Switzerland): \$262 billion
Lehman Brothers Holdings, Inc. - NYC: \$183 billion
Bank of Scotland PLC (UK): \$181 billion

*BNP Paribas SA (France): \$175 billion
Dexia SA (Belgium): \$105 billion
Wachovia Corporation: \$142 billion
Dresdner Bank AG (Germany): \$123 billion

*Societe Generale SA (France): \$124 billion

The asterisks (*) are intended to mark companies which also appear in the list of top 50 TNCs of Vitali et al. [1, p.33].

From the two lists above, we can conclude that there are 9 (nine) out of 19 (nineteen) recipients of the Fed's money between 2007-2010, which also appear in the Vitali et al.'s list of top 50 TNCs. Therefore we can also conclude that apparently the Fed is behind almost all of the top 50 TNCs. That is why some people think that the Fed is the most powerful private entity all over the world.

DISCUSSION

The owners of the Fed remain mystery, although from history it is known that the Fed was formed after a Jekyll Island meeting.

"The Federal Reserve System was allegedly conceived at a secretive, confidential "duck hunting" Jekyll Island meeting of people related to J. P. Morgan, Kuhn, Loeb and Company, the Rothschilds, the Rockefellers, and the Warburgs." [7, p.22]

However in recent years, there have been enough leaks to confirm the identities of the key banking families who founded the Federal Reserve [3, p.37]. J. W. McCallister, an oil industry insider with House of Saud connections, wrote in The Grim Reaper that information he acquired from Saudi bankers cited 80% ownership of the New York Federal Reserve Bank- by far the most powerful Fed branch- by just eight families, four of which reside in the US.

They are the Goldman Sachs, Rockefellers, Lehmans and Kuhn Loeb's of New York; the Rothschilds of Paris and London; the Warburgs of Hamburg; the Lazards of Paris; and the Israel Moses Seifs of Rome.

CPA Thomas D. Schauf corroborates McCallister's claims, adding that ten banks control all twelve Federal Reserve Bank branches.

He names N.M. Rothschild of London, Rothschild Bank of Berlin, Warburg Bank of Hamburg, Warburg Bank of Amsterdam, Lehman Brothers of New York, Lazard

Brothers of Paris, Kuhn Loeb Bank of New York, Israel Moses Seif Bank of Italy, Goldman Sachs of New York and JP Morgan Chase Bank of New York.

Schauf lists William Rockefeller, Paul Warburg,

Jacob Schiff and James Stillman as individuals who own large shares of the Fed. The Schiffs are insiders at Kuhn Loeb. The Stillmans are Citigroup insiders, who married into the Rockefeller clan at the turn of the century.

According to O'Leary [4, p.5]

"To begin with, the Federal Reserve system is neither Federal nor does hold its own capital as bank "reserves". The Federal Reserve is a private institution owned by private bankers which has no reserves other than what it creates for itself . . . out of nothing."

O'Leary continues [4, p.6]

"The Federal Reserve Act, passed by Congress just prior to its annual Christmas recess on December 22, 1913, was signed into law the very next day by President Woodrow Wilson. It transferred the right to print currency from the United States sovereign government to a bank which is quasi-federal in form but private in operation. The Fed was created by the powers of international capital, known in the 19th century as The Money Trust, and given a clever but deceptive name which disguises the fact that it is a private money monopoly owned by its member banks but controlled by a handful of super-banks which are conveniently described as "too big to fail"."

Furthermore he writes [4, p.7]

"The larger the member bank, the more Federal Reserve corporate stock it owns, the greater degree of control it exercises over the Fed's policies. The major New York banks own a majority share of the Fed. Since Federal Reserve Banks are not governmental agencies, their employees do not fall under Federal Civil Service."

Now we know that it is possible that the Fed is owned by a handful of very powerful international banks, which also may form the „super-entity" group, as reported by Vitali et al. [1].

O'Leary also explains why the Fed was never audited.

"The secrecy surrounding the operations of the Federal Reserve is phenomenal. Its actions are even more secret than the CIA's. The Federal Reserve System has never been audited. This bears repetition: the Federal Reserve has never been subject to a full and complete independent audit. No government official has the power to require the Fed to open up its books to public scrutiny. The only power the government has is to modify the Fed's charter by an act of Congress. Attempts to legislate a full and complete audit have always been vehemently opposed by the "powers that be". [4, p.13]

Since money created by the Fed is not backed up by anything except by the US Government and all US

citizens, they are called „fiat money". According to Hoppe [8, p.64]:

"Since abolishing the last remnants of the gold commodity money standard, he realizes, inflationary tendencies have dramatically increased on a world-wide scale; the predictability of future price movements has sharply decreased; the market for long-term bonds (such as consols) has been largely wiped out; the number of investment and "hard money" advisors and the resources bound up in such businesses have drastically increased; money market funds and currency futures markets have developed and absorbed significant amounts of real resources which otherwise-without the increased inflation and unpredictability-would not have come into existence at all or at least would never have assumed the same importance that they now have; and finally, it appears that even the direct resource costs devoted to the production of gold accumulated in private hoards as a hedge against inflation have increased."

In the last analysis, if money is created by the Fed without permission of US Congress, then it can be called as an act of theft.

"In history, sovereigns and states have stolen the wealth of their subordinates and citizens a zillion of times, and they will do so again and again if they consider it necessary. Often monetary policy and instruments effectively amount to more or less obvious ways to plunder the public." [7]

Now we can conclude that not only 9 out of 19 TNCs are recipients of the Fed's secret loans between 2007-2010, but they also belong to the top 50 „super-entity" list of Vitali et al [1]. Therefore we can conclude that they participate in the Great Theft act of the Fed, and the Fed is at the center of this massive fraud of US economy. Now it seems that this discovery demands thorough investigations on the Fed's part and also on the nineteen recipients of secret loans from the Fed between 2007-2010.

One thing should be kept in mind, that the Fed has become the center of the problem, that is why it will lead to financial crises in the future, especially if the financial integration will be implemented. As concluded by Stiglitz [12], a full financial integration may be not desirable. Stiglitz also writes that the "centralized" lending architecture may be more vulnerable to shocks to the "centers" (illustrated by the global impact of the US credit crisis) [12].

CONCLUSION

In accordance with David Wilcock [3] and O'Leary [4], there was the Great Theft event, when the Fed secretly gave funds to US and foreign financial companies, at breathtaking amount of trillions of US dollar.

The fiat money created by the Fed is deeply flawed [7][8][10][11]. Another flaw is the fractional reserve

banking (FRB) practice all over the world, which only leads to great business cycles and crises. The fractional reserve banking system is defined as one in which only a fraction of the demand deposits are held in reserve; the remainder is in the form of long term loans, or illiquid assets [10, p.46]. There is a singular group of economists who concede that all FRB systems that have ever existed may have been equivalent to theft [10, p.47].

This problem of FRB has been discussed by many economists especially from Austrian school; see for instance [9], [10] and [11]. The crises in Cyprus can be tracked by to this FRB practice (see Appendix). If this tendency of FRB practice continues, it only leads to hyperinflation. According to Hoppe [8, p.59]:

“The result would be hyperinflation. No one would accept paper money anymore, and a flight into real values would set in. The monetary economy would break down completely and society would revert back to a primitive, highly inefficient barter economy. Out of barter then, once again a new (most likely a gold) commodity money would emerge (and the note producers once again, so as to gain acceptability for their notes, would begin backing them by this money).”

A number of solutions have been offered by economists in order to find a way out of the many crises and business cycles; to mention a few of them:

Applying theories of complex systems into economics, especially in order to assist decision makers[6].

Going back to gold-backed currency, which is perhaps not so realistic; see [7][11]. According to Hoppe [8,p.74]: “Only a system of universal commodity money (gold), competitive banks, and 100 percent reserve deposit banking with a strict functional separation of loan and deposit banking is in accordance with justice, can assure economic stability and represents a genuine answer to the current monetarist fiasco.”

Going to full-reserve banking, this is also not so realistic; see [11].

Accepting the nature of business cycles and repeating financial crises, as promoted by Svozil [7]. This means that someday there will be a Great Crash as a consequence [11].

According to some analysts, there is no solution to the present problems of world economy; see [11]. This seems to support Svozil’s argument that there is no alternative to present situation of the fiat money and fractional reserve banking: “Thus, for pragmatic reasons, the only remaining alternative appears to be fiat money not directly backed by any commodity.” [7, p.4]

Note: This paper is not intended to give a prescription on how to improve the global economy architecture. We leave this issue to a future paper.

REFERENCES

- [1]. Vitali S, Glattfelder JB, Battiston S (2011). The network of global corporate control, arXiv:1107.5728 [q-fin.GN] 36p., URL: <http://arxiv.org/pdf/1107.5728.pdf> ; [1a] J.B. Glattfelder, <http://www.newscientist.com/article/mg21228354.500-revealed--the-capitalist-network-that-runs-the-world.html>
- [2]. Glattfelde JB, Battiston S (2009) Backbone of complex network of corporations: The flow of control, Physical Review E 80, 2009, also available at arXiv:0902.0878 [q-fin.GN] 24p., URL: <http://arxiv.org/pdf/0902.0878.pdf>
- [3]. Wilcock D (2012). Financial Tyranny: Defeating the Greatest Cover-up of all time, February 13, 2012, URL: http://www.vigil.org/FINANCIAL_TYRANNY_Defeating_the-Greatest_Cover-Up_of_All_Time_David-Wilcock_Feb-13-2012.pdf, [3a] see also: <http://divinecosmos.com/start-here/davids-blog/1023-financial-tyranny>
- [4]. O’Leary PV (2012). The Federal Reserve System, Fiat Money and Fractional Reserve Banking, URL: http://www.perseus.ch/wp-content/uploads/2012/03/The_Federal_Reserve_System.pdf
- [5]. Krause SM, Peixoto TP, Bornholdt S (2013). Spontaneous centralization of control in a network of company ownerships, URL: <http://arxiv.org/pdf/1306.3422.pdf>
- [6]. Doyne Farmer J et al. (2012). A complex systems approach to constructing better models for managing financial markets and the economy, Eur. Phys. J. Special Topics 214, 295–324, 2012, URL: <http://www.allariz.uc3m.es/~anxosanchez/ep/EconFinancialFuturITC16.pdf>
- [7]. Svozil K (2008). An apology for money. arXiv: 0811.3130 [q-fin.GN]. URL: <http://arxiv.org/pdf/0811.3130v6.pdf>
- [8]. Hoppe HH (1994). How is fiat money possible? – or, the Devolution of Money and Credit, The Review of Austrian Economics Vol.7, No.2, 1994:49-74, URL: http://mises.org/journals/rae/pdf/rae7_2_3.pdf
- [9]. Rothbard M (2008). The Mystery of Banking. 2nd ed. Auburn, Ala.: Ludwig von Mises Institute, 2008. URL: <http://mises.org/books/mysteryofbanking.pdf>
- [10]. Block M (1988). “Fractional Reserve Banking: An Interdisciplinary Perspective,” in Man, Economy, and Liberty: Essays in Honor of Murray N. Rothbard, Walter Block and Llewellyn H. Rockwell, Jr., eds., Auburn, Ala.: Ludwig von Mises Institute, 1988
- [11]. URL: http://wiki.mises.org/wiki/Criticism_of_fractional_reserve_banking
- [12]. Stiglitz JE (2010). Risk and Global Economic Architecture: Why Full Financial Integration May Be Undesirable, Am. Econ. Rev. Papers and Proceedings 100 (May 2010): 388–392, URL: [www.aeaweb.org/articles.php?doi=10.1257/aer.100\(2\):388](http://www.aeaweb.org/articles.php?doi=10.1257/aer.100(2):388).

Appendix:

Source: <http://www.zerohedge.com/news/2013-03-31/visualization-modern-fractional-reserve-banking-and-how-cyprus-fits>

How Cyprus Exposed The Fundamental Flaw Of Fractional Reserve Banking Submitted by Tyler Durden on 03/31/2013 18:03 -0400

In the past week much has been written about the emerging distinction between the Cypriot Euro and the currency of the Eurozone proper, even though the two are (or were) identical. The argument goes that all €'s are equal, but those that are found elsewhere than on the doomed island in the eastern Mediterranean are more equal than the Cypriot euros, or something along those lines. This of course, while superficially right, is woefully inaccurate as it misses the core of the problem, which is a distinction between electronic currency and hard, tangible banknotes. Which is why the capital controls imposed in Cyprus do little to limit the distribution and dissemination of electronic payments within the confines of the island (when it comes to payments leaving the island to other jurisdictions it is a different matter entirely), and are focused exclusively at limiting the procurement and allowance of paper banknotes in the hands of Cypriots (hence the limits on ATM and bank branch withdrawals, as well as the hard limit on currency exiting the island).

In other words, what the Cyprus fiasco should have taught those lucky enough to be in a net equity position vis-a-vis wealth (i.e., have cash savings greater than debts) is that suddenly a €100 banknote is worth far more than €100 in the bank, especially if the €100 is over the insured €100,000 limit, and especially in a time of ZIRP when said €100 collects no interest but is certainly an impairable liability if and when the bank goes tits up.

Said otherwise, there is now a very distinct premium to the value of hard cash over electronic cash.

And while this is true for Euros, it is just as true for US Dollars, Mexican Pesos, Iranian Rials and all other currencies in a fiat regime.

Which brings us to the crux of the issue, namely fractional reserve banking, or a system in which one currency unit in hard fiat currency can be re-deposited with the bank that created it (as a reminder in a fiat system currency is created at the commercial bank level: as the Fed itself has made quite clear, "The actual process of money creation takes place primarily in banks") to be lent out and re-re-deposited an (un)limited number of times, until there is a literal pyramid of liabilities and obligations lying on top of every dollar, euro, or whatever other currency, is in circulation. The issue is that the bulk of such obligations are electronic, and in its purest form, a bank run such as that seen in Cyprus, and pre-empted with the imposition of the first capital controls in the history of the Eurozone, seeks to convert electronic deposits into hard currency.

Alas, as the very name "fractional reserve banking" implies, there is a very big problem with this, and is why every bank run ultimately would end in absolute disaster and the collapse of a fiat regime, hyperinflation, and systemic bank and sovereign defaults, war, and other un-pleasantries, if not halted while in process.

Why?

One look at the chart below should be sufficient to explain this rather problematic issue of a broken banking system in which trust is evaporating faster than Ice Cubes in the circle of hell reserved for economist PhD's.

A Quarter of Century for Octagon Mathematical Magazine

Dedicated to the 25 years of Octagon Mathematical Magazine

Florentin Smarandache

Florentin Smarandache (2017). A Quarter of Century for Octagon Mathematical Magazine. Dedicated to the 25 years of Octagon Mathematical Magazine. Octagon Mathematical Magazine 25(2), 6

The mathematics professor and prolific creator Mihail Bencze dedicated from his whole soul to the scientific and pedagogical activity. A great organizer for high school and university students, as well as for researchers, and a permanent passionate, he attracted in his ring of contributors to the Gamma journal (as it was named before 1989) of Tractorul College of Brasov, Romania, and later called Octagon Mathematical Journal, high collaborators from around the world. I had the honor to publish math papers and proposed problems too. Now, at a quarter of century (1993-2017), we wish to the editor-in-chief and his new Octagon Mathematical Magazine, by deviating a little a Latin aphorism (life is short, but the art is long) as: *vita brevis, longa scientia!*

On the Efficacy of High-dose Ascorbic Acid as Anticancer Treatment: A Literature Survey

Victor Christianto, Florentin Smarandache

Victor Christianto, Florentin Smarandache (2018). On the Efficacy of High-dose Ascorbic Acid as Anticancer Treatment: A Literature Survey. *BAOJ Cancer Research & Therapy* 4:2, 4

Abstract

Vitamin C (ascorbic acid, ascorbate) has a controversial history in cancer treatment. Emerging evidence indicates that ascorbate in cancer treatment deserves re-examination. As research results concerning ascorbate pharmacokinetics and its mechanisms of action against tumor cells have been published, and as evidence from case studies has continued to mount that ascorbate therapy could be effective if the right protocols were used, interest among physicians and scientists has increased.

Key Words: Vitamin C; Antioxidant; Anticancer

Introduction

Ascorbic acid (vitamin C, ascorbate) has been shown to protect cells against various types of oxidant injury at physiologically relevant concentrations. Vitamin C has been suggested as having both a preventative and therapeutic role in a number of pathologies when administered at much higher-than-recommended dietary allowance levels. Despite some initial skepticism on the use and efficacy of high-dose Vitamin C as anticancer treatment, some recent findings seem to support such a practice. Here we will survey some recent literatures around this controversial topic. There is even one book devoted to the use of Vitamin C for anticancer [1].

Vitamin C (ascorbic acid, ascorbate) has been well documented to reduce the incidence of most malignancies in humans. What has been hotly debated is whether vitamin C has any therapeutic effect in the treatment of cancer. Cameron and Pauling reported in 1976 and 1978 that highdose vitamin C (typically 10 g/day, by intravenous infusion for about 10 days and orally thereafter) increased the average survival of advanced cancer patients and for a small group of responders, survival was increased to up to 20 times longer than that of controls [2]. According to Cameron and Pauling, results of the use of Vitamin C to extend live of patients are encouraging. See table 1 below.

(after Cameron & Pauling [2])

Other researchers reported benefit consisting of increased survival, improved well-being and reduced pain. However, two randomized clinical trials with oral ascorbate conducted by the Mayo Clinic showed no benefit. These negative results dampened, but did not permanently extinguish, interest in ascorbate therapy or research. Some research groups conducted rigorous research, particularly in the area of administering mega-doses of ascorbate intravenously [3].

History

A more complete historical account of Vitamin C can be found in Gonzalez & Miranda-Massari [1].

Such an early development around 60s and 70s have been supported by later findings, therefore the use of highdose Vitamin C for anticancer purpose has become more or less accepted. But the remaining question is: what are the exact mechanism of Vitamin C as anticancer agent?

TABLE 1
Differences in Average Survival Times of Ascorbate-Treated Patients and Matched Controls

Primary Tumor Type	Number of Patients		Mean survival times (days)				Increased survival times of ascorbate-treated patients (days)		
	Test	Controls	Measured from date of first hospital attendance	Measured from date of "untreatability"	Measured from date of first hospital attendance	Measured from date of "untreatability"	A-B	C-D	G
Colon	17	170	458+	316	352+	33	142+	319+	324+
Bronchus	17	170	219+	118	186+	31	101+	155+	184+
Stomach	13	130	286+	159	182+	32	127+	150+	134+
Breast	11	110	1396+	1020	487+	52	376+	435+	378+
Kidney	8	80	774+	492	381+	39	282+	342+	348+
Bladder	7	70	1669+	420	355+	21	1249+	334+	226+
Rectum	7	70	634	336	270	43	298	227	247+
Ovary	6	60	884	366	183	69	518	114	157+
Others	14	140	706+	279	278+	37	427+	241+	189+
All	100	1000	681+	360	293+	38	321+	255+	234+

A. Mean survival time for ascorbate-treated patients measured from date of first hospital attendance. B. Corresponding time for controls. C. Mean survival time for ascorbate-treated patients measured from date of "untreatability." D. Corresponding time for controls. E. Additional survival time of ascorbate-treated patients, A-B. F. Additional survival time of ascorbate-treated patients, C-D. G. Additional survival time of first set of ascorbate-treated patients with first set of controls, ref. 1, to May 15, 1978, when seven were still living (measured from the date of "untreatability").

Figure 1: Differences of Average Survival Times of Ascorbate-treated Patients

Pharmacokinetics

According to Mikirova et al.

“Vitamin C is water-soluble, and is limited in how well it can be absorbed when given orally. While ascorbate tends to accumulate in adrenal glands, the brain, and in some white blood cell types, plasma levels stay relatively low. According to the study, the plasma levels in healthy adults stayed below 100 µM, even if 2.5 grams were taken when administered once daily by the oral route.

Cancer patients tend to be depleted of vitamin C: fourteen out of twenty-two terminal cancer patients in our phase I study were depleted of vitamin C, with ten of those having zero detectable ascorbate in their plasma. In a study of cancer patients in hospice care, thirty percent of the subjects were deficient in vitamin C. Deficiency (below 10 µM) was correlated with elevated inflammation marker C-reactive protein (CRP) and shorter survival times. Given the role of vitamin C in collagen production, immune system functioning, and antioxidant protection, it is not surprising that subjects depleted of ascorbate would fare poorly in mounting defenses against cancer. This also suggests that supplementation to replenish vitamin C stores might serve as adjunctive therapy for these patients”[4].

While generally speaking, such use of high dose of Vitamin C is considered harmless, there are potential side effects as reported by Unlu et al. [5].

Possible Mechanism

We shall emphasize here that many mechanisms of action for ascorbate efficacy against cancer have been proposed over the years. Cancer patients are often deficient in vitamin C, and require large doses to replenish depleted stores. It has been demonstrated in vitro and in animal studies that vitamin C is preferentially toxic to tumor cells at millimolar concentrations; moreover, pharmacokinetic data suggest that these concentrations are clinically achievable when ascorbate is administered intravenously. Data suggests that ascorbate may serve as a biological response modifier, affecting inflammation and angiogenesis as well as improving immune function parameters [4].

More descriptions of mechanism of Vitamin C as anticancer agent can be found in Gonzalez & Miranda-Massari [1].

Frei and Lawson also add some interesting fact that Vitamin C is able to kill cancer cells without harming normal cells. They wrote[6]:

“Why is it important to understand how vitamin C can produce H₂O₂ and kill cancer cells but not normal cells? Because without this detailed knowledge, we do not have a scientific rationale to revisit the question of whether i.v. infusion of vitamin C may have value in treating cancer patients. The potential cancer-therapeutic activity of vitamin C has a long and controversial history. In 1973, Linus Pauling and Ewan Cameron postulated that vitamin C inhibits tumor growth by enhancing immune response and stabilizing glycosaminoglycans

of the extracellular matrix by inhibiting hyaluronidase. Cameron and Campbell reported on the response of 50 consecutive patients with advanced cancer to continuous i.v. infusions (5–45 g/d) and/or oral doses (5–20 g/d) of vitamin C. No or minimal response was observed in 27 patients; 19 patients exhibited tumor retardation, cytostasis, or regression; and 4 patients experienced tumor hemorrhage and necrosis. The first clinical study by Cameron and Pauling compared survival times between 100 patients with terminal cancer treated with i.v. and oral vitamin C, usually 10 g/d, and 1,000 comparable patients not given vitamin C. Patients treated with vitamin C survived approximately four times longer than controls, with a high degree of statistical significance ($P < 0.0001$). A follow-up study reported that patients given vitamin C had a mean survival time almost 1 year longer than matched controls. Overall, 22% of vitamin C-treated patients but only 0.4% of controls survived for more than 1 year.”

Chemotherapy Controversy

With regards to possible interaction with chemotherapy, Mikirova et al. have reported:

“The observations that ascorbate is an antioxidant and that it preferentially accumulates in tumors have raised fears that ascorbate supplementation would compromise the efficacy of chemotherapy. In support of this, Heaney and coworkers found that tumor cells in vitro and xenografts in mice were more resistant to a variety of anticancer agents when the tumor cells were pretreated with dehydroascorbic acid. Questions have been raised, however, whether the experimental conditions used in this study are clinically or biochemically relevant, considering, among other issues, that dehydroascorbic acid rather than ascorbic acid was used [7]. A variety of laboratory studies suggest that, at high concentrations, ascorbate does not interfere with chemotherapy or irradiation and may enhance efficacy in some situations. This is supported by meta-analyses of clinical studies involving cancer and vitamins; these studies conclude that antioxidant supplementation does not interfere with the toxicity of chemotherapeutic regimens” [4].

A Few Recent Reports

There are a number of recent studies which indicate that interest in the efficacy of ascorbic acid for preventing and cure of tumor and cancer cells have revived. We will review a few of these recent literatures:

a. Ali Ghanem et al. reported: “The notion of mega doses of ascorbic acid (vitamin C) for cancer treatment has recently been revived. Besides animal experimentation, evidence from cellular and molecular research suggests a combined oxidative and metabolic mechanism behind the specific cytotoxicity of vitamin C towards cancerous cells.

Here we investigate the efficacy of vitamin C against breast cancer cell lines. This work showcases a distinctive metabolic shift induced by ascorbate across multiple cell lines, disruption in the RedOx homeostasis, and the consequent cytotoxic effects. To further define the source of ascorbate’s toxicity we probed the potential uptake route of both ascorbic acid and dehydroascorbate (the oxidized form of ascorbic acid) and the extra and intra cellular ROS resulting from ascorbate treatment” [8].

b. But what kind of mechanism of anticancer effect of ascorbic? A number of recent papers try to elucidate these question. In a report, Birandra K. Sinha et al. suggests that Topotecan may hold an answer. Their abstract goes as follows: “Topotecan, a derivative of camptothecin, is an important anticancer drug for the treatment of various human cancers in the clinic. While the principal mechanism of tumor cell killing by topotecan is due to its interactions with topoisomerase I, other mechanisms, e.g., oxidative stress induced by reactive free radicals, have also been proposed. However, very little is known about how topotecan induces free radical-dependent oxidative stress in tumor cells. In this report we describe the formation of a topotecan radical, catalyzed by a peroxidase-hydrogen peroxide system. While this topotecan radical did not undergo oxidation-reduction with molecular O_2 , it rapidly reacted with reduced glutathione and cysteine, regenerating topotecan and forming the corresponding glutathionyl and cysteinyl radicals. Ascorbic acid, which produces hydrogen peroxide in tumor cells, significantly increased topotecan cytotoxicity in MCF-7 tumor cells. The presence of ascorbic acid also increased both topoisomerase I dependent topotecan-induced DNA cleavage complex formation and topotecan-induced DNA double-strand breaks, suggesting that ascorbic acid participated in enhancing DNA damage induced by topotecan and that the enhanced DNA damage is responsible for the synergistic interactions of topotecan and ascorbic acid. Cell death by topotecan and the combination of topotecan and ascorbic acid was predominantly due to necrosis of MCF-7 breast tumor cells” [9].

C. Jiliang Xia et al. also conclude that pharmacologically-dosed ascorbic acid can help to kill multiple myeloma tumor cells. Their abstract goes as follows: “High-dose chemotherapy to treat multiple myeloma (MM) can be life-threatening due to toxicities to normal cells and there is a need to target only tumor cells and/or lower standard drug dosage without losing efficacy. We show that pharmacologically-dosed ascorbic acid (PAA), in the presence of iron, leads to the formation of highly reactive oxygen species (ROS) resulting in cell death. PAA selectively kills CD138+MM tumor cells derived from MM and smoldering MM (SMM) but not from monoclonal gammopathy undetermined significance (MGUS) patients. PAA alone or in combination with melphalan inhibits tumor formation in MM xeno graft mice. This study shows PAA efficacy on primary cancer cells and cell lines *in vitro* and *in vivo*” [10].

d. But there is caveat too, other report shows that pyruvate diminishes the anticancer effect of ascorbic acid. Their abstract goes as follows: “The anticancer potential of ascorbic acid (AA) has been controversially discussed for decades. Although the cytotoxic effect of pharmacologic concentrations of ascorbic acid has already been successfully demonstrated in numerous studies *invitro*, it could not be verified to the same extent *invivo*. We propose that the ubiquitous metabolite pyruvate diminishes the effect of AA by reacting with its presumable cytotoxic mediator hydrogen peroxide (H_2O_2). MTT assays confirm that co-incubation with 1.4 mM pyruvate abolishes the cytotoxic effect of pharmacologic concentrations of AA in all cancer cell lines tested (human melanoma (WM451-Lu), breast (MCF-7) and hypopharyngeal cancer cells (FaDu)). We further investigated whether pyruvate diminishes the anticancer effect of AA by interfering with the generation of (H_2O_2). Therefore, we analyzed the concentration of AFR, a proposed intermediate in the AA-dependent formation of H_2O_2 , by electron paramagnetic resonance spectroscopy, during incubation with AA and pyruvate in WM451-Lu cells as a model system. In addition, we measured H_2O_2 concentration by indirect detection with Clark-type oxygen electrode. AFR concentration was not significantly influenced by pyruvate, whereas H_2O_2 concentration was significantly reduced. In parallel, pyruvate concentrations of the stimulation medium declined with increasing AA and consequently H_2O_2 concentrations. In summary, pyruvate diminishes the cytotoxic activity of ascorbic acid in vitro. The AFR concentration measured remains unaffected by pyruvate whereas the H_2O_2 concentration is reduced; confirming that pyruvate directly reacts with AA-induced H_2O_2 , without influencing its formation” [11].

Concluding Remarks

We have discussed some real positive effects on the use and efficacy of ascorbic acid as anticancer treatment.

To conclude this short review, allow us to quote Cameron & Pauling: “There is good evidence that high intakes of ascorbate potentiate the immune system in various ways: increasing the production and effectiveness of antibodies and crucial components of the complement cascade, enhancing lymphocyte blastogenesis, stimulating macrophage chemotaxis, improving phagocytic ability, amplifying lymphocyte trapping, and increasing the proliferation and differentiation of antigen-triggered lymphocytes.

Ascorbate offers some protection against oncogenic viruses and against a variety of known chemical and physical carcinogens, and is also involved in a number of biological processes, discussed in this review, that are known to contribute to host resistance to neoplastic disease. There is a growing suspicion that “host resistance to cancer,” no matter how measured, is largely dependent upon the dietary intake

of this simple nutrient” [2].

Nonetheless, this short review is not sufficient, it is recommended to continue further studies and procedures to maximize such positive impact of ascorbic acid as anticancer treatment.

References

1. Michael J G, Miranda-Massari JR (2014) New Insights on Vitamin C and cancer. Springer.
2. Cameron E, Linus P (1979) Ascorbic Acid as a Therapeutic agent in Cancer. Journal of the International Academy of Preventive Medicine 1(1): 8-29.
3. Satoshi O, Yumiko O, Nobutaka S, Gen-Ichiro S, Masaki Inoue (2009) High-dose Vitamin C (Ascorbic Acid) Therapy in the Treatment of Patients with Advanced Cancer. Anticancer Research 29(3): 809-815.
4. Mikirova NA, Casciari JJ, Hunninghake RE, Riordan NH (2013) Intravenous ascorbic acid protocol for cancer patients: scientific rationale, pharmacology, and clinical experience. Functional Foods in Health and Disease 3(8): 344-366.
5. Unlu A, Onder K, Mustafa O, Erdinç N (2015) High-dose vitamin C and cancer. Journal of Oncological Science 1: 10-12.
6. Balz F, Stephen L (2008) Vitamin C and Cancer revisited. PNAS 105(32) :11037-11038.
7. Seyeon Park (2013) The Effects of High Concentrations of Vitamin C on Cancer Cells. Nutrients 5(9): 3496-3505.
8. Ali Ghanem, Anna-Maria M, Esther Zaal, Celia Berkers, Stefan Wolf (2018) Ascorbic acid kills breast cancer cells by reprogramming metabolism via a RedOx dependent mechanism. Free Radical Biology and Medicine 120(1): S45.
9. Sinha BK, van 't Erve TJ, Kumar A, Bortner CD, Motten A, et al. (2017) Synergistic enhancement of topotecan-induced cell death by ascorbic acid in human breast MCF-7 tumor cell. Free Radical Biology and Medicine 113: 406-412.
10. Jiliang X, Xu H, Zhang X, Allamargot C, Coleman KL et al. (2017) Multiple myeloma tumor cells are selectively killed by pharmacologically-dosed ascorbic acid. EBioMedicine18: 41-49.
11. Sandra R, Katharina H (2017) Pyruvate diminishes the cytotoxic activity of ascorbic acid in several tumor cell lines in vitro. Biochemical and Biophysical Research Communications 493(3): 1184-1189.

Preface

Mohamed Abdel-Basset & Florentin Smarandache

Mohamed Abdel-Basset, Florentin Smarandache (2020). Preface. *Revista Investigacion Operacional* 41(5), i

In the rising trends of information technology, the concepts of uncertainty have started gaining greater importance with time in solving operational research problems in supply chain model, project management, transportation problem, or inventory control problems. Moreover, day-by-day competition is becoming tougher in imprecise environments. For instance, customer demand is often being affected by several varying factors like production price, income level, and the like. In these cases, the demand either remains unfulfilled or is difficult to obtain with certainty in the real-world market. Fuzzy sets are not always able to directly depict such uncertainties because they exhibit numeric only membership functions, whereas neutrosophic sets are found to be more suitable to accommodate inherent uncertainties. Neutrosophic Set is a Generalization of Intuitionistic Fuzzy Set, Inconsistent Intuitionistic Fuzzy Set (Picture Fuzzy Set, Ternary Fuzzy Set), Pythagorean Fuzzy Set (Atanassov's Intuitionistic Fuzzy Set of second type), q-Rung Orthopair Fuzzy Set, Spherical Fuzzy Set, and n-HyperSpherical Fuzzy Set, while Neutrosophication is a Generalization of Regret Theory, Grey System Theory, and Three-Ways Decision. These different uncertain systems can handle higher levels of uncertainty in more complex real world problems.

Neutrosophic sets and logic are gaining significant attention in solving many real life problems that involve uncertainty, impreciseness, vagueness, incompleteness, inconsistency, and indeterminacy. A number of new neutrosophic theories have been proposed and have been applied in computational intelligence, image processing, medical diagnosis, fault diagnosis, optimization design, and so on.

The main objective of this issue is to understand the applicability of Multi-Criteria Decision Making (MCDM) and neutrosophic theory in operations research and also to know the various types of Neutrosophic Optimization and Neutrosophic Mathematical Programming Models.

This special issue will explore the possibilities and advantages created by Multi-Criteria Decision Making (MCDM) and neutrosophic tools, through both the presentation of thorough research and case studies.

MARINELA PREOTEASA (1952 – 2020)

Florentin Smarandache

Născută în comuna Perieți, jud. Olt, în prima zi a anului 1952. A plecat la stele în anul 2020. A absolvit Facultatea de Științe ale Naturii, secția Matematică, a Universității din Craiova. Profesoară de matematică (1977-2011), profesând pentru 21 de ani la Liceul Pedagogic din Slatina (actualmente Colegiul Național Vocațional „N. Titulescu”, Slatina, Olt).

A debutat literar în volumul “Reliefuri ’88”, cu grupajul de proză scurtă “Chemarea” (semnat Marinela Iacob; Craiova: Editura Scrisul Românesc, 1988), Marin Sorescu fiind președintele comitetului de selecție.



Din volumele de autor: “Iarba iubirii”, poezie (Oradea: Editura Anotimp, 1994), cu un cuvânt înainte de George Sorescu; “Clarviziuni astrale”, poezie, vol. I (Rm. Vâlcea: Ed CuArt, 2005), “Extraveral pentru iubire”, volum de poezie, tradus în limbile engleză, franceză și latină; “În exercițiul funcțiunii (Haz de necaz)” (Rm. Vâlcea: Editura CuArt, 2009), volum apărut în colaborare cu Florentin Smarandache, prefața fiind semnată de Florea Florescu; “Românul care l-a contrazis pe Einstein” (Rm. Vâlcea: Editura CuArt, 2012); “Paralelism vizionar” (Rm. Vâlcea: Editura CuArt, 2012), cu o prefață de Florentin Smarandache; “Ultimul zbor” (Rm. Vâlcea: Editura CuArt, 2013), volum dedicat poetului Nichita Stănescu, cu o prefață semnată de Nicolae Bălașa; “În vârful peniței” (Rm. Vâlcea: Editura CuArt, 2019); “Cultură cu băutură” (Rm. Vâlcea: Editura CuArt, 2019);

Marinela Preoteasa a fost coautoarea mai multor cărți, culegeri de exerciții și probleme de matematică, reviste de matematică: “Să gândim distractiv” (Rm. Vâlcea: Editura CuArt, 2013), în limbile română și engleză (autori: Marinela Preoteasa și Doina Mihai); “Teste de matematică pentru concursul de admitere în liceu”, autori Marinela Preoteasa și Neguț Maria; “Culegere de exerciții și probleme” (Rm. Vâlcea: Editura Cu Art, 1999), cu avizul MEC; “Matematică fără profesor” (Rm. Vâlcea: Editura CuArt, 2006), autori fiind Marinela Preoteasa, Ion Neață și Ion Burcă-Florea; “Revista de matematică”, editor și redactor-șef, cu apariție din 1994.

Editor și redactor-șef al revistei “Scurt Circuit Oltean”, cu apariție lunară, fondată în 1994.

A fost membru a Societății Scriitorilor Olteni, membră a Ligii Scriitorilor Români de pretutindeni, administrator al Editurii CuArt, editor al revistei naționale “Columbofilia Română”, coordonatoare a cenaclului literar “Iris” de la Liceul Agricol Slatina Olt, coordonatoare a cenaclului literar “Scurt Circuit Oltean”, coordonatoare a cenaclului “Dumitru Caracostea” ș.a.m.d. Peste 30 premii la diverse concursuri.

Au apreciat și au scris despre creația Marinelei Preoteasa Aureliu Goci, Victor Atanasiu, Ion Gheorghe, George Sorescu, Luminița Suse, Nicole Pottier, Mădălina Maroga, Virgil Dumitrescu, Florentin Smarandache, Ioana Stuparu ș.a.

A Deep Transfer Learning Model with Classical Data Augmentation and CGAN to Detect COVID-19 from Chest CT Radiography Digital Images

Mohamed Loey, Florentin Smarandache, Nour Eldeen M. Khalifa

Mohamed Loey, Florentin Smarandache, Nour Eldeen M. Khalifa (2020). A Deep Transfer Learning Model with Classical Data Augmentation and CGAN to Detect COVID-19 from Chest CT Radiography Digital Images. In press, 17. DOI: 10.20944/preprints202004.0252.v1

Abstract: The coronavirus disease 2019 (COVID-19) is the fastest transmittable virus caused by severe acute respiratory syndrome coronavirus 2 (SARS-CoV-2). The detection of COVID-19 using artificial intelligence techniques and especially deep learning will help to detect this virus in early stages which will reflect in increasing the opportunities of fast recovery of patients worldwide. This will lead to release the pressure off the healthcare system around the world. In this research, classical data augmentation techniques along with CGAN based on a deep transfer learning model for COVID-19 detection in chest CT scan images will be presented. The limited benchmark datasets for covid-19 especially in chest CT images is the main motivation of this research. The main idea is to collect all the possible images for covid-19 that exists until the very writing of this research and use the classical data augmentations along with CGAN to generate more images to help in the detection of the COVID-19. In this study, five different deep convolutional neural network-based models (AlexNet, VGGNet16, VGGNet19, GoogleNet, and ResNet50) have been selected for the investigation to detect the coronavirus infected patient using chest CT radiographs digital images. The classical data augmentations along with CGAN improve the performance of classification in all selected deep transfer models. The Outcomes show that ResNet50 is the most appropriate classifier to detect the COVID-19 from chest CT dataset using the classical data augmentation and CGAN with testing accuracy of 82.91%.

Keywords: COVID-19, 2019 novel coronavirus, SARS-CoV-2, Deep Transfer Learning, Convolutional Neural Network, Machine Learning, CGAN.

1. Introduction

At the end of February 2003, the Chinese population was infected with a Severe Acute Respiratory Syndrome (SARS) virus causing in Guangdong province in China. SARS was named SARS-CoV and confirmed as a member of the beta coronavirus subgroup [1]. In 2019, Wuhan in China infected by a 2019 novel coronavirus that killed more than hundreds and infected over thousands of humans within few days of the 2019 novel coronavirus epidemic. The World Health Organization (WHO) named The 2019 novel virus as Wuhan coronavirus (2019-nCov) which can cause respiratory disease and severe pneumonia [2]. In 2020, the International Committee on Taxonomy of Viruses (ICTV) announced the Wuhan coronavirus as Severe Acute Respiratory

Syndrome CoronaVirus-2 (SARS-CoV-2) and the disease as Coronavirus disease 2019 (COVID-19) [3–5]. The family of coronaviruses is alpha (α), beta (β), gamma (γ), and delta (δ) coronavirus. 2019-nCov was reported to be a member of the β group of coronaviruses. An epidemic of SARS coronavirus affected 26 countries and outcomes in more than 8000 cases in 2003. An epidemic of SARS-CoV-2 infected more than 1.5 million individuals with death-rate of 4%, across 150 countries, till the date of this writing. The transmission rate of SARS-CoV-2 is higher than SARS coronavirus because of S protein in the RBD region of SARS-CoV-2 may have enhanced its transmission [6].

In 2012, Middle East Respiratory Syndrome (MERS) was reported in Saudi Arabia as an illness caused by a coronavirus. SARS and MERS are Betacoronaviruses (β -CoVs or Beta-CoVs) that transmitted to people from some cats and Arabian camels respectively [7,8]. The sale of wild animals may be the source of coronavirus infection. The discovery of multiple offspring of pangolin coronavirus and their similarity to SARS-CoV-2 suggests that pangolins should be considered as possible hosts of novel coronaviruses. WHO recommendations to reduce the risk of transmission of Coronavirus from animals to humans in wild animal markets [9]. Human-to-human transmission of coronavirus Coronavirus transmission from different cases outside China, namely in Italy [10], US [11], Germany [12], and Vietnam [13], Nepal [14]. On 11 April 2020, SARS-CoV-2 Confirmed more than 1.7 million cases, 400000 recovered cases, and 100000 death cases. Figure 1 shows some statistics about recovered and death cases of COVID-19 [15].

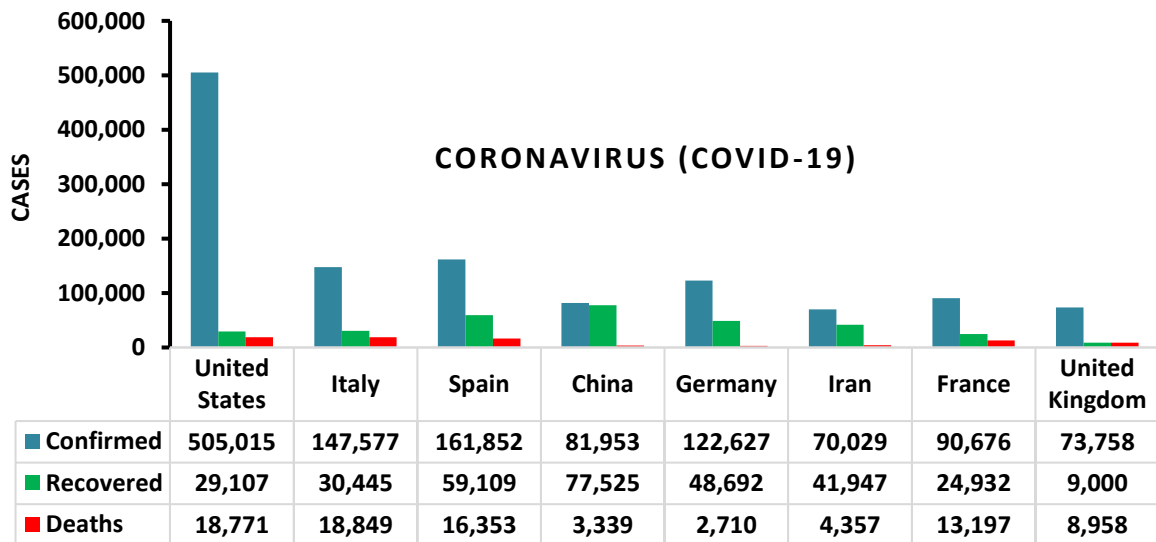

Fig. 1. Statistics of COVID-19 in some countries

Deep Transfer Learning (DTL) is a deep learning technique that reused a trained deep learning model that inspired by neurons of the brain [16]. DTL is quickly becoming a critical technique in image/video classification and detection. DTL improves such a medical system to realize higher outcomes, widen illness scope, and implementing applicable real-time medical image [17,18] disease detection systems. In 2012, Krizhevsky and et al. and Ciregan et al. [19,20] showed how Convolutional Neural Networks (CNN/ ConvNet) based on Graphics Processing Unit (GPU) can enhance many image benchmark classification such as MNIST [21], Chinese characters [22], NORB

(jittered, cluttered) [23], traffic signs [24], large-scale ImageNet [25], Arabic digits recognition [26], and Arabic handwritten characters recognition [27]. In the following years, various advances in CNN further decreased the error rate on the image/video classification competition. Many DTL models were introduced as AlexNet [20], VGGNet [28], GoogleNet [29], ResNet [30], Xception [31], DenseNet [32], Inception-V3 [33].

This section conducts the recent scientific papers for applying deep learning in the field of medical chest computerized tomography (CT) classification. Christie et al. [34] introduced a computer-aided detection method based on deep learning was able to detect idiopathic pulmonary fibrosis with similar accuracy to a human reader. The CAD system used for the automatic classification of CT images into 4 radiological diagnostic categories. The model was achieved an F-score (harmonic mean for precision and recall) of 80%. In [35], the authors introduced a novel system for automated classify of Interstitial Lung Abnormality patterns in computed tomography (CT) images. The proposed system was an ensemble of deep convolutional neural networks (DCNNs) that detect more features by incorporating dimensional architectures. The outcome of the ensemble is the sensitivity of 91,41% and specificity of 98,18%.

In this paper, we introduced a deep transfer learning (DTL) models to classify COVID-19 chest CT scan digital images. To input adopting CT images of the chest to the deep convolutional neural network (DCNN), we enriched the medical chest CT images using classical data augmentation and CGAN to generate more CT images. After that, a classifier is used to ensemble the class (COVID/NonCOVID) outputs of the classification outcomes. The proposed DTL model was evaluated on the COVID-19 CT scan images dataset. The novelty of this research is conducted as follows: i) The introduced DTL models have end-to-end structure without classical feature extraction and selection methods. ii) We show that data augmentation and Conditional Generative Adversarial Network (CGAN) is an effective technique to generate CT images. iii) Chest CT images are one of the best tools for the classification of COVID-19. iv) The DTL models have been shown to yield very high accuracy in the limited dataset COVID-19. The rest of the paper is organized as follows. In section 2, discusses the dataset used in our research. In section 3, introduces the proposed models, while section 4 illustrates the achieved outcomes and its discussion. Finally, section 5 provides conclusions and directions for further research.

2. Dataset

The COVID-19 CT scan digital images dataset [36] utilized in this research was created by Zhao et al (<https://github.com/UCSD-AI4H/COVID-CT>). The authors collected 760 preprints about COVID-19 from bioRxiv1 (<https://www.biorxiv.org>) and, medRxiv2 (<https://www.medrxiv.org>) posted from Jan 19th to Mar 25th that report patient cases of COVID-19 CT. The dataset is organized into 3 folders (train, validation, and test) and contains subfolders for each image category (COVID/NonCOVID). There are 742 CT images and 2 categories (COVID/NonCOVID). The number of images for each class is presented in Table 1. Table 1 illustrates that the proposed method to increase the number of COVID-19 CT images using augmentation and CGAN. Figure 2 illustrates samples of CT images used for this research.

Table 1. Number of images for each class in Covid-19 CT dataset

Dataset	Train set		Validation set		Test set	
	COVID	NonCOVID	COVID	NonCOVID	COVID	NonCOVID
COVID19	191	234	60	58	94	105
COVID19 +Aug	2292	2808	720	696	94	105
COVID19 +CGAN	2191	2234	210	208	94	105
COVID19 +Aug+CGAN	4292	4808	870	846	94	105

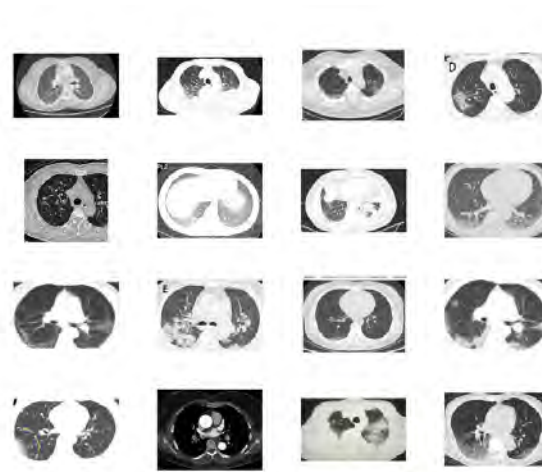

Fig. 2. Samples of the used COVID-19/NonCOVID CT images used in this research

3. Proposed Model

The proposed architecture consists of two main components, the first component is the data augmentation using classical data augmentation techniques along with CGAN, while the second component is the DTL model as shown in figure 3. Mainly, the classical data augmentation and CGAN used in the preprocessing phase while the DTL used in the performance measurement phase.

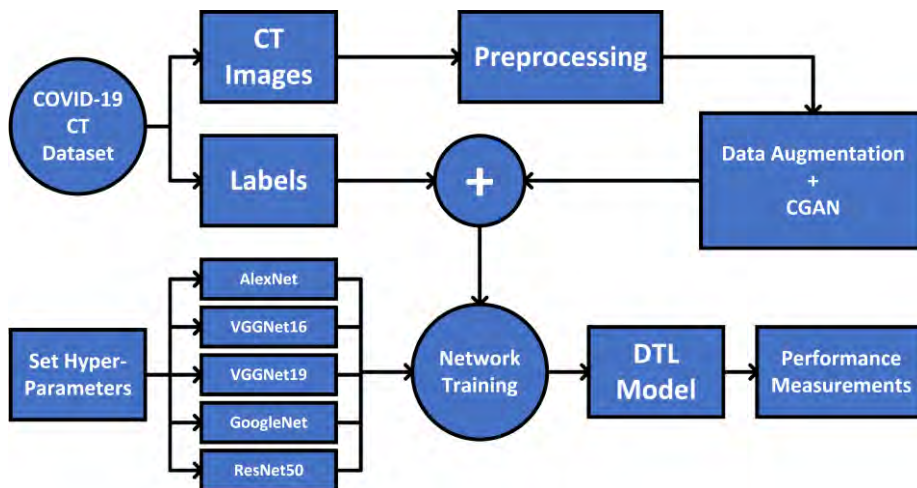

Fig. 3. The proposed architecture of the classical data augmentation along with CGAN and DTL models

Algorithm 1 Proposed Algorithm

Require: COVID-19 CT scan Images (X, Z) ; where $Z = \{z/z \in \{ \text{COVID}; \text{NonCOVID} \}\}$

Output: The trained DTL model that classifies the COVID-19 CT image $x \in X$

Preprocessing:

- Resize the image to dimension 256×256
- Perform data augmentation: Generate COVID-19 CT images
- Perform CGAN: Generate COVID-19 CT images
- Mean normalize each COVID-19 CT scan images

Import a set of DTL models $D = \{ \text{AlexNet}, \text{VGGNet16}, \text{VGGNet19}, \text{GoogleNet}, \text{ResNet50} \}$

Replace the last fully connected layer of each model by a layer of (2×1) dimension.

foreach $\forall m \in M$ **do**

$\mu = 0.001$

for epochs = 1 to 50 **do**

foreach mini-batch $(X_i; Z_i) \in (X_{\text{train}}; Z_{\text{train}})$ **do**

Update the parameters of the model $m(\cdot)$

if the validation error is not improving for five epochs **then**

$\mu = \mu \times 0.01$

end

end

end

end

foreach $\forall x \in Z_{\text{test}}$ **do**

the output of all models, $m \in M$

end

Algorithm 1 introduces the proposed model in detail below. Let $M = \{ \text{AlexNet}, \text{VGGNet16}, \text{VGGNet19}, \text{GoogleNet}, \text{ResNet50} \}$ be the set of DTL models. Each DTL is fine-tuned with the COVID-19 CT Images dataset (X, Z) ; where X the set of N images, each of size, 256×256 , and Z contain the corresponding labels, $Z = \{z/z \in \{ \text{COVID}; \text{NonCOVID} \}\}$. The dataset divided to train, validate, and test, training set $(X_{\text{train}}; Z_{\text{train}})$, validate set $(X_{\text{val}}; Z_{\text{val}})$, test set $(X_{\text{test}}; Z_{\text{test}})$. The training data then divided into mini-batches, each of size $n = 32$, such that $(X_i; Z_i) \in (X_{\text{train}}; Z_{\text{train}}); i = 1, 2, \dots, \frac{N}{n}$

and iteratively optimizes (fine-tuning) the DCNN model $d \in D$ to reduce the empirical loss as illustrated in equation (1).

$$L(w, X_i) = \frac{1}{n} \sum_{x \in X_i, z \in Z_i} l(m(x, w), z) \quad (1)$$

where $l(\cdot)$ is the categorical cross – entropy loss penalty function, and $m(x, w)$ is the DCNN model that predicts class z for input x given w is a weight.

3.1 Deep Transfer Learning

Deep Transfer Learning (DTL) is the most successful reuse type of deep convolutional neural network model for image/video classification. A single DTL model contains many different layers of convolution and pooling layer that work on feature extraction from image/video and more complex deep features in deeper layers.

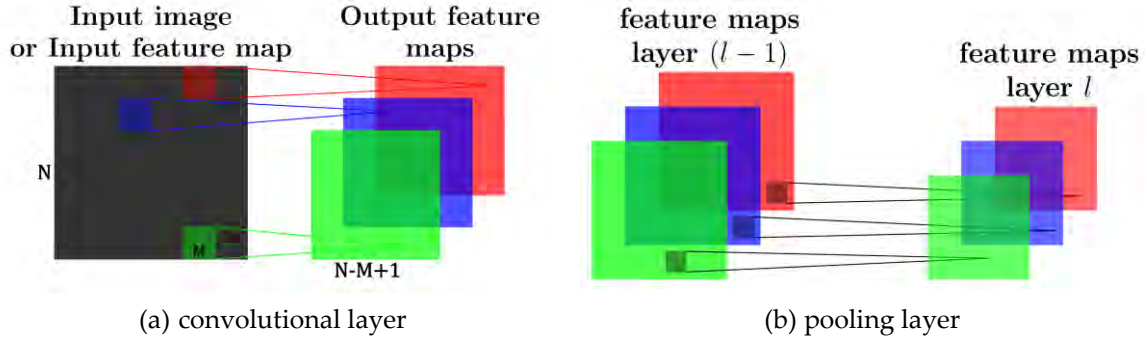

Fig. 4. Illustration of the convolutional and pooling layer which produce feature maps

Let layer l be a convolutional layer. Suppose that we have some $N \times N$ square neuron nodes which are followed by a convolutional layer. If we use an $M \times M$ filter (mask) W then convolutional layer output will be of size $(N - M + 1) \times (N - M + 1)$ which produces k -feature maps that are illustrated in Fig. 4. The convolutional layer acts as a feature extractor that grabs features of the inputs. The convolution layer extract features from the image like edges, lines, and corners. To compute the pre-nonlinearity input to some unit. Then, the input of layer $l - 1$ comprises is computed in equation (2):

$$Z_i^l = B_i^l + \sum_{a=1}^N \sum_{b=1}^N W_i X_{(i+a)(j+b)}^{l-1} \quad (2)$$

where B_i^l is a bias matrix and W_i is the mask of size $M \times M$. Then, the convolutional layer applies its activation function in equation (3):

$$Net = \sigma(Z_i^l) \quad (3)$$

where $\sigma(\cdot)$ is called non-linearity, function applied to achieve non-linearity in DTL, which contains many types such as tanh, sigmoid, Rectified Linear Units (ReLU). In our method, we utilize ReLU in equation (4) as the activation function for faster training process:

$$\sigma(u) = \max(0, u) \quad (4)$$

The loss function is the criterion for the training process. Our loss function in equation (5) is defined as the sum of the cross-entropy loss and the box regression loss:

$$Loss(s, t) = Loss_{cls}(s_{c^*}) + \lambda[p^* > 0]L_{reg}(v, v^*) \quad (5)$$

where s_{c^*} denotes the predicted score class c^* while v and v^* denote $[v_x, v_y, v_w, v_h]$ of bounding boxes. $\lambda[p^* > 0]$ indicates that we only consider the boxes of non-background (the box is background if $p^* = 0$). This loss function contains two parts for bounding box regression loss $Loss_{reg}$ and classification loss $Loss_{cls}$ and, in equation (6-8):

$$Loss_{cls}(s_{c^*}) = -\log(s_{c^*}) \quad (6)$$

and

$$Loss_{reg}(v, v^*) = \sum_{i \in (x,y,w,h)} R_{L1}(v_i - v_i^*) \tag{7}$$

where:

$$R_{L1}(u) = \begin{cases} 0.5u^2, & \text{if } |u| < 0 \\ |u| - 0.5, & \text{otherwise} \end{cases} \tag{8}$$

3.2 Data Augmentation

The main idea behind this research is to perform a transfer learning with augmented COVID-19 CT images. To increase the performance of the proposed transfer learning models, training data amount and validate data amounts is a very important factor. The most popular classical data augmentation method is to perform a combination of the affine image transformations [37]. Different methods for classical data augmentation such as rotation, shifting, flipping, zooming, transformation, add noise were selected to be applied in the original dataset. Figure 5 shows examples of COVID-19 CT augmented images. The achieved performance measurement will be discussed in the experimental results section.

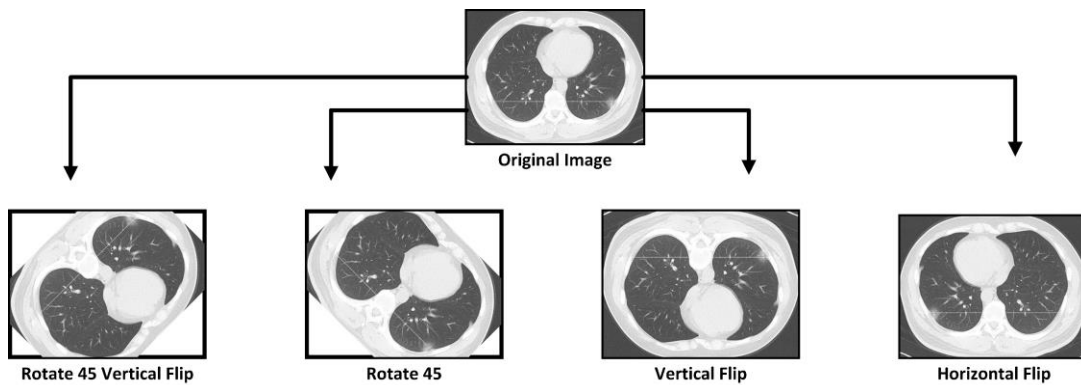

Fig. 5. Perform augmentation methods to increase limited COVID-19 CT scan images

3.3 Conditional Generative Adversarial Network

CGANs consist of two different types of networks (generator Network, discriminator network) with the conditional label as shown in Figure 6. A CGAN is a type of GAN that takes labels in the training process. The generator network in this paper consists of 4 transposed convolutional layers, 3 ReLU layers, 3 batch normalization layers, and Tanh Layer at the end of the model, while the discriminator network consists of 4 convolutional layers, 3 leaky ReLU, and 2 batch normalization layers. All the convolutional and transposed convolutional layers used the same filter size of 5x5 pixels with 20,10, 5 filters for each layer for the generated network but 5,10,20,40 for each layer in the Discriminator network. Figure 7 presents the structure and the sequence of layers of the CGAN network proposed in this research. We trained our CGAN model as shown in the right figure 8, and on the left, some generated CT images.

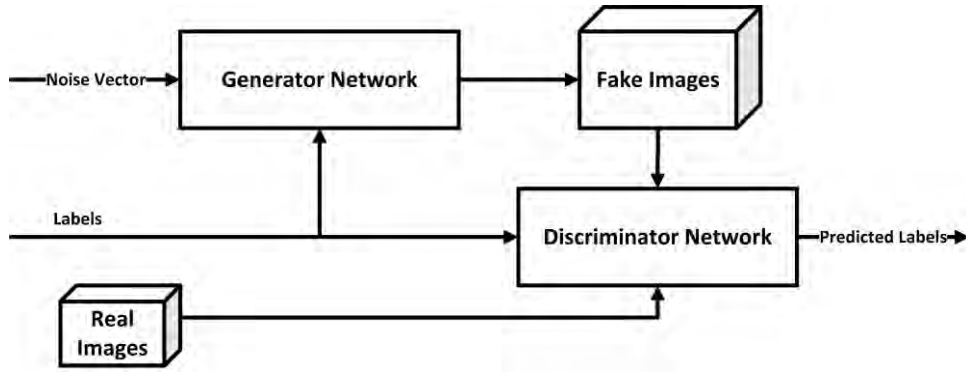

Fig. 6. Conditional Generative Adversarial Network model

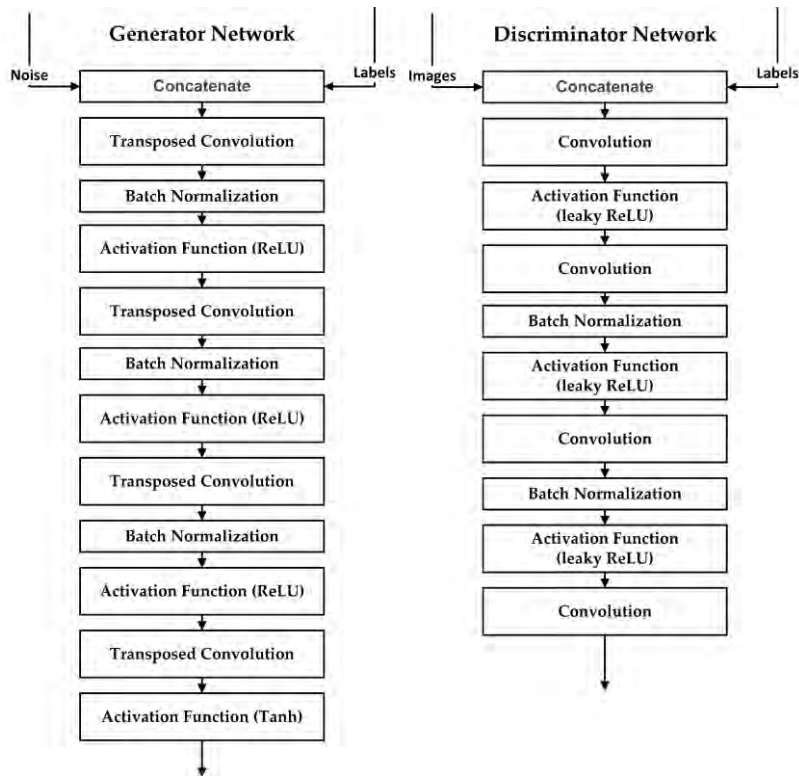

Fig. 7. The structure of the proposed CGAN network

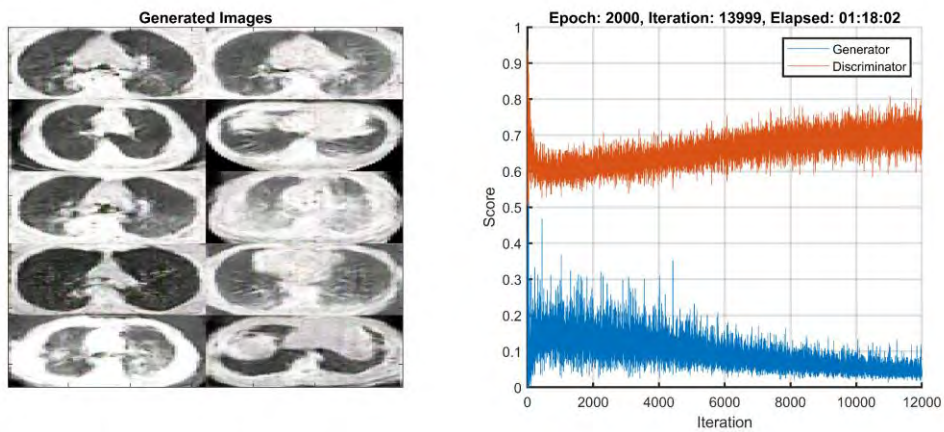

Fig. 8. CGAN training and samples of the generated image

The CGAN network helped in overcoming the overfitting problem caused by the limited number of CT images in the COVID-19 dataset. Figure 7 presents samples of the output of the GAN network for the covid-19 class. Moreover, it increased the dataset images to be 10 times larger than the original one. The dataset number of images reached 4425 images in the train set and 418 in the validation set after using the CGAN network for 2 classes. This will help in achieving better testing accuracy and performance matrices. The achieved performance measurement will be discussed in the experimental results section.



Fig. 9. Samples of COVID-19 CT images generated by the CGAN model.

4. Experimental Results

The proposed model is trained on a high-end Graphics Processing Unit (GPU). The GPU used (NVIDIA RTX 2070) contains 2304 CUDA core and comes with the CUDA Deep Neural Network library (CuDNN) for GPU learning. The deep learning package TensorFlow machine learning and Matlab as back end library. The proposed model has been tested under four different scenarios, the first scenario is to test the DTL models with original COVID-19 CT dataset, the second scenario with data augmentation, the third one with CGAN, and the last one combines all three scenarios. All the test experiment scenarios included the two classes (COVID/NonCOVID). Every scenario consists of the validation phase and the testing phase as shown in Table 2.

Table 2. Configuration of DTL models

Model	Layers	Batch size	Momentum	Epoch	Learning Rate	Optimizer
AlexNet	8	32	0.9	50	0.001	Adam
VGGNet16	16					
VGGNet19	19					
GoogleNet	22					
ResNet50	50					

Table 2 shows the five DTL models with initial learning rate (μ) equal to 0.001 and the number of epochs equal to 50. Also, the mini-batch size is set to 32 and early-stopping to be 5 epochs if the accuracy didn't improve. In terms of optimizer technique, Adam [38] is chosen as our optimizer

technique, which updates weights parameters. This optimizer technique is a combination of Root Mean Square Propagation (RMSprop) and Stochastic Gradient Descent (SGD) with momentum. To avoid deep learning network overfitting problems, we utilize this problem by using the dropout method [39] as well as the early-stopping technique [40] to select the most appropriate training iteration.

4.1 Verification and Testing Accuracy Measurement

Testing accuracy is one of the estimations which demonstrates the performance measurement of any DTL models. The confusion matrix also is one of the performance measurements which give more insights into the achieved testing accuracy. The first DTL model will be investigated is AlexNet along with four scenarios as shown in Figure 10. Figure 10 shows that the highest testing accuracy is 76.4% when the COVID-19 CT dataset is augmented with data augmentation along with CGAN. The Second DTL model will be investigated with VGGNet16. Figure 10 shows that the highest testing accuracy is 78.9% when the COVID-19 CT dataset is augmented with classical data augmentation along with CGAN. The Third DTL model will be investigated with VGGNet19. Figure 10 shows that the highest testing accuracy is 76.9% when the COVID-19 CT dataset is not augmented. The Fourth DTL model will be investigated with GoogleNet. Figure 10 shows that the highest testing accuracy is 77.4% when the COVID-19 CT dataset is augmented with the classical data augmentation along with CGAN.

The Final DTL model will be investigated with ResNet50. Figure 10 shows that the highest testing accuracy is 82.9% when the COVID-19 CT dataset is augmented with classical data augmentation as shown in Figure 11. Table 3 summarizes the testing accuracy for the different deep transfer learning models for 2 classes with the four scenarios. Table 3 illustrates according to testing accuracy, the Resnet50 achieved the highest accuracy with 82.9%, this is due to the large number of parameters in the Resnet50 architecture which contains millions of parameters which are not larger than VGGNet and GoogleNet but the VGGNet and GoogleNet only include 16, and 22 layers while the Resnet50 includes 50 layers.

Table 3. DTL testing accuracy for the different four scenarios

Dataset	AlexNet	VGGNet16	VGGNet19	GoogleNet	ResNet50
COVID-19	67.34%	72.36%	76.88%	75.38%	76.38%
COVID-19 with augmentation	75.38%	77.89%	69.35%	76.88%	82.91%
COVID-19 with GAN	68.34%	70.85%	73.37%	75.88%	77.39%
COVID-19 with aug and GAN	76.38%	78.89%	73.87%	77.39%	81.41%

Confusion Matrix of AlexNet

<i>COVID</i>	83	54	69	24	74	43	60	13
<i>NonCOVID</i>	11	51	25	81	20	62	34	92

Confusion Matrix of VGGNet16

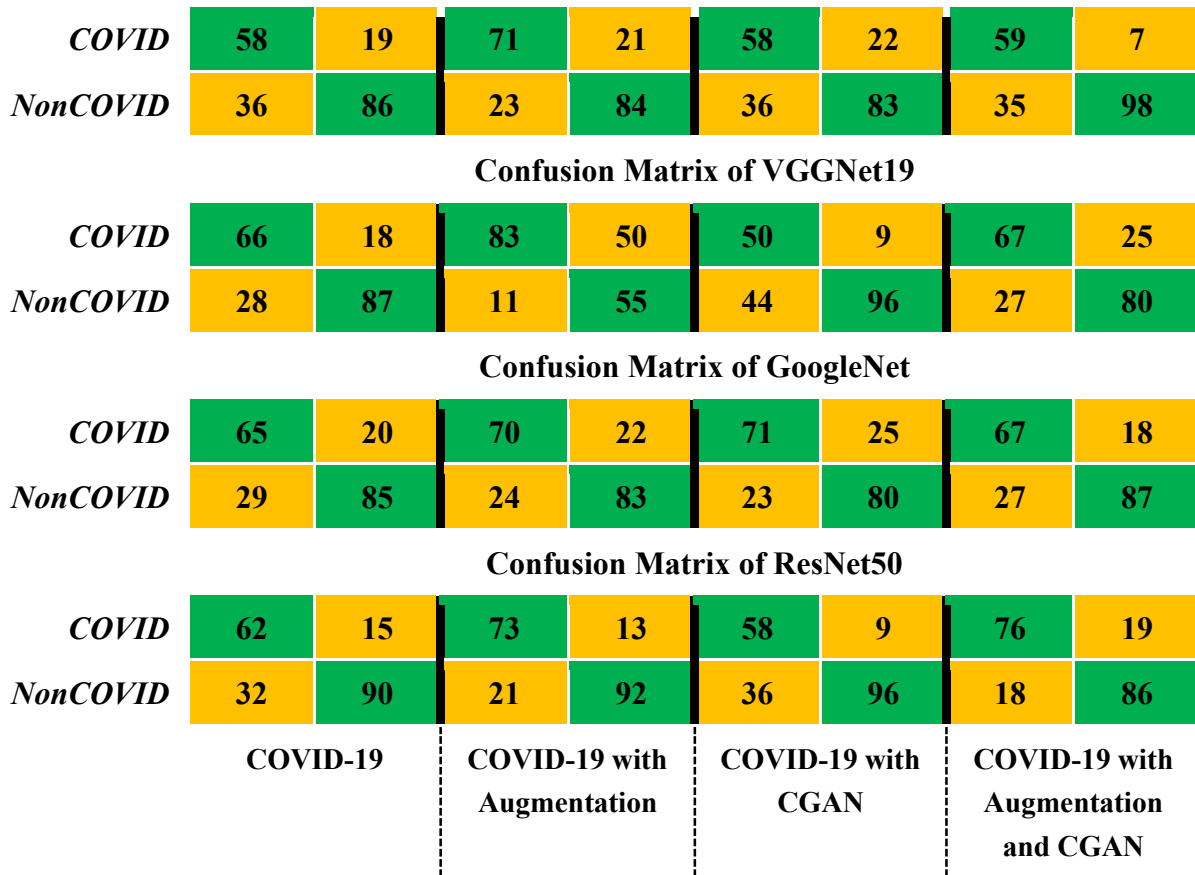

Fig. 10. DTL Confusion matrices for two classes with different scenarios

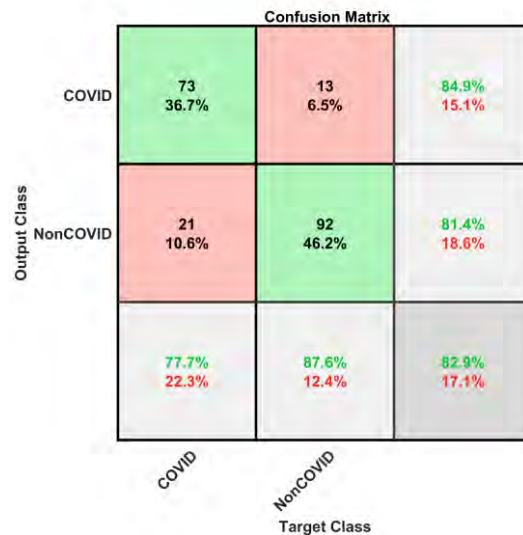

Fig. 11. Confusion matrix of highest accuracy for ResNet50 in COVID-19 with classical data augmentation

4.2 Performance Evaluation and Discussion

To quantitatively evaluate the performance measurement of the proposed model, more performance matrices are needed to be investigated through this paper. The most common performance measures in the field of deep learning are Sensitivity, Specificity, Precision, Accuracy and F1 Score [41] and they are presented from equation (9) to equation (13).

$$\text{Accuracy} = \frac{TP+TN}{(TP+FP)+(TN+FN)} \tag{9}$$

where TP (True Positives) is the count of correctly labeled instances of the class under observation, FP (False Positives) is the count of miss-classified labeled of rest of the classes, TN (True Negatives) is the count of correctly labeled instances of rest of the classes, and FN (False Negatives) is the count of miss-classified labeled of the class under observation.

$$\text{Sensitivity} = \frac{TP}{(TP+FN)} \tag{10}$$

$$\text{Specificity} = \frac{TN}{(FP+TN)} \tag{11}$$

$$\text{Precision} = \frac{TP}{(TP+FP)} \tag{12}$$

$$\text{F1 Score} = \frac{2TP}{(2TP+FP+FN)} \tag{13}$$

Figure 12 presents the performance metrics for different scenarios with DTL models for the COVID-19 CT dataset. The highest sensitivity of 88.3% (Table 4) is achieved by scenario-1 and scenario-2 (COVID-19 only and with augmentation) based on AlexNet and VGGNet19 that refers to the test's ability to correctly classify COVID-19 CT patients who do have the condition. In the example of a CT scan medical test used to classify and detect a COVID-19 disease, the detection rate (sensitivity) of the test is the proportion of people who test positive for the COVID-19 malady among those who have the COVID-19 malady. A negative result in a test with a high detection rate is useful for getting rid of the COVID-19 CT malady.

A test with high specificity would be able to determine the human that does not have the COVID-19 as shown in Table 5. Sensitivity and specificity can be summarized by a single quantity called the balanced accuracy as shown in Table 6, which is defined as the mean of both measures in equation (14):

$$\text{Balanced accuracy} = \frac{\text{Sensitivity}+\text{Specificity}}{2} \tag{14}$$

The balanced accuracy is in the range [0,1] where a value of 0 and 1 indicate the worst and the best classifier, respectively.

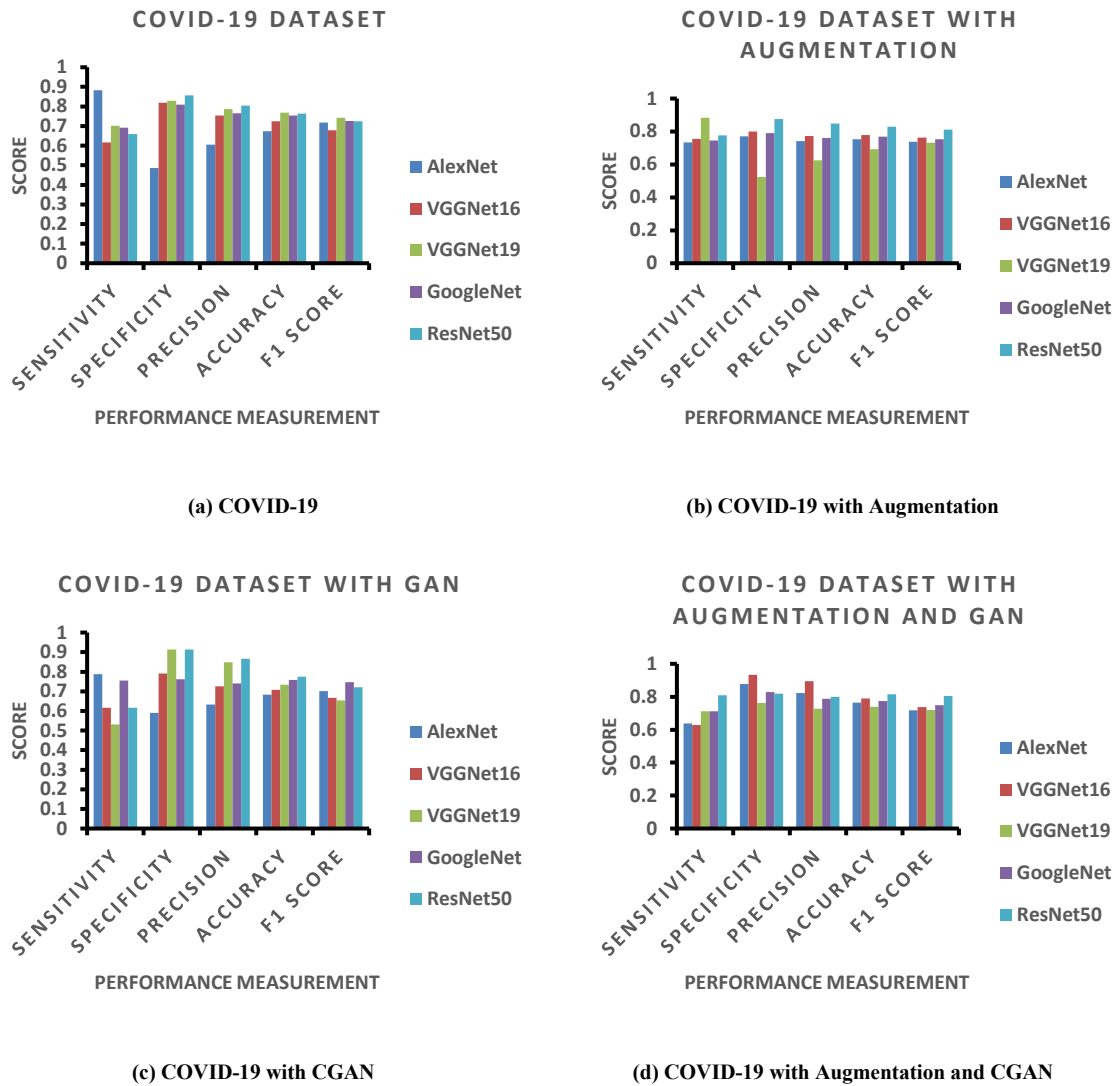

Fig. 12. Performance measurements for COVID-19 CT in four scenarios

Table 4. Testing Sensitivity for the different 4 scenarios

Dataset	AlexNet	VGGNet16	VGGNet19	GoogleNet	ResNet50
COVID-19	88.30%	61.70%	70.21%	69.15%	65.96%
COVID-19 with augmentation	73.40%	75.53%	88.30%	74.47%	77.66%
COVID-19 with CGAN	78.72%	61.70%	53.19%	75.53%	61.70%
COVID-19 with aug and CGAN	63.83%	62.77%	71.28%	71.28%	80.85%

Table 5. Testing Specificity for the different 4 scenarios

Dataset	AlexNet	VGGNet16	VGGNet19	GoogleNet	ResNet50
COVID-19	48.57%	81.90%	82.86%	80.95%	85.71%
COVID-19 with augmentation	77.14%	80.00%	52.38%	79.05%	87.62%
COVID-19 with CGAN	59.05%	79.05%	91.43%	76.19%	91.43%
COVID-19 with aug and CGAN	87.62%	93.33%	76.19%	82.86%	81.90%

Table 6. Testing Balanced accuracy for the different 4 scenarios

Dataset	AlexNet	VGGNet16	VGGNet19	GoogleNet	ResNet50
COVID-19	68.44%	71.80%	76.54%	75.05%	75.84%
COVID-19 with augmentation	75.27%	77.77%	70.34%	76.76%	82.64%
COVID-19 with CGAN	68.89%	70.38%	72.31%	75.86%	76.57%
COVID-19 with aug and CGAN	75.73%	78.05%	73.74%	77.07%	81.38%

As shown in Table 6, the balanced accuracy for different scenarios. The table also indicates that ResNet50 is the best classifier to detect the COVID-19 in CT dataset with classical data augmentation along with CGAN. The classical data augmentation along with CGAN improves the performance of classification in all deep transfer models (AlexNet, VGGNet16, VGGNet19, GoogleNet, ResNet50). The other bottleneck is the limited size of the COVID-19 CT database. Predictably the performance of deep transfer models can be further improved if more data are collected in the future. Although, we have achieved promising accuracy rates, however, the proposed model in this study needs to be tested on larger scale datasets that include different COVID-19 CT images to increase the testing accuracy and extend it in other medical applications. As future work, we plan to classify COVID-19 using a neutrosophic approach [42] and deep learning.

5. Conclusion and future works

In 2019, World infected by a 2019 novel coronavirus that killed more than thousands and infected over millions of humans within few months of the 2019 novel coronavirus epidemic. In this paper, classical data augmentations along with CGAN with deep transfer learning for COVID-19 detection in limited chest CT scan images is presented. The number of COVID-19 CT images of the collected dataset was 742 images for two types of labels. The classical data augmentation and CGAN help to increase the CT dataset and overcoming the overfitting problem. Moreover, five deep transfer learning models (AlexNet, VGGNet16, VGGNet19, GoogleNet, ResNet50) were selected in this paper for investigation. Using a combination of classical data augmentation and CGAN with deep transfer learning improve testing accuracy, and performance measurements such as sensitivity, specificity, precision, accuracy, and F1 score. The results show that ResNet50 with classical data augmentation along with CGAN is the best classifier to detect the COVID-19 from chest CT dataset. As future work, we plan to approach the COVID-19 study from a neutrosophic environment with deep learning.

References

1. Chang, L.; Yan, Y.; Wang, L. Coronavirus Disease 2019: Coronaviruses and Blood Safety. *Transfusion Medicine Reviews* **2020**, doi:https://doi.org/10.1016/j.tmr.2020.02.003.
2. Singhal, T. A Review of Coronavirus Disease-2019 (COVID-19). *The Indian Journal of Pediatrics* **2020**, *87*, 281–286, doi:10.1007/s12098-020-03263-6.
3. Lai, C.-C.; Shih, T.-P.; Ko, W.-C.; Tang, H.-J.; Hsueh, P.-R. Severe acute respiratory syndrome coronavirus 2 (SARS-CoV-2) and coronavirus disease-2019 (COVID-19):

- The epidemic and the challenges. *International Journal of Antimicrobial Agents* **2020**, *55*, 105924, doi:<https://doi.org/10.1016/j.ijantimicag.2020.105924>.
4. Li, J.; Li, J. (Justin); Xie, X.; Cai, X.; Huang, J.; Tian, X.; Zhu, H. Game consumption and the 2019 novel coronavirus. *The Lancet Infectious Diseases* **2020**, *20*, 275–276, doi:[10.1016/S1473-3099\(20\)30063-3](https://doi.org/10.1016/S1473-3099(20)30063-3).
 5. Sharfstein, J.M.; Becker, S.J.; Mello, M.M. Diagnostic Testing for the Novel Coronavirus. *JAMA* **2020**, doi:[10.1001/jama.2020.3864](https://doi.org/10.1001/jama.2020.3864).
 6. Shereen, M.A.; Khan, S.; Kazmi, A.; Bashir, N.; Siddique, R. COVID-19 infection: Origin, transmission, and characteristics of human coronaviruses. *Journal of Advanced Research* **2020**, *24*, 91–98, doi:<https://doi.org/10.1016/j.jare.2020.03.005>.
 7. Rabi, F.A.; Al Zoubi, M.S.; Kasasbeh, G.A.; Salameh, D.M.; Al-Nasser, A.D. SARS-CoV-2 and Coronavirus Disease 2019: What We Know So Far. *Pathogens* **2020**, *9*, 231, doi:[10.3390/pathogens9030231](https://doi.org/10.3390/pathogens9030231).
 8. York, A. Novel coronavirus takes flight from bats? *Nature Reviews Microbiology* **2020**, *18*, 191, doi:[10.1038/s41579-020-0336-9](https://doi.org/10.1038/s41579-020-0336-9).
 9. Lam, T.T.-Y.; Shum, M.H.-H.; Zhu, H.-C.; Tong, Y.-G.; Ni, X.-B.; Liao, Y.-S.; Wei, W.; Cheung, W.Y.-M.; Li, W.-J.; Li, L.-F.; et al. Identifying SARS-CoV-2 related coronaviruses in Malayan pangolins. *Nature* **2020**, doi:[10.1038/s41586-020-2169-0](https://doi.org/10.1038/s41586-020-2169-0).
 10. Giovanetti, M.; Benvenuto, D.; Angeletti, S.; Ciccozzi, M. The first two cases of 2019-nCoV in Italy: Where they come from? *Journal of Medical Virology* **2020**, *92*, 518–521, doi:[10.1002/jmv.25699](https://doi.org/10.1002/jmv.25699).
 11. Holshue, M.L.; DeBolt, C.; Lindquist, S.; Lofy, K.H.; Wiesman, J.; Bruce, H.; Spitters, C.; Ericson, K.; Wilkerson, S.; Tural, A.; et al. First Case of 2019 Novel Coronavirus in the United States. *New England Journal of Medicine* **2020**, *382*, 929–936, doi:[10.1056/NEJMoa2001191](https://doi.org/10.1056/NEJMoa2001191).
 12. Rothe, C.; Schunk, M.; Sothmann, P.; Bretzel, G.; Froeschl, G.; Wallrauch, C.; Zimmer, T.; Thiel, V.; Janke, C.; Guggemos, W.; et al. Transmission of 2019-nCoV Infection from an Asymptomatic Contact in Germany. *New England Journal of Medicine* **2020**, *382*, 970–971, doi:[10.1056/NEJMc2001468](https://doi.org/10.1056/NEJMc2001468).
 13. Phan, L.T.; Nguyen, T. V; Luong, Q.C.; Nguyen, T. V; Nguyen, H.T.; Le, H.Q.; Nguyen, T.T.; Cao, T.M.; Pham, Q.D. Importation and Human-to-Human Transmission of a Novel Coronavirus in Vietnam. *New England Journal of Medicine* **2020**, *382*, 872–874, doi:[10.1056/NEJMc2001272](https://doi.org/10.1056/NEJMc2001272).
 14. Bastola, A.; Sah, R.; Rodriguez-Morales, A.J.; Lal, B.K.; Jha, R.; Ojha, H.C.; Shrestha, B.; Chu, D.K.W.; Poon, L.L.M.; Costello, A.; et al. The first 2019 novel coronavirus case in Nepal. *The Lancet Infectious Diseases* **2020**, *20*, 279–280, doi:[10.1016/S1473-3099\(20\)30067-0](https://doi.org/10.1016/S1473-3099(20)30067-0).
 15. Coronavirus (COVID-19) map Available online: <https://www.google.com/covid19-map/> (accessed on Apr 11, 2020).
 16. Rong, D.; Xie, L.; Ying, Y. Computer vision detection of foreign objects in walnuts using deep learning. *Computers and Electronics in Agriculture* **2019**, *162*, 1001–1010, doi:<https://doi.org/10.1016/j.compag.2019.05.019>.

17. Lundervold, A.S.; Lundervold, A. An overview of deep learning in medical imaging focusing on MRI. *Zeitschrift für Medizinische Physik* **2019**, *29*, 102–127, doi:<https://doi.org/10.1016/j.zemedi.2018.11.002>.
18. Maier, A.; Syben, C.; Lasser, T.; Riess, C. A gentle introduction to deep learning in medical image processing. *Zeitschrift für Medizinische Physik* **2019**, *29*, 86–101, doi:<https://doi.org/10.1016/j.zemedi.2018.12.003>.
19. Ciregan, D.; Meier, U.; Schmidhuber, J. Multi-column deep neural networks for image classification. In Proceedings of the 2012 IEEE Conference on Computer Vision and Pattern Recognition; 2012; pp. 3642–3649.
20. Krizhevsky Ilya and Hinton Alex and Sutskever, G.E. Imagenet classification with deep convolutional neural networks. *Advances in neural information processing systems* **2012**, 1097–1105.
21. Lecun, Y.; Bottou, L.; Bengio, Y.; Haffner, P. Gradient-based learning applied to document recognition. *Proceedings of the IEEE* **1998**, *86*, 2278–2324, doi:10.1109/5.726791.
22. Yin, F.; Wang, Q.; Zhang, X.; Liu, C. ICDAR 2013 Chinese Handwriting Recognition Competition. In Proceedings of the 2013 12th International Conference on Document Analysis and Recognition; 2013; pp. 1464–1470.
23. LeCun, Y.; Huang, F.J.; Bottou, L. Learning methods for generic object recognition with invariance to pose and lighting. In Proceedings of the Proceedings of the 2004 IEEE Computer Society Conference on Computer Vision and Pattern Recognition, 2004. CVPR 2004.; 2004; Vol. 2, pp. II-104 Vol.2.
24. Stallkamp, J.; Schlipsing, M.; Salmen, J.; Igel, C. The German Traffic Sign Recognition Benchmark: A multi-class classification competition. In Proceedings of the The 2011 International Joint Conference on Neural Networks; 2011; pp. 1453–1460.
25. Deng, J.; Dong, W.; Socher, R.; Li, L.; Kai, L.; Li, F.-F. ImageNet: A large-scale hierarchical image database. In Proceedings of the 2009 IEEE Conference on Computer Vision and Pattern Recognition; 2009; pp. 248–255.
26. El-Sawy, A.; EL-Bakry, H.; Loey, M. CNN for Handwritten Arabic Digits Recognition Based on LeNet-5 BT - Proceedings of the International Conference on Advanced Intelligent Systems and Informatics 2016.; Hassanien, A.E., Shaalan, K., Gaber, T., Azar, A.T., Tolba, M.F., Eds.; Springer International Publishing: Cham, 2017; pp. 566–575.
27. El-Sawy, A.; Loey, M.; EL-Bakry, H. Arabic Handwritten Characters Recognition Using Convolutional Neural Network. *WSEAS Transactions on Computer Research* **2017**, *5*.
28. Liu, S.; Deng, W. Very deep convolutional neural network based image classification using small training sample size. In Proceedings of the 2015 3rd IAPR Asian Conference on Pattern Recognition (ACPR); 2015; pp. 730–734.
29. Szegedy, C.; Wei, L.; Yangqing, J.; Sermanet, P.; Reed, S.; Anguelov, D.; Erhan, D.; Vanhoucke, V.; Rabinovich, A. Going deeper with convolutions. In Proceedings of the 2015 IEEE Conference on Computer Vision and Pattern Recognition (CVPR); 2015; pp. 1–9.

30. He, K.; Zhang, X.; Ren, S.; Sun, J. Deep Residual Learning for Image Recognition. In Proceedings of the 2016 IEEE Conference on Computer Vision and Pattern Recognition (CVPR); 2016; pp. 770–778.
31. Chollet, F. Xception: Deep Learning with Depthwise Separable Convolutions. In Proceedings of the 2017 IEEE Conference on Computer Vision and Pattern Recognition (CVPR); 2017; pp. 1800–1807.
32. Huang, G.; Liu, Z.; Maaten, L. v. d.; Weinberger, K.Q. Densely Connected Convolutional Networks. In Proceedings of the 2017 IEEE Conference on Computer Vision and Pattern Recognition (CVPR); 2017; pp. 2261–2269.
33. Szegedy, C.; Vanhoucke, V.; Ioffe, S.; Shlens, J.; Wojna, Z. Rethinking the inception architecture for computer vision. In Proceedings of the Proceedings of the IEEE conference on computer vision and pattern recognition; 2016; pp. 2818–2826.
34. Christe, A.; Peters, A.A.; Drakopoulos, D.; Heverhagen, J.T.; Geiser, T.; Stathopoulou, T.; Christodoulidis, S.; Anthimopoulos, M.; Mougiakakou, S.G.; Ebner, L. Computer-Aided Diagnosis of Pulmonary Fibrosis Using Deep Learning and CT Images. *Investigative Radiology* **2019**, *54*, 627–632, doi:10.1097/RLI.0000000000000574.
35. Bermejo-Peláez, D.; Ash, S.Y.; Washko, G.R.; San José Estépar, R.; Ledesma-Carbayo, M.J. Classification of Interstitial Lung Abnormality Patterns with an Ensemble of Deep Convolutional Neural Networks. *Scientific Reports* **2020**, *10*, 1–15, doi:10.1038/s41598-019-56989-5.
36. Zhao, J.; Zhang, Y.; He, X.; Xie, P. COVID-CT-Dataset: A CT Scan Dataset about COVID-19. *arXiv:2003.13865 [cs, eess, stat]* **2020**.
37. Mikołajczyk, A.; Grochowski, M. Data augmentation for improving deep learning in image classification problem. In Proceedings of the 2018 International Interdisciplinary PhD Workshop (IIPhDW); 2018; pp. 117–122.
38. Kingma, D.P. Adam: A Method for Stochastic Optimization. **2015**.
39. Srivastava, N.; Hinton, G.; Krizhevsky, A.; Sutskever, I.; Salakhutdinov, R. Dropout: A Simple Way to Prevent Neural Networks from Overfitting. *Journal of Machine Learning Research* **2014**, *15*, 1929–1958.
40. Caruana, R.; Lawrence, S.; Giles, L. Overfitting in Neural Nets: Backpropagation, Conjugate Gradient, and Early Stopping. In Proceedings of the Proceedings of the 13th International Conference on Neural Information Processing Systems; MIT Press: Cambridge, MA, USA, 2000; pp. 381–387.
41. Goutte, C.; Gaussier, E. A Probabilistic Interpretation of Precision, Recall and F-Score, with Implication for Evaluation. In; 2010.
42. Smarandache, F. Neutrosophic Set is a Generalization of Intuitionistic Fuzzy Set, Inconsistent Intuitionistic Fuzzy Set (Picture Fuzzy Set, Ternary Fuzzy Set), Pythagorean Fuzzy Set, q-Rung Orthopair Fuzzy Set, Spherical Fuzzy Set, etc. *arXiv:1911.07333 [math]* **2019**.

Remark on Recent Experimental Findings Supporting Smarandache's Hypothesis and Quantum Sorites Paradoxes and Sub Quantum Kinetic Model of Electron

Victor Christianto, Robert N. Boyd, Florentin Smarandache

Victor Christianto, Robert N. Boyd, Florentin Smarandache (2021). Remark on Recent Experimental Findings Supporting Smarandache's Hypothesis and Quantum Sorites Paradoxes and Sub Quantum Kinetic Model of Electron. 4th International Conference on Materials Science and Materials Chemistry, *Advanced Materials Science Research* 1(4), 1

Statement of the Problem: Smarandache Hypothesis states that there's no regulation of something, together with lightweight and particles. While the idea is quite simple and based on a known hypothesis of quantum mechanics, called Einstein-Podolski-Rosen (EPR) paradox, in reality such a superluminal physics seems still hard to accept by the majority of physicists. Here we have a tendency to review some experiments to support superluminal physics and additionally findings to elucidate Smarandache Quantum contradictions and Quantum Sorites Paradox. We also touch briefly on a new experiment on magneton, supporting the SubQuantum Kinetic Model of Electron, and as well as discussing its implications on virus modelling and RNA/DNA.

Aim of this paper: We discuss some experimental results which will likely open new directions of research toward evidence-based physics.

Conclusion & Significance: Multi Experimental findings assessment allows one to verify conjectures by two of us (FS & RNB), namely: Smarandache Hypothesis, Smarandache Quantum Sorites Paradoxes and SubQuantum Kinetic Model of Electron.

While the idea is quite simple and based on known hypothesis of quantum mechanics, called Einstein-Podolski-Rosen paradox, in reality such a superluminal physics seems still hard to accept by the majority of physicists. Say, since 2011, there was an apparent surprising result as announced by the OPERA team. Nonetheless, few months later it was renounced, on the ground of errors in handling the measurement.

Allow us to make few comments on such an apparent failure to detect faster than light speed as follows: Anyway we thought that a more convincing experiment has been done by Alain Aspect etc., showing quantum nonlocal interaction is real. In 1980, Alain Aspect performed the first EPR experiment which proved the existence of space nonlocality. Alain Aspect and his team experimented with three Bell tests using Cascade sources. The first and last used the CH74 inequality while the next was the first application of the CHSH inequality. The third was arranged such that the choice between the two settings on each side were made during the flight of the photons. Some experimenters have repeated this experiment and prove similar results until distances of more than 90 km. So the notion of spooky action at a distance has real effects.

Moreover, action at a distance is already in Newton's Principia. Einstein was trying to make all of Newton's expressions into nothing to be "superseded" by E's vastly inferior version of relativity.

In a recent, forthcoming paper, RN Boyd discusses resolutions of some of those Smarandache Quantum Paradoxes and Quantum Sorites Paradoxes.

Now allow us to describe briefly a new experiment on magneton and structure of electrons. In the past few months, we got in contact with a wonderful experimenters team from Greece, led by Emmanouil Markoulakis. They have published a number of wonderful experiment results, confirming that the structure of electrons is deeply related to Kelvin-Helmholtz vortex theory, just as we described earlier last year. At the most fundamental level, E and B are mutually causational. Each causes the other. This is well known in plasma physics.

That looks like the generation of the electric charge of the electron due the horizontally radially spinning magnetosphere. Vortexing, vertical spiraling magnetic flux on its poles creates its magnetic moment and magnetic field whereas its radially horizontally spinning around its equator magnetic flux creates its electric charge and electric field. Moreover, we can add here:

1 - "Similar to this finding, our recent findings, where DNA formed inside a sealed test tube filled with pure water that was placed adjacent to an identical test tube filled with pure water, which contained a very small sample of DNA, where both test tubes were irradiated by a very small amplitude low frequency of EMF, over night.

2 - This implies that DNA/RNA information exists everywhere in the infinite volume Universe, and is held in the aether, most probably in the solid and fluidic phase states. The DNA information already existing in the aether media, everywhere, expresses forms of life perfectly suited to all environments capable of supporting life at a given time and place.

This is related to local developments of new virus types, which types will change, as the local stellar and energetic environments change. This is all the more reason to prohibit 5G, since 5G is an environmental factor which may cause new forms of viruses to express in the DNA/RNA environment which is local to this planet and to this star, because of modifications to our life environment caused by 5G EMFs.

Further experiments are recommended toward evidence-based physics.

Octogon magazine celebrates 30 years of existence

Florentin Smarandache

Florentin Smarandache (2022). Octogon magazine celebrates 30 years of existence. *Octogon Mathematical Magazine* 30(1), 25-26

This year (2022) the Octogon magazine celebrates 30 years of existence, and is the continuation of Gamma magazine, which in May 1989 (after having continuously functioning between 1978-1989) was banned by the communist regime. I was part of the Gamma and Octogon editorial staff right from the start. This is a homage article, about what meant Gamma magazine during the communist era, and Octogon magazine for Romanian and universal mathematics. The Octogon was published first in Romanian and then in English, attracting an international audience and cooperation.

In the Fall of 1987 I have writing a note about Gamma [1, 2]:

This 1987 autumn there will mark a few years since the school math journal “Gamma” was founded at the “Steagul Roșu” College in Brașov, Romania, under the guidance of the good-hearted professor MIHAIL BENCZE, who has not spared any effort for it.

In the 28 numbers issued up to September 1987, the “Gamma” journal has encouraged over two thousands students in solving problems of mathematics, helping them prepare for scientific competitions, exams for grades and degrees for universities. Each year, the Editorial Office grants prizes and honorable mentions to the most hardworking pupils who solve problems.

The journal’s structure is classic. The wider space is dedicated to the original proposed problems of mathematics for grades 8-12 and college levels of computer science, up to present exceeding 7000, out of which we are sure that any time a bunch of very interesting problems, highly difficult, can be selected. We remember that some of those have already appeared in prestigious foreign journals – i.e. “American Mathematical Monthly”, “Mathematics Magazine”, etc. We also remember the over 80 open problems. Among which some may constitute topics of research for the mathematicians of tomorrow. Some elegant and ingenious problems are solved/resolved in the pages of this journal. The journal also contains problems translated from foreign magazines (“Kvant”, A. M. M.) or foreign collections, problems given at Olympiads of mathematics from other countries (Spain, Belgium, Tunisia, Morocco, etc.) as well as from our country (GMB, RMT, Matematikai Lapok) some with solutions or even with generalizations of problems from the magazines mentioned above. Also, over one hundred “Where is the fault? (in demonstrations)” notes of mathematics.

There have been over 130 papers for popularization of mathematics or matters concerning interdisciplinary, mathematics and other domains (physics, philosophy, psychology, etc.) or even of creation.

The column “Mini Mathematical History”, sustained with regularity by Prof. M. Bencze, schematically presented approximately 150 Romanian and foreign biographies of mathematicians.

Among the journal’s collaborators included (other than the students, who are the most numerous, because, in fact, it is their journal) are professors, engineers, computer science specialists, and university faculty. Many are recognized in their field of specialty. The foreign collaborators Dr. E. Grosswald, Dr. Leroy F. Meyers (U. S. A.), Prof. Francisco Bellot Rosado (Spain), are famous in the world of Mathematics.

Additionally, the Editorial Office sporadically published Mathematical Paradoxes, cross words, “Mathematical Poems”, and columns (such as “...did you know that...”), graphic themes and mottos (let us better call them, words of wisdom) of famous people.

Long Life in Mathematics!

References

[1] F. Smarandache, Jubilee of Gamma journal, Gamma, Brasov, Romania, XXIX-XXX, Anul X, 1-2, October 1987, pp. 7-8.

[2] F. Smarandache, Jubilee of Gamma journal, in Collected Papers, Vol. I, (first edition 1996, second edition 2007), Translated from Romanian and French into English by the author, pp. 177-178, ProQuest Information & Learning, Ann Arbor, MI, USA, <http://fs.unm.edu/CP1.pdf>.

Notes on the other side of creativity in mathematical physics development: schizotypy and the need for a new approach in exploring new physics

Victor Christianto, Florentin Smarandache

Victor Christianto, Florentin Smarandache (2022). Notes on the other side of creativity in mathematical physics development: schizotypy and the need for a new approach in exploring new physics. *Octagon Mathematical Magazine* 30(1), 302-308

1 Introduction

As one of the authors (VC) notes a few days ago, there is a book we have just published by one of the publishers in Jakarta, entitled *Koinomics: Relational Economics to bring Pancasila to life* (Jakarta: Bina Warga, 2022). At the end of the book, a senior writer as well as a lecturer and practitioner at one of Management Studies School in Jakarta, wrote a Reflective Closing as follows: "We have long observed that various fields of science are engrossed in playing with methods and techniques each other's logic. Also what is the focus is rarely enriched by focus and findings in other areas that are completely beyond his concerns. As if they prison in strict scientific rules according to their fields, such as methods of theology, diction, and tradition of their respective logics and basic assumptions that are rarely explored repeat. This book is different. When the metaphor of a river is used, the flow of the water brings with it gravel, leaves, roots, stones, and sand. As a result, going with the flow is not always easy. Especially if the author is someone who is brave and tries to find the relationship of one thing in a field of science with other things outside the field of science which at first glance have absolutely nothing to do and make jumps. Moreover, linking theology or spirituality with economics, mysticism, ways of working brain, mathematics, and so on will indeed stretch the ability of appreciation-active reader." Then we can ask: How do we approach a creative process? If you look at the latest articles, it seems that an "sane-acceptable level of insanity" is needed, or perhaps it can be called, within the framework of Fuzzy Logic or Neutrosophic Logic: "Neutrosophic Degree of Madness in Creativity Theoretical Development." How then to address the "acceptable insanity" . . . or

the accepted a fair-degree of madness? In another article, we call it: Principle of Minimal Madness.

2 A few recent literatures

Is it true: People with a little mental disorder are more creative? (From daily news: Kompas.com) - Art lovers may have known for a long time that Van Gogh, who cut off his own ear, suffered from a mental disorder. Another exemplary case is, just for the sake of giving an example: the late mathematician Prof. John Forbes Nash, Jr., whose biography has been made into a major movie: "A beautiful mind." This fact seems to be the same as the conclusion of a study conducted by a team from Sweden's Karolinska Institute which states that an artist's creativity may be linked to mental disorders. By studying 1.2 million patients, including inpatients and outpatients, the researchers found that artists, scientists, and professions that require creativity generally come from families with a history of bipolar disorder, depression, anxiety, autism, anorexia, suicide-tendency, ADHD etc.[13] Another news from Stockholm - There are people who have a high level of creativity and ideas that other people don't think of. But often such people are suspected of suffering from mental illness. Is there a relationship between creativity and mental illness? Recent studies have shown that the brain responds similarly to the chemical dopamine in people with schizophrenia as well as highly creative people. The results showed that there were similarities between highly creative people and those with mental disorder, which then it is called "schizotypy." These findings suggest that creative people may not be able to filter information in their heads like normal people, so creative people are better able to make connections to create unique ideas.[14] Besides their own disadvantages of being quite-awkward people among their society, they can be expected to give a contribution, to find new physics beyond just "Dirac recipe." As we know, mathematical physicists are often so obsessed in finding new physics by exploring new mathematics; which can be attributed to Paul A.M. Dirac' advise, as we will discuss as follows. As Anderson Joshi wrote, which can be para-phrased as follows: "One of the significant ways improvement happens in math is through a course of generalization. A portrayal given by Kitcher of one of the significant ways math advances, which he distinguishes as one of "generalization." This refines an idea communicated by Dirac in 1931 on the manner by which certain progressions in science can play a huge heuristic occupation in material science." [1] See also how Maxwell and Heavy-side worked out their way. [2][3] Actually, Dirac advises as follows: "...that a "powerful new method" for the physicist comprises of picking a branch of arithmetic and afterward continuing "to foster it along appropriate lines, simultaneously searching for that manner by which it seems to loan itself normally to actual translation." [4] While initially such an advise sounds clear and worth to follow, but from the last few decades, there is a quite unhealthy trend, a kind of obsession to find new and the largest group ever, and then physicists try to find if there is signature of Nature's approval of their wild adventure. Such a gloomy

situation has been reported in Hossenfelder's "Lost in Math," which attracts responses from various luminaries such as Wilczek etc. Ref. cf. [5] As far as we can consider, these situations are caused because physicists tend to be absorbed more on mathematical structures, symmetry, beauty -so to speak. While they often forget to ask Nature what it actually says - through experiments. Such a simple problem. Even, there are rumours that Michelson-Morley experiment was designed and ordered as such to prove that "ether" the all-filling-primary fluid does not exist. Therefore, many more precise experiments which came later, such as Miller etc., are systematically discarded. They say: ether is not required - by definition, they would prefer "mathematical beauty" over reality itself (these are the attitude of many mathematicians and physicists alike, even if some of them do not agree with special relativity). Such and such is the case, until we found the arrogance of string theorists, who insist that string and superstring etc. should be the only game in town. Thanks to Peter Woit etc., we know that superstring theories are far from being the correct theory we sought for.[7][8] Part of the problem, as we can think, is that most physicists forget the latter part of Dirac's advise above : "at the same time looking for that way in which it appears to lend itself naturally to physical interpretation." [4] Therefore, what Dirac actually wrote is to find a balance between mathematical structures but we shall keep our feet on the grounds. See our paper in J, where we argue that it is actually Kolmogorov's theorem of contradiction that show the possibility of complicated mathematical theories to yield so many paradoxes and problems, as it also was proved by Godel (1931). Therefore allow us to argue a few guides, including a simple one-to-one correspondence between mathematical variables and physical observables, as well as keep our postulates to a minimum. [6] In a more general parlance, provided we can accept that actually all of us are crazy, especially we mathematical physicists in general, only with varying degree of madness, then what we argue is to keep principle of parsimony. This may be called, in a rather light way, as "Principle of minimal madness." The question is how to find ways beyond mere Dirac's recipe. One way is to suggest to look not only at more and more general mathematics, but to merge ideas, which of course require certain degree of inclusive thinking. See 2 examples that we will discuss here: phase transition in city dynamics, and also topology of data modeling, especially in the world of new data structures offered by new language Go and Golang database. See also, ref. [9]-[12].

3 Example 1: Merging ideas, Phase transition + city dynamics

Phase transition is known concept in experimental physics, but to merge this observed concept with city dynamics is entirely something else. Phase transition to turbulence is also known in studies related to non-equilibrium dynamics or self-organized criticality. According to Joel Dearden et al. [15] in their abstract: "We also identify key characteristics of the dynamics such as velocity

and how the phase space landscape changes over time. This analysis is then linked with equilibrium-size graphs, which allow insights from state space to be applicable to models with large numbers of zones. More generally this type of analysis can potentially offer insights into the nature of the dynamics in any dynamical-systems-type urban model. This is critical for increasing our understanding and helping stakeholders and policy-makers to plan for future urban changes.” We believe that such an approach is very promising to combine concept already known in experimental physics, e.g. phase transition dynamics; towards analysing spatial dynamics or urban development problems.

4 Example 2: Merging ideas, Topology + data modeling

Beyond just relational tables and relational databases, there is growing need for new types of data structures and new ways of data modeling. For instance, by introducing geometric triangulation. As N. Sharp wrote in introduction to his dissertation (2021): ”As geometric data becomes more ubiquitous in applications ranging from scientific computing (...), there is a pressing need to develop algorithms that work reliably on low-quality data. Intrinsic triangulations provide a powerful framework for these problems, by decoupling the mesh used to encode geometry from the one used for computation. The basic shift in perspective is to encode the geometry of a mesh not with ordinary vertex positions, but instead with only edge lengths.” [9] Besides, there are a number of new programming languages, for instance Go and its particular database, called Golang. And one of its new features is the so-called topological relationship, which can be viewed as merging two ideas: topology from advanced geometry studies and data modeling.[18] See the following figures for illustrating the new approach to relationship in data modeling.

To summarize, we can expect new fields of study, not only by finding more general mathematics, but by merging two or more ideas as per required by problem at hand. From that perspective, sometimes we can find a unique role of schizotypic persons with their unique view of reality and also their ”inclusive thinking” approach, such as we observed in the biography of Prof. John F. Nash, Jr.

5 Concluding remark

There is indeed an apparent fine line between unconventional creativity and true madness. Although we are aware of the role of schizotypy which includes, among other things, inclusiveness in thinking (meaning crossing common boundaries in scientific disciplines), there is a certain point when creativity becomes pure madness. To summarize, we can expect new fields of study, not only by finding more general mathematics, but by merging two or more ideas as per required by problem at hand. From that perspective, sometimes we can find a unique role

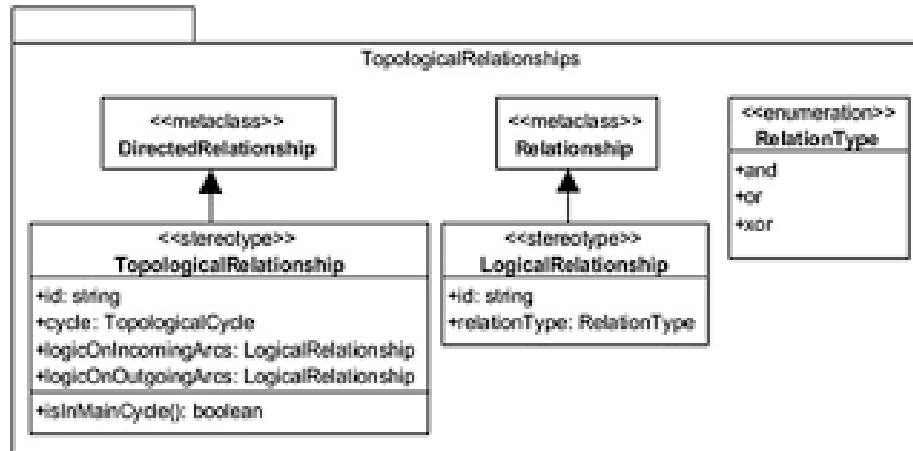

Figure 1: Example: Topological relationship.

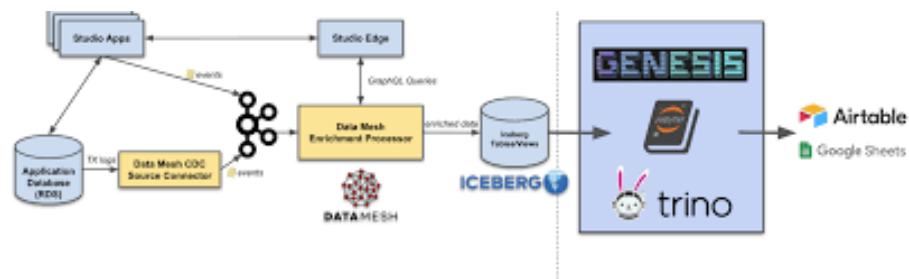

Figure 2: Example: Data Mesh and Data Modeling of Netflix services.

of schizotypic persons with their unique view of reality and also their "inclusive thinking" approach, such as we observed in the biography of Prof. John F. Nash, Jr.

References

- [1] R. Anderson G.C. Joshi (1992) *Quaternions and the Heuristic Role of Mathematical Structures in Physics*. UM-P-92/61, OZ-92/20. arXiv:hep-ph/9208222v2
- [2] J.C. Maxwell (1891) *A Treatise on Electricity and Magnetism* (Oxford: reprinted in 1954, Dover Publications: New York, Clarendon Press, 1891).
- [3] O. Heaviside (1893) "Vectors versus Quaternions" *Nature*, 47, 533–534 (1893).
- [4] P.A.M. Dirac (1939) "The Relation between Mathematics and Physics" *Proceedings of the Royal Society of Edinburgh*, 59, 122–129 (1939).
- [5] Sabine Hossenfelder (2020) *Lost in Math*. NY: Basic Books, 2020. ISBN: ISBN-13: 9781541646766. url: <https://www.basicbooks.com/titles/sabine-hossenfelder/lost-in-math/9781541646766/>
- [6] V. Christianto, F. Smarandache (2019). *A Review of Seven Applications of Neutrosophic Logic: In Cultural Psychology, Economics Theorizing, Conflict Resolution, Philosophy of Science, etc.* J, 2(2), 128-137. <https://doi.org/10.3390/j2020010>. url: <https://www.mdpi.com/2571-8800/2/2/10>
- [7] J. Stachel 1972) *The rise and fall of Geometrodynamics* *Proceedings of the Biennial Meeting of the Philosophy of Science Association* Vol. 1972 (1972), pp. 31-54 (24 pages) Published by: Springer. url: <https://www.jstor.org/stable/3698959>
- [8] P. Woit (2016) *Not even wrong: ten years later* Rutgers Physics Colloquium, Feb. 3. url: <http://www.math.columbia.edu/woit/rutgers.pdf>
- [9] F. Smarandache (2019) *Introduction to NeutroAlgebraic Structures and AntiAlgebraic Structure* in his book *Advances of Standard and Nonstandard Neutrosophic Theories*, Pons Publishing House Brussels, Belgium, Chapter 6, pages 240-265, 2019; <http://fs.unm.edu/AdvancesOfStandardAndNonstandard.pdf>
- [10] F. Smarandache (2020) *NeutroAlgebra is a Generalization of Partial Algebra* *International Journal of Neutrosophic Science (IJNS)*, Volume 2, 2020, pp. 8-17. DOI: <http://doi.org/10.5281/zenodo.3989285>, <http://fs.unm.edu/NeutroAlgebra.pdf>
- [11] F. Smarandache (2020) *Introduction to NeutroAlgebraic Structures and AntiAlgebraic Structures (revisited)* *Neutrosophic Sets and Systems*, vol. 31, pp. 1-16, 2020. DOI: 10.5281/zenodo.3638232. url: <http://fs.unm.edu/NSS/NeutroAlgebraic-AntiAlgebraic-Structures.pdf>

- [12] F. Smarandache (2020) *Generalizations and Alternatives of Classical Algebraic Structures to NeutroAlgebraic Structures and AntiAlgebraic Structures* Journal of Fuzzy Extension and Applications (JFEA), J. Fuzzy. Ext. Appl. Vol. 1, No. 2 (2020) 85–87, DOI: 10.22105/jfea.2020.248816.1008. url: <http://fs.unm.edu/NeutroAlgebra-general.pdf>
- [13] Lusia Kus Anna (2012). *Temuan penelitian di Karolinska* url: <https://amp.kompas.com/otomotif/read/2012/10/18/15185148/psikologi>; also URL <https://health.detik.com/berita-detikhealth/d-1360577/orang-kreatif-dan-penderita-penyakit-mental-otaknya-sama>
- [14] Hariansyah (). *Imajinasi Kreatif*. Disertasi submitted to UIN. Jakarta: Transwacana Press. Url: <https://repository.uinjkt.ac.id/dspace/handle/123456789/49412>
- [15] Joel Dearden, Yi Gong et al. *Using the State Space of a BLV Retail Model to Analyse the Dynamics and Categorise Phase Transitions of Urban Development* Urban Sci. 2019 (MDPI), 3, 31; doi:10.3390/urbansci301003
- [16] H.L. Swinney J.R. Gollub (1978) *The transition to turbulence* Phys. Today 31(8), 41 (1978); doi: 10.1063/1.2995142
- [17] N. Karumanchi () emphData structures and algorithms made easy Published by: CareerMonk.com, 2017.
- [18] Hemant Jain () emphData structures and algorithms in Go Published by Hemant Jain, 2017 (ebook version).
- [19] Nicholas Sharp (2021) emphIntrinsic Triangulations in Geometry Processing PhD. Dissertation submitted to Carnegie Mellon University Pittsburgh, PA 15213, unpublished (2021).

Florentin Smarandache's Collected Papers series:

Collected Papers, Vol. I

(first edition 1996, second edition 2007)

Free download: <http://fs.unm.edu/CP1.pdf>

Collected Papers, Vol. II

(Chişinău, Moldova, 1997)

Free download: <http://fs.unm.edu/CP2.pdf>

Collected Papers, Vol. III

(Oradea, Romania, 2000)

Free download: <http://fs.unm.edu/CP3.pdf>

Collected Papers, Vol. IV (100 Collected Papers of Sciences)

Multispace & Multistructure. Neutrosophic Transdisciplinarity

(Hanko, Finland, 2010)

Free download: <http://fs.unm.edu/MultispaceMultistructure.pdf>

Collected Papers, Vol. V: Papers of Mathematics or Applied mathematics

(Brussels, Belgium, 2014)

Free download: <http://fs.unm.edu/CP5.pdf>

Collected Papers, Vol. VI: on Neutrosophic Theory and Applications

(Global Knowledge, 2022)

Free download: <http://fs.unm.edu/CP6.pdf>

Collected Papers, Vol. VII: on Neutrosophic Theory and Applications

(Global Knowledge, 2022)

Free download: <http://fs.unm.edu/CP7.pdf>

Collected Papers, Vol. VIII: on Neutrosophic Theory and Applications

(Global Knowledge, 2022)

Free download: <http://fs.unm.edu/CP8.pdf>

Collected Papers, Vol. IX: on Neutrosophic Theory and Its Applications in Algebra

(Global Knowledge, 2022)

Free download: <http://fs.unm.edu/CP9.pdf>

Collected Papers, Vol. X: on Neutrosophics, Plithogenics, Hypersoft Set, Hypergraphs, and other topics

(Global Knowledge, 2022)

Free download: <http://fs.unm.edu/CP10.pdf>

Collected Papers, Vol. XI: on Physics, Artificial Intelligence, Decision Making, Economics, Statistics

(Global Knowledge, 2022)

Free download: <http://fs.unm.edu/CP11.pdf>

Collected Papers, Vol. XII: on Neutrosophics Theory and Applications

(Global Knowledge, 2022)

Free download: <http://fs.unm.edu/CP12.pdf>

Collected Papers, Vol. XIII: on various scientific topics

(Global Knowledge, 2022)

Free download: <http://fs.unm.edu/CP13.pdf>

This fourteenth volume of *Collected Papers* is an eclectic tome of 87 papers in Neutrosophics and other fields, such as mathematics, fuzzy sets, intuitionistic fuzzy sets, picture fuzzy sets, information fusion, robotics, statistics, or extenics, comprising 930 pages, published between 2008-2022 in different scientific journals or currently in press, by the author alone or in collaboration with the following 99 co-authors (alphabetically ordered) from 26 countries: Ahmed B. Al-Nafee, Adesina Abdul Akeem Agboola, Akbar Rezaei, Shariful Alam, Marina Alonso, Fran Andujar, Toshinori Asai, Assia Bakali, Azmat Hussain, Daniela Baran, Bijan Davvaz, Bilal Hadjadji, Carlos Díaz Bohorquez, Robert N. Boyd, M. Caldas, Cenap Özel, Pankaj Chauhan, Victor Christiano, Salvador Coll, Shyamal Dalapati, Irfan Deli, Balasubramanian Elavarasan, Fahad Alsharari, Yonfei Feng, Daniela Gîfu, Rafael Rojas Gualdrón, Haipeng Wang, Hemant Kumar Gianey, Noel Batista Hernández, Abdel-Nasser Hussein, Ibrahim M. Hezam, Ilanthenral Kandasamy, W.B. Vasantha Kandasamy, Muthusamy Karthika, Nour Eldeen M. Khalifa, Madad Khan, Kifayat Ullah, Valeri Kroumov, Tapan Kumar Roy, Deepesh Kunwar, Le Thi Nhung, Pedro López, Mai Mohamed, Manh Van Vu, Miguel A. Quiroz-Martínez, Marcel Migdalovici, Kritika Mishra, Mohamed Abdel-Basset, Mohamed Talea, Mohammad Hamidi, Mohammed Alshumrani, Mohamed Loey, Muhammad Akram, Muhammad Shabir, Mumtaz Ali, Nassim Abbas, Munazza Naz, Ngan Thi Roan, Nguyen Xuan Thao, Rishwanth Mani Parimala, Ion Pătraşcu, Surapati Pramanik, Quek Shio Gai, Qiang Guo, Rajab Ali Borzooei, Nimitha Rajesh, Jesús Estupiñan Ricardo, Juan Miguel Martínez Rubio, Saeed Mirvakili, Arsham Borumand Saeid, Saeid Jafari, Said Broumi, Ahmed A. Salama, Nirmala Sawan, Gheorghe Săvoiu, Ganeshsree Selvachandran, Seok-Zun Song, Shahzaib Ashraf, Jayant Singh, Rajesh Singh, Son Hoang Le, Tahir Mahmood, Kenta Takaya, Mirela Teodorescu, Ramalingam Udhayakumar, Maikel Y. Leyva Vázquez, V. Venkateswara Rao, Luige Vlădăreanu, Victor Vlădăreanu, Gabriela Vlădeanu, Michael Voskoglou, Yaser Saber, Yong Deng, You He, Youcef Chibani, Young Bae Jun, Wadei F. Al-Omeri, Hongbo Wang, Zayen Azzouz Omar.

Keywords: Neutrosophy; Neutrosophic Logic; Neutrosophic Sets; Neutrosophic Probability; Decision Making; Extenics; Plithogeny; Plithogenic Set; Plithogenic Logic; Plithogenic Probability; Plithogenic Statistics; COVID-19; Dezert-Smarandache Theory; Single Valued Neutrosophic Set; Interval Neutrosophic Sets; Set-Theoretic Operator; Neutrosophic-Tendential Fuzzy Logic; Neutrosophic Index; Index Statistical Method; Price Index; Interpreter Index; Neutrosophic Interpreter Index; Neutrosophic Soft Expert Set; Neutrosophic Soft Expert Images; Neutrosophic Soft Expert Inverse Images; Mapping On Neutrosophic Soft Expert Set; Single Valued Neutrosophic Graph; Strong Single Valued Neutrosophic Graph; Constant Single Valued Neutrosophic Graph; Complete Single Valued Neutrosophic Graph; Dijkstra Algorithm; Interval Valued Neutrosophic Number; Shortest Path Problem; Network; Triangular Fuzzy Neutrosophic Sets; Score Function; Bipolar Neutrosophic Graph; Generalized Bipolar Neutrosophic Graphs; Matrix Representation; Adjacency Matrix; Neutrosophic Optimization; Goal Programming Problem; Project Management; Score And Accuracy Functions; Generalized Neutrosophic Set; Generalized Neutrosophic Subalgebra; Generalized Neutrosophic Ideal; Spanning Tree Problem; Entropy Measure; Intuitionistic Fuzzy Set; Inconsistent Intuitionistic Fuzzy Set; Picture Fuzzy Set; Ternary Fuzzy Set; Pythagorean Fuzzy Set; Atanassov's Intuitionistic Fuzzy Set of second type; Spherical Fuzzy Set; n-HyperSpherical Neutrosophic Set; q-Rung Orthopair Fuzzy Set; truth-membership; indeterminacy-membership; falsehood-nonmembership; Regret Theory; Grey System Theory; Three-Ways Decision; n-Ways Decision; Neutrosophication; Refined Neutrosophy; Refined Neutrosophication; Sentiment Analysis; Speech Analysis; Clustering Algorithm; K-means; Hierarchical Agglomerative Clustering; Neutrosophic Minimal Structure.

ISBN 978-1-59973-744-7



9 781599 737447 >