

Florentin Smarandache

(author and editor)

Collected Papers

(on Neutrosophic Theory and Applications)

Volume VII

Florentin Smarandache

(author and editor)

Collected Papers

(on Neutrosophic Theory and Applications)

Volume VII

Peer-Reviewers:

Muhammad Aslam

King Abdulaziz University, Jeddah, SAUDI ARABIA
magmuhammad@kau.edu.sa

Akbar Rezaei

Department of Mathematics, Payame Noor University, Tehran, IRAN
rezaei@pnu.ac.ir

Xindong Peng

School of Information Science and Engineering, Shaoguan University, Shaoguan, PR CHINA
952518336@qq.com

Muhammad Saeed

Department of Mathematics, University of Management and Technology, Lahore, PAKISTAN
muhammad.saeed@umt.edu.pk

Selçuk Topal

Mathematics Department, Bitlis Eren University, TURKEY
s.topal@beu.edu.tr

Florentin Smarandache

(author and editor)

Collected Papers

(on Neutrosophic Theory and Applications)

Volume VII

GLOBAL KNOWLEDGE

Publishing House

Miami, United States of America

2022

Publishing:

GLOBAL KNOWLEDGE - Publishing House
848 Brickell Ave Ste 950 Miami
Florida 33131, United States
<https://egk.ccgecon.us>
info@egk.ccgecon.us

ADSUMUS – Scientific and Cultural Society
13, Dimitrie Cantemir St.
410473 Oradea City, Romania
<https://adsumus.wordpress.com/>
ad.sumus@protonmail.com

NSIA Publishing House
Neutrosphic Science International Association
<https://www.publishing-nsia.com/>
University of New Mexico, Gallup, United States Universidad
Regional Autónoma de los Andes (UNIANDES), Babahoyo,
Los Rios, Ecuador

Editors:

Publishing:
Prof. Dan Florin Lazar
lazar.danflorin@yahoo.com
Prof. Dr. Maykel Yelandí Leyva Vazquez
ub.c.investigacion@uniandes.edu.ec

ISBN 978-1-59973-729-4

Introductory Note

This seventh volume of *Collected Papers* includes 70 papers comprising 974 pages on (theoretic and applied) neutrosophics, written between 2013-2021 by the author alone or in collaboration with the following 122 co-authors from 22 countries: Mohamed Abdel-Basset, Abdel-Nasser Hussian, C. Alexander, Mumtaz Ali, Yaman Akbulut, Amir Abdullah, Amira S. Ashour, Assia Bakali, Kousik Bhattacharya, Kainat Bibi, R. N. Boyd, Ümit Budak, Lulu Cai, Cenap Özel, Chang Su Kim, Victor Christianto, Chunlai Du, Chunxin Bo, Rituparna Chutia, Cu Nguyen Giap, Dao The Son, Vinayak Devvrat, Arindam Dey, Partha Pratim Dey, Fahad Alsharari, Feng Yongfei, S. Ganesan, Shivam Ghildiyal, Bibhas C. Giri, Masooma Raza Hashmi, Ahmed Refaat Hawas, Hoang Viet Long, Le Hoang Son, Hongbo Wang, Hongnian Yu, Mihaiela Iliescu, Saeid Jafari, Temitope Gbolahan Jaiyeola, Naeem Jan, R. Jeevitha, Jun Ye, Anup Khan, Madad Khan, Salma Khan, Ilanthenral Kandasamy, W.B. Vasantha Kandasamy, Darjan Karabašević, Kifayat Ullah, Kishore Kumar P.K., Sujit Kumar De, Prasun Kumar Nayak, Malayalan Lathamaheswari, Luong Thi Hong Lan, Anam Luqman, Luu Quoc Dat, Tahir Mahmood, Hafsa M. Malik, Nivetha Martin, Mai Mohamed, Parimala Mani, Mingcong Deng, Mohammed A. Al Shumrani, Mohammad Hamidi, Mohamed Talea, Kalyan Mondal, Muhammad Akram, Muhammad Gulistan, Farshid Mofidnakhaci, Muhammad Shoaib, Muhammad Riaz, Karthika Muthusamy, Nabeela Ishfaq, Deivanayagampillai Nagarajan, Sumera Naz, Nguyen Dinh Hoa, Nguyen Tho Thong, Nguyen Xuan Thao, Noor ul Amin, Dragan Pamučar, Gabrijela Popović, S. Krishna Prabha, Surapati Pramanik, Priya R, Qiaoyan Li, Yaser Saber, Said Broumi, Saima Anis, Saleem Abdullah, Ganeshsree Selvachandran, Abdulkadir Sengür, Seyed Ahmad Edalatpanah, Shahbaz Ali, Shahzaib Ashraf, Shouzhen Zeng, Shio Gai Quek, Shuangwu Zhu, Shumaiza, Sidra Sayed, Sohail Iqbal, Songtao Shao, Sundas Shahzadi, Dragiša Stanujkić, Željko Stević, Udhayakumar Ramalingam, Zunaira Rashid, Hossein Rashmanlou, Rajkumar Verma, Luige Vlădăreanu, Victor Vlădăreanu, Desmond Jun Yi Tey, Selçuk Topal, Naveed Yaqoob, Yanhui Guo, Yee Fei Gan, Yingcang Ma, Young Bae Jun, Yuping Lai, Hafiz Abdul Wahab, Wei Yang, Xiaohong Zhang, Edmundas Kazimieras Zavadskas, Lemnaouar Zedam.

Florentin Smarandache's Collected Papers series:

Collected Papers, Vol. I

(first edition 1996, second edition 2007)

Free download: <http://fs.unm.edu/CP1.pdf>

Collected Papers, Vol. II

(Chişinău, Moldova, 1997)

Free download: <http://fs.unm.edu/CP2.pdf>

Collected Papers, Vol. III

(Oradea, Romania, 2000)

Free download: <http://fs.unm.edu/CP3.pdf>

*Collected Papers, Vol. IV (100 Collected Papers of Sciences)
Multispace & Multistructure. Neutrosophic Transdisciplinarity*

(Hanko, Finland, 2010)

Free download: <http://fs.unm.edu/MultispaceMultistructure.pdf>

Collected Papers, Vol. V: Papers of Mathematics or Applied mathematics

(Brussels, Belgium, 2014)

Free download: <http://fs.unm.edu/CP5.pdf>

Collected Papers, Vol. VI: on Neutrosophic Theory and Applications

(Neutrosophic Science International Association, 2022)

Free download: <http://fs.unm.edu/CP6.pdf>

Contents

- Said Broumi, Florentin Smarandache
Intuitionistic Neutrosophic Soft Set / 27
- Said Broumi, Florentin Smarandache
More on Intuitionistic Neutrosophic Soft Sets / 37
- Said Broumi, Florentin Smarandache
Single Valued Neutrosophic Trapezoid Linguistic Aggregation Operators Based Multi-Attribute Decision Making / 49
- Said Broumi, Assia Bakali, Mohamed Talea, Florentin Smarandache, Luige Vladareanu
Applying Dijkstra Algorithm for Solving Neutrosophic Shortest Path Problem / 70
- Luige Vladareanu, Mihaiela Iliescu, Hongbo Wang, Feng Yongfei, Victor Vladareanu, Hongnian Yu, Florentin Smarandache
CSP and “omics” Technology Applied on Versatile and Intelligent Portable Platform for Modeling Complex Bio-Medical Data / 75
- Said Broumi, Assia Bakali, Mohamed Talea, Florentin Smarandache, Luige Vladareanu
Computation of Shortest Path Problem in a Network with SV-Trapezoidal Neutrosophic Numbers / 81
- Ilanthenral Kandasamy, Florentin Smarandache
Triple Refined Indeterminate Neutrosophic Sets for Personality Classification / 86
- Luige Vladareanu, Florentin Smarandache, Mumtaz Ali, Victor Vladareanu, Mingcong Deng
Robot System Identification using 3D Simulation Component Applied on VIPRO Platform / 94
- Said Broumi, Mohamed Talea, Florentin Smarandache, Assia Bakali
Single Valued Neutrosophic Graphs: Degree, Order and Size / 100
- Florentin Smarandache
Classical Logic and Neutrosophic Logic. Answers to K. Georgiev / 107
- Yaman Akbulut, Abdulkadir Sengür, Yanhui Guo, Florentin Smarandache
A Novel Neutrosophic Weighted Extreme Learning Machine for Imbalanced Data Set / 112
- Yaman Akbulut, Abdulkadir Sengür, Yanhui Guo, Florentin Smarandache
NS-k-NN: Neutrosophic Set-Based k-Nearest Neighbors Classifier / 125
- Yanhui Guo, Ümit Budak, Abdulkadir Sengür, Florentin Smarandache
A Retinal Vessel Detection Approach Based on Shearlet Transform and Indeterminacy Filtering on Fundus Images / 133

- Said Broumi, Assia Bakali, Mohamed Talea, Florentin Smarandache, Rajkumar Verma
Computing Minimum Spanning Tree in Interval Valued Bipolar Neutrosophic Environment / 143
- Young Bae Jun, Florentin Smarandache, Chang Su Kim
Neutrosophic Cubic Sets / 148
- Abdel-Nasser Hussian, Mai Mohamed, Mohamed Abdel-Basset, Florentin Smarandache
Neutrosophic Linear Programming Problem / 162
- Said Broumi, Mohamed Talea, Assia Bakali, Florentin Smarandache, Kishore Kumar P.K.
Shortest Path Problem on Single Valued Neutrosophic Graphs / 167
- Florentin Smarandache
Theory of Neutrosophic Evolution: Degrees of Evolution, Indeterminacy, and Involution / 173
- Mohamed Abdel-Basset, Mai Mohamed, Florentin Smarandache
An Extension of Neutrosophic AHP–SWOT Analysis for Strategic Planning and Decision-Making / 183
- Shio Gai Quek, Said Broumi, Ganeshsree Selvachandran, Assia Bakali, Mohamed Talea, Florentin Smarandache
Some Results on the Graph Theory for Complex Neutrosophic Sets / 199
- Muhammad Gulistan, Naveed Yaqoob, Zunaira Rashid, Florentin Smarandache, Hafiz Abdul Wahab
A Study on Neutrosophic Cubic Graphs with Real Life Applications in Industries / 229
- Parimala Mani, Karthika Muthusamy, Saeid Jafari, Florentin Smarandache, Udhayakumar Ramalingam
Decision-Making via Neutrosophic Support Soft Topological Spaces / 251
- Mohamed Abdel-Basset, Mai Mohamed, Florentin Smarandache
A Hybrid Neutrosophic Group ANP-TOPSIS Framework for Supplier Selection Problems / 260
- Ganeshsree Selvachandran, Shio Gai Quek, Florentin Smarandache, Said Broumi
An Extended Technique for Order Preference by Similarity to an Ideal Solution (TOPSIS) with Maximizing Deviation Method Based on Integrated Weight Measure for Single-Valued Neutrosophic Sets / 281
- Chunxin Bo, Xiaohong Zhang, Songtao Shao, Florentin Smarandache
Multi-Granulation Neutrosophic Rough Sets on a Single Domain and Dual Domains with Applications / 298
- Muhammad Gulistan, Hafiz Abdul Wahab, Florentin Smarandache, Salma Khan, Sayed Inayat Ali Shah
Some Linguistic Neutrosophic Cubic Mean Operators and Entropy with Applications in a Corporation to Choose an Area Supervisor / 311
- Muhammad Gulistan, Florentin Smarandache, Amir Abdullah
An Application of Complex Neutrosophic Sets to The Theory of Groups / 341
- Surapati Pramanik, Partha Pratim Dey, Florentin Smarandache, Jun Ye
Cross Entropy Measures of Bipolar and Interval Bipolar Neutrosophic Sets and Their Application for Multi-Attribute Decision-Making / 360

- Muhammad Akram, Nabeela Ishfaq, Sidra Sayed, Florentin Smarandache
Decision-Making Approach Based on Neutrosophic Rough Information / 385
- Temitope Gbolahan Jaiyeola, Florentin Smarandache
Inverse Properties in Neutrosophic Triplet Loop and Their Application to Cryptography / 405
- Desmond Jun Yi Tey, Yee Fei Gan, Ganeshsree Selvachandran, Shio Gai Quek, Florentin Smarandache, Le Hoang Son, Mohamed Abdel-Basset, Hoang Viet Long
A Novel Neutrosophic Data Analytic Hierarchy Process for Multi-Criteria Decision-Making Method: A Case Study in Kuala Lumpur Stock Exchange / 425
- Muhammad Akram, Sundas Shahzadi, Florentin Smarandache
Multi-Attribute Decision-Making Method Based on Neutrosophic Soft Rough Information / 438
- Muhammad Akram, Shumaiza, Florentin Smarandache
Decision-Making with Bipolar Neutrosophic TOPSIS and Bipolar Neutrosophic ELECTRE-I / 462
- Muhammad Akram, Sidra Sayed, Florentin Smarandache
Neutrosophic Incidence Graphs with Application / 479
- Mani Parimala, R. Jeevitha, Saeid Jafari, Florentin Smarandache, Karthika Muthusamy
Neutrosophic Nano $A\psi$ Closed Sets in Neutrosophic Nano Topological Spaces / 493
- Muhammad Akram, Hafsa M. Malik, Sundas Shahzadi, Florentin Smarandache
Neutrosophic Soft Rough Graphs with Application / 502
- Kalyan Mondal, Surapati Pramanik, Bibhas C. Giri, Florentin Smarandache
NN-Harmonic Mean Aggregation Operators-Based MCGDM Strategy in a Neutrosophic Number Environment / 529
- Sidra Sayed, Nabeela Ishfaq, Muhammad Akram, Florentin Smarandache
Rough Neutrosophic Digraphs with Application / 545
- Said Broumi, Assia Bakali, Mohamed Talea, Florentin Smarandache, Arindam Dey, Le Hoang Son
Spanning Tree Problem with Neutrosophic Edge Weights / 565
- Qiaoyan Li, Yingchang Ma, Florentin Smarandache, Shuangwu Zhu
Single-Valued Neutrosophic Clustering Algorithm Based on Tsallis Entropy Maximization / 575
- Surapati Pramanik, Partha Pratim Dey, Florentin Smarandache
Correlation Coefficient Measures of Interval Bipolar Neutrosophic Sets for Solving Multi-Attribute Decision Making Problems / 585
- Nguyen Xuan Thao, Florentin Smarandache
Divergence Measure of Neutrosophic Sets and Applications / 597
- Naeem Jan, Lemnaouar Zedam, Tahir Mahmood, Kifayat Ullah, Said Broumi, Florentin Smarandache
Constant Single Valued Neutrosophic Graphs with Applications / 608

Said Broumi, Arindam Dey, Mohamed Talea, Assia Bakali, Florentin Smarandache, Deivanayagampillai Nagarajan, Malayalan Lathamaheswari, Ranjan Kumar

Shortest Path Problem Using Bellman Algorithm under Neutrosophic Environment / 621

Muhammad Akram, Sumera Naz, Florentin Smarandache

Generalization of Maximizing Deviation and TOPSIS Method for MADM in Simplified Neutrosophic Hesitant Fuzzy Environment / 629

Shahzaib Ashraf, Saleem Abdullah, Florentin Smarandache, Noor ul Amin

Logarithmic Hybrid Aggregation Operators Based on Single Valued Neutrosophic Sets and Their Applications in Decision Support Systems / 655

Anam Luqman, Muhammad Akram, Florentin Smarandache

Complex Neutrosophic Hypergraphs: New Social Network Models / 677

Mohammed A. Al Shumrani, Selçuk Topal, Florentin Smarandache, Cenap Ozel

Covering-Based Rough Fuzzy, Intuitionistic Fuzzy and Neutrosophic Nano Topology and Applications / 705

Amira S. Ashour, Chunlai Du, Yanhui Guo, Ahmed Refaat Hawas, Yuping Lai, Florentin Smarandache

A Novel Neutrosophic Subsets Definition for Dermoscopic Image Segmentation / 713

Nguyen Tho Thong, Luu Quoc Dat, Le Hoang Son, Nguyen Dinh Hoa, Mumtaz Ali, Florentin Smarandache

Dynamic Interval Valued Neutrosophic Set: Modeling Decision Making in Dynamic Environments / 719

Victor Christianto, R. N. Boyd, Florentin Smarandache

How to Balance Intuitive and Analytical Functions of Brain: A Neutrosophic Way of Scientific Discovery Process / 727

Luu Quoc Dat, Nguyen Tho Thong, Le Hoang Son, Mumtaz Ali, Florentin Smarandache, Mohamed Abdel-Basset, Hoang Viet Long

Linguistic Approaches to Interval Complex Neutrosophic Sets in Decision Making / 732

Masooma Raza Hashmi, Muhammad Riaz, Florentin Smarandache

m-Polar Neutrosophic Topology with Applications to Multi-criteria Decision-Making in Medical Diagnosis and Clustering Analysis / 747

Florentin Smarandache

Neutrosophic Modal Logic / 766

Said Broumi, Mohamed Talea, Assia Bakali, Florentin Smarandache, Deivanayagampillai Nagarajan, Malayalan Lathamaheswari, Mani Parimala

Shortest Path Problem in Fuzzy, Intuitionistic Fuzzy and Neutrosophic Environment: An Overview / 777

S. Krishna Prabha, Said Broumi, Florentin Smarandache

Interval Valued Neutrosophic Shortest Path Problem by A* Algorithm / 785

Nivetha Martin, Priya R, Florentin Smarandache

Decision Making on Teachers' adaptation to Cybergogy in Saturated Interval-Valued Refined Neutrosophic overset /underset /offset Environment / 794

Nguyen Tho Thong, Florentin Smarandache, Nguyen Dinh Hoa, Le Hoang Son, Luong Thi Hong Lan, Cu Nguyen Giap, Dao The Son, Hoang Viet Long

A Novel Dynamic Multi-Criteria Decision-Making Method Based on Generalized Dynamic Interval-Valued Neutrosophic Set / 808

Wei Yang, Lulu Cai, Seyed Ahmad Edalatpanah, Florentin Smarandache

Triangular Single Valued Neutrosophic Data Envelopment Analysis: Application to Hospital Performance Measurement / 828

Vasanth W. B., Ilanthenral Kandasamy, Florentin Smarandache, Vinayak Devvrat, Shivam Ghildiyal

Study of Imaginative Play in Children Using Single-Valued Refined Neutrosophic Sets / 842

Mohammad Hamidi, Florentin Smarandache

Derivable Single Valued Neutrosophic Graphs Based on KM-Fuzzy Metric / 859

Sujit Kumar De, Prasun Kumar Nayak, Anup Khan, Kousik Bhattacharya, Florentin Smarandache

Solution of an EPQ Model for Imperfect Production Process under Game and Neutrosophic Fuzzy Approach / 871

Shouzhen Zeng, Muhammad Shoaib, Shahbaz Ali, Florentin Smarandache, Hossein Rashmanlou

Certain Properties of Single-Valued Neutrosophic Graph with Application in Food and Agriculture Organization / 884

Madad Khan, Saima Anis, Kainat Bibi, Sohail Iqbal, Florentin Smarandache

Complex Neutrosophic Soft Matrices Framework: An Application in Signal Processing / 909

Dragiša Stanujkić, Darjan Karabašević, Gabrijela Popović, Dragan Pamučar, Željko Stević, Edmundas Kazimieras Zavadskas, Florentin Smarandache

A Single-Valued Neutrosophic Extension of the EDAS Method / 918

Victor Christianto, Florentin Smarandache

Exploring the Historical Debates on Irrational Numbers Using Neutrosophic Logic as a Balance between Intuition and Rational / 931

Florentin Smarandache, Said Broumi

Neutro-Intelligent Set is a particular case of the Refined Neutrosophic Set / 939

S. Ganesan, C. Alexander, F. Smarandache

On N_m - α -Open Sets in Neutrosophic Minimal Structure Spaces / 942

Rituparna Chutia, Florentin Smarandache

Ranking of Single-Valued Neutrosophic Numbers Through the Index of Optimism and Its Reasonable Properties / 952

Fahad Alsharari, Florentin Smarandache, Yaser Saber

Compactness on Single-Valued Neutrosophic Ideal Topological Spaces / 982

List of Countries

ALGERIA (1)
SAUDI ARABIA (5)
BOSNIA AND HERZEGOVINA (1)
PR CHINA (15)
DENMARK (1)
EGYPT (5)
INDIA (27)
INDONESIA (1)
IRAN (3)
JAPAN (1)
SOUTH KOREA (2)
LITHUANIA (1)
MALAYSIA (4)
MOROCCO (3)
NIGERIA (1)
PAKISTAN (28)
ROMANIA (3)
SERBIA (4)
TURKEY (4)
UNITED KINGDOM (1)
UNITED STATES OF AMERICA (3)
SR VIETNAM (9)

List of Authors

A

Mohamed Abdel-Basset

Department of Operations Research, Faculty of Computers and Informatics, Zagazig University, Sharqiyah, EGYPT
analyst_mohamed@yahoo.com

Abdel-Nasser Hussian

Department of Computer Science, Faculty of Computers and Informatics, Zagazig University, EGYPT

C. Alexander

PG & Research Department of Mathematics, Raja Doraisingam Government Arts College, Sivagangai, Tamil Nadu, INDIA
samy.vc20@gmail.com

Mumtaz Ali

Department of Mathematics, Quaid-i-Azam University, Islamabad, PAKISTAN
mumtazali770@yahoo.com

Yaman Akbulut

Department of Electrical and Electronics Engineering, Technology Faculty, Firat University, Elazig, TURKEY
ksengur@gmail.com

Amir Abdullah

Department of Mathematics and Statistics, Hazara University, Mansehra, PAKISTAN
amirabdullahk@k@gmail.com

Amira S. Ashour

Department of Electronics and Electrical Communications Engineering, Tanta University, Tanta, EGYPT
amirasashour@yahoo.com

Assia Bakali

Ecole Royale Navale, Boulevard Sour Jdid, Casablanca, MOROCCO
assiabakali@yahoo.fr

B

Kousik Bhattacharya

Department of Mathematics, Midnapore College, Midnapore, West Bengal, INDIA
kousikbhattacharya12@gmail.com

Kainat Bibi

Department of Mathematics, COMSATS University Islamabad, Abbottabad Campus, Islamabad, PAKISTAN

R. N. Boyd

Princeton Biotechnology Corporation, Department Information Physics Research, UNITED STATES OF AMERICA

Ümit Budak

Engineering Faculty, Department of Electrical-Electronics Engineering, Bitlis Eren University, Bitlis, TURKEY
umbudak@gmail.com

C**Lulu Cai**

Department of Electrical Automation, Quzhou University, Quzhou, PR CHINA
ysu-fbg@163.com

Cenap Özel

Department of Mathematics, King Abdulaziz University, Makkah, SAUDI ARABIA

Chang Su Kim

Department of Mathematics Education, Gyeongsang National University, Jinju, SOUTH KOREA
cupncap@gmail.com

Victor Christianto

Department of Forestry, Malang Institute of Agriculture, Malang, INDONESIA
victorchristianto@gmail.com

Chunlai Du

School of Information Science and Technology, North China University of Technology, Beijing, PR CHINA
duchunlai@ncut.edu.cn

Chunxin Bo

College of Information Engineering, Shanghai Maritime University, Shanghai, PR CHINA
201640311001@stu.shmtu.edu.cn

Rituparna Chutia

Department of Mathematics, Cotton University, Guwahati, Assam, INDIA
rituparnachutia7@gmail.com

Cu Nguyen Giap

Faculty of Management Information System & E-commerce, Thuongmai University, Nam Tu Liem, Hanoi, SR VIETNAM
cunguyengiap@tmu.edu.vn

D**Dao The Son**

Department of Economics, Thuongmai University, Nam Tu Liem, Hanoi, SR VIETNAM
daotheson@tmu.edu.vn

Vinayak Devvrat

School of Computer Science and Engineering, VIT, Vellore, Tamilnadu, INDIA
vinayak.devvrat2015@vit.ac.in

Arindam Dey

Saroj Mohan Institute of Technology, West Bengal, INDIA
arindam84nit@gmail.com

Partha Pratim Dey

Department of Mathematics, Patipukur Pallisree Vidyapith, Patipukur, Kolkata, INDIA
parsur.fuzz@gmail.com

F**Fahad Alsharari**

Department of Mathematics, College of Science and Human Studies, Majmaah University, Majmaah, SAUDI ARABIA
f.alsharari@mu.edu.sa

Feng Yongfei

Parallel Robot & Mechatronic System, Laboratory of Hebei Province, Yanshan University, Qinhuangdao, PR CHINA

G**S. Ganesan**

PG & Research Department of Mathematics, Raja Doraisingam Government Arts College, Sivagangai, Tamil Nadu, INDIA
sgsgsgsg77@gmail.com

Shivam Ghildiyal

School of Computer Science and Engineering, VIT, Vellore, Tamilnadu, INDIA
shivam.ghildiyal2015@vit.ac.in

Bibhas C. Giri

Department of Mathematics, Jadavpur University, Kolkata, West Bengal, INDIA
bibhasc.giri@jadavpuruniversity.in

H**Masooma Raza Hashmi**

Department of Mathematics, University of the Punjab, Lahore, PAKISTAN
masoomaraza25@gmail.com

Ahmed Refaat Hawas

Electronics and Electrical Communications Engineering Department, Tanta University, Tanta, EGYPT

Hoang Viet Long

Division of Computational Mathematics and Engineering, Institute for Computational Science, Ton Duc Thang University, Ho Chi Minh City, SR VIETNAM
hoangvietlong@tdtu.edu.vn

Le Hoang Son

VNU Information Technology Institute, Vietnam National University, Hanoi, SR VIETNAM
sonlh@vnu.edu.vn

Hongbo Wang

Parallel Robot & Mechatronic System, Laboratory of Hebei Province, Yanshan University, Qinhuangdao, PR CHINA
hongbo_w@ysu.edu.cn

Hongnian Yu

School of Design, Engineering and Computing, Bournemouth University, Poole, Dorset, UNITED KINGDOM
yuh@bournemouth.ac.uk

I**Mihaiela Iliescu**

Robotics and Mechatronics Department, Institute of Solid Mechanics, Romanian Academy, Bucharest, ROMANIA
iliescumihaiela7@gmail.com

J**Saeid Jafari**

College of Vestsjaelland South, Slagelse, DENMARK
jafaripersia@gmail.com

Temitope Gbolahan Jaiyeola

Department of Mathematics, Obafemi Awolowo University, Ile Ife, NIGERIA
tjaiyeola@oauife.edu.ng

Naeem Jan

Department of Mathematics and Statistic, International Islamic University Islamabad, PAKISTAN
naeem.phdma73@iiu.edu.pk

R. Jeevitha

Department of Mathematics, Dr.N.G.P. Institute of Technology, Coimbatore, Tamil Nadu, INDIA

Jun Ye

Department of Electrical and Information Engineering, Shaoxing University, Shaoxing, PR CHINA
yehjun@aliyun.com

K**Anup Khan**

Department of Mathematics, Midnapore College, Midnapore, West Bengal, INDIA
mrnanupkhan@gmail.com

Madad Khan

Department of Mathematics, COMSATS University, Abbottabad Campus, Abbottabad, PAKISTAN
madadmath@yahoo.com

Salma Khan

Department of Mathematics, Hazara University, Manshara, PAKISTAN
salmakhan359@gmail.com

Ilanthenral Kandasamy

School of Computer Science and Engineering, VIT, Vellore, Tamil Nadu, INDIA
ilanthenal.k@vit.ac.in

W.B. Vasantha Kandasamy

School of Computer Science and Engineering, VIT, Vellore, Tamil Nadu, INDIA
vasantha.wb@vit.ac.in

Darjan Karabašević

Faculty of Applied Management, Economics and Finance, University Business Academy in Novi Sad, Belgrade, SERBIA
darjan.karabasevic@mef.edu.rs

Kifayat Ullah

Department of Mathematics & Statistics, International Islamic University, Islamabad, PAKISTAN
kifayat.phdma72@iiu.edu.pk

Kishore Kumar P.K.

Bharathiar University, Coimbatore, INDIA
kishore2982@gmail.com

Sujit Kumar De

Department of Mathematics, Midnapore College, Midnapore, West Bengal, INDIA
skdemamo2008.com@gmail.com

Prasun Kumar Nayak

Department of Mathematics, Midnapore College, Midnapore, West Bengal, INDIA
prasunkrnayak@gmail.com

L**Malayalan Lathamaheswari**

Department of Mathematics, Hindustan Institute of Technology and Science, Chennai, INDIA
lathamax@gmail.com

Luong Thi Hong Lan

Faculty of Computer Science and Engineering, Thuyloi University, Dong Da, Hanoi, SR VIETNAM
lanlhbk@tlu.edu.vn

Anam Luqman

Department of Mathematics, University of the Punjab, New Campus, Lahore 54590, PAKISTAN
anamluqman7@yahoo.com

Luu Quoc Dat

VNU University of Economics and Business, Vietnam National University, Hanoi, SR VIETNAM
datlq@vnu.edu.vn

M**Tahir Mahmood**

Department of Mathematics & Statistics, International Islamic University, Islamabad, PAKISTAN
tahirbakhata@iiu.edu.pk

Hafsa M. Malik

Department of Mathematics, University of the Punjab, New Campus, Lahore, PAKISTAN
hafsa.masood.malik@gmail.com

Nivetha Martin

Department of Mathematics, ArulAnandar College, Karumathur, INDIA
nivetha.martin710@gmail.com

Mai Mohamed

Department of Operations Research, Faculty of Computers and Informatics, Zagazig University, Sharqiyah, EGYPT

Parimala Mani

Department of Mathematics, Bannari Amman Institute of Technology, Sathyamangalam, Tamil Nadu, INDIA

rishwanthpari@gmail.com

Mingcong Deng

The Graduate School of Engineering, Tokyo University of Agriculture and Technology, Tokyo, JAPAN

deng@cc.tuat.ac.jp

Mohammed A. Al Shumrani

Department of Mathematics, King Abdulaziz University, Jeddah, SAUDI ARABIA

maalshmrani1@kau.edu.sa

Mohammad Hamidi

Department of Mathematics, Payame Noor University, Tehran, IRAN

m.hamidi@pnu.ac.ir

Mohamed Talea

Laboratory of Information Processing, Faculty of Science Ben M'Sik, University Hassan II, Casablanca, MOROCCO

taleamohamed@yahoo.fr

Kalyan Mondal

Department of Mathematics, Jadavpur University, Kolkata, West Bengal, INDIA

kalyanmathematic@gmail.com

Muhammad Akram

Department of Mathematics, University of the Punjab, New Campus, Lahore, PAKISTAN

m.akram@pucit.edu.pk

Muhammad Gulistan

Department of Mathematics, Hazara University, Manshara, PAKISTAN

gulistanmath@hu.edu.pk

Farshid Mofidnakhai

Department of Physics, Sari Branch, Islamic Azad University, Sari, IRAN

farshid.mofidnakhai@gmail.com

Muhammad Shoab

Department of Mathematics, University of the Punjab, New Campus, Lahore, PAKISTAN

Muhammad Riaz

Department of Mathematics, University of the Punjab, Lahore, PAKISTAN

mriaz.math@pu.edu.pk

Karthika Muthusamy

Department of Mathematics, Bannari Amman Institute of Technology, Sathyamangalam, Tamil Nadu, INDIA

karthikamuthusamy1991@gmail.com

N**Nabeela Ishfaq**

Department of Mathematics, University of the Punjab, New Campus, Lahore, PAKISTAN
nabeelaishfaq123@gmail.com

Deivanayagampillai Nagarajan

Department of Mathematics, Hindustan Institute of Technology and Science, Chennai, INDIA
dnrmsu2002@yahoo.com

Sumera Naz

Department of Mathematics, Government College Women University Faisalabad, Punjab, PAKISTAN

Nguyen Dinh Hoa

VNU Information Technology Institute, Vietnam National University, Hanoi, SR VIETNAM
hoand@vnu.edu.vn

Nguyen Tho Thong

VNU Information Technology Institute, Vietnam National University, Hanoi, SR VIETNAM
17028003@vnu.edu.vn

Nguyen Xuan Thao

Faculty of Information Technology, Vietnam National University of Agriculture, SR VIETNAM
nxthao2000@gmail.com

Noor ul Amin

Department of Information Technology, Hazara University, Manshra, PAKISTAN
namin@hu.edu.pk

P**Dragan Pamučar**

Department of Logistics, Military Academy, University of Defence in Belgrade, Belgrade, SERBIA
dragan.pamucar@va.mod.gov.rs

Gabrijela Popović

Faculty of Applied Management, Economics and Finance, University Business Academy in Novi Sad, Belgrade, SERBIA
gabrijela.popovic@mef.edu.rs

S. Krishna Prabha

Department of Mathematics, PSNA College of Engineering and Technology, Dindigul, Tamilnadu, INDIA
jvprbh1@gmail.com

Surapati Pramanik

Department of Mathematics, Nandalal Ghosh B.T. College, Panpur, Bhatpara, West Bengal, INDIA
sura_pati@yahoo.co.in

Priya R

Department of Mathematics, PKN Arts and Science College, Thirumangalam, INDIA
iampriyaravi@gmail.com

Q**Qiaoyan Li**

School of Science, Xi'an Polytechnic University, Xi'an, PR CHINA
liqiaoyan@xpu.edu.cn

S**Yaser Saber**

Department of Mathematics, College of Science and Human Studies, Majmaah University, Majmaah, SAUDI ARABIA
y.sber@mu.edu.sa

Said Broumi

Laboratory of Information Processing, Faculty of Science Ben M'Sik, University Hassan II, Casablanca, MOROCCO
broumisaid78@gmail.com

Saima Anis

Department of Mathematics, COMSATS University Islamabad, Abbottabad Campus, Islamabad, PAKISTAN

Saleem Abdullah

Department of Mathematics, Abdul Wali Khan University, Mardan, PAKISTAN
saleemabdullah@awkum.edu.pk

Ganeshsree Selvachandran

Department of Actuarial Science and Applied Statistics, Faculty of Business & Information Science, UCSI University, Kuala Lumpur, MALAYSIA
ganeshsree@ucsiuniversity.edu.my

Abdulkadir Sengür

Department of Electrical and Electronics Engineering, Technology Faculty, Firat University, Elazig, TURKEY
yamanakbulut@gmail.com

Seyed Ahmad Edalatpanah

Department of Applied Mathematics, Quzhou University, Quzhou, PR CHINA
saedalat@yahoo.com

Shahbaz Ali

Department of Mathematics, Khwaja Fareed University of Engineering & Information Technology, Rahim Yar Khan, PAKISTAN
shahbaz.ali@kfueit.edu.pk

Shahzaib Ashraf

Department of Mathematics, Abdul Wali Khan University, Mardan, PAKISTAN
shahzaibashraf@awkum.edu.pk

Shouzhen Zeng

School of Business, Ningbo University, Ningbo, PR CHINA
zszzxl@163.com

Shio Gai Quek

UCSI College KL Campus, Jalan Choo Lip Kung, Taman Taynton View, Kuala Lumpur, MALAYSIA
queksg@ucsicollege.edu.my

Shuangwu Zhu

School of Textile and Materials, Xi'an Polytechnic University, Xi'an, PR CHINA
zhushuangwu@263.net

Shumaiza

Department of Mathematics, University of the Punjab, New Campus, Lahore, PAKISTAN
shumaiza00@gmail.com

Sidra Sayed

Department of Mathematics, University of the Punjab, New Campus, Lahore, PAKISTAN
sidratulmuntha228@yahoo.com

Sohail Iqbal

Department of Mathematics, COMSATS University Islamabad, Islamabad Campus, PAKISTAN

Songtao Shao

Department of Mathematics, Shanghai Maritime University, Shanghai, PR CHINA
201740310005@stu.shmtu.edu.cn

Florentin Smarandache

University of New Mexico, Gallup, NM, UNITED STATES OF AMERICA
smarand@unm.edu

Sundas Shahzadi

Department of Mathematics, University of the Punjab, New Campus, Lahore, PAKISTAN
sundas1011@gmail.com

Dragiša Stanujkić

Technical Faculty in Bor, University of Belgrade, Bor, SERBIA
dstanujkic@tfbor.bg.ac.rs

Željko Stević

Faculty of Transport and Traffic Engineering, University of East Sarajevo, Dobož, BOSNIA AND HERZEGOVINA
zeljko.stevic@sf.ues.rs.ba

R**Udhayakumar Ramalingam**

Department of Mathematics, School of Advanced Sciences, Vellore Institute of Technology, Tamil Nadu, INDIA
udhayaram_v@yahoo.co.in

Zunaira Rashid

Department of Mathematics, Hazara University, Manshara, PAKISTAN
zunairarashed95@gmail.com

Hossein Rashmanlou

Mazandaran Adib Institute of Higher Education, Sari, IRAN

V

Rajkumar Verma

Guru Gobind Singh Indraprastha University, Delhi, INDIA
rkver83@gmail.com

Luige Vlădăreanu

Robotics and Mechatronics Department, Institute of Solid Mechanics, Romanian Academy, Bucharest, ROMANIA
luigiv@imsar.bu.edu.ro

Victor Vlădăreanu

Faculty of Electronics, University Politehnica of Bucharest, Bucharest, ROMANIA
vladareanuv@gmail.com

T

Desmond Jun Yi Tey

Department of Actuarial Science and Applied Statistics, UCSI University, Kuala Lumpur, MALAYSIA
teydesmond@gmail.com

Selçuk Topal

Department of Mathematics, Faculty of Arts and Sciences, Bitlis Eren University, Bitlis, TURKEY
selcuk.topal@yandex.com

Y

Naveed Yaqoob

Department of Mathematics, College of Science Al-Zulfi, Majmaah University, Al-Zulfi, SAUDI ARABIA
na.yaqoob@mu.edu.sa

Yanhui Guo

Department of Computer Science, University of Illinois at Springfield, Springfield, IL, UNITED STATES OF AMERICA
guoyanhui@gmail.com

Yee Fei Gan

Department of Actuarial Science and Applied Statistics, UCSI University, Kuala Lumpur, MALAYSIA
yeefei97@gmail.com

Yingcang Ma

School of Science, Xi'an Polytechnic University, Xi'an, PR CHINA
mayingcang@126.com

Young Bae Jun

Department of Mathematics Education, Gyeongsang National University, Jinju, SOUTH KOREA
Email: skywine@gmail.com

Yuping Lai

School of Information Science and Technology, North China University of Technology, Beijing, PR CHINA

W

Hafiz Abdul Wahab

Department of Mathematics, Hazara University, Mansehra, PAKISTAN
wahab@hu.edu.pk

Wei Yang

State Grid Quzhou Power Supply Company, Quzhou University, Quzhou, PR CHINA
easteryang@163.com

X

Xiaohong Zhang

Department of Mathematics, Shaanxi University of Science & Technology, Xi'an, PR CHINA
zhangxiaohong@sust.edu.cn

Z

Edmundas Kazimieras Zavadskas

Institute of Sustainable Construction, Vilnius Gediminas Technical University, Vilnius, LITHUANIA
edmundas.zavadskas@vilniustech.lt

Lemnaouar Zedam

Laboratory of Pure and Applied Mathematics, Department of Mathematics, Med Boudiaf University, Msila, ALGERIA
l.zedam@gmail.com

List of Papers

1. Said Broumi, Florentin Smarandache (2013). Intuitionistic Neutrosophic Soft Set. *Journal of Information and Computing Science* 8(2): 130-140
2. Said Broumi, Florentin Smarandache (2013). More on Intuitionistic Neutrosophic Soft Sets. *Computer Science and Information Technology* 1(4): 257-268; DOI: 10.13189/csit.2013.010404
3. Said Broumi, Florentin Smarandache (2014). Single Valued Neutrosophic Trapezoid Linguistic Aggregation Operators Based Multi-Attribute Decision Making. *Bulletin of Pure and Applied Sciences* 33 E (Math & Stat.) (2): 135-155; DOI 10.5958/2320-3226.2014.00006.X
4. Said Broumi, Assia Bakali, Mohamed Talea, Florentin Smarandache, Luige Vladareanu (2016). Applying Dijkstra Algorithm for Solving Neutrosophic Shortest Path Problem. Proceedings of the 2016 International Conference on Advanced Mechatronic Systems, Melbourne, Australia, 5
5. Luige Vladareanu, Mihaela Iiescu, Hongbo Wang, Feng Yongfei, Victor Vladareanu, Hongnian Yu, Florentin Smarandache (2016). CSP and “omics” Technology Applied on Versatile and Intelligent Portable Platform for Modeling Complex Bio-Medical Data. Proceedings of the 2016 International Conference on Advanced Mechatronic Systems, Melbourne, Australia, 6
6. Said Broumi, Assia Bakali, Mohamed Talea, Florentin Smarandache, Luige Vladareanu (2016). Computation of Shortest Path Problem in a Network with SV-Trapezoidal Neutrosophic Numbers. Proceedings of the 2016 International Conference on Advanced Mechatronic Systems, Melbourne, Australia, 5
7. Ilanthenral Kandasamy, Florentin Smarandache (2016). Triple Refined Indeterminate Neutrosophic Sets for Personality Classification. IEEE Symposium Series on Computational Intelligence (SSCI), 2016, 8; DOI: 10.1109/SSCI.2016.7850153
8. Luige Vladareanu, Florentin Smarandache, Mumtaz Ali, Victor Vladareanu, Mingcong Deng (2016). Robot System Identification using 3D Simulation Component Applied on VIPRO Platform. Proceedings of the 2016 International Conference on Advanced Mechatronic Systems, Melbourne, Australia, 6
9. Said Broumi, Mohamed Talea, Florentin Smarandache, Assia Bakali (2016). Single Valued Neutrosophic Graphs: Degree, Order and Size. IEEE International Conference on Fuzzy Systems (FUZZ-IEEE), 2016: 2444-2451, DOI: 10.1109/FUZZ-IEEE.2016.7738000
10. Florentin Smarandache (2016). Classical Logic and Neutrosophic Logic. Answers to K. Georgiev. *Neutrosophic Sets and Systems* 13: 79-83
11. Yaman Akbulut, Abdulkadir Sengür, Yanhui Guo, Florentin Smarandache (2017). A Novel Neutrosophic Weighted Extreme Learning Machine for Imbalanced Data Set. *Symmetry* 9, 142; DOI: 10.3390/sym9080142
12. Yaman Akbulut, Abdulkadir Sengür, Yanhui Guo, Florentin Smarandache (2017). NS-k-NN: Neutrosophic Set-Based k-Nearest Neighbors Classifier. *Symmetry* 9, 179; DOI: 10.3390/sym9090179
13. Yanhui Guo, Ümit Budak, Abdulkadir Sengür, Florentin Smarandache (2017). A Retinal Vessel Detection Approach Based on Shearlet Transform and Indeterminacy Filtering on Fundus Images. *Symmetry* 9, 235; DOI: 10.3390/sym9100235
14. Said Broumi, Assia Bakali, Mohamed Talea, Florentin Smarandache, Rajkumar Verma (2017). Computing Minimum Spanning Tree in Interval Valued Bipolar Neutrosophic Environment. *International Journal of Modeling and Optimization* 7(5): 300-304
15. Young Bae Jun, Florentin Smarandache, Chang Su Kim (2017). Neutrosophic Cubic Sets. *New Mathematics and Natural Computation* 13(1): 41-54; DOI: 10.1142/S1793005717500041
16. Abdel-Nasser Hussian, Mai Mohamed, Mohamed Abdel-Basset, Florentin Smarandache (2017). Neutrosophic Linear Programming Problem. *Mathematical Sciences Letters* 6(3): 319-324; DOI: 10.18576/msl/060315
17. Said Broumi, Mohamed Talea, Assia Bakali, Florentin Smarandache, Kishore Kumar P.K. (2017). Shortest Path Problem on Single Valued Neutrosophic Graphs. International Symposium on Networks, Computers and Communications (ISNCC), Marrakech, Morocco, 6
18. Florentin Smarandache (2017). Theory of Neutrosophic Evolution: Degrees of Evolution, Indeterminacy, and Involution. *Progress in Nonlinear Dynamics and Chaos* 5(1), 10; DOI: 10.22457/pindac.v5n1a1

19. Mohamed Abdel-Basset, Mai Mohamed, Florentin Smarandache (2018). An Extension of Neutrosophic AHP–SWOT Analysis for Strategic Planning and Decision-Making. *Symmetry* 10, 116; DOI: 10.3390/sym10040116
20. Shio Gai Quek, Said Broumi, Ganeshsree Selvachandran, Assia Bakali, Mohamed Talea, Florentin Smarandache (2018). Some Results on the Graph Theory for Complex Neutrosophic Sets. *Symmetry* 10, 190; DOI: 10.3390/sym10060190
21. Muhammad Gulistan, Naveed Yaqoob, Zunaira Rashid, Florentin Smarandache, Hafiz Abdul Wahab (2018). A Study on Neutrosophic Cubic Graphs with Real Life Applications in Industries. *Symmetry* 10, 203; DOI: 10.3390/sym10060203
22. Parimala Mani, Karthika Muthusamy, Saeid Jafari, Florentin Smarandache, Udhayakumar Ramalingam (2018). Decision-Making via Neutrosophic Support Soft Topological Spaces. *Symmetry* 10, 217; DOI: 10.3390/sym10060217
23. Mohamed Abdel-Basset, Mai Mohamed, Florentin Smarandache (2018). A Hybrid Neutrosophic Group ANP-TOPSIS Framework for Supplier Selection Problems. *Symmetry* 10, 226; DOI: 10.3390/sym10060226
24. Ganeshsree Selvachandran, Shio Gai Quek, Florentin Smarandache, Said Broumi (2018). An Extended Technique for Order Preference by Similarity to an Ideal Solution (TOPSIS) with Maximizing Deviation Method Based on Integrated Weight Measure for Single-Valued Neutrosophic Sets. *Symmetry* 10, 236; DOI: 10.3390/sym10070236
25. Chunxin Bo, Xiaohong Zhang, Songtao Shao, Florentin Smarandache (2018). Multi-Granulation Neutrosophic Rough Sets on a Single Domain and Dual Domains with Applications. *Symmetry* 10, 296; DOI: 10.3390/sym10070296
26. Muhammad Gulistan, Hafiz Abdul Wahab, Florentin Smarandache, Salma Khan, Sayed Inayat Ali Shah (2018). Some Linguistic Neutrosophic Cubic Mean Operators and Entropy with Applications in a Corporation to Choose an Area Supervisor. *Symmetry* 10, 428; DOI: 10.3390/sym10100428
27. Muhammad Gulistan, Florentin Smarandache, Amir Abdullah (2018). An Application of Complex Neutrosophic Sets to The Theory of Groups. *International Journal of Algebra and Statistics* 7: 1-2, 94–112; DOI :10.20454/ijas.2018.1455
28. Surapati Pramanik, Partha Pratim Dey, Florentin Smarandache, Jun Ye (2018). Cross Entropy Measures of Bipolar and Interval Bipolar Neutrosophic Sets and Their Application for Multi-Attribute Decision-Making. *Axioms* 7, 21; DOI: 10.3390/axioms7020021
29. Muhammad Akram, Nabeela Ishfaq, Sidra Sayed, Florentin Smarandache (2018). Decision-Making Approach Based on Neutrosophic Rough Information. *Algorithms* 11, 59; DOI: 10.3390/a11050059
30. Temitope Gbolahan Jaiyeola, Florentin Smarandache (2018). Inverse Properties in Neutrosophic Triplet Loop and Their Application to Cryptography. *Algorithms* 11, 32; DOI: 10.3390/a11030032
31. Desmond Jun Yi Tey, Yee Fei Gan, Ganeshsree Selvachandran, Shio Gai Quek, Florentin Smarandache, Le Hoang Son, Mohamed Abdel-Basset, Hoang Viet Long (2018). A Novel Neutrosophic Data Analytic Hierarchy Process for Multi-Criteria Decision-Making Method: A Case Study in Kuala Lumpur Stock Exchange. *IEEE Access* 7: 53687-53697, DOI: 10.1109/ACCESS.2019.2912913
32. Muhammad Akram, Sundas Shahzadi, Florentin Smarandache (2018). Multi-Attribute Decision-Making Method Based on Neutrosophic Soft Rough Information. *Axioms* 7, 19; DOI: 10.3390/axioms7010019
33. Muhammad Akram, Shumaiza, Florentin Smarandache (2018). Decision-Making with Bipolar Neutrosophic TOPSIS and Bipolar Neutrosophic ELECTRE-I. *Axioms* 7, 33; DOI: 10.3390/axioms7020033
34. Muhammad Akram, Sidra Sayed, Florentin Smarandache (2018). Neutrosophic Incidence Graphs with Application. *Axioms* 7, 47; DOI: 10.3390/axioms7030047
35. Mani Parimala, R. Jeevitha, Saeid Jafari, Florentin Smarandache, Karthika Muthusamy (2018). Neutrosophic Nano A_{ψ} Closed Sets in Neutrosophic Nano Topological Spaces. *Journal of Advanced Research in Dynamical & Control Systems* 10: 523-531
36. Muhammad Akram, Hafsa M. Malik, Sundas Shahzadi, Florentin Smarandache (2018). Neutrosophic Soft Rough Graphs with Application. *Axioms* 7, 14; DOI: 10.3390/axioms7010014
37. Kalyan Mondal, Surapati Pramanik, Bibhas C. Giri, Florentin Smarandache (2018). NN-Harmonic Mean Aggregation Operators-Based MCGDM Strategy in a Neutrosophic Number Environment. *Axioms* 7, 12; DOI: 10.3390/axioms7010012

38. Sidra Sayed, Nabeela Ishfaq, Muhammad Akram, Florentin Smarandache (2018). Rough Neutrosophic Digraphs with Application. *Axioms* 7, 5; DOI: 10.3390/axioms7010005
39. Said Broumi, Assia Bakali, Mohamed Talea, Florentin Smarandache, Arindam Dey, Le Hoang Son (2018). Spanning Tree Problem with Neutrosophic Edge Weights. The First International Conference on Intelligent Computing in Data Sciences, *Procedia Computer Science* 127: 190–199; DOI: 10.1016/j.procs.2018.01.114
40. Qiaoyan Li, Yingcang Ma, Florentin Smarandache, Shuangwu Zhu (2018). Single-Valued Neutrosophic Clustering Algorithm Based on Tsallis Entropy Maximization. *Axioms* 7, 57; DOI: 10.3390/axioms7030057
41. Surapati Pramanik, Partha Pratim Dey, Florentin Smarandache (2018). Correlation Coefficient Measures of Interval Bipolar Neutrosophic Sets for Solving Multi-Attribute Decision Making Problems. *Neutrosophic Sets and Systems* 19: 70-79
42. Nguyen Xuan Thao, Florentin Smarandache (2018). Divergence Measure of Neutrosophic Sets and Applications. *Neutrosophic Sets and Systems* 21: 142-152
43. Naeem Jan, Lemnaouar Zedam, Tahir Mahmood, Kifayat Ullah, Said Broumi, Florentin Smarandache (2019). Constant Single Valued Neutrosophic Graphs with Applications. *Neutrosophic Sets and Systems* 24: 77-89
44. Said Broumi, Arindam Dey, Mohamed Talea, Assia Bakali, Florentin Smarandache, Deivanayagampillai Nagarajan, Malayalan Lathamaheswari, Ranjan Kumar (2019). Shortest path problem using Bellman algorithm under neutrosophic environment. *Complex & Intelligent Systems* 5: 409-416; DOI: 10.1007/s40747-019-0101-8
45. Muhammad Akram, Sumera Naz, Florentin Smarandache (2019). Generalization of Maximizing Deviation and TOPSIS Method for MADM in Simplified Neutrosophic Hesitant Fuzzy Environment. *Symmetry* 11, 1058; DOI: 10.3390/sym1108105
46. Shahzaib Ashraf, Saleem Abdullah, Florentin Smarandache, Noor ul Amin (2019). Logarithmic Hybrid Aggregation Operators Based on Single Valued Neutrosophic Sets and Their Applications in Decision Support Systems. *Symmetry* 11, 364; DOI: 10.3390/sym11030364
47. Anam Luqman, Muhammad Akram, Florentin Smarandache (2019). Complex Neutrosophic Hypergraphs: New Social Network Models. *Algorithms* 12, 234; DOI: 10.3390/a12110234
48. Mohammed A. Al Shumrani, Selçuk Topal, Florentin Smarandache, Cenap Ozel (2019). Covering-Based Rough Fuzzy, Intuitionistic Fuzzy and Neutrosophic Nano Topology and Applications. *IEEE Access* 7: 172839-172846, DOI: 10.1109/ACCESS.2019.2955923
49. Amira S. Ashour, Chunlai Du, Yanhui Guo, Ahmed Refaat Hawas, Yuping Lai, Florentin Smarandache (2019). A Novel Neutrosophic Subsets Definition for Dermoscopic Image Segmentation. *IEEE Access* 7: 151047-151053, DOI: 10.1109/ACCESS.2019.2946762
50. Nguyen Tho Thong, Luu Quoc Dat, Le Hoang Son, Nguyen Dinh Hoa, Mumtaz Ali, Florentin Smarandache (2019). Dynamic interval valued neutrosophic set: Modeling decision making in dynamic environments. *Computers in Industry* 108: 45-52; DOI: 10.1016/j.compind.2019.02.009
51. Victor Christianto, R. N. Boyd, Florentin Smarandache (2019). How to Balance Intuitive and Analytical Functions of Brain: A Neutrosophic Way of Scientific Discovery Process. *EC Neurology* 11.7: 495-499
52. Luu Quoc Dat, Nguyen Tho Thong, Le Hoang Son, Mumtaz Ali, Florentin Smarandache, Mohamed Abdel-Basset, Hoang Viet Long (2019). Linguistic Approaches to Interval Complex Neutrosophic Sets in Decision Making. *IEEE Access* 7: 38902-38917; DOI: 10.1109/ACCESS.2019.2902841
53. Masooma Raza Hashmi, Muhammad Riaz, Florentin Smarandache (2019). m-Polar Neutrosophic Topology with Applications to Multi-criteria Decision-Making in Medical Diagnosis and Clustering Analysis. *International Journal of Fuzzy Systems* 22, 273-292; DOI: 10.1007/s40815-019-00763-2
54. Florentin Smarandache (2019). Neutrosophic Modal Logic. *Broad Research in Artificial Intelligence and Neuroscience* 10(2): 26-36
55. Said Broumi, Mohamed Talea, Assia Bakali, Florentin Smarandache, Deivanayagampillai Nagarajan, Malayalan Lathamaheswari, Mani Parimala (2019). Shortest path problem in fuzzy, intuitionistic fuzzy and neutrosophic environment: an overview. *Complex & Intelligent Systems* 5: 371-378
56. S. Krishna Prabha, Said Broumi, Florentin Smarandache (2020). Interval Valued Neutrosophic Shortest Path Problem by A* Algorithm. *International Journal of Neutrosophic Science* 11(1): 53-61

57. Nivetha Martin, Priya R, Florentin Smarandache (2020). Decision Making on Teachers' adaptation to Cybergogy in Saturated Interval-Valued Refined Neutrosophic overset /underset /offset Environment. *International Journal of Neutrosophic Science* 12(2): 58-70; DOI: 10.5281/zenodo.4268284
58. Nguyen Tho Thong, Florentin Smarandache, Nguyen Dinh Hoa, Le Hoang Son, Luong Thi Hong Lan, Cu Nguyen Giap, Dao The Son, Hoang Viet Long (2020). A Novel Dynamic Multi-Criteria Decision-Making Method Based on Generalized Dynamic Interval-Valued Neutrosophic Set. *Symmetry*, 12, 618; DOI: 10.3390/sym12040618
59. Wei Yang, Lulu Cai, Seyed Ahmad Edalatpanah, Florentin Smarandache (2020). Triangular Single Valued Neutrosophic Data Envelopment Analysis: Application to Hospital Performance Measurement. *Symmetry* 12, 588; DOI: 10.3390/sym12040588
60. Vasantha W. B., Ilanthenral Kandasamy, Florentin Smarandache, Vinayak Devvrat, Shivam Ghildiyal (2020). Study of Imaginative Play in Children Using Single-Valued Refined Neutrosophic Sets. *Symmetry* 12, 402; DOI: 10.3390/sym12030402
61. Mohammad Hamidi, Florentin Smarandache (2020). Derivable Single Valued Neutrosophic Graphs Based on KM-Fuzzy Metric. *IEEE Access* 8: 131076-131087, DOI: 10.1109/ACCESS.2020.3006164
62. Sujit Kumar De, Prasun Kumar Nayak, Anup Khan, Kousik Bhattacharya, Florentin Smarandache (2020). Solution of an EPQ Model for Imperfect Production Process under Game and Neutrosophic Fuzzy Approach. *Applied Soft Computing Journal* 93, 106397; DOI: 10.1016/j.asoc.2020.106397
63. Shouzhen Zeng, Muhammad Shoaib, Shahbaz Ali, Florentin Smarandache, Hossein Rashmanlou (2021). Certain Properties of Single-Valued Neutrosophic Graph with Application in Food and Agriculture Organization. *International Journal of Computational Intelligence Systems* 14(1): 1516–1540; DOI: 10.2991/ijcis.d.210413.001
64. Madad Khan, Saima Anis, Kainat Bibi, Sohail Iqbal, Florentin Smarandache (2021). Complex Neutrosophic Soft Matrices Framework: An Application in Signal Processing. *Journal of Mathematics* 8887824, 10; DOI: 10.1155/2021/8887824
65. Dragiša Stanujkić, Darjan Karabašević, Gabrijela Popović, Dragan Pamučar, Željko Stević, Edmundas Kazimieras Zavadskas, Florentin Smarandache (2021). A Single-Valued Neutrosophic Extension of the EDAS Method. *Axioms* 10, 245. DOI: 10.3390/axioms10040245
66. Victor Christianto, Florentin Smarandache (2021). Exploring the Historical Debates on Irrational Numbers Using Neutrosophic Logic as a Balance between Intuition and Rational. *EC Neurology* 13.6: 28-36
67. Florentin Smarandache, Said Broumi (2021). Neutro-Intelligent Set is a particular case of the Refined Neutrosophic Set. *Journal of Neutrosophic and Fuzzy Systems* 1(1): 34-36; DOI: 10.54216/JNFS.010103
68. S. Ganesan, C. Alexander, F. Smarandache (2021). On $nm-\alpha$ -Open Sets in Neutrosophic Minimal Structure Spaces. *Journal of Mathematics and Computational Intelligence* 1(1): 23–32
69. Rituparna Chutia, Florentin Smarandache (2021). Ranking of Single-Valued Neutrosophic Numbers Through the Index of Optimism and Its Reasonable Properties. *Artificial Intelligence Review* 2, 30; DOI: 10.1007/s10462-021-09981-3
70. Fahad Alsharari, Florentin Smarandache, Yaser Saber (2021). Compactness on Single-Valued Neutrosophic Ideal Topological Spaces. *Neutrosophic Sets and Systems* 41: 127-145

Intuitionistic Neutrosophic Soft Set

Said Broumi, Florentin Smarandache

Said Broumi, Florentin Smarandache (2013). Intuitionistic Neutrosophic Soft Set.
Journal of Information and Computing Science 8(2): 130-140

Abstract. In this paper we study the concept of intuitionistic neutrosophic set of Bhowmik and Pal. We have introduced this concept in soft sets and defined intuitionistic neutrosophic soft set. Some definitions and operations have been introduced on intuitionistic neutrosophic soft set. Some properties of this concept have been established.

Keywords: Soft sets, Neutrosophic set, Intuitionistic neutrosophic set, Intuitionistic neutrosophic soft set.

1. Introduction

In wide varieties of real problems like , engineering problems, social, economic, computer science, medical science...etc. The data associated are often uncertain or imprecise, all real data are not necessarily crisp, precise, and deterministic because of their fuzzy nature. Most of these problem were solved by different theories, firstly by fuzzy set theory provided by Lotfi , Zadeh [1] ,Later several researches present a number of results using different direction of fuzzy set such as : interval fuzzy set [13], intuitionistic fuzzy set by Atanassov[2], all these are successful to some extent in dealing with the problems arising due to the vagueness present in the real world ,but there are also cases where these theories failed to give satisfactory results, possibly due to indeterminate and inconsistent information which exist in belief system, then in 1995, Smarandache [3] initiated the theory of neutrosophic as new mathematical tool for handling problems involving imprecise, indeterminacy, and inconsistent data. Later on authors like Bhowmik and Pal [7] have further studied the intuitionistic neutrosophic set and presented various properties of it. In 1999 Molodtsov [4] introduced the concept of soft set which was completely a new approach for dealing with vagueness and uncertainties ,this concept can be seen free from the inadequacy of parameterization tool. After Molodtsov's work, there have been many researches in combining fuzzy set with soft set, which incorporates the beneficial properties of both fuzzy set and soft set techniques (see [12] [6] [8]). Recently , by the concept of neutrosophic set and soft set, first time, Maji [11] introduced neutrosophic soft set, established its application in decision making, and thus opened a new direction, new path of thinking to engineers, mathematicians, computer scientists and many others in various tests. This paper is an attempt to combine the concepts: intuitionistic neutrosophic set and soft set together by introducing a new concept called intuitionistic neutrosophic soft set, thus we introduce its operations namely equal ,subset, union ,and intersection, We also present an application of intuitionistic neutrosophic soft set in decision making problem.

The organization of this paper is as follow : in section 2, we briefly present some basic definitions and preliminary results are given which will be used in the rest of the paper. In section 3, Intuitionistic neutrosophic soft set. In section 4 an application of intuitionistic neutrosophic soft set in a decision making problem. Conclusions are there in the concluding section 5.

2. Preliminaries

Throughout this paper, let U be a universal set and E be the set of all possible parameters under consideration with respect to U , usually, parameters are attributes, characteristics, or properties of objects in U . We now recall some basic notions of neutrosophic set, intuitionistic neutrosophic set and soft set.

Definition 2.1 (see[3]). Let U be an universe of discourse then the neutrosophic set A is an object having the form $A = \{ \langle x: T_{A(x)}, I_{A(x)}, F_{A(x)} \rangle, x \in U \}$, where the functions $T, I, F : U \rightarrow]0, 1^+[$ define respectively the degree of membership, the degree of indeterminacy, and the degree of non-membership of the element $x \in X$ to the set A with the condition.

$$0 \leq T_{A(x)} + I_{A(x)} + F_{A(x)} \leq 3^+$$

From philosophical point of view, the neutrosophic set takes the value from real standard or non-standard subsets of $]0, 1^+[$. so instead of $]0, 1^+[$ we need to take the interval $[0, 1]$ for technical applications, because $]0, 1^+[$ will be difficult to apply in the real applications such as in scientific and engineering problems.

Definition 2.2 (see [3]). A neutrosophic set A is contained in another neutrosophic set B i.e. $A \subseteq B$ if $\forall x \in U, T_A(x) \leq T_B(x), I_A(x) \leq I_B(x), F_A(x) \geq F_B(x)$.

A complete account of the operations and application of neutrosophic set can be seen in [3] [10].

Definition 2.3(see[7]). intuitionistic neutrosophic set

An element x of U is called significant with respect to neutrosophic set A of U if the degree of truth-membership or falsity-membership or indeterminacy-membership value, i.e., $T_{A(x)}$ or $F_{A(x)}$ or $I_{A(x)} \leq 0.5$. Otherwise, we call it insignificant. Also, for neutrosophic set the truth-membership, indeterminacy-membership and falsity-membership all can not be significant. We define an intuitionistic neutrosophic set by $A = \{ \langle x: T_{A(x)}, I_{A(x)}, F_{A(x)} \rangle, x \in U \}$, where

$$\begin{aligned} \min \{ T_{A(x)}, F_{A(x)} \} &\leq 0.5, \\ \min \{ T_{A(x)}, I_{A(x)} \} &\leq 0.5, \\ \min \{ F_{A(x)}, I_{A(x)} \} &\leq 0.5, \text{ for all } x \in U, \end{aligned}$$

with the condition $0 \leq T_{A(x)} + I_{A(x)} + F_{A(x)} \leq 2$.

As an illustration, let us consider the following example.

Example 2.4. Assume that the universe of discourse $U = \{x_1, x_2, x_3\}$, where x_1 characterizes the capability, x_2 characterizes the trustworthiness and x_3 indicates the prices of the objects. It may be further assumed that the values of x_1, x_2 and x_3 are in $[0, 1]$ and they are obtained from some questionnaires of some experts. The experts may impose their opinion in three components viz. the degree of goodness, the degree of indeterminacy and that of poorness to explain the characteristics of the objects. Suppose A is an intuitionistic neutrosophic set (INS) of U , such that, $A = \{ \langle x_1, 0.3, 0.5, 0.4 \rangle, \langle x_2, 0.4, 0.2, 0.6 \rangle, \langle x_3, 0.7, 0.3, 0.5 \rangle \}$, where the degree of goodness of capability is 0.3, degree of indeterminacy of capability is 0.5 and degree of falsity of capability is 0.4 etc.

Definition 2.5 (see[4]). Let U be an initial universe set and E be a set of parameters. Let $P(U)$ denotes the power set of U . Consider a nonempty set $A, A \subset E$. A pair (F, A) is called a soft set over U , where F is a mapping given by $F : A \rightarrow P(U)$.

As an illustration, let us consider the following example.

Example 2.6. Suppose that U is the set of houses under consideration, say $U = \{h_1, h_2, \dots, h_5\}$. Let E be the set of some attributes of such houses, say $E = \{e_1, e_2, \dots, e_8\}$, where e_1, e_2, \dots, e_8 stand for the attributes “expensive”, “beautiful”, “wooden”, “cheap”, “modern”, and “in bad repair”, respectively.

In this case, to define a soft set means to point out expensive houses, beautiful houses, and so on. For example, the soft set (F, A) that describes the “attractiveness of the houses” in the opinion of a buyer, say Thomas, may be defined like this:

$$\begin{aligned} A &= \{e_1, e_2, e_3, e_4, e_5\}; \\ F(e_1) &= \{h_2, h_3, h_5\}, F(e_2) = \{h_2, h_4\}, F(e_3) = \{h_1\}, F(e_4) = U, F(e_5) = \{h_3, h_5\}. \end{aligned}$$

For more details on the algebra and operations on intuitionistic neutrosophic set and soft set, the reader may refer to [5, 6, 8, 9, 12].

3. Intuitionistic Neutrosophic Soft Set

In this section, we will initiate the study on hybrid structure involving both intuitionistic neutrosophic set and soft set theory.

Definition 3.1. Let U be an initial universe set and $A \subset E$ be a set of parameters. Let $N(U)$ denotes the set of all intuitionistic neutrosophic sets of U . The collection (F,A) is termed to be the soft intuitionistic neutrosophic set over U , where F is a mapping given by $F : A \rightarrow N(U)$.

Remark 3.2. we will denote the intuitionistic neutrosophic soft set defined over an universe by $INSS$.

Let us consider the following example.

Example 3.3. Let U be the set of blouses under consideration and E is the set of parameters (or qualities). Each parameter is a intuitionistic neutrosophic word or sentence involving intuitionistic neutrosophic words. Consider $E = \{ \text{Bright, Cheap, Costly, very costly, Colorful, Cotton, Polystyrene, long sleeve , expensive} \}$. In this case, to define a intuitionistic neutrosophic soft set means to point out Bright blouses, Cheap blouses, Blouses in Cotton and so on. Suppose that, there are five blouses in the universe U given by, $U = \{b_1, b_2, b_3, b_4, b_5\}$ and the set of parameters $A = \{e_1, e_2, e_3, e_4\}$, where each e_i is a specific criterion for blouses:

- e_1 stands for ‘Bright’,
- e_2 stands for ‘Cheap’,
- e_3 stands for ‘costly’,
- e_4 stands for ‘Colorful’,

Suppose that,

$$F(\text{Bright}) = \{ \langle b_1, 0.5, 0.6, 0.3 \rangle, \langle b_2, 0.4, 0.7, 0.2 \rangle, \langle b_3, 0.6, 0.2, 0.3 \rangle, \langle b_4, 0.7, 0.3, 0.2 \rangle, \langle b_5, 0.8, 0.2, 0.3 \rangle \}.$$

$$F(\text{Cheap}) = \{ \langle b_1, 0.6, 0.3, 0.5 \rangle, \langle b_2, 0.7, 0.4, 0.3 \rangle, \langle b_3, 0.8, 0.1, 0.2 \rangle, \langle b_4, 0.7, 0.1, 0.3 \rangle, \langle b_5, 0.8, 0.3, 0.4 \rangle \}.$$

$$F(\text{Costly}) = \{ \langle b_1, 0.7, 0.4, 0.3 \rangle, \langle b_2, 0.6, 0.1, 0.2 \rangle, \langle b_3, 0.7, 0.2, 0.5 \rangle, \langle b_4, 0.5, 0.2, 0.6 \rangle, \langle b_5, 0.7, 0.3, 0.2 \rangle \}.$$

$$F(\text{Colorful}) = \{ \langle b_1, 0.8, 0.1, 0.4 \rangle, \langle b_2, 0.4, 0.2, 0.6 \rangle, \langle b_3, 0.3, 0.6, 0.4 \rangle, \langle b_4, 0.4, 0.8, 0.5 \rangle, \langle b_5, 0.3, 0.5, 0.7 \rangle \}.$$

The intuitionistic neutrosophic soft set $(INSS) (F, E)$ is a parameterized family $\{F(e_i), i = 1, \dots, 10\}$ of all intuitionistic neutrosophic sets of U and describes a collection of approximation of an object. The mapping F here is ‘blouses (.)’, where dot(.) is to be filled up by a parameter $e_i \in E$. Therefore, $F(e_1)$ means ‘blouses (Bright)’ whose functional-value is the intuitionistic neutrosophic set

$$\{ \langle b_1, 0.5, 0.6, 0.3 \rangle, \langle b_2, 0.4, 0.7, 0.2 \rangle, \langle b_3, 0.6, 0.2, 0.3 \rangle, \langle b_4, 0.7, 0.3, 0.2 \rangle, \langle b_5, 0.8, 0.2, 0.3 \rangle \}.$$

Thus we can view the intuitionistic neutrosophic soft set $(INSS) (F, A)$ as a collection of approximation as below:

$$(F, A) = \{ \text{Bright blouses} = \{ \langle b_1, 0.5, 0.6, 0.3 \rangle, \langle b_2, 0.4, 0.7, 0.2 \rangle, \langle b_3, 0.6, 0.2, 0.3 \rangle, \langle b_4, 0.7, 0.3, 0.2 \rangle, \langle b_5, 0.8, 0.2, 0.3 \rangle \}, \text{Cheap blouses} = \{ \langle b_1, 0.6, 0.3, 0.5 \rangle, \langle b_2, 0.7, 0.4, 0.3 \rangle, \langle b_3, 0.8, 0.1, 0.2 \rangle, \langle b_4, 0.7, 0.1, 0.3 \rangle, \langle b_5, 0.8, 0.3, 0.4 \rangle \}, \text{costly blouses} = \{ \langle b_1, 0.7, 0.4, 0.3 \rangle, \langle b_2, 0.6, 0.1, 0.2 \rangle, \langle b_3, 0.7, 0.2, 0.5 \rangle, \langle b_4, 0.5, 0.2, 0.6 \rangle, \langle b_5, 0.7, 0.3, 0.2 \rangle \}, \text{Colorful blouses} = \{ \langle b_1, 0.8, 0.1, 0.4 \rangle, \langle b_2, 0.4, 0.2, 0.6 \rangle, \langle b_3, 0.3, 0.6, 0.4 \rangle, \langle b_4, 0.4, 0.8, 0.5 \rangle, \langle b_5, 0.3, 0.5, 0.7 \rangle \} \}.$$

where each approximation has two parts: (i) a predicate p , and (ii) an approximate value-set v (or simply to be called value-set v).

For example, for the approximation ‘Bright blouses = $\{ \langle b_1, 0.5, 0.6, 0.3 \rangle, \langle b_2, 0.4, 0.7, 0.2 \rangle, \langle b_3, 0.6, 0.2, 0.3 \rangle, \langle b_4, 0.7, 0.3, 0.2 \rangle, \langle b_5, 0.8, 0.2, 0.3 \rangle \}$ ’.

we have (i) the predicate name ‘Bright blouses’, and (ii) the approximate value-set is $\{ \langle b_1, 0.5, 0.6, 0.3 \rangle, \langle b_2, 0.4, 0.7, 0.2 \rangle, \langle b_3, 0.6, 0.2, 0.3 \rangle, \langle b_4, 0.7, 0.3, 0.2 \rangle, \langle b_5, 0.8, 0.2, 0.3 \rangle \}$. Thus, an intuitionistic neutrosophic soft set (F, E) can be viewed as a collection of approximation like $(F, E) = \{p_1 = v_1, p_2 = v_2, \dots, p_{10} = v_{10}\}$. In order to store an intuitionistic neutrosophic soft set in a computer, we could represent it in the form of a table as shown below (corresponding to the intuitionistic neutrosophic soft set in the above example). In this table, the entries are c_{ij} corresponding to the blouse b_i and the parameter e_j , where $c_{ij} = (\text{true-membership value of } b_i, \text{ indeterminacy-membership value of } b_i, \text{ falsity membership value of } b_i)$ in $F(e_j)$. The table 1 represent the intuitionistic neutrosophic soft set (F, A) described above.

U	bright	cheap	costly	colorful
b ₁	(0.5,0.6, 0.3)	(0.6,0.3, 0.5)	(0.7,0.4, 0.3)	(0.8,0.1, 0.4)
b ₂	(0.4,0.7, 0.2)	(0.7,0.4, 0.3)	(0.6,0.1, 0.2)	(0.4,0.2, 0.6)
b ₃	(0.6,0.2, 0.3)	(0.8,0.1, 0.2)	(0.7,0.2, 0.5)	(0.3,0.6, 0.4)
b ₄	(0.7,0.3, 0.2)	(0.7,0.1, 0.3)	(0.5,0.2, 0.6)	(0.4,0.8, 0.5)
b ₅	(0.8,0.2, 0.3)	(0.8,0.3, 0.4)	(0.7,0.3, 0.2)	(0.3,0.5, 0.7)

Table 1: Tabular form of the INSS (F, A).

Remark 3.4.An intuitionistic neutrosophic soft set is not an intuitionistic neutrosophic set but a parametrized family of an intuitionistic neutrosophic subsets.

Definition 3.5. Containment of two intuitionistic neutrosophic soft sets.

For two intuitionistic neutrosophic soft sets (F, A) and (G, B) over the common universe U. We say that (F, A) is an intuitionistic neutrosophic soft subset of (G, B) if and only if

- (i) $A \subset B$.
- (ii) $F(e)$ is an intuitionistic neutrosophic subset of $G(e)$.

Or $T_{F(e)}(x) \leq T_{G(e)}(x), I_{F(e)}(x) \leq I_{G(e)}(x), F_{F(e)}(x) \geq F_{G(e)}(x), \forall e \in A, x \in U$.

We denote this relationship by $(F, A) \subseteq (G, B)$.

(F, A) is said to be intuitionistic neutrosophic soft super set of (G, B) if (G, B) is an intuitionistic neutrosophic soft subset of (F, A). We denote it by $(F, A) \supseteq (G, B)$.

Example 3.6. Let (F,A) and (G,B) be two INSSs over the same universe $U = \{o_1, o_2, o_3, o_4, o_5\}$. The INSS (F,A) describes the sizes of the objects whereas the INSS (G, B) describes its surface textures. Consider the tabular representation of the INSS (F, A) is as follows.

U	small	large	colorful
O ₁	(0.4,0.3, 0.6)	(0.3,0.1, 0.7)	(0.4,0.1, 0.5)
O ₂	(0.3,0.1, 0.4)	(0.4,0.2, 0.8)	(0.6,0.3, 0.4)
O ₃	(0.6,0.2, 0.5)	(0.3,0.1, 0.6)	(0.4,0.3, 0.8)
O ₄	(0.5,0.1, 0.6)	(0.1,0.5, 0.7)	(0.3,0.3, 0.8)
O ₅	(0.3,0.2, 0.4)	(0.3,0.1, 0.6)	(0.5,0.2, 0.4)

Table 2: Tabular form of the INSS (F, A).

The tabular representation of the INSS (G, B) is given by table 3.

U	small	large	colorful	very smooth
O1	(0.6,0.4, 0.3)	(0.7,0.2, 0.5)	(0.5,0.7, 0.4)	(0.1,0.8, 0.4)
O2	(0.7,0.5, 0.2)	(0.4,0.7, 0.3)	(0.7,0.3, 0.2)	(0.5,0.7, 0.3)
O3	(0.6,0.3, 0.5)	(0.7,0.2, 0.4)	(0.6,0.4, 0.3)	(0.2,0.9, 0.4)
O4	(0.8,0.1, 0.4)	(0.3,0.6, 0.4)	(0.4,0.5, 0.7)	(0.4,0.4, 0.5)
O5	(0.5,0.4, 0.2)	(0.4,0.1, 0.5)	(0.6,0.4, 0.3)	(0.5,0.8, 0.3)

Table 3: Tabular form of the INSS (G, B).

Clearly, by definition 3.5 we have $(F, A) \subset (G, B)$.

Definition 3.7. Equality of two intuitionistic neutrosophic soft sets.

Two INSSs (F, A) and (G, B) over the common universe U are said to be intuitionistic neutrosophic soft equal if (F, A) is an intuitionistic neutrosophic soft subset of (G, B) and (G, B) is an intuitionistic neutrosophic soft subset of (F, A) which can be denoted by $(F, A) = (G, B)$.

Definition 3.8. NOT set of a set of parameters.

Let $E = \{e_1, e_2, \dots, e_n\}$ be a set of parameters. The NOT set of E is denoted by $\neg E$ is defined by $\neg E = \{ \neg e_1, \neg e_2, \dots, \neg e_n \}$, where $\neg e_i = \text{not } e_i, \forall i$ (it may be noted that \neg and \neg are different operators).

Example 3.9. Consider the example 3.3. Here $\neg E = \{ \text{not bright, not cheap, not costly, not colorful } \}$.

Definition 3.10. Complement of an intuitionistic neutrosophic soft set.

The complement of an intuitionistic neutrosophic soft set (F, A) is denoted by $(F, A)^c$ and is defined by $(F, A)^c = (F^c, \neg A)$, where $F^c : \neg A \rightarrow N(U)$ is a mapping given by $F^c(\alpha) = \text{intuitionistic neutrosophic soft complement with } T_{F^c(x)} = F_{F(x)}, I_{F^c(x)} = I_{F(x)} \text{ and } F_{F^c(x)} = T_{F(x)}$.

Example 3.11. As an illustration consider the example presented in the example 3.2. the complement $(F, A)^c$ describes the ‘not attractiveness of the blouses’. Is given below.

$$F(\text{ not bright}) = \{ \langle b_1, 0.3, 0.6, 0.5 \rangle, \langle b_2, 0.2, 0.7, 0.4 \rangle, \langle b_3, 0.3, 0.2, 0.6 \rangle, \langle b_4, 0.2, 0.3, 0.7 \rangle, \langle b_5, 0.3, 0.2, 0.8 \rangle \}.$$

$$F(\text{ not cheap}) = \{ \langle b_1, 0.5, 0.3, 0.6 \rangle, \langle b_2, 0.3, 0.4, 0.7 \rangle, \langle b_3, 0.2, 0.1, 0.8 \rangle, \langle b_4, 0.3, 0.1, 0.7 \rangle, \langle b_5, 0.4, 0.3, 0.8 \rangle \}.$$

$$F(\text{ not costly}) = \{ \langle b_1, 0.3, 0.4, 0.7 \rangle, \langle b_2, 0.2, 0.1, 0.6 \rangle, \langle b_3, 0.5, 0.2, 0.7 \rangle, \langle b_4, 0.6, 0.2, 0.5 \rangle, \langle b_5, 0.2, 0.3, 0.7 \rangle \}.$$

$$F(\text{ not colorful}) = \{ \langle b_1, 0.4, 0.1, 0.8 \rangle, \langle b_2, 0.6, 0.2, 0.4 \rangle, \langle b_3, 0.4, 0.6, 0.3 \rangle, \langle b_4, 0.5, 0.8, 0.4 \rangle, \langle b_5, 0.7, 0.5, 0.3 \rangle \}.$$

Definition 3.12: Empty or Null intuitionistic neutrosophic soft set.

An intuitionistic neutrosophic soft set (F, A) over U is said to be empty or null intuitionistic neutrosophic soft (with respect to the set of parameters) denoted by Φ_A or (Φ, A) if $T_{F(e)}(m) = 0, F_{F(e)}(m) = 0$ and $I_{F(e)}(m) = 0, \forall m \in U, \forall e \in A$.

Example 3.13. Let $U = \{b_1, b_2, b_3, b_4, b_5\}$, the set of five blouses be considered as the universal set and $A = \{ \text{Bright, Cheap, Colorful} \}$ be the set of parameters that characterizes the blouses. Consider the intuitionistic neutrosophic soft set (F, A) which describes the cost of the blouses and

$$F(\text{bright}) = \{ \langle b_1, 0, 0, 0 \rangle, \langle b_2, 0, 0, 0 \rangle, \langle b_3, 0, 0, 0 \rangle, \langle b_4, 0, 0, 0 \rangle, \langle b_5, 0, 0, 0 \rangle \},$$

$$F(\text{cheap}) = \{ \langle b_1, 0, 0, 0 \rangle, \langle b_2, 0, 0, 0 \rangle, \langle b_3, 0, 0, 0 \rangle, \langle b_4, 0, 0, 0 \rangle, \langle b_5, 0, 0, 0 \rangle \},$$

$$F(\text{colorful}) = \{ \langle b_1, 0, 0, 0 \rangle, \langle b_2, 0, 0, 0 \rangle, \langle b_3, 0, 0, 0 \rangle, \langle b_4, 0, 0, 0 \rangle, \langle b_5, 0, 0, 0 \rangle \}.$$

Here the NINSS (F, A) is the null intuitionistic neutrosophic soft set.

Definition 3.14. Union of two intuitionistic neutrosophic soft sets.

Let (F, A) and (G, B) be two INSSs over the same universe U . Then the union of (F, A) and (G, B) is denoted by $(F, A) \cup (G, B)$ and is defined by $(F, A) \cup (G, B) = (K, C)$, where $C = A \cup B$ and the truth-membership, indeterminacy-membership and falsity-membership of (K, C) are as follows:

$$\begin{aligned} T_{K(e)}(m) &= T_{F(e)}(m), \text{ if } e \in A - B, \\ &= T_{G(e)}(m), \text{ if } e \in B - A, \\ &= \max(T_{F(e)}(m), T_{G(e)}(m)), \text{ if } e \in A \cap B. \end{aligned}$$

$$\begin{aligned} I_{K(e)}(m) &= I_{F(e)}(m), \text{ if } e \in A - B, \\ &= I_{G(e)}(m), \text{ if } e \in B - A, \\ &= \min(I_{F(e)}(m), I_{G(e)}(m)), \text{ if } e \in A \cap B. \end{aligned}$$

$$\begin{aligned} F_{K(e)}(m) &= F_{F(e)}(m), \text{ if } e \in A - B, \\ &= F_{G(e)}(m), \text{ if } e \in B - A, \\ &= \min(F_{F(e)}(m), F_{G(e)}(m)), \text{ if } e \in A \cap B. \end{aligned}$$

Example 3.15. Let (F, A) and (G, B) be two INSSs over the common universe U . Consider the tabular representation of the INSS (F, A) is as follow:

	Bright	Cheap	Colorful
b_1	(0.6, 0.3, 0.5)	(0.7, 0.3, 0.4)	(0.4, 0.2, 0.6)
b_2	(0.5, 0.1, 0.8)	(0.6, 0.1, 0.3)	(0.6, 0.4, 0.4)
b_3	(0.7, 0.4, 0.3)	(0.8, 0.3, 0.5)	(0.5, 0.7, 0.2)
b_4	(0.8, 0.4, 0.1)	(0.6, 0.3, 0.2)	(0.8, 0.2, 0.3)
b_5	(0.6, 0.3, 0.2)	(0.7, 0.3, 0.5)	(0.3, 0.6, 0.5)

Table 4: Tabular form of the INSS (F, A) .

The tabular representation of the INSS (G, B) is as follow:

U	Costly	Colorful
b ₁	(0.6,0.2, 0.3)	(0.4,0.6, 0.2)
b ₂	(0.2,0.7, 0.2)	(0.2,0.8, 0.3)
b ₃	(0.3,0.6, 0.5)	(0.6,0.3, 0.4)
b ₄	(0.8,0.4, 0.1)	(0.2,0.8, 0.3)
b ₅	(0.7,0.1, 0.4)	(0.5,0.6, 0.4)

Table 5: Tabular form of the INSS (G, B).

Using definition 3.12 the union of two INSS (F, A) and (G, B) is (K, C) can be represented into the following Table.

U	Bright	Cheap	Colorful	Costly
b ₁	(0.6,0.3, 0.5)	(0.7,0.3, 0.4)	(0.4,0.2, 0.2)	(0.6,0.2, 0.3)
b ₂	(0.5,0.1, 0.8)	(0.6,0.1, 0.3)	(0.6,0.4, 0.3)	(0.2,0.7, 0.2)
b ₃	(0.7,0.4, 0.3)	(0.8,0.3, 0.5)	(0.6,0.3, 0.2)	(0.3,0.6, 0.5)
b ₄	(0.8,0.4, 0.1)	(0.6,0.3, 0.2)	(0.8,0.2, 0.3)	(0.8,0.4, 0.1)
b ₅	(0.6,0.3, 0.2)	(0.7,0.3, 0.5)	(0.5,0.6, 0.4)	(0.7,0.1, 0.4)

Table 6: Tabular form of the INSS (K, C).

Definition 3.16. Intersection of two intuitionistic neutrosophic soft sets.

Let (F,A) and (G,B) be two INSSs over the same universe U such that $A \cap B \neq \emptyset$. Then the intersection of (F,A) and (G,B) is denoted by ‘(F,A) \cap (G, B)’ and is defined by (F, A) \cap (G, B) = (K,C),where C =A \cap B and the truth-membership, indeterminacy membership and falsity-membership of (K, C) are related to those of (F,A) and (G,B) by:

$$T_{K(e)}(m) = \min (T_{F(e)}(m), T_{G(e)}(m)),$$

$$I_{K(e)}(m) = \min (I_{F(e)}(m), I_{G(e)}(m)),$$

$$F_{K(e)}(m) = \max (F_{F(e)}(m), F_{G(e)}(m)), \text{ for all } e \in C.$$

Example 3.17. Consider the above example 3.15. The intersection of (F, A) and (G, B) can be represented into the following table :

U	Colorful
b ₁	(0.4,0.2,0.6)
b ₂	(0.2,0.4,0.4)
b ₃	(0.6,0.3,0.4)
b ₄	(0.8,0.2,0.3)
b ₅	(0.3,0.6,0.5)

Table 7: Tabular form of the INSS (K, C).

Proposition 3.18. If (F, A) and (G, B) are two INSSs over U and on the basis of the operations defined above ,then:

- (1) idempotency laws: $(F,A) \cup (F,A) = (F,A)$.
 $(F,A) \cap (F,A) = (F,A)$.
- (2) Commutative laws : $(F,A) \cup (G,B) = (G,B) \cup (F,A)$.
 $(F,A) \cap (G,B) = (G,B) \cap (F,A)$.
- (3) $(F,A) \cup \Phi = (F,A)$.
- (4) $(F,A) \cap \Phi = \Phi$.
- (5) $[(F,A)^c]^c = (F,A)$.

Proof. The proof of the propositions 1 to 5 are obvious.

Proposition 3.19 . If (F, A) , (G, B) and (K, C) are three INSSs over U , then:

- (1) $(F,A) \cap [(G,B) \cap (K,C)] = [(F,A) \cap (G,B)] \cap (K,C)$.
- (2) $(F,A) \cup [(G,B) \cup (K,C)] = [(F,A) \cup (G,B)] \cup (K,C)$.
- (3) Distributive laws: $(F,A) \cup [(G,B) \cap (K,C)] = [(F,A) \cup (G,B)] \cap [(F,A) \cup (K,C)]$.
- (4) $(F,A) \cap [(G,B) \cup (K,C)] = [(F,A) \cap (G,B)] \cup [(F,A) \cap (K,C)]$.

Example 3.20. Let $(F,A) = \{ \langle b_1, 0.6, 0.3, 0.1 \rangle, \langle b_2, 0.4, 0.7, 0.5 \rangle, \langle b_3, 0.4, 0.1, 0.8 \rangle \}$, $(G,B) = \{ \langle b_1, 0.2, 0.2, 0.6 \rangle, \langle b_2, 0.7, 0.2, 0.4 \rangle, \langle b_3, 0.1, 0.6, 0.7 \rangle \}$ and $(K,C) = \{ \langle b_1, 0.3, 0.8, 0.2 \rangle, \langle b_2, 0.4, 0.1, 0.6 \rangle, \langle b_3, 0.9, 0.1, 0.2 \rangle \}$ be three INSSs of U . Then:

$$(F,A) \cup (G,B) = \{ \langle b_1, 0.6, 0.2, 0.1 \rangle, \langle b_2, 0.7, 0.2, 0.4 \rangle, \langle b_3, 0.4, 0.1, 0.7 \rangle \}.$$

$$(F,A) \cup (K,C) = \{ \langle b_1, 0.6, 0.3, 0.1 \rangle, \langle b_2, 0.4, 0.1, 0.5 \rangle, \langle b_3, 0.9, 0.1, 0.2 \rangle \}.$$

$$(G,B) \cap (K,C) = \{ \langle b_1, 0.2, 0.2, 0.6 \rangle, \langle b_2, 0.4, 0.1, 0.6 \rangle, \langle b_3, 0.1, 0.1, 0.7 \rangle \}.$$

$$(F,A) \cup [(G,B) \cap (K,C)] = \{ \langle b_1, 0.6, 0.2, 0.1 \rangle, \langle b_2, 0.4, 0.1, 0.5 \rangle, \langle b_3, 0.4, 0.1, 0.7 \rangle \}.$$

$$[(F,A) \cup (G,B)] \cap [(F,A) \cup (K,C)] = \{ \langle b_1, 0.6, 0.2, 0.1 \rangle, \langle b_2, 0.4, 0.1, 0.5 \rangle, \langle b_3, 0.4, 0.1, 0.7 \rangle \}.$$

Hence distributive (3) proposition verified.

Proof, can be easily proved from definition 3.14. and 3.16.

Definition 3.21. AND operation on two intuitionistic neutrosophic soft sets.

Let (F, A) and (G, B) be two INSSs over the same universe U . then (F, A) ‘AND’ (G, B) denoted by $(F, A) \wedge (G, B)$ and is defined by $(F, A) \wedge (G, B) = (K, A \times B)$, where $K(\alpha, \beta) = F(\alpha) \cap B(\beta)$ and the truth-membership, indeterminacy-membership and falsity-membership of $(K, A \times B)$ are as follows:

$$T_{K(\alpha,\beta)}(m) = \min(T_{F(\alpha)}(m), T_{G(\beta)}(m)), I_{K(\alpha,\beta)}(m) = \min(I_{F(\alpha)}(m), I_{G(\beta)}(m))$$

$$F_{K(\alpha,\beta)}(m) = \max(F_{F(\alpha)}(m), F_{G(\beta)}(m)), \forall \alpha \in A, \forall \beta \in B.$$

Example 3.22. Consider the same example 3.15 above. Then the tabular representation of (F,A) AND (G, B) is as follow:

u	(bright, costly)	(bright, Colorful)	(cheap, costly)
b ₁	(0.6, 0.2, 0.5)	(0.4, 0.3, 0.5)	(0.6, 0.2, 0.4)
b ₂	(0.2, 0.1, 0.8)	(0.2, 0.1, 0.8)	(0.2, 0.1, 0.3)
b ₃	(0.3, 0.4, 0.5)	(0.6, 0.3, 0.4)	(0.3, 0.3, 0.5)
b ₄	(0.8, 0.4, 0.1)	(0.2, 0.4, 0.3)	(0.6, 0.3, 0.2)
b ₅	(0.6, 0.1, 0.4)	(0.5, 0.3, 0.4)	(0.7, 0.1, 0.5)
u	(cheap, colorful)	(colorful, costly)	(colorful, colorful)
b ₁	(0.4, 0.3, 0.4)	(0.4, 0.2, 0.6)	(0.4, 0.2, 0.6)
b ₂	(0.2, 0.1, 0.3)	(0.2, 0.4, 0.4)	(0.2, 0.4, 0.4)
b ₃	(0.6, 0.3, 0.5)	(0.3, 0.6, 0.5)	(0.5, 0.3, 0.4)
b ₄	(0.2, 0.3, 0.3)	(0.8, 0.2, 0.3)	(0.2, 0.2, 0.3)
b ₅	(0.5, 0.3, 0.5)	(0.3, 0.1, 0.5)	(0.3, 0.6, 0.5)

Table 8: Tabular representation of the INSS $(K, A \times B)$.

Definition 3.23. If (F,A) and (G,B) be two INSSs over the common universe U then ‘ (F,A) OR (G,B) ’ denoted by $(F,A) \vee (G,B)$ is defined by $(F, A) \vee (G, B) = (O, A \times B)$, where, the truth-membership, indeterminacy membership and falsity-membership of $O(\alpha, \beta)$ are given as follows:

$$TO(\alpha, \beta)^{(m)} = \max(T_F(\alpha)^{(m)}, T_G(\beta)^{(m)}),$$

$$I_{O(\alpha, \beta)}^{(m)} = \min(I_F(\alpha)^{(m)}, I_G(\beta)^{(m)}),$$

$$FO(\alpha, \beta)^{(m)} = \min(F_F(\alpha)^{(m)}, F_G(\beta)^{(m)}), \forall \alpha \in A, \forall \beta \in B.$$

Example 3.24 Consider the same example 3.14 above. Then the tabular representation of $(F, A) \text{ OR } (G, B)$ is as follow:

u	(bright, costly)	(bright, colorful)	(cheap, costly)
b ₁	(0.6,0.2, 0.3)	(0.6,0.3, 0.2)	(0.7,0.2, 0.3)
b ₂	(0.5,0.1, 0.2)	(0.5,0.1, 0.3)	(0.6,0.1, 0.2)
b ₃	(0.7,0.4, 0.3)	(0.7,0.3, 0.3)	(0.8,0.3, 0.5)
b ₄	(0.8,0.4, 0.1)	(0.8,0.4, 0.1)	(0.8,0.3, 0.1)
b ₅	(0.7,0.1, 0.2)	(0.6,0.3, 0.4)	(0.7,0.1, 0.4)
u	(cheap, colorful)	(colorful, costly)	(colorful, colorful)
b ₁	(0.7,0.3, 0.2)	(0.6,0.2, 0.3)	(0.4,0.2, 0.2)
b ₂	(0.6,0.1, 0.3)	(0.6,0.4, 0.2)	(0.6,0.4, 0.3)
b ₃	(0.8,0.3, 0.4)	(0.5,0.6, 0.2)	(0.5,0.7, 0.2)
b ₄	(0.6,0.3, 0.2)	(0.8,0.2, 0.1)	(0.8,0.2, 0.3)
b ₅	(0.7,0.3, 0.4)	(0.7,0.1, 0.4)	(0.5,0.6, 0.4)

Table 9: Tabular representation of the INSS $(O, A \times B)$.

Proposition 3.25. if (F, A) and (G, B) are two INSSs over U , then :

- (1) $[(F,A) \wedge (G,B)]^c = (F,A)^c \vee (G,B)^c$
- (2) $[(F,A) \vee (G,B)]^c = (F,A)^c \wedge (G,B)^c$

Proof1. Let $(F,A) = \{ \langle b, T_{F(x)}(b), I_{F(x)}(b), F_{F(x)}(b) \rangle | b \in U \}$
and

$$(G,B) = \{ \langle b, T_{G(x)}(b), I_{G(x)}(b), F_{G(x)}(b) \rangle | b \in U \}$$

be two INSSs over the common universe U . Also let $(K, A \times B) = (F,A) \wedge (G,B)$,
where, $K(\alpha, \beta) = F(\alpha) \cap G(\beta)$ for all $(\alpha, \beta) \in A \times B$ then

$$K(\alpha, \beta) = \{ \langle b, \min(T_{F(\alpha)}(b), T_{G(\beta)}(b)), \min(I_{F(\alpha)}(b), I_{G(\beta)}(b)), \max(F_{F(\alpha)}(b), F_{G(\beta)}(b)) \rangle | b \in U \}.$$

Therefore,

$$[(F,A) \wedge (G,B)]^c = (K, A \times B)^c$$

$$= \{ \langle b, \max(F_{F(\alpha)}(b), F_{G(\beta)}(b)), \min(I_{F(\alpha)}(b), I_{G(\beta)}(b)), \min(T_{F(\alpha)}(b), T_{G(\beta)}(b)) \rangle | b \in U \}.$$

Again

$$(F,A)^c \vee (G,B)^c$$

$$= \{ \langle b, \max(F_{F(\alpha)}^c(b), F_{G(\beta)}^c(b)), \min(I_{F(\alpha)}^c(b), I_{G(\beta)}^c(b)), \min(T_{F(\alpha)}^c(b), T_{G(\beta)}^c(b)) \rangle | b \in U \}.$$

$$= \{ \langle b, \min(T_{F(\alpha)}(b), T_{G(\beta)}(b)), \min(I_{F(\alpha)}(b), I_{G(\beta)}(b)), \max(F_{F(\alpha)}(b), F_{G(\beta)}(b)) \rangle | b \in U \}^c.$$

$$= \{ \langle b, \max(F_{F(\alpha)}(b), F_{G(\beta)}(b)), \min(I_{F(\alpha)}(b), I_{G(\beta)}(b)), \min(T_{F(\alpha)}(b), T_{G(\beta)}(b)) \rangle | b \in U \}.$$

It follows that $[(F,A) \wedge (G,B)]^c = (F,A)^c \vee (G,B)^c$.

Proof 2.

Let $(F, A) = \{ \langle b, T_{F(x)}(b), I_{F(x)}(b), F_{F(x)}(b) \rangle | b \in U \}$ and
 $(G,B) = \{ \langle b, T_{G(x)}(b), I_{G(x)}(b), F_{G(x)}(b) \rangle | b \in U \}$ be two INSSs over the common universe U .

Also let $(O, A \times B) = (F,A) \vee (G,B)$, where, $O(\alpha, \beta) = F(\alpha) \cup G(\beta)$ for all $(\alpha, \beta) \in A \times B$. then
 $O(\alpha, \beta) = \{ \langle b, \max(T_{F(\alpha)}(b), T_{G(\beta)}(b)), \min(I_{F(\alpha)}(b), I_{G(\beta)}(b)), \min(F_{F(\alpha)}(b), F_{G(\beta)}(b)) \rangle | b \in U \}.$

$$[(F,A) \vee (G,B)]^c = (O, A \times B)^c = \{ \langle b, \min(F_{F(\alpha)}(b), F_{G(\beta)}(b)), \min(I_{F(\alpha)}(b), I_{G(\beta)}(b)), \max(T_{F(\alpha)}(b), T_{G(\beta)}(b)) \rangle | b \in U \}.$$

Again

$$(H,A)^c \wedge (G,B)^c$$

$$= \{ \langle b, \min(F_{F(\alpha)}^c(b), F_{G(\beta)}^c(b)), \min(I_{F(\alpha)}^c(b), I_{G(\beta)}^c(b)), \max(T_{F(\alpha)}^c(b), T_{G(\beta)}^c(b)) \rangle | b \in U \}.$$

$$= \{ \langle b, \max(T_{F(\omega)}(b), T_{G(\beta)}(b)), \min(I_{F^c(\omega)}(b), I_{G^c(\beta)}(b)), \min(F_{F(\omega)}(b), F_{G(\beta)}(b)) \rangle \mid b \in U \}^c .$$

$$= \{ \langle b, \min(F_{F(\omega)}(b), F_{G(\beta)}(b)), \min(I_{F(\omega)}(b), I_{G(\beta)}(b)), \max(T_{F(\omega)}(b), T_{G(\beta)}(b)) \rangle \mid b \in U \} .$$

It follows that $[(F,A) \vee (G,B)]^c = (F,A)^c \wedge (G,B)^c .$

4. An application of intuitionistic neutrosophic soft set in a decision making problem

For a concrete example of the concept described above, we revisit the blouse purchase problem in Example 3.3. So let us consider the intuitionistic neutrosophic soft set $S = (F,P)$ (see also Table 10 for its tabular representation), which describes the "attractiveness of the blouses" that Mrs. X is going to buy. on the basis of her m number of parameters (e_1, e_2, \dots, e_m) out of n number of blouses (b_1, b_2, \dots, b_n) . We also assume that corresponding to the parameter $e_j (j = 1, 2, \dots, m)$ the performance value of the blouse $b_i (i = 1, 2, \dots, n)$ is a tuple $p_{ij} = (T_{F(e_j)}(b_i), I_{F(e_j)}(b_i), T_{F(e_j)}(b_i))$, such that for a fixed i that values $p_{ij} (j = 1, 2, \dots, m)$ represents an intuitionistic neutrosophic soft set of all the n objects. Thus the performance values could be arranged in the form of a matrix called the 'criteria matrix'. The more are the criteria values, the more preferability of the corresponding object is. Our problem is to select the most suitable object i.e. the object which dominates each of the objects of the spectrum of the parameters e_j . Since the data are not crisp but intuitionistic neutrosophic soft the selection is not straightforward. Our aim is to find out the most suitable blouse with the choice parameters for Mrs. X. The blouse which is suitable for Mrs. X need not be suitable for Mrs. Y or Mrs. Z, as the selection is dependent on the choice parameters of each buyer. We use the technique to calculate the score for the objects.

4.1. Definition: Comparison matrix

The Comparison matrix is a matrix whose rows are labelled by the object names of the universe such as b_1, b_2, \dots, b_n and the columns are labelled by the parameters e_1, e_2, \dots, e_m . The entries are c_{ij} , where c_{ij} is the number of parameters for which the value of b_i exceeds or is equal to the value b_j . The entries are calculated by $c_{ij} = a + d - c$, where 'a' is the integer calculated as 'how many times $T_{b_i}(e_j)$ exceeds or equal to $T_{b_k}(e_j)$ ', for $b_i \neq b_k, \forall b_k \in U$, 'd' is the integer calculated as 'how many times $I_{b_i(e_j)}$ exceeds or equal to $I_{b_k(e_j)}$ ', for $b_i \neq b_k, \forall b_k \in U$ and 'c' is the integer 'how many times $F_{b_i(e_j)}$ exceeds or equal to $F_{b_k}(e_j)$ ', for $b_i \neq b_k, \forall b_k \in U$.

Definition 4.2. Score of an object. The score of an object b_i is S_i and is calculated as :

$$S_i = \sum_j c_{ij}$$

Now the algorithm for most appropriate selection of an object will be as follows.

Algorithm

- (1) input the intuitionistic Neutrosophic Soft Set (F, A).
- (2) input P, the choice parameters of Mrs. X which is a subset of A.
- (3) consider the INSS (F, P) and write it in tabular form.
- (4) compute the comparison matrix of the INSS (F, P).
- (5) compute the score S_i of $b_i, \forall i$.
- (6) find $S_k = \max_i S_i$
- (7) if k has more than one value then any one of b_i may be chosen.

To illustrate the basic idea of the algorithm, now we apply it to the intuitionistic neutrosophic soft set based decision making problem.

Suppose the wishing parameters for Mrs. X where $P = \{ \text{Bright, Costly, Polystyreneing, Colorful, Cheap} \}$.

Consider the INSS (F, P) presented into the following table.

U	Bright	costly	Polystyreneing	Colorful	Cheap
b_1	(0.6, 0.3, 0.4)	(0.5, 0.2, 0.6)	(0.5, 0.3, 0.4)	(0.8, 0.2, 0.3)	(0.6, 0.3, 0.2)
b_2	(0.7, 0.2, 0.5)	(0.6, 0.3, 0.4)	(0.4, 0.2, 0.6)	(0.4, 0.8, 0.3)	(0.8, 0.1, 0.2)
b_3	(0.8, 0.3, 0.4)	(0.8, 0.5, 0.1)	(0.3, 0.5, 0.6)	(0.7, 0.2, 0.1)	(0.7, 0.2, 0.5)
b_4	(0.7, 0.5, 0.2)	(0.4, 0.8, 0.3)	(0.8, 0.2, 0.4)	(0.8, 0.3, 0.4)	(0.8, 0.3, 0.4)

b_5	(0.3,0.8, 0.4)	(0.3,0.6, 0.1)	(0.7,0.3, 0.2)	(0.6,0.2, 0.4)	(0.6,0.4, 0.2)
-------	------------------	------------------	------------------	------------------	------------------

Table 10: Tabular form of the INSS (F, P).

The comparison-matrix of the above INSS (F, P) is represented into the following table.

U	Bright	Costly	Polystyreneing	Colorful	Cheap
b_1	0	-2	3	0	2
b_2	-1	1	-2	2	2
b_3	3	5	0	4	-1
b_4	6	3	3	3	4
b_5	7	2	6	-1	3

Table 11: Comparison matrix of the INSS (F, P).

Next we compute the score for each b_i as shown below:

U	Score (S_i)
b_1	3
b_2	2
b_3	11
b_4	19
b_5	17

Clearly, the maximum score is the score 19, shown in the table above for the blouse b_4 . Hence the best decision for Mrs. X is to select b_4 , followed by b_5 .

5. Conclusions

In this paper we study the notion of intuitionistic neutrosophic set initiated by Bhowmik and Pal. We use this concept in soft sets considering the fact that the parameters (which are words or sentences) are mostly intuitionistic neutrosophic set; but both the concepts deal with imprecision, We have also defined some operations on INSS and prove some propositions. Finally, we present an application of INSS in a decision making problem.

6 References

[1]. Zadeh, L. (1965). "Fuzzy sets", Inform and Control 8 338-353.
 [2]. Atanassov, K. (1986). "Intuitionistic fuzzy sets".Fuzzy Sets and Systems 20 87-96.
 [3]. Smarandache, F. (1999). A Unifying Field in Logics. Neutrosophy: Neutrosophic Probability, Set and Logic. Rehoboth: American Research Press.
 [4]. D. Molodtsov, Soft set theory - First results, Comput. Math. Appl. 37 (1999) 19-31.
 [5]. P. K. Maji, R. Biswas, A. R. Roy, Soft set theory, Comput. Math. Appl. 45 (2003) 555-562.
 [6]. M. Irfan Ali, Feng Feng, Xiaoyan Liu, Won Keun Min, M. Shabir, On some new operations in soft set theory, Comput. Math. Appl. 57 (2009) 1547-1553.
 [7]. M. Bhowmik and M.Pal. Intuitionistic neutrosophic set, Journal of Information and Computing Science Vol. 4, No. 2, 2009, pp. 142-152.
 [8]. P. K. Maji, R. Biswas, and A. R. Roy, Soft Set Theory, Comput. Math. Appl. 45 (2003) 555–562.
 [9]. P.K.Maji,R.Biswas,andA.R.Roy,An application of soft sets in a decision making problem, Comput. Math. Appl. 44 (2002) 1077–1083.
 [10]. F. Smarandache, Neutrosophic set, a generalisation of the intuitionistic fuzzy sets, Inter. J.Pure Appl. Math. 24 (2005) 287–297.
 [11]. R. Roy and P. K. Maji, A fuzzy soft set theoretic approach application of soft set in a decision making problem, Comput. Appl. Math. 203 (2007) 412–418
 [12]. Turksen, "Interval valued fuzzy sets based on normal forms," Fuzzy Sets and Systems, vol. 20, pp. 191-210, 1986.

More on Intuitionistic Neutrosophic Soft Sets

Said Broumi, Florentin Smarandache

Said Broumi, Florentin Smarandache (2013). More on Intuitionistic Neutrosophic Soft Sets. *Computer Science and Information Technology* 1(4): 257-268; DOI: 10.13189/csit.2013.010404

Abstract Intuitionistic Neutrosophic soft set theory proposed by S.Broumi and F.Samarandache [28], has been regarded as an effective mathematical tool to deal with uncertainties. In this paper new operations on intuitionistic neutrosophic soft sets have been introduced . Some results relating to the properties of these operations have been established. Moreover ,we illustrate their interconnections between each other.

1. Introduction

The theory of neutrosophic set (NS), which is the generalization of the classical sets, conventional fuzzy set [1], intuitionistic fuzzy set [2] and interval valued fuzzy set [3], was introduced by Samarandache [4]. This concept has been applied in many fields such as Databases [5, 6], Medical diagnosis problem [7], Decision making problem [8], Topology [9], control theory [10] and so on. The concept of neutrosophic set handle indeterminate data whereas fuzzy set theory, and intuitionistic fuzzy set theory failed when the relation are indeterminate.

Later on, several researchers have extended the neutrosophic set theory, such as Bhowmik and M.Pal in [11, 12], in their paper, they defined “intuitionistic neutrosophic set”. In [13], A.A.Salam, S.A.Alblowi introduced another concept called “Generalized neutrosophic set”. In [14], Wang et al. proposed another extension of neutrosophic set which is “single valued neutrosophic”. In 1998 a Russian researcher, Molodtsov proposed a new mathematical tool called “Soft set theory” [15], for dealing with uncertainty and how soft set theory is free from the parameterization inadequacy syndrome of fuzzy set theory, rough set theory, probability theory.

In recent time, researchers have contributed a lot towards fuzzification of soft set theory which leads to a series of mathematical models such as Fuzzy soft set [17, 18, 19, 20],

generalized fuzzy soft set [21, 22], possibility fuzzy soft set [23] and so on, thereafter, P.K.Maji and his coworker [24] introduced the notion of intuitionistic fuzzy soft set which is based on a combination of the intuitionistic fuzzy sets and soft set models and studied the properties of intuitionistic fuzzy soft set. Later a lot of extensions of intuitionistic fuzzy soft set are appeared such as generalized intuitionistic fuzzy soft set [25], Possibility intuitionistic fuzzy soft set [26] and so on. Few studies are focused on neutrosophication of soft set theory. In [25] P.K.Maji, first proposed a new mathematical model called “Neutrosophic Soft Set” and investigate some properties regarding neutrosophic soft union, neutrosophic soft intersection, complement of a neutrosophic soft set, De Morgan law etc. Furthermore, in 2013, S.Broumi and F. Smarandache [26] combined the intuitionistic neutrosophic and soft set which lead to a new mathematical model called “intuitionistic neutrosophic soft set”. They studied the notions of intuitionistic neutrosophic soft set union, intuitionistic neutrosophic soft set intersection, complement of intuitionistic neutrosophic soft set and several other properties of intuitionistic neutrosophic soft set along with examples and proofs of certain results. Also, in [27] S.Broumi presented the concept of “Generalized neutrosophic soft set” by combining the generalized neutrosophic sets [13] and soft set models, studied some properties on it, and presented an application of generalized neutrosophic soft set in decision making problem.

In the present work, we have extended the intuitionistic neutrosophic soft sets defining new operations on it. Some properties of these operations have also been studied.

The rest of this paper is organized as follow: section II deals with some definitions related to soft set theory, neutrosophic set, intuitionistic neutrosophic set, intuitionistic neutrosophic soft set theory. Section III deals with the necessity operation on intuitionistic neutrosophic soft set. Section IV deals with the possibility operation on intuitionistic neutrosophic soft set. Finally, section V give the conclusion.

2. Preliminaries

In this section we represent definitions needful for next section, we denote by $N(u)$ the set of all intuitionistic neutrosophic set.

2.1. Soft Sets (see [15]).

Let U be a universe set and E be a set of parameters. Let $\zeta(U)$ denotes the power set of U and $A \subset E$.

2.1.1. Definition [15]

A pair (P, A) is called a soft set over U , where F is a mapping given by $P: A \rightarrow \zeta(U)$. In other words, a soft set over U is a parameterized family of subsets of the universe U . For $e \in A$, $P(e)$ may be considered as the set of e-approximate elements of the soft set (P, A) .

2.2 Intuitionistic Fuzzy Soft Set

Let U be an initial universe set and E be the set of parameters. Let IF^U denote the collection of all intuitionistic fuzzy subsets of U . Let (P, A) pair (P, A) is called an intuitionistic fuzzy soft set over U where P is a mapping given by $P: A \rightarrow IF^U$.

2.2.1. Defintion

Let $P: A \rightarrow IF^U$ then F is a function defined as $P(\varepsilon) = \{x, \mu_{P(\varepsilon)}(x), \nu_{P(\varepsilon)}(x) : x \in U, \varepsilon \in E\}$ where μ, ν denote the degree of membership and degree of non-membership respectively and $\pi = 1 - \mu - \nu$, denote the hesitancy degree.

2.3. Neutrosophic Sets (see [4]).

Let U be an universe of discourse then the neutrosophic set A is an object having the form

$A = \{ \langle x: T_A(x), I_A(x), F_A(x) \rangle, x \in U \}$, where the functions $T, I, F: U \rightarrow]0, 1^+[$ define respectively the degree of membership (or Truth), the degree of indeterminacy, and the degree of non-membership (or Falsehood) of the element $x \in U$ to the set A with the condition.

$$0 \leq T_A(x) + I_A(x) + F_A(x) \leq 3^+ \quad (1)$$

From philosophical point of view, the neutrosophic set takes the value from real standard or non-standard subsets of $]0, 1^+[$. So instead of $]0, 1^+[$ we need to take the interval $[0, 1]$ for technical applications, because $]0, 1^+[$ will be difficult to apply in the real applications such as in scientific and engineering problems.

2.4. Single Valued Neutrosophic Set(see [14]).

2.4.1. Definition (see [14])

Let X be a space of points (objects) with generic elements in X denoted by x . An SVNS A in X is characterized by a truth-membership function $T_A(x)$, an indeterminacy-membership function $I_A(x)$, and a

falsity-membership function $F_A(x)$ for each point x in X , $T_A(x), I_A(x), F_A(x) \in [0, 1]$.

When X is continuous, an SVNS A can be written as

$$A = \int_X \frac{\langle T_A(x), I_A(x), F_A(x) \rangle}{x}, x \in X. \quad (2)$$

When X is discrete, an SVNS A can be written as

$$A = \sum_1^n \frac{\langle T_A(x_i), I_A(x_i), F_A(x_i) \rangle}{x_i}, x_i \in X \quad (3)$$

2.4.2. Definition (see [4,14])

A neutrosophic set or single valued neutrosophic set (SVNS) A is contained in another neutrosophic set B i.e. $A \subseteq B$ if $\forall x \in U, T_A(x) \leq T_B(x), I_A(x) \geq I_B(x), F_A(x) \geq F_B(x)$.

2.4.3. Definition (see [2])

The complement of a neutrosophic set A is denoted by A^c and is defined as $T_{A^c}(x) = F_A(x), I_{A^c}(x) = I_A(x)$ and $F_{A^c}(x) = T_A(x)$ for every x in X .

A complete study of the operations and application of neutrosophic set can be found in [4].

2.5. Intuitionistic Neutrosophic Set

2.5.1. Definition (see[11])

An element x of U is called significant with respect to neutrosophic set A of U if the degree of truth-membership or falsity-membership or indeterminacy-membership value, i.e., $T_A(x)$ or $F_A(x)$ or $I_A(x) \leq 0.5$. Otherwise, we call it insignificant. Also, for neutrosophic set the truth-membership, indeterminacy-membership and falsity-membership all can not be significant. We define an intuitionistic neutrosophic set by $A = \{ \langle x: T_A(x), I_A(x), F_A(x) \rangle, x \in U \}$, where

$$\begin{aligned} \min \{ T_A(x), F_A(x) \} &\leq 0.5, \\ \min \{ T_A(x), I_A(x) \} &\leq 0.5, \\ \min \{ F_A(x), I_A(x) \} &\leq 0.5, \text{ for all } x \in U, \end{aligned} \quad (4)$$

with the condition

$$0 \leq T_A(x) + I_A(x) + F_A(x) \leq 2. \quad (5)$$

As an illustration, let us consider the following example.

2.5.2. Example

Assume that the universe of discourse $U = \{x_1, x_2, x_3\}$, where x_1 characterizes the capability, x_2 characterizes the trustworthiness and x_3 indicates the prices of the objects. It may be further assumed that the values of x_1, x_2 and x_3 are in $[0, 1]$ and they are obtained from some questionnaires of some experts. The experts may impose their opinion in three components viz. the degree of goodness, the degree of indeterminacy and that of poorness to explain the characteristics of the objects. Suppose A is an intuitionistic neutrosophic set (INS) of U , such that,

$$A = \{ \langle x_1, 0.3, 0.5, 0.4 \rangle, \langle x_2, 0.4, 0.2, 0.6 \rangle, \langle x_3, 0.7, 0.3, 0.5 \rangle \},$$

where the degree of goodness of capability is 0.3, degree of indeterminacy of capability is 0.5 and degree of falsity of capability is 0.4 etc.

2.6. Intuitionistic Neutrosophic Soft Sets (see [28]).

2.6.1. Definition

Let U be an initial universe set and $A \subset E$ be a set of parameters. Let $N(U)$ denotes the set of all intuitionistic neutrosophic sets of U . The collection (P, A) is termed to be the soft intuitionistic neutrosophic set over U , where F is a mapping given by $P : A \rightarrow N(U)$.

2.6.2. Example

Let U be the set of blouses under consideration and E is the set of parameters (or qualities). Each parameter is a intuitionistic neutrosophic word or sentence involving intuitionistic neutrosophic words. Consider $E = \{ \text{Bright, Cheap, Costly, very costly, Colorful, Cotton, Polystyrene, long sleeve, expensive} \}$. In this case, to define a intuitionistic neutrosophic soft set means to point out Bright blouses, Cheap blouses, Blouses in Cotton and so on. Suppose that, there are five blouses in the universe U given by, $U = \{b_1, b_2, b_3, b_4, b_5\}$ and the set of parameters $A = \{e_1, e_2, e_3, e_4\}$, where each e_i is a specific criterion for blouses:

- e_1 stands for ‘Bright’,
- e_2 stands for ‘Cheap’,
- e_3 stands for ‘Costly’,
- e_4 stands for ‘Colorful’,

Suppose that,

$$\begin{aligned} P(\text{Bright}) &= \{ \langle b_1, 0.5, 0.6, 0.3 \rangle, \langle b_2, 0.4, 0.7, 0.2 \rangle, \langle b_3, 0.6, 0.2, 0.3 \rangle, \langle b_4, 0.7, 0.3, 0.2 \rangle, \langle b_5, 0.8, 0.2, 0.3 \rangle \}. \\ P(\text{Cheap}) &= \{ \langle b_1, 0.6, 0.3, 0.5 \rangle, \langle b_2, 0.7, 0.4, 0.3 \rangle, \langle b_3, 0.8, 0.1, 0.2 \rangle, \langle b_4, 0.7, 0.1, 0.3 \rangle, \langle b_5, 0.8, 0.3, 0.4 \rangle \}. \\ P(\text{Costly}) &= \{ \langle b_1, 0.7, 0.4, 0.3 \rangle, \langle b_2, 0.6, 0.1, 0.2 \rangle, \langle b_3, 0.7, 0.2, 0.5 \rangle, \langle b_4, 0.5, 0.2, 0.6 \rangle, \langle b_5, 0.7, 0.3, 0.2 \rangle \}. \\ P(\text{Colorful}) &= \{ \langle b_1, 0.8, 0.1, 0.4 \rangle, \langle b_2, 0.4, 0.2, 0.6 \rangle, \langle b_3, 0.3, 0.6, 0.4 \rangle, \langle b_4, 0.4, 0.8, 0.5 \rangle, \langle b_5, 0.3, 0.5, 0.7 \rangle \}. \end{aligned}$$

2.6.3. Definition ([28]). Containment of two intuitionistic neutrosophic soft sets

For two intuitionistic neutrosophic soft sets (P, A) and (Q, B) over the common universe U . We say that (P, A) is an intuitionistic neutrosophic soft subset of (Q, B) if and only if

(i) $A \subset B$.

(ii) $P(e)$ is an intuitionistic neutrosophic subset of $Q(e)$.

Or $T_{P(e)}(x) \leq T_{Q(e)}(m)$, $I_{P(e)}(m) \geq I_{Q(e)}(m)$, $F_{P(e)}(m) \geq F_{Q(e)}(m), \forall e \in A, x \in U$.

We denote this relationship by $(P, A) \subseteq (Q, B)$.

(P, A) is said to be intuitionistic neutrosophic soft super set of (Q, B) if (Q, B) is an intuitionistic neutrosophic soft subset of (P, A) . We denote it by $(P, A) \supseteq (Q, B)$.

2.6.4. Definition [28]. Equality of two intuitionistic neutrosophic soft sets

Two INSSs (P, A) and (Q, B) over the common universe U are said to be intuitionistic neutrosophic soft equal if (P, A) is an intuitionistic neutrosophic soft subset of (Q, B) and (Q, B) is an intuitionistic neutrosophic soft subset of (P, A) which can be denoted by $(P, A) = (Q, B)$.

2.6.5. Definition [28]. Complement of an intuitionistic neutrosophic soft set

The complement of an intuitionistic neutrosophic soft set (P, A) is denoted by $(P, A)^c$ and is defined by $(P, A)^c = (P^c, A)$, where $P^c : A \rightarrow N(U)$ is a mapping given by $P^c(\alpha) =$ intuitionistic neutrosophic soft complement with $T_{P^c(x)} = F_{P(x)}$, $I_{P^c(x)} = I_{P(x)}$ and $F_{P^c(x)} = T_{P(x)}$.

2.6.6. Definition [28] Union of two intuitionistic neutrosophic soft sets

Let (P, A) and (Q, B) be two INSSs over the same universe U . Then the union of (P, A) and (Q, B) is denoted by ‘ $(P, A) \cup (Q, B)$ ’ and is defined by $(P, A) \cup (Q, B) = (K, C)$, where $C = A \cup B$ and the truth-membership, indeterminacy-membership and falsity-membership of (K, C) are as follows:

$$T_{K(e)}(m) = \begin{cases} T_{P(e)}(m), & \text{if } e \in A - B \\ T_{Q(e)}(m), & \text{if } e \in B - A \\ \max\{T_{P(e)}(m), T_{Q(e)}(m)\}, & \text{if } e \in A \cap B \end{cases}$$

$$\begin{aligned}
 I_{K(e)}(m) &= \begin{cases} I_{P(e)}(m) , & \text{if } e \in A - B \\ I_{Q(e)}(m) , & \text{if } e \in B - A \\ \min \{I_{P(e)}(m), I_{Q(e)}(m)\} , & \text{if } e \in A \cap B \end{cases} \\
 F_{K(e)}(m) &= \begin{cases} F_{P(e)}(m) , & \text{if } e \in A - B \\ F_{Q(e)}(m) , & \text{if } e \in B - A \\ \min \{F_{P(e)}(m), F_{Q(e)}(m)\} , & \text{if } e \in A \cap B \end{cases} \tag{6}
 \end{aligned}$$

2.6.7. Definition. Intersection of two intuitionistic neutrosophic soft sets [28]

Let (P,A) and (Q,B) be two INSSs over the same universe U such that $A \cap B \neq \emptyset$. Then the intersection of (P,A) and (Q, B) is denoted by '(P,A) \cap (Q, B)' and is defined by $(P, A) \cap (Q, B) = (K,C)$, where $C = A \cap B$ and the truth-membership, indeterminacy membership and falsity-membership of (K, C) are related to those of (P,A) and (Q,B) by:

$$\begin{aligned}
 T_{K(e)}(m) &= \begin{cases} T_{P(e)}(m) , & \text{if } e \in A - B \\ T_{Q(e)}(m) , & \text{if } e \in B - A \\ \min \{T_{P(e)}(m), T_{Q(e)}(m)\} , & \text{if } e \in A \cap B \end{cases} \\
 I_{K(e)}(m) &= \begin{cases} I_{P(e)}(m) , & \text{if } e \in A - B \\ I_{Q(e)}(m) , & \text{if } e \in B - A \\ \min \{I_{P(e)}(m), I_{Q(e)}(m)\} , & \text{if } e \in A \cap B \end{cases} \\
 F_{K(e)}(m) &= \begin{cases} F_{P(e)}(m) , & \text{if } e \in A - B \\ F_{Q(e)}(m) , & \text{if } e \in B - A \\ \max \{F_{P(e)}(m), F_{Q(e)}(m)\} , & \text{if } e \in A \cap B \end{cases} \tag{7}
 \end{aligned}$$

In this paper we are concerned with intuitionistic neutrosophic sets whose T_A, I_A and F_A values are single points in $[0, 1]$ instead of subintervals/subsets in $[0, 1]$

3. The Necessity Operation on Intuitionistic Neutrosophic Soft Set

In this section, we shall introduce the necessity operation on intuitionistic neutrosophic soft set

3.1. Remark

$$s_A = T_A + I_A + F_A, \quad s_B = T_B + I_B + F_B \quad \text{.if } s_A = s_B \quad \text{we put } S = s_A = s_B$$

3.2. Definition

The necessity operation on an intuitionistic neutrosophic soft set (P, A) is denoted by $\square(P, A)$ and is defined as

$$\square(P, A) = \{ \langle m, T_{P(e)}(m), I_{P(e)}(m), s_A - T_{P(e)}(m) \rangle \mid m \in U \text{ and } e \in A \},$$

where $s_A = T + I + F$.

Here $T_{P(e)}(m)$ is the neutrosophic membership degree that object m hold on parameter e, $I_{P(e)}(m)$ represent the indeterminacy function and P is a mapping $P : A \rightarrow N(U)$, $N(U)$ is the set of aintuitionistic neutrosophic sets of U.

3.3. Example

Let there are five objects as the universal set where $U = \{ m_1, m_2, m_3, m_4, m_5 \}$ and the set of parameters as $E = \{ \text{beautiful, moderate, wooden, muddy, cheap, costly} \}$ and

Let $A = \{ \text{beautiful, moderate, wooden} \}$. Let the attractiveness of the objects represented by the intuitionistic neutrosophic soft sets (P, A) is given as

$$\begin{aligned}
 P(\text{beautiful}) &= \{ m_1/(.6, .2, .4), m_2/(.7, .3, .2), m_3/(.5, .4, .4), m_4/(.6, .4, .3), m_5/(.8, .4, .1) \}, \\
 P(\text{moderate}) &= \{ m_1/(.7, .3, .2), m_2/(.8, .1, .1), m_3/(.7, .5, .2), m_4/(.8, .5, .1), m_5/(1, .2, 0) \} \\
 \text{and } P(\text{wooden}) &= \{ m_1/(.8, .5, .1), m_2/(.6, .4, 0), m_3/(.6, .5, .2), m_4/(.2, .3, .4), m_5/(.3, .2, .5) \}.
 \end{aligned}$$

Then the intuitionistic neutrosophic soft sets $\square(P,A)$ becomes as

$$P(\text{beautiful}) = \{ m_{1/(.6,.2,.6)}, m_{2/(.7,.3,.5)}, m_{3/(.5,.4,.8)}, m_{4/(.6,.4,.7)}, m_{5/(.8,.4,.5)} \},$$

$$P(\text{moderate}) = \{ m_{1/(.7,.3,.5)}, m_{2/(.8,.1,.2)}, m_{3/(.7,.5,.7)}, m_{4/(.8,.5,.6)}, m_{5/(.1,.2,.2)} \}$$

And

$$P(\text{wooden}) = \{ m_{1/(.8,.5,.6)}, m_{2/(.6,.4,.4)}, m_{3/(.6,.5,.7)}, m_{4/(.2,.3,.7)}, m_{5/(.3,.2,.7)} \}.$$

Let (P, A) and (Q, B) be two intuitionistic neutrosophic soft sets over a universe U and A, B be two sets of parameters. Then we have the following propositions:

3.4. Proposition

$$i. \square [(P, A) \cup (Q, B)] = \square (P, A) \cup \square (Q, B). \tag{8}$$

$$ii. \square [(P, A) \cap (Q, B)] = \square (P, A) \cap \square (Q, B). \tag{9}$$

$$iii. \square \square (P, A) = \square (P, A). \tag{10}$$

$$iv. \square [(P, A)]^n = [\square (P, A)]^n \tag{11}$$

for any finite positive integer n.

$$v. \square [(P, A) \cup (Q, B)]^n = [\square (P, A) \cup \square (Q, B)]^n. \tag{12}$$

$$vi. \square [(P, A) \cap (Q, B)]^n = [\square (P, A) \cap \square (Q, B)]^n. \tag{13}$$

Proof

$$i. [(P, A) \cup (Q, B)]$$

suppose $(P, A) \cup (Q, B) = (H, C)$, where $C = A \cup B$ and for all $e \in C$ and

$$s_A = T_{P(e)} + I_{P(e)} + F_{P(e)} \text{ and } s_B = T_{Q(e)} + I_{Q(e)} + F_{Q(e)}, s_A - T_{P(e)}(m) = I_{P(e)}(m) + F_{P(e)}(m), s_B - T_{Q(e)}(m) = I_{Q(e)}(m) + F_{Q(e)}(m),$$

$$T_{H(e)}(m) = \begin{cases} T_{P(e)}(m), & \text{if } e \in A - B \\ T_{Q(e)}(m), & \text{if } e \in B - A \\ \max\{T_{P(e)}(m), T_{Q(e)}(m)\}, & \text{if } e \in A \cap B \end{cases}$$

$$I_{H(e)}(m) = \begin{cases} I_{P(e)}(m), & \text{if } e \in A - B \\ I_{Q(e)}(m), & \text{if } e \in B - A \\ \min\{I_{P(e)}(m), I_{Q(e)}(m)\}, & \text{if } e \in A \cap B \end{cases}$$

$$F_{H(e)}(m) = \begin{cases} F_{P(e)}(m), & \text{if } e \in A - B \\ F_{Q(e)}(m), & \text{if } e \in B - A \\ \min\{F_{P(e)}(m), F_{Q(e)}(m)\}, & \text{if } e \in A \cap B \end{cases}$$

Since $[(P, A) \cup (Q, B)] = (H, C)$ and $m \in U$, by definition 3.2 we Have

$$T_{H(e)}(m) = \begin{cases} T_{P(e)}(m), & \text{if } e \in A - B \\ T_{Q(e)}(m), & \text{if } e \in B - A \\ \max\{T_{P(e)}(m), T_{Q(e)}(m)\}, & \text{if } e \in A \cap B \end{cases}$$

$$I_{H(e)}(m) = \begin{cases} I_{P(e)}(m), & \text{if } e \in A - B \\ I_{Q(e)}(m), & \text{if } e \in B - A \\ \min\{I_{P(e)}(m), I_{Q(e)}(m)\}, & \text{if } e \in A \cap B \end{cases}$$

$$F_{H(e)}(m) = \begin{cases} s_A - T_{P(e)}(m), & \text{if } e \in A - B, \\ s_B - T_{Q(e)}(m), & \text{if } e \in B - A \\ s - \max\{T_{P(e)}(m), T_{Q(e)}(m)\}, & \text{if } e \in A \cap B \end{cases}$$

For all $e \in C = A \cup B$ and $m \in U$. Assume that $\square (P, A) = \{ \langle m, T_{P(e)}(m), I_{P(e)}(m), s_A - T_{P(e)}(m) \rangle, m \in U \}$ and $\square (Q, B) = \{ \langle m, T_{Q(e)}(m), I_{Q(e)}(m), s_B - T_{Q(e)}(m) \rangle, m \in U \}$. Suppose that $(P, A) \cup (Q, B) = (O, C)$, where $C = A \cup B$, and for all $e \in C$ and $m \in U$.

$$\begin{aligned}
 T_{O(e)}(m) &= \begin{cases} T_{P(e)}(m), & \text{if } e \in A - B \\ T_{Q(e)}(m), & \text{if } e \in B - A \\ \max\{T_{P(e)}(m), T_{Q(e)}(m)\}, & \text{if } e \in A \cap B \end{cases} \\
 I_{O(e)}(m) &= \begin{cases} I_{P(e)}(m), & \text{if } e \in A - B \\ I_{Q(e)}(m), & \text{if } e \in B - A \\ \min\{I_{P(e)}(m), I_{Q(e)}(m)\}, & \text{if } e \in A \cap B \end{cases} \\
 F_{O(e)}(m) &= \begin{cases} s_A - T_{P(e)}(m), & \text{if } e \in A - B \\ s_B - T_{Q(e)}(m), & \text{if } e \in B - A \\ \min\{s_A - T_{P(e)}(m), s_A - T_{Q(e)}(m)\}, & \text{if } e \in A \cap B \end{cases} \\
 &= \begin{cases} s_A - T_{P(e)}(m), & \text{if } e \in A - B \\ s_B - T_{Q(e)}(m), & \text{if } e \in B - A \\ S - \max\{T_{P(e)}(m), T_{Q(e)}(m)\}, & \\ \text{if } e \in A \cap B \text{ with } S = s_A = s_B \end{cases}
 \end{aligned}$$

Consequently, (H,C) and (O, C) are the same intuitionistic neutrosophic soft sets. Thus ,

$$\square ((P,A) \cup (Q,B)) = \square (P,A) \cup \square (Q,B).$$

Hence the result is proved.

(ii) and (iii) are proved analogously.

iii. Let

$$(P, A) = \{ \langle m, T_{P(e)}(m), I_{P(e)}(m), F_{P(e)}(m), \rangle | m \in U \text{ and } e \in A \}.$$

Then

$$\square (P, A) = \{ \langle m, T_{P(e)}(m), I_{P(e)}(m), s_A - T_{P(e)}(m) \rangle | m \in U \text{ and } e \in A \}.$$

So

$$\square \square (P, A) = \{ \langle m, T_{P(e)}(m), I_{P(e)}(m), s_A - T_{P(e)}(m) \rangle | m \in U \text{ and } e \in A \}.$$

Hence the result follows.

iv. Let the intuitionistic neutrosophic soft set

$$(P, A) = \{ \langle m, T_{P(e)}(m), I_{P(e)}(m), F_{P(e)}(m) \rangle | m \in U \text{ and } e \in A \}.$$

Then for any finite positive integer n

$$(P, A)^n = \{ \langle m, [T_{P(e)}(m)]^n, [I_{P(e)}(m)]^n, s_A - [s_A - F_{P(e)}(m)]^n \rangle | m \in U \text{ and } e \in A \}$$

So,

$$\square (P, A)^n = \{ \langle m, [T_{P(e)}(m)]^n, [I_{P(e)}(m)]^n, s_A - [T_{P(e)}(m)]^n \rangle | m \in U \text{ and } e \in A \}.$$

Again, $[\square (P, A)]^n = \{ \langle m, [T_{P(e)}(m)]^n, [I_{P(e)}(m)]^n, s_A - [T_{P(e)}(m)]^n \rangle | m \in U \text{ and } e \in A \}$ as

$$\square (P, A) = \{ \langle m, T_{P(e)}(m), I_{P(e)}(m), s_A - T_{P(e)}(m) \rangle | m \in U \text{ and } e \in A \}.$$

Hence the result.

v. As $(P, A)^n \cup (Q, B)^n = [(P, A) \cup (Q, B)]^n$

$$\begin{aligned}
 \square [(P, A) \cup (Q, B)]^n &= [\square [(P, A) \cup (Q, B)]]^n && \text{by the proposition 3.4.iv} \\
 &= [\square (P, A) \cup \square (Q, B)]^n && \text{by the proposition 3.4.i}
 \end{aligned}$$

vi. As $(P, A)^n \cap (Q, B)^n = [(P, A) \cap (Q, B)]^n$

$$\begin{aligned}
 \square [(P, A) \cap (Q, B)]^n &= [\square [(P, A) \cap (Q, B)]]^n && \text{by the proposition 3.4.iv} \\
 &= [\square (P, A) \cap \square (Q, B)]^n && \text{by the proposition 3.4.ii}
 \end{aligned}$$

The result is proved.

The concept of necessity operation on intuitionistic neutrosophic soft set can also be applied to measure the necessity operation on intuitionistic fuzzy soft set (IFSS), proposed by P.K .Maji [30], where the indeterminacy degree $I_{P(e)}(m)$

should be replaced by $I_{P(e)}(m) = 1 - T_{P(e)}(m) - F_{P(e)}(m)$ in case of IFSS. In this case, we conclude that the necessity operation on intuitionistic neutrosophic soft set is a generalization of the necessity operation on intuitionistic fuzzy soft set

4. The Possibility Operation on Intuitionistic Neutrosophic Soft Sets

In this section, we shall define another operation, the possibility operation on intuitionistic neutrosophic soft sets.

Let U be a universal set. E be a set of parameters and A be a subset of E . Let the intuitionistic neutrosophic soft set. $(P, A) = \{ \langle m, T_{P(e)}(m), I_{P(e)}(m), F_{P(e)}(m) \rangle \mid m \in U \text{ and } e \in A \}$, where $T_{P(e)}(m), I_{P(e)}(m), F_{P(e)}(m)$ be the membership, indeterminacy and non-membership functions respectively.

4.1. Definition

Let U be the universal set and E be the set of parameters. The possibility operation on the intuitionistic neutrosophic soft set (P, A) is denoted by $\diamond(P, A)$ and is defined as

$$\diamond(P, A) = \{ \langle m, s_A - F_{P(e)}(m), I_{P(e)}(m), F_{P(e)}(m) \rangle \mid m \in U \text{ and } e \in A \},$$

where

$$s_A = T_{P(e)}(m) + I_{P(e)}(m) + F_{P(e)}(m) \text{ and } 0 \leq s_A \leq 3^+$$

4.2. Example

Let there are five objects as the universal set where $U = \{m_1, m_2, m_3, m_4, m_5\}$. Also let the set of parameters as $E = \{ \text{beautiful, costly, cheap, moderate, wooden, muddy} \}$ and $A = \{ \text{costly, cheap, moderate} \}$. The cost of the objects represented by the intuitionistic neutrosophic soft sets (P, A) is given as

$$P(\text{costly}) = \{ m_1/(.7, .1, .2), m_2/(.8, .3, 0), m_3/(.8, .2, .1), m_4/(.9, .4, 0), m_5/(.6, .2, .2) \},$$

$$P(\text{cheap}) = \{ m_1/(.5, .3, .2), m_2/(.7, .5, .1), m_3/(.4, .3, .2), m_4/(.8, .5, .1), m_5/(.4, .4, .2) \}$$

and

$$P(\text{moderate}) = \{ m_1/(.8, .4, .2), m_2/(.6, .1, .3), m_3/(.5, .5, .1), m_4/(.9, .4, 0), m_5/(.7, .3, .1) \}.$$

Then the neutrosophic soft set $\diamond(P, A)$ is as

$$P(\text{costly}) = \{ m_1/(.8, .1, .2), m_2/(1.1, .3, 0), m_3/(1, .2, .1), m_4/(1.3, .4, 0), m_5/(.8, .2, .2) \},$$

$$P(\text{cheap}) = \{ m_1/(.8, .3, .2), m_2/(1.2, .5, .1), m_3/(.7, .3, .2), m_4/(1.3, .5, .1), m_5/(.8, .4, .2) \}$$

and

$$P(\text{moderate}) = \{ m_1/(1.2, .4, .2), m_2/(.7, .1, .3), m_3/(1, .5, .1), m_4/(1.3, .4, 0), m_5/(1, .3, .1) \}.$$

The concept of possibility operation on intuitionistic neutrosophic soft set can also be applied to measure the necessity operation on intuitionistic fuzzy soft set (IFSS), proposed by P.K. Maji [30], where the indeterminacy degree $I_{P(e)}(m)$ should be replaced by $I_{P(e)}(m) = 1 - T_{P(e)}(m) - F_{P(e)}(m)$ in case of IFSS. In this case, we conclude that the possibility operation on intuitionistic neutrosophic soft set is a generalization of the possibility operation on intuitionistic fuzzy soft set.

Let (P, A) and (Q, B) be two intuitionistic neutrosophic soft sets over the same universe U and A, B be two sets of parameters. Then we have the propositions

4.3. Proposition

$$i. \diamond [(P, A) \cup (Q, B)] = \diamond(P, A) \cup \diamond(Q, B). \tag{14}$$

$$ii. \diamond [(P, A) \cap (Q, B)] = \diamond(P, A) \cap \diamond(Q, B) \tag{15}$$

$$iii. \diamond \diamond (P, A) = \diamond(P, A). \tag{16}$$

$$iv. \diamond [(P, A)]^n = [\diamond(P, A)]^n \tag{17}$$

for any finite positive integer n .

$$v. \diamond [(P, A) \cup (Q, B)]^n = [\diamond (P, A) \cup \diamond (Q, B)]^n. \quad (18)$$

$$vi. \diamond [(P, A) \cap (Q, B)]^n = [\diamond (P, A) \cap \diamond (Q, B)]^n \quad (19)$$

Proof

i. $\diamond [(P, A) \cup (Q, B)]$

suppose $(P, A) \cup (Q, B) = (H, C)$, where $C = A \cup B$ and for all $e \in C$ and

$$s_A = T_{P(e)}(m) + I_{P(e)}(m) + F_{P(e)}(m) \quad \text{and} \quad s_B = T_{Q(e)}(m) + I_{Q(e)}(m) + F_{Q(e)}(m)$$

$$s_A - F_{P(e)}(m) = I_{P(e)}(m) + T_{P(e)}(m) ,$$

$$s_B - F_{Q(e)}(m) = I_{Q(e)}(m) + T_{Q(e)}(m)$$

$$T_{H(e)}(m) = \begin{cases} T_{P(e)}(m) , & \text{if } e \in A - B \\ T_{Q(e)}(m) , & \text{if } e \in B - A \\ \max\{T_{P(e)}(m) , T_{Q(e)}(m)\} , & \text{if } e \in A \cap B \end{cases}$$

$$I_{H(e)}(m) = \begin{cases} I_{P(e)}(m) , & \text{if } e \in A - B \\ I_{Q(e)}(m) , & \text{if } e \in B - A \\ \min\{I_{P(e)}(m) , I_{Q(e)}(m)\} , & \text{if } e \in A \cap B \end{cases}$$

$$F_{H(e)}(m) = \begin{cases} F_{P(e)}(m) , & \text{if } e \in A - B \\ F_{Q(e)}(m) , & \text{if } e \in B - A \\ \min\{F_{P(e)}(m) , F_{Q(e)}(m)\} , & \text{if } e \in A \cap B \end{cases}$$

Since $\diamond [(P, A) \cup (Q, B)] = \diamond (H, C)$ and $m \in U$, by definition 4.1 we Have

$$T_{H(e)}(m) = \begin{cases} s_A - F_{P(e)}(m) , & \text{if } e \in A - B \\ s_B - F_{Q(e)}(m) , & \text{if } e \in B - A \\ S - \min\{F_{P(e)}(m) , F_{Q(e)}(m)\} , & \text{if } e \in A \cap B , \text{ with } S = s_A = s_B \end{cases}$$

$$I_{H(e)}(m) = \begin{cases} I_{P(e)}(m) , & \text{if } e \in A - B \\ I_{Q(e)}(m) , & \text{if } e \in B - A \\ \min\{I_{P(e)}(m) , I_{Q(e)}(m)\} , & \text{if } e \in A \cap B \end{cases}$$

$$F_{H(e)}(m) = \begin{cases} F_{P(e)}(m) , & \text{if } e \in A - B \\ F_{Q(e)}(m) , & \text{if } e \in B - A \\ \min\{F_{P(e)}(m) , F_{Q(e)}(m)\} , & \text{if } e \in A \cap B \end{cases}$$

For all $e \in C = A \cup B$ and $m \in U$. Assume that

$$\diamond (P, A) = \{ \langle m, s_A - F_{P(e)}(m), I_{P(e)}(m), F_{P(e)}(m) \rangle, m \in U \}$$

and

$$\diamond (Q, B) = \{ \langle m, s_B - F_{Q(e)}(m), I_{Q(e)}(m), F_{Q(e)}(m) \rangle, m \in U \} .$$

Suppose that

$$\diamond (P, A) \cup \diamond (Q, B) = (O, C) ,$$

where $C = A \cup B$, and for all $e \in C$ and $m \in U$.

$$\begin{aligned} T_{O(e)}(m) &= \begin{cases} s_A - F_{P(e)}(m) , & \text{if } e \in A - B \\ s_B - F_{Q(e)}(m) , & \text{if } e \in B - A \\ \max\{s_A - F_{P(e)}(m) , s_B - F_{Q(e)}(m)\} , & \text{if } e \in A \cap B \end{cases} \\ &= \begin{cases} s_A - F_{P(e)}(m) , & \text{if } e \in A - B \\ s_B - F_{Q(e)}(m) , & \text{if } e \in B - A \\ S - \min\{F_{P(e)}(m) , F_{Q(e)}(m)\} , & \text{if } e \in A \cap B , \\ \text{with } S = s_A = s_B \end{cases} \end{aligned}$$

$$I_{O(e)}(m) = \begin{cases} I_{P(e)}(m) , & \text{if } e \in A - B \\ I_{Q(e)}(m) , & \text{if } e \in B - A \\ \min \{I_{P(e)}(m) , I_{Q(e)}(m)\} , & \text{if } e \in A \cap B \end{cases}$$

$$F_{O(e)}(m) = \begin{cases} F_{P(e)}(m) , & \text{if } e \in A - B \\ F_{Q(e)}(m) , & \text{if } e \in B - A \\ \min \{F_{P(e)}(m) , F_{Q(e)}(m)\} , & \text{if } e \in A \cap B \end{cases}$$

Consequently, $\diamond (H,C)$ and (O, C) are the same intuitionistic neutrosophic soft sets. Thus ,

$$\diamond ((P, A) \cup (Q, B)) = \diamond (P, A) \cup \diamond (Q, B).$$

Hence the result is proved.

(ii) and (iii) are proved analogously.

$$\text{iii. } \diamond (P, A) = \{ \langle m, s_A - F_{P(e)}(m), I_{P(e)}(m) \rangle \mid m \in U \text{ and } e \in A \}.$$

So

$$\diamond \diamond (P, A) = \{ \langle m, s_A - F_{P(e)}(m) , I_{P(e)}(m), F_{P(e)}(m) \rangle \mid m \in U \text{ and } e \in A \}.$$

Hence the result.

iv. For any positive finite integer n,

$$(P, A)^n = \{ \langle m, [T_{P(e)}(m)]^n, [I_{P(e)}(m)]^n, s_A - [s_A - F_{P(e)}(m)]^n \rangle \mid m \in U \} \forall e \in A,$$

So,

$$\begin{aligned} \diamond (P, A)^n &= \{ \langle m, s_A - [s_A - F_{P(e)}(m)]^n, [I_{P(e)}(m)]^n, s_A - [s_A - F_{P(e)}(m)]^n \rangle \mid m \in U \} \\ &= \{ \langle m, [s_A - F_{P(e)}(m)]^n, [I_{P(e)}(m)]^n, s_A - [s_A - F_{P(e)}(m)]^n \rangle \mid m \in U \} \forall e \in A. \end{aligned}$$

Again

$$[\diamond (P, A)]^n = \{ \langle m, [s_A - F_{P(e)}(m)]^n, [I_{P(e)}(m)]^n, s_A - [s_A - F_{P(e)}(m)]^n \rangle \mid m \in U \} \forall e \in A.$$

Hence the result follows.

$$\text{v. As } [(P, A) \cup (Q, B)]^n = (P, A)^n \cup (Q, B)^n,$$

$$\diamond [(P, A) \cup (Q, B)]^n = \diamond (P, A)^n \cup \diamond (Q, B)^n.$$

the result is proved

$$\text{vi. As } [(P, A) \cap (Q, B)]^n = (P, A)^n \cap (Q, B)^n,$$

$$\diamond [(P, A) \cap (Q, B)]^n = \diamond (P, A)^n \cap \diamond (Q, B)^n.$$

Hence the result follows.

For any intuitionistic neutrosophic soft set (P, A) we have the following propositions.

4.4. Proposition

$$\text{i. } \diamond \square (P, A) = \square (P, A) \tag{20}$$

$$\text{ii. } \square \diamond (P, A) = \diamond (P, A) \tag{21}$$

Proof

i. Let (P, A) be a intuitionistic neutrosophic soft set over the universe U .

Then $(P, A) = \{ \langle m, T_{P(e)}(m), I_{P(e)}(m), F_{P(e)}(m) \rangle \mid m \in U \}$ where $e \in A$.

So, $\square (P, A) = \{ \langle m, T_{P(e)}(m), I_{P(e)}(m), s_A - T_{P(e)}(m) \rangle \mid m \in U \}$, and

$\diamond (P, A) = \{ \langle m, s_A - F_{P(e)}(m), I_{P(e)}(m), F_{P(e)}(m) \rangle \mid m \in U \}$.

So $\diamond \square (P, A) = \{ \langle m, s_A - (s_A - T_{P(e)}(m)), I_{P(e)}(m), s_A - T_{P(e)}(m) \rangle \mid m \in U \}$.

$= \{ \langle m, T_{P(e)}(m), I_{P(e)}(m), s_A - T_{P(e)}(m) \rangle \mid m \in U \}$.

$= \square (P, A)$

ii. The proof is similar to the proof of the proposition 3.4.i.

Let (P, A) and (Q, B) be two intuitionistic neutrosophic soft sets over the common universe U , then we have the following propositions:

4.5. Proposition

$$i. \square [(P, A) \wedge (Q, B)] = \square (P, A) \wedge \square (Q, B). \tag{22}$$

$$ii. \square [(P, A) \vee (Q, B)] = \square (P, A) \vee \square (Q, B). \tag{23}$$

$$iii. \diamond [(P, A) \wedge (Q, B)] = \diamond (P, A) \wedge \diamond (Q, B). \tag{24}$$

$$iv. \diamond [(P, A) \vee (Q, B)] = \diamond (P, A) \vee \diamond (Q, B). \tag{25}$$

Proof

i. Let $(H, A \times B) = (P, A) \wedge (Q, B)$.

Hence,

$$(H, A \times B) = \{ \langle m, T_{H(\alpha,\beta)}(m), I_{H(\alpha,\beta)}(m), F_{H(\alpha,\beta)}(m) \rangle | m \in U \},$$

where

$$T_{H(\alpha,\beta)}(m) = \min \{ T_{P(\alpha)}(m), T_{Q(\beta)}(m) \}, F_{H(\alpha,\beta)}(m) = \max \{ F_{P(\alpha)}(m), F_{Q(\beta)}(m) \}$$

and

$$I_{H(\alpha,\beta)}(m) = \max \{ I_{P(\alpha)}(m), I_{Q(\beta)}(m) \}.$$

So,

$$\begin{aligned} \square (H, A \times B) &= \{ \langle m, T_{H(\alpha,\beta)}(m), I_{H(\alpha,\beta)}(m), S - T_{H(\alpha,\beta)}(m) \rangle | m \in U \}, (\alpha, \beta) \in A \times B \\ &= \{ \langle m, \min (T_{P(\alpha)}(m), T_{Q(\beta)}(m)), \max (I_{P(\alpha)}(m), I_{Q(\beta)}(m)), S - \min (T_{P(\alpha)}(m), T_{Q(\beta)}(m)) \rangle | m \in U \} \\ &= \{ \langle m, \min (T_{P(\alpha)}(m), T_{Q(\beta)}(m)), \max (I_{P(\alpha)}(m), I_{Q(\beta)}(m)), \max (S - T_{P(\alpha)}(m), S - T_{Q(\beta)}(m)) \rangle | m \in U \} \\ &= \{ \langle m, T_{P(\alpha)}(m), I_{P(\alpha)}(m), S - T_{P(\alpha)}(m) \rangle | m \in U \} \text{ AND } \{ \langle m, T_{Q(\beta)}(m), I_{Q(\beta)}(m), S - T_{Q(\beta)}(m) \rangle | m \in U \} \\ &= \square (P, A) \wedge \square (Q, B). \end{aligned}$$

Hence the result is proved

ii. Let $(L, A \times B) = (P, A) \vee (Q, B)$.

Hence ,

$$(L, A \times B) = \{ \langle m, T_{L(\alpha,\beta)}(m), I_{L(\alpha,\beta)}(m), F_{L(\alpha,\beta)}(m) \rangle | m \in U \},$$

where

$$T_{L(\alpha,\beta)}(m) = \max \{ T_{P(\alpha)}(m), T_{Q(\beta)}(m) \}, I_{L(\alpha,\beta)}(m) = \min \{ I_{P(\alpha)}(m), I_{Q(\beta)}(m) \}$$

And $F_{L(\alpha,\beta)}(m) = \min \{ F_{P(\alpha)}(m), F_{Q(\beta)}(m) \}.$

So,

$$\begin{aligned} \square (L, A \times B) &= \{ \langle m, T_{L(\alpha,\beta)}(m), I_{L(\alpha,\beta)}(m), S - T_{L(\alpha,\beta)}(m) \rangle | m \in U \}, \text{ for } (\alpha, \beta) \in A \times B \\ &= \{ \langle m, \max (T_{P(\alpha)}(m), T_{Q(\beta)}(m)), \min (I_{P(\alpha)}(m), I_{Q(\beta)}(m)), S - \max (T_{P(\alpha)}(m), T_{Q(\beta)}(m)) \rangle | m \in U \} \\ &= \{ \langle m, \max (T_{P(\alpha)}(m), T_{Q(\beta)}(m)), \min (I_{P(\alpha)}(m), I_{Q(\beta)}(m)), \min (S - T_{P(\alpha)}(m), S - T_{Q(\beta)}(m)) \rangle | m \in U \} \\ &= \{ \langle m, T_{P(\alpha)}(m), I_{P(\alpha)}(m), S - T_{P(\alpha)}(m) \rangle | m \in U \} \text{ OR } \{ \langle m, T_{Q(\beta)}(m), I_{Q(\beta)}(m), S - T_{Q(\beta)}(m) \rangle | m \in U \} \\ &= \square (P, A) \vee \square (Q, B). \end{aligned}$$

Hence the result is proved

iii. Let $(H, A \times B) = (P, A) \wedge (Q, B)$.

Hence,

$$(H, A \times B) = \{ \langle m, T_{H(\alpha,\beta)}(m), I_{H(\alpha,\beta)}(m), F_{H(\alpha,\beta)}(m) \rangle | m \in U \},$$

where

$$T_{H(\alpha,\beta)}(m) = \min \{ T_{P(\alpha)}(m), T_{Q(\beta)}(m) \}, I_{H(\alpha,\beta)}(m) = \max \{ I_{P(\alpha)}(m), I_{Q(\beta)}(m) \}.$$

and

$$F_{H(\alpha,\beta)}(m) = \max \{F_{P(\alpha)}(m), F_{Q(\beta)}(m)\}.$$

So,

$$\begin{aligned} \diamond (H, A \times B) &= \{ \langle m, S - F_{H(\alpha,\beta)}(m), I_{H(\alpha,\beta)}(m), F_{H(\alpha,\beta)}(m) \rangle | m \in U \}, \text{ for } (\alpha, \beta) \in A \times B \\ &= \{ \langle m, S - \max (F_{P(\alpha)}(m), F_{Q(\beta)}(m)), \max (I_{P(\alpha)}(m), I_{Q(\beta)}(m)), \max (F_{P(\alpha)}(m), F_{Q(\beta)}(m)) \rangle | m \in U \} \\ &= \{ \langle m, \min (S - F_{P(\alpha)}(m), S - F_{Q(\beta)}(m)), \max (I_{P(\alpha)}(m), I_{Q(\beta)}(m)), \max (F_{P(\alpha)}(m), F_{Q(\beta)}(m)) \rangle | m \in U \} \\ &= \{ \langle m, S - F_{P(\alpha)}(m), I_{P(\alpha)}(m), F_{P(\alpha)}(m) \rangle | m \in U \} \text{ AND } \{ \langle m, S - F_{Q(\beta)}(m), I_{Q(\beta)}(m), F_{Q(\beta)}(m) \rangle | m \in U \} \end{aligned}$$

$= \diamond (P, A) \wedge \diamond (Q, B)$. Hence the result is proved

iv. The proof is similar to the proof of the proposition 3.5.iii.

5. Conclusion

In the present work, We have continued to study the properties of intuitionistic neutrosophic soft set. New operations such as necessity and possibility on the intuitionistic neutrosophic soft set are introduced. Some properties of these operations and their interconnection between each other are also presented and discussed. We conclude that necessity and possibility operations on the intuitionistic neutrosophic soft set are generalization of necessity and possibility operations on the intuitionistic fuzzy soft set. The new operations can be applied also on neutrosophic soft set [27] and generalized neutrosophic soft set [29]. We hope that the findings, in this paper will help researcher enhance the study on the intuitionistic neutrosophic soft set theory.

REFERENCES

- [1] L.A.Zadeh. Fuzzy sets. Information and Control.(1965), 8: pp.338-353.
- [2] K.Atanassov. Intuitionistic fuzzy sets.Fuzzy Sets and Systems.(1986), 20,pp.87-96.
- [3] Turksen, "Interval valued fuzzy sets based on normal forms".Fuzzy Sets and Systems, 20,(1968),pp.191-210.
- [4] F.Smarandache,"A Unifying Field in Logics. Neutrosophy: Neutrosophic Probability, Set and Logic". Rehoboth: American Research Press,(1999).
- [5] M.Arora, R.Biswas,U.S.Pandy, "Neutrosophic Relational Database Decomposition", International Journal of Advanced Computer Science and Applications, Vol. 2, No. 8, (2011), pp.121-125.
- [6] M. Arora and R. Biswas," Deployment of Neutrosophic technology to retrieve answers for queries posed in natural language", in 3rdInternational Conference on Computer Science and Information Technology ICCSIT, IEEE catalog Number CFP1057E-art,Vol.3, ISBN: 978-1-4244-5540-9,(2010), pp. 435-439.
- [7] Ansari, Biswas, Aggarwal,"Proposal for Applicability of Neutrosophic Set Theory in Medical AI", International Journal of Computer Applications (0975 – 8887),Vo 27– No.5, (2011), pp:5-11
- [8] A. Kharal, "A Neutrosophic Multicriteria Decision Making Method",New Mathematics & Natural Computation, to appear in Nov 2013.
- [9] F.G Lupiáñez, "On neutrosophic topology", Kybernetes, Vol. 37 Iss: 6,(2008), pp.797 - 800 ,Doi:10.1108/03684920810876990.
- [10] S. Aggarwal, R. Biswas,A.Q.Ansari,"Neutrosophic Modeling and Control",978-1-4244-9034-/10/\$26.00©2010 IEEE, pp.718-723.
- [11] M. Bhowmik and M. Pal ," Intuitionistic Neutrosophic Set", ISSN 1746-7659, England, UK, Journal of Information and Computing Science,Vol. 4, No. 2, (2009), pp. 142-152.
- [12] M. Bhowmik and M. Pal ," Intuitionistic Neutrosophic Set Relations and Some of Its Properties ,ISSN 1746-7659, England, UK, Journal of Information and Computing Science, Vol. 5, No. 3, (2010), pp. 183-192.
- [13] A. A. Salama, S.A.Alblowi, "Generalized Neutrosophic Set and Generalized Neutrosophic Topological Spaces" ,Computer Science and Engineering, p-ISSN: 2163-1484 e-ISSN: 2163-1492 DOI: 10.5923/j.computer.20120207.01,(2012), 2(7), pp. 129-132
- [14] Wang, H., Smarandache, F., Zhang, Y. Q., Sunderraman,R,"Singlevalued neutrosophic",sets.Multispace and Multistructure, 4,(2010) , pp. 410-413.
- [15] D. A. Molodtsov, "Soft Set Theory - First Result", Computers and Mathematics with Applications, Vol. 37, (1999), pp. 19-31.
- [16] P. K. Maji, R. Biswas and A.R. Roy, "Fuzzy Soft Sets", Journal of Fuzzy Mathematics, Vol 9 , no.3, (2001), pp. 589-602.
- [17] B. Ahmad, and A. Kharal, On Fuzzy Soft Sets, Hindawi Publishing Corporation, Advances in Fuzzy Systems, volume Article ID 586507, (2009), 6pages doi: 10.1155/2009/586507.

- [18] P. K. Maji, A. R. Roy and R. Biswas, "Fuzzy soft sets" ,Journal of Fuzzy Mathematics. 9 (3),(2001), pp.589-602.
- [19] T. J. Neog and D. K. Sut, "On Fuzzy Soft Complement and Related Properties", Accepted for publication in International Journal of Energy, Information and communications (IJEIC).
- [20] M. Borah, T. J. Neog and D. K. Sut," A study on some operations of fuzzy soft sets", International Journal of Modern Engineering Research (IJMER), Vol.2, Issue. 2,(2012), pp. 157-168..
- [21] H. L. Yang, "Notes On Generalized Fuzzy Soft Sets", Journal of Mathematical Research and Exposition, Vol 31, No. 3, (2011), pp.567-570
- [22] P. Majumdar, S. K. Samanta, "Generalized Fuzzy Soft Sets", Computers and Mathematics with Applications,59,(2010), pp.1425-1432.
- [23] S. Alkhazaleh, A. R. Salleh, and N. Hassan,"Possibility Fuzzy Soft Set",Advances in Decision Sciences,Vol2011, Article ID 479756,18 pages,doi:10.1155/2011/479756.
- [24] P. K. Maji, R. Biswas, A. R. Roy, "Intuitionistic fuzzy soft sets", The journal of fuzzy mathematics 9(3),(2001), pp.677-692.
- [25] K.V .Babitha.and J. J. Sunil,"Generalized Intuitionistic Fuzzy Soft Sets and Its Applications ",Gen. Math. Notes, ISSN 2219-7184; Copyright © ICSRS Publication, (2011), Vol. 7, No. 2, (2011), pp.1-14.
- [26] M.Bashir, A.R. Salleh, and S. Alkhazaleh," Possibility Intuitionistic Fuzzy Soft Set", Advances in Decision Sciences Volume 2012 (2012), Article ID 404325, 24 pages, doi:10.1155/2012/404325.
- [27] P. K. Maji," Neutrosophic Soft Set", Annals of Fuzzy Mathematics and Informatics,Vol 5, No. 1,ISSN: 2093-9310(online) ,ISSN: 2287-623(print).
- [28] S.Broumi and F. Smarandache, "Intuitionistic Neutrosophic Soft Set", Journal of Information and Computing Science, England, UK ,ISSN 1746-7659,Vol. 8, No. 2, (2013), pp.130-140.
- [29] S.Broumi, "Generalized Neutrosophic Soft Set", International Journal of Computer Science, Engineering and Information Technology (IJCSEIT), ISSN: 2231-3605, E-ISSN : 2231-3117, Vol.3, No.2, (2013), pp.17-30.
- [30] P. K. Maji," More on Intuitionistic Fuzzy Soft Set",Springer –Verlag Berlin Heidelberg, H.Sakai et al.(Eds):RSFDGrC 2009.LNAI 5908, pp231-240.

Single Valued Neutrosophic Trapezoid Linguistic Aggregation Operators Based Multi-Attribute Decision Making

Said Broumi, Florentin Smarandache

Said Broumi, Florentin Smarandache (2014). Single Valued Neutrosophic Trapezoid Linguistic Aggregation Operators Based Multi-Attribute Decision Making. *Bulletin of Pure and Applied Sciences* 33 E (Math & Stat.) (2): 135-155; DOI 10.5958/2320-3226.2014.00006.X

ABSTRACT

Multi-attribute decision making (MADM). Play an important role in many applications, due to the efficiency to handle indeterminate and inconsistent information, single valued neutrosophic sets is widely used to model indeterminate information. In this paper, a new MADM method based on neutrosophic trapezoid linguistic weighted arithmetic averaging aggregation SVNTrLWAA operator and neutrosophic trapezoid linguistic weighted geometric aggregation SVNTrLWGA operator is presented. A numerical example is presented to demonstrate the application and efficiency of the proposed method.

Keywords: Single valued neutrosophic trapezoid linguistic weighted arithmetic averaging aggregation (SVNTrLWAA) operator, neutrosophic trapezoid linguistic weighted weighted geometric aggregation (SVNTrLWGA) operator, single valued neutrosophic sets.

1.INTRODUCTION

F. Smarandache [6] proposed the neutrosophic set (NS) by adding an independent indeterminacy-membership function. The concept of neutrosophic set is generalization of classic set, fuzzy set [26], intuitionistic fuzzy set [22], interval intuitionistic fuzzy set [24,25] and so on. In NS, the indeterminacy is quantified explicitly and truth-membership, indeterminacy membership, and false-membership are completely independent. From scientific or engineering point of view, the neutrosophic set and set-theoretic view, operators need to be specified. Otherwise, it will be difficult to apply in

the real applications. Therefore, H. Wang et al [7] defined a single valued neutrosophic set (SVNS) and then provided the set theoretic operations and various properties of single valued neutrosophic sets. Furthermore, H. Wang et al.[8] proposed the set theoretic operations on an instance of neutrosophic set called interval valued neutrosophic set (IVNS) which is more flexible and practical than NS. The works on neutrosophic set (NS) and interval valued neutrosophic set (IVNS), in theories and application have been progressing rapidly (e.g, [1,2,3,4,5,7,9,10,11,12,13,14,15,16,17, 21,28,29,30,31,32,33,34,35,36,37,38,39,40,41,42,43,44,45,46,47,48,49]).

Multiple attribute decision making (MADM) problem are of importance in most kinds of fields such as engineering, economics, and management. In many situations decision makers have incomplete, indeterminate and inconsistent information about alternatives with respect to attributes. It is well known that the conventional and fuzzy or intuitionistic fuzzy decision making analysis [27, 50, 51, 52] using different techniques tools have been found to be inadequate to handle indeterminate and inconsistent data. So, Recently, neutrosophic multicriteria decision making problems have been proposed to deal with such situation.

In addition, because the aggregation operators are the important tools to process the neutrosophic decision making problems. Lately, research on aggregation methods and multiple attribute decision making theories under neutrosophic environment is very active and lot of results have been obtained from neutrosophic information. Based on the aggregation operators, J. Ye [20] developed some new weighted arithmetic averaging and weighted geometric averaging operators for simplified neutrosophic sets. P. Liu [28] present the generalized neutrosophic Hamacher aggregation operators such as Generalized neutrosophic number Hamacher weighted averaging (GNNHWA) operator, Generalized neutrosophic number Hamacher ordered weighted averaging (GNNHOWA) operator, and Generalized neutrosophic number Hamacher hybrid averaging (GNNHA) operator and studied some properties of these operators and analyzed some special cases and gave a decision-making method based on these operators for multiple attribute group decision making with neutrosophic numbers. Based on the idea of Bonferroni mean, P. Liu [32] proposed some Bonferroni mean operators such as the single-valued neutrosophic normalized weighted Bonferroni mean. J. J. Peng et al [22] defined the novel operations and aggregation operators, which were based on the operations in J. Ye [20].

Based on the linguistic variable and the concept of interval neutrosophic sets, J. Ye [18] defined interval neutrosophic linguistic variable, as well as its operation principles, and developed some new aggregation operators for the interval neutrosophic linguistic information, including interval neutrosophic linguistic arithmetic weighted average (INLAWA) operator, linguistic geometric weighted average (INLGWA) operator

and discuss some properties. Furthermore, he proposed the decision making method for multiple attribute decision making (MAGDM) problems with an illustrated example to show the process of decision making and the effectiveness of the proposed method.

In order to deal with the more complex neutrosophic information. J. Ye [19] ,further proposed the interval neutrosophic uncertain linguistic variables by extending an uncertain linguistic variables with an interval neutrosophic set, and proposed the operational rules, score function, accuracy function and certainty function of interval neutrosophic uncertain linguistic variables. Then, the interval neutrosophic uncertain linguistic weighted arithmetic averaging operator and interval neutrosophic uncertain linguistic weighted geometric averaging operator are developed, and a multiple attribute decision making method with interval neutrosophic linguistic information is proposed.

To the our knowledge, The existing approaches under the neutrosophic linguistic environment are not suitable for dealing with MADM problems under single valued neutrosophic trapezoid linguistic environment. Indeed, human judgments including preference information may be stated by possible trapezoid linguistic variable which has a membership ,indeterminacy and non-membership degree. Therefore, it is necessary to pay enough attention on this issue and propose more appropriate methods for dealing with MADM, which is also our motivation. Based on Trapezoid linguistic terms and the single valued neutrosophic sets, in this paper, we define a new concept called single valued neutrosophic trapezoid linguistic variable, then propose score function and and some new aggregation operators, and an approach for dealing with single valued neutrosophic trapezoid linguistic environment in the MADM process. The main advantage of the SVNTrLS is that is composed of trapezoid linguistic term, which is generalization case of SVINLS, a special case of INLS, proposed by J. Ye [18].

In order to process incomplete, indeterminate and inconsistent information more efficiency and precisely, it is necessary to make a further study on the extended form of the single valued neutrosophic uncertain linguistic variables by combining trapezoid fuzzy linguistic variables and single valued neutrosophic set. For example, we can evaluate the investment alternatives problem by the linguistic set: $S = \{s_0(\text{extremely low}); s_1(\text{very low}); s_2(\text{low}); s_3(\text{medium}); s_4(\text{high}); s_5(\text{very high}); s_6(\text{extermley high})\}$. Perhaps, we can use the trapezoid fuzzy linguistic $[s_\theta, s_p, s_\mu, s_v]$, $(0 \leq \theta \leq p \leq \mu \leq v \leq 1 - 1)$ to describe the evaluation result, but this is not accurate, because it merely provides a linguistic range. In this paper , we can use single valued neutrosophic trapezoid linguistic (SVNNTrL), $[s_{(x)}, s_{(x)}, s_{\mu(x)}, s_{(x)}], (T_A(x), I_A(x), F_A(x))$ to describe the investment problem giving the membership degree, indeterminacy degree, and non-membership degree to $[s, s, s_\mu, s]$. This is the motivation of our study .As a

fact, SVNTrL avoids the information distortions and losing in decision making process, and overcomes the shortcomings of the single valued neutrosophic linguistic variables [18] and single valued neutrosophic uncertain linguistic variables [19].

To achieve the above purposes, The remainder of this paper is organized as follows: some basic definitions of trapezoid linguistic term set, neutrosophic set, single valued neutrosophic set and single valued neutrosophic uncertain linguistic set are briefly reviewed in section 2. In section3, the concept, operational laws, score function, accuracy function and certainty function of including single valued neutrosophic trapezoid linguistic elements are defined. In Section 4, some single valued neutrosophic trapezoid linguistic aggregation operators are proposed, such single valued neutrosophic trapezoid linguistic weighted average (SVNTrLWAA) operator, single valued neutrosophic trapezoid linguistic weighted average (SVNTrLWGA) operators , then some desirable properties of the proposed operators are investigated. In section 5, we develop an approach for multiple attribute decision making problems with single valued neutrosophic trapezoid linguistic information based on the proposed operators. In section 6, a numerical example is given to illustrate the application of the proposed method. The paper is concluded in section 7.

2-PRELIMINARIES

In the following, we shall introduce some basic concepts related to trapezoidal fuzzy linguistic variables, single valued neutrosophic set , single valued neutrosophic linguistic sets and single valued neutrosophic uncertain linguistic sets.

2.1 Trapezoid fuzzy linguistic variables

A linguistic set is defined as a finite and completely ordered discreet term set,

$S=(s_0, s_1, \dots, s_{l-1})$, where l is the odd value. For example, when $l=7$, the linguistic term set S can be defined as follows: $S=\{s_0(\text{extremely low}); s_1(\text{very low}); s_2(\text{low}); s_3(\text{medium}); s_4(\text{high}); s_5(\text{very high}); s_6(\text{extermley high})\}$

Definition 2.1 :[49]

Let $\bar{S} = \{s_\theta | s_0 \leq s_\theta \leq s_{l-1} \theta \in [0, l-1]\}$, which is the continuous form of linguistic set S . $s_\theta, s_\rho, s_\mu, s_\nu$ are four linguistic terms in S , and $s_0 \leq s_\theta \leq s_\rho \leq s_\mu \leq s_\nu \leq s_{l-1}$ if $0 \leq \theta \leq \rho \leq \mu \leq \nu \leq l-1$, then the trapezoid linguistic variable is defined as $\hat{s}=[s_\theta, s_\rho, s_\mu, s_\nu]$, and \hat{S} denotes a set of the trapezoid linguistic variables.

In particular , if any two of $s_\theta, s_\rho, s_\mu, s_\nu$ are equal, then \mathfrak{S} is reduced to triangular fuzzy linguistic variable; if any three of $s_\theta, s_\rho, s_\mu, s_\nu$ are equal, then \mathfrak{S} is reduced to uncertain linguistic variable

2.2 The expected value of trapezoid fuzzy linguistic variable

Let $\mathfrak{S} = ([s_\theta, s_\rho, s_\mu, s_\nu])$ be a trapezoid fuzzy linguistic variable, then the expected value $E(\mathfrak{S})$ of \mathfrak{S} is defined as:

$$E(\mathfrak{S}) = \frac{\theta + \rho + \mu + \nu}{4}$$

2.3 Neutrosophic sets

Definition 2.2 [7]

Let U be a universe of discourse then the neutrosophic set A is an object having the form $A = \{ \langle x: T_A(x), I_A(x), F_A(x) \rangle, x \in X \}$,

Where the functions $T_A(x), I_A(x), F_A(x) : U \rightarrow]^-0, 1^+[$ define respectively the degree of membership, the degree of indeterminacy, and the degree of non-membership of the element $x \in X$ to the set A with the condition.

$$^-0 \leq \sup T_A(x) + \sup I_A(x) + \sup F_A(x) \leq 3^+.$$

From philosophical point of view, the neutrosophic set takes the value from real standard or non-standard subsets of $]^-0, 1^+[$. So instead of $]^-0, 1^+[$ we need to take the interval $[0, 1]$ for technical applications, because $]^-0, 1^+[$ will be difficult to apply in the real applications such as in scientific and engineering problems.

2.4 Single valued Neutrosophic Sets

Definition 2.3 [7]

Let X be an universe of discourse then the neutrosophic set A is an object having the form

$$A = \{ \langle x: T_A(x), I_A(x), F_A(x) \rangle, x \in X \},$$

where the functions $T_A(x), I_A(x), F_A(x) : U \rightarrow [0, 1]$ define respectively the degree of membership , the degree of indeterminacy, and the degree of non-membership of the element $x \in X$ to the set A with the condition.

$$0 \leq T_A(x) + I_A(x) + F_A(x) \leq 3$$

Definition 2.4 [7]

A single valued neutrosophic set A is contained in another single valued neutrosophic set B i.e. $A \subseteq B$ if $\forall x \in U, T_A(x) \leq T_B(x), I_A(x) \geq I_B(x), F_A(x) \geq F_B(x)$

Based on interval neutrosophic set and linguistic variables, J. Ye [18] presented the extension form of the linguistic set, i.e, interval neutrosophic linguistic set. The interval neutrosophic linguistic set is reduced to single valued neutrosophic linguistic sets if the components $T_A^L(x) = T_A^U(x) = T_A(x)$, $I_A^L(x) = I_A^U(x) = I_A(x)$ and $F_A^L(x) = F_A^U(x) = F_A(x)$ and is defined as follows as follows:

2.5 Single valued neutrosophic linguistic set

Based on single valued neutrosophic set and linguistic variables, Ye [18] presented the extension form of the linguistic set, i.e., single valued neutrosophic linguistic set, which is shown as follows:

Definition 2.5: [18] A single valued neutrosophic linguistic set A in X can be defined as

$$A = \{ \langle x, s_{(x)}, (T_A(x), I_A(x), F_A(x)) \rangle \mid x \in X \}$$

Where $s_{(x)} \in \mathfrak{S}$, $T_A(x) \subseteq [0,1]$, $I_A(x) \subseteq [0,1]$, and $F_A(x) \subseteq [0,1]$ with the condition $0 \leq T_A(x) + I_A(x) + F_A(x) \leq 3$ for any $x \in X$. The function $T_A(x), I_A(x)$ and $F_A(x)$ express, respectively, the truth-membership degree, the indeterminacy –membership degree, and the falsity-membership degree with values of the element x in X to the linguistic variable $s_{(x)}$.

Also. Based on interval neutrosophic set and linguistic variables, J. Ye [19] presented the extension form of the uncertain linguistic set, i.e., interval neutrosophic uncertain linguistic set. The interval neutrosophic uncertain linguistic set is reduced to single valued neutrosophic uncertain linguistic sets if the components $T_A^L(x) = T_A^U(x) = T_A(x)$, $I_A^L(x) = I_A^U(x) = I_A(x)$ and $F_A^L(x) = F_A^U(x) = F_A(x)$ and is defined as follows:

2.6 Single valued neutrosophic uncertain linguistic set.

Definition2.6:[19] A single valued neutrosophic uncertain linguistic set A in X can be defined as

$$A = \{ \langle x, [s_{(x)}, s_{(x)}], (T_A(x), I_A(x), F_A(x)) \rangle : x \in X \}$$

Where $s_{(x)}, s_{(x)} \in \mathfrak{S}$, $T_A(x) \in [0,1]$, $I_A(x) \in [0,1]$, and $F_A(x) \in [0,1]$ with the condition $0 \leq T_A(x) + I_A(x) + F_A(x) \leq 3$ for any $x \in X$. $[s_{(x)}, s_{(x)}]$ is an uncertain linguistic term, The function $T_A(x), I_A(x)$ and $F_A(x)$ express, respectively, the truth-membership degree , the indeterminacy –membership degree, and the falsity-membership degree of the element x in X belonging to the linguistic term $[s_{(x)}, s_{(x)}]$.

Definition 2.7 Let $A = \{ \langle x, [s_{(x)}, s_{(x)}], (T_A(x), I_A(x), F_A(x)) \rangle : x \in X \}$ be a SVNULN. Then the eight tuple $\langle [s_{(x)}, s_{(x)}], (T_A(x), I_A(x), F_A(x)) \rangle$ is called an NULV and A can be viewed as a collection of NULVs. Thus, the SVNULNs can also be expressed as

$$A = \{ \langle x, [s_{(x)}, s_{(x)}], (T_A(x), I_A(x), F_A(x)) \rangle : x \in X \}$$

For any two SVNULVNs $\tilde{a}_1 = \langle [s_{(\tilde{a}_1)}, s_{(\tilde{a}_1)}], (T(\tilde{a}_1), I(\tilde{a}_1), F(\tilde{a}_1)) \rangle$ and $\tilde{a}_2 = \langle [s_{(\tilde{a}_2)}, s_{(\tilde{a}_2)}], (T(\tilde{a}_2), I(\tilde{a}_2), F(\tilde{a}_2)) \rangle$ and $\tilde{a}_i \geq 0$, defined the following operational rules:

$$\tilde{a}_1 \oplus \tilde{a}_2 = \langle [s_{(\tilde{a}_1) + (\tilde{a}_2)}, s_{(\tilde{a}_1) + (\tilde{a}_2)}], ((T(\tilde{a}_1) + T(\tilde{a}_2) - T(\tilde{a}_1) T(\tilde{a}_2)), I(\tilde{a}_1) I(\tilde{a}_2), F(\tilde{a}_1) F(\tilde{a}_2)) \rangle$$

$$\tilde{a}_1 \otimes \tilde{a}_2 = \langle [s_{(\tilde{a}_1) \times (\tilde{a}_2)}, s_{(\tilde{a}_1) \times (\tilde{a}_2)}], (T(\tilde{a}_1) T(\tilde{a}_2), (I(\tilde{a}_1) + I(\tilde{a}_2) - I(\tilde{a}_1) I(\tilde{a}_2)), (F(\tilde{a}_1) + F(\tilde{a}_2) - F(\tilde{a}_1) F(\tilde{a}_2)) \rangle$$

$$\tilde{a}_1 = \langle [s_{(\tilde{a}_1)}, s_{(\tilde{a}_1)}], (1 - (1 - T(\tilde{a}_1))^{\tilde{a}_1}, (I(\tilde{a}_1))^{\tilde{a}_1}, (F(\tilde{a}_1))^{\tilde{a}_1}) \rangle$$

$$\tilde{a}_1 = \langle [s_{(\tilde{a}_1)}, s_{(\tilde{a}_1)}], ((T(\tilde{a}_1))^{\tilde{a}_1}, (1 - (1 - I(\tilde{a}_1))^{\tilde{a}_1}), (1 - (1 - F(\tilde{a}_1))^{\tilde{a}_1})) \rangle$$

Definition 2.8 Let $\tilde{a}_i = \langle [S_{\tilde{a}_i}, S_{\tilde{a}_i}], (T(\tilde{a}_i), I(\tilde{a}_i), F(\tilde{a}_i)) \rangle$ be a SVNULN, the expected function $E(\tilde{a}_i)$, the accuracy $H(\tilde{a}_i)$ and the certainty $C(\tilde{a}_i)$ are define as follows:

$$E(\tilde{a}_i) = \frac{1}{3}(2 + T(\tilde{a}_i) - I(\tilde{a}_i) - F(\tilde{a}_i)) \times \frac{S_{(\tilde{a}_i) + (\tilde{a}_i)}}{2}$$

$$= \frac{S_1}{6}(2 + T(\tilde{a}_i) - I(\tilde{a}_i) - F(\tilde{a}_i)) \times ((\tilde{a}_i) + (\tilde{a}_i))$$

$$H(\tilde{a}_i) = (T(\tilde{a}_i) - F(\tilde{a}_i)) \times \frac{S_{(\tilde{a}_i) + (\tilde{a}_i)}}{2}$$

$$= \frac{S_1}{2}(T(\tilde{a}_i) - F(\tilde{a}_i)) \times ((\tilde{a}_i) + (\tilde{a}_i))$$

$$C(\tilde{a}_i) = (T(\tilde{a}_i)) \times \frac{S_{(\tilde{a}_i) + (\tilde{a}_i)}}{2}$$

$$= \frac{S_1}{2}(T(\tilde{a}_i)) \times ((\tilde{a}_i) + (\tilde{a}_i))$$

Assume that \tilde{a}_i and \tilde{a}_j are two SVNULNs, they can be compared by the following rules:

1.If $E(\tilde{a}_i) > E(\tilde{a}_j)$, then $\tilde{a}_i > \tilde{a}_j$;

2.If $E(\tilde{a}_i) = E(\tilde{a}_j)$, then

If $H(\tilde{a}_i) > H(\tilde{a}_j)$, then $\tilde{a}_i > \tilde{a}_j$,

If $H(\tilde{a}_i) = H(\tilde{a}_j)$, then $\tilde{a}_i = \tilde{a}_j$,

$H(\tilde{a}_i) < H(\tilde{a}_j)$, then $\tilde{a}_i < \tilde{a}_j$,

3- SINGLE VALUED NEUTROSOPHIC TRAPEZOID LINGUISTIC SETS.

Based on the concept of SVNLS and trapezoid linguistic variable, we extend the SVNLS to define the SVNTrLS and SVNTrLNs. The operations and ranking method of SVNTrLNs are also given in this section

Definition 3.1 Let X be a finite universal set and $[s_{(x)}, s_{(x)}, s_{\mu(x)}, s_{(x)}] \in \mathfrak{S}$ be trapezoid linguistic variable. A SVNTrLs in X is defined as

$$A = \{ \langle x, [s_{(x)}, s_{(x)}, s_{\mu(x)}, s_{(x)}], (T_A(x), I_A(x), F_A(x)) \rangle \mid x \in X \}$$

Where $s_{(x)}, s_{(x)}, s_{\mu(x)}, s_{(x)} \in \mathfrak{S}$, $T_A(x) \in [0,1]$, $I_A(x) \in [0,1]$, and $F_A(x) \in [0,1]$ with the condition $0 \leq T_A(x) + I_A(x) + F_A(x) \leq 3$ for any $x \in X$. $[s_{(x)}, s_{(x)}, s_{\mu(x)}, s_{(x)}]$ is a trapezoid linguistic term, The function $T_A(x)$, $I_A(x)$ and $F_A(x)$ express, respectively, the truth-membership degree, the indeterminacy –membership degree, and the falsity-membership degree of the element x in X belonging to the linguistic term $[s_{(x)}, s_{(x)}, s_{\mu(x)}, s_{(x)}]$.

Definition 3.2 Let $A = \{ \langle x, [s_{(x)}, s_{(x)}, s_{\mu(x)}, s_{(x)}], (T_A(x), I_A(x), F_A(x)) \rangle : x \in X \}$ be an SVNTrLN. Then the eight tuple $\langle [s_{(x)}, s_{(x)}, s_{\mu(x)}, s_{(x)}], (T_A(x), I_A(x), F_A(x)) \rangle$ is called an SVNTrLV and A can be viewed as a collection of SVNTrLV s. Thus, the SVNTrLVs can also be expressed as

$$A = \{ \langle x, [s_{(x)}, s_{(x)}, s_{\mu(x)}, s_{(x)}], (T_A(x), I_A(x), F_A(x)) \rangle : x \in X \} [s_{(\tilde{a}_1)}, s_{(\tilde{a}_1)}, s_{\mu(\tilde{a}_1)}, s_{(\tilde{a}_1)}]$$

Definition 3.3 Let $\tilde{a}_1 = \langle [s_{(\tilde{a}_1)}, s_{(\tilde{a}_1)}, s_{\mu(\tilde{a}_1)}, s_{(\tilde{a}_1)}], (T(\tilde{a}_1), I(\tilde{a}_1), F(\tilde{a}_2)) \rangle$ and $\tilde{a}_2 = \langle x, [s_{(\tilde{a}_2)}, s_{(\tilde{a}_2)}, s_{\mu(\tilde{a}_2)}, s_{(\tilde{a}_2)}], (T(\tilde{a}_2), I(\tilde{a}_2), F(\tilde{a}_2)) \rangle$ be two SVNTrLVs and ≥ 0 , then the operational laws of SVNTrLVs are defined as follows:

1. $\tilde{a}_1 \oplus \tilde{a}_2 = \langle [s_{(\tilde{a}_1) + (\tilde{a}_2)}, s_{(\tilde{a}_1) + (\tilde{a}_2)}, s_{\mu(\tilde{a}_1) + \mu(\tilde{a}_2)}, s_{(\tilde{a}_1) + (\tilde{a}_2)}], ((T(\tilde{a}_1) + T(\tilde{a}_2) - T(\tilde{a}_1) T(\tilde{a}_2)), I(\tilde{a}_1) I(\tilde{a}_2), F(\tilde{a}_1) F(\tilde{a}_2)) \rangle$

2. $\tilde{a}_1 \otimes \tilde{a}_2 = \langle [s_{(\tilde{a}_1)} \times s_{(\tilde{a}_2)}, s_{(\tilde{a}_1)} \times s_{(\tilde{a}_2)}, s_{\mu(\tilde{a}_1)} \times \mu(\tilde{a}_2)}, s_{(\tilde{a}_1)} \times s_{(\tilde{a}_2)}], (T(\tilde{a}_1) T(\tilde{a}_2), (I(\tilde{a}_1) + I(\tilde{a}_2) - I(\tilde{a}_1) I(\tilde{a}_2)), (F(\tilde{a}_1) + F(\tilde{a}_2) - F(\tilde{a}_1) F(\tilde{a}_2))) \rangle$
3. $\tilde{a}_1 = \langle [s_{(\tilde{a}_1)}, s_{(\tilde{a}_1)}, s_{(\tilde{a}_1)}, s_{(\tilde{a}_1)}], ((1 - (1 - T(\tilde{a}_1))), (I(\tilde{a}_1)), (F(\tilde{a}_1))) \rangle$
4. $\tilde{a}_1 = \langle [s_{(\tilde{a}_1)}, s_{(\tilde{a}_1)}, s_{\mu(\tilde{a}_1)}, s_{(\tilde{a}_1)}], ((T(\tilde{a}_1)), (1 - (1 - I(\tilde{a}_1))), (1 - (1 - F(\tilde{a}_1)))) \rangle$

Obviously, the above operational results are still SVNTrLVs.

Theorem 3.4: Let $\tilde{a}_1 = \langle [s_{(\tilde{a}_1)}, s_{(\tilde{a}_1)}, s_{\mu(\tilde{a}_1)}, s_{(\tilde{a}_1)}], (T(\tilde{a}_1), I(\tilde{a}_1), F(\tilde{a}_1)) \rangle$ and $\tilde{a}_2 = \langle [s_{(\tilde{a}_2)}, s_{(\tilde{a}_2)}, s_{\mu(\tilde{a}_2)}, s_{(\tilde{a}_2)}], (T(\tilde{a}_2), I(\tilde{a}_2), F(\tilde{a}_2)) \rangle$ be any two single valued neutrosophic trapezoid linguistic variables, and $\lambda, \lambda_1, \lambda_2 \geq 0$, then the characteristics of single valued neutrosophic trapezoid linguistic variables are shown as follows:

1. $\tilde{a}_1 \oplus \tilde{a}_2 = \tilde{a}_2 \oplus \tilde{a}_1$
2. $\tilde{a}_1 \otimes \tilde{a}_2 = \tilde{a}_2 \otimes \tilde{a}_1$
3. $\lambda (\tilde{a}_1 \oplus \tilde{a}_2) = \lambda \tilde{a}_1 \oplus \lambda \tilde{a}_2$
4. $\lambda \tilde{a}_1 \oplus \lambda \tilde{a}_2 = (\lambda_1 + \lambda_2) \tilde{a}_1$;
5. $\tilde{a}_1^{\lambda_1} \otimes \tilde{a}_1^{\lambda_2} = \tilde{a}_1^{\lambda_1 + \lambda_2}$;
6. $\tilde{a}_1^{\lambda_1} \otimes \tilde{a}_2^{\lambda_2} = (\tilde{a}_1 \otimes \tilde{a}_2)^{\lambda_1}$

Theorem 3.4 can be easily proven according to **definition 3.3** (omitted).

To rank SVNTrLNs, we define the score function, accuracy function and certainty function of an SVNTrLN based on [7, 49], which are important indexes for ranking alternatives in decision-making problems.

Definition 3.5. $\tilde{a} = \langle [s_{(\tilde{a})}, s_{(\tilde{a})}, s_{\mu(\tilde{a})}, s_{(\tilde{a})}], (T(\tilde{a}), I(\tilde{a}), F(\tilde{a})) \rangle$ be a SVNTrLV. Then, the score function, accuracy function and certainty function of a SVNTrLN \tilde{a} are defined, respectively, as follows:

$$\begin{aligned}
 E(\tilde{a}) &= \frac{1}{3} (2+T(\tilde{a}) - I(\tilde{a}) - F(\tilde{a})) \times S_{\frac{(T(\tilde{a}) + (I(\tilde{a}) + \mu(\tilde{a}) + F(\tilde{a})))}{4}} \\
 &= S_{\frac{1}{12} (2+T(\tilde{a}) - I(\tilde{a}) - F(\tilde{a})) \times (T(\tilde{a}) + (I(\tilde{a}) + \mu(\tilde{a}) + F(\tilde{a})))} \tag{1}
 \end{aligned}$$

$$\begin{aligned}
 H(\tilde{a}) &= (T(\tilde{a}) - F(\tilde{a})) \times S_{\frac{(T(\tilde{a}) + (\tilde{a}) + \mu(\tilde{a}) + (\tilde{a}))}{4}} \\
 &= S_{\frac{1}{4}(T(\tilde{a}) - F(\tilde{a})) \times (T(\tilde{a}) + (\tilde{a}) + \mu(\tilde{a}) + (\tilde{a}))} \tag{2}
 \end{aligned}$$

$$\begin{aligned}
 C(\tilde{a}) &= (T(\tilde{a})) \times S_{\frac{(T(\tilde{a}) + (\tilde{a}) + \mu(\tilde{a}) + (\tilde{a}))}{4}} \\
 &= S_{\frac{1}{4}(T(\tilde{a})) \times (T(\tilde{a}) + (\tilde{a}) + \mu(\tilde{a}) + (\tilde{a}))} \tag{3}
 \end{aligned}$$

Based on definition 3.5, a ranking method between SVNTrLVs can be given as follows.

Definition 3.6 Let \tilde{a}_1 and \tilde{a}_2 be two SVNTrLVNs. Then, the ranking method can be defined as follows:

If $E(\tilde{a}_1) > E(\tilde{a}_2)$, then $\tilde{a}_1 > \tilde{a}_2$

If $E(\tilde{a}_1) = E(\tilde{a}_2)$ and $H(\tilde{a}_1) > H(\tilde{a}_2)$, then $\tilde{a}_1 > \tilde{a}_2$,

If $E(\tilde{a}_1) = E(\tilde{a}_2)$ and $H(\tilde{a}_1) = H(\tilde{a}_2)$ and $C(\tilde{a}_1) > C(\tilde{a}_2)$, then $\tilde{a}_1 > \tilde{a}_2$,

If $E(\tilde{a}_1) = E(\tilde{a}_2)$ and $H(\tilde{a}_1) = H(\tilde{a}_2)$ and $C(\tilde{a}_1) = C(\tilde{a}_2)$, then $\tilde{a}_1 = \tilde{a}_2$,

4. SINGLE VALUED NEUTROSOPHIC TRAPEZOID LINGUISTIC AGGREGATION OPERATORS

Based on the operational laws in definition 3.3, we can propose the following weighted arithmetic aggregation operator and weighted geometric aggregation operator for SVNTrLVNs, which are usually utilized in decision making.

4.1 Single valued neutrosophic trapezoid linguistic weighted arithmetic Averaging operator.

Definition 4.1. Let $\tilde{a}_j = \langle [s_{(a_j)}, s_{(a_j)}, s_{\mu(a_j)}, s_{(a_j)}], (T_{a_j}, I_{a_j}, F_{a_j}) \rangle$ ($j=1,2,\dots,n$) be a collection of SVNTrLVNs. The single valued neutrosophic trapezoid linguistic weighted arithmetic **averaging** average SVNTrLWAA operator can be defined as follows and

SVNTrLWAA: $\Omega^n \rightarrow \Omega$

$$\text{SVNTrLWAA}(\tilde{a}_1, \tilde{a}_2, \dots, \tilde{a}_n) = \sum_{j=1}^n j \tilde{a}_j \tag{4}$$

Where, $\omega_j = (\omega_1, \omega_2, \dots, \omega_n)^T$ is the weight vector of \tilde{a}_j ($j= 1,2,\dots,n$), $\omega_j \in [0,1]$ and $\sum_{j=1}^n \omega_j = 1$.

Theorem 4.2 : $\tilde{a}_j = \langle [s_{\tilde{a}_j}, s_{\tilde{a}_j}, s_{\mu(\tilde{a}_j)}, s_{\tilde{a}_j}], (T_{\tilde{a}_j}, I_{\tilde{a}_j}, F_{\tilde{a}_j}) \rangle$ ($j=1,2,\dots,n$) be a collection of SVNTrLNs, Then by Equation (4) and the operational laws in Definition 3.3 , we have the following result

$$\text{SVNTrLWAA} (\tilde{a}_1, \tilde{a}_2, \dots, \tilde{a}_n) = \langle [\sum_{j=1}^n \omega_j s_{\tilde{a}_j}, \sum_{j=1}^n \omega_j s_{\tilde{a}_j}, \sum_{j=1}^n \omega_j \mu(\tilde{a}_j), \sum_{j=1}^n \omega_j s_{\tilde{a}_j}], (1 - \prod_{j=1}^n (1 - T(\tilde{a}_j))^{\omega_j}, \prod_{j=1}^n (I(\tilde{a}_j))^{\omega_j}, \prod_{j=1}^n (F(\tilde{a}_j))^{\omega_j}) \rangle \tag{5}$$

Where, $\omega = (\omega_1, \omega_2, \dots, \omega_n)^T$ is the weight vector of \tilde{a}_j ($j= 1,2,\dots,n$), $\omega_j \in [0,1]$ and $\sum_{j=1}^n \omega_j = 1$.

Proof

The proof of Eq.(5) can be done by means of mathematical induction

(1) When $n=2$, then

$$\begin{aligned} \tilde{a}_1 &= \langle [s_{\tilde{a}_1}, s_{\tilde{a}_1}, s_{\mu(\tilde{a}_1)}, s_{\tilde{a}_1}], (1 - (1 - T(\tilde{a}_1))^{\omega_1}, (I(\tilde{a}_1))^{\omega_1}, (F(\tilde{a}_1))^{\omega_1}) \rangle \\ \tilde{a}_2 &= \langle [s_{\tilde{a}_2}, s_{\tilde{a}_2}, s_{\mu(\tilde{a}_2)}, s_{\tilde{a}_2}], (1 - (1 - T(\tilde{a}_2))^{\omega_2}, (I(\tilde{a}_2))^{\omega_2}, (F(\tilde{a}_2))^{\omega_2}) \rangle \end{aligned}$$

Thus,

$$\begin{aligned} \text{SVNTrLWAA} (\tilde{a}_1, \tilde{a}_2) &= \tilde{a}_1 \oplus \tilde{a}_2 \\ &= \langle [\sum_{j=1}^2 \omega_j s_{\tilde{a}_j}, \sum_{j=1}^2 \omega_j s_{\tilde{a}_j}, \sum_{j=1}^2 \omega_j \mu(\tilde{a}_j), \sum_{j=1}^2 \omega_j s_{\tilde{a}_j}], ((1 - (1 - T(\tilde{a}_1))^{\omega_1} + 1 - (1 - T(\tilde{a}_2))^{\omega_2}) - (1 - (1 - T(\tilde{a}_1))^{\omega_1}) (1 - (1 - T(\tilde{a}_2))^{\omega_2}), (I(\tilde{a}_1))^{\omega_1} (I(\tilde{a}_2))^{\omega_2}, (F(\tilde{a}_1))^{\omega_1} (F(\tilde{a}_2))^{\omega_2}) \rangle \\ &= \langle [\sum_{j=1}^2 \omega_j s_{\tilde{a}_j}, \sum_{j=1}^2 \omega_j s_{\tilde{a}_j}, \sum_{j=1}^2 \omega_j \mu(\tilde{a}_j), \sum_{j=1}^2 \omega_j s_{\tilde{a}_j}], ((1 - (1 - T(\tilde{a}_1))^{\omega_1}) (1 - (1 - T(\tilde{a}_2))^{\omega_2}), \prod_{j=1}^2 (F(\tilde{a}_j))^{\omega_j} \rangle \end{aligned} \tag{6}$$

(2) When $n=k$, by applying Eq.(5) , we get

$$SVNTrLWAA (\tilde{a}_1, \tilde{a}_2, \dots, \tilde{a}_k) = \left\langle \left[\sum_{j=1}^{s_k} (\tilde{a}_j), \sum_{j=1}^{s_k} (\tilde{a}_j), \sum_{j=1}^{s_k} \mu(\tilde{a}_j), \sum_{j=1}^{s_k} (\tilde{a}_j) \right], (1 - \prod_{j=1}^k (1 - T(\tilde{a}_j))^j), \prod_{j=1}^k (I(\tilde{a}_j))^j, \prod_{j=1}^k (F(\tilde{a}_j))^j \right\rangle \quad (7)$$

(3) When $n=k+1$, by applying Eq.(6) and Eq.(7), we can get

$$\begin{aligned} SVNTrLWAA (\tilde{a}_1, \tilde{a}_2, \dots, \tilde{a}_k, \tilde{a}_{k+1}) &= \\ &\left\langle \left[\sum_{j=1}^{s_{k+1}} (\tilde{a}_j)_{+k+1} (\tilde{a}_{k+1}), \sum_{j=1}^{s_{k+1}} (\tilde{a}_j)_{+k+1} (\tilde{a}_{k+1}), \sum_{j=1}^{s_{k+1}} \mu(\tilde{a}_j)_{+k+1} (\tilde{a}_{k+1}), \sum_{j=1}^{s_{k+1}} (\tilde{a}_j)_{+k+1} (\tilde{a}_{k+1}) \right], \left[(1 - \prod_{j=1}^k (1 - T(\tilde{a}_j))^j + 1 - (1 - T(\tilde{a}_{k+1}))^{k+1} - (1 - \prod_{j=1}^k (1 - T(\tilde{a}_j))^j) (1 - \prod_{j=1}^k (1 - T(\tilde{a}_{k+1}))^{k+1}), \right. \right. \\ &\prod_{j=1}^{k+1} (I(\tilde{a}_j))^j, \prod_{j=1}^{k+1} (F(\tilde{a}_j))^j \left. \right\rangle \\ &= \left\langle \left[\sum_{j=1}^{s_{k+1}} (\tilde{a}_j), \sum_{j=1}^{s_{k+1}} (\tilde{a}_j), \sum_{j=1}^{s_{k+1}} \mu(\tilde{a}_j), \sum_{j=1}^{s_{k+1}} (\tilde{a}_j) \right], (1 - \prod_{j=1}^{k+1} (1 - T(\tilde{a}_j))^j), \prod_{j=1}^{k+1} (I(\tilde{a}_j))^j, \right. \\ &\left. \prod_{j=1}^{k+1} (F(\tilde{a}_j))^j \right\rangle \end{aligned}$$

Therefore, considering the above results, we have Eq.(5) for any. This completes the proof.

Especially when $\omega = (\frac{1}{n}, \frac{1}{n}, \dots, \frac{1}{n})^T$, then SVNTrLWAA operator reduces to a neutrosophic trapezoid linguistic arithmetic averaging operator for SVNTrLVs.

It is obvious that the SVNTrLWAA operator satisfies the following properties:

- (1) **Idempotency** : Let \tilde{a}_j ($j=1,2,\dots,n$) be a collection of SVNTrLVs. If \tilde{a}_j ($j=1,2,\dots,n$) is equal, i.e $\tilde{a}_j = \tilde{a}$ for $j=1,2,\dots,n$, then

$$NTrFLWAA (\tilde{a}_1, \tilde{a}_2, \dots, \tilde{a}_n) = \tilde{a} .$$

- (2) **Boundedness**: Let \tilde{a}_j ($j=1,2,\dots,n$) be a collection of SVNTrLVs and

$$\tilde{a}_{\min} = \min(\tilde{a}_1, \tilde{a}_2, \dots, \tilde{a}_n) \text{ and } \tilde{a}_{\max} = \max(\tilde{a}_1, \tilde{a}_2, \dots, \tilde{a}_n) \text{ for } j=1,2,\dots,n, \tilde{a}_{\min} \leq SVNTrLWAA(\tilde{a}_1, \tilde{a}_2, \dots, \tilde{a}_n) \leq \tilde{a}_{\max} \text{ then be a collection of SVNTrLVs.}$$

- (3) **Monotonicity** : Let \tilde{a}_j ($j=1,2,\dots,n$) be a collection of SVNTrLVs. If $\tilde{a}_j \leq \tilde{a}_j^*$ for $j= 1,2,\dots,n$. Then $SVNTrLWAA(\tilde{a}_1, \tilde{a}_2, \dots, \tilde{a}_n) \leq SVNTrLWAA(\tilde{a}_1^*, \tilde{a}_2^*, \dots, \tilde{a}_n^*)$.

Proof.

(1) Since $\tilde{a}_j = \tilde{a}$ for $j=1,2,\dots,n$, we have

$$\begin{aligned} \text{SVNTrLWAA}(\tilde{a}_1, \tilde{a}_2, \dots, \tilde{a}_n) &= \langle [s_{\sum_{j=1}^n}(\tilde{a}_j), s_{\sum_{j=1}^n}(\tilde{a}_j), s_{\sum_{j=1}^n}(\mu(\tilde{a}_j)), s_{\sum_{j=1}^n}(\tilde{a}_j)], (1- \\ &\Pi_{j=1}^n(1-T(\tilde{a}_j))^j, \Pi_{j=1}^n(I(\tilde{a}_j))^j, \Pi_{j=1}^n(F(\tilde{a}_j))^j) \rangle \\ &= \langle [s_{(\tilde{a})\sum_{j=1}^n}, s_{(\tilde{a})\sum_{j=1}^n}, s_{\mu(\tilde{a})\sum_{j=1}^n}, s_{(\tilde{a})\sum_{j=1}^n}], (1-(1-T(\tilde{a})^{\sum_{j=1}^n}), (I(\tilde{a}))^{\sum_{j=1}^n}, (F(\tilde{a}))^{\sum_{j=1}^n}) \rangle \\ &= \langle [s_{(\tilde{a})}, s_{(\tilde{a})}, s_{\mu(\tilde{a})}, s_{(\tilde{a})}], (T_{\tilde{a}}, I_{\tilde{a}}, F_{\tilde{a}}) \rangle \\ &= \tilde{a} \end{aligned}$$

(2) Since $\tilde{a}_{\min} = \min(\tilde{a}_1, \tilde{a}_2, \dots, \tilde{a}_n)$ and $\tilde{a}_{\max} = \max(\tilde{a}_1, \tilde{a}_2, \dots, \tilde{a}_n)$ for $j=1,2,\dots,n$, there is $\tilde{a}_{\min} \leq \tilde{a}_j \leq \tilde{a}_{\max}$. Thus, there exist is $\sum_{j=1}^n \omega_j \tilde{a}_{\min} \leq \sum_{j=1}^n \omega_j \tilde{a}_j \leq \sum_{j=1}^n \omega_j \tilde{a}_{\max}$. This is $\tilde{a}_{\min} \leq \sum_{j=1}^n \omega_j \tilde{a}_j \leq \tilde{a}_{\max}$. i.e., $\tilde{a}_{\min} \leq \text{SVNTrLWAA}(\tilde{a}_1, \tilde{a}_2, \dots, \tilde{a}_n) \leq \tilde{a}_{\max}$.

(3) Since $\tilde{a}_j \leq \tilde{a}_j^*$ for $j= 1,2,\dots,n$. There is $\sum_{j=1}^n \omega_j \tilde{a}_j \leq \sum_{j=1}^n \omega_j \tilde{a}_j^*$. Then $\text{INTRLWAA}(\tilde{a}_1, \tilde{a}_2, \dots, \tilde{a}_n) \leq \text{SVNTrLWAA}(\tilde{a}_1^*, \tilde{a}_2^*, \dots, \tilde{a}_n^*)$.

Thus, we complete the proofs of these properties.

4.2 Single valued neutrosophic trapezoid linguistic weighted geometric averaging operator

Definition 4.3. Let : $\tilde{a}_j = \langle [s_{(\tilde{a}_j)}, s_{(\tilde{a}_j)}, s_{\mu(\tilde{a}_j)}, s_{(\tilde{a}_j)}], (T_{\tilde{a}_j}, I_{\tilde{a}_j}, F_{\tilde{a}_j}) \rangle$ ($j=1,2,\dots,n$) be a collection of SVNTrLNs. The single valued neutrosophic trapezoid linguistic weighted geometric averaging SVNTrLWGA operator can be defined as follows:

SVNTrLWGA: $\Omega^n \rightarrow \Omega$

$$\text{SVNTrLWGA}(\tilde{a}_1, \tilde{a}_2, \dots, \tilde{a}_n) = \Pi_{j=1}^n \tilde{a}_j^{\omega_j} \tag{8}$$

Where, $\omega_j = (\omega_1, \omega_2, \dots, \omega_n)^T$ is the weight vector of \tilde{a}_j ($j= 1,2,\dots,n$), $\omega_j \in [0,1]$ and $\sum_{j=1}^n \omega_j = 1$.

Theorem 4.4 : $\tilde{a}_j = \langle [s_{(\tilde{a}_j)}, s_{(\tilde{a}_j)}, s_{\mu(\tilde{a}_j)}, s_{(\tilde{a}_j)}], (T_{\tilde{a}_j}, I_{\tilde{a}_j}, F_{\tilde{a}_j}) \rangle$ ($j=1,2,\dots,n$) be a collection of SVNTrLS, Then by Equation (8) and the operational laws in Definition 3.3 , we have the following result

$$\text{SVNTrLWGA} (\tilde{a}_1, \tilde{a}_2, \dots, \tilde{a}_n) = \langle [s_{\prod_{j=1}^n \omega_j (\tilde{a}_j)}, s_{\prod_{j=1}^n \omega_j (\tilde{a}_j)}, s_{\prod_{j=1}^n \omega_j (\tilde{a}_j)}, s_{\prod_{j=1}^n \omega_j (\tilde{a}_j)}], (\prod_{j=1}^n (T(\tilde{a}_j))^{\omega_j}, 1 - \prod_{j=1}^n (1 - I(\tilde{a}_j))^{\omega_j}, 1 - \prod_{j=1}^n (1 - F(\tilde{a}_j))^{\omega_j}) \rangle \tag{9}$$

Where, $\omega = (\omega_1, \omega_2, \dots, \omega_n)^T$ is the weight vector of \tilde{a}_j ($j= 1,2,\dots,n$), $\omega_j \in [0,1]$ and $\sum_{j=1}^n \omega_j = 1$.

By a similar proof manner of theorem 4.2, we can also give the proof of theorem 4.4 (omitted).

Especially when $\omega = (\frac{1}{n}, \frac{1}{n}, \dots, \frac{1}{n})^T$, then SVNTrLWGA operator reduces to a single valued neutrosophic trapezoid linguistic geometric averaging operator for SVNTrLVs.

It is obvious that the SVNTrLWGA operator satisfies the following properties:

- (1) **Idempotency :** Let \tilde{a}_j ($j=1,2,\dots,n$) be a collection of SVNTrLVs. If \tilde{a}_j ($j=1,2,\dots,n$) is equal, i.e $\tilde{a}_j = \tilde{a}$ for $j=1,2,\dots,n$, then

$$\text{SVNTrLWGA} (\tilde{a}_1, \tilde{a}_2, \dots, \tilde{a}_n) = \tilde{a} .$$

- (2) **Boundedness:** Let \tilde{a}_j ($j=1,2,\dots,n$) be a collection of SVNTrLVs and

$$\tilde{a}_{\min} = \min(\tilde{a}_1, \tilde{a}_2, \dots, \tilde{a}_n) \text{ and } \tilde{a}_{\max} = \max(\tilde{a}_1, \tilde{a}_2, \dots, \tilde{a}_n) \text{ for } j=1,2,\dots,n, \tilde{a}_{\min} \leq \text{SVNTrLWGA} (\tilde{a}_1, \tilde{a}_2, \dots, \tilde{a}_n) \leq \tilde{a}_{\max} \text{ then be a collection of SVNTrLVs.}$$

- (3) **Monotonicity :** Let \tilde{a}_j ($j=1,2,\dots,n$) be a collection of SVNTrLVs. If $\tilde{a}_j \leq \tilde{a}_j^*$ for $j= 1,2,\dots,n$. Then $\text{SVNTrLWGA} (\tilde{a}_1, \tilde{a}_2, \dots, \tilde{a}_n) \leq \text{SVNTrLWGA} (\tilde{a}_1^*, \tilde{a}_2^*, \dots, \tilde{a}_n^*)$.

Since the proof process of these properties is similar to the above proofs, we do not repeat it here.

5.DECISION –MAKING METHOD BY SVNTrLWAA AND SVNTrLWGA OPERATORS.

This section presents a method for multi attribute decision making problems based on the SVNTrLWAA and SVNTrLWGA operators and the score, accuracy, and

certainty functions of SVNTrLVs under single valued neutrosophic trapezoid linguistic variable environment.

In a multiple attribute decision-making problem, assume that $A = \{A_1, A_2, A_3, \dots, A_m\}$ is a set of alternatives and $C = \{C_1, C_2, \dots, C_n\}$ is a set of attributes. The weight vector of the attributes C_j ($j=1,2,\dots,n$), entered by the decision maker, is $\omega = (\omega_1, \omega_2, \dots, \omega_n)^T$ where $\omega_j \in [0,1]$ and $\sum_{j=1}^n \omega_j = 1$. In the decision process, the evaluation information of the alternatives A_i ($i=1,2,\dots,m$) with respect to the attribute C_j ($j=1,2,\dots,n$) is represented by the form of an SVNTrLS:

$$A_i = \{ [s_{i(C_j)}, s_{i(C_j)}, s_{\mu_i(C_j)}, s_{i(C_j)}], (T_{A_i}(C_j), I_{A_i}(C_j), F_{A_i}(C_j)) \mid C_j \in C \}$$

Where $[s_{i(C_j)}, s_{i(C_j)}, s_{\mu_i(C_j)}, s_{i(C_j)}] \in \mathbb{S}$, $T_{A_i}(C_j) \in [0,1]$, $I_{A_i}(C_j) \in [0,1]$, and $F_{A_i}(C_j) \in [0,1]$ with the condition $0 \leq T_{A_i}(C_j) + I_{A_i}(C_j) + F_{A_i}(C_j) \leq 3$ for $j=1,2,\dots,n$ and $i=1,2,\dots,m$. For convenience, an SVNTrLV is a SVNTrLS is denoted by

$\tilde{d}_{ij} = \langle [s_{ij}, s_{ij}, s_{\mu_{ij}}, s_{ij}], (T_{ij}, I_{ij}, F_{ij}) \rangle$ ($i=1,2,\dots,m$) $j=1,2,\dots,n$) thus, one can establish a single valued neutrosophic trapezoid linguistic decision matrix $D = (\tilde{d}_{ij})_{m \times n}$.

Using the SVNTrLWAA or SVNTrLWGA operator, we now formulate an algorithm to solve multiple attribute decision making problem with single valued neutrosophic linguistic information.

Step1 : Calculate the individual overall value of the SVNTrLV \tilde{d}_i for A_i ($i=1,2,\dots,m$) by the following aggregation formula:

$$\begin{aligned} \tilde{d}_i &= \langle [s_i, s_i, s_{\mu_i}, s_i], (T_i, I_i, F_i) \rangle \\ &= \text{SVNTrLWAA} (\tilde{d}_{i1}, \tilde{d}_{i2}, \dots, \tilde{d}_{in}) \\ &= \langle [s_{\sum_{j=1}^n \omega_j}, s_{\sum_{j=1}^n \omega_j}, s_{\sum_{j=1}^n \omega_j \mu_{ij}}, s_{\sum_{j=1}^n \omega_j}], (1 - \prod_{j=1}^n (1 - T_{ij})^{\omega_j}, \prod_{j=1}^n (I_{ij})^{\omega_j}, \prod_{j=1}^n (F_{ij})^{\omega_j}) \rangle \end{aligned} \quad (10)$$

$$\begin{aligned} \tilde{d}_i &= \langle [s_i, s_i, s_{\mu_i}, s_i], (T_i, I_i, F_i) \rangle \\ &= \text{SVNTrLWGA} (\tilde{d}_{i1}, \tilde{d}_{i2}, \dots, \tilde{d}_{in}) = \langle [s_{\prod_{j=1}^n \omega_j}, s_{\prod_{j=1}^n \omega_j}, s_{\prod_{j=1}^n \omega_j \mu_{ij}}, s_{\prod_{j=1}^n \omega_j}], \\ &(\prod_{j=1}^n (T_{ij})^{\omega_j}, 1 - \prod_{j=1}^n (1 - I_{ij})^{\omega_j}, 1 - \prod_{j=1}^n (1 - F_{ij})^{\omega_j}) \rangle \end{aligned} \quad (11)$$

Step 2 : Calculate the score function $E(\tilde{d}_i)$ ($i=1,2,\dots,m$) (accuracy function $H(\tilde{d}_i)$ and certainty function $C(\tilde{d}_i)$ by applying Eq.(1) (Eqs.(2) and (3)).

Step 3 : Rank the alternatives according to the values of $E(\tilde{d}_i)$ ($H(\tilde{d}_i)$ and $C(\tilde{d}_i)$) ($i=1,2,\dots,m$) by the ranking method in Definition 3.5, and then select the best one(s).

Step 4 : End

6.ILLUSTRATIVE EXAMPLE

An illustrative example about investment alternatives problem adapted from [18] is used to demonstrate the applications of the proposed decision –making method under single valued neutrosophic trapezoid linguistic environment. There is an investment company, which wants to invest a sum of money in the best option. To invest the money, there is a panel with four possible alternatives: (1) A_1 is car company; (2) A_2 is food company; (3) A_3 is a computer company; (4) A_4 is an arms company. The investement company must take a decision according to the three attributes: (1) C_1 is the risk; (2) C_2 is the growth; (3) C_3 is a the environmental impact. The weight vector of the attributes is $\omega = (0.35, 0.25, 0.4)^T$. The expert evaluates the four possible alternatives of A_i ($i=1,2,3,4$) with respect to the three attributes of C_j ($j=1,2,3$), where the evaluation information is expressed by the form of SVNTrLV values under the linguistic term set $S = \{s_0 = \text{extremely poor}, s_1 = \text{very poor}, s_2 = \text{poor}, s_3 = \text{medium}, s_4 = \text{good}, s_5 = \text{very good}, s_6 = \text{extremely good}\}$.

The evaluation information of an alternative A_i ($i=1,2, 3,4$) with respect to an attribute C_j ($j=1, 2, 3$) can be given by the expert. For example, the SVNTrL value of an alternative A_1 with respect to an attribute C_1 is given as $\langle [s_{1.4}, s_{2.7}, s_3, s_{5.3}] (0.4, 0.2, 0.3) \rangle$ by the expert, which indicates that the mark of the alternative A_1 with respect to the attribute C_1 is about the trapezoid linguistic value $[s_{1.4}, s_{2.7}, s_3, s_{5.3}]$ with the satisfaction degree 0.4 indeterminacy degree 0.2, and dissatisfaction degree 0.3, similarly, the four possible alternatives with respect to the three attributes can be evaluated by the expert, thus we can obtain the following single valued neutrosophic trapezoid linguistic decision matrix:

$$D = (d_{ij})_{m \times n}$$

$$\left[\begin{array}{lll} < (s_{1.8}, s_{3.4}, s_{4.5}, s_{5.5}), (0.7, 0.3, 0.4) < (s_{1.3}, s_{2.3}, s_{4.4}, s_{5.4}), (0.4, 0.2, 0.4) < (s_{0.8}, s_{2.2}, s_{3.8}, s_{5.1}), (0.3, 0.4, 0.4) \\ < (s_{1.4}, s_{2.8}, s_{3.8}, s_{5.1}), (0.4, 0.3, 0.4) < (s_{1.5}, s_{2.5}, s_{4.5}, s_{5.5}), (0.4, 0.5, 0.4) < (s_{1.1}, s_{2.1}, s_{1.4}, s_{5.4}), (0.6, 0.6, 0.5) \\ < (s_{2.1}, s_{3.2}, s_{4.5}, s_{5.7}), (0.6, 0.2, 0.4) < (s_{1.8}, s_{2.8}, s_{4.4}, s_{5.5}), (0.6, 0.5, 0.4) < (s_{1.4}, s_{2.7}, s_{3.3}, s_{5.3}), (0.6, 0.3, 0.5) \\ < (s_{1.5}, s_{3.1}, s_{4.7}, s_{5.9}), (0.8, 0.2, 0.5) < (s_{1.7}, s_{2.9}, s_{4.4}, s_{5.4}), (0.7, 0.3, 0.4) < (s_{1.2}, s_{1.8}, s_{4.3}, s_{5.3}), (0.6, 0.7, 0.4) \end{array} \right]$$

The proposed decision –making method can handle this decision –making problem according to the following calculation steps:

Step1: By applying Eq.(10), we can obtain the individual overall value of the SVNTrLV \tilde{d}_i for A_i ($i=1,2,3,4$).

$$\tilde{d}_1 = \langle [s_{1.275}, s_{2.645}, s_{4.195}, s_{5.315}], (0.4933, 0.1397, 0.400) \rangle$$

$$\tilde{d}_2 = \langle [s_{1.305}, s_{2.445}, s_{3.015}, s_{5.320}], (0.4898, 0.2612, 0.4373) \rangle$$

$$\tilde{d}_3 = \langle [s_{1.745}, s_{2.900}, s_{3.875}, s_{5.490}], (0.600, 0.2460, 0.4373) \rangle$$

$$\tilde{d}_4 = \langle [s_{1.430}, s_{2.530}, s_{4.365}, s_{5.535}], (0.7079, 0.4379, 0.4325) \rangle$$

Step 2: By applying Eq.(1) , we can obtain the score value of $E(\tilde{d}_i)$ ($i=1,2,3,4$)

$$E(\tilde{d}_1) = s_{2.1931}, E(\tilde{d}_2) = s_{1.8040}, E(\tilde{d}_3) = s_{2.2378}, E(\tilde{d}_4) = s_{2.1224}$$

Step 3 : since $E(\tilde{d}_3) \succ E(\tilde{d}_4) \succ E(\tilde{d}_1) \succ E(\tilde{d}_2)$, the ranking order of four alternatives . Therefore, we can see that the alternative A_3 is the best choice among all the alternative.

On the other hand, we can also utilize the SVNTrLWGA operator as the following computational steps:

Step 1:By applying Eq.(11) , we can obtain the individual overall value of the SVNTrLV \tilde{d}_i for A_i ($i=1,2,3,4$)

$$\tilde{d}_1 = \langle [s_{1.200}, s_{2.591}, s_{4.182}, s_{5.312}], (0.4337, 0.3195, 0.4000) \rangle$$

$$\tilde{d}_2 = \langle [s_{1.293}, s_{2.426}, s_{2.659}, s_{5.317}], (0.4704, 0.4855, 0.4422) \rangle$$

$$\tilde{d}_3 = \langle [s_{1.718}, s_{2.892}, s_{3.805}, s_{5.487}], (0.6, 0.3527, 0.4422) \rangle$$

$$\tilde{d}_4 = \langle [s_{1.416}, s_{2.453}, s_{4.356}, s_{5.528}], (0.690, 0.477, 0.437) \rangle$$

Step2: By applying Eq.(1), we can obtain the score value of $E(\tilde{d}_i)$ ($i=1,2,3,4$)

$$E(\tilde{d}_1) = s_{1.8978}, E(\tilde{d}_2) = s_{1.5035}, E(\tilde{d}_3) = s_{2.1146}, E(\tilde{d}_4) = s_{2.0354}$$

Step 3 : since $E(\tilde{d}_3) \succ E(\tilde{d}_4) \succ E(\tilde{d}_1) \succ E(\tilde{d}_2)$, the ranking order of four alternatives . Therefore, we can see that the alternative A_3 is the best choice among all the alternative.

Obviously, we can see that the above two kinds of ranking orders of the alternatives are the same and the most desirable choice is the alternative A_3 .

7-CONCLUSION

In this paper, we have proposed some single valued neutrosophic trapezoid linguistic operators such as single valued neutrosophic trapezoid linguistic weighted arithmetic averaging SVNTrLWAA and single valued neutrosophic trapezoid linguistic weighted geometric averaging SVNTrLWGA operator. We have studied some desirable properties of the proposed operators, such as commutativity, idempotency and monotonicity, and applied the SVNTrLWAA and SVNTrLWGA operator to decision making with single valued neutrosophic trapezoid linguistic information. Finally, an illustrative example has been given to show the developed operators.

REFERENCES

1. Kharal, A., A Neutrosophic Multicriteria Decision Making Method, New Mathematics and Natural Computation, Creighton University, USA, 2013.
2. Ansaria, A.Q., Biswas,R. and Aggarwal,S.(2013). Neutrosophic classifier: An extension of fuzzy classifier, *Applied Soft Computing* 13 (2013) 563-573.
3. Saha,A. and Mukherjee ,A.(2013).A study on Interval Valued Intuitionistic Fuzzy Set of Type-2,*The journal of fuzzy Mathematics* Vol.21,No 4 (2013) 759-772.
4. Rabounski, D., Smarandache, F. and Borissova, L. Neutrosophic Methods in General Relativity, Hexis, (2005).
5. Lupiáñez, F.G. (2008).On neutrosophic topology, *Kybernetes*, 37/6 (2008) 797-800.
6. Smarandache, F. A Unifying Field in Logics. Neutrosophy: Neutrosophic Probability, Set and Logic. Rehoboth: American Research Press, (1998).
7. Wang, H., Smarandache, S., Zhang, Y. and Sunderraman, R.(2010). Single valued Neutrosophic Sets , *Multispace and Multistructure* 4(2010) 410-413.
8. Wang, H., Smarandache, F., Zhang, Y. and Sunderraman, R. Interval Neutrosophic Sets and Logic: Theory and Applications in Computing, Hexis, Phoenix, AZ, (2005).

9. Deli ,I. and Broumi,S. Neutrosophic multisets and its application in medical diagnosis, 2014, (submmited)
10. Deli, I. .Interval-valued neutrosophic soft sets and its decision making <http://arxiv.org/abs/1402.3130>.
11. Deli,I., and Broumi, S. Neutrosophic soft sets and neutrosophic soft matrices based on decision making,<http://arxiv:1404.0673>.
12. Deli, I., Toktas, Y. and Broumi,S.(2014). Neutrosophic Parameterized Soft relations and Their Application, *Neutrosophic Sets and Systems*, Vol. 4, (2014) 25-34.
13. Ye, J. (2014). Similarity measure between interval neutrosophic sets and their applications in multicriteria decision making , *Journal of intelligent and fuzzy systems* 26,(2014)165-172.
14. Ye,J.(2014). Multiple attribute group decision –making method with completely unknown weights based on similarity measures under single valued neutrosophic environment, *Journal of intelligent and Fuzzy systems*,2014,DOI:10.3233/IFS-141252.
15. Ye, J.(2014). Single valued neutrosophic cross-entropy for multicriteria decision making problems, *Applied Mathematical Modelling*,38,(2014)1170-1175.
16. Ye, J.(2014). Single valued neutrosophic minimum spanning tree and it clustering method, *Journal of intelligent Systems* 23(3),(2014)311-324.
17. Ye, J.(2013). Multicriteria decision-making method using the correlation coefficient under single-valued neutrosophic environment. *International Journal of General Systems*, 2013,Vol. 42, No. 4, 386–394, <http://dx.doi.org/10.1080/03081079.2012.761609>.
18. Ye, J. (2014). Some aggregation operators of interval neutrosophic Linguistic numbers for multiple attribute decision making, *Journal of Intelligent and Fuzzy System* (2014) -, DOI:10.3233/IFS-141187
19. Ye, J. (2014). Multiple attribute decision making based on interval neutrosophic Uncertain Linguistic variables , *Neural Computing and Applications*,2014 (submitted).
20. Ye, J. (2014). A Multicriteria decision-making method using aggregation operators for simplified neutrosophic Sets, *Journal of Intelligent and Fuzzy System* (2014)2459-2466, DOI:10.3233/IFS-130916.
21. Ye, J.(2013). Another form of correlation coefficient between single valued neutrosophic sets and its multiple attribute decision-making method, *Neutrosophic Sets and systems*,Vol.1,no1(2013) 8-12.
22. Peng, J., J., Wang, J.Q.J. and Chen,H.(2015). Simplified neutrosophic sets and their applications in multi-criteria group decision making problems, *International Journal System and Science*,2015 (in press).
23. Atanassov, K. (1989). More on intuitionistic fuzzy sets, *Fuzzy Sets and Systems* Vol 33,no.5,(1989) 37-46.

24. Atanassov, K. (1989). Gargov, interval valued intuitionistic fuzzy sets, *Fuzzy Sets and Systems* 31 (1989) 343-349.
25. Atanassov, K. (1994). Operators over interval valued intuitionistic fuzzy sets, *Fuzzy Sets and Systems* 64 (1994) 159-174.
26. Zadeh, L.A. (1965). Fuzzy sets, *Information and control*, Vol 8 (1965) 338-356.
27. Zeng, L. (2006). Expected value method for fuzzy multiple attribute decision making, *Tsinghua Science and Technology*, 11, (2006) 102-106.
28. Peide, L., Li, Y., and Chen, Y. (2014). Some Generalized Neutrosophic number Hamacher Aggregation Operators and Their Application to Group Decision Making, *International Journal of Fuzzy Systems*, Vol, 16, No. 2, (2014) 212-255.
29. Arora, M., Biswas, R. and Pandey, U.S. (2011). Neutrosophic Relational Database Decomposition, *International Journal of Advanced Computer Science and Applications*, 2(8) (2011) 121-125.
30. Arora, M. and Biswas, R. (2010). Deployment of Neutrosophic Technology to Retrieve Answers for Queries Posed in Natural Language, in 3rd International Conference on Computer Science and Information Technology, (2010) 435-439.
31. Chi, P. and Peide, L. (2013). An Extended TOPSIS Method for the Multiple Attribute Decision Making Problems Based on Interval Neutrosophic, *Neutrosophic Sets and Systems*, 1 (2013) 63-70.
32. Liu, P., and Wang, Y. Multiple attribute decision-making method based on single-valued neutrosophic normalized weighted Bonferroni mean, *Neural Computing and Applications*, 2014.
33. Biswas, P., Paramanik, S. and Giri, B.C. (2014). A New Methodology for neutrosophic Multi-attribute Decision Making with Unknown Weight Information, *Neutrosophic Sets and Systems*, Vol 3, (2014) 44-54.
34. Maji, P.K. Neutrosophic Soft Set, *Annals of Fuzzy Mathematics and Informatics*, Vol 5, No. 1, ISSN: 2093-9310, ISSN: 2287-623.
35. Sahin, R. and Kucuk, A. (2014). Generalized Neutrosophic Soft Set and its Integration to Decision Making Problem, *Appl. Math. Inf. Sci.* 8(6) (2014) 2751-2759.
36. Şahin, R. and Küçük, A. On Similarity and Entropy of Neutrosophic Soft Sets, *Journal of Intelligent and Fuzzy Systems*, DOI: 10.3233/IFS-141211.
37. Aggarwal, S., Biswas, R. and Ansari, A.Q. (2010). Neutrosophic Modeling and Control, *Computer and Communication Technology* (2010) 718-723.
38. Broumi, S. and Smarandache, F. (2013). Intuitionistic Neutrosophic Soft Set, *Journal of Information and Computing Science*, England, UK, 8(2) (2013) 130-140.
39. Broumi, S. (2013). Generalized Neutrosophic Soft Set, *International Journal of Computer Science, Engineering and Information Technology*, 3(2) (2013) 17-30.

40. Broumi, S. and Smarandache, F.(2013). Correlation Coefficient of Interval Neutrosophic set, *Periodical of Applied Mechanics and Materials*, Vol. 436, 2013, with the title Engineering Decisions and Scientific Research in Aerospace, Robotics, Biomechanics, Mechanical Engineering and Manufacturing; Proceedings of the International Conference ICMERA, Bucharest, October 2013.
41. Broumi, S. and Smarandache, F.(2013). Several Similarity Measures of Neutrosophic Sets, *Neutrosophic Sets and Systems*, 1, (2013) 54-62.
42. Broumi, S. , Deli, I. and Smarandache, F. (2014). Relations on Interval Valued Neutrosophic Soft Sets, *Journal of New Results in Science*, 5 (2014) 1-20.
43. Broumi, S. and Smarandache, F.(2013).More on Intuitionistic Neutrosophic Soft Sets, *Computer Science and Information Technology* 1(4): 257-268, 2013; DOI: 10.13189/csit.2013.010404.
44. Broumi, S., Deli, I. and Smarandache, F.(2014). Neutrosophic Parametrized Soft Set theory and its decision making problem, *Italian journal of pure and applied mathematics* N. 32 2014 ,1-12.
45. Broumi, S. and Smarandache,F.(2014). On Neutrosophic Implications. *Neutrosophic Sets and Systems*, Vol. 2, (2014) 9-17.
46. Broumi, S., Sahin, R. and Smarandache, F. (2014).Generalized Interval Neutrosophic Soft Set and its Decision Making Problem , *Journal of New Results in Science* No 7, (2014)29-47.
47. Broumi, S. , Smarandache, F. and Maji, P.K.(2014). Intuitionistic Neutrosophic Soft Set over Rings, *Mathematics and Statistics* 2(3): (2014) 120-126 ,DOI: 10.13189/ms.2014.020303.
48. Broumi, S. and Smarandache, F.(2014). New Operations over Interval Valued Intuitionistic Hesitant Fuzzy Set, *Mathematics and Statistics* 2(2): 62-71, 2014 DOI: 10.13189/ms.2014.020202.
49. Broumi, S., Smarandache, F. and Dhar, M.(2014). Rough Neutrosophic Sets, *Neutrosophic sets and systems*, Vol 3.(2014) 60-65.
50. Chen,Z.P. and Yang,W.(2011). A new multiple attribute group decision making method in intuitionistic fuzzy setting, *Applied Mathematical Modelling*,Vol.355,(2011) 4424-4437.
51. Xu, Z. (2010). A method based on distance measure for interval –valued intuitionistic fuzzy group decision making, *Information Science*,180 (2010)181-190.
52. Xu, Z.(2005). An approach based on similarity measure to multiple attribute decision making with trapezoid fuzzy linguistic variables, Springer, Berlin, Heidelberg, (2005)110-117.

Applying Dijkstra Algorithm for Solving Neutrosophic Shortest Path Problem

Said Broumi, Assia Bakali, Mohamed Talea, Florentin Smarandache, Luige Vladareanu

Said Broumi, Assia Bakali, Mohamed Talea, Florentin Smarandache, Luige Vladareanu (2016). Applying Dijkstra Algorithm for Solving Neutrosophic Shortest Path Problem. Proceedings of the 2016 International Conference on Advanced Mechatronic Systems, Melbourne, Australia, 5

Abstract— The selection of shortest path problem is one the classic problems in graph theory. In literature, many algorithms have been developed to provide a solution for shortest path problem in a network. One of common algorithms in solving shortest path problem is Dijkstra's algorithm. In this paper, Dijkstra's algorithm has been redesigned to handle the case in which most of parameters of a network are uncertain and given in terms of neutrosophic numbers. Finally, a numerical example is given to explain the proposed algorithm.

Keywords— *Dijkstra's algorithm; Single valued neutrosophic number; Shortest path problem; Network.*

I. INTRODUCTION

To express indeterminate and inconsistent information which exist in real world, Smarandache [1] originally proposed the concept of a neutrosophic set from a philosophical point of view. The concept of the neutrosophic set (NS for short) is powerful mathematical tool which generalizes the concept of classical sets, fuzzy sets [3], intuitionistic fuzzy sets [4], interval-valued fuzzy sets [5] and interval-valued intuitionistic fuzzy sets [6]. The concept of the neutrosophic has three basic components such that a truth-membership (T), indeterminacy-membership (I) and a falsity membership (F), which are defined independently of one another. But a neutrosophic set So will be more difficult to apply it in real scientific and engineering areas. Thus, Wang et al. [7] proposed the concept of single valued neutrosophic set (for short SVNS), which is an instance of a neutrosophic set, whose functions of truth, indeterminacy and falsity lie in $[0, 1]$ and provided the set theoretic operators and various properties of SVNSs. Some of the recent research works on neutrosophic set theory and its applications in various fields can be found in [8]. In addition, Thamaraiselvi and Santhi [9] introduced a mathematical representation of a transportation problems in neutrosophic

environment based on single valued trapezoidal neutrosophic numbers and also provided the solution method. The operations on neutrosophic sets and the ranking methods are presented in [10]

The shortest path problem (SPP) is one of the most fundamental and well-known combinatorial problems that appear in various fields of science and engineering, e.g. road networks application, transportation and other applications. In a network, the shortest path problem aims at finding the path from one source node to destination node with minimum weight, where some weight is attached to each edge connecting a pair of nodes. The edge length of the network may represent the real life quantities such as, time, cost, etc. In conventional shortest path problem, it is assumed that decision maker is certain about the parameters (distance, time etc) between different nodes. But in real life situations, there always exist uncertainty about the parameters between different nodes. For this purpose, many algorithms have been developed to find the shortest path under different types of input data, including fuzzy set, intuitionistic fuzzy sets, vague sets [11-15]. One of the most used methods to solve the shortest path problem is the Dijkstra's algorithm [16]. Dijkstra's algorithm solves the problem of finding the shortest path from a point in a graph (the source) to a destination.

Recently, numerous papers have been published on neutrosophic graph theory [17-23]. In addition, Broumi et al. [24-26] proposed some algorithms to find the shortest path of a network (graph) where edge weights are characterized by a neutrosophic numbers including single valued neutrosophic numbers, bipolar neutrosophic numbers and interval valued neutrosophic numbers.

The main purpose of this paper is to propose a new version of Dijkstra algorithm for solving shortest path problem on a network where the edge weights are characterized by a single

valued neutrosophic numbers. The proposed method is more efficient due to the fact that the summing operation and the ranking of SVNNs can be done in a easy and straight manner. The rest of the article is organized as follows. Section 2 introduces some basic concepts of neutrosophic sets, single valued neutrosophic sets. In Section 3, a network terminology is presented, In section 4, we propose the new version of Dijkstra'algorithm for solving the shortest path with connected edges in neutrosophic data. Section 5 illustrates a practical example which is solved by the proposed algorithm. Conclusions and further research are given in section 6.

II. PRELIMINARIES

In this section, some basic concepts and definitions on neutrosophic sets and single valued neutrosophic sets are reviewed from the literature.

Definition 2.1 [1]. Let X be a space of points (objects) with generic elements in X denoted by x; then the neutrosophic set A (NS A) is an object having the form $A = \{< x: T_A(x), I_A(x), F_A(x) \succ, x \in X\}$, where the functions T, I, F: $X \rightarrow]0, 1^+[$ define respectively the truth-membership function, an indeterminacy-membership function, and a falsity-membership function of the element $x \in X$ to the set A with the condition:

$$0 \leq T_A(x) + I_A(x) + F_A(x) \leq 3^+ \tag{1}$$

The functions $T_A(x), I_A(x)$ and $F_A(x)$ are real standard or nonstandard subsets of $]0, 1^+[$. Since it is difficult to apply NSs to practical problems, Wang et al. [7] introduced the concept of a SVNS, which is an instance of a NS and can be used in real scientific and engineering applications.

Definition 2.2 [7]. Let X be a space of points (objects) with generic elements in X denoted by x. A single valued neutrosophic set A (SVNS A) is characterized by truth-membership function $T_A(x)$, an indeterminacy-membership function $I_A(x)$, and a falsity-membership function $F_A(x)$.

For each point x in X $T_A(x), I_A(x), F_A(x) \in [0, 1]$. A SVNS A can be written as

$$A = \{< x: T_A(x), I_A(x), F_A(x) \succ, x \in X\} \tag{2}$$

Definition 2.3 [10]. Let $\tilde{A}_1 = (T_1, I_1, F_1)$ and $\tilde{A}_2 = (T_2, I_2, F_2)$ be two single valued neutrosophic number. Then, the operations for SVNNs are defined as below;

- i. $\tilde{A}_1 \oplus \tilde{A}_2 = \langle T_1 + T_2 - T_1 T_2, I_1 I_2, F_1 F_2 \rangle$ (3)
- ii. $\tilde{A}_1 \otimes \tilde{A}_2 = \langle T_1 T_2, I_1 + I_2 - I_1 I_2, F_1 + F_2 - F_1 F_2 \rangle$ (4)
- iii. $\lambda \tilde{A}_1 = \langle 1 - (1 - T_1)^\lambda, I_1^\lambda, F_1^\lambda \rangle$ (5)
- iv. $\tilde{A}_1^\lambda = \langle T_1^\lambda, 1 - (1 - I_1)^\lambda, 1 - (1 - F_1)^\lambda \rangle$ where $\lambda > 0$ (6)

Definition 2.4 [10]. 0_n may be defined as follow:

$$0_n = \{< x, (0, 1, 1) \succ: x \in X\} \tag{7}$$

A convenient method for comparing of single valued neutrosophic number is by use of score function.

Definition 2.5 [11]. Let $\tilde{A}_1 = (T_1, I_1, F_1)$ be a single valued neutrosophic number. Then, the score function $s(\tilde{A}_1)$, accuracy function $a(\tilde{A}_1)$ and certainty function $c(\tilde{A}_1)$ of a SVNN are defined as follows:

$$(i) \quad s(\tilde{A}_1) = \frac{2 + T_1 - I_1 - F_1}{3} \tag{8}$$

$$(ii) \quad a(\tilde{A}_1) = T_1 - F_1 \tag{9}$$

$$(iii) \quad c(\tilde{A}_1) = T_1 \tag{10}$$

Definition 2.6 [11]. Suppose that $\tilde{A}_1 = (T_1, I_1, F_1)$

and $\tilde{A}_2 = (T_2, I_2, F_2)$ are two single valued neutrosophic numbers. Then, we define a ranking method as follows:

- i. If $s(\tilde{A}_1) \succ s(\tilde{A}_2)$, then \tilde{A}_1 is greater than \tilde{A}_2 , that is, \tilde{A}_1 is superior to \tilde{A}_2 , denoted by $\tilde{A}_1 \succ \tilde{A}_2$
- ii. If $s(\tilde{A}_1) = s(\tilde{A}_2)$, and $a(\tilde{A}_1) \succ a(\tilde{A}_2)$ then \tilde{A}_1 is greater than \tilde{A}_2 , that is, \tilde{A}_1 is superior to \tilde{A}_2 , denoted by $\tilde{A}_1 \succ \tilde{A}_2$
- iii. If $s(\tilde{A}_1) = s(\tilde{A}_2)$, $a(\tilde{A}_1) = a(\tilde{A}_2)$, and $c(\tilde{A}_1) \succ c(\tilde{A}_2)$ then \tilde{A}_1 is greater than \tilde{A}_2 , that is, \tilde{A}_1 is superior to \tilde{A}_2 , denoted by $\tilde{A}_1 \succ \tilde{A}_2$
- iv. If $s(\tilde{A}_1) = s(\tilde{A}_2)$, $a(\tilde{A}_1) = a(\tilde{A}_2)$, and $c(\tilde{A}_1) = c(\tilde{A}_2)$ then \tilde{A}_1 is equal to \tilde{A}_2 , that is, \tilde{A}_1 is indifferent to \tilde{A}_2 , denoted by $\tilde{A}_1 = \tilde{A}_2$

III. NETWORK TERMINOLOGY

Consider a directed network $G = (V, E)$ consisting of a finite set of nodes $V = \{1, 2, \dots, n\}$ and a set of m directed edges $E \subseteq V \times V$. Each edge is denoted by an ordered pair (i, j) where $i, j \in V$ and $i \neq j$. In this network, we specify two nodes, denoted by s and t, which are the source node and the destination node, respectively. We define a path as a sequence $P_{ij} = \{i = i_1, (i_1, i_2), i_2, \dots, i_{l-1}, (i_{l-1}, i_l), i_l = j\}$ of alternating nodes and edges. The existence of at least one path P_{st} in $G(V, E)$ is assumed for every $i \in V - \{s\}$.

d_{ij} Denotes a single valued neutrosophic number associated with the edge (i, j) , corresponding to the length necessary to traverse (i, j) from i to j. In real problems, the lengths correspond to the cost, the time, the distance, etc. Then neutrosophic distance along the path P is denoted as $d(P)$ is defined as

$$d(P) = \sum_{(i,j \in P)} d_{ij} \quad (14)$$

Remark: A node i is said to be predecessor node of node j if
 (i) Node i is directly connected to node j .
 (ii) The direction of path connecting node i and j from i to j .

IV. SINGLE VALUED NEUTROSOPHIC DIJKSTRA ALGORITHM

In this subsection, we slightly modified the fuzzy Dijkstra algorithm adapted from [27] in order to deal on a network with parameters characterized by a single valued neutrosophic numbers.

This algorithm finds the shortest path and the shortest distance between a source node and any other node in the network. The algorithm advances from a node i to an immediately successive node j using a neutrosophic labeling procedure. Let \tilde{u}_i be the shortest distance from node 1 to node i and $s(\tilde{d}_{ij}) \geq 0$ be the length of (i, j) edge. Then, the neutrosophic label for node j is defined as:

$$[\tilde{u}_j, i] = [\tilde{u}_i \oplus \tilde{d}_{ij}, i], \quad S(\tilde{d}_{ij}) \geq 0. \quad (15)$$

Here label $[\tilde{u}_j, i]$ mean we are coming from nodes i after covering a distance \tilde{u}_j from the starting node. Dijkstra’s algorithm divides the nodes into two subset groups: **Temporary set (T) and Permanent set (P)**. A temporary neutrosophic label can be replaced with another temporary neutrosophic label, if shortest path to the same neutrosophic node is detected. At the point when no better path can be found, the status of temporary label is changed to permanent. The steps of the algorithm are summarized as follows:

Step 1 Assign to source node (say node 1) the permanent label $[(0,1,1), -]$. Set $i=1$.

Making a node permanent means that it has been included in the short path.

Step 2 Compute the temporary label $[\tilde{u}_i \oplus \tilde{d}_{ij}, i]$ for each node j that can be reached from i , provided j is not permanently labeled. If node j is already labeled as $[\tilde{u}_j, k]$ through another node k , and if $S(\tilde{u}_i \oplus \tilde{d}_{ij}) < S(\tilde{u}_j)$ replace $[\tilde{u}_j, k]$ with $[\tilde{u}_i \oplus \tilde{d}_{ij}, i]$.

Step 3 If all the nodes are permanently labeled, the algorithm terminates. Otherwise, choose the label $[\tilde{u}_r, s]$ with shortest distance (\tilde{u}_r) from the list of temporary labels. Set $i=r$ and repeat step 2.

Step 4 Obtain the shortest path between node 1 and the destination node j by tracing backward through the network using the label’s information.

Remark:

At each iteration among all temporary nodes, make those nodes permanent which have smallest distance. Note that at any iteration we can not move to permanent node, however, reverse is possible. After all the nodes have permanent labels and only one temporary node remains, make it permanent.

After describing the proposed algorithm, in next section we solve a numerical example and explain the proposed method completely.

V. ILLUSTRATIVE EXAMPLE

Now we solve an hypothetical example to verify the proposed approach. Consider the network shown in figure1; we want to obtain the shortest path from node 1 to node 6 where edges have a single valued neutrosophic numbers. Let us now apply the extended Dijkstra algorithm to the network given in figure 1.

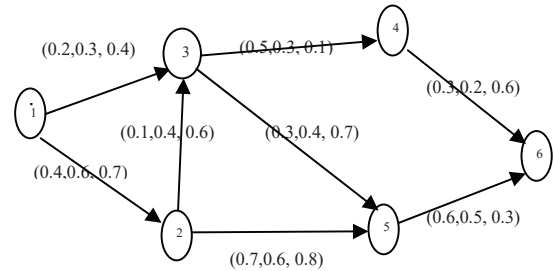

Fig. 1. A network with single valued neutrosophic weights

In this network each edge have been assigned to single valued neutrosophic number as follows:

Edges	Single valued Neutrosophic distance
1-2	(0.4, 0.6, 0.7)
1-3	(0.2, 0.3, 0.4)
2-3	(0.1, 0.4, 0.6)
2-5	(0.7, 0.6, 0.8)
3-4	(0.5, 0.3, 0.1)
3-5	(0.3, 0.4, 0.7)
4-6	(0.3, 0.2, 0.6)
5-6	(0.6, 0.5, 0.3)

Table 1. weights of the graphs

According to Dijkstra’s algorithm we start with

Iteration 0: Assign the permanent label $[(0,1,1), -]$ to node 1.

Iteration 1: Node 2 and node 3 can be reached from (the last permanently labeled) node 1. Thus, the list of labeled nodes (temporary and permanent) becomes

Nodes	label	Status
1	$[(0,1,1), -]$	P
2	$[(0.4, 0.6, 0.7), 1]$	T
3	$[(0.2, 0.3, 0.4), 1]$	T

In order to compare the (0.4, 0.6, 0.7) and (0.2, 0.3, 0.4) we use the Eq.8

$$S(0.2, 0.3, 0.4) = \frac{2+T-I-F}{3} = \frac{2+0.2-0.3-0.4}{3} = 0.5$$

$$S(0.4, 0.6, 0.7) = \frac{2+T-I-F}{3} = \frac{2+0.4-0.6-0.7}{3} = 0.36$$

Since the rank of [(0.4, 0.6, 0.7), 1] is less than [(0.2, 0.3, 0.4), 1]. Thus the status of node 2 is changed to permanent.

Iteration 2: Node 3 and 5 can be reached from node 2. Thus, the list of labeled nodes (temporary and permanent) becomes

Nodes	label	Status
1	[(0,1,1), -]	P
2	[(0.4, 0.6, 0.7), 1]	P
3	[(0.2, 0.3, 0.4), 1] or [(0.46, 0.24, 0.42), 2]	T
5	[(0.82, 0.36, 0.56), 2]	T

$$S(0.46, 0.24, 0.42) = \frac{2+0.46-0.24-0.42}{3} = 0.6$$

$$S(0.82, 0.36, 0.56) = \frac{2+0.82-0.36-0.56}{3} = 0.63$$

Among the temporary labels [(0.2, 0.3, 0.4), 1] or [(0.46, 0.24, 0.42), 2], [(0.82, 0.36, 0.56), 2] and since the rank of (0.2, 0.3, 0.4) is less than of (0.46, 0.24, 0.42) and (0.82, 0.36, 0.56), So the status of node 3 is changed to permanent.

Iteration 3: Node 4 and 5 can be reached from node 3. Thus , the list of labeled nodes (temporary and permanent) becomes

Nodes	label	Status
1	[(0,1,1), -]	P
2	[(0.4, 0.6, 0.7), 1]	P
3	[(0.2, 0.3, 0.4), 1]	P
4	[(0.6, 0.09, 0.04), 3]	T
5	[(0.82, 0.36, 0.56), 2] or [(0.44, 0.12, 0.28), 3]	T

$$S(0.6, 0.09, 0.04) = \frac{2+0.6-0.09-0.04}{3} = 0.82$$

$$S(0.44, 0.12, 0.28) = \frac{2+0.44-0.12-0.28}{3} = 0.68$$

Among the temporary labels [(0.6, 0.09, 0.04), 3] or [(0.82, 0.36, 0.56), 2], [(0.44, 0.12, 0.28), 3] and since the rank of (0.82, 0.36, 0.56), is less than of (0.44, 0.12, 0.28) and (0.6, 0.09, 0.04). So the status of node 5 is changed to permanent.

Iteration 4: Node 6 can be reached from node 5. Thus , the list of labeled nodes (temporary and permanent) becomes

Nodes	label	Status
1	[(0,1,1), -]	P
2	[(0.4, 0.6, 0.7), 1]	P
3	[(0.2, 0.3, 0.4), 1]	P
4	[(0.6, 0.09, 0.04), 3]	T

5	[(0.82, 0.36, 0.56), 2]	P
6	[(0.93, 0.18, 0.17), 5]	T

Since, there exit one permanent node from where we can reach at node 6. So, make temporary label [(0.93, 0.18, 0.17), 5] as permanent.

Iteration 5: the only temporary node is 4, this node can be reached from node 3 and 6. Thus , the list of labeled nodes (temporary and permanent) becomes

Nodes	label	Status
1	[(0,1,1), -]	P
2	[(0.4, 0.6, 0.7), 1]	P
3	[(0.2, 0.3, 0.4), 1]	P
4	[(0.6, 0.09, 0.04), 3] or [(0.95, 0.04, 0.10),6]	T
5	[(0.82, 0.36, 0.56), 2]	P
6	[(0.93, 0.18, 0.17), 5]	P

In order to compare the (0.6, 0.09, 0.04) and (0.95, 0.04, 0.10) we use the Eq.8

$$S(0.6, 0.09, 0.04) = 0.82 \text{ and } S(0.95, 0.04, 0.10) = 0.94$$

Since the rank of [(0.6, 0.09, 0.04), 3] is less than [(0.95, 0.04, 0.10),6]. And the node 4 is the only one temporary node remains then, the status of node 4 is changed to permanent.

Nodes	label	Status
1	[(0,1,1), -]	P
2	[(0.4, 0.6, 0.7), 1]	P
3	[(0.2, 0.3, 0.4), 1]	P
4	[(0.6, 0.09, 0.04), 3]	P
5	[(0.82, 0.36, 0.56), 2]	P
6	[(0.93, 0.18, 0.17), 5]	P

Based on the step 4, the following sequence determines the shortest path from node 1 to node 6

(6) → [(0.93, 0.18, 0.17), 5] → (5) → [(0.82, 0.36, 0.56), 2] → (2) → [(0.4, 0.6, 0.7), 1] → (1)

Thus, the required shortest path is 1 → 2 → 5 → 6

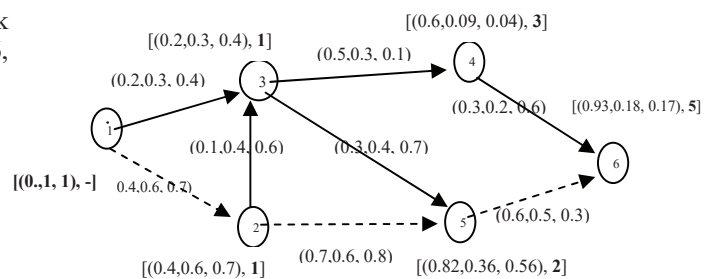

FIG 2. Network with single valued neutrosophic shortest distance of each node from node 1

Conclusion

This paper extended the fuzzy Dijkstra's algorithm to find the shortest path of a network with single valued neutrosophic edge weights. The use of neutrosophic numbers as weights in the graph express more uncertainty than fuzzy numbers. The proposed algorithm proposes solution to one issue, this issue is addressed by identification of shortest path in neutrosophic environment. A numerical example was used to illustrate the efficiency of the proposed method. In future, we will research the application of this algorithm.

REFERENCES

- [1] F. Smarandache, A unifying field in logic. Neutrosophy: neutrosophic probability, set and logic, American Research Press, Rehoboth, 1998.
- [2] F. Smarandache, A geometric interpretation of the neutrosophic set — A generalization of the intuitionistic fuzzy set, Granular Computing (GrC), 2011 IEEE International Conference, 2011, pp.602–606 .
- [3] L. Zadeh, Fuzzy sets. Inform and Control, 8, 1965, pp.338-353
- [4] K. Atanassov, Intuitionistic fuzzy sets, Fuzzy Sets and Systems, vol. 20, 1986, pp. 87-96.
- [5] I. Turksen, "Interval valued fuzzy sets based on normal forms," Fuzzy Sets and Systems, vol. 20,1986, pp. 191-210.
- [6] K. Atanassov and G. Gargov, Interval valued intuitionistic fuzzy sets. Fuzzy Sets and Systems, vol.31, 1989, pp.343-349.
- [7] H. Wang, F. Smarandache, Y. Zhang, and R. Sunderraman, "Single valued Neutrosophic Sets, Multispace and Multistructure 4, 2010, pp. 410-413.
- [8] <http://fs.gallup.unm.edu/NSS>
- [9] A. Thamaraiselvi and R.Santhi, A New Approach for Optimization of Real Life Transportation Problems in Neutrosophic Environment, Mathematical Problems in Engineering,2016, 9 pages.
- [10] P. Chi and P. Liu, An extended TOPSIS method for the multiple attribute decision making problems based on interval neutrosophic set, Neutrosophic Set and Systems,1, 2013, pp. 1-8.
- [11] P. Jayagowri and G. Geetha Ramani, Using Trapezoidal Intuitionistic Fuzzy Number to Find Optimized Path in a Network, Volume 2014, Advances in Fuzzy Systems, 2014, 6 pages.
- [12] A. Kumar and M. Kaur, A New Algorithm for Solving Shortest Path Problem on a Network with Imprecise Edge Weight, Applications and Applied Mathematics, Vol. 6, Issue 2, 2011, pp. 602 – 619.
- [13] A. Kumar, and M. Kaur, Solution of fuzzy maximal flow problems using fuzzy linear programming. World Academy of Science and Technology. 87: 28-31, (2011).
- [14] S. Majumder and A. Pal, Shortest Path Problem on Intuitionistic Fuzzy Network, Annals of Pure and Applied Mathematics, Vol. 5, No. 1, November 2013, pp. 26-36.
- [15] S. Okada and M. Gen, Fuzzy shortest path problems, Computers and Industrial Engineering, vol 27, N1-4, 1994, pp.465-468.
- [16] E.W.Dijkstra, A note on two problems in connexion with graphs, Numerische Mathematik, 11959, pp. 269-271.
- [17] S. Broumi, M. Talea, A. Bakali, F. Smarandache, Single Valued Neutrosophic Graphs, Journal of New Theory, N 10, 2016, pp. 86-101.
- [18] S. Broumi, M. Talea, A. Bakali, F. Smarandache, On Bipolar Single Valued Neutrosophic Graphs, *Journal of New Theory*, N11, 2016, pp.84-102.
- [19] S. Broumi, M. Talea, A. Bakali, F. Smarandache, Interval Valued Neutrosophic Graphs, (2016) in press.
- [20] S. Broumi, A. Bakali, M. Talea, and F. Smarandache, Isolated Single Valued Neutrosophic Graphs. Neutrosophic Sets and Systems, Vol. 11, 2016, pp.74-78
- [21] S. Broumi, F. Smarandache, M. Talea and A. Bakali, An Introduction to Bipolar Single Valued Neutrosophic Graph Theory. Applied Mechanics and Materials, vol.841, 2016, 184-191.
- [22] S. Broumi, M. Talea, F. Smarandache and A. Bakali, Single Valued Neutrosophic Graphs: Degree, Order and Size, 2016 IEEE International Conference on Fuzzy Systems (FUZZ), 2016, pp.2445-2451
- [23] F. Smarandache, Symbolic Neutrosophic Theory, Europeanova asbl, Brussels, 2015, 195p.
- [24] S. Broumi, Bakali, M. Talea, and F. Smarandache, A Computation of Shortest Path Problem in a Network with Single Valued Neutrosophic Number Based on Ranking Method, 2016 (submitted)
- [25] S. Broumi, A. Bakali, M. Talea and F. Smarandache, M. Ali, Shortest Path Problem Under Bipolar Neutrosophic Setting, 2016 (submitted).
- [26] S. Broumi, A. Bakali M. Talea, F. Smarandache, and, Shortest Path Problem Under Interval Valued Neutrosophic Setting , 2016 (submitted)
- [27] N.Bhatia, Algorithms for Some Fuzzy Network Problems Using Ranking Function, (master Thesis, Thapar university Patiala-147004(PUNJAB), School of Mathematics and Computer Applications, 2009.

CSP and “omics” Technology Applied on Versatile and Intelligent Portable Platform for Modeling Complex Bio-Medical Data

Luige Vladareanu, Mihaiela Ilescu, Hongbo Wang, Feng Yongfei, Victor Vladareanu, Hongnian Yu, Florentin Smarandache

Luige Vladareanu, Mihaiela Ilescu, Hongbo Wang, Feng Yongfei, Victor Vladareanu, Hongnian Yu, Florentin Smarandache (2016). CSP and “omics” Technology Applied on Versatile and Intelligent Portable Platform for Modeling Complex Bio-Medical Data. Proceedings of the 2016 International Conference on Advanced Mechatronic Systems, Melbourne, Australia, 6

Abstract - This paper presents relevant aspects of the idea of using the digital medicine in cancer, so that to shape a viable strategy for creating and implementing an interactive digital platform, NEO-VIP, that should be the basic support to design the strategy for integration of basic, clinical and environmental research on neoplasia progression to cancer. The two main components of the VIPRO Platform are represented by the workstation “Engineering Station” for CPS (Cyber Physical System) and “omics” technology and by the “Graphical Station” for the development of a virtual mechatronic system environment and virtual reality for system components' motion. The NEO-VIP Platform will consolidate the collaboration of specialized institutions in IT, medicine, health, life standards so that to enhance their capabilities to work as a consortium. The results lead to the possibility developing NEO-VIP Platform in the IT modelling field, applied on bio-medical data, as a new player alongside with the existing ones. So, new improved methodologies for investigating social implications of machines working with and for people will be applied.

Keywords—*intelligent control systems; cyber physical system, “omics” technology; modelling system; virtual reality; digital medicine in cancer*

I. INTRODUCTION

In recent years the identification of missing information/links/principles on different biological, medical, and organizational levels regarding carcinogenesis and possible solutions for designing an integrative platform able to use the data and merge, complement and develop in a transformative approach the high impacting tools have gained attention among the research community [1-3], but also in manufacturing industry, resulting in an outstanding development in terms of hardware and software [4-6].

According to the World Health Organization (WHO) report “Health in 2015: from MDGs to SDGs”, cancer is a leading cause of death worldwide and accounted for 8.2 million deaths (22% of all non-communicable disease deaths) in 2012. The emergence of this disease is caused by molecular, genetic,

epigenetic alterations and environmental factors that favor neoplasia. Cancer incidence and mortality increase with age, and both the absolute number and the percentage of the population that is older are increasing in all regions of the globe. Dealing with a context characterized by ageing populations, rapid urbanization and globalization of markets that promote inactivity and unhealthy diets is a priority for WHO that will focus on the development and implementation of strong national plans that emphasize prevention and treatment access for all [7, 8].

The paper main objective is that of supporting the use of digital medicine in cancer, so that to shape a viable strategy for creating and implementing an interactive digital platform that should be the basic support, to design the strategy for integration of basic, clinical and environmental research on neoplasia progression to cancer.

The paper main objective supporting the use of digital medicine in cancer, is to shape a viable strategy for creating and implementing an interactive digital platform, and to design the strategy to integrate basic, clinical and environmental research on neoplasia progression to cancer and use the support of the NEO-VIP platform, by developing of the VIPRO Platform [9-11], to progress beyond the state of art.

A lot of initiatives were launched in the last decade in the purpose of coordinating research projects that have the common aim to elucidate comprehensively mainly the genomic changes present in many forms of cancers. One of these initiatives, the International Cancer Genome Consortium (ICGC) was launched in 2010 [12] with the scope to generate comprehensive database of genomic abnormalities (somatic mutations, abnormal expression of genes, epigenetic modifications) in tumors from 50 different cancer types and/or subtypes which are of clinical and societal importance and make the data available to the entire research community.

In United States exists a wide interest in developing databases on different types of cancers that would be fit to be connected and explored by a the new integrative NEO-VIP Platform presented in paper. The NAR Database (https://www.oxfordjournals.org/our_journals/nar/database/subcat/8/33) provides a summary of the most known and used databases grouped on categories addressing to genomic, transcriptomic, and proteomic-field, and also library databases on several others domains.

Most of existing databases are "niche specific" and an represent integration approach of different "omics" with suggestions for treatment or adequate nutrition to minimize the risks of cancer development , so this is why they might be very useful for clinical practice and ultimately to the patients. To the best of our knowledge, none of the existing databases focus on

the early detection of neoplastic transformation and none of them relates to the prevention.

The innovative NEO-VIP platform, developed as open architecture system and adaptive networks integrates Future Internet Systems vision enabling: cyber-physical systems by adaptive networks, intelligent network control systems, human in the loop principles, data mining, big data, intelligent control interfaces, network quality of service, shared resources and distributed server network - remote control and e-learning users by interconnected global clouds. Based on all the above, the challenges and, therefore, expected progress of NEO-VIP are its ability to be interactive, integrated and competitive with scientific research DMC (Digital Medicine for Cancer) platforms such as ICGC Data Portal, TCGA Data Portal, NCI Genomic Data Commons (GDC) thus supporting the ITfoM (IT Future of Medicine) concepts.

II. CSP AND OMICS TECHNOLOGY APLLIED ON NEO-VIP PLATFORM

NEO-VIP is extendable for integration, testing and experimenting clinical research on neoplasia progression through building an open architecture system and adaptive networks, combining the expertise of a team of specialists in biomedical engineering, electronics, mathematics, computer sciences with the expertise of a diverse group of researchers in different oncologic specialties (hematologic, head and neck, breast, hepatic, gastric, pancreatic, lung, cervical), immunology, pharmacogenomics. NEO-VIP will facilitate new ways to corroborate data to produce predictive models of neoplastic transformation and prevention and nucleate scientific groups that will be able to answer the extremely complex problems posed by oncogenesis. The computational platform NEO-VIP developed in this project is based on the virtual projection method [9, 13- 15].

Human remotely controlled intelligent networks, are estimated to have an increasingly significant role in events that could put at risk human lives. This is why, the development of an Interactive and Versatile Intelligent Portable Platform, NEO-VIPP is of high benefit. This platform should be able to integrate clinical research on neoplasia progression to cancer and fit these data in predictive patterns of oncogenesis. Nowadays neoplasia research encounters some barriers that prevent researchers from completely exploring all the genomic data available, thus impeding progress. Some of these weaknesses are mentioned next

- Neoplasia data that would be available from various projects, clinical trials, and neoplasia tests are stored on various media with secured management systems, for accessing these data.

- Neoplasia data are many times generated by different methods, so that even if two different datasets are explored, the researcher cannot use both in the same time
- Large size of datasets files, difficult access to efficient storage media and specific software represent a barriers for researchers to get efficient knowledge and information.

The Versatile, Intelligent, Portable NEO-VIPP platform breaks down these barriers by bringing neoplasia progression datasets and associated clinical data into one location that any researcher may access, and “harmonizing” the data so that datasets that were generated with different protocols can be studied side by side. These data are available by modern computing and network technology, so that NEO-VIPP enables any researcher to study, search and ask new and fundamental questions about cancer.

As foster of large scale cooperation at the European level is the development of an e-learning and remote-control platform that should enable community interested in the topic and long-term plans to further develop research and innovation. This, in fact, is the tool of ensuring the ability of continuously learning, adapting and improving in “real world” complex environments, modeling in real time the information gathered by “omics” technologies, clinical, imaging so as to provide support in “big data” management and development of international clusters able to process the information in an unifying vision. This way, networking activities will be in good balance with scientific

and technical activities contributing equally to advance the scientific research and to improve people life by prevention of neoplasia progression to cancer.

The VIPRO architecture for humanoid and cooperative robots [9, 11], is extendable for integration, testing and experimenting clinical research on neoplasia progression through building an open architecture system and adaptive networks over the classic control system, as shown in Figure 1. The virtual platform developed and extended, NEO-VIPP, is the tool for transforming data in knowledge on oncogenesis and use it in personalized/precision medicine. The need to manage all behaviours and interactions is solved by developing a new interface for intelligent control based on advanced control strategies, such as extended control (Extenics), neutrosophic control, human adaptive mechatronics, implemented by high speed processing IT&C techniques in real time communication for a high amount of data processing, including a remote control & e-learning component and an adaptive networked control. This will allow the development of new methodologies, evaluation metrics, test platforms, reproducibility of experiments, novel approaches to academia-industry co-operation for enabling disruptive product and process innovation and last but not least an inter-academic network for research and modeling complex bio-medical data for neoplasia early diagnosis of progression and management towards personalized medicine.

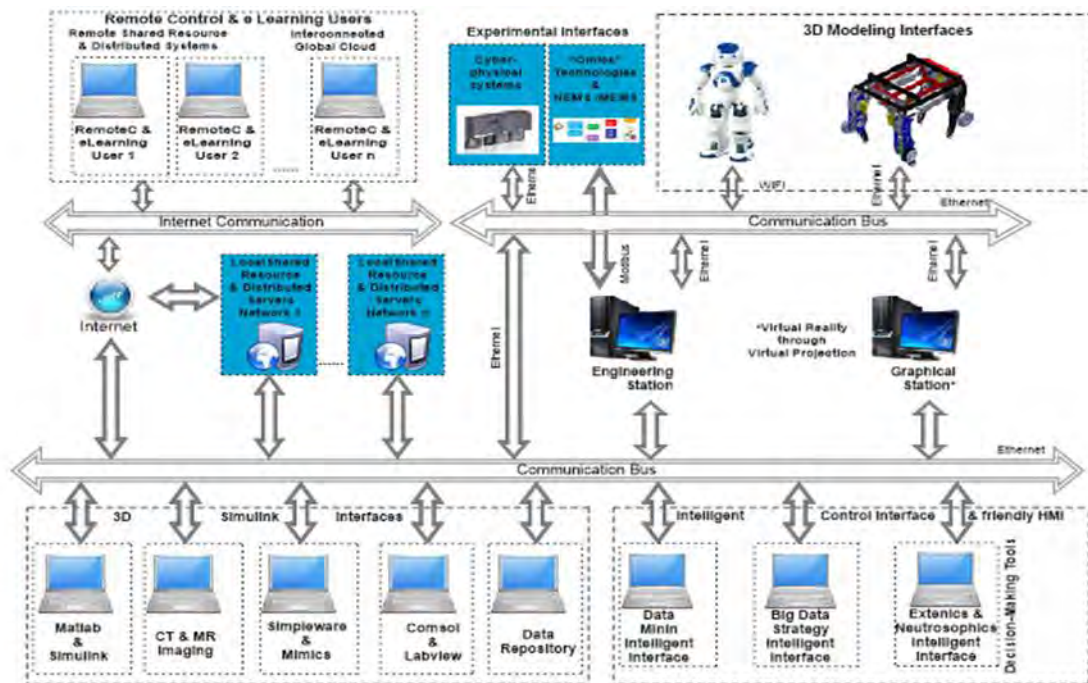

Fig. 1. Architecture of the NEO-VIP Platform

The NEO-VIPP innovative platform will be competitive with other similar DMC virtual application platforms, ICGC Data Portal, TCGA Data Portal, NCI Genomic Data Commons (GDC), or the powerful worldwide platforms for CAD applications (SolidWorks), medical imaging reconstruction (Simpleware, Mimics), multiphysics numerical modeling (Comsol), mathematical and biomedical modeling (Matlab+Simulink, Mathematica), virtual instrumentation and measurements (Labview), or virtual reality environment (Coreograph, Webot, USARSIM, V-RAP), but additionally to these platforms, it enables the design, test and experimentation by intelligent control methods in real time integrating classical control in modelling and simulation [16-18].

The VIPRO Platform architecture for modelling and simulation of mobile robots is based on the virtual projection method, through which robotics and mechatronics systems are developed in a virtual environment.

The technical solution, presented in an open architecture real time control structure, contains the main modules of the VIPRO Platform. The intelligent control interface module uses advanced control strategies adapted to the research environment such as research data mining, big data or decision control through extenics [19-20], neutrosophic logics control [21-23], etc., implemented through computational techniques for fast processing and real time communication. The following intelligent control interfaces have been designed and implemented on the NEO-VIP Platform: data mining intelligent interface, big data strategy intelligent interface, extenics & neutrosophic intelligent interface.

The two main components of the VIPRO Platform are represented by the workstation “Engineering Station” for CPS (Cyber Physical System) and “omics” Technology and by the “Graphical Station” for the development of a virtual robot environment and virtual reality for system motion.

The NEO-VIP Platform has allotted 5 user stations dedicated to simulation using data repository, Comsol & Labview, Simpleware & Mimics, CT&MR Imaging or Matlab & Simulink.

For remote control in establishing the e-learning component of the NEO-VIP Platform, a PC server was integrated to ensure large data traffic for internet communication, with two addition workstations for end-user applications.

The “Engineering Station” component is mainly aimed at integrating the AC500 development environment for programmable automate (PLC) applications, control of the CPS application through the virtual projection method and decision testing of the intelligent neutrosophic control, extenics control, and dynamic hybrid force position control DHFPC interfaces.

After testing, these are integrated in real-time control of a new CPS or “omics” technology with improved system performance through the Graphical Station, as follows: for multi-users through the components of the NEO-VIP Platform consisting of Remote_Control & eLearning_User1, Remote_Control&eLearning_User2 or individually through the NEO-VIP Platform components consisting of the dedicated intelligent interfaces on the Notebook workstations, namely simulation by data repository, Comsol_ & Labview, Simpleware_ & Mimics, CT&MR Imaging or Matlab_ & Simulink or intelligent interfaces: neutrosophic, extenics and DHFPC interfaces.

NEO-VIPP is an innovative platform which makes the difference from existing ones in that it is the only one which ensures real-time testing and experimentation on its own real time control system and adaptive networked control for remote users through e-learning & remote communication in addition to the design, modelling and simulation facilitated by scientific research platforms such as ICGC Data Portal, TCGA Data Portal, NCI Genomic Data Commons (GDC), being integrated into the DMC platforms ~~through~~ using the ITfoM (IT Future of Medicine) concepts.

The NEO-VIPP platform is more than just a data repository; it will continue to evolve by encouraging scientists to submit the data for early diagnosis of **neoplasia** progression from their own investigations. When researchers submit data to the NEO-VIPP, they will be able to access and, analyze all NEO-VIPP available datasets in neoplasia, while further expanding these resources to the cancer research community.

The NEO-VIPP will also house data from a new era of NCI programs that will sequence the DNA of patients enrolled in clinical trials. These datasets will lead to a much deeper understanding of which therapies are most effective for individual neoplasia patients. There is also to be developed an interface to e-Health Literacy that ensures that data and results from NEO_VIPP will be accessed, explored and applied by all interested people.

Each new datasets entry to NEO-VIPP will evolve into a smarter, more comprehensive knowledge base that will foster important achievements in neoplasia research. It will increase the success of neoplasia early diagnosis and management, basically from Virtual Patient” health models to personalized cancer treatment.

Personalized treatment may benefit of using reliable biomedical numerical models concerning patient-specific, morphologically realistic computational domains (built out of medical MRI, CT, PET, Doppler, etc. images) that present detailed and accurate virtualizations of organs, tissues or regions of interest (ROI) that may produce results, which can

be checked against experimental data. Along this path, medication delivery through existing or yet to be accepted techniques (*e.g.*, magnetic drug targeting, general or localized hyperthermia) may be explored.

III. RESULTES AND CONCLUSIONS

NEO-VIP Platform aims to demonstrate and validate the usability and benefit of DMC in healthcare as well as to enable stockholders to adopt and implement models, strategy and the platform.

The platform represent a tool and a warrant of sustainable learning, testing, adjusting and improving in “real world” various complex environments, mining data gathered from H2020 research programs such as FET (Future and Emerging Technologies) and HDCW (Health, Demographic Change and Wellbeing). It should also enable real time modeling of the information got from “omics” technologies, validation by multinational and multidisciplinary scientists work, appropriate link with various medical, imaging, environmental exposure data, in predictive patient treatment algorithms and strategies for patient management.

New enabling methodologies, and techniques, relying inclusively on medical physics, statistical and applied mathematics (methods, protocols and algorithms, implementation; procedures for data mining; procedures for exploring, handling and connecting big data, etc.), and biomedical engineering, developed by NEO-VIP Platform, may be needed to provide the patient-related approach in DMC.

To provide the patient-related approach in Digital Medicine for Cancer, the NEO_VIPP platform would represent a reliable tool for providing vital support to “big data” management so that data processing in an unified vision to be ensured.

The platform aims to bring high value and positive impact on accessing, exploring and management of impressive amount of data generated by research prevention, detection, treatment and management of neoplasia and its associated diseases. Establishing original links, by the NEO-VIP Platform, between novel genomic alterations in oncogenesis, is estimated to make possible the identification of new, relevant biomarkers and, consequently to indicate new ways of cancer therapy.

At the same time, NEO-VIP Platform allows in a dynamic way, our understanding of the causes and mechanisms underlying healthy ageing and disease, providing opportunity an approach for multiscale modeling in real time the information gathered by “omics” technologies, clinical, imaging, nutritional, and environmental exposure data, in predictive algorithms and personalized strategies for patient management, completing and increasing the impact of the existing initiatives in disease prevention, detection, treatment and management.

Multidisciplinary, large scale cooperation in the development and implementation of the NEO_VIP Platform, will establish a nucleus of competence that will integrate various specialists (biomedical engineers, mathematicians, biochemists, biologists, physicians, bio-physicists, etc.) and will deliver coherent recommendations for implementing this interactive platform. So, through the networking activities will increase the awareness of all stakeholders, including healthcare professionals and patients. The NEO-VIP Platform will consolidate the collaboration of the specialized institutions in IT, medicine, health, life standards so that to enhance their capabilities to work as a consortium.

This will lead VIP Platform to be integrated in the IT modelling field as a new player alongside with the existing ones. The NEO-VIP knowledge transfer facility aims to achieve a strategic, sustainable and long-term partnership (pole of excellence) that will improve the theoretical, technical and best practices of researchers in the EU and worldwide on neoplasia progression. So, new improved methodologies for investigating social implications of machines working with and for people will be applied.

ACKNOWLEDGMENT

This work was developed with the support of MEN-UEFISCDI, PN-II-PT-PCCA-2013-4, VIPRO project No.009/2014, Romanian Academy, “Joint Laboratory of Intelligent Rehabilitation Robot” collaborative research agreement between Romanian Academy by IMSAR and Yanshan University, China and of Ministry of Science and Technology of the People's Republic of China, MOST of PRC, STAP-DC project No. KY201501009.

REFERENCES

- [1] Vucic EA, Thu KL, Robison K, Rybaczyk LA, Chari R, Alvarez CE, Lam WL, “Translating cancer 'omics' to improved outcomes”. *Genome Res.*2012,doi:10.1101/gr.124354.111.
- [2] Csermelya P, Korcsmárosa T, Kissa HJM, Londond G, Nussinove R, “Structure and dynamics of molecular(networks: A novel paradigm of drug discovery, A comprehensive review”, *Pharmacology & Therapeutics*, 2013, 138, 333–408.
- [3] Alyass A, Turcotte M, Meyre D, “From big data analysis to personalized medicine for all: challenges and opportunities”, *BMC Medical Genomics*, 2015, 8:33.
- [4] Robin R. Murphy, “Human-Robot Interaction in Rescue Robotics”, *IEEE Trans on Systems, Man, and Cybernetics, Part C*, vol.34, no. 2, pp.138-158.
- [5] Marina Shitikova, Luige Vladareanu, Claudio Guarnaccia, „Recent advances in mechanical engineering”, WSEAS Press, 2014, pg.207-2014, ISBN ISBN: 978-960-474-402-2
- [6] Stanescu, Aurelian Mihai, Dragos Repta, Mihnea Alexandru Moisescu, Ioan Stefan Sacala, and Monika Benea. "Towards a Generic Enterprise Systems Architecture Based on Cyber-Physical Systems Principles." In *Collaborative Systems for Smart Networked Environments*, IFIP Advances in Information and Communication Technology Volume 434,

- 2014, pp 245-252, Springer Berlin Heidelberg, 2014, DOI 10.1007/978-3-662-44745-1_24, Print ISBN 978-3-662-44744-4, Online ISBN 978-3-662-44745-1
- [7] European Commission Horizon 2020 Work Programme 2016 –2018. Health, Demographic Change (and Wellbeing).
- [8] World Health Organization (WHO), the International Agency for Research on Cancer (IARC), United Nations (UN) Non communicable Diseases ((NCD) Interagency taskforce “Global Action Plan for the prevention and control of non communicable Diseases 2013-2020”
- [9] Vladareanu L., Velea L.M., Munteanu R.I, Curaj A., Cononovici S., Sireteanu T., Capitanu L., Munteanu M.S., “Real time control method and device for robots in virtual projection”, patent EPO-09464001, 18.05.2009, EP2105263. Patent OSIM 123527/30.04.2013.
- [10] Victor Vladareanu, Radu I. Munteanu, Ali Mumtaz, Florentin Smarandache and Luige Vladareanu, “The optimization of intelligent control interfaces using Versatile Intelligent Portable Robot Platform”, *Procedia Computer Science* 65 (2015): 225 – 232, ELSEVIER, www.sciencedirect.com, doi:10.1016/j.procs.2015.09.115.
- [11] Victor Vladareanu, Ioan Dumitrache, Luige Vladareanu, Ioan Stefan Sacala, Gabriela Tonț, Mihnea Alexandru Moisescu “Versatile Intelligent Portable Robot Platform applied to dynamic control of the walking robots”, *Studies in Informatics and Control* 24(4):409-418 • December 2015, ISSN: 1220 – 1766.
- [12] International network of cancer genome projects. *Nature* 2010, 464, 993-998
- [13] Victor Vladareanu, Paul Schiopu, Mingcong Deng, Hongnian Yu „Extended control of walking motion for use in an autonomous robot platform”, ” *International Journal of Advanced Mechatronic Systems*, Vol.6, No.4, 2015, pg.137 – 146, Print ISSN: 1756-8412, Online ISSN: 1756-8420, DOI: 10.1504/IJAMECHS.2015.072697, Publisher Inderscience Publishers (IEL) 2015
- [14] Vladareanu, L., Spirleanu, Cristian ; Iliescu, Mihaiela ; Yu, Hongnian ; Deng, Mingcong ; Guo, Weizhong ; Gao, Feng, „Versatile Intelligent Portable Robot Platform for flexible robotic cells with AGV”, *Advanced Mechatronic Systems (ICAMechS)*, 2015 International Conference on, 22-24 Aug. 2015, Beijing, China, pg. 42 – 49, DOI: 10.1109/ICAMechS.2015.7287126, INSPEC Accession Number: 15501965, Publisher: IEEE, 2015.
- [15] Vladareanu, Victor, Corina Boscoianu, Radu I. Munteanu, Hongnian Yu, and Luige Vladareanu. "Dynamic Control of a Walking Robot Using the Versatile Intelligent Portable Robot Platform." *Control Systems and Computer Science (CSCS)*, 2015 20th International Conference on, Print ISBN: 978-1-4799-1779-2, pp. 38-45, DOI: 10.1109/CSCS.2015.48, INSPEC Accession Number: 15397713, Publisher IEEE
- [16] S. van Noort and A. Visser, "Validation of the dynamics of an humanoid robot in USARSim", *Proceedings of the Performance Metrics for Intelligent Systems Workshop (PerMIS'12)*, (Edited by Rajmohan Madhavan, Elena R. Messina and Brian A. Weiss), NIST Special Publication 1136, pp. 190-197, National Institute of Standards and Technology, November 2012
- [17] S.B. Balakirsky and Z. Kootbally, "USARSim/ROS: A Combined Framework for Robotic Control and Simulation", *Proceedings of the ASME 2012 International Symposium on Flexible Automation (ISFA 2012)*, St. Louis, June 18-20, 2012.
- [18] J. Alemany, "Design of high quality, efficient simulation environments for USARSim", *Technical Report ICC 2011-10-01*, Universitat Jaume I, Castello, Spain, October 2011.
- [19] Vladareanu V., Şchiopu P., Vladareanu L., *Theory And Application Of Extension Hybrid Force-Position Control in Robotics*, U.P.B. Sci. Bull., Series A, Vol. 76 (3), 2014, pg.43-54, ISSN 1223-7027
- [20] Smarandache Florentin, “Extenics in Higher Dimensions, Institute of Extenics and Innovation Methods”, Guangdong University of Technology, ISBN: 9781599732039
- [21] Smarandache F., Vladareanu L., “Applications of Neutrosophic Logic to Robotics - An Introduction”, *The 2011 IEEE International Conference on Granular Computing Kaohsiung, Taiwan*, Nov. 8-10, 2011, pp. 607-612, ISBN 978-1-4577-0370-6
- [22] Şandru Ovidiu Ilie, Luige Vladareanu, Paul Şchiopu, Victor Vlădareanu, Alexandra Şandru, “Multidimensional Extenics Theory”, U.P.B. Sci. Bull., Series A, Vol. 75, Iss. 1, 2013, pg.3-12, ISSN 1223-7027
- [23] Luige Vladareanu, Cai Wen, R.I. Munteanu, Yan Chuyan, Li Weihua, F. Smarandache, Alexandru Gal “Method and Device for Hybrid Force-Position extended control of robotic and mechatronic systems”, Patent: OSIM A2012 1077/28.12.2012.

Computation of Shortest Path Problem in a Network with SV-Trapezoidal Neutrosophic Numbers

Said Broumi, Assia Bakali, Mohamed Talea, Florentin Smarandache, Luige Vladareanu

Said Broumi, Assia Bakali, Mohamed Talea, Florentin Smarandache, Luige Vladareanu (2016).
Computation of Shortest Path Problem in a Network with SV-Trapezoidal Neutrosophic Numbers.
Proceedings of the 2016 International Conference on Advanced Mechatronic Systems, Melbourne,
Australia, 5

Abstract— In this work, a neutrosophic network method is proposed for finding the shortest path length with single valued trapezoidal neutrosophic number. The proposed algorithm gives the shortest path length using score function from source node to destination node. Here the weights of the edges are considered to be single valued trapezoidal neutrosophic number. Finally, a numerical example is used to illustrate the efficiency of the proposed approach

Keywords— *Single valued trapezoidal neutrosophic number; Score function; Network; Shortest path problem.*

I. INTRODUCTION

In 1998, the concept of the neutrosophic set (NS for short) and neutrosophic logic were introduced by Smarandache in [1, 2] in order to efficiently handle the indeterminate and inconsistent information in real world. Neutrosophic set is a generalization of the theory of fuzzy set [3], intuitionistic fuzzy sets [4], interval-valued fuzzy sets [5] and interval-valued intuitionistic fuzzy sets [6]. The concept of the neutrosophic set is characterized by a truth-membership degree (t), an indeterminacy-membership degree (i) and a falsity-membership degree (f) independently, which are within the real standard or nonstandard unit interval $]0, 1[$. However, the neutrosophic theory is difficult to be directly applied in real scientific and engineering areas. To easily use it in science and engineering areas, Wang et al. [7] proposed the concept of SVNNS, which is an instance of a neutrosophic set, whose functions of truth, indeterminacy and falsity lie in $[0, 1]$. Recent research works on neutrosophic set theory and its applications in various fields are progressing rapidly [8].

Recently, based on the neutrosophic set theory, Subas [9] presented the concept of triangular and trapezoidal neutrosophic numbers and applied to multiple-attribute decision making problems. Then Biswas et al [10] presented a special case of trapezoidal neutrosophic numbers and applied to multiple-attribute decision making problems by introducing the cosine similarity measure. Deli and Subas [11] presented the single valued trapezoidal neutrosophic numbers (SVN-numbers) as a generalization of the intuitionistic trapezoidal fuzzy numbers and proposed a methodology for solving multiple-attribute decision making problems with SVN-numbers. In addition, Thamaraiselvi and Santhi [12] introduced a mathematical representation of a transportation problems in neutrosophic environment based on single valued trapezoidal neutrosophic numbers and also provided the solution method.

The shortest path problem (SPP) is one of the most fundamental and well-known combinatorial problems that appear in various fields of science and engineering, e.g. road networks application, transportation, routing in communication channels and scheduling problems. The main objective of the shortest path problem is to find a path with minimum length between any pair of vertices. The edge (arc) length of the network may represent the real life quantities such as, time, cost, etc. In a classical shortest path problem, the distances of the edge between different nodes of a network are assumed to be certain. Numerous algorithms have been developed with the weights on edges on network being fuzzy numbers, intuitionistic fuzzy numbers, vague numbers [13-16].

Recently, Broumi et al. [17-22] presented the concept of neutrosophic graphs, interval valued neutrosophic graphs and bipolar single valued neutrosophic graphs. To this day, only a few papers dealing with shortest path problem in neutrosophic environment. The paper proposed by Broumi et al. [23] is one of the first on this subject. The authors proposed an algorithm for solving neutrosophic shortest path problem based on score function. The same authors [24] proposed another algorithm for solving shortest path problem in a bipolar neutrosophic environment. Also, in [25] they proposed the shortest path algorithm in a network with its edge lengths as interval valued neutrosophic numbers.

The goal of this work is to propose an approach for solving shortest path problem in a network where edge weights are characterized by a single valued trapezoidal neutrosophic numbers .

In order to do, the paper is organized as follows: In Section 2, we review some basic concepts about neutrosophic sets, single valued neutrosophic sets and single valued trapezoidal neutrosophic sets. In Section 3, we propose some modified operations of single valued trapezoidal neutrosophic numbers. In section 4, a network terminology is presented, In section 5, we propose an algorithm for finding the shortest path and shortest distance in single valued trapezoidal neutrosophic graph. In section 6, we illustrate a practical example which is solved by the proposed algorithm. Finally, some concluding remarks are presented in section 7.

II. PRELIMINARIES

In this section, some basic concepts and definitions on neutrosophic sets, single valued neutrosophic sets and single valued trapezoidal neutrosophic sets are reviewed from the literature.

Definition 2.1 [1]. Let X be a space of points (objects) with generic elements in X denoted by x ; then the neutrosophic set A (NS A) is an object having the form $A = \{ \langle x: T_A(x), I_A(x), F_A(x) \rangle, x \in X \}$, where the functions $T, I, F: X \rightarrow]0, 1^+[$ define respectively the truth-membership function, an indeterminacy-membership function, and a falsity-membership function of the element $x \in X$ to the set A with the condition:

$$0 \leq T_A(x) + I_A(x) + F_A(x) \leq 3^+ \quad (1)$$

The functions $T_A(x), I_A(x)$ and $F_A(x)$ are real standard or nonstandard subsets of $]0, 1^+[$.

Since it is difficult to apply NSs to practical problems, Wang et al. [7] introduced the concept of a SVNS, which is an instance of a NS and can be used in real scientific and engineering applications.

Definition 2.2 [7]. Let X be a space of points (objects) with generic elements in X denoted by x . A single valued neutrosophic set A (SVNS A) is characterized by truth-membership function $T_A(x)$, an indeterminacy-membership

function $I_A(x)$, and a falsity-membership function $F_A(x)$.

For each point x in X $T_A(x), I_A(x), F_A(x) \in [0, 1]$. A SVNS A can be written as

$$A = \{ \langle x: T_A(x), I_A(x), F_A(x) \rangle, x \in X \} \quad (2)$$

Definition 2.3 [11]. A single valued trapezoidal neutrosophic number (SVTN-number) $\tilde{a} = \langle (a_1, b_1, c_1, d_1); T_a, I_a, F_a \rangle$ is a special neutrosophic set on the real number set R , whose truth membership, indeterminacy-membership, and a falsity-membership are given as follows

$$T_a(x) = \begin{cases} \frac{(x - a_1)T_a}{(b_1 - a_1)} & (a_1 \leq x \leq b_1) \\ T_a & (b_1 \leq x \leq c_1) \\ \frac{(d_1 - x)T_a}{(d_1 - c_1)} & (c_1 \leq x \leq d_1) \\ 0 & \text{otherwise} \end{cases} \quad (3)$$

$$I_a(x) = \begin{cases} \frac{(b_1 - x + I_a(x - a_1))}{(b_1 - a_1)} & (a_1 \leq x \leq b_1) \\ I_a & (b_1 \leq x \leq c_1) \\ \frac{(x - c_1 + I_a(d_1 - x))}{(d_1 - c_1)} & (c_1 \leq x \leq d_1) \\ 1 & \text{otherwise} \end{cases} \quad (4)$$

$$F_a(x) = \begin{cases} \frac{(b_1 - x + F_a(x - a_1))}{(b_1 - a_1)} & (a_1 \leq x \leq b_1) \\ F_a & (b_1 \leq x \leq c_1) \\ \frac{(x - c_1 + F_a(d_1 - x))}{(d_1 - c_1)} & (c_1 \leq x \leq d_1) \\ 1 & \text{otherwise} \end{cases} \quad (5)$$

Where $0 \leq T_a \leq 1; 0 \leq I_a \leq 1; 0 \leq F_a \leq 1$ and

$$0 \leq T_a + I_a + F_a \leq 3; a_1, b_1, c_1, d_1 \in R$$

Definition 2.3 [11]. Let $\tilde{A}_1 = \langle (a_1, a_2, a_3, a_4); T_1, I_1, F_1 \rangle$ and $\tilde{A}_2 = \langle (b_1, b_2, b_3, b_4); T_2, I_2, F_2 \rangle$ be two single valued trapezoidal neutrosophic numbers. Then, the operations for SVTN-numbers are defined as below;

(i) $\tilde{A}_1 \oplus \tilde{A}_2 = \langle (a_1 + b_1, a_2 + b_2, a_3 + b_3, a_4 + b_4); \min(T_1, T_2), \max(I_1, I_2), \max(F_1, F_2) \rangle$ (6)

(ii) $\tilde{A}_1 \otimes \tilde{A}_2 = \langle (a_1 b_1, a_2 b_2, a_3 b_3, a_4 b_4); \min(T_1, T_2), \max(I_1, I_2), \max(F_1, F_2) \rangle$ (7)

(iii) $\lambda \tilde{A}_1 = \langle (\lambda a_1, \lambda a_2, \lambda a_3, \lambda a_4); \min(T_1, T_2), \max(I_1, I_2), \max(F_1, F_2) \rangle$ (8)

A convenient method for comparing of single valued trapezoidal neutrosophic number is by use of score function.

Definition 2.4 [11]. Let $\tilde{A}_1 = \langle (a_1, a_2, a_3, a_4); T_1, I_1, F_1 \rangle$ be a single valued trapezoidal neutrosophic number. Then, the score function $s(\tilde{A}_1)$ and accuracy function $a(\tilde{A}_1)$ of a SVTN-numbers are defined as follows:

$$(i) s(\tilde{A}_1) = \left(\frac{1}{12}\right) [a_1 + a_2 + a_3 + a_4] \times [2 + T_1 - I_1 - F_1] \quad (9)$$

$$(ii) a(\tilde{A}_1) = \left(\frac{1}{12}\right) [a_1 + a_2 + a_3 + a_4] \times [2 + T_1 - I_1 + F_1] \quad (10)$$

Definition 2.5 [11]. Let \tilde{A}_1 and \tilde{A}_2 be two SVTN-numbers the ranking of \tilde{A}_1 and \tilde{A}_2 by score function is defined as follows:

- (i) If $s(\tilde{A}_1) < s(\tilde{A}_2)$ then $\tilde{A}_1 < \tilde{A}_2$
- (ii) If $s(\tilde{A}_1) = s(\tilde{A}_2)$ and if
 - (1) $a(\tilde{A}_1) < a(\tilde{A}_2)$ then $\tilde{A}_1 < \tilde{A}_2$
 - (2) $a(\tilde{A}_1) > a(\tilde{A}_2)$ then $\tilde{A}_1 > \tilde{A}_2$
 - (3) $a(\tilde{A}_1) = a(\tilde{A}_2)$ then $\tilde{A}_1 = \tilde{A}_2$

III. ARITHMETIC OPERATIONS BETWEEN TWO SINGLE VALUED TRAPEZOIDAL NEUTROSOPHIC NUMBERS

In this subsection, we make a slight modification of the operations between single valued trapezoidal neutrosophic numbers proposed by Deli and Subas [11], required for the proposed algorithm.

Let $\tilde{A}_1 = \langle (a_1, a_2, a_3, a_4); T_1, I_1, F_1 \rangle$ and $\tilde{A}_2 = \langle (b_1, b_2, b_3, b_4); T_2, I_2, F_2 \rangle$ be two single valued trapezoidal neutrosophic number. Then, the operations for SVTNNs are defined as below;

$$(i) \tilde{A}_1 \oplus \tilde{A}_2 = \langle (a_1 + b_1, a_2 + b_2, a_3 + b_3, a_4 + b_4); T_1 + T_2 - T_1 T_2, I_1 I_2, F_1 F_2 \rangle \quad (11)$$

$$(ii) \tilde{A}_1 \otimes \tilde{A}_2 = \langle (a_1 b_1, a_2 b_2, a_3 b_3, a_4 b_4); T_1 T_2, I_1 + I_2 - I_1 I_2, F_1 + F_2 - F_1 F_2 \rangle \quad (12)$$

$$(iii) \lambda \tilde{A}_1 = \langle (\lambda a_1, \lambda a_2, \lambda a_3, \lambda a_4); 1 - (1 - T_1)^\lambda, I_1^\lambda, F_1^\lambda \rangle \quad (13)$$

IV. NETWORK TERMINOLOGY

Consider a directed network $G = (V, E)$ consisting of a finite set of nodes $V = \{1, 2, \dots, n\}$ and a set of m directed edges $E \subseteq V \times V$. Each edge is denoted by an ordered pair (i, j) where $i, j \in V$ and $i \neq j$. In this network, we specify two nodes, denoted by s and t , which are the source node and the destination node, respectively. We define a path as a sequence $P_{ij} = \{i = i_1, (i_1, i_2), i_2, \dots, i_{l-1}, (i_{l-1}, i_l), i_l = j\}$ of alternating nodes and edges. The existence of at least one path P_{st} in $G(V, E)$ is assumed for every $i \in V - \{s\}$.

d_{ij} denotes a single valued trapezoidal neutrosophic number associated with the edge (i, j) , corresponding to the length necessary to traverse (i, j) from i to j . In real problems, the lengths correspond to the cost, the time, the distance, etc. Then, neutrosophic distance along the path P is denoted as $d(P)$ is defined as

$$d(P) = \sum_{(i,j) \in P} d_{ij} \quad (14)$$

Remark : A node i is said to be predecessor node of node j if

- (i) Node i is directly connected to node j .
- (ii) The direction of path connecting node i and j from i to j .

V. SINGLE VALUED TRAPEZOIDAL NEUTROSOPHIC PATH PROBLEM

In this section, motivated by the work of Kumar [14], an algorithm is proposed to find the path of minimum distance between the source node (i) and the destination node (j) in a single valued trapezoidal neutrosophic graph.

The main steps of the algorithm are as follows:

Step 1 Assume $\tilde{d}_1 = \langle (0, 0, 0, 0); 0, 1, 1 \rangle$ and label the source node (say node 1) as $[\tilde{d}_1 = \langle (0, 0, 0, 0); 0, 1, 1 \rangle, -]$. The label indicating that the node has no predecessor.

Step 2 Find $\tilde{d}_j = \text{minimum} \{ \tilde{d}_i \oplus \tilde{d}_{ij} \}; j=2, 3, \dots, n$.

Step 3 If minimum occurs corresponding to unique value of i i.e., $i = r$ then label node j as $[\tilde{d}_j, r]$. If minimum occurs

corresponding to more than one values of i then it represents that there are more than one single valued trapezoidal neutrosophic path between source node and node j but single valued trapezoidal neutrosophic distance along path is \tilde{d}_j , so choose any value of i .

Step 4 Let the destination node (node n) be labeled as $[\tilde{d}_n, l]$, then the single valued trapezoidal neutrosophic shortest distance between source node and destination node is \tilde{d}_n .

Step 5 Since destination node is labeled as $[\tilde{d}_n, l]$, so, to find the single valued trapezoidal neutrosophic shortest path between source node and destination node, check the label of node l . Let it be $[\tilde{d}_l, p]$, now check the label of node p and so on. Repeat the same procedure until node 1 is obtained.

Step 6 Now the single valued trapezoidal neutrosophic shortest path can be obtained by combining all the nodes obtained by the step 5.

Remark 5.1 Let $\tilde{A}_i; i = 1, 2, \dots, n$ be a set of single valued trapezoidal neutrosophic numbers, if $S(\tilde{A}_k) < S(\tilde{A}_i)$, for all i , the single valued trapezoidal neutrosophic number is the minimum of \tilde{A}_k .

After describing the proposed algorithm, in next section we solve a numerical example and explain the proposed method completely.

IV. ILLUSTRATIVE EXAMPLE

Now we solve an hypothetical example to verify the proposed approach. Consider the network shown in figure 1, we want to obtain the shortest path from node 1 to node 6 where edges have a single valued trapezoidal neutrosophic numbers. Let us now apply the proposed algorithm to the network given in figure 1.

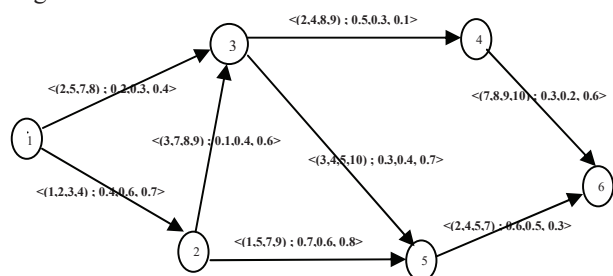

Fig. 1. A network with single valued trapezoidal neutrosophic edges

In this network each edge have been assigned to single valued trapezoidal neutrosophic number as follows:

Edges	single valued trapezoidal Neutrosophic distance
1-2	$\langle(1, 2, 3, 4); 0.4, 0.6, 0.7\rangle$
1-3	$\langle(2, 5, 7, 8); 0.2, 0.3, 0.4\rangle$
2-3	$\langle(3, 7, 8, 9); 0.1, 0.4, 0.6\rangle$
2-5	$\langle(1, 5, 7, 9); 0.7, 0.6, 0.8\rangle$
3-4	$\langle(2, 4, 8, 9); 0.5, 0.3, 0.1\rangle$
3-5	$\langle(3, 4, 5, 10); 0.3, 0.4, 0.7\rangle$
4-6	$\langle(7, 8, 9, 10); 0.3, 0.2, 0.6\rangle$
5-6	$\langle(2, 4, 5, 7); 0.6, 0.5, 0.3\rangle$

Table 1. Weights of the graphs

The calculations for this problem are as follows: since node 6 is the destination node, so $n=6$.

Assume $\tilde{d}_1 = \langle(0, 0, 0, 0); 0, 1, 1\rangle$ and label the source node (say node 1) as $[\langle(0, 0, 0, 0); 0, 1, 1\rangle, -]$, the value of $\tilde{d}_j; j=2, 3, 4, 5, 6$ can be obtained as follows:

Iteration 1 Since only node 1 is the predecessor node of node 2, so putting $i=1$ and $j=2$ in step2 of the proposed algorithm, the value of \tilde{d}_2 is

$$\tilde{d}_2 = \text{minimum}\{\tilde{d}_1 \oplus \tilde{d}_{12}\} = \text{minimum}\{\langle(0, 0, 0, 0); 0, 1, 1\rangle \oplus \langle(1, 2, 3, 4); 0.4, 0.6, 0.7\rangle\} = \langle(1, 2, 3, 4); 0.4, 0.6, 0.7\rangle$$

Since minimum occurs corresponding to $i=1$, so label node 2 as $[\langle(1, 2, 3, 4); 0.4, 0.6, 0.7\rangle, 1]$

Iteration 2 The predecessor node of node 3 are node 1 and node 2, so putting $i=1, 2$ and $j=3$ in step 2 of the proposed algorithm, the value of \tilde{d}_3 is

$$\tilde{d}_3 = \text{minimum}\{\tilde{d}_1 \oplus \tilde{d}_{13}, \tilde{d}_2 \oplus \tilde{d}_{23}\} = \text{minimum}\{\langle(0, 0, 0, 0); 0, 1, 1\rangle \oplus \langle(2, 5, 7, 8); 0.2, 0.3, 0.4\rangle, \langle(1, 2, 3, 4); 0.4, 0.6, 0.7\rangle \oplus \langle(3, 7, 8, 9); 0.1, 0.4, 0.6\rangle\} = \text{minimum}\{\langle(2, 5, 7, 8); 0.2, 0.3, 0.4\rangle, \langle(4, 9, 11, 13); 0.46, 0.24, 0.42\rangle\}$$

$$S(\{\langle(2, 5, 7, 8); 0.2, 0.3, 0.4\rangle\}) = \left(\frac{1}{12}\right)[a_1 + a_2 + a_3 + a_4] \times [2 + T_1 - I_1 - F_1] = 2.75$$

$$S(\langle(4, 9, 11, 13); 0.46, 0.24, 0.42\rangle) = 5.55$$

Since $S(\{\langle(2, 5, 7, 8); 0.2, 0.3, 0.4\rangle\}) < S(\langle(4, 9, 11, 13); 0.46, 0.24, 0.42\rangle)$

$$\text{So minimum}\{\langle(2, 5, 7, 8); 0.2, 0.3, 0.4\rangle, \langle(4, 9, 11, 13); 0.46, 0.24, 0.42\rangle\} = \langle(2, 5, 7, 8); 0.2, 0.3, 0.4\rangle$$

Since minimum occurs corresponding to $i=1$, so label node 3 as $[\langle(2, 5, 7, 8); 0.2, 0.3, 0.4\rangle, 1]$

Iteration 3. The predecessor node of node 4 is node 3, so putting $i=3$ and $j=4$ in step 2 of the proposed algorithm, the value of \tilde{d}_4 is $\tilde{d}_4 = \text{minimum}\{\tilde{d}_3 \oplus \tilde{d}_{34}\} = \text{minimum}\{\langle(2, 5, 7, 8); 0.2, 0.3, 0.4\rangle, \langle(2, 4, 8, 9); 0.5, 0.3, 0.1\rangle\} = \langle(4, 9, 15, 17); 0.6, 0.09, 0.04\rangle$

$$\text{So minimum}\{\langle(2, 5, 7, 8); 0.2, 0.3, 0.4\rangle, \langle(2, 4, 8, 9); 0.5, 0.3, 0.1\rangle\} = \langle(4, 9, 15, 17); 0.6, 0.09, 0.04\rangle$$

Since minimum occurs corresponding to $i=3$, so label node 4 as $[\langle(4, 9, 15, 17); 0.6, 0.09, 0.04\rangle, 3]$

Iteration 4 The predecessor node of node 5 are node 2 and node 3, so putting $i=2, 3$ and $j=5$ in step 2 of the proposed algorithm, the value of \tilde{d}_5 is

$$\tilde{d}_5 = \text{minimum}\{\tilde{d}_2 \oplus \tilde{d}_{25}, \tilde{d}_3 \oplus \tilde{d}_{35}\} = \text{minimum}\{\langle(1, 2, 3, 4); 0.4, 0.6, 0.7\rangle \oplus \langle(1, 5, 7, 9); 0.7, 0.6, 0.8\rangle, \langle(2, 5, 7, 8); 0.2, 0.3, 0.4\rangle \oplus \langle(3, 4, 5, 10); 0.3, 0.4, 0.7\rangle\} = \text{minimum}\{\langle(2, 7, 10, 13); 0.82, 0.36, 0.56\rangle, \langle(5, 9, 12, 18); 0.44, 0.12, 0.28\rangle\}$$

$$S(\langle(2, 7, 10, 13); 0.82, 0.36, 0.56\rangle) = 5.06$$

$$S(\langle(5, 9, 12, 18); 0.44, 0.12, 0.28\rangle) = 7.48$$

$$\text{Since } S(\langle(2, 7, 10, 13); 0.82, 0.36, 0.56\rangle) < S(\langle(5, 9, 12, 18); 0.44, 0.12, 0.28\rangle)$$

$$\text{minimum}\{\langle(2, 7, 10, 13); 0.82, 0.36, 0.56\rangle, \langle(5, 9, 12, 18); 0.44, 0.12, 0.28\rangle\} = \langle(2, 7, 10, 13); 0.82, 0.36, 0.56\rangle$$

$$\tilde{d}_5 = \langle(2, 7, 10, 13); 0.82, 0.36, 0.56\rangle$$

Since minimum occurs corresponding to $i=2$, so label node 5 as $[\langle(2, 7, 10, 13); 0.82, 0.36, 0.56\rangle, 2]$

Iteration 5 The predecessor node of node 6 are node 4 and node 5, so putting $i=4, 5$ and $j=6$ in step 2 of the proposed algorithm, the value of \tilde{d}_6 is

$$\tilde{d}_6 = \text{minimum}\{\tilde{d}_4 \oplus \tilde{d}_{46}, \tilde{d}_5 \oplus \tilde{d}_{56}\} = \text{minimum}\{\langle(4, 9, 15, 17); 0.6, 0.09, 0.04\rangle \oplus \langle(7, 8, 9, 10); 0.3, 0.2, 0.6\rangle, \langle(2, 7, 10, 13); 0.82, 0.36, 0.56\rangle \oplus \langle(2, 4, 5, 7); 0.6, 0.5, 0.3\rangle\} = \text{minimum}\{\langle(11, 17, 24, 27); 0.72, 0.018, 0.024\rangle, \langle(4, 11, 15, 20); 0.93, 0.18, 0.17\rangle\}$$

$$S(\langle(11, 17, 24, 27); 0.72, 0.018, 0.024\rangle) = 17.63$$

$$S(\langle(4, 11, 15, 20); 0.93, 0.18, 0.17\rangle) = 10.75$$

$$\text{Since } S(\langle(4, 11, 15, 20); 0.93, 0.18, 0.17\rangle) < S(\langle(11, 17, 24, 27); 0.72, 0.018, 0.024\rangle)$$

$$\text{So minimum}\{\langle(11, 17, 24, 27); 0.72, 0.018, 0.024\rangle, \langle(4, 11, 15, 20); 0.93, 0.18, 0.17\rangle\} = \langle(4, 11, 15, 20); 0.93, 0.18, 0.17\rangle$$

$$\tilde{d}_6 = \langle(4, 11, 15, 20); 0.93, 0.18, 0.17\rangle$$

Since minimum occurs corresponding to $i=5$, so label node 6 as $[\langle(4, 11, 15, 20); 0.93, 0.18, 0.17\rangle, 5]$

Since node 6 is the destination node of the given network, so the single valued trapezoidal neutrosophic shortest distance

between node 1 and node 6 is $\langle(4, 11, 15, 20); 0.93, 0.18, 0.17\rangle$.

Now the single valued trapezoidal neutrosophic shortest path between node 1 and node 6 can be obtained by using the following procedure:

Since node 6 is labeled by $\langle(4, 11, 15, 20); 0.93, 0.18, 0.17\rangle$, 5], which represents that we are coming from node 5. Node 5 is labeled by $\langle(2, 7, 10, 13); 0.82, 0.36, 0.56\rangle$, 2], which represents that we are coming from node 2. Node 2 is labeled by $\langle(1, 2, 3, 4); 0.4, 0.6, 0.7\rangle$, 1], which represents that we are coming from node 1. Now the single valued trapezoidal neutrosophic shortest path between node 1 and node 6 is obtaining by joining all the obtained nodes. Hence the single valued trapezoidal neutrosophic shortest path is $1 \rightarrow 2 \rightarrow 5 \rightarrow 6$

The single valued trapezoidal neutrosophic shortest distance and the single valued trapezoidal neutrosophic shortest path of all nodes from node 1 is shown in the table 2 and the labeling of each node is shown in figure 2

Node No.(j)	\tilde{d}_i	Single valued trapezoidal Neutrosophic shortest path between jth and 1st node
2	$\langle(1, 2, 3, 4); 0.4, 0.6, 0.7\rangle$	$1 \rightarrow 2$
3	$\langle(2, 5, 7, 8); 0.2, 0.3, 0.4\rangle$	$1 \rightarrow 3$
4	$\langle(4, 9, 15, 17); 0.6, 0.09, 0.04\rangle$	$1 \rightarrow 3 \rightarrow 4$
5	$\langle(2, 7, 10, 13); 0.82, 0.36, 0.56\rangle$	$1 \rightarrow 2 \rightarrow 5$
6	$\langle(4, 11, 15, 20); 0.93, 0.18, 0.17\rangle$	$1 \rightarrow 2 \rightarrow 5 \rightarrow 6$

Table 2. Tabular representation of different single valued trapezoidal neutrosophic shortest paths

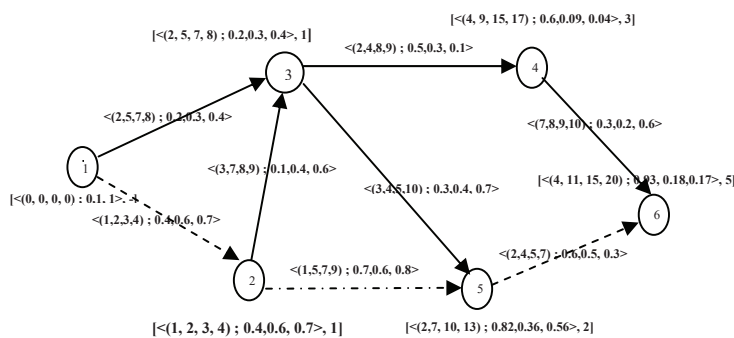

FIG 2. Network with single valued trapezoidal neutrosophic shortest distance of each node from node 1

VI. CONCLUSION

In this paper, we have developed an algorithm for solving shortest path problem on a network with single valued trapezoidal neutrosophic edge lengths. The process of ranking the path is very useful to make decisions in choosing the best of all possible path alternatives. Numerical example via six node network showed the performance of the proposed methodology for the shortest path. Next, we will research the application of this algorithm.

REFERENCES

[1] F. Smarandache, "Neutrosophic set - a generalization of the intuitionistic fuzzy set," Granular Computing, 2006 IEEE International Conference, 2006, p. 38 – 42.
 [2] F. Smarandache, "A geometric interpretation of the neutrosophic set — A generalization of the intuitionistic fuzzy set," Granular Computing (GrC), 2011 IEEE International Conference, 2011, pp.602–606 .
 [3] L. Zadeh, Fuzzy sets. Inform and Control, 8, 1965, pp.338-353
 [4] K. Atanassov, "Intuitionistic fuzzy sets," Fuzzy Sets and Systems, vol. 20, 1986, pp. 87-96.
 [5] I. Turksen, "Interval valued fuzzy sets based on normal forms," Fuzzy Sets and Systems, vol. 20,1986, pp. 191-210.
 [6] K. Atanassov and G. Gargov, Interval valued intuitionistic fuzzy sets. Fuzzy Sets and Systems, vol.31, 1989, pp.343-349.
 [7] H. Wang, F. Smarandache, Y. Zhang, and R. Sunderraman, "Single valued Neutrosophic Sets," Multisspace and Multistructure 4, 2010, pp. 410-413.
 [8] <http://fs.gallup.unm.edu/NSS>
 [9] Y. Subas, Neutrosophic numbers and their application to multi-attribute decision making problems,(in Turkish) (master Thesis, 7 Arak university, Graduate School of Natural and Applied Science, 2015.
 [10] P. Biswas, S. Parmanik and B. C. Giri, Cosine Similarity Measure Based Multi-attribute Decision-Making with Trapezoidal fuzzy Neutrosophic numbers, Neutrosophic sets and systems, 8, 2014,pp. 47-57.
 [11] I. Deli and Y. Subas, A Ranking methods of single valued neutrosophic numbers and its application to multi-attribute decision making problems, International Journal of Machine Learning and Cybernetics, 2016,pp.1-14.
 [12] A. Thamaraiselvi and R.Santhi, A New Approach for Optimization of Real Life Transportation Problems in Neutrosophic Environment, Mathematical Problems in Enginnering,2016, 9 pages.
 [13] P. Jayagowri and G. Geetha Ramani, Using Trapezoidal Intuitionistic Fuzzy Number to Find Optimized Path in a Network, Volume 2014, Advances in Fuzzy Systems, 2014, 6 pages.
 [14] A. Kumar and M. Kaur, A New Algorithm for Solving Shortest Path Problem on a Network with Imprecise Edge Weight, Applications and Applied Mathematics, Vol. 6, Issue 2, 2011, pp. 602 – 619.
 [15] A. Kumar, and M. Kaur, Solution of fuzzy maximal flow problems using fuzzy linear programming. World Academy of Science and Technology. 87, 2011,pp. 28-31.
 [16] S. Majumder and A. Pal, Shortest Path Problem on Intuitionistic Fuzzy Network, Annals of Pure and Applied Mathematics, Vol. 5, No. 1, November 13, pp.26-36.
 [17] S. Broumi, M. Talea, A. Bakali, F. Smarandache, "Single Valued Neutrosophic Graphs," Journal of New Theory, N 10, 2016, pp. 86-101.
 [18] S. Broumi, M. Talea, A. Bakali, F. Smarandache, "On Bipolar Single Valued Neutrosophic Graphs," Journal of New Theory, N11, 2016, pp.84-102.
 [19] S. Broumi, M. Talea, A. Bakali, F. Smarandache, Interval Valued Neutrosophic Graphs, (2016) in press.
 [20] S. Broumi, A. Bakali, M. Talea, and F. Smarandache, Isolated Single Valued Neutrosophic Graphs. Neutrosophic Sets and Systems, Vol. 11, 2016, pp.74-78
 [21] S. Broumi, F. Smarandache, M. Talea and A. Bakali, An Introduction to Bipolar Single Valued Neutrosophic Graph Theory. Applied Mechanics and Materials, vol.841, 2016, pp. 184-191.
 [22] S. Broumi, M. Talea, F. Smarandache and A. Bakali, Single Valued Neutrosophic Graphs: Degree, Order and Size, 2016 IEEE International Conference on Fuzzy Systems (FUZZ), 2016, pp.2445-2451
 [23] S. Broumi, A. Bakali, M. Talea and F. Smarandache, Computation of Shortest Path Problem in a Network with Single Valued Neutrosophic Number Based on Ranking Method, 2016 (submitted)
 [24] S. Broumi, A. Bakali, M. Talea, F. Smarandache, M. Ali, Shortest Path Problem Under Bipolar Neutrosophic Setting, 2016 (submitted).
 [25] S. Broumi, A. Bakali, M. Talea and F. Smarandache, Shortest Path Problem Under Interval Valued Neutrosophic Setting , 2016 (submitted).

Triple Refined Indeterminate Neutrosophic Sets for Personality Classification

Ilanthenral Kandasamy, Florentin Smarandache

Ilanthenral Kandasamy, Florentin Smarandache (2016). Triple Refined Indeterminate Neutrosophic Sets for Personality Classification. IEEE Symposium Series on Computational Intelligence (SSCI), 2016, 8; DOI: 10.1109/SSCI.2016.7850153

Abstract—Personality tests are most commonly objective type, where the users rate their behaviour. Instead of providing a single forced choice, they can be provided with more options. A person may not be in general capable to judge his/her behaviour very precisely and categorize it into a single category. Since it is self rating there is a lot of uncertain and indeterminate feelings involved. The results of the test depend a lot on the circumstances under which the test is taken, the amount of time that is spent, the past experience of the person, the emotion the person is feeling and the person's self image at that time and so on.

In this paper Triple Refined Indeterminate Neutrosophic Set (TRINS) which is a type of the refined neutrosophic set is introduced. It provides the additional possibility to represent with sensitivity and accuracy the imprecise, uncertain, inconsistent and incomplete information which are available in real world. More precision is provided in handling indeterminacy; by classifying indeterminacy (I) into three, based on membership; as indeterminacy leaning towards truth membership (I_T), indeterminacy membership (I) and indeterminacy leaning towards false membership (I_F). This kind of classification of indeterminacy is not feasible with the existing Single Valued Neutrosophic Set (SVNS), but it is a particular category of the refined neutrosophic set (where each T, I, F can be refined into $T_1, T_2, \dots; I_1, I_2, \dots; F_1, F_2, \dots$). TRINS is better equipped at dealing indeterminate and inconsistent information, with more accuracy than SVNS and Double Refined Indeterminate Neutrosophic Set (DRINS), which fuzzy sets and Intuitionistic Fuzzy Sets (IFS) are incapable of. TRINS can be used in any place where the Likert scale is used. Personality test usually make use of the Likert scale. In this paper a indeterminacy based personality test is introduced for the first time. Here personality classification is made based on the Open Extended Jung Type Scale test and TRINS.

I. INTRODUCTION

Carl Jung in his collected work [1] had theorized the eight psychological types based on two main attitude types: extroversion and introversion, two observing functions: intuition and sensation and two judging functions: feeling and thinking. Psychological types are Extraverted sensation, Introverted sensation, Extraverted intuition, Introverted intuition, Extraverted thinking, Introverted thinking, Extraverted feeling and Introverted feeling. The MyersBriggs Type Indicator (MBTI) [2], is based on the theory given by Carl Jung. The psychological variations are sorted into four contrary pairs, or "dichotomies", that provides 16 feasible psychological types. The MBTI is a reflective self-analytic questionnaire designed to find the psychological inclinations of people's view of the world and their decision making. These personality tests are

mostly objective in nature, where the test taker is forced to select a dominant choice. Quoting Carl Jung himself "There is no such thing as a pure extrovert or a pure introvert. Such a man would be in the lunatic asylum.", it is clear that there are degrees of variations, no person fits into a category 100%. Since it is not feasible for a person to put down his answer as single choice in reality, without ignoring the other degrees of variation. It necessitates a tool which can give more than one choice to represent their personality. The choice also depends highly on the situation and circumstance the individual faces at that time,

Fuzzy set theory introduced by Zadeh (1965) [3] proposes a constructive analytic method for soft division of sets. Zadeh's fuzzy set theory [3] was extended to intuitionistic fuzzy set (A-IFS), in which every entity is assigned a non-membership degree and a membership degree by Atanassov (1986) [4]. A-IFS is more suitable than fuzzy set in dealing with data that has fuzziness and uncertainty. A-IFS was further generalized into the concept of interval valued intuitionistic fuzzy set (IVIFS) by Atanassov and Gargov (1989) [5].

To characterize inconsistent, imprecise, uncertain, and incomplete information which are existing in real world, the notion of neutrosophic set from philosophical angle was given by Smarandache [6]. The neutrosophic set is a existing framework that generalizes the notion of the tautological set, fuzzy set, paraconsistent set, interval valued fuzzy set, intuitionistic fuzzy set, paradoxist set, interval valued intuitionistic fuzzy set and classic set. The neutrosophic set articulates independently truth, indeterminacy and falsity memberships. From the philosophical angle the aforesaid sets are generalized by the neutrosophic set. Its functions $T_A(x)$, $I_A(x)$, and $F_A(x)$ are real standard or nonstandard subsets of $]^{-0, 1^+}$, that is, $T_A(x) : X \rightarrow]^{-0, 1^+}$, $I_A(x) : X \rightarrow]^{-0, 1^+}$, and $F_A(x) : X \rightarrow]^{-0, 1^+}$, respectively with the condition $-0 \leq \sup T_A(x) + \sup I_A(x) + \sup F_A(x) \leq 3^+$.

It is challenging to adapt neutrosophic set in this structure in engineering fields and scientific research. To overcome this difficulty, Wang et al. [7] introduced a Single Valued Neutrosophic Set (SVNS), which is another form of a neutrosophic set. Fuzzy sets and intuitionistic fuzzy sets cannot deal with inconsistent and indeterminate information, which SVNS is capable of.

Owing to the fuzziness, uncertainty and indeterminate na-

ture of many practical problems in the real world, neutrosophy has found application in various fields including Social Network Analysis (Salama et al [8]), Decision-making problems (Ye [9], [10], [11], [12]), Image Processing (Cheng and Guo[13], Sengur and Guo[14], Zhang et al [15]), Social problems (Vasantha and Smarandache [16], [17]) etc.

To provide more accuracy and precision to indeterminacy, the value of indeterminacy present in the neutrosophic set has been classified into two; based on membership; as indeterminacy leaning towards truth membership and as indeterminacy leaning towards false membership. They make the indeterminacy involved in the scenario to be more accurate and precise. This modified refined neutrosophic set was defined as Double Refined Indeterminacy Neutrosophic Set (DRINS) alias Double Valued Neutrosophic Set (DVNS) by Kandasamy [18] and Kandasamy and Smarandache [19].

To increase the accuracy, precision and to fit in the Likert's scale which is usually used in personality test; here the indeterminacy concept is divided into three, as indeterminacy leaning towards truth, indeterminacy and indeterminacy leaning towards false. This refined neutrosophic set is known as the Triple Refined Indeterminate Neutrosophic Sets (TRINS).

Consider an example from a personality test "You tend to sympathize with others". The person need not be forced to opt for a single choice; cause it is natural that the behaviour is dependent on several external and internal factors, varying from the person's mood to surrounding. So a person might not always react in a particular way, in a particular scenario. There is always a degree to which the person will strongly agree to the statement (say 0.7), will just agree (0.1), neither agree or disagree (0.05), will agree (0.1) and will strongly disagree(0.05). When a person is taking a personality test he/she is forced to opt for a single choice, thereby the degrees of membership of others are completely lost. Whereas using TRINS this statement is represented as $\langle 0.7, 0.1, 0.05, 0.1, 0.05 \rangle$, it can be evaluated accurately; thereby giving very useful necessary precision to the result. All the various choices are captured thereby avoiding the preferential choice that is executed in the classical method.

Section one is introductory in nature. Section two recalls some basic concepts about neutrosophy and The Open Extended Jungian Type Scales (OEJTS) personality test. Section three introduces TRINS and related set theoretic concepts. Section four defines the distance measure over TRINS. The indeterminacy based OEJTS is introduced in section five. Section six provides the comparison of existing personality test and the indeterminacy based OEJTS test. The conclusions and future research on this topic is provided in the final section.

II. BASIC CONCEPTS

A. Personality test

Of all the categories of personality tests, the usual type is the objective personality tests.

It comprises of several questions/statements given to people who answer by rating the degree to which each item reveals their nature and which can be evaluated objectively. These

statements on questionnaires allow people to specify the degree of acceptance.

Frequently taken personality test is the Myers-Briggs Type Indicator test. Many personality tests available on the internet provide meagre information about their formulation or evaluation.

A comparative study of different tests has not been carried out. There are currently no criteria for what makes a good Myers-Briggs/Jungian type. Of course, it could just be accepted that the Myers-Briggs Type Indicator (MBTI) defines Myers-Briggs/Jungian types and so that means that the measure of a test is just how similar it is to the MBTI.

The Open Extended Jungian Type Scales test [20] is an open source alternative to the Myers Briggs type indicator test. A comparative validity study of the Open Extended Jungian Type Scales was done using three other on-line tests. The OEJTS test has the capacity to distinguish personalities considerably better than other tests. It indicates OEJTS test is best precise on-line Myers-Briggs/Jungian type test. Of the numerous on-line Myers-Briggs tests, only three were selected on the basis of their acceptance within Myers-Briggs supporters. The Human Metrics Jung Typology Test, Similar Minds Jung Personality Test and 16-Personalities personality test were the selected ones.

The OEJTS test alone is taken for future discussion in this paper.

B. The Open Extended Jungian Type Scales (OEJTS)

An extension of the Jung's Theory of psychological type casting is the Myers-Briggs Type Indicator (MBTI). It has four personality dichotomies that are combined to yield 16 personality types. The dichotomies given in [20] are

- 1) Introversion (I) vs. Extroversion (E); sometimes is described as a persons orientation, they either orient within themselves or to the outside world. Other times the focus is put more openly on social communication and interactions, with some stating that social activities and interactions tires introverts whereas it increases the energy level of extroverts.
- 2) Sensing (S) vs. Intuition (N); how a person takes in information. Sensors generally focus on the five senses while intuitives focus on possibilities.
- 3) Feeling (F) vs. Thinking (T); is based on what a person uses to take their decisions: whether it is interpersonal considerations or through dispassionate logic.
- 4) Judging (J) vs. Perceiving (P); was a dichotomy added by Myers and Briggs to choose between the 2nd and 3rd pair of functions. Individuals who desire a organized lifestyle are supposed to use their judging functions (thinking and feeling) while individuals who prefer a flexible lifestyle use their sensing functions (intuition and sensing).

The Open Extended Jungian Type Scales (OEJTS) evaluates four scales, each planned to produce a huge score differential along one dichotomy.

TABLE I
QUESTIONNAIRE

Q		Scale	
Q ₁	makes lists	1 2 3 4 5	relies on memory
Q ₂	sceptical	1 2 3 4 5	wants to believe
Q ₃	bored by time alone	1 2 3 4 5	needs time alone
Q ₇	energetic	1 2 3 4 5	mellow
Q ₁₁	works best in groups	1 2 3 4 5	works best alone
Q ₁₅	worn out by parties	1 2 3 4 5	gets fired up by parties
Q ₁₉	talks more	1 2 3 4 5	listens more
Q ₂₃	stays at home	1 2 3 4 5	goes out on the town
Q ₂₇	finds it difficult to yell very loudly	1 2 3 4 5	yelling to others when they are far away comes naturally
Q ₃₁	perform in public	1 2 3 4 5	avoids public speaking

The format for the OEJTS has been preferred to be two statements that form a bipolar scale (e.g. humble to arrogant), operationalized on a five point scale. A sample questionnaire is shown in Table I.

C. Working of the Open Extended Jungian Type Scales

The OEJTS personality test provides a result equivalent to the Myers-Briggs Type Indicator, even though it is not the MBTI and has no association with it. In this test 32 pairs of personality descriptions are connected by a five point scale. For each pair, marking on the scale is a choice based on what you think you are. For example, if the personality description is angry versus calm, you should circle 1 if you think you are mostly angry and never calm; 3 if you are sometimes angry and sometimes calm, and so on. Sample questions are as shown in Table I. Questions 3, 7, 11, 15, 19, 23, 17 and 31 are related to Extrovert Introvert.

The scoring instructions from [20] are as follows:

$$IE = 30 - Q_3 - Q_7 - Q_{11} + Q_{15} - Q_{19} + Q_{23} + Q_{27} - Q_{31}$$

$$SN = 12 + Q_4 + Q_8 + Q_{12} + Q_{16} + Q_{20} - Q_{24} - Q_{28} + Q_{32}$$

$$FT = 30 - Q_2 + Q_6 + Q_{10} - Q_{14} - Q_{18} + Q_{22} - Q_{26} - Q_{30}$$

$$JP = 18 + Q_1 + Q_5 - Q_9 + Q_{13} - Q_{17} + Q_{21} - Q_{25} + Q_{29}$$

If *IE* score is more than 24, you are extrovert (E), otherwise you are introvert (I). If *SN* score is greater than 24, you are intuitive (N), otherwise you are sensing (S). If *FT* score is more than 24, you are thinking (T), otherwise you are feeling (F). If *JP* score is higher than 24, you are perceiving (P), otherwise you are judging (J). The four letters are combined together to obtain the personality type (e.g. I, S, F, P = ISFP).

D. Neutrosophy and Single Valued Neutrosophic Set (SVNS)

Neutrosophy is a section of philosophy, familiarized by Smarandache [6], that analyses the beginning, property, and scope of neutralities, as well as their connections with various concepts. It studies a concept, event, theory, proposition, or entity, “*A*” in relation to its contrary, “Anti-*A*” and that which is not *A*, “Non-*A*”, and that which is neither “*A*” nor “Anti-*A*”, denoted by “Neut-*A*”. Neutrosophy is the foundation

of neutrosophic set, neutrosophic probability, neutrosophic statistics and neutrosophic logic.

The notion of a neutrosophic set from philosophical angle, founded by Smarandache [6], is as follows.

Definition 1. [6] Let *X* be a space of points (objects), with a generic element in *X* denoted by *x*. A neutrosophic set *A* in *X* is described by a truth membership function $T_A(x)$, an indeterminacy membership function $I_A(x)$, and a falsity membership function $F_A(x)$. The functions $T_A(x)$, $I_A(x)$, and $F_A(x)$ are nonstandard or real standard subsets of $]^{-0}, 1^+[$, that is, $T_A(x) : X \rightarrow]^{-0}, 1^+[$, $I_A(x) : X \rightarrow]^{-0}, 1^+[$, and $F_A(x) : X \rightarrow]^{-0}, 1^+[$, under the rule $-0 \leq \sup T_A(x) + \sup I_A(x) + \sup F_A(x) \leq 3^+$.

This concept of neutrosophic set is not easy to use in real world application of scientific and engineering fields. Therefore, the concept of Single Valued Neutrosophic Set (SVNS), which is an instance of a neutrosophic set was introduced by Wang et al. [7].

Definition 2. [7] Let *X* be a space of points (objects) with generic elements in *X* denoted by *x*. An Single Valued Neutrosophic Set (SVNS) *A* in *X* is characterized by truth membership function $T_A(x)$, indeterminacy membership function $I_A(x)$, and falsity membership function $F_A(x)$. For each point *x* in *X*, there are $T_A(x), I_A(x), F_A(x) \in [0, 1]$, and $0 \leq T_A(x) + I_A(x) + F_A(x) \leq 3$. Therefore, an SVNS *A* can be represented by $A = \{ \langle x, T_A(x), I_A(x), F_A(x) \rangle \mid x \in X \}$. The following expressions are defined in [7] for SVNSs *A, B*:

- $A \in B \iff T_A(x) \leq T_B(x), I_A(x) \geq I_B(x), F_A(x) \geq F_B(x)$ for any *x* in *X*.
- $A = B \iff A \subseteq B$ and $B \subseteq A$.
- $A^c = \{ \langle x, F_A(x), 1 - I_A(x), T_A(x) \rangle \mid x \in X \}$.

The refined neutrosophic logic defined by [21] is as follows:

Definition 3. *T* can be split into many types of truths: T_1, T_2, \dots, T_p , and *I* into many types of indeterminacies: I_1, I_2, \dots, I_r , and *F* into many types of falsities: F_1, F_2, \dots, F_s , where all *p, r, s* ≥ 1 are integers, and $p + r + s = n$. In the same way, but all subcomponents T_j, I_k, F_l are not symbols, but subsets of $[0, 1]$, for all $j \in \{1, 2, \dots, p\}$ all $k \in \{1, 2, \dots, r\}$ and all $l \in \{1, 2, \dots, s\}$. If all sources of information that separately provide neutrosophic values for a specific subcomponent are independent sources, then in the general case we consider that each of the subcomponents T_j, I_k, F_l is independent with respect to the others and it is in the non-standard set $]^{-0}, 1^+[$.

III. TRIPLE REFINED INDETERMINACY NEUTROSOPHIC SET (TRINS)

Here the indeterminacy concept is divided into three, as indeterminacy leaning towards truth membership, indeterminacy membership and indeterminacy leaning towards false membership. This division aids in increasing the accuracy and precision of the indeterminacy and to fit in the Likert’s scale which is usually used in personality test. This refined

neutrosophic set is defined as the Triple Refined Indeterminate Neutrosophic Sets (TRINS).

Definition 4. Consider X to be a set of points (objects) with generic entities in X denoted by x . A Triple Refined Indeterminate Neutrosophic Set (TRINS) A in X is considered as truth membership function $T_A(x)$, indeterminacy leaning towards truth membership function $I_{TA}(x)$, indeterminacy leaning towards falsity membership function $I_{FA}(x)$, and falsity membership function $F_A(x)$. Each membership function has a weight $w_m \in [0, 5]$ associated with it. For each generic element $x \in X$, there are

$$T_A(x), I_{TA}(x), I_A(x), I_{FA}(x), F_A(x) \in [0, 1],$$

$$w_T(T_A(x)), w_{I_T}(I_{TA}(x)), w_I(I_A(x)), w_{I_F}(I_{FA}(x)),$$

$$w_F(F_A(x)) \in [0, 5],$$

and

$$0 \leq T_A(x) + I_{TA}(x) + I_A(x) + I_{FA}(x) + F_A(x) \leq 5.$$

Therefore, a TRINS A can be represented by

$$A = \{ \langle x, T_A(x), I_{TA}(x), I_A(x), I_{FA}(x), F_A(x) \rangle \mid x \in X \}.$$

A TRINS A is represented as

$$A = \int_X \{ \langle T(x), I_T(x), I(x), I_F(x), F(x) \rangle / dx, x \in X \} \quad (1)$$

when X is continuous. It is represented as

$$A = \sum_{i=1}^n \{ \langle T(x_i), I_T(x_i), I(x_i), I_F(x_i), F(x_i) \rangle \mid x_i, x_i \in X \} \quad (2)$$

when X is discrete.

Example 1. Let $X = [x_1, x_2]$ where x_1 is question 1 and x_2 is question 2 from Table II. Let $x_1, x_2 \in [0, 1]$ and when the membership weight is applied the values of $w_m(x_1)$ and $w_m(x_2)$ are in $[1, 5]$. This is obtained from the questionnaire of the user.

Consider question 1, instead of a forced single choice; their option for question 1 would be a degree of “make list”, a degree of indeterminacy choice towards “make list”, a degree of uncertain and indeterminate combination of making list and depending on memory, an degree of indeterminate choice more of relying on memory, and a degree of “relying on memory”.

A is a TRINS of X defined by

$$A = \langle 0.0, 0.4, 0.1, 0.0, 0.5 \rangle / x_1 + \langle 0.5, 0.1, 0.1, 0.1, 0.2 \rangle / x_2.$$

The associated membership weights are $w_T = 1, w_{I_T} = 2, w_I = 3, w_{I_F} = 4, w_F = 5$. Then the weighted TRINS $w_T(T_A(x)), w_{I_T}(I_{TA}(x)), w_I(I_A(x)), w_{I_F}(I_{FA}(x)), w_F(F_A(x)) \in [0, 5]$, will be

$$A = \langle 0.0, 0.8, 0.3, 0.0, 1.5 \rangle / x_1 + \langle 0.5, 0.2, 0.3, 0.4, 1.0 \rangle / x_2.$$

Definition 5. Consider TRINS A , its complement is denoted by $c(A)$ and is defined as

- 1) $T_{c(A)}(x) = F_A(x)$

- 2) $I_{Tc(A)}(x) = 1 - I_{TA}(x)$
- 3) $I_{c(A)}(x) = 1 - I_A(x)$
- 4) $I_{Fc(A)}(x) = 1 - I_{FA}(x)$
- 5) $F_{c(A)}(x) = T_A(x)$

for all x in X .

Definition 6. A TRINS A is contained in the other TRINS B , $A \subseteq B$, if and only if

- 1) $T_A(x) \leq T_B(x)$
- 2) $I_{TA}(x) \leq I_{TB}(x)$
- 3) $I_A(x) \leq I_B(x)$
- 4) $I_{FA}(x) \leq I_{FB}(x)$
- 5) $F_A(x) \geq F_B(x)$

for all x in X .

X is a partially ordered set and not a totally ordered set, by the containment relation definition.

For example, let A and B be the TRINSs as defined in Example 1, then $A \not\subseteq B$ and $B \not\subseteq A$.

Definition 7. Two TRINSs A and B are equal, denoted as $A = B \iff A \subseteq B$ and $B \subseteq A$.

Theorem 1. $A \subseteq B \iff c(B) \subseteq c(A)$.

Definition 8. The union of two TRINSs A and B is a TRINS C , denoted as $C = A \cup B$, whose truth membership, indeterminacy leaning towards truth membership, indeterminacy leaning towards falsity membership and falsity membership functions are associated to A and B by the following

- 1) $T_C(x) = \max(T_A(x), T_B(x))$
- 2) $I_{TC}(x) = \max(I_{TA}(x), I_{TB}(x))$
- 3) $I_C(x) = \max(I_A(x), I_B(x))$
- 4) $I_{FC}(x) = \max(I_{FA}(x), I_{FB}(x))$
- 5) $F_C(x) = \min(F_A(x), F_B(x))$

$\forall x$ in X .

Theorem 2. $A \cup B$ is the smallest TRINS containing both A and B .

Proof. It is direct from definition of union operator. \square

Definition 9. The intersection of two TRINSs A and B is a TRINS C , denoted as $C = A \cap B$, whose truth, indeterminacy leaning towards truth, indeterminacy, indeterminacy leaning towards falsity, and falsity memberships functions are associated to A and B by the following

- 1) $T_C(x) = \min(T_A(x), T_B(x))$
- 2) $I_{TC}(x) = \min(I_{TA}(x), I_{TB}(x))$
- 3) $I_C(x) = \min(I_A(x), I_B(x))$
- 4) $I_{FC}(x) = \min(I_{FA}(x), I_{FB}(x))$
- 5) $F_C(x) = \max(F_A(x), F_B(x))$

for all $x \in X$.

Theorem 3. The largest TRINS contained in both A and B is $A \cap B$.

Proof. From the intersection operator definition, it is direct. \square

Definition 10. The difference of two TRINSs D , written as $D = A \setminus B$, whose truth membership, indeterminacy leaning towards truth membership, indeterminacy membership, indeterminacy leaning towards falsity membership and falsity membership functions are related to those of A and B by

- 1) $T_D(x) = \min(T_A(x), F_B(x))$
- 2) $I_{TD}(x) = \min(I_{TA}(x), 1 - I_{TB}(x))$
- 3) $I_D(x) = \min(I_A(x), 1 - I_B(x))$
- 4) $I_{FD}(x) = \min(I_{FA}(x), 1 - I_{FB}(x))$
- 5) $F_D(x) = \min(F_A(x), T_B(x))$

for all x in X .

Three operators truth favourite (Δ), falsity favourite (∇) and indeterminacy neutral (∇) are defined over TRINSs. Two operators truth favourite (Δ) and falsity favourite (∇) are defined to alter the indeterminacy in the TRINSs and convert it into intuitionistic fuzzy sets or paraconsistent sets. Similarly the TRINS is transformed into a SVNS by operator indeterminacy neutral (∇) by combining the indeterminacy values of the TRINS. These three operators are unique on TRINS.

Definition 11. The truth favourite of a TRINS A is a TRINS B , written as $B = \Delta A$, whose truth membership and falsity membership functions are related to those of A by

- 1) $T_B(x) = \min(T_A(x) + I_{TA}(x), 1)$
- 2) $I_{TB}(x) = 0$
- 3) $I_B(x) = 0$
- 4) $I_{FB}(x) = 0$
- 5) $F_B(x) = F_A(x)$

for all x in X .

Definition 12. The falsity favourite of a TRINS A , written as $B = \nabla A$, whose truth membership and falsity membership functions are related to those of A by

- 1) $T_B(x) = T_A(x)$
- 2) $I_{TB}(x) = 0$
- 3) $I_B(x) = 0$
- 4) $I_{FB}(x) = 0$
- 5) $F_B(x) = \min(F_A(x) + I_{FA}(x), 1)$

for all x in X .

Definition 13. The indeterminacy neutral of a TRINS A is a TRINS B , written as $B = \nabla A$, whose truth membership, indeterminate membership and falsity membership functions are related to those of A by

- 1) $T_B(x) = T_A(x)$
- 2) $I_{TB}(x) = \min(I_{TA}(x) + I_B(x) + I_{FB}(x), 1)$
- 3) $I_B(x) = 0$
- 4) $I_{FB}(x) = 0$
- 5) $F_B(x) = F_A(x)$

for all x in X .

Proposition 1. The following set theoretic operators are defined over TRINS X , Y and Z .

- 1) (Property 1) (Commutativity):
$$X \cup Y = Y \cup X,$$

$$X \cap Y = Y \cap X,$$

$$X \times Y = Y \times X.$$

2) (Property 2) (Associativity):

$$X \cup (Y \cup Z) = (X \cup Y) \cup Z,$$

$$X \cap (Y \cap Z) = (X \cap Y) \cap Z,$$

$$X \times (Y \times Z) = (X \times Y) \times Z.$$

3) (Property 3) (Distributivity):

$$X \cup (Y \cap Z) = (X \cup Y) \cap (X \cup Z),$$

$$X \cap (Y \cup Z) = (X \cap Y) \cup (X \cap Z).$$

4) (Property 4) (Idempotency):

$$X \cup X = X, X \cap X = X,$$

$$\Delta \Delta X = \Delta X, \nabla \nabla X = \nabla X.$$

5) (Property 5)

$$X \cap \phi = \phi, X \cap X = X,$$

where $T\phi = I\phi = 0, F\phi = 1$ and $T_X = I_{TX} = I_{FX} = 1, F_X = 0$.

6) (Property 6)

$$X \cup \phi = X, X \cap X = X,$$

where $T\phi = I\phi = I_{F\phi} = 0, F\phi = 1$ and $T_X = I_X = 1, F_X = 0$.

7) (Property 7) (Absorption):

$$X \cup (X \cap Y) = X, X \cap (X \cup Y) = X.$$

8) (Property 8) (De Morgan's Laws):

$$c(X \cup Y) = c(X) \cap c(Y), c(X \cap Y) = c(X) \cup c(Y).$$

9) (Property 9) (Involution): $c(c(X)) = X$.

Almost all properties of classical set, fuzzy set, intuitionistic fuzzy set and SNVS are satisfied by TRINS. The principle of middle exclude is not satisfied by these sets.

IV. DISTANCE MEASURES OF TRINS

The weight measures over TRINS is defined in the following:

Consider TRINS A in a universe of discourse, $X = \{x_1, x_2, \dots, x_n\}$, which are denoted by $A = \{(x_i, T_A(x_i), I_{TA}(x_i), I_A(x_i), I_{FA}(x_i), F_A(x_i)) \mid x_i \in X\}$, where $T_A(x_i), I_{TA}(x_i), I_A(x_i), I_{FA}(x_i), F_A(x_i) \in [0, 1]$ for every $x_i \in X$. Let w_m be the weight of each membership, then $w_T(T_A(x)), w_{I_T}(I_{TA}(x)), w_I(I_A(x)), w_{I_F}(I_{FA}(x)), w_F(F_A(x)) \in [0, 5]$. Hereafter by the membership $T_A(x_i), I_{TA}(x_i), I_A(x_i), I_{FA}(x_i), F_A(x_i)$, we mean the weight membership $w_T(T_A(x)), w_{I_T}(I_{TA}(x)), w_I(I_A(x)), w_{I_F}(I_{FA}(x)), w_F(F_A(x))$.

Then, the generalized Triple Refined Indeterminate Neutrosophic weight is defined as follows:

$$w(A) = \left\{ \sum_{i=1}^n \{w_T(T_A(x_i)) + w_{I_T}(I_{TA}(x_i)) + w_I(I_A(x_i)) + w_{I_F}(I_{FA}(x_i)) + w_F(F_A(x_i))\} \right\} \quad (3)$$

The distance measures over TRINSs is defined in the following and the related algorithm for determining the distance is given:

Consider two TRINSs A and B in a universe of discourse, $X = x_1, x_2, \dots, x_n$, which are denoted by

$A = \{\langle x_i, T_A(x_i), I_{TA}(x_i), I_A(x_i), I_{FA}(x_i), F_A(x_i) \rangle \mid x_i \in X\}$, and $B = \{\langle x_i, T_B(x_i), I_{TB}(x_i), I_B(x_i), I_{FB}(x_i), F_A(x_i) \rangle \mid x_i \in X\}$, where $T_A(x_i), I_{TA}(x_i), I_A(x_i), I_{FA}(x_i), F_A(x_i), T_B(x_i), I_{TB}(x_i), I_B(x_i), I_{FB}(x_i), F_B(x_i) \in [0, 5]$ for every $x_i \in X$. Let $w_i (i = 1, 2, \dots, n)$ be the weight of an element $x_i (i = 1, 2, \dots, n)$, with $w_i \geq 0 (i = 1, 2, \dots, n)$ and $\sum_{i=1}^n w_i = 1$.

Then, the generalized Triple Refined Indeterminate Neutrosophic weighted distance is defined as follows:

$$d_\lambda(A, B) = \left\{ \frac{1}{5} \sum_{i=1}^n w_i [|T_A(x_i) - T_B(x_i)|^\lambda + |I_{TA}(x_i) - I_{TB}(x_i)|^\lambda + |I_A(x_i) - I_B(x_i)|^\lambda + |I_{FA}(x_i) - I_{FB}(x_i)|^\lambda + |F_A(x_i) - F_B(x_i)|^\lambda] \right\}^{1/\lambda} \quad (4)$$

where $\lambda > 0$.

Equation 4 reduces to the Triple Refined Indeterminate Neutrosophic weighted Hamming distance and the Triple Refined Indeterminate Neutrosophic weighted Euclidean distance, when $\lambda = 1, 2$, respectively. The Triple Refined Indeterminate Neutrosophic weighted Hamming distance is given as

$$d_\lambda(A, B) = \frac{1}{5} \sum_{i=1}^n w_i [|T_A(x_i) - T_B(x_i)| + |I_{TA}(x_i) - I_{TB}(x_i)| + |I_A(x_i) - I_B(x_i)| + |I_{FA}(x_i) - I_{FB}(x_i)| + |F_A(x_i) - F_B(x_i)|] \quad (5)$$

where $\lambda = 1$ in Equation 4.

The Triple Refined Indeterminate Neutrosophic weighted Euclidean distance is given as

$$d_\lambda(A, B) = \left\{ \frac{1}{5} \sum_{i=1}^n w_i [|T_A(x_i) - T_B(x_i)|^2 + |I_{TA}(x_i) - I_{TB}(x_i)|^2 + |I_A(x_i) - I_B(x_i)|^2 + |I_{FA}(x_i) - I_{FB}(x_i)|^2 + |F_A(x_i) - F_B(x_i)|^2] \right\}^{1/2} \quad (6)$$

where $\lambda = 2$ in Equation 4.

The algorithm to obtain the generalized Triple Refined Indeterminate Neutrosophic weighted distance $d_\lambda(A, B)$ is given in Algorithm 1.

The following proposition is given for the distance measure.

Proposition 2. *The generalized Triple Refined Indeterminate Neutrosophic weighted distance $d_\lambda(A, B)$ for $\lambda > 0$ satisfies the following properties:*

- 1) (Property 1) $d_\lambda(A, B) \geq 0$;
- 2) (Property 2) $d_\lambda(A, B) = 0$ if and only if $A = B$;
- 3) (Property 3) $d_\lambda(A, B) = d_\lambda(B, A)$;
- 4) (Property 4) If $A \subseteq B \subseteq C$, C is an TRINS in X , then $d_\lambda(A, C) \geq d_\lambda(A, B)$ and $d_\lambda(A, C) \geq d_\lambda(B, C)$.

It can be easily seen that $d_\lambda(A, B)$ satisfies the properties (Property 1) to (Property 4).

The Triple Refined Indeterminate Neutrosophic distance matrix D is defined in the following.

Algorithm 1: Generalized Triple Refined Indeterminate Neutrosophic weighted distance $d_\lambda(A, B)$

Input: $X = x_1, x_2, \dots, x_n$, TRINS A, B where $A = \{\langle x_i, T_A(x_i), I_{TA}(x_i), I_A(x_i), I_{FA}(x_i), F_A(x_i) \rangle \mid x_i \in X\}$, $B = \{\langle x_i, T_B(x_i), I_{TB}(x_i), I_B(x_i), I_{FB}(x_i), F_A(x_i) \rangle \mid x_i \in X\}$, $w_i (i = 1, 2, \dots, n)$

Output: $d_\lambda(A, B)$

```

begin
   $d_\lambda \leftarrow 0$ 
  for  $i = 1$  to  $n$  do
     $d_\lambda \leftarrow d_\lambda + w_i [ |T_A(x_i) - T_B(x_i)|^\lambda + |I_{TA}(x_i) - I_{TB}(x_i)|^\lambda + |I_A(x_i) - I_B(x_i)|^\lambda + |I_{FA}(x_i) - I_{FB}(x_i)|^\lambda + |F_A(x_i) - F_B(x_i)|^\lambda ]$ 
  end
   $d_\lambda \leftarrow d_\lambda / 5$ 
   $d_\lambda \leftarrow d_\lambda^{\{\frac{1}{\lambda}\}}$ 
end

```

Definition 14. Let $A_j (j = 1, 2, \dots, m)$ be a collection of m TRINSs, then $D = (d_{ij})_{m \times m}$ is called a Triple valued neutrosophic distance matrix, where $d_{ij} = d_\lambda(A_i, A_j)$ is the generalized Triple distance valued neutrosophic between A_i and A_j , and its properties are as follows:

- 1) $0 \leq d_{ij} \leq 5$ for all $i, j = 1, 2, \dots, m$;
- 2) $d_{ij} = 0$ if and only if $A_i = A_j$;
- 3) $d_{ij} = d_{ji}$ for all $i, j = 1, 2, \dots, m$.

The algorithm to calculate the Triple Refined Indeterminate Neutrosophic weighted distance matrix D is given in Algorithm 2.

Algorithm 2: Triple Refined Indeterminate Neutrosophic weighted distance matrix D

Input: TRINS A_1, \dots, A_m ,

Output: Distance matrix D with elements d_{ij}

```

begin
  for  $i = 1$  to  $m$  do
    for  $j = 1$  to  $m$  do
      if  $i = j$  then
         $d_{ij} \leftarrow 0$ 
      else
         $d_{ij} \leftarrow \{d_\lambda(A_i, A_j)\}$ 
      end
    end
  end
end

```

V. THE INDETERMINACY BASED OPEN EXTENDED JUNGIAN TYPE SCALES USING TRINS

A. Sample Questionnaire

A sample questionnaire of the indeterminacy based Open Extended Jungian Type Scales personality test using TRINS

TABLE II
SAMPLE QUESTIONNAIRE OF THE INDETERMINACY BASED OEJTS

Q		Scale weight					
		1	2	3	4	5	
Q ₁	makes lists	<input type="checkbox"/>	<input type="checkbox"/>	<input type="checkbox"/>	<input type="checkbox"/>	<input type="checkbox"/>	relies on memory
Q ₂	sceptical	<input type="checkbox"/>	<input type="checkbox"/>	<input type="checkbox"/>	<input type="checkbox"/>	<input type="checkbox"/>	wants to believe
Q ₃	bored by time alone	<input type="checkbox"/>	<input type="checkbox"/>	<input type="checkbox"/>	<input type="checkbox"/>	<input type="checkbox"/>	needs time alone
Q ₇	energetic	<input type="checkbox"/>	<input type="checkbox"/>	<input type="checkbox"/>	<input type="checkbox"/>	<input type="checkbox"/>	mellow
Q ₁₁	works best in groups	<input type="checkbox"/>	<input type="checkbox"/>	<input type="checkbox"/>	<input type="checkbox"/>	<input type="checkbox"/>	works best alone
Q ₁₅	worn out by parties	<input type="checkbox"/>	<input type="checkbox"/>	<input type="checkbox"/>	<input type="checkbox"/>	<input type="checkbox"/>	gets fired up by parties
Q ₁₉	talks more	<input type="checkbox"/>	<input type="checkbox"/>	<input type="checkbox"/>	<input type="checkbox"/>	<input type="checkbox"/>	listens more
Q ₂₃	stays at home	<input type="checkbox"/>	<input type="checkbox"/>	<input type="checkbox"/>	<input type="checkbox"/>	<input type="checkbox"/>	goes out on the town
Q ₂₇	finds it difficult to yell very loudly	<input type="checkbox"/>	<input type="checkbox"/>	<input type="checkbox"/>	<input type="checkbox"/>	<input type="checkbox"/>	yelling to others ... comes naturally
Q ₃₁	perform in public	<input type="checkbox"/>	<input type="checkbox"/>	<input type="checkbox"/>	<input type="checkbox"/>	<input type="checkbox"/>	avoids public speaking

will be as given in table II.

The user is expected to fill the degree accordingly.

Example 2. Consider question 1, the different options would be

- 1) a degree of “make list”,
- 2) a degree of indeterminacy choice towards “make list”,
- 3) a degree of uncertain and indeterminate combination of making list and depending on memory,
- 4) a degree of indeterminate choice more of relying on memory, and
- 5) a degree of “relying on memory”.

Suppose the user thinks and marks a degree of “make list” is 0.0, a degree of indeterminate choice towards “make list” is 0.4, a degree of uncertain and indeterminate combination of making list and depending on memory is 0.1, an degree of indeterminate choice more of relying on memory 0.3, and a degree of “relying on memory” is 0.2.

A is a TRINS of $Q = \{q_1\}$ defined by

$$A = \langle 0.0, 0.4, 0.1, 0.3, 0.2 \rangle / q_1.$$

When the weight of each membership is applied, the TRINS A becomes

$$A = \langle 0.0, 0.8, 0.3, 1.2, 1.0 \rangle / q_1$$

$$w(A) = 3.3.$$

In the general test, a whole number value from 1 to 5 will be obtained, whereas in the indeterminacy based OEJTS an accurate value is obtained. Thus the accuracy of the test is evident.

B. Calculating Results

Depending on the questionnaire the following grouping was carried out

TRINS E is defined in the discourse $Q_E = \{Q_{15}, Q_{23}, Q_{27}\}$ deals with the extrovert aspect and the introvert aspect is defined by TRINS I which is defined in the discourse $Q_I = \{Q_3, Q_7, Q_{11}, Q_{19}, Q_{31}\}$. The Sensing versus Intuition dichotomy is given by TRINSs S and N ; S is defined in the discourse $Q_S = \{Q_{24}, Q_{28}\}$ and N is defined in the discourse $Q_N = \{Q_4, Q_8, Q_{12}, Q_{16}, Q_{20}, Q_{32}\}$.

Similarly Feeling versus Thinking dichotomy is given by TRINSs F and T ; F is defined in the discourse $Q_F = \{Q_2, Q_{14}, Q_{18}, Q_{26}, Q_{30}\}$ and T is defined the discourse $Q_T = \{Q_6, Q_{10}, Q_{22}\}$. TRINSs J and P are used to represent the judging versus perceiving dichotomy; J is defined in the discourse $Q_J = \{Q_{17}, Q_{25}\}$ and P is defined in the discourse $Q_P = \{Q_1, Q_5, Q_{13}, Q_{21}, Q_{29}\}$.

The weight of a TRINS E is given in Equations 3.

The calculation for scoring is as follows:

$$IE = 30 - w(I) + w(E)$$

$$SN = 12 - w(S) + w(N)$$

$$FT = 30 - w(F) + w(T)$$

$$JP = 18 - w(J) + w(P).$$

The score results are based on the following rules:

- 1) If IE is greater than 24, you are extrovert (E), otherwise you are introvert (I).
- 2) If SN is greater than 24, you are intuitive (N), otherwise you are sensing (S).
- 3) If FT is higher than 24, you are thinking (T), otherwise you are feeling (F).
- 4) If JP is higher than 24, you are perceiving (P), otherwise you are judging (J).

C. Comparing results of two people

Consider this personality test is taken by a group of people. Using the distance measure given in Algorithm 1 is defined over TRINS the difference and similarity in two or more person’s personality can be analysed along a particular dichotomy. They can be analysed along extroversion (E), introversion (I), Intuitive (N), Sensing (S), Thinking (T), Feeling (F), Perceiving (P) or judging (J) or any combination of the eight. Clustering of the results using the distance matrix given in Algorithm 2 can also be carried out, it cluster and find similar personality people. This topic is left for future research.

VI. COMPARISON

The existing classical personality test force the test taker to select only one option and it is mostly what the user thinks he/she does often. The other options are lost to the test taker. It fails to capture the complete picture realistically. The dominant choice is selected, the selection might have very small margin. In such cases the accuracy of the test fails. Whereas when the indeterminacy based OEJTS Test is considered, it provides five different options to the test taker using TRINS for representing the choice.

It is important to understand why TRINS makes the candidate for this kind of personality test. The reason can be obtained by the following comparative analysis of the methods and their capacity to deal indeterminate, inconsistent and incomplete information.

TRINS is an instance of a neutrosophic set, which approaches the problem more logically with accuracy and precision to represent the existing uncertainty, imprecise, incomplete, and inconsistent information. It has the additional

feature of being able to describe with more sensitivity the indeterminate and inconsistent information. TRINS alone can give scope for a person to express accurately the exact realistic choices instead of opting for a dominant choice. While, the SVNS can handle indeterminate information and inconsistent information, it is cannot describe with accuracy about the existing indeterminacy. It is known that the connector in fuzzy set is defined with respect to T (membership only) so the information of indeterminacy and non membership is lost. The connectors in intuitionistic fuzzy set are defined with respect to truth membership and false membership only; here the indeterminacy is taken as what is left after the truth and false membership. Hence a personality test based on TRINS gives the most accurate and realistic result, because it captures the complete scenario realistically.

VII. CONCLUSIONS

In objective type personality test like the MBTI or the OEJTS, the user is forced to select an option, and mostly lands up selecting the most dominant choice. The rest of the options are lost. A person may not be in general capable to judge his/her behaviour very precisely and categorize it into a particular choice. Since it is the person doing self rating there is a lot of uncertain, inexpressible and indeterminate feelings involved. The results of the test depend on a number of internal and external factors. To provide a more accurate and realistic result, a personality test needs to provide more choices and a degree of acceptance with that particular choice. To represent the Likert scale using neutrosophy, the concept of Triple Refined Indeterminate Neutrosophic Set (TRINS) was introduced. More precision is provided in handling indeterminacy; by classifying indeterminacy (I) into three, based on membership; as indeterminacy leaning towards truth membership (I_T), indeterminacy membership (I) and indeterminacy leaning towards false membership (I_F). TRINS can be used in any place where the Likert scale is used like personality test. In this paper a indeterminacy based personality test based on the OEJTS and TRINS was proposed. The calculation of results and personality types was discussed. This personality test is capable of accurately describing the perception of the test taker and their decision making tendencies. The personality of two people can be compared in detail using the distance measures defined over TRINS, however this is left for future study.

REFERENCES

- [1] C. G. Jung, *Psychological types*. Routledge, 2014.
- [2] I. B. Myers, *The myers-briggs type indicator*. Consulting Psychologists Press Palo Alto, CA, 1962.
- [3] L. A. Zadeh, "Fuzzy sets," *Information and control*, vol. 8, no. 3, pp. 338–353, 1965.
- [4] K. T. Atanassov, "Intuitionistic fuzzy sets," *Fuzzy sets and Systems*, vol. 20, no. 1, pp. 87–96, 1986.
- [5] K. Atanassov and G. Gargov, "Interval valued intuitionistic fuzzy sets," *Fuzzy sets and systems*, vol. 31, no. 3, pp. 343–349, 1989.
- [6] F. Smarandache, *A Unifying Field in Logics: Neutrosophic Logic. Neutrosophy, Neutrosophic Set, Probability, and Statistics*. American Research Press, Rehoboth, 2000.
- [7] H. Wang, F. Smarandache, Y. Zhang, and R. Sunderraman, "Single valued neutrosophic sets," *Review*, p. 10, 2010.
- [8] A. Salama, A. Haitham, A. Manie, and M. Lotfy, "Utilizing neutrosophic set in social network analysis e-learning systems," *International Journal of Information Science and Intelligent System*, vol. 3, no. 2, 2014.
- [9] J. Ye, "Multicriteria decision-making method using the correlation coefficient under single-valued neutrosophic environment," *International Journal of General Systems*, vol. 42, no. 4, pp. 386–394, 2013.
- [10] —, "A multicriteria decision-making method using aggregation operators for simplified neutrosophic sets," *Journal of Intelligent & Fuzzy Systems*, vol. 26, no. 5, pp. 2459–2466, 2014.
- [11] —, "Single valued neutrosophic cross-entropy for multicriteria decision making problems," *Applied Mathematical Modelling*, vol. 38, no. 3, pp. 1170–1175, 2014.
- [12] —, "Similarity measures between interval neutrosophic sets and their applications in multicriteria decision-making," *Journal of Intelligent & Fuzzy Systems*, vol. 26, no. 1, pp. 165–172, 2014.
- [13] H.-D. Cheng and Y. Guo, "A new neutrosophic approach to image thresholding," *New Mathematics and Natural Computation*, vol. 4, no. 03, pp. 291–308, 2008.
- [14] A. Sengur and Y. Guo, "Color texture image segmentation based on neutrosophic set and wavelet transformation," *Computer Vision and Image Understanding*, vol. 115, no. 8, pp. 1134–1144, 2011.
- [15] M. Zhang, L. Zhang, and H. Cheng, "A neutrosophic approach to image segmentation based on watershed method," *Signal Processing*, vol. 90, no. 5, pp. 1510–1517, 2010.
- [16] W. Vasantha and F. Smarandache, *Fuzzy cognitive maps and neutrosophic cognitive maps*. Infinite Study, 2003.
- [17] —, "Analysis of social aspects of migrant labourers living with hiv/aids using fuzzy theory and neutrosophic cognitive maps: With special reference to rural tamil nadu in india," *arXiv preprint math/0406304*, 2004.
- [18] I. Kandasamy, "Double-valued neutrosophic sets, their minimum spanning trees, and clustering algorithm," 2016, accepted for publication in *Journal of Intelligent Systems*.
- [19] I. Kandasamy and Smarandache, "Multicriteria decision making using double refined indeterminacy neutrosophic cross entropy and indeterminacy based cross entropy," *Applied Mechanics and Materials*, vol. 859, pp. 129–143, 2016.
- [20] E. Jorgenson, "Development of the open extended jungian type scales 1.2," *Creative Commons Attribution NonCommercial-Share Alike 4.0 International License*, pp. 1–13, 2015.
- [21] F. Smarandache, "n-valued refined neutrosophic logic and its applications in physics," *Progress in Physics*, vol. 4, pp. 143–146, 2013.

Robot System Identification using 3D Simulation Component Applied on VIPRO Platform

**Luige Vladareanu, Florentin Smarandache, Mumtaz Ali, Victor Vladareanu,
Mingcong Deng**

Luige Vladareanu, Florentin Smarandache, Mumtaz Ali, Victor Vladareanu, Mingcong Deng (2016). Robot System Identification using 3D Simulation Component Applied on VIPRO Platform. Proceedings of the 2016 International Conference on Advanced Mechatronic Systems, Melbourne, Australia, 6

Abstract. The paper presents automated estimation techniques for robot parameters through system identification, for both PID control and future implementation of intelligent control laws, with the aim of designing the experimental model in a 3D virtual reality for testing and validating control laws in the joints of NAO humanoid robots. After identifying the maximum likelihood model, the PID amplification factors are optimized and introduced into the Unity environment as a script for controlling the joint. The program used for identifying PID parameters for the NAO robot is developed using the virtual reality platform Unity 3D and integrated into the Graphical Station component of the VIPRO Platform for the control of versatile, intelligent, portable robots. The obtained results, validated in the virtual reality environment, have led to the implementation of the PID identification and optimization component on the VIPRO Platform.

Keywords—*intelligent robotic control systems; robotic system identification; modelling system; virtual reality; robot stability*

I. INTRODUCTION

The last few years have seen mobile robots gain increased attention in the research community, as well as in the manufacturing industry, resulting in remarkable hardware and software development. Among the applications of great interest for researchers are: dangerous activities such as detection of antipersonnel mines and other explosives, surveillance

activities (“Remotec” has developed the Marauder technology which later led to the development of the Andros Mark V robot) and rescue operation in case of calamity.

Following the devastating earthquakes in Japan, an international project has been developed which reunites renowned research teams from all over the world for the design of search and rescue robots, under the banner of the RoboCup – Rescue Project, divided into two sub-projects: multi-agent simulation using a virtual robot and development of a real robot.

Developing remote-controlled, autonomous mobile robots, which can support humans in search and rescue operations in a contaminated nuclear environment, after fires or in calamitous earthquake areas has become a priority and entails a complex challenge. To this end, numerous robot control methods have been developed for moving on uneven and uncertain environments, which allows improvements in robot mobility and stability, through intelligent algorithms: fuzzy logic, extenics, neutrosophy, neural networks, Petri nets with Markov models, hybrid force-position control method, among others.

II. 3D UNITY SIMULATION COMPONENT APPLIED ON VIPRO PLATFORM

Real time, remotely-controlled robots with the capabilities of a human operator have an increasingly important role in hazardous or challenging environments, where human life

might be endangered, such as nuclear contamination areas, fires and earthquake zones [1 - 3].

Research in these fields have led to an accumulation of important expertise regarding robot movement in virtual environments, with improvements in navigation, obstacle avoidance, high fidelity environment simulation, etc., but lacking the environment – virtual robot – robot interactions. In this context by developing an innovative platform [4 - 7], the VIPRO Platform has been conceived for brings virtual robots into the real world, mainly consisting in the projection into a virtual environment of the robot mechanical structure, and communicate in real time through a high-speed interface with real robotic control systems, in order to improve performances of the robot control laws. The result is a versatile, intelligent, portable robot platform (VIPRO), which allows improved of the robot motion and stability performance in a virtual and real environment on uneven and unstructured terrain for mobile, autonomous, intelligent robots, such as the NAO robots, or in particular the search and rescue robots RABOT.

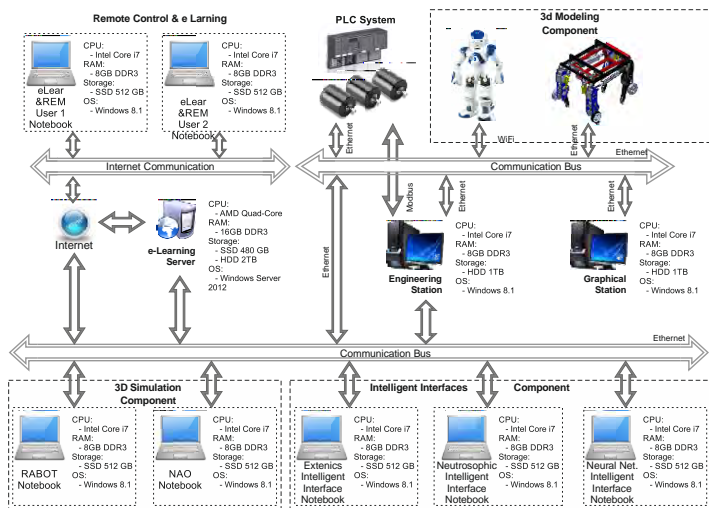

Figure 1. VIPRO Platform Architecture

The VIPRO Platform architecture for modelling and simulation of mobile robots is based on the virtual projection method [6, 8-11], through which robotics and mechatronics systems are developed in a virtual environment.

The technical solution, presented in an open architecture real time control structure (Figure 1), contains the main modules of the VIPRO Platform. The intelligent control interface module uses advanced control strategies adapted to the robot environment such as extended control (extenics) [12 - 14], neutrosophic control [15 - 18], human adaptive mechatronics, etc., implemented through computational techniques for fast processing and real time communication. The following intelligent control interfaces have been designed and implemented on the VIPRO Platform: neutrosophic robot control interface (ICNs), extended control interface for robot extenics control (ICEx) and the neural network interface (INN) for dynamic hybrid force position control DHFPC [19, 20].

The two main components of the VIPRO Platform are the workstation “Engineering Station” for the PLC classic position control of robot joint actuators and speed control of load actuators, and the “Graphical Station” for the development of a virtual robot environment and virtual reality for robot motion.

The VIPRO Platform has allotted 5 user stations dedicated to modelling the NAO robot using direct and inverse kinematics, modelling the RABOT robot in the Unity development environment, neutrosophic intelligent control (ICN) through the integration of the RNC method, extended control through the extenics method (ICEx) and modelling inverse kinematics in the robot motion control using fuzzy inference systems and neural networks.

For remote control in establishing the e-learning component of the VIPRO Platform, a PC server was integrated to ensure large data traffic for internet communication, with two addition workstations for end-user applications.

The “Engineering Station” component is mainly aimed at integrating the AC500 development environment for programmable automate (PLC) applications, control of the application stand for the virtual projection method on 6 DOF, and testing of the intelligent neutrosophic control (ICNs), extenics control (ICEx) and dynamic hybrid force position control DHFPC interfaces.

After testing, these are integrated in real-time control of a new robot with improved performance and stability of motion through the Graphical Station, as follows: for multi-users through the components of the VIPRO Platform consisting of Remote Control& eLearning User 1, Remote Control& eLearning User 2 or individually through the VIPRO Platform components consisting of the dedicated intelligent interfaces on the Notebook workstations, namely “Extenics Intelligent Interface Notebook”, “Neutrosophic Intelligent Interface Notebook” and “Neural Network Intelligent Interface Notebook”.

Using 3D UNITY Simulation Component Applied to the VIPRO Platform, the paper presents automated estimation techniques for robot system identification.

III. AUTOMATED TECHNIQUES FOR PARAMETER ESTIMATION

A. Identification of PID parameters for the NAO robot

Designing the experimental model in a virtual 3D environment for testing and validation of the PID control law parameters of the robot joints entails an accurate identification of the system model through automated parameter estimation algorithms for both the PID controller, as well as the future implementation of intelligent control laws [21 - 23].

Ensuring the stability of the experimental virtual model, using PID control in the robot joints, requires knowledge of an approximate model of the controlled process, based on which the amplification factors for the parallel PID structure are established. The model is developed through system identification algorithms using known vectors of input and related output data of the unknown system. The Unity 3D environment allows data generation for input references to a virtual robot joint and monitoring its behavior, thus obtaining the required output data. These are used for the parameter estimation of system models applied to the phenomenon. After identifying the maximum likelihood model, the amplification factors for a PID controller structure are optimized and introduced into the Unity environment as a controller script for the robot joint. The robot joint in the Unity environment is treated as a black-box system, without the need to intervene on

the development environment's libraries or source code (as relates to understanding or modifying the physics engine).

B. NAO Leg Joint 3D Simulation Data in UNITY

The two sets of data (the input and output vectors, respectively) are exported to an Excel working file in *.csv

format, to be further imported into the numerical processing environment. An example is shown in Figure 2.

The data is imported into Matlab using the function xlsread, resulting in a data vector structure used to identify the position controlled system.

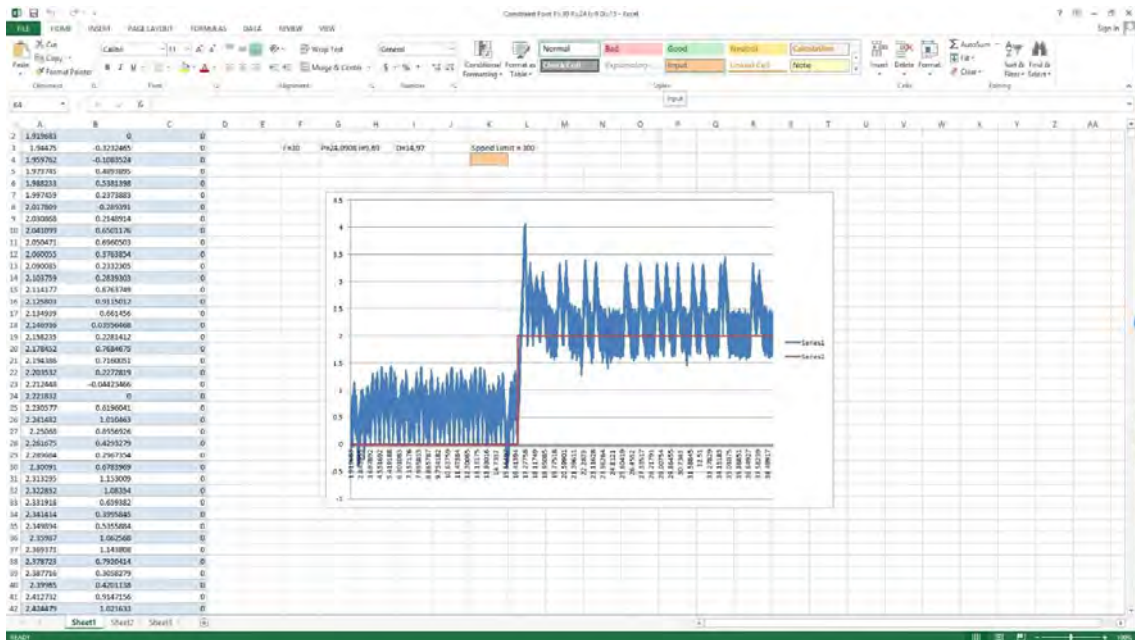

Figure 2. Data structure exported from Unity to a *.csv file

With the help of the native xlsread function, the file obtained in the Unity 3D tests can be imported into the Matlab environment for processing.

The result is shown in Figure 3, in which the data is structured as two vectors representing the reference (input variable) and the system output.

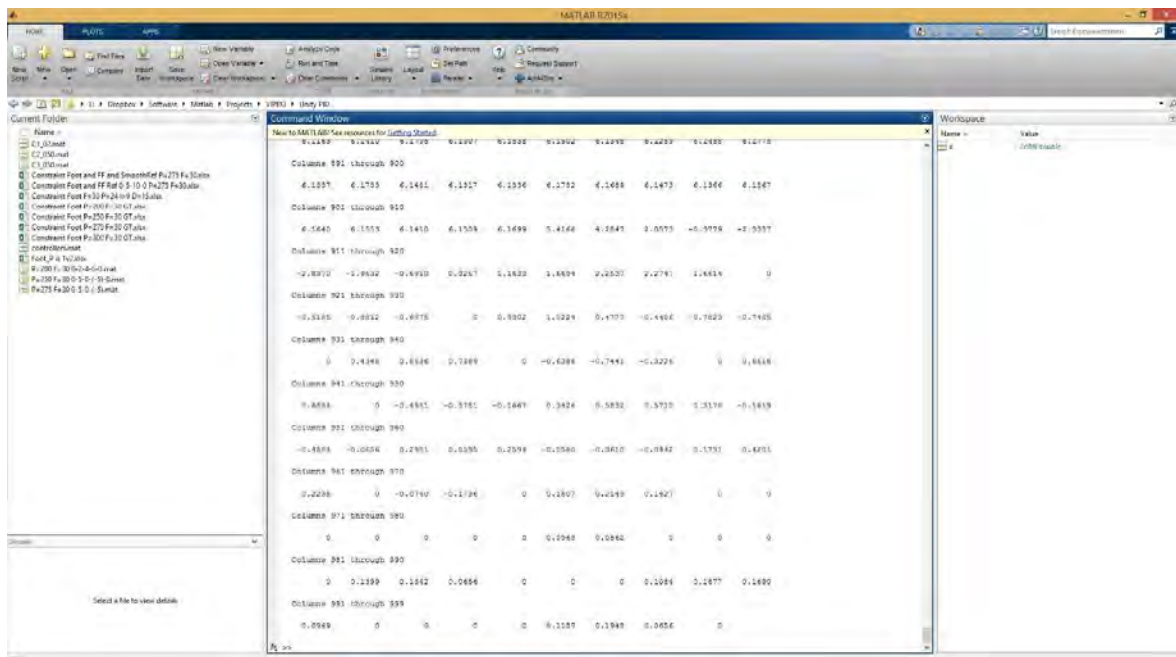

Figure 3. Vector imported into the workspace

C. Data pre-processing

The obtained data is pre-processed, as can be seen in Figure 4, to ease the task of system identification by eliminating nonessential areas and their respective noise. For example, the

reference has a null value for the beginning of the test in order to calibrate the system. However, the acquired data shows nonzero values due to the existing noise in the simulation environment and the inexactness assumed in representing the mechanical system.

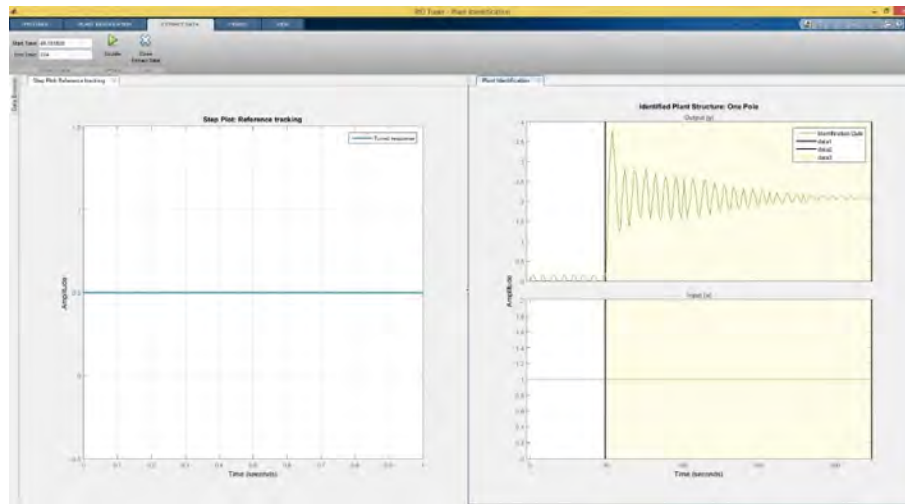

Figure 4. Pre-processing the obtained data

IV. SYSTEM IDENTIFICATION

System identification using the automated identification function from the Matlab toolbox is tried for a number of various order systems.

After the input data has been brought to a desired form and the possible noise components removed, system identification

can begin in earnest. In the respective application in the Matlab programming environment are investigated a number of possible system models, with the program handling the automatic parameter identification.

Given a certain model chosen for representation, the interface optimizes automatically the model parameters using the samples from the input and output vectors (Figure 5).

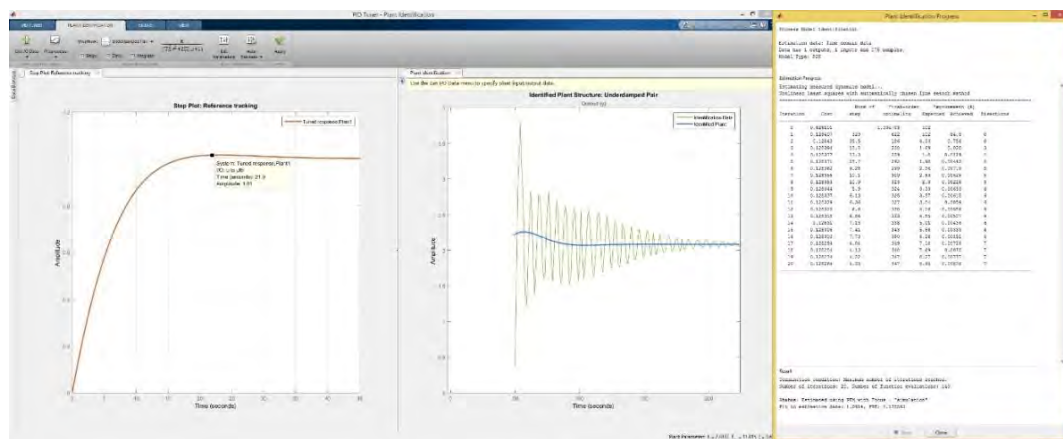

Figure 5. Model identification for two paired poles

A. Control model adaptation

For complex black-box system identification and adaptation to the nonlinear behaviour of the data set, the separate system identification interface is used. The various available options and the parameter optimization algorithms are shown in Figure 6.

B. Control law optimization interface

Optimization of the PID controller in a varied number of options and of the amplification factors for each of these, which control the chosen process, is developed in the virtual environment through an intelligent control interface.

Within the existing interface, the controller type was chosen (P/PI/PD/PID), as well as the desired response for a closed

loop system including this controller. The estimated result, seen within the interface in Figure 7, has allowed establishing the desired transitive response, the convergence speed and the

direct adjustment of the amplification factors of the three branches of the controller.



Figure 6. Comprehensive interface for robotic system identification

After the theoretical validation of the model, the obtained data is exported back into the virtual reality 3D environment in Unity, in which the controller behaviour is simulated through a

compiled script, which generated the amplifications determined in the Matlab control interface presented above.

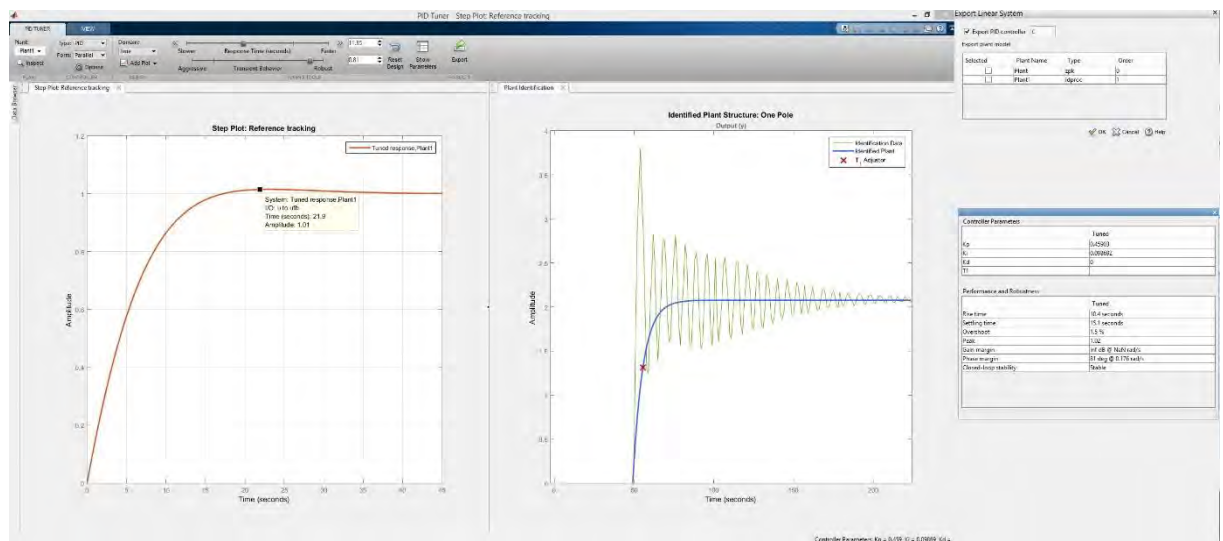

Figure 7. PID answer estimated

V. RESULTS AND CONCLUSIONS

Identifying the control law parameters for the Nao walking robot, using the 3D simulation component of the virtual reality platform Unity 3D, through automated parameter estimation techniques, for both PID control and future implementations of intelligent control laws, allows an improvement in stability and robot motion control in a virtual reality environment.

By applying the virtual projection method, the improvement in robot performance is transferred from the virtual world of modelling and simulation to the real world of

experimental models, representing a powerful experimental validation tool.

The PID parameter identification program for the Nao humanoid robot using the virtual reality platform Unity 3D and the 3D simulation component are shown in Figure 8, are available for users of the VIPRO platform and accessible from the VIPRO interface, either locally or from a remote location.

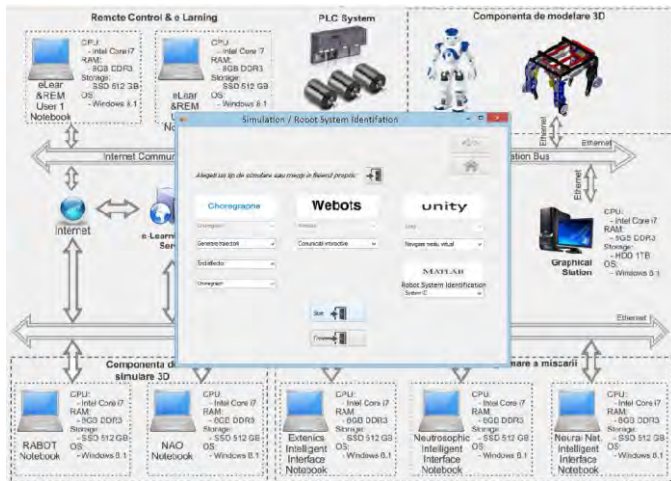

Fig.8. Robot system identification on VIPRO Platform

The obtained results, validated in the virtual reality environment, have led to the implementation on the VIPRO Platform in the 3D environment Unity, of the simulation component for the PID parameter identification for the NAO humanoid robot, with the possibility of extension to the RABOT search and rescue robot.

ACKNOWLEDGMENT

This work was developed with the support of MEN-UEFISCDI, PN-II-PT-PCCA-2013-4, VIPRO project No.009/2014, Romanian Academy and “Joint Laboratory of Intelligent Rehabilitation Robot” collaborative research agreement between Romanian Academy by IMSAR and Yanshan University, China.

REFERENCES

[1] Robin R. Murphy, “Human-Robot Interaction in Rescue Robotics”, IEEE Trans on Systems, Man, and Cybernetics, Part C, vol.34, no. 2, pp.138-158, 2004. Yu, Proceedings of the Romanian Academy, Series A, Volume10, Number 1, 2009

[2] Yang Liu, Hongnian Yu, Luige Vladareanu, Shuang Cang, and T. C. Yang, “Trajectory Optimization of a Pendulum-Driven Underactuated Cart”, SISOM 2011 and Session of the Commission of Acoustics, pp 287-299, Bucharest 25-26 May, 2011

[3] Yang Liu, Hongnian Yu and Luige Vladareanu, An Iterative Learning Control Scheme for the Capsbot, UKACC International Conference on Control 2008, University of Manchester, UK, 2-4 September 2008..

[4] Vladareanu L., Velea L.M., Munteanu R.I, Curaj A., Cononovici S., Sireteanu T., Capitanu L., Munteanu M.S., Real time control method and device for robots in virtual projection, patent EPO-09464001, 18.05.2009, EP2105263. Patent OSIM 123527/30.04.2013.

[5] Victor Vladareanua, Radu I. Munteanub, Ali Mumtazc, Florentin Smarandached and Luige Vladareanua *, “The optimization of intelligent control interfaces using Versatile Intelligent Portable Robot Platform”, Procedia Computer Science 65 (2015): 225 – 232, ELSEVIER, www.sciencedirect.com, doi:10.1016/j.procs.2015.09.115.

[6] Victor Vladareanu, Ioan Dumitrache, Luige Vladareanu, Ioan Stefan Sacala, Gabriela Tonț, Mihnea Alexandru Moisescu “Versatile Intelligent Portable Robot Platform applied to dynamic control of the walking robots”, Studies in Informatics and Control 24(4):409-418 · December 2015, ISSN: 1220 – 1766.

[7] Kagami S., Nishiwaki K., Kuffner J., Kuniyoshi Y., Inaba M. and Inoue H., “Online 3D vision, motion planning and bipedal locomotion control

coupling system of humanoid robot H7”, Proceedings of the 2002 IEEE/RSJ International Conference on Intelligent Robots and Systems, Lausanne, Switzerland, 2557-2562 (2002)

[8] Luige Vladareanu, Radu I. Munteanu, Shuang Cang , Hongnian Yu, Hongbo Wang, Victor Vladareanu, Zeng-Guang Hou, Octavian Melinte, Xiaojie Wang, Guibin Bian, Yongfei I Feng, “Haptic interfaces for the rescue walking robots motion in the disaster areas”, Patent: OSIM A2014 00577 din 29/07/2014

[9] Danut A. Bucur, Luige Vladareanu, Hongnian Yu, Xianchao Zhao, Stefan Dumitru, „Hybrid Force-Position Humanoid Hand Control in 3D Virtual Environment”, Applied Mechanics and Materials Vol 762 (May 2015), pp 91-97, ISBN-13: 978-3-03835-444-4, ISSN: 1660-9336, DOI 10.4028/www.scientific.net/AMM.762.91.

[10] Vladareanu, L., Spirleanu, Cristian ; Iliescu, Mihaiela ; Yu, Hongnian ; Deng, Mingcong ; Guo, Weizhong ; Gao, Feng, „Versatile Intelligent Portable Robot Platform for flexible robotic cells with AGV”. Advanced Mechatronic Systems (ICAMEchS), 2015 International Conference on, 22-24 Aug. 2015, Beijing, China, pg. 42 – 49, DOI: 10.1109/ICAMEchS.2015.7287126, INSPEC, IEEE, 2015.

[11] S.B. Balakirsky and Z. Kootbally, “USARSim/ROS: A Combined Framework for Robotic Control and Simulation”, Proceedings of the ASME 2012 International Symposium on Flexible Automation (ISFA 2012), St. Louis, June 18-20, 2012.

[12] Luige Vladareanu, Cai Wen, R.I. Munteanu, Yan Chuyan, Li Weihua, F. Smarandache, Alexandru Gal “Method and Device for Hybrid Force-Position extended control of robotic and machatronic systems”, Patent: OSIM A2012 1077/28.12.2012

[13] Vladareanu V. , Şchiopu P., Vladareanu L., Theory And Application Of Extension Hybrid Force-Position Control În Robotics, U.P.B. Sci. Bull., Series A, Vol. 76 (3), 2014, pg.43-54, ISSN 1223-7027

[14] Florentin Smarandache, Extenics in Higher Dimensions, Institute of Extenics and Innovation Methods, Guangdong University of Technology, ISBN: 9781599732039

[15] SmarandacheF.,L.Vladareanu, Applications of Neutrosophic Logic to Robotics - An Introduction, The 2011 IEEE International Conference on Granular Computing Kaohsiung, Taiwan, Nov. 8-10, 2011, pp. 607-612, ISBN 978-1-4577-0370-6

[16] OvidiuIlieŞandru, LuigeVlădareanu, Paul Şchiopu, Victor Vlădareanu, Alexandra Şandru, Multidimensional Extenics Theory, U.P.B. Sci. Bull., Series A, Vol. 75, Iss. 1, 2013, pg.3-12, ISSN 1223-7027

[17] Luige Vladareanu, Cai Wen, R.I. Munteanu, Yan Chuyan, Li Weihua, F. Smarandache, Alexandru Gal “Method and Device for Hybrid Force-Position extended control of robotic and machatronic systems”, Patent: OSIM A2012 1077/28.12.2012

[18] Victor Vladareanua, Radu I. Munteanub, Ali Mumtazc, Florentin Smarandachedand Luige Vladareanua, “The optimization of intelligent control interfaces using Versatile Intelligent Portable Robot Platform”, Procedia Computer Science 65 (2015): 225 – 232, ELSEVIER, www.sciencedirect.com, doi:10.1016/j.procs.2015.09.115

[19] Yi Dong, Hongnian Yu, FengGao, Design, modelling and control of a light touch Mechanism, International Conference on Advanced Mechatronic Systems, Zhengzhou, China, 11-13 August 2011

[20] Pop,N., Vladareanu,I., Popescu,I.N., Ghiță,C., Gal,I.A., Cang, S., Yu,H.N., Bratu, V., Deng,M., “A numerical dynamic behaviour model for 3D contact problems with friction”, Computational Materials Science, Volume 94, November 2014, Pages 285-291, ISSN 0927-0256,

[21] Marina Shitikova, Luige Vladareanu, Claudio Guarnaccia, „Recent advances in mechanical engineering”, WSEAS Press, 2014, pg.207-2014, ISBN ISBN: 978-960-474-402-2

[22] Mihaiela Iliescu, Cristian Spirleanu, Nicolae Bercan And Luige Vladareanu, “Flexible Robotic Cell for Optimization of Grinding Process for 40c130 Metallized Coating”, Academic Journal of Manufacturing Engineering, AJME, Vol. 13, ISSUE 2/2015, pg. 30-35, ISSN: 15837904, Cod CNCISIS-127

[23] Vladareanu V., Schiopu P., Cang S and Yu H.N, “Reduced Base Fuzzy Logic Controller for Robot Actuators”, Applied Mechanics and Materials Vol. 555 (2014) pp 249-258© (2014) Trans Tech Publications, Switzerland doi:10.4028/ www.scientific.net/AMM.555.2497.

Single Valued Neutrosophic Graphs: Degree, Order and Size

Said Broumi, Mohamed Talea, Florentin Smarandache, Assia Bakali

Said Broumi, Mohamed Talea, Florentin Smarandache, Assia Bakali (2016). Single Valued Neutrosophic Graphs: Degree, Order and Size. IEEE International Conference on Fuzzy Systems (FUZZ-IEEE), 2016: 2444-2451, DOI: 10.1109/FUZZ-IEEE.2016.7738000

Abstract—The single valued neutrosophic graph is a new version of graph theory presented recently as a generalization of fuzzy graph and intuitionistic fuzzy graph. The single valued neutrosophic graph (SVN-graph) is used when the relation between nodes (or vertices) in problems are indeterminate. In this paper, we examine the properties of various types of degrees, order and size of single valued neutrosophic graphs and a new definition for regular single valued neutrosophic graph is given.

Keywords— *single valued neutrosophic graph; total degree; effective degree; neighborhood degree; Order; Size.*

I. INTRODUCTION

Neutrosophic set (NS for short) proposed by Smarandache [11, 12] is a powerful tool to deal with incomplete, indeterminate and inconsistent information in real world. It is a generalization of the theory of fuzzy set [16], intuitionistic fuzzy sets [22, 24], interval-valued fuzzy sets [18] and interval-valued intuitionistic fuzzy sets [23], then the neutrosophic set is characterized by a truth-membership degree (t), an indeterminacy-membership degree (i) and a falsity-membership degree (f) independently, which are within the real standard or nonstandard unit interval $]0, 1[$. Therefore, if their range is restrained within the real standard unit interval $[0, 1]$, Nevertheless, NSs are hard to be apply in practical problems since the values of the functions of truth, indeterminacy and falsity lie in $]0, 1[$. Therefore, Wang et al.[14] presented single-valued neutrosophic sets (SVNSs) whose functions of truth, indeterminacy and falsity lie in $[0, 1]$. The same authors introduced the notion of interval valued neutrosophic sets [15] as subclass of neutrosophic sets in which the value of truth-membership, indeterminacy-membership and falsity-membership degrees are intervals of numbers instead of the real numbers. neutrosophic sets and its extensions such as single valued neutrosophic sets, interval neutrosophic sets, simplified neutrosophic sets and so on have been applied in a wide variety of fields including computer science, engineering, mathematics, medicine and economic [1, 2, 3, 7, 8, 10, 11, 12, 13, 17,19, 20, 21, 27, 33, 34, 35].

Many works on fuzzy graphs and intuitionistic fuzzy graphs [4, 5, 6, 27, 28, 41] have been carried out and all of them have considered the vertex sets and edge sets as fuzzy and /or intuitionistic fuzzy sets. But, when the relations between nodes (or vertices) in problems are indeterminate, the fuzzy graphs and intuitionistic fuzzy graphs are failed. For this purpose, Smarandache [9] have defined four main categories of neutrosophic graphs, two based on literal indeterminacy (I), which called them; I-edge neutrosophic graph and I-vertex neutrosophic graph, these concepts are studied deeply and has gained popularity among the researchers due to its applications via real world problems [38, 39, 40]. The two others graphs are based on (t, i, f) components and called them; The (t, i, f)-edge neutrosophic graph and the (t, i, f)-vertex neutrosophic graph, these concepts are not developed at all. Later on, Broumi et al. [30] introduced a third neutrosophic graph model combined the (t, i, f)-edge and the (t, i, f)-vertex neutrosophic graph and investigated some of their properties. The third neutrosophic graph model is called ‘single valued neutrosophic graph’ (SVNG for short). The single valued neutrosophic graph is the generalization of fuzzy graph and intuitionistic fuzzy graph. Also, Broumi et al.[31] introduced the concept of bipolar single valued neutrosophic graph as a generalization of fuzzy graphs, intuitionistic fuzzy graph, N-graph, bipolar fuzzy graph and single valued neutrosophic graph and studied some of their related properties. The same authors [32, 33, 34], introduced the concept of interval valued neutrosophic graph as a generalization of single valued neutrosophic graph and have discussed some of their properties with proof and examples. The remainder of this paper is organized as follows. In Section 2, we review some basic concepts about neutrosophic sets, single valued neutrosophic sets, single valued neutrosophic graph and complete single valued neutrosophic graph. The type of degrees in single valued neutrosophic graphs such as degree of vertex, total degree, effective degree, neighborhood degree, closed neighborhood degree are defined in Section 3. Furthermore, some properties of the proposed degrees are discussed with numerical examples. In Section 4, we present

the concept of regular single valued neutrosophic graph and proved some propositions. In addition, Section 5 also present the concept of order and size of single valued neutrosophic graph. Finally, Section 6 outlines the conclusion of this paper and suggests several directions for future research.

II. PRELIMINARIES

In this section, we mainly recall some notions related to neutrosophic sets, single valued neutrosophic sets, fuzzy graph, intuitionistic fuzzy graph, single valued neutrosophic graphs, relevant to the present work. See especially [12, 14, 26, 28] for further details and background.

Definition 2.1 [12]. Let X be a space of points (objects) with generic elements in X denoted by x; then the neutrosophic set A (NS A) is an object having the form $A = \{ \langle x: T_A(x), I_A(x), F_A(x) \rangle, x \in X \}$, where the functions T, I, F: $X \rightarrow]0, 1^+[$ define respectively the truth-membership function, an indeterminacy-membership function, and a falsity-membership function of the element $x \in X$ to the set A with the condition:

$$0 \leq T_A(x) + I_A(x) + F_A(x) \leq 3^+ \quad (1)$$

The functions $T_A(x)$, $I_A(x)$ and $F_A(x)$ are real standard or nonstandard subsets of $]0, 1^+[$. Since it is difficult to apply NSs to practical problems, Wang et al. [14] introduced the concept of a SVNS, which is an instance of a NS and can be used in real scientific and engineering applications.

Definition 2.2 [14]. Let X be a space of points (objects) with generic elements in X denoted by x. A single valued neutrosophic set A (SVNS A) is characterized by truth-membership function $T_A(x)$, an indeterminacy-membership function $I_A(x)$, and a falsity-membership function $F_A(x)$. For each point x in X $T_A(x), I_A(x), F_A(x) \in [0, 1]$. A SVNS A can be written as

$$A = \{ \langle x: T_A(x), I_A(x), F_A(x) \rangle, x \in X \} \quad (2)$$

Definition 2.3[7]. A fuzzy graph is a pair of functions $G = (\sigma, \mu)$ where σ is a fuzzy subset of a non empty set V and μ is a symmetric fuzzy relation on σ . i.e $\sigma : V \rightarrow [0, 1]$ and $\mu: V \times V \rightarrow [0, 1]$ such that $\mu(uv) \leq \sigma(u) \wedge \sigma(v)$ for all $u, v \in V$ where uv denotes the edge between u and v and $\sigma(u) \wedge \sigma(v)$ denotes the minimum of $\sigma(u)$ and $\sigma(v)$. σ is called the fuzzy vertex set of V and μ is called the fuzzy edge set of E.

Definition 2.4 [26]: An intuitionistic fuzzy graph (IFG) is of the form $G = (V, E)$ where

1. $V = \{ v_1, v_2, \dots, v_n \}$ such that $\mu_1 : V \rightarrow [0, 1]$ and $\gamma_1 : V \rightarrow [0, 1]$ denotes the degree of membership and non-membership of the element $v_i \in V$, respectively, and

$$0 \leq \mu_1(v_i) + \gamma_1(v_i) \leq 1 \text{ for every } v_i \in V (i=1, 2, \dots, n) \quad (3)$$

2. $E \subseteq V \times V$ where $\mu_2 : V \times V \rightarrow [0, 1]$ and $\gamma_2 : V \times V \rightarrow [0, 1]$ are such that

$$\mu_2(v_i, v_j) \leq \min[\mu_1(v_i), \mu_1(v_j)] \quad (4)$$

$$\gamma_2(v_i, v_j) \geq \max[\gamma_1(v_i), \gamma_1(v_j)] \quad (5)$$

$$0 \leq \mu_2(v_i, v_j) + \gamma_2(v_i, v_j) \leq 1 \text{ for every } (v_i, v_j) \in E (i, j= 1, 2, \dots, n) \quad (6)$$

Definition 2.4 [28]. A single valued neutrosophic graph (SVN-graph) with underlying set V is defined to be a pair $G = (A, B)$ where

1. The functions $T_A : V \rightarrow [0, 1]$, $I_A : V \rightarrow [0, 1]$ and $F_A : V \rightarrow [0, 1]$ denote the degree of truth-membership, degree of indeterminacy-membership and falsity-membership of the element $v_i \in V$, respectively, and

$$0 \leq T_A(v_i) + I_A(v_i) + F_A(v_i) \leq 3 \text{ for all } v_i \in V.$$

2. The functions $T_B : E \subseteq V \times V \rightarrow [0, 1]$, $I_B : E \subseteq V \times V \rightarrow [0, 1]$ and $F_B : E \subseteq V \times V \rightarrow [0, 1]$ are defined by

$$F_B(v_i, v_j) \leq \min [T_A(v_i), T_A(v_j)], I_B(v_i, v_j) \geq \max [I_A(v_i), I_A(v_j)] \text{ and } F_B(v_i, v_j) \geq \max [F_A(v_i), F_A(v_j)]$$

Denotes the degree of truth-membership, indeterminacy-membership and falsity-membership of the edge $(v_i, v_j) \in E$ respectively, where

$$0 \leq T_B(v_i, v_j) + I_B(v_i, v_j) + F_B(v_i, v_j) \leq 3 \text{ for all } (v_i, v_j) \in E (i, j= 1, 2, \dots, n)$$

We call A the single valued neutrosophic vertex set of V, B the single valued neutrosophic edge set of E, respectively.

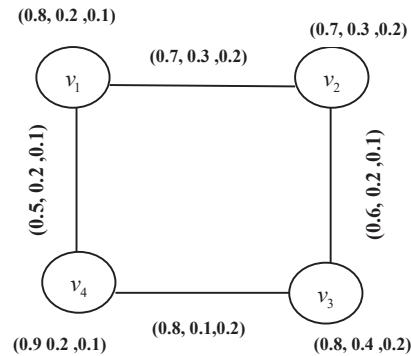

Fig.1. Single valued neutrosophic graph

Definition 2.5 [28]. A partial SVN-subgraph of SVN-graph $G = (A, B)$ is a SVN-graph $H = (V', E')$ such that
 - $V' \subseteq V$, where $T'_A(v_i) \leq T_A(v_i), I'_A(v_i) \geq I_A(v_i)$, and $F'_A(v_i) \geq F_B(v_i)$, for all $v_i \in V$.
 - $E' \subseteq E$, where $T'_B(v_i, v_j) \leq T_B(v_i, v_j), I'_B(v_i, v_j) \geq I_B(v_i, v_j)$, and $F'_B(v_i, v_j) \geq F_B(v_i, v_j)$, for all $(v_i, v_j) \in E$.

Definition 2.6[28]. A single valued neutrosophic graph $G=(A, B)$ of $G^*=(V, E)$ is called complete single valued neutrosophic graph if
 $T_B(v_i, v_j) = \min [T_A(v_i), T_A(v_j)]$
 $I_B(v_i, v_j) = \max [I_A(v_i), I_A(v_j)]$
 $F_B(v_i, v_j) = \max [F_A(v_i), F_A(v_j)]$ for all $v_i, v_j \in V$.

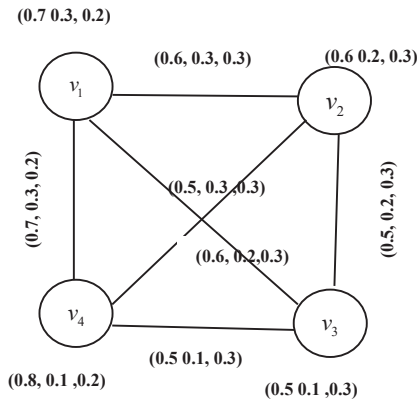

FIG. 2. COMPLETE SINGLE VALUED NEUTROSOPHIC GRAPH

III. TYPE OF DEGREES IN SINGLE VALUED NEUTROSOPHIC GRAPHS

In this section, degree of vertex, total degree, effective degree, neighbourhood degree, closed neighbourhood degree are introduced.

Definition 3.1: Let $G=(A, B)$ be a single valued neutrosophic graph. Then the degree of a vertex $v_i \in G$ is sum of degree of truth-membership, sum of degree of indeterminacy-membership and sum of degree of falsity-membership of all those edges which are incident on vertex v denoted by

$d(v_i) = (d_T(v_i), d_I(v_i), d_F(v_i))$ where
 $d_T(v_i) = \sum_{v_j \neq v_i} T_B(v_i, v_j)$ denotes degree of truth-membership vertex.
 $d_I(v_i) = \sum_{v_j \neq v_i} I_B(v_i, v_j)$ denotes degree of indeterminacy-membership vertex.

$d_F(v_i) = \sum_{v_j \neq v_i} F_B(v_i, v_j)$ denotes degree of falsity-membership vertex, for $v_i, v_j \in A$ and $T_B(v_i, v_j) = 0, I_B(v_i, v_j) = 0, F_B(v_i, v_j) = 0$ for $v_i, v_j \notin A$.

Definition 3.2: Let $G=(A, B)$ be a single valued neutrosophic graph. Then the total degree of a vertex $v_i \in G$ is defined by $td(v_i) = (td_T(v_i), td_I(v_i), td_F(v_i))$ where
 $td_T(v_i) = \sum_{v_j \neq v_i} T_B(v_i, v_j) + T_A(v_i)$ denotes total degree of truth-membership vertex.

$td_I(v_i) = \sum_{v_j \neq v_i} I_B(v_i, v_j) + I_A(v_i)$ denotes total degree of indeterminacy-membership vertex.
 $td_F(v_i) = \sum_{v_j \neq v_i} F_B(v_i, v_j) + F_A(v_i)$ denotes total degree of falsity-membership vertex. for $v_i, v_j \in A$.

Definition 3.2:The minimum degree of G is $\delta(G) = (\delta_T(G), \delta_I(G), \delta_F(G))$, where

$\delta_T(G) = \wedge \{ d_T(v) \mid v \in V \}$ denotes the minimum T-degree.
 $\delta_I(G) = \wedge \{ d_I(v) \mid v \in V \}$ denotes the minimum I-degree.
 $\delta_F(G) = \wedge \{ d_F(v) \mid v \in V \}$ denotes the minimum F-degree.

Definition 3.3: The maximum degree of G is $\Delta(G) = (\Delta_T(G), \Delta_I(G), \Delta_F(G))$, where

$\Delta_T(G) = \vee \{ d_T(v) \mid v \in V \}$ denotes the maximum T-degree.
 $\Delta_I(G) = \vee \{ d_I(v) \mid v \in V \}$ denotes the maximum I-degree.
 $\Delta_F(G) = \vee \{ d_F(v) \mid v \in V \}$ denotes the maximum F-degree.

Example 3.4: Consider a SVN-graph $G=(V, E)$, such that $V=\{v_1, v_2, v_3, v_4\}$ and $E=\{(v_1, v_2), (v_2, v_3), (v_3, v_4), (v_4, v_1)\}$

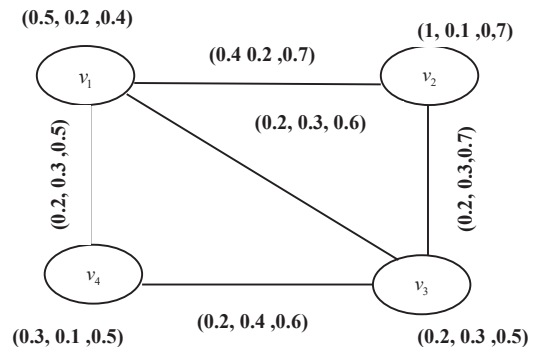

Fig. 3. Single valued neutrosophic graph

By usual computation, we have

$$\begin{aligned} d(v_1) &= (0.8, 0.8, 1.8), & d(v_2) &= (0.6, 0.5, 1.4) \\ d(v_3) &= (0.6, 1, 1.9), & d(v_4) &= (0.4, 0.7, 1.1) \\ td(v_1) &= (1.3, 1, 2.2), & td(v_2) &= (1.6, 0.6, 2.1) \\ td(v_3) &= (0.8, 1.3, 1.3), & td(v_4) &= (0.7, 0.8, 1.6) \text{ and} \\ \delta(G) &= (0.4, 0.5, 1.1) & \Delta(G) &= (0.8, 1, 1.9). \end{aligned}$$

Proposition 3.5: In any single valued neutrosophic graph $G=(V, E)$, the sum of the degree of truth-membership value of all vertices is equal to twice the sum of the truth-membership value of all edges, the sum of the degree of indeterminacy-membership value of all vertices is equal to twice the sum of the indeterminacy-membership value of all edges and the sum of the degree of falsity-membership value of all vertices is equal to twice the sum of the falsity-membership value of all edges.

$$\begin{aligned} & \left[\begin{array}{c} d(v_i) = [\left[\begin{array}{c} d_T(v_i), \\ d_I(v_i), \\ d_F(v_i) \end{array} \right] \\ 2 \left[\begin{array}{c} \sum_{v_i \neq v_j} T_B(v_i, v_j), \\ \sum_{v_i \neq v_j} I_B(v_i, v_j), \\ \sum_{v_i \neq v_j} F_B(v_i, v_j) \end{array} \right] \end{array} \right] \end{aligned} \quad (9)$$

Let $G = (A, B)$ be a SVN-graph where $V = \{v_1, v_2, \dots, v_n\}$

$$\begin{aligned} & \left[\begin{array}{c} d(v_i) = [\left[\begin{array}{c} d_T(v_i), \\ d_I(v_i), \\ d_F(v_i) \end{array} \right] \\ ((d_T(v_1), d_I(v_1), d_F(v_1)) + (d_T(v_2), d_I(v_2), d_F(v_2)) + \dots + (d_T(v_n), d_I(v_n), d_F(v_n))) \\ + ((T_B(v_1, v_2), I_B(v_1, v_2), F_B(v_1, v_2)) + (T_B(v_1, v_3), I_B(v_1, v_3), F_B(v_1, v_3)) + \dots + (T_B(v_1, v_n), I_B(v_1, v_n), F_B(v_1, v_n))) \\ + ((T_B(v_2, v_1), I_B(v_2, v_1), F_B(v_2, v_1)) + (T_B(v_2, v_3), I_B(v_2, v_3), F_B(v_2, v_3)) + \dots + (T_B(v_2, v_n), I_B(v_2, v_n), F_B(v_2, v_n))) \\ + ((T_B(v_n, v_1), I_B(v_n, v_1), F_B(v_n, v_1)) + (T_B(v_n, v_2), I_B(v_n, v_2), F_B(v_n, v_2)) + \dots + (T_B(v_{n-1}, v_n), I_B(v_{n-1}, v_n), F_B(v_{n-1}, v_n))) \end{array} \right] \\ &= 2[((T_B(v_1, v_2), I_B(v_1, v_2), F_B(v_1, v_2)) + (T_B(v_1, v_3), I_B(v_1, v_3), F_B(v_1, v_3)) + \dots + (T_B(v_1, v_n), I_B(v_1, v_n), F_B(v_1, v_n))) \\ &+ ((T_B(v_2, v_1), I_B(v_2, v_1), F_B(v_2, v_1)) + (T_B(v_2, v_3), I_B(v_2, v_3), F_B(v_2, v_3)) + \dots + (T_B(v_2, v_n), I_B(v_2, v_n), F_B(v_2, v_n))) \\ &+ ((T_B(v_n, v_1), I_B(v_n, v_1), F_B(v_n, v_1)) + (T_B(v_n, v_2), I_B(v_n, v_2), F_B(v_n, v_2)) + \dots + (T_B(v_{n-1}, v_n), I_B(v_{n-1}, v_n), F_B(v_{n-1}, v_n))) \end{aligned}$$

Proposition 3.6: The maximum degree of any vertex in a SVN-graph with n vertices is n-1.

Proof: Let $G = (A, B)$ be a SVN-graph. The maximum truth-membership value given to an edge is 1 and the number of edges incident on a vertex can be at most n-1. Hence, the maximum truth-membership degree $d_T(v_i)$ of any vertex v_i in a SVN-graph with n vertices is n-1. Similarly, the maximum indeterminacy-membership value given to an edge is 1 and the number of edges incident on a vertex can be at most n-1. Hence the maximum indeterminacy-membership degree $d_I(v_i)$. Also, the maximum falsity-membership value given to an edge is 1 and the number of edges incident on a vertex can be at most n-1. Hence the maximum falsity-membership degree $d_F(v_i)$ of any vertex v_i in a SVN-graph with n vertices is n-1. Hence the result.

Definition 3.7: An edge $e = (v, w)$ of a SVN-graph $G = (A, B)$ is called an effective edge if $T_B(v, w) = T_A(v) \wedge T_A(w)$, $I_B(v, w) = I_A(v) \vee I_A(w)$ and $F_B(v, w) = F_A(v) \vee F_A(w)$ for all $(v, w) \in E$. In this case, the vertex v is called a neighbor of w and conversely.

$N(v) = \{w \in V : w \text{ is a neighbor of } v\}$ is called the neighborhood of v .

Example 3.8. Consider a SVN-graph $G = (A, B)$, such that $A = \{v_1, v_2, v_3, v_4\}$ and $B = \{(v_1, v_2), (v_2, v_3), (v_3, v_4), (v_4, v_1)\}$

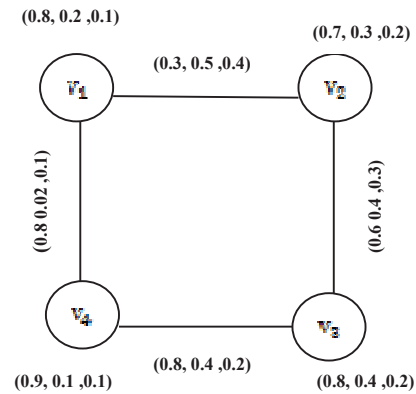

Fig. 4. Single valued neutrosophic graph

In this example, $v_4 v_1$ and $v_4 v_3$ are effective edges. Also $N(v_4) = \{v_1, v_3\}$, $N(v_3) = \{v_4\}$, $N(v_1) = \{v_4\}$, $N(v_2) = \emptyset$ (the empty set).

Definition 3.9: The effective degree of a vertex ‘v’ in G is defined by $d_E(v) = (d_{ET}(v), d_{EI}(v), d_{EF}(v))$, where $d_{ET}(v)$ is the sum of the truth-membership values of the effective edges incident with v, $d_{EI}(v)$ is the sum of the indeterminacy-membership values of the effective edges

incident with v and $d_{EF}(v)$ is the sum of the falsity-membership values of effective edges incident with v .

Definition 3.10: The minimum effective degree of G is $\delta_E[G] = (\delta_{ET}[G], \delta_{EI}[G], \delta_{EF}[G])$ where

$\delta_{ET}[G] = \wedge \{ d_{ET}[v] \mid v \in V \}$ denotes the minimum effective T-degree.

$\delta_{EI}[G] = \wedge \{ d_{EI}[v] \mid v \in V \}$ denotes the minimum effective I-degree.

$\delta_{EF}[G] = \wedge \{ d_{EF}[v] \mid v \in V \}$ denotes the minimum effective F-degree.

Definition 3.11: The maximum effective degree of G is $\Delta_E[G] = (\Delta_{ET}[G], \Delta_{EI}[G], \Delta_{EF}[G])$ where

$\Delta_{ET}[G] = \vee \{ d_{ET}[v] \mid v \in V \}$ denotes the maximum effective T-degree.

$\Delta_{EI}[G] = \vee \{ d_{EI}[v] \mid v \in V \}$ denotes the maximum effective I-degree.

$\Delta_{EF}[G] = \vee \{ d_{EF}[v] \mid v \in V \}$ denotes the maximum effective F-degree.

Example 3.12: Consider a SVN-graph as in Fig.3. By usual computation, we have the effective degrees for all vertices

$$\begin{aligned} d_E(v_1) &= (0, 0, 0) & d_E(v_2) &= (0.2, 0.3, 0.7), \\ d_E(v_3) &= (0.2, 0.3, 0.7) & d_E(v_4) &= (0, 0, 0) \\ \delta_E(G) &= (0, 0, 0) & \Delta_E(G) &= (0.2, 0.3, 0.7) \end{aligned}$$

Here v_2, v_3 is only effective degree.

Note: $d_E(v_1) = (0, 0, 0)$ means that there is no effective edge incident on v_1 .

Now, we can defined the neighborhood concept in SVN-graph.

Definition 3.13: Let $G = (A, B)$ be a SVN-graph. The neighbourhood of any vertex v is defined as $N(v) = (N_T(v), N_I(v), N_F(v))$, where

$N_T(v) = \{ T_B(v, w) = T_A(v) \wedge T_A(w); w \in V \}$ denotes the neighbourhood T-vertex.

$N_I(v) = \{ I_B(v, w) = I_A(v) \vee I_A(w); w \in V \}$ denotes the neighbourhood I-vertex.

$N_F(v) = \{ F_B(v, w) = F_A(v) \vee F_A(w); w \in V \}$ denotes the neighbourhood F-vertex.

And $N[v] = N(v) \cup \{v\}$ is called the closed neighbourhood of v .

Definition 3.14: Let $G = (A, B)$ be a single valued neutrosophic graph (SVN-graph). The neighbourhood degree of a vertex ' v ' is defined as the sum of truth-membership, indeterminacy-

membership and falsity-membership value of the neighbourhood vertices of v and is denoted by

$$d_N(v) = (d_{NT}(v), d_{NI}(v), d_{NF}(v)), \text{ where}$$

$d_{NT}(v) = \left| \bigcup_{w \in N(v)} T_A(w) \right|$ denotes the neighbourhood T-degree.

$d_{NI}(v) = \left| \bigcup_{w \in N(v)} I_A(w) \right|$ denotes the neighbourhood I-degree.

$d_{NF}(v) = \left| \bigcup_{w \in N(v)} F_A(w) \right|$ denotes neighbourhood F-degree.

Definition 3.15: The minimum neighbourhood degree is defined as

$$\delta_N(G) = (\delta_{NT}(G), \delta_{NI}(G), \delta_{NF}(G)), \text{ where}$$

$\delta_{NT}(G) = \wedge \{ d_{NT}(v) \mid v \in V \}$ denotes the minimum neighbourhood T-degree.

$\delta_{NI}(G) = \wedge \{ d_{NI}(v) \mid v \in V \}$ denotes the minimum neighbourhood I-degree.

$\delta_{NF}(G) = \wedge \{ d_{NF}(v) \mid v \in V \}$ denotes the minimum neighbourhood F-degree.

Definition 3.16: The maximum neighbourhood degree is defined as

$$\Delta_N(G) = (\Delta_{NT}(G), \Delta_{NI}(G), \Delta_{NF}(G)) \text{ where}$$

$\Delta_{NT}(G) = \vee \{ d_{NT}(v) \mid v \in V \}$ denotes the maximum neighbourhood T-degree.

$\Delta_{NI}(G) = \vee \{ d_{NI}(v) \mid v \in V \}$ denotes the maximum neighbourhood I-degree.

$\Delta_{NF}(G) = \vee \{ d_{NF}(v) \mid v \in V \}$ denotes the maximum neighbourhood F-degree.

Example 3.17: Consider a SVN-graph as in Fig. 2. By usual computation, we have the neighbourhood degrees for all vertices, minimum and maximum neighbourhood degrees

$$\begin{aligned} d_N(v_1) &= (1.9, 0.4, 0.8) & d_N(v_2) &= (2, 0.5, 0.7) \\ d_N(v_3) &= (2.1, 0.6, 0.7) & d_N(v_4) &= (1.8, 0.6, 0.8) \\ \delta_N(G) &= (1.8, 0.4, 0.7) & \Delta_N(G) &= (2.1, 0.6, 0.8). \end{aligned}$$

Definition 3.18: A vertex $v \in V$ of SVN-graph $G = (A, B)$ is said to be an isolated vertex if $T_B(v_i, v_j) = I_B(v_i, v_j) =$

$F_B(v_i, v_j) = 0$ For all $v \in V, v_i \neq v_j$ that is $N(v) = \emptyset$ (the empty set).

Definition 3.19: Let $G = (A, B)$ be a single valued neutrosophic graph (SVN-graph). The closed neighbourhood degree of a vertex ' v ' is defined as the sum of truth-membership, indeterminacy- membership and falsity-membership value of the neighbourhood vertices of v and including truth-membership, indeterminacy- membership and

falsity-membership value of v , and is denoted by $d_N[v] = (d_{NT}[v], d_{NI}[v], d_{NF}[v])$ where

$d_{NT}[v] = \bigvee_{w \in N(v)} T_A(w) + T_A(v)$ denotes the closed neighborhood T- degree.

$d_{NI}[v] = \bigvee_{w \in N(v)} I_A(w) + I_A(v)$ denotes the closed neighborhood I- degree.

$d_{NF}[v] = \bigvee_{w \in N(v)} F_A(w) + F_A(v)$ denotes the closed neighborhood F- degree.

Definition 3.20: The minimum closed neighborhood degree is defined as

$\delta_N[G] = (\delta_{NT}[G], \delta_{NI}[G], \delta_{NF}[G])$ where

$\delta_{NT}[G] = \bigwedge \{d_{NT}[v] \mid v \in V\}$ denotes the minimum closed neighborhood T- degree

$\delta_{NI}[G] = \bigwedge \{d_{NI}[v] \mid v \in V\}$ denotes the minimum closed neighborhood I- degree

$\delta_{NF}[G] = \bigwedge \{d_{NF}[v] \mid v \in V\}$ denotes the minimum closed neighborhood F- degree

Definition 3.21: The maximum closed neighborhood degree is defined as

$\Delta_N[G] = (\Delta_{NT}[G], \Delta_{NI}[G], \Delta_{NF}[G])$ where

$\Delta_{NT}[G] = \bigvee \{d_{NT}[v] \mid v \in V\}$ denotes the maximum closed neighborhood T- degree

$\Delta_{NI}[G] = \bigvee \{d_{NI}[v] \mid v \in V\}$ denotes the maximum closed neighborhood I- degree

$\Delta_{NF}[G] = \bigvee \{d_{NF}[v] \mid v \in V\}$ denotes the maximum closed neighborhood F- degree.

IV. REGULAR SINGLE VALUED NEUTROSOPHIC GRAPH.

Definition 4.1: A single valued neutrosophic graph $G = (A, B)$ is said to be regular single valued neutrosophic graph (RSVN-graph), if all the vertices have the same closed neighborhood degree. (i.e) if $\delta_{NT}[G] = \Delta_{NT}[G]$, $\delta_{NI}[G] = \Delta_{NI}[G]$ and $\delta_{NF}[G] = \Delta_{NF}[G]$

Example 4.2: Consider a SVN-graph as in Fig. 2. By usual computation, we have the closed neighborhood degrees for all vertices, minimum and maximum neighborhood degrees

$$d_N[v_1] = d_N[v_2] = d_N[v_3] = d_N[v_4] = (2.6, 0.7, 1)$$

$$\delta_N[G] = \Delta_N[G] = (2.6, 0.7, 1)$$

It is clear from calculation that G is regular single valued neutrosophic graph (RSVN-graph).

Theorem 4.3: Every complete single valued neutrosophic is a regular single valued neutrosophic graph

Proof:

Let $G = (A, B)$ be a complete SVN-graph then by definition of complete SVN-graph we have

$$T_B(v, w) = T_A(v) \wedge T_A(w), \quad I_B(v, w) = I_A(v) \vee I_A(w), \\ F_B(v, w) = F_A(v) \vee F_A(w), \text{ for every } v, w \in V.$$

By definition, the closed neighborhood T-degree of each vertex is the sum of the truth-membership values of the vertices and itself, the closed neighborhood I-degree of each vertex is the sum of the indeterminacy- membership values of the vertices and itself and the closed neighborhood F-degree of each vertex is the sum of the falsity-membership values of the vertices and itself, Therefore all the vertices will have the same closed neighborhood T-degree, closed neighborhood I-degree and closed neighborhood F-degree. This implies minimum closed neighborhood degree is equal to maximum closed neighborhood degree (i.e) $\delta_{NT}[G] = \Delta_{NT}[G]$, $\delta_{NI}[G] = \Delta_{NI}[G]$ and $\delta_{NF}[G] = \Delta_{NF}[G]$. This implies G is a regular single valued neutrosophic graph. Hence the theorem.

V. ORDER AND SIZE OF SINGLE VALUED NEUTROSOPHIC GRAPH

In this section we introduce the definition of order and size of a single valued neutrosophic graph which are an important terms in single valued neutrosophic graph theory.

Definition 5.1: Let $G = (A, B)$ be a SVN-graph. The order of G , denoted $O(G)$ is defined as $O(G) = (O_T(G), O_I(G), O_F(G))$, where

$$O_T(G) = \bigvee_{v \in V} T_A \text{ denotes the T- order of } G.$$

$$O_I(G) = \bigvee_{v \in V} I_A \text{ denotes the I- order of } G.$$

$$O_F(G) = \bigvee_{v \in V} F_A \text{ denotes the F- order of } G.$$

Definition 5.2: Let $G = (A, B)$ be a SVN-graph. The size of G , denoted $S(G)$ is defined as:

$$S(G) = (S_T(G), S_I(G), S_F(G)), \text{ where}$$

$$S_T(G) = \bigvee_{u \neq v} T_B(u, v) \text{ denotes the T- size of } G.$$

$$S_I(G) = \bigvee_{u \neq v} I_B(u, v) \text{ denotes the I- size of } G$$

$$S_F(G) = \bigvee_{u \neq v} F_B(u, v) \text{ denotes the F- size of } G$$

Example 5.3: Consider a SVN-graph as in Fig. 3. By routine computation, we have

$$O(G) = (2, 0.7, 2.1), \quad S(G) = (1.2, 1.5, 3.1)$$

Proposition 5.4: In a complete single valued neutrosophic graph $G = (A, B)$, the closed neighbourhood degree of any vertex is equal to the order of single valued neutrosophic graph

$$(i.e) \quad O_T(G) = (d_{NT}[v] \mid v \in V), \quad O_I(G) = (d_{NI}[v] \mid v \in V) \text{ and } O_F(G) = (d_{NF}[v] \mid v \in V)$$

Proof:

Let $G = (A, B)$ be a complete single valued neutrosophic graph. The T-order of G , $O_T(G)$ is the sum of the truth-membership value of all the vertices, the I-order of G , $O_I(G)$ is the sum of the indeterminacy-membership value of all the vertices and the F-order of G , $O_F(G)$ is the sum of the falsity-membership value of all the vertices. Since G is a complete SVN-graph, the closed neighborhood T-degree of each vertex is the sum of the truth-membership value of vertices, the closed neighborhood I-degree of each vertex is the sum of the indeterminacy-membership value of vertices and the closed neighborhood F-degree of each vertex is the sum of the falsity-membership value of vertices. Hence the result.

VI. CONCLUSION

In this paper we have described degree of a vertex, total degree, effective degree, neighborhood degree, closed neighborhood, order and size of single valued neutrosophic graphs. The necessary and sufficient conditions for a single valued neutrosophic graph to be the regular single valued neutrosophic graphs have been presented. Further, we are going to study some types of single valued neutrosophic graphs such irregular and totally irregular single valued neutrosophic graphs and single valued neutrosophic hypergraphs.

REFERENCES

- [1] A. Q. Ansari, R. Biswas & S. Aggarwal, "Neutrosophic classifier: An extension of fuzzy classifier," Elsevier- *Applied Soft Computing*, 13, 2013, pp.563-573.
- [2] A. Q. Ansari, R. Biswas & S. Aggarwal, "Neutrosophication of Fuzzy Models," IEEE Workshop On Computational Intelligence: Theories, Applications and Future Directions (hosted by IIT Kanpur), 14th July'13.
- [3] A. Q. Ansari, R. Biswas & S. Aggarwal, "Extension to fuzzy logic representation: Moving towards neutrosophic logic - A new laboratory rat," *Fuzzy Systems (FUZZ)*, 2013 IEEE International Conference, 2013, pp.1-8.
- [4] A. Nagoor Gani and M. Basheer Ahamed, "Order and Size in Fuzzy Graphs," *Bulletin of Pure and Applied Sciences*, Vol 22E ,No.1, 2003, pp.145-148.
- [5] A. Nagoor Gani. A and S. Shajitha Begum, "Degree, Order and Size in Intuitionistic Fuzzy Graphs," *International Journal of Algorithms, Computing and Mathematics*, (3)3,2010, pp.11-16.
- [6] A. Nagoor Gani and S.R Latha, "On Irregular Fuzzy Graphs," *Applied Mathematical Sciences*, Vol.6, no.11, 2012, pp.517-523.
- [7] A. V. Devadoss, A. Rajkumar & N. J. P .Praveena, "A Study on Miracles through Holy Bible using Neutrosophic Cognitive Maps (NCMS)," *International Journal of Computer Applications*, 69(3), 2013,
- [8] G. Garg, K. Bhutani, M. Kumar and S. Aggarwal, "Hybrid model for medical diagnosis using Neutrosophic Cognitive Maps with Genetic Algorithms," *FUZZ-IEEE*, 2015, 6page.
- [9] F. Smarandache, "Refined Literal Indeterminacy and the Multiplication Law of Sub-Indeterminacies," *Neutrosophic Sets and Systems*, Vol.9, 2015, pp.58.63.
- [10] F. Smarandache, "Types of Neutrosophic Graphs and neutrosophic Algebraic Structures together with their Applications in Technology," seminar, Universitatea Transilvania din Brasov, Facultatea de Design de Produs si Mediu, Brasov, Romania 06 June 2015.
- [11] F. Smarandache, "Neutrosophic set - a generalization of the intuitionistic fuzzy set," *Granular Computing*, 2006 IEEE International Conference, 2006, p. 38 - 42.
- [12] F. Smarandache, "A geometric interpretation of the neutrosophic set - A generalization of the intuitionistic fuzzy set," *Granular Computing (GrC)*, 2011 IEEE International Conference, 2011, pp.602-606
- [13] H .Wang, Y. Zhang, R. Sunderraman, "Truth-value based interval neutrosophic sets," *Granular Computing*, 2005 IEEE International Conference, vol. 1, 2005, pp. 274 - 277.
- [14] H. Wang, F. Smarandache, Y. Zhang, and R. Sunderraman, "Single valued Neutrosophic Sets," *Multispace and Multistructure* 4, 2010, pp. 410-413.
- [15] H. Wang, F. Smarandache, Zhang, Y.-Q. and R. Sunderraman, "Interval Neutrosophic Sets and Logic: Theory and Applications in Computing," Hexis, Phoenix, AZ, 2005.
- [16] H.J. Zimmermann, *Fuzzy Set Theory and its Applications*, Kluwer-Nijhoff, Boston, 1985.
- [17] I. Deli, M. Ali, F. Smarandache, "Bipolar neutrosophic sets and their application based on multi-criteria decision making problems," *Advanced Mechatronic Systems (ICAMEchS)*, 2015 International Conference, 2015, pp.249 - 254.
- [18] I. Turksen, "Interval valued fuzzy sets based on normal forms," *Fuzzy Sets and Systems*, vol. 20,1986, pp. 191-210.
- [19] J. Ye, "Vector similarity measures of simplified neutrosophic sets and their application in multicriteria decision making," *International Journal of Fuzzy Systems*, Vol. 16, No. 2, 2014, pp.204-211.
- [20] J. Ye, "Single-Valued Neutrosophic Minimum Spanning Tree and Its Clustering Method," *Journal of Intelligent Systems* 23(3), 2014, pp. 311-324.
- [21] J. Ye, "Another form of correlation coefficient between single valued neutrosophic sets and its multiple attribute decision-making method," *Neutrosophic Sets and Systems*, 1(1), 2013, pp. 8-12.
- [22] K. Atanassov, "Intuitionistic fuzzy sets," *Fuzzy Sets and Systems*, vol. 20, 1986, pp. 87-96.
- [23] K. Atanassov and G. Gargov, Interval valued intuitionistic fuzzy sets, *Fuzzy Sets and Systems*, vol.31, 1989, pp. 343-349.
- [24] K. Atanassov, "Intuitionistic fuzzy sets: theory and applications," *Physica*, New York, 1999.
- [25] M. Ali, and F. Smarandache, "Complex Neutrosophic Set," *Neural Computing and Applications*, Vol. 25, 2016, pp.1-18.
- [26] M. Ali, I. Deli, F. Smarandache, "The Theory of Neutrosophic Cubic Sets and Their Applications in Pattern Recognition," *Journal of Intelligent and Fuzzy Systems*, (In press), pp. 1-7.
- [27] P. Bhattacharya, "Some remarks on fuzzy graphs," *Pattern Recognition Letters* 6, 1987, pp.297-302.
- [28] R. Parvathi and M. G. Karunambigai, "Intuitionistic Fuzzy Graphs," *Computational Intelligence, Theory and applications*, International Conference in Germany, 2006, pp.18 -20.
- [29] R. Şahin, "Neutrosophic hierarchical clustering algorithms," *Neutrosophic Sets and Systems*, vol 2, 2014, 18-24.
- [30] S. Broumi, M. Talea, A. Bakali, F. Smarandache, "Single Valued Neutrosophic Graphs," *Journal of New Theory*, N 10, 2016, pp. 86-101.
- [31] S. Broumi, M. Talea, A. Bakali, F. Smarandache, "On Bipolar Single Valued Neutrosophic Graphs," *Journal of New Theory*, N11, 2016, pp.84-102.
- [32] S. Broumi, M. Talea, A. Bakali, F. Smarandache, Interval Valued Neutrosophic Graphs, (2016) in press.
- [33] S. Broumi, M. Talea, A. Bakali, F. Smarandache, "Operations on Interval Valued Neutrosophic Graphs," (2016) unpublished.
- [34] S. Broumi, M. Talea, A. Bakali, F. Smarandache, "Strong Interval Valued Neutrosophic Graphs," (2016) unpublished.
- [35] S. Aggarwal, R. Biswas, A. Q. Ansari, "Neutrosophic modeling and control," *Computer and Communication Technology (ICCCCT)*, 2010 International Conference, 2010, pp. 718-723.
- [36] S. Broumi, F. Smarandache, "New distance and similarity measures of interval neutrosophic sets," *Information Fusion (FUSION)*, 2014 IEEE 17th International Conference, 2014, pp. 1 - 7.
- [37] Y. Hai-Long, G. She, Yanhonge, L. Xiuwu, "On single valued neutrosophic relations," *Journal of Intelligent & Fuzzy Systems*, vol. Preprint, no. Preprint, 2015, pp. 1-12.
- [38] W. B. Vasantha Kandasamy and F. Smarandache, "Fuzzy Cognitive Maps and Neutrosophic Cognitive Maps" 2013.
- [39] W.B. Vasantha Kandasamy, K. Ilanthenral and Florentin Smarandache, "Neutrosophic Graphs: A New Dimension to Graph Theory," Kindle Edition, 2015.

Classical Logic and Neutrosophic Logic. Answers to K. Georgiev

Florentin Smarandache

Florentin Smarandache (2016). Classical Logic and Neutrosophic Logic. Answers to K. Georgiev. *Neutrosophic Sets and Systems* 13: 79-83

Abstract. In this paper, we make distinctions between Classical Logic (where the propositions are 100% true, or 100 false) and the Neutrosophic Logic (where one deals with partially true, partially indeterminate and partially false propositions) in order to respond to K. Georgiev's

criticism [1]. We recall that if an axiom is true in a classical logic system, it is not necessarily that the axiom be valid in a modern (fuzzy, intuitionistic fuzzy, neutrosophic etc.) logic system.

Keywords: Neutrosophic Logic, Neutrosophic Logical Systems, Single Valued Neutrosophic Set, Neutrosophic Logic Negations, Degree of Dependence and Independence, Degrees of Membership, Standard and Non-Standard Real Subsets.

1 Single Valued Neutrosophic Set

We read with interest the paper [1] by K. Georgiev. The author asserts that he proposes "a general simplification of the Neutrosophic Sets a subclass of theirs, comprising of elements of R^3 ", but this was actually done before, since the first world publication on neutrosophics [2]. The simplification that Georgiev considers, is called single valued neutrosophic set.

The single valued neutrosophic set was introduced for the first time by us [Smarandache, [2], 1998].

Let

$$n = t + i + f \quad (1)$$

In Section 3.7, "Generalizations and Comments", [pp. 129, last edition online], from this book [2], we wrote:

"Hence, the neutrosophic set generalizes:

- the intuitionistic set, which supports incomplete set theories (for $0 < n < 1$; $0 \leq t, i, f \leq 1$) and incomplete known elements belonging to a set;

- the fuzzy set (for $n = 1$ and $i = 0$, and $0 \leq t, i, f \leq 1$);

- the classical set (for $n = 1$ and $i = 0$, with t, f either 0 or 1);

- the paraconsistent set (for $n > 1$, with all $t, i, f < 1$);

- the faillibilist set ($i > 0$);

- the dialetheist set, a set M whose at least one of its elements also belongs to its complement $C(M)$; thus, the intersection of some disjoint sets is not empty;

- the paradoxist set ($t = f = 1$);

- the pseudoparadoxist set ($0 < i < 1$; $t = 1$ and $f > 0$ or $t > 0$ and $f = 1$);

- the tautological set ($i, f < 0$)."

It is clear that we have worked with single-valued neutrosophic sets, we mean that t, i, f were explicitly real numbers from $[0, 1]$.

See also (Smarandache, [3], 2002, p. 426).

More generally, we have considered that: t varies in the

set T , i varies in the set I , and f varies in the set F , but in the same way taking crisp numbers $n = t + i + f$, where all t, i, f are single (crisp) real numbers in the interval $[0, 1]$. See [2] pp. 123-124, and [4] pp. 418-419.

Similarly, in *The Free Online Dictionary of Computing* [FOLDOC], 1998, updated in 1999, ed. by Denis Howe [3].

Unfortunately, Dr. Georgiev in 2005 took into consideration only the neutrosophic publication [6] from year 2003, and he was not aware of previous publications [2, 3, 4] on the neutrosophics from the years 1998 - 2002.

The misunderstanding was propagated to other authors on neutrosophic set and logic, which have considered that Haibin Wang, Florentin Smarandache, Yanqing Zhang, Rajshekhar Sunderraman (2010, [5]) have defined the single valued neutrosophic set.

2 Standard and Non-Standard Real Subsets

Section 3 of paper [1] by Georgiev is called "Reducing Neutrosophic Sets to Subsets of R^3 ". But this was done already since 1998. In our Section 0.2, [2], p. 12, we wrote:

"Let T, I, F be standard or non-standard real subsets...".

"Standard real subsets", which we talked about above, mean just the classical real subsets.

We have taken into consideration the non-standard analysis in our attempt to be able to describe the absolute truth as well [i.e. truth in all possible worlds, according to Leibniz's denomination, whose neutrosophic value is equal to 1+], and relative truth [i.e. truth in at least one world, whose truth value is equal to 1]. Similarly, for absolute indeterminacy and absolute falsehood.

We tried to get a definition as general as possible for the neutrosophic logic (and neutrosophic set respectively), including the propositions from a philosophical point of [absolute or relative] view.

Of course, in technical and scientific applications we do not consider non-standard things, we take the classical unit interval $[0, 1]$ only, while T, I, F are classical real subsets of it.

In Section 0.2, Definition of Neutrosophic Components [2], 1998, p. 12, we wrote:

“The sets T, I, F are not necessarily intervals, but may be any real sub-unitary subsets: discrete or continuous; single-element, finite, or (countable or uncountable) infinite; union or intersection of various subsets; etc.

They may also overlap. The real subsets could represent the relative errors in determining t, i, f (in the case when the subsets T, I, F are reduced to points).”

So, we have mentioned many possible real values for T, I, F . Such as: each of T, I, F can be “single-element” {as Georgiev proposes in paper [1]}, “interval” {developed later in [7], 2005, and called interval-neutrosophic set and interval-neutrosophic logic respectively}, “discrete” [called hesitant neutrosophic set and hesitant neutrosophic logic respectively] etc.

3 Degrees of Membership > 1 or < 0 of the Elements

In Section 4 of paper [1], Georgiev says that: “Smarandache has adopted Leibniz’s ‘worlds’ in his work, but it seems to be more like a game of words.”

As we have explained above, “Leibniz’s worlds” are not simply a game of words, but they help making a distinction in philosophy between absolute and relative truth / indeterminacy / falsehood respectively. {In technics and science yes they are not needed.}

Besides absolute and relative, the non-standard values or hyper monads (-0 and $1+$) have permitted us to introduce, study and show applications of the neutrosophic overset (when there are elements into a set whose real (standard) degree of membership is > 1), neutrosophic underset (when there are elements into a set whose real degree of membership is < 0), and neutrosophic offset (when there are both elements whose real degree of membership is > 1 and other elements whose real degree of membership is < 0). Check the references [8-11].

4 Neutrosophic Logic Negations

In Section 4 of the same paper [1], Georgiev asserts that “according to the neutrosophic operations we have

$$\neg\neg A = A \tag{2}$$

and since

$$\neg\neg A \neq A \tag{3}$$

is just the assumption that has brought intuitionism to life, the neutrosophic logic could not be a generalization of any Intuitionistic logic.”

First of all, Georgiev’s above assertion is partially true, partially false, and partially indeterminate (as in the neutrosophic logic).

In neutrosophic logic, there is a class of neutrosophic negation operators, not only one. For some neutrosophic negations the equality (2) holds, for others it is invalid, or indeterminate.

Let $A(t, i, f)$ be a neutrosophic proposition A whose neutrosophic truth value is (t, i, f) , where t, i, f are single real numbers of $[0, 1]$. We consider the easiest case.

a) For examples, if the neutrosophic truth value of

$\neg A$, the negation of A , is defined as:

$$(1-t, 1-i, 1-f) \text{ or } (f, i, t) \text{ or } (f, 1-i, t) \tag{4}$$

then the equality (2) is valid.

b) Other examples, if the neutrosophic truth value of

$\neg A$, the negation of A , is defined as:

$$(f, (t+i+f)/3, t) \text{ or } (1-t, (t+i+f)/3, 1-f) \tag{5}$$

then the equality (2) is invalid, as in intuitionistic fuzzy logic, and as a consequence the inequality (3) holds.

c) For the future new to be designed/invented neutrosophic negations (needed/adjusted for new applications) we do not know {so (2) has also a percentage of indeterminacy.

5 Degree of Dependence and Independence between (Sub)Components

In Section 4 of [1], Georgiev also asserts that “The neutrosophic logic is not capable of maintaining modal operators, since there is no normalization rule for the components T, I, F ”. This is also partially true, and partially false.

In our paper [12] about the dependence / independence between components, we wrote that:

“For single valued neutrosophic logic, the sum of the components $t+i+f$ is:

$0 \leq t+i+f \leq 3$ when all three components are 100% independent;

$0 \leq t+i+f \leq 2$ when two components are 100% dependent, while the third one is 100% independent from them;

$0 \leq t+i+f \leq 1$ when all three components are 100% dependent.

When three or two of the components t, i, f are 100% independent, one leaves room for incomplete information (therefore the sum $t+i+f < 1$), paraconsistent and contradictory information ($t+i+f > 1$), or complete information ($t+i+f = 1$).

If all three components t, i, f are 100% dependent, then similarly one leaves room for incomplete information ($t+i+f < 1$), or complete information ($t+i+f = 1$).”

Therefore, for complete information the normalization to 1, 2, 3 or so respectively {see our paper [12] for the case when one has degrees of dependence between components or between subcomponents (for refined neutrosophic set respectively) which are different from 100% or 0%} is done.

But, for incomplete information and paraconsistent information, in general, the normalization is not done.

Neutrosophic logic is capable of maintaining modal operators. The connection between Neutrosophic Logic and Modal Logic will be shown in a separate paper, since it is much longer, called Neutrosophic Modal Logic (under press).

6 Definition of Neutrosophic Logic

In Section 5, paper [1], it is said: “Apparently there isn’t a clear definition of truth value of the neutrosophic formulas.” The author is right that “apparently”, but in reality the definition of neutrosophic logic is very simple and common sense:

In neutrosophic logic a proposition P has a degree of truth (T); a degree of indeterminacy (I) that means neither true nor false, or both true and false, or unknown, indeterminate; and a degree of falsehood (F); where T, I, F are subsets (either real numbers, or intervals, or any subsets) of the interval [0, 1].

What is unclear herein?

In a soccer game, as an easy example, between two teams, Bulgaria and Romania, there is a degree of truth about Bulgaria winning, degree of indeterminacy (or neutrality) of tie game, and degree of falsehood about Bulgaria being defeated.

7 Neutrosophic Logical Systems

a) Next sentence of Georgiev is

“in every meaningful logical system if A and B are sets (formulas) such that $A \subseteq B$ then $B \supseteq A$, i.e. when B is true then A is true.” (6)

In other words, when $B \rightarrow A$ (B implies A), and B is true, then A is true.

This is true for the Boolean logic where one deals with 100% truths, but in modern logics we work with partial truths.

If an axiom is true in the classical logic, it does not mean that that axiom has to be true in the modern logical system. Such counter-example has been provided by Georgiev himself, who pointed out that the law of double negation {equation (2)}, which is valid in the classical logic, is not valid any longer in intuitionistic fuzzy logic.

A similar response we have with respect to his above statement on the logical system axiom (6): it is partially true, partially false, and partially indeterminate. All depend on the types of chosen neutrosophic implication operators.

In neutrosophic logic, let’s consider the neutrosophic propositions $A(t_A, i_A, f_A)$ and $B(t_B, i_B, f_B)$,

and the neutrosophic implication:

$$B(t_B, i_B, f_B) \rightarrow A(t_A, i_A, f_A), \tag{7}$$

that has the neutrosophic truth value

$$(B \rightarrow A)(t_{B \rightarrow A}, i_{B \rightarrow A}, f_{B \rightarrow A}). \tag{8}$$

Again, we have a class of many neutrosophic implication operators, not only one; see our publication [13], 2015, pp. 79-81.

Let’s consider one such neutrosophic implication for single valued neutrosophic logic:

$$(B \rightarrow A)(t_{B \rightarrow A}, i_{B \rightarrow A}, f_{B \rightarrow A}) \text{ is equivalent to } B(t_B, i_B, f_B) \rightarrow A(t_A, i_A, f_A) \text{ which is equivalent to } \neg B(f_B, 1-i_B, t_B) \vee A(t_A, i_A, f_A) \text{ which is equivalent to } (\neg B \vee A)(\max\{f_B, t_A\}, \min\{1-i_B, i_A\}, \min\{t_B, f_A\}). \tag{9}$$

Or:

$$(t_{B \rightarrow A}, i_{B \rightarrow A}, f_{B \rightarrow A}) = (\max\{f_B, t_A\}, \min\{1-i_B, i_A\}, \min\{t_B, f_A\}). \tag{10}$$

Now, a question arises: what does “ $(B \rightarrow) A$ is true” mean in fuzzy logic, intuitionistic fuzzy logic, and respectively in neutrosophic logic?

Similarly for the “B is true”, what does it mean in these modern logics? Since in these logics we have infinitely many truth values $t(B) \in (0, 1)$; {we made abstraction of the truth values 0 and 1, which represent the classical logic}.

b) Theorem 1, by Georgiev, “Either $A \vee k(A)$ [i.e. A is true if and only if $k(A)$ is true] or the neutrosophic logic is contradictory.”

We prove that his theorem is a nonsense.

First at all, the author forgets that when he talks about neutrosophic logic he is referring to a modern logic, not to the classical (Boolean) logic. The logical propositions in neutrosophic logic are partially true, in the form of (t, i, f), not totally 100% true or (1, 0, 0). Similarly for the implications and equivalences, they are not classical (i.e. 100% true), but partially true {i.e. their neutrosophic truth values are in the form of (t, i, f) too}.

- The author starts using the previous classical logical system axiom (6), i.e.

“since $k(A) \subseteq A$ we have $A \supseteq k(A)$ ” meaning that $A \rightarrow k(A)$ and when A is true, then $k(A)$ is true.

- Next Georgiev’s sentence: “Let assume $k(A)$ be true and assume that A is not true”.

The same comments as above:

What does it mean in fuzzy logic, intuitionistic fuzzy logic, and neutrosophic logic that a proposition is true? Since in these modern logics we have infinitely many values for the truth value of a given proposition. Does, for example, $t(k(A)) = 0.8$ {i.e. the truth value of $k(A)$ is equal to 0.8}, mean that $k(A)$ is true?

If one takes $t(k(A)) = 1$, then one falls in the classical logic.

Similarly, what does it mean that proposition A is not true? Does it mean that its truth value

$t(A) = 0.1$ or in general $t(A) < 1$? Since, if one takes $t(A) = 0$, then again we fall into the classical logic.

The author confuses the classical logic with modern logics.

- In his “proof” he states that “since the Neutrosophic logic is not an intuitionistic one, $\neg A$ should be true leading to the conclusion that $k(\neg A) = \neg k(A)$ is true”.

For the author an “intuitionistic logic” means a logic that invalidates the double negation law {equation (3)}. But we have proved before in Section 4, of this paper, that depending on the type of neutrosophic negation operator used, one has cases when neutrosophic logic invalidates the double negation law [hence it is “intuitionistic” in his words], cases when the neutrosophic logic does not invalidate the double negation law {formula (2)}, and indeterminate cases {depending on the new possible neutrosophic negation operators to be design in the future}.

- The author continues with “We found that $k(A) \wedge \neg k(A)$ is true which means that the simplified neutrosophic logic is contradictory.”

Georgiev messes up the classical logic with modern logic. In classical logic, indeed

$k(A) \wedge \neg k(A)$ is false, being a contradiction.

But we are surprised that Georgiev does not know that in modern logic we may have

$k(A) \wedge \neg k(A)$ that is not contradictory, but partially true and partially false.

For example, in fuzzy logic, let’s say that the truth value (t) of $k(A)$ is

$t(k(A)) = 0.4$, then the truth value of its negation, $\neg k(A)$, is $t(\neg k(A)) = 1 - 0.4 = 0.6$.

Now, we apply the t-norm “min” in order to do the fuzzy conjunction, and we obtain:

$t(k(A) \wedge \neg k(A)) = \min\{0.4, 0.6\} = 0.4 \neq 0$.

Hence, $k(A) \wedge \neg k(A)$ is not a contradiction, since its truth value is 0.4, not 0. Similarly in intuitionistic fuzzy logic. The same in neutrosophic logic, for example:

Let the neutrosophic truth value of $k(A)$ be (0.5, 0.4, 0.2), that we denote as:

$k(A)(0.5, 0.4, 0.2)$, then its negation $\neg k(A)$ will have the neutrosophic truth value:

$\neg k(A)(0.2, 1-0.4, 0.5) = \neg k(A)(0.2, 0.6, 0.5)$.

Let’s do now the neutrosophic conjunction:

$k(A)(0.5, 0.4, 0.2) \wedge \neg k(A)(0.2, 0.6, 0.5) = (k(A) \wedge \neg k(A))(\min\{0.5, 0.2\}, \max\{0.4, 0.6\}, \max\{0.2, 0.5\}) = (k(A) \wedge \neg k(A))(0.2, 0.6, 0.5)$.

In the same way, $k(A) \wedge \neg k(A)$ is not a contradiction in neutrosophic logic, since its neutrosophic truth value is (0.2, 0.6, 0.5), which is different from (0, 0, 1) or from (0, 1, 1). Therefore, Georgiev’s “proof” that the simplified neutrosophic logic [= single valued neutrosophic logic] is a contradiction has been disproved!

His following sentence, “But since the simplified neutrosophic logic is only a subclass of the neutrosophic logic, then the neutrosophic logic is a contradiction” is false. Simplified neutrosophic logic is indeed a subclass of the neutrosophic logic, but he did not prove that the so-called simplified neutrosophic logic is contradictory (we have showed above that his “proof” was wrong).

Conclusion

We have showed in this paper that Georgiev’s critics on the neutrosophic logic are not founded. We made distinctions between the Boolean logic systems and the neutrosophic logic systems.

Neutrosophic logic is developing as a separate entity with its specific neutrosophic logical systems, neutrosophic proof theory and their applications.

References

- [1] K. Georgiev, A simplification of the Neutrosophic Sets. Neutrosophic Logic and Intuitionistic Fuzzy Sets, Ninth Int. Conf. on IFSs, Sofia, 7-8 May 2005. NIFS Vol. 11, 2, 28-31, 2005.
- [2] Florentin Smarandache, Neutrosophy. Neutrosophic Probability, Set, and Logic, ProQuest Information & Learning, Ann Arbor, Michigan, USA, 105 p., 1998; <http://fs.gallup.unm.edu/eBook-neutrosophics6.pdf> (last edition); reviewed in Zentralblatt für Mathematik (Berlin, Germany): <https://zbmath.org/?q=an:01273000>
- [3] Denis Howe, The Free Online Dictionary of Computing [FOLDOC], England, <http://foldoc.org/>, 1998; <http://foldoc.org/neutrosophic>, <http://foldoc.org/neutrosophic%20logic>, <http://foldoc.org/neutrosophic%20set>
- [4] F. Smarandache, A Unifying Field in Logics: Neutrosophic Logic, Multiple Valued Logic / An International Journal, Taylor & Francis, USA, ISSN 1023-6627, Vol. 8, No. 3, pp. 385-438, 2002. The whole issue of this journal is dedicated to Neutrosophy and Neutrosophic Logic.
- [5] Haibin Wang, Florentin Smarandache, Yanqing Zhang, Rajshekhar Sunderraman, Single Valued Neutrosophic Sets, Review of the Air Force Academy / The Scientific Informative Review, No. 1 (16), 10-14, 2010.
- [6] F. Smarandache, Definition of Neutrosophic Logic – A generalization of Intuitionistic Fuzzy Logic, Proc. of the Third Conf. of the European Society for Fuzzy Logic and Technology (EUSFLAT 2003), Zittau, 141-146, 10-12 September 2003; <http://fs.gallup.unm.edu/IFS-generalized.pdf> (updated version)
- [7] H. Wang, F. Smarandache, Y.-Q. Zhang, R. Sunderraman, Interval Neutrosophic Sets and Logic: Theory and Applications in Computing, Hexis, 87 p., 2005; <http://arxiv.org/pdf/cs/0505014.pdf>
- [8] Florentin Smarandache, Neutrosophic Overset, Neutrosophic Underset, and Neutrosophic Offset. Similarly for Neutrosophic Over-/Under-/Off- Logic, Probability, and Statistics, 168 p., Pons Editions, Bruxelles, Belgique, 2016; <https://hal.archives-ouvertes.fr/hal-01340830> ; <https://arxiv.org/ftp/arxiv/papers/1607/1607.00234.pdf>

- [9] Florentin Smarandache, Interval-Valued Neutrosophic Oversets, Neutrosophic Understes, and Neutrosophic Offsets, International Journal of Science and Engineering Investigations, Vol. 5, Issue 54, 1-4, July 2016;
<http://fs.gallup.unm.edu/IV-Neutrosophic-Overset-Under-Offset.pdf>
- [10] Florentin Smarandache, Operators on Single-Valued Neutrosophic Oversets, Neutrosophic Undersets, and Neutrosophic Offsets, Journal of Mathematics and Informatics, Vol. 5, 63-67, 2016; <https://hal.archives-ouvertes.fr/hal-01340833>
- [11] F. Smarandache Degrees of Membership > 1 and < 0 of the Elements With Respect to a Neutrosophic Off-Set, Neutrosophic Sets and Systems, Vol. 12, 3-8, 2016;
<http://fs.gallup.unm.edu/NSS/DegreesOf-Over-Under-Off-Membership.pdf>
- [12] F. Smarandache, Degree of Dependence and Independence of the (Sub)Components of Fuzzy Set and Neutrosophic Set, Neutrosophic Sets and Systems, Vol. 11, 95-97, 2016;
<http://fs.gallup.unm.edu/NSS/DegreeOfDependenceAndIndependence.pdf>
- [13] F. Smarandache, Symbolic Neutrosophic Theory, EuropaNova, Brussels, Belgium, 194 p., 2015;
<https://arxiv.org/ftp/arxiv/papers/1512/1512.00047.pdf>

A Novel Neutrosophic Weighted Extreme Learning Machine for Imbalanced Data Set

Yaman Akbulut, Abdulkadir Sengür, Yanhui Guo, Florentin Smarandache

Yaman Akbulut, Abdulkadir Sengür, Yanhui Guo, Florentin Smarandache (2017). A Novel Neutrosophic Weighted Extreme Learning Machine for Imbalanced Data Set. *Symmetry* 9, 142; DOI: 10.3390/sym9080142

Abstract: Extreme learning machine (ELM) is known as a kind of single-hidden layer feedforward network (SLFN), and has obtained considerable attention within the machine learning community and achieved various real-world applications. It has advantages such as good generalization performance, fast learning speed, and low computational cost. However, the ELM might have problems in the classification of imbalanced data sets. In this paper, we present a novel weighted ELM scheme based on neutrosophic set theory, denoted as neutrosophic weighted extreme learning machine (NWELM), in which neutrosophic c -means (NCM) clustering algorithm is used for the approximation of the output weights of the ELM. We also investigate and compare NWELM with several weighted algorithms. The proposed method demonstrates advantages to compare with the previous studies on benchmarks.

Keywords: extreme learning machine (ELM); weight; neutrosophic c -means (NCM); imbalanced data set

1. Introduction

Extreme learning machine (ELM) was put forward in 2006 by Huang et al. [1] as a single-hidden layer feedforward network (SLFN). The hidden layer parameters of ELM are arbitrarily initialized and output weights are determined by utilizing the least squares algorithm. Due to this characteristic, ELM has fast learning speed, better performance and efficient computation cost [1–4], and has, as a result, been applied in different areas.

However, ELM suffers from the presence of irrelevant variables in the large and high dimensional real data set [2,5]. The unbalanced data set problem occurs in real applications such as text categorization, fault detection, fraud detection, oil-spills detection in satellite images, toxicology, cultural modeling, and medical diagnosis [6]. Many challenging real problems are characterized by imbalanced training data in which at least one class is under-represented relative to others.

The problem of imbalanced data is often associated with asymmetric costs of misclassifying elements of different classes. In addition, the distribution of the test data set might differ from that of the training samples. Class imbalance happens when the number of samples in one class is much more than that of the other [7]. The methods aiming to tackle the problem of imbalance can be classified into four groups such as algorithmic based methods, data based methods, cost-sensitive methods and ensembles of classifiers based methods [8]. In algorithmic based approaches, the minority class classification accuracy is improved by adjusting the weights for each class [9]. Re-sampling methods

can be viewed in the data based approaches where these methods did not improve the classifiers [10]. The cost-sensitive approaches assign various cost values to training samples of the majority class and the minority class, respectively [11]. Recently, ensembles based methods have been widely used in classification of imbalanced data sets [12]. Bagging and boosting methods are the two popular ensemble methods.

The problem of class imbalance has received much attention in the literature [13]. Synthetic minority over-sampling technique (SMOTE) [9] is known as the most popular re-sampling method that uses pre-processing for obtaining minority class instances artificially. For each minority class sample, SMOTE creates a new sample on the line joining it to the nearest minority class neighbor. Borderline SMOTE [14], SMOTE-Boost [15], and modified SMOTE [14] are some of the improved variants of the SMOTE algorithm. In addition, an oversampling method was proposed that identifies some minority class samples that are hard to classify [16]. Another oversampling method was presented that uses bagging with oversampling [17]. In [18], authors opted to use double ensemble classifier by combining bagging and boosting. In [19], authors combined sampling and ensemble techniques to improve the classification performance for skewed data. Another method, namely random under sampling (RUS), was proposed that removes the majority class samples randomly until the training set becomes balanced [19]. In [20], authors proposed an ensemble of an support vector machine (SVM) structure with boosting (Boosting-SVM), where the minority class classification accuracy was increased compared to pure SVM. In [21], a cost sensitive approach was proposed where k-nearest neighbors (k-NN) classifier was adopted. In addition, in [22], an SVM based cost sensitive approach was proposed for class imbalanced data classification. Decision trees [23] and logistic regression [24] based methods were also proposed in order to handle with the imbalanced data classification.

An ELM classifier trained with an imbalanced data set can be biased towards the majority class and obtain a high accuracy on the majority class by compromising minority class accuracy. Weighted ELM (WELM) was employed to alleviate the ELM's classification deficiency on imbalanced data sets, and which can be seen as one of the cost-proportionate weighted sampling methods [25]. ELM assigns the same misclassification cost value to all data points such as positive and negative samples in a two-class problem. When the number of negative samples is much larger than that of the number of positive samples or vice versa, assigning the same misclassification cost value to all samples can be seen one of the drawbacks of traditional ELM. A straightforward solution is to obtain misclassification cost values adaptively according to the class distribution, in the form of a weight scheme inversely proportional to the number of samples in the class.

In [7], the authors proposed a weighted online sequential extreme learning machine (WOS-ELM) algorithm for alleviating the imbalance problem in chunk-by-chunk and one-by-one learning. A weight setting was selected in a computationally efficient way. Weighted Tanimoto extreme learning machine (T-WELM) was used to predict chemical compound biological activity and other data with discrete, binary representation [26]. In [27], the authors presented a weight learning machine for a SLFN to recognize handwritten digits. Input and output weights were globally optimized with the batch learning type of least squares. Features were assigned into the prescribed positions. Another weighted ELM algorithm, namely ESOS-ELM, was proposed by Mirza et al. [28], which was inspired from WOS-ELM. ESOS-ELM aims to handle class imbalance learning (CIL) from a concept-drifting data stream. Another ensemble-based weighted ELM method was proposed by Zhang et al. [29], where the weight of each base learner in the ensemble is optimized by differential evolution algorithm. In [30], the authors further improved the re-sampling strategy inside Over-sampling based online bagging (OOB) and Under-sampling based online bagging (UOB) in order to learn class imbalance.

Although much awareness of the imbalance has been raised, many of the key issues remain unresolved and encountered more frequently in massive data sets. How to determine the weight values is key to designing WELM. Different situations such as noises and outlier data should be considered.

The noises and outlier data in a data set can be treated as a kind of indeterminacy. Neutrosophic set (NS) has been successfully applied for indeterminate information processing, and demonstrates

advantages to deal with the indeterminacy information of data and is still a technique promoted for data analysis and classification application. NS provides an efficient and accurate way to define imbalance information according to the attributes of the data.

In this study, we present a new weighted ELM scheme using neutrosophic c -means (NCM) clustering to overcome the ELM's drawbacks in highly imbalanced data sets. A novel clustering algorithm NCM was proposed for data clustering [31,32]. NCM is employed to determine a sample's belonging, noise, and indeterminacy memberships, and is then used to compute a weight value for that sample [31–33]. A weighted ELM is designed using the weights from NCM and utilized for imbalanced data set classification.

The rest of the paper is structured as follows. In Section 2, a brief history of the theory of ELM and weighted ELM is introduced. In addition, Section 2 introduces the proposed method. Section 3 discusses the experiments and comparisons, and conclusions are drawn in Section 4.

2. Proposed Method

2.1. Extreme Learning Machine

Backpropagation, which is known as gradient-based learning method, suffers from slow convergence speed. In addition, stuck in the local minimum can be seen as another disadvantage of a gradient-based learning algorithm. ELM was proposed by Huang et al. [1] as an alternative method that overcomes the shortcomings of gradient-based learning methods. The ELM was designed as an SLFN, where the input weights and hidden biases are selected randomly. These weights do not need to be adjusted during the training process. The output weights are determined analytically with Moore–Penrose generalized inverse of the hidden-layer output matrix.

Mathematically speaking, the output of the ELM with L hidden nodes and activation function $g(\cdot)$ can be written as:

$$o_i = \sum_{j=1}^L \beta_j g(a_j, b_j, x_j), \quad i = 1, 2, \dots, N, \quad (1)$$

where x_j is the j th input data, $a_j = [a_{j1}, a_{j2}, \dots, a_{jn}]^T$ is the weight vector, $\beta_j = [\beta_{j1}, \beta_{j2}, \dots, \beta_{jn}]^T$ is the output weight vector, b_j is the bias of the j th hidden node and o_i is the i th output node and N shows the number of samples. If ELM learns these N samples with 0 error, then Equation (1) can be updated as follows:

$$t_i = \sum_{j=1}^L \beta_j g(a_j, b_j, x_j), \quad i = 1, 2, \dots, N, \quad (2)$$

where t_i shows the actual output vector. Equation (2) can be written compactly as shown in Equation (3):

$$H\beta = T, \quad (3)$$

where $H = \{h_{ij}\} = g(a_j, b_j, x_j)$ is the hidden-layer output matrix. Thus, the output weight vector can be calculated analytically with Moore–Penrose generalized inverse of the hidden-layer output matrix as shown in Equation (4):

$$\hat{\beta} = H^+ T, \quad (4)$$

where H^+ is the Moore–Penrose generalized inverse of matrix H .

2.2. Weighted Extreme Learning Machine

Let us consider a training data set $[x_i, t_i], i = 1, \dots, N$ belonging to two classes, where $x_i \in R^n$ and t_i are the class labels. In binary classification, t_i is either -1 or $+1$. Then, a $N \times N$ diagonal matrix W_{ii} is considered, where each of them is associated with a training sample x_i . The weighting procedure generally assigns larger W_{ii} to x_i , which comes from the minority class.

An optimization problem is employed to maximize the marginal distance and to minimize the weighted cumulative error as:

$$\text{Minimize : } \|H\beta - T\|^2 \text{ and } \|\beta\|. \quad (5)$$

Furthermore:

$$\text{Minimize : } L_{ELM} = \frac{1}{2}\|\beta\|^2 + CW\frac{1}{2}\sum_{i=1}^N \|\xi_i\|^2, \quad (6)$$

$$\text{Subjected to : } h(x_i)\beta = t_i^T - \xi_i^T, \quad i = 1, 2, \dots, N, \quad (7)$$

where $T = [t_1, \dots, t_N]$, ξ_i is the error vector and $h(x_i)$ is the feature mapping vector in the hidden layer with respect to x_i , and β . By using the Lagrange multiplier and Karush–Kuhn–Tucker theorem, the dual optimization problem can be solved. Thus, hidden layer's output weight vector β becomes can be derived from Equation (7) regarding left pseudo-inverse or right pseudo-inverse. When presented data with small size, right pseudo-inverse is recommended because it involves the inverse of an $N \times N$ matrix. Otherwise, left pseudo-inverse is more suitable since it is much easier to compute matrix inversion of size $L \times L$ when L is much smaller than N :

$$\text{When } N \text{ is small : } \beta = H^T\left(\frac{I}{C} + WHH^T\right)^{-1}WT, \quad (8)$$

$$\text{When } N \text{ is large : } \beta = H^T\left(\frac{I}{C} + H^TWT\right)^{-1}H^TWT. \quad (9)$$

In the weighted ELM, the authors adopted two different weighting schemes. In the first one, the weights for the minority and majority classes are calculated as:

$$W_{minority} = \frac{1}{\#(t_i^+)} \text{ and } W_{majority} = \frac{1}{\#(t_i^-)}, \quad (10)$$

and, for the second one, the related weights are calculated as:

$$W_{minority} = \frac{0.618}{\#(t_i^+)} \text{ and } W_{majority} = \frac{1}{\#(t_i^-)}. \quad (11)$$

The readers may refer to [25] for detail information about determination of the weights.

2.3. Neutrosophic Weighted Extreme Learning Machine

Weighted ELM assigns the same weight value to all samples in the minority class and another same weight value to all samples in the majority class. Although this procedure works quite well in some imbalanced data sets, assigning the same weight value to all samples in a class may not be a good choice for data sets that have noise and outlier samples. In other words, to deal with noise and outlier data samples in an imbalanced data set, different weight values are needed for each sample in each class that reflects the data point's significance in its class. Therefore, we present a novel method to determine the significance of each sample in its class. NCM clustering can determine a sample's belonging, noise and indeterminacy memberships, which can then be used in order to compute a weight value for that sample.

Guo and Sengur [31] proposed the NCM clustering algorithms based on the neutrosophic set theorem [34–37]. In NCM, a new cost function was developed to overcome the weakness of the Fuzzy c -Means (FCM) method on noise and outlier data points. In the NCM algorithm, two new types of rejection were developed for both noise and outlier rejections. The objective function in NCM is given as follows:

$$J_{NCM}(T, I, F, C) = \sum_{i=1}^N \sum_{j=1}^C (\bar{w}_1 T_{ij})^m \|x_i - c_j\|^2 + \sum_{i=1}^N (\bar{w}_2 I_i)^m \|x_i - \bar{c}_{imax}\|^2 + \delta^2 \sum_{i=1}^N (\bar{w}_3 F_i)^m, \quad (12)$$

where m is a constant. For each point i , the \bar{c}_{imax} is the mean of two centers. T_{ij} , I_i and F_i are the membership values belonging to the determinate clusters, boundary regions and noisy data set. $\theta < T_{ij}, I_i, F_i < 1$:

$$\sum_{j=1}^c T_{ij} + I_i + F_i = 1. \quad (13)$$

Thus, the related membership functions are calculated as follows:

$$T_{ij} = \frac{\bar{w}_2 \bar{w}_3 (x_i - c_j)^{-\left(\frac{2}{m-1}\right)}}{\sum_{j=1}^C (x_i - c_j)^{-\left(\frac{2}{m-1}\right)} + (x_i - \bar{c}_{imax})^{-\left(\frac{2}{m-1}\right)} + \delta^{-\left(\frac{2}{m-1}\right)}}, \quad (14)$$

$$I_i = \frac{\bar{w}_1 \bar{w}_3 (x_i - c_{imax})^{-\left(\frac{2}{m-1}\right)}}{\sum_{j=1}^C (x_i - c_j)^{-\left(\frac{2}{m-1}\right)} + (x_i - \bar{c}_{imax})^{-\left(\frac{2}{m-1}\right)} + \delta^{-\left(\frac{2}{m-1}\right)}}, \quad (15)$$

$$F_i = \frac{\bar{w}_1 \bar{w}_2 (\delta)^{-\left(\frac{2}{m-1}\right)}}{\sum_{j=1}^C (x_i - c_j)^{-\left(\frac{2}{m-1}\right)} + (x_i - \bar{c}_{imax})^{-\left(\frac{2}{m-1}\right)} + \delta^{-\left(\frac{2}{m-1}\right)}}, \quad (16)$$

$$C_j = \frac{\sum_{i=1}^N (\bar{w}_1 T_{ij})^m x_i}{\sum_{i=1}^N (\bar{w}_1 T_{ij})^m}, \quad (17)$$

where c_j shows the center of cluster j , \bar{w}_1 , \bar{w}_2 , and \bar{w}_3 are the weight factors and δ is a regularization factor which is data dependent [31]. Under the above definitions, every input sample in each minority and majority class is associated with a triple T_{ij} , I_i , F_i . While the larger T_{ij} means that the sample belongs to the labeled class with a higher probability, the larger I_i means that the sample is indeterminate with a higher probability. Finally, the larger F_i means that the sample is highly probable to be a noise or outlier data.

After clustering procedure is applied in NCM, the weights for each sample of minority and majority classes are obtained as follows:

$$W_{ii}^{minority} = \frac{C_r}{T_{ij} + I_i - F_i} \quad \text{and} \quad W_{ii}^{majority} = \frac{1}{T_{ij} + I_i - F_i}, \quad (18)$$

$$C_r = \frac{\#(t_i^-)}{\#(t_i^+)}, \quad (19)$$

where C_r is the ratio of the number of samples in the majority class to the number of the samples in the minority class.

The algorithm of the neutrosophic weighted extreme learning machine (NWELM) is composed of four steps. The first step necessitates applying the NCM algorithm based on the pre-calculated cluster centers, according to the class labels of the input samples. Thus, the T , I and F membership values are determined for the next step. The related weights are calculated from the determined T , I and F membership values in the second step of the algorithm.

In Step 3, the ELM parameters are tuned and samples and weights are fed into the ELM in order to calculate the H matrix. The hidden layer weight vector β is calculated according to the H , W and class labels. Finally, the determination of the labels of the test data set is accomplished in the final step of the algorithm (Step 4).

The neutrosophic weighted extreme learning machine (NWELM) algorithm is given as following:

Input: Labelled training data set.

Output: Predicted class labels.

Step 1: Initialize the cluster centers according to the labelled data set and run NCM algorithm in order to obtain the T , I and F value for each data point.

Step 2: Compute $W_{ii}^{minority}$ and $W_{ii}^{majority}$ according to Equations (18) and (19).

Step 3: Adapt the ELM parameters and run NWELM. Compute H matrix and obtain β according to Equation (8) or Equation (9).

Step 4: Calculate the labels of test data set based on β .

3. Experimental Results

The geometric mean (G_{mean}) is used to evaluate the performance of the proposed NWELM method. The G_{mean} is computed as follows:

$$G_{mean} = \sqrt{R \frac{TN}{TN + FP}}, \quad (20)$$

$$R = \frac{TP}{TP + FN}, \quad (21)$$

where R denotes the recall rate and TN , FP denotes true-negative and false-positive detections, respectively. G_{mean} values are in the range of [0–1] and it represents the square root of positive class accuracy and negative class accuracy. The performance evaluation of NWELM classifier is tested on both toy data sets and real data sets, respectively. The five-fold cross-validation method is adopted in the experiments. In the hidden node of the NWELM, the radial basis function (RBF) kernel is considered. A grid search of the trade-off constant C on $\{2^{-18}, 2^{-16}, \dots, 2^{48}, 2^{50}\}$ and the number of hidden nodes L on $\{10, 20, \dots, 990, 2000\}$ was conducted in seeking the optimal result using five-fold cross-validation. For real data sets, a normalization of the input attributes into $[-1, 1]$ is considered. In addition, for NCM, the following parameters are chosen such as $\varepsilon = 10^{-5}$, $\bar{w}_1 = 0.75$, $\bar{w}_2 = 0.125$, $\bar{w}_3 = 0.125$ respectively, which were obtained by means of trial and error. The δ parameter of NCM method is also searched on $\{2^{-10}, 2^{-8}, \dots, 2^8, 2^{10}\}$.

3.1. Experiments on Artificial Data Sets

Four two-class artificial imbalance data sets were used to evaluate the classification performance of the proposed NWELM scheme. The illustration of the data sets is shown in Figure 1 [38]. The decision boundary between classes is complicated. In Figure 1a, we illustrate the first artificial data set that follows a uniform distribution. As can be seen, the red circles of Figure 1a belong to the minority class, with the rest of the data samples shown by blue crosses as the majority class. The second imbalance data set, namely Gaussian-1, is obtained using two Gaussian distributions with a 1:9 ratio of samples as shown in Figure 1b. While the red circles illustrate the minority class, the blue cross samples show the majority class.

Another Gaussian distribution-based imbalance data set, namely Gaussian-2, is given in Figure 1c. This data set consists of nine Gaussian distributions with the same number of samples arranged in a 3×3 grid. The red circle samples located in the middle belong to the minority class while the blue cross samples belong to the majority class. Finally, Figure 1d shows the last artificial imbalance data set. It is known as a complex data set because it has a 1:9 ratio of samples for the minority and majority classes.

Table 1 shows the G_{mean} achieved by the two methods on these four data sets in ten independent runs. For Gaussian-1, Gaussian-2 and the Uniform artificial data sets, the proposed NWELM method yields better results when compared to the weighted ELM scheme; however, for the Complex artificial data sets, the weighted ELM method achieves better results. The better resulting cases are shown in bold text. It is worth mentioning that, for the Gaussian-2 data set, NWELM achieves a higher G_{mean} across all trials.

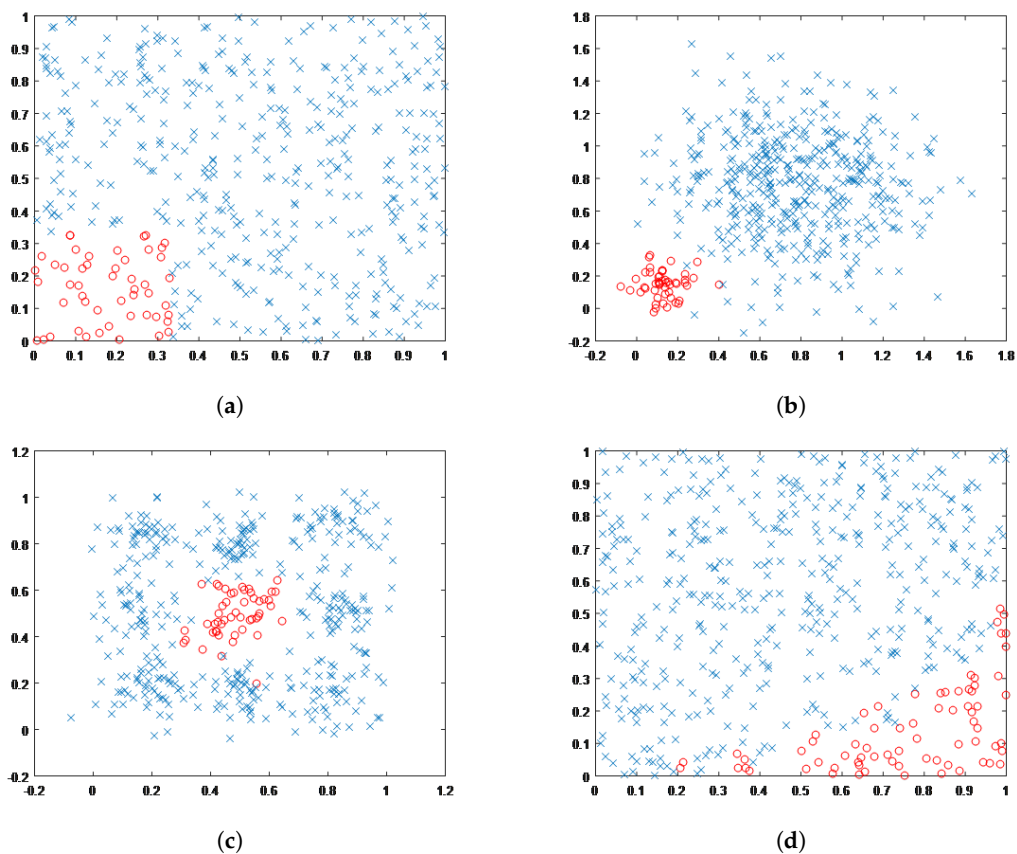

Figure 1. Four 2-dimensional artificial imbalance data sets (X_1, X_2): (a) uniform; (b) gaussian-1; (c) gaussian-2; and (d) complex.

Table 1. Comparison of weighted extreme learning machine (ELM) vs. NWELM on artificial data sets.

Data Sets	Weighted ELM	NWELM	Data Sets	Weighted ELM	NWELM
	G_{mean}	G_{mean}		G_{mean}	G_{mean}
Gaussian-1-1	0.9811	0.9822	Gaussian-2-1	0.9629	0.9734
Gaussian-1-2	0.9843	0.9855	Gaussian-2-2	0.9551	0.9734
Gaussian-1-3	0.9944	0.9955	Gaussian-2-3	0.9670	0.9747
Gaussian-1-4	0.9866	0.9967	Gaussian-2-4	0.9494	0.9649
Gaussian-1-5	0.9866	0.9833	Gaussian-2-5	0.9467	0.9724
Gaussian-1-6	0.9899	0.9685	Gaussian-2-6	0.9563	0.9720
Gaussian-1-7	0.9833	0.9685	Gaussian-2-7	0.9512	0.9629
Gaussian-1-8	0.9967	0.9978	Gaussian-2-8	0.9644	0.9785
Gaussian-1-9	0.9944	0.9798	Gaussian-2-9	0.9441	0.9559
Gaussian-1-10	0.9846	0.9898	Gaussian-2-10	0.9402	0.9623
Uniform-1	0.9836	0.9874	Complex-1	0.9587	0.9481
Uniform-2	0.9798	0.9750	Complex-2	0.9529	0.9466
Uniform-3	0.9760	0.9823	Complex-3	0.9587	0.9608
Uniform-4	0.9811	0.9836	Complex-4	0.9482	0.9061
Uniform-5	0.9811	0.9823	Complex-5	0.9587	0.9297
Uniform-6	0.9772	0.9772	Complex-6	0.9409	0.9599
Uniform-7	0.9734	0.9403	Complex-7	0.9644	0.9563
Uniform-8	0.9785	0.9812	Complex-8	0.9575	0.9553
Uniform-9	0.9836	0.9762	Complex-9	0.9551	0.9446
Uniform-10	0.9695	0.9734	Complex-10	0.9351	0.9470

3.2. Experiments on Real Data Set

In this section, we test the achievement of the proposed NWELM method on real data sets [39]. A total of 21 data sets with different numbers of features, training and test samples, and imbalance ratios are shown in Table 2. The selected data sets can be categorized into two classes according to their imbalance ratios. The first class has the imbalance ratio range of 0 to 0.2 and contains yeast-1-2-8-9_vs_7, abalone9_18, glass-0-1-6_vs_2, vowel0, yeast-0-5-6-7-9_vs_4, page-blocks0, yeast3, ecoli2, new-thyroid1 and the new-thyroid2 data sets.

Table 2. Real data sets and their attributes.

Data Sets	Features (#)	Training Data (#)	Test Data (#)	Imbalance Ratio
yeast-1-2-8-9_vs_7	8	757	188	0.0327
abalone9_18	8	584	147	0.0600
glass-0-1-6_vs_2	9	153	39	0.0929
vowel0	13	790	198	0.1002
yeast-0-5-6-7-9_vs_4	8	422	106	0.1047
page-blocks0	10	4377	1095	0.1137
yeast3	8	1187	297	0.1230
ecoli2	7	268	68	0.1806
new-thyroid1	5	172	43	0.1944
new-thyroid2	5	172	43	0.1944
ecoli1	7	268	68	0.2947
glass-0-1-2-3_vs_4-5-6	9	171	43	0.3053
vehicle0	18	676	170	0.3075
vehicle1	18	676	170	0.3439
haberman	3	244	62	0.3556
yeast1	8	1187	297	0.4064
glass0	9	173	43	0.4786
iris0	4	120	30	0.5000
pima	8	614	154	0.5350
wisconsin	9	546	137	0.5380
glass1	9	173	43	0.5405

On the other hand, second class contains the data sets, such as ecoli1, glass-0-1-2-3_vs_4-5-6, vehicle0, vehicle1, haberman, yeast, glass0, iris0, pima, wisconsin and glass1, that have imbalance ratio rates between 0.2 and 1.

The comparison results of the proposed NWELM with the weighted ELM, unweighted ELM and SVM are given in Table 3. As the weighted ELM method used a different weighting scheme (W_1, W_2), in our comparisons, we used the higher G_{mean} value. As can be seen in Table 3, the NWELM method yields higher G_{mean} values for 17 of the imbalanced data sets. For three of the data sets, both methods yield the same G_{mean} . Just for the page-blocks0 data set, the weighted ELM method yielded better results. It is worth mentioning that the NWELM method achieves 100% G_{mean} values for four data sets (vowel0, new-thyroid1, new-thyroid2, iris0). In addition, NWELM produced higher G_{mean} values than SVM for all data sets.

The obtained results were further evaluated by area under curve (AUC) values [40]. In addition, we compared the proposed method with unweighted ELM, weighted ELM and SVM based on the achieved AUC values as tabulated in Table 4. As seen in Table 4, for all examined data sets, our proposal's AUC values were higher than the compared other methods. For further comparisons of the proposed method with unweighted ELM, weighted ELM and SVM methods appropriately, statistical tests on AUC results were considered. The paired t -test was chosen [41]. The paired t -test results between each compared method and the proposed method for AUC was tabulated in Table 5 in terms of p -value. In Table 5, the results showing a significant advantage to the proposed method were shown in bold-face where p -values are equal or smaller than 0.05. Therefore, the proposed method performed better than the other methods in 39 tests out of 63 tests when each data set and pairs of methods are considered separately.

Table 3. Experimental results of binary data sets in terms of the G_{mean} . The best results on each data set are emphasized in bold-face.

G_{mean}		Data (Imbalance Ratio)						
		Gaussian Kernel				Radial Base Kernel		
		Unweighted ELM		Weighted ELM max (W_1, W_2)		SVM	Neutrosophic Weighted ELM	
		C	$G_{mean}(\%)$	C	$G_{mean}(\%)$	$G_{mean}(\%)$	C	$G_{mean}(\%)$
imbalance ratio: 0, 0.2	yeast-1-2-8-9_vs_7 (0.0327)	2^{48}	60.97	2^4	71.41	47.88	2^{-7}	77.57
	abalone9_18 (0.0600)	2^{18}	72.71	2^{28}	89.76	51.50	2^{23}	94.53
	glass-0-1-6_vs_2 (0.0929)	2^{50}	63.20	2^{32}	83.59	51.26	2^7	91.86
	vowel0 (0.1002)	2^{-18}	100.00	2^{-18}	100.00	99.44	2^7	100.00
	yeast-0-5-6-7-9_vs_4 (0.1047)	2^{-6}	68.68	2^4	82.21	62.32	2^{-10}	85.29
	page-blocks0 (0.1137)	2^4	89.62	2^{16}	93.61	87.72	2^{20}	93.25
	yeast3 (0.1230)	2^{44}	84.13	2^{48}	93.11	84.71	2^3	93.20
	ecoli2 (0.1806)	2^{-18}	94.31	2^8	94.43	92.27	2^{10}	95.16
	new-thyroid1 (0.1944)	2^0	99.16	2^{14}	99.72	96.75	2^7	100.00
	new-thyroid2 (0.1944)	2^2	99.44	2^{12}	99.72	98.24	2^7	100.00
imbalance ratio: 0.2, 1	ecoli1 (0.2947)	2^0	88.75	2^{10}	91.04	87.73	2^{20}	92.10
	glass-0-1-2-3_vs_4-5-6 (0.3053)	2^{10}	93.26	2^{-18}	95.41	91.84	2^7	95.68
	vehicle0 (0.3075)	2^8	99.36	2^{20}	99.36	96.03	2^{10}	99.36
	vehicle1 (0.3439)	2^{18}	80.60	2^{24}	86.74	66.04	2^{10}	88.06
	haberman (0.3556)	2^{42}	57.23	2^{14}	66.26	37.35	2^7	67.34
	yeast1 (0.4064)	2^0	65.45	2^{10}	73.17	61.05	2^{10}	73.19
	glass0 (0.4786)	2^0	85.35	2^0	85.65	79.10	2^{13}	85.92
	iris0 (0.5000)	2^{-18}	100.00	2^{-18}	100.00	98.97	2^{10}	100.00
	pima (0.5350)	2^0	71.16	2^8	75.58	70.17	2^{10}	76.35
	wisconsin (0.5380)	2^{-2}	97.18	2^8	97.70	95.67	2^7	98.22
	glass1 (0.5405)	2^{-18}	77.48	2^2	80.35	69.64	2^{17}	81.77

Table 4. Experimental result of binary data sets in terms of the average area under curve (AUC). The best results on each data set are emphasized in bold-face.

AUC		Data (Imbalance Ratio)						
		Gaussian Kernel				Radial Base Kernel		
		Unweighted ELM		Weighted ELM max (W_1, W_2)		SVM	Neutrosophic Weighted ELM	
		C	AUC (%)	C	AUC (%)	AUC (%)	C	AUC (%)
imbalance ratio: 0, 0.2	yeast-1-2-8-9_vs_7 (0.0327)	2^{48}	61.48	2^4	65.53	56.67	2^{-7}	74.48
	abalone9_18 (0.0600)	2^{18}	73.05	2^{28}	89.28	56.60	2^{23}	95.25
	glass-0-1-6_vs_2 (0.0929)	2^{50}	67.50	2^{32}	61.14	53.05	2^7	93.43
	vowel0 (0.1002)	2^{-18}	93.43	2^{-18}	99.22	99.44	2^7	99.94
	yeast-0-5-6-7-9_vs_4 (0.1047)	2^{-6}	66.35	2^4	80.09	69.88	2^{-10}	82.11
	page-blocks0 (0.1137)	2^4	67.42	2^{16}	71.55	88.38	2^{20}	91.49
	yeast3 (0.1230)	2^{44}	69.28	2^{48}	90.92	83.92	2^3	93.15
	ecoli2 (0.1806)	2^{-18}	71.15	2^8	94.34	92.49	2^{10}	94.98
	new-thyroid1 (0.1944)	2^0	90.87	2^{14}	98.02	96.87	2^7	100.00
	new-thyroid2 (0.1944)	2^2	84.29	2^{12}	96.63	98.29	2^7	100.00
imbalance ratio: 0.2, 1	ecoli1 (0.2947)	2^0	66.65	2^{10}	90.28	88.16	2^{20}	92.18
	glass-0-1-2-3_vs_4-5-6 (0.3053)	2^{10}	88.36	2^{-18}	93.94	92.02	2^7	95.86
	vehicle0 (0.3075)	2^8	71.44	2^{20}	62.41	96.11	2^{10}	98.69
	vehicle1 (0.3439)	2^{18}	58.43	2^{24}	51.80	69.10	2^{10}	88.63
	haberman (0.3556)	2^{42}	68.11	2^{14}	55.44	54.05	2^7	72.19
	yeast1 (0.4064)	2^0	56.06	2^{10}	70.03	66.01	2^{10}	73.66
	glass0 (0.4786)	2^0	74.22	2^0	75.99	79.81	2^{13}	81.41
	iris0 (0.5000)	2^{-18}	100.00	2^{-18}	100.00	99.00	2^{10}	100.00
	pima (0.5350)	2^0	59.65	2^8	50.01	71.81	2^{10}	75.21
	wisconsin (0.5380)	2^{-2}	83.87	2^8	80.94	95.68	2^7	98.01
	glass1 (0.5405)	2^{-18}	75.25	2^2	80.46	72.32	2^{17}	81.09

Table 5. Paired t -test results between each method and the proposed method for AUC results.

	Data Sets	Unweighted ELM	Weighted ELM	SVM
imbalance ratio: 0, 0.2	yeast-1-2-8-9_vs_7 (0.0327)	0.0254	0.0561	0.0018
	abalone9_18 (0.0600)	0.0225	0.0832	0.0014
	glass-0-1-6_vs_2 (0.0929)	0.0119	0.0103	0.0006
	vowel0 (0.1002)	0.0010	0.2450	0.4318
	yeast-0-5-6-7-9_vs_4 (0.1047)	0.0218	0.5834	0.0568
	page-blocks0 (0.1137)	0.0000	0.0000	0.0195
	yeast3 (0.1230)	0.0008	0.0333	0.0001
	ecoli2 (0.1806)	0.0006	0.0839	0.0806
	new-thyroid1 (0.1944)	0.0326	0.2089	0.1312
	new-thyroid2 (0.1944)	0.0029	0.0962	0.2855
imbalance ratio: 0.2, 1	ecoli1 (0.2947)	0.0021	0.1962	0.0744
	glass-0-1-2-3_vs_4-5-6 (0.3053)	0.0702	0.4319	0.0424
	vehicle0 (0.3075)	0.0000	0.0001	0.0875
	vehicle1 (0.3439)	0.0000	0.0000	0.0001
	haberman (0.3556)	0.1567	0.0165	0.0007
	yeast1 (0.4064)	0.0001	0.0621	0.0003
	glass0 (0.4786)	0.0127	0.1688	0.7072
	iris0 (0.5000)	NaN	NaN	0.3739
	pima (0.5350)	0.0058	0.0000	0.0320
	wisconsin (0.5380)	0.0000	0.0002	0.0071
	glass1 (0.5405)	0.0485	0.8608	0.0293

Another statistical test, namely the Friedman aligned ranks test, has been applied to compare the obtained results based on AUC values [42]. This test is a non-parametric test and the Holm method was chosen as the post hoc control method. The significance level was assigned 0.05. The statistics were obtained with the STAC tool [43] and recorded in Table 6. According to these results, the highest rank value was obtained by the proposed NWELM method and SVM and WELM rank values were greater than the ELM. In addition, the comparison's statistics, adjusted p -values and hypothesis results were given in Table 6.

Table 6. Friedman Aligned Ranks test (significance level of 0.05).

Statistic	p -Value	Result	
29.6052	0.0000	H0 is rejected	
Ranking			
Algorithm	Rank		
ELM	21.7619		
WELM	38.9047		
SVM	41.5238		
NWELM	67.8095		
Comparison	Statistic	Adjusted p -Value	Result
NWELM vs. ELM	6.1171	0.0000	H0 is rejected
NWELM vs. WELM	3.8398	0.0003	H0 is rejected
NWELM vs. SVM	3.4919	0.0005	H0 is rejected

We further compared the proposed NWELM method with two ensemble-based weighted ELM methods on 12 data sets [29]. The obtained results and the average classification G_{mean} values are recorded in Table 7. The best classification result for each data set is shown in bold text. A global view on the average classification performance shows that the NWELM yielded the highest average G_{mean} value against both the ensemble-based weighted ELM methods. In addition, the proposed NWELM

method evidently outperforms the other two compared algorithms in terms of G_{mean} in 10 out of 12 data sets, with the only exceptions being the yeast3 and glass2 data sets.

As can be seen through careful observation, the NWELM method has not significantly improved the performance in terms of the glass1, haberman, yeast1_7 and abalone9_18 data sets, but slightly outperforms both ensemble-based weighted ELM methods.

Table 7. Comparison of the proposed method with two ensemble-based weighted ELM methods.

	Vote-Based Ensemble		DE-Based Ensemble		NWELM	
	C	$G_{mean}(\%)$	C	$G_{mean}(\%)$	C	$G_{mean}(\%)$
glass1	2 ³⁰	74.32	2 ¹⁸	77.72	2 ¹⁷	81.77
haberman	2 ¹²	63.10	2 ²⁸	62.68	2 ⁷	67.34
ecoli1	2 ⁴⁰	89.72	2 ⁰	91.39	2 ²⁰	92.10
new-thyroid2	2 ¹⁰	99.47	2 ³²	99.24	2 ⁷	100.00
yeast3	2 ⁴	94.25	2 ²	94.57	2 ³	93.20
ecoli3	2 ¹⁰	88.68	2 ¹⁸	89.50	2 ¹⁷	92.16
glass2	2 ⁸	86.45	2 ¹⁶	87.51	2 ⁷	85.58
yeast1_7	2 ²⁰	78.95	2 ³⁸	78.94	2 ⁻⁶	84.66
ecoli4	2 ⁸	96.33	2 ¹⁴	96.77	2 ¹⁰	98.85
abalone9_18	2 ⁴	89.24	2 ¹⁶	90.13	2 ²³	94.53
glass5	2 ¹⁸	94.55	2 ¹²	94.55	2 ⁷	95.02
yeast5	2 ¹²	94.51	2 ²⁸	94.59	2 ¹⁷	98.13
Average		87.46		88.13		90.53

A box plots illustration of the compared methods is shown in Figure 2. The box generated by the NWELM is shorter than the boxes generated by the compared vote-based ensemble and differential evolution (DE)- based ensemble methods. The dispersion degree of NWELM method is relatively low. It is worth noting that the box plots of all methods consider the G_{mean} of the haberman data set as an exception. Finally, the box plot determines the proposed NWELM method to be more robust when compared to the ensemble-based weighted ELM methods.

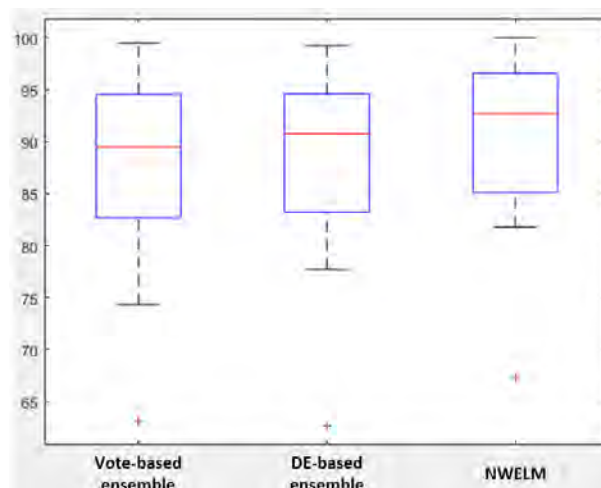

Figure 2. Box plots illustration of the compared methods.

4. Conclusions

In this paper, we propose a new weighted ELM model based on neutrosophic clustering. This new weighting scheme introduces true, indeterminacy and falsity memberships of each data point into ELM. Thus, we can remove the effect of noises and outliers in the classification stage and yield better classification results. Moreover, the proposed NWELM scheme can handle the problem of

class imbalance more effectively. In the evaluation experiments, we compare the performance of the NWELM method with weighted ELM, unweighted ELM, and two ensemble-based weighted ELM methods. The experimental results demonstrate the NEWLM to be more effective than the compared methods for both artificial and real binary imbalance data sets. In the future, we are planning to extend our study to multiclass imbalance learning.

References

1. Huang, G.B.; Zhu, Q.Y.; Siew, C.K. Extreme learning machine: Theory and applications. *Neurocomputing* **2006**, *70*, 489–501.
2. Míche, Y.; Van Heeswijk, M.; Bas, P.; Simula, O.; Lendasse, A. TROP-ELM: A double-regularized ELM using LARS and Tikhonov regularization. *Neurocomputing* **2011**, *74*, 2413–2421.
3. Deng, W.; Zheng, Q.; Chen, L. Regularized Extreme Learning Machine. In Proceedings of the 2009 IEEE Symposium on Computational Intelligence and Data Mining, Nashville, TN, USA, 30 March–2 April 2009; pp. 389–395.
4. MartíNez-MartíNez, J.M.; Escandell-Montero, P.; Soria-Olivas, E.; MartíN-Guerrero, J.D.; Magdalena-Benedito, R.; Gómez-Sanchis, J. Regularized extreme learning machine for regression problems. *Neurocomputing* **2011**, *74*, 3716–3721.
5. Míche, Y.; Sorjamaa, A.; Bas, P.; Simula, O.; Jutten, C.; Lendasse, A. OP-ELM: Optimally pruned extreme learning machine. *IEEE Trans. Neural Netw.* **2010**, *21*, 158–162.
6. Vajda, S.; Fink, G.A. Strategies for Training Robust Neural Network Based Digit Recognizers on Unbalanced Data Sets. In Proceedings of the 2010 International Conference on Frontiers in Handwriting Recognition (ICFHR), Kolkata, India, 16–18 November 2010; pp. 148–153.
7. Mirza, B.; Lin, Z.; Toh, K.A. Weighted online sequential extreme learning machine for class imbalance learning. *Neural Process. Lett.* **2013**, *38*, 465–486.
8. Beyan, C.; Fisher, R. Classifying imbalanced data sets using similarity based hierarchical decomposition. *Pattern Recognit.* **2015**, *48*, 1653–1672.
9. Chawla, N.V.; Bowyer, K.W.; Hall, L.O.; Kegelmeyer, W.P. SMOTE: Synthetic minority over-sampling technique. *J. Artif. Intell. Res.* **2002**, *16*, 321–357.
10. Pazzani, M.; Merz, C.; Murphy, P.; Ali, K.; Hume, T.; Brunk, C. Reducing Misclassification Costs. In Proceedings of the Eleventh International Conference on Machine Learning, New Brunswick, NJ, USA, 10–13 July 1994; pp. 217–225.
11. Japkowicz, N. The Class Imbalance Problem: Significance and Strategies. In Proceedings of the 2000 International Conference on Artificial Intelligence (IC-AI'2000), Las Vegas, NV, USA, 26–29 June 2000.
12. Galar, M.; Fernandez, A.; Barrenechea, E.; Bustince, H.; Herrera, F. A Review on Ensembles for the Class Imbalance Problem: Bagging-, Boosting-, and Hybrid-Based Approaches. *IEEE Trans. Syst. Man Cybern. Part C (Appl. Rev.)* **2012**, *42*, 463–484.
13. He, H.; Garcia, E.A. Learning from imbalanced data. *IEEE Trans. Knowl. Data Eng.* **2009**, *21*, 1263–1284.
14. Hu, S.; Liang, Y.; Ma, L.; He, Y. MSMOTE: Improving Classification Performance when Training Data is Imbalanced. In Proceedings of the Second International Workshop on Computer Science and Engineering (WCSE'09), Qingdao, China, 28–30 October 2009; IEEE: Washington, DC, USA, 2009; Volume 2, pp. 13–17.
15. Chawla, N.; Lazarevic, A.; Hall, L.; Bowyer, K. SMOTEBoost: Improving Prediction of the Minority Class in Boosting. In Proceedings of the 7th European Conference on Principles and Practice of Knowledge Discovery in Databases: Cavtat-Dubrovnik, Croatia, 22–26 September 2003; pp. 107–119.
16. Barua, S.; Islam, M.M.; Yao, X.; Murase, K. MWMOTE—majority weighted minority oversampling technique for imbalanced data set learning. *IEEE Trans. Knowl. Data Eng.* **2014**, *26*, 405–425.
17. Radivojac, P.; Chawla, N.V.; Dunker, A.K.; Obradovic, Z. Classification and knowledge discovery in protein databases. *J. Biomed. Inf.* **2004**, *37*, 224–239.
18. Liu, X.Y.; Wu, J.; Zhou, Z.H. Exploratory undersampling for class-imbalance learning. *IEEE Trans. Syst. Man Cybern. Part B (Cybern.)* **2009**, *39*, 539–550.
19. Seiffert, C.; Khoshgoftaar, T.M.; Van Hulse, J.; Napolitano, A. RUSBoost: A hybrid approach to alleviating class imbalance. *IEEE Trans. Syst. Man Cybern. Part A Syst. Hum.* **2010**, *40*, 185–197.
20. Wang, B.X.; Japkowicz, N. Boosting support vector machines for imbalanced data sets. *Knowl. Inf. Syst.* **2010**, *25*, 1–20.
21. Tan, S. Neighbor-weighted k-nearest neighbor for unbalanced text corpus. *Expert Syst. Appl.* **2005**, *28*, 667–671.

22. Fumera, G.; Roli, F. Cost-sensitive learning in support vector machines. In Proceedings of the VIII Convegno Associazione Italiana per l'Intelligenza Artificiale, Siena, Italy, 10–13 September 2002.
23. Drummond, C.; Holte, R.C. Exploiting the cost (in) sensitivity of decision tree splitting criteria. In Proceedings of the Seventeenth International Conference on Machine Learning (ICML-2000), Stanford, CA, USA, 29 June–2 July 2000; Morgan Kaufmann Publishers Inc.: San Francisco, CA, USA, 2000; Volume 1, pp. 239–246.
24. Williams, D.P.; Myers, V.; Silvious, M.S. Mine classification with imbalanced data. *IEEE Geosci. Remote Sens. Lett.* **2009**, *6*, 528–532.
25. Zong, W.; Huang, G.B.; Chen, Y. Weighted extreme learning machine for imbalance learning. *Neurocomputing* **2013**, *101*, 229–242.
26. Czarnecki, W.M. Weighted tanimoto extreme learning machine with case study in drug discovery. *IEEE Comput. Intell. Mag.* **2015**, *10*, 19–29.
27. Man, Z.; Lee, K.; Wang, D.; Cao, Z.; Khoo, S. An optimal weight learning machine for handwritten digit image recognition. *Signal Process.* **2013**, *93*, 1624–1638.
28. Mirza, B.; Lin, Z.; Liu, N. Ensemble of subset online sequential extreme learning machine for class imbalance and concept drift. *Neurocomputing* **2015**, *149*, 316–329.
29. Zhang, Y.; Liu, B.; Cai, J.; Zhang, S. Ensemble weighted extreme learning machine for imbalanced data classification based on differential evolution. *Neural Comput. Appl.* **2016**, 1–9, doi:10.1007/s00521-016-2342-4.
30. Wang, S.; Minku, L.L.; Yao, X. Resampling-based ensemble methods for online class imbalance learning. *IEEE Trans. Knowl. Data Eng.* **2015**, *27*, 1356–1368.
31. Guo, Y.; Sengur, A. NCM: Neutrosophic *c*-means clustering algorithm. *Pattern Recognit.* **2015**, *48*, 2710–2724.
32. Guo, Y.; Sengur, A. NECM: Neutrosophic evidential *c*-means clustering algorithm. *Neural Comput. Appl.* **2015**, *26*, 561–571.
33. Guo, Y.; Sengur, A. A novel 3D skeleton algorithm based on neutrosophic cost function. *Appl. Soft Comput.* **2015**, *36*, 210–217.
34. Smarandache, F. A Unifying Field in Logics: Neutrosophic Logic. Neutrosophic Probability, Neutrosophic Set. In Proceedings of the 2000 Western Section Meeting (Meeting #951), Preliminary Report, Santa Barbara, CA, USA, 11–12 March 2000; Volume 951, pp. 11–12.
35. Smarandache, F. *Introduction to Neutrosophic Measure, Neutrosophic Integral, and Neutrosophic Probability*; Sitech: Craiova, Romania, 2013.
36. Smarandache, F. *Neutrosophy, Neutrosophic Probability, Set, and Logic*; American Research Press: Rehoboth, DE, USA, 1998; 105p.
37. Smarandache, F. *A Unifying Field in Logics: Neutrosophic Logic. Neutrosophy, Neutrosophic Set, Neutrosophic Probability: Neutrosophic Logic. Neutrosophy, Neutrosophic Set, Neutrosophic Probability*; Infinite Study: Ann Arbor, MI, USA, 2005; ISBN 9781599730806.
38. Ng, W.W.; Hu, J.; Yeung, D.S.; Yin, S.; Roli, F. Diversified sensitivity-based undersampling for imbalance classification problems. *IEEE Trans. Cybern.* **2015**, *45*, 2402–2412.
39. Alcalá-Fdez, J.; Fernández, A.; Luengo, J.; Derrac, J.; García, S.; Sánchez, L.; Herrera, F. Keel data-mining software tool: Data set repository, integration of algorithms and experimental analysis framework. *J. Mult. Valued Log. Soft Comput.* **2011**, *17*, 255–287.
40. Huang, J.; Ling, C.X. Using AUC and accuracy in evaluating learning algorithms. *IEEE Trans. Knowl. Data Eng.* **2005**, *17*, 299–310.
41. Demšar, J. Statistical comparisons of classifiers over multiple data sets. *J. Mach. Learn. Res.* **2006**, *7*, 1–30.
42. Hodges, J., Jr.; Lehmann, E. Rank methods for combination of independent experiments in analysis of variance. In *Selected Works of E.L. Lehmann; Selected Works in Probability and Statistics*; Springer: Boston, MA, USA, 2012; pp. 403–418.
43. Rodríguez-Fdez, I.; Canosa, A.; Mucientes, M.; Bugarín, A. STAC: A Web Platform for the Comparison of Algorithms Using Statistical Tests. In Proceedings of the 2015 IEEE International Conference on Fuzzy Systems (FUZZ-IEEE), Istanbul, Turkey, 2–5 August 2015; pp. 1–8.

NS- k -NN: Neutrosophic Set-Based k -Nearest Neighbors Classifier

Yaman Akbulut, Abdulkadir Sengür, Yanhui Guo, Florentin Smarandache

Yaman Akbulut, Abdulkadir Sengür, Yanhui Guo, Florentin Smarandache (2017). NS- k -NN: Neutrosophic Set-Based k -Nearest Neighbors Classifier. *Symmetry* 9, 179; DOI: 10.3390/sym9090179

Abstract: k -nearest neighbors (k -NN), which is known to be a simple and efficient approach, is a non-parametric supervised classifier. It aims to determine the class label of an unknown sample by its k -nearest neighbors that are stored in a training set. The k -nearest neighbors are determined based on some distance functions. Although k -NN produces successful results, there have been some extensions for improving its precision. The neutrosophic set (NS) defines three memberships namely T , I and F . T , I , and F shows the truth membership degree, the false membership degree, and the indeterminacy membership degree, respectively. In this paper, the NS memberships are adopted to improve the classification performance of the k -NN classifier. A new straightforward k -NN approach is proposed based on NS theory. It calculates the NS memberships based on a supervised neutrosophic c -means (NCM) algorithm. A final belonging membership U is calculated from the NS triples as $U = T + I - F$. A similar final voting scheme as given in fuzzy k -NN is considered for class label determination. Extensive experiments are conducted to evaluate the proposed method's performance. To this end, several toy and real-world datasets are used. We further compare the proposed method with k -NN, fuzzy k -NN, and two weighted k -NN schemes. The results are encouraging and the improvement is obvious.

Keywords: k -NN; Fuzzy k -NN; neutrosophic sets; data classification

1. Introduction

The k -nearest neighbors (k -NN), which is known to be the oldest and simplest approach, is a non-parametric supervised classifier [1,2]. It aims to determine the class label of an unknown sample by its k -nearest neighbors that are stored in a training set. The k -nearest neighbors are determined based on some distance functions. As it is simplest and oldest approach, there have been so many data mining and pattern recognition applications, such as ventricular arrhythmia detection [3], bankruptcy prediction [4], diagnosis of diabetes diseases [5], human action recognition [6], text categorization [7], and many other successful ones.

Although k -NN produces successful results, there have been some extensions for improving its precision. Fuzzy theory-based k -NN (Fuzzy k -NN) has been among the most successful ones. As k -NN produces crisp memberships for training data samples, fuzzy k -NN replaces the crisp memberships with a continuous range of memberships which enhances the class label determination. Keller et al. [8] was the one who incorporated the fuzzy theory in the k -NN approach. Authors proposed three different methods for assigning fuzzy memberships to the labeled samples. After determination of the fuzzy memberships, some distance function was used to weight the fuzzy memberships for

final class label determination of the test sample. The membership assignment by the conventional fuzzy k -NN algorithm has a disadvantage in that it depends on the choice of some distance function. To alleviate this drawback, Pham et al. [9] proposed an optimally-weighted fuzzy k -NN approach. Author introduced a computational scheme for determining optimal weights which were used to improve the efficiency of the fuzzy k -NN approach. Dencœux et al. [10] proposed a k -NN method where Dempster-Shafer theory was used to calculate the memberships of the training data samples. Author assumed that each neighbor of a sample to be classified was considered as an item of evidence and the degree of support was defined as a function of the distance. The final class label assignment was handled by Dempster's rule of combination. Another evidential theory-based k -NN approach, denoted by Ek -NN, has been proposed by Zouhal et al. [11]. In addition to the belonging degree, the authors introduced the ignorant class to model the uncertainty. Then, Zouhal et al. [12] proposed the generalized Ek -NN approach, denoted by FEk -NN. Authors adopted fuzzy theory for improving the Ek -NN classification performance. The motivation for the FEk -NN was arisen from the fact that each training sample was considered having some degree of membership to each class. In addition, Liu et al. [13] proposed an evidential reasoning based fuzzy-belief k -nearest neighbor (FBK-NN) classifier. In FBK-NN, each labeled sample was assigned with a fuzzy membership to each class according to its neighborhood and the test sample's class label was determined by the K basic belief assignments which were determined from the distances between the object and its K nearest neighbors. A belief theory based k -NN, denoted by the BK-NN classifier was introduced by Liu et al. [14]. The author aimed to deal with uncertain data using the meta-class. Although, the proposed method produced successful results, the computation complexity and the sensitivity to k makes the approach inconvenient for many classification application. Derrac et al. [15] proposed an evolutionary fuzzy k -NN approach where interval-valued fuzzy sets were used. The authors not only defined a new membership function, but also a new voting scheme was proposed. Dudani et al. [16] proposed a weighted voting method for k -NN which was called the distance-weighted k -NN (WKNN). Authors presumed that the closer neighbors were weighted more heavily than the farther ones, using the distance-weighted function. Gou et al. [17] proposed a distance-weighted k -NN (DWKNN) method where a dual distance-weighted function was introduced. The proposed method has improved the traditional k -NN's performance by using a new method for selection of the k value.

In [18–21], Smarandache proposed neutrosophic theories. Neutrosophy was introduced as a new branch of philosophy which deals with the origin, nature, and scope of neutralities, and their interactions with different ideational spectra [19]. Neutrosophy is the base for the neutrosophic set (NS), neutrosophic logic, neutrosophic probability, neutrosophic statistics, and so on. In NS theory, every event has not only a certain degree of truth, but also a falsity degree and an indeterminacy degree that have to be considered independently from each other [20]. Thus, an event, or entity, $\{A\}$ is considered with its opposite $\{\text{Anti-}A\}$ and the neutrality $\{\text{Neut-}A\}$. NS provides a powerful tool to deal with the indeterminacy. In this paper, a new straightforward k -NN approach was developed which is based on NS theory. We adopted the NS memberships to improve the classification performance of the k -NN classifier. To do so, the neutrosophic c -means (NCM) algorithm was considered in a supervised manner, where labeled training data was used to obtain the centers of clusters. A final belonging membership degree U was calculated from the NS triples as $U = T + I - F$. A similar final voting scheme as given in fuzzy k -NN was employed for class label determination.

The paper is organized as follows: In the next section, we briefly reviewed the theories of k -NN and fuzzy k -NN. In Section 3, the proposed method was introduced and the algorithm of the proposed method was tabulated in Table 1. The experimental results and related comparisons were given in Section 4. The paper was concluded in Section 5.

2. Related works

2.1. *k*-Nearest Neighbor (*k*-NN) Classifier

As it was mentioned earlier, *k*-NN is the simplest, popular, supervised, and non-parametric classification method which was proposed in 1951 [1]. It is a distance based classifier which needs to measure the similarity of the test data to the data samples stored in the training set. Then, the test data is labelled by a majority vote of its *k*-nearest neighbors in the training set.

Let $X = \{x_1, x_2, \dots, x_N\}$ denote the training set where $x_i \in R^n$ is a training data point in the *n*-dimensional feature space and let $Y = \{y_1, y_2, \dots, y_N\}$ denotes the corresponding class labels. Given a test data point \hat{x} whose class label is unknown, it can be determined as follows:

- Calculate the similarity measures between test sample and training samples by using a distance function (e.g., Euclidean distance)
- Find the test sample's *k* nearest neighbors in training data samples according to the similarity measure and determine the class label by the majority voting of its nearest neighbors.

2.2. Fuzzy *k*-Nearest Neighbor (*k*-NN) Classifier

In *k*-NN, a training data sample x is assumed to belong to one of the given classes so the membership U of that training sample to each class of C is given by an array of values in $\{0, 1\}$. If training data sample x belongs to class c_1 then $U_{c_1}(x) = 1$ and $U_{c_2}(x) = 0$ where $C = \{c_1, c_2\}$.

However, in fuzzy *k*-NN, instead of using crisp memberships, continuous range of memberships is used due to the nature of fuzzy theory [8]. So, the membership of training data sample can be calculated as:

$$U_{c_1}(x) = \begin{cases} 0.51 + 0.49 \frac{k_{c_1}}{K} & \text{if } c = c_1 \\ 0.49 \frac{k_{c_1}}{K} & \text{otherwise} \end{cases} \quad (1)$$

where k_{c_1} shows the number of instances belonging to class c_1 found among the *k* neighbors of \hat{x} and *k* is an integer value between [3,9].

After fuzzy membership calculation, a test sample's class label can be determined as following. Determine the *k* nearest neighbors of the test sample via Euclidean distance and produce a final vote for each class and neighbor using the Euclidean norm and the memberships:

$$V(k_j, c) = \frac{\frac{U_c(k_j)}{(\|\hat{x} - k_j\|)^{\frac{2}{m-1}}}}{\sum_{i=1}^k \frac{1}{(\|\hat{x} - k_i\|)^{\frac{2}{m-1}}}} \quad (2)$$

where k_j is the *j*th nearest neighbor and $m = 2$ is a parameter. The votes of each neighbor are then added to obtain the final classification.

3. Proposed Neutrosophic-*k*-NN Classifier

As traditional *k*-NN suffers from assigning equal weights to class labels in the training dataset, neutrosophic memberships are adopted in this work to overcome this limitation. Neutrosophic memberships reflect the data point's significance in its class and these memberships can be used as a new procedure for *k*-NN approach.

Neutrosophic set can determine a sample's memberships belonging to truth, false, and indeterminacy. An unsupervised neutrosophic clustering algorithm (NCM) is used in a supervised manner [22,23]. Crisp clustering methods assumed that every data points should belong to a cluster according to their nearness to the center of clusters. Fuzzy clustering methods assigned fuzzy memberships to each data point according to their nearness to the center of cluster. Neutrosophic clustering assigned memberships (*T*, *I*, and *F*) to each data point not only according to its nearness to a cluster center, but also according to the nearness to the center mean of the two clusters. Readers may

refer to [22] for detailed information about the NCM clustering. As the labels of a training dataset samples are known in a supervised learning, the centers of the clusters can be calculated accordingly. Then, the related memberships of true (T), false (F), and indeterminacy (I) can be calculated as follows:

$$T_{ij} = \frac{(x_i - c_j)^{-\left(\frac{2}{m-1}\right)}}{\sum_{j=1}^C (x_i - c_j)^{-\left(\frac{2}{m-1}\right)} + (x_i - \bar{c}_{imax})^{-\left(\frac{2}{m-1}\right)} + \delta^{-\left(\frac{2}{m-1}\right)}} \quad (3)$$

$$F_i = \frac{(\delta)^{-\left(\frac{2}{m-1}\right)}}{\sum_{j=1}^C (x_i - c_j)^{-\left(\frac{2}{m-1}\right)} + (x_i - \bar{c}_{imax})^{-\left(\frac{2}{m-1}\right)} + \delta^{-\left(\frac{2}{m-1}\right)}} \quad (4)$$

$$I_i = \frac{(x_i - \bar{c}_{imax})^{-\left(\frac{2}{m-1}\right)}}{\sum_{j=1}^C (x_i - c_j)^{-\left(\frac{2}{m-1}\right)} + (x_i - \bar{c}_{imax})^{-\left(\frac{2}{m-1}\right)} + \delta^{-\left(\frac{2}{m-1}\right)}} \quad (5)$$

where m is a constant, δ is a regularization parameter and c_j shows the center of cluster j . For each point i , the \bar{c}_{imax} is the mean of two cluster centers where the true membership values are greater than the others. T_{ij} shows the true membership value of point i for class j . F_i shows the falsity membership of point i and I_i determines the indeterminacy membership value for point i . Larger T_{ij} means that the point i is near a cluster and less likely to be a noise. Larger I_i means that the point i is between any two clusters and larger F_i indicates that point i is likely to be a noise. A final membership value for point i can be calculated by adding indeterminacy membership value to true membership value and subtracting the falsity membership value as shown in Equation (6).

After determining the neutrosophic membership triples, the membership for an unknown sample x_u to class label j , can be calculated as [9]:

$$\mu_{ju} = \frac{\sum_{i=1}^k d_i (T_{ij} + I_i - F_i)}{\sum_{i=1}^k d_i} \quad (6)$$

$$d_i = \frac{1}{\|x_u - x_i\|^{\frac{2}{q-1}}} \quad (7)$$

where d_i is the distance function to measure the distance between x_i and x_u , k shows the number of k -nearest neighbors and q is an integer. After the assignment of the neutrosophic membership grades of an unknown sample x_u to all class labels, the neutrosophic k -NN assigns x_u to the class whose neutrosophic membership is maximum. The following steps are used for construction of the proposed NS- k -NN method:

- Step 1:** Initialize the cluster centers according to the labelled dataset and employ Equations (3)–(5) to calculate the T , I , and F values for each data training data point.
- Step 2:** Compute membership grades of test data samples according to the Equations (6) and (7).
- Step 3:** Assign class labels of the unknown test data points to the class whose neutrosophic membership is maximum.

4. Experimental Works

The efficiency of the proposed method was evaluated with several toy and real datasets. Two toy datasets were used to test the proposed method and investigate the effect of the parameters change on classification accuracy. On the other hand, several real datasets were used to compare the proposed method with traditional k -NN and fuzzy k -NN methods. We further compare the proposed method with several weighted k -NN methods such as weighted k -NN (WKNN) and distance-weighted k -nearest neighbor (DWKNN).

Figure 1. Toy datasets. (a) Corner data; (b) line data.

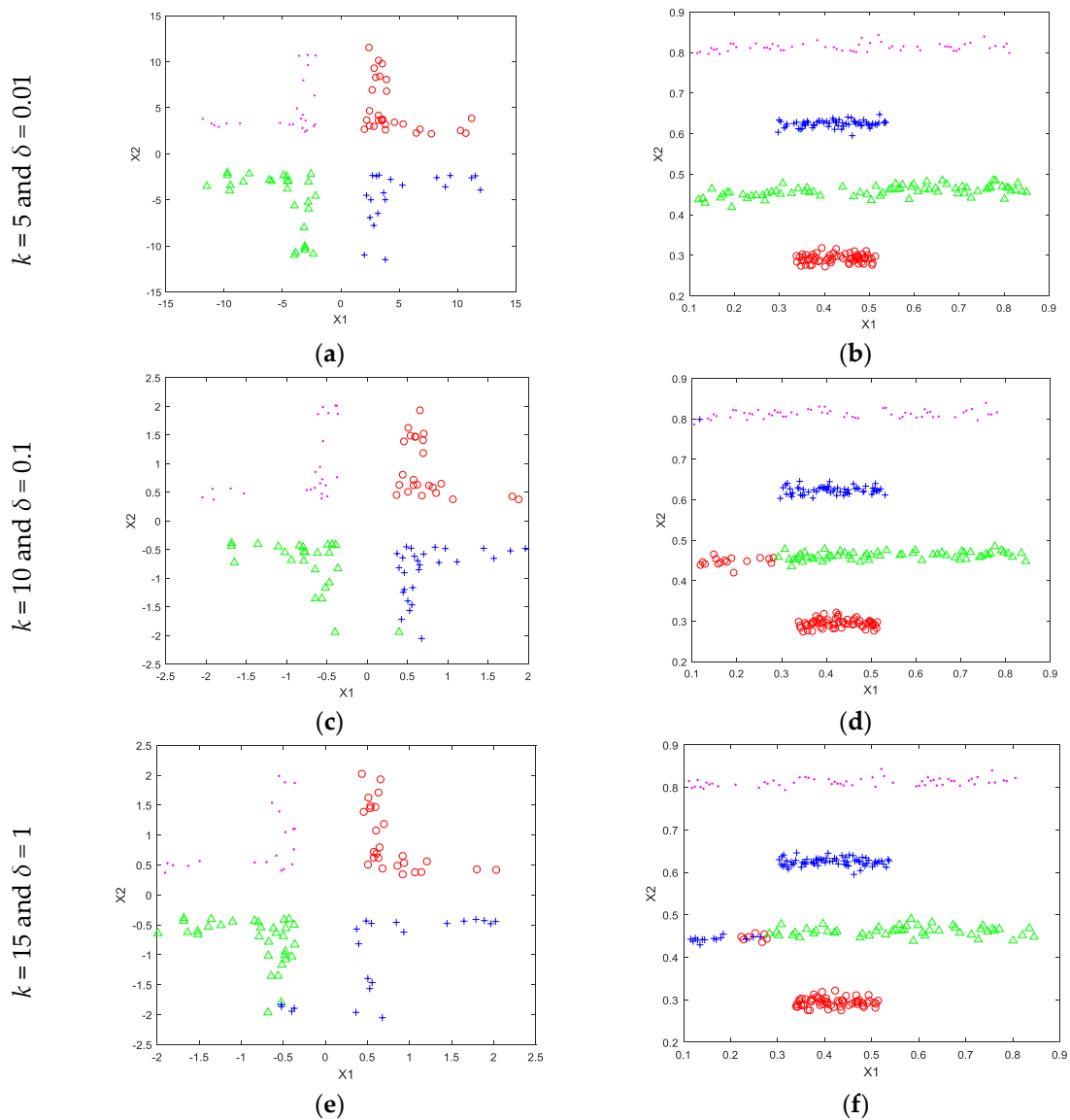

In addition to our results, we also compared our results with k -NN and fuzzy k -NN results on the same datasets. The obtained results were tabulated in Table 2 where the best results were indicated with bold-face. As seen in Table 2, the proposed method performed better than the other methods in 27 of 39 datasets. In addition, k -NN and fuzzy k -NN performed better on six and seven datasets out of 39 datasets, respectively. Our proposal obtained 100% accuracy for two datasets (new thyroid and wine). Moreover, for 13 datasets, the proposed method obtained accuracy values higher than 90%. On the other hand, the worse result was recorded for “Wine quality-white” dataset where the accuracy was 33.33%. Moreover, there were a total of three datasets where the accuracy was lower than 50%. We further conducted experiments on several datasets from UCI-data repository [25]. Totally, 11 datasets were considered in these experiments and compared results with two weighted k -NN approaches, namely WKNN and DWKNN. The characteristics of the each dataset from UCI-data

repository were shown in Table 3, and the obtained all results were tabulated in Table 4. The boldface in Table 4 shows the higher accuracy values for each dataset.

Table 2. Experimental results of k -NN and fuzzy k -NN vs. the proposed method.

Data Sets	k -NN	Fuzzy k -NN	Proposed Method	Data Sets	k -NN	Fuzzy k -NN	Proposed Method
Appendicitis	87.91	97.91	90.00	Penbased	99.32	99.34	86.90
Balance	89.44	88.96	93.55	Phoneme	88.49	89.64	79.44
Banana	89.89	89.42	60.57	Pima	73.19	73.45	81.58
Bands	71.46	70.99	75.00	Ring	71.82	63.07	72.03
Bupa	62.53	66.06	70.59	Satimage	90.94	90.61	92.53
Cleveland	56.92	56.95	72.41	Segment	95.41	96.36	97.40
Dermatology	96.90	96.62	97.14	Sonar	83.10	83.55	85.00
Ecoli	82.45	83.34	84.85	Spectfheart	77.58	78.69	80.77
Glass	70.11	72.83	76.19	Tae	45.79	67.67	86.67
Haberman	71.55	68.97	80.00	Texture	98.75	98.75	80.73
Hayes-roth	30.00	65.63	68.75	Thyroid	94.00	93.92	74.86
Heart	80.74	80.74	88.89	Twonorm	97.11	97.14	98.11
Hepatitis	89.19	85.08	87.50	Vehicle	72.34	71.40	54.76
Ionosphere	96.00	96.00	97.14	Vowel	97.78	98.38	49.49
Iris	85.18	84.61	93.33	Wdbc	97.18	97.01	98.21
Mammographic	81.71	80.37	86.75	Wine	96.63	97.19	100.00
Monk-2	96.29	89.69	97.67	Winequality-red	55.60	68.10	46.84
Movement	78.61	36.11	50.00	Winequality-white	51.04	68.27	33.33
New thyroid	95.37	96.32	100.00	Yeast	57.62	59.98	60.81
Page-blocks	95.91	95.96	96.34	-	-	-	-

Table 3. Several datasets and their properties from UCI dataset.

Data set	Features	Samples	Classes	Training Samples	Testing Samples
Glass	10	214	7	140	74
Wine	13	178	3	100	78
Sonar	60	208	2	120	88
Parkinson	22	195	2	120	75
Iono	34	351	2	200	151
Musk	166	476	2	276	200
Vehicle	18	846	4	500	346
Image	19	2310	7	1310	1000
Cardio	21	2126	10	1126	1000
Landsat	36	6435	7	3435	3000
Letter	16	20,000	26	10,000	10,000

Table 4. The accuracy values for DWKNN vs. NSKNN.

Data set	WKNN (%)	DWKNN (%)	Proposed Method (%)
Glass	69.86	70.14	60.81
Wine	71.47	71.99	79.49
Sonar	81.59	82.05	85.23
Parkinson	83.53	83.93	90.67
Iono	84.27	84.44	85.14
Musk	84.77	85.10	86.50
Vehicle	63.96	64.34	71.43
Image	95.19	95.21	95.60
Cardio	70.12	70.30	66.90
Landsat	90.63	90.65	91.67
Letter	94.89	94.93	63.50

As seen in Table 4, the proposed method performed better than the other methods in eight of 11 datasets and DWKNN performed better in the rest datasets. For three datasets (Parkinson, Image and Landsat), the proposed method yielded accuracy value higher than 90% and the worse

result was found for the 'Glass' dataset where the accuracy was 60.81%. DWKNN and the WKNN produced almost same accuracy values and performed significantly better than the proposed method on 'Letter and Glass' datasets. We further compared the running times of each method on each KEEL dataset and the obtained running times were tabulated in Table 5. We used MATLAB 2014b (The MathWorks Inc., Natick, MA, USA) on a computer having an Intel Core i7-4810 CPU and 32 GB memory. As seen in Table 5, for some datasets, the k -NN and fuzzy k -NN methods achieved lower running times than our proposal's achievement. However, when the average running times took into consideration, the proposed method achieved the lowest running time with 0.69 s. The k -NN method also obtained the second lowest running time with 1.41 s. The fuzzy k -NN approach obtained the average slowest running time when compared with the other methods. The fuzzy k -NN method's achievement was 3.17 s.

Table 5. Comparison of running times for each method.

Data Sets	k -NN	Fuzzy k -NN	Proposed Method	Data Sets	k -NN	Fuzzy k -NN	Proposed Method
Appendicitis	0.11	0.16	0.15	Penbased	10.21	18.20	3.58
Balance	0.15	0.19	0.18	Phoneme	0.95	1.88	0.71
Banana	1.03	1.42	0.57	Pima	0.45	0.58	0.20
Bands	0.42	0.47	0.19	Ring	6.18	10.30	2.55
Bupa	0.14	0.28	0.16	Satimage	8.29	15.25	1.96
Cleveland	0.14	0.18	0.19	Segment	1.09	1.76	0.63
Dermatology	0.33	0.31	0.22	Sonar	0.15	0.21	0.23
Ecoli	0.12	0.26	0.17	Spectfheart	0.14	0.25	0.22
Glass	0.10	0.18	0.18	Tae	0.13	0.12	0.16
Haberman	0.13	0.24	0.16	Texture	6.72	12.78	4.30
Hayes-roth	0.07	0.11	0.16	Thyroid	5.86	9.71	2.14
Heart	0.22	0.33	0.17	Twonorm	5.89	10.27	2.69
Hepatitis	0.06	0.06	0.16	Vehicle	0.17	0.31	0.27
Ionosphere	0.13	0.30	0.25	Vowel	0.47	0.62	0.31
Iris	0.23	0.13	0.16	Wdbc	0.39	0.46	0.26
Mammographic	0.21	0.22	0.20	Wine	0.08	0.14	0.17
Monk-2	0.27	0.33	0.17	Winequality-red	0.28	0.46	0.34
Movement	0.16	0.34	0.35	Winequality-white	1.38	1.95	0.91
New thyroid	0.14	0.18	0.17	Yeast	0.44	0.78	0.30
Page-blocks	1.75	2.20	0.93	Average	1.41	3.17	0.69

Generally speaking, the proposed NS- k -NN method can be announced successful when the accuracy values which were tabulated in Tables 3–5, were considered. The NS- k -NN method obtained these high accuracies because it incorporated the NS theory with the distance learning for constructing an efficient supervised classifier. The running time evaluation was also proved that the NS- k -NN was quite an efficient classifier than the compared other related classifiers.

5. Conclusions

In this paper, we propose a novel supervised classification method based on NS theory called neutrosophic k -NN. The proposed method assigns the memberships to training samples based on the supervised NCM clustering algorithm, and classifies the samples based on their neutrosophic memberships. This approach can be seen as an extension of the previously-proposed fuzzy k -NN method by incorporating the falsity and indeterminacy sets. The efficiency of the proposed method was demonstrated with extensive experimental results. The results were also compared with other improved k -NN methods. According to the obtained results, the proposed method can be used in various classification applications. In the future works, we plan to apply the proposed NS- k -NN on imbalanced dataset problems. We would like to analyze the experimental results with some non-parametric statistical methods, such as the Freidman test and Wilcoxon signed-ranks test. In addition, some other evaluation metrics such as AUC will be used for comparison purposes. We will also explore the k -NN method where Dezert-Smarandache theory will be used to calculate the

data samples' memberships, replacing Dempster's rule by Proportional Conflict Redistribution Rule #5 (PCR5), which is more performative in order to handle the assignments of the final class.

References

1. Fix, E.; Hodges, J.L. *Discriminatory Analysis, Nonparametric Discrimination: Consistency Properties*; Technique Report No. 4; U.S. Air Force School of Aviation Medicine, Randolph Field Texas: Universal City, TX, USA, 1951; pp. 238–247.
2. Duda, R.; Hart, P. *Pattern Classification and Scene Analysis*; John Wiley & Sons: New York, NY, USA, 1973.
3. Cabello, D.; Barro, S.; Salceda, J.; Ruiz, R.; Mira, J. Fuzzy k -nearest neighbor classifiers for ventricular arrhythmia detection. *Int. J. Biomed. Comput.* **1991**, *27*, 77–93. [[CrossRef](#)]
4. Chen, H.-L.; Yang, B.; Wang, G.; Liu, J.; Xu, X.; Wang, S.; Liu, D. A novel bankruptcy prediction model based on an adaptive fuzzy k -nearest neighbor method. *Knowl. Based Syst.* **2011**, *24*, 1348–1359. [[CrossRef](#)]
5. Chikh, M.A.; Saidi, M.; Settouti, N. Diagnosis of diabetes diseases using an artificial immune recognition system2 (AIRS2) with fuzzy k -nearest neighbor. *J. Med. Syst.* **2012**, *36*, 2721–2729. [[CrossRef](#)] [[PubMed](#)]
6. Aslan, M.; Akbulut, Y.; Sengur, A.; Ince, M.C. Skeleton based efficient fall detection. *J. Fac. Eng. Archit. Gazi Univ.* **2017**, accepted (in press).
7. Li, B.; Lu, Q.; Yu, S. An adaptive k -nearest neighbor text categorization strategy. *ACM Trans. Asian Lang. Inf. Process.* **2004**, *3*, 215–226.
8. Keller, J.M.; Gray, M.R.; Givens, J.A. A fuzzy k -nearest neighbor algorithm. *IEEE Trans. Syst. Man Cybern.* **1985**, *15*, 580–585. [[CrossRef](#)]
9. Pham, T.D. An optimally weighted fuzzy k -NN algorithm. In *Pattern Recognition and Data Mining*; Volume 3686 of Lecture Notes in Computer Science; Singh, S., Singh, M., Apte, C., Perner, P., Eds.; Springer: Berlin/Heidelberg, Germany, 2005; pp. 239–247.
10. Denœux, T. A k -nearest neighbor classification rule based on Dempster-Shafer theory. *IEEE Trans. Syst. Man Cybern.* **1995**, *25*, 804–813. [[CrossRef](#)]
11. Zouhal, L.M.; Denœux, T. An evidence-theoretic k -NN rule with parameter optimization. *IEEE Trans. Syst. Man Cybern. Part C* **1998**, *28*, 263–271. [[CrossRef](#)]
12. Zouhal, L.M.; Denœux, T. Generalizing the evidence theoretic k -NN rule to fuzzy pattern recognition. In *Proceedings of the 2nd International ICSC Symposium on Fuzzy Logic and Applications*, Zurich, Switzerland, 12–14 February 1997; pp. 294–300.
13. Liu, Z.G.; Pan, Q.; Dezert, J.; Mercier, G.; Liu, Y. Fuzzy-belief k -nearest neighbor classifier for uncertain data. In *Proceedings of the Fusion 2014: 17th International Conference on Information Fusion*, Salamanca, Spain, 7–10 July 2014; pp. 1–8.
14. Liu, Z.; Pan, Q.; Dezert, J. A new belief-based K -nearest neighbor classification method. *Pattern Recognit.* **2013**, *46*, 834–844. [[CrossRef](#)]
15. Derrac, J.; Chiclana, F.; García, S.; Herrera, F. Evolutionary fuzzy k -nearest neighbors algorithm using interval-valued fuzzy sets. *Inf. Sci.* **2016**, *329*, 144–163. [[CrossRef](#)]
16. Dudani, S.A. The distance-weighted k -nearest neighbor rule. *IEEE Trans. Syst. Man Cybern.* **1976**, *6*, 325–327. [[CrossRef](#)]
17. Gou, J.; Du, L.; Zhang, Y.; Xiong, T. A new distance-weighted k -nearest neighbor classifier. *J. Inf. Comput. Sci.* **2012**, *9*, 1429–1436.
18. Smarandache, F. *Neutrosophy. Neutrosophic Probability, Set, and Logic*, ProQuest Information & Learning; Infolearnquest: Ann Arbor, MI, USA, 1998; p. 105. Available online: <http://fs.gallup.unm.edu/eBook-neutrosophics6.pdf> (accessed on 2 August 2017).
19. Smarandache, F. *Introduction to Neutrosophic Measure, Neutrosophic Integral and Neutrosophic Probability*; Sitech: Craiova, Romania, 2013.
20. Smarandache, F. *Neutrosophy. Neutrosophic Probability, Set, and Logic*; American Research Press: Rehoboth, DE, USA, 1998; p. 105.
21. Smarandache, F. *A Unifying Field in Logics Neutrosophic Logic. Neutrosophy, Neutrosophic Set, Neutrosophic Probability*, 3rd ed.; American Research Press: Rehoboth, DE, USA, 2003.
22. Guo, Y.; Sengur, A. NCM: Neutrosophic c -means clustering algorithm. *Pattern Recognit.* **2015**, *48*, 2710–2724. [[CrossRef](#)]

A Retinal Vessel Detection Approach Based on Shearlet Transform and Indeterminacy Filtering on Fundus Images

Yanhui Guo, Ümit Budak, Abdulkadir Sengür, Florentin Smarandache

Yanhui Guo, Ümit Budak, Abdulkadir Sengür, Florentin Smarandache (2017). A Retinal Vessel Detection Approach Based on Shearlet Transform and Indeterminacy Filtering on Fundus Images. *Symmetry* 9, 235; DOI: 10.3390/sym9100235

Abstract: A fundus image is an effective tool for ophthalmologists studying eye diseases. Retinal vessel detection is a significant task in the identification of retinal disease regions. This study presents a retinal vessel detection approach using shearlet transform and indeterminacy filtering. The fundus image's green channel is mapped in the neutrosophic domain via shearlet transform. The neutrosophic domain images are then filtered with an indeterminacy filter to reduce the indeterminacy information. A neural network classifier is employed to identify the pixels whose inputs are the features in neutrosophic images. The proposed approach is tested on two datasets, and a receiver operating characteristic curve and the area under the curve are employed to evaluate experimental results quantitatively. The area under the curve values are 0.9476 and 0.9469 for each dataset respectively, and 0.9439 for both datasets. The comparison with the other algorithms also illustrates that the proposed method yields the highest evaluation measurement value and demonstrates the efficiency and accuracy of the proposed method.

Keywords: retinal vessels detection; shearlet transform; neutrosophic set; indeterminacy filtering; neural network; fundus image

1. Introduction

A fundus image is an important and effective tool for ophthalmologists who diagnose the eyes for determination of various diseases such as cardiovascular, hypertension, arteriosclerosis and diabetes. Recently, diabetic retinopathy (DR) has become a prevalent disease and it is seen as the major cause of permanent vision loss in adults worldwide [1]. Prevention of such adult blindness necessitates the early detection of the DR. DR can be detected early by inspection of the changes in blood vessel structure in fundus images [2,3]. In particular, the detection of the new retinal vessel growth is quite important. Experienced ophthalmologists can apply various clinical methods for the manual diagnosis of DR which require time and steadiness. Hence, automated diagnosis systems for retinal screening are in demand.

Various works have been proposed so far where the authors have claimed to find the retinal vessels automatically on fundus images. Soares et al. proposed two-dimensional Gabor wavelets and supervised classification method to segment retinal vessel [4], which classifies pixels as vessel and non-vessel pixels. Dash et al. presented a morphology-based algorithm to segment retinal

vessel [5]. Authors used 2-D Gabor wavelets and the CLAHE method for enhancing retinal images. Segmentation was achieved by geodesic operators. The obtained segmentation result was then refined with post-processing.

Zhao et al. introduced a methodology where level sets and region growing methods were used for retinal vessel segmentation [6]. These authors also used CLAHE and 2D Gabor filters for image enhancement. The enhanced images were further processed by an anisotropic diffusion filter to smooth the retinal images. Finally, the vessels segmentation was achieved by using level sets and region growing method. Levet et al. developed a retinal vessel segmentation method using shearlet transform [7]. The authors introduced a term called ridgeness which was calculated for all pixels at a given scale. Hysteresis thresholding was then applied for extracting the retinal vessels. Another multi-resolution approach was proposed by Bankhead et al. [8], where the authors used wavelets. The authors achieved the vessel segmentation by thresholding the wavelet coefficients. The authors further introduced an alternative approach for center line detection by use of spline fitting. Staal et al. extracted the ridges in images [9]. The extracted ridges were then used to form the line elements which produced a number of image patches. After obtaining the feature vectors, a feature selection mechanism was applied to reduce the number of features. Finally, a K-nearest-neighbors classifier was used for classification. Kande et al. introduced a methodology combining vessel enhancement and the SWFCM method [10]. The vessel enhancement was achieved by matched filtering and the extraction of the vessels was accomplished by the SWFCM method. Chen et al. introduced a hybrid model for automatic retinal vessel extraction [11], which combined the signed pressure force function and the local intensity to construct a robust model for handling the segmentation problem against the low contrast. Wang et al. proposed a supervised approach which segments the vessels in the retinal images hierarchically [12]. It opted to extract features with a trained CNN (convolutional neural network) and used an ensemble random forest to categorize the pixels as a non-vessel or vessel classes. Liskowski et al. utilized a deep learning method to segment the retinal vessels in fundus images [13] using two types of CNN models. One was a standard CNN architecture with nine layers and the other just consisted of convolution layers. Maji et al. introduced an ensemble based methodology for retinal vessels segmentation [14] which considered 12 deep CNN models for constructing the classifier structure. The mean operation was used for the outputs of all networks for the final decision.

In this study, a retinal vessel detection approach is presented using shearlet transform and indeterminacy filtering. Shearlets are capable to capture the anisotropic information which makes it strong in the detection of edges, corners, and blobs where there exists a discontinuity [15–17]. Shearlets are employed to describe the vessel's features and map the image into the neutrosophic domain. An indeterminacy filter is used to remove the uncertain information on the neutrosophic set. A line-like filter is also utilized to enhance the vessel regions. Finally, the vessel is identified via a neural network classifier.

2. Proposed Method

2.1. Shearlet Transform

Shearlet transformation enables image features to be analyzed in more flexible geometric structures with simpler mathematical approaches and is also able to reveal directional and anisotropic information at multi-scales [18]. In the 2-D case, the affine systems are defined as the collection:

$$SH_{\phi}f(a, s, t) = \langle f, \phi_{a,s,t} \rangle \quad (1)$$

$$\phi_{a,s,t}(x) = |\det M_{a,s}|^{-\frac{1}{2}} \phi(M_{a,s}^{-1}x - t) \quad (2)$$

where $\phi_{a,s,t}$ is the shearlet coefficient. $M_{a,s} = B_s A_a = \begin{pmatrix} a & \sqrt{as} \\ 0 & \sqrt{a} \end{pmatrix}$, and $A_a = \begin{pmatrix} a & 0 \\ 0 & \sqrt{a} \end{pmatrix}$ is parabolic scaling matrix and $B_s = \begin{pmatrix} 1 & s \\ 0 & 1 \end{pmatrix}$ is shear matrix ($a > 0, s \in R, t \in R^2$). In this equation a scale parameter is a real number greater than zero and s is a real number. In this case $M_{a,s}$ is the composition of the A_a and B_s .

2.2. Neutrosophic Indeterminacy Filtering

Recently, the neutrosophic theory extended from classical fuzzy theory denotes that neutrosophy has been successfully used in many applications for reducing the uncertainty and indeterminacy [19]. An element g in the neutrosophic set (NS) is defined as $g(T, I, F)$, where T identifies true degree in the set, I identify the indeterminate degree in the set, and F identifies false in the set. T, I and F are the neutrosophic components. The previously reported studies demonstrated that the NS has a vital role in image processing [20–22].

A pixel $P(x, y)$ at the location of (x, y) in an image is described in the NS domain as $P_{NS}(x, y) = \{T(x, y), I(x, y), F(x, y)\}$, where $T(x, y), I(x, y)$ and $F(x, y)$ are the membership values belonging to the bright pixel set, indeterminate set, and non-white set, respectively.

In this study, the fundus image’s green channel is mapped into NS domain via shearlet feature values:

$$T(x, y) = \frac{ST_L(x, y) - ST_{Lmin}}{ST_{Lmax} - ST_{Lmin}} \tag{3}$$

$$I(x, y) = \frac{ST_H(x, y) - ST_{Hmin}}{ST_{Hmax} - ST_{Hmin}} \tag{4}$$

where T and I are the true and indeterminate membership values. $ST_L(x, y)$ is the low-frequency component of the shearlet feature at the current pixel $P(x, y)$. In addition, ST_{Lmin} and ST_{Lmax} are the minimum value and maximum value of the low-frequency component of the shearlet feature in the whole image, respectively. $ST_H(x, y)$ is the high-frequency component of the shearlet feature at the current pixel $P(x, y)$. Moreover, ST_{Hmin} and ST_{Hmax} are the minimum value and maximum value of the high-frequency component of the shearlet feature in the whole image, respectively. In the proposed algorithm, we only utilize neutrosophic components T and I for segmentation.

Then an IF (indeterminacy filter) is defined using the indeterminacy membership to reduce the indeterminacy in images. The IF is defined based on the indeterminacy value $I_s(x, y)$ having the kernel function as:

$$O_I(u, v) = \frac{1}{2\pi\sigma_I^2} e^{\left(-\frac{u^2+v^2}{2\sigma_I^2(x,y)}\right)} \tag{5}$$

$$\sigma_I(x, y) = f(I(x, y)) = rI(x, y) + q \tag{6}$$

where $O_I(u, v)$ is the kernel function in the local neighborhood. u and v are coordinator values of local neighborhood in kernel function. σ_I is the standard deviation of the kernel function, which is defined as a linear function associated to the indeterminate degree. r and q are the coefficients in the linear function to control the standard deviation value according to the indeterminacy value. Since the σ_I becomes large with a high indeterminate degree, the IF can create a smooth current pixel by using its neighbors, while with a low indeterminate degree, the value of σ_I is small and the IF performs less smoothing operation.

$$T'(x, y) = T(x, y) \oplus O_I(u, v) = \sum_{v=y-m/2}^{y+m/2} \sum_{u=x-m/2}^{x+m/2} T(x-u, y-v) O_I(u, v) \tag{7}$$

where T' is the indeterminate filtering result.

2.3. Line Structure Enhancement

A multiscale filter is employed on the image to enhance the line-like structure [17]. The local second-order partial derivatives, Hessian matrix, is computed and a line-likeness is defined using its eigenvalues. This measure can describe the vessels region in the fundus images and is shown as follows:

$$En(s) = \begin{cases} 0 & \text{if } \lambda_2 > 0 \text{ or } \lambda_3 > 0 \\ \left(1 - e^{-\frac{R_A^2}{2\alpha^2}}\right) \cdot e^{-\frac{R_B^2}{2\beta^2}} \cdot \left(1 - e^{-\frac{s^2}{2c^2}}\right) & \text{otherwise} \end{cases} \quad (8)$$

$$S = \sqrt{\sum_{j \leq D} \lambda_j^2} \quad (9)$$

$$R_A = R_A = \frac{|\lambda_2|}{|\lambda_3|} \quad (10)$$

$$R_B = R_B = \frac{|\lambda_1|}{\sqrt{|\lambda_2 \lambda_3|}} \quad (11)$$

where λ_k is the eigenvalue with the k -th smallest magnitude of the Hessian matrix. D is the dimension of the image. α , β and c are thresholds to control the sensitivity of the line filter to the measures R_A , R_B and S .

2.4. Algorithm of the Proposed Approach

A retinal vessel detection approach is proposed using shearlet transform and indeterminacy filtering on fundus images. Shearlet transform is employed to describe the vessel's features and map the green channel of the fundus image into the NS domain. An indeterminacy filter is used to remove the indeterminacy information on the neutrosophic set. A multiscale filter is utilized to enhance the vessel regions. Finally, the vessel is detected via a neural network classifier using the neutrosophic image and the enhanced image. The proposed method is summarized as:

1. Take the shearlet transform on green channel I_g ;
2. Transform the I_g into neutrosophic set domain using the shearlet transform results, and the neutrosophic components are denoted as T and I ;
3. Process indeterminacy filtering on T using I and the result is denoted as T' ;
4. Perform the line-like structure enhancement filter on T' and obtain the En ;
5. Obtain the feature vector $FV = [T' \ I \ En]$ for the input of the neural network;
6. Train the neural network as a classifier to identify the vessel pixels;
7. Identify the vessel pixels using the classification results by the neural network.

The whole steps can be summarized using a flowchart in Figure 1.

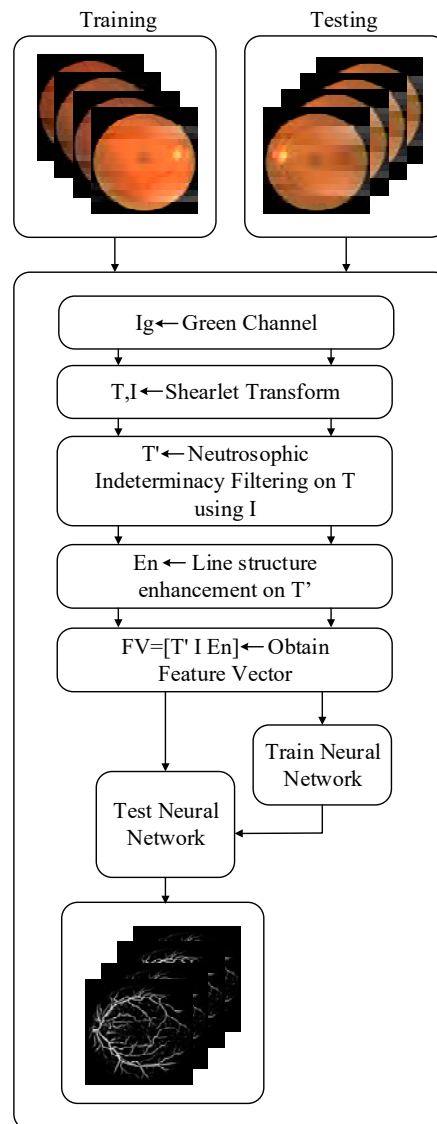

3. Experimental Results

3.1. Retinal Fundus Image Datasets

STARE (S**TR**uctured Analysis of the **R**ETina) Project was designed and initialized in 1975 by Michael Goldbaum, M.D. at the University of California, San Diego.

3.2. Experiment on Retinal Vessel Detection

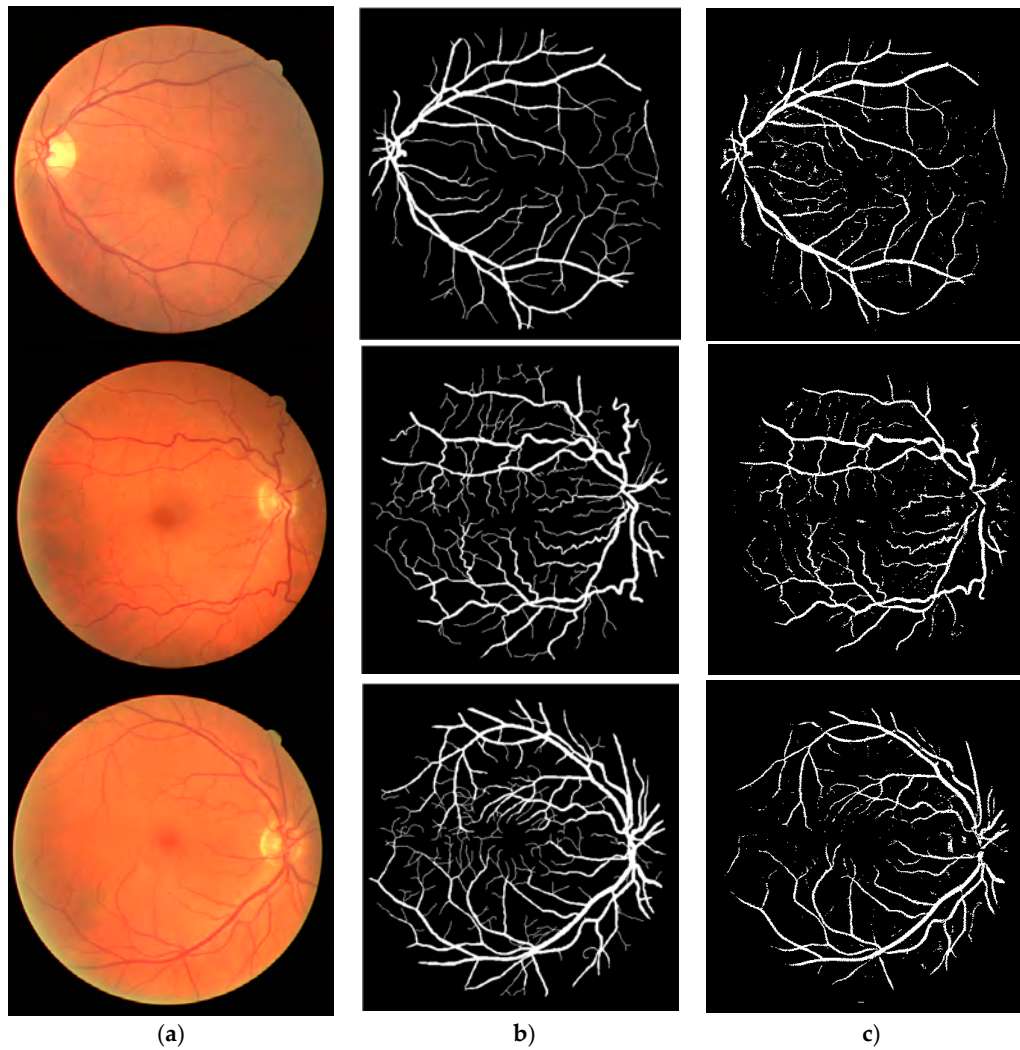

Figure 2. Detection results by our proposed method on three samples randomly taken

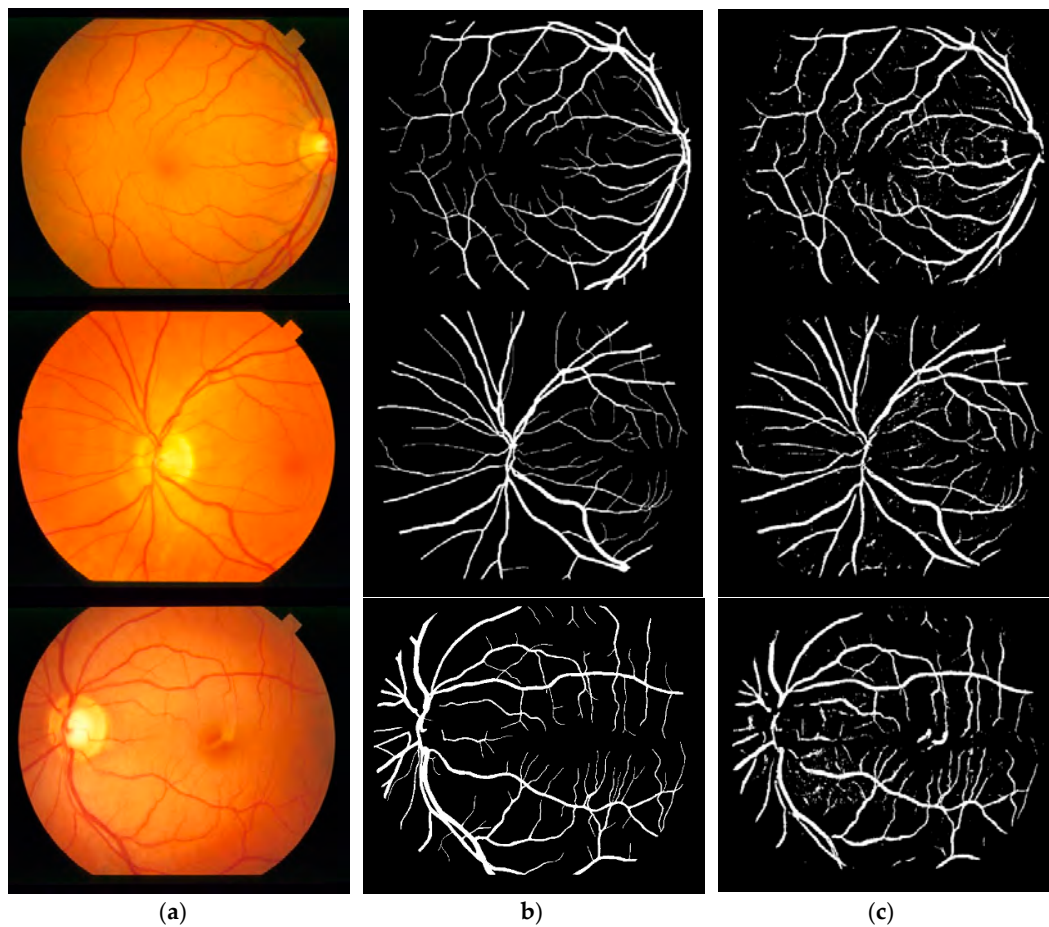

Figure 3. Detection results by our proposed methods on three samples randomly taken

In Table 1, Maji et al. [14] have developed a collective learning method using 12 deep CNN models for vessel segmentation, Fu et al. [25] have proposed an approach combining CNN and CRF (Conditional Random Field) layers, and Niemeijer et al. [26] presented a vessel segmentation algorithm based on pixel classification using a simple feature vector. The proposed method achieved the highest AUC value for the DRIVE dataset. Fu et al. [25] also achieved the second highest AUC value.

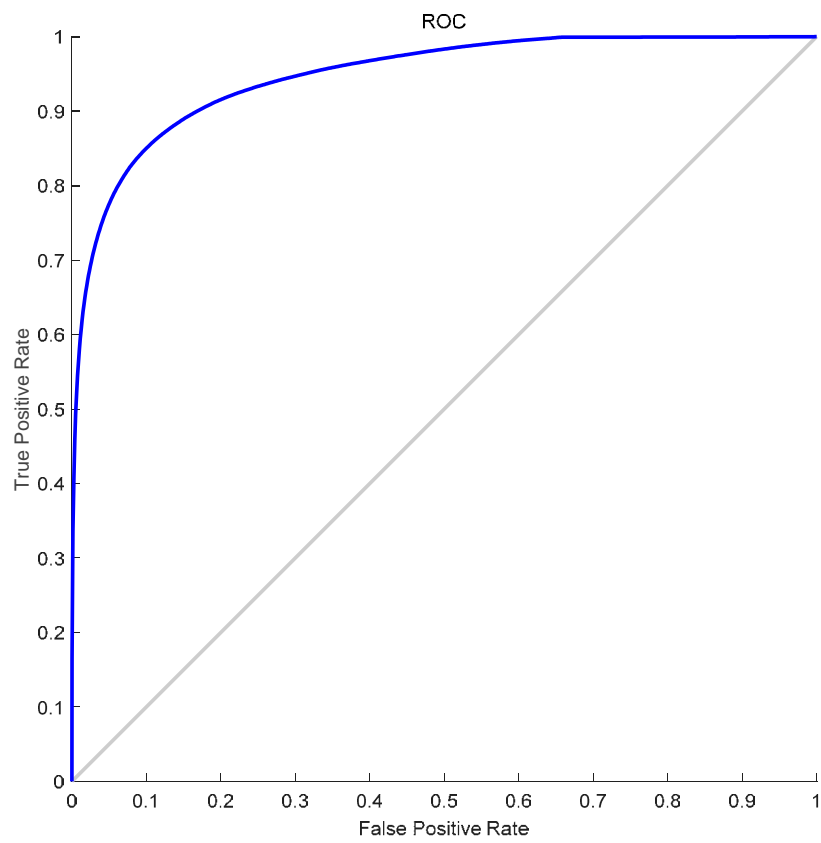

Figure 4

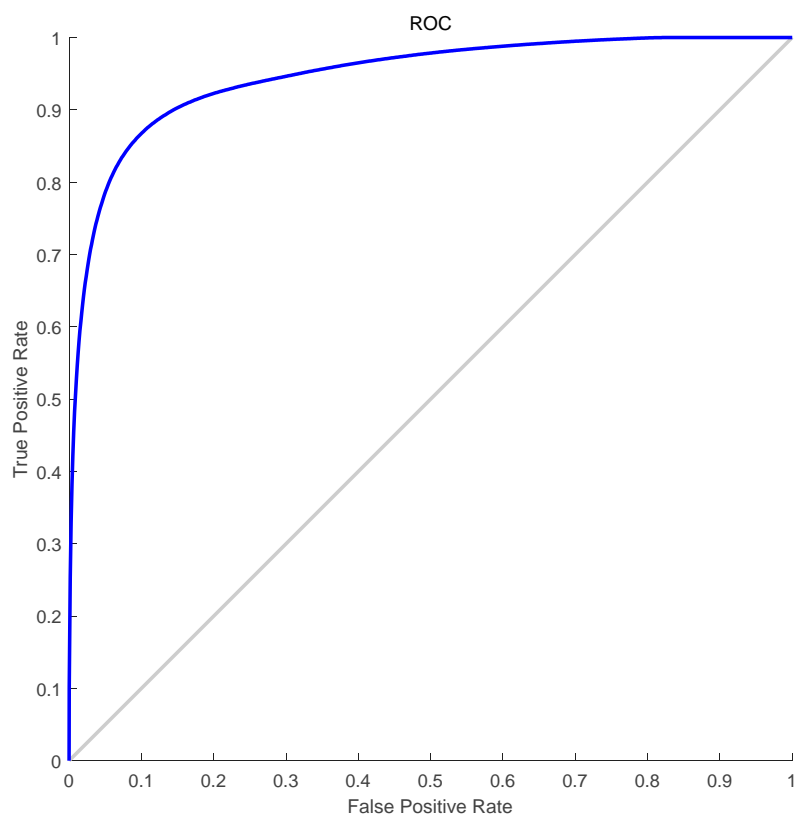

Figure 5

In Table 2, Kande et al. [10] have recommended an unsupervised fuzzy based vessel segmentation method, Jiang et al. [2] have proposed an adaptive local thresholding method and Hoover et al. [27] also have combined local and region-based properties to segment blood vessels in retinal images. The highest AUC value was also obtained for STARE dataset with the proposed method.

In the proposed method, the post-processing procedure is not used to deal with the classification results from neural network. In future, we will employ some post-processing methods for improving the quality of the vessel detection.

Table 1. Comparison with the other algorithms on DRIVE dataset.

Method	AUC
Maji et al. [14]	0.9283
Fu et al. [25]	0.9470
Niemeijer et al. [26]	0.9294
Proposed method	0.9476

Table 2. Comparison with the other algorithm on STARE dataset.

Method	AUC
Jiang et al. [2]	0.9298
Hoover et al. [27]	0.7590
Kande et al. [10]	0.9298
Proposed method	0.9469

5. Conclusions

This study proposes a new method for retinal vessel detection. It initially forwards the input retinal fundus images into the neutrosophic domain via shearlet transform. The neutrosophic domain images are then filtered with two neutrosophic filters for noise reduction. Feature extraction and classification steps come after the filtering steps. The presented approach was tested on DRIVE and STARE. The results were evaluated quantitatively. The proposed approach outperformed the others by means of both evaluation methods. The comparison with the existing algorithms also stressed the high accuracy of the proposed approach. In future, we will employ some post-processing methods for improving the quality of the vessel detection.

References

1. Kanski, J.J. *Clinical Ophthalmology: A Systematic Approach*; Butterworth-Heinemann: London, UK, 1989.
2. Jiang, X.; Mojon, D. Adaptive local thresholding by verification-based multithreshold probing with application to vessel detection in retinal images. *IEEE Trans. Pattern Anal.* **2003**, *25*, 131–137. [[CrossRef](#)]
3. Walter, T.; Klein, J.C. Segmentation of color fundus images of the human retina: Detection of the optic disc and the vascular tree using morphological techniques. *Med. Data Anal.* **2001**, *2199*, 282–287. [[CrossRef](#)]
4. Soares, J.V.; Leandro, J.J.; Cesar, R.M.; Jelinek, H.F.; Cree, M.J. Retinal vessel segmentation using the 2-D Gabor wavelet and supervised classification. *IEEE Trans. Med. Imaging* **2006**, *25*, 1214–1222. [[CrossRef](#)] [[PubMed](#)]
5. Dash, J.; Bhoi, N. Detection of Retinal Blood Vessels from Ophthalmoscope Images Using Morphological Approach. *ELCVIA* **2017**, *16*, 1–14. [[CrossRef](#)]
6. Zhao, Y.Q.; Wang, X.H.; Wang, X.F.; Shih, F.Y. Retinal vessels segmentation based on level set and region growing. *Pattern Recognit.* **2014**, *47*, 2437–2446. [[CrossRef](#)]

7. Levet, F.; Duval-Poo, M.A.; De Vito, E.; Odone, F. Retinal image analysis with shearlets. In Proceedings of the Smart Tools and Apps in computer Graphics, Genova, Italy, 3–4 October 2016; pp. 151–156. [[CrossRef](#)]
8. Bankhead, P.; Scholfield, C.N.; McGeown, J.G.; Curtis, T.M. Fast retinal vessel detection and measurement using wavelets and edge location refinement. *PLoS ONE* **2012**, *7*, e32435. [[CrossRef](#)] [[PubMed](#)]
9. Staal, J.; Abramoff, M.D.; Niemeijer, M.; Viergever, M.A.; Van Ginneken, B. Ridge-based vessel segmentation in color images of the retina. *IEEE Trans. Med. Imaging* **2004**, *23*, 501–509. [[CrossRef](#)] [[PubMed](#)]
10. Kande, G.B.; Subbaiah, P.V.; Savithri, T.S. Unsupervised fuzzy based vessel segmentation in pathological digital fundus images. *J. Med. Syst.* **2010**, *34*, 849–858. [[CrossRef](#)] [[PubMed](#)]
11. Chen, G.; Chen, M.; Li, J.; Zhang, E. Retina Image Vessel Segmentation Using a Hybrid CGLI Level Set Method. *Biomed. Res. Int.* **2017**, *2017*, 1263056. [[CrossRef](#)] [[PubMed](#)]
12. Wang, S.; Yin, Y.; Cao, G.; Wei, B.; Zheng, Y.; Yang, G. Hierarchical retinal blood vessel segmentation based on feature and ensemble learning. *Neurocomputing* **2015**, *149*(Part B), 708–717. [[CrossRef](#)]
13. Liskowski, P.; Krawiec, K. Segmenting Retinal Blood Vessels with Deep Neural Networks. *IEEE Trans. Med. Imaging* **2016**, *35*, 2369–2380. [[CrossRef](#)] [[PubMed](#)]
14. Maji, D.; Santara, A.; Mitra, P.; Sheet, D. Ensemble of deep convolutional neural networks for learning to detect retinal vessels in fundus images. *CoRR* **2016**.
15. Yi, S.; Labate, D.; Easley, G.R.; Krim, H. A shearlet approach to edge analysis and detection. *IEEE Trans. Image Process.* **2009**, *18*, 929–941. [[CrossRef](#)] [[PubMed](#)]
16. Easley, G.; Labate, D.; Lim, W.Q. Sparse directional image representations using the discrete shearlet transform. *Appl. Comput. Harmon. A* **2008**, *25*, 25–46. [[CrossRef](#)]
17. Frangi, A.F.; Niessen, W.J.; Vincken, K.L.; Viergever, M.A. Multiscale vessel enhancement filtering. In *International Conference on Medical Image Computing and Computer-Assisted Intervention*; Springer: Berlin/Heidelberg, Germany, 1998; pp. 130–137. [[CrossRef](#)]
18. Labate, D.; Lim, W.Q.; Kutyniok, G.; Weiss, G. Sparse multidimensional representation using shearlets. In Proceedings of the SPIE 5914 Wavelets XI Optics and Photonics, San Diego, CA, USA, 17 September 2005; p. 59140U. [[CrossRef](#)]
19. Smarandache, F. *A Unifying Field in Logics: Neutrosophic Logic. Neutrosophy, Neutrosophic Set, Neutrosophic Probability*; American Research Press: Rehoboth, NM, USA, 2003.
20. Guo, Y.; Xia, R.; Şengür, A.; Polat, K. A novel image segmentation approach based on neutrosophic c-means clustering and indeterminacy filtering. *Neural Comput. Appl.* **2016**, *28*, 3009–3019. [[CrossRef](#)]
21. Guo, Y.; Şengür, A.; Ye, J. A novel image thresholding algorithm based on neutrosophic similarity score. *Measurement* **2014**, *58*, 175–186. [[CrossRef](#)]
22. Guo, Y.; Sengur, A. A novel color image segmentation approach based on neutrosophic set and modified fuzzy c-means. *Circ. Syst. Signal Process.* **2013**, *32*, 1699–1723. [[CrossRef](#)]
23. DRIVE: Digital Retinal Images for Vessel Extraction. Available online: <http://www.isi.uu.nl/Research/Databases/DRIVE/> (accessed on 3 May 2017).
24. STructured Analysis of the Retina. Available online: <http://cecas.clemson.edu/~ahoover/stare/> (accessed on 3 May 2017).
25. Fu, H.; Xu, Y.; Lin, S.; Wong, D.W.K.; Liu, J. Deepvessel: Retinal vessel segmentation via deep learning and conditional random field. In Proceedings of the 19th International Conference on Medical Image Computing and Computer-Assisted Intervention, MICCAI 2016, Athens, Greece, 17–21 October 2016; pp. 132–139. [[CrossRef](#)]
26. Niemeijer, M.; Staal, J.; Van Ginneken, B.; Loog, M.; Abramoff, M.D. Comparative study of retinal vessel segmentation methods on a new publicly available database. In Proceedings of the SPIE Medical Imaging 2004: Image Processing, San Diego, CA, USA, 14–19 February 2004; Volume 5370, pp. 648–656. [[CrossRef](#)]
27. Hoover, A.D.; Kouznetsova, V.; Goldbaum, M. Locating blood vessels in retinal images by piecewise threshold probing of a matched filter response. *IEEE Trans. Med. Imaging* **2000**, *19*, 203–210. [[CrossRef](#)] [[PubMed](#)]

Computing Minimum Spanning Tree in Interval Valued Bipolar Neutrosophic Environment

Said Broumi, Assia Bakali, Mohamed Talea, Florentin Smarandache,
Rajkumar Verma

Said Broumi, Assia Bakali, Mohamed Talea, Florentin Smarandache, Rajkumar Verma (2017).
Computing Minimum Spanning Tree in Interval Valued Bipolar Neutrosophic Environment.
International Journal of Modeling and Optimization 7(5): 300-304

Abstract—Interval valued bipolar neutrosophic sets is a new generalization of fuzzy set, bipolar fuzzy set, neutrosophic set and bipolar neutrosophic set so that it can handle uncertain information more flexibly in the process of decision making. In this paper, an algorithm for finding minimum spanning tree (MST) of an undirected neutrosophic weighted connected graph (UNWCG) in which the edge weights is represented by a an interval valued bipolar neutrosophic number is presented. The proposed algorithm is based on matrix approach to design the MST of UNWCG. A numerical example is provided to show the effectiveness of the proposed algorithm. Lastly, a comparative study with other existing methods is proposed.

I. INTRODUCTION

In 1998, Smarandache [1] explored the concept of neutrosophic set (NS) from the philosophical point of view, to represent uncertain, imprecise, incomplete, inconsistent, and indeterminate information that are exist in the real world. The concept of neutrosophic set is a generalization of the concept of the classic set, fuzzy set, intuitionistic fuzzy set (IFS). The neutrosophic sets are characterized by a truth-membership function (t), an indeterminate-membership function (i) and a false-membership function (f) independently, which are within the real standard or nonstandard unit interval $]0, 1^+[$. To apply the concept of neutrosophic sets (NS) in science and engineering applications, Smarandache [6] introduced for the first time, the single valued neutrosophic set (SVNS). Later on, Wang *et al.* [2] studied some properties related to single valued neutrosophic sets. The neutrosophic set model is an important tool for dealing with real scientific and engineering applications because it can handle not only incomplete information but also the inconsistent information and indeterminate information. Some more literature about the extension of neutrosophic sets and their applications in various fields can be found in the literature [17].

In classical graph theory, there are common algorithms for solving the minimum spanning tree including Prim and kruskal algorithm. By applying the concept of single valued neutrosophic sets on graph theory, a new theory is developed and called single valued neutrosophic graph theory (SVNGT). The concept of SVNGT and their extensions finds its applications in diverse fields [6]-[16]. Very recently few researchers have used neutrosophic methods to find minimum spanning tree in neutrosophic environment. Ye [4] proposed a method to find minimum spanning tree of a graph where nodes (samples) are represented in the form of SVNS and distance between two nodes which represents the dissimilarity between the corresponding samples has been derived.

Kandasamy [3] proposed a double-valued Neutrosophic Minimum Spanning Tree (DVN-MST) clustering algorithm, to cluster the data represented by double-valued neutrosophic information. Mandal and Basu [5] presented a solution approach of the optimum spanning tree problems considering the inconsistency, incompleteness and indeterminacy of the information. The authors consider a network problem with multiple criteria which are represented by weight of each edge in neutrosophic sets. The approach proposed by the authors is based on similarity measure. Recently Mullai [18] solved the minimum spanning tree problem on a graph in which a bipolar neutrosophic number is associated to each edge as its edge length, and illustrated it by a numerical example.

The principal objective of this paper is to propose a new version of Prim's algorithm based on matrix approach for finding the cost minimum spanning tree of an undirected graph in which an interval valued bipolar neutrosophic number [19] is associated to each edge as its edge length.

The rest of the paper is organized as follows. Section 2 briefly introduces the concepts of neutrosophic sets, single valued neutrosophic sets and the score function of interval valued bipolar neutrosophic number. Section 3 proposes a novel approach for finding the minimum spanning tree of interval valued bipolar neutrosophic undirected graph. In Section 4, an illustrative example is presented to illustrate the proposed method. In section 5, a comparative study with other existing methods is provided. Finally, Section 6 concludes the paper.

II. PRELIMINARIES

Some of the important background knowledge for the materials that are presented in this paper is presented in this section. These results can be found in [1], [2], [19].

Definition 2.1 [1] Let ξ be an universal set. The neutrosophic set A on the universal set ξ categorized in to three membership functions called the true $T_A(x)$,

indeterminate $I_A(x)$ and false $F_A(x)$ contained in real standard or non-standard subset of $]0, 1^+[$ respectively.

$$0 \leq \sup T_A(x) + \sup I_A(x) + \sup F_A(x) \leq 3^+ \quad (1)$$

Definition 2.2 [2] Let ξ be a universal set. The single valued neutrosophic sets (SVNs) A on the universal ξ is denoted as following

$$A = \{ \langle x: T_A(x), I_A(x), F_A(x) \rangle \mid x \in \xi \} \quad (2)$$

The functions $T_A(x) \in [0, 1]$, $I_A(x) \in [0, 1]$ and $F_A(x) \in [0, 1]$ are named degree of truth, indeterminacy and falsity membership of x in A, satisfy the following condition:

$$0 \leq T_A(x) + I_A(x) + F_A(x) \leq 3 \quad (3)$$

Definition 2.3 [4]. An interval valued bipolar neutrosophic set A in X is defined as an object of the form

$$A = \{ \langle x, [T_L^p, T_M^p], [I_L^p, I_M^p], [F_L^p, F_M^p], [T_L^n, T_M^n], [I_L^n, I_M^n], [F_L^n, F_M^n] \rangle \mid x \in X \}$$

where $T_L^p, T_M^p, I_L^p, I_M^p, F_L^p, F_M^p : X \rightarrow [0, 1]$ and $T_L^n, T_M^n, I_L^n, I_M^n, F_L^n, F_M^n : X \rightarrow [-1, 0]$. The positive interval membership degree where $T_L^p, T_M^p, I_L^p, I_M^p, F_L^p, F_M^p$ denotes the lower and upper truth membership, lower and upper indeterminate membership and lower and upper false membership of an element $\in X$ corresponding to a bipolar neutrosophic set A and the negative interval membership degree $T_L^n, T_M^n, I_L^n, I_M^n, F_L^n, F_M^n$: denotes the lower and upper truth membership, lower and upper indeterminate membership and lower and upper false membership of an element $\in X$ to some implicit counter-property corresponding to an interval valued bipolar neutrosophic set A.

Deli *et al.* [19], introduced a concept of score function. The score function is applied to compare the grades of IVBNS. This function shows that greater is the value, the greater is the interval valued bipolar neutrosophic sets and by using this concept paths can be ranked

Definition 2.4 [19]. Let

$$\tilde{A} = \langle [T_L^p, T_M^p], [I_L^p, I_M^p], [F_L^p, F_M^p], [T_L^n, T_M^n], [I_L^n, I_M^n], [F_L^n, F_M^n] \rangle$$

be an

interval valued bipolar neutrosophic number, Then, the score function $s(\tilde{A})$, accuracy function $a(\tilde{A})$ and certainty function $c(\tilde{A})$ of an IVBNN are defined as follows:

$$(i) \quad s(\tilde{A}) = \left(\frac{1}{12} \right) \times \begin{bmatrix} T_L^p + T_M^p + 1 - I_L^p + 1 - I_M^p + 1 - \\ F_L^p + 1 - F_M^p + 1 + T_L^n \\ + 1 + T_M^n - I_L^n - I_M^n - F_L^n - F_M^n \end{bmatrix} \quad (4)$$

$$(ii) \quad a(\tilde{A}) = T_L^p + T_M^p - F_L^p - F_M^p + T_L^n + T_M^n - F_L^n - F_M^n \quad (5)$$

$$(iii) \quad c(\tilde{A}) = T_L^p + T_M^p - F_L^n - F_M^n \quad (6)$$

Comparison of interval valued bipolar neutrosophic numbers

Let $\tilde{A}_1 = \langle [T_{L1}^p, T_{M1}^p], [I_{L1}^p, I_{M1}^p], [F_{L1}^p, F_{M1}^p], [T_{L1}^n, T_{M1}^n], [I_{L1}^n, I_{M1}^n], [F_{L1}^n, F_{M1}^n] \rangle$ and $\tilde{A}_2 = \langle [T_{L2}^p, T_{M2}^p], [I_{L2}^p, I_{M2}^p], [F_{L2}^p, F_{M2}^p], [T_{L2}^n, T_{M2}^n], [I_{L2}^n, I_{M2}^n], [F_{L2}^n, F_{M2}^n] \rangle$ be two interval valued bipolar neutrosophic numbers then

If $s(\tilde{A}_1) > s(\tilde{A}_2)$, then \tilde{A}_1 is greater than \tilde{A}_2 , that is, \tilde{A}_1 is superior to \tilde{A}_2 , denoted by $\tilde{A}_1 \succ \tilde{A}_2$

If $s(\tilde{A}_1) = s(\tilde{A}_2)$, and $a(\tilde{A}_1) > a(\tilde{A}_2)$ then \tilde{A}_1 is greater than \tilde{A}_2 , that is, \tilde{A}_1 is superior to \tilde{A}_2 , denoted by $\tilde{A}_1 \succ \tilde{A}_2$

If $s(\tilde{A}_1) = s(\tilde{A}_2)$, $a(\tilde{A}_1) = a(\tilde{A}_2)$, and $c(\tilde{A}_1) > c(\tilde{A}_2)$ then \tilde{A}_1 is greater than \tilde{A}_2 , that is, \tilde{A}_1 is superior to \tilde{A}_2 , denoted by $\tilde{A}_1 \succ \tilde{A}_2$

If $s(\tilde{A}_1) = s(\tilde{A}_2)$, $a(\tilde{A}_1) = a(\tilde{A}_2)$, and $c(\tilde{A}_1) = c(\tilde{A}_2)$ then \tilde{A}_1 is equal to \tilde{A}_2 , that is, \tilde{A}_1 is indifferent to \tilde{A}_2 , denoted by $\tilde{A}_1 = \tilde{A}_2$

III. MINIMUM SPANNING TREE ALGORITHM OF IVBN-UNDIRECTED GRAPH

In this section, a neutrosophic version of Prim's algorithm is proposed to handle minimum spanning tree in a neutrosophic environment. In the following, we propose an interval valued bipolar neutrosophic minimum spanning tree algorithm (IVBNMST), whose steps are described below:

Algorithm:

Input: The weight matrix $M = [W_{ij}]_{n \times n}$ for the undirected weighted neutrosophic graph G.

Output: Minimum cost Spanning tree T of G.

Step 1: Input interval valued bipolar neutrosophic adjacency matrix A.

Step 2: Translate the IVBN-matrix into score matrix $[S_{ij}]_{n \times n}$ by using score.

Step 3: Iterate step 4 and step 5 until all (n-1) entries matrix of S are either marked or set to zero or other words all the nonzero elements are marked.

Step 4: Find the score matrix S either columns-wise or row-wise to find the unmarked minimum entries S_{ij} , which is the weight of the corresponding edge e_{ij} in S.

Step 5: If the corresponding edge e_{ij} of selected S_{ij} produce a cycle with the previous marked entries of the score matrix S then set $S_{ij} = 0$ else mark S_{ij} .

Step 6: Construct the graph T including only the marked entries from the score matrix S which shall be desired minimum cost spanning tree of G.

Step 7: Stop.

IV. NUMERICAL EXAMPLE

In this section, a numerical example of IVBNMST is used to demonstrate of the proposed algorithm. Consider the following graph $G=(V, E)$ shown in Figure 2, with five nodes and five edges. The different steps involved in the construction of the minimum cost spanning tree are described as follow:

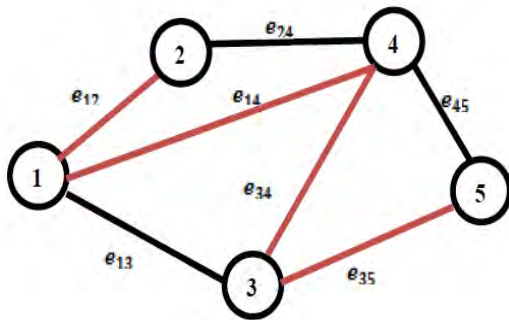

Fig. 2. Undirected IVBN- graphs.

e	Edge length
e_{12}	$\langle [0.3, 0.4], [0.1, 0.2], [0.2, 0.4], [-0.8, -0.7], [-0.5, -0.3], [-0.1, 0] \rangle$
e_{13}	$\langle [0.4, 0.5], [0.2, 0.6], [0.4, 0.6], [-0.2, -0.1], [-0.4, -0.2], [-0.5, -0.4] \rangle$
e_{14}	$\langle [0.6, 0.7], [0.7, 0.8], [0.8, 0.9], [-0.6, -0.5], [-0.4, -0.3], [-0.4, -0.2] \rangle$
e_{24}	$\langle [0.4, 0.5], [0.8, 0.9], [0.3, 0.4], [-0.2, -0.1], [-0.5, -0.1], [-0.7, -0.5] \rangle$
e_{34}	$\langle [0.2, 0.4], [0.3, 0.4], [0.7, 0.8], [-0.2, -0.1], [-0.4, -0.1], [-0.4, -0.3] \rangle$
e_{35}	$\langle [0.4, 0.5], [0.6, 0.7], [0.5, 0.6], [-0.4, -0.3], [-0.4, -0.2], [-0.3, -0.2] \rangle$
e_{45}	$\langle [0.5, 0.6], [0.4, 0.5], [0.3, 0.4], [-0.4, -0.2], [-0.5, -0.2], [-0.8, -0.6] \rangle$

The IVBN- adjacency matrix A is given below:

$$A = \begin{bmatrix} 0 & e_{12} & e_{13} & e_{14} & 0 \\ e_{12} & 0 & 0 & e_{24} & 0 \\ e_{13} & 0 & 0 & e_{34} & e_{35} \\ e_{14} & e_{24} & e_{34} & 0 & e_{45} \\ 0 & 0 & e_{35} & e_{45} & 0 \end{bmatrix}$$

Thus, using the score function, we get the score matrix

$$S = \begin{bmatrix} 0 & 0.433 & 0.525 & 0.358 & 0 \\ 0.433 & 0 & 0 & 0.5 & 0 \\ 0.525 & 0 & 0 & 0.442 & 0.408 \\ 0.358 & 0.5 & 0.422 & 0 & 0.583 \\ 0 & 0 & 0.408 & 0.583 & 0 \end{bmatrix}$$

Fig. 3. Score matrix.

According to the Fig. 3, we observe that the minimum entries 0.358 is selected and the corresponding edge (1, 4) is marked by the brown color. Repeat the procedure until the iteration will exist.

According to the Fig. 4 and Fig. 5, the next non zero minimum entries 0.408 is marked and corresponding edges (3, 5) are also colored

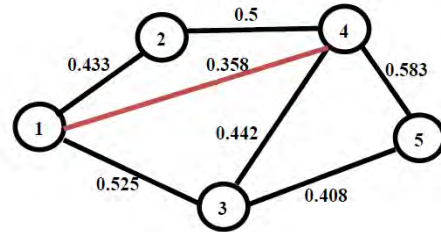

Fig. 4. The marked edge (1,4) of G in next iteration.

$$S = \begin{bmatrix} 0 & 0.433 & 0.525 & 0.358 & 0 \\ 0.433 & 0 & 0 & 0.5 & 0 \\ 0.525 & 0 & 0 & 0.442 & 0.408 \\ 0.358 & 0.5 & 0.422 & 0 & 0.583 \\ 0 & 0 & 0.408 & 0.583 & 0 \end{bmatrix}$$

Fig. 5. The marked next minimum entries 0.408 of S.

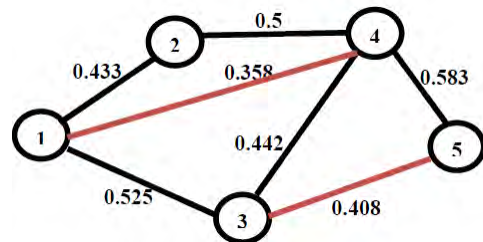

Fig. 6. The marked edge (3,5) of G in next iteration.

$$S = \begin{bmatrix} 0 & 0.433 & 0.525 & 0.358 & 0 \\ 0.433 & 0 & 0 & 0.5 & 0 \\ 0.525 & 0 & 0 & 0.442 & 0.408 \\ 0.358 & 0.5 & 0.422 & 0 & 0.583 \\ 0 & 0 & 0.408 & 0.583 & 0 \end{bmatrix}$$

Fig. 7. The marked next minimum entries 0.433 of S

According to the Fig. 7, the next minimum non zero element 0.433 is marked.

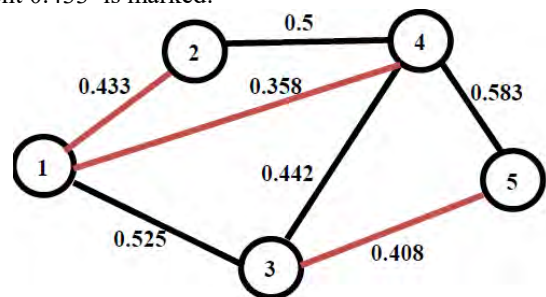

Fig. 8. The marked edge (1, 2) of G in next iteration.

According to the Fig. 9. The next minimum non zero element 0.442 is marked, and corresponding edges (3, 4) are also colored

$$S = \begin{bmatrix} 0 & 0.433 & 0.525 & 0.358 & 0 \\ 0.433 & 0 & 0 & 0.5 & 0 \\ 0.525 & 0 & 0 & 0.442 & 0.408 \\ 0.358 & 0.5 & 0.422 & 0 & 0.583 \\ 0 & 0 & 0.408 & 0.583 & 0 \end{bmatrix}$$

Fig. 9. The marked next minimum entries 0.442 of S.

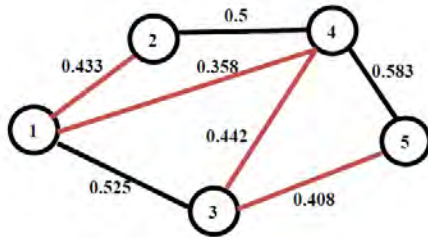

Fig. 10. The marked edge (3, 4) of G in next iteration.

According to the figure 11. The next minimum non zero element 0.5 is marked. But while drawing the edges it produces the cycle. So we delete and mark it as 0 instead of 0.5

$$S = \begin{bmatrix} 0 & 0.433 & 0.525 & 0.358 & 0 \\ 0.433 & 0 & 0 & 0.5 & 0 \\ 0.525 & 0 & 0 & 0.442 & 0.408 \\ 0.358 & 0.5 & 0.422 & 0 & 0.583 \\ 0 & 0 & 0.408 & 0.583 & 0 \end{bmatrix}$$

Fig. 11. The marked next minimum entries 0.5 of S.

The next non zero minimum entries 0.525 is marked it is shown in the Fig. 12. But while drawing the edges it produces the cycle. So, we delete and mark it as 0 instead of 0.525

$$S = \begin{bmatrix} 0 & 0.433 & 0.525 & 0 & 0.358 & 0 \\ 0.433 & 0 & 0 & 0.5 & 0 & 0 \\ 0.525 & 0 & 0 & 0.442 & 0.408 \\ 0.358 & 0.5 & 0.422 & 0 & 0.583 \\ 0 & 0 & 0.408 & 0.583 & 0 \end{bmatrix}$$

Fig. 12. The marked next minimum entries 0.525 of S.

According to the Fig. 13. The next minimum non zero element 0.583 is marked. But while drawing the edges it produces the cycle so we delete and mark it as 0 instead of 0.583.

$$S = \begin{bmatrix} 0 & 0.433 & 0.525 & 0 & 0.358 & 0 \\ 0.433 & 0 & 0 & 0.5 & 0 & 0 \\ 0.525 & 0 & 0 & 0.442 & 0.408 \\ 0.358 & 0.5 & 0.422 & 0 & 0.583 & 0 \\ 0 & 0 & 0.408 & 0.583 & 0 \end{bmatrix}$$

Fig. 13. The marked next minimum entries 0.583 of S.

After the above steps, the final path of minimum cost of spanning tree of G is portrayed in Fig. 14.

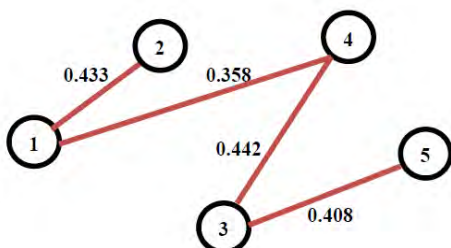

Fig. 14. Final path of minimum cost of spanning tree of G.

Using the above steps described in section 4, hence, the crisp minimum cost spanning tree is 1,641 and the final path of minimum cost of spanning tree is {2,1},{1, 4},{4, 3},{3, 5}.

V. Comparative STUDY

In order to illustrate the rationality and effectiveness of the proposed method, we apply the algorithm proposed by Mullai *et al.* [18] on our IVBN-graph presented in Section 4. Following the setps of Mullai’s algorithm we obtained the results

Iteration 1:

Let $C_1 = \{1\}$ and $\bar{C}_1 = \{2, 3, 4, 5\}$

Iteration 2:

Let $C_2 = \{1, 4\}$ and $\bar{C}_2 = \{2, 3, 5\}$

Iteration 3:

Let $C_3 = \{1, 4, 2\}$ and $\bar{C}_3 = \{3, 5\}$

Iteration 4:

Let $C_4 = \{1, 4, 2, 3\}$ and $\bar{C}_4 = \{5\}$

Finally, IVBN minimal spanning tree is

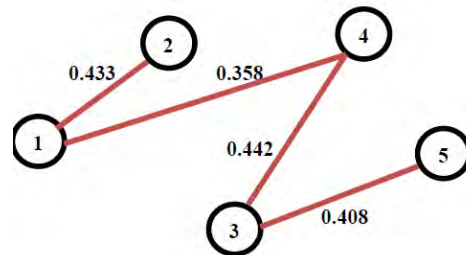

Fig. 15. IVBN minimal spanning tree obtained by Mullai’s algorithm.

So, it can be seen that the IVBN minimal spanning tree {2, 1},{1, 4},{4, 3},{3, 5}obtained by Mullai’s algorithm, After deneutrosophication of edges’weight using the score function, is the same as the path obtained by proposed algorithm.

The difference between the proposed algorithm and Mullai’s algorithm is that our approach is based on Matrix approach, which can be easily implemented in Matlab, whereas the Mullai’s algorithm is based on the comparison of edges the in each iteration of the algorithm, which leads to high computation.

VI. CONCLUSION

This paper deals with minimum spanning tree problem on a network where the edges weights are represented by an interval valued bipolar neutrosophic numbers. This work can be extended to the case of directed neutrosophic graphs and other types of neutrosophic graphs .

REFERENCES

- [1] F. Smarandache, "Neutrosophy, neutrosophic probability, set, and logic," *ProQuest Information & Learning*, Ann Arbor, Michigan, USA, 1998, 105 p.
- [2] H. Wang, F. Smarandache, Y. Zhang, and R. Sunderraman, "Single valued neutrosophic sets," *Multispace and Multistructure*, vol. 4, 2010, pp. 410-413.
- [3] I. Kandasamy, "Double-valued neutrosophic sets, their minimum spanning trees, and clustering algorithm," *Journal of Intelligent System*, 2016, pp.1-17.
- [4] J. Ye, "Single valued neutrosophic minimum spanning tree and its clustering method," *Journal of Intelligent System*, vol. 23, 2014, pp. 311-324.
- [5] K. Mandal and K. Basu, "Improved similarity measure in neutrosophic environment and its application in finding minimum spanning tree," *Journal of Intelligent & Fuzzy System*, vol. 31, 2016, pp. 1721-1730.
- [6] S. Broumi, A. Bakali, M. Talea, F. Smarandache, and L. Vladareanu, "Computation of Shortest Path Problem in a Network with SV-Trapezoidal Neutrosophic Numbers," in *Proc. the 2016 International Conference on Advanced Mechatronic Systems*, Melbourne, Australia, 2016, pp. 417-422.
- [7] S. Broumi, A. Bakali, M. Talea, F. Smarandache, and L. Vladareanu, "Applying Dijkstra Algorithm for Solving Neutrosophic Shortest Path Problem," in *Proc. the 2016 International Conference on Advanced Mechatronic Systems, Melbourne*, Australia, November 30 - December 3, 2016, pp. 412-416.
- [8] S. Broumi, M. Talea, A. Bakali, and F. Smarandache, "Single valued neutrosophic graphs," *Journal of New Theory*, no. 10, 2016, pp. 86-101.
- [9] S. Broumi, M. Talea, A. Bakali, and F. Smarandache, "On bipolar single valued neutrosophic graphs," *Journal of New Theory*, no. 11, 2016, pp. 84-102.
- [10] S. Broumi, M. Talea, A. Bakali, and F. Smarandache, "Interval valued neutrosophic graphs," *Critical Review*, XII, 2016, pp.5-33.
- [11] S. Broumi, M. Talea, F. Smarandache, and A. Bakali, "Single valued neutrosophic graphs: Degree, order and size," in *Proc. the IEEE International Conference on Fuzzy Systems (FUZZ)*, 2016, pp. 2444-2451.
- [12] S. Broumi, F. Smarandache, M. Talea, and A. Bakali, "Decision-making method based on the interval valued neutrosophic graph," *Future Technologie*, 2016, IEEE, pp. 44-50.
- [13] S. Broumi, F. Smarandache, M. Talea, and A. Bakali, "Operations on interval valued neutrosophic graphs, chapter in book- new trends in neutrosophic theory and applications- florentin smarandache and surpati pramanik (editors)," 2016, pp. 231-254.
- [14] S. Broumi, A. Bakali, T. Mohamed, F. Smarandache, and L. Vladareanu, "Shortest path problem under triangular fuzzy neutrosophic information," in *Proc. 10th International Conference on Software, Knowledge, Information Management & Applications (SKIMA)*, 2016, pp.169-174.
- [15] S. Broumi, A. Bakali, M. Talea, F. Smarandache, and M. Ali, "Shortest path problem under bipolar neutrosophic setting," *Applied Mechanics and Materials*, vol. 859, 2016, pp 59-66.
- [16] S. Broumi, F. Smarandache, M. Talea, and A. Bakali, "An introduction to bipolar single valued neutrosophic graph theory," *Applied Mechanics and Materials*, vol.841, 2016, pp. 184-191.
- [17] Gallup. [Online]. Available: <http://fs.gallup.unm.edu/NSS/>.
- [18] M. Mullai, S. Broumi, and A. Stephen, "Shortest path problem by minimal spanning tree algorithm using bipolar neutrosophic numbers," *International Journal of Mathematic Trends and Technology*, vol. 46, 2017, pp. 80-87.
- [19] I. Deli, Y. Şubaş, F. Smarandache, and M. Ali, "Interval valued bipolar neutrosophic sets and their application in pattern recognition," in *Proc. 2016 IEEE International Conference on Fuzzy Systems (FUZZ-IEEE)*, 2016, pp.2460 - 2467.

Neutrosophic Cubic Sets

Young Bae Jun, Florentin Smarandache, Chang Su Kim

Young Bae Jun, Florentin Smarandache, Chang Su Kim (2017). Neutrosophic Cubic Sets. *New Mathematics and Natural Computation* 13(1): 41-54; DOI: 10.1142/S1793005717500041

The aim of this paper is to extend the concept of cubic sets to the neutrosophic sets. The notions of truth-internal (indeterminacy-internal, falsity-internal) neutrosophic cubic sets and truth-external (indeterminacy-external, falsity-external) neutrosophic cubic sets are introduced, and related properties are investigated.

Keywords: Neutrosophic (cubic) set; truth-internal (indeterminacy-internal, falsity-internal) neutrosophic cubic set; truth-external (indeterminacy-external, falsity-external) neutrosophic cubic set.

1. Introduction

Fuzzy sets, which were introduced by Zadeh,⁹ deal with possibilistic uncertainty, connected with imprecision of states, perceptions and preferences. Based on the (interval-valued) fuzzy sets, Jun *et al.*¹ introduced the notion of (internal, external) cubic sets, and investigated several properties. Jun *et al.* applied the notion of cubic sets to BCK/BCI-algebras. They introduced the notions of cubic subalgebras/ideals, cubic \circ -subalgebras and closed cubic ideals in BCK/BCI-algebras, and then they investigated several properties.²⁻⁵ The concept of neutrosophic set (NS) developed by Smarandache^{6,7} is a more general platform which extends the concepts of the classic set and fuzzy set, intuitionistic fuzzy set and interval valued intuitionistic fuzzy set. Neutrosophic set theory is applied to various part (refer to the site <http://fs.gallup.unm.edu/neutrosophy.htm>).

In this paper, we extend the concept of cubic sets to the neutrosophic sets. We introduce the notions of truth-internal (indeterminacy-internal, falsity-internal) neutrosophic cubic sets and truth-external (indeterminacy-external, falsity-external) neutrosophic cubic sets, and investigate related properties. We show that the P-union and the P-intersection of truth-internal (indeterminacy-internal, falsity-internal)

neutrosophic cubic sets are also truth-internal (indeterminacy-internal, falsity-internal) neutrosophic cubic sets. We provide examples to show that the P-union and the P-intersection of truth-external (indeterminacy-external, falsity-external) neutrosophic cubic sets may not be truth-external (indeterminacy-external, falsity-external) neutrosophic cubic sets, and the R-union and the R-intersection of truth-internal (indeterminacy-internal, falsity-internal) neutrosophic cubic sets may not be truth-internal (indeterminacy-internal, falsity-internal) neutrosophic cubic sets. We provide conditions for the R-union of two T-internal (resp. I-internal and F-internal) neutrosophic cubic sets to be a T-internal (resp. I-internal and F-internal) neutrosophic cubic set.

2. Preliminaries

A fuzzy set in a set X is defined to be a function $\lambda : X \rightarrow [0, 1]$. Denote by $[0, 1]^X$ the collection of all fuzzy sets in a set X . Define a relation \leq on $[0, 1]^X$ as follows:

$$(\forall \lambda, \mu \in [0, 1]^X) (\lambda \leq \mu \Leftrightarrow (\forall x \in X)(\lambda(x) \leq \mu(x))).$$

The join (\vee) and meet (\wedge) of λ and μ are defined by

$$\begin{aligned} (\lambda \vee \mu)(x) &= \max\{\lambda(x), \mu(x)\}, \\ (\lambda \wedge \mu)(x) &= \min\{\lambda(x), \mu(x)\}, \end{aligned}$$

respectively, for all $x \in X$. The complement of λ , denoted by λ^c , is defined by

$$(\forall x \in X) (\lambda^c(x) = 1 - \lambda(x)).$$

For a family $\{\lambda_i | i \in \Lambda\}$ of fuzzy sets in X , we define the join (\vee) and meet (\wedge) operations as follows:

$$\begin{aligned} \left(\bigvee_{i \in \Lambda} \lambda_i\right)(x) &= \sup\{\lambda_i(x) | i \in \Lambda\}, \\ \left(\bigwedge_{i \in \Lambda} \lambda_i\right)(x) &= \inf\{\lambda_i(x) | i \in \Lambda\}, \end{aligned}$$

respectively, for all $x \in X$.

By an interval number we mean a closed subinterval $\tilde{a} = [a^-, a^+]$ of $[0, 1]$, where $0 \leq a^- \leq a^+ \leq 1$. The interval number $\tilde{a} = [a^-, a^+]$ with $a^- = a^+$ is denoted by \mathbf{a} . Denote by $[[0, 1]]$ the set of all interval numbers. Let us define what is known as refined minimum (briefly, rmin) of two elements in $[[0, 1]]$. We also define the symbols “ \succeq ”, “ \preceq ”, “ $=$ ” in case of two elements in $[[0, 1]]$. Consider two interval numbers $\tilde{a}_1 := [a_1^-, a_1^+]$ and $\tilde{a}_2 := [a_2^-, a_2^+]$. Then

$$\begin{aligned} \text{rmin}\{\tilde{a}_1, \tilde{a}_2\} &= [\min\{a_1^-, a_2^-\}, \min\{a_1^+, a_2^+\}], \\ \tilde{a}_1 \succeq \tilde{a}_2 &\text{ if and only if } a_1^- \geq a_2^- \text{ and } a_1^+ \geq a_2^+, \end{aligned}$$

and similarly we may have $\tilde{a}_1 \preceq \tilde{a}_2$ and $\tilde{a}_1 = \tilde{a}_2$. To say $\tilde{a}_1 \succ \tilde{a}_2$ (resp. $\tilde{a}_1 \prec \tilde{a}_2$) we mean $\tilde{a}_1 \succeq \tilde{a}_2$ and $\tilde{a}_1 \neq \tilde{a}_2$ (resp. $\tilde{a}_1 \preceq \tilde{a}_2$ and $\tilde{a}_1 \neq \tilde{a}_2$). Let $\tilde{a}_i \in [[0, 1]]$ where $i \in \Lambda$. We define

$$\text{rinf}_{i \in \Lambda} \tilde{a}_i = \left[\inf_{i \in \Lambda} a_i^-, \inf_{i \in \Lambda} a_i^+ \right] \quad \text{and} \quad \text{rsup}_{i \in \Lambda} \tilde{a}_i = \left[\sup_{i \in \Lambda} a_i^-, \sup_{i \in \Lambda} a_i^+ \right].$$

For any $\tilde{a} \in [[0, 1]]$, its complement, denoted by \tilde{a}^c , is defined by the interval number

$$\tilde{a}^c = [1 - a^+, 1 - a^-].$$

Let X be a nonempty set. A function $A : X \rightarrow [[0, 1]]$ is called an interval-valued fuzzy set (briefly, an IVF set) in X . Let $IVF(X)$ stand for the set of all IVF sets in X . For every $A \in IVF(X)$ and $x \in X$, $A(x) = [A^-(x), A^+(x)]$ is called the degree of membership of an element x to A , where $A^- : X \rightarrow I$ and $A^+ : X \rightarrow I$ are fuzzy sets in X which are called a lower fuzzy set and an upper fuzzy set in X , respectively. For simplicity, we denote $A = [A^-, A^+]$. For every $A, B \in IVF(X)$, we define

$$A \subseteq B \Leftrightarrow A(x) \preceq B(x) \quad \text{for all } x \in X,$$

and

$$A = B \Leftrightarrow A(x) = B(x) \quad \text{for all } x \in X.$$

The complement A^c of $A \in IVF(X)$ is defined as follows: $A^c(x) = A(x)^c$ for all $x \in X$, that is,

$$A^c(x) = [1 - A^+(x), 1 - A^-(x)] \quad \text{for all } x \in X.$$

For a family $\{A_i | i \in \Lambda\}$ of IVF sets in X where Λ is an index set, the union $G = \cup_{i \in \Lambda} A_i$ and the intersection $F = \cap_{i \in \Lambda} A_i$ are defined as follows:

$$G(x) = \left(\bigcup_{i \in \Lambda} A_i \right) (x) = \text{rsup}_{i \in \Lambda} A_i(x)$$

and

$$F(x) = \left(\bigcap_{i \in \Lambda} A_i \right) (x) = \text{rinf}_{i \in \Lambda} A_i(x)$$

for all $x \in X$, respectively.

Let X be a non-empty set. A neutrosophic set (NS) in X (see Ref. 6) is a structure of the form:

$$\Lambda := \{ \langle x; \lambda_T(x), \lambda_I(x), \lambda_F(x) \rangle | x \in X \},$$

where $\lambda_T : X \rightarrow [0, 1]$ is a truth membership function, $\lambda_I : X \rightarrow [0, 1]$ is an indeterminate membership function, and $\lambda_F : X \rightarrow [0, 1]$ is a false membership function.

Let X be a non-empty set. An interval neutrosophic set (INS) in X (see Ref. 8) is a structure of the form:

$$\mathbf{A} := \{ \langle x; A_T(x), A_I(x), A_F(x) \rangle | x \in X \},$$

where A_T , A_I and A_F are interval-valued fuzzy sets in X , which are called an interval truth membership function, an interval indeterminacy membership function and an interval falsity membership function, respectively.

3. Neutrosophic Cubic Sets

Jun *et al.*¹ have defined the cubic set as follows:

Let X be a non-empty set. A cubic set in X is a structure of the form:

$$\mathbf{C} = \{(x, A(x), \lambda(x)) | x \in X\},$$

where A is an interval-valued fuzzy set in X and λ is a fuzzy set in X .

We consider the notion of neutrosophic set sets as an extension of cubic sets.

Definition 3.1. Let X be a non-empty set. A neutrosophic cubic set (NCS) in X is a pair $\mathcal{A} = (\mathbf{A}, \Lambda)$ where $\mathbf{A} := \{(x; A_T(x), A_I(x), A_F(x)) | x \in X\}$ is an interval neutrosophic set in X and $\Lambda := \{(x; \lambda_T(x), \lambda_I(x), \lambda_F(x)) | x \in X\}$ is a neutrosophic set in X .

Example 3.2. For $X = \{a, b, c\}$, the pair $\mathcal{A} = (\mathbf{A}, \Lambda)$ with the tabular representation in Table 1 is a neutrosophic set in X .

Example 3.3. For a non-empty set X and any INS

$$\mathbf{A} := \{(x; A_T(x), A_I(x), A_F(x)) | x \in X\}$$

in X , we know that $\mathcal{C} = (\mathbf{C}, \Phi)_1 := (\mathbf{A}, \Lambda_1)$ and $\mathcal{C} = (\mathbf{C}, \Phi)_0 := (\mathbf{A}, \Lambda_0)$ are neutrosophic cubic sets in X where $\Lambda_1 := \{(x; 1, 1, 1) | x \in X\}$ and $\Lambda_0 := \{(x; 0, 0, 0) | x \in X\}$ in X . If we take $\lambda_T(x) = \frac{A_T^-(x) + A_T^+(x)}{2}$, $\lambda_I(x) = \frac{A_I^-(x) + A_I^+(x)}{2}$, and $\lambda_F(x) = \frac{A_F^-(x) + A_F^+(x)}{2}$, then $\mathcal{A} = (\mathbf{A}, \Lambda)$ is a neutrosophic cubic set in X

Definition 3.4. Let X be a non-empty set. A neutrosophic cubic set $\mathcal{A} = (\mathbf{A}, \Lambda)$ in X is said to be

- truth-internal (briefly, T-internal) if the following inequality is valid

$$(\forall x \in X)(A_T^-(x) \leq \lambda_T(x) \leq A_T^+(x)), \tag{3.1}$$

- indeterminacy-internal (briefly, I-internal) if the following inequality is valid

$$(\forall x \in X)(A_I^-(x) \leq \lambda_I(x) \leq A_I^+(x)), \tag{3.2}$$

Table 1. Tabular representation of $\mathcal{A} = (\mathbf{A}, \Lambda)$.

X	$\mathbf{A}(x)$	$\Lambda(x)$
a	$([0.2, 0.3], [0.3, 0.5], [0.3, 0.5])$	$(0.1, 0.2, 0.3)$
b	$([0.4, 0.7], [0.1, 0.4], [0.2, 0.4])$	$(0.3, 0.2, 0.7)$
c	$([0.6, 0.9], [0.0, 0.2], [0.3, 0.4])$	$(0.5, 0.2, 0.3)$

Table 2. Tabular representation of $\mathcal{A} = (\mathbf{A}, \Lambda)$.

X	$\mathbf{A}(x)$	$\Lambda(x)$
a	$([0.2, 0.3], [0.3, 0.5], [0.3, 0.5])$	$(0.25, 0.35, 0.40)$
b	$([0.4, 0.7], [0.1, 0.4], [0.2, 0.4])$	$(0.50, 0.30, 0.30)$
c	$([0.6, 0.9], [0.0, 0.2], [0.3, 0.4])$	$(0.70, 0.10, 0.35)$

- falsity-internal (briefly, F-internal) if the following inequality is valid

$$(\forall x \in X)(A_{\bar{F}}(x) \leq \lambda_F(x) \leq A_F^+(x)). \tag{3.3}$$

If a neutrosophic cubic set $\mathcal{A} = (\mathbf{A}, \Lambda)$ in X satisfies (3.1), (3.2) and (3.3), we say that $\mathcal{A} = (\mathbf{A}, \Lambda)$ is an internal neutrosophic cubic set in X .

Example 3.5. For $X = \{a, b, c\}$, the pair $\mathcal{A} = (\mathbf{A}, \Lambda)$ with the tabular representation in Table 2 is an internal neutrosophic cubic set in X .

Definition 3.6. Let X be a non-empty set. A neutrosophic cubic set $\mathcal{A} = (\mathbf{A}, \Lambda)$ in X is said to be

- truth-external (briefly, T-external) if the following inequality is valid

$$(\forall x \in X)(\lambda_T(x) \notin (A_{\bar{T}}(x), A_T^+(x))), \tag{3.4}$$

- indeterminacy-external (briefly, I-external) if the following inequality is valid

$$(\forall x \in X)(\lambda_I(x) \notin (A_{\bar{I}}(x), A_I^+(x))), \tag{3.5}$$

- falsity-external (briefly, F-external) if the following inequality is valid

$$(\forall x \in X)(\lambda_F(x) \notin (A_{\bar{F}}(x), A_F^+(x))). \tag{3.6}$$

If a neutrosophic cubic set $\mathcal{A} = (\mathbf{A}, \Lambda)$ in X satisfies (3.4)–(3.6), we say that $\mathcal{A} = (\mathbf{A}, \Lambda)$ is an external neutrosophic cubic in X .

Proposition 3.7. Let $\mathcal{A} = (\mathbf{A}, \Lambda)$ be a neutrosophic cubic set in a non-empty set X which is not external. Then there exists $x \in X$ such that $\lambda_T(x) \in (A_{\bar{T}}(x), A_T^+(x))$, $\lambda_I(x) \in (A_{\bar{I}}(x), A_I^+(x))$, or $\lambda_F(x) \in (A_{\bar{F}}(x), A_F^+(x))$.

Proof. Straightforward. □

Proposition 3.8. Let $\mathcal{A} = (\mathbf{A}, \Lambda)$ be a neutrosophic cubic set in a non-empty set X . If $\mathcal{A} = (\mathbf{A}, \Lambda)$ is both T-internal and T-external, then

$$(\forall x \in X)(\lambda_T(x) \in \{A_{\bar{T}}(x)|x \in X\} \cup \{A_T^+(x)|x \in X\}). \tag{3.7}$$

Proof. Two conditions (3.1) and (3.4) imply that $A_{\bar{T}}(x) \leq \lambda_T(x) \leq A_T^+(x)$ and $\lambda_T(x) \notin (A_{\bar{T}}(x), A_T^+(x))$ for all $x \in X$. It follows that $\lambda_T(x) = A_{\bar{T}}(x)$ or $\lambda_T(x) = A_T^+(x)$, and so that $\lambda_T(x) \in \{A_{\bar{T}}(x)|x \in X\} \cup \{A_T^+(x)|x \in X\}$. □

Similarly, we have the following propositions.

Proposition 3.9. Let $\mathcal{A} = (\mathbf{A}, \Lambda)$ be a neutrosophic cubic set in a non-empty set X . If $\mathcal{A} = (\mathbf{A}, \Lambda)$ is both I-internal and I-external, then

$$(\forall x \in X)(\lambda_I(x) \in \{A_I^-(x)|x \in X\} \cup \{A_I^+(x)|x \in X\}). \quad (3.8)$$

Proposition 3.10. Let $\mathcal{A} = (\mathbf{A}, \Lambda)$ be a neutrosophic cubic set in a non-empty set X . If $\mathcal{A} = (\mathbf{A}, \Lambda)$ is both F-internal and F-external, then

$$(\forall x \in X)(\lambda_F(x) \in \{A_F^-(x)|x \in X\} \cup \{A_F^+(x)|x \in X\}). \quad (3.9)$$

Definition 3.11. Let $\mathcal{A} = (\mathbf{A}, \Lambda)$ and $\mathcal{B} = (\mathbf{B}, \Psi)$ be neutrosophic sets in a non-empty set X where

$$\begin{aligned} \mathbf{A} &:= \{ \langle x; A_T(x), A_I(x), A_F(x) \rangle | x \in X \}, \\ \Lambda &:= \{ \langle x; \lambda_T(x), \lambda_I(x), \lambda_F(x) \rangle | x \in X \}, \\ \mathbf{B} &:= \{ \langle x; B_T(x), B_I(x), B_F(x) \rangle | x \in X \}, \\ \Psi &:= \{ \langle x; \psi_T(x), \psi_I(x), \psi_F(x) \rangle | x \in X \}. \end{aligned}$$

Then we define the equality, P-order and R-order as follows:

- (a) (Equality) $\mathcal{A} = \mathcal{B} \Leftrightarrow \mathbf{A} = \mathbf{B}$ and $\Lambda = \Psi$.
- (b) (P-order) $\mathcal{A} \subseteq_P \mathcal{B} \Leftrightarrow \mathbf{A} \subseteq \mathbf{B}$ and $\Lambda \leq \Psi$.
- (b) (R-order) $\mathcal{A} \subseteq_R \mathcal{B} \Leftrightarrow \mathbf{A} \subseteq \mathbf{B}$ and $\Lambda \geq \Psi$.

We now define the P-union, P-intersection, R-union and R-intersection of neutrosophic cubic sets as follows:

Definition 3.12. For any neutrosophic cubic sets $\mathcal{A}_i = (\mathbf{A}_i, \Lambda_i)$ in a non-empty set X where

$$\begin{aligned} \mathbf{A}_i &:= \{ \langle x; A_{iT}(x), A_{iI}(x), A_{iF}(x) \rangle | x \in X \}, \\ \Lambda_i &:= \{ \langle x; \lambda_{iT}(x), \lambda_{iI}(x), \lambda_{iF}(x) \rangle | x \in X \} \end{aligned}$$

for $i \in J$ and J is any index set, we define

- (a) $\bigcup_P \mathcal{A}_i = \left(\bigcup_{i \in J} \mathbf{A}_i, \bigvee_{i \in J} \Lambda_i \right)$, (P-union)
- (b) $\bigcap_P \mathcal{A}_i = \left(\bigcap_{i \in J} \mathbf{A}_i, \bigwedge_{i \in J} \Lambda_i \right)$, (P-intersection)
- (c) $\bigcup_R \mathcal{A}_i = \left(\bigcup_{i \in J} \mathbf{A}_i, \bigwedge_{i \in J} \Lambda_i \right)$, (R-union)
- (d) $\bigcap_R \mathcal{A}_i = \left(\bigcap_{i \in J} \mathbf{A}_i, \bigvee_{i \in J} \Lambda_i \right)$, (R-intersection)

where

$$\bigcup_{i \in J} \mathbf{A}_i = \left\{ \left\langle x; \left(\bigcup_{i \in J} A_{iT} \right)(x), \left(\bigcup_{i \in J} A_{iI} \right)(x), \left(\bigcup_{i \in J} A_{iF} \right)(x) \right\rangle \middle| x \in X \right\},$$

$$\begin{aligned} \bigvee_{i \in J} \Lambda_i &= \left\{ \left\langle x; \left(\bigvee_{i \in J} \lambda_{iT} \right)(x), \left(\bigvee_{i \in J} \lambda_{iI} \right)(x), \left(\bigvee_{i \in J} \lambda_{iF} \right)(x) \right\rangle \mid x \in X \right\}, \\ \bigcap_{i \in J} \mathbf{A}_i &= \left\{ \left\langle x; \left(\bigcap_{i \in J} A_{iT} \right)(x), \left(\bigcap_{i \in J} A_{iI} \right)(x), \left(\bigcap_{i \in J} A_{iF} \right)(x) \right\rangle \mid x \in X \right\}, \\ \bigwedge_{i \in J} \Lambda_i &= \left\{ \left\langle x; \left(\bigwedge_{i \in J} \lambda_{iT} \right)(x), \left(\bigwedge_{i \in J} \lambda_{iI} \right)(x), \left(\bigwedge_{i \in J} \lambda_{iF} \right)(x) \right\rangle \mid x \in X \right\}. \end{aligned}$$

The complement of $\mathcal{A} = (\mathbf{A}, \Lambda)$ is defined to be the neutrosophic cubic set $\mathcal{A}^c = (\mathbf{A}^c, \Lambda^c)$ where $\mathbf{A}^c := \{ \langle x; A_T^c(x), A_I^c(x), A_F^c(x) \rangle \mid x \in X \}$ is an interval neutrosophic cubic in X and $\Lambda^c := \{ \langle x; \lambda_T^c(x), \lambda_I^c(x), \lambda_F^c(x) \rangle \mid x \in X \}$ is a neutrosophic set in X .

Obviously, $(\mathcal{A}^c)^c = \mathcal{A}$, $\left(\bigcup_{i \in J} \mathcal{A}_i \right)^c = \bigcap_{i \in J} \mathcal{A}_i^c$, $\left(\bigcap_{i \in J} \mathcal{A}_i \right)^c = \bigcup_{i \in J} \mathcal{A}_i^c$, $\left(\bigcup_{i \in J} \mathcal{A}_i \right)^c = \bigcup_{i \in J} \mathcal{A}_i^c$, and $\left(\bigcap_{i \in J} \mathcal{A}_i \right)^c = \bigcup_{i \in J} \mathcal{A}_i^c$.

The following proposition is clear.

Proposition 3.13. *For any neutrosophic cubic sets $\mathcal{A} = (\mathbf{A}, \Lambda)$, $\mathcal{B} = (\mathbf{B}, \Psi)$, $\mathcal{C} = (\mathbf{C}, \Phi)$, and $\mathcal{D} = (\mathbf{D}, \Omega)$ in a non-empty set X , we have*

- (1) if $\mathcal{A} \subseteq_P \mathcal{B}$ and $\mathcal{B} \subseteq_P \mathcal{C}$ then $\mathcal{A} \subseteq_P \mathcal{C}$.
- (2) if $\mathcal{A} \subseteq_P \mathcal{B}$ then $\mathcal{B}^c \subseteq_P \mathcal{A}^c$.
- (3) if $\mathcal{A} \subseteq_P \mathcal{B}$ and $\mathcal{A} \subseteq_P \mathcal{C}$ then $\mathcal{A} \subseteq_P \mathcal{B} \cap_P \mathcal{C}$.
- (4) if $\mathcal{A} \subseteq_P \mathcal{B}$ and $\mathcal{C} \subseteq_P \mathcal{B}$ then $\mathcal{A} \cup_P \mathcal{C} \subseteq_P \mathcal{B}$.
- (5) if $\mathcal{A} \subseteq_P \mathcal{B}$ and $\mathcal{C} \subseteq_P \mathcal{D}$ then $\mathcal{A} \cup_P \mathcal{C} \subseteq_P \mathcal{B} \cup_P \mathcal{D}$ and $\mathcal{A} \cap_P \mathcal{C} \subseteq_P \mathcal{B} \cap_P \mathcal{D}$.
- (6) if $\mathcal{A} \subseteq_R \mathcal{B}$ and $\mathcal{B} \subseteq_R \mathcal{C}$ then $\mathcal{A} \subseteq_R \mathcal{C}$.
- (7) if $\mathcal{A} \subseteq_R \mathcal{B}$ then $\mathcal{B}^c \subseteq_R \mathcal{A}^c$.
- (8) if $\mathcal{A} \subseteq_R \mathcal{B}$ and $\mathcal{A} \subseteq_R \mathcal{C}$ then $\mathcal{A} \subseteq_R \mathcal{B} \cap_R \mathcal{C}$.
- (9) if $\mathcal{A} \subseteq_R \mathcal{B}$ and $\mathcal{C} \subseteq_R \mathcal{B}$ then $\mathcal{A} \cup_R \mathcal{C} \subseteq_R \mathcal{B}$.
- (10) if $\mathcal{A} \subseteq_R \mathcal{B}$ and $\mathcal{C} \subseteq_R \mathcal{D}$ then $\mathcal{A} \cup_R \mathcal{C} \subseteq_R \mathcal{B} \cup_R \mathcal{D}$ and $\mathcal{A} \cap_R \mathcal{C} \subseteq_R \mathcal{B} \cap_R \mathcal{D}$.

Theorem 3.14. *Let $\mathcal{A} = (\mathbf{A}, \Lambda)$ be a neutrosophic cubic set in a non-empty set X . If $\mathcal{A} = (\mathbf{A}, \Lambda)$ is I-internal (resp. I-external), then the complement $\mathcal{A}^c = (\mathbf{A}^c, \Lambda^c)$ of $\mathcal{A} = (\mathbf{A}, \Lambda)$ is an I-internal (resp. I-external) neutrosophic cubic set in X .*

Proof. If $\mathcal{A} = (\mathbf{A}, \Lambda)$ is an I-internal (resp. I-external) neutrosophic cubic set in a non-empty set X , then $A_I^-(x) \leq \lambda_I(x) \leq A_I^+(x)$ (resp., $\lambda_I(x) \notin (A_I^-(x), A_I^+(x))$) for all $x \in X$. It follows that $1 - A_I^+(x) \leq 1 - \lambda_I(x) \leq 1 - A_I^-(x)$ (resp., $1 - \lambda_I(x) \notin (1 - A_I^+(x), 1 - A_I^-(x))$). Therefore, $\mathcal{A}^c = (\mathbf{A}^c, \Lambda^c)$ is an I-internal (resp. I-external) neutrosophic cubic set in X . □

Similarly, we have the following theorems.

Theorem 3.15. *Let $\mathcal{A} = (\mathbf{A}, \Lambda)$ be a neutrosophic cubic set in a non-empty set X . If $\mathcal{A} = (\mathbf{A}, \Lambda)$ is T-internal (resp. T-external), then the complement $\mathcal{A}^c = (\mathbf{A}^c, \Lambda^c)$ of $\mathcal{A} = (\mathbf{A}, \Lambda)$ is a T-internal (resp. T-external) neutrosophic cubic set in X .*

Theorem 3.16. Let $\mathcal{A} = (\mathbf{A}, \Lambda)$ be a neutrosophic cubic set in a non-empty set X . If $\mathcal{A} = (\mathbf{A}, \Lambda)$ is F -internal (resp. F -external), then the complement $\mathcal{A}^c = (\mathbf{A}^c, \Lambda^c)$ of $\mathcal{A} = (\mathbf{A}, \Lambda)$ is an F -internal (resp. F -external) neutrosophic cubic set in X .

Corollary 3.17. Let $\mathcal{A} = (\mathbf{A}, \Lambda)$ be a neutrosophic cubic set in a non-empty set X . If $\mathcal{A} = (\mathbf{A}, \Lambda)$ is internal (resp. external), then the complement $\mathcal{A}^c = (\mathbf{A}^c, \Lambda^c)$ of $\mathcal{A} = (\mathbf{A}, \Lambda)$ is an internal (resp. external) neutrosophic cubic set in X .

Theorem 3.18. If $\{\mathcal{A}_i = (\mathbf{A}_i, \Lambda_i) | i \in J\}$ is a family of F -internal neutrosophic cubic sets in a non-empty set X , then the P -union and the P -intersection of $\{\mathcal{A}_i = (\mathbf{A}_i, \Lambda_i) | i \in J\}$ are F -internal neutrosophic cubic sets in X .

Proof. Since $\mathcal{A}_i = (\mathbf{A}_i, \Lambda_i)$ is an F -internal neutrosophic cubic set in a non-empty set X , we have $A_{iF}^-(x) \leq \lambda_{iF}(x) \leq A_{iF}^+(x)$ for $i \in J$. It follows that

$$\left(\bigcup_{i \in J} \mathbf{A}_{iF}\right)^-(x) \leq \left(\bigvee_{i \in J} \Lambda_{iF}\right)(x) \leq \left(\bigcup_{i \in J} \mathbf{A}_{iF}\right)^+(x)$$

and

$$\left(\bigcap_{i \in J} \mathbf{A}_{iF}\right)^-(x) \leq \left(\bigwedge_{i \in J} \Lambda_{iF}\right)(x) \leq \left(\bigcap_{i \in J} \mathbf{A}_{iF}\right)^+(x).$$

Therefore, $\bigcup_P \mathcal{A}_i = \left(\bigcup_{i \in J} \mathbf{A}_i, \bigvee_{i \in J} \Lambda_i\right)$ and $\bigcap_P \mathcal{A}_i = \left(\bigcap_{i \in J} \mathbf{A}_i, \bigwedge_{i \in J} \Lambda_i\right)$ are F -internal neutrosophic cubic sets in X . □

Similarly, we have the following theorems.

Theorem 3.19. If $\{\mathcal{A}_i = (\mathbf{A}_i, \Lambda_i) | i \in J\}$ is a family of T -internal neutrosophic cubic sets in a non-empty set X , then the P -union and the P -intersection of $\{\mathcal{A}_i = (\mathbf{A}_i, \Lambda_i) | i \in J\}$ are T -internal neutrosophic cubic sets in X .

Theorem 3.20. If $\{\mathcal{A}_i = (\mathbf{A}_i, \Lambda_i) | i \in J\}$ is a family of I -internal neutrosophic cubic sets in a non-empty set X , then the P -union and the P -intersection of $\{\mathcal{A}_i = (\mathbf{A}_i, \Lambda_i) | i \in J\}$ are I -internal neutrosophic cubic sets in X .

Corollary 3.21. If $\{\mathcal{A}_i = (\mathbf{A}_i, \Lambda_i) | i \in J\}$ is a family of internal neutrosophic cubic sets in a non-empty set X , then the P -union and the P -intersection of $\{\mathcal{A}_i = (\mathbf{A}_i, \Lambda_i) | i \in J\}$ are internal neutrosophic cubic sets in X .

The following example shows that P -union and P -intersection of F -external (resp. I -external and T -external) neutrosophic cubic sets may not be F -external (resp. I -external and T -external) neutrosophic cubic sets.

Example 3.22. Let $\mathcal{A} = (\mathbf{A}, \Lambda)$, and $\mathcal{B} = (\mathbf{B}, \Psi)$ be neutrosophic cubic sets in $[0, 1]$ where

$$\begin{aligned} \mathbf{A} &= \{\langle x; [0.2, 0.5], [0.5, 0.7], [0.3, 0.5] \rangle | x \in [0, 1]\}, \\ \Lambda &= \{\langle x; 0.3, 0.4, 0.8 \rangle | x \in [0, 1]\}, \end{aligned}$$

$$\mathbf{B} = \{ \langle x; [0.6, 0.8], [0.4, 0.7], [0.7, 0.9] \rangle | x \in [0, 1] \},$$

$$\Psi = \{ \langle x; 0.7, 0.3, 0.4 \rangle | x \in [0, 1] \}.$$

Then $\mathcal{A} = (\mathbf{A}, \Lambda)$, and $\mathcal{B} = (\mathbf{B}, \Psi)$ are F-external neutrosophic cubic sets in $[0, 1]$, and $\mathcal{A} \cup_P \mathcal{B} = (\mathbf{A} \cup \mathbf{B}, \Lambda \vee \Psi)$ with

$$\mathbf{A} \cup \mathbf{B} = \{ \langle x; [0.6, 0.8], [0.5, 0.7], [0.7, 0.9] \rangle | x \in [0, 1] \},$$

$$\Lambda \vee \Psi = \{ \langle x; 0.7, 0.4, 0.8 \rangle | x \in [0, 1] \}$$

is not an F-external neutrosophic cubic set in $[0, 1]$ since

$$(\lambda_F \vee \psi_F)(x) = 0.8 \in (0.7, 0.9) = ((A_F \cup B_F)^-(x), (A_F \cup B_F)^+(x)).$$

Also $\mathcal{A} \cap_P \mathcal{B} = (\mathbf{A} \cap \mathbf{B}, \Lambda \wedge \Psi)$ with

$$\mathbf{A} \cap \mathbf{B} = \{ \langle x; [0.2, 0.5], [0.4, 0.7], [0.3, 0.5] \rangle | x \in [0, 1] \},$$

$$\Lambda \wedge \Psi = \{ \langle x; 0.3, 0.3, 0.4 \rangle | x \in [0, 1] \}$$

is not an F-external neutrosophic cubic set in $[0, 1]$ since

$$(\lambda_F \wedge \psi_F)(x) = 0.4 \in (0.3, 0.5) = ((A_F \cap B_F)^-(x), (A_F \cap B_F)^+(x)).$$

Example 3.23. For $X = \{a, b, c\}$, let $\mathcal{A} = (\mathbf{A}, \Lambda)$, and $\mathcal{B} = (\mathbf{B}, \Psi)$ be neutrosophic cubic sets in X with the tabular representations in Tables 3 and 4, respectively.

Then $\mathcal{A} = (\mathbf{A}, \Lambda)$, and $\mathcal{B} = (\mathbf{B}, \Psi)$ are both T-external and I-external neutrosophic cubic sets in X . Note that the tabular representation of $\mathcal{A} \cup_P \mathcal{B} = (\mathbf{A} \cup \mathbf{B}, \Lambda \vee \Psi)$ and $\mathcal{A} \cap_P \mathcal{B} = (\mathbf{A} \cap \mathbf{B}, \Lambda \wedge \Psi)$ are given by Tables 5 and 6, respectively.

Table 3. Tabular representation of $\mathcal{A} = (\mathbf{A}, \Lambda)$.

X	$\mathbf{A}(x)$	$\Lambda(x)$
a	$([0.2, 0.3], [0.3, 0.5], [0.3, 0.5])$	$(0.35, 0.25, 0.40)$
b	$([0.4, 0.7], [0.1, 0.4], [0.2, 0.4])$	$(0.35, 0.50, 0.30)$
c	$([0.6, 0.9], [0.0, 0.2], [0.3, 0.4])$	$(0.50, 0.60, 0.55)$

Table 4. Tabular representation of $\mathcal{B} = (\mathbf{B}, \Psi)$.

X	$\mathbf{B}(x)$	$\Psi(x)$
a	$([0.3, 0.7], [0.3, 0.5], [0.1, 0.5])$	$(0.25, 0.25, 0.60)$
b	$([0.5, 0.8], [0.5, 0.6], [0.2, 0.5])$	$(0.45, 0.30, 0.30)$
c	$([0.4, 0.9], [0.4, 0.7], [0.3, 0.5])$	$(0.35, 0.10, 0.45)$

Table 5. Tabular representation of $\mathcal{A} \cup_P \mathcal{B} = (\mathbf{A} \cup \mathbf{B}, \Lambda \vee \Psi)$.

X	$(\mathbf{A} \cup \mathbf{B})(x)$	$(\Lambda \vee \Psi)(x)$
a	$([0.3, 0.7], [0.3, 0.5], [0.3, 0.5])$	$(0.35, 0.25, 0.60)$
b	$([0.5, 0.8], [0.5, 0.6], [0.2, 0.5])$	$(0.45, 0.50, 0.30)$
c	$([0.6, 0.9], [0.4, 0.7], [0.3, 0.5])$	$(0.50, 0.60, 0.55)$

Table 6. Tabular representation of $\mathcal{A} \cap_P \mathcal{B} = (\mathbf{A} \cap \mathbf{B}, \Lambda \wedge \Psi)$.

X	$(\mathbf{A} \cap \mathbf{B})(x)$	$(\Lambda \wedge \Psi)(x)$
a	$([0.2, 0.3], [0.3, 0.5], [0.1, 0.5])$	$(0.25, 0.25, 0.40)$
b	$([0.4, 0.7], [0.1, 0.4], [0.2, 0.4])$	$(0.35, 0.30, 0.30)$
c	$([0.4, 0.9], [0.0, 0.2], [0.3, 0.4])$	$(0.35, 0.10, 0.45)$

Then $\mathcal{A} \cup_P \mathcal{B} = (\mathbf{A} \cup \mathbf{B}, \Lambda \vee \Psi)$ is neither an I-external neutrosophic cubic set nor a T-external neutrosophic cubic set in X since

$$(\lambda_I \vee \psi_I)(c) = 0.60 \in (0.4, 0.7) = ((A_I \cup B_I)^-(c), (A_I \cup B_I)^+(c))$$

and

$$(\lambda_T \vee \psi_T)(a) = 0.35 \in (0.3, 0.7) = ((A_T \cup B_T)^-(a), (A_T \cup B_T)^+(a)).$$

Also $\mathcal{A} \cap_P \mathcal{B} = (\mathbf{A} \cap \mathbf{B}, \Lambda \wedge \Psi)$ is neither an I-external neutrosophic cubic set nor a T-external neutrosophic cubic set in X since

$$(\lambda_I \wedge \psi_I)(b) = 0.30 \in (0.1, 0.4) = ((A_I \cap B_I)^-(b), (A_I \cap B_I)^+(b))$$

and

$$(\lambda_T \wedge \psi_T)(a) = 0.25 \in (0.2, 0.3) = ((A_T \cap B_T)^-(a), (A_T \cap B_T)^+(a)).$$

We know that R-union and R-intersection of T-internal (resp. I-internal and F-internal) neutrosophic cubic sets may not be T-internal (resp. I-internal and F-internal) neutrosophic cubic sets as seen in the following examples.

Example 3.24. Let $\mathcal{A} = (\mathbf{A}, \Lambda)$ and $\mathcal{B} = (\mathbf{B}, \Psi)$ be neutrosophic cubic sets in $[0, 1]$ where

$$\begin{aligned} \mathbf{A} &= \{\langle x; [0.3, 0.5], [0.5, 0.7], [0.3, 0.5] \rangle | x \in [0, 1]\}, \\ \Lambda &= \{\langle x; 0.4, 0.4, 0.8 \rangle | x \in [0, 1]\}, \\ \mathbf{B} &= \{\langle x; [0.7, 0.9], [0.4, 0.7], [0.7, 0.9] \rangle | x \in [0, 1]\}, \\ \Psi &= \{\langle x; 0.8, 0.3, 0.8 \rangle | x \in [0, 1]\}. \end{aligned}$$

Then $\mathcal{A} = (\mathbf{A}, \Lambda)$ and $\mathcal{B} = (\mathbf{B}, \Psi)$ are T-internal neutrosophic cubic sets in $[0, 1]$. The R-union $\mathcal{A} \cup_R \mathcal{B} = (\mathbf{A} \cup \mathbf{B}, \Lambda \wedge \Psi)$ of $\mathcal{A} = (\mathbf{A}, \Lambda)$ and $\mathcal{B} = (\mathbf{B}, \Psi)$ is given as follows:

$$\begin{aligned} \mathbf{A} \cup \mathbf{B} &= \{\langle x; [0.7, 0.9], [0.5, 0.7], [0.7, 0.9] \rangle | x \in [0, 1]\}, \\ \Lambda \wedge \Psi &= \{\langle x; 0.4, 0.3, 0.8 \rangle | x \in [0, 1]\}. \end{aligned}$$

Note that $(\lambda_T \wedge \psi_T)(x) = 0.4 < 0.7 = (A_T \cup B_T)^-(x)$ and $(\lambda_I \wedge \psi_I)(x) = 0.3 < 0.5 = (A_I \cup B_I)^-(x)$. Hence, $\mathcal{A} \cup_R \mathcal{B} = (\mathbf{A} \cup \mathbf{B}, \Lambda \wedge \Psi)$ is neither a T-internal neutrosophic cubic set nor an I-internal neutrosophic cubic set in $[0, 1]$. But, we know that $\mathcal{A} \cup_R \mathcal{B} = (\mathbf{A} \cup \mathbf{B}, \Lambda \wedge \Psi)$ is an F-internal neutrosophic cubic set in $[0, 1]$. Also, the R-intersection $\mathcal{A} \cap_R \mathcal{B} = (\mathbf{A} \cap \mathbf{B}, \Lambda \vee \Psi)$ of $\mathcal{A} = (\mathbf{A}, \Lambda)$ and $\mathcal{B} = (\mathbf{B}, \Psi)$ is

given as follows:

$$\begin{aligned} \mathbf{A} \cap \mathbf{B} &= \{ \langle x; [0.3, 0.5], [0.4, 0.7], [0.3, 0.5] \rangle | x \in [0, 1] \}, \\ \Lambda \vee \Psi &= \{ \langle x; 0.8, 0.4, 0.8 \rangle | x \in [0, 1] \}. \end{aligned}$$

Since

$$(A_I \cap B_I)^-(x) \leq (\lambda_I \vee \psi_I)(x) \leq (A_I \cap B_I)^+(x)$$

for all $x \in [0, 1]$, $\mathcal{A} \cap_R \mathcal{B} = (\mathbf{A} \cap \mathbf{B}, \Lambda \vee \Psi)$ is an I-internal neutrosophic cubic set in $[0, 1]$. But it is neither a T-internal neutrosophic cubic set nor an F-internal neutrosophic cubic set in $[0, 1]$.

Example 3.25. Let $\mathcal{A} = (\mathbf{A}, \Lambda)$ and $\mathcal{B} = (\mathbf{B}, \Psi)$ be neutrosophic cubic sets in $[0, 1]$ where

$$\begin{aligned} \mathbf{A} &= \{ \langle x; [0.1, 0.3], [0.5, 0.7], [0.3, 0.5] \rangle | x \in [0, 1] \}, \\ \Lambda &= \{ \langle x; 0.4, 0.6, 0.8 \rangle | x \in [0, 1] \}, \\ \mathbf{B} &= \{ \langle x; [0.7, 0.9], [0.4, 0.5], [0.7, 0.9] \rangle | x \in [0, 1] \}, \\ \Psi &= \{ \langle x; 0.5, 0.45, 0.2 \rangle | x \in [0, 1] \}. \end{aligned}$$

Then $\mathcal{A} = (\mathbf{A}, \Lambda)$ and $\mathcal{B} = (\mathbf{B}, \Psi)$ are I-internal neutrosophic cubic sets in $[0, 1]$. The R-union $\mathcal{A} \cup_R \mathcal{B} = (\mathbf{A} \cup \mathbf{B}, \Lambda \wedge \Psi)$ of $\mathcal{A} = (\mathbf{A}, \Lambda)$ and $\mathcal{B} = (\mathbf{B}, \Psi)$ is given as follows:

$$\begin{aligned} \mathbf{A} \cup \mathbf{B} &= \{ \langle x; [0.7, 0.9], [0.5, 0.7], [0.7, 0.9] \rangle | x \in [0, 1] \}, \\ \Lambda \wedge \Psi &= \{ \langle x; 0.4, 0.45, 0.2 \rangle | x \in [0, 1] \}. \end{aligned}$$

Since $(\lambda_I \wedge \psi_I)(x) = 0.45 < 0.5 = (A_I \cup B_I)^-(x)$, we know that $\mathcal{A} \cup_R \mathcal{B}$ is not an I-internal neutrosophic cubic set in $[0, 1]$. Also, the R-intersection $\mathcal{A} \cap_R \mathcal{B} = (\mathbf{A} \cap \mathbf{B}, \Lambda \vee \Psi)$ of $\mathcal{A} = (\mathbf{A}, \Lambda)$ and $\mathcal{B} = (\mathbf{B}, \Psi)$ is given as follows:

$$\begin{aligned} \mathbf{A} \cap \mathbf{B} &= \{ \langle x; [0.1, 0.3], [0.4, 0.5], [0.3, 0.5] \rangle | x \in [0, 1] \}, \\ \Lambda \vee \Psi &= \{ \langle x; 0.5, 0.6, 0.8 \rangle | x \in [0, 1] \}, \end{aligned}$$

and it is not an I-internal neutrosophic cubic set in $[0, 1]$.

Example 3.26. Let $\mathcal{A} = (\mathbf{A}, \Lambda)$ and $\mathcal{B} = (\mathbf{B}, \Psi)$ be neutrosophic cubic sets in $[0, 1]$ where

$$\begin{aligned} \mathbf{A} &= \{ \langle x; [0.1, 0.3], [0.5, 0.7], [0.3, 0.8] \rangle | x \in [0, 1] \}, \\ \Lambda &= \{ \langle x; 0.4, 0.6, 0.4 \rangle | x \in [0, 1] \}, \\ \mathbf{B} &= \{ \langle x; [0.4, 0.7], [0.4, 0.7], [0.5, 0.8] \rangle | x \in [0, 1] \}, \\ \Psi &= \{ \langle x; 0.5, 0.3, 0.6 \rangle | x \in [0, 1] \}. \end{aligned}$$

Then $\mathcal{A} = (\mathbf{A}, \Lambda)$ and $\mathcal{B} = (\mathbf{B}, \Psi)$ are F-internal neutrosophic cubic sets in $[0, 1]$. The R-union $\mathcal{A} \cup_R \mathcal{B} = (\mathbf{A} \cup \mathbf{B}, \Lambda \wedge \Psi)$ of $\mathcal{A} = (\mathbf{A}, \Lambda)$ and $\mathcal{B} = (\mathbf{B}, \Psi)$ is

given as follows:

$$\begin{aligned} \mathbf{A} \cup \mathbf{B} &= \{ \langle x; [0.4, 0.7], [0.5, 0.7], [0.5, 0.8] \rangle | x \in [0, 1] \}, \\ \Lambda \wedge \Psi &= \{ \langle x; 0.4, 0.3, 0.4 \rangle | x \in [0, 1] \}, \end{aligned}$$

which is not an F-internal neutrosophic cubic set in $[0, 1]$. If $\mathcal{A} = (\mathbf{A}, \Lambda)$ and $\mathcal{B} = (\mathbf{B}, \Psi)$ are neutrosophic cubic sets in \mathcal{R} with

$$\begin{aligned} \mathbf{A} &= \{ \langle x; [0.2, 0.6], [0.3, 0.7], [0.7, 0.8] \rangle | x \in \mathcal{R} \}, \\ \Lambda &= \{ \langle x; 0.7, 0.6, 0.75 \rangle | x \in \mathcal{R} \}, \\ \mathbf{B} &= \{ \langle x; [0.3, 0.7], [0.6, 0.7], [0.2, 0.6] \rangle | x \in \mathcal{R} \}, \\ \Psi &= \{ \langle x; 0.5, 0.3, 0.5 \rangle | x \in \mathcal{R} \}, \end{aligned}$$

then $\mathcal{A} = (\mathbf{A}, \Lambda)$ and $\mathcal{B} = (\mathbf{B}, \Psi)$ are F-internal neutrosophic cubic sets in \mathcal{R} and the R-intersection $\mathcal{A} \cap_R \mathcal{B} = (\mathbf{A} \cap \mathbf{B}, \Lambda \vee \Psi)$ of $\mathcal{A} = (\mathbf{A}, \Lambda)$ and $\mathcal{B} = (\mathbf{B}, \Psi)$ which is given as follows:

$$\begin{aligned} \mathbf{A} \cap \mathbf{B} &= \{ \langle x; [0.2, 0.6], [0.3, 0.7], [0.2, 0.6] \rangle | x \in \mathcal{R} \}, \\ \Lambda \vee \Psi &= \{ \langle x; 0.7, 0.6, 0.75 \rangle | x \in \mathcal{R} \}, \end{aligned}$$

is not an F-internal neutrosophic cubic set in $[0, 1]$.

We provide conditions for the R-union of two T-internal (resp. I-internal and F-internal) neutrosophic cubic sets to be a T-internal (resp. I-internal and F-internal) neutrosophic cubic set.

Theorem 3.27. *Let $\mathcal{A} = (\mathbf{A}, \Lambda)$ and $\mathcal{B} = (\mathbf{B}, \Psi)$ be T-internal neutrosophic cubic sets in a non-empty set X such that*

$$(\forall x \in X)(\max\{A_T^-(x), B_T^-(x)\} \leq (\lambda_T \wedge \tau_T)(x)). \tag{3.10}$$

Then the R-union of $\mathcal{A} = (\mathbf{A}, \Lambda)$ and $\mathcal{B} = (\mathbf{B}, \Psi)$ is a T-internal neutrosophic cubic set in X .

Proof. Let $\mathcal{A} = (\mathbf{A}, \Lambda)$ and $\mathcal{B} = (\mathbf{B}, \Psi)$ be T-internal neutrosophic cubic sets in a non-empty set X which satisfy the condition (3.10). Then

$$A_T^-(x) \leq \lambda_T(x) \leq A_T^+(x) \quad \text{and} \quad B_T^-(x) \leq \tau_T(x) \leq B_T^+(x),$$

and so $(\lambda_T \wedge \tau_T)(x) \leq (A_T \cup B_T)^+(x)$. It follows from (3.10) that

$$(A_T \cup B_T)^-(x) = \max\{A_T^-(x), B_T^-(x)\} \leq (\lambda_T \wedge \tau_T)(x) \leq (A_T \cup B_T)^+(x).$$

Hence, $\mathcal{A} \cup_R \mathcal{B} = (\mathbf{A} \cup \mathbf{B}, \Lambda \wedge \Psi)$ is a T-internal neutrosophic cubic set in X . □

Similarly, we have the following theorems.

Theorem 3.28. Let $\mathcal{A} = (\mathbf{A}, \Lambda)$ and $\mathcal{B} = (\mathbf{B}, \Psi)$ be I-internal neutrosophic cubic sets in a non-empty set X such that

$$(\forall x \in X)(\max\{A_I^-(x), B_I^-(x)\} \leq (\lambda_I \wedge \psi_I)(x)). \tag{3.11}$$

Then the R-union of $\mathcal{A} = (\mathbf{A}, \Lambda)$ and $\mathcal{B} = (\mathbf{B}, \Psi)$ is an I-internal neutrosophic cubic set in X .

Theorem 3.29. Let $\mathcal{A} = (\mathbf{A}, \Lambda)$ and $\mathcal{B} = (\mathbf{B}, \Psi)$ be F-internal neutrosophic cubic sets in a non-empty set X such that

$$(\forall x \in X)(\max\{A_F^-(x), B_F^-(x)\} \leq (\lambda_F \wedge \psi_F)(x)). \tag{3.12}$$

Then the R-union of $\mathcal{A} = (\mathbf{A}, \Lambda)$ and $\mathcal{B} = (\mathbf{B}, \Psi)$ is an F-internal neutrosophic cubic set in X .

Corollary 3.30. If two internal neutrosophic cubic sets $\mathcal{A} = (\mathbf{A}, \Lambda)$ and $\mathcal{B} = (\mathbf{B}, \Psi)$ satisfy conditions (3.10)–(3.12), then the R-union of $\mathcal{A} = (\mathbf{A}, \Lambda)$ and $\mathcal{B} = (\mathbf{B}, \Psi)$ is an internal neutrosophic cubic set in X .

We provide conditions for the R-intersection of two T-internal (resp. I-internal and F-internal) neutrosophic cubic sets to be a T-internal (resp. I-internal and F-internal) neutrosophic cubic set.

Theorem 3.31. Let $\mathcal{A} = (\mathbf{A}, \Lambda)$ and $\mathcal{B} = (\mathbf{B}, \Psi)$ be I-internal neutrosophic cubic sets in a non-empty set X such that

$$(\forall x \in X)((\lambda_I \vee \psi_I)(x) \leq \min\{A_I^+(x), B_I^+(x)\}). \tag{3.13}$$

Then the R-intersection of $\mathcal{A} = (\mathbf{A}, \Lambda)$ and $\mathcal{B} = (\mathbf{B}, \Psi)$ is an I-internal neutrosophic cubic set in X .

Proof. Assume that the condition (3.13) is valid. Then

$$A_I^-(x) \leq \lambda_I(x) \leq A_I^+(x) \quad \text{and} \quad B_I^-(x) \leq \psi_I(x) \leq B_I^+(x)$$

for all $x \in X$. It follows from (3.13) that

$$(A_I \cap B_I)^-(x) \leq (\lambda_I \vee \psi_I)(x) \leq \min\{A_I^+(x), B_I^+(x)\} = (A_I \cap B_I)^+(x)$$

for all $x \in X$. Therefore, $\mathcal{A} \cap_R \mathcal{B} = (\mathbf{A} \cap \mathbf{B}, \Lambda \vee \Psi)$ is an I-internal neutrosophic cubic set in X . □

Similarly, we have the following theorems.

Theorem 3.32. Let $\mathcal{A} = (\mathbf{A}, \Lambda)$ and $\mathcal{B} = (\mathbf{B}, \Psi)$ be T-internal neutrosophic cubic sets in a non-empty set X such that

$$(\forall x \in X)((\lambda_T \vee \psi_T)(x) \leq \min\{A_T^+(x), B_T^+(x)\}). \tag{3.14}$$

Then the R-intersection of $\mathcal{A} = (\mathbf{A}, \Lambda)$ and $\mathcal{B} = (\mathbf{B}, \Psi)$ is a T-internal neutrosophic cubic set in X .

Theorem 3.33. Let $\mathcal{A} = (\mathbf{A}, \Lambda)$ and $\mathcal{B} = (\mathbf{B}, \Psi)$ be F -internal neutrosophic cubic sets in a non-empty set X such that

$$(\forall x \in X)((\lambda_F \vee _F)(x) \leq \min\{A_F^+(x), B_F^+(x)\}). \quad (3.15)$$

Then the R -intersection of $\mathcal{A} = (\mathbf{A}, \Lambda)$ and $\mathcal{B} = (\mathbf{B}, \Psi)$ is an F -internal neutrosophic cubic set in X .

Corollary 3.34. If two internal neutrosophic cubic sets $\mathcal{A} = (\mathbf{A}, \Lambda)$ and $\mathcal{B} = (\mathbf{B}, \Psi)$ satisfy conditions (3.13)–(3.15), then the R -intersection of $\mathcal{A} = (\mathbf{A}, \Lambda)$ and $\mathcal{B} = (\mathbf{B}, \Psi)$ is an internal neutrosophic cubic set in X .

References

1. Y. B. Jun, C. S. Kim and K. O. Yang, Cubic sets, *Annals of Fuzzy Mathematics and Informatics* **4**(1) (2012) 83–98.
2. Y. B. Jun, C. S. Kim and M. S. Kang, Cubic subalgebras and ideals of BCK/BCI-algebras, *Far East Journal of Mathematical Sciences (FJMS)* **44** (2010) 239–250.
3. Y. B. Jun, C. S. Kim and J. G. Kang, Cubic q -ideals of BCI-algebras, *Annals of Fuzzy Mathematics and Informatics* **1** (2011) 25–34.
4. Y. B. Jun and K. J. Lee, Closed cubic ideals and cubic \circ -subalgebras in BCK/BCI-algebras, *Applied Mathematical Sciences* **4** (2010) 3395–3402.
5. Y. B. Jun, K. J. Lee and M. S. Kang, Cubic structures applied to ideals of BCI-algebras, *Computers and Mathematics with Applications* **62** (2011) 3334–3342.
6. F. Smarandache, *A Unifying Field in Logics: Neutrosophic Logic. Neutrosophy, Neutrosophic Set, Neutrosophic Probability* (American Reserch Press, Rehoboth, NM, 1999).
7. F. Smarandache, Neutrosophic set — a generalization of the intuitionistic fuzzy set, *International Journal of Pure and Applied Mathematics* **24**(3) (2005) 287–297.
8. H. Wang, F. Smarandache, Y. Q. Zhang and R. Sunderraman, *Interval Neutrosophic Sets and Logic: Theory and Applications in Computing* (Hexis, Phoenix, Ariz, USA, 2005).
9. L. A. Zadeh, Fuzzy sets, *Information Control* **8** (1965) 338–353.

Neutrosophic Linear Programming Problem

Abdel-Nasser Hussian, Mai Mohamed, Mohamed Abdel-Basset,
Florentin Smarandache

Abdel-Nasser Hussian, Mai Mohamed, Mohamed Abdel-Basset, Florentin Smarandache (2017).
Neutrosophic Linear Programming Problem. *Mathematical Sciences Letters* 6(3): 319-324; DOI:
10.18576/msl/060315

Abstract: Smarandache presented neutrosophic theory as a tool for handling undetermined information, and together with Wang et al. introduced single valued neutrosophic sets that is a special neutrosophic set and can be used expediently to deal with real-world problems, especially in decision support. In this paper, we propose linear programming problems based on neutrosophic environment. Neutrosophic sets characterized by three independent parameters, namely truth-membership degree (T), indeterminacy-membership degree (I) and falsity-membership degree (F), which is more capable to handle imprecise parameters. We also transform the neutrosophic linear programming problem into a crisp programming model by using neutrosophic set parameters. To measure the efficiency of our proposed model we solved several numerical examples.

Keywords: linear programming problem; neutrosophic; neutrosophic sets.

1 Introduction

Linear programming is a method for achieving the best outcome (such as maximum profit or minimum cost) in a mathematical model represented by linear relationships. Decision making is a process of solving the problem and achieving goals under asset of constraints, and it is very difficult in some cases due to incomplete and imprecise information. And in Linear programming problems the decision maker may not be able to specify the objective function and/or constraints functions precisely. In 1995, Smarandache [5-7] introduce neutrosophy which is the study of neutralities as an extension of dialectics. Neutrosophic is the derivative of neutrosophy and it includes neutrosophic set, neutrosophic probability, neutrosophic statistics and neutrosophic logic. Neutrosophic theory means neutrosophy applied in many fields of sciences, in order to solve problems related to indeterminacy. Although intuitionistic fuzzy sets can only handle incomplete information not indeterminate, the neutrosophic set can handle both incomplete and indeterminate information.[2,5-7] Neutrosophic sets characterized by three independent degrees namely truth-membership degree (T), indeterminacy-membership degree(I), and falsity-membership degree (F), where T, I, F are standard or non-standard subsets of $]0-, 1+[$. The decision makers in neutrosophic set want to increase the degree of truth-membership and decrease the degree of indeterminacy and falsity membership.

The structure of the paper is as follows: the next section is a preliminary discussion; the third section describes the formulation of linear programming problem using the proposed model; the fourth section presents some illustrative examples to put on view how the approach can be applied; The last section summarizes the conclusions and gives an outlook for future research.

2 Some Preliminaries

2.1 Neutrosophic Set [2]

Let X be a space of points (objects) and $x \in X$. A neutrosophic set A in X is defined by a truth-membership function (x), an indeterminacy-membership function (x) and a falsity-membership function (x). $T(x)$, $I_A(x)$ and $F_A(x)$ are real standard or real nonstandard subsets of $]0-, 1+[$. That is $T_A(x): X \rightarrow]0-, 1+[$, $I_A(x): X \rightarrow]0-, 1+[$ and $F_A(x): X \rightarrow]0-, 1+[$. There is no restriction on the sum of (x), (x) and (x), so

$$0- \leq \sup(T_A(x) + \sup I_A(x) + \sup F_A(x) \leq 3+.$$

In the following, we adopt the notations $\mu(x)$, $\sigma_A(x)$ and $\nu_A(x)$ instead of $T_A(x)$, $I_A(x)$ and $F_A(x)$, respectively. Also we write SVN numbers instead of single valued neutrosophic numbers.

2.2 Single Valued Neutrosophic Sets (SVNS)[2,7]

Let X be a universe of discourse. A single valued neutrosophic set A over X is an object having the form

$$A = \{ \langle x, \mu_A(x), \sigma_A(x), \nu_A(x) \rangle : x \in X \}$$

where $\mu_A(x):X \rightarrow [0,1]$, $\sigma_A(x):X \rightarrow [0,1]$ and $\nu_A(x):X \rightarrow [0,1]$ with $0 \leq \mu_A(x) + \sigma_A(x) + \nu_A(x) \leq 3$ for all $x \in X$. The intervals $\mu(x)$, $\sigma_A(x)$ and $\nu_A(x)$ denote the truth-membership degree, the indeterminacy-membership degree and the falsity membership degree of x to A , respectively.

For convenience, a SVN number is denoted by $A = (a,.,)$, where $a, b, c \in [0,1]$ and $a+b+c \leq 3$.

2.3 Complement [3]

The complement of a single valued neutrosophic set A is denoted by $^c(A)$ and is defined by

$$\begin{aligned} T_c(A)(x) &= F(A)(x), \\ I_c(A)(x) &= 1 - I(A)(x), \\ F_c(A)(x) &= T(A)(x), \end{aligned} \text{ for all } x \text{ in } X$$

2.4 Union [3]

The union of two single valued neutrosophic sets A and B is a single valued neutrosophic set C , written as $C = A \cup B$, whose truth-membership, indeterminacy membership and falsity-membership functions are given by

$$\begin{aligned} T(C)(x) &= \max (T(A)(x), T(B)(x)), \\ I(C)(x) &= \max (I(A)(x), I(B)(x)), \\ F(C)(x) &= \min (F(A)(x), F(B)(x)), \end{aligned} \text{ for all } x \text{ in } X.$$

2.5 Intersection [3]

The intersection of two single valued neutrosophic sets A and B is a single valued neutrosophic set C , written as $C = A \cap B$, whose truth-membership, indeterminacy membership and falsity-membership functions are given by

$$\begin{aligned} T(C)(x) &= \min (T(A)(x), T(B)(x)), \\ I(C)(x) &= \min (I(A)(x), I(B)(x)), \\ F(C)(x) &= \max (F(A)(x), F(B)(x)) \text{ for all } x \text{ in } X. \end{aligned}$$

3 Neutrosophic Linear Programming Problem

Linear programming problem with neutrosophic coefficients (NLPP) is defined as the following:

$$\text{Maximize } Z = \sum_{j=1}^n c_j x_j$$

Subject to

$$\begin{aligned} \sum_{j=1}^n \tilde{a}_{ij} x_j &\leq b_i \quad 1 \leq i \leq m \\ x_j &\geq 0, \quad 1 \leq j \leq n \end{aligned} \quad (1)$$

where \tilde{a}_{ij}^n is a neutrosophic number.

The single valued neutrosophic number (\tilde{a}_{ij}^n) is given by $A = (a, b, c)$ where $a, b, c \in [0,1]$ and $a+b+c \leq 3$

The truth- membership function of *neutrosophic number*

\tilde{a}_{ij}^n is defined as:

$$T \tilde{a}_{ij}^n(x) = \begin{cases} \frac{x-a_1}{a_2-a_1} & a_1 \leq x \leq a_2 \\ \frac{a_2-x}{a_3-a_2} & a_2 \leq x \leq a_3 \\ 0 & \text{otherwise} \end{cases} \quad (2)$$

The indeterminacy- membership function of

neutrosophic number \tilde{a}_{ij}^n is defined as:

$$I \tilde{a}_{ij}^n(x) = \begin{cases} \frac{x-b_1}{b_2-b_1} & b_1 \leq x \leq b_2 \\ \frac{b_2-x}{b_3-b_2} & b_2 \leq x \leq b_3 \\ 0 & \text{otherwise} \end{cases} \quad (3)$$

And its falsity- membership function of *neutrosophic number* \tilde{a}_{ij}^n is defined as:

$$F \tilde{a}_{ij}^n(x) = \begin{cases} \frac{x-c_1}{c_2-c_1} & C_1 \leq x \leq C_2 \\ \frac{c_2-x}{c_3-c_2} & C_2 \leq x \leq C_3 \\ 1 & \text{otherwise} \end{cases} \quad (4)$$

Then we find the upper and lower bounds of the objective function for truth-membership, indeterminacy and falsity membership as follows:

$$z_{ij}^T = \max\{z(x_i^*)\} \text{ and } z_{ij}^L = \min\{z(x_i^*)\} \text{ where } 1 \leq i \leq k$$

$$z_{ij}^F = z_{ij}^T \text{ and } z_{ij}^F = z_{ij}^T - R(z_{ij}^T - z_{ij}^L)$$

$$z_{ij}^L = z_{ij}^L \text{ and } z_{ij}^L = z_{ij}^L - S(z_{ij}^T - z_{ij}^L)$$

Where R, S are predetermined real number in $(0,1)$

The truth membership, indeterminacy membership, falsity membership of objective function as follows:

$$T_O^{(Z)} = \begin{cases} 1 & \text{if } z \geq z_u^T \\ \frac{z-z_l^T}{z_u^T-z_l^T} & \text{if } z_l^T \leq z \leq z_u^T \\ 0 & \text{if } z < z_l^T \end{cases} \quad (5)$$

$$I_O^{(Z)} = \begin{cases} 1 & \text{if } z \geq z_u^T \\ \frac{z-z_l^I}{z_u^I-z_l^I} & \text{if } z_l^I \leq z \leq z_u^I \\ 0 & \text{if } z < z_l^I \end{cases} \quad (6)$$

$$F_O^{(Z)} = \begin{cases} 1 & \text{if } z \geq z_u^T \\ \frac{z_u^F-z}{z_u^F-z_l^F} & \text{if } z_l^F \leq z \leq z_u^F \\ 0 & \text{if } z < z_l^F \end{cases} \quad (7)$$

The neutrosophic set of the i^{th} constraint c_i is defined as:

$$T_{c_i}^{(x)} = \begin{cases} 1 & \text{if } b_i \geq \sum_{j=1}^n (a_{ij} + d_{ij}) x_j \\ \frac{b_i - \sum_{j=1}^n a_{ij} x_j}{\sum_{j=1}^n d_{ij} x_j} & \text{if } \sum_{j=1}^n a_{ij} x_j \leq b_i < \sum_{j=1}^n (a_{ij} + d_{ij}) x_j \\ 0 & \text{if } b_i < \sum_{j=1}^n a_{ij} x_j \end{cases} \quad (8)$$

$$F_{c_i}^{(x)} = \begin{cases} 1 & \text{if } b_i < \sum_{j=1}^n a_{ij} x_j \\ 1 - T_{c_i}^{(x)} & \text{if } \sum_{j=1}^n a_{ij} x_j \leq b_i < \sum_{j=1}^n (a_{ij} + d_{ij}) x_j \\ 0 & \text{if } b_i \geq \sum_{j=1}^n (a_{ij} + d_{ij}) x_j \end{cases} \quad (9)$$

$$I_{c_i}^{(x)} = \begin{cases} 0 & \text{if } b_i < \sum_{j=1}^n a_{ij} x_j \\ \frac{b_i - \sum_{j=1}^n d_{ij} x_j}{\sum_{j=1}^n a_{ij} x_j} & \text{if } \sum_{j=1}^n a_{ij} x_j \leq b_i < \sum_{j=1}^n (a_{ij} + d_{ij}) x_j \\ 0 & \text{if } b_i \geq \sum_{j=1}^n (a_{ij} + d_{ij}) x_j \end{cases} \quad (10)$$

$$\begin{aligned} 0 \leq \alpha + \beta + \theta \leq 3 \\ X \geq 0 \end{aligned} \quad (12)$$

Where α denotes the minimal acceptable degree, β denote the maximal degree of rejection and θ denote maximal degree of indeterminacy.

The neutrosophic optimization model can be changed into the following optimization model:

$$\begin{aligned} \max(\alpha - \beta - \theta) \\ \text{Subject to} \\ \alpha \leq T(x) \\ \beta \geq F(x) \\ \theta \geq I(x) \\ \alpha \geq \beta \\ \alpha \geq \theta \\ 0 \leq \alpha + \beta + \theta \leq 3 \\ \alpha, \beta, \theta \geq 0 \\ x \geq 0 \end{aligned} \quad (13)$$

The previous model can be written as:

$$\begin{aligned} \min (1 - \alpha)\beta\theta \\ \text{Subject to} \\ \alpha \leq T(x) \\ \beta \geq F(x) \\ \theta \geq I(x) \\ \alpha \geq \beta \\ \alpha \geq \theta \\ 0 \leq \alpha + \beta + \theta \leq 3 \\ x \geq 0 \end{aligned} \quad (14)$$

4 Neutrosophic Optimization Model

In our neutrosophic model we want to maximize the degree of acceptance and minimize the degree of rejection and indeterminacy of the neutrosophic objective function and constraints. Neutrosophic optimization model can be defined as:

$$\begin{aligned} \max T(x) \\ \min F(x) \\ \min I(x) \end{aligned}$$

Subject to

$$\begin{aligned} T(x) \geq F(x) \\ T(x) \geq I(x) \\ 0 \leq T(x) + I(x) + F(x) \leq 3 \\ T(x), I(x), F(x) \geq 0 \\ x \geq 0 \end{aligned} \quad (11)$$

Where $T(x), F(x), I(x)$ denotes the degree of acceptance, rejection and indeterminacy of x respectively.

The above problem is equivalent to the following:

$$\begin{aligned} \max \alpha, \min \beta, \min \theta \\ \text{Subject to} \end{aligned}$$

$$\begin{aligned} \alpha \leq T(x) \\ \beta \leq F(x) \\ \theta \leq I(x) \\ \alpha \geq \beta \\ \alpha \geq \theta \end{aligned}$$

5 The Algorithm for Solving Neutrosophic Linear Programming Problem (NLPP)

Step 1: Solve the objective function subject to the constraints.

Step 2: Create the decision set which include the highest degree of truth-membership and the least degree of falsity and indeterminacy memberships.

Step 3: Declare goals and tolerance.

Step 4: Construct membership functions.

Step 5: Set α, β, θ in the interval $]-0, 1+[$ for each neutrosophic number .

Step 6: Find the upper and lower bound of objective function as we illustrated previously in section 3.

Step 7: Construct neutrosophic optimization model as in equation (13).

6 Numerical Examples

To measure the efficiency of our proposed model we solved four numerical examples.

6.1 Illustrative Example#1

$$\begin{aligned}
 &max\ x\ \tilde{5}x_1 + \tilde{3}x_2 \\
 &s.t. \\
 &\tilde{4}x_1 + \tilde{3}x_2 \leq \tilde{12} \\
 &\tilde{1}x_1 + \tilde{3}x_2 \leq \tilde{6} \\
 &x_1, x_2 \geq 0
 \end{aligned}
 \tag{15}$$

where

$$\begin{aligned}
 c_1 &= \tilde{5} = \{(4,5,6), (0.5, 0.8, 0.3)\}; \\
 c_2 &= \tilde{3} = \{(2.5, 3, 3.2), (0.6, 0.4, 0)\}; \\
 a_{11} &= \tilde{4} = \{(3.5, 4, 4.1), (0.75, 0.5, 0.25)\}; \\
 a_{12} &= \tilde{3} = \{(2.5, 3, 3.2), (0.2, 0.8, 0.4)\}; \\
 a_{21} &= \tilde{1} = \{(0, 1, 2), (0.15, 0.5, 0)\}; \\
 a_{22} &= \tilde{3} = \{(2.8, 3, 3.2), (0.75, 0.5, 0.25)\}; \\
 b_1 &= \tilde{12} = \{(11, 12, 13), (0.2, 0.6, 0.5)\}; \\
 b_2 &= \tilde{6} = \{(5.5, 6, 7.5), (0.8, 0.6, 0.4)\}.
 \end{aligned}$$

The equivalent crisp formulation is:

$$\begin{aligned}
 &max\ 1.3125x_1 + 0.0158x_2 \\
 &s.t. \\
 &2.5375x_1 + 0.54375x_2 \leq 2.475 \\
 &0.3093x_1 + 1.125x_2 \leq 2.1375 \\
 &x_1, x_2 \geq 0
 \end{aligned}$$

The optimal solution is $x_1 = 0.9754$; $x_2 = 0$; with optimal objective value 1.2802

6.2 Illustrative Example#2

$$\begin{aligned}
 &max\ 25x_1 + 48x_2 \\
 &s.t. \\
 &15x_1 + 30x_2 \leq 45000 \\
 &24x_1 + 6x_2 \leq 24000 \\
 &21x_1 + 14x_2 \leq 28000 \\
 &x_1, x_2 \geq 0
 \end{aligned}
 \tag{16}$$

where

$$\begin{aligned}
 c_1 &= \tilde{25} = \{(19, 25, 33), (0.8, 0.1, 0.4)\}; \\
 c_2 &= \tilde{48} = \{(44, 48, 54), (0.75, 0.25, 0)\}.
 \end{aligned}$$

The corresponding crisp linear programs given as follows:

$$\begin{aligned}
 &max\ 11.069x_1 + 22.8125x_2 \\
 &s.t. \\
 &15x_1 + 30x_2 \leq 45000 \\
 &24x_1 + 6x_2 \leq 24000 \\
 &x_1, x_2 \geq 0
 \end{aligned}$$

The optimal solution is $x_1 = 0$; $x_2 = 1500$; with optimal objective value 34218.75

6.3 Illustrative Example#3

$$\begin{aligned}
 &max\ 25x_1 + 48x_2 \\
 &s.t. \\
 &\tilde{15}x_1 + \tilde{30}x_2 \leq \tilde{45000} \\
 &\tilde{24}x_1 + \tilde{6}x_2 \leq \tilde{24000} \\
 &\tilde{21}x_1 + \tilde{14}x_2 \leq \tilde{28000} \\
 &x_1, x_2 \geq 0
 \end{aligned}
 \tag{17}$$

where

$$\begin{aligned}
 a_{11} &= \tilde{15} = \{(14, 15, 17), (0.75, 0.5, 0.25)\}; \\
 a_{12} &= \tilde{30} = \{(25, 30, 34), (0.25, 0.7, 0.4)\}; \\
 a_{21} &= \tilde{24} = \{(21, 24, 26), (0.4, 0.6, 0)\}; \\
 a_{22} &= \tilde{6} = \{(4, 6, 8), (0.75, 0.5, 0.25)\}; \\
 a_{31} &= \tilde{21} = \{(17, 21, 22), (1, 0.25, 0)\}; \\
 a_{32} &= \tilde{14} = \{(12, 14, 19), (0.6, 0.4, 0)\};
 \end{aligned}$$

$$b_1 = \tilde{45000} = \{(44980, 45000, 45030), (0.3, 0.4, 0.8)\};$$

$$b_2 = \tilde{24000} = \{(23980, 24000, 24050), (0.4, 0.25, 0.5)\};$$

$$b_3 = \tilde{28000} = \{(27990, 28000, 28030), (0.9, 0.2, 0)\}.$$

The associated crisp linear programs model will be:

$$\begin{aligned}
 &max\ 25x_1 + 48x_2 \\
 &s.t. \\
 &5.75x_1 + 6.397x_2 \leq 9282 \\
 &10.312x_1 + 6.187x_2 \leq 14178.37 \\
 &x_1, x_2 \geq 0
 \end{aligned}$$

The optimal solution is $x_1 = 0$; $x_2 = 1450.993$; with optimal objective value 69647.65

6.4 Illustrative Example#4

$$\begin{aligned}
 & \max 7x_1 + 5x_2 \\
 & s.t. \\
 & \tilde{1}x_1 + \tilde{2}x_2 \leq 6 \\
 & \tilde{4}x_1 + \tilde{3}x_2 \leq 12 \\
 & x_1, x_2 \geq 0
 \end{aligned} \tag{18}$$

where

$$\begin{aligned}
 a_{11} &= \tilde{1} = \{(0.5, 1, 2), (0.2, 0.6, 0.3)\}; \\
 a_{12} &= \tilde{2} = \{(2.5, 3, 3.2), (0.6, 0.4, 0.1)\}; \\
 a_{21} &= \tilde{4} = \{(3.5, 4, 4.1), (0.5, 0.25, 0.25)\}; \\
 a_{22} &= \tilde{3} = \{(2.5, 3, 3.2), (0.75, 0.25, 0)\};
 \end{aligned}$$

The associated crisp linear programs model will be:

$$\begin{aligned}
 & \max 7x_1 + 5x_2 \\
 & s.t. \\
 & 0.284x_1 + 1.142x_2 \leq 6 \\
 & 1.45x_1 + 1.36x_2 \leq 12 \\
 & x_1, x_2 \geq 0
 \end{aligned}$$

The optimal solution is $x_1 = 4.3665$; $x_2 = 4.168$; with optimal objective value 63.91

The result of our NLP model in this example is better than the results obtained by intuitionistic fuzzy set [4].

7 Conclusion and Future Work

Neutrosophic sets and fuzzy sets are two hot research topics. In this paper, we propose linear programming model based on neutrosophic environment, simultaneously considering the degrees of acceptance, indeterminacy and rejection of objectives, by proposed model for solving neutrosophic linear programming problems (NIPP). In the proposed model, we maximize the degrees of acceptance and minimize indeterminacy and rejection of objectives. NIPP was transformed into a crisp programming model using truth membership, indeterminacy membership, and falsity membership functions. We also give a numerical examples to show the efficiency of the proposed method. As far as future directions are concerned, these will include studying the duality theory of linear programming problems based on neutrosophic environment.

References

- [1] Smarandache, F. "A Unifying Field in Logics: Neutrosophic Logic. Neutrosophy, Neutrosophic Set, Neutrosophic Probability: Neutrosophic Logic. Neutrosophy, Neutrosophic Set, Neutrosophic Probability. Infinite Study, 2005.
- [2] Smarandache, F. "A Geometric Interpretation of the Neutrosophic Set-A Generalization of the Intuitionistic Fuzzy Set." arXiv preprint math/0404520(2004).
- [3] R. Şahin, and Muhammed Y. "A Multi-criteria neutrosophic group decision making method based TOPSIS for supplier selection." arXiv preprint arXiv:1412.5077 (2014).
- [4] Parvathi, R., and C. Malathi. "Intuitionistic fuzzy linear programming problems." World applied sciences journal 1.1 (2012): 1-5.
- [5] I. M. Hezam, M. Abdel-Baset, F. Smarandache 2015 Taylor Series Approximation to Solve Neutrosophic Multiobjective Programming Problem Neutrosophic Sets and Systems An International Journal in Information Science and Engineering Vol.10 pp.39-45.
- [6] El-Hefenawy, N., Metwally, M. A., Ahmed, Z. M., & El-Henawy, I. M. (2016). A Review on the Applications of Neutrosophic Sets. Journal of Computational and Theoretical Nanoscience, 13(1), 936-944.
- [7] Abdel-Baset, M., Hezam, I. M., & Smarandache, F. (2016). Neutrosophic Goal Programming. Neutrosophic Sets & Systems, 11.

Shortest Path Problem on Single Valued Neutrosophic Graphs

Said Broumi, Mohamed Talea, Assia Bakali, Florentin Smarandache,
Kishore Kumar P.K.

Said Broumi, Mohamed Talea, Assia Bakali, Florentin Smarandache, Kishore Kumar P.K. (2017). Shortest Path Problem on Single Valued Neutrosophic Graphs. International Symposium on Networks, Computers and Communications (ISNCC), Marrakech, Morocco, 6

Abstract— A single valued neutrosophic graph is a generalized structure of fuzzy graph, intuitionistic fuzzy graph that gives more precision, flexibility and compatibility to a system when compared with systems that are designed using fuzzy graphs and intuitionistic fuzzy graphs. This paper addresses for the first time, the shortest path in an acyclic neutrosophic directed graph using ranking function. Here each edge length is assigned to single valued neutrosophic numbers instead of a real number. The neutrosophic number is able to represent the indeterminacy in the edge (arc) costs of neutrosophic graph. A proposed algorithm gives the shortest path and shortest path length from source node to destination node. Finally an illustrative example also included to demonstrate the proposed method in solving path problems with single valued neutrosophic arcs.

Keywords— Single valued neutrosophic sets; Single valued neutrosophic graph; Shortest path problem.

I. Introduction

The concept of neutrosophic set (NS for short) proposed by Smarandache [8, 9] is a powerful tool to deal with incomplete, indeterminate and inconsistent information in real world. It is a generalization of the theory of fuzzy set [26], intuitionistic fuzzy sets [22, 23], interval-valued fuzzy sets [18] and interval-valued intuitionistic fuzzy sets [25], then the neutrosophic set is characterized by a truth-membership degree (t), an indeterminacy-membership degree (i) and a falsity-membership degree (f) independently, which are within the real standard or nonstandard unit interval $]0, 1^+[$. Therefore, if their range is restrained within the real standard unit interval $[0, 1]$, Nevertheless, NSs are hard to be apply in practical problems since the values of the functions of truth, indeterminacy and falsity lie in $]0, 1^+[$. The single valued neutrosophic set was introduced for the first time by Smarandache in his 1998 book. The single valued neutrosophic sets as subclass of neutrosophic

sets in which the value of truth-membership, indeterminacy-membership and falsity-membership degrees are intervals of numbers instead of the real numbers. Later on, Wang et al. [12] studied some properties related to single valued neutrosophic sets. The concept of neutrosophic sets and its extensions such as single valued neutrosophic sets, interval neutrosophic sets, simplified neutrosophic sets and so on have been applied in a wide variety of fields including computer science, engineering, mathematics, medicine and economic [1,4-11, 15-17, 20-21, 25, 27-31,32-38, 40]. The shortest path problem (SPP) is one of the most fundamental and well-known combinatorial problems that appear in various fields of science and engineering, e.g., road networks application, transportation, routing in communication channels and scheduling problems. The shortest path problems concentrate on finding the path of minimum length between any pair of vertices. The arc (edge) length of the network may represent the real life quantities such as, time, cost, etc. In a classical shortest path problem, the distance of the arc between different nodes of a network are assumed to be certain. In some uncertain situation, the distance will be computed as a fuzzy number depending on the number of parameters is considered.

In the recent past, There are many shortest path problems that have been studied with different types of input data, including fuzzy set, intuitionistic fuzzy sets, vague sets [2, 3, 30,39]. many new algorithm have been developed so far. To the best of our knowledge, determining the shortest path in the networks in terms of indeterminacy and inconsistency has been not studied yet.

The shortest path problem involves addition and comparison of the edge lengths. Since, the addition and comparison between two single valued neutrosophic numbers are not alike those between two precise real numbers, we have used the ranking method proposed by Ye [20].

Therefore, in this study we extend the proposed method for solving fuzzy shortest path proposed by [2] to SVN-numbers for solving neutrosophic shortest path problems in which the arc lengths of a network are assigned by SVN-numbers

The remainder of this paper is organized as follows. In Section 2, we review some basic concepts about neutrosophic sets, single valued neutrosophic sets, single valued neutrosophic graph and complete single valued neutrosophic graph. In Section 3, an algorithm is proposed for finding the shortest path and shortest distance in single valued neutrosophic graph. In section 4 an illustrative example is provided to find the shortest path and shortest distance between the source node and destination node. Finally, Section 5 outlines the conclusion of this paper and suggests several directions for future research.

II. Preliminaries

In this section, we mainly recall some notions related to neutrosophic sets, single valued neutrosophic sets, single valued neutrosophic graphs, relevant to the present work. See especially [8, 12, 32, 37, 41] for further details and background.

Definition 2.1 [8]. Let X be a space of points (objects) with generic elements in X denoted by x ; then the neutrosophic set A (NS A) is an object having the form $A = \{ \langle x: T_A(x), I_A(x), F_A(x) \rangle, x \in X \}$, where the functions $T, I, F: X \rightarrow]0, 1^+[$ define respectively the truth-membership function, indeterminacy-membership function, and falsity-membership function of the element $x \in X$ to the set A with the condition:

$$0 \leq T_A(x) + I_A(x) + F_A(x) \leq 3^+. \quad (1)$$

The functions $T_A(x), I_A(x)$ and $F_A(x)$ are real standard or nonstandard subsets of $]0, 1^+[$. Since it is difficult to apply NSs to practical problems, Smarandache [1998] introduced the concept of a SVNS, which is an instance of a NS and can be used in real scientific and engineering applications.

Definition 2.2 [12]. Let X be a space of points (objects) with generic elements in X denoted by x . A single valued neutrosophic set A (SVNS A) is characterized by truth-membership function $T_A(x)$, an indeterminacy-membership function $I_A(x)$, and a falsity-membership function $F_A(x)$. For each point x in X , $T_A(x), I_A(x), F_A(x) \in [0, 1]$. A SVNS A can be written as

$$A = \{ \langle x: T_A(x), I_A(x), F_A(x) \rangle, x \in X \} \quad (2)$$

Definition 2.3 [20]. Let $\tilde{A}_1 = (T_1, I_1, F_1)$ and $\tilde{A}_2 = (T_2, I_2, F_2)$ be two single valued neutrosophic number. Then, the operations for NNs are defined as below;

$$(i) \tilde{A}_1 \oplus \tilde{A}_2 = (T_1 + T_2 - T_1 T_2, I_1 I_2, F_1 F_2) \quad (3)$$

$$(ii) \tilde{A}_1 \otimes \tilde{A}_2 = (T_1 T_2, I_1 + I_2 - I_1 I_2, F_1 + F_2 - F_1 F_2) \quad (4)$$

$$(iii) \lambda \tilde{A} = (1 - (1 - T_1)^\lambda, I_1^\lambda, F_1^\lambda) \quad (5)$$

$$(iv) \tilde{A}_1^\lambda = (T_1^\lambda, 1 - (1 - I_1)^\lambda, 1 - (1 - F_1)^\lambda) \text{ where } \lambda > 0 \quad (6)$$

Definition 2.4 [20]. Let $\tilde{A}_1 = (T_1, I_1, F_1)$ be a single valued neutrosophic number. Then, the score function $s(\tilde{A}_1)$, accuracy function $a(\tilde{A}_1)$ and certainty function $c(\tilde{A}_1)$ of an SVNN are defined as follows:

$$(i) s(\tilde{A}_1) = \frac{2 + T_1 - I_1 - F_1}{3} \quad (7)$$

$$(ii) a(\tilde{A}_1) = T_1 - F_1 \quad (8)$$

$$(iii) c(\tilde{A}_1) = T_1 \quad (9)$$

Comparison of single valued neutrosophic numbers

Let $\tilde{A}_1 = (T_1, I_1, F_1)$ and $\tilde{A}_2 = (T_2, I_2, F_2)$ be two single valued neutrosophic numbers then

$$(i) \tilde{A}_1 < \tilde{A}_2 \text{ if } s(\tilde{A}_1) < s(\tilde{A}_2) \quad (10)$$

$$(ii) \tilde{A}_1 > \tilde{A}_2 \text{ if } s(\tilde{A}_1) > s(\tilde{A}_2) \quad (11)$$

$$(iii) \tilde{A}_1 = \tilde{A}_2 \text{ if } s(\tilde{A}_1) = s(\tilde{A}_2) \quad (12)$$

Definition 2.5 [41]. 0_n may be defined as four types:

$$(0_1) \text{ Type 1. } 0_n = \{ \langle x, (0, 0, 1) \rangle : x \in X \}$$

$$(0_2) \text{ Type 2. } 0_n = \{ \langle x, (0, 1, 1) \rangle : x \in X \}$$

$$(0_3) \text{ Type 3. } 0_n = \{ \langle x, (0, 1, 0) \rangle : x \in X \}$$

$$(0_4) \text{ Type 4. } 0_n = \{ \langle x, (0, 0, 0) \rangle : x \in X \}$$

1_n may be defined as four types:

$$(1_1) \text{ Type 1. } 1_n = \{ \langle x, (1, 0, 0) \rangle : x \in X \}$$

$$(1_2) \text{ Type 2. } 1_n = \{ \langle x, (1, 0, 1) \rangle : x \in X \}$$

$$(1_3) \text{ Type 3. } 1_n = \{ \langle x, (1, 1, 0) \rangle : x \in X \}$$

$$(1_4) \text{ Type 4. } 1_n = \{ \langle x, (1, 1, 1) \rangle : x \in X \}$$

Definition 2.6 [32, 37]. A single valued neutrosophic graph (SVN-graph) with underlying set V is defined to be a pair $G = (A, B)$ where

1. The functions $T_A: V \rightarrow [0, 1]$, $I_A: V \rightarrow [0, 1]$ and $F_A: V \rightarrow [0, 1]$ denote the degree of truth-membership, degree of indeterminacy-membership and falsity-membership of the element $v_i \in V$, respectively, and

$$0 \leq T_A(v_i) + I_A(v_i) + F_A(v_i) \leq 3 \text{ for all } v_i \in V. \quad (13)$$

2. The Functions $T_B: E \subseteq V \times V \rightarrow [0, 1]$, $I_B: E \subseteq V \times V \rightarrow [0, 1]$ and $F_B: E \subseteq V \times V \rightarrow [0, 1]$ are defined by

$$T_B(v_i, v_j) \leq \min [T_A(v_i), T_A(v_j)], \quad (14)$$

$$I_B(v_i, v_j) \geq \max [I_A(v_i), I_A(v_j)] \text{ and} \quad (15)$$

$$F_B(v_i, v_j) \geq \max [F_A(v_i), F_A(v_j)] \quad (16)$$

denotes the degree of truth-membership, indeterminacy-membership and falsity-membership of the edge $(v_i, v_j) \in E$ respectively, where

$$0 \leq T_B(v_i, v_j) + I_B(v_i, v_j) + F_B(v_i, v_j) \leq 3 \text{ for all } (v_i, v_j) \in E \text{ (i, j = 1, 2, \dots, n)} \quad (17)$$

A is the single valued neutrosophic vertex set of V, B is the single valued neutrosophic edge set of E, respectively.

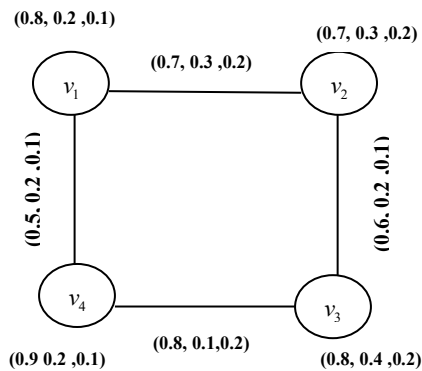

Fig.1. Single valued neutrosophic graph

III. An Algorithm for Neutrosophic Shortest Path in a Network

In this section an algorithm is proposed to find the shortest path and shortest distance of each node from source node. The algorithm is a labeling technique. Since the algorithm is direct extension of existing algorithm [30, 39, 41] with slightly modification. So it is very easy to understand and apply for solving shortest path problems occurring in real life problems.

Remark: In this paper, we are only interested in neutrosophic zero, given by:

$$0_n = (0, 1, 1)$$

Step 1 : Assume $\tilde{d}_1 = (0, 1, 1)$ and label the source node (say node 1) as $[(0, 1, 1), -]$.

Step 2: Find $\tilde{d}_j = \text{minimum} \{ \tilde{d}_i \oplus \tilde{d}_{ij} \}; j=2, 3, \dots, n$.

Step 3 : If minimum occurs corresponding to unique value of i i.e., $i = r$ then label node j as $[\tilde{d}_j, r]$. If minimum occurs corresponding to more than one values of i then it represents that there are more than one neutrosophic path between source node and node j but neutrosophic distance along path is \tilde{d}_j , so choose any value of i .

Step 4 : Let the destination node (node n) be labeled as $[\tilde{d}_n, l]$, then the neutrosophic shortest distance between source node is \tilde{d}_n .

Step 5 : Since destination node is labeled as $[\tilde{d}_n, l]$, so, to find the neutrosophic shortest path between source node and

destination node, check the label of node l . Let it be $[\tilde{d}_l, p]$, now check the label of node p and so on. Repeat the same procedure until node 1 is obtained.

Step 6 : Now the neutrosophic shortest path can be obtained by combining all the nodes obtained by the step 5.

Remark 1. Let $\tilde{A}_i; i = 1, 2, \dots, n$ be a set of neutrosophic numbers, if $S(\tilde{A}_k) < S(\tilde{A}_i)$, for all i , the neutrosophic number is the minimum of \tilde{A}_k

Remark 2 : A node i is said to be predecessor node of node j if
 (i) Node i is directly connected to node j .
 (ii) The direction of path connecting node i and j from i to j .

In Fig 3, we present the flow diagram representing the neutrosophic shortest path algorithm

IV. ILLUSTRATIVE EXAMPLE

Let us consider a single valued neutrosophic graph given in figure 1, where the distance between a pair of vertices is a single valued neutrosophic number. The problem is to find the shortest distance and shortest path between source node and destination node on the network.

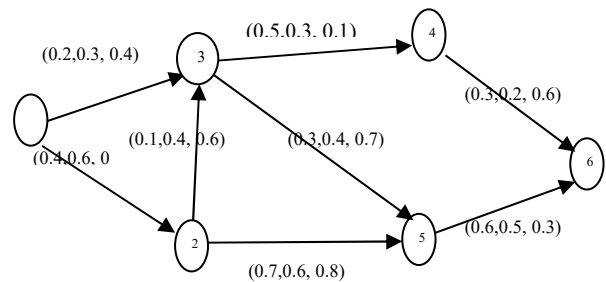

Fig.2 Network with neutrosophic shortest distance

Edges	Single valued Neutrosophic distance
1-2	(0.4, 0.6, 0.7)
1-3	(0.2, 0.3, 0.4)
2-3	(0.1, 0.4, 0.6)
2-5	(0.7, 0.6, 0.8)
3-4	(0.5, 0.3, 0.1)
3-5	(0.3, 0.4, 0.7)
4-6	(0.3, 0.2, 0.6)
5-6	(0.6, 0.5, 0.3)

Table 1. Weights of the graphs

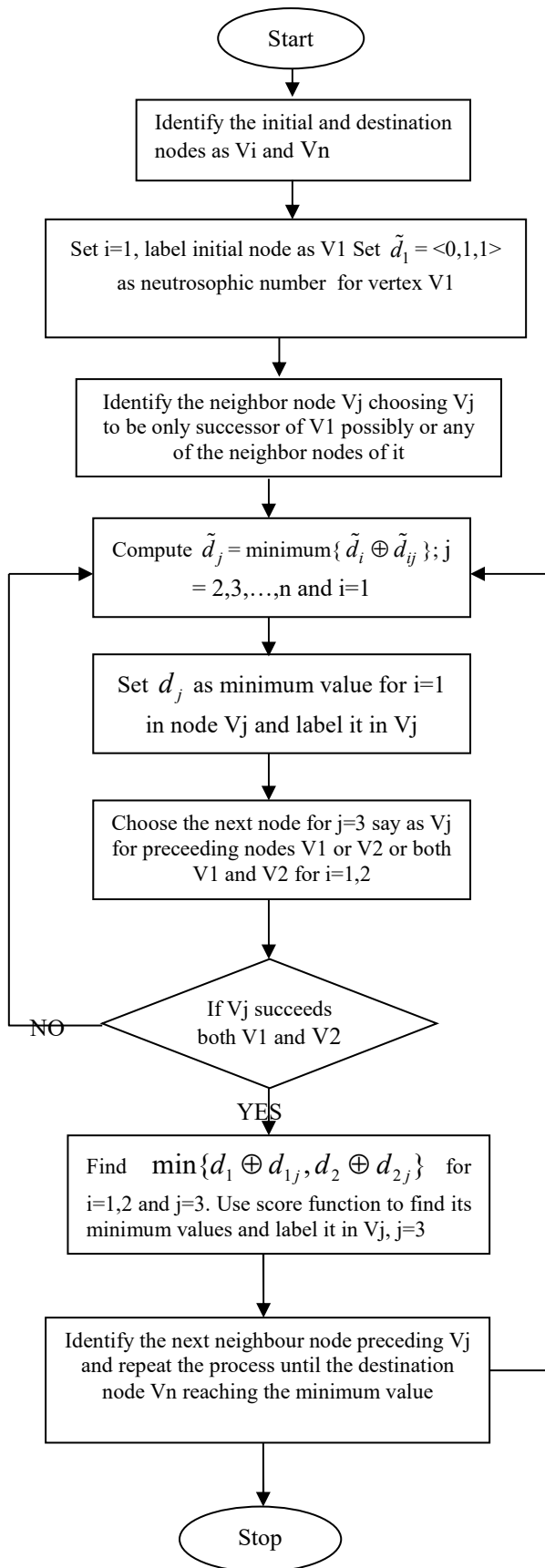

Fig 3. Flow diagram representing the neutrosophic shortest path algorithm.

Using the algorithm described in section 3, the following computational results are obtained

Since node 6 is the destination node, so $n = 6$.

assume $\tilde{d}_1 = (0, 1, 1)$ and label the source node (say node 1) as $[(0, 1, 1), -]$, the value of \tilde{d}_j ; $j = 2, 3, 4, 5, 6$ can be obtained as follows:

Iteration 1 : Since only node 1 is the predecessor node of node 2, so putting $i=1$ and $j=2$ in step2 of the proposed algorithm, the value of \tilde{d}_2 is

$$\tilde{d}_2 = \text{minimum}\{\tilde{d}_1 \oplus \tilde{d}_{12}\} = \text{minimum}\{(0, 1, 1) \oplus (0.4, 0.6, 0.7)\} = (0.4, 0.6, 0.7)$$

Since minimum occurs corresponding to $i=1$, so label node 2 as $[(0.4, 0.6, 0.7), 1]$

Iteration 2 : The predecessor node of node 3 are node 1 and node 2, so putting $i=1, 2$ and $j=3$ in step 2 of the proposed algorithm, the value of \tilde{d}_3 is $\tilde{d}_3 = \text{minimum}\{\tilde{d}_1 \oplus \tilde{d}_{13}, \tilde{d}_2 \oplus \tilde{d}_{23}\} = \text{minimum}\{(0, 1, 1) \oplus (0.2, 0.3, 0.4), (0.4, 0.6, 0.7) \oplus (0.1, 0.4, 0.6)\} = \text{minimum}\{(0.2, 0.3, 0.4), (0.46, 0.24, 0.42)\}$

$$S(0.2, 0.3, 0.4) = \frac{2+T-I-F}{3} = \frac{2+0.2-0.3-0.4}{3} = 1.5$$

$$S(0.46, 0.24, 0.42) = \frac{2+T-I-F}{3} = \frac{2+0.46-0.24-0.42}{3}$$

$$= 1.8$$

Since $S(0.2, 0.3, 0.4) < S(0.46, 0.24, 0.42)$

So $\text{minimum}\{(0.2, 0.3, 0.4) \oplus (0.46, 0.24, 0.42)\} = (0.2, 0.3, 0.4)$

Since minimum occurs corresponding to $i=1$, so label node 3 as $[(0.2, 0.3, 0.4), 1]$

Iteration 3. The predecessor node of node 4 is node 3, so putting $i=3$ and $j=4$ in step 2 of the proposed algorithm, the value of \tilde{d}_4 is $\tilde{d}_4 = \text{minimum}\{\tilde{d}_3 \oplus \tilde{d}_{34}\} = \text{minimum}\{(0.2, 0.3, 0.4) \oplus (0.5, 0.3, 0.1)\} = \{0.6, 0.09, 0.04\}$

Since minimum occurs corresponding to $i=3$, so label node 4 as $[(0.6, 0.09, 0.04), 3]$

Iteration 4 The predecessor node of node 5 are node 2 and node 3, so putting $i=2, 3$ and $j=5$ in step 2 of the proposed algorithm, the value of \tilde{d}_5 is $\tilde{d}_5 = \text{minimum}\{\tilde{d}_2 \oplus \tilde{d}_{25}, \tilde{d}_3 \oplus \tilde{d}_{35}\} = \text{minimum}\{(0.4, 0.6, 0.7) \oplus (0.7, 0.6, 0.8), (0.2, 0.3, 0.4) \oplus (0.3, 0.4, 0.7)\} = \text{minimum}\{(0.82, 0.36, 0.56), (0.44, 0.12, 0.28)\}$

$$S(0.82, 0.36, 0.56) = \frac{2+T-I-F}{3} = 1.9$$

$$S(0.44, 0.12, 0.28) = \frac{2+T-I-F}{3} = 2.04$$

Since $S(0.82, 0.36, 0.56) < S(0.44, 0.12, 0.28)$
 $\text{minimum}\{(0.82, 0.36, 0.56), (0.44, 0.12, 0.28)\} = (0.82, 0.36, 0.56)$

$$\tilde{d}_5 = (0.82, 0.36, 0.56)$$

Since minimum occurs corresponding to $i=2$, so label node 5 as $[(0.82, 0.36, 0.56), 2]$

Iteration 5 The predecessor node of node 6 are node 4 and node 5, so putting $i=4$, $j=6$ in step 2 of the proposed algorithm, the value of \tilde{d}_6 is $\tilde{d}_6 = \text{minimum}\{$

$$\tilde{d}_4 \oplus \tilde{d}_{46}, \tilde{d}_5 \oplus \tilde{d}_{56}\} = \text{minimum}\{(0.6, 0.09, 0.04) \oplus (0.7, 0.6, 0.8), (0.82, 0.36, 0.56) \oplus (0.6, 0.5, 0.3)\} = \text{minimum}\{(0.88, 0.054, 0.32), (0.93, 0.18, 0.17)\}$$

Using scoring function we have the values to be 2.5 and 2.58

Since $S(0.88, 0.054, 0.32) < S(0.93, 0.18, 0.17)$

So $\text{minimum}\{(0.88, 0.054, 0.32), (0.93, 0.18, 0.17)\} = (0.88, 0.054, 0.32)$

$$\tilde{d}_6 = (0.88, 0.054, 0.32)$$

Since minimum occurs corresponding to $i=4$, so label node 6 as $[(0.88, 0.054, 0.32), 4]$

Since node 6 is the destination node of the given network, so the neutrosophic shortest distance between node 1 and node 6 is $(0.88, 0.054, 0.32)$.

Now the neutrosophic shortest path between node 1 and node 6 can be obtained by using the following procedure:

Since node 6 is labeled by $[(0.88, 0.054, 0.32), 4]$, which represents that we are coming from node 4. Node 4 is labeled by $[(0.6, 0.09, 0.04), 3]$ which represents that we are coming from node 3. Node 3 is labeled by $[(0.2, 0.3, 0.4), 1]$, which represents that we are coming from node 1. Now the neutrosophic shortest path between node 1 and node 6 is obtained by joining all the obtained nodes. Hence the neutrosophic shortest path is $1 \rightarrow 3 \rightarrow 4 \rightarrow 6$ with the neutrosophic value $(0.88, 0.054, 0.32)$. In figure 4, the dashed lines indicate the shortest path from the source node to the destination node.

The neutrosophic shortest distance and the neutrosophic shortest path of all nodes from node 1 is shown in the table 2 and the labeling of each node is shown in figure 4

Node No.(j)	\tilde{d}_i	Neutrosophic shortest path between j^{th} and 1^{st} node
2	$(0.4, 0.6, 0.7)$	$1 \rightarrow 2$
3	$(0.2, 0.3, 0.4)$	$1 \rightarrow 3$
4	$(0.6, 0.09, 0.04)$	$1 \rightarrow 3 \rightarrow 4$
5	$(0.82, 0.36, 0.56)$	$1 \rightarrow 2 \rightarrow 5$
6	$(0.88, 0.054, 0.32)$	$1 \rightarrow 3 \rightarrow 4 \rightarrow 6$

Table 2. Tabular representation of different neutrosophic shortest paths

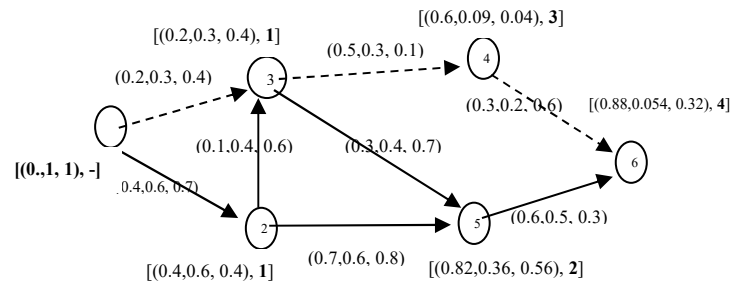

Fig.4. Network with neutrosophic shortest distance of each node from node 1

Since there is no other work on shortest path problem using single valued neutrosophic parameters for the edges (arcs), numerical comparison of this work with others work could not be done.

In this paper we find the shortest path from any source node to destination node using the Neutrosophic shortest path algorithm. The idea of this algorithm is to carry the distance function which works as a tool to identify the successor node from the source at the beginning till it reaches the destination node with a shortest path. Hence our neutrosophic shortest path algorithm is much efficient providing the fuzziness between the intervals classified with true, indeterministic and false membership values. This concept is ultimately differing with intuitionistic membership values as the case of intuitionistic considers only the true and the false membership values. Hence in neutrosophy all the cases of fuzziness is discussed and so the algorithm is effective in finding the shortest path.

V. CONCLUSION

In this paper we proposed an algorithm for finding shortest path and shortest path length from source node to destination node on a network where the edges weights are assigned by single valued neutrosophic number. The procedure of finding shortest path has been well explained and suitably discussed. Further, the implementation of the proposed algorithm is successfully illustrated with the help of an example. The algorithm is easy to understand and can be used for all types of shortest path problems with arc length as triangular neutrosophic, trapezoidal neutrosophic and interval neutrosophic numbers.

REFERENCES

- [1] A. Q. Ansari, R. Biswas & S. Aggarwal, "Neutrosophication of Fuzzy Models," IEEE Workshop On Computational Intelligence: Theories, Applications and Future Directions (hosted by IIT Kanpur), 14th July'13.
- [2] A. Kumar and M. Kaur, A New Algorithm for Solving Shortest Path Problem on a Network with Imprecise Edge Weight, Applications and Applied Mathematics, Vol. 6, Issue 2, 2011, pp. 602 – 619.

- [3] A. Kumar, and M. Kaur, Solution of fuzzy maximal flow problems using fuzzy linear programming. *World Academy of Science and Technology*, 87, 2011, pp.28-31.
- [4] A.Thamaraiselvi and R.Santhi, A New Approach for Optimization of Real Life Transportation Problems in Neutrosophic Environment, *Mathematical Problems in Engineering*,2016, 9 pages.
- [5] A. Q. Ansari, R. Biswas& S. Aggarwal, "Extension to fuzzy logic representation: Moving towards neutrosophic logic - A new laboratory rat," *Fuzzy Systems (FUZZ)*, 2013 IEEE International Conference, 2013, pp.1 –8.
- [6] F. Smarandache, "Refined Literal Indeterminacy and the Multiplication Law of Sub-Indeterminacies," *Neutrosophic Sets and Systems*, Vol. 9, 2015, pp.58.63.
- [7] F. Smarandache, "Types of Neutrosophic Graphs and neutrosophic Algebraic Structures together with their Applications in Technology," seminar, Universitatea Transilvania din Brasov, Facultatea de Design de Prodsuși Mediu, Brasov, Romania 06 June 2015.
- [8] F. Smarandache, "Neutrosophic set - a generalization of the intuitionistic fuzzy set," *Granular Computing*, 2006 IEEE International Conference, 2006, p. 38 – 42.
- [9] F. Smarandache, "A geometric interpretation of the neutrosophic set — A generalization of the intuitionistic fuzzy set," *Granular Computing (GrC)*, 2011 IEEE International Conference, 2011, pp.602–606 .
- [10] G. Garg, K. Bhutani, M. Kumar and S. Aggarwal, "Hybrid model for medical diagnosis using Neutrosophic Cognitive Maps with Genetic Algorithms," *FUZZ-IEEE*, 2015, 6page.
- [11] H. Wang, Y. Zhang, R. Sunderraman, "Truth-value based interval neutrosophic sets," *Granular Computing*, 2005 IEEE International Conference, vol. 1, 2005, pp. 274 – 277.
- [12] H. Wang, F. Smarandache, Y. Zhang, and R. Sunderraman, "Single valued Neutrosophic Sets," *MultiSpace and MultiStructure 4*, 2010, pp. 410-413.
- [13] H. Wang, F. Smarandache, Zhang, Y.-Q. and R. Sunderraman, "Interval Neutrosophic Sets and Logic: Theory and Applications in Computing," *Hexis*, Phoenix, AZ, 2005.
- [14] H.J. Zimmermann, *Fuzzy Set Theory and its Applications*, Kluwer-Nijhoff, Boston, 1985.
- [15] I. Deli, M.Ali, F. Smarandache, "Bipolar neutrosophic sets and their application based on multi-criteria decision making problems," *Advanced Mechatronic Systems (ICAMEchS)*, 2015 International Conference, 2015, pp.249 – 254.
- [16] I. Deli, S. Yusuf, F. Smarandache and M. Ali, Interval valued bipolar neutrosophic sets and their application in pattern recognition, *IEEE World Congress on Computational Intelligence 2016*.
- [17] I. Deli and Y.Subas, A Ranking methods of single valued neutrosophic numbers and its application to multi-attribute decision making problems, *International Journal of Machine Learning and Cybernetics*, 2016, pp.1-14.
- [18] I. Turksen, "Interval valued fuzzy sets based on normal forms," *Fuzzy Sets and Systems*, vol. 20,1986, pp. 191-210.
- [19] J. Ye, "Single-Valued Neutrosophic Minimum Spanning Tree and Its Clustering Method," *Journal of Intelligent Systems* 23(3), 2014, pp. 311–324.
- [20] J. Ye, "Another form of correlation coefficient between single valued neutrosophic sets and its multiple attribute decision-making method," *Neutrosophic Sets and Systems*, 1(1), 2013, pp. 8-12.
- [21] J. Ye. Trapezoidal fuzzy neutrosophic set and its application to multiple attribute decision making. *Neural Computing and Applications*, 2014. DOI 10.1007/s00521-014-1787-6.
- [22] K. Atanassov, "Intuitionistic fuzzy sets," *Fuzzy Sets and Systems*, vol. 20, 1986, pp. 87-96.
- [23] K. Atanassov, "Intuitionistic fuzzy sets: theory and applications," *Physica*, New York, 1999.
- [24] K. Atanassov and G. Gargov, Interval valued intuitionistic fuzzy sets, *Fuzzy Sets and Systems*, vol.31, 1989, pp. 343-349.
- [25] K. Georgiev, A Simplification of the Neutrosophic Sets. *Neutrosophic Logic and Intuitionistic Fuzzy Sets*. NIFS vol 11, 2015, pp.28-31.
- [26] L. Zadeh, *Fuzzy sets*. *Inform and Control*, 8, 1965, pp.338-353
- [27] M. Ali, and F. Smarandache, "Complex Neutrosophic Set," *Neural Computing and Applications*, Vol. 25, 2016, pp.1-18.
- [28] M. Ali, I. Deli, F. Smarandache, "The Theory of Neutrosophic Cubic Sets and Their Applications in Pattern Recognition," *Journal of Intelligent and Fuzzy Systems*, (In press), pp. 1-7.
- [29] P. Biswas, S.Parmanik and B.C.Giri, Cosine Similarity Measure Based Multi-attribute Decision-Making with Trapezoidal fuzzy Neutrosophic numbers, *Neutrosophic sets and systems*,8, 2014, pp.47-57.
- [30] P. Jayagowri and G. GeethaRamani, Using Trapezoidal Intuitionistic Fuzzy Number to Find Optimized Path in a Network, Volume 2014, *Advances in Fuzzy Systems*, 2014, 6 pages.
- [31] R. Şahin, "Neutrosophic hierarchical clustering algorithms," *Neutrosophic Sets and Systems*, vol 2, 2014, pp.18-24.
- [32] S. Broumi, M. Talea, A. Bakali, F. Smarandache, "Single Valued Neutrosophic Graphs," *Journal of New Theory*, N 10, 2016, pp. 86-101.
- [33] S. Broumi, M. Talea, A. Bakali, F. Smarandache, "On Bipolar Single Valued Neutrosophic Graphs," *Journal of New Theory*, N11, 2016, pp.84-102.
- [34] S. Broumi, M. Talea, A. Bakali, F. Smarandache, Interval Valued Neutrosophic Graphs, *SISOM & ACOUSTICS 2016*, Bucharest 12-13 May, pp.79-91.
- [35] S. Broumi, A. Bakali, M. Talea, and F. Smarandache, Isolated Single Valued Neutrosophic Graphs. *Neutrosophic Sets and Systems*, Vol. 11, 2016, pp.74-78.
- [36] S. Broumi, F. Smarandache, M. Talea and A. Bakali, An Introduction to Bipolar Single Valued Neutrosophic Graph Theory. *Applied Mechanics and Materials*, vol.841, 2016, pp.184-191.
- [37] S. Broumi, M. Talea, F. Smarandache and A. Bakali, Single Valued Neutrosophic Graphs: Degree, Order and Size. *IEEE International Conference on Fuzzy Systems (FUZZ)*,2016, pp. 2444-2451.
- [38] S. Broumi, F. Smarandache, "New distance and similarity measures of interval neutrosophic sets," *Information Fusion (FUSION)*, 2014 IEEE 17th International Conference, 2014, pp. 1 – 7.
- [39] S. Majumder and A. Pal, Shortest Path Problem on Intuitionistic Fuzzy Network, *Annals of Pure and Applied Mathematics*, Vol. 5, No. 1, November 2013, pp. 26-36.
- [40] Y.Subas, Neutrosophic numbers and their application to multi-attribute decision making problems,(in Turkish) (master Thesis, 7 Arak university, Graduate School of Natural and Applied Science, 2015.
- [41] A. A. Salama and S.A.Alblowi, Neutrosophic Set and Neutrosophic Topological Spaces, *IOSR Journal of Math*, vol 3, issue 4, 2012, pp.31-35

Theory of Neutrosophic Evolution: Degrees of Evolution, Indeterminacy, and Involution

Florentin Smarandache

Florentin Smarandache (2017). Theory of Neutrosophic Evolution: Degrees of Evolution, Indeterminacy, and Involution. *Progress in Nonlinear Dynamics and Chaos* 5(1), 10; DOI: 10.22457/pindac.v5n1a1

Abstract. During the process of adaptation of a being (plant, animal, or human), to a new environment or conditions, the being partially *evolves*, partially *devolves* (degenerates), and partially is *indeterminate* {i.e. neither evolving nor devolving, therefore unchanged (neutral), or the change is unclear, ambiguous, vague}, as in neutrosophic logic. Thank to adaptation, one therefore has: *evolution*, *involution*, and *indeterminacy* (or *neutrality*), each one of these three neutrosophic components in some degree.

The degrees of evolution / indeterminacy / involution are referred to both: the *structure* of the being (its body parts), and *functionality* of the being (functionality of each part, or inter-functionality of the parts among each other, or functionality of the being as a whole).

We therefore introduce now for the first time the *Neutrosophic Theory of Evolution, Involution, and Indeterminacy (or Neutrality)*.

Keywords: neutrosophic logic, evolution, involution, indeterminacy

1. Introduction

During the 2016-2017 winter, in December-January, I went to a cultural and scientific trip to Galápagos Archipelago, Ecuador, in the Pacific Ocean, and visited seven islands and islets: Mosquera, Isabela, Fernandina, Santiago, Sombrero Chino, Santa Cruz, and Rabida, in a cruise with Golondrina Ship. I had extensive discussions with our likeable guide, señor Milton Ulloa, about natural habitats and their transformations.

After seeing many animals and plants, that evolved differently from their ancestors that came from the continental land, I consulted, returning back to my University of New Mexico, various scientific literature about the life of animals and plants, their reproductions, and about multiple theories of evolutions. I used the online scientific databases that UNM Library (<http://library.unm.edu/>) has subscribed to, such as: MathSciNet, Web of Science, EBSCO, Thomson Gale (Cengage), ProQuest, IEEE/IET Electronic Library, IEEE Xplore Digital Library etc., and DOAJ, Amazon Kindle, Google Play Books as well, doing searches for keywords related to origins of life, species, evolution, controversial ideas about evolution, adaptation and in adaptation, life curiosities, mutations, genetics, embryology, and so on.

My general conclusion was that each evolution theory had some degree of truth, some degree of indeterminacy, and some degree of untruth (as in neutrosophic logic),

depending on the types of species, environment, timespan, and other hidden parameters that may exist.

And all these degrees are different from a species to another species, from an environment to another environment, from a timespan to another timespan, and in general from a parameter to another parameter.

By environment, one understands: geography, climate, preys and predators of that species, i.e. the whole ecosystem.

I have observed that the animals and plants (and even human beings) not only *evolve*, but also *devolve* (i.e. involve back, decline, atrophy, pass down, regress, degenerate). Some traits increase, other traits decrease, while others remain unchanged (neutrality).

One also sees: adaptation by physical or functional evolution of a body part, and physical or functional involution of another body part, while other body parts and functions remain unchanged. After evolution, a new process starts, re-evaluation, and so on.

In the society it looks that the most opportunistic (which is the fittest!) succeeds, not the smartest. And professional deformation signifies evolution (specialization in a narrow field), and involution (incapability of doing things in another field).

The paper is organized as follows: some information on taxonomy, species, a short list of theories of origin of life, another list of theories and ideas about evolution. Afterwards the main contribution of this paper, the *theory of neutrosophic evolution*, the dynamicity of species, several examples of evolution, involution, and indeterminacy (neutrality), neutrosophic selection, refined neutrosophic theory of evolution, and the paper ends with open questions on evolution / neutrality / involution.

2. Taxonomy

Let's recall several notions from classical biology.

The **taxonomy** is a classification, from a scientifically point of view, of the living things, and it classifies them into three categories: **species**, **genus**, and **family**.

3. Species

A **species** means a group of organisms, living in a specific area, sharing many characteristics, and able to reproduce with each other.

In some cases, the distinction between a population subgroup to be a different species, or not, is unclear, as in the *Sorites Paradoxes* in the frame of *neutrosophy*: the frontier between <A> (where <A> can be a species, a genus, or a family), and <non A> (which means that is not <A>) is vague, incomplete, ambiguous. Similarly, for the distinction between a series and its subseries.

4. Theories of origin of life

Louis Pasteur (1822-1895) developed in 1860 the theory of *precellular (prebiotic) evolution*, which says that life evolved from non-living chemical combinations that, over long time, arose spontaneously.

In the late 19th century a theory, called *abiogenesis*, promulgated that the living organisms originated from lifeless matter spontaneously, without any living parents' action.

Carl R. Woese (b. 1928) has proposed in 1970's that the *progenotes* were the very first living cells, but their biological specificity was small. The genes were considered probable (rather than identical) proteins.

John Burdon Sanderson Haldane (1872-1964) proposed in 1929 the *theory that the viruses were precursors to the living cells* [1].

John Bernal and A. G. Cairns-Smith stated in 1966 *the mineral theory*: that life evolved from inorganic crystals found in the clay, by natural selection [2].

According to the *little bags theory of evolution*, the life is considered as having evolved from organic chemicals that happened to get trapped in some tiny vesicles.

Eigen and Schuster, adepts of *the hypercycle theory*, asserted in 1977 that the precursors of single cells were these little bags, and their chemical reactions cycles were equivalent to the life's functionality [3].

Other theories about the origin of life have been proposed in the biology literature, such as: *primordial soup*, *dynamic state theory*, and *phenotype theory*, but they were later dismissed by experiments.

5. Theories and ideas about evolution

The theory of *fixism* says that species are fixed, they do not evolve or devolve, and therefore the today's species are identical to the past species.

Of course, the *creationism* is a fixism theory, from a religious point of view. Opposed to the fixism is the theory of *transformism*, antecedent to the evolutionary doctrine, in the pre-Darwinian period, which asserts that plants and animals are modified and transformed gradually from one species into another through many generations [22].

Jean Baptiste Pierre Antoine de Monet Lamarck (1749-1829), in 1801, ahead of Charles Darwin, is associated with the *theory of inheritance of acquired characteristics* (or *use-inheritance*), and even of *acquired habits*. Which is called *Lamarckism* or *Lamarckian Evolution*.

If an animal repeatedly stresses in the environment, its body part under stress will modify in order to overcome the environmental stress, and the modification will be transmitted to its offspring.

For example: the giraffe having a long neck in order to catch the tree leaves [4].

Herbert Spencer (1820-1903) used for the first time the term *evolution* in biology, showing that a population's gene pool changes from a generation to another generation, producing new species after a time [5].

Charles Darwin (1809-1882) introduced the *natural selection*, meaning that individuals that are more endowed with characteristics for reproduction and survival will prevail ("selection of the fittest"), while those less endowed would perish [6].

Darwin had also explained the structure similarities of leaving things in genera and families, due to the common descent of related species [7].

In his *gradualism* (or *phyletic gradualism*), Darwin said that species evolve slowly, rather than suddenly.

The adaptation of an organism means nervous response change, after being exposed to a permanent stimulus.

In the *modern gradualism*, from the genetic point of view, the beneficial genes of the individuals best adapted to the environment, will have a higher frequency into the population over a period of time, giving birth to a new species [8].

Herbert Spencer also coined the phrase *survival of the fittest* in 1864, that those individuals the best adapted to the environment are the most likely to survive and reproduce.

Alfred Russel Wallace (1823-1913) coined in 1828 the terms *Darwinism* (individuals the most adapted to environment pass their characteristics to their offspring), and *Darwinian fitness* (the better adapted, the better surviving chance) [9].

One has upward evolution {*anagenesis*, coined by Alpheus Hyatt (1838-1902) in 1889}, as the progressive evolution of the species into another [10], and a *branching evolution* {*cladogenesis*, coined by Sir Julian Sorell Huxley (1887-1975) in 1953}, when the population diverges and new species evolve [11].

George John Romanes (1848-1894) coined the word *neo-Darwinism*, related to natural selection and the theory of genetics that explains the *synthetic theory of evolution*. What counts for the natural selection is the gene frequency in the population [12]. The Darwinism is put together with the paleontology, systematics, embryology, molecular biology, and genetics.

In the 19th century Gregor Johann Mendel (1822-1884) set the base of *genetics*, together with other scientists, among them Thomas Hunt Morgan (1866-1945).

The *Mendelism* is the study of heredity according to the chromosome theory: the living thing reproductive cells contain factors which transmit to their offspring particular characteristics [13].

August Weismann (1834-1914) in year 1892 enounced the *germ plasm theory*, saying that the offspring do not inherit the acquired characteristics of the parents [14].

Hugo de Vries (1848-1935) published a book in 1901/1903 on *mutation theory*, considering that randomly genetic mutations may produce new forms of living things. Therefore, new species may occur suddenly [15].

Louis Antoine Marie Joseph Dollo (1857-1931) enunciated the *Dollo's principle* (*law or rule*) that evolution is irreversible, i.e. the lost functions and structures in species are not regained by future evolving species.

In the present, the *synergetic theory of evolution* considers that one has a natural or artificial multipolar selection, which occurs at all life levels, from the molecule to the ecosystem – not only at the population level.

But nowadays it has been discovered organisms that have re-evolved structured similar to those lost by their ancestors [16].

!Life is... complicated!

The genetic assimilation {for *Baldwin Effect*, after James Mark Baldwin (1861-1934)} considered that an advantageous trait (or phenotype) may appear in several individuals of a population in response to the environmental cues, which would determine the gene responsible for the trait to spread through this population [17].

The British geneticist Sir Ronald A. Fisher (1890-1962) elaborated in 1930 *the evolutionary or directional determinism*, when a trait of individuals is preferred for the new generations (for example the largest grains to replant, chosen by farmers) [18].

The *theory of speciation* was associated with Ernst Mayr (b. 1904) and asserts that because of geographic isolation new species arise, that diverge genetically from the larger original population of sexually reproducing organisms. A subgroup becomes new species if its distinct characteristics allow it to survive and its genes do not mix with other species [19].

In the 20th century, Trofim Denisovitch Lysenko (1898-1976) revived the Lamarckism to the *Lysenkoism* school of genetics, proclaiming that the new characteristics acquired by parents will be passed on to the offspring [20].

Richard Goldschmidt (1878-1958) in 1940 has coined the terms of *macroevolution*, which means evolution from a long time span (geological) perspective, and *microevolution*, which means evolution from a small timespan (a few generations) perspective with observable changes [1].

Sewall Wright (1889-1988), in the mid-20th century, developed the *founders effect of principle*, that in isolated places population arrived from the continent or from another island, becomes little by little distinct from its original place population. This is explained because the founders are few in number and therefore the genetic pool is smaller in diversity, whence their offspring are more similar in comparison to the offspring of the original place population.

The founders effect or principle is regarded as a particular case of the *genetic drift* (by the same biologist, Sewall Wright), which tells that the change in gene occurs by chance [21].

The mathematician John Maynard Smith has applied the game theory to animal behavior and in 1976 he stated *the evolutionary stable strategy* in a population. It means that, unless the environment changes, the best strategy will evolve, and persist for solving problems.

Other theories related to evolution such as: *punctuated equilibrium* (instantaneous evolution), *hopeful monsters*, and *saltation (quantum) speciation* (that new species suddenly occur; by Ernst Mayr) have been criticized by the majority of biologists.

6. Open research

By genetic engineering it is possible to make another combination of genes, within the same number of chromosomes. Thus, it is possible to mating a species with another closer species, but their offspring is sterile (the offspring cannot reproduce).

Despite the tremendous genetic engineering development in the last decades, there has not been possible to prove by experiments in the laboratory that: from an inorganic matter one can make organic matter that may reproduce and assimilate energy; nor was possible in the laboratory to transform a species into a new species that has a number of chromosomes different from the existent species.

7. Involution

According to several online dictionaries, **involution** means:

— Decay, retrogression or shrinkage in size; or return to a former state [Collins Dictionary of Medicine, Robert M. Youngson, 2005];

— Returning of an enlarged organ to normal size; or turning inward of the edges of a part; mental decline associated with advanced age (psychiatry) [Medical Dictionary for the Health Professions and Nursing, Farlex, 2012];

— Having rolled-up margins (for the plant organs) [Collins Dictionary of Biology, 3rd edition, W.G. Hale, V.A. Saunders, J.P. Margham, 2005];

— A retrograde change of the body or of an organ [Dorland's Medical Dictionary for Health Consumers, Saunders, an imprint of Elsevier, Inc., 2007];

— A progressive decline or degeneration of normal physiological functioning [The American Heritage, Houghton Mifflin Company, 2007].

8. Theory of neutrosophic evolution

During the process of adaptation of a being (plant, animal, or human) B, to a new environment η ,

- B partially *evolves*;
- B partially *devolves* (involves, regresses, degenerates);
- and B partially remains *indeterminate* {which means *neutral*(unchanged), or ambiguous – i.e. not sure if it is evolution or involution}.

Any action has a reaction. We see, thank to adaptation: evolution, involution, and neutrality (indeterminacy), each one of these three *neutrosophic components* in some degree.

The degrees of evolution / indeterminacy / involution are referred to both: the **structure** of B (its body parts), and **functionality** of B (functionality of each part, or inter-functionality of the parts among each other, or functionality of B as a whole).

Adaptation to new environment conditions means **de-adaptation** from the old environment conditions.

Evolution in one direction means involution in the opposite direction.

Loosing in one direction, one has to gain in another direction in order to survive (for equilibrium). And reciprocally.

A species, with respect to an environment, can be:

- in equilibrium, disequilibrium, or indetermination;
- stable, unstable, or indeterminate (ambiguous state);
- optimal, suboptimal, or indeterminate.

One therefore has a **Neutrosophic Theory of Evolution, Involution, and Indeterminacy** (neutrality, or fluctuation between Evolution and Involution). The evolution, the involution, and the indeterminate-evolution depend not only on natural selection, but also on many other factors such as: artificial selection, friends and enemies, bad luck or good luck, weather change, environment juncture etc.

9. Dynamicity of the species

If the species is in indeterminate (unclear, vague, ambiguous) state with respect to its environment, it tends to converge towards one extreme:

either to equilibrium / stability / optimality, or to disequilibrium / instability / suboptimality with respect to an environment;

therefore the species either rises up gradually or suddenly by mutation towards equilibrium / stability / optimality;

or the species deeps down gradually or suddenly by mutation to disequilibrium / instability / suboptimality and perish.

The **attraction point** in this neutrosophic dynamic system is, of course, the state of equilibrium / stability / optimality. But even in this state, the species is not fixed, it may get, due to new conditions or accidents, to a degree of disequilibrium / instability / suboptimality, and from this new state again the struggle on the long way back of the species to its attraction point.

10. Several examples of evolution, involution, and indeterminacy (neutrality)

10.1. Cormorants example

Let's take the flightless cormorants (*Nannopterum harrisi*) in Galápagos Islands, their wings and tail have atrophied (hence **devolved**) due to their no need to fly (for they having no predators on the land), and because their permanent need to dive on near-shore bottom after fish, octopi, eels etc.

Their avian breastbone vanished (**involution**), since no flying muscles to support were needed.

But their neck got longer, their legs stronger, and their feet got huge webbed in order to catch fish underwater (**evolution**).

Yet, the flightless cormorants kept several of their ancestors' habits (functionality as a whole): make nests, hatch the eggs etc. (hence **neutrality**).

10.2. Cosmos example

The astronauts, in space, for extended period of time get accustomed to low or no gravity (**evolution**), but they lose bone density (**involution**). Yet other body parts do not change, or it has not been found out so far (**neutrality / indeterminacy**).

10.3. Example of evolution and involution

The whales **evolved** with respect to their teeth from pig-like teeth to cusped teeth. Afterwards, the whales **devolved** from cusped teeth back to conical teeth without cusps.

10.4. Penguin example

The Galápagos Penguin (*Spheniscus mendiculus*) **evolved** from the Humboldt Penguin by shrinking its size at 35 cm high (adaptation by **involution**) in order to be able to stay cool in the equatorial sun.

10.5. Frigate birds example

The Galápagos Frigate birds are birds that lost their ability to dive for food, since their feathers are not waterproof (**involution**), but they became masters of faster-and-maneuverable flying by stealing food from other birds, called kleptoparasite feeding (**evolution**).

10.6. Example of Darwin's finches

The 13 Galápagos species of Darwin's Finches manifest various degrees of evolution upon their beak, having different shapes and sizes for each species in order to gobble different types of foods (hence **evolution**):

- for cracking hard seeds, a thick beak (ground finch);
- for insects, flowers and cacti, a long and slim beak (another finch species).

Besides their beaks, the finches look similar, proving they came from a common ancestor (hence **neutrality**).

If one experiments, let's suppose one moves the thick-beak ground finches back to an environment with soft seeds, where it is not needed a thick beak, then the thick beak will atrophy and, in time, since it becomes hard for the finches to use the heavy beak, the thin-beak finches will prevail (hence **involution**).

10.7. El Niño example

Professor of ecology, ethology, and evolution Martin Wikelski, from the University of Illinois at Urbana – Champaign, has published in the journal "Nature" a curious report, regarding data he and his team collected about marine iguanas since 1987. During the 1997 – 1998 El Niño, the marine algae died, and because the lack of food, on one of the Galápagos islands some marine iguanas shrank a quarter of their length and lost half of their weight (adaptation by **involution**).

After plentiful of food became available again, the marine iguanas grew back to their original length and weight (re-adaptation by **evolution**).

[J. Smith, J. Brown, The Incredible Shrinking Iguanas, in Ecuador & The Galápagos Islands, Moon Handbook, Avalon Travel, p. 325.]

10.8. Bat example

The bats are the only mammals capable of naturally flying, due to the fact that the irforelimbs have developed into web bed wings (**evolution** by transformation). But navigating and foraging in the darkness, have caused their eyes' functionality to diminish (**involution**), yet the bats "see" with their ears (**evolution** by transformation) using the echolocation (or the bio sonar) in the following way: the bats emit sounds by mouth (one emitter), and their ears receive echoes (two receivers); the time delay (between emission and reception of the sound) and the relative intensity of the received sound give to the bats information about the distance, direction, size and type of animal in its environment.

10.9. Mole example

For the moles, mammals that live underground, the ireyes and ears have degenerated and become minuscule since their functions are not much needed (hence adaptation by **involution**), yet therefore limbs became more power ful and their paws larger for better digging (adaptation by **evolution**).

11. Neutrosophic selection with respect to a population of a species means that over a specific time span a percentage of its individuals evolve, another percentage of individuals devolve, and a third category of individuals do not change or their change is indeterminate (not knowing if it is evolution or involution). We may have a natural or artificial neutrosophic selection.

12. Refined neutrosophic theory of evolution is an extension of the neutrosophic theory of evolution, when the degrees of evolution / indeterminacy / involution are considered separately with respect to each body part, and with respect to each body part functionality, and with respect to the whole organism functionality.

13. Open questions on evolution / neutrality / involution

13.1. How to measure the degree of evolution, degree of involution, and degree of indeterminacy (neutrality) of a species in a given environment and a specific timespan?

13.2. How to compute the degree of similarity to ancestors, degree of dissimilarity to ancestors, and degree of indeterminate similarity-dissimilarity to ancestors?

13.3. Experimental Question. Let's suppose that a partial population of species S_1 moves from environment η_1 to a different environment η_2 ; after a while, a new species S_2 emerges by adaptation to η_2 ; then a partial population S_2 moves back from η_2 to η_1 ; will S_2 evolve back (actually devolve to S_1)?

13.4. Are all species needed by nature, or they arrived by accident?

14. Conclusion

We have introduced for the first time the concept of *Neutrosophic Theory of Evolution, Indeterminacy (or Neutrality), and Involution*.

For each being, during a long time span, there is a process of partial evolution, partial indeterminacy or neutrality, and partial involution with respect to the being body parts and functionalities.

The function creates the organ. The lack of organ functioning, brings atrophy to the organ. In order to survive, the being has to adapt. One has adaptation by evolution, or adaptation by involution – as many examples have been provided in this paper. The being partially evolves, partially devolves, and partially remains unchanged (fixed) or its process of evolution–involution is indeterminate. There are species partially adapted and partially struggling to adapt.

REFERENCES

1. M.Barbieri, *The Semantic Theory of Evolution*, Chur, Switzerland, 1985.
2. A.G.Cairns-Smith, *The Origin of Life and the Nature of Primitive Gene*, Journal of Theoretical Biology, X (1966) 53-88.
3. M.Eigen and P.Schuster, *The Hypercycle. A Principle of Natural Self-Organization*, in Naturwissenschaften, LXIV (1977) 541-565.
4. J.B.Lamarck, *Zoological Philosophy*, 1809.
5. J.Reader, *The Rise of Life*, New York, 1988
6. E.Sober, *The Nature of Selection*, Cambridge, MA, 1984.
7. D.Kohn, *The Darwinian Heritage*, Princeton, NJ, 1985.
8. N.Eldredge, *Life Pulse: Episodes from the Story of the Fossil Record*, New York, 1987.
9. A.R.Wallace, *Darwinism: An Exposition of the Theory of Natural Selection with Some of its Applications*, 1889.
10. J.Brown, *Biogeography*, St. Louis, Mo, 1983.
11. E.Delson, *Ancestors: The Hard Evidence*, New York, 1985.
12. P.Bowler, *Evolution: The History of an Idea*, Berkeley, California, 1984.
13. R.Olby, *The Origins of Mendelism*, London-Chicago, 1985.
14. A.Weismann, *The Germ Plasm: A Theory of Heredity*, London, 1893.
15. H.de Vries, *Mutationstheorie [Mutation Theory]*, 1901 and 1903.
16. R.Milner, *The Encyclopedia of Evolution: Humanity's Search for its Origins*, New York, 1987.
17. F.Hitching, *The Neck of the Giraffe: Where Darwin Went Wrong*, New Haven, Connecticut, 1987.
18. N.Eldredge, *Unfinished Synthesis*, Oxford, 1985.
19. M.Ereshefsky, *The Units of Evolution: Essays on the Nature of Species*, Cambridge, Massachusetts, 1992.

20. D.Joravsky, *The Lysenko Affair*, Cambridge, Massachusetts, 1970.
21. F.Magill, *Magill's Survey of Science: Life Science Series*, Englewood Cliffs, NJ. 1991.
22. The Great Soviet Encyclopedia, 3rd Edition (1970-1970), The Gale Group, Inc., 2010.
23. Linfan Mao, *Biological n-System with Global Stability*, International Conference on Applications of Mathematics in Topological Dynamics, Physica, Biological and Chemical Systems, Kolkata, India, December 9 - 11, 2016.
24. F.Smarandache, *Galápagos sau Ținutul Broaștelor Țestoase Gigantice / Teoria Neutrosifică a Evoluției*, fotovideo jurnalinstantaneu, Editura Agora, Sibiu, 2017.

An Extension of Neutrosophic AHP–SWOT Analysis for Strategic Planning and Decision-Making

Mohamed Abdel-Basset, Mai Mohamed, Florentin Smarandache

Mohamed Abdel-Basset, Mai Mohamed, Florentin Smarandache (2018). An Extension of Neutrosophic AHP–SWOT Analysis for Strategic Planning and Decision-Making. *Symmetry* 10, 116; DOI: 10.3390/sym10040116

Abstract: Every organization seeks to set strategies for its development and growth and to do this, it must take into account the factors that affect its success or failure. The most widely used technique in strategic planning is SWOT analysis. SWOT examines strengths (S), weaknesses (W), opportunities (O) and threats (T), to select and implement the best strategy to achieve organizational goals. The chosen strategy should harness the advantages of strengths and opportunities, handle weaknesses, and avoid or mitigate threats. SWOT analysis does not quantify factors (i.e., strengths, weaknesses, opportunities and threats) and it fails to rank available alternatives. To overcome this drawback, we integrated it with the analytic hierarchy process (AHP). The AHP is able to determine both quantitative and the qualitative elements by weighting and ranking them via comparison matrices. Due to the vague and inconsistent information that exists in the real world, we applied the proposed model in a neutrosophic environment. A real case study of Starbucks Company was presented to validate our model.

Keywords: analytic hierarchy process (AHP); SWOT analysis; multi-criteria decision-making (MCDM) techniques; neutrosophic set theory

1. Introduction

To achieve an organization's goals, the strategic factors affecting its performance should be considered. These strategic factors are classified as internal factors, that are under its control, and external factors, that are not under its control.

The most popular technique for analyzing strategic cases is SWOT analysis. SWOT is considered a decision-making tool. The SWOT acronym stands for Strengths, Weaknesses, Opportunities and Threats [1]. Strengths and weaknesses are internal factors, while opportunities and threats are external factors. The successful strategic plan of an organization should focus on strengths and opportunities, try to handle weaknesses, and avoid or mitigate threats.

By using SWOT analysis, an organization can choose one of four strategic plans as follows:

- SO: The good use of opportunities through existing strengths.
- ST: The good use of strengths to eliminate or reduce the impact of threats.
- WO: Taking into account weaknesses to obtain the benefits of opportunities.
- WT: Seeking to reduce the impact of threats by considering weaknesses.

SWOT analysis can be used to build successful company strategies, but it fails to provide evaluations and measures. Therefore, in the present research, we integrated it with the neutrosophic analytic hierarchy process (AHP).

The analytic hierarchy process (AHP) is a multi-criterion decision-making technique (MCDM) used for solving and analyzing complex problems. MCDM is an important branch in operations research, when seeking to construct mathematical and programming tools to select the superior alternative between various choices, according to particular criteria.

The AHP consists of several steps. The first step is structuring the hierarchy of the problem to understand it more clearly. The hierarchy of the AHP consists of a goal (objective), decision criteria, sub-criteria, and, finally, all available alternatives.

After structuring the AHP hierarchy, pair-wise comparison matrices are constructed by decision makers to weight criteria using Saaty's scale [2].

Finally, the final weight of alternatives are determined and ranked.

Then, the AHP is able to estimate both qualitative and the quantitative elements. For this reason, it is one of the most practical multi-criteria decision-making techniques [3].

In real life applications, decision criteria are often vague, complex and inconsistent in nature. In addition, using crisp values in a comparison matrix is not always accurate due to uncertainty and the indeterminate information available to decision makers. Many researchers have begun to use fuzzy set theory [4]. However, fuzzy set theory considers only a truth-membership degree. Atanassov introduced intuitionistic fuzzy set theory [5], which considers both truth and falsity degrees, but it fails to consider indeterminacy. To deal with the previous drawbacks of fuzzy and intuitionistic fuzzy sets, Smarandache introduced neutrosophic sets [6], which consider truth, indeterminacy and falsity degrees altogether to represent uncertain and inconsistent information. Therefore, neutrosophic sets are a better representation of reality. For this reason, in our research, we employed the AHP under a neutrosophic environment.

This research represents the first attempt at combining SWOT analysis with a neutrosophic analytic hierarchy process.

The structure of this paper is as follows: a literature review of SWOT analysis and the AHP is presented in Section 2; the basic definitions of neutrosophic sets are introduced in Section 3; the proposed model is discussed in Section 4; a real case study illustrates the applicability of the model proposed in Section 5; and, finally, Section 6 concludes the paper, envisaging future work.

2. Literature Review

In this section, we present an overview of the AHP technique and SWOT analysis, which are used across various domains.

SWOT analysis [7] is a practical methodology pursued by managers to construct successful strategies by analyzing strengths, weaknesses, opportunities and threats. SWOT analysis is a powerful methodology for making accurate decisions [8]. Organization's construct strategies to enhance their strengths, remove weaknesses, seize opportunities, and avoid threats.

Kotler et al. used SWOT analysis to attain an orderly approach to decision-making [9–11]. Many researchers in different fields [4] apply SWOT analysis. An overview of the applications of SWOT analysis is given by Helms and Nixon [8]. SWOT analysis has been applied in the education domain by Dyson [12]. It has also been applied to healthcare, government and not-for-profit organizations, to handle country-level issues [13] and for sustainable investment-related decisions [14]. It has been recommended for use when studying the relationships among countries [15]. SWOT analysis is mainly qualitative. This is the main disadvantage of SWOT, because it cannot assign strategic factor weights to alternatives. In order to overcome this drawback, many researchers have integrated it with the analytic hierarchy process (AHP).

Since the AHP is convenient and easy to understand, some managers find it a very useful decision-making technique. Vaidya and Kumar reviewed 150 publications, published in international journals between 1983 and 2003, and concluded that the AHP technique was useful for solving, selecting, evaluating and making decisions [16]. Achieving a consensus decision despite the large number of decision makers is another advantage of the AHP [17].

Several researchers have combined SWOT analysis methodology with the analytic hierarchy process (AHP). Leskinen et al. integrated SWOT with the AHP in an environmental domain [18–20], Kajanus used SWOT–AHP in tourism [21], and Setwart used SWOT–AHP in project management [22]. Competitive strength, environment and company strategy, were integrated by Chan and Heide [23]. Because the classical version of the AHP fails to handle uncertainty, many researchers have integrated SWOT analysis with the fuzzy AHP (FAHP). Demirtas et al. used SWOT with the fuzzy AHP for project management methodology selection [24]. Lumaksono used SWOT-FAHP to define the best strategy of expansion for a traditional shipyard [25]. Tavana et al. integrated SWOT analysis with intuitionistic fuzzy AHP to outsource reverse logistics [26].

Fuzzy sets focus only on the membership function (truth degree) and do not take into account the non-membership (falsity degree) and the indeterminacy degrees, so fail to represent uncertainty and indeterminacy. To overcome these drawbacks of the fuzzy set, we integrated SWOT analysis with the analytic hierarchy process in a neutrosophic environment.

A neutrosophic set is an extension of a classical set, fuzzy set, and intuitionistic fuzzy set, and it effectively represents real world problems by considering all facets of a decision situation, (i.e., truthiness, indeterminacy and falsity) [27–48]. This research attempted, for the first time, to present the mathematical representation of SWOT analysis with an AHP in a neutrosophic environment. The neutrosophic set acted as a symmetric tool in the proposed method, since membership was the symmetric equivalent of non-membership, with respect to indeterminacy.

3. Definition of a Neutrosophic Set

In this section, some important definitions of neutrosophic sets are introduced.

Definition 1. [33,34] *The neutrosophic set N is characterized by three membership functions, which are the truth-membership function $T_{Ne}(x)$, indeterminacy-membership function $I_{Ne}(x)$ and falsity-membership function $F_{Ne}(x)$, where $x \in X$ and X are a space of points. Also, $T_{Ne}(x):X \rightarrow [-0, 1^+]$, $I_{Ne}(x):X \rightarrow [-0, 1^+]$ and $F_{Ne}(x):X \rightarrow [-0, 1^+]$. There is no restriction on the sum of $T_{Ne}(x)$, $I_{Ne}(x)$ and $F_{Ne}(x)$, so $0^- \leq \sup T_{Ne}(x) + \sup I_{Ne}(x) + \sup F_{Ne}(x) \leq 3^+$.*

Definition 2. [33,35] *A single valued neutrosophic set Ne over X takes the following form: $A = \{ \langle x, T_{Ne}(x), I_{Ne}(x), F_{Ne}(x) \rangle : x \in X \}$, where $T_{Ne}(x):X \rightarrow [0,1]$, $I_{Ne}(x):X \rightarrow [0,1]$ and $F_{Ne}(x):X \rightarrow [0,1]$, with $0 \leq T_{Ne}(x) + I_{Ne}(x) + F_{Ne}(x) \leq 3$ for all $x \in X$. The single valued neutrosophic (SVN) number is symbolized by $Ne = (d, e, f)$, where $d, e, f \in [0,1]$ and $d + e + f \leq 3$.*

Definition 3. [36,37] *The single valued triangular neutrosophic number, $\tilde{a} = \langle (a_1, a_2, a_3); \alpha_{\tilde{a}}, \theta_{\tilde{a}}, \beta_{\tilde{a}} \rangle$, is a neutrosophic set on the real line set R , whose truth, indeterminacy and falsity membership functions are as follows:*

$$T_{\tilde{a}}(x) = \begin{cases} \alpha_{\tilde{a}} \left(\frac{x-a_1}{a_2-a_1} \right) & (a_1 \leq x \leq a_2) \\ \alpha_{\tilde{a}} & (x = a_2) \\ \alpha_{\tilde{a}} \left(\frac{a_3-x}{a_3-a_2} \right) & (a_2 < x \leq a_3) \\ 0 & \text{otherwise} \end{cases} \tag{1}$$

$$I_{\tilde{a}}(x) = \begin{cases} \frac{(a_2-x+\theta_{\tilde{a}}(x-a_1))}{(a_2-a_1)} & (a_1 \leq x \leq a_2) \\ \theta_{\tilde{a}} & x = a_2 \\ \frac{(x-a_2+\theta_{\tilde{a}}(a_3-x))}{(a_3-a_2)} & (a_2 < x \leq a_3) \\ 1 & \text{otherwise} \end{cases} \tag{2}$$

$$F_{\tilde{a}}(x) = \begin{cases} \frac{(a_2-x+\beta_{\tilde{a}}(x-a_1))}{(a_2-a_1)} & (a_1 \leq x \leq a_2) \\ \beta_{\tilde{a}} & (x = a_2) \\ \frac{(x-a_2+\beta_{\tilde{a}}(a_3-x))}{(a_3-a_2)} & (a_2 < x \leq a_3) \\ 1 & \text{otherwise} \end{cases} \quad (3)$$

where $\alpha_{\tilde{a}}, \theta_{\tilde{a}}, \beta_{\tilde{a}} \in [0, 1]$ and $a_1, a_2, a_3 \in \mathbb{R}, a_1 \leq a_2 \leq a_3$.

Definition 4. [34,36] Let $\tilde{a} = \langle (a_1, a_2, a_3); \alpha_{\tilde{a}}, \theta_{\tilde{a}}, \beta_{\tilde{a}} \rangle$ and $\tilde{b} = \langle (b_1, b_2, b_3); \alpha_{\tilde{b}}, \theta_{\tilde{b}}, \beta_{\tilde{b}} \rangle$ be two single-valued triangular neutrosophic numbers and $\gamma \neq 0$ be any real number. Then:

1. Addition of two triangular neutrosophic numbers

$$\tilde{a} + \tilde{b} = \langle (a_1 + b_1, a_2 + b_2, a_3 + b_3); \alpha_{\tilde{a}} \wedge \alpha_{\tilde{b}}, \theta_{\tilde{a}} \vee \theta_{\tilde{b}}, \beta_{\tilde{a}} \vee \beta_{\tilde{b}} \rangle$$

2. Subtraction of two triangular neutrosophic numbers

$$\tilde{a} - \tilde{b} = \langle (a_1 - b_3, a_2 - b_2, a_3 - b_1); \alpha_{\tilde{a}} \wedge \alpha_{\tilde{b}}, \theta_{\tilde{a}} \vee \theta_{\tilde{b}}, \beta_{\tilde{a}} \vee \beta_{\tilde{b}} \rangle$$

3. Inverse of a triangular neutrosophic number

$$\tilde{a}^{-1} = \langle \left(\frac{1}{a_3}, \frac{1}{a_2}, \frac{1}{a_1} \right); \alpha_{\tilde{a}}, \theta_{\tilde{a}}, \beta_{\tilde{a}} \rangle, \text{ where } (\tilde{a} \neq 0)$$

4. Multiplication of a triangular neutrosophic number by a constant value

$$\gamma \tilde{a} = \begin{cases} \langle (\gamma a_1, \gamma a_2, \gamma a_3); \alpha_{\tilde{a}}, \theta_{\tilde{a}}, \beta_{\tilde{a}} \rangle & \text{if } (\gamma > 0) \\ \langle (\gamma a_3, \gamma a_2, \gamma a_1); \alpha_{\tilde{a}}, \theta_{\tilde{a}}, \beta_{\tilde{a}} \rangle & \text{if } (\gamma < 0) \end{cases}$$

5. Division of a triangular neutrosophic number by a constant value

$$\frac{\tilde{a}}{\gamma} = \begin{cases} \langle \left(\frac{a_1}{\gamma}, \frac{a_2}{\gamma}, \frac{a_3}{\gamma} \right); \alpha_{\tilde{a}}, \theta_{\tilde{a}}, \beta_{\tilde{a}} \rangle & \text{if } (\gamma > 0) \\ \langle \left(\frac{a_3}{\gamma}, \frac{a_2}{\gamma}, \frac{a_1}{\gamma} \right); \alpha_{\tilde{a}}, \theta_{\tilde{a}}, \beta_{\tilde{a}} \rangle & \text{if } (\gamma < 0) \end{cases}$$

6. Division of two triangular neutrosophic numbers

$$\frac{\tilde{a}}{\tilde{b}} = \begin{cases} \langle \left(\frac{a_1}{b_3}, \frac{a_2}{b_2}, \frac{a_3}{b_1} \right); \alpha_{\tilde{a}} \wedge \alpha_{\tilde{b}}, \theta_{\tilde{a}} \vee \theta_{\tilde{b}}, \beta_{\tilde{a}} \vee \beta_{\tilde{b}} \rangle & \text{if } (a_3 > 0, b_3 > 0) \\ \langle \left(\frac{a_3}{b_3}, \frac{a_2}{b_2}, \frac{a_1}{b_1} \right); \alpha_{\tilde{a}} \wedge \alpha_{\tilde{b}}, \theta_{\tilde{a}} \vee \theta_{\tilde{b}}, \beta_{\tilde{a}} \vee \beta_{\tilde{b}} \rangle & \text{if } (a_3 < 0, b_3 > 0) \\ \langle \left(\frac{a_3}{b_1}, \frac{a_2}{b_2}, \frac{a_1}{b_3} \right); \alpha_{\tilde{a}} \wedge \alpha_{\tilde{b}}, \theta_{\tilde{a}} \vee \theta_{\tilde{b}}, \beta_{\tilde{a}} \vee \beta_{\tilde{b}} \rangle & \text{if } (a_3 < 0, b_3 < 0) \end{cases}$$

7. Multiplication of two triangular neutrosophic numbers

$$\tilde{a} \tilde{b} = \begin{cases} \langle (a_1 b_1, a_2 b_2, a_3 b_3); \alpha_{\tilde{a}} \wedge \alpha_{\tilde{b}}, \theta_{\tilde{a}} \vee \theta_{\tilde{b}}, \beta_{\tilde{a}} \vee \beta_{\tilde{b}} \rangle & \text{if } (a_3 > 0, b_3 > 0) \\ \langle (a_1 b_3, a_2 b_2, a_3 b_1); \alpha_{\tilde{a}} \wedge \alpha_{\tilde{b}}, \theta_{\tilde{a}} \vee \theta_{\tilde{b}}, \beta_{\tilde{a}} \vee \beta_{\tilde{b}} \rangle & \text{if } (a_3 < 0, b_3 > 0) \\ \langle (a_3 b_3, a_2 b_2, a_1 b_1); \alpha_{\tilde{a}} \wedge \alpha_{\tilde{b}}, \theta_{\tilde{a}} \vee \theta_{\tilde{b}}, \beta_{\tilde{a}} \vee \beta_{\tilde{b}} \rangle & \text{if } (a_3 < 0, b_3 < 0) \end{cases}$$

4. Neutrosophic AHP (N-AHP) in SWOT Analysis

This section describes the proposed model of integrating SWOT analysis with the neutrosophic AHP. A step-by-step procedure for the model described is provided in this section.

Step 1 Select a group of experts at performing SWOT analysis.

In this step, experts identify the internal and the external factors of the SWOT analysis by employing questionnaires/interviews.

Figure 1 presents the SWOT analysis diagram:

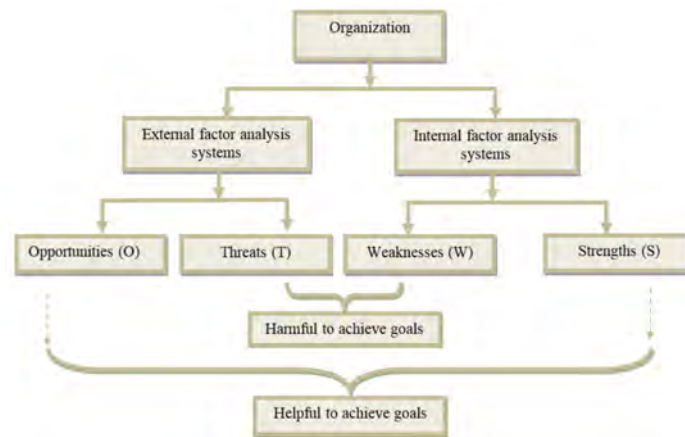

Figure 1. Strengths, Weaknesses, Opportunities and Threats (SWOT) analysis diagram.

To transform a complex problem to a simple and easy to understand problem, the following step is applied:

Step 2 Structure the hierarchy of the problem.

The hierarchy of the problem has four levels:

- The first level is the goal the organization wants to achieve.
- The second level consists of the four strategic criteria that are defined by the SWOT analysis (i.e., criteria).
- The third level are the factors that are included in each strategic factor of the previous level (i.e., sub-criteria).
- The final level includes the strategies that should be evaluated and compared.

The general hierarchy is presented in Figure 2.

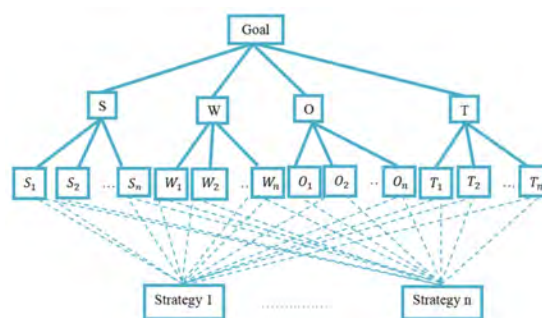

Figure 2. The hierarchy of a problem.

The next step is applied for weighting factors (criteria), sub-factors (sub-criteria) and strategies (alternatives), according to experts' opinions.

Step 3 Structure the neutrosophic pair-wise comparison matrix of factors, sub-factors and strategies, through the linguistic terms which are shown in Table 1.

Table 1. Linguistic terms and the identical triangular neutrosophic numbers.

Saaty Scale	Explanation	Neutrosophic Triangular Scale
1	Equally influential	$\tilde{1} = \langle (1, 1, 1); 0.50, 0.50, 0.50 \rangle$
3	Slightly influential	$\tilde{3} = \langle (2, 3, 4); 0.30, 0.75, 0.70 \rangle$
5	Strongly influential	$\tilde{5} = \langle (4, 5, 6); 0.80, 0.15, 0.20 \rangle$
7	Very strongly influential	$\tilde{7} = \langle (6, 7, 8); 0.90, 0.10, 0.10 \rangle$
9	Absolutely influential	$\tilde{9} = \langle (9, 9, 9); 1.00, 0.00, 0.00 \rangle$
2	Sporadic values between two close scales	$\tilde{2} = \langle (1, 2, 3); 0.40, 0.65, 0.60 \rangle$
4		$\tilde{4} = \langle (3, 4, 5); 0.60, 0.35, 0.40 \rangle$
6		$\tilde{6} = \langle (5, 6, 7); 0.70, 0.25, 0.30 \rangle$
8		$\tilde{8} = \langle (7, 8, 9); 0.85, 0.10, 0.15 \rangle$

The neutrosophic scale is attained according to expert opinion.

The neutrosophic pair-wise comparison matrix of factors, sub-factors and strategies are as follows:

$$\tilde{A} = \begin{bmatrix} \tilde{1} & \tilde{a}_{12} \cdots & \tilde{a}_{1n} \\ \vdots & \ddots & \vdots \\ \tilde{a}_{n1} & \tilde{a}_{n2} \cdots & \tilde{1} \end{bmatrix} \tag{4}$$

where $\tilde{a}_{ji} = \tilde{a}_{ij}^{-1}$, and is the triangular neutrosophic number that measures the decision makers vagueness.

Step 4 Check the consistency of experts' judgments.

If the pair-wise comparison matrix has a transitive relation, i.e., $a_{ik} = a_{ij}a_{jk}$ for all i, j and k , then the comparison matrix is consistent [38], focusing only on the lower, median and upper values of the triangular neutrosophic number of the comparison matrix.

Step 5 Calculate the weight of the factors (S, W, O, T), sub-factors $\{(S_1, \dots, S_n), (W_1, \dots, W_n), (O_1, \dots, O_n), (T_1, \dots, T_n)\}$ and strategies/alternatives (Alt_1, \dots, Alt_n) from the neutrosophic pair-wise comparison matrix, by transforming it to a deterministic matrix using the following equations.

Let $\tilde{a}_{ij} = \langle (a_1, b_1, c_1), \alpha_{\tilde{a}}, \theta_{\tilde{a}}, \beta_{\tilde{a}} \rangle$ be a single valued triangular neutrosophic number; then,

$$S(\tilde{a}_{ij}) = \frac{1}{8}[a_1 + b_1 + c_1] \times (2 + \alpha_{\tilde{a}} - \theta_{\tilde{a}} - \beta_{\tilde{a}}) \tag{5}$$

and

$$A(\tilde{a}_{ij}) = \frac{1}{8}[a_1 + b_1 + c_1] \times (2 + \alpha_{\tilde{a}} - \theta_{\tilde{a}} + \beta_{\tilde{a}}) \tag{6}$$

which are the score and accuracy degrees of \tilde{a}_{ij} respectively.

To get the score and the accuracy degree of \tilde{a}_{ji} , we use the following equations:

$$S(\tilde{a}_{ji}) = 1 / S(\tilde{a}_{ij}) \tag{7}$$

$$A(\tilde{a}_{ji}) = 1/A(\tilde{a}_{ij}) \tag{8}$$

With compensation by score value of each triangular neutrosophic number in the neutrosophic pair-wise comparison matrix, we derive the following deterministic matrix:

$$A = \begin{bmatrix} 1 & a_{12} \cdots & a_{1n} \\ \vdots & \ddots & \vdots \\ a_{n1} & a_{n2} \cdots & 1 \end{bmatrix} \tag{9}$$

Determine the ranking of priorities, namely the Eigen Vector X , from the previous matrix as follows:

1. Normalize the column entries by dividing each entry by the sum of the column.
2. Take the total of the row averages.

Step 6 Calculate the total priority of each strategy (alternative) for the final ranking of all strategies using Equation (10).

The total weight value of the alternative j ($j = 1, \dots, n$) can be written as follows:

$$Tw_{Alt_j} = w_S * \sum_{i=1}^n w_{S_i} * w_{Alt_j} + w_W * \sum_{i=1}^n w_{W_i} * w_{Alt_j} + w_O * \sum_{i=1}^n w_{O_i} * w_{Alt_j} + w_T * \sum_{i=1}^n w_{T_i} * w_{Alt_j} \tag{10}$$

where ($i = 1, \dots, n$) and (w_S, w_W, w_O, w_T) are the weights of Strengths, Weaknesses, Opportunities and Threats; ($w_{S_i}, w_{W_i}, w_{O_i}, w_{T_i}$) are the sub-factor weights; and w_{Alt_j} is the weight of the alternative j , corresponding to its sub-factor.

From previous steps, we obtain the phases of integrating SWOT analysis with neutrosophic analytic hierarchy processes, as shown in Figure 3.

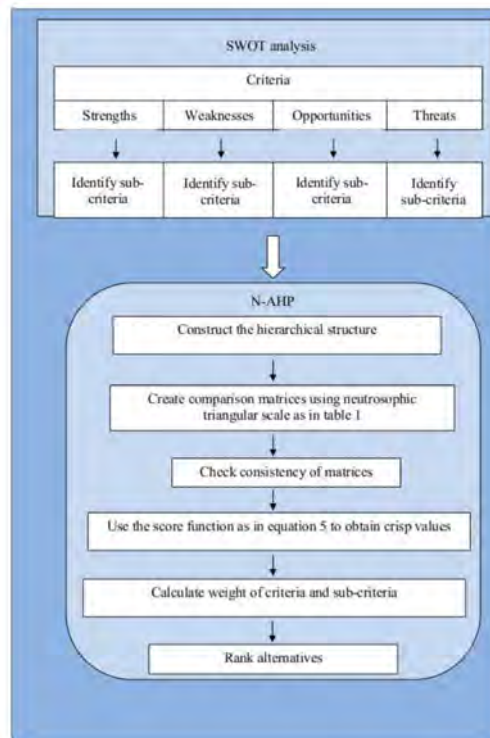

Figure 3. SWOT-neutrosophic analytic hierarchy process (N-AHP) diagram.

Step 3 Structure the neutrosophic pair-wise comparison matrix of factors, sub-factors and strategies, through the linguistic terms which are shown in Table 1. The values in Table 2 pertain to the experts' opinions.

The pair-wise comparison matrix of SWOT factors is presented in Table 2.

Table 2. The neutrosophic comparison matrix of factors.

Factors	Strengths	Weaknesses	Opportunities	Threats
Strengths	$\langle(1, 1, 1); 0.50, 0.50, 0.50\rangle$	$\langle(1, 1, 1); 0.50, 0.50, 0.50\rangle$	$\langle(4, 5, 6); 0.80, 0.15, 0.20\rangle$	$\langle(6, 7, 8); 0.90, 0.10, 0.10\rangle$
Weaknesses	$\langle(1, 1, 1); 0.50, 0.50, 0.50\rangle$	$\langle(1, 1, 1); 0.50, 0.50, 0.50\rangle$	$\langle(4, 5, 6); 0.80, 0.15, 0.20\rangle$	$\langle(6, 7, 8); 0.90, 0.10, 0.10\rangle$
Opportunities	$\langle(\frac{1}{6}, \frac{1}{5}, \frac{1}{4}); 0.80, 0.15, 0.20\rangle$	$\langle(\frac{1}{6}, \frac{1}{5}, \frac{1}{4}); 0.80, 0.15, 0.20\rangle$	$\langle(1, 1, 1); 0.50, 0.50, 0.50\rangle$	$\langle(\frac{1}{4}, \frac{1}{3}, \frac{1}{2}); 0.30, 0.75, 0.70\rangle$
Threats	$\langle(\frac{1}{8}, \frac{1}{7}, \frac{1}{6}); 0.90, 0.10, 0.10\rangle$	$\langle(\frac{1}{8}, \frac{1}{7}, \frac{1}{6}); 0.90, 0.10, 0.10\rangle$	$\langle(2, 3, 4); 0.30, 0.75, 0.70\rangle$	$\langle(1, 1, 1); 0.50, 0.50, 0.50\rangle$

Step 4 Check the consistency of experts' judgments.

The previous comparison matrix was consistent when applying the method proposed in [38].

Step 5 Calculate the weight of the factors, sub-factors and strategies.

To calculate weight, we first transformed the neutrosophic comparison matrix to its crisp form by using Equation (5). The crisp matrix is presented in Table 3.

Table 3. The crisp comparison matrix of factors.

Factors	Strengths	Weaknesses	Opportunities	Threats
Strengths	1	1	4	7
Weaknesses	1	1	4	7
Opportunities	$\frac{1}{4}$	$\frac{1}{4}$	1	1
Threats	$\frac{1}{7}$	$\frac{1}{7}$	1	1

Then, we determined the ranking of the factors, namely the Eigen Vector X, from the previous matrix, as illustrated previously in the detailed steps of the proposed model.

The normalized comparison matrix of factors is presented in Table 4.

Table 4. The normalized comparison matrix of factors.

Factors	Strengths	Weaknesses	Opportunities	Threats
Strengths	0.4	0.4	0.4	0.44
Weaknesses	0.4	0.4	0.4	0.44
Opportunities	0.1	0.1	0.1	0.06
Threats	0.06	0.06	0.1	0.06

By taking the total of the row averages:

$$X = \begin{bmatrix} 0.41 \\ 0.41 \\ 0.1 \\ 0.1 \end{bmatrix}$$

The neutrosophic comparison matrix of strengths is presented in Table 5.

Table 5. The neutrosophic comparison matrix of strengths.

Strengths	S ₁	S ₂	S ₃	S ₄
S ₁	$\langle(1, 1, 1); 0.50, 0.50, 0.50\rangle$	$\langle(4, 5, 6); 0.80, 0.15, 0.20\rangle$	$\langle(2, 3, 4); 0.30, 0.75, 0.70\rangle$	$\langle(2, 3, 4); 0.30, 0.75, 0.70\rangle$
S ₂	$\langle(\frac{1}{6}, \frac{1}{5}, \frac{1}{4}); 0.80, 0.15, 0.20\rangle$	$\langle(1, 1, 1); 0.50, 0.50, 0.50\rangle$	$\langle(\frac{1}{6}, \frac{1}{5}, \frac{1}{4}); 0.80, 0.15, 0.20\rangle$	$\langle(2, 3, 4); 0.30, 0.75, 0.70\rangle$
S ₃	$\langle(\frac{1}{4}, \frac{1}{3}, \frac{1}{2}); 0.30, 0.75, 0.70\rangle$	$\langle(4, 5, 6); 0.80, 0.15, 0.20\rangle$	$\langle(1, 1, 1); 0.50, 0.50, 0.50\rangle$	$\langle(2, 3, 4); 0.30, 0.75, 0.70\rangle$
S ₄	$\langle(\frac{1}{4}, \frac{1}{3}, \frac{1}{2}); 0.30, 0.75, 0.70\rangle$	$\langle(\frac{1}{4}, \frac{1}{3}, \frac{1}{2}); 0.30, 0.75, 0.70\rangle$	$\langle(\frac{1}{4}, \frac{1}{3}, \frac{1}{2}); 0.30, 0.75, 0.70\rangle$	$\langle(1, 1, 1); 0.50, 0.50, 0.50\rangle$

The crisp pair-wise comparison matrix of strengths is presented in Table 6 and the normalized comparison matrix of strengths is presented in Table 7.

Table 6. The crisp comparison matrix of strengths.

Strengths	S ₁	S ₂	S ₃	S ₄
S ₁	1	3	1	1
S ₂	$\frac{1}{3}$	1	$\frac{1}{4}$	1
S ₃	1	4	1	1
S ₄	1	1	1	1

Table 7. The normalized comparison matrix of strengths.

Strengths	S ₁	S ₂	S ₃	S ₄
S ₁	0.3	0.3	0.3	0.25
S ₂	0.1	0.1	0.1	0.25
S ₃	0.3	0.4	0.3	0.25
S ₄	0.3	0.1	0.3	0.25

By taking the total of the row averages:

$$X = \begin{bmatrix} 0.29 \\ 0.14 \\ 0.31 \\ 0.24 \end{bmatrix}$$

The neutrosophic comparison matrix of weaknesses is presented in Table 8.

Table 8. The neutrosophic comparison matrix of weaknesses.

Weaknesses	W ₁	W ₂	W ₃
W ₁	$\langle(1, 1, 1); 0.50, 0.50, 0.50\rangle$	$\langle(\frac{1}{6}, \frac{1}{5}, \frac{1}{4}); 0.80, 0.15, 0.20\rangle$	$\langle(\frac{1}{4}, \frac{1}{3}, \frac{1}{2}); 0.30, 0.75, 0.70\rangle$
W ₂	$\langle(4, 5, 6); 0.80, 0.15, 0.20\rangle$	$\langle(1, 1, 1); 0.50, 0.50, 0.50\rangle$	$\langle(4, 5, 6); 0.80, 0.15, 0.20\rangle$
W ₃	$\langle(2, 3, 4); 0.30, 0.75, 0.70\rangle$	$\langle(\frac{1}{6}, \frac{1}{5}, \frac{1}{4}); 0.80, 0.15, 0.20\rangle$	$\langle(1, 1, 1); 0.50, 0.50, 0.50\rangle$

The crisp comparison matrix of weaknesses is presented in Table 9.

Table 9. The crisp comparison matrix of weaknesses.

Weaknesses	W ₁	W ₂	W ₃
W ₁	1	$\frac{1}{4}$	1
W ₂	4	1	4
W ₃	1	$\frac{1}{4}$	1

The normalized comparison matrix of weaknesses is presented in Table 10.

Table 10. The normalized comparison matrix of weaknesses.

Weaknesses	W_1	W_2	W_3
W_1	0.2	0.2	0.2
W_2	0.7	0.7	0.7
W_3	0.2	0.2	0.2

By taking the total of the row averages:

$$X = \begin{bmatrix} 0.2 \\ 0.35 \\ 0.2 \end{bmatrix}$$

The neutrosophic comparison matrix of opportunities is presented in Table 11.

Table 11. The neutrosophic comparison matrix of opportunities.

Opportunities	O_1	O_2	O_3
O_1	$\langle(1, 1, 1); 0.50, 0.50, 0.50\rangle$	$\langle(\frac{1}{4}, \frac{1}{3}, \frac{1}{2}); 0.30, 0.75, 0.70\rangle$	$\langle(\frac{1}{6}, \frac{1}{5}, \frac{1}{4}); 0.80, 0.15, 0.20\rangle$
O_2	$\langle(2, 3, 4); 0.30, 0.75, 0.70\rangle$	$\langle(1, 1, 1); 0.50, 0.50, 0.50\rangle$	$\langle(\frac{1}{4}, \frac{1}{3}, \frac{1}{2}); 0.30, 0.75, 0.70\rangle$
O_3	$\langle(4, 5, 6); 0.80, 0.15, 0.20\rangle$	$\langle(2, 3, 4); 0.30, 0.75, 0.70\rangle$	$\langle(1, 1, 1); 0.50, 0.50, 0.50\rangle$

The crisp comparison matrix of opportunities is presented in Table 12.

Table 12. The crisp comparison matrix of opportunities.

Opportunities	O_1	O_2	O_3
O_1	1	1	$\frac{1}{4}$
O_2	1	1	1
O_3	4	1	1

The normalized comparison matrix of opportunities is presented in Table 13.

Table 13. The normalized comparison matrix of opportunities.

Opportunities	O_1	O_2	O_3
O_1	0.2	0.3	0.1
O_2	0.2	0.3	0.4
O_3	0.7	0.3	0.4

By taking the total of the row averages:

$$X = \begin{bmatrix} 0.2 \\ 0.3 \\ 0.5 \end{bmatrix}$$

The neutrosophic comparison matrix of threats is presented in Table 14.

Table 14. The neutrosophic comparison matrix of threats.

Threats	T ₁	T ₂	T ₃
T ₁	$\langle(1, 1, 1); 0.50, 0.50, 0.50\rangle$	$\langle(2, 3, 4); 0.30, 0.75, 0.70\rangle$	$\langle(4, 5, 6); 0.80, 0.15, 0.20\rangle$
T ₂	$\langle(\frac{1}{4}, \frac{1}{3}, \frac{1}{2}); 0.30, 0.75, 0.70\rangle$	$\langle(1, 1, 1); 0.50, 0.50, 0.50\rangle$	$\langle(\frac{1}{4}, \frac{1}{3}, \frac{1}{2}); 0.30, 0.75, 0.70\rangle$
T ₃	$\langle(\frac{1}{6}, \frac{1}{5}, \frac{1}{4}); 0.80, 0.15, 0.20\rangle$	$\langle(2, 3, 4); 0.30, 0.75, 0.70\rangle$	$\langle(1, 1, 1); 0.50, 0.50, 0.50\rangle$

The crisp comparison matrix of threats is presented in Table 15.

Table 15. The crisp comparison matrix of threats.

Threats	T ₁	T ₂	T ₃
T ₁	1	1	4
T ₂	1	1	1
T ₃	4	1	1

The normalized comparison matrix of threats is presented in Table 16.

Table 16. The normalized comparison matrix of threats.

Opportunities	T ₁	T ₂	T ₃
T ₁	0.2	0.3	0.7
T ₂	0.2	0.3	0.2
T ₃	0.7	0.3	0.2

By taking the total of the row averages:

$$X = \begin{bmatrix} 0.4 \\ 0.2 \\ 0.4 \end{bmatrix}$$

Similar to the factors and sub-factors calculation methodology, the weights of alternatives (strategies), with respect to sub-factors, were as follows:

$$\begin{aligned} \text{The Eigen Vector } X \text{ of strategies with respect to } S_1 &= \begin{bmatrix} 0.4 \\ 0.1 \\ 0.3 \\ 0.2 \end{bmatrix} \\ \text{The Eigen Vector } X \text{ of strategies with respect to } S_2 &= \begin{bmatrix} 0.4 \\ 0.3 \\ 0.2 \\ 0.1 \end{bmatrix} \\ \text{The Eigen Vector } X \text{ of strategies with respect to } S_3 &= \begin{bmatrix} 0.5 \\ 0.3 \\ 0.1 \\ 0.1 \end{bmatrix} \\ \text{The Eigen Vector } X \text{ of strategies with respect to } S_4 &= \begin{bmatrix} 0.3 \\ 0.2 \\ 0.4 \\ 0.1 \end{bmatrix} \end{aligned}$$

$$\begin{aligned}
 \text{The Eigen Vector } X \text{ of strategies with respect to } W_1 &= \begin{bmatrix} 0.2 \\ 0.2 \\ 0.3 \\ 0.3 \end{bmatrix} \\
 \text{The Eigen Vector } X \text{ of strategies with respect to } W_2 &= \begin{bmatrix} 0.4 \\ 0.1 \\ 0.3 \\ 0.2 \end{bmatrix} \\
 \text{The Eigen Vector } X \text{ of strategies with respect to } W_3 &= \begin{bmatrix} 0.6 \\ 0.1 \\ 0.2 \\ 0.1 \end{bmatrix} \\
 \text{The Eigen Vector } X \text{ of strategies with respect to } O_1 &= \begin{bmatrix} 0.1 \\ 0.4 \\ 0.2 \\ 0.3 \end{bmatrix} \\
 \text{The Eigen Vector } X \text{ of strategies with respect to } O_2 &= \begin{bmatrix} 0.1 \\ 0.4 \\ 0.2 \\ 0.3 \end{bmatrix} \\
 \text{The Eigen Vector } X \text{ of strategies with respect to } O_3 &= \begin{bmatrix} 0.3 \\ 0.2 \\ 0.3 \\ 0.2 \end{bmatrix} \\
 \text{The Eigen Vector } X \text{ of strategies with respect to } T_1 &= \begin{bmatrix} 0.1 \\ 0.4 \\ 0.2 \\ 0.3 \end{bmatrix} \\
 \text{The Eigen Vector } X \text{ of strategies with respect to } T_2 &= \begin{bmatrix} 0.6 \\ 0.2 \\ 0.1 \\ 0.1 \end{bmatrix} \\
 \text{The Eigen Vector } X \text{ of strategies with respect to } T_3 &= \begin{bmatrix} 0.5 \\ 0.1 \\ 0.2 \\ 0.2 \end{bmatrix}
 \end{aligned}$$

Step 6 Determine the total priority of each strategy (alternative) and define the final ranking of all strategies using Equation (10).

The weights of SWOT factors, sub-factors and alternative strategies are presented in Table 17.

According to our analysis of Starbucks Company using SWOT–N-AHP, the strategies were ranked as follows: SO, WO, ST and WT, as presented in detail in Table 17 and in Figure 7. In conclusion, SO was the best strategy for achieving Starbuck’s goals since it had the greatest weight value.

Table 17. The weights of SWOT factors, sub-factors, alternatives strategies and their ranking.

Factors/Sub-Factors	Weight	Alternatives (Strategies)			
		SO	ST	WO	WT
Strengths	0.41				
S ₁	0.29	0.4	0.1	0.3	0.2
S ₂	0.14	0.4	0.3	0.2	0.1
S ₃	0.31	0.5	0.3	0.1	0.1
S ₄	0.24	0.3	0.2	0.4	0.1
Weaknesses	0.41				
W ₁	0.2	0.2	0.2	0.3	0.3
W ₂	0.35	0.4	0.1	0.3	0.2
W ₃	0.2	0.6	0.1	0.2	0.1
Opportunities	0.1				
O ₁	0.2	0.1	0.4	0.2	0.3
O ₂	0.3	0.1	0.4	0.2	0.3
O ₃	0.5	0.3	0.2	0.3	0.2
Threats	0.1				
T ₁	0.4	0.1	0.4	0.2	0.3
T ₂	0.2	0.6	0.2	0.1	0.1
T ₃	0.4	0.5	0.1	0.2	0.2
Total		0.34	0.2	0.22	0.15
Rank of strategies		1	3	2	4

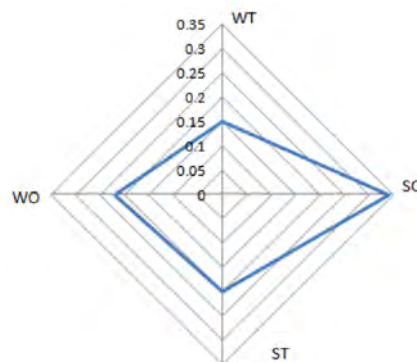

Figure 7. The final ranking of strategies.

To evaluate the quality of the proposed model, we compared it with other existing methods:

- The authors in [18–21] combined the AHP with SWOT analysis to solve the drawbacks of SWOT analysis, as illustrated in the introduction section, but in the comparison matrices of the AHP they used crisp values, which were not accurate due to the vague and uncertain information of decision makers.
- In order to solve the drawbacks of classical AHP, several researchers combined SWOT analysis with the fuzzy AHP [24–26]. Since fuzzy sets consider only the truth degree and fail to deal with the indeterminacy and falsity degrees, it also does not offer the best representation of vague and uncertain information.
- Since neutrosophic sets consider truth, indeterminacy and falsity degrees altogether, it is the best representation for the vague and uncertain information that exists in the real world. We were the first to integrate the neutrosophic AHP with SWOT analysis. In addition, our model considered all aspects of vague and uncertain information by creating a triangular neutrosophic scale for comparing factors and strategies. Due to its versatility, this method can be applied to various problems across different fields.

6. Conclusions and Future Works

SWOT analysis is an important tool for successful planning, but it has some drawbacks because it fails to provide measurements and evaluations of factors (criteria) and strategies (alternatives). In order to deal with SWOT analysis drawbacks, this research integrated the neutrosophic AHP (N-AHP) approach. Using the N-AHP in SWOT analysis produced both quantitative and qualitative measurements of factors. The reasons for applying an AHP in a neutrosophic environment are as follows: due to vague, uncertain and inconsistent information, which usually exists in real world applications, the crisp values in the classical AHP are not accurate; in the fuzzy AHP, only the truth degree is considered, which makes it incompatible with real world applications; and the intuitionistic AHP holds only truth and falsity degrees, therefore failing to deal with indeterminacy. The neutrosophic AHP is useful to interpret vague, inconsistent and incomplete information by deeming the truth, indeterminacy and falsity degrees altogether. Therefore, by integrating the N-AHP with SWOT analysis we were able to effectively and efficiently deal with vague information better than fuzzy and intuitionistic fuzzy set theories. The parameters of the N-AHP comparison matrices were triangular neutrosophic numbers and a score function was used to transform the neutrosophic AHP parameters to deterministic values. By applying our proposed model to Starbucks Company, the evaluation process of its performance was effective, and the selection between the different strategies became simpler and more valuable.

In the future, this research should be extended by employing different multi-criteria decision-making (MCDM) techniques and studying their effect on SWOT analysis. In particular, it would be useful to integrate SWOT analysis with the neutrosophic network process (ANP) to effectively deal with interdependencies between decision criteria and handle the vague, uncertain and inconsistent information that exists in real world applications.

Appendix A

Four experts were selected to perform the SWOT analysis to determine the four strategic factors of Starbucks Company. The experts were specialized in manufacturing, sales and quality. To implement the SWOT analysis, we prepared the following questionnaire and sent it out online to the experts:

1. What is your specialty?
2. How many years of experience in coffee industry you have?
3. What are in your opinion the strengths of the Starbucks Company?
4. What are in your opinion the weaknesses of the Starbucks Company?
5. What are in your opinion the opportunities of the Starbucks Company?
6. What are in your opinion the threats of the Starbucks Company?
7. Please use the triangular neutrosophic scale introduced in Table 1 to compare all factors and present your answers in a table format.
8. Please use the triangular neutrosophic scale introduced in Table 1 to compare all strategies and present your answers in a table format.
9. In your opinion, which strategy from below will achieve the Starbucks goals:
 - SO, A strategic plan involving a good use of opportunities through existing strengths.
 - ST, A good use of strengths to remove or reduce the impact of threats.
 - WO, Taking into accounts weaknesses to gain benefit from opportunities.
 - WT, Reducing threats by becoming aware of weaknesses.

References

1. Killen, C.P.; Walker, M.; Hunt, R.A. Strategic planning using QFD. *Int. J. Qual. Reliab. Manag.* **2005**, *22*, 17–29. [[CrossRef](#)]
2. Saaty, T.L. What is the analytic hierarchy process? In *Mathematical Models for Decision Supported*; Springer: Berlin, Germany, 1988; pp. 109–121.
3. Saaty, T.L. *Theory and Applications of the Analytic Network Process: Decision Making with Benefits, Opportunities, Costs, and Risks*; RWS: Chalfont St Peter, UK, 2005.
4. Taghavifard, M.T.; Amoozad Mahdiraji, H.; Alibakhshi, A.M.; Zavadskas, E.K.; Bausys, R. An Extension of Fuzzy SWOT Analysis: An Application to Information Technology. *Information* **2018**, *9*, 46. [[CrossRef](#)]
5. Atanassov, K.T. Intuitionistic fuzzy sets. *Fuzzy Sets Syst.* **1986**, *20*, 87–96. [[CrossRef](#)]
6. Abdel-Basset, M.; Mohamed, M.; Chang, V. NMCDA: A framework for evaluating cloud computing services. *Future Gener. Comput. Syst.* **2018**, *86*, 12–29. [[CrossRef](#)]
7. Arslan, O.; Er, I.D. SWOT analysis for safer carriage of bulk liquid chemicals in tankers. *J. Hazard. Mater.* **2008**, *154*, 901–913. [[CrossRef](#)] [[PubMed](#)]
8. Helms, M.M.; Nixon, J. Exploring SWOT analysis—Where are we now? A review of academic research from the last decade. *J. Strategy Manag.* **2010**, *3*, 215–251. [[CrossRef](#)]
9. Kotler, P. *Marketing Management, Analysis, Planning, Implementation, and Control*, Philip Kotler; Prentice-Hall International: London, UK, 1994.
10. Wheelen, T.L.; Hunger, J.D. *Strategic Management and Business Policy*; Addison-Wesley: Boston, MA, USA, 1986.
11. Kajanus, M.; Leskinen, P.; Kurttila, M.; Kangas, J. Making use of MCDS methods in SWOT analysis—Lessons learnt in strategic natural resources management. *For. Policy Econ.* **2012**, *20*, 1–9. [[CrossRef](#)]
12. Dyson, R.G. Strategic development and SWOT analysis at the University of Warwick. *Eur. J. Oper. Res.* **2004**, *152*, 631–640. [[CrossRef](#)]
13. Chang, L.; Lin, C. The exploratory study of competitive advantage of Hsin-Chu city government by using diamond theory. *Bus. Rev.* **2005**, *3*, 180–185.
14. Khatri, J.K.; Metri, B. SWOT-AHP approach for sustainable manufacturing strategy selection: A case of Indian SME. *Glob. Bus. Rev.* **2016**, *17*, 1211–1226. [[CrossRef](#)]
15. Mehta, A.; Armenakis, A.; Mehta, N.; Irani, F. Challenges and opportunities of business process outsourcing in India. *J. Lab. Res.* **2006**, *27*, 323–338. [[CrossRef](#)]
16. Vaidya, O.S.; Kumar, S. Analytic hierarchy process: An overview of applications. *Eur. J. Oper. Res.* **2006**, *169*, 1–29. [[CrossRef](#)]
17. Akyuz, E.; Celik, M. A hybrid decision-making approach to measure effectiveness of safety management system implementations on-board ships. *Saf. Sci.* **2014**, *68*, 169–179. [[CrossRef](#)]
18. Leskinen, L.A.; Leskinen, P.; Kurttila, M.; Kangas, J.; Kajanus, M. Adapting modern strategic decision support tools in the participatory strategy process—A case study of a forest research station. *For. Policy Econ.* **2006**, *8*, 267–278. [[CrossRef](#)]
19. Pesonen, M.; Kurttila, M.; Kangas, J.; Kajanus, M.; Heinonen, P. Assessing the priorities using A'WOT among resource management strategies at the Finnish Forest and Park Service. *For. Sci.* **2001**, *47*, 534–541.
20. Masozera, M.K.; Alavalapati, J.R.; Jacobson, S.K.; Shrestha, R.K. Assessing the suitability of community-based management for the Nyungwe Forest Reserve, Rwanda. *For. Policy Econ.* **2006**, *8*, 206–216. [[CrossRef](#)]
21. Shrestha, R.K.; Alavalapati, J.R.; Kalmbacher, R.S. Exploring the potential for silvopasture adoption in south-central Florida: An application of SWOT–AHP method. *Agric. Syst.* **2004**, *81*, 185–199. [[CrossRef](#)]
22. Stewart, R.A.; Mohamed, S.; Daet, R. Strategic implementation of IT/IS projects in construction: A case study. *Autom. Constr.* **2002**, *11*, 681–694. [[CrossRef](#)]
23. Chan, P.S.; Heide, D. Information technology and the new environment: Developing and sustaining competitive advantage. *SAM Adv. Manag. J.* **1992**, *57*, 4.
24. Demirtas, N.; Tuzkaya, U.R.; Seker, S. Project Management Methodology Selection Using SWOT-Fuzzy AHP. In Proceedings of the World Congress on Engineering, London, UK, 2–4 July 2014.

25. Lumaksono, H. Implementation of SWOT-FAHP method to determine the best strategy on development of traditional shipyard in Sumenep. *Acad. Res. Int.* **2014**, *5*, 56.
26. Tavana, M.; Zareinejad, M.; Di Caprio, D.; Kaviani, M.A. An integrated intuitionistic fuzzy AHP and SWOT method for outsourcing reverse logistics. *Appl. Soft Comput.* **2016**, *40*, 544–557. [[CrossRef](#)]
27. Zhang, C.; Li, D.; Sangaiah, A.K.; Broumi, S. Merger and Acquisition Target Selection Based on Interval Neutrosophic Multi-granulation Rough Sets over Two Universes. *Symmetry* **2017**, *9*, 126. [[CrossRef](#)]
28. Goyal, R.K.; Kaushal, S.; Sangaiah, A.K. The utility based non-linear fuzzy AHP optimization model for network selection in heterogeneous wireless networks. *Appl. Soft Comput.* **2017**. [[CrossRef](#)]
29. Abdel-Basset, M.; Mohamed, M.; Hussien, A.N.; Sangaiah, A.K. A novel group decision-making model based on triangular neutrosophic numbers. *Soft Comput.* **2017**, 1–15. [[CrossRef](#)]
30. Wang, L.; Wang, Y.; Sangaiah, A.K.; Liao, B. Intuitionistic linguistic group decision-making methods based on generalized compensative weighted averaging aggregation operators. *Soft Comput.* **2017**, 1–13. [[CrossRef](#)]
31. Abdel-Basset, M.; Mohamed, M.; Sangaiah, A.K. Neutrosophic AHP-Delphi Group decision-making model based on trapezoidal neutrosophic numbers. *J. Ambient Intell. Humaniz. Comput.* **2017**, 1–17. [[CrossRef](#)]
32. Chan, F.T.; Chan, H.K.; Lau, H.C.; Ip, R.W. An AHP approach in benchmarking logistics performance of the postal industry. *Benchmarking* **2006**, *13*, 636–661. [[CrossRef](#)]
33. Gallego Lupiáñez, F. Interval neutrosophic sets and topology. *Kybernetes* **2009**, *38*, 621–624. [[CrossRef](#)]
34. Abdel-Basset, M.; Mohamed, M. The role of single valued neutrosophic sets and rough sets in smart city: imperfect and incomplete information systems. *Measurement* **2018**, *124*, 47–55. [[CrossRef](#)]
35. El-Hefenawy, N.; Metwally, M.A.; Ahmed, Z.M.; El-Henawy, I.M. A review on the applications of neutrosophic sets. *J. Comput. Theor. Nanosci.* **2016**, *13*, 936–944. [[CrossRef](#)]
36. Deli, I.; Subas, Y. Single valued neutrosophic numbers and their applications to multicriteria decision making problem. *Neutrosophic Sets Syst.* **2014**, *2*, 1–3.
37. Abdel-Basset, M.; Hezam, I.M.; Smarandache, F. Neutrosophic goal programming. *Neutrosophic Sets Syst.* **2016**, *11*, 112–118.
38. Buckley, J.J. Fuzzy hierarchical analysis. *Fuzzy Sets Syst.* **1985**, *17*, 233–247. [[CrossRef](#)]
39. Li, X.; Zhang, X.; Choonkil, P. Generalized Interval Neutrosophic Choquet Aggregation Operators and Their Applications. *Symmetry* **2018**, *10*, 85. [[CrossRef](#)]
40. Li, X.; Zhang, X. Single-Valued Neutrosophic Hesitant Fuzzy Choquet Aggregation Operators for Multi-Attribute Decision Making. *Symmetry* **2018**, *10*, 50. [[CrossRef](#)]
41. Zhang, X.; Florentin, S.; Liang, X. Neutrosophic Duplet Semi-Group and Cancellable Neutrosophic Triplet Groups. *Symmetry* **2017**, *9*, 275. [[CrossRef](#)]
42. Guan, H.; Guan, S.; Zhao, A. Forecasting model based on neutrosophic logical relationship and Jaccard similarity. *Symmetry* **2017**, *9*, 191. [[CrossRef](#)]
43. Chen, J.; Ye, J.; Du, S. Vector similarity measures between refined simplified neutrosophic sets and their multiple attribute decision-making method. *Symmetry* **2017**, *9*, 153. [[CrossRef](#)]
44. Liang, W.; Zhao, G.; Wu, H. Evaluating investment risks of metallic mines using an extended TOPSIS method with linguistic neutrosophic numbers. *Symmetry* **2017**, *9*, 149. [[CrossRef](#)]
45. Jiang, W.; Shou, Y. A Novel Single-Valued Neutrosophic Set Similarity Measure and Its Application in Multicriteria Decision-Making. *Symmetry* **2017**, *9*, 127. [[CrossRef](#)]
46. Fang, Z.; Ye, J. Multiple attribute group decision-making method based on linguistic neutrosophic numbers. *Symmetry* **2017**, *9*, 111. [[CrossRef](#)]
47. Ye, J. Multiple attribute decision-making method using correlation coefficients of normal neutrosophic sets. *Symmetry* **2017**, *9*, 80. [[CrossRef](#)]
48. Guo, Z.-L.; Liu, Y.-L.; Yang, H.-L. A Novel Rough Set Model in Generalized Single Valued Neutrosophic Approximation Spaces and Its Application. *Symmetry* **2017**, *9*, 119. [[CrossRef](#)]

Some Results on the Graph Theory for Complex Neutrosophic Sets

Shio Gai Quek, Said Broumi, Ganeshsree Selvachandran, Assia Bakali,
Mohamed Talea, Florentin Smarandache

Shio Gai Quek, Said Broumi, Ganeshsree Selvachandran, Assia Bakali, Mohamed Talea, Florentin Smarandache (2018). Some Results on the Graph Theory for Complex Neutrosophic Sets. *Symmetry* 10, 190; DOI: 10.3390/sym10060190

Abstract: Fuzzy graph theory plays an important role in the study of the symmetry and asymmetry properties of fuzzy graphs. With this in mind, in this paper, we introduce new neutrosophic graphs called complex neutrosophic graphs of type 1 (abbr. CNG1). We then present a matrix representation for it and study some properties of this new concept. The concept of CNG1 is an extension of the generalized fuzzy graphs of type 1 (GFG1) and generalized single-valued neutrosophic graphs of type 1 (GSVNG1). The utility of the CNG1 introduced here are applied to a multi-attribute decision making problem related to Internet server selection.

Keywords: complex neutrosophic set; complex neutrosophic graph; fuzzy graph; matrix representation

1. Introduction

Smarandache [1] introduced a new theory called neutrosophic theory, which is basically a branch of philosophy that focuses on the origin, nature, and scope of neutralities and their interactions with different ideational spectra. On the basis of neutrosophy, Smarandache defined the concept of a neutrosophic set (NS) which is characterized by a degree of truth membership T , a degree of indeterminacy membership I , and a degree of falsity membership F . The concept of neutrosophic set theory generalizes the concept of classical sets, fuzzy sets by Zadeh [2], intuitionistic fuzzy sets by Atanassov [3], and interval-valued fuzzy sets by Turksen [4]. In fact, this mathematical tool is apt for handling problems related to imprecision, indeterminacy, and inconsistency of data. The indeterminacy component present in NSs is independent of the truth and falsity membership values. To make it more convenient to apply NSs to real-life scientific and engineering problems, Smarandache [1] proposed the single-valued neutrosophic set (SVNS) as a subclass of neutrosophic sets. Later on, Wang et al. [5] presented the set-theoretic operators and studied some of the properties of SVNSs. The NS model and its generalizations have been successfully applied in many diverse areas, and these can be found in [6].

Graphs are among the most powerful and convenient tools to represent information involving the relationship between objects and concepts. In crisp graphs, two vertices are either related or not related to one another so, mathematically, the degree of relationship is either 0 or 1. In fuzzy graphs on the other hand, the degree of relationship takes on values from the interval $[0, 1]$. Subsequently,

Shannon and Atanassov [7] defined the concept of intuitionistic fuzzy graphs (IFGs) using five types of Cartesian products. The concept fuzzy graphs and their extensions have a common property that each edge must have a membership value of less than, or equal to, the minimum membership of the nodes it connects.

In the event that the description of the object or their relations or both is indeterminate and inconsistent, it cannot be handled by fuzzy, intuitionistic fuzzy, bipolar fuzzy, vague, or interval-valued fuzzy graphs. For this reason, Smarandache [8] proposed the concept of neutrosophic graphs based on the indeterminacy (I) membership values to deal with such situations. Smarandache [9,10] then gave another definition for neutrosophic graph theory using the neutrosophic truth-values (T, I, F) and constructed three structures of neutrosophic graphs: neutrosophic edge graphs, neutrosophic vertex graphs and neutrosophic vertex-edge graphs. Subsequently, Smarandache [11] proposed new versions of these neutrosophic graphs, such as the neutrosophic off graph, neutrosophic bipolar graph, neutrosophic tripolar graph, and neutrosophic multipolar graph. Presently, works on neutrosophic vertex-edge graphs and neutrosophic edge graphs are progressing rapidly. Broumi et al. [12] combined the SVNS model and graph theory to introduce certain types of SVNS graphs (SVNG), such as strong SVNG, constant SVNG, and complete SVNG, and proceeded to investigate some of the properties of these graphs with proofs and examples. Broumi et al. [13] then introduced the concept of neighborhood degree of a vertex and closed neighborhood degree of a vertex in SVNG as a generalization of the neighborhood degree of a vertex and closed neighborhood degree of a vertex found in fuzzy graphs and intuitionistic fuzzy graphs. In addition, Broumi et al. [14] proved a necessary and sufficient condition for a SVNG to be an isolated SVNG.

Recently, Smarandache [15] initiated the idea of the removal of the edge degree restriction for fuzzy graphs, intuitionistic fuzzy graphs and SVNGs. Samanta et al. [16] proposed a new concept called generalized fuzzy graphs (GFG) and defined two types of GFG. Here the authors also studied some of the major properties of GFGs, such as the completeness and regularity of GFGs, and verified the results. In [16], the authors claim that fuzzy graphs and their extensions are limited to the representations of only certain systems, such as social networks. Broumi et al. [17] then discussed the removal of the edge degree restriction of SVNGs and presented a new class of SVNG, called generalized SVNG of type 1, which is an extension of generalized fuzzy graphs of type 1 proposed in [16]. Since the introduction of complex fuzzy sets (CFSs) by Ramot et al. in [18], several new extensions of CFSs have been proposed in literature [19–25]. The latest model related to CFS is the complex neutrosophic set (CNS) model which is a combination of CFSs [18] and complex intuitionistic fuzzy sets [21] proposed by Ali and Smarandache [26]. The CNS model is defined by three complex-valued membership functions which represent the truth, indeterminate, and falsity components. Therefore, a complex-valued truth membership function is a combination of the traditional truth membership function with the addition of the phase term. Similar to fuzzy graphs, complex fuzzy graphs (CFG) introduced by Thirunavukarasu et al. [27] have a common property that each edge must have a membership value of less than or equal to the minimum membership of the nodes it connects.

In this paper, we extend the research works mentioned above, and introduce the novel concept of type 1 complex neutrosophic graphs (CNG1) and a matrix representation of CNG1. To the best of our knowledge, there is no research on CNGs in the literature at present. We also present an investigation pertaining to the symmetric properties of CNG1 in this paper. In the study of fuzzy graphs, a symmetric fuzzy graph refers to a graph structure with one edge (i.e., two arrows on opposite directions) or no edges, whereas an asymmetric fuzzy graph refers to a graph structure with no arcs or only one arc present between any two vertices. Motivated by this, we have dedicated an entire section in this paper (Section 7) to study the symmetric properties of our proposed CNG1.

The remainder of this paper is organized as follows: in Section 2, we review some basic concepts about NSs, SVNSs, CNSs, and generalized SVNGs of type 1; in Section 3, the formal definition of CNG1 is introduced and supported with illustrative examples; in Section 4 a representation matrix of CNG1 is introduced; some advanced theoretical results pertaining to our CNG1 is presented in Section 5, followed by an investigation on the shortest CNG1 in Section 6; the symmetric properties of ordinary

simple CNG1 is presented in Section 7; and Section 8 outlines the conclusion of this paper and suggests directions for future research. This is followed by the acknowledgments and the list of references.

2. Preliminaries

In this section, we present brief overviews of NSs, SVNSs, SVNGs, and generalize fuzzy graphs that are relevant to the present work. We refer the readers to [1,5,17,18,27] for further information related to these concepts.

The key feature that distinguishes the NS from the fuzzy and intuitionistic fuzzy set (IFS) models is the presence of the indeterminacy membership function. In the NS model the indeterminacy membership function is independent from the truth and falsity membership functions, and we are able to tell the exact value of the indeterminacy function. In the fuzzy set model this indeterminacy function is non-existent, whereas in the IFS model, the value of the indeterminacy membership function is dependent on the values of the truth and falsity membership functions. This is evident from the structure of the NS model in which $T + I + F \leq 3$, whereas it is $T + F \leq 1$ and $I = 1 - T - F$ in the IFS model. This structure is reflective of many real-life situations, such as in sports (winning, losing, draw), voting (for, against, abstain from voting), and decision-making (affirmative, negative, undecided), in which the proportions of one outcome is independent of the others. The NS model is able to model these situations more accurately compared to fuzzy sets and IFSs as it is able to determine the degree of indeterminacy from the truth and falsity membership function more accurately, whereas this distinction cannot be done when modelling information using the fuzzy sets and IFSs. Moreover, the NS model has special structures called neutrosophic oversets and neutrosophic undersets that were introduced by Smarandache in [11], in which the values of the membership functions can exceed 1 or be below 0, in order to cater to special situations. This makes the NS more flexible compared to fuzzy sets and IFSs, and gives it the ability to cater to a wider range of applications. The flexibility of this model and its ability to clearly distinguish between the truth, falsity, and indeterminacy membership functions served as the main motivation to study a branch of graph theory of NSs in this paper. We refer the readers to [28,29] for more information on the degree of dependence and independence of neutrosophic sets, and [11] for further information on the concepts of neutrosophic oversets and undersets.

Definition 1 [1]. Let X be a space of points and let $x \in X$. A neutrosophic set $A \in X$ is characterized by a truth membership function T , an indeterminacy membership function I , and a falsity membership function F . The values of T, I, F are real standard or nonstandard subsets of $]^{-0}, 1^{+}[$, and $T, I, F: X \rightarrow]^{-0}, 1^{+}[$. A neutrosophic set can therefore be represented as:

$$A = \{(x, T_A(x), I_A(x), F_A(x)): x \in X\} \tag{1}$$

Since $T, I, F \in [0, 1]$, the only restriction on the sum of T, I, F is as given below:

$$^{-0} \leq T_A(x) + I_A(x) + F_A(x) \leq 3^{+} \tag{2}$$

Although theoretically the NS model is able to handle values from the real standard or non-standard subsets of $]^{-0}, 1^{+}[$, it is often unnecessary or computationally impractical to use values from this non-standard range when dealing with real-life applications. Most problems in engineering, and computer science deal with values from the interval $[0, 1]$ instead of the interval $]^{-0}, 1^{+}[$, and this led to the introduction of the single-valued neutrosophic set (SVNS) model in [5]. The SVNS model is a special case of the general NS model in which the range of admissible values are from the standard interval of $[0, 1]$, thereby making it more practical to be used to deal with most real-life problems. The formal definition of the SVNS model is given in Definition 2.

Definition 2 [5]. Let X be a space of points (objects) with generic elements in X denoted by x . A single-valued neutrosophic set A (SVNS A) is characterized by a truth-membership function $T_A(x)$, an indeterminacy-membership function $I_A(x)$, and a falsity-membership function $F_A(x)$. For each point $x \in X$, $T_A(x), I_A(x), F_A(x) \in [0, 1]$. The SVNS A can therefore be written as:

$$A = \{(x, T_A(x), I_A(x), F_A(x)): x \in X\} \quad (3)$$

Definition 3 [26]. Denote $i = \sqrt{-1}$. A complex neutrosophic set A defined on a universe of discourse X , which is characterized by a truth membership function $T_A(x)$, an indeterminacy-membership function $I_A(x)$, and a falsity-membership function $F_A(x)$ that assigns a complex-valued membership grade to $T_A(x), I_A(x), F_A(x)$ for any $x \in X$. The values of $T_A(x), I_A(x), F_A(x)$ and their sum may be any values within a unit circle in the complex plane and is therefore of the form $T_A(x) = p_A(x)e^{i\mu_A(x)}$, $I_A(x) = q_A(x)e^{i\nu_A(x)}$, and $F_A(x) = r_A(x)e^{i\omega_A(x)}$. All the amplitude and phase terms are real-valued and $p_A(x), q_A(x), r_A(x) \in [0, 1]$, whereas $\mu_A(x), \nu_A(x), \omega_A(x) \in (0, 2\pi]$, such that the condition:

$$0 \leq p_A(x) + q_A(x) + r_A(x) \leq 3 \quad (4)$$

is satisfied. A complex neutrosophic set A can thus be represented in set form as:

$$A = \{(x, T_A(x) = a_T, I_A(x) = a_I, F_A(x) = a_F): x \in X\}, \quad (5)$$

where $T_A: X \rightarrow \{a_T: a_T \in \mathbb{C}, |a_T| \leq 1\}$, $I_A: X \rightarrow \{a_I: a_I \in \mathbb{C}, |a_I| \leq 1\}$, $F_A: X \rightarrow \{a_F: a_F \in \mathbb{C}, |a_F| \leq 1\}$, and also:

$$|T_A(x) + I_A(x) + F_A(x)| \leq 3. \quad (6)$$

Definition 4 [26]. Let $A = \{(x, T_A(x), I_A(x), F_A(x)): x \in X\}$ and $B = \{(x, T_B(x), I_B(x), F_B(x)): x \in X\}$ be two CNSs in X . The union and intersection of A and B are as defined below.

(i) The union of A and B , denoted as $A \cup_N B$, is defined as:

$$A \cup_N B = \{(x, T_{A \cup B}(x), I_{A \cup B}(x), F_{A \cup B}(x)): x \in X\}, \quad (7)$$

where $T_{A \cup B}(x), I_{A \cup B}(x), F_{A \cup B}(x)$ are given by:

$$\begin{aligned} T_{A \cup B}(x) &= \max(p_A(x), p_B(x)) \cdot e^{i\mu_{A \cup B}(x)}, \\ I_{A \cup B}(x) &= \min(q_A(x), q_B(x)) \cdot e^{i\nu_{A \cup B}(x)}, \\ F_{A \cup B}(x) &= \min(r_A(x), r_B(x)) \cdot e^{i\omega_{A \cup B}(x)}. \end{aligned}$$

(ii) The intersection of A and B , denoted as $A \cap_N B$, is defined as:

$$A \cap_N B = \{(x, T_{A \cap B}(x), I_{A \cap B}(x), F_{A \cap B}(x)): x \in X\}, \quad (8)$$

where $T_{A \cap B}(x), I_{A \cap B}(x), F_{A \cap B}(x)$ are given by:

$$\begin{aligned} T_{A \cap B}(x) &= \min(p_A(x), p_B(x)) \cdot e^{i\mu_{A \cap B}(x)}, \\ I_{A \cap B}(x) &= \max(q_A(x), q_B(x)) \cdot e^{i\nu_{A \cap B}(x)}, \\ F_{A \cap B}(x) &= \max(r_A(x), r_B(x)) \cdot e^{i\omega_{A \cap B}(x)}. \end{aligned}$$

The union and the intersection of the phase terms of the complex truth, falsity and indeterminacy membership functions can be calculated from, but not limited to, any one of the following operations:

(a) Sum:

$$\begin{aligned} \mu_{A \cup B}(x) &= \mu_A(x) + \mu_B(x), \\ \nu_{A \cup B}(x) &= \nu_A(x) + \nu_B(x), \\ \omega_{A \cup B}(x) &= \omega_A(x) + \omega_B(x). \end{aligned}$$

(b) Max:

$$\begin{aligned} \mu_{A \cup B}(x) &= \max(\mu_A(x), \mu_B(x)), \\ \nu_{A \cup B}(x) &= \max(\nu_A(x), \nu_B(x)), \\ \omega_{A \cup B}(x) &= \max(\omega_A(x), \omega_B(x)). \end{aligned}$$

(c) Min:

$$\begin{aligned} \mu_{A \cup B}(x) &= \min(\mu_A(x), \mu_B(x)), \\ \nu_{A \cup B}(x) &= \min(\nu_A(x), \nu_B(x)), \\ \omega_{A \cup B}(x) &= \min(\omega_A(x), \omega_B(x)). \end{aligned}$$

(d) "The game of winner, neutral, and loser":

$$\mu_{A \cup B}(x) = \begin{cases} \mu_A(x) & \text{if } p_A > p_B \\ \mu_B(x) & \text{if } p_B > p_A \end{cases},$$

$$\nu_{A \cup B}(x) = \begin{cases} \nu_A(x) & \text{if } q_A < q_B \\ \nu_B(x) & \text{if } q_B < q_A \end{cases},$$

$$\omega_{A \cup B}(x) = \begin{cases} \omega_A(x) & \text{if } r_A < r_B \\ \omega_B(x) & \text{if } r_B < r_A \end{cases}.$$

Definition 5 [17]. Let the following statements hold:

- (a) V is a non-void set.
- (b) $\check{\rho}_T, \check{\rho}_I, \check{\rho}_F$ are three functions, each from V to $[0, 1]$.
- (c) $\check{\omega}_T, \check{\omega}_I, \check{\omega}_F$ are three functions, each from $V \times V$ to $[0, 1]$.
- (d) $\check{\rho} = (\check{\rho}_T, \check{\rho}_I, \check{\rho}_F)$ and $\check{\omega} = (\check{\omega}_T, \check{\omega}_I, \check{\omega}_F)$.

Then the structure $\check{\xi} = \langle V, \check{\rho}, \check{\omega} \rangle$ is said to be a generalized single valued neutrosophic graph of type 1 (GSVNG1).

Remark 1. (i) $\check{\rho}$ depends on $\check{\rho}_T, \check{\rho}_I, \check{\rho}_F$ and $\check{\omega}$ depends on $\check{\omega}_T, \check{\omega}_I, \check{\omega}_F$. Hence there are seven mutually independent parameters in total that make up a CNG1: $V, \check{\rho}_T, \check{\rho}_I, \check{\rho}_F, \check{\omega}_T, \check{\omega}_I, \check{\omega}_F$.

- (i) For each $x \in V$, x is said to be a vertex of $\check{\xi}$. The entire set V is thus called the vertex set of $\check{\xi}$.
- (ii) For each $u, v \in V$, (u, v) is said to be a directed edge of $\check{\xi}$. In particular, (v, v) is said to be a loop of $\check{\xi}$.
- (iii) For each vertex: $\check{\rho}_T(v), \check{\rho}_I(v), \check{\rho}_F(v)$ are called the truth-membership value, indeterminate membership value, and false-membership value, respectively, of that vertex v . Moreover, if $\check{\rho}_T(v) = \check{\rho}_I(v) = \check{\rho}_F(v) = 0$, then v is said to be a void vertex.
- (iv) Likewise, for each edge (u, v) : $\check{\omega}_T(u, v), \check{\omega}_I(u, v), \check{\omega}_F(u, v)$ are called the truth-membership value, indeterminate-membership value, and false-membership value, respectively of that directed edge (u, v) . Moreover, if $\check{\omega}_T(u, v) = \check{\omega}_I(u, v) = \check{\omega}_F(u, v) = 0$, then (u, v) is said to be a void directed edge.

Here we shall restate the concept of complex fuzzy graph of type 1. Moreover, for all the remaining parts of this paper, we shall denote the set $\{z \in \mathbb{C}: |z| \leq 1\}$ as O_1 .

Definition 6 [27]. Let the following statements hold:

- (a) V is a non-void set.
- (b) $\hat{\rho}$ is a function from V to O_1 .
- (c) $\hat{\omega}$ is a function from $V \times V$ to O_1 .

Then:

- (i) the structure $\hat{\xi} = \langle V, \hat{\rho}, \hat{\omega} \rangle$ is said to be a complex fuzzy graph of type 1 (abbr. CFG1).
- (ii) For each $x \in V$, x is said to be a vertex of $\hat{\xi}$. The entire set V is thus called the vertex set of $\hat{\xi}$.
- (iii) For each $u, v \in V$, (u, v) is said to be a directed edge of $\hat{\xi}$. In particular, (v, v) is said to be a loop of $\hat{\xi}$.

3. Complex Neutrosophic Graphs of Type 1

By using the concept of complex neutrosophic sets [26], the concept of complex fuzzy graph of type 1 [27], and the concept of generalized single valued neutrosophic graph of type 1 [17], we define the concept of *complex neutrosophic graph of type 1* as follows:

Definition 7. Let the following statements hold:

- (a) V is a non-void set.
- (b) ρ_T, ρ_I, ρ_F are three functions, each from V to O_1 .
- (c) $\omega_T, \omega_I, \omega_F$ are three functions, each from $V \times V$ to O_1 .

(d) $\rho = (\rho_T, \rho_I, \rho_F)$ and $\omega = (\omega_T, \omega_I, \omega_F)$.

Then the structure $\xi = \langle V, \rho, \omega \rangle$ is said to be a complex neutrosophic graph of type 1 (abbr. CNG1).

Remark 2. ρ depends on ρ_T, ρ_I, ρ_F , and ω depends on $\omega_T, \omega_I, \omega_F$. Hence there are seven mutually independent parameters in total that make up a CNG1: $V, \rho_T, \rho_I, \rho_F, \omega_T, \omega_I, \omega_F$. Furthermore, in analogy to a GSVNG1:

- (i) For each $x \in V$, x is said to be a vertex of ξ . The entire set V is thus called the vertex set of ξ .
- (ii) For each $u, v \in V$, (u, v) is said to be a directed edge of ξ . In particular, (v, v) is said to be a loop of ξ .
- (iii) For each vertex: $\rho_T(v), \rho_I(v), \rho_F(v)$ are called the complex truth, indeterminate, and falsity membership values, respectively, of the vertex v . Moreover, if $\rho_T(v) = \rho_I(v) = \rho_F(v) = 0$, then v is said to be a void vertex.
- (iv) Likewise, for each directed edge (u, v) : $\omega_T(u, v), \omega_I(u, v), \omega_F(u, v)$ are called the complex truth, indeterminate and falsity membership value, of the directed edge (u, v) . Moreover, if $\omega_T(u, v) = \omega_I(u, v) = \omega_F(u, v) = 0$, then (u, v) is said to be a void directed edge.

For the sake of brevity, we shall denote $\omega(u, v) = (\omega_T(u, v), \omega_I(u, v), \omega_F(u, v))$ and $\rho(v) = (\rho_T(v), \rho_I(v), \rho_F(v))$ for all the remaining parts of this paper.

As mentioned, CNG1 is generalized from both GSVNG1 and CFG1. As a result, we have ω_T, ω_I and ω_F being functions themselves. This further implies that $\omega_T(u, v), \omega_I(u, v)$ and $\omega_F(u, v)$ can only be single values from O_1 . In particular, $\omega_T(v, v), \omega_I(v, v)$, and $\omega_F(v, v)$ can only be single values.

As a result, each vertex v in a CNG1 possess a single, undirected loop, whether void or not. And each of the two distinct vertices u, v in a CNG1 possess *two* directed edges, resulting from (u, v) and (v, u) , whether void or not.

Recall that in classical graph theory, we often deal with ordinary (or undirected) graphs, and also simple graphs. To further relate our CNG1 with it, we now proceed with the following definition.

Definition 8. Let $\xi = \langle V, \rho, \omega \rangle$ be a CNG1.

- (a) If $\omega(a, b) = \omega(b, a)$, then $\{a, b\} = \{(a, b), (b, a)\}$ is said to be an (ordinary) edge of ξ . Moreover, $\{a, b\}$ is said to be a void (ordinary) edge if both (a, b) and (b, a) are void.
- (b) If $\omega(u, v) = \omega(v, u)$ holds for all $u, v \in V$, then ξ is said to be ordinary (or undirected), otherwise it is said to be directed.
- (c) If all the loops of ξ are void, then ξ is said to be simple.

Definition 9. Let $\xi = \langle V, \rho, \omega \rangle$ be an ordinary CNG1. If for all $u, v \in V$ with $u \neq v$, there exist non-void edges $\{u = w_1, w_2\}, \{w_2, w_3\}, \dots, \{w_{n-1}, w_n = v\}$ for some $n \geq 2$, then ξ is said to be connected.

Definition 10. Let $\xi = \langle V, \rho, \omega \rangle$ be an ordinary CNG1. Let $u, v \in V$. Then:

- (a) $\{u, v\}$ is said to be adjacent to u (and to v).
- (b) u (and v as well) is said to be an end-point of $\{u, v\}$.

We now discuss a real life scenario that can only be represented by a CNG1.

The Scenario

Note: All the locations mentioned are fictional

Suppose there is a residential area in Malaysia with four families: a, b, c, d . All of them have Internet access. In other words, they are Internet clients, which will access the Internet servers from around the world (including those servers located within Malaysia) depending on which website they are visiting.

If they access the internet on their own, the outcomes can be summarized as given in the Table 1 and Figure 1.

Table 1. The outcomes of individuals, for Scenario 3.1.

Activities	a	b	c	d
Some members will seek excitement (e.g., playing online games)	Happens on 80% of the day, and those will be connecting towards 0° (because that server is located in China *)	Happens on 70% of the day, and those will be connecting towards 30°	Happens on 90% of the day, and those will be connecting towards 120°	Happens on 80% of the day, and those will be connecting towards 250°
Some members will want to surf around (e.g., online shopping)	Happens on 50% of the day, and those will be connecting towards 130° (because that server is located in Australia *)	Happens on 60% of the day, and those will be connecting towards 180°	Happens on 20% of the day, and those will be connecting towards 340°	Happens on 40% of the day, and those will be connecting towards 200°
Some members will need to relax (e.g., listening to music)	Happens on 20% of the day, and those will be connecting towards 220° (because that server is located in Sumatra *, Indonesia)	Happens on 30% of the day, and those will be connecting towards 200°	Happens on 50% of the day, and those will be connecting towards 40°	Happens on 10% of the day, and those will be connecting towards 110°

(*) as illustrated in Figure 1.

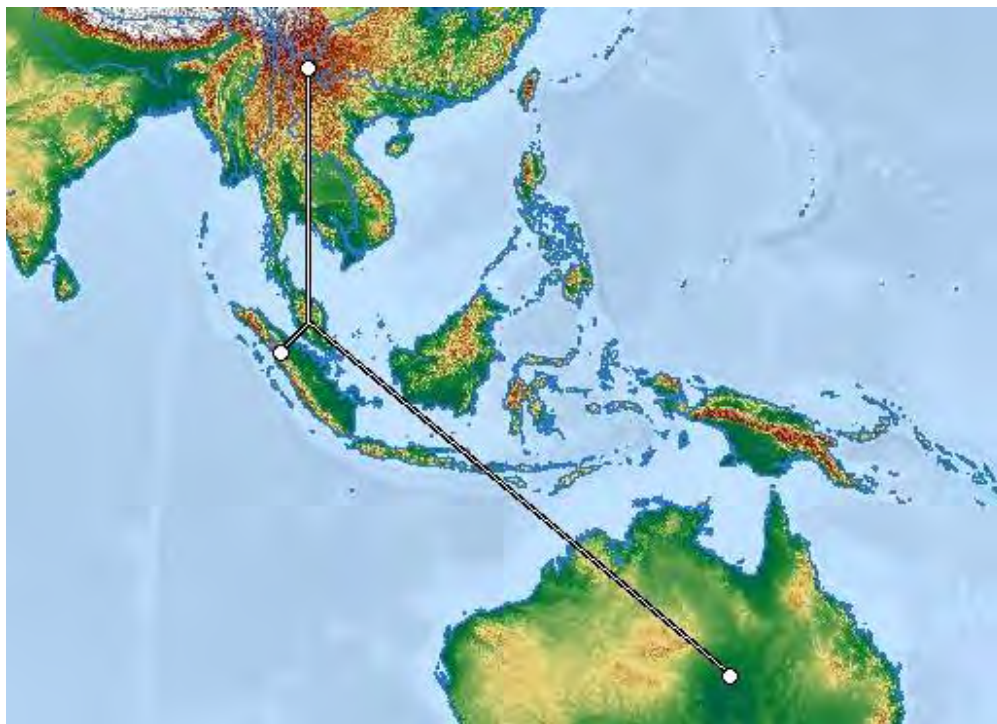

Figure 1. The illustration of the servers' relative positions using a public domain map, for Scenario 3.1.

Moreover, the following (unordered) pairs of the four families are close friends or relatives:

$$\{a, b\}, \{a, c\}, \{a, d\}, \{b, d\}.$$

Thus, each pair of family mentioned (e.g., $\{a, b\}$) may invite one another for a visit, accessing the Internet as one team. In particular:

- (i) When $\{a, b\}$ or $\{a, d\}$ access the internet together, they will simply search for "a place of common interest". This is regardless of who initiates the invitation.
- (ii) a and c rarely meet. Thus, each time they do, everyone (especially the children) will be so excited that they would like to try something fresh, so all will seek excitement and connect towards to a local broadcasting server at 240° to watch soccer matches (that server will take care

of which country to connect to) for the entire day. This is also regardless of who initiates the visitation.

- (iii) The size and the wealth of d far surpasses b . Thus, it would always be d who invites b to their house, never the other way, and during the entire visit, members of b will completely behave like members of d and, therefore, will visit the same websites as d .

Denote the first term of the ordered pair (u, v) as the family who initiates the invitation, and the second term as family who receives the invitation and visit the other family. The outcomes of the seven possible teams (a, b) , (a, c) , (a, d) , (b, a) , (c, a) , (d, a) , (d, b) are, thus, summarized by Table 2.

Table 2. The outcomes of teams in pairs, for the scenario.

Activities	$(a, b), (b, a)$	$(a, c), (c, a)$	$(a, d), (d, a)$	(d, b)
Some members will seek excitement	Happens on 80% of the day, and those will be connecting towards 15°	Happens on the entire day, all will be connecting towards 240°	Happens on 80% of the day, and those will be connecting towards 305°	Happens on 80% of the day, and those will be connecting towards 250°
Some members will want to surf around	Happens on 60% of the day, and those will be connecting towards 155°	Does not happen	Happens on 50% of the day, and those will be connecting towards 165°	Happens on 40% of the day, and those will be connecting towards 200°
Some members will need to relax	Happens on 30% of the day, and those will be connecting towards 210°	Does not happen	Happens on 50% of the day, and those will be connecting towards 40°	Happens on 10% of the day, and those will be connecting towards 110°

On the other hand, $\{c, b\}$ and $\{d, c\}$ are mutual strangers. So c and b will visit each other. The same goes to d and c .

3.2. Representation of the Scenario with CNG1

We now follow all the steps from (a) to (e) in Definition 7, to represent the scenario with a particular CNG1.

- (a) Take $V_0 = \{a, b, c, d\}$.
- (b) In accordance with the scenario, define the three functions on $V_0 : \rho_T, \rho_I, \rho_F$, as illustrated in Table 3.

Table 3. $k(v)$, where k represents any of the 3 functions on $V_0 : \rho_T, \rho_I, \rho_F$, for the scenario. Also mentioned in Section 4.2.

$v \backslash k$	a	b	c	d
ρ_T	$0.8e^{i2\pi}$	$0.7e^{i\frac{\pi}{6}}$	$0.9e^{i\frac{2\pi}{3}}$	$0.8e^{i\frac{25\pi}{18}}$
ρ_I	$0.5e^{i\frac{13\pi}{18}}$	$0.6e^{i\pi}$	$0.2e^{i\frac{17\pi}{9}}$	$0.4e^{i\frac{10\pi}{9}}$
ρ_F	$0.2e^{i\frac{11\pi}{9}}$	$0.3e^{i\frac{10\pi}{9}}$	$0.5e^{i\frac{2\pi}{9}}$	$0.1e^{i\frac{11\pi}{18}}$

- (c) In accordance with the scenario, define the three functions $\omega_T, \omega_I, \omega_F$, as illustrated in Tables 4–6.

Table 4. The outcomes of $\omega_T(u, v)$, for the scenario. Also mentioned in Section 4.2.

$v \backslash u$	a	b	c	d
a	0	$0.8e^{i\frac{\pi}{12}}$	$1e^{i\frac{4\pi}{3}}$	$0.8e^{i\frac{61\pi}{36}}$
b	$0.8e^{i\frac{\pi}{12}}$	0	0	0
c	$1e^{i\frac{4\pi}{3}}$	0	0	0
d	$0.8e^{i\frac{61\pi}{36}}$	$0.8e^{i\frac{25\pi}{18}}$	0	0

Table 5. The outcomes of $\omega_I(u, v)$, for the scenario. Also mentioned in Section 4.2.

$v \backslash u$	a	b	c	d
a	0	$0.6e^{i\frac{31\pi}{36}}$	0	$0.5e^{i\frac{33\pi}{36}}$
b	$0.6e^{i\frac{31\pi}{36}}$	0	0	0
c	0	0	0	0
d	$0.5e^{i\frac{33\pi}{36}}$	$0.4e^{i\frac{10\pi}{9}}$	0	0

Table 6. The outcomes of $\omega_F(u, v)$, for the scenario. Also mentioned in Section 4.2.

$v \backslash u$	a	b	c	d
a	0	$0.3e^{i\frac{7\pi}{6}}$	0	$0.5e^{i\frac{2\pi}{9}}$
b	$0.3e^{i\frac{7\pi}{6}}$	0	0	0
c	0	0	0	0
d	$0.5e^{i\frac{2\pi}{9}}$	$0.1e^{i\frac{11\pi}{18}}$	0	0

(d) By statement (d) from Definition 7, let $\rho_0 = (\rho_T, \rho_I, \rho_F)$, and $\omega_0 = (\omega_T, \omega_I, \omega_F)$. We have now formed a CNG1 $\langle V_0, \rho_0, \omega_0 \rangle$.

One of the way of representing the entire $\langle V_0, \rho_0, \omega_0 \rangle$ is by using a diagram that is analogous with graphs as in classical graph theory, as shown in the Figure 2.

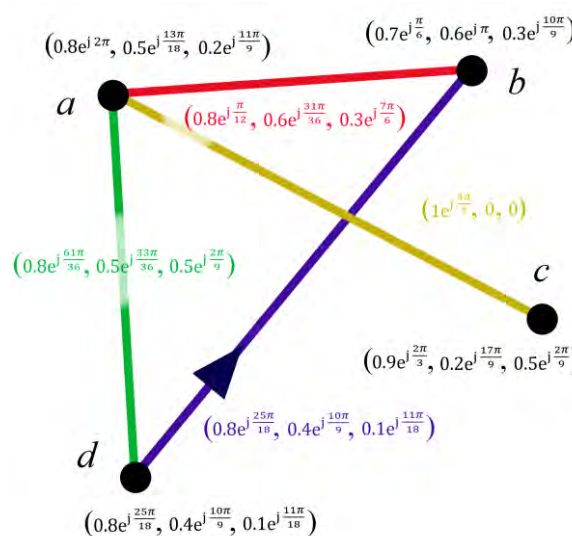

Figure 2. A diagram representing $\langle V_0, \rho_0, \omega_0 \rangle$, for the scenario.

In other words, only the non-void edges (whether directed or ordinary) and vertices are to be drawn in such a diagram.

Hence, we have shown how a CGN1 can be constructed from a data set with four homes. The same concept mentioned can certainly be used on a larger dataset, such as one with thousands of locations and thousands of homes, which will result in a more complicated diagram being generated. However, one will definitely require computer algebraic systems, such as SAGE, to process the data and to display the data in diagram form.

Additionally, recall that, in classical graph theory, a graph can be represented by an adjacency matrix, for which the entries are either a positive integer (connected) or 0 (not connected).

This motivates us to represent CNG1 using a matrix as well, in a similar manner. Nonetheless, instead of a single value that is either 0 or 1, we have *three* values to deal with: $\omega_T, \omega_I, \omega_F$, with each of them capable of being anywhere in O_1 . Moreover, each of the vertices themselves also contain ρ_T, ρ_I, ρ_F , which must be taken into account as well.

4. Representation of a CNG1 by an Adjacency Matrix

4.1. Two Methods of Representation

In this section, we discuss the representation of CNG1 in two ways, which are both analogous to the one encountered in classical literature.

Let $\xi = \langle V, \rho, \omega \rangle$ be a CNG1 where vertex set $V = \{v_1, v_2, \dots, v_n\}$ (i.e., CNG1 has finite vertices). We first form an $n \times n$ matrix as shown:

$$\mathbf{M} = [\mathbf{a}_{i,j}]_n = \begin{pmatrix} \mathbf{a}_{1,1} & \mathbf{a}_{1,2} & \cdots & \mathbf{a}_{1,n} \\ \mathbf{a}_{2,1} & \mathbf{a}_{2,2} & & \mathbf{a}_{2,n} \\ \vdots & \vdots & \ddots & \vdots \\ \mathbf{a}_{n,1} & \mathbf{a}_{n,2} & \cdots & \mathbf{a}_{n,n} \end{pmatrix},$$

where $\mathbf{a}_{i,j} = \omega(v_i, v_j)$ for all i, j .

In other words, each element of the matrix \mathbf{M} is itself an ordered set of three elements, instead of just a number of either 0 or 1 in the classical literature.

Remark 3. Since ξ can only possess undirected loops, we decided not to multiply the main diagonal elements of \mathbf{M} by 2, as seen in adjacency matrices for graphs classical literature (2 for undirected, 1 for directed, 0 for void).

Meanwhile, also recall that each of the vertices in ξ contains ρ_T, ρ_I, ρ_F , which must be taken into account as well.

Thus, we form another matrix \mathbf{K} as shown:

$$\mathbf{K} = [\mathbf{k}_i]_{n,1} = \begin{pmatrix} \mathbf{k}_1 \\ \mathbf{k}_2 \\ \vdots \\ \mathbf{k}_n \end{pmatrix}, \text{ where } \mathbf{k}_i = \rho(v_i) \text{ for all } i.$$

To accomplish one of our methods of representing the entire ξ we, therefore, augment the matrix \mathbf{K} with \mathbf{M} , forming the *adjacency matrix* of CNG1, $[\mathbf{K}|\mathbf{M}]$, as shown:

$$[\mathbf{K}|\mathbf{M}] = \begin{pmatrix} \mathbf{k}_1 & \mathbf{a}_{1,1} & \mathbf{a}_{1,2} & \cdots & \mathbf{a}_{1,n} \\ \mathbf{k}_2 & \mathbf{a}_{2,1} & \mathbf{a}_{2,2} & & \mathbf{a}_{2,n} \\ \vdots & \vdots & \vdots & \ddots & \vdots \\ \mathbf{k}_n & \mathbf{a}_{n,1} & \mathbf{a}_{n,2} & \cdots & \mathbf{a}_{n,n} \end{pmatrix},$$

where $\mathbf{a}_{i,j} = \omega(v_i, v_j)$, and $\mathbf{k}_i = \rho(v_i)$, for all i, j .

Although $[\mathbf{K}|\mathbf{M}]$ is an $n \times (n + 1)$ matrix and therefore not a square, this representation will save us another *separate* ordered set to represent the ρ_T, ρ_I, ρ_F values of the vertices themselves.

Sometimes it is more convenient to separately deal with each of the three kinds of membership values for both edges and vertices. As a result, here we provide another method of representing the entire ξ : using three $n \times (n + 1)$ matrices, $[\mathbf{K}|\mathbf{M}]_T, [\mathbf{K}|\mathbf{M}]_I,$ and $[\mathbf{K}|\mathbf{M}]_F,$ each derived from $[\mathbf{K}|\mathbf{M}]$ by taking only one kind of the membership values from its elements:

$$[\mathbf{K}|\mathbf{M}]_T = [\mathbf{K}_T|\mathbf{M}_T] = \begin{pmatrix} \rho_T(v_1) & \omega_T(v_1, v_1) & \omega_T(v_1, v_2) & \cdots & \omega_T(v_1, v_n) \\ \rho_T(v_2) & \omega_T(v_2, v_1) & \omega_T(v_2, v_2) & & \omega_T(v_2, v_n) \\ \vdots & \vdots & \vdots & \ddots & \vdots \\ \rho_T(v_n) & \omega_T(v_n, v_1) & \omega_T(v_n, v_2) & \cdots & \omega_T(v_n, v_n) \end{pmatrix},$$

$$\begin{aligned}
 [\mathbf{K}|\mathbf{M}]_I = [\mathbf{K}_I|\mathbf{M}_I] &= \begin{pmatrix} \rho_I(v_1) & \omega_I(v_1, v_1) & \omega_I(v_1, v_2) & \dots & \omega_I(v_1, v_n) \\ \rho_I(v_2) & \omega_I(v_2, v_1) & \omega_I(v_2, v_2) & \dots & \omega_I(v_2, v_n) \\ & \vdots & & \ddots & \vdots \\ \rho_I(v_n) & \omega_I(v_n, v_1) & \omega_I(v_n, v_2) & \dots & \omega_I(v_n, v_n) \end{pmatrix}, \\
 [\mathbf{K}|\mathbf{M}]_F = [\mathbf{K}_F|\mathbf{M}_F] &= \begin{pmatrix} \rho_F(v_1) & \omega_F(v_1, v_1) & \omega_F(v_1, v_2) & \dots & \omega_F(v_1, v_n) \\ \rho_F(v_2) & \omega_F(v_2, v_1) & \omega_F(v_2, v_2) & \dots & \omega_F(v_2, v_n) \\ & \vdots & & \ddots & \vdots \\ \rho_F(v_n) & \omega_F(v_n, v_1) & \omega_F(v_n, v_2) & \dots & \omega_F(v_n, v_n) \end{pmatrix}.
 \end{aligned}$$

$[\mathbf{K}|\mathbf{M}]_T$, $[\mathbf{K}|\mathbf{M}]_I$, and $[\mathbf{K}|\mathbf{M}]_F$ shall, thus, be called, respectively, the *truth-adjacency matrix*, the *indeterminate-adjacency matrix*, and the *false-adjacency matrix* of ξ .

Remark 4. If $[\mathbf{K}|\mathbf{M}]_I = [\mathbf{K}|\mathbf{M}]_F = [0]_{n,n+1}$, $\mathbf{K}_T = [1]_{n,1}$, all the entries of \mathbf{M}_T are either 1 or 0, then ξ is reduced to a graph in classical literature. Furthermore, if that \mathbf{M}_T is symmetrical and with main diagonal elements being zero, then ξ is further reduced to a simple ordinary graph in the classical literature.

Remark 5. If $[\mathbf{K}|\mathbf{M}]_I = [\mathbf{K}|\mathbf{M}]_F = [0]_{n,n+1}$, and all the entries of $[\mathbf{K}|\mathbf{M}]_T$ are real values from the interval $[0,1]$, then ξ is reduced to a generalized fuzzy graph type 1 (GFG1).

Remark 6. If all the entries of $[\mathbf{K}|\mathbf{M}]_T$, $[\mathbf{K}|\mathbf{M}]_I$, and $[\mathbf{K}|\mathbf{M}]_F$ are real values from the interval $[0, 1]$, then ξ is reduced to a generalized single valued neutrosophic graphs of type 1 (GSVNG1).

Remark 7. If \mathbf{M}_T , \mathbf{M}_I , and \mathbf{M}_F are symmetric matrices, then ξ is ordinary.

4.2. Illustrative Example

For the sake of brevity, we now give representation for our example for the scenario in 3.1 by the latter method using three matrices: $[\mathbf{K}|\mathbf{M}]_T$, $[\mathbf{K}|\mathbf{M}]_I$, and $[\mathbf{K}|\mathbf{M}]_F$:

$$\begin{aligned}
 [\mathbf{K}|\mathbf{M}]_T &= \begin{pmatrix} 0.8e^{i2\pi} & 0 & 0.8e^{i\frac{\pi}{12}} & 1e^{i\frac{4\pi}{3}} & 0.8e^{i\frac{61\pi}{36}} \\ 0.7e^{i\frac{\pi}{6}} & 0.8e^{i\frac{\pi}{12}} & 0 & 0 & 0 \\ 0.9e^{i\frac{2\pi}{3}} & 1e^{i\frac{4\pi}{3}} & 0 & 0 & 0 \\ 0.8e^{i\frac{25\pi}{18}} & 0.8e^{i\frac{61\pi}{36}} & 0.8e^{i\frac{25\pi}{18}} & 0 & 0 \end{pmatrix} \\
 [\mathbf{K}|\mathbf{M}]_I &= \begin{pmatrix} 0.5e^{i\frac{13\pi}{18}} & 0 & 0.6e^{i\frac{31\pi}{36}} & 0 & 0.5e^{i\frac{33\pi}{36}} \\ 0.6e^{i\pi} & 0.6e^{i\frac{31\pi}{36}} & 0 & 0 & 0 \\ 0.2e^{i\frac{17\pi}{9}} & 0 & 0 & 0 & 0 \\ 0.4e^{i\frac{10\pi}{9}} & 0.5e^{i\frac{33\pi}{36}} & 0.4e^{i\frac{10\pi}{9}} & 0 & 0 \end{pmatrix} \\
 [\mathbf{K}|\mathbf{M}]_F &= \begin{pmatrix} 0.2e^{i\frac{11\pi}{9}} & 0 & 0.3e^{i\frac{7\pi}{6}} & 0 & 0.5e^{i\frac{2\pi}{9}} \\ 0.3e^{i\frac{10\pi}{9}} & 0.3e^{i\frac{7\pi}{6}} & 0 & 0 & 0 \\ 0.5e^{i\frac{2\pi}{9}} & 0 & 0 & 0 & 0 \\ 0.1e^{i\frac{11\pi}{18}} & 0.5e^{i\frac{2\pi}{9}} & 0.1e^{i\frac{11\pi}{18}} & 0 & 0 \end{pmatrix}
 \end{aligned}$$

As in Section 3, we have shown how a matrix representation of a CNG1 with $|V| = 4$ can be constructed. Likewise, the same concept mentioned can certainly be used on a larger CNG1 but, again, one will definitely require computer algebraic systems, such as SAGE to process the data and to display such a matrix representation.

5. Some Theoretical Results on Ordinary CNG1

We now discuss some theoretical results that follows from the definition of ordinary CNG1, as well as its representation with adjacency matrix. Since we are concerned about ordinary CNG1, all the edges that we will be referring to are ordinary edges.

Definition 11. Let $\xi = \langle V, \rho, \omega \rangle$ be an ordinary CNG1. Let $V = \{v_1, v_2, \dots, v_n\}$ be the vertex set of ξ . Then, for each i , the resultant degree of v_i , denoted as $D(v_i)$, is defined to be the ordered set $(D_T(v_i), D_I(v_i), D_F(v_i))$, for which:

- (a) $D_T(v_i) = \sum_{r=1}^n \omega_T(v_i, v_r) + \omega_T(v_i, v_i)$,
- (b) $D_I(v_i) = \sum_{r=1}^n \omega_I(v_i, v_r) + \omega_I(v_i, v_i)$,
- (c) $D_F(v_i) = \sum_{r=1}^n \omega_F(v_i, v_r) + \omega_F(v_i, v_i)$.

Remark 8. In analogy to classical graph theory, each undirected loop has both its ends connected to the same vertex, so is counted twice.

Remark 9. Each of the values of $D_T(v_i)$, $D_I(v_i)$, and $D_F(v_i)$ need not be an integer as in a classical graph.

Definition 12. Let $\xi = \langle V, \rho, \omega \rangle$ be an ordinary CNG1. Let $V = \{v_1, v_2, \dots, v_n\}$ be the vertex set of ξ . Then, the resultant amount of edges of ξ , denoted as E_ξ , is defined to be the ordered set (E_T, E_I, E_F) for which:

- (a) $E_T = \sum_{\{r,s\} \subseteq \{1,2,\dots,n\}} \omega_T(v_r, v_s)$,
- (b) $E_I = \sum_{\{r,s\} \subseteq \{1,2,\dots,n\}} \omega_I(v_r, v_s)$,
- (c) $E_F = \sum_{\{r,s\} \subseteq \{1,2,\dots,n\}} \omega_F(v_r, v_s)$.

Remark 10. As in classical graph theory, each edge is counted only once, as shown by $\{r, s\} \subseteq \{1, 2, \dots, n\}$ in the expression. For example, if $\omega_T(v_a, v_b)$ is added, we will not add $\omega_T(v_b, v_a)$ again since $\{a, b\} = \{b, a\}$.

Remark 11. Each of the values of E_T , E_I and E_F need not be an integer as in a classical graph. As a result, we call it the "amount" of edges, instead of the "number" of edges as in the classical literature.

For each vertex v_i , just because $D(v_i)$ equals 0, that does not mean that all the edges connect to v_i are void. It could be two distinct edges $\{v_i, v_1\}$ and $\{v_i, v_2\}$ with $\omega_T(v_i, v_1) = -\omega_T(v_i, v_2)$, $\omega_I(v_i, v_1) = -\omega_I(v_i, v_2)$ and $\omega_F(v_i, v_1) = -\omega_F(v_i, v_2)$ (i.e., equal in magnitude, but opposite in phase). The same goes to the value of E_ξ . This differs from the classical theory of graphs and, therefore, it motivates us to look at a CNG1 in yet another approach. We, thus, further define the following:

Definition 13. Let $\xi = \langle V, \rho, \omega \rangle$ be an ordinary CNG1. Let $V = \{v_1, v_2, \dots, v_n\}$ be the vertex set of ξ . Then, for each i , the absolute degree of v_i , denoted as $|D|(v_i)$, is defined to be the ordered set $(|D|_T(v_i), |D|_I(v_i), |D|_F(v_i))$, for which:

- (a) $|D|_T(v_i) = \sum_{r=1}^n |\omega_T(v_i, v_r)| + |\omega_T(v_i, v_i)|$,
- (b) $|D|_I(v_i) = \sum_{r=1}^n |\omega_I(v_i, v_r)| + |\omega_I(v_i, v_i)|$,
- (c) $|D|_F(v_i) = \sum_{r=1}^n |\omega_F(v_i, v_r)| + |\omega_F(v_i, v_i)|$.

Definition 14. Let $\xi = \langle V, \rho, \omega \rangle$ be an ordinary CNG1. Let $V = \{v_1, v_2, \dots, v_n\}$ be the vertex set of ξ . Then, the absolute amount of edges of ξ , denoted as $|E|_\xi$, is defined to be the ordered set $(|E|_T, |E|_I, |E|_F)$ for which:

- (a) $|E|_T = \sum_{\{r,s\} \subseteq \{1,2,\dots,n\}} |\omega_T(v_r, v_s)|$,
- (b) $|E|_I = \sum_{\{r,s\} \subseteq \{1,2,\dots,n\}} |\omega_I(v_r, v_s)|$,
- (c) $|E|_F = \sum_{\{r,s\} \subseteq \{1,2,\dots,n\}} |\omega_F(v_r, v_s)|$.

On the other hand, sometimes we are particularly concerned about the number of non-void edges in an ordinary CNG1. In other words, we just want to know how many edges $\{v_i, v_j\}$ with:

$$\omega(v_i, v_j) \neq (0,0,0).$$

Instead of a mere visual interpretation, we must however form a precise definition as follows:

Definition 15. Let $\xi = \langle V, \rho, \omega \rangle$ be an ordinary CNG1. Let $V = \{v_1, v_2, \dots, v_n\}$ to be the vertex set of ξ . Then, the number of non-void edges of ξ , denoted as M_ξ , is defined to be the cardinality of the set:

$$\{ \{v_i, v_j\} \subseteq V \mid \omega(v_i, v_j) \neq (0,0,0) \}.$$

Definition 16. Let $\xi = \langle V, \rho, \omega \rangle$ be an ordinary CNG1. Let $V = \{v_1, v_2, \dots, v_n\}$ to be the vertex set of ξ . Then, the number of vertices of ξ , denoted as N_ξ , is defined to be the cardinality of the set V itself.

Remark 12. In this paper, we often deal with both M_ξ and N_ξ at the same time. Thus, we will not denote N_ξ as $|V|$.

Remark 13. By Definition 7, V is non-void, so $N_\xi \geq 1$ follows.

Lemma 1. Let $\xi = \langle V, \rho, \omega \rangle$ be an ordinary CNG1. Let $V = \{v_1, v_2, \dots, v_n\}$ be the vertex set of ξ . Then, for each i :

- (a) $D_T(v_i) = \sum_{r=1}^n \omega_T(v_r, v_i) + \omega_T(v_i, v_i)$,
- (b) $D_I(v_i) = \sum_{r=1}^n \omega_I(v_r, v_i) + \omega_I(v_i, v_i)$,
- (c) $D_F(v_i) = \sum_{r=1}^n \omega_F(v_r, v_i) + \omega_F(v_i, v_i)$.

Proof. Since ξ is ordinary, $\omega(v_r, v_i) = \omega(v_i, v_r)$ for all i and r . The lemma thus follows. \square

Lemma 2. Let $\xi = \langle V, \rho, \omega \rangle$ to be an ordinary CNG1. If ξ is simple. then, for each i :

- (a) $D_T(v_i) = \sum_{r \in \{1,2,\dots,n\} - \{i\}} \omega_T(v_i, v_r)$,
- (b) $D_I(v_i) = \sum_{r \in \{1,2,\dots,n\} - \{i\}} \omega_I(v_i, v_r)$,
- (c) $D_F(v_i) = \sum_{r \in \{1,2,\dots,n\} - \{i\}} \omega_F(v_i, v_r)$.

Proof. Since ξ is simple, $\omega(v_i, v_i) = (0,0,0)$ for all i . The lemma thus follows. \square

Lemma 3. Let $\xi = \langle V, \rho, \omega \rangle$ be an ordinary CNG1. Let $V = \{v_1, v_2, \dots, v_n\}$ be the vertex set of ξ . Then, for each i :

- (a) $|D|_T(v_i) = \sum_{r=1}^n |\omega_T(v_r, v_i)| + |\omega_T(v_i, v_i)|$,
- (b) $|D|_I(v_i) = \sum_{r=1}^n |\omega_I(v_r, v_i)| + |\omega_I(v_i, v_i)|$,
- (c) $|D|_F(v_i) = \sum_{r=1}^n |\omega_F(v_r, v_i)| + |\omega_F(v_i, v_i)|$.

Proof. The arguments are similar to Lemma 1. \square

Lemma 4. Let $\xi = \langle V, \rho, \omega \rangle$ be an ordinary CNG1. If ξ is simple. then, for each i :

- (a) $|D|_T(v_i) = \sum_{r \in \{1,2,\dots,n\} - \{i\}} |\omega_T(v_i, v_r)|$,
- (b) $|D|_I(v_i) = \sum_{r \in \{1,2,\dots,n\} - \{i\}} |\omega_I(v_i, v_r)|$,
- (c) $|D|_F(v_i) = \sum_{r \in \{1,2,\dots,n\} - \{i\}} |\omega_F(v_i, v_r)|$.

Proof. The arguments are similar to Lemma 2. \square

Lemma 5. Let $\xi = \langle V, \rho, \omega \rangle$ be an ordinary CNG1. Then $\sum_{r=1}^n |D|(v_r) = (0,0,0)$ if and only if $|D|(v_i) = (0,0,0)$ for all i .

Proof. Without loss of generality, since $|D|_T(v_i) = \sum_{r=1}^n |\omega_T(v_i, v_r)| + |\omega_T(v_i, v_i)|$ by Definition 13, it is always a non-negative real number. Thus, in order that $\sum_{r=1}^n |D|_T(v_r) = 0$, there can be only one possibility: all $|D|_T(v_i)$ must be zero. \square

Remark 14. A similar statement does not hold for the resultant degree.

We now proceed with two of our theorems which both serve as generalizations of the well-known theorem in classical literature:

“For an ordinary graph, the sum of the degree of all its vertices is always twice the number of its edges.”

Theorem 1. Let $\xi = \langle V, \rho, \omega \rangle$ be an ordinary CNG1. Then $\sum_{r=1}^n D(v_r) = 2E_\xi$.

Proof. As $D(v_i) = (D_T(v_i), D_I(v_i), D_F(v_i))$ for all i , and $E_\xi = (E_T, E_I, E_F)$. Without loss of generality, it suffices to prove that $2E_T = \sum_{r=1}^n D_T(v_r)$:

$$E_T = \sum_{\{r,s\} \subseteq \{1,2,\dots,n\}} \omega_T(v_r, v_s) = \sum_{\substack{\{r,s\} \subseteq \{1,2,\dots,n\} \\ r \neq s}} \omega_T(v_r, v_s) + \sum_{r=1}^n \omega_T(v_r, v_r).$$

Since $\{r, s\} = \{s, r\}$ for all s and r , it follows that:

$$\begin{aligned} 2E_T &= 2 \sum_{\substack{\{r,s\} \subseteq \{1,2,\dots,n\} \\ r \neq s}} \omega_T(v_r, v_s) + 2 \sum_{r=1}^n \omega_T(v_r, v_r) \\ &= \sum_{\substack{r \in \{1,2,\dots,n\} \\ s \in \{1,2,\dots,n\} \\ r \neq s}} \omega_T(v_r, v_s) + 2 \sum_{r=1}^n \omega_T(v_r, v_r) \\ &= \sum_{\substack{r \in \{1,2,\dots,n\} \\ s \in \{1,2,\dots,n\}}} \omega_T(v_r, v_s) + \sum_{r=1}^n \omega_T(v_r, v_r) \\ &= \sum_{r=1}^n \sum_{s=1}^n \omega_T(v_r, v_s) + \sum_{r=1}^n \omega_T(v_r, v_r) \\ &= \sum_{r=1}^n (\sum_{s=1}^n \omega_T(v_r, v_s) + \omega_T(v_r, v_r)) \\ &= \sum_{r=1}^n D_T(v_r). \end{aligned}$$

This completes the proof. \square

Theorem 2. Let $\xi = \langle V, \rho, \omega \rangle$ be an ordinary CNG1. Then $\sum_{r=1}^n |D|(v_r) = 2|E|_\xi$.

Proof. The arguments are similar to Theorem 1 and can be easily proven by replacing all the terms $\omega_T(v_i, v_j)$ with $|\omega_T(v_i, v_j)|$. \square

Lemma 6. Let $\xi = \langle V, \rho, \omega \rangle$ be an ordinary CNG1, with $\sum_{r=1}^n D(v_r) = (0,0,0)$. If $M_\xi > 0$, then $M_\xi \geq 2$.

Proof. By Theorem 1, $\sum_{r=1}^n D(v_r) = 2E_\xi$, so $E_\xi = (0,0,0)$ as well.

If only one edge is non-void, then $\omega(v_{r_0}, v_{s_0}) \neq (0,0,0)$ only for one particular set $\{r_0, s_0\}$. This implies that:

$$\begin{aligned} E_T &= \sum_{\{r,s\} \subseteq \{1,2,\dots,n\}} \omega_T(v_r, v_s) = \omega_T(v_{r_0}, v_{s_0}), \\ E_I &= \sum_{\{r,s\} \subseteq \{1,2,\dots,n\}} \omega_I(v_r, v_s) = \omega_I(v_{r_0}, v_{s_0}), \\ E_F &= \sum_{\{r,s\} \subseteq \{1,2,\dots,n\}} \omega_F(v_r, v_s) = \omega_F(v_{r_0}, v_{s_0}), \end{aligned}$$

which contradicts the statement that $E_\xi = (0,0,0)$. \square

Since $M_\xi \geq 2$, one may have thought either M_ξ or N_ξ must be even. However, this is proven to be false, even by letting ξ to be simple and by letting $D(v) = (0,0,0)$ for all i , as shown by the following counter-example (Figure 3):

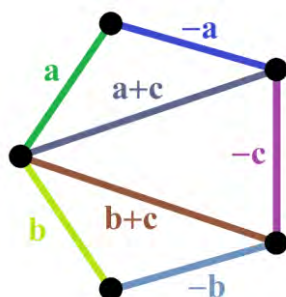

Figure 3. A counterexample, showing that M_ξ or N_ξ need not be even. $\mathbf{a} = (\frac{1}{5}e^{i2\pi}, \frac{1}{5}e^{i\frac{4}{3}\pi}, \frac{1}{5}e^{i\frac{2}{3}\pi})$, $\mathbf{b} = (\frac{1}{5}e^{i\frac{4}{3}\pi}, \frac{1}{5}e^{i\frac{2}{3}\pi}, \frac{1}{5}e^{i2\pi})$, $\mathbf{c} = (\frac{1}{5}e^{i\frac{2}{3}\pi}, \frac{1}{5}e^{i2\pi}, \frac{1}{5}e^{i\frac{4}{3}\pi})$.

for which $M_\xi = 7$, $N_\xi = 5$, and with all vertices being end-points of some edges. Moreover, such a result is not related to the value of $\rho(v)$ for any of the vertex v .

This motivates to consider what is the least possible values of M_ξ and N_ξ , for the special case of an ordinary ξ being simple, with $D(v) = (0,0,0)$ and $\rho(v) = (1,0,0)$ for all of its vertices v .

6. The Shortest CNG1 of Certain Conditions

We now proceed with the following definitions.

Definition 17. Let $\xi = \langle V, \rho, \omega \rangle$ be an ordinary CNG1. ξ is said to be *net* if all of the following are satisfied:

- (a) ξ is simple.
- (b) ξ is connected.
- (c) for all $v \in V$, $D(v) = (0,0,0)$ and $\rho(v) = (1,0,0)$.

Furthermore, ξ is said to be *trivial* if the entire ξ consist of one single vertex v with $\rho(v) = (1,0,0)$.

On the other hand, ξ is said to be *gross* if it is not net.

Lemma 7. Let $\xi = \langle V, \rho, \omega \rangle$ be a non-trivial net CNG1. Then each vertex must have least two non-void edges adjacent to it.

Proof. Let $v \in V$. Since $N_\xi \geq 2$ and ξ is connected, there must exist a non-void edge $\{v, u\}$ for some $u \in V - \{v\}$.

If $\{v, u\}$ is the only non-void edge adjacent to v , then $D(v) = \omega(v, u) \neq (0,0,0)$. This a contradiction. \square

Theorem 3. Let $\xi = \langle V, \rho, \omega \rangle$ be a non-trivial net CNG1. Then $M_\xi \geq 4$. Moreover, two of those non-void edges must be $\{a, b\}$ and $\{a, c\}$, for some mutually distinct vertices a, b, c .

Proof. Since $N_\xi \geq 2$ and ξ is connected, non-void edge(s) must exist, so $M_\xi > 0$. Furthermore, $D(v) = (0,0,0)$ for all $v \in V$ would imply $\sum_{v \in V} D(v) = (0,0,0)$. $M_\xi \geq 2$ now follows by Lemma 6.

Let a be an end-point of some of those non-void edges. From Lemma 7, we conclude that at least two non-void edges must be adjacent to a .

Since ξ is simple, it now follows that those 2 non-void edges must be $\{a, b\}$ and $\{a, c\}$, with a, b, c being 3 mutually distinct vertices of ξ .

If $M_\xi = 2$:

$\{a, b\}$ and $\{a, c\}$ are therefore the only two non-void edges. By Lemma 7, both $\{a, b\}$ and $\{a, c\}$ must be adjacent to b . This is a contradiction.

If $M_\xi = 3$:

There can only be one more non-void edges besides $\{a, b\}$ and $\{a, c\}$.

By Lemma 7: b must be an end-point of another non-void edge besides $\{a, b\}$; and c must also be an end-point of another non-void edge besides $\{a, c\}$.

We now deduce that the third non-void edge must therefore be adjacent to both b and c . This yields Figure 4:

Since $\{a, b\}$ and $\{c, a\}$ are non void, $\omega(a, b) = \mathbf{k} = -\omega(c, a)$ for some $\mathbf{k} \neq (0,0,0)$.

Since $\{b, c\}$ is adjacent to both b and c , $\omega(b, c) = \mathbf{k} = -\mathbf{k}$. This is again a contradiction.

$M_\xi \geq 4$ now follows. \square

Theorem 4. Let $\xi = \langle V, \rho, \omega \rangle$ be a non-trivial net CNG1. Then $M_\xi \geq 4$ and $N_\xi \geq 4$.

Proof. By Theorem 3, $M_\xi \geq 4$, and two of those non-void edges must be $\{a, b\}$ and $\{a, c\}$, for some mutually distinct vertices a, b, c .

Suppose $N_\xi < 4$. Since ξ is simple, the maximum possible number of edges (whether it is void or not) is $3 + \frac{3}{2}(3 - 3) = 3 < 4$, which is a contradiction. $N_\xi \geq 4$ now follows. \square

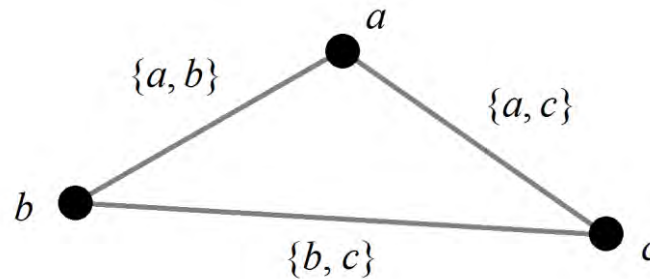

Figure 4. The triangle formed when $\{a, b\}$, $\{a, c\}$ and $\{b, c\}$ are all non-void. Mentioned in Theorem 3, 6.

Theorem 5. *The smallest non-trivial net CNG1 must be of the structure in Figure 5:*

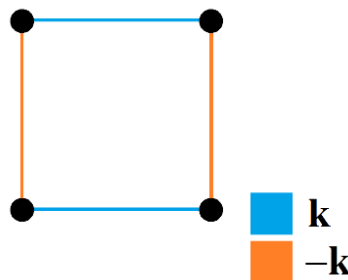

Figure 5. The smallest non-trivial net CNG1. Mentioned in Theorem 5 and Example 4. $\mathbf{k} \neq (0,0,0)$.

Proof. Let $\xi = \langle V, \rho, \omega \rangle$ be a non-trivial net CNG1. By Theorem 4, $M_\xi \geq 4$ and $N_\xi \geq 4$. By Theorem 3, two of those non-void edges must be $\{a, b\}$ and $\{a, c\}$, with a, b, c being three mutually distinct vertices of ξ .

Consider the scenario where $M_\xi = 4$ and $N_\xi = 4$ (i.e., the least possible number).

If the edge $\{b, c\}$ is non-void, then we would have formed Figure 4, as mentioned in the proof of Theorem 3

That leaves us with only one vertex d and only one extra non-void edge being adjacent to d . This is a contradiction.

There is now only one choice left: both the edges $\{d, b\}$ and $\{d, c\}$ must be non-void. This gives rise to the following structure in Figure 6:

Without loss of generality, let $\omega(a, b) = \mathbf{k}$. Then both $\omega(b, d) = -\mathbf{k}$ and $\omega(a, c) = -\mathbf{k}$ must follow, leaving us with $\omega(c, d) = \mathbf{k}$ as the only valid option.

We are therefore left with the only way of assigning ω as shown by the theorem. \square

Lemma 8. *Let $\xi = \langle V, \rho, \omega \rangle$ be a non-trivial net CNG1. Then $M_\xi \geq N_\xi$.*

Proof. Every single non-void edge is connected to two vertices. Thus, if we count the total number of adjacent non-void edges for each vertex, and then summing the results for all the vertices together, the result will be $2M_\xi$ (note: *this paragraph is analogous to classical graph theory*).

By Lemma 7, each vertex must have at least two non-void edges connect to it. We now have $2M_\xi \geq 2N_\xi$, so $M_\xi \geq N_\xi$ follows. \square

Theorem 6. Let $\xi = \langle V, \rho, \omega \rangle$ be a non-trivial net CNG1 with both M_ξ and N_ξ being odd numbers. Then $M_\xi \geq 7$ and $N_\xi \geq 5$.

Proof. Let $\xi = \langle V, \rho, \omega \rangle$ be a non-trivial net CNG1. By Theorem 4, $M_\xi \geq 4$ and $N_\xi \geq 4$. By Theorem 3, two of those non-void edges must be $\{a, b\}$ and $\{a, c\}$, for some a, b and c being three mutually distinct vertices of ξ .

Since both M_ξ and N_ξ are odd, it follows that $M_\xi \geq 5$ and $N_\xi \geq 5$. So in addition to a, b, c , there exist another 2 vertices d, e .

Consider the scenario where $M_\xi = 5$ and $N_\xi = 5$ (i.e., the least possible number).

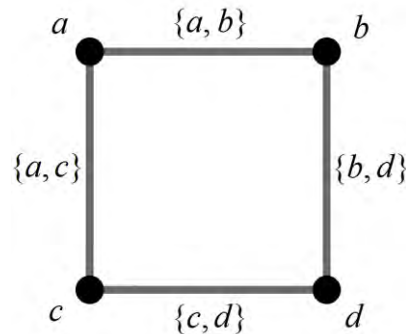

Figure 6. The only choices left because each vertex must have at least 2 adjacent non void edges. Mentioned in Theorem 5, 6.

Case 1. Suppose the edge $\{b, c\}$ is non-void. Then we would have formed Figure 4, as mentioned in the proof of Theorem 3.

That leaves us with two vertices d and e , and two extra non-void edge, which both of them must be adjacent to d . Even if $\{d, e\}$ is non-void, the other non-void edge adjacent to d cannot possibly be $\{d, e\}$ itself. Therefore, we have, at most, one non-void edge being adjacent to e . This is a contradiction.

Case 2. Without loss of generality, suppose the edges $\{b, d\}$ and $\{c, d\}$ are non-void. Then we would have formed Figure 6, as mentioned in the proof of Theorem 5.

That leaves us with only one vertex e and only one extra edge being adjacent to e , which is, again, a contradiction.

Case 3. Without loss of generality, suppose the edges $\{b, d\}$ and $\{c, e\}$ are non-void. Then, besides $\{b, d\}$, another edge must be adjacent to d . Likewise, besides $\{c, e\}$, another edge must be adjacent to e . Since we are left with one edge, it must, therefore, be $\{d, e\}$. This gives rise to the following structure in Figure 7:

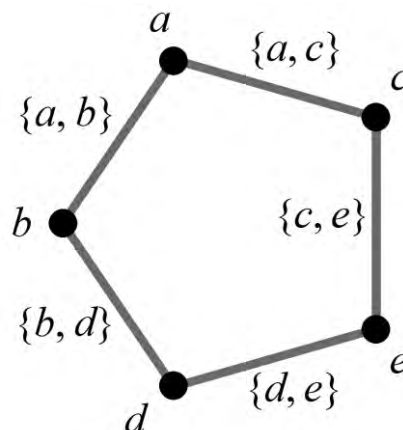

Figure 7. The only choice left for the case of 5 non-void edges connecting to 5 vertices. Mentioned in Theorem 6.

Without loss of generality, let $\omega(a, b) = \mathbf{k}$. Then both $\omega(b, d) = -\mathbf{k}$ and $\omega(a, c) = -\mathbf{k}$ must follow, leaving us with both $\omega(c, e) = \mathbf{k}$ and $\omega(d, e) = \mathbf{k}$.

We have, thus, arrived at $D(e) = 2\mathbf{k} \neq (0,0,0)$, again a contradiction.

Hence, it is either $M_\xi > 5$ or $N_\xi > 5$.

Since both M_ξ and N_ξ are odd, either one of the following must hold:

- (a) $M_\xi \geq 7$ and $N_\xi \geq 7$.
- (b) $M_\xi = 7$ and $N_\xi = 5$.
- (c) $M_\xi = 5$ and $N_\xi = 7$.

Furthermore, by Lemma 8, $M_\xi \geq N_\xi$. Hence (c) will not occur, which implies that $M_\xi \geq 7$ and $N_\xi \geq 5$. This completes the proof. \square

Theorem 7. *The smallest non-trivial net CNG1 ξ , with both M_ξ and N_ξ being odd numbers, must be of the structure as shown in Figure 8:*

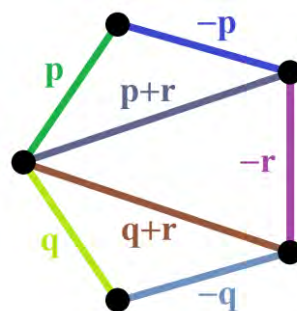

Figure 8. The smallest non-trivial net CNG1, with both M_ξ and N_ξ being odd numbers. . Mentioned in Theorem 7 and Example 5. $\mathbf{p} + \mathbf{q} + \mathbf{r} = (0,0,0)$; $|\mathbf{p} + \mathbf{r}|, |\mathbf{q} + \mathbf{r}| \leq 1$.

Proof. Let $\xi = \langle V, \rho, \omega \rangle$ be a non-trivial net CNG1 with both M_ξ and N_ξ being odd numbers. Then $M_\xi \geq 7$ and $N_\xi \geq 5$.

Consider the scenario where $M_\xi = 7$ and $N_\xi = 5$ (i.e., the least possible number).

Since ξ is an ordinary CNG1, each vertex must have 5 edges adjacent to it (whether void or not). Since ξ is simple, one of the five edges for each vertex, which is a loop, must be void. As a result, we now conclude that each vertex must have at most 4 non-void edges adjacent to it.

On the other hand, by Lemma 7, each vertex must have at least two non-void edges adjacent to it.

Since every single non-void edge is adjacent to two vertices. Thus, if we count the total number of adjacent non-void edges for each vertex, and then summing the results for all the vertices together, the result will be $7 \times 2 = 14$ (note: this paragraph is analogous to classical graph theory).

Hence, the set representing the number of non-void edges adjacent to each of the five vertices, must be one of the following:

- (a) $\{2,3,3,3,3\}$ (most “widely spread” possibility)
- (b) $\{2,2,3,3,4\}$
- (c) $\{2,2,2,4,4\}$ (most “concentrated” possibility)

We now consider each the three cases:

Case 1. $\{2,3,3,3,3\}$

Without loss of generality:

Let a be that one vertex which is an end-point to only 2 non-void edges $\{a, b\}$ and $\{a, c\}$. (i.e., $\{a, d\}, \{a, e\}$ are void) (Figure 9) (9)

Then, each one among b, c, d, e must be an end-point of three non-void edges.

Besides $\{d, a\}$ and $\{d, d\}$, which are both void, there are three more edges adjacent to d : $\{d, b\}, \{d, c\}, \{d, e\}$.

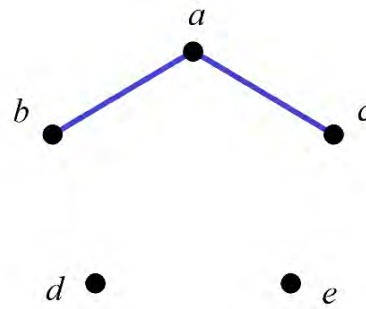

Figure 9. The 2 non-void edges $\{a, b\}$ and $\{a, c\}$, for all the 3 cases of Theorem 7.

Since d is an end-point of exactly three non-void edges, we conclude that:

$$\{d, b\}, \{d, c\}, \{d, e\} \text{ are all non-void} \tag{10}$$

Similarly, besides $\{e, a\}$ and $\{e, e\}$, which are both void, there are three more edges adjacent to e : $\{e, b\}, \{e, c\}, \{e, d\}$.

Since e is also an end-point of exactly three non-void edges, we conclude that:

$$\{e, b\}, \{e, c\}, \{e, d\} \text{ are all non-void.} \tag{11}$$

From (10) and (11), we conclude that:

$$\{d, b\}, \{d, c\}, \{e, b\}, \{e, c\}, \{d, e\} = \{e, d\} \text{ are all non void.} \tag{12}$$

From (9) and (12), we have obtained all the seven non-void edges:

$$\{d, b\}, \{d, c\}, \{e, b\}, \{e, c\}, \{d, e\}, \{a, b\}, \{a, c\}.$$

Hence, $\{b, c\}, \{a, d\}, \{a, e\}$ must be all void. We, thus, obtain the following structure (Figure 10):

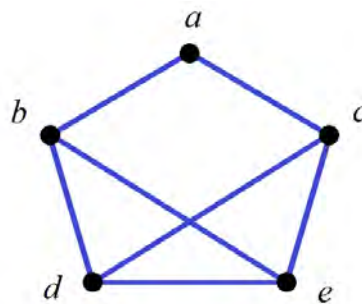

Figure 10. The only possible way of connection for $\{2,3,3,3,3\}$.

Let $\omega(a, b) = p$, $\omega(b, d) = q$, $\omega(b, e) = r$, $\omega(c, d) = s$, $\omega(c, e) = t$, $\omega(d, e) = u$.

Since $\{a, b\}$ and $\{a, c\}$ are the only two non-void edges adjacent to a , we now have $\omega(a, c) = -p$ (Figure 11).

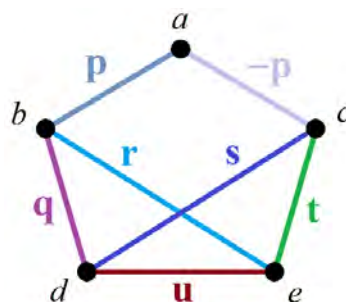

Figure 11. The labeling of the non-void edges for $\{2,3,3,3,3\}$.

We now have: $\mathbf{r} + \mathbf{q} + \mathbf{p} = \mathbf{s} + \mathbf{t} - \mathbf{p} = \mathbf{s} + \mathbf{q} + \mathbf{u} = \mathbf{r} + \mathbf{t} + \mathbf{u} = (0,0,0)$.

This further implies that: $\mathbf{r} + \mathbf{q} + \mathbf{p} + \mathbf{s} + \mathbf{t} - \mathbf{p} = \mathbf{s} + \mathbf{q} + \mathbf{u} + \mathbf{r} + \mathbf{t} + \mathbf{u} = (0,0,0)$.

Therefore, $\mathbf{q} + \mathbf{r} + \mathbf{s} + \mathbf{t} = \mathbf{q} + \mathbf{r} + \mathbf{s} + \mathbf{t} + 2\mathbf{u}$, which implies that $\mathbf{u} = (0,0,0)$. This is a contradiction.

Case 2. $\{2,2,3,3,4\}$

Without loss of generality:

Let a be a vertex which is an end-point to only two non-void edges $\{a, b\}$ and $\{a, c\}$. (13)
 (i.e., $\{a, d\}, \{a, e\}$ are void)

as shown in Figure 9.

Since $\{a, d\}, \{a, e\}$ are void, both d and e cannot be that vertex which is an end-point to four non-void edges.

By symmetry, fix b to be that vertex which is an end-point to four non-void edges. Then:

$\{b, a\}, \{b, c\}, \{b, d\}, \{b, e\}$ are all non-void. (14)

From (13) and (14), we have now arrived at the following structure (Figure 12):

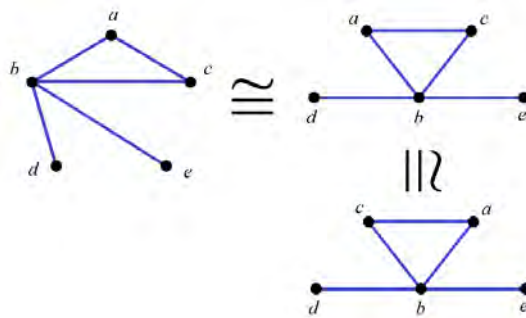

Figure 12. The first 5 non-void edges for $\{2,2,3,3,4\}$.

Suppose $\{d, e\}$ is void. Then exactly one out of $\{d, c\}$ and $\{d, a\}$ must be non-void. Similarly, exactly one out of $\{e, c\}$ and $\{e, a\}$ must be non-void. By symmetry and the rules of graph isomorphism, fix $\{d, a\}$ to be non-void, then a would have been an end-point of three non-void edges: $\{d, a\}, \{b, a\}, \{c, a\}$. So $\{e, a\}$ must be void and, therefore, $\{e, c\}$ is non-void. We, thus, obtain the following structure (Figure 13):

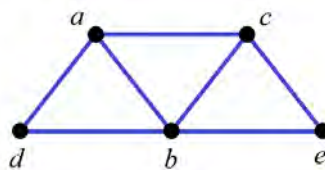

Figure 13. The only possible way of connection for $\{2,2,3,3,4\}$, if $\{d, e\}$ is void.

Suppose $\{d, e\}$ is non-void. Then we now arrived at the following structure (Figure 14):

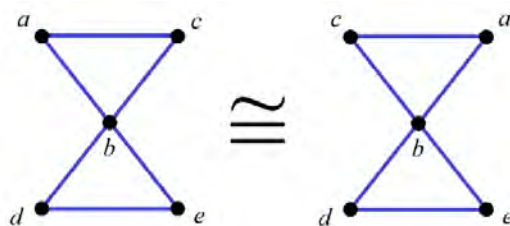

Figure 14. The first 6 non-void edges for $\{2,2,3,3,4\}$, for the case of non-void $\{d, e\}$.

By symmetry, fix a to be a vertex which is an end-point of three non-void edges. Then exactly one edge out of $\{a, d\}$ and $\{a, e\}$ must be non-void. By the rules of graph isomorphism, we can fix $\{a, d\}$ to be non-void. Again we obtain the following structure (Figure 15):

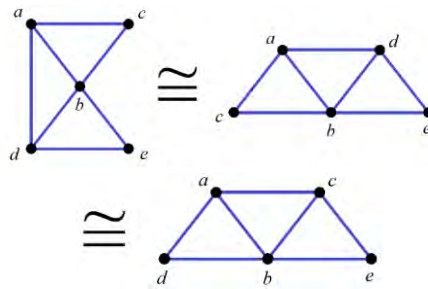

Figure 15. The only possible way of connection for $\{2,2,3,3,4\}$, if $\{d, e\}$ is non-void.

Let $\omega(a, b) = \mathbf{g}$, $\omega(c, b) = \mathbf{h}$, $\omega(a, c) = \mathbf{k}$, $\omega(b, d) = \mathbf{p}$, $\omega(b, e) = \mathbf{q}$.
 Since $\{a, d\}$ and $\{b, d\}$ are the only two non-void edges adjacent to d , we now have $\omega(a, d) = -\mathbf{p}$.

Likewise, since $\{c, e\}$ and $\{b, e\}$ are the only two non-void edges adjacent to e , we now have $\omega(c, e) = -\mathbf{q}$ (Figure 16).

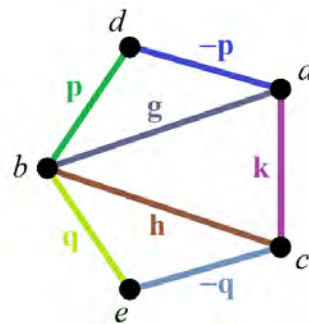

Figure 16. The labeling of the non-void edges for $\{2,2,3,3,4\}$.

We now have: $\mathbf{p} + \mathbf{q} + \mathbf{g} + \mathbf{h} = \mathbf{g} + \mathbf{k} - \mathbf{p} = \mathbf{h} + \mathbf{k} - \mathbf{q} = (0,0,0)$.
 Therefore, $\mathbf{g} = \mathbf{p} - \mathbf{k}$, $\mathbf{h} = \mathbf{q} - \mathbf{k}$. As a result: $\mathbf{p} + \mathbf{q} + \mathbf{p} - \mathbf{k} + \mathbf{q} - \mathbf{k} = 2\mathbf{p} + 2\mathbf{q} - 2\mathbf{k} = (0,0,0)$, which implies $\mathbf{p} + \mathbf{q} - \mathbf{k} = (0,0,0)$.

Denote $-\mathbf{k} = \mathbf{r}$. Then $\mathbf{g} = \mathbf{p} + \mathbf{r}$, $\mathbf{h} = \mathbf{q} + \mathbf{r}$, and $\mathbf{p} + \mathbf{q} + \mathbf{r} = (0,0,0)$ follows. We have, thus, formed the structure as mentioned in this theorem.

Case 3. $\{2,2,2,4,4\}$

Without loss of generality:

Let a be one of that two vertices which is an end-point to four non-void edges. Then:

$$\{a, b\}, \{a, c\}, \{a, d\}, \{a, e\} \text{ are non-void.} \tag{15}$$

Let b be the other one vertices which is also an end-point to four non-void edges. Then:

$$\{b, a\}, \{b, c\}, \{b, d\}, \{b, e\} \text{ are non-void.} \tag{16}$$

From (15) and (16), we have obtained the seven non-void edges:

$$\{a, c\}, \{a, d\}, \{a, e\}, \{b, c\}, \{b, d\}, \{b, e\}, \{a, b\}.$$

Hence, $\{c, d\}, \{c, e\}, \{d, e\}$ are all void. We, thus, obtain the following structure (Figure 17):

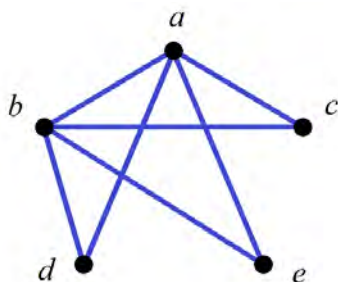

Figure 17. The only possible way of connection for $\{2,2,2,4,4\}$.

Let $\omega(b, d) = \mathbf{p}$, $\omega(b, e) = \mathbf{q}$, $\omega(b, c) = \mathbf{r}$, $\omega(b, a) = \mathbf{s}$,
 Since $\{a, d\}$ and $\{b, d\}$ are the only two non-void edges adjacent to d , we now have $\omega(a, d) = -\mathbf{p}$.
 Since $\{a, e\}$ and $\{b, e\}$ are the only two non-void edges adjacent to e , we now have $\omega(a, e) = -\mathbf{q}$.
 Since $\{a, c\}$ and $\{b, c\}$ are the only two non-void edges adjacent to c , we now have $\omega(a, c) = -\mathbf{r}$ (Figure 18).

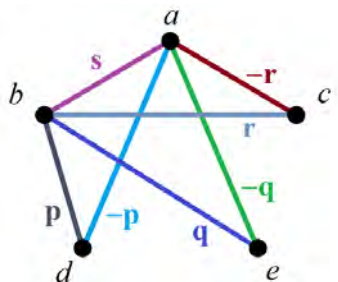

Figure 18. The labeling of the non-void edges for $\{2,2,2,4,4\}$.

We now have: $\mathbf{s} + \mathbf{p} + \mathbf{q} + \mathbf{r} = \mathbf{s} - \mathbf{p} - \mathbf{q} - \mathbf{r} = (0,0,0)$.
 This further implies that: $\mathbf{s} + \mathbf{p} + \mathbf{q} + \mathbf{r} + \mathbf{s} - \mathbf{p} - \mathbf{q} - \mathbf{r} = (0,0,0)$.
 We now have $2\mathbf{s} = (0,0,0)$, which implies that $\mathbf{s} = (0,0,0)$. This is a contradiction.
 Our proof is now complete. \square

Note that both 5 and 7 are not divisible even by 3, the next prime number after 2. This yields the following corollary:

Corollary 1. *The smallest non-trivial net CNG1 ξ , with both M_ξ and N_ξ not divisible by 2 or 3, must also be of the structure as shown in Figure:*

7. Symmetric Properties of Ordinary Simple CNG1

Definition 18. *Let V and W be two non-void sets. Let $\xi = \langle V, \rho, \omega \rangle$ and $\zeta = \langle W, \varsigma, \psi \rangle$ be two ordinary CNG1s. If $V = W$, $\rho = \varsigma$ and $\omega = \psi$, then ξ and ζ are said to be equal, and shall be denoted by $\xi \equiv \zeta$.*

Definition 19. *Let V and W be a non-void set. Let $\xi = \langle V, \rho, \omega \rangle$ and $\zeta = \langle W, \varsigma, \psi \rangle$ be two ordinary CNG1s. If there exist a bijection $\mathfrak{f}: V \rightarrow W$ such that:*

- (a) $\rho(u) = \varsigma(\mathfrak{f}(u))$ for all $u \in V$.
- (b) $\omega(u, v) = \psi(\mathfrak{f}(u), \mathfrak{f}(v))$ for all $u, v \in V$.

Then:

- (i) Such \mathfrak{f} is said to be an isomorphism from ξ to ζ , and we shall denote such case by $\mathfrak{f}[\xi] \equiv \zeta$.
- (ii) ξ and ζ are said to be isomorphic, and shall be denoted by $\xi \cong \zeta$.

Remark 15. As both ξ and ζ are ordinary, $\omega(u, v) = \omega(v, u)$ and $\psi(\mathcal{f}(u), \mathcal{f}(v)) = \psi(\mathcal{f}(v), \mathcal{f}(u))$ follow for all $u, v \in V$.

Example 1. Consider $\xi_0 = \langle V_0, \rho_0, \omega_0 \rangle$ and $\zeta_0 = \langle W_0, \varsigma_0, \psi_0 \rangle$ as follows:

$$V_0 = \{v_1, v_2, v_3, v_4, v_5, v_6\}.$$

$$\rho_0(v_1) = \mathbf{p}, \rho_0(v_2) = \mathbf{q}, \rho_0(v_3) = \mathbf{t},$$

$$\rho_0(v_4) = \rho_0(v_6) = \mathbf{r}, \rho_0(v_5) = \mathbf{s}.$$

$$\omega_0(v_1, v_2) = \omega_0(v_2, v_1) = \omega_0(v_2, v_2) = \mathbf{a},$$

$$\omega_0(v_1, v_3) = \omega_0(v_3, v_1) = \mathbf{c},$$

$$\omega_0(v_2, v_3) = \omega_0(v_3, v_2) = \mathbf{b},$$

$$\omega_0(v_3, v_4) = \omega_0(v_4, v_3) = \mathbf{d},$$

$$\omega_0(v_3, v_5) = \omega_0(v_5, v_3) = \mathbf{e},$$

$$\omega_0(v_5, v_6) = \omega_0(v_6, v_5) = \mathbf{f},$$

$$\text{otherwise, } \omega_0(u, v) = (0,0,0).$$

$$W_0 = \{w_1, w_2, w_3, w_4, w_5, w_6\}.$$

$$\varsigma_0(w_1) = \mathbf{t}, \varsigma_0(w_3) = \mathbf{p}, \varsigma_0(w_4) = \mathbf{s},$$

$$\varsigma_0(w_2) = \varsigma_0(w_4) = \mathbf{r}, \varsigma_0(w_6) = \mathbf{q}.$$

$$\psi_0(w_1, w_2) = \psi_0(w_2, w_1) = \mathbf{d},$$

$$\psi_0(w_1, w_3) = \psi_0(w_3, w_1) = \mathbf{c},$$

$$\psi_0(w_1, w_4) = \psi_0(w_4, w_1) = \mathbf{e},$$

$$\psi_0(w_4, w_5) = \psi_0(w_5, w_4) = \mathbf{f},$$

$$\psi_0(w_1, w_6) = \psi_0(w_6, w_1) = \mathbf{b},$$

$$\psi_0(w_3, w_6) = \psi_0(w_6, w_3) = \psi_0(w_6, w_6) = \mathbf{a},$$

$$\text{otherwise, } \psi_0(w, v) = (0,0,0).$$

Moreover, $|\{\mathbf{p}, \mathbf{q}, \mathbf{r}, \mathbf{s}, \mathbf{t}\}| = 5$ and $|\{\mathbf{a}, \mathbf{b}, \mathbf{c}, \mathbf{d}, \mathbf{e}, \mathbf{f}\}| = 6$ (Figure 19).

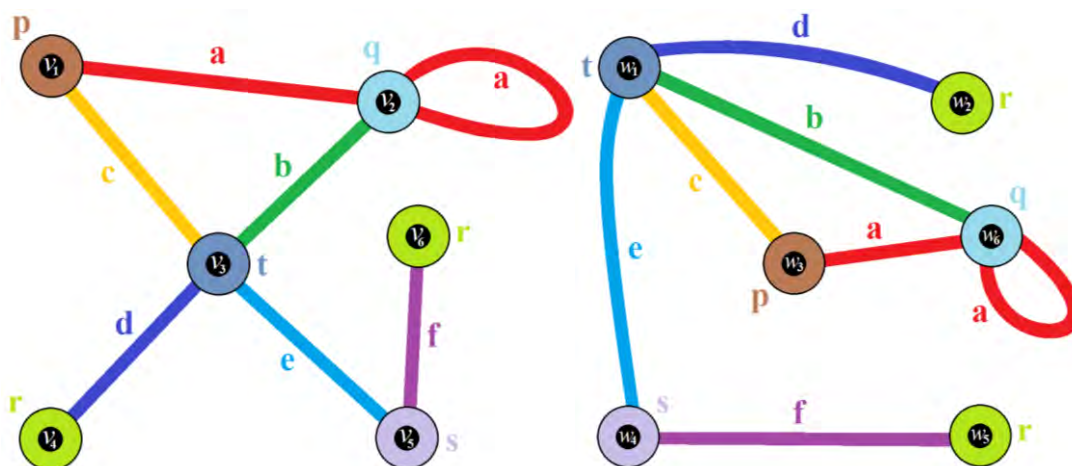

Figure 19. Two isomorphic CNG1's, as mentioned in Example 1.

Thus, we define the bijection $\mathcal{f}_0: V \rightarrow W$ as:

$$\mathcal{f}_0(v_1) = v_3, \mathcal{f}_0(v_2) = v_6, \mathcal{f}_0(v_3) = v_1, \mathcal{f}_0(v_4) = v_2, \mathcal{f}_0(v_5) = v_4, \mathcal{f}_0(v_6) = v_5.$$

It now follows that \mathcal{f}_0 is an isomorphism from ξ_0 to ζ_0 , so $\xi_0 \cong \zeta_0$. Still, $\xi_0 \not\equiv \zeta_0$ in accordance with Definition 18.

In all the following passages of this paper, let $\mathcal{J}: V \rightarrow V$ be the identity mapping from V to itself.

Like classical graph theory, whenever $\zeta \equiv \xi$, \mathcal{J} is an isomorphism from ξ to ξ itself in accordance with Definition 19. It is, therefore, motivational to investigate if there are other non-identity bijections from V to itself, which is also an isomorphism from ξ to ξ itself. Additionally, recall that, in classical graph theory, an isomorphism from a graph to itself will be called an automorphism on that graph. Thus, we proceed with the following definition:

Definition 20. Let V be a non-void set. Let $\xi = \langle V, \rho, \omega \rangle$ be an ordinary CNG1's. Let $\mathcal{f}: V \rightarrow V$ be a bijection such that:

(a) $\rho(u) = \rho(\mathcal{f}(u))$ for all $u \in V$.

(b) $\omega(u, v) = \omega(\mathcal{f}(u), \mathcal{f}(v))$ for all $u, v \in V$.

Then \mathcal{f} is said to be an automorphism of ξ .

Remark 16. As ξ is ordinary, $\omega(u, v) = \omega(v, u)$ follows for all $u, v \in V$.

Remark 17. Just because $\rho(u) = \rho(\mathcal{f}(u))$ and $\omega(u, v) = \omega(\mathcal{f}(u), \mathcal{f}(v))$, does not mean that $u = \mathcal{f}(u)$ or $v = \mathcal{f}(v)$.

Remark 18. \mathcal{J} is thus called the trivial automorphism of ξ .

Example 2. Consider $\xi_1 = \langle V_1, \rho_1, \omega_1 \rangle$ as shown in Figure 20:

$V_1 = \{a, b, c, d\}$. $\rho_1(a) = \rho_1(b) = \rho_1(d) = \mathbf{p}$, $\rho_1(c) = \mathbf{q}$.
 $\omega_1(a, c) = \omega_1(c, a) = \mathbf{h}$, $\omega_1(b, c) = \omega_1(c, b) = \omega_1(d, c) = \omega_1(c, d) = \mathbf{g}$, otherwise, $\omega_1(u, v) = (0,0,0)$.
 $|\{\mathbf{p}, \mathbf{q}\}| = |\{\mathbf{g}, \mathbf{h}\}| = 2$.

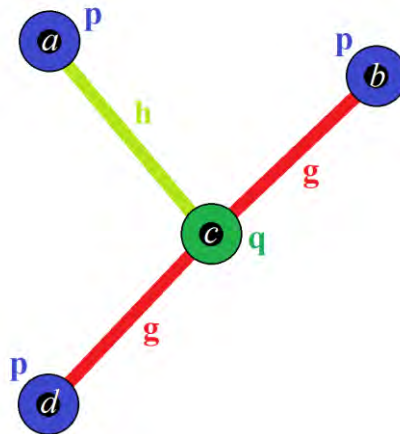

Figure 20. ξ_1 as mentioned in Example 2.

Let $\mathcal{f}_1, \mathcal{b}_1, \mathcal{h}_1: V_1 \rightarrow V_1$ be three bijections defined as follows:

- (a) $\mathcal{f}_1(c) = a, \mathcal{f}_1(a) = d, \mathcal{f}_1(d) = c, \mathcal{f}_1(b) = b$.
- (b) $\mathcal{b}_1(b) = a, \mathcal{b}_1(d) = d, \mathcal{b}_1(c) = c, \mathcal{b}_1(a) = b$.
- (c) $\mathcal{h}_1(b) = d, \mathcal{h}_1(a) = a, \mathcal{h}_1(c) = c, \mathcal{h}_1(d) = b$.

Then:

- (i) \mathcal{f}_1 is an isomorphism from V_1 to the following ordinary CNG1 (Figure 21).

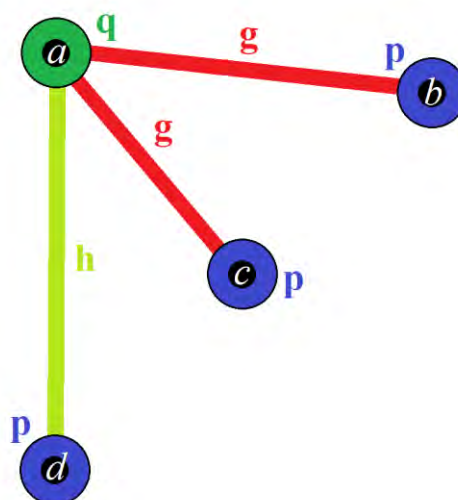

Figure 21. This is not an automorphism of ξ_1 as mentioned in Example 2.

which is not equal to ξ_1 in accordance with Definition 18. \mathfrak{f}_1 is therefore not an automorphism of ξ_1 .
 (ii) \mathfrak{h}_1 is an isomorphism from V_1 to the following ordinary CNG1 (Figure 22).

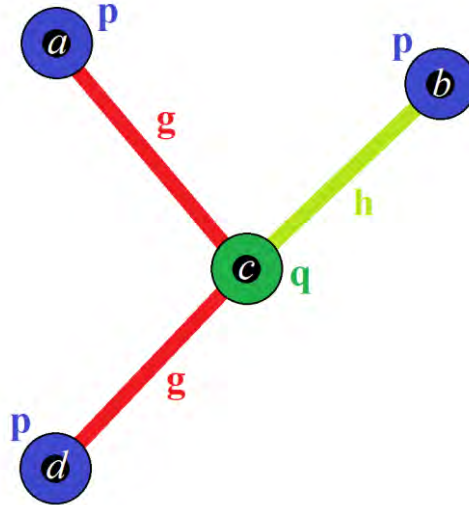

Figure 22. This is not an automorphism of ξ_1 as mentioned in Example 2.

which is also not equal to ξ_1 in accordance with Definition 18. Likewise \mathfrak{h}_1 is, therefore, not an automorphism of ξ_1 .

(iii) \mathfrak{h}_1 is an isomorphism from V_1 to itself and, therefore, it is an automorphism of ξ_1 . Note that, even if $\mathfrak{h}_1(b) = d$ and $\mathfrak{h}_1(d) = b$, as $\rho_1(b) = \rho_1(d) = \mathbf{p}$ and $\omega_1(b, c) = \omega_1(d, c) = \mathbf{g}$, so $\mathfrak{h}_1[\xi_1] \equiv \xi_1$ still holds.

Definition 21. Let $\xi = \langle V, \rho, \omega \rangle$ be an ordinary simple CNG1. ξ is said to be total symmetric if, for all $\{u_1, v_1\}, \{u_2, v_2\} \subseteq V$, with $|\{u_1, v_1\}| = |\{u_2, v_2\}|$, there exist an automorphism of ξ , \mathfrak{f} , such that $u_2 = \mathfrak{f}(u_1)$, $v_2 = \mathfrak{f}(v_1)$.

Remark 19. In other words, $\{u_1, v_1\}, \{u_2, v_2\}$ can either be two edges, or two vertices as when $u_1 = v_1$ and $u_2 = v_2$.

Example 3. With this definition, the following CNG1 (Figure 23) is, thus, totally-symmetric.

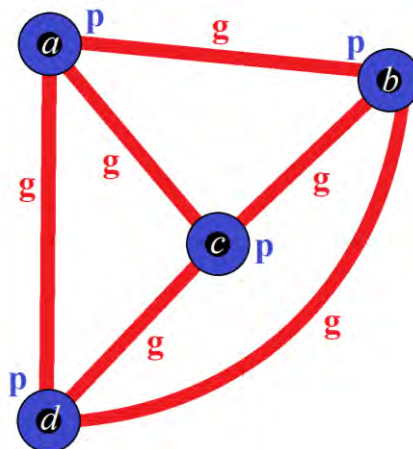

Figure 23. A totally-symmetric CNG1, as mentioned in Example 3.

However, unlike symmetry of classical graphs, the concept of total symmetry takes all the edges into account, whether void or not. As a result, the following graph (Figure 24), though looks familiar to the classical literature, is not totally-symmetric.

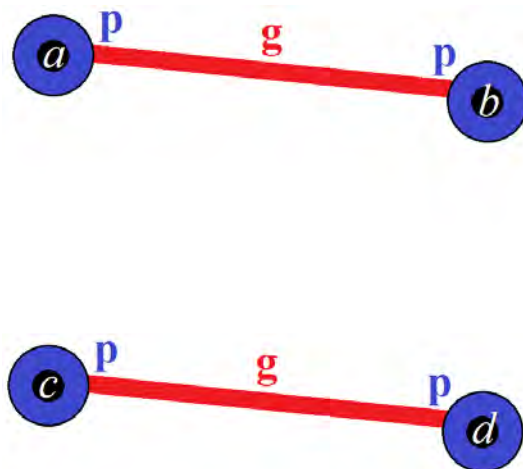

Figure 24. This graph is not totally-symmetric. Mentioned in Example 3.

As a result, the concept of total-symmetry in ordinary simple CNG1 proves even more stringent than the concept of symmetry in classical ordinary simple graphs. Additionally, recall that edges and vertices in CNG1 have three membership values instead of only 0 (disconnected, void) and 1 (connected). To give more characterization of symmetry among ordinary simple CNG1, we now proceed with the following definitions.

Definition 22. Let $\xi = \langle V, \rho, \omega \rangle$ be an ordinary simple CNG1. ξ is said to be strong edge-wise symmetric (abbr. SES) if: For all $\{u_1, v_1\}, \{u_2, v_2\} \subseteq V$ with both $\omega(u_1, v_1)$ and $\omega(u_2, v_2)$ non-void, there exist an automorphism $\#$ of ξ , such that $u_2 = \#(u_1)$, $v_2 = \#(v_1)$.

Remark 20. As ξ is simple, it follows that $|\{u_1, v_1\}| = |\{u_2, v_2\}| = 2$.

Remark 21. An ordinary simple CNG1 with all edges being void is classified as strong edge-wise symmetric as well.

Definition 23. Let $\xi = \langle V, \rho, \omega \rangle$ be an ordinary simple CNG1. ξ is said to be strong point-wise(or vertex-wise) symmetric (abbr. SPS) if: For all $u_1, u_2 \in V$ with both $\rho(u_1)$ and $\rho(u_2)$ non-void, there exists an automorphism $\#$ of ξ , such that $u_2 = \#(u_1)$.

Remark 22. An ordinary simple CNG1 with all vertices being void is classified as strong point-wise symmetric as well.

Definition 24. Let $\xi = \langle V, \rho, \omega \rangle$ be an ordinary simple CNG1. ξ is said to be strong symmetric (abbr. SS) if it is both strong edge-wise symmetric and strong point-wise symmetric.

Definition 25. Let $\xi = \langle V, \rho, \omega \rangle$ be an ordinary simple CNG1. ξ is said to be weak edge-wise symmetric (abbr. wES) if: For all $\{u_1, v_1\}, \{u_2, v_2\} \subseteq V$ with $\omega(u_1, v_1) = \omega(u_2, v_2) \neq (0,0,0)$, there exists an automorphism $\#$ of ξ , such that $u_2 = \#(u_1)$, $v_2 = \#(v_1)$. Otherwise, ξ is said to be edge-wise asymmetric (abbr. EA).

Remark 23. Again, as ξ is simple, it follows that $|\{u_1, v_1\}| = |\{u_2, v_2\}| = 2$.

Remark 24. An ordinary simple CNG1 with all non-void edges having different membership value is classified as weak edge-wise symmetric as well.

Definition 26. Let $\xi = \langle V, \rho, \omega \rangle$ be an ordinary simple CNG1. ξ is said to be weak point-wise (or vertex-wise) symmetric (abbr. wPS) if: For all $u_1, u_2 \in V$ with $\rho(u_1) = \rho(u_2) \neq (0,0,0)$, there exists an automorphism \mathfrak{f} of ξ , such that $u_2 = \mathfrak{f}(u_1)$. Otherwise, ξ is said to be point-wise asymmetric (abbr. PA).

Remark 25. An ordinary simple CNG1 with all non-void vertices having different membership value is classified as weak point-wise symmetric as well.

Definition 27. Let $\xi = \langle V, \rho, \omega \rangle$ be an ordinary simple CNG1. ξ is said to be asymmetric if it is both edge-wise asymmetric and point-wise asymmetric.

Based on the definition, we now state such symmetric properties on the smallest non-trivial net CNG1, as mentioned in Theorem 5, as well as the smallest non-trivial net CNG1 with both M_ξ and N_ξ being odd numbers, as mentioned in Theorem 7.

Example 4. With regards to the structure of Figure 5, as mentioned in Theorem 5, with $\rho(a) = \rho(b) = \rho(c) = \rho(d) = (1,0,0)$.

Consider the following three automorphisms $\mathfrak{f}, \mathfrak{b}, \mathfrak{h}$ of $\xi_{4,4}$:

- (a) $\mathfrak{f}(a) = b, \mathfrak{f}(b) = a, \mathfrak{f}(c) = d, \mathfrak{f}(d) = c,$
- (b) $\mathfrak{b}(a) = c, \mathfrak{b}(b) = d, \mathfrak{b}(c) = a, \mathfrak{b}(d) = b,$
- (c) $\mathfrak{h}(a) = d, \mathfrak{h}(b) = c, \mathfrak{h}(c) = b, \mathfrak{h}(d) = a,$

together with \mathcal{J} , the trivial automorphism of ξ .

As a result, $\xi_{4,4}$ is thus strong point-wise symmetric (SPS) and weak edge-wise symmetric (wES).

Example 5. With regards to the structure of Figure 8, as mentioned in Theorem in Theorem 7, with $\mathbf{p} + \mathbf{q} + \mathbf{r} = (0,0,0)$; $|\mathbf{p} + \mathbf{r}|, |\mathbf{q} + \mathbf{r}| \leq 1$; and $\rho(a) = \rho(b) = \rho(c) = \rho(d) = \rho(e) = (1,0,0)$.

In this case, as non-void vertices having different membership values, only one automorphism of $\xi_{5,7}$, which is the identity mapping $\mathcal{J}: V \rightarrow V$ where $\mathcal{J}(v) = v$ for all $v \in V$. As $\mathcal{J}(a) \neq b$, $\xi_{5,7}$ is, thus, point-wise asymmetric (PA). It is, nonetheless, weak edge-wise symmetric (wES).

We now give an example of CNG1 which is asymmetric (i.e., both edge-wise and point-wise).

Example 6. $\tilde{\xi} = \langle V, \rho, \omega \rangle$ has the structure as shown in Figure 25:



Figure 25. A $\tilde{\xi}$ which is both point-wise asymmetric and edge asymmetric, as mentioned in Example 6.

with $|\{\mathbf{p}, \mathbf{q}, \mathbf{r}\}| = 3, |\{\mathbf{a}, \mathbf{b}\}| = 2$.

Only the trivial automorphism \mathcal{J} can be formed. As $\mathcal{J}(a) \neq d$, $\tilde{\xi}$ is point-wise asymmetric. Moreover, as $\mathcal{J}(a) \neq b$, $\tilde{\xi}$ is edge asymmetric.

We end this section by giving a conjecture, which shall be dealt with in our future work:

Conjecture 1. The smallest non-trivial net CNG1 ξ , with both M_ξ and N_ξ being odd numbers, and is both SPS and wES, must be of the structure as shown in Figure 26:

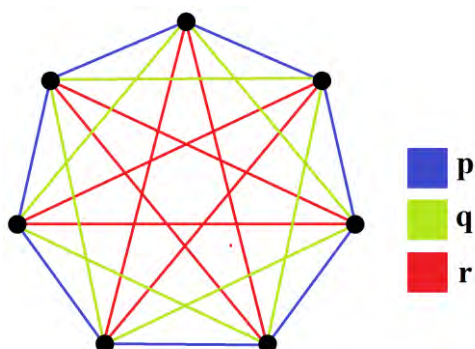

Figure 26. ξ for conjecture 1. $\mathbf{p} + \mathbf{q} + \mathbf{r} = (0,0,0)$.

8. Conclusions

In this article, we presented a new concept of the neutrosophic graph called complex neutrosophic graphs of type 1 (CNG1), and also proceeded to present a matrix representation of it.

The strength of CNG1 lies in the presence of both magnitude and direction for the parameters involved, as has been illustrated in Section 3. As the parameters have directions, even when the resultant degree of a vertex is zero, the edges to that vertex need not necessarily be void. Thus the concept of CNG1 may also be used in engineering, such as in metal frameworks, for example in the construction of power lines, so that even when the beams are under tension, the resultant force at a point (possibly being a cornerstone) joining all those beams are zero.

The concept of CNG1 can also be applied to the case of bipolar complex neutrosophic graphs (BCNG1). We have plans to expand on this interesting concept in the near future, and plan to study the concept of completeness, regularity, and CNGs of type 2.

As we can see in Section 6, when the choices of M_ξ and N_ξ becomes more restrictive, the smallest non-trivial net CNG1 ξ increases in complexity. This makes us wonder what will be the smallest non-trivial net CNG1 ξ in the case when both M_ξ and N_ξ are not divisible by all primes up to 5 (7, 11, etc.), as well as whether their symmetric properties, as outlined in Section 7. However, the proof of such cases will become much more tedious and, therefore, we would have to utilize computer programs, such as MATLAB and SAGE, in order to find those non-trivial net CNG1 ξ . Therefore our future research in this area involves plans to deal with those non-trivial net CNG1 ξ . We are motivated by the interest to know if there exist some general patterns or general theorems governing such smallest non-trivial net CNG1 as M_ξ and N_ξ become more restrictive.

We are currently working on developing a more in-depth theoretical framework concerning the symmetric properties of CNG1, and have plans to extend this to other types of fuzzy graphs in the future. We are also motivated by the works presented in [30–32], and look forward to extending our work to other generalizations of neutrosophic sets, such as interval complex neutrosophic sets, and apply the work in medical imaging problems and recommender systems.

Funding: This research was funded by the Ministry of Education, Malaysia under grant no. FRGS/1/2017/STG06/UCSI/03/1 and UCSI University, Malaysia under grant no. Proj-In-FOBIS-014.

References

1. Smarandache, F. *Neutrosophic Probability, Set, and Logic*; ProQuest Information & Learning: Ann Arbor, MI, USA, 1998; 105p.
2. Zadeh, L.A. Fuzzy sets. *Inform. Control* **1965**, *8*, 338–353, doi:10.1016/S0019-9958(65)90241-X.
3. Atanassov, K.T. Intuitionistic fuzzy sets. *Fuzzy Sets Syst.* **1986**, *20*, 87–96, doi:10.1016/S0165-0114(86)80034-3.
4. Turksen, I. Interval valued fuzzy sets based on normal forms. *Fuzzy Sets Syst.* **1986**, *20*, 191–210.
5. Wang, H.; Smarandache, F.; Zhang, Y.; Sunderraman, R. Single valued neutrosophic sets. *Multispace Multistruct.* **2010**, *4*, 410–413.
6. Neutrosophic Set Theory. Available online: <http://fs.gallup.unm.edu/NSS/> (accessed on 1 December 2017).
7. Shannon, A.; Atanassov, K. A first step to a theory of the intuitionistic fuzzy graphs. In Proceedings of the First Workshop on Fuzzy Based Expert Systems, Sofia, Bulgaria, 28–30 September 1994; Akov, D., Ed.; 1994; pp. 59–61.
8. Smarandache, F. *Symbolic Neutrosophic Theory*; Europeanova Asbl: Brussels, Belgium, 2015.
9. Smarandache, F. Refined literal indeterminacy and the multiplication law of sub-indeterminacies. *Neutrosophic Sets Syst.* **2015**, *9*, 58–63.
10. Smarandache, F. Types of Neutrosophic Graphs and neutrosophic Algebraic Structures together with their Applications in Technology. In Proceedings of the Seminar Universitatea Transilvania din Brasov, Facultatea de Design de Produsii Mediu, Brasov, Romania, 6 June 2015.
11. Smarandache, F. (Ed.) Neutrosophic overset, neutrosophic underset, neutrosophic offset. In *Similarly for Neutrosophic Over-/Under-/Off-Logic, Probability, and Statistics*; Pons Editions: Brussels, Belgium, 2016; pp. 158–168.
12. Broumi, S.; Talea, M.; Bakali, A.; Smarandache, F. Single valued neutrosophic graphs. *J. New Theory* **2016**, *10*, 86–101.
13. Broumi, S.; Talea, M.; Smarandache, F.; Bakali, A. Single valued neutrosophic graphs: Degree, order and size. In Proceedings of the IEEE International Conference on Fuzzy Systems, Vancouver, BC, Canada, 24–29 July 2016; IEEE: Piscataway, NJ, USA, 2016; pp. 2444–2451.
14. Broumi, S.; Bakali, A.; Talea, M.; Hassan, A.; Smarandache, F. Isolated single valued neutrosophic graphs. *Neutrosophic Sets Syst.* **2016**, *11*, 74–78.
15. Smarandache, F. (Ed.) Nidus idearum. In *Scilogs, III: Viva la Neutrosophia*; Pons asbl: Brussels, Belgium, 2017; ISBN 978-1-59973-508-5.
16. Samanta, S.; Sarkar, B.; Shin, D.; Pal, M. Completeness and regularity of generalized fuzzy graphs. *SpringerPlus* **2016**, *5*, 1–14, doi:10.1186/s40064-016-3558-6.
17. Broumi, S.; Bakali, A.; Talea, M.; Hassan, A.; Smarandache, F. Generalized single valued neutrosophic graphs of first type. In Proceedings of the 2017 IEEE International Conference on Innovations in Intelligent Systems and Applications (INISTA), Gdynia Maritime University, Gdynia, Poland, 3–5 July 2017; pp. 413–420.
18. Ramot, D.; Menahem, F.; Gideon, L.; Abraham, K. Complex Fuzzy Set. *IEEE Trans. Fuzzy Syst.* **2002**, *10*, 171–186.
19. Selvachandran, G.; Maji, P.K.; Abed, I.E.; Salleh, A.R. Complex vague soft sets and its distance measures. *J. Intell. Fuzzy Syst.* **2016**, *31*, 55–68.
20. Selvachandran, G.; Maji, P.K.; Abed, I.E.; Salleh, A.R. Relations between complex vague soft sets. *Appl. Soft Comp.* **2016**, *47*, 438–448.
21. Kumar, T.; Bajaj, R.K. On complex intuitionistic fuzzy soft sets with distance measures and entropies. *J. Math.* **2014**, *2014*, 1–12, doi:10.1155/2014/972198.
22. Alkouri, A.; Salleh, A. Complex intuitionistic fuzzy sets. *AIP Conf. Proc.* **2012**, *1482*, 464–470.
23. Selvachandran, G.; Hafeed, N.A.; Salleh, A.R. Complex fuzzy soft expert sets. *AIP Conf. Proc.* **2017**, *1830*, 1–8, doi:10.1063/1.4980969.
24. Selvachandran, G.; Salleh, A.R. Interval-valued complex fuzzy soft sets. *AIP Conf. Proc.* **2017**, *1830*, 1–8, doi:10.1063/1.4980958.
25. Greenfield, S.; Chiclana, F.; Dick, S. Interval-valued Complex Fuzzy Logic. In Proceedings of the IEEE International Conference on Fuzzy Systems, Vancouver, BC, Canada, 24–29 July 2016; IEEE: Piscataway, NJ, USA, 2016; pp. 1–6.
26. Ali, M.; Smarandache, F. Complex neutrosophic set. *Neural Comp. Appl.* **2017**, *28*, 1817–1834.

27. Thirunavukarasu, P.; Suresh, R.; Viswanathan, K.K. Energy of a complex fuzzy graph. *Int. J. Math. Sci. Eng. Appl.* **2016**, *10*, 243–248.
28. Smarandache, F. A geometric interpretation of the neutrosophic set—A generalization of the intuitionistic fuzzy set. In Proceedings of the IEEE International Conference on Granular Computing, National University of Kaohsiung, Kaohsiung, Taiwan, 8–10 November 2011; Hong, T.P., Kudo, Y., Kudo, M., Lin, T.Y., Chien, B.C., Wang, S.L., Inuiguchi, M., Liu, G.L., Eds.; IEEE Computer Society; IEEE: Kaohsiung, Taiwan, 2011; pp. 602–606.
29. Smarandache, F. Degree of dependence and independence of the (sub) components of fuzzy set and neutrosophic set. *Neutrosophic Sets Syst.* **2016**, *11*, 95–97.
30. Ali, M.; Son, L.H.; Khan, M.; Tung, N.T. Segmentation of dental X-ray images in medical imaging using neutrosophic orthogonal matrices. *Expert Syst. Appl.* **2018**, *91*, 434–441, doi:10.1016/j.eswa.2017.09.027.
31. Ali, M.; Dat, L.Q.; Son, L.H.; Smarandache, F. Interval complex neutrosophic set: Formulation and applications in decision-making. *Int. J. Fuzzy Syst.* **2018**, *20*, 986–999.
32. Ali, M.; Son, L.H.; Thanh, N.D.; Minh, N.V. A neutrosophic recommender system for medical diagnosis based on algebraic neutrosophic measures. *Appl. Soft Comp.* **2017**, doi:10.1016/j.asoc.2017.10.012.

A Study on Neutrosophic Cubic Graphs with Real Life Applications in Industries

Muhammad Gulistan, Naveed Yaqoob, Zunaira Rashid, Florentin Smarandache,
Hafiz Abdul Wahab

Muhammad Gulistan, Naveed Yaqoob, Zunaira Rashid, Florentin Smarandache, Hafiz Abdul Wahab (2018). A Study on Neutrosophic Cubic Graphs with Real Life Applications in Industries. *Symmetry* 10, 203; DOI: 10.3390/sym10060203

Abstract: Neutrosophic cubic sets are the more generalized tool by which one can handle imprecise information in a more effective way as compared to fuzzy sets and all other versions of fuzzy sets. Neutrosophic cubic sets have the more flexibility, precision and compatibility to the system as compared to previous existing fuzzy models. On the other hand the graphs represent a problem physically in the form of diagrams, matrices etc. which is very easy to understand and handle. So the authors applied the Neutrosophic cubic sets to graph theory in order to develop a more general approach where they can model imprecise information through graphs. We develop this model by introducing the idea of neutrosophic cubic graphs and introduce many fundamental binary operations like cartesian product, composition, union, join of neutrosophic cubic graphs, degree and order of neutrosophic cubic graphs and some results related with neutrosophic cubic graphs. One of very important futures of two neutrosophic cubic sets is the R -union that R -union of two neutrosophic cubic sets is again a neutrosophic cubic set, but here in our case we observe that R -union of two neutrosophic cubic graphs need not be a neutrosophic cubic graph. Since the purpose of this new model is to capture the uncertainty, so we provide applications in industries to test the applicability of our defined model based on present time and future prediction which is the main advantage of neutrosophic cubic sets.

Keywords: neutrosophic cubic set; neutrosophic cubic graphs; applications of neutrosophic cubic graphs

1. Introduction

In 1965, Zadeh [1] published his seminal paper "Fuzzy Sets" which described fuzzy set theory and consequently fuzzy logic. The purpose of Zadeh's paper was to develop a theory which could deal with ambiguity and imprecision of certain classes or sets in human thinking, particularly in the domains of pattern recognition, communication of information and abstraction. This theory proposed making the grade of membership of an element in a subset of a universal set a value in the closed interval $[0, 1]$ of real numbers. Zadeh's ideas have found applications in computer sciences, artificial intelligence, decision analysis, information sciences, system sciences, control engineering, expert systems, pattern recognition, management sciences, operations research and robotics. Theoretical mathematics has

also been touched by fuzzy set theory. The ideas of fuzzy set theory have been introduced into topology, abstract algebra, geometry, graph theory and analysis. Further, he made the extension of fuzzy set to interval-valued fuzzy sets in 1975, where one is not bound to give a specific membership to a certain element. In 1975, Rosenfeld [2] discussed the concept of fuzzy graphs whose basic idea was introduced by Kauffmann [3] in 1973. The fuzzy relations between fuzzy sets were also considered by Rosenfeld and he developed the structure of fuzzy graphs obtaining analogs of several graph theoretical concepts [4]. Bhattacharya provided further studies on fuzzy graphs [5]. Akram and Dudek gave the idea of interval valued fuzzy graphs in 2011 where they used interval membership for an element in the vertex set [6]. Akram further extended the idea of interval valued fuzzy graphs to Interval-valued fuzzy line graphs in 2012. More detail of fuzzy graphs, we refer the reader to [7–12]. In 1986, Atanassov [13] use the notion of membership and non-membership of an element in a set X and gave the idea of intuitionistic fuzzy sets. He extended this idea to intuitionistic fuzzy graphs and for more detail in this direction, we refer the reader to [14–20]. Akram and Davvaz [21] introduced the notion of strong intuitionistic fuzzy graphs and investigated some of their properties. They discussed some propositions of self complementary and self weak complementary strong intuitionistic fuzzy graphs. In 1994, Zhang [22] started the theory of bipolar fuzzy sets as a generality of fuzzy sets. Bipolar fuzzy sets are postponement of fuzzy sets whose membership degree range is $[-1, 1]$. Akram [23,24] introduced the concepts of bipolar fuzzy graphs, where he introduced the notion of bipolar fuzzy graphs, described various methods of their construction, discussed the concept of isomorphisms of these graphs and investigated some of their important properties. He then introduced the notion of strong bipolar fuzzy graphs and studied some of their properties. He also discussed some propositions of self complementary and self weak complementary strong bipolar fuzzy graphs and applications, for example see [25]. Smarandache [26–28] extended the concept of Atanassov and gave the idea of neutrosophic sets. He proposed the term “neutrosophic” because “neutrosophic” etymologically comes from “neutrosophy” This comes from the French neutre < Latin neuter, neutral, and Greek sophia, skill/wisdom, which means knowledge of neutral thought, and this third/neutral represents the main distinction between “fuzzy” and “intuitionistic fuzzy” logic/set, i.e., the included middle component (Lupasco-Niculescu’s logic in philosophy), i.e., the neutral/indeterminate/unknown part (besides the “truth”/“membership” and “falsehood”/“non-membership” components that both appear in fuzzy logic/set). See the Proceedings of the First International Conference on Neutrosophic Logic, The University of New Mexico, Gallup Campus, 1–3 December 2001, at <http://www.gallup.unm.edu/~smarandache/FirstNeutConf.htm>.

After that, many researchers used the idea of neutrosophic sets in different directions. The idea of neutrosophic graphs is provided by Kandasamy et al. in the book title as Neutrosophic graphs, where they introduce idea of neutrosophic graphs [29]. This study reveals that these neutrosophic graphs give a new dimension to graph theory. An important feature of this book is that it contains over 200 neutrosophic graphs to provide better understandings of these concepts. Akram and others discussed different aspects of neutrosophic graphs [30–33]. Further Jun et al. [34] gave the idea of cubic set and it was characterized by interval valued fuzzy set and fuzzy set, which is more general tool to capture uncertainty and vagueness, while fuzzy set deals with single value membership and interval valued fuzzy set ranges the membership in the form of interval. The hybrid platform provided by the cubic set is the main advantage, in that it contains more information than a fuzzy set and interval valued fuzzy set. By using this concept, we can solve different problems arising in several areas and can pick finest choice by means of cubic sets in various decision making problems. This hybrid nature of the cubic set attracted these researchers to work in this field. For more detail about cubic sets and their applications in different research areas, we refer the reader to [35–37]. Recently, Rashid et al. [38] introduced the notion of cubic graphs where they introduced many new types of graphs and provided their application. More recently Jun et al. [39,40] combined neutrosophic set with cubic sets and gave the idea of Neutrosophic cubic set and defined different operations.

Therefore, the need was felt to develop a model for neutrosophic cubic graphs which is a more generalized tool to handle uncertainty. In this paper, we introduce the idea of neutrosophic cubic graphs and introduce the fundamental binary operations, such as the cartesian product, composition, union, join of neutrosophic cubic graphs, degree, order of neutrosophic cubic graphs and some results related to neutrosophic cubic graphs. We observe that R -union of two neutrosophic cubic graphs need not to be a neutrosophic cubic graph. At the end, we provide applications of neutrosophic cubic graphs in industries to test the applicability of our presented model.

2. Preliminaries

We recall some basic definitions related to graphs, fuzzy graphs and neutrosophic cubic sets.

Definition 1. A graph is an ordered pair $G^* = (V, E)$, where V is the set of vertices of G^* and E is the set of edges of G^* .

Definition 2. A fuzzy graph [2–4] with an underlying set V is defined to be a pair $G = (\mu, \nu)$ where μ is a fuzzy function in V and ν is a fuzzy function in $E \subseteq V \times V$ such that $\nu(\{x, y\}) \leq \min(\mu(x), \mu(y))$ for all $\{x, y\} \in E$.

We call μ the fuzzy vertex function of V , ν the fuzzy edge function of E , respectively. Please note that ν is a symmetric fuzzy relation on μ . We use the notation xy for an element $\{x, y\}$ of E . Thus, $G = (\mu, \nu)$ is a fuzzy graph of $G^* = (V, E)$ if $\nu(xy) \leq \min(\mu(x), \mu(y))$ for all $xy \in E$.

Definition 3. Let $G = (\mu, \nu)$ be a fuzzy graph. The order of a fuzzy graph [2–4] is defined by $O(G) = \sum_{x \in V} \mu(x)$. The degree of a vertex x in G is defined by $\deg(x) = \sum_{xy \in E} \nu(xy)$.

Definition 4. Let μ_1 and μ_2 be two fuzzy functions of V_1 and V_2 and let ν_1 and ν_2 be fuzzy functions of E_1 and E_2 , respectively. The Cartesian product of two fuzzy graphs G_1 and G_2 [2–4] of the graphs G_1^* and G_2^* is denoted by $G_1 \times G_2 = (\mu_1 \times \mu_2, \nu_1 \times \nu_2)$ and is defined as follows:

- (i) $(\mu_1 \times \mu_2)(x_1, x_2) = \min(\mu_1(x_1), \mu_2(x_2))$, for all $(x_1, x_2) \in V$.
- (ii) $(\nu_1 \times \nu_2)((x, x_2)(x, y_2)) = \min(\mu_1(x), \nu_2(x_2 y_2))$, for all $x \in V_1$, for all $x_2 y_2 \in E_2$.
- (iii) $(\nu_1 \times \nu_2)((x_1, z)(y_1, z)) = \min(\nu_1(x_1 y_1), \mu_2(z))$, for all $z \in V_2$, for all $x_1 y_1 \in E_1$.

Definition 5. Let μ_1 and μ_2 be fuzzy functions of V_1 and V_2 and let ν_1 and ν_2 be fuzzy functions of E_1 and E_2 , respectively. The composition of two fuzzy graphs G_1 and G_2 of the graphs G_1^* and G_2^* [2–4] is denoted by $G_1[G_2] = (\mu_1 \circ \mu_2, \nu_1 \circ \nu_2)$ and is defined as follows:

- (i) $(\mu_1 \circ \mu_2)(x_1, x_2) = \min(\mu_1(x_1), \mu_2(x_2))$, for all $(x_1, x_2) \in V$.
- (ii) $(\nu_1 \circ \nu_2)((x, x_2)(x, y_2)) = \min(\mu_1(x), \nu_2(x_2 y_2))$, for all $x \in V_1$, for all $x_2 y_2 \in E_2$.
- (iii) $(\nu_1 \circ \nu_2)((x_1, z)(y_1, z)) = \min(\nu_1(x_1 y_1), \mu_2(z))$, for all $z \in V_2$, for all $x_1 y_1 \in E_1$.
- (iv) $(\nu_1 \circ \nu_2)((x_1, x_2)(y_1, y_2)) = \min(\mu_2(x_2), \mu_2(y_2), \nu_1(x_1 y_1))$, for all $z \in V_2$, for all $(x_1, x_2)(y_1, y_2) \in E^0 - E$.

Definition 6. Let μ_1 and μ_2 be fuzzy functions of V_1 and V_2 and let ν_1 and ν_2 be fuzzy functions of E_1 and E_2 , respectively. Then union of two fuzzy graphs G_1 and G_2 of the graphs G_1^* and G_2^* [2–4] is denoted by $G_1 \cup G_2 = (\mu_1 \cup \mu_2, \nu_1 \cup \nu_2)$ and is defined as follows:

- (i) $(\mu_1 \cup \mu_2)(x) = \mu_1(x)$ if $x \in V_1 \cap V_2$,
- (ii) $(\mu_1 \cup \mu_2)(x) = \mu_2(x)$ if $x \in V_2 \cap V_1$,
- (iii) $(\mu_1 \cup \mu_2)(x) = \max(\mu_1(x), \mu_2(x))$ if $x \in V_1 \cap V_2$,
- (iv) $(\nu_1 \cup \nu_2)(xy) = \nu_1(xy)$ if $xy \in E_1 \cap E_2$,
- (v) $(\nu_1 \cup \nu_2)(xy) = \nu_2(xy)$ if $xy \in E_2 \cap E_1$,
- (vi) $(\nu_1 \cup \nu_2)(xy) = \max(\nu_1(xy), \nu_2(xy))$ if $xy \in E_1 \cap E_2$.

Definition 7. Let μ_1 and μ_2 be fuzzy functions of V_1 and V_2 and let ν_1 and ν_2 be fuzzy functions of E_1 and E_2 , respectively. Then join of two fuzzy graphs G_1 and G_2 of the graphs G_1^* and G_2^* [2–4] is denoted by $G_1 + G_2 = (\mu_1 + \mu_2, \nu_1 + \nu_2)$ and is defined as follows:

- (i) $(\mu_1 + \mu_2)(x) = (\mu_1 \cup \mu_2)(x)$ if $x \in V_1 \cup V_2$,
- (ii) $(\nu_1 + \nu_2)(xy) = (\nu_1 \cup \nu_2)(xy) = \nu_1(xy)$ if $xy \in E_1 \cup E_2$,
- (iii) $(\nu_1 + \nu_2)(xy) = \min(\mu_1(x), \mu_2(y))$ if $xy \in E'$.

Definition 8. Let X be a non-empty set. A neutrosophic cubic set (NCS) in X [39] is a pair $A = (\mathbf{A}, \mathbf{\Lambda})$ where $\mathbf{A} = \{ \langle x, A_T(x), A_I(x), A_F(x) \rangle \mid x \in X \}$ is an interval neutrosophic set in X and $\mathbf{\Lambda} = \{ \langle x, \lambda_T(x), \lambda_I(x), \lambda_F(x) \rangle \mid x \in X \}$ is a neutrosophic set in X .

3. Neutrosophic Cubic Graphs

The motivation behind this section is to combine the concept of neutrosophic cubic sets with graphs theory. We introduce the concept of neutrosophic cubic graphs, order and degree of neutrosophic cubic graph and different fundamental operations on neutrosophic cubic graphs with examples.

Definition 9. Let $G^* = (V, E)$ be a graph. By neutrosophic cubic graph of G^* , we mean a pair $G = (M, N)$ where $M = (A, B) = ((\tilde{T}_A, T_B), (\tilde{I}_A, I_B), (\tilde{F}_A, F_B))$ is the neutrosophic cubic set representation of vertex set V and $N = (C, D) = ((\tilde{T}_C, T_D), (\tilde{I}_C, I_D), (\tilde{F}_C, F_D))$ is the neutrosophic cubic set representation of edges set E such that;

- (i) $(\tilde{T}_C(u_i v_i) \preceq \text{rmin}\{\tilde{T}_A(u_i), \tilde{T}_A(v_i)\}, T_D(u_i v_i) \leq \max\{T_B(u_i), T_B(v_i)\})$,
- (ii) $(\tilde{I}_C(u_i v_i) \preceq \text{rmin}\{\tilde{I}_A(u_i), \tilde{I}_A(v_i)\}, I_D(u_i v_i) \leq \max\{I_B(u_i), I_B(v_i)\})$,
- (iii) $(\tilde{F}_C(u_i v_i) \preceq \text{rmax}\{\tilde{F}_A(u_i), \tilde{F}_A(v_i)\}, F_D(u_i v_i) \leq \min\{F_B(u_i), F_B(v_i)\})$.

Example 1. Let $G^* = (V, E)$ be a graph where $V = \{a, b, c, d\}$ and $E = \{ab, bc, ac, ad, cd\}$, where

$$M = \left\langle \begin{array}{l} \{a, ([0.2, 0.3], 0.5), ([0.1, 0.4], 0.6), ([0.5, 0.6], 0.3)\}, \\ \{b, ([0.1, 0.2], 0.4), ([0.4, 0.5], 0.6), ([0.7, 0.8], 0.4)\}, \\ \{c, ([0.4, 0.7], 0.1), ([0.7, 0.8], 0.9), ([0.3, 0.4], 0.5)\}, \\ \{d, ([0.3, 0.5], 0.2), ([0.9, 1], 0.5), ([0.2, 0.4], 0.1)\} \end{array} \right\rangle$$

$$N = \left\langle \begin{array}{l} \{ab, ([0.1, 0.2], 0.5), ([0.1, 0.4], 0.6), ([0.7, 0.8], 0.3)\}, \\ \{ac, ([0.2, 0.3], 0.5), ([0.1, 0.4], 0.9), ([0.5, 0.6], 0.3)\}, \\ \{ad, ([0.2, 0.3], 0.5), ([0.1, 0.4], 0.6), ([0.5, 0.6], 0.1)\}, \\ \{bc, ([0.1, 0.2], 0.4), ([0.4, 0.5], 0.9), ([0.7, 0.8], 0.4)\}, \\ \{bd, ([0.1, 0.2], 0.4), ([0.4, 0.5], 0.6), ([0.7, 0.8], 0.1)\}, \\ \{cd, ([0.3, 0.5], 0.2), ([0.7, 0.8], 0.9), ([0.3, 0.4], 0.1)\} \end{array} \right\rangle$$

Then clearly $G = (M, N)$ is a neutrosophic cubic graph of $G^* = (V, E)$ as shown in Figure 1.

Remark 1.

1. If $n \geq 3$ in the vertex set and $n \geq 3$ in the set of edges then the graphs is a neutrosophic cubic polygon only when we join each vertex to the corresponding vertex through an edge.
2. If we have infinite elements in the vertex set and by joining the each and every edge with each other we get a neutrosophic cubic curve.

Definition 10. Let $G = (M, N)$ be a neutrosophic cubic graph. The order of neutrosophic cubic graph is defined by $O(G) = \sum_{x \in V} \{(\tilde{T}_A, T_B)(x), (\tilde{I}_A, I_B)(x), (\tilde{F}_A, F_B)(x)\}$ and degree of a vertex x in G is defined by $\text{deg}(x) = \sum_{xy \in E} \{(\tilde{T}_C, T_D)(xy), (\tilde{I}_C, I_D)(xy), (\tilde{F}_C, F_D)(xy)\}$.

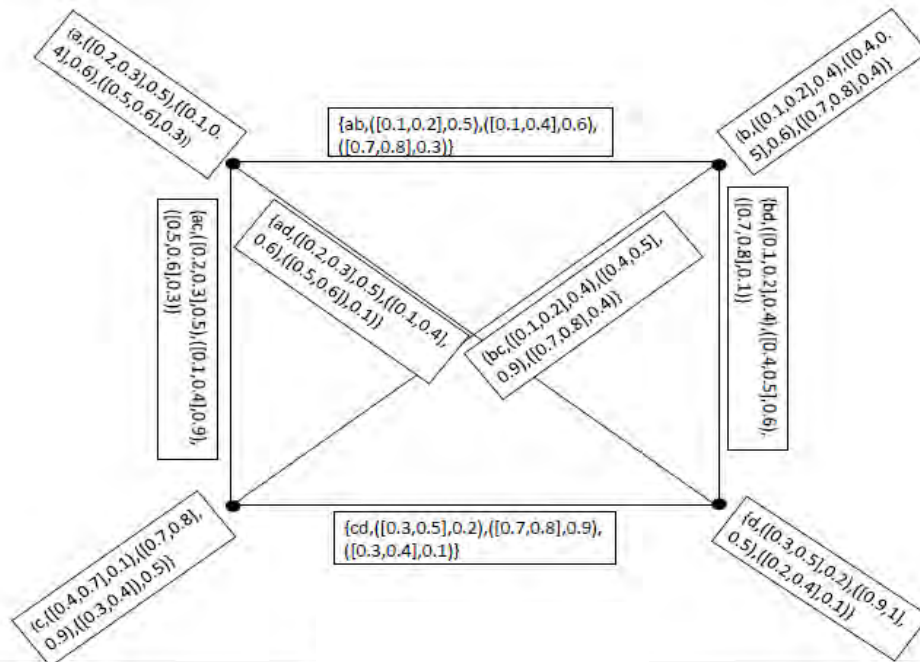

Figure 1. Neutrosophic Cubic Graph.

Then clearly $G = (M, N)$ is a neutrosophic cubic graph of $G^* = (V, E)$.

Remark 1. If $n > 3$ in the vertex set and $n > 3$ in the set of edges then the graphs is a neutrosophic cubic polygon only when we join each vertex to the corresponding vertex through an edge.

Example 2. In Example 1, Order of a neutrosophic cubic graph is

$$O(G) = \{([1.0, 1.7], 1.2), ([2.1, 1.8], 2.6), ([1.7, 2.2], 1.3)\}$$

2. If we have infinite elements in the vertex set and by joining the each and every edge with each other we get a neutrosophic cubic cure.

$$\deg(a) = \{([0.5, 0.8], 1.5), ([0.3, 1.2], 2.1), ([1.7, 2.0], 0.7)\}$$

Definition 3.2 Let $G = (M, N)$ be a neutrosophic cubic graph defined by $O(G) = \sum_{x \in V} \{(\tilde{T}_A, \tilde{T}_B)(x), (\tilde{I}_A, \tilde{I}_B)(x), (\tilde{F}_A, \tilde{F}_B)(x)\}$ and degree of a vertex x in G is defined by $\deg(x) = \sum_{xy \in E} \{(\tilde{T}_C, \tilde{T}_D)(xy), (\tilde{I}_C, \tilde{I}_D)(xy), (\tilde{F}_C, \tilde{F}_D)(xy)\}$.

Definition 11. Let $G_1 = (M_1, N_1)$ be a neutrosophic cubic graph of $G_1^* = (V_1, E_1)$, and $G_2 = (M_2, N_2)$ be

Example 3.3 In Example 3.2 of G_1^* of (V_1, E_1) Then Cartesian product of G_1 and G_2 is denoted by

$$G_1 \times G_2 = ((A_1 \times A_2, B_1 \times B_2), (C_1 \times C_2, D_1 \times D_2))$$

and degree of each vertex in G is

$$\deg(a) = \left\{ \begin{aligned} &((\tilde{T}_{A_1 \times A_2}, \tilde{T}_{B_1 \times B_2}), (\tilde{I}_{A_1 \times A_2}, \tilde{I}_{B_1 \times B_2}), (\tilde{F}_{A_1 \times A_2}, \tilde{F}_{B_1 \times B_2})), \\ &((\tilde{T}_{C_1 \times C_2}, \tilde{T}_{D_1 \times D_2}), (\tilde{I}_{C_1 \times C_2}, \tilde{I}_{D_1 \times D_2}), (\tilde{F}_{C_1 \times C_2}, \tilde{F}_{D_1 \times D_2})) \end{aligned} \right\}$$

and is defined as follows $\deg(b) = \{([0.3, 0.6], 1.3), ([0.9, 1.4], 2.1), ([2.1, 2.4], 0.8)\}$

$$\deg(c) = \{([0.6, 1.0], 1.1), ([1.2, 1.7], 2.7), ([1.5, 1.8], 0.8)\}$$

- (i) $(\tilde{T}_{A_1 \times A_2}(x, y) = \min(\tilde{T}_{A_1}(x), \tilde{T}_{A_2}(y)), \tilde{T}_{B_1 \times B_2}(x, y) = \max(\tilde{T}_{B_1}(x), \tilde{T}_{B_2}(y)))$,
- (ii) $(\tilde{I}_{A_1 \times A_2}(x, y) = \min(\tilde{I}_{A_1}(x), \tilde{I}_{A_2}(y)), \tilde{I}_{B_1 \times B_2}(x, y) = \max(\tilde{I}_{B_1}(x), \tilde{I}_{B_2}(y)))$,

Definition 3.3 Let $G_1 = (M_1, N_1)$ be a neutrosophic cubic graph of $G_1^* = (V_1, E_1)$, and $G_2 = (M_2, N_2)$ be a neutrosophic cubic graph of $G_2^* = (V_2, E_2)$. Then Cartesian product of G_1 and G_2 is denoted by

$$G_1 \times G_2 = ((A_1 \times A_2, B_1 \times B_2), (C_1 \times C_2, D_1 \times D_2))$$

$$= \left\{ \begin{aligned} &((\tilde{T}_{A_1 \times A_2}, \tilde{T}_{B_1 \times B_2}), (\tilde{I}_{A_1 \times A_2}, \tilde{I}_{B_1 \times B_2}), (\tilde{F}_{A_1 \times A_2}, \tilde{F}_{B_1 \times B_2})), \\ &((\tilde{T}_{C_1 \times C_2}, \tilde{T}_{D_1 \times D_2}), (\tilde{I}_{C_1 \times C_2}, \tilde{I}_{D_1 \times D_2}), (\tilde{F}_{C_1 \times C_2}, \tilde{F}_{D_1 \times D_2})) \end{aligned} \right\}$$

$$\begin{aligned}
 & (vi) \left(\begin{aligned} \tilde{F}_{C_1 \times C_2}((x, y_1)(x, y_2)) &= rmax(\tilde{F}_{A_1}(x), \tilde{F}_{C_2}(y_1 y_2)), \\ F_{D_1 \times D_2}((x, y_1)(x, y_2)) &= \min(F_{B_1}(x), F_{D_2}(y_1 y_2)) \end{aligned} \right), \\
 & (vii) \left(\begin{aligned} \tilde{T}_{C_1 \times C_2}((x_1, y)(x_2, y)) &= rmin(\tilde{T}_{C_1}(x_1 x_2), \tilde{T}_{A_2}(y)), \\ T_{D_1 \times D_2}((x_1, y)(x_2, y)) &= \max(T_{D_1}(x_1 x_2), T_{B_2}(y)) \end{aligned} \right), \\
 & (viii) \left(\begin{aligned} \tilde{I}_{C_1 \times C_2}((x_1, y)(x_2, y)) &= rmin(\tilde{I}_{C_1}(x_1 x_2), \tilde{I}_{A_2}(y)), \\ I_{D_1 \times D_2}((x_1, y)(x_2, y)) &= \max(I_{D_1}(x_1 x_2), I_{B_2}(y)) \end{aligned} \right), \\
 & (ix) \left(\begin{aligned} \tilde{F}_{C_1 \times C_2}((x_1, y)(x_2, y)) &= rmax(\tilde{F}_{C_1}(x_1 x_2), \tilde{F}_{A_2}(y)), \\ F_{D_1 \times D_2}((x_1, y)(x_2, y)) &= \min(F_{D_1}(x_1 x_2), F_{B_2}(y)) \end{aligned} \right), \forall (x, y) \in (V_1, V_2) = V \text{ for (i) -} \\
 & \text{(iii), } \forall x \in V_1 \text{ and } y_1 y_2 \in E_2 \text{ for (iv) - (vi), } \forall y \in V_2 \text{ and } x_1 x_2 \in E_1 \text{ for (vi) - (ix).}
 \end{aligned}$$

Example 3. Let $G_1 = (M_1, N_1)$ be a neutrosophic cubic graph of $G_1^* = (V_1, E_1)$ as showin in Figure 2, where $V_1 = \{a, b, c\}$, $E_1 = \{ab, bc, ac\}$

$$\begin{aligned}
 M_1 &= \left\langle \begin{aligned} \{a, ([0.1, 0.2], 0.5), ([0.4, 0.5], 0.3), ([0.6, 0.7], 0.2)\}, \\ \{b, ([0.2, 0.4], 0.1), ([0.5, 0.6], 0.4), ([0.1, 0.2], 0.3)\}, \\ \{c, ([0.3, 0.4], 0.2), ([0.1, 0.3], 0.7), ([0.4, 0.6], 0.3)\} \end{aligned} \right\rangle \\
 N_1 &= \left\langle \begin{aligned} \{ab, ([0.1, 0.2], 0.5), ([0.4, 0.5], 0.4), ([0.6, 0.7], 0.2)\}, \\ \{bc, ([0.2, 0.4], 0.2), ([0.1, 0.3], 0.7), ([0.4, 0.6], 0.3)\}, \\ \{ac, ([0.1, 0.2], 0.5), ([0.1, 0.3], 0.7), ([0.6, 0.7], 0.2)\} \end{aligned} \right\rangle
 \end{aligned}$$

and $G_2 = (M_2, N_2)$ be a neutrosophic cubic graph of $G_2^* = (V_2, E_2)$ as showin in Figure 3, where $V_2 = \{x, y, z\}$ and $E_2 = \{xy, yz, xz\}$

$$\begin{aligned}
 M_2 &= \left\langle \begin{aligned} \{x, ([0.7, 0.8], 0.6), ([0.2, 0.4], 0.5), ([0.3, 0.4], 0.7)\}, \\ \{y, ([0.2, 0.3], 0.4), ([0.6, 0.7], 0.3), ([0.9, 1.0], 0.5)\}, \\ \{z, ([0.4, 0.5], 0.2), ([0.3, 0.4], 0.1), ([0.6, 0.7], 0.4)\} \end{aligned} \right\rangle \\
 N_2 &= \left\langle \begin{aligned} \{xy, ([0.2, 0.3], 0.6), ([0.2, 0.4], 0.5), ([0.9, 1.0], 0.5)\}, \\ \{yz, ([0.2, 0.3], 0.4), ([0.3, 0.4], 0.3), ([0.9, 1.0], 0.4)\}, \\ \{xz, ([0.4, 0.5], 0.6), ([0.2, 0.4], 0.5), ([0.6, 0.7], 0.4)\} \end{aligned} \right\rangle
 \end{aligned}$$

then $G_1 \times G_2$ is a neutrosophic cubic graph of $G_1^* \times G_2^*$, as showin in Figure 4, where $V_1 \times V_2 = \{(a, x), (a, y), (a, z), (b, x), (b, y), (b, z), (c, x), (c, y), (c, z)\}$ and

$$\begin{aligned}
 M_1 \times M_2 &= \left\langle \begin{aligned} \{(a, x), ([0.1, 0.2], 0.6), ([0.2, 0.4], 0.5), ([0.6, 0.7], 0.2)\}, \\ \{(a, y), ([0.1, 0.2], 0.5), ([0.4, 0.5], 0.3), ([0.9, 1.0], 0.2)\}, \\ \{(a, z), ([0.1, 0.2], 0.5), ([0.3, 0.4], 0.3), ([0.6, 0.7], 0.2)\}, \\ \{(b, x), ([0.2, 0.4], 0.6), ([0.2, 0.4], 0.5), ([0.3, 0.4], 0.3)\}, \\ \{(b, y), ([0.2, 0.3], 0.4), ([0.5, 0.6], 0.4), ([0.9, 1.0], 0.3)\}, \\ \{(b, z), ([0.2, 0.4], 0.2), ([0.3, 0.4], 0.4), ([0.6, 0.7], 0.3)\}, \\ \{(c, x), ([0.3, 0.4], 0.6), ([0.1, 0.3], 0.7), ([0.4, 0.6], 0.3)\}, \\ \{(c, y), ([0.2, 0.3], 0.4), ([0.1, 0.3], 0.7), ([0.9, 1.0], 0.3)\}, \\ \{(c, z), ([0.3, 0.4], 0.2), ([0.1, 0.3], 0.7), ([0.6, 0.7], 0.3)\} \end{aligned} \right\rangle \\
 N_1 \times N_2 &= \left\langle \begin{aligned} \{((a, x)(a, y)), ([0.1, 0.2], 0.6), ([0.2, 0.4], 0.5), ([0.9, 1.0], 0.2)\}, \\ \{((a, y)(a, z)), ([0.1, 0.2], 0.5), ([0.3, 0.4], 0.3), ([0.9, 1.0], 0.2)\}, \\ \{((a, z)(b, z)), ([0.1, 0.2], 0.5), ([0.3, 0.4], 0.4), ([0.6, 0.7], 0.2)\}, \\ \{((b, x)(b, z)), ([0.2, 0.4], 0.6), ([0.2, 0.4], 0.5), ([0.6, 0.7], 0.3)\}, \\ \{((b, x)(b, y)), ([0.2, 0.3], 0.6), ([0.2, 0.4], 0.5), ([0.9, 1.0], 0.3)\}, \\ \{((b, y)(c, y)), ([0.2, 0.3], 0.4), ([0.1, 0.3], 0.7), ([0.9, 1.0], 0.3)\}, \\ \{((c, y)(c, z)), ([0.2, 0.3], 0.4), ([0.1, 0.3], 0.7), ([0.9, 1.0], 0.3)\}, \\ \{((c, x)(c, z)), ([0.3, 0.4], 0.6), ([0.1, 0.3], 0.7), ([0.6, 0.7], 0.3)\}, \\ \{((a, x)(c, x)), ([0.1, 0.2], 0.6), ([0.1, 0.3], 0.7), ([0.6, 0.7], 0.2)\} \end{aligned} \right\rangle
 \end{aligned}$$

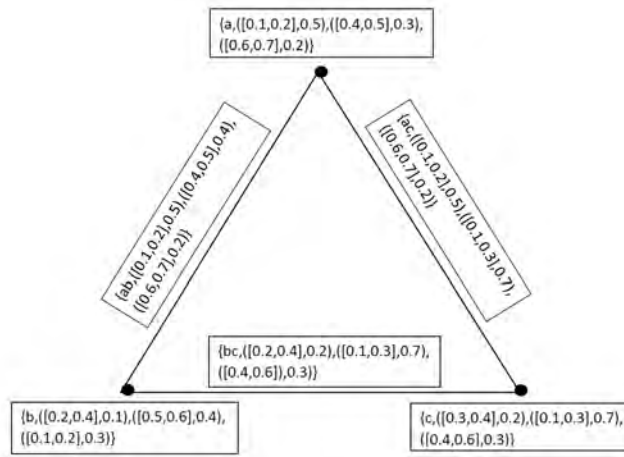
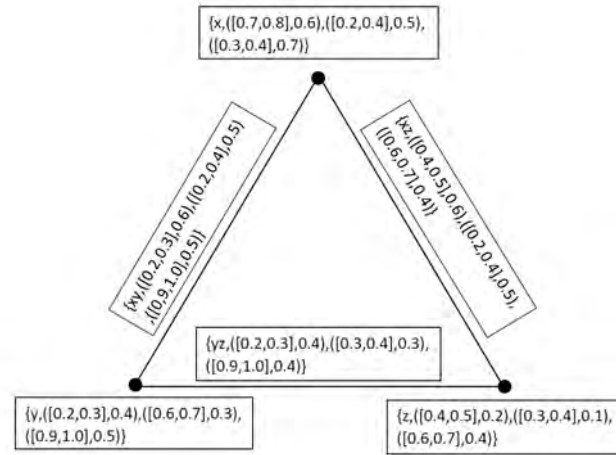

Figure 2. Neutrosophic Cubic Graph G_1 .

Figure 2: Neutrosophic cubic graph G_1

and G_2
 $\{xy, yz, xz\}$



and $E_2 =$

Figure 3. Neutrosophic Cubic Graph G_2 .

Figure:3 Neutrosophic cubic graph G_2

then $G_1 \times G_2$ is a neutrosophic cubic graph.
 $V_1 \times V_2 = \{(a, x), (a, y), (a, z), (b, x), (b, y), (b, z), (c, x), (c, y), (c, z)\}$

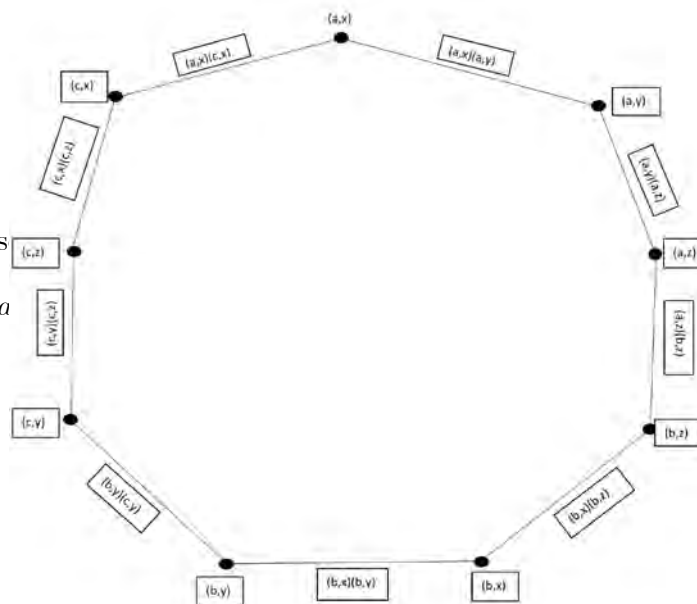

$M_1 \times M_2 =$

Figure 4. Cartesian Product of G_1 and G_2 .

Figure: 4 Cartesian Product of G_1 and G_2

Proposition 3.4 The Cartesian product of two neutrosophic cubic graphs is again a neutrosophic cubic graph.
 $\{(c, x), ([0.3, 0.4], 0.6), ([0.1, 0.3], 0.7), ([0.4, 0.6], 0.3)\},$
 $\{(c, y), ([0.2, 0.3], 0.4), ([0.1, 0.3], 0.7), ([0.9, 1.0], 0.3)\},$
 $\{(c, z), ([0.3, 0.4], 0.2), ([0.1, 0.3], 0.7), ([0.6, 0.7], 0.3)\}$

Proposition 1. *The cartesian product of two neutrosophic cubic graphs is again a neutrosophic cubic graph.*

Proof. Condition is obvious for $M_1 \times M_2$. Therefore we verify conditions only for $N_1 \times N_2$, where $N_1 \times N_2 = \{((\tilde{T}_{C_1 \times C_2}, T_{D_1 \times D_2}), (\tilde{I}_{C_1 \times C_2}, I_{D_1 \times D_2}), (\tilde{F}_{C_1 \times C_2}, F_{D_1 \times D_2}))\}$. Let $x \in V_1$ and $x_2 y_2 \in E_2$. Then

$$\begin{aligned} \tilde{T}_{C_1 \times C_2}((x, x_2)(x, y_2)) &= rmin\{(\tilde{T}_{A_1}(x), \tilde{T}_{C_2}(x_2 y_2))\} \\ &\preceq rmin\{(\tilde{T}_{A_1}(x), rmin((\tilde{T}_{A_2}(x_2), (\tilde{T}_{A_2}(y_2))))\} \\ &= rmin\{rmin((\tilde{T}_{A_1}(x), (\tilde{T}_{A_2}(x_2))), rmin((\tilde{T}_{A_1}(x), (\tilde{T}_{A_2}(y_2))))\} \\ &= rmin\{(\tilde{T}_{A_1} \times \tilde{T}_{A_2})(x, x_2), ((\tilde{T}_{A_1} \times \tilde{T}_{A_2})(x, y_2))\} \\ T_{D_1 \times D_2}((x, x_2)(x, y_2)) &= \max\{(T_{B_1}(x), T_{D_2}(x_2 y_2))\} \\ &\leq \max\{(T_{B_1}(x), \max((T_{B_2}(x_2), (T_{B_2}(y_2))))\} \\ &= \max\{\max((T_{B_1}(x), (T_{B_2}(x_2))), \max((T_{B_1}(x), (T_{B_2}(y_2))))\} \\ &= \max\{(T_{B_1} \times T_{B_2})(x, x_2), ((T_{B_1} \times T_{B_2})(x, y_2))\} \\ \tilde{I}_{C_1 \times C_2}((x, x_2)(x, y_2)) &= rmin\{(\tilde{I}_{A_1}(x), \tilde{I}_{C_2}(x_2 y_2))\} \\ &\preceq rmin\{(\tilde{I}_{A_1}(x), rmin((\tilde{I}_{A_2}(x_2), (\tilde{I}_{A_2}(y_2))))\} \\ &= rmin\{rmin((\tilde{I}_{A_1}(x), (\tilde{I}_{A_2}(x_2))), rmin((\tilde{I}_{A_1}(x), (\tilde{I}_{A_2}(y_2))))\} \\ &= rmin\{(\tilde{I}_{A_1} \times \tilde{I}_{A_2})(x, x_2), ((\tilde{I}_{A_1} \times \tilde{I}_{A_2})(x, y_2))\} \\ I_{D_1 \times D_2}((x, x_2)(x, y_2)) &= \max\{(I_{B_1}(x), I_{D_2}(x_2 y_2))\} \\ &\leq \max\{(I_{B_1}(x), \max((I_{B_2}(x_2), (I_{B_2}(y_2))))\} \\ &= \max\{\max((I_{B_1}(x), (I_{B_2}(x_2))), \max((I_{B_1}(x), (I_{B_2}(y_2))))\} \\ &= \max\{(I_{B_1} \times I_{B_2})(x, x_2), ((I_{B_1} \times I_{B_2})(x, y_2))\} \\ \tilde{F}_{C_1 \times C_2}((x, x_2)(x, y_2)) &= rmax\{(\tilde{F}_{A_1}(x), \tilde{F}_{C_2}(x_2 y_2))\} \\ &\preceq rmax\{(\tilde{F}_{A_1}(x), rmax((\tilde{F}_{A_2}(x_2), (\tilde{F}_{A_2}(y_2))))\} \\ &= rmax\{rmax((\tilde{F}_{A_1}(x), (\tilde{F}_{A_2}(x_2))), rmax((\tilde{F}_{A_1}(x), (\tilde{F}_{A_2}(y_2))))\} \\ &= rmax\{(\tilde{F}_{A_1} \times \tilde{F}_{A_2})(x, x_2), ((\tilde{F}_{A_1} \times \tilde{F}_{A_2})(x, y_2))\} \\ F_{D_1 \times D_2}((x, x_2)(x, y_2)) &= \min\{(F_{B_1}(x), F_{D_2}(x_2 y_2))\} \\ &\leq \min\{(F_{B_1}(x), \min((F_{B_2}(x_2), (F_{B_2}(y_2))))\} \\ &= \min\{\min((F_{B_1}(x), (F_{B_2}(x_2))), \min((F_{B_1}(x), (F_{B_2}(y_2))))\} \\ &= \min\{(F_{B_1} \times F_{B_2})(x, x_2), (F_{B_1} \times F_{B_2})(x, y_2)\} \end{aligned}$$

similarly we can prove it for $z \in V_2$ and $x_1 y_1 \in E_1$. \square

Definition 12. *Let $G_1 = (M_1, N_1)$ and $G_2 = (M_2, N_2)$ be two neutrosophic cubic graphs. The degree of a vertex in $G_1 \times G_2$ can be defined as follows, for any $(x_1, x_2) \in V_1 \times V_2$*

$$\begin{aligned} \deg(\tilde{T}_{A_1} \times \tilde{T}_{A_2})(x_1, x_2) &= \sum_{(x_1, x_2)(y_1, y_2) \in E_2} rmax(\tilde{T}_{C_1} \times \tilde{T}_{C_2})((x_1, x_2)(y_1, y_2)) \\ &= \sum_{x_1=y_1=x, x_2 y_2 \in E_2} rmax(\tilde{T}_{A_1}(x), \tilde{T}_{C_2}(x_2 y_2)) \\ &\quad + \sum_{x_2=y_2=z, x_1 y_1 \in E_1} rmax(\tilde{T}_{A_2}(z), \tilde{T}_{C_1}(x_1 y_1)) \\ &\quad + \sum_{x_1 y_1 \in E_1, x_2 y_2 \in E_2} rmax(\tilde{T}_{C_1}(x_1 y_1), \tilde{T}_{C_2}(x_2 y_2)) \end{aligned}$$

$$\begin{aligned}
 \deg(T_{B_1} \times T_{B_2})(x_1, x_2) &= \sum_{(x_1, x_2)(y_1, y_2) \in E_2} \min(T_{D_1} \times T_{D_2})((x_1, x_2)(y_1, y_2)) \\
 &= \sum_{x_1=y_1=x, x_2y_2 \in E_2} \min(T_{B_1}(x), T_{D_2}(x_2y_2)) \\
 &\quad + \sum_{x_2=y_2=z, x_1y_1 \in E} \min(T_{B_2}(z), T_{D_1}(x_1y_1)) \\
 &\quad + \sum_{x_1y_1 \in E_1, x_2y_2 \in E_2} \min(T_{D_1}(x_1y_1), T_{D_2}(x_2y_2)) \\
 \\
 \deg(\tilde{I}_{A_1} \times \tilde{I}_{A_2})(x_1, x_2) &= \sum_{(x_1, x_2)(y_1, y_2) \in E_2} rmax(\tilde{I}_{C_1} \times \tilde{I}_{C_2})((x_1, x_2)(y_1, y_2)) \\
 &= \sum_{x_1=y_1=x, x_2y_2 \in E_2} rmax(\tilde{I}_{A_1}(x), \tilde{I}_{C_2}(x_2y_2)) \\
 &\quad + \sum_{x_2=y_2=z, x_1y_1 \in E} rmax(\tilde{I}_{A_2}(z), \tilde{I}_{C_1}(x_1y_1)) \\
 &\quad + \sum_{x_1y_1 \in E_1, x_2y_2 \in E_2} rmax(\tilde{I}_{C_1}(x_1y_1), \tilde{I}_{C_2}(x_2y_2)) \\
 \\
 \deg(I_{B_1} \times I_{B_2})(x_1, x_2) &= \sum_{(x_1, x_2)(y_1, y_2) \in E_2} \min(I_{D_1} \times I_{D_2})((x_1, x_2)(y_1, y_2)) \\
 &= \sum_{x_1=y_1=x, x_2y_2 \in E_2} \min(I_{B_1}(x), I_{D_2}(x_2y_2)) \\
 &\quad + \sum_{x_2=y_2=z, x_1y_1 \in E} \min(I_{B_2}(z), I_{D_1}(x_1y_1)) \\
 &\quad + \sum_{x_1y_1 \in E_1, x_2y_2 \in E_2} \min(I_{D_1}(x_1y_1), I_{D_2}(x_2y_2)) \\
 \\
 \deg(\tilde{F}_{A_1} \times \tilde{F}_{A_2})(x_1, x_2) &= \sum_{(x_1, x_2)(y_1, y_2) \in E_2} rmin(\tilde{F}_{C_1} \times \tilde{F}_{C_2})((x_1, x_2)(y_1, y_2)) \\
 &= \sum_{x_1=y_1=x, x_2y_2 \in E_2} rmin(F_{B_1}(x), F_{D_2}(x_2y_2)) \\
 &\quad + \sum_{x_2=y_2=z, x_1y_1 \in E} rmin(F_{B_2}(z), F_{D_1}(x_1y_1)) \\
 &\quad + \sum_{x_1y_1 \in E_1, x_2y_2 \in E_2} rmin(F_{D_1}(x_1y_1), F_{D_2}(x_2y_2)) \\
 \\
 \deg(F_{B_1} \times F_{B_2})(x_1, x_2) &= \sum_{(x_1, x_2)(y_1, y_2) \in E_2} \max(F_{D_1} \times F_{D_2})((x_1, x_2)(y_1, y_2)) \\
 &= \sum_{x_1=y_1=x, x_2y_2 \in E_2} \max(F_{B_1}(x), F_{D_2}(x_2y_2)) \\
 &\quad + \sum_{x_2=y_2=z, x_1y_1 \in E} \max(F_{B_2}(z), F_{D_1}(x_1y_1)) \\
 &\quad + \sum_{x_1y_1 \in E_1, x_2y_2 \in E_2} \max(F_{D_1}(x_1y_1), F_{D_2}(x_2y_2))
 \end{aligned}$$

Example 4. In Example 3

$$\begin{aligned}
 d_{G_1 \times G_2}(a, x) &= \{([0.9, 1.1], 1.0), ([0.6, 0.9], 0.8), ([0.9, 1.1], 1.2)\} \\
 d_{G_1 \times G_2}(a, y) &= \{([0.4, 0.6], 0.9), ([0.8, 1.0], 0.6), ([1.2, 1.4], 0.9)\} \\
 d_{G_1 \times G_2}(a, z) &= \{([0.6, 0.8], 0.6), ([0.8, 1.0], 0.4), ([1.2, 1.4], 0.8)\} \\
 d_{G_1 \times G_2}(b, z) &= \{([0.8, 1.0], 0.3), ([0.9, 1.1], 0.5), ([0.7, 0.9], 1.1)\} \\
 d_{G_1 \times G_2}(b, x) &= \{([0.6, 0.9], 0.6), ([1.0, 1.2], 0.7), ([0.2, 0.4], 1.2)\} \\
 d_{G_1 \times G_2}(b, y) &= \{([0.4, 0.8], 0.7), ([1.1, 1.3], 0.6), ([0.5, 0.8], 1.0)\} \\
 d_{G_1 \times G_2}(c, y) &= \{([0.5, 0.8], 0.4), ([0.9, 1.1], 0.6), ([0.8, 1.2], 0.9)\} \\
 d_{G_1 \times G_2}(c, z) &= \{([0.7, 0.9], 0.4), ([0.5, 0.8], 0.8), ([0.8, 1.2], 1.1)\} \\
 d_{G_1 \times G_2}(c, x) &= \{([1.1, 1.3], 0.7), ([0.4, 0.8], 1.0), ([0.7, 1.0], 1.4)\}
 \end{aligned}$$

Definition 13. Let $G_1 = (M_1, N_1)$ be a neutrosophic cubic graph of $G_1^* = (V_1, E_1)$ and $G_2 = (M_2, N_2)$ be a neutrosophic cubic graph of $G_2^* = (V_2, E_2)$. Then composition of G_1 and G_2 is denoted by $G_1[G_2]$ and defined as follow

$$\begin{aligned}
 G_1[G_2] &= (M_1, N_1)[(M_2, N_2)] = \{M_1[M_2], N_1[N_2]\} = \{(A_1, B_1)[(A_2, B_2)], (C_1, D_1)[(C_2, D_2)]\} \\
 &= \{(A_1[A_2], B_1[B_2]), (C_1[C_2], D_1[D_2])\} \\
 &= \left\{ \langle ((\tilde{T}_{A_1} \circ \tilde{T}_{A_2}), (T_{B_1} \circ T_{B_2})), ((\tilde{I}_{A_1} \circ \tilde{I}_{A_2}), (I_{B_1} \circ I_{B_2})), ((\tilde{F}_{A_1} \circ \tilde{F}_{A_2}), (F_{B_1} \circ F_{B_2})) \rangle, \right. \\
 &\quad \left. \langle ((\tilde{T}_{C_1} \circ \tilde{T}_{C_2}), (T_{D_1} \circ T_{D_2})), ((\tilde{I}_{C_1} \circ \tilde{I}_{C_2}), (I_{D_1} \circ I_{D_2})), ((\tilde{F}_{C_1} \circ \tilde{F}_{C_2}), (F_{D_1} \circ F_{D_2})) \rangle \right\}
 \end{aligned}$$

where

(i) $\forall (x, y) \in (V_1, V_2) = V,$

$$(\tilde{T}_{A_1} \circ \tilde{T}_{A_2})(x, y) = rmin(\tilde{T}_{A_1}(x), \tilde{T}_{A_2}(y)), (T_{B_1} \circ T_{B_2})(x, y) = \max(T_{B_1}(x), T_{B_2}(y))$$

$$(\tilde{I}_{A_1} \circ \tilde{I}_{A_2})(x, y) = rmin(\tilde{I}_{A_1}(x), \tilde{I}_{A_2}(y)), (I_{B_1} \circ I_{B_2})(x, y) = \max(I_{B_1}(x), I_{B_2}(y))$$

$$(\tilde{F}_{A_1} \circ \tilde{F}_{A_2})(x, y) = rmax(\tilde{F}_{A_1}(x), \tilde{F}_{A_2}(y)), (F_{B_1} \circ F_{B_2})(x, y) = \min(F_{B_1}(x), F_{B_2}(y))$$

(ii) $\forall x \in V_1$ and $y_1 y_2 \in E$

$$(\tilde{T}_{C_1} \circ \tilde{T}_{C_2})((x, y_1)(x, y_2)) = rmin(\tilde{T}_{C_1}(x), \tilde{T}_{C_2}(y_1 y_2)), (T_{D_1} \circ T_{D_2})((x, y_1)(x, y_2)) = \max(T_{D_1}(x), T_{D_2}(y_1 y_2))$$

$$(\tilde{I}_{C_1} \circ \tilde{I}_{C_2})((x, y_1)(x, y_2)) = rmin(\tilde{I}_{C_1}(x), \tilde{I}_{C_2}(y_1 y_2)), (I_{D_1} \circ I_{D_2})((x, y_1)(x, y_2)) = \max(I_{D_1}(x), I_{D_2}(y_1 y_2))$$

$$(\tilde{F}_{C_1} \circ \tilde{F}_{C_2})((x, y_1)(x, y_2)) = rmax(\tilde{F}_{C_1}(x), \tilde{F}_{C_2}(y_1 y_2)), (F_{D_1} \circ F_{D_2})((x, y_1)(x, y_2)) = \min(F_{D_1}(x), F_{D_2}(y_1 y_2))$$

(iii) $\forall y \in V_2$ and $x_1 x_2 \in E_1$

$$(\tilde{T}_{C_1} \circ \tilde{T}_{C_2})((x_1, y)(x_2, y)) = rmin(\tilde{T}_{C_1}(x_1 x_2), \tilde{T}_{C_2}(y)), (T_{D_1} \circ T_{D_2})((x_1, y)(x_2, y)) = \max(T_{D_1}(x_1 x_2), T_{D_2}(y))$$

$$(\tilde{I}_{C_1} \circ \tilde{I}_{C_2})((x_1, y)(x_2, y)) = rmin(\tilde{I}_{C_1}(x_1 x_2), \tilde{I}_{C_2}(y)), (I_{D_1} \circ I_{D_2})((x_1, y)(x_2, y)) = \max(I_{D_1}(x_1 x_2), I_{D_2}(y))$$

$$(\tilde{F}_{C_1} \circ \tilde{F}_{C_2})((x_1, y)(x_2, y)) = rmax(\tilde{F}_{C_1}(x_1 x_2), \tilde{F}_{C_2}(y)), (F_{D_1} \circ F_{D_2})((x_1, y)(x_2, y)) = \min(F_{D_1}(x_1 x_2), F_{D_2}(y))$$

(iv) $\forall (x_1, y_1)(x_2, y_2) \in E^0 - E$

$$\begin{aligned} (\tilde{T}_{C_1} \circ \tilde{T}_{C_2})((x_1, y_1)(x_2, y_2)) &= rmin(\tilde{T}_{A_2}(y_1), \tilde{T}_{A_2}(y_2), \tilde{T}_{C_1}(x_1 x_2)), (T_{D_1} \circ T_{D_2})((x_1, y_1)(x_2, y_2)) \\ &= \max(T_{B_2}(y_1), T_{B_2}(y_2), T_{D_1}(x_1 x_2)) \end{aligned}$$

$$\begin{aligned} (\tilde{I}_{C_1} \circ \tilde{I}_{C_2})((x_1, y_1)(x_2, y_2)) &= rmin(\tilde{I}_{A_2}(y_1), \tilde{I}_{A_2}(y_2), \tilde{I}_{C_1}(x_1 x_2)), (I_{D_1} \circ I_{D_2})((x_1, y_1)(x_2, y_2)) \\ &= \max(I_{B_2}(y_1), I_{B_2}(y_2), I_{D_1}(x_1 x_2)) \end{aligned}$$

$$\begin{aligned} (\tilde{F}_{C_1} \circ \tilde{F}_{C_2})((x_1, y_1)(x_2, y_2)) &= rmax(\tilde{F}_{A_2}(y_1), \tilde{F}_{A_2}(y_2), \tilde{F}_{C_1}(x_1 x_2)), (F_{D_1} \circ F_{D_2})((x_1, y_1)(x_2, y_2)) \\ &= \min(F_{B_2}(y_1), F_{B_2}(y_2), F_{D_1}(x_1 x_2)) \end{aligned}$$

Example 5. Let $G_1^* = (V_1, E_1)$ and $G_1^* = (V_2, E_2)$ be two graphs as shown in Figure 5, where $V_1 = (a, b)$ and $V_2 = (c, d)$. Suppose M_1 and M_2 be the neutrosophic cubic set representations of V_1 and V_2 . Also N_1 and N_2 be the neutrosophic cubic set representations of E_1 and E_2 defined as

$$\begin{aligned} M_1 &= \langle \{a, ([0.5, 0.6], 0.1), ([0.1, 0.2], 0.5), ([0.8, 0.9], 0.3)\}, \rangle \\ &\quad \langle \{b, ([0.4, 0.5], 0.3), ([0.2, 0.3], 0.2), ([0.5, 0.6], 0.6)\} \rangle \\ N_1 &= \langle \{ab, ([0.4, 0.5], 0.3), ([0.1, 0.2], 0.5), ([0.8, 0.9], 0.3)\} \rangle \end{aligned}$$

and

$$\begin{aligned} M_2 &= \langle \{c, ([0.6, 0.7], 0.4), ([0.8, 0.9], 0.8), ([0.1, 0.2], 0.6)\}, \rangle \\ &\quad \langle \{d, ([0.3, 0.4], 0.7), ([0.6, 0.7], 0.5), ([0.9, 1.0], 0.9)\} \rangle \\ N_2 &= \langle \{cd, ([0.3, 0.4], 0.7), ([0.6, 0.7], 0.8), ([0.9, 1.0], 0.6)\} \rangle \end{aligned}$$

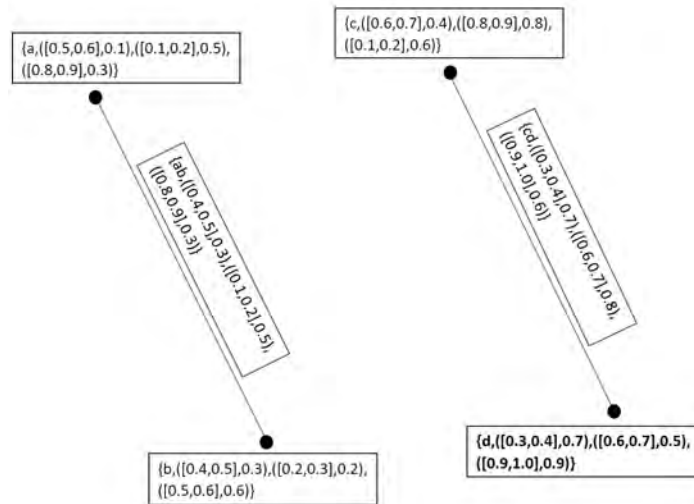

Figure 5. Neutrosophic Cubic Graph G_1 and G_2 .

Figure: 5 Neutrosophic cubic graphs G_1 and G_2

Clearly $G_1 = (M_1, N_1)$ and $G_2 = (M_2, N_2)$ are neutrosophic cubic graphs. So, the composition of two neutrosophic cubic graphs $G - 1$ and $G - 2$ is again a neutrosophic cubic graph as shown in Figure 6, where

$$M_1 [M_2] = \left\langle \begin{aligned} &\{(a, c), ([0.5, 0.6], 0.4), ([0.1, 0.2], 0.8), ([0.8, 0.9], 0.3)\}, \\ &\{(a, d), ([0.3, 0.4], 0.7), ([0.1, 0.2], 0.5), ([0.9, 1.0], 0.3)\}, \\ &\{(b, c), ([0.4, 0.5], 0.4), ([0.2, 0.3], 0.8), ([0.5, 0.6], 0.6)\}, \\ &\{(b, d), ([0.3, 0.4], 0.7), ([0.2, 0.3], 0.5), ([0.9, 1.0], 0.6)\} \end{aligned} \right\rangle$$

Clearly $G_1 = (M_1, N_1)$ and $G_2 = (M_2, N_2)$ are neutrosophic cubic graphs. So

$$N_1 [N_2] = \left\langle \begin{aligned} &\{(a, c)(a, d), ([0.3, 0.4], 0.7), ([0.1, 0.2], 0.8), ([0.9, 1.0], 0.3)\}, \\ &\{(a, d)(b, d), ([0.3, 0.4], 0.7), ([0.1, 0.2], 0.5), ([0.9, 1.0], 0.3)\}, \\ &\{(b, d)(b, c), ([0.3, 0.4], 0.7), ([0.2, 0.3], 0.8), ([0.9, 1.0], 0.6)\}, \\ &\{(b, c)(a, c), ([0.4, 0.5], 0.4), ([0.1, 0.2], 0.8), ([0.8, 0.9], 0.3)\}, \\ &\{(a, c)(b, d), ([0.3, 0.4], 0.7), ([0.1, 0.2], 0.5), ([0.9, 1.0], 0.3)\}, \\ &\{(a, d)(b, c), ([0.3, 0.4], 0.7), ([0.2, 0.3], 0.8), ([0.9, 1.0], 0.6)\}, \\ &\{(a, c)(b, d), ([0.3, 0.4], 0.7), ([0.1, 0.2], 0.8), ([0.9, 1.0], 0.3)\} \end{aligned} \right\rangle$$

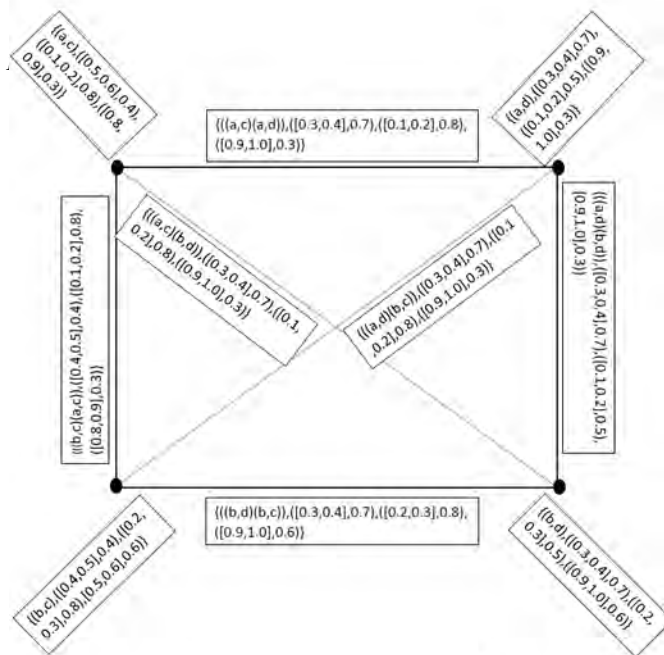

Figure 6. Composition of G_1 and G_2 .

Proposition 3.7 The composition of two neutrosophic cubic graphs is again a neutrosophic cubic graph.

Proposition 2. *The composition of two neutrosophic cubic graphs is again a neutrosophic cubic graph.*

Definition 14. *Let $G_1 = (M_1, N_1)$ and $G_2 = (M_2, N_2)$ be two neutrosophic cubic graphs of the graphs G_1^* and G_2^* respectively. Then P-union is denoted by $G_1 \cup_p G_2$ and is defined as*

$$\begin{aligned} G_1 \cup_p G_2 &= \{(M_1, N_1) \cup_p (M_2, N_2)\} = \{M_1 \cup_p M_2, N_1 \cup_p N_2\} \\ &= \{ \langle \langle (\tilde{T}_{A_1} \cup_p \tilde{T}_{A_2}), (T_{B_1} \cup_p T_{B_2}), ((\tilde{I}_{A_1} \cup_p \tilde{I}_{A_2}), (I_{B_1} \cup_p I_{B_2})), ((\tilde{F}_{A_1} \cup_p \tilde{F}_{A_2}), (F_{B_1} \cup_p F_{B_2})) \rangle \rangle, \\ &\quad \langle \langle (\tilde{T}_{C_1} \cup_p \tilde{T}_{C_2}), (T_{D_1} \cup_p T_{D_2}), ((\tilde{I}_{C_1} \cup_p \tilde{I}_{C_2}), (I_{D_1} \cup_p I_{D_2})), ((\tilde{F}_{C_1} \cup_p \tilde{F}_{C_2}), (F_{D_1} \cup_p F_{D_2})) \rangle \rangle \} \end{aligned}$$

where

$$\begin{aligned} (\tilde{T}_{A_1} \cup_p \tilde{T}_{A_2})(x) &= \begin{cases} \tilde{T}_{A_1}(x) & \text{if } x \in V_1 - V_2 \\ \tilde{T}_{A_2}(x) & \text{if } x \in V_2 - V_1 \\ rmax\{\tilde{T}_{A_1}(x), \tilde{T}_{A_2}(x)\} & \text{if } x \in V_1 \cap V_2 \end{cases} \\ (T_{B_1} \cup_p T_{B_2})(x) &= \begin{cases} T_{B_1}(x) & \text{if } x \in V_1 - V_2 \\ T_{B_2}(x) & \text{if } x \in V_2 - V_1 \\ \max\{T_{B_1}(x), T_{B_2}(x)\} & \text{if } x \in V_1 \cap V_2 \end{cases} \end{aligned}$$

$$(\tilde{I}_{A_1} \cup_p \tilde{I}_{A_2})(x) = \begin{cases} \tilde{I}_{A_1}(x) & \text{if } x \in V_1 - V_2 \\ \tilde{I}_{A_2}(x) & \text{if } x \in V_2 - V_1 \\ rmax\{\tilde{I}_{A_1}(x), \tilde{I}_{A_2}(x)\} & \text{if } x \in V_1 \cap V_2 \end{cases}$$

$$(I_{B_1} \cup_p I_{B_2})(x) = \begin{cases} I_{B_1}(x) & \text{if } x \in V_1 - V_2 \\ I_{B_2}(x) & \text{if } x \in V_2 - V_1 \\ \max\{I_{B_1}(x), I_{B_2}(x)\} & \text{if } x \in V_1 \cap V_2 \end{cases}$$

$$(\tilde{F}_{A_1} \cup_p \tilde{F}_{A_2})(x) = \begin{cases} \tilde{F}_{A_1}(x) & \text{if } x \in V_1 - V_2 \\ \tilde{F}_{A_2}(x) & \text{if } x \in V_2 - V_1 \\ rmax\{\tilde{F}_{A_1}(x), \tilde{F}_{A_2}(x)\} & \text{if } x \in V_1 \cap V_2 \end{cases}$$

$$(F_{B_1} \cup_p F_{B_2})(x) = \begin{cases} F_{B_1}(x) & \text{if } x \in V_1 - V_2 \\ F_{B_2}(x) & \text{if } x \in V_2 - V_1 \\ \max\{F_{B_1}(x), F_{B_2}(x)\} & \text{if } x \in V_1 \cap V_2 \end{cases}$$

$$\begin{aligned} (\tilde{T}_{C_1} \cup_p \tilde{T}_{C_2})(x_2y_2) &= \begin{cases} \tilde{T}_{C_1}(x_2y_2) & \text{if } x_2y_2 \in V_1 - V_2 \\ \tilde{T}_{C_2}(x_2y_2) & \text{if } x_2y_2 \in V_2 - V_1 \\ rmax\{\tilde{T}_{C_1}(x_2y_2), \tilde{T}_{C_2}(x_2y_2)\} & \text{if } x_2y_2 \in E_1 \cap E_2 \end{cases} \\ (T_{D_1} \cup_p T_{D_2})(x_2y_2) &= \begin{cases} T_{D_1}(x_2y_2) & \text{if } x_2y_2 \in V_1 - V_2 \\ T_{D_2}(x_2y_2) & \text{if } x_2y_2 \in V_2 - V_1 \\ \max\{T_{D_1}(x_2y_2), T_{D_2}(x_2y_2)\} & \text{if } x_2y_2 \in E_1 \cap E_2 \end{cases} \end{aligned}$$

$$(\tilde{I}_{C_1} \cup_p \tilde{I}_{C_2})(x_2y_2) = \begin{cases} \tilde{I}_{C_1}(x_2y_2) & \text{if } x_2y_2 \in V_1 - V_2 \\ \tilde{I}_{C_2}(x_2y_2) & \text{if } x_2y_2 \in V_2 - V_1 \\ rmax\{\tilde{I}_{C_1}(x_2y_2), \tilde{I}_{C_2}(x_2y_2)\} & \text{if } x_2y_2 \in E_1 \cap E_2 \end{cases}$$

$$(I_{D_1} \cup_p I_{D_2})(x_2y_2) = \begin{cases} I_{D_1}(x_2y_2) & \text{if } x_2y_2 \in V_1 - V_2 \\ I_{D_2}(x_2y_2) & \text{if } x_2y_2 \in V_2 - V_1 \\ \max\{I_{D_1}(x_2y_2), I_{D_2}(x_2y_2)\} & \text{if } x_2y_2 \in E_1 \cap E_2 \end{cases}$$

$$\begin{aligned}
 (\tilde{F}_{C_1} \cup_p \tilde{F}_{C_2})(x_2y_2) &= \begin{cases} \tilde{F}_{C_1}(x_2y_2) & \text{if } x_2y_2 \in V_1 - V_2 \\ \tilde{F}_{C_2}(x_2y_2) & \text{if } x_2y_2 \in V_2 - V_1 \\ rmax\{\tilde{F}_{C_1}(x_2y_2), \tilde{F}_{C_2}(x_2y_2)\} & \text{if } x_2y_2 \in E_1 \cap E_2 \end{cases} \\
 (F_{D_1} \cup_p F_{D_2})(x_2y_2) &= \begin{cases} F_{D_1}(x_2y_2) & \text{if } x_2y_2 \in V_1 - V_2 \\ F_{D_2}(x_2y_2) & \text{if } x_2y_2 \in V_2 - V_1 \\ \max\{F_{D_1}(x_2y_2), F_{D_2}(x_2y_2)\} & \text{if } x_2y_2 \in E_1 \cap E_2 \end{cases}
 \end{aligned}$$

and R-union is denoted by $G_1 \cup_R G_2$ and is defined by

$$\begin{aligned}
 G_1 \cup_R G_2 &= \{(M_1, N_1) \cup_R (M_2, N_2)\} = \{M_1 \cup_R M_2, N_1 \cup_R N_2\} \\
 &= \{((\tilde{T}_{A_1} \cup_R \tilde{T}_{A_2}), (T_{B_1} \cup_R T_{B_2})), ((\tilde{I}_{A_1} \cup_R \tilde{I}_{A_2}), (I_{B_1} \cup_R I_{B_2})), ((\tilde{F}_{A_1} \cup_R \tilde{F}_{A_2}), (F_{B_1} \cup_R F_{B_2})), \\
 &\quad \langle (\tilde{T}_{C_1} \cup_R \tilde{T}_{C_2}), (T_{D_1} \cup_R T_{D_2}), (\tilde{I}_{C_1} \cup_R \tilde{I}_{C_2}), (I_{D_1} \cup_R I_{D_2}), (\tilde{F}_{C_1} \cup_R \tilde{F}_{C_2}), (F_{D_1} \cup_R F_{D_2}) \rangle\}
 \end{aligned}$$

where

$$\begin{aligned}
 (\tilde{T}_{A_1} \cup_R \tilde{T}_{A_2})(x) &= \begin{cases} \tilde{T}_{A_1}(x) & \text{if } x \in V_1 - V_2 \\ \tilde{T}_{A_2}(x) & \text{if } x \in V_2 - V_1 \\ rmax\{\tilde{T}_{A_1}(x), \tilde{T}_{A_2}(x)\} & \text{if } x \in V_1 \cap V_2 \end{cases} \\
 (T_{B_1} \cup_R T_{B_2})(x) &= \begin{cases} T_{B_1}(x) & \text{if } x \in V_1 - V_2 \\ T_{B_2}(x) & \text{if } x \in V_2 - V_1 \\ \min\{T_{B_1}(x), T_{B_2}(x)\} & \text{if } x \in V_1 \cap V_2 \end{cases}
 \end{aligned}$$

$$\begin{aligned}
 (\tilde{I}_{A_1} \cup_R \tilde{I}_{A_2})(x) &= \begin{cases} \tilde{I}_{A_1}(x) & \text{if } x \in V_1 - V_2 \\ \tilde{I}_{A_2}(x) & \text{if } x \in V_2 - V_1 \\ rmax\{\tilde{I}_{A_1}(x), \tilde{I}_{A_2}(x)\} & \text{if } x \in V_1 \cap V_2 \end{cases} \\
 (I_{B_1} \cup_R I_{B_2})(x) &= \begin{cases} I_{B_1}(x) & \text{if } x \in V_1 - V_2 \\ I_{B_2}(x) & \text{if } x \in V_2 - V_1 \\ \min\{I_{B_1}(x), I_{B_2}(x)\} & \text{if } x \in V_1 \cap V_2 \end{cases}
 \end{aligned}$$

$$\begin{aligned}
 (\tilde{F}_{A_1} \cup_R M_{T_{F_2}})(x) &= \begin{cases} \tilde{F}_{A_1}(x) & \text{if } x \in V_1 - V_2 \\ \tilde{F}_{A_2}(x) & \text{if } x \in V_2 - V_1 \\ rmax\{\tilde{F}_{A_1}(x), \tilde{F}_{A_2}(x)\} & \text{if } x \in V_1 \cap V_2 \end{cases} \\
 (F_{B_1} \cup_R F_{B_2})(x) &= \begin{cases} F_{B_1}(x) & \text{if } x \in V_1 - V_2 \\ F_{B_2}(x) & \text{if } x \in V_2 - V_1 \\ \min\{F_{B_1}(x), F_{B_2}(x)\} & \text{if } x \in V_1 \cap V_2 \end{cases}
 \end{aligned}$$

$$\begin{aligned}
 (\tilde{T}_{C_1} \cup_R \tilde{T}_{C_2})(x_2y_2) &= \begin{cases} \tilde{T}_{C_1}(x_2y_2) & \text{if } x_2y_2 \in V_1 - V_2 \\ \tilde{T}_{C_2}(x_2y_2) & \text{if } x_2y_2 \in V_2 - V_1 \\ rmax\{\tilde{T}_{C_1}(x_2y_2), \tilde{T}_{C_2}(x_2y_2)\} & \text{if } x_2y_2 \in E_1 \cap E_2 \end{cases} \\
 (T_{D_1} \cup_R N_{D_2})(x_2y_2) &= \begin{cases} T_{D_1}(x_2y_2) & \text{if } x_2y_2 \in V_1 - V_2 \\ T_{D_2}(x_2y_2) & \text{if } x_2y_2 \in V_2 - V_1 \\ \min\{T_{D_1}(x_2y_2), T_{D_2}(x_2y_2)\} & \text{if } x_2y_2 \in E_1 \cap E_2 \end{cases}
 \end{aligned}$$

$$\begin{aligned}
 (\tilde{F}_{C_1} \cup_R \tilde{F}_{C_2})(x_2y_2) &= \begin{cases} \tilde{F}_{C_1}(x_2y_2) & \text{if } x_2y_2 \in V_1 - V_2 \\ \tilde{F}_{C_2}(x_2y_2) & \text{if } x_2y_2 \in V_2 - V_1 \\ r\max\{\tilde{F}_{C_1}(x_2y_2), \tilde{F}_{C_2}(x_2y_2)\} & \text{if } x_2y_2 \in E_1 \cap E_2 \end{cases} \\
 (F_{D_1} \cup_R F_{D_2})(x_2y_2) &= \begin{cases} F_{D_1}(x_2y_2) & \text{if } x_2y_2 \in V_1 - V_2 \\ F_{D_2}(x_2y_2) & \text{if } x_2y_2 \in V_2 - V_1 \\ \min\{F_{D_1}(x_2y_2), F_{D_2}(x_2y_2)\} & \text{if } x_2y_2 \in E_1 \cap E_2 \end{cases}
 \end{aligned}$$

Example 6. Let G_1 and G_2 be two neutrosophic cubic graphs as represented by Figures 7 and 8, where

$$\begin{aligned}
 M_1 &= \left\langle \begin{aligned} &\{a, ([0.2, 0.3], 0.5), ([0.4, 0.5], 0.9), ([0.1, 0.3], 0.2)\}, \\ &\{b, ([0.3, 0.4], 0.2), ([0.1, 0.2], 0.1), [0.4, 0.6], 0.5\}, \\ &\{c, ([0.2, 0.4], 0.6), ([0.7, 0.8], 0.8), ([0.3, 0.5], 0.7)\} \end{aligned} \right\rangle \\
 N_1 &= \left\langle \begin{aligned} &\{ab, ([0.2, 0.3], 0.5), ([0.1, 0.2], 0.9), ([0.4, 0.6], 0.2)\}, \\ &\{bc, ([0.2, 0.4], 0.6), ([0.1, 0.2], 0.8), ([0.4, 0.6], 0.5)\}, \\ &\{ac, ([0.2, 0.3], 0.6), ([0.4, 0.5], 0.9), ([0.3, 0.5], 0.2)\} \end{aligned} \right\rangle
 \end{aligned}$$

and

$$\begin{aligned}
 M_2 &= \left\langle \begin{aligned} &\{a, ([0.5, 0.6], 0.3), ([0.1, 0.2], 0.6), ([0.3, 0.4], 0.5)\}, \\ &\{b, ([0.6, 0.7], 0.6), ([0.7, 0.8], 0.4), ([0.1, 0.2], 0.5)\}, \\ &\{c, ([0.4, 0.5], 0.1), ([0.2, 0.5], 0.5), ([0.5, 0.6], 0.3)\} \end{aligned} \right\rangle \\
 N_2 &= \left\langle \begin{aligned} &\{ab, ([0.5, 0.6], 0.6), ([0.1, 0.2], 0.6), ([0.3, 0.4], 0.5)\}, \\ &\{bc, ([0.4, 0.5], 0.6), ([0.2, 0.5], 0.5), ([0.5, 0.6], 0.3)\}, \\ &\{ac, ([0.4, 0.5], 0.3), ([0.1, 0.2], 0.6), ([0.5, 0.6], 0.3)\} \end{aligned} \right\rangle
 \end{aligned}$$

then $G_1 \cup_p G_2$ will be a neutrosophic cubic graph as shown in Figure 9, where

$$\begin{aligned}
 M_1 \cup_p M_2 &= \left\langle \begin{aligned} &\{a, ([0.5, 0.6], 0.5), ([0.4, 0.5], 0.9), ([0.3, 0.4], 0.5)\}, \\ &\{b, ([0.6, 0.7], 0.6), ([0.7, 0.8], 0.4), ([0.4, 0.6], 0.5)\}, \\ &\{c, ([0.4, 0.5], 0.6), ([0.7, 0.8], 0.8), ([0.5, 0.6], 0.7)\} \end{aligned} \right\rangle \\
 N_1 \cup_p N_2 &= \left\langle \begin{aligned} &\{ab, ([0.5, 0.6], 0.6), ([0.1, 0.2], 0.9), ([0.4, 0.6], 0.5)\}, \\ &\{bc, ([0.4, 0.5], 0.6), ([0.2, 0.5], 0.8), [0.5, 0.6], 0.5\}, \\ &\{ac, ([0.4, 0.5], 0.6), ([0.4, 0.5], 0.9), ([0.5, 0.6], 0.3)\} \end{aligned} \right\rangle
 \end{aligned}$$

and $G_1 \cup_R G_2$ will be a neutrosophic cubic graph as shown in Figure 10, where

$$\begin{aligned}
 M_1 \cup_R M_2 &= \begin{aligned} &\{a, ([0.5, 0.6], 0.3), ([0.4, 0.5], 0.6), ([0.3, 0.4], 0.2)\}, \\ &\{b, ([0.6, 0.7], 0.2), ([0.7, 0.8], 0.1), [0.4, 0.6], 0.5\}, \\ &\{c, ([0.4, 0.5], 0.1), ([0.7, 0.8], 0.5), ([0.5, 0.6], 0.3)\} \end{aligned} \\
 N_1 \cup_R N_2 &= \begin{aligned} &\{ab, ([0.5, 0.6], 0.5), ([0.1, 0.2], 0.6), ([0.4, 0.6], 0.2)\}, \\ &\{bc, ([0.4, 0.5], 0.6), ([0.2, 0.5], 0.5), ([0.5, 0.6], 0.3)\}, \\ &\{ac, ([0.4, 0.5], 0.3), ([0.4, 0.5], 0.6), ([0.5, 0.6], 0.2)\} \end{aligned}
 \end{aligned}$$

Proposition 3. The P-union of two neutrosophic cubic graphs is again a neutrosophic cubic graph.

Remark 2. The R-union of two neutrosophic cubic graphs may or may not be a neutrosophic cubic graph as in the Example 6 we see that

$$T_{D_1 \cup_R D_2}(ab) = 0.5 \not\leq \max\{0.3, 0.2\} = 0.3 = \max\{T_{D_1 \cup_R D_2}(a), T_{D_1 \cup_R D_2}(b)\}$$

and

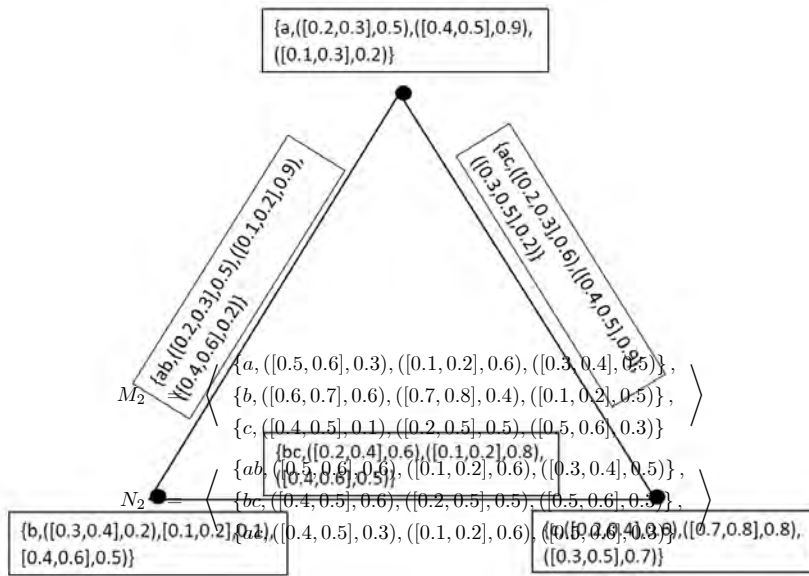

Figure 7. Neutrosophic Cubic Graph G_1 .

Figure: 7 Neutrosophic cubic

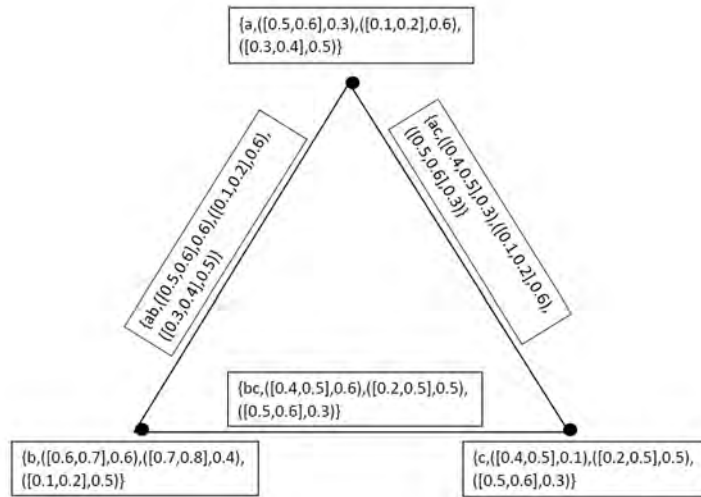

Figure 8. Neutrosophic Cubic Graph G_2 .

Figure: 8 Neutrosophic cubic graph G_2

then $G_1 \cup_p G_2$

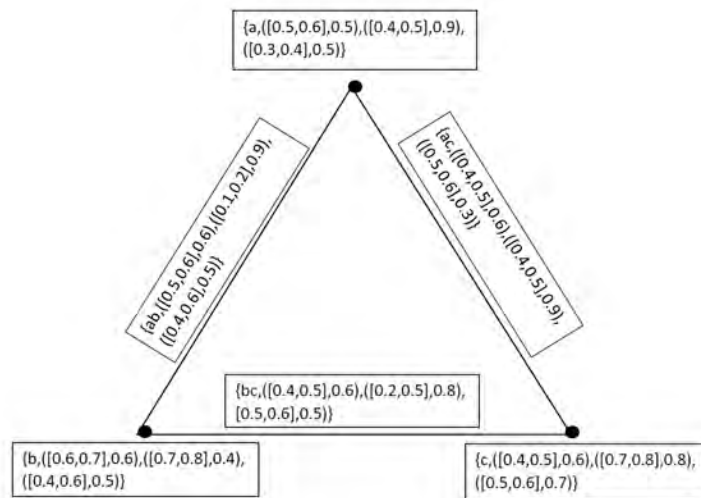

Figure 9. P-Union of G_1 and G_2 .

Figure: 9 P-union of G_1 and G_2

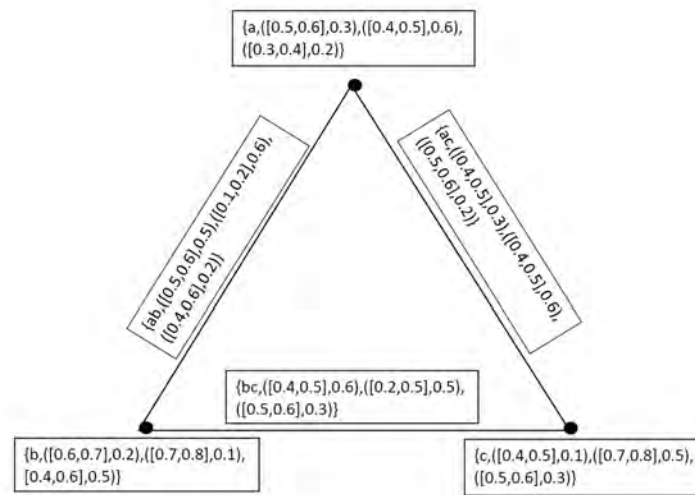

Figure 10. R-Union of G_1 and G_2 .

Figure: 10 R-union of G_1 and G_2

Definition 15. Let $G_1 = (M_1, N_1)$ and $G_2 = (M_2, N_2)$ be two neutrosophic cubic graphs of the graphs G_1^* and G_2^* respectively then P-join is denoted by $G_1 +_P G_2$ and is defined by

Proposition 3.9 The P-union of two neutrosophic cubic graphs is again a neutrosophic cubic graph.

$$G_1 +_P G_2 = (M_1, N_1) +_P (M_2, N_2) = (M_1 +_P M_2, N_1 +_P N_2)$$

Remark 3.10 The R-union of two neutrosophic cubic graphs $G_1 = (M_1, N_1)$ and $G_2 = (M_2, N_2)$ is denoted by $G_1 +_R G_2$ and is defined by $\langle \langle ((\tilde{T}_{C_1} +_P \tilde{T}_{C_2}), (\tilde{T}_{D_1} +_P \tilde{T}_{D_2})), ((\tilde{I}_{C_1} +_P \tilde{I}_{C_2}), (\tilde{I}_{D_1} +_P \tilde{I}_{D_2})), ((\tilde{F}_{C_1} +_P \tilde{F}_{C_2}), (\tilde{F}_{D_1} +_P \tilde{F}_{D_2})) \rangle \rangle$, as in the **Example 3.7** we see that

$$T_{D_1 \cup_R D_2}(ab) = 0.5 \not\leq \max\{0.3, 0.2\} = 0.3 = \max\{T_{D_1 \cup_R D_2}(a), T_{D_1 \cup_R D_2}(b)\}$$

where

(i) if $x \in V_1 \cup V_2$ **Definition 3.11** Let $G_1 = (M_1, N_1)$ and $G_2 = (M_2, N_2)$ be two neutrosophic cubic graphs of the graphs G_1^* and G_2^* respectively then P-join is denoted by $G_1 +_P G_2$ and is defined by

$$\begin{aligned} (\tilde{T}_{A_1} +_P \tilde{T}_{A_2})(x) &= (\tilde{T}_{A_1} \cup_P \tilde{T}_{A_2})(x), (T_{B_1} +_P T_{B_2})(x) = (T_{B_1} \cup_P T_{B_2})(x) \\ G_1 +_P G_2 &= (M_1, N_1) +_P (M_2, N_2) = (M_1 +_P M_2, N_1 +_P N_2) \\ (\tilde{I}_{A_1} +_P \tilde{I}_{A_2})(x) &= (\tilde{I}_{A_1} \cup_P \tilde{I}_{A_2})(x), (\tilde{I}_{B_1} +_P \tilde{I}_{B_2})(x) = (\tilde{I}_{B_1} \cup_P \tilde{I}_{B_2})(x) \\ &= \langle \langle ((\tilde{T}_{A_1} +_P \tilde{T}_{A_2}), (\tilde{T}_{B_1} +_P \tilde{T}_{B_2})), ((\tilde{I}_{A_1} +_P \tilde{I}_{A_2}), (\tilde{I}_{B_1} +_P \tilde{I}_{B_2})), ((\tilde{F}_{A_1} +_P \tilde{F}_{A_2}), (\tilde{F}_{B_1} +_P \tilde{F}_{B_2})) \rangle \rangle, \\ (\tilde{F}_{A_1} +_P \tilde{F}_{A_2})(x) &= (\tilde{F}_{A_1} \cup_P \tilde{F}_{A_2})(x), (\tilde{F}_{B_1} +_P \tilde{F}_{B_2})(x) = (\tilde{F}_{B_1} \cup_P \tilde{F}_{B_2})(x) \\ &= \langle \langle ((\tilde{T}_{C_1} +_P \tilde{T}_{C_2}), (\tilde{T}_{D_1} +_P \tilde{T}_{D_2})), ((\tilde{I}_{C_1} +_P \tilde{I}_{C_2}), (\tilde{I}_{D_1} +_P \tilde{I}_{D_2})), ((\tilde{F}_{C_1} +_P \tilde{F}_{C_2}), (\tilde{F}_{D_1} +_P \tilde{F}_{D_2})) \rangle \rangle \end{aligned}$$

(ii) if $xy \in E_1 \cup E_2$ where $(x, y) \in V_1 \cup V_2$

$$\begin{aligned} (\tilde{T}_{C_1} +_P \tilde{T}_{C_2})(xy) &= (\tilde{T}_{C_1} \cup_P \tilde{T}_{C_2})(xy), (\tilde{T}_{D_1} +_P \tilde{T}_{D_2})(xy) = (\tilde{T}_{D_1} \cup_P \tilde{T}_{D_2})(xy) \\ (\tilde{I}_{C_1} +_P \tilde{I}_{C_2})(xy) &= (\tilde{I}_{C_1} \cup_P \tilde{I}_{C_2})(xy), (\tilde{I}_{D_1} +_P \tilde{I}_{D_2})(xy) = (\tilde{I}_{D_1} \cup_P \tilde{I}_{D_2})(xy) \\ (\tilde{F}_{C_1} +_P \tilde{F}_{C_2})(xy) &= (\tilde{F}_{C_1} \cup_P \tilde{F}_{C_2})(xy), (\tilde{F}_{D_1} +_P \tilde{F}_{D_2})(xy) = (\tilde{F}_{D_1} \cup_P \tilde{F}_{D_2})(xy) \end{aligned}$$

(iii) if $xy \in E^*$, where E^* is the set of all edges joining the vertices of V_1 and V_2

$$\begin{aligned} (\tilde{T}_{C_1} +_P \tilde{T}_{C_2})(xy) &= \text{rmin}\{\tilde{T}_{A_1}(x), \tilde{T}_{A_2}(y)\}, (T_{D_1} +_P T_{D_2})(xy) = \min\{T_{B_1}(x), T_{B_2}(y)\} \\ (\tilde{I}_{C_1} +_P \tilde{I}_{C_2})(xy) &= \text{rmin}\{\tilde{I}_{A_1}(x), \tilde{I}_{A_2}(y)\}, (I_{D_1} +_P I_{D_2})(xy) = \min\{I_{B_1}(x), I_{B_2}(y)\} \\ (\tilde{F}_{C_1} +_P \tilde{F}_{C_2})(xy) &= \text{rmin}\{\tilde{F}_{A_1}(x), \tilde{F}_{A_2}(y)\}, (F_{D_1} +_P F_{D_2})(xy) = \min\{F_{B_1}(x), F_{B_2}(y)\} \end{aligned}$$

Definition 16. Let $G_1 = (M_1, N_1)$ and $G_2 = (M_2, N_2)$ be two neutrosophic cubic graphs of the graphs G_1^* and G_2^* respectively then R-join is denoted by $G_1 +_R G_2$ and is defined by

$$\begin{aligned} G_1 +_R G_2 &= (M_1, N_1) +_R (M_2, N_2) = (M_1 +_R M_2, N_1 +_R N_2) \\ &= \langle \langle ((\tilde{T}_{A_1} +_R \tilde{T}_{A_2}), (T_{B_1} +_R T_{B_2})), ((\tilde{I}_{A_1} +_R \tilde{I}_{A_2}), (I_{B_1} +_R I_{B_2})), ((\tilde{F}_{A_1} +_R \tilde{F}_{A_2}), (F_{B_1} +_R F_{B_2})) \rangle \rangle, \\ &\langle \langle ((\tilde{T}_{C_1} +_R \tilde{T}_{C_2}), (T_{D_1} +_R T_{D_2})), ((\tilde{I}_{C_1} +_R \tilde{I}_{C_2}), (I_{D_1} +_R I_{D_2})), ((\tilde{F}_{C_1} +_R \tilde{F}_{C_2}), (F_{D_1} +_R F_{D_2})) \rangle \rangle \end{aligned}$$

where

(i) if $x \in V_1 \cup V_2$

$$\begin{aligned} (\tilde{T}_{A_1} +_R \tilde{T}_{A_2})(x) &= (\tilde{T}_{A_1} \cup_R \tilde{T}_{A_2})(x), (T_{B_1} +_R T_{B_2})(x) = (T_{B_1} \cup_R T_{B_2})(x) \\ (\tilde{I}_{A_1} +_R \tilde{I}_{A_2})(x) &= (\tilde{I}_{A_1} \cup_R \tilde{I}_{A_2})(x), (I_{B_1} +_R I_{B_2})(x) = (I_{B_1} \cup_R I_{B_2})(x) \\ (\tilde{F}_{A_1} +_R \tilde{F}_{A_2})(x) &= (\tilde{F}_{A_1} \cup_R \tilde{F}_{A_2})(x), (F_{B_1} +_R F_{B_2})(x) = (F_{B_1} \cup_R F_{B_2})(x) \end{aligned}$$

(ii) if $xy \in E_1 \cup E_2$

$$\begin{aligned} 2a. \quad &\{(\tilde{T}_{C_1} +_R \tilde{T}_{C_2})(xy) = (\tilde{T}_{C_1} \cup_R \tilde{T}_{C_2})(xy), (T_{D_1} +_R T_{D_2})(xy) = (T_{D_1} \cup_R T_{D_2})(xy)\} \\ 2b. \quad &\{(\tilde{I}_{C_1} +_R \tilde{I}_{C_2})(xy) = (\tilde{I}_{C_1} \cup_R \tilde{I}_{C_2})(xy), (I_{D_1} +_R I_{D_2})(xy) = (I_{D_1} \cup_R I_{D_2})(xy)\} \\ 2c. \quad &\{(\tilde{F}_{C_1} +_R \tilde{F}_{C_2})(xy) = (\tilde{F}_{C_1} \cup_R \tilde{F}_{C_2})(xy), (F_{D_1} +_R F_{D_2})(xy) = (F_{D_1} \cup_R F_{D_2})(xy)\} \end{aligned}$$

(iii) if $xy \in E^*$, where E^* is the set of all edges joining the vertices of V_1 and V_2

$$\begin{aligned} 3a. \quad &\begin{cases} (\tilde{T}_{C_1} +_R \tilde{T}_{C_2})(xy) = \text{rmin}\{\tilde{T}_{A_1}(x), \tilde{T}_{A_2}(y)\}, \\ (T_{D_1} +_R T_{D_2})(xy) = \text{max}\{T_{B_1}(x), T_{B_2}(y)\} \end{cases} \\ 3b. \quad &\begin{cases} (\tilde{I}_{C_1} +_R \tilde{I}_{C_2})(xy) = \text{rmin}\{\tilde{I}_{A_1}(x), \tilde{I}_{A_2}(y)\}, \\ (I_{D_1} +_R I_{D_2})(xy) = \text{max}\{I_{B_1}(x), I_{B_2}(y)\} \end{cases} \\ 3c. \quad &\begin{cases} (\tilde{F}_{C_1} +_R \tilde{F}_{C_2})(xy) = \text{rmin}\{\tilde{F}_{A_1}(x), \tilde{F}_{A_2}(y)\}, \\ (F_{D_1} +_R F_{D_2})(xy) = \text{max}\{F_{B_1}(x), F_{B_2}(y)\} \end{cases} \end{aligned}$$

Proposition 4. The P-join and R-join of two neutrosophic cubic graphs is again a neutrosophic cubic graph.

4. Applications

Fuzzy graph theory is an effective field having a vast range of applications in Mathematics. Neutrosophic cubic graphs are more general and effective approach used in daily life very effectively.

Here in this section we test the applicability of our proposed model by providing applications in industries.

Example 7. Let us suppose a set of three industries representing a vertex set $V = \{A, B, C\}$ and let the truth-membership of each vertex in V denotes “win win” situation of industry, where they do not harm each other and do not capture other’s customers. Indetermined-membership of members of vertex set represents the situation in which industry works in a diplomatic and social way, that is, they are ally being social and competitive being industry. Falsity-membership shows a brutal competition where price war starts among industries. We want to observe the effect of one industry on other industry with respect to their business power and strategies. Let we have a neutrosophic cubic graph for industries having the following data with respect to business strategies

$$M = \left\langle \begin{aligned} &\{A, ([0.3, 0.4], 0.3), ([0.5, 0.7], 0.6), ([0.4, 0.5], 0.2)\}, \\ &\{B, ([0.4, 0.5], 0.4), ([0.7, 0.8], 0.5), ([0.2, 0.3], 0.3)\}, \\ &\{C, ([0.6, 0.8], 0.8), ([0.4, 0.5], 0.3), ([0.1, 0.2], 0.1)\} \end{aligned} \right\rangle$$

where interval memberships indicate the business strength and strategies of industries for the present time while fixed membership indicates the business strength and strategies of industries for future based on given information. So on the basis of M we get a set of edges defined as

$$N = \left\langle \begin{aligned} &\{AB, ([0.3, 0.4], 0.4), ([0.5, 0.7], 0.6), ([0.4, 0.5], 0.2)\}, \\ &\{BC, ([0.4, 0.5], 0.8), ([0.4, 0.5], 0.5), ([0.2, 0.3], 0.1)\}, \\ &\{AC, ([0.3, 0.4], 0.8), ([0.4, 0.5], 0.6), ([0.4, 0.5], 0.1)\} \end{aligned} \right\rangle$$

where interval memberships indicate the business strength and strategies of industries for the present time while fixed membership indicate the business strength and strategies of industries for future when it will be the time of more competition. It is represented in Figure 11.

Finally we see that the business strategies of one industry strongly affect its business with other industries. Here

$$\text{order}(G) = \{([1.3, 1.7], 1.5), ([1.6, 2.0], 1.4), ([0.7, 1.0], 0.6)\}$$

and

$$\text{deg}(A) = \{([0.6, 0.8], 1.2), ([0.9, 1.2], 1.2), ([0.8, 1.0], 0.3)\}$$

$$\text{deg}(B) = \{([0.7, 0.9], 1.2), ([0.9, 1.2], 1.1), ([0.6, 0.8], 0.3)\}$$

$$\text{deg}(C) = \{([0.7, 0.9], 1.6), ([0.8, 1.0], 1.1), ([0.6, 0.8], 0.2)\}$$

Order of G represents the overall effect on market of above given industries A , B and C . Degree of A represents the effect of other industries on A link through an edge with the industry A . The minimum degree of A is 0 when it has no link with any other.

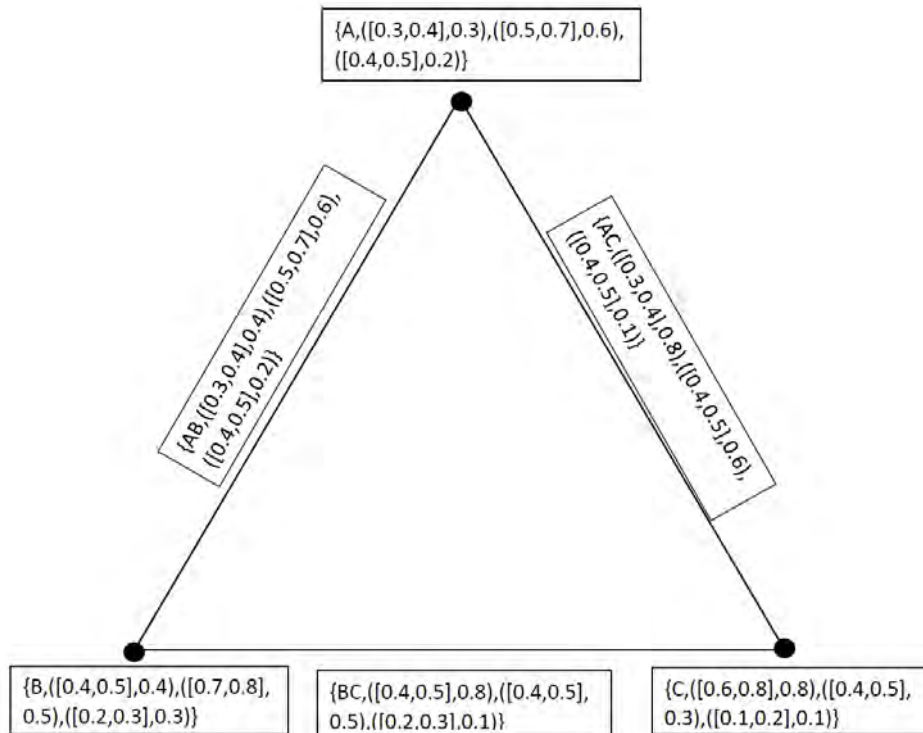

Figure 11. Neutrosophic Cubic Graph.

Figure: 18 Neutrosophic cubic graph

Example 8. Let us take an industry and we want to evaluate its overall performance. There are a lot of factors affecting it. However, some of the important factors influencing industrial productivity are with neutrosophic cubic sets as under where the data is provided in the form of interval based on future prediction and data given. Here we see that the business strategies of one industry strongly affect its business with other industries. Here in the form of a number from the unit interval $[0, 1]$ is dependent on the present time after a careful testing of different models as a sample in each case.

$$\text{order}(G) = \{([1.3, 1.7], 1.5), ([1.6, 2.0], 1.4), ([0.7, 1.0], 0.6)\}$$

1. Technological Development $A = ((\tilde{T}_A, T_A), (\tilde{I}_A, I_A), (\tilde{F}_A, F_A)) = ((\text{degree of mechanization}), (\text{technical know-how}), (\text{product design})) = \{A, ([0.3, 0.4], 0.3), ([0.5, 0.7], 0.6), ([0.4, 0.5], 0.2)\}$,

2. Quality of Human Resources $B = ((\tilde{T}_B, T_B), (\tilde{I}_B, I_B), (\tilde{F}_B, F_B)) = ((\text{ability of the worker}), (\text{willingness of the worker}), (\text{the environment under which he has to work})) = \{B, ([0.4, 0.5], 0.4), ([0.7, 0.8], 0.5), ([0.2, 0.3], 0.3)\}$,

$$\text{deg}(C) = \{([0.7, 0.9], 1.6), ([0.8, 1.0], 1.1), ([0.6, 0.8], 0.2)\}$$

Order of G represents the overall effect on market of above given industries A , B and C . Degree of A represents the effect of other industries on A link through an edge with the industry A . The minimum degree of A is 0 when it has no link with any other.

3. *Availability of Finance* $C = ((\tilde{T}_C, T_C), (\tilde{I}_C, I_C), (\tilde{F}_C, F_C)) = ((\text{advertisement campaign}), (\text{better working conditions to the workers}), (\text{up-keep of plant and machinery})) = \{C, ([0.6, 0.8], 0.8), ([0.4, 0.5], 0.3), ([0.1, 0.2], 0.1)\},$
4. *Managerial Talent* $D = ((\tilde{T}_D, T_D), (\tilde{I}_D, I_D), (\tilde{F}_D, F_D)) = ((\text{devoted towards their profession}), (\text{Links with workers, customers and suppliers}), (\text{conceptual, human relations and technical skills})) = \{D, ([0.3, 0.6], 0.4), ([0.2, 0.7], 0.9), ([0.3, 0.5], 0.6)\},$
5. *Government Policy* $E = ((\tilde{T}_E, T_E), (\tilde{I}_E, I_E), (\tilde{F}_E, F_E)) = \text{Government Policy} = ((\text{favorable conditions for saving}), (\text{investment}), (\text{flow of capital from one industrial sector to another})) = \{E, ([0.2, 0.4], 0.5), ([0.5, 0.6], 0.1), ([0.4, 0.5], 0.2)\},$
6. *Natural Factors* $F = ((\tilde{T}_F, T_F), (\tilde{I}_F, I_F), (\tilde{F}_F, F_F)) = ((\text{physical}), (\text{geographical}), (\text{climatic exercise})) = \{F, ([0.1, 0.4], 0.8), ([0.5, 0.7], 0.2), ([0.4, 0.5], 0.2)\}.$ As these factors affecting industrial productivity are inter-related and inter-dependent, it is a difficult task to evaluate the influence of each individual factor on the overall productivity of industrial units. The use of neutrosophic cubic graphs give us a more reliable information as under. Let $X = \{A, B, C, D, F, E\}$ we have a neutrosophic cubic set for the vertex set as under

$$M = \left\langle \begin{array}{l} \{A, ([0.3, 0.4], 0.3), ([0.5, 0.7], 0.6), ([0.4, 0.5], 0.2)\}, \\ \{B, ([0.4, 0.5], 0.4), ([0.7, 0.8], 0.5), ([0.2, 0.3], 0.3)\}, \\ \{C, ([0.6, 0.8], 0.8), ([0.4, 0.5], 0.3), ([0.1, 0.2], 0.1)\}, \\ \{D, ([0.3, 0.6], 0.4), ([0.2, 0.7], 0.9), ([0.3, 0.5], 0.6)\}, \\ \{E, ([0.2, 0.4], 0.5), ([0.5, 0.6], 0.1), ([0.4, 0.5], 0.2)\}, \\ \{F, ([0.1, 0.4], 0.8), ([0.5, 0.7], 0.2), ([0.4, 0.5], 0.2)\} \end{array} \right\rangle$$

Now, in order to find the combined effect of all these factors we need to use neutrosophic cubic sets for edges as under

$$N = \left\langle \begin{array}{l} \{AB, ([0.3, 0.4], 0.4), ([0.5, 0.7], 0.6), ([0.4, 0.5], 0.2)\}, \\ \{AC, ([0.3, 0.4], 0.8), ([0.4, 0.5], 0.6), ([0.4, 0.5], 0.1)\}, \\ \{AD, ([0.3, 0.4], 0.4), ([0.2, 0.7], 0.9), ([0.4, 0.5], 0.2)\}, \\ \{AE, ([0.2, 0.4], 0.5), ([0.5, 0.6], 0.6), ([0.4, 0.5], 0.2)\}, \\ \{AF, ([0.1, 0.4], 0.8), ([0.5, 0.7], 0.6), ([0.4, 0.5], 0.2)\}, \\ \{BC, ([0.4, 0.5], 0.8), ([0.4, 0.5], 0.5), ([0.2, 0.3], 0.1)\}, \\ \{BD, ([0.3, 0.5], 0.4), ([0.2, 0.7], 0.9), ([0.3, 0.5], 0.3)\}, \\ \{BE, ([0.2, 0.4], 0.5), ([0.5, 0.6], 0.5), ([0.4, 0.5], 0.2)\}, \\ \{BF, ([0.1, 0.4], 0.8), ([0.5, 0.7], 0.5), ([0.4, 0.5], 0.2)\}, \\ \{CD, ([0.3, 0.6], 0.8), ([0.2, 0.5], 0.9), ([0.3, 0.5], 0.1)\}, \\ \{CE, ([0.2, 0.4], 0.8), ([0.4, 0.5], 0.3), ([0.4, 0.5], 0.1)\}, \\ \{CF, ([0.1, 0.4], 0.8), ([0.4, 0.5], 0.3), ([0.4, 0.5], 0.1)\}, \\ \{DE, ([0.2, 0.4], 0.5), ([0.2, 0.6], 0.9), ([0.4, 0.5], 0.2)\}, \\ \{DF, ([0.1, 0.4], 0.8), ([0.2, 0.7], 0.9), ([0.4, 0.5], 0.2)\}, \\ \{EF, ([0.1, 0.4], 0.8), ([0.5, 0.6], 0.2), ([0.4, 0.5], 0.2)\} \end{array} \right\rangle$$

where the edge $\{AB, ([0.3, 0.4], 0.4), ([0.5, 0.7], 0.6), ([0.4, 0.5], 0.2)\}$ denotes the combined effect of technological development and quality of human resources on the productivity of the industry. Now, if we are interested to find which factors are more effective to the productivity of the industry, we may use the score and accuracy of the neutrosophic cubic sets, which will give us a closer view of the factors. It is represented in Figure 12.

Remark. We used degree and order of the neutrosophic cubic graphs in an application see Example 7 and if we have two different sets of industries having finite number of elements, we can easily find the applications of cartesian product, composition, union, join, order and degree of neutrosophic cubic graphs.

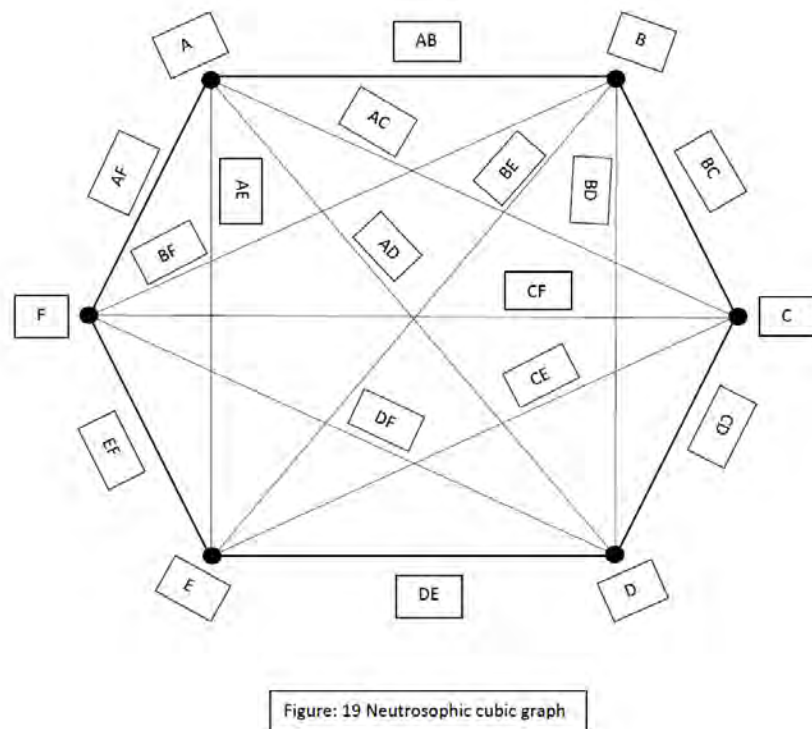

Re 5. Comparison Analysis

The idea of neutrosophic graphs provided by Kandasamy et al. in the book [29]. [38] Recently Rashid et al., introduced the notion of cubic graphs. In this paper, we introduced the study of neutrosophic cubic graphs. We claim that our model is more generalized from the previous models, as if we both indeterminacy and falsity part of neutrosophic cubic graphs $G = (M, N)$ where $M = (A, B) = ((\tilde{T}_A, T_B), (\tilde{I}_A, I_B), (\tilde{F}_A, F_B))$ is the neutrosophic cubic set representation of vertex set V and $N = (C, D) = ((\tilde{T}_C, T_D), (\tilde{I}_C, I_D), (\tilde{F}_C, F_D))$ is the neutrosophic cubic set representation of edges set E vanishes we get a cubic graph provided by Rashid et al., in [38]. Similarly, by imposing certain conditions on cubic graphs, we may obtain intuitionistic fuzzy graphs provided by Atanassov in 1995 and after that fuzzy graphs provided by Rosenfeld in 1975. So our proposed model is a generalized model and it has the ability to capture the uncertainty in a better way.

6. Conclusions

A generalization of the old concepts is the main motive of research. So in this paper, we proposed a generalized model of neutrosophic cubic graphs with different binary operations. We also provided applications of neutrosophic cubic graphs in industries. We also discussed conditions under which our model reduces to the previous models. In future, we will try to discuss different types of neutrosophic cubic graphs such as internal neutrosophic cubic graphs, external neutrosophic cubic graphs and many more with applications.

References

1. Zadeh, L.A. Fuzzy sets. *Inf. Control* **1965**, *8*, 338–353.
2. Rosenfeld, A. *Fuzzy Graphs, Fuzzy Sets and Their Applications*; Academic Press: New York, NY, USA, 1975; pp. 77–95.

3. Kauffman, A. *Introduction a la Theorie des Sous-Emsembles Flous*; Masson: Issy-les-Moulineaux, French, 1973; Volume 1.
4. Bhattacharya, P. Some remarks on fuzzy graphs. *Pattern Recognit. Lett.* **1987**, 6, 297–302.
5. Akram, M.; Dudek, W.A. Interval-valued fuzzy graphs. *Comput. Math. Appl.* **2011**, 61, 289–299.
6. Akram, M. Interval-valued fuzzy line graphs. *Neural Comput. Appl.* **2012**, 21, 145–150.
7. Mordeson, J.N.; Nair, P.S. *Fuzzy Graphs and Fuzzy Hypergraphs*; Springer: Berlin/Heidelberg, Germany, 2001.
8. Sunitha, M.S.; Sameena, K. Characterization of g-self centered fuzzy graphs. *J. Fuzzy Math.* **2008**, 16, 787–791.
9. Borzooei, R.A.; Rashmanlou, H. Cayley interval-valued fuzzy threshold graphs, U.P.B. *Sci. Bull. Ser. A* **2016**, 78, 83–94.
10. Pal, M.; Samanta, S.; Rashmanlou, H. Some results on interval-valued fuzzy graphs. *Int. J. Comput. Sci. Electron. Eng.* **2015**, 3, 2320–4028.
11. Pramanik, T.; Pal, M.; Mondal, S. Interval-valued fuzzy threshold graph. *Pac. Sci. Rev. A Nat. Sci. Eng.* **2016**, 18, 66–71.
12. Pramanik, T.; Samanta, S.; Pal, M. Interval-valued fuzzy planar graphs. *Int. J. Mach. Learn. Cybern.* **2016**, 7, 653–664.
13. Atanassov, K.T. Intuitionistic fuzzy sets. *Fuzzy Sets Syst.* **1986**, 20, 87–96.
14. Atanassov, K.T. On Intuitionistic Fuzzy Graphs and Intuitionistic Fuzzy Relations. In Proceedings of the VI IFSA World Congress, Sao Paulo, Brazil, 22–28 July 1995; Volume 1, pp. 551–554.
15. Atanassov, K.T.; Shannon, A. On a generalization of intuitionistic fuzzy graphs. *Notes Intuit. Fuzzy Sets* **2006**, 12, 24–29.
16. Karunambigai, M.G.; Parvathi, R. Intuitionistic Fuzzy Graphs. In *Computational Intelligence, Theory and Applications*; Springer: Berlin/Heidelberg, Germany, 2006; Volume 20, pp. 139–150.
17. Shannon, A.; Atanassov, K.T. A first step to a theory of the intuitionistic fuzzy graphs. In Proceedings of the 1st Workshop on Fuzzy Based Expert Systems, Sofia, Bulgaria, 26–29 June 1994; pp. 59–61.
18. Mishra, S.N.; Rashmanlou, H.; Pal, A. Coherent category of interval-valued intuitionistic fuzzy graphs. *J. Mult. Val. Log. Soft Comput.* **2017**, 29, 355–372.
19. Parvathi, R.; Karunambigai, M.G.; Atanassov, K. Operations on Intuitionistic Fuzzy Graphs. In Proceedings of the IEEE International Conference on Fuzzy Systems, Jeju Island, Korea, 20–24 August 2009; pp. 1396–1401.
20. Sahoo, S.; Pal, M. Product of intuitionistic fuzzy graphs and degree. *J. Intell. Fuzzy Syst.* **2017**, 32, 1059–1067.
21. Akram, M.; Davvaz, B. Strong intuitionistic fuzzy graphs. *Filomat* **2012**, 26, 177–196.
22. Zhang, W.R. Bipolar Fuzzy Sets and Relations: A Computational Framework for Cognitive Modeling and Multiagent Decision Analysis. In Proceedings of the IEEE Industrial Fuzzy Control and Intelligent Systems Conference, and the NASA Joint Technology Workshop on Neural Networks and Fuzzy Logic, Fuzzy Information Processing Society Biannual Conference, San Antonio, TX, USA, 18–21 December 1994; pp. 305–309.
23. Akram, M. Bipolar fuzzy graphs. *Inf. Sci.* **2011**, 181, 5548–5564.
24. Akram, M. Bipolar fuzzy graphs with applications. *Knowl. Based Syst.* **2013**, 39, 1–8.
25. Akram, M.; Karunambigai, M.G. Metric in bipolar fuzzy graphs. *World Appl. Sci. J.* **2012**, 14, 1920–1927.
26. Smarandache, F. *A Unifying Field in Logics: Neutrosophic Logic. Neutrosophy, Neutrosophic Set, Neutrosophic Probability*; American Research Press: Rehoboth, NM, USA, 1999.
27. Smarandache, F. Neutrosophic set—a generalization of the intuitionistic fuzzy set. *Int. J. Pure Appl. Math.* **2005**, 24, 287–297.
28. Wang, H.; Smarandache, F.; Zhang, Y.Q.; Sunderraman, R. *Interval Neutrosophic Sets and Logic: Theory and Applications in Computing*; Hexis: phoenix, AZ, USA, 2005.
29. Kandasamy, W.B.V.; Ilanthenral, K.; Smarandache, F. *Neutrosophic Graphs: A New Dimension to Graph Theory*; EuropaNova ASBL: Bruxelles, Belgium, 2015.
30. Akram, M.; Rafique, S.; Davvaz, B. New concepts in neutrosophic graphs with application. *J. Appl. Math. Comput.* **2018**, 57, 279–302.
31. Akram, M.; Nasir, M. Concepts of Interval-Valued Neutrosophic Graphs. *Int. J. Algebra Stat.* **2017**, 6, 22–41.
32. Akram, M. Single-valued neutrosophic planar graphs. *Int. J. Algebra Stat.* **2016**, 5, 157–167.
33. Akram, M.; Shahzadi, S. Neutrosophic soft graphs with application. *J. Intell. Fuzzy Syst.* **2017**, 32, 841–858.
34. Jun, Y.B.; Kim, C.S.; Yang, K.O. Cubic Sets. *Ann. Fuzzy Math. Inf.* **2012**, 4, 83–98.

35. Jun, Y.B.; Kim, C.S.; Kang, M.S. Cubic subalgebras and ideals of BCK/BCI-algebras. *Far East J. Math. Sci.* **2010**, *44*, 239–250.
36. Jun, Y.B.; Lee, K.J.; Kang, M.S. Cubic structures applied to ideals of BCI-algebras. *Comput. Math. Appl.* **2011**, *62*, 3334–3342.
37. Kang, J.G.; Kim, C.S. Mappings of cubic sets. *Commun. Korean Math. Soc.* **2016**, *31*, 423–431.
38. Rashid, S.; Yaqoob, N.; Akram, M.; Gulistan, M. Cubic Graphs with Application. *Int. J. Anal. Appl.* **2018**, in press.
39. Jun, Y.B.; Smarandache, F.; Kim, C.S. Neutrosophic cubic sets. *New Math. Nat. Comput.* **2017**, *13*, 41–54.
40. Jun, Y.B.; Smarandache, F.; Kim, C.S. P-union and P-intersection of neutrosophic cubic sets. *Anal. Univ. Ovid. Constant. Seria Mat.* **2017**, *25*, 99–115.

Decision-Making via Neutrosophic Support Soft Topological Spaces

**Parimala Mani, Karthika Muthusamy, Saeid Jafari, Florentin Smarandache,
Udhayakumar Ramalingam**

Parimala Mani, Karthika Muthusamy, Saeid Jafari, Florentin Smarandache, Udhayakumar Ramalingam (2018). Decision-Making via Neutrosophic Support Soft Topological Spaces. *Symmetry* 10, 217; DOI: 10.3390/sym10060217

Abstract: The concept of interval neutrosophic sets has been studied and the introduction of a new kind of set in topological spaces called the interval valued neutrosophic support soft set has been suggested. We study some of its basic properties. The main purpose of this paper is to give the optimum solution to decision-making in real life problems the using interval valued neutrosophic support soft set.

Keywords: soft sets; support soft sets; interval valued neutrosophic support soft sets

1. Introduction

To deal with uncertainties, many theories have been recently developed, including the theory of probability, the theory of fuzzy sets, the theory of rough sets, and so on. However, difficulties are still arising due to the inadequacy of parameters. The concept of fuzzy sets, which deals with the nonprobabilistic uncertainty, was introduced by Zadeh [1] in 1965. Since then, many researchers have defined the concept of fuzzy topology that has been widely used in the fields of neural networks, artificial intelligence, transportation, etc. The intuitionistic fuzzy set (IFS for short) on a universe X was introduced by K. Atanasiu [2] in 1983 as a generalization of the fuzzy set in addition to the degree of membership and the degree of nonmembership of each element.

In 1999, Molodtsov [3] successfully proposed a completely new theory called soft set theory using classical sets. This theory is a relatively new mathematical model for dealing with uncertainty from a parametrization point of view. After Molodtsov, many researchers have shown interest in soft sets and their applications. Maji [4,5] introduced neutrosophic soft sets with operators, which are free from difficulties since neutrosophic sets [6–9] can handle indeterminate information. However, the neutrosophic sets and operators are hard to apply in real life applications. Therefore, Smarandache [10] proposed the concept of interval valued neutrosophic sets which can represent uncertain, imprecise, incomplete, and inconsistent information.

Nguyen [11] introduced the new concept in a type of soft computing, called the support-neutrosophic set. Deli [12] defined a generalized concept of the interval-valued neutrosophic soft set. In this paper, we combine interval-valued neutrosophic soft sets and support sets to yield the

interval-valued neutrosophic support soft set, and we study some of its basic operations. Our main aim of this paper is to make decisions using interval-valued neutrosophic support soft topological spaces.

2. Preliminaries

In this paper, we provide the basic definitions of neutrosophic and soft sets. These are very useful for what follows.

Definition 1. ([13]) Let X be a non-empty set. A neutrosophic set, A , in X is of the form $A = \{ \langle x, \mu_A(x), \sigma_A(x), \omega_A(x), \gamma_A(x); x \in X \rangle \}$, where $\mu_A : X \rightarrow [0, 1]$, $\sigma_A : X \rightarrow [0, 1]$ and $\gamma_A : X \rightarrow [0, 1]$ represent the degree of membership function, degree of indeterminacy, and degree of non-membership function, respectively and $0 \leq \sup \mu_A(x) + \sup \sigma_A(x) + \sup \gamma_A(x) \leq 3, \forall x \in X$.

Definition 2. ([5]) Let X be a non-empty set, let $P(X)$ be the power set of X , and let E be a set of parameters, and $A \subseteq E$. The soft set function, f_X , is defined by

$$f_X : A \rightarrow P(X) \text{ such that } f_X(x) = \emptyset \text{ if } x \notin X.$$

The function f_X may be arbitrary. Some of them may be empty and may have non-empty intersections. A soft set over X can be represented as the set of order pairs $F_X = \{ (x, f_X(x)) : x \in X, f_X(x) \in P(X) \}$.

Example 1. Consider the soft set $\langle E, A \rangle$, where X is a set of six mobile phone models under consideration to be purchased by decision makers, which is denoted by $X = \{x_1, x_2, x_3, x_4, x_5, x_6\}$, and A is the parameter set, where $A = \{y_1, y_2, y_3, y_4, y_5\} = \{\text{price, look, camera, efficiency, processor}\}$. A soft set, F_X , can be constructed such that $f_X(y_1) = \{x_1, x_2\}$, $f_X(y_2) = \{x_1, x_4, x_5, x_6\}$, $f_X(y_3) = \emptyset$, $f_X(y_4) = X$, and $f_X(y_5) = \{x_1, x_2, x_3, x_4, x_5\}$. Then,

$$F_X = \{ (y_1, x_1, x_2), (y_2, x_1, x_4, x_5, x_6), (y_3, \emptyset), (y_4, X), (y_5, x_1, x_2, x_3, x_4, x_5) \}.$$

X	x_1	x_2	x_3	x_4	x_5	x_6
y_1	1	1	0	0	0	0
y_2	1	0	0	1	1	1
y_3	0	0	0	0	0	0
y_4	1	1	1	1	1	1
y_5	1	1	1	1	1	0

Definition 3. ([4]) Let X be a non-empty set, and $A = \{y_1, y_2, y_3, \dots, y_n\}$, the subset of X and F_X is a soft set over X . For any $y_i \in A$, $f_X(y_i)$ is a subset of X . Then, the choice value of an object, $x_i \in X$, is $C_{V_i} = \sum_j x_{ij}$, where x_{ij} are the entries in the table of F_X :

$$x_{ij} = \begin{cases} 1, & \text{if } x_i \in f_X(y_j) \\ 0, & \text{if } x_i \notin f_X(y_j). \end{cases}$$

Example 2. Consider Example 2. Clearly, $C_{V_1} = \sum_{j=1}^5 x_{1j} = 4$, $C_{V_3} = C_{V_6} = \sum_{j=1}^5 x_{3j} = \sum_{j=1}^5 x_{6j} = 2$, $C_{V_2} = C_{V_4} = C_{V_5} = \sum_{j=1}^5 x_{2j} = \sum_{j=1}^5 x_{4j} = \sum_{j=1}^5 x_{5j} = 3$.

Definition 4. ([13]) Let F_X and F_Y be two soft sets over X and Y . Then,

- (1) The complement of F_X is defined by $F_{X^c}(x) = X \setminus f_X(x)$ for all $x \in A$;
- (2) The union of two soft sets is defined by $f_{X \cup Y}(x) = f_X(x) \cup f_Y(x)$ for all $x \in A$;
- (3) The intersection of two soft sets is defined by $f_{X \cap Y}(x) = f_X(x) \cap f_Y(x)$ for all $x \in A$.

3. Interval Valued Neutrosophic Support Soft Set

In this paper, we provide the definition of a interval-valued neutrosophic support soft set and perform some operations along with an example.

Definition 5. Let X be a non-empty fixed set with a generic element in X denoted by a . An interval-valued neutrosophic support set, A , in X is of the form

$$A = \{ \langle x, \mu_A(x), \sigma_A(x), \omega_A(x), \gamma_A(x) \rangle / a; a \in X \}.$$

For each point, $a \in X, x, \mu_A(x), \sigma_A(x), \omega_A(x)$, and $\gamma_A(x) \in [0, 1]$.

Example 3. Let $X = \{a, b\}$ be a non-empty set, where $a, b \subseteq [0, 1]$. An interval valued neutrosophic support set, $A \subseteq X$, constructed according to the degree of membership function, $(\mu_A(x))$, indeterminacy $(\sigma_A(x))$, support function $(\omega_A(x))$, and non-membership function $(\gamma_A(x))$ is as follows:

$$A = \{ \langle (0.2, 1.0), (0.2, 0.4), (0.1, 0.7), (0.5, 0.7) \rangle / a, \langle (0.6, 0.8), (0.8, 1.0), (0.4, 0.6), (0.4, 0.6) \rangle / b \}.$$

Definition 6. Let X be a non-empty set; the interval-valued neutrosophic support set A in X is of the form $A = \{ \langle x, \mu_A(x), \sigma_A(x), \omega_A(x), \gamma_A(x) \rangle; x \in X \}$.

- (i) An empty set A , denoted by $A = \emptyset$, is defined by $\emptyset = \{ \langle (0, 0), (1, 1), (0, 0), (1, 1) \rangle / x : x \in X \}$.
- (ii) The universal set is defined by $U = \{ \langle (1, 1), (0, 0), (1, 1), (0, 0) \rangle / x : x \in X \}$.
- (iii) The complement of A is defined by $A^c = \{ \langle (\inf \gamma_A(x), \sup \gamma_A(x)), (1 - \sup \sigma_A(x), 1 - \inf \sigma_A(x)), (1 - \sup \omega_A(x), 1 - \inf \omega_A(x)), (\inf \mu_A(x), \sup \mu_A(x)) \rangle / x : x \in X \}$.
- (iv) A and B are two interval-valued neutrosophic support sets of X . A is a subset of B if $\mu_A(x) \leq \mu_B(x), \sigma_A(x) \geq \sigma_B(x), \omega_A(x) \leq \omega_B(x), \gamma_A(x) \geq \gamma_B(x)$.
- (v) Two interval-valued neutrosophic support sets A and B in X are said to be equal if $A \subseteq B$ and $B \subseteq A$.

Definition 7. Let A and B be two interval-valued neutrosophic support sets. Then, for every $x \in X$

- (i) The intersection of A and B is defined by $A \cap B = \{ \langle (\min[\inf \mu_A(x), \inf \mu_B(x)], \min[\sup \mu_A(x), \sup \mu_B(x)]), (\max[\inf \sigma_A(x), \inf \sigma_B(x)], \max[\sup \sigma_A(x), \sup \sigma_B(x)]), (\min[\inf \omega_A(x), \inf \omega_B(x)], \min[\sup \omega_A(x), \sup \omega_B(x)]), (\max[\inf \gamma_A(x), \inf \gamma_B(x)], \max[\sup \gamma_A(x), \sup \gamma_B(x)]) \rangle / x : x \in X \}$.
- (ii) The union of A and B is defined by $A \cup B = \{ \langle (\max[\inf \mu_A(x), \inf \mu_B(x)], \max[\sup \mu_A(x), \sup \mu_B(x)]), (\min[\inf \sigma_A(x), \inf \sigma_B(x)], \min[\sup \sigma_A(x), \sup \sigma_B(x)]), (\max[\inf \omega_A(x), \inf \omega_B(x)], \max[\sup \omega_A(x), \sup \omega_B(x)]), (\min[\inf \gamma_A(x), \inf \gamma_B(x)], \min[\sup \gamma_A(x), \sup \gamma_B(x)]) \rangle / x : x \in X \}$.
- (iii) A difference, B , is defined by $A \setminus B = \{ \langle (\min[\inf \mu_A(x), \inf \gamma_B(x)], \min[\sup \mu_A(x), \sup \gamma_B(x)]), (\max[\inf \sigma_A(x), 1 - \sup \sigma_B(x)], \max[\sup \sigma_A(x), 1 - \inf \sigma_B(x)]), (\min[\inf \omega_A(x), 1 - \sup \omega_B(x)], \min[\sup \omega_A(x), 1 - \inf \omega_B(x)]), (\max[\inf \gamma_A(x), \inf \mu_B(x)], \max[\sup \gamma_B(x), \sup \mu_B(x)]) \rangle / x : x \in X \}$.
- (iv) Scalar multiplication of A is defined by $A.a = \{ \langle (\min[\inf \mu_A(x).a, 1], \min[\sup \mu_A(x).a, 1]), (\min[\inf \sigma_A(x).a, 1], \min[\sup \sigma_A(x).a, 1]), (\min[\inf \omega_A(x).a, 1], \min[\sup \omega_A(x).a, 1]), (\min[\inf \gamma_A(x).a, 1], \min[\sup \gamma_A(x).a, 1]) \rangle / x : x \in X \}$.
- (v) Scalar division of A is defined by $A/a = \{ \langle (\min[\inf \mu_A(x)/a, 1], \min[\sup \mu_A(x)/a, 1]), (\min[\inf \sigma_A(x)/a, 1], \min[\sup \sigma_A(x)/a, 1]), (\min[\inf \omega_A(x)/a, 1], \min[\sup \omega_A(x)/a, 1]), (\min[\inf \gamma_A(x)/a, 1], \min[\sup \gamma_A(x)/a, 1]) \rangle / x : x \in X \}$.

Definition 8. Let X be a non-empty set; $IVNSS(X)$ denotes the set of all interval-valued neutrosophic support soft sets of X and a subset, A , of X . The soft set function is

$$g_i : A \rightarrow IVNSS(x).$$

The interval valued neutrosophic support soft set over X can be represented by

$$G_i = \{(y, g_i(y)) : y \in A\}, \text{ such that } g_i(y) = \emptyset \text{ if } x \notin X.$$

Example 4. Consider the interval-valued neutrosophic support soft set, $\langle G_i, A \rangle$, where X is a set of two brands of mobile phones being considered by a decision maker to purchase, which is denoted by $X = \{a, b\}$, and A is a parameter set, where $A = \{y_1 = \text{price}, y_2 = \text{camera specification}, y_3 = \text{Efficiency}, \text{ and } y_4 = \text{size}, y_5 = \text{processor}\}$. In this case, we define a set G_i over X as follows:

G_i	a	b
y_1	[0.6,0.8],[0.8,0.9][0.5,0.6][0.1,0.5]	[0.6,0.8][0.1,0.8][0.3,0.7][0.1,0.7]
y_2	[0.2,0.4][0.5,0.8][0.4,0.3][0.3,0.8]	[0.2,0.8][0.6,0.9][0.5,0.8][0.2,0.3]
y_3	[0.1,0.9][0.2,0.5][0.5,0.7][0.6,0.8]	[0.4,0.9][0.2,0.6][0.5,0.6][0.5,0.7]
y_4	[0.6,0.8][0.8,0.9][0.1,0.9][0.8,0.9]	[0.5,0.7][0.6,0.8][0.7,0.9][0.1,0.8]
y_5	[0.0,0.9][1.0,0.1][1.0,0.9][1.0,1.0]	[0.0,0.9][0.8,1.0][0.3,0.5][0.2,0.5]

Clearly, we can see that the exact evaluation of each object on each parameter is unknown, while the lower limit and upper limit of such an evaluation are given. For instance, we cannot give the exact membership degree, support, indeterminacy and nonmembership degree of price 'a'; however, the price of model 'a' is at least on the membership degree of 0.6 and at most on the membership degree of 0.8.

Definition 9. Let G_i be a interval valued neutrosophic support soft set of X . Then, G_i is known as an empty interval valued neutrosophic support soft set, if $g_i(y) = \emptyset$.

Definition 10. Let G_i be a interval valued neutrosophic support soft set of X . Then, G_i is known as the universal interval valued neutrosophic support soft set, if $g_i(y) = X$.

Definition 11. Let G_i, G_j be two interval valued neutrosophic support soft set of X . Then, G_i is said to be subset of G_j , if $g_i(y) \subseteq g_j(y)$.

Example 5. Two interval-valued neutrosophic support soft sets, G_i and G_j , are constructed as follows:

G_i	a	b
y_1	[0.6,0.8],[0.8,0.9][0.5,0.6][0.1,0.5]	[0.6,0.8][0.1,0.8][0.3,0.7][0.1,0.7]
y_2	[0.2,0.4][0.5,0.8][0.4,0.3][0.3,0.8]	[0.2,0.8][0.6,0.9][0.5,0.8][0.2,0.3]
y_3	[0.1,0.9][0.2,0.5][0.5,0.7][0.6,0.8]	[0.4,0.9][0.2,0.6][0.5,0.6][0.5,0.7]
y_4	[0.6,0.8][0.8,0.9][0.1,0.9][0.8,0.9]	[0.5,0.7][0.6,0.8][0.7,0.9][0.1,0.8]
y_5	[0.0,0.9][1.0,0.1][1.0,0.9][1.0,1.0]	[0.0,0.9][0.8,1.0][0.3,0.5][0.2,0.5]

G_j	a	b
y_1	[0.7,0.8],[0.7,0.9][0.6,0.6][0.1,0.5]	[0.7,0.9][0.0,0.8][0.4,0.8][0.1,0.6]
y_2	[0.3,0.6][0.5,0.5][0.5,0.3][0.2,0.6]	[0.4,0.8][0.6,0.9][0.5,0.8][0.1,0.2]
y_3	[0.2,1.0][0.2,0.5][0.5,0.7][0.5,0.7]	[0.5,0.9][0.2,0.6][0.6,0.6][0.5,0.5]
y_4	[0.6,0.8][0.8,0.9][0.1,0.7][0.8,0.9]	[0.6,0.8][0.6,0.8][0.9,0.9][0.1,0.4]
y_5	[0.1,1.0][0.9,0.1][1.0,1.0][0.9,0.8]	[0.2,0.9][0.7,0.9][0.3,0.5][0.2,0.5]

Following Definition 11, G_i is a subset of G_j .

Definition 12. The two interval valued neutrosophic support soft sets, G_i, G_j , such that $G_i \subseteq G_j$, is said to be classical subset of X where every element of G_i does not need to be an element of G_j

Proposition 1. Let G_i, G_j, G_k be an interval valued neutrosophic support soft set of X . Then,

- (1) Each G_n is a subset of G_X , where $n= i,j,k$;
- (2) Each G_n is a superset of G_\emptyset , where $n= i,j,k$;
- (3) If G_i is a subset of G_j and G_j is a subset of G_k , then, G_i is a subset of G_k .

Proof. The proof of this proposition is obvious. \square

Definition 13. The two interval valued neutrosophic support soft sets of X are said to be equal, if and only if $g_i = g_j$, for all $i, j \in X$

Proposition 2. Let X be a non-empty set and G_i, G_j be an interval valued neutrosophic support soft set of X . G_i is a subset of G_j , and G_j is a subset of G_i , if and only if G_i is equal to G_j

Definition 14. The complement of the interval valued neutrosophic support soft set, G_i , of X is denoted by G_i^c , for all $i \in A$

- (i) The complement of the empty interval valued neutrosophic support soft set of X is the universal interval valued neutrosophic support soft set of X .
- (ii) The complement of the universal interval valued neutrosophic support soft set of X is the empty interval valued neutrosophic support soft set of X .

Theorem 1. Let G_i, G_j be an interval valued neutrosophic support soft set of X . Then, G_i is a subset of G_j and the complement of G_j is a subset of the complement of G_i .

Proof. Let G_i , and G_j be an interval valued neutrosophic support soft set of X . By definition, 3.7 G_i is a subset of G_j if $g_i(y) \subseteq g_j(y)$. Then, the complement of $g_i(y) \subseteq g_j(y)$ is $g_i^c(y) \supseteq g_j^c(y)$. Hence, the complement of G_j is a subset of the complement of G_i . \square

Example 6. From Example 4, the complement of G_i is constructed as follows:

G_i^c	a	b
y_1	[0.1,0.5],[0.1,0.2][0.4,0.5][0.6,0.8]	[0.1,0.7][0.2,0.9][0.3,0.7][0.6,0.8]
y_2	[0.3,0.8][0.2,0.5][0.6,0.7][0.2,0.4]	[0.2,0.3][0.1,0.4][0.2,0.5][0.2,0.8]
y_3	[0.6,0.8][0.5,0.8][0.3,0.5][0.1,0.9]	[0.5,0.7][0.4,0.8][0.4,0.5][0.4,0.9]
y_4	[0.8,0.9][0.1,0.2][0.3,0.9][0.6,0.8]	[0.1,0.8][0.2,0.4][0.1,0.3][0.5,0.7]
y_5	[1.0,1.0][0.0,0.9][0.0,0.1][0.0,0.9]	[0.2,0.5][0.0,0.2][0.5,0.7][0.0,0.8]

Definition 15. The union of the interval valued neutrosophic support soft set of X is denoted by $G_i \cup G_j$ and is defined by $g_i(y) \cup g_j(y) = g_j(y) \cup g_i(y)$ for all $y \in A$.

Proposition 3. Let G_i, G_j, G_k be an interval valued neutrosophic support soft set of X . Then,

- (i) $G_i \cup G_\emptyset = G_i$.
- (ii) $G_i \cup G_X = G_X$.
- (iii) $G_i \cup G_j = G_j \cup G_i$.
- (iv) $(G_i \cup G_j) \cup G_k = G_i \cup (G_j \cup G_k)$.

Example 7. From Example 4, the union of two sets is represented as follows:

$G_i \cup G_j$	a	b
y_1	$[0.7,0.8],[0.7,0.9][0.6,0.6][0.1,0.5]$	$[0.7,0.9][0.0,0.8][0.4,0.8][0.1,0.6]$
y_2	$[0.3,0.6][0.5,0.5][0.5,0.3][0.2,0.6]$	$[0.4,0.8][0.6,0.9][0.5,0.8][0.1,0.2]$
y_3	$[0.2,1.0][0.2,0.5][0.5,0.7][0.5,0.7]$	$[0.5,0.9][0.2,0.6][0.6,0.6][0.5,0.5]$
y_4	$[0.6,0.8][0.8,0.9][0.1,0.7][0.8,0.9]$	$[0.6,0.8][0.6,0.8][0.9,0.9][0.1,0.4]$
y_5	$[0.1,1.0][0.1,0.9][1.0,1.0][0.8,0.9]$	$[0.2,0.9][0.7,0.9][0.3,0.5][0.2,0.5]$

Definition 16. Let G_i, G_j be an interval valued neutrosophic support soft set of X . Then, the intersection of two sets denoted by $G_i \cap G_j$ is defined as $g_i(y) \cap g_j(y) = g_j(y) \cap g_i(y)$ for all $y \in A$.

Proposition 4. Let G_i, G_j, G_k be an interval valued neutrosophic support soft set of X . Then,

- (i) $G_i \cap G_\emptyset = G_\emptyset$.
- (ii) $G_i \cap G_X = G_i$.
- (iii) $G_i \cap G_j = G_j \cap G_i$.
- (iv) $(G_i \cap G_j) \cap G_k = G_i \cap (G_j \cap G_k)$.

Proof. The proof is obvious. \square

Example 8. In accordance with Example 4, the intersection operation is performed as follows:

$G_i \cap G_j$	a	b
y_1	$[0.6,0.8],[0.8,0.9][0.5,0.6][0.1,0.5]$	$[0.6,0.8][0.1,0.8][0.3,0.7][0.1,0.7]$
y_2	$[0.2,0.4][0.5,0.8][0.3,0.4][0.3,0.8]$	$[0.2,0.8][0.6,0.9][0.5,0.8][0.2,0.3]$
y_3	$[0.1,0.9][0.2,0.5][0.5,0.7][0.6,0.8]$	$[0.4,0.9][0.2,0.6][0.5,0.6][0.5,0.7]$
y_4	$[0.6,0.8][0.8,0.9][0.1,0.7][0.8,0.9]$	$[0.5,0.7][0.6,0.8][0.7,0.9][0.1,0.8]$
y_5	$[0.0,0.9][0.1,0.9][0.9,1.0][1.0,1.0]$	$[0.0,0.8][0.8,1.0][0.3,0.5][0.2,0.5]$

Definition 17. Let G_i be an interval valued neutrosophic support soft set of X . Then, the union of interval valued neutrosophic support soft set and its complement is not a universal set and it is not mutually disjoint.

Proposition 5. Let G_i, G_j be an interval valued neutrosophic support soft set of X . Then, the D’Margan Laws hold.

- (i) $(G_i \cup G_j)^c = G_i^c \cap G_j^c$.
- (ii) $(G_i \cap G_j)^c = G_i^c \cup G_j^c$.

Proposition 6. Let G_i, G_j, G_k be an interval valued neutrosophic support soft set of X . Then, the following hold.

- (i) $G_i \cup (G_j \cap G_k) = (G_i \cup G_j) \cap (G_i \cup G_k)$.
- (ii) $G_i \cap (G_j \cup G_k) = (G_i \cap G_j) \cup (G_i \cap G_k)$.

Definition 18. Let G_i, G_j be an interval valued neutrosophic support soft set of X . Then, the difference between two sets is denoted by G_i / G_j and is defined by

$$g_{i/j}(y) = g_i(y) / g_j(y)$$

for all $y \in A$.

Definition 19. Let G_i, G_j be an interval valued neutrosophic support soft set of X . Then the addition of two sets are denoted by $G_i + G_j$ and is defined by

$$g_{i+j}(y) = g_i(y) + g_j(y)$$

for all $y \in A$.

Definition 20. Let G_i be an interval valued neutrosophic support soft set of X . Then, the scalar division of G_i is denoted by G_i/a and is defined by

$$g_{i/a}(y) = g_i(y) / a$$

for all $y \in A$.

4. Decision-Making

In this paper, we provide the definition of relationship between the interval valued neutrosophic support soft set, the average interval valued neutrosophic support soft set and the algorithm to get the optimum decision.

Definition 21. Let G_i be an interval valued neutrosophic support soft set of X . Then, the relationship, R , for G_i is defined by

$$R_{G_i} = \{r_{G_i}(y, a) : r_{G_i}(y, a) \in \text{interval valued neutrosophic support set. } y \in A, a \in X\}$$

where $r_{G_i} : A \times X \Rightarrow$ interval valued neutrosophic support soft set (X) and $r_{G_i}(y, a) = g_i(y)(a)$ for all $y \in A$ and $a \in X$

Example 9. From Example 4, the relationship for the interval valued neutrosophic support soft set of X is given below.

$$\begin{aligned} g_{i(y_1)}(a) &= \langle [0.6, 0.8], [0.8, 0.9], [0.5, 0.6], [0.1, 0.5] \rangle, \\ g_{i(y_1)}(b) &= \langle [0.6, 0.8], [0.1, 0.8], [0.3, 0.7], [0.1, 0.7] \rangle, \\ g_{i(y_2)}(a) &= \langle [0.2, 0.4], [0.5, 0.8], [0.4, 0.3], [0.3, 0.8] \rangle, \\ g_{i(y_2)}(b) &= \langle [0.2, 0.8], [0.6, 0.9], [0.5, 0.8], [0.4, 0.3] \rangle, \\ g_{i(y_3)}(a) &= \langle [0.1, 0.9], [0.2, 0.5], [0.5, 0.7], [0.6, 0.8] \rangle, \\ g_{i(y_3)}(b) &= \langle [0.4, 0.9], [0.2, 0.6], [0.5, 0.6], [0.5, 0.7] \rangle, \\ g_{i(y_4)}(a) &= \langle [0.6, 0.8], [0.8, 0.9], [0.1, 0.7], [0.8, 0.9] \rangle, \\ g_{i(y_4)}(b) &= \langle [0.5, 0.7], [0.6, 0.8], [0.7, 0.9], [0.1, 0.8] \rangle, \\ g_{i(y_5)}(a) &= \langle [0.0, 0.9], [1.0, 0.1], [1.0, 0.9], [1.0, 1.0] \rangle, \\ g_{i(y_5)}(b) &= \langle [0.0, 0.8], [0.8, 1.0], [0.3, 0.5], [0.2, 0.5] \rangle. \end{aligned}$$

Definition 22. Let G_i be an interval valued neutrosophic support soft set of X . For $\mu, \sigma, \omega, \gamma \subseteq [0, 1]$, the $(\mu, \sigma, \omega, \gamma)$ -level support soft set of G_i defined by $\langle G_i; (\mu, \sigma, \omega, \gamma) \rangle = \{(y_i, \{a_{ij}: a_{ij} \in X, \mu(a_{ij}) = 1\}): y \in A\}$, where

$$\mu(a_{ij}) = \begin{cases} 1, & \text{if } (\mu, \sigma, \omega, \gamma) \leq g_i(y_i)(a_j) \\ 0, & \text{if otherwise} \end{cases} \text{ For all } a_j \in X.$$

Definition 23. Let G_i be an interval valued neutrosophic support soft set of X . The average interval valued neutrosophic support soft set is defined by $\langle \mu, \sigma, \omega, \gamma \rangle \text{Avg}_{G_i}(y_i) = \sum_{a \in X} g_i(y_i)(a) / |X|$ for all $y \in A$

Example 10. Considering Example 4, the average interval valued neutrosophic support soft set is calculated as follows:

$$\begin{aligned} \langle \mu, \sigma, \omega, \gamma \rangle \text{Avg}_{G_i}(y_1) &= \sum_{i=1}^2 g_{i(y_1)}(a) / |X| = \langle [0.6, 0.8], [0.45, 0.85], [0.4, 0.65], [0.1, 0.6] \rangle \\ \langle \mu, \sigma, \omega, \gamma \rangle \text{Avg}_{G_i}(y_2) &= \sum_{i=1}^2 g_{i(y_2)}(a) / |X| = \langle [0.2, 0.6], [0.55, 0.85], [0.45, 0.55], [0.25, 0.55] \rangle \end{aligned}$$

G_i	a	b
y_1	[0.4,0.7][0.8,0.8][0.4,0.8][0.3,0.5]	[0.3,0.6][0.3,0.8][0.3,0.7][0.3,0.8]
y_2	[0.1,0.3][0.6,0.7][0.2,0.3][0.3,0.8]	[0.2,0.7][0.7,0.9][0.3,0.6][0.3,0.4]
y_3	[0.2,0.6][0.4,0.5][0.1,0.5][0.7,0.8]	[0.4,0.9][0.1,0.6][0.3,0.8][0.5,0.7]
y_4	[0.6,0.9][0.6,0.9][0.6,0.9][0.6,0.9]	[0.5,0.9][0.6,0.8][0.2,0.8][0.1,0.7]
y_5	[0.0,0.9][1.0,1.0][1.0,1.0][1.0,1.0]	[0.0,0.9][0.8,1.0][0.1,0.4][0.2,0.5]

G_i	c	d
y_1	[0.5,0.7][0.8,0.9][0.4,0.8][0.2,0.5]	[0.3,0.6][0.3,0.9][0.2,0.8][0.2,0.8]
y_2	[0.0,0.3][0.6,0.8][0.1,0.4][0.3,0.9]	[0.1,0.8][0.8,0.9][0.2,0.9][0.3,0.5]
y_3	[0.1,0.7][0.4,0.5][0.2,0.8][0.8,0.9]	[0.2,0.5][0.5,0.7][0.3,0.6][0.6,0.8]
y_4	[0.2,0.4][0.7,0.9][0.6,0.8][0.6,0.9]	[0.3,0.9][0.6,0.9][0.2,0.8][0.3,0.9]
y_5	[0.0,0.2][1.0,1.0][1.0,1.0][1.0,1.0]	[0.0,0.1][0.9,1.0][0.2,0.2][0.2,0.9]

1. The average interval valued neutrosophic support soft set is determined as follows:

$$\langle \mu, \sigma, \omega, \gamma \rangle Avg_{G_i} = \{ \langle (0.375, 0.65), (0.55, 0.85), (0.325, 0.775), (0.25, 0.6), \rangle / y_1, \langle (0.125, 0.575), (0.675, 0.825), (0.2, 0.5), (0.3, 0.65) \rangle / y_2, \langle (0.225, 0.675), (0.35, 0.575), (0.225, 0.675), (0.65, 0.8) \rangle / y_3, \langle (0.4, 0.775), (0.625, 0.875), (0.4, 0.825), (0.4, 0.85) \rangle / y_4, \langle (0.0, 0.525), (0.825, 1.0), (0.575, 0.625), (0.6, 0.85) \rangle / y_5 \};$$

2. $\{G_i; \langle \mu, \sigma, \omega, \gamma \rangle Avg_{G_i}\} = \{(y_2, b), (y_3, b), (y_4, a), (y_5, b)\};$

3. The average-level support soft set, $\{G_i; \langle \mu, \sigma, \omega, \gamma \rangle Avg_{G_i}\}$ is represented in tabular form.

X	a	b	c	d
y_1	0	0	0	0
y_2	0	1	0	0
y_3	0	1	0	0
y_4	1	0	0	0
y_5	0	1	0	0

4. Compute the choice value, C_{v_i} , of a_i for all $a_i \in X$ as

$$C_{v_3} = C_{v_4} = \sum_{j=1}^4 a_{3j} = \sum_{j=1}^4 a_{4j} = 0, \quad C_{v_1} = \sum_{j=1}^4 a_{1j} = 1, \quad C_{v_2} = \sum_{j=1}^4 a_{2j} = 3;$$

5. C_{v_2} gives the maximum value. Therefore b is the optimum choice.

Now, we conclude that there are a few ways to get rid of cancer, but surgery chemotherapy is preferred by most of the physicians with respect to the cost of treatment and extending the life of the patient with the least side effects. Moreover, side effects will be reduced or vanish completely after finished chemotherapy, and the cancer and its growth will be controlled.

5. Conclusions and Future Work

Fuzzy sets are inadequate for representing some parameters. Therefore, intuitionistic fuzzy sets were introduced to overcome this inadequacy. Further, neutrosophic sets were introduced to represent the indeterminacy. In order to make decisions efficiently, we offer this new research work which does not violate the basic definitions of neutrosophic sets and their properties. In this paper, we add one more function called the support function in interval-valued neutrosophic soft set, and we also provide the basic definition of interval valued neutrosophic support soft set and some of its properties. Further, we framed an algorithm for making decisions in medical science with a real-life problem. Here, we found the best treatment for cancer under some constraints using interval valued neutrosophic support soft set. In the future, motivated by the interval valued neutrosophic support soft set, we aim to develop interval valued neutrosophic support soft set in ideal topological spaces. In addition, weaker forms of open sets, different types of functions and theorems can be developed using interval valued neutrosophic support soft set to allow continuous function. This concept may be applied in operations research, data analytics, medical sciences, etc. Industry may adopt this technique to minimize the cost of investment and maximize the profit.

References

1. Zadeh, L.A. Fuzzy sets. *Inf. Control* **1965**, *8*, 338–353. [[CrossRef](#)]
2. Atanassov, K.T. Intuitionistic fuzzy sets. *Fuzzy Sets Syst.* **1986**, *20*, 87–96. [[CrossRef](#)]
3. Molodtsov, D. Soft set theory—First results. *Comput. Math. Appl.* **1999**, *37*, 19–31. [[CrossRef](#)]
4. Maji, P.K. Neutrosophic soft sets. *Ann. Fuzzy Math. Inf.* **2013**, *5*, 157–168.
5. Maji, P. K.; Roy, A.R.; Biswass, R. An application of soft sets in a decision making problem. *Comput. Math. Appl.* **2002**, *44*, 1077–1083. [[CrossRef](#)]
6. Parimala, M.; Smarandache, F.; Jafari, S.; Udhayakumar, R. On Neutrosophic $\alpha\psi$ -Closed Sets. *Information* **2018**, *9*, 103. [[CrossRef](#)]
7. Parimala, M.; Karthika, M.; Dhavaseelan, R.; Jafari, S. On neutrosophic supra pre-continuous functions in neutrosophic topological spaces. In *New Trends in Neutrosophic Theory and Applications*; European Union: Brussels, Belgium, 2018; Volume 2, pp. 371–383.
8. Smarandache, F. *Neutrosophy. Neutrosophic Probability, Set, and Logic*; ProQuest Information & Learning: Ann Arbor, MI, USA, 1998; 105p.
9. Broumi, S.; Smarandache, F. Intuitionistic neutrosophic soft set. *J. Inf. Comput. Sc.* **2013**, *8*, 130–140.
10. Wang, H.; Smarandache, F.; Zhang, Y.Q.; Sunderraman, R. *Interval Neutrosophic Sets and Logic: Theory and Applications in Computing*; Neutrosophic Book Series, No. 5; Hexis: Staffordshire, UK, 2005.
11. Thao, N.X.; Smarandache, F.; Dinh, N.V. Support-Neutrosophic Set: A New Concept in Soft Computing. *Neutrosophic Sets Syst.* **2017**, *16*, 93–98.
12. Deli, I. Interval-valued neutrosophic soft sets and its decision making. *Int. J. Mach. Learn. Cyber.* **2017**, *8*, 665–676. [[CrossRef](#)]
13. Cagman, N.; Citak, F.; Enginoglu, S. FP-soft set theory and its applications. *Ann. Fuzzy Math. Inform.* **2011**, *2*, 219–226.

A Hybrid Neutrosophic Group ANP-TOPSIS Framework for Supplier Selection Problems

Mohamed Abdel-Basset, Mai Mohamed, Florentin Smarandache

Mohamed Abdel-Basset, Mai Mohamed, Florentin Smarandache (2018). A Hybrid Neutrosophic Group ANP-TOPSIS Framework for Supplier Selection Problems. *Symmetry* 10, 226; DOI: 10.3390/sym10060226

Abstract: One of the most significant competitive strategies for organizations is sustainable supply chain management (SSCM). The vital part in the administration of a sustainable supply chain is the sustainable supplier selection, which is a multi-criteria decision-making issue, including many conflicting criteria. The valuation and selection of sustainable suppliers are difficult problems due to vague, inconsistent and imprecise knowledge of decision makers. In the literature on supply chain management for measuring green performance, the requirement for methodological analysis of how sustainable variables affect each other, and how to consider vague, imprecise and inconsistent knowledge, is still unresolved. This research provides an incorporated multi-criteria decision-making procedure for sustainable supplier selection problems (SSSPs). An integrated framework is presented via interval-valued neutrosophic sets to deal with vague, imprecise and inconsistent information that exists usually in real world. The analytic network process (ANP) is employed to calculate weights of selected criteria by considering their interdependencies. For ranking alternatives and avoiding additional comparisons of analytic network processes, the technique for order preference by similarity to ideal solution (TOPSIS) is used. The proposed framework is turned to account for analyzing and selecting the optimal supplier. An actual case study of a dairy company in Egypt is examined within the proposed framework. Comparison with other existing methods is implemented to confirm the effectiveness and efficiency of the proposed approach.

Keywords: sustainable supplier selection problems (SSSPs); analytic network process; interdependency of criteria; TOPSIS; neutrosophic set

1. Introduction

The major priority for decision makers and managers in many fields such as agriculture, tourism, business development or manufacturing is the management of environmental and social issues, and the emergency to address them with the economic factors [1]. The sustainability is the synthesis of social, environmental and economic development [2]. The sustainability applies to all pertinent supply chain sides in supply chain management [3]. In sustainable supply chain management, managers seek to enhance the economic realization of their organization not only to survive, but also to succeed in close and distant future. The social and environmental activities that can enhance economic goals of organizations should be undertaken by managers in sustainable supply chain management [4]. Selecting the sustainable suppliers is very significant when designing new strategies and models in the case of lack of available knowledge and resources. Thus, the most important part in sustainable supply chain management is to construct and implement an effective and efficient supplier section process [5]. The supplier selection problems, combining social and

environmental factors for estimating and ranking suppliers to select the best, can be regarded as a sustainable supplier selection problems (SSSPs). The selection process of sustainable suppliers involves several conflicting criteria. The evaluation and selection of suppliers is very difficult due to vague, inconsistent and imprecise knowledge of decision makers. In order to deal with vague information, Zadeh introduced the theory of fuzzy sets in 1965 [6]. It is difficult to identify the truth-membership degree of a fuzzy set to a specific value. Therefore, Turksen introduced interval-valued fuzzy sets in 1986 [7]. Because fuzzy set only considers the truth-membership (membership) degree and fails to consider falsity-membership (non-membership) degree, Atanassov introduced intuitionistic fuzzy sets [8]. Moreover, intuitionistic fuzzy sets were expanded to interval-valued intuitionistic fuzzy sets [9]. The intuitionistic fuzzy sets have been exercised to disband multi-criteria decision-making problems [10–12]. The fuzzy and intuitionistic fuzzy sets fail to treat all types of uncertainties such as indeterminacy and inconsistency that exist usually in natural decision-making processes. For instance, when a decision maker gives his/her judgment toward anything, he/she may say that: this statement is 50% correct, 60% false and 20% I am not sure [13]. From this concept, Smarandache suggested the neutrosophic logic, probability and sets [14–16]. In neutrosophy, the indeterminacy degree is independent of truth and falsity degrees [17]. To facilitate the practical side of neutrosophic sets, a single-valued neutrosophic set (SVNS) was presented [13,18]. In real life problems, the statement could not be accurately defined by a certain degree of truth, indeterminacy and falsity, but indicated by various interval values. Therefore, interval neutrosophic set (INS) was conceptualized. The interval neutrosophic set (INS) was introduced by Wang et al. [19]. The authors in [17] used interval-valued neutrosophic set to present multi-criteria decision-making (MCDM) problems using aggregation operators. The neutrosophic linguistic environment was used by Broumi and Smarandache [20] to deal with multi-criteria decision-making problems. Zhang et al. [21] introduced an outranking technique to solve MCDM problems by using an interval-valued neutrosophic set. However, the current literature did not advance the integration of ANP and TOPSIS using INS for solving sustainable supplier selection problems. Consequently, we are the first to use an interval-valued neutrosophic set for representing a group ANP-TOPSIS framework for sustainable supplier selection.

1.1. Research Contribution

Our contribution can be summed up as follows:

- The sustainable supplier selection is a multi-criteria decision-making issue including many conflicting criteria. The valuation and selection of sustainable suppliers is a difficult problem due to vague, inconsistent and imprecise knowledge of decision makers. The literature on supply chain management for measuring green performance, the requirement for methodological analysis of how sustainable variables affect each other and of how to consider vague, imprecise and inconsistent knowledge is somehow inconclusive, but these drawbacks have been treated in our research.
- In most cases, the truth, falsity and indeterminacy degrees cannot be defined precisely in the real selection of sustainable suppliers, but denoted by several possible interval values. Therefore, we presented ANP TOPSIS, and combined them with interval-valued neutrosophic sets to select sustainable suppliers for the first time.
- The integrated framework leads to accurate decisions due to the way it treats uncertainty. The sustainable criteria for selecting suppliers are determined from the cited literature and the features of organizations under analysis. Then, the decision makers gather data and information.
- We select ANP and TOPSIS for solving sustainable supplier selection problems for the following reasons:
 - Since the independent concept of criteria is not constantly right and in actual life, there exist criteria dependent on each other, and we used ANP for precise weighting of criteria.

- The ANP needs many pairwise comparison matrices based on numerals and interdependence of criteria and alternatives, and, to escape this drawback, the TOPSIS was used to rank alternatives.
- The main problem of sustainable supplier selection problems is how to design and implement a flexible model for evaluating all available suppliers; since it considers the uncertainty that usually exists in real life, our model is the best.
- The proposed framework is used to study the case of a dairy and foodstuff company in Egypt, and can be employed to solve any sustainable supplier selection problem of any other company.
- Comparison with other existing methods, which are popular and attractive, was presented to validate our model.

The plan of this research is as follows: a literature review on the multi-criteria decision-making techniques to disband sustainable supplier selection problems is presented in Section 2. The basic concepts and definitions of interval-valued neutrosophic sets and its operations are discussed in Section 3. The ANP and TOPSIS methods are described in Section 4. The proposed framework for selecting optimal suppliers is presented in Section 5. An actual case study of a dairy and foodstuff company in Egypt is examined in Section 6. The conclusion and future directions are presented in Section 7.

2. Literature Review

Many research works intensify a supplier selection problem using various MCDM methods. For listing the optimal supplier under environmental factors, Govindan et al. [22] proposed a fuzzy TOPSIS framework. For evaluating sustainable suppliers' performance in a supply chain, Erol et al. [23] validated a multi-criteria setting based on fuzzy multi-attribute utility. The fuzzy inference system, the fuzzy logic and ranking method are used to address the subjectivity of DM estimation.

To handle sustainable supplier selection in a group decision environment, Wen et al. [24] proposed a fuzzy intuitionistic TOPSIS model. To analyze sustainability criteria and select the optimal sustainable supplier, Orji and Wei [25] used fuzzy logic, decision-making trial and evaluation laboratory (DEMATEL) and TOPSIS.

To bridge the gap between numerous existing research works on supplier selection and others who depend on environmental issues, Shaw et al. [26] were the first to employ AHP in fuzzy environment for green supplier selection. The fuzzy ANP and multi-person decision-making schema through imperfect preference relations are used by Buyukozkan and Cifci [27].

The requirements of company stakeholders are translated into multiple criteria for supplier selection by Ho et al. [28] by using a QFD approach. A family group decision-making model was developed by Dursun and Karsak [29] by using a QFD method to determine the characteristics that a product must hold to achieve customer needs and construct the assessment criteria for suppliers. A two-stage structure including data envelopment analysis (DEA) and rough set theory was proposed by Bai and Sarkis [30] to determine and evaluate relative performance of suppliers.

To rank sustainable suppliers, Kumar et al. [31] proposed a unified green DEA model. A fuzzy DEA model was used by Azadi et al. [32] to measure the efficiency, effectiveness and productivity of sustainable suppliers. To optimize supplier selection processes, numerous models have been integrated. The integrated analytic frameworks were combined through the recent research: ANP and/or AHP integrated with QFD by many researchers [33–38]. The DEMATEL was integrated with fuzzy ANP and TOPSIS as in [39]. Kumaraswamy et al. [40] integrated QFD with TOPSIS.

The integration of a fuzzy Delphi approach, ANP and TOPSIS were proposed by Chung et al. [41] for supplier selection. A review of multi-attribute decision-making techniques for evaluating and selecting suppliers in fuzzy environment is presented in [42]. In addition, the ANP was integrated with intuitionistic fuzzy TOPSIS by Rouyendegh [43] for selecting an optimal supplier. Tavana et al. [44] integrated ANP with QFD for sustainable supplier selection.

A neutrosophic group decision-making technique based on TOPSIS was proposed by Şahin and Yiğider for a supplier selection problem [45]. A hybrid multi-criteria group decision-making

technique based on interval-valued neutrosophic sets was proposed by Reddy et al. [46] for lean supplier selection. An extended version of EDAS using an interval valued neutrosophic set for a supplier selection problem is presented in [47]. A quality function deployment technique for supplier selection and evaluation based on an interval neutrosophic set is presented in [48]. To develop supplier selection criteria, the DEMATEL technique is presented in neutrosophic environment, as in [49].

The main criteria for supplier selection problems have been identified in many studies. The economic factors, which were considered in traditional supplier selection methods, are as follows:

- Cost,
- Quality,
- Flexibility,
- Technology capability.

There exist environmental factors for sustainable supplier selection as follows:

- Defilement production,
- Resource exhaustion,
- Eco-design and environmental administration.

The critical aspects of selecting green sustainable factors of supply chain design were provided by Dey and Ho [38] in a review of the recent research development.

3. Preliminaries

The significant definitions of interval-valued neutrosophic sets and its operations are presented in this section.

3.1. Interval-Valued Neutrosophic Sets (INS)

The interval-valued neutrosophic set V in X is described by truth $T_V(x)$, indeterminacy $I_V(x)$ and falsity $F_V(x)$ membership degrees for each $x \in X$. Here, $T_V(x) = [T_V^L(x), T_V^U(x)] \subseteq [0, 1]$, $I_V(x) = [I_V^L(x), I_V^U(x)] \subseteq [0, 1]$ and $F_V(x) = [F_V^L(x), F_V^U(x)] \subseteq [0, 1]$. Then, we can write interval-valued neutrosophic set as $V = \langle [T_V^L(x), T_V^U(x)], [I_V^L(x), I_V^U(x)], [F_V^L(x), F_V^U(x)] \rangle$.

The INS is a neutrosophic set.

3.2. The Related Operations of Interval-Valued Neutrosophic Sets

- Addition

Let A_1, A_2 be two INSs, where

$$A_1 = \langle [T_{A_1}^L, T_{A_1}^U], [I_{A_1}^L, I_{A_1}^U], [F_{A_1}^L, F_{A_1}^U] \rangle, \quad A_2 = \langle [T_{A_2}^L, T_{A_2}^U], [I_{A_2}^L, I_{A_2}^U], [F_{A_2}^L, F_{A_2}^U] \rangle$$

then $A_1 + A_2 = \langle [T_{A_1}^L + T_{A_2}^L - T_{A_1}^L T_{A_2}^L, T_{A_1}^U + T_{A_2}^U - T_{A_1}^U T_{A_2}^U], [I_{A_1}^L I_{A_2}^L, I_{A_1}^U I_{A_2}^U], [F_{A_1}^L F_{A_2}^L, F_{A_1}^U F_{A_2}^U] \rangle$.

- Subset

$$A_1 \subseteq A_2 \text{ if and only if } T_{A_1}^L \leq T_{A_2}^L, T_{A_1}^U \leq T_{A_2}^U; I_{A_1}^L \geq I_{A_2}^L, I_{A_1}^U \geq I_{A_2}^U; F_{A_1}^L \geq F_{A_2}^L, F_{A_1}^U \geq F_{A_2}^U.$$

- Equality

$$A_1 = A_2 \text{ if and only if } A_1 \subseteq A_2 \text{ and } A_2 \subseteq A_1.$$

- Complement

Let $V = \langle [T_V^L(x), T_V^U(x)], [I_V^L(x), I_V^U(x)], [F_V^L(x), F_V^U(x)] \rangle$, then

$$V^c = \langle [F_V^L(x), F_V^U(x)], [1 - I_V^U(x), 1 - I_V^L(x)], [T_V^L(x), T_V^U(x)] \rangle.$$

- Multiplication

$$A_1 \times A_2 = \langle [T_{A_1}^L T_{A_2}^L, T_{A_1}^U T_{A_2}^U], [I_{A_1}^L + I_{A_2}^L - I_{A_1}^L I_{A_2}^L, I_{A_1}^U + I_{A_2}^U - I_{A_1}^U I_{A_2}^U], [F_{A_1}^L + F_{A_2}^L - F_{A_1}^L F_{A_2}^L, F_{A_1}^U + F_{A_2}^U - F_{A_1}^U F_{A_2}^U] \rangle.$$

- Subtraction

$$A_1 - A_2 = \langle [T_{A_1}^L - F_{A_2}^U, T_{A_1}^U - F_{A_2}^L], [\max(I_{A_1}^L, I_{A_2}^L), \max(I_{A_1}^U, I_{A_2}^U)], [F_{A_1}^L - T_{A_2}^U, F_{A_1}^U - T_{A_2}^L] \rangle.$$

- Multiplication by a constant value

$$\lambda A_1 = \langle [1 - (1 - T_{A_1}^L)^\lambda, 1 - (1 - T_{A_1}^U)^\lambda], [(I_{A_1}^L)^\lambda, (I_{A_1}^U)^\lambda], [(F_{A_1}^L)^\lambda, (F_{A_1}^U)^\lambda] \rangle,$$

where $\lambda > 0$.

- Addition

Let A_1, A_2 two INs where

$$A_1 = \langle [T_{A_1}^L, T_{A_1}^U], [I_{A_1}^L, I_{A_1}^U], [F_{A_1}^L, F_{A_1}^U] \rangle, A_2 = \langle [T_{A_2}^L, T_{A_2}^U], [I_{A_2}^L, I_{A_2}^U], [F_{A_2}^L, F_{A_2}^U] \rangle \text{ then } A_1 + A_2 = \langle [T_{A_1}^L + T_{A_2}^L - T_{A_1}^L T_{A_2}^L, T_{A_1}^U + T_{A_2}^U - T_{A_1}^U T_{A_2}^U], [I_{A_1}^L I_{A_2}^L, I_{A_1}^U I_{A_2}^U], [F_{A_1}^L F_{A_2}^L, F_{A_1}^U F_{A_2}^U] \rangle.$$

- Subset

$$A_1 \subseteq A_2 \text{ if and only if } T_{A_1}^L \leq T_{A_2}^L, T_{A_1}^U \leq T_{A_2}^U; I_{A_1}^L \geq I_{A_2}^L, I_{A_1}^U \geq I_{A_2}^U; F_{A_1}^L \geq F_{A_2}^L, F_{A_1}^U \geq F_{A_2}^U.$$

- Equality

$$A_1 = A_2 \text{ if and only if } A_1 \subseteq A_2 \text{ and } A_2 \subseteq A_1.$$

- Complement

$$\text{Let } V = \langle [T_V^L(x), T_V^U(x)], [I_V^L(x), I_V^U(x)], [F_V^L(x), F_V^U(x)] \rangle, \text{ then } V^c = \langle [F_V^L(x), F_V^U(x)], [1 - I_V^U(x), 1 - I_V^L(x)], [T_V^L(x), T_V^U(x)] \rangle.$$

- Multiplication

$$A_1 \times A_2 = \langle [T_{A_1}^L T_{A_2}^L, T_{A_1}^U T_{A_2}^U], [I_{A_1}^L + I_{A_2}^L - I_{A_1}^L I_{A_2}^L, I_{A_1}^U + I_{A_2}^U - I_{A_1}^U I_{A_2}^U], [F_{A_1}^L + F_{A_2}^L - F_{A_1}^L F_{A_2}^L, F_{A_1}^U + F_{A_2}^U - F_{A_1}^U F_{A_2}^U] \rangle.$$

- Subtraction

$$A_1 - A_2 = \langle [T_{A_1}^L - F_{A_2}^U, T_{A_1}^U - F_{A_2}^L], [\max(I_{A_1}^L, I_{A_2}^L), \max(I_{A_1}^U, I_{A_2}^U)], [F_{A_1}^L - T_{A_2}^U, F_{A_1}^U - T_{A_2}^L] \rangle.$$

- Multiplication by a constant value

$$\lambda A_1 = \langle [1 - (1 - T_{A_1}^L)^\lambda, 1 - (1 - T_{A_1}^U)^\lambda], [(I_{A_1}^L)^\lambda, (I_{A_1}^U)^\lambda], [(F_{A_1}^L)^\lambda, (F_{A_1}^U)^\lambda] \rangle, \text{ where } \lambda > 0.$$

3.3. Weighted Average for Interval-Valued Neutrosophic Numbers (INN)

Let $y_j = \langle [T_j^L, T_j^U], [I_j^L, I_j^U], [F_j^L, F_j^U] \rangle$ be a group of interval-valued neutrosophic numbers, $j = 1, 2, \dots, n$ is the number of decision makers. The weighted arithmetic average of interval-valued neutrosophic number

$$\begin{aligned} \text{INNWAA } (y_1, y_2, \dots, y_n) &= \sum_{k=1}^n w_k y_j = \\ &\langle [1 - \prod_{k=1}^n (1 - T_j^L)^{w_k}, 1 - \prod_{k=1}^n (1 - T_j^U)^{w_k}], \\ &[\prod_{k=1}^n (I_j^L)^{w_k}, \prod_{k=1}^n (I_j^U)^{w_k}], [\prod_{k=1}^n (F_j^L)^{w_k}, \prod_{k=1}^n (F_j^U)^{w_k}] \rangle, \end{aligned} \tag{1}$$

where w_k is the decision maker's weight vector.

$$\langle [1 - \prod_{k=1}^n (1 - T_j^L)^{w_k}, 1 - \prod_{k=1}^n (1 - T_j^U)^{w_k}], [\prod_{k=1}^n (I_j^L)^{w_k}, \prod_{k=1}^n (I_j^U)^{w_k}], [\prod_{k=1}^n (F_j^L)^{w_k}, \prod_{k=1}^n (F_j^U)^{w_k}] \rangle \quad (1)$$

where w_k is the decision maker's weight vector.

3.4. INS Deneutrosophication Function

The deneutrosophication function converts each interval-valued neutrosophic number into crisp number. Let $A = \langle [T_A^L, T_A^U], [I_A^L, I_A^U], [F_A^L, F_A^U] \rangle$ be an interval-valued neutrosophic number, then the deneutrosophication function $D(A)$ will be defined by

$$D(A) = 10^{\left(\frac{2+(T_A^L+T_A^U)-2(I_A^L+I_A^U)-(F_A^L+F_A^U)}{4}\right)} \quad (2)$$

1.2 Ranking Method for Interval-Valued Neutrosophic Numbers

Let A_1, A_2 be interval-valued neutrosophic numbers, then,

- if $D(A_1)$ greater than $D(A_2)$, then $A_1 > A_2$;
- if $D(A_1)$ less than $D(A_2)$, then $A_1 < A_2$;
- if $D(A_1)$ equals $D(A_2)$, then $A_1 = A_2$.

4. The ANP and TOPSIS Methods

In this section, we present an overview of the two techniques used in our proposed research.

4.1. The Analytic Network Process (ANP)

The ANP is a development of analytic hierarchy process (AHP), and it was advanced by Saaty in 1996 for considering dependency and feedback among decision-making problem's elements. The ANP structures the problem as a network, not as hierarchies as with the AHP. In the analytic hierarchy process, it is assumed that the alternatives depend on criteria and criteria depend on goal. Therefore, in AHP, the criteria do not depend on alternatives, criteria do not affect (depend on) each other, and alternatives do not depend on each other. Nevertheless, in the analytic network process, the dependencies between decision-making elements are allowed. The differences between ANP and AHP are presented with the structural graph in Figure 1. The upper side of Figure 1 shows the hierarchy of AHP in which elements from the lower level have an influence on the higher level or, in other words, the upper level depends on the lower level. However, in the lower side of Figure 1, which shows the network model of ANP, we have a cluster network, and there exists some dependencies between them. The dependencies may be inner-dependencies when the cluster influence itself or may be outer-dependencies when cluster depends on another one. The complex decision-making problem in real life may contain dependencies between problem's elements, but AHP does not consider them, so it may lead to less optimal decisions, and ANP is more appropriate.

The general steps of ANP [50]:

1. The decision-making problem should be structured as a network that consists of a main objective, criteria for achieving this objective and can be divided to sub-criteria, and finally all available alternatives. The feedback among network elements should be considered here.
2. To calculate criteria's and alternatives' weights, the comparisons matrices should be constructed utilizing the 1–9 scale of Saaty. After then, we should check the consistency ratio of these matrices, and it must be ≤ 0.1 for each comparison matrix. The comparison matrix's eigenvector should be calculated after that by summing up the columns of comparison matrix. A new matrix is constructed by dividing each value in a column by the summation of that column, and then taking the average of new matrix rows. For more information, see [51]. The ANP comparison matrices may be constructed for comparing:

- Criteria with respect to goal,
 - Sub-criteria with respect to criterion from the same cluster,
 - Alternatives with respect to each criterion,
 - Criteria that belong to the same cluster with respect to each alternative.
3. Use the eigenvectors calculated in the previous step for constructing the super-matrix columns. For obtaining a weighted super-matrix, a normalization process must be established. Then, raise the weighted matrix to a larger power until the raw values will be equal to each column values of super-matrix for obtaining the limiting matrix.
 4. Finally, choose the best alternative by depending on weight values.

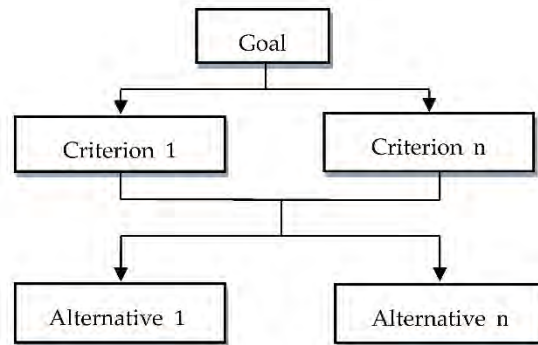

(a) The AHP hierarchy.

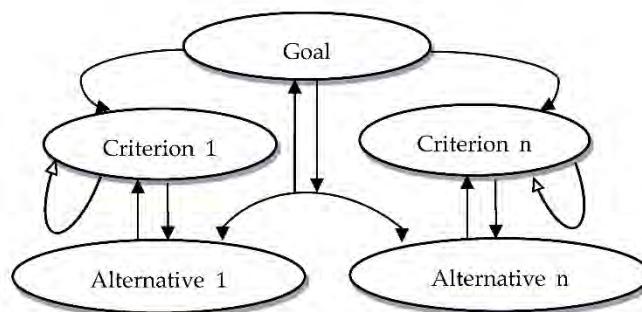

(b) The ANP network.

Figure 1. The structural difference between hierarchy and network model.

4.2. The TOPSIS Technique

The technique for order preference by similarity to ideal solution (TOPSIS) is proposed by Hwang and Yoon for aiding decision makers in determining positive (A^+) and negative (A^-) ideal solutions [52]. The chosen alternative is the one with the least distance from the positive ideal solution and the greatest distance from the negative ideal solution. The TOPSIS steps summarized as follows:

1. The decision makers should construct the evaluation matrix that consists of m alternatives and n criteria. The intersection of each alternative and criterion is denoted as x_{ij} , and then we have $(x_{ij})_{m \times n}$ matrix.
2. Use the following equation for obtaining the normalized evaluation matrix:

$$r_{ij} = \frac{x_{ij}}{\sqrt{\sum_{i=1}^m x_{ij}^2}}; \quad i = 1, 2, \dots, m; \quad j = 1, 2, \dots, n. \tag{3}$$

3. Structure the weighted matrix through multiplying criteria's weights w_j , by the normalized decision matrix r_{ij} as follows:

$$v_{ij} = w_j \times r_{ij}. \tag{4}$$

4. Calculate the positive A^+ and negative ideal solution A^- using the following:

$$A^+ = \{ \langle \max(v_{ij} | i = 1, 2, \dots, m) | j \in J^+ \rangle, \langle \min(v_{ij} | i = 1, 2, \dots, m) | j \in J^- \rangle \}, \tag{5}$$

$$A^- = \{ \langle \min(v_{ij} | i = 1, 2, \dots, m) | j \in J^+ \rangle, \langle \max(v_{ij} | i = 1, 2, \dots, m) | j \in J^- \rangle \}, \tag{6}$$

where J^+ associated with the criteria that have a beneficial influence and J^- associated with the criteria that have a non-beneficial influence.

5. Calculate the Euclidean distance among positive (d_i^+) and negative ideal solution (d_i^-) as follows:

$$d_i^+ = \sqrt{\sum_{j=1}^n (v_{ij} - v_j^+)^2} \quad i = 1, 2, \dots, m, \tag{7}$$

$$d_i^- = \sqrt{\sum_{j=1}^n (v_{ij} - v_j^-)^2} \quad i = 1, 2, \dots, m. \tag{8}$$

- 6. Calculate the relative closeness to the ideal solution and make the final ranking of alternatives $c_i = \frac{d_i^-}{d_i^+ + d_i^-}$ for $i = 1, 2, \dots, m$, and based on the largest c_i value, begin to rank alternatives. (9)
- 7. According to your rank of alternatives, take your final decision.

5. The Proposed Framework

The steps of the proposed interval-valued neutrosophic ANP-TOPSIS framework are presented with details in this section.

The proposed framework consists of four phases, which contains a number of steps as follows:

Phase 1: For better understanding of a complex problem, we must firstly breakdown it.

- Step 1.1. Select a group of experts to share in making decisions. If we select n experts, then we have the panel = $[e_1, e_2, \dots, e_n]$.
- Step 1.2. Use the literature review to determine problem’s criteria and ask experts for confirming these criteria.
- Step 1.3. Determine the alternatives of the problem.
- Step 1.4. Begin to structure the hierarchy of the problem.

In an analytic hierarchy process, it is assumed that the alternatives depend on criteria, criteria affects goal, and in real complex problems, there likely is a dependency between a problem’s elements. In order to overcome this drawback of AHP, we utilized ANP for solving the problem. Figure 2 presents a sample of an ANP network.

Phase 2: Calculate the weight of problem’s elements as follows:

- Step 2.1. The interval-valued comparison matrices should be constructed according to each expert and then aggregate experts’ matrices by using Equation (1).

In this step, we compare criteria according to overall goals, sub-criteria according to criteria, and alternatives according to criteria. In addition, the interdependencies among problem’s elements must be pair-wisely compared. The 9-point scale of Saaty [53] was used to represent comparisons in traditional ANP.

In our research, we used the interval-valued neutrosophic numbers for clarifying pair-wise comparisons as presented in Table 1, and these values returned to authors’ opinions. When comparing alternative 1 with alternative 2, and the first alternative was “Very strongly significant” than second one, then the truth degree is high and indeterminacy degree is very small because the term “Very strongly important” means that the decision makers are very confident of comparison

results in a large percentage. Therefore, we represented this linguistic term using interval-neutrosophic number equals $([0.8, 0.9], [0.0, 0.1], [0.0, 0.1])$, as it appears in Table 1. All other values in Table 1 were scaled with the same approach.

Step 2.2. Use the de-neutrosophication function for transforming the interval-valued neutrosophic numbers to crisp numbers as in Equation (2).

Step 2.3. Use super decision software, which is available here (<http://www.superdecisions.com/downloads/>) to check the consistency of comparison matrices.

Step 2.4. Calculate the eigenvectors for determining weight that will be used in building a super-matrix.

Step 2.5. The super-matrix of interdependencies should be constructed after then.

Step 2.6. Multiply the local weight, which was obtained from experts' comparison matrices of criteria according to goal, by the weight of interdependence matrix of criteria for calculating global weight of criteria. In addition, calculate the global weights of sub-criteria by multiplying its local weight by the inner interdependent weight of the criterion to which it belongs.

Table 1. The interval-valued neutrosophic scale for comparison matrix.

Linguistic Variables	Interval-Valued Neutrosophic Numbers for Relative Importance $\langle T, I, F \rangle$
Evenly significant	$([0.5,0.5], [0.5,0.5], [0.5,0.5])$
Low significant	$([0.4,0.5], [0.1,0.2], [0.2,0.3])$
Basically important	$([0.6,0.7], [0.0,0.1], [0.0,0.1])$
Very strongly significant	$([0.8,0.9], [0.0,0.1], [0.0,0.1])$
Absolutely significant	$([1,1], [0.0,0.1], [0.0,0.0])$
Intermediate values	$([0.3,0.4], [0.1,0.2], [0.6,0.7]),$ $([0.6,0.7], [0.1,0.2], [0.0,0.1]),$ $([0.7,0.8], [0.0,0.1], [0.0,0.1]),$ $([0.9,1], [0.0,0.1], [0.0,0.1]).$

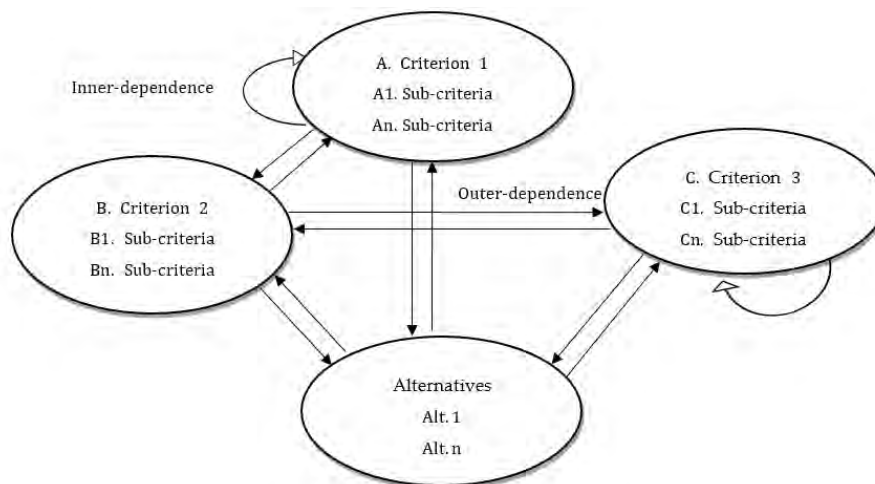

Figure 2. An example of ANP interdependencies.

Phase 3: Rank alternatives of problems.

Step 3.1. Make the evaluation matrix, and then a normalization process must be performed for obtaining the normalized evaluation matrix using Equation (3).

Step 3.2. Multiply criteria's weights, which was obtained from ANP by the normalized evaluation matrix as in Equation (4) to construct the weighted matrix.

Step 3.4. Determine positive and negative ideal solutions using Equations (5) and (6).

Step 3.5. Calculate the Euclidean distance between positive solution (d_i^+) and negative ideal solution (d_i^-) using Equations (7) and (8).

Step 3.6. Make the final ranking of alternatives based on closeness coefficient.

Phase 4: Compare the proposed method with other existing methods for validating it. The framework of the suggested method is presented in Figure 3.

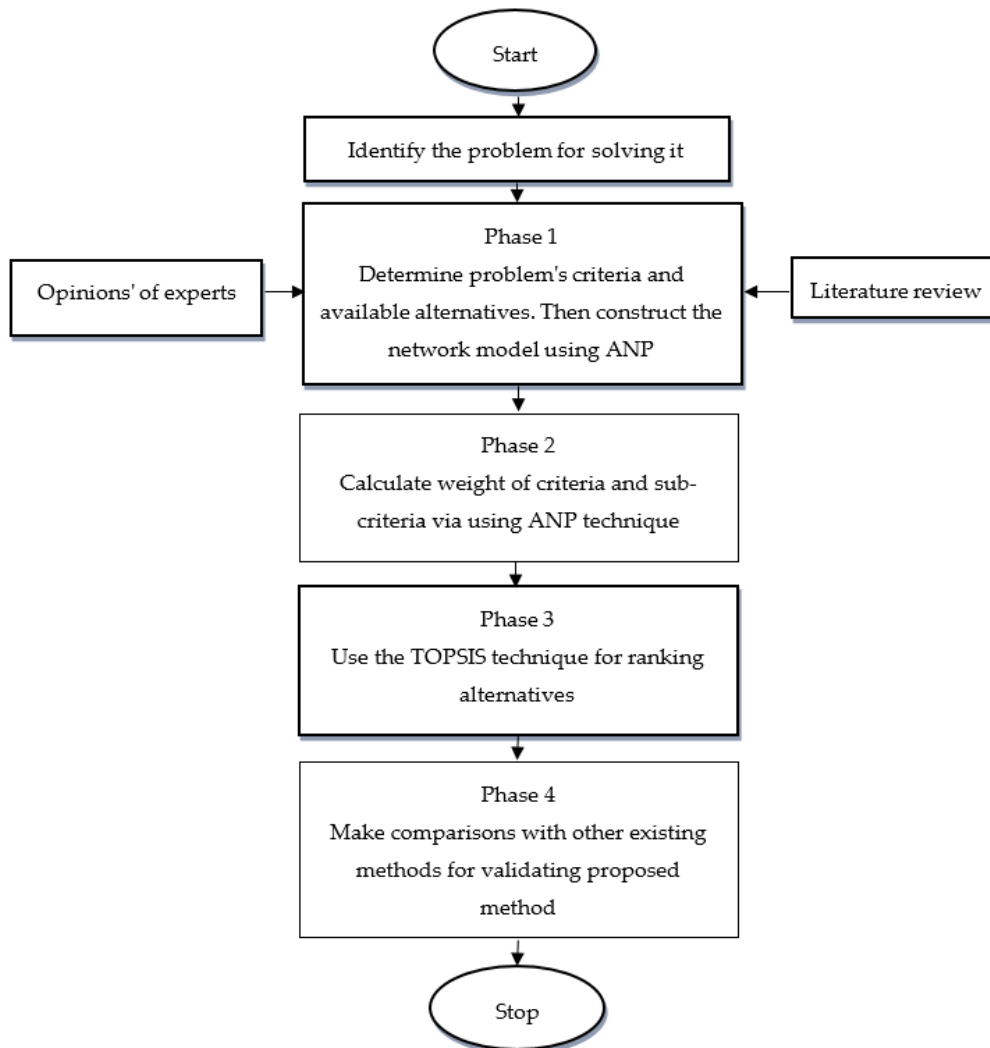

Figure 3. The framework’s proposed phases.

6. The Case Study: Results and Analysis

The proposed framework has been applied to a real sustainable supplier selection problem, and the results are analyzed in this section.

An Egyptian dairy and foodstuff corporation was founded in 1999 and is based in 10th of Ramadan City, Egypt. The corporation products include cream and skimmed milk, flavored milk, juice nectars, junior milk and juices, and tomato paste. The procurement department of the corporation is responsible for providing the required raw materials with the lowest possible cost, and purchasing corporation’s required equipment. The types of equipment are material-handling, laboratory, technical parts and machinery. The procurement department supplies packaging pure materials, pure materials and manufacturing technology. The dairy and foodstuff corporation must evaluate available suppliers and their sustainability to improve their productivity and be more competitive. Therefore, improving a system to assess and identify the superior suppliers is a significant component of this corporation’s objectives. The corporation consulted the executive manager and asked three experts to help in gathering required information for this study. The experts are in marketing, manufacturing and strategy with more than five years of experience. There are four suppliers, denoted in this study by $A_1 \dots A_4$.

Phase 1: Breakdown the complex problem for understanding it better.

The criteria and available suppliers which are relevant to our case study are identified from the literature review. The experts vote to confirm the information. The criteria, sub-criteria and available suppliers are presented in Figure 4. In order to determine how criteria and sub-criteria influence each other and correlate, for being able to apply the ANP and weighting them, we interviewed the experts.

Phase 2: Calculate the weights of problem elements.

The verdicts of experts were applied through using the interval-valued neutrosophic numbers in Table 1. We used interval-valued neutrosophic numbers because they are more realistic and accurate than crisp values, and can deal efficiently and effectively with vague and inconsistent information.

Let experts express their judgments by constructing the pairwise comparison matrices using the presented scale in Table 1—after that, aggregate comparison matrices using Equation (1). The aggregated comparison matrices of experts are presented in Tables 2–11.

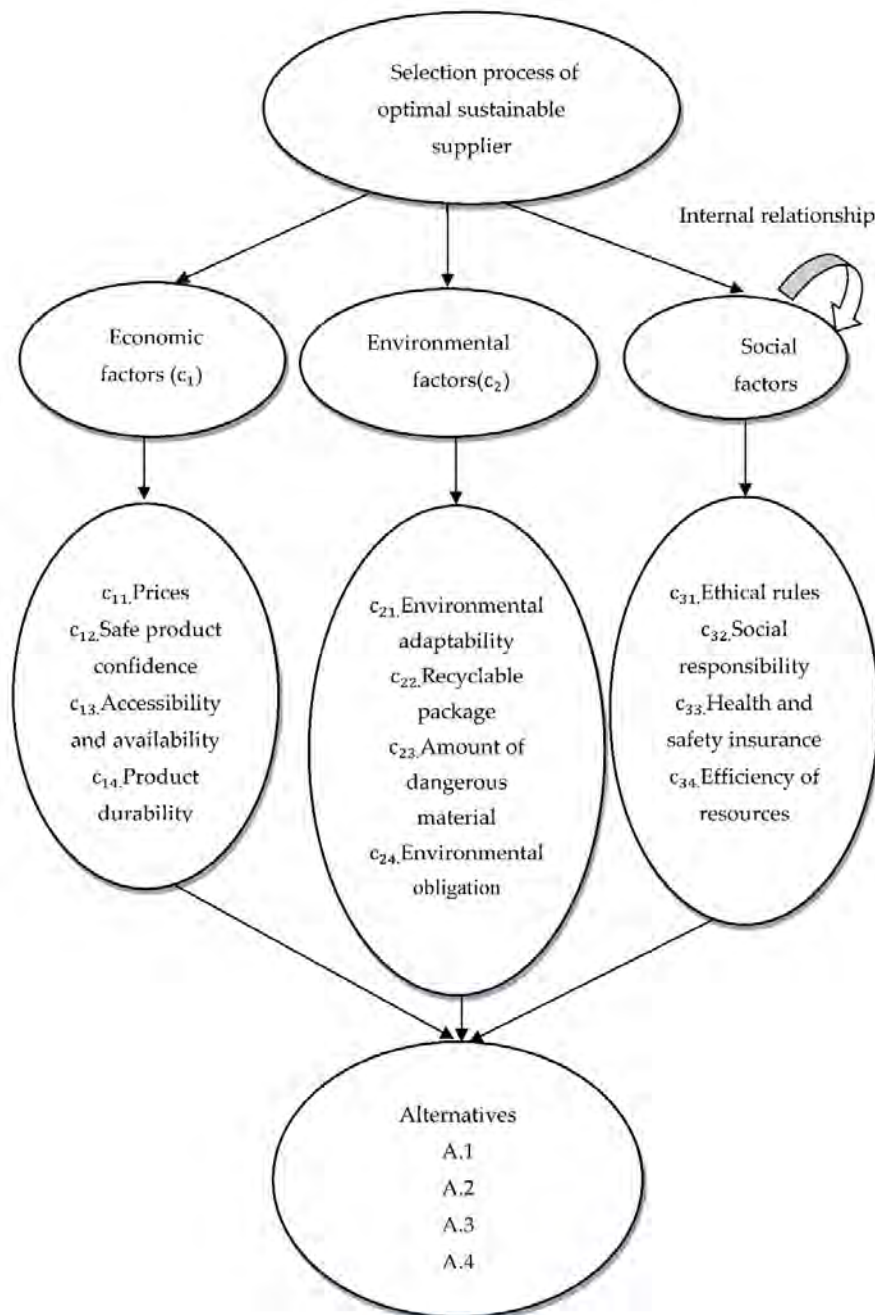

Figure 4. Hierarchy for dairy and foodstuff corporation to select the optimal supplier.

Table 2. The pairwise comparison matrix of criteria with respect to goal.

Goal	C_1	C_2	C_3
C_1	[0.5,0.5], [0.5,0.5], [0.5,0.5]	[0.3,0.4], [0.1,0.2], [0.6,0.7]	[0.7,0.8], [0.0,0.1], [0.0,0.1]
C_2		[0.5,0.5], [0.5,0.5], [0.5,0.5]	[0.6,0.7], [0.1,0.2], [0.0,0.1]
C_3			[0.5,0.5], [0.5,0.5], [0.5,0.5]

By using the deneutrosophication function through Equation (2), we will obtain the crisp matrix of comparison as in Table 3.

Table 3. The equivalent crisp matrix of criteria with respect to goal.

Goal	C_1	C_2	C_3	Weights
C_1	1	2	6	0.59
C_2	0.5	1	4	0.32
C_3	0.17	0.25	1	0.09

By checking consistency of the previous matrix using super decision software, we noted that the matrix is consistent with consistency ratio (CR) = 1%.

The inner interdependency of main criteria according to C_1 is presented in Table 4.

Table 4. Internal interdependencies of criteria with respect to C_1 .

C_1	C_2	C_3
C_2	[0.5,0.5], [0.5,0.5], [0.5,0.5]	[0.7,0.8], [0.0,0.1], [0.0,0.1]
C_3		[0.5,0.5], [0.5,0.5], [0.5,0.5]

Table 5. The crisp interdependencies values of factors with respect to C_1 .

C_1	C_2	C_3	Weights
C_2	1	6	0.86
C_3	0.17	1	0.14

Table 6. Internal interdependencies of criteria with respect to C_2 .

C_2	C_1	C_3
C_1	[0.5,0.5], [0.5,0.5], [0.5,0.5]	[0.6,0.7], [0.1,0.2], [0.0,0.1]
C_3		[0.5,0.5], [0.5,0.5], [0.5,0.5]

Table 7. The crisp interdependencies values of factors with respect to C_2 .

C_2	C_1	C_3	Weights
C_1	1	4	0.8
C_3	0.25	1	0.2

Table 8. Internal interdependencies of criteria with respect to C_3 .

C_3	C_1	C_2
C_1	[0.5,0.5], [0.5,0.5], [0.5,0.5]	[1,1], [0.0,0.1], [0.0,0.0]
C_2		[0.5,0.5], [0.5,0.5], [0.5,0.5]

Table 9. The crisp interdependencies values of factors with respect to C_3 .

C_3	C_1	C_2	Weights
C_1	1	9	0.9
C_2	0.11	1	0.1

Table 10. The relative impact of decision criteria.

	C_1	C_2	C_3
C_1	1	0.8	0.9
C_2	0.86	1	0.1
C_3	0.14	0.2	1

Table 11. The normalized relative impact of decision criteria.

	C_1	C_2	C_3
C_1	0.5	0.4	0.45
C_2	0.43	0.5	0.05
C_3	0.07	0.1	0.5

Then, the weights of decision criteria based on their inner interdependencies are as follows:

$$w_{criteria} = \begin{bmatrix} \text{economical} \\ \text{environmental} \\ \text{social} \end{bmatrix} = \begin{bmatrix} 0.5 & 0.4 & 0.45 \\ 0.43 & 0.5 & 0.05 \\ 0.07 & 0.1 & 0.5 \end{bmatrix} \times \begin{bmatrix} 0.59 \\ 0.32 \\ 0.09 \end{bmatrix} = \begin{bmatrix} 0.46 \\ 0.42 \\ 0.12 \end{bmatrix}.$$

It is obvious that the economic factors are the most significant factors when evaluating suppliers, followed by environmental and social factors, according to experts' opinions.

We should also note the influence of inner interdependencies of criteria on its weights. It changed the weights of main criteria from (0.59, 0.32, 0.09) to (0.46, 0.42, 0.12).

The comparison matrices and local weights of sub-criteria relevant to their clusters are expressed in Tables 12–17.

Table 12. The comparison matrix and local weight of C_1 indicators.

C_1	C_{11}	C_{12}	C_{13}	C_{14}
C_{11}	[0.5,0.5], [0.5,0.5], [0.5,0.5]	[0.4,0.5], [0.1,0.2], [0.2,0.3]	[0.6,0.7], [0.1,0.2], [0.0,0.1]	[0.6,0.7], [0.0,0.1], [0.0,0.1]
C_{12}		[0.5,0.5], [0.5,0.5], [0.5,0.5]	[0.3,0.4], [0.1,0.2], [0.6,0.7]	[0.6,0.7], [0.1,0.2], [0.0,0.1]
C_{13}			[0.5,0.5], [0.5,0.5], [0.5,0.5]	[0.3,0.4], [0.1,0.2], [0.6,0.7]
C_{14}				[0.5,0.5], [0.5,0.5], [0.5,0.5]

Table 13. The crisp comparison matrix and local weight of C_1 indicators.

	C_1	C_{11}	C_{12}	C_{13}	C_{14}	Weights
C_{11}	1	3	4	5	0.54	
C_{12}	0.33	1	2	4	0.23	
C_{13}	0.25	0.50	1	2	0.13	
C_{14}	0.20	0.25	0.5	1	0.08	

The consistency ratio (CR) of previous matrix = 0.03.

Table 14. The comparison matrix and local weight of C_2 indicators.

C_2	C_{21}	C_{22}	C_{23}	C_{24}
C_{21}	[0.5,0.5], [0.5,0.5], [0.5,0.5]	[0.4,0.5], [0.1,0.2], [0.2,0.3]	[0.8,0.9], [0.0,0.1], [0.0,0.1]	[1,1], [0.0,0.1], [0.0,0.0]
C_{22}		[0.5,0.5], [0.5,0.5], [0.5,0.5]	[0.6,0.7], [0.0,0.1], [0.0,0.1]	[0.8,0.9], [0.0,0.1], [0.0,0.1]
C_{23}			[0.5,0.5], [0.5,0.5], [0.5,0.5]	[0.3,0.4], [0.1,0.2], [0.6,0.7]
C_{24}				[0.5,0.5], [0.5,0.5], [0.5,0.5]

Table 15. The crisp comparison matrix and local weight of C_2 indicators.

	C_2	C_{21}	C_{22}	C_{23}	C_{24}	Weights
C_{21}	1	3	7	9	0.59	
C_{22}	0.33	1	5	7	0.29	
C_{23}	0.14	0.20	1	2	0.08	
C_{24}	0.11	0.14	0.50	1	0.05	

The consistency ratio (CR) of previous matrix = 0.04.

Table 16. The comparison matrix and local weight of C_3 indicators.

C_3	C_{31}	C_{32}	C_{33}	C_{34}
C_{31}	[0.5,0.5], [0.5,0.5], [0.5,0.5]	[0.3,0.4], [0.1,0.2], [0.6,0.7]	[0.4,0.5], [0.1,0.2], [0.2,0.3]	[1,1], [0.0,0.1], [0.0,0.0]
C_{32}		[0.5,0.5], [0.5,0.5], [0.5,0.5]	[0.3,0.4], [0.1,0.2], [0.6,0.7]	[0.7,0.8], [0.0,0.1], [0.0,0.1]
C_{33}			[0.5,0.5], [0.5,0.5], [0.5,0.5]	[0.4,0.5], [0.1,0.2], [0.2,0.3]
C_{34}				[0.5,0.5], [0.5,0.5], [0.5,0.5]

Table 17. The crisp comparison matrix and local weight of C_3 indicators.

C_3	C_{31}	C_{32}	C_{33}	C_{34}	Weights
C_{31}	1	2	3	9	0.50
C_{32}	0.50	1	2	6	0.29
C_{33}	0.33	0.50	1	3	0.15
C_{34}	0.11	0.17	0.33	1	0.05

The consistency ratio (CR) of previous matrix = 0.004.

Each sub-criteria global weight is calculated via multiplying its local weight by the inner interdependent weight of the criterion to which it belongs as in Table 18.

Table 18. The sub-criteria global weights.

Criteria	Local Weight	Sub-Criteria	Local Weight	Global Weight
Economic factors (0.46)		C_{11}	0.54	0.25
		C_{12}	0.23	0.11
		C_{13}	0.13	0.06
		C_{14}	0.08	0.04
Environmental factors (0.42)		C_{21}	0.59	0.25
		C_{22}	0.29	0.12
		C_{23}	0.08	0.03
		C_{24}	0.05	0.02
Social factors (0.12)		C_{31}	0.50	0.06
		C_{32}	0.29	0.03
		C_{33}	0.15	0.02
		C_{34}	0.05	0.006

Phase 3: Rank alternatives of problems.

Let each expert build the evaluation matrix via comparing the four alternatives relative to each criterion, by utilizing the interval-valued scale, which is presented in Table 1. After that, use Equation (1) to aggregate the evaluation matrices and obtain the final evaluation matrix relevant to experts' committee. Proceed to denetrosophication function to convert the interval-valued neutrosophic evaluation matrix to its crisp form using Equation (2). Then, make a normalization process to obtain the normalized evaluation matrix using Equation (3), as observed in Table 19.

Table 19. The normalized evaluation matrix.

	C_{11}	C_{12}	C_{13}	C_{14}	C_{21}	C_{22}	C_{23}	C_{24}	C_{31}	C_{32}	C_{33}	C_{34}
A_1	0.53	0.46	0.46	0.43	0.52	0.54	0.45	0.58	0.48	0.59	0.59	0.51
A_2	0.46	0.58	0.53	0.48	0.43	0.58	0.59	0.52	0.54	0.54	0.46	0.64
A_3	0.44	0.43	0.56	0.53	0.49	0.45	0.36	0.46	0.49	0.38	0.47	0.47
A_4	0.56	0.52	0.43	0.55	0.54	0.41	0.56	0.43	0.48	0.45	0.46	0.32

Then, build the weighted matrix by multiplying the weights of criteria, obtained from ANP by the normalized evaluation matrix using Equation (4), as in Table 20.

Table 20. The weighted evaluation matrix.

	C_{11}	C_{12}	C_{13}	C_{14}	C_{21}	C_{22}	C_{23}	C_{24}	C_{31}	C_{32}	C_{33}	C_{34}
A_1	0.13	0.05	0.03	0.02	0.13	0.06	0.01	0.01	0.03	0.02	0.01	0.003
A_2	0.11	0.06	0.03	0.02	0.11	0.07	0.02	0.01	0.03	0.02	0.01	0.004
A_3	0.11	0.05	0.03	0.02	0.12	0.05	0.01	0.01	0.03	0.01	0.01	0.003
A_4	0.14	0.06	0.03	0.02	0.13	0.05	0.02	0.01	0.03	0.01	0.01	0.002

Determine the ideal solutions using Equations (5) and (6) as follows:

$$A^+ = \{0.14, 0.06, 0.03, 0.02, 0.13, 0.07, 0.02, 0.01, 0.03, 0.02, 0.01, 0.004\},$$

$$A^- = \{0.11, 0.05, 0.03, 0.02, 0.11, 0.05, 0.01, 0.01, 0.03, 0.01, 0.01, 0.002\}.$$

After that, measure the Euclidean distance between positive solution (d_i^+) and negative ideal solution (d_i^-) using Equations (7) and (8) as follows:

$$d_1^+ = \{0.020\}, d_2^+ = \{0.036\}, d_3^+ = \{0.041\}, d_4^+ = \{0.022\},$$

$$d_1^- = \{0.032\}, d_2^- = \{0.026\}, d_3^- = \{0.010\}, d_4^- = \{0.040\}.$$

Step 3.7. Calculate the closeness coefficient using Equation (9), and make the final ranking of alternatives as in Table 21.

Table 21. TOPSIS results and ranking of alternatives.

	d_i^+	d_i^-	c_i	Rank
A_1	0.020	0.032	0.615	2
A_2	0.036	0.026	0.419	3
A_3	0.041	0.010	0.196	4
A_4	0.022	0.040	0.645	1

The ranking for the optimal sustainable suppliers of dairy and foodstuff corporation is Alternative 4, Alternative 1, Alternative 2 and Alternative 3, as shown in Figure 5.

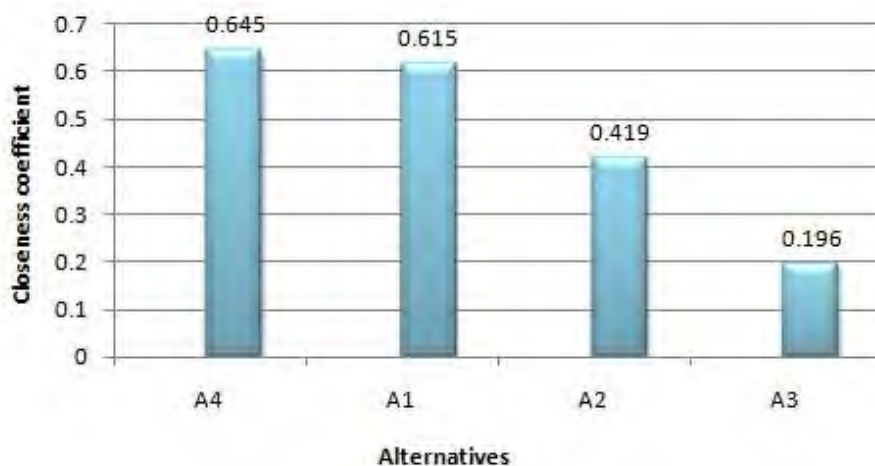

Figure 5. The ranking for the optimal alternatives of dairy and foodstuff corporation.

Phase 4: Validate the model and make comparisons with other existing methods.

In this phase, the obtained ranking of optimal suppliers by the proposed framework is compared with the obtained results by the analytic hierarchy process, the analytic network process, MOORA and MOOSRA techniques.

The obtained ranking of suppliers by using an AHP technique is as follows:

Since AHP does not consider inner interdependency between problem’s elements, then weights of sub-criteria are as follows:

$$\begin{bmatrix} 0.32 \\ 0.14 \\ 0.08 \\ 0.47 \\ 0.19 \\ 0.09 \\ 0.03 \\ 0.02 \\ 0.04 \\ 0.03 \\ 0.01 \\ 0.00 \end{bmatrix}$$

The comparison matrix of alternatives relevant to each sub-criterion is as follows:

$$\begin{bmatrix} 0.53 & 0.46 & 0.46 & 0.43 & 0.52 & 0.54 & 0.45 & 0.58 & 0.48 & 0.59 & 0.59 & 0.51 \\ 0.46 & 0.58 & 0.53 & 0.48 & 0.43 & 0.58 & 0.59 & 0.52 & 0.54 & 0.54 & 0.46 & 0.64 \\ 0.44 & 0.43 & 0.56 & 0.53 & 0.49 & 0.45 & 0.36 & 0.46 & 0.49 & 0.38 & 0.47 & 0.47 \\ 0.56 & 0.52 & 0.43 & 0.55 & 0.54 & 0.41 & 0.56 & 0.43 & 0.48 & 0.45 & 0.46 & 0.32 \end{bmatrix}$$

The final weights of alternatives after multiplying two previous matrices and making normalization of results are as in Table 22.

Table 22. Ranking alternatives relevant to AHP.

Alternatives	Weights	Rank
A_1	0.245	3
A_2	0.250	2
A_3	0.244	4
A_4	0.267	1

Our proposed framework and the analytic hierarchy process agreed that the Alternative 3 is the worst alternative for the company. The two methods are different in ranking the optimal alternative due to the inner interdependencies between the problem’s criteria effect on the global weight of alternatives, and, in our case study, it reduced weights of main criteria from (0.59, 0.32, 0.09) to (0.46, 0.42, 0.12), and this surely regarded the global weight of sub-criteria and also ranking of alternatives.

The weights of sub-criteria when we applied the analytic network process are as follows (see also Table 18):

$$\begin{bmatrix} 0.25 \\ 0.11 \\ 0.06 \\ 0.04 \\ 0.25 \\ 0.12 \\ 0.03 \\ 0.02 \\ 0.06 \\ 0.03 \\ 0.02 \\ 0.006 \end{bmatrix}$$

In addition, the comparison matrix of alternatives relevant to each sub-criterion is as follows:

$$\begin{bmatrix} 0.53 & 0.46 & 0.46 & 0.43 & 0.52 & 0.54 & 0.45 & 0.58 & 0.48 & 0.59 & 0.59 & 0.51 \\ 0.46 & 0.58 & 0.53 & 0.48 & 0.43 & 0.58 & 0.59 & 0.52 & 0.54 & 0.54 & 0.46 & 0.64 \\ 0.44 & 0.43 & 0.56 & 0.53 & 0.49 & 0.45 & 0.36 & 0.46 & 0.49 & 0.38 & 0.47 & 0.47 \\ 0.56 & 0.52 & 0.43 & 0.55 & 0.54 & 0.41 & 0.56 & 0.43 & 0.48 & 0.45 & 0.46 & 0.32 \end{bmatrix}$$

After proceeding to the normalization process, the ranking of alternatives relevant to the ANP technique is presented in Table 23.

Table 23. Ranking alternatives relevant to ANP.

Alternatives	Weights	Rank
A_1	0.26	1
A_2	0.25	2
A_3	0.23	3
A_4	0.26	1

By using the ANP technique for solving the same case study, we noted that Alternative 1 and Alternative 4 have the same rank and are the best alternatives, followed by Alternative 2 and finally Alternative 3. The proposed framework and the ANP agreed that Alternative 3 is the worst alternative.

We not only used the AHP and ANP techniques for solving the case study of a dairy and foodstuff corporation, but also two other multi-objective decision-making techniques.

The first technique is the multi-objective optimization based on simple ratio analysis (MOORA), proposed by Brauers and Zavadskas [54]. There are two approaches under the MOORA: the ratio system and the reference point approaches [53]. Here, we used the ratio system method of the MOORA to validate our proposed framework.

The normalized weighted matrix and ranking of alternatives using the MOORA technique are presented in Tables 24 and 25. The equations that we used in our calculation of MOORA normalized weighted matrix, and the equations that we employed in the ranking process are available with details in [53].

Table 24. The weighted normalized matrix under the MOORA technique.

	C_{11}	C_{12}	C_{13}	C_{14}	C_{21}	C_{22}	C_{23}	C_{24}	C_{31}	C_{32}	C_{33}	C_{34}
A_1	0.13	0.05	0.03	0.02	0.13	0.06	0.01	0.01	0.03	0.02	0.01	0.003
A_2	0.11	0.06	0.03	0.02	0.11	0.07	0.02	0.01	0.03	0.02	0.01	0.004
A_3	0.11	0.05	0.03	0.02	0.12	0.05	0.01	0.01	0.03	0.01	0.01	0.003
A_4	0.14	0.06	0.03	0.02	0.13	0.05	0.02	0.01	0.03	0.01	0.01	0.002

Table 25. The ranking of alternatives using the MOORA technique.

	$\sum_{j=1}^g x_{ij}^*$	$\sum_{j=g+1}^n x_{ij}^*$	p_i^*	Ranking
A_1	0.43	0.073	0.357	2
A_2	0.41	0.084	0.326	4
A_3	0.39	0.063	0.327	3
A_4	0.44	0.072	0.368	1

The fourth column in Table 25 is the index of the total performance p_i^* and equals the difference between beneficial criteria summation and non-beneficial criteria summation. The beneficial and non-beneficial criteria were determined according to experts' weights of criteria. In other words, the total performance p_i^* is the difference between the second column and third column values in Table 25.

The other technique we applied to the same case study for validating our proposed framework is MOOSRA. The MOOSRA technique determines the simple ratio of beneficial and non-beneficial criteria. The MOOSRA is a multi-objective optimization technique. The steps of the MOOSRA technique are similar to the MOORA technique, except in calculating total performance index p_i^* . For more details, see [53]. The ranking of alternatives using MOOSRA technique is presented in Table 26.

Table 26. The ranking of alternatives using the MOOSRA technique.

	$\sum_{j=1}^g x_{ij}^*$	$\sum_{j=g+1}^n x_{ij}^*$	p_i^*	Ranking
A_1	0.43	0.073	5.89	3
A_2	0.41	0.084	4.88	4
A_3	0.39	0.063	6.19	1
A_4	0.44	0.072	6.11	2

The ranking of suppliers using the proposed framework and the other four techniques are aggregated in Table 27. The correlation coefficient between the proposed framework and other techniques is presented in Table 28; we calculated it using Microsoft Excel (version, Manufacturer, City, US State abbrev. if applicable, Country) by using the CORREL() function.

Table 27. The ranking of alternatives relevant to various applied techniques.

Suppliers	Proposed Technique (1)	AHP (2)	ANP (3)	MOORA (4)	MOOSRA (5)
A_1	2	3	1	2	3
A_2	3	2	2	4	4
A_3	4	4	3	3	1
A_4	1	1	1	1	2

Table 28. The correlation coefficients between the proposed model and other applied techniques.

Correlation (1, 2)	Correlation (1, 3)	Correlation (1, 4)	Correlation (1, 5)
0.8	0.9	0.8	0.2

The proposed framework and the first three applied techniques (i.e., AHP, ANP, MOORA) agreed that Alternative 4 is the best alternative. The correlation coefficients help to measure the efficiency of various MCDM techniques. The correlation coefficients between our proposed framework and AHP, ANP, MOORA are very high, as shown in Table 28. The high value of Spearman correlation coefficients reflects the high consistency and validity of the proposed framework. However, the correlation coefficient between our proposed model and MOOSRA is low. Our framework is valid and consistent because the proposed framework and the first three applied techniques agreed that Alternative 4 is the optimal supplier for the dairy and foodstuff corporation.

7. Conclusions and Future Directions

For solving the sustainable supplier selection problem, many steps must be performed: the sustainability criteria must be determined; the interdependencies between these criteria must be identified—ranking and evaluating supplier performance. For more accuracy, we have suggested a framework consisting of four phases, by integrating ANP with TOPSIS using the interval-valued neutrosophic numbers. The ANP is used to weight problem criteria and sub-criteria because of its capability to consider interdependencies between problem’s elements. The TOPSIS is used to rank available suppliers for avoiding additional comparisons of analytic network process. The suggested method provides a reliable and easy to implement procedure, which is suitable for a broad range of real life applications. A case study of a dairy and foodstuff corporation has been solved employing the proposed framework. The dairy corporation trying to earn an important market share and competitive benefits faces competition from other corporations. The objectives of food corporation are to improve the green food process, to get the standard certificate. Many customers consider the ISO standard as a priority for them. Suppliers are a great part of the production process; consequently, they must be sorted and analyzed carefully using efficient framework. The selection process of experts is not an easy matter. Therefore, the provided data and information from experts must be more accurate; otherwise, it will affect the selection process of optimal suppliers. Because real life has a great amount of vague and inconsistent information and surely affects experts’

judgment, we presented our suggested framework using interval-valued neutrosophic numbers. Neutrosophic sets make a simulation of natural decision-making process, since it considers all aspects of making a decision (i.e., agree, not sure and falsity). In the future, we plan to solve the sustainable supplier selection problem with more difficult and complex dependencies between criteria using different multi-criteria decision-making techniques and presenting them in a neutrosophic environment using the alpha cut method.

References

1. Amindoust, A.; Ahmed, S.; Saghafia, A.; Bahreininejad, A. Sustainable supplier selection: A ranking model based on fuzzy inference system. *Appl. Soft Comput.* **2012**, *12*, 1668–1677.
2. Abdel-Basset, M.; Manogaran, G.; Mohamed, M. Internet of Things (IoT) and its impact on supply chain: A framework for building smart, secure and efficient systems. *Future Gener. Comput. Syst.* **2018**, in press.
3. Lin, C.-Y.; Ho, Y.-H. Determinants of green practice adoption for logistics companies in China. *J. Bus. Ethics* **2011**, *98*, 67–83.
4. Carter, C.R.; Easton, P.L. Sustainable supply chain management: Evolution and future directions. *Int. J. Phys. Distrib. Logist. Manag.* **2011**, *41*, 46–62.
5. El-Hefenawy, N.; Metwally, M.A.; Ahmed, Z.M.; El-Henawy, I.M. A review on the applications of neutrosophic sets. *J. Comput. Theor. Nanosci.* **2016**, *13*, 1, 936–944.
6. Zadeh, L.A. Information and control. *Fuzzy Sets* **1965**, *8*, 338–353.
7. Turksen, I.B. Interval valued fuzzy sets based on normal forms. *Fuzzy Sets Syst.* **1986**, *20*, 191–210.
8. Atanassov, K.T. Intuitionistic fuzzy sets. *Fuzzy Sets Syst.* **1986**, *20*, 87–96.
9. Atanassov, K.; Gargov, G. Interval valued intuitionistic fuzzy sets. *Fuzzy Sets Syst.* **1989**, *31*, 343–349.
10. Liu, H.-W.; Wang, G.-J. Multi-criteria decision-making methods based on intuitionistic fuzzy sets. *Eur. J. Oper. Res.* **2007**, *179*, 220–233.
11. Pei, Z.; Zheng, L. A novel approach to multi-attribute decision-making based on intuitionistic fuzzy sets. *Expert Syst. Appl.* **2012**, *39*, 2560–2566.
12. Chen, T.-Y. An outcome-oriented approach to multicriteria decision analysis with intuitionistic fuzzy optimistic/pessimistic operators. *Expert Syst. Appl.* **2010**, *37*, 7762–7774.
13. Wang, H.; Smarandache, F.; Zhang, Y.; Sunderraman, R. *Single Valued Neutrosophic Sets*; Review of the Air Force Academy: Colorado Springs, CO, USA, 2010; p. 10.
14. Smarandache, F. *Neutrosophy: A Unifying Field in Logics: Neutrosophic Logic. Neutrosophy, Neutrosophic Set, Neutrosophic Probability*; American Research Press: Santa Fe, NM, USA, 1999.
15. Abdel-Basset, M.; Mohamed, M.; Smarandache, F.; Chang, V. Neutrosophic Association Rule Mining Algorithm for Big Data Analysis. *Symmetry* **2018**, *10*, 106.
16. Abdel-Basset, M.; Mohamed, M.; Smarandache, F. An Extension of Neutrosophic AHP–SWOT Analysis for Strategic Planning and Decision-Making. *Symmetry* **2018**, *10*, 116.
17. Zhang, H.-Y.; Wang, J.-Q.; Chen, X.-H. Interval neutrosophic sets and their application in multicriteria decision-making problems. *Sci. World J.* **2014**, *2014*, doi:10.1155/2014/645953.
18. Majumdar, P.; Samanta, S.K. On similarity and entropy of neutrosophic sets. *J. Intell. Fuzzy Syst.* **2014**, *26*, 1245–1252.
19. Wang, H.; Smarandache, F.; Zhang, Ya.; Sunderraman, R. *Interval Neutrosophic Sets and Logic: Theory and Applications in Computing*; Hexis: Phoenix, AZ, USA, 2005.
20. Broumi, S.; Smarandache, F. Single Valued Neutrosophic Trapezoid Linguistic Aggregation Operators Based Multi-Attribute Decision Making. *Bull. Pure Appl. Sci.-Math.* **2014**, *33*, 135–155.

21. Zhang, H.; Wang, J.; Chen, X. An outranking approach for multi-criteria decision-making problems with interval-valued neutrosophic sets. *Neural Comput. Appl.* **2016**, *27*, 615–627.
22. Govindan, K.; Khodaverdi, R.; Jafarian, A. A fuzzy multi criteria approach for measuring sustainability performance of a supplier based on triple bottom line approach. *J. Clean. Prod.* **2013**, *47*, 345–354.
23. Erol, I.; Sencer, S.; Sari, R. A new fuzzy multi-criteria framework for measuring sustainability performance of a supply chain. *Ecol. Econ.* **2011**, *70*, 1088–1100.
24. Wen, L.; Xu, L.; Wang, R. Sustainable supplier evaluation based on intuitionistic fuzzy sets group decision methods. *J. Inf. Comput. Sci.* **2013**, *10*, 3209–3220.
25. Orji, I.; Wei, S. A decision support tool for sustainable supplier selection in manufacturing firms. *J. Ind. Eng. Manag.* **2014**, *7*, 1293.
26. Shaw, K.; Shankar, R.; Yadav, S.S.; Thakur, L.S. Supplier selection using fuzzy AHP and fuzzy multi-objective linear programming for developing low carbon supply chain. *Expert Syst. Appl.* **2012**, *39*, 8182–8192.
27. Büyüközkan, G.; Çifçi, G. A novel fuzzy multi-criteria decision framework for sustainable supplier selection with incomplete information. *Comput. Ind.* **2011**, *62*, 164–174.
28. Ho, W.; He, T.; Lee, C.K.M.; Emrouznejad, A. Strategic logistics outsourcing: An integrated QFD and fuzzy AHP approach. *Expert Syst. Appl.* **2012**, *39*, 10841–10850.
29. Dursun, M.; Karsak, E.E. A QFD-based fuzzy MCDM approach for supplier selection. *Appl. Math. Model.* **2013**, *37*, 5864–5875.
30. Dai, J.; Blackhurst, J. A four-phase AHP-QFD approach for supplier assessment: A sustainability perspective. *Int. J. Prod. Res.* **2012**, *50*, 5474–5490.
31. Kumar, A.; Jain, V.; Kumar, S. A comprehensive environment friendly approach for supplier selection. *Omega* **2014**, *42*, 109–123.
32. Azadi, M.; Jafarian, M.; Saen, R.F.; Mirhedayatian, S.M. A new fuzzy DEA model for evaluation of efficiency and effectiveness of suppliers in sustainable supply chain management context. *Comput. Oper. Res.* **2015**, *54*, 274–285.
33. Choy, K.L.; Lee, W.; Lo, V. An enterprise collaborative management system—A case study of supplier relationship management. *J. Enterp. Inf. Manag.* **2004**, *17*, 191–207.
34. Bhattacharya, A.; Geraghty, J.; Young, P. Supplier selection paradigm: An integrated hierarchical QFD methodology under multiple-criteria environment. *Appl. Soft Comput.* **2010**, *10*, 1013–1027.
35. Amin, S.H.; Razmi, J.; Zhang, G. Supplier selection and order allocation based on fuzzy SWOT analysis and fuzzy linear programming. *Expert Syst. Appl.* **2011**, *38*, 334–342.
36. Rajesh, G.; Malliga, P. Supplier selection based on AHP QFD methodology. *Procedia Eng.* **2013**, *64*, 1283–1292.
37. Taghizadeh, H.; Ershadi, M.S.S. Selection in Supply Chain with Combined QFD and ANP Approaches (Case study). *Res. J. Recent Sci.* **2013**, *2*, 66–76.
38. Dey, P.K.; Bhattacharya, A.; Ho, W. Strategic supplier performance evaluation: A case-based action research of a UK manufacturing organisation. *Int. J. Prod. Econ.* **2015**, *166*, 192–214.
39. Bayrak, M.; Celebi, N.; Taşkin, H. A fuzzy approach method for supplier selection. *Prod. Plan. Control* **2007**, *18*, 54–63.
40. Kumaraswamy, A.H.; Bhattacharya, A.; Kumar, V.; Brady, M. An integrated QFD-TOPSIS methodology for supplier selection in SMEs. In Proceedings of the 2011 Third International Conference on Computational Intelligence, Modelling and Simulation (CIMSIM), Langkawi, Malaysia, 20–22 September 2011; pp. 271–276.
41. Wu, C.-M.; Hsieh, C.-L.; Chang, K.-L. A hybrid multiple criteria decision-making model for supplier selection. *Math. Probl. Eng.* **2013**, *2013*, doi:10.1155/2013/324283.
42. Ghorabae, M.K.; Amiri, M.; Zavadskas, E.K.; Antucheviciene, J. Supplier evaluation and selection in fuzzy environments: A review of MADM approaches. *Econ. Res.-Ekon. Istraž.* **2017**, *30*, 1073–1118.
43. Rouyendegh, B.D. Developing an integrated ANP and intuitionistic fuzzy TOPSIS model for supplier selection. *J. Test. Eval.* **2014**, *43*, 664–672.
44. Tavana, M.; Yazdani, M.; di Caprio, D. An application of an integrated ANP-QFD framework for sustainable supplier selection. *Int. J. Logist. Res. Appl.* **2017**, *20*, 254–275.
45. Şahin, R.; Yiğider, M. A Multi-criteria neutrosophic group decision-making method based TOPSIS for supplier selection. *arXiv* **2014**, arXiv:1412.5077.

46. Reddy, R.; Reddy, D.; Krishnaiah, G. Lean supplier selection based on hybrid MCGDM approach using interval valued neutrosophic sets: A case study. *Int. J. Innov. Res. Dev.* **2016**, *5*, 291–296.
47. Karaşan, A.; Kahraman, C. Interval-Valued Neutrosophic Extension of EDAS Method. In *Advances in Fuzzy Logic and Technology 2017*; Springer: Berlin, Germany, 2017; pp. 343–357.
48. Van, L.H.; Yu, V.F.; Dat, L.Q.; Dung, C.C.; Chou, S.-Y.; Loc, N.V. New Integrated Quality Function Deployment Approach Based on Interval Neutrosophic Set for Green Supplier Evaluation and Selection. *Sustainability* **2018**, *10*, 838.
49. Abdel-Basset, M.; Manogaran, G.; Gamal, A.; Smarandache, F. A hybrid approach of neutrosophic sets and DEMATEL method for developing supplier selection criteria. In *Design Automation for Embedded Systems*; Springer: Berlin, Germany, 2018; pp. 1–22.
50. Saaty, T.L. Decision making—The analytic hierarchy and network processes (AHP/ANP). *J. Syst. Sci. Syst. Eng.* **2004**, *13*, 1–35.
51. Saaty, T.L. What is the analytic hierarchy process? In *Mathematical Models for Decision Support*; Springer: Berlin, Germany, 1988; pp. 109–121.
52. Yoon, K.; Hwang, C.-L. *Multiple Attribute Decision Making: Methods and Applications*; Springer: Berlin, Germany, 1981.
53. Brauers, W.K.; Zavadskas, E.K. The MOORA method and its application to privatization in a transition economy. *Control Cybern.* **2006**, *35*, 445–469.
54. Adalı, E.A.; Işık, A.T. The multi-objective decision-making methods based on MULTIMOORA and MOOSRA for the laptop selection problem. *J. Ind. Eng. Int.* **2017**, *13*, 229–237.

An Extended Technique for Order Preference by Similarity to an Ideal Solution (TOPSIS) with Maximizing Deviation Method Based on Integrated Weight Measure for Single-Valued Neutrosophic Sets

Ganeshsree Selvachandran, Shio Gai Quek, Florentin Smarandache, Said Broumi

Ganeshsree Selvachandran, Shio Gai Quek, Florentin Smarandache, Said Broumi (2018). An Extended Technique for Order Preference by Similarity to an Ideal Solution (TOPSIS) with Maximizing Deviation Method Based on Integrated Weight Measure for Single-Valued Neutrosophic Sets. *Symmetry* 10, 236; DOI: 10.3390/sym10070236

Abstract: A single-valued neutrosophic set (SVNS) is a special case of a neutrosophic set which is characterized by a truth, indeterminacy, and falsity membership function, each of which lies in the standard interval of $[0, 1]$. This paper presents a modified Technique for Order Preference by Similarity to an Ideal Solution (TOPSIS) with maximizing deviation method based on the single-valued neutrosophic set (SVNS) model. An integrated weight measure approach that takes into consideration both the objective and subjective weights of the attributes is used. The maximizing deviation method is used to compute the objective weight of the attributes, and the non-linear weighted comprehensive method is used to determine the combined weights for each attributes. The use of the maximizing deviation method allows our proposed method to handle situations in which information pertaining to the weight coefficients of the attributes are completely unknown or only partially known. The proposed method is then applied to a multi-attribute decision-making (MADM) problem. Lastly, a comprehensive comparative studies is presented, in which the performance of our proposed algorithm is compared and contrasted with other recent approaches involving SVNSs in literature.

Keywords: Single-valued neutrosophic set; Technique for Order Preference by Similarity to an Ideal Solution (TOPSIS); integrated weight; maximizing deviation; multi-attribute decision-making (MADM)

1. Introduction

The study of fuzzy set theory proposed by Zadeh [1] was an important milestone in the study of uncertainty and vagueness. The widespread success of this theory has led to the introduction of many extensions of fuzzy sets such as the intuitionistic fuzzy set (IFS) [2], interval-valued fuzzy set (IV-FS) [3], vague set [4], and hesitant fuzzy set [5]. The most widely used among these models is the IFS model which has also spawned other extensions such as the interval-valued intuitionistic fuzzy set [6] and bipolar intuitionistic fuzzy set [7]. Smarandache [8] then introduced an improvement to IFS theory called neutrosophic set theory which loosely refers to neutral knowledge. The study of the

neutrality aspect of knowledge is the main distinguishing criteria between the theory of fuzzy sets, IFSs, and neutrosophic sets. The classical neutrosophic set (NS) is characterized by three membership functions which describe the degree of truth (T), the degree of indeterminacy (I), and the degree of falsity (F), whereby all of these functions assume values in the non-standard interval of $]0^-, 1^+[$. The truth and falsity membership functions in a NS are analogous to the membership and non-membership functions in an IFS, and expresses the degree of belongingness and non-belongingness of the elements, whereas the indeterminacy membership function expresses the degree of neutrality in the information. This additional indeterminacy membership function gives NSs the ability to handle the neutrality aspects of the information, which fuzzy sets and its extensions are unable to handle. Another distinguishing factor between NSs and other fuzzy-based models is the fact that all the three membership functions in a NS are entirely independent of one another, unlike the membership and non-membership functions in an IFS or other fuzzy-based models in which values of the membership and non-membership functions are dependent on one another. This gives NSs the ability to handle uncertain, imprecise, inconsistent, and indeterminate information, particularly in situations whereby the factors affecting these aspects of the information are independent of one another. This also makes the NS more versatile compared to IFSs and other fuzzy- or IF-based models in literature.

Smarandache [8] and Wang et al. [9] pointed out that the non-standard interval of $]0^-, 1^+[$ in which the NS is defined in, makes it impractical to be used in real-life problems. Furthermore, values in this non-standard interval are less intuitive and the significance of values in this interval can be difficult to be interpreted. This led to the conceptualization of the single-valued neutrosophic set (SVNS). The SVNS is a straightforward extension of NS which is defined in the standard unit interval of $[0, 1]$. As values in $[0, 1]$ are compatible with the range of acceptable values in conventional fuzzy set theory and IFS theory, it is better able to capture the intuitiveness of the process of assigning membership values. This makes the SVNS model easier to be applied in modelling real-life problems as the results obtained are a lot easier to be interpreted compared to values in the interval $]0^-, 1^+[$.

The SVNS model has garnered a lot of attention since its introduction in [9], and has been actively applied in various multi-attribute decision-making (MADM) problems using a myriad of different approaches. Wang et al. [9] introduced some set theoretic operators for SVNSs, and studied some additional properties of the SVNS model. Ye [10,11] introduced a decision-making algorithm based on the correlation coefficients for SVNSs, and applied this algorithm in solving some MADM problems. Ye [12,13] introduced a clustering method and also some decision-making methods that are based on the similarity measures of SVNSs, whereas Huang [14] introduced a new decision-making method for SVNSs and applied this method in clustering analysis and MADM problems. Peng and Liu [15] on the other hand proposed three decision-making methods based on a new similarity measure, the EDAS method and level soft sets for neutrosophic soft sets, and applied this new measure to MADM problems set in a neutrosophic environment. The relations between SVNSs and its properties were first studied by Yang et al. [16], whereas the graph theory of SVNSs and bipolar SVNSs were introduced by Broumi et al. in [17–19] and [20–22], respectively. The aggregation operators of simplified neutrosophic sets (SNSs) were studied by Tian et al. [23] and Wu et al. [24]. Tian et al. [23] introduced a generalized prioritized aggregation operator for SNSs and applied this operator in a MADM problem set in an uncertain linguistic environment, whereas Wu et al. [24] introduced a cross-entropy measure and a prioritized aggregation operator for SNSs and applied these in a MADM problem. Sahin and Kucuk [25] proposed a subethood measure for SVNSs and applied these to MADM problems.

The fuzzy Technique for Order Preference by Similarity to an Ideal Solution (TOPSIS) method for SVNSs were studied by Ye [26] and Biswas et al. [27]. Ye [26] introduced the TOPSIS method for group decision-making (MAGDM) that is based on single-valued neutrosophic linguistic numbers, to deal with linguistic decision-making. This TOPSIS method uses subjective weighting method whereby attribute weights are randomly assigned by the users. Maximizing deviation method or any other objective weighting methods are not used. Biswas et al. [27] proposed a TOPSIS method for group decision-making (MAGDM) based on the SVNS model. This TOPSIS method is based on the

original fuzzy TOPSIS method and does not use the maximizing deviation method to calculate the objective weights for each attribute. The subjective weight of each attribute is determined by using the single-valued neutrosophic weighted averaging aggregation operator to calculate the aggregated weights of the attributes using the subjective weights that are assigned by each decision maker.

The process of assigning weights to the attributes is an important phase of decision making. Most research in this area usually use either objective or subjective weights. However, considering the fact that different values for the weights of the attributes has a significant influence on the ranking of the alternatives, it is imperative that both the objective and subjective weights of the attributes are taken into account in the decision-making process. In view of this, we consider the attributes' subjective weights which are assigned by the decision makers, and the objective weights which are computed using the maximizing deviation method. These weights are then combined using the non-linear weighted comprehensive method to obtain the integrated weight of the attributes.

The advantages and drawbacks of the methods that were introduced in the works described above served as the main motivation for the work proposed in this paper, as we seek to introduce an effective SVN-based decision-making method that is free of all the problems that are inherent in the other existing methods in literature. In addition to these advantages and drawbacks, the works described above have the added disadvantage of not being able to function (i.e., provide reasonable solutions) under all circumstances. In view of this, the objective of this paper is to introduce a novel TOPSIS with maximizing deviation method for SVNSs that is able to provide effective solutions under any circumstances. Our proposed TOPSIS method is designed to handle MADM problems, and uses the maximizing deviation method to calculate the objective weights of attributes, utilizing an integrated weight measure that takes into consideration both the subjective and objective weights of the attributes. The robustness of our TOPSIS method is verified through a comprehensive series of tests which proves that our proposed method is the only method that shows compliance to all the tests, and is able to provide effective solutions under all different types of situations, thus out-performing all of the other considered methods.

The remainder of this paper is organized as follows. In Section 2, we recapitulate some of the fundamental concepts related to neutrosophic sets and SVNSs. In Section 3, we define an SVN-based TOPSIS and maximizing deviation methods and an accompanying decision-making algorithm. The proposed decision-making method is applied to a supplier selection problem in Section 4. In Section 5, a comprehensive comparative analysis of the results obtained via our proposed method and other recent approaches is presented. The similarities and differences in the performance of the existing algorithms and our algorithm is discussed, and it is proved that our algorithm is effective and provides reliable results in every type of situation. Concluding remarks are given in Section 6, followed by the acknowledgements and list of references.

2. Preliminaries

In this section, we recapitulate some important concepts pertaining to the theory of neutrosophic sets and SVNSs. We refer the readers to [8,9] for further details pertaining to these models.

The neutrosophic set model [8] is a relatively new tool for representing and measuring uncertainty and vagueness of information. It is fast becoming a preferred general framework for the analysis of uncertainty in data sets due to its capability in the handling big data sets, as well as its ability in representing all the different types of uncertainties that exists in data, in an effective and concise manner via a triple membership structure. This triple membership structure captures not only the degree of belongingness and non-belongingness of the objects in a data set, but also the degree of neutrality and indeterminacy that exists in the data set, thereby making it superior to ordinary fuzzy sets [1] and its extensions such as IFSs [2], vague sets [4], and interval-valued fuzzy sets [3]. The formal definition of a neutrosophic set is as given below.

Let U be a universe of discourse, with a class of elements in U denoted by x .

Definition 1. [8] A neutrosophic set A is an object having the form $A = \{x, T_A(x), I_A(x), F_A(x) : x \in U\}$, where the functions $T, I, F : U \rightarrow]-0, 1^+[$ denote the truth, indeterminacy, and falsity membership functions, respectively, of the element $x \in U$ with respect to A . The membership functions must satisfy the condition $-0 \leq T_A(x) + I_A(x) + F_A(x) \leq 3^+$.

Definition 2. [8] A neutrosophic set A is contained in another neutrosophic set B , if $T_A(x) \leq T_B(x)$, $I_A(x) \geq I_B(x)$, and $F_A(x) \geq F_B(x)$, for all $x \in U$. This relationship is denoted as $A \subseteq B$.

Wang et al. [9] then introduced a special case of the NS model called the single-valued neutrosophic set (SVNS) model, which is as defined below. This SVNS model is better suited to applied in real-life problems compared to NSs due to the structure of its membership functions which are defined in the standard unit interval of $[0, 1]$.

Definition 3. [9] A SVNS A is a neutrosophic set that is characterized by a truth-membership function $T_A(x)$, an indeterminacy-membership function $I_A(x)$, and a falsity-membership function $F_A(x)$, where $T_A(x), I_A(x), F_A(x) \in [0, 1]$. This set A can thus be written as

$$A = \{\langle x, T_A(x), I_A(x), F_A(x) \rangle : x \in U\}. \quad (1)$$

The sum of $T_A(x)$, $I_A(x)$ and $F_A(x)$ must fulfill the condition $0 \leq T_A(x) + I_A(x) + F_A(x) \leq 3$. For a SVNS A in U , the triplet $(T_A(x), I_A(x), F_A(x))$ is called a single-valued neutrosophic number (SVNN). For the sake of convenience, we simply let $x = (T_x, I_x, F_x)$ to represent a SVNN as an element in the SVNS A .

Next, we present some important results pertaining to the concepts and operations of SVNSs. The subset, equality, complement, union, and intersection of SVNSs, and some additional operations between SVNSs were all defined by Wang et al. [9], and these are presented in Definitions 4 and 5, respectively.

Definition 4. [9] Let A and B be two SVNSs over a universe U .

- (i) A is contained in B , if $T_A(x) \leq T_B(x)$, $I_A(x) \geq I_B(x)$, and $F_A(x) \geq F_B(x)$, for all $x \in U$. This relationship is denoted as $A \subseteq B$.
- (ii) A and B are said to be equal if $A \subseteq B$ and $B \subseteq A$.
- (iii) $A^c = (x, (F_A(x), 1 - I_A(x), T_A(x)))$, for all $x \in U$.
- (iv) $A \cup B = (x, (\max(T_A, T_B), \min(I_A, I_B), \min(F_A, F_B)))$, for all $x \in U$.
- (v) $A \cap B = (x, (\min(T_A, T_B), \max(I_A, I_B), \max(F_A, F_B)))$, for all $x \in U$.

Definition 5. [9] Let $x = (T_x, I_x, F_x)$ and $y = (T_y, I_y, F_y)$ be two SVNNs. The operations for SVNNs can be defined as follows:

- (i) $x \oplus y = (T_x + T_y - T_x * T_y, I_x * I_y, F_x * F_y)$
- (ii) $x \otimes y = (T_x * T_y, I_x + I_y - I_x * I_y, F_x + F_y - F_x * F_y)$
- (iii) $\lambda x = (1 - (1 - T_x)^\lambda, (I_x)^\lambda, (F_x)^\lambda)$, where $\lambda > 0$
- (iv) $x^\lambda = ((T_x)^\lambda, 1 - (1 - I_x)^\lambda, 1 - (1 - F_x)^\lambda)$, where $\lambda > 0$.

Majumdar and Samanta [28] introduced the information measures of distance, similarity, and entropy for SVNSs. Here we only present the definition of the distance measures between SVNSs as it is the only component that is relevant to this paper.

Definition 6. [28] Let A and B be two SVNSs over a finite universe $U = \{x_1, x_2, \dots, x_n\}$. Then the various distance measures between A and B are defined as follows:

(i) The Hamming distance between A and B are defined as:

$$d_H(A, B) = \sum_{i=1}^n \{|T_A(x_i) - T_B(x_i)| + |I_A(x_i) - I_B(x_i)| + |F_A(x_i) - F_B(x_i)|\} \quad (2)$$

(ii) The normalized Hamming distance between A and B are defined as:

$$d_H^N(A, B) = \frac{1}{3n} \sum_{i=1}^n \{|T_A(x_i) - T_B(x_i)| + |I_A(x_i) - I_B(x_i)| + |F_A(x_i) - F_B(x_i)|\} \quad (3)$$

(ii) The Euclidean distance between A and B are defined as:

$$d_E(A, B) = \sqrt{\sum_{i=1}^n \{(T_A(x_i) - T_B(x_i))^2 + (I_A(x_i) - I_B(x_i))^2 + (F_A(x_i) - F_B(x_i))^2\}} \quad (4)$$

(iv) The normalized Euclidean distance between A and B are defined as:

$$d_E^N(A, B) = \sqrt{\frac{1}{3n} \sum_{i=1}^n \{(T_A(x_i) - T_B(x_i))^2 + (I_A(x_i) - I_B(x_i))^2 + (F_A(x_i) - F_B(x_i))^2\}} \quad (5)$$

3. A TOPSIS Method for Single-Valued Neutrosophic Sets

In this section, we present the description of the problem that is being studied followed by our proposed TOPSIS method for SVN S s. The accompanying decision-making algorithm which is based on the proposed TOPSIS method is presented. This algorithm uses the maximizing deviation method to systematically determine the objective weight coefficients for the attributes.

3.1. Description of Problem

Let $U = \{u_1, u_2, \dots, u_m\}$ denote a finite set of m alternatives, $A = \{e_1, e_2, \dots, e_n\}$ be a set of n parameters, with the weight parameter w_j of each e_j completely unknown or only partially known, $w_j \in [0, 1]$, and $\sum_{j=1}^n w_j = 1$.

Let A be an SVN S in which $x_{ij} = (T_{ij}, I_{ij}, F_{ij})$ represents the SVN N that represents the information pertaining to the i th alternative x_i that satisfies the corresponding j th parameter e_j . The tabular representation of A is as given in Table 1.

Table 1. Tabular representation of the Single Valued Neutrosophic Set (SVNS) A .

u	e_1	e_2	\dots	e_n
x_1	(T_{11}, I_{11}, F_{11})	(T_{12}, I_{12}, F_{12})	\dots	(T_{1n}, I_{1n}, F_{1n})
x_2	(T_{21}, I_{21}, F_{21})	(T_{22}, I_{22}, F_{22})	\dots	(T_{2n}, I_{2n}, F_{2n})
\vdots	\vdots	\vdots	\ddots	\vdots
x_m	(T_{m1}, I_{m1}, F_{m1})	(T_{m2}, I_{m2}, F_{m2})	\dots	(T_{mn}, I_{mn}, F_{mn})

3.2. The Maximizing Deviation Method for Computing Incomplete or Completely Unknown Attribute Weights

The maximizing deviation method was proposed by Wang [29] with the aim of applying it in MADM problems in which the weights of the attributes are completely unknown or only partially known. This method uses the law of input arguments i.e., it takes into account the magnitude of the membership functions of each alternative for each attribute, and uses this information to obtain exact and reliable evaluation results pertaining to the weight coefficients for each attribute. As such,

this method is able to compute the weight coefficients of the attributes without any subjectivity, in a fair and objective manner.

The maximizing deviation method used in this paper is a modification of the original version introduced in Wang [29] that has been made compatible with the structure of the SVN model. The definitions of the important concepts involved in this method are as given below.

Definition 7. For the parameter $e_j \in A$, the deviation of the alternative x_i to all the other alternatives is defined as:

$$D_{ij}(w_j) = \sum_{k=1}^m w_j d(x_{ij}, x_{kj}), \tag{6}$$

where x_{ij}, x_{kj} are the elements of the SVN $A, i = 1, 2, \dots, m, j = 1, 2, \dots, n$ and $d(x_{ij}, x_{kj})$ denotes the distance between elements x_{ij} and x_{kj} .

The other deviation values include the deviation value of all alternatives to other alternatives, and the total deviation value of all parameters to all alternatives, both of which are as defined below:

- (i) The deviation value of all alternatives to other alternatives for the parameter $e_j \in A$, denoted by $D_j(w_j)$, is defined as:

$$D_j(w_j) = \sum_{i=1}^m D_{ij}(w_j) = \sum_{i=1}^m \sum_{k=1}^m w_j d(x_{ij}, x_{kj}), \tag{7}$$

where $j = 1, 2, \dots, n$.

- (ii) The total deviation value of all parameters to all alternatives, denoted by $D(w_j)$, is defined as:

$$(w_j) = \sum_{j=1}^n D_j(w_j) = \sum_{j=1}^n \sum_{i=1}^m \sum_{k=1}^m w_j d(x_{ij}, x_{kj}), \tag{8}$$

where w_j represents the weight of the parameter $e_j \in A$.

- (iii) The individual objective weight of each parameter $e_j \in A$, denoted by θ_j , is defined as:

$$\theta_j = \frac{\sum_{i=1}^m \sum_{k=1}^m d(x_{ij}, x_{kj})}{\sum_{j=1}^n \sum_{i=1}^m \sum_{k=1}^m d(x_{ij}, x_{kj})} \tag{9}$$

It should be noted that any valid distance measure between SVN models can be used in Equations (6)–(9). However, to improve the effective resolution of the decision-making process, in this paper, we use the normalized Euclidean distance measure given in Equation (5) in the computation of Equations (6)–(9).

3.3. TOPSIS Method for MADM Problems with Incomplete Weight Information

The Technique for Order of Preference by Similarity to Ideal Solution (TOPSIS) was originally introduced by Hwang and Yoon [30], and has since been extended to fuzzy sets, IFSs, and other fuzzy-based models. The TOPSIS method works by ranking the alternatives based on their distance from the positive ideal solution and the negative ideal solution. The basic guiding principle is that the most preferred alternative should have the shortest distance from the positive ideal solution and the farthest distance from the negative ideal solution (Hwang and Yoon [30], Chen and Tzeng [31]). In this section, we present a decision-making algorithm for solving MADM problems in single-valued neutrosophic environments, with incomplete or completely unknown weight information.

3.3.1. The Proposed TOPSIS Method for SVNSs

After obtaining information pertaining to the weight values for each parameter based on the maximizing deviation method, we develop a modified TOPSIS method for the SVNS model. To achieve our goal, we introduce several definitions that are the important components of our proposed TOPSIS method.

Let the relative neutrosophic positive ideal solution (RNPIS) and relative neutrosophic negative ideal solution (RNNIS) be denoted by b^+ and b^- , respectively, where these solutions are as defined below:

$$b^+ = \left\{ \left(\max_i T_{ij}, \min_i I_{ij}, \min_i F_{ij} \right) \mid j = 1, 2, \dots, n \right\}, \tag{10}$$

and

$$b^- = \left\{ \left(\min_i T_{ij}, \max_i I_{ij}, \max_i F_{ij} \right) \mid j = 1, 2, \dots, n \right\} \tag{11}$$

The difference between each object and the RNPIS, denoted by D_i^+ , and the difference between each object and the RNNIS, denoted by D_i^- , can then be calculated using the normalized Euclidean distance given in Equation (5) and by the formula given in Equations (12) and (13).

$$D_i^+ = \sum_{j=1}^n w_j d_{NE}(b_{ij}, b_j^+), \quad i = 1, 2, \dots, m \tag{12}$$

and

$$D_i^- = \sum_{j=1}^n w_j d_{NE}(b_{ij}, b_j^-), \quad i = 1, 2, \dots, m \tag{13}$$

Here, w_j denotes the integrated weight for each of the attributes.

The optimal alternative can then be found using the measure of the relative closeness coefficient of each alternative, denoted by C_i , which is as defined below:

$$C_i = \frac{D_i^-}{\max_j D_j^-} - \frac{D_i^+}{\min_j D_j^+}, \quad i, j = 1, 2, \dots, m \tag{14}$$

From the structure of the closeness coefficient in Equation (14), it is obvious that the larger the difference between an alternative and the fuzzy negative ideal object, the larger the value of the closeness coefficient of the said alternative. Therefore, by the principal of maximum similarity between an alternative and the fuzzy positive ideal object, the objective of the algorithm is to determine the alternative with the maximum closeness coefficient. This alternative would then be chosen as the optimal alternative.

3.3.2. Attribute Weight Determination Method: An Integrated WEIGHT MEASure

In any decision-making process, there are two main types of weight coefficients, namely the subjective and objective weights that need to be taken into consideration. Subjective weight refers to the values assigned to each attribute by the decision makers based on their individual preferences and experience, and is very much dependent on the risk attitude of the decision makers. Objective weight refers to the weights of the attributes that are computed mathematically using any appropriate computation method. Objective weighting methods uses the law of input arguments (i.e., the input values of the data) as it determines the attribute weights based on the magnitude of the membership functions that are assigned to each alternative for each attribute.

Therefore, using only subjective weighting in the decision-making process would be inaccurate as it only reflects the opinions of the decision makers while ignoring the importance of each attribute that are reflected by the input values. Using only objective weighting would also be inaccurate as it only

reflects the relative importance of the attributes based on the law of input arguments, but fails to take into consideration the preferences and risk attitude of the decision makers.

To overcome this drawback and improve the accuracy and reliability of the decision-making process, we use an integrated weight measure which combines the subjective and objective weights of the attributes. This factor makes our decision-making algorithm more accurate compared to most of the other existing methods in literature that only take into consideration either the objective or subjective weights.

Based on the formula and weighting method given above, we develop a practical and effective decision-making algorithm based on the TOPSIS approach for the SVNS model with incomplete weight information. The proposed Algorithm 1 is as given below.

Algorithm 1. (based on a modified TOPSIS approach).

- Step 1.** Input the SVNS A which represents the information pertaining to the problem.
- Step 2.** Input the subjective weight h_j for each of the attributes $e_j \in A$ as given by the decision makers.
- Step 3.** Compute the objective weight θ_j for each of the attributes $e_j \in A$, using Equation (9).
- Step 4.** The integrated weight coefficient w_j for each of the attributes $e_j \in A$, is computed using Equation as follow:

$$w_j = \frac{h_j \theta_j}{\sum_{j=1}^n h_j \theta_j}$$

- Step 5.** The values of RNPIS b^+ and RNNIS b^- are computed using Equations (10) and (11).
 - Step 6.** The difference between each alternative and the RNPIS, D^+ and the RNNIS D^- are computed using Equations (12) and (13), respectively.
 - Step 7.** The relative closeness coefficient C_i for each alternative is calculated using Equation (14).
 - Step 8.** Choose the optimal alternative based on the principal of maximum closeness coefficient.
-

4. Application of the Topsis Method in a Made Problem

The implementation process and utility of our proposed decision-making algorithm is illustrated via an example related to a supplier selection problem.

4.1. Illustrative Example

In today’s extremely competitive business environment, firms must be able to produce good quality products at reasonable prices in order to be successful. Since the quality of the products is directly dependent on the effectiveness and performance of its suppliers, the importance of supplier selection has become increasingly recognized. In recent years, this problem has been handled using various mathematical tools. Some of the recent research in this area can be found in [32–38].

Example 1. A manufacturing company is looking to select a supplier for one of the products manufactured by the company. The company has shortlisted ten suppliers from an initial list of suppliers. These ten suppliers form the set of alternatives U that are under consideration,

$$U = \{x_1, x_2, x_3, x_4, x_5, x_6, x_7, x_8, x_9, x_{10}\}.$$

The procurement manager and his team of buyers evaluate the suppliers based on a set of evaluation attributes E which is defined as:

$$E = \{e_1 = \text{service quality}, e_2 = \text{pricing and cost structure}, e_3 = \text{financial stability}, \\ e_4 = \text{environmental regulation compliance}, e_5 = \text{reliability}, \\ e_6 = \text{relevant experience}\}.$$

The firm then evaluates each of the alternatives x_i ($i = 1, 2, \dots, 10$), with respect to the attributes e_j ($j = 1, 2, \dots, 6$). The evaluation done by the procurement team is expressed in the form of SVNNS in a SVNS A .

Now suppose that the company would like to select one of the five shortlisted suppliers to be their supplier. We apply the proposed Algorithm 1 outlined in Section 3.3 to this problem with the aim of selecting a supplier that best satisfies the specific needs and requirements of the company. The steps involved in the implementation process of this algorithm are outlined below (Algorithm 2).

Algorithm 2. (based on the modified TOPSIS approach).

Step 1. The SVNS A constructed for this problem is given in tabular form in Table 2

Step 2. The subjective weight h_j for each attribute $e_j \in A$ as given by the procurement team (the decision makers) are $h = \{h_1 = 0.15, h_2 = 0.15, h_3 = 0.22, h_4 = 0.25, h_5 = 0.14, h_6 = 0.09\}$.

Step 3. The objective weight θ_j for each attribute $e_j \in A$ is computed using Equation (9) are as given below:
 $\theta = \{\theta_1 = 0.139072, \theta_2 = 0.170256, \theta_3 = 0.198570, \theta_4 = 0.169934, \theta_5 = 0.142685, \theta_6 = 0.179484\}$.

Step 4. The integrated weight w_j for each attribute $e_j \in A$ is computed using Equation (15). The integrated weight coefficient obtained for each attribute is:

$$w = \{w_1 = 0.123658, w_2 = 0.151386, w_3 = 0.258957, w_4 = 0.251833, w_5 = 0.118412, w_6 = 0.0957547\}.$$

Step 5. Use Equations (10) and (11) to compute the values of b^+ and b^- from the neutrosophic numbers given in Table 2. The values are as given below:

$$b^+ = \{b_1^+ = [0.7, 0.2, 0.1], b_2^+ = [0.9, 0, 0.1], b_3^+ = [0.8, 0, 0], b_4^+ = [0.9, 0.3, 0], b_5^+ = [0.7, 0.2, 0.2], b_6^+ = [0.8, 0.2, 0.1]\}$$

and

$$b^- = \{b_1^- = [0.5, 0.8, 0.5], b_2^- = [0.6, 0.8, 0.5], b_3^- = [0.1, 0.7, 0.5], b_4^- = [0.3, 0.8, 0.7], b_5^- = [0.5, 0.8, 0.7], b_6^- = [0.5, 0.8, 0.9]\}.$$

Step 6. Use Equations (12) and (13) to compute the difference between each alternative and the RNPIS and the RNNIS, respectively. The values of D^+ and D^- are as given below:

$$D^+ = \{D_1^+ = 0.262072, D_2^+ = 0.306496, D_3^+ = 0.340921, D_4^+ = 0.276215, D_5^+ = 0.292443, D_6^+ = 0.345226, D_7^+ = 0.303001, D_8^+ = 0.346428, D_9^+ = 0.271012, D_{10}^+ = 0.339093\}.$$

and

$$D^- = \{D_1^- = 0.374468, D_2^- = 0.307641, D_3^- = 0.294889, D_4^- = 0.355857, D_5^- = 0.323740, D_6^- = 0.348903, D_7^- = 0.360103, D_8^- = 0.338725, D_9^- = 0.379516, D_{10}^- = 0.349703\}.$$

Step 7. Using Equation (14), the closeness coefficient C_i for each alternative is:

$$C_1 = -0.0133, C_2 = -0.3589, C_3 = -0.5239, C_4 = -0.1163, C_5 = -0.2629, C_6 = -0.3980, C_7 = -0.2073, C_8 = -0.4294, C_9 = -0.0341, C_{10} = -0.3725.$$

Step 8. The ranking of the alternatives obtained from the closeness coefficient is as given below:

$$x_1 > x_9 > x_4 > x_7 > x_5 > x_2 > x_{10} > x_6 > x_8 > x_3.$$

Therefore the optimal decision is to select supplier x_1 .

Table 2. Tabular representation of SVNS A .

U	e₁	e₂	e₃
x_1	(0.7, 0.5, 0.1)	(0.7, 0.5, 0.3)	(0.8, 0.6, 0.2)
x_2	(0.6, 0.5, 0.2)	(0.7, 0.5, 0.1)	(0.6, 0.3, 0.5)
x_3	(0.6, 0.2, 0.3)	(0.6, 0.6, 0.4)	(0.7, 0.7, 0.2)
x_4	(0.5, 0.5, 0.4)	(0.6, 0.4, 0.4)	(0.7, 0.7, 0.3)
x_5	(0.7, 0.5, 0.5)	(0.8, 0.3, 0.1)	(0.7, 0.6, 0.2)
U	e₁	e₂	e₃
x_6	(0.5, 0.5, 0.5)	(0.7, 0.8, 0.1)	(0.7, 0.3, 0.5)
x_7	(0.6, 0.8, 0.1)	(0.7, 0.2, 0.1)	(0.6, 0.3, 0.4)
x_8	(0.7, 0.8, 0.3)	(0.6, 0.6, 0.5)	(0.8, 0, 0.5)
x_9	(0.6, 0.7, 0.1)	(0.7, 0, 0.1)	(0.6, 0.7, 0)
x_{10}	(0.5, 0.7, 0.4)	(0.9, 0, 0.3)	(1, 0, 0)

Table 2. *Cont.*

U	e₄	e₅	e₆
x_1	(0.9, 0.4, 0.2)	(0.6, 0.4, 0.7)	(0.6, 0.5, 0.4)
x_2	(0.6, 0.4, 0.3)	(0.7, 0.5, 0.4)	(0.7, 0.8, 0.9)
x_3	(0.5, 0.5, 0.3)	(0.6, 0.8, 0.6)	(0.7, 0.2, 0.5)
x_4	(0.9, 0.4, 0.2)	(0.7, 0.3, 0.5)	(0.6, 0.4, 0.4)
x_5	(0.7, 0.5, 0.2)	(0.7, 0.5, 0.6)	(0.6, 0.7, 0.8)
U	e₄	e₅	e₆
x_6	(0.4, 0.8, 0)	(0.7, 0.4, 0.2)	(0.5, 0.6, 0.3)
x_7	(0.3, 0.5, 0.1)	(0.6, 0.3, 0.6)	(0.5, 0.2, 0.6)
x_8	(0.7, 0.3, 0.6)	(0.6, 0.8, 0.5)	(0.6, 0.2, 0.4)
x_9	(0.7, 0.4, 0.3)	(0.6, 0.6, 0.7)	(0.7, 0.3, 0.2)
x_{10}	(0.5, 0.6, 0.7)	(0.5, 0.2, 0.7)	(0.8, 0.4, 0.1)

4.2. Adaptation of the Algorithm to Non-Integrated Weight Measure

In this section, we present an adaptation of our algorithm introduced in Section 4.1 to cases where only the objective weights or subjective weights of the attributes are taken into consideration. The results obtained via these two new variants are then compared to the results obtained via the original algorithm in Section 4.1. Further, we also compare the results obtained via these two new variants of the algorithm to the results obtained via the other methods in literature that are compared in Section 5.

To adapt our proposed algorithm in Section 3 for these special cases, we hereby represent the objective-only and subjective-only adaptations of the algorithm. This is done by taking only the objective (subjective) weight is to be used, then simply take $w_j = \theta_j$ ($w_j = h_j$). The two adaptations of the algorithm are once again applied to the dataset for SVNS A given in Table 2.

4.2.1. Objective-Only Adaptation of Our Algorithm

All the steps remain the same as the original algorithm; however, only the objective weights of the attributes are used, i.e., we take $w_j = \theta_j$.

The results of applying this variant of the algorithm produces the ranking given below:

$$x_9 > x_1 > x_4 > x_{10} > x_7 > x_6 > x_5 > x_8 > x_3 > x_2.$$

Therefore, if only the objective weight is to be considered, then the optimal decision is to select supplier x_9 .

4.2.2. Subjective-Only Adaptation of Our Algorithm

All the steps remain the same as the original algorithm; however, only the subjective weights of the attributes are used, i.e., we take $w_j = h_j$.

The results of applying this variant of the algorithm produces the ranking given below:

$$x_1 > x_9 > x_4 > x_7 > x_5 > x_2 > x_6 > x_{10} > x_8 > x_3$$

Therefore, if only the objective weight is to be considered, then the optimal decision is to select supplier x_1 .

From the results obtained above, it can be observed that the ranking of the alternatives are clearly affected by the decision of the decision maker to use only the objective weights, only the subjective weights of the attributes, or an integrated weight measure that takes into consideration both the objective and subjective weights of the attributes.

5. Comparatives Studies

In this section, we present a brief comparative analysis of some of the recent works in this area and our proposed method. These recent approaches are applied to our Example 1, and the limitations that exist in these methods are elaborated, and the advantages of our proposed method are discussed and analyzed. The results obtained are summarized in Table 3.

5.1. Comparison of Results Obtained Through Different Methods

Table 3. The results obtained using different methods for Example 1.

Method	The Final Ranking	The Best Alternative
Ye [39]		
(i) WAAO *	$x_1 > x_4 > x_9 > x_5 > x_7 > x_2 > x_{10} > x_8 > x_3 > x_6$	x_1
(ii) WGAO **	$x_{10} > x_9 > x_8 > x_1 > x_5 > x_7 > x_4 > x_2 > x_6 > x_3$	x_{10}
Ye [10]		
(i) Weighted correlation coefficient	$x_1 > x_4 > x_5 > x_9 > x_2 > x_8 > x_7 > x_3 > x_6 > x_{10}$	x_1
(ii) Weighted cosine similarity measure	$x_1 > x_9 > x_4 > x_5 > x_2 > x_{10} > x_8 > x_3 > x_7 > x_6$	x_1
Ye [11]	$x_1 > x_9 > x_4 > x_7 > x_5 > x_2 > x_8 > x_6 > x_3 > x_{10}$	x_1
Huang [14]	$x_1 > x_9 > x_4 > x_5 > x_2 > x_7 > x_8 > x_6 > x_3 > x_{10}$	x_1
Peng et al. [40]		
(i) GSNNA ***	$x_9 > x_{10} > x_8 > x_6 > x_1 > x_7 > x_4 > x_5 > x_2 > x_3$	x_9
(ii) GSNNWG ****	$x_1 > x_9 > x_4 > x_5 > x_7 > x_2 > x_8 > x_3 > x_6 > x_{10}$	x_1
Peng & Liu [15]		
(i) EDAS	$x_1 > x_4 > x_6 > x_9 > x_{10} > x_3 > x_2 > x_7 > x_5 > x_8$	x_1
(ii) Similarity measure	$x_{10} > x_8 > x_7 > x_4 > x_1 > x_2 > x_5 > x_9 > x_3 > x_6$	x_{10}
Maji [41]	$x_5 > x_1 > x_9 > x_6 > x_2 > x_4 > x_3 > x_8 > x_7 > x_{10}$	x_5
Karaaslan [42]	$x_1 > x_9 > x_4 > x_5 > x_7 > x_2 > x_8 > x_3 > x_6 > x_{10}$	x_1
Ye [43]	$x_1 > x_9 > x_4 > x_5 > x_7 > x_2 > x_8 > x_3 > x_6 > x_{10}$	x_1
Biswas et al. [44]	$x_{10} > x_9 > x_7 > x_1 > x_4 > x_6 > x_5 > x_8 > x_2 > x_3$	x_{10}
Ye [45]	$x_9 > x_7 > x_1 > x_4 > x_2 > x_{10} > x_5 > x_8 > x_3 > x_6$	x_9
Adaptation of our algorithm (objective weights only)	$x_9 > x_1 > x_4 > x_{10} > x_7 > x_6 > x_5 > x_8 > x_3 > x_2$	x_9
Adaptation of our algorithm (subjective weights only)	$x_1 > x_9 > x_4 > x_7 > x_5 > x_2 > x_6 > x_{10} > x_8 > x_3$	x_1
Our proposed method (using integrated weight measure)	$x_1 > x_9 > x_4 > x_7 > x_5 > x_2 > x_{10} > x_6 > x_8 > x_3$	x_1

* WAAO = weighted arithmetic average operator; ** WGAO = weighted geometric average operator; *** GSNNA = generalized simplified neutrosophic number weighted averaging operator; **** GSNNWG = generalized simplified neutrosophic number weighted geometric operator.

5.2. Discussion of Results

From the results obtained in Table 3, it can be observed that different rankings and optimal alternatives were obtained from the different methods that were compared. This difference is due to a number of reasons. These are summarized briefly below:

- (i) The method proposed in this paper uses an integrated weight measure which considers both the subjective and objective weights of the attributes, as opposed to some of the methods that only consider the subjective weights or objective weights.
- (ii) Different operators emphasizes different aspects of the information which ultimately leads to different rankings. For example, in [40], the GSNNA operator used is based on an arithmetic average which emphasizes the characteristics of the group (i.e., the whole information), whereas the GSNNWG operator is based on a geometric operator which emphasizes the characteristics of each individual alternative and attribute. As our method places more importance on the characteristics of the individual alternatives and attributes, instead of the entire information

as a whole, our method produces the same ranking as the GSNNWG operator but different results from the GSNNWA operator.

5.3. Analysis of the Performance and Reliability of Different Methods

The performance of these methods and the reliability of the results obtained via these methods are further investigated in this section.

Analysis

In all of the 11 papers that were compared in this section, the different authors used different types of measurements and parameters to determine the performance of their respective algorithms. However, all of these inputs *always* contain a tensor with at least three degrees. This tensor can refer to different types of neutrosophic sets depending on the context discussed in the respective papers, e.g., simplified neutrosophic sets, single-valued neutrosophic sets, neutrosophic sets, or INSs. For the sake of simplicity, we shall denote them simply as S .

Furthermore, all of these methods consider a weighted approach i.e., the weight of each attribute is taken into account in the decision-making process. The decision-making algorithms proposed in [10,11,14,39,40,43,45] use the subjective weighting method, the algorithms proposed in [42,44] use the objective weighting method, whereas only the decision-making methods proposed in [15] use an integrated weighting method which considers both the subjective and objective weights of the attributes. The method proposed by Maji [41] did not take the attribute weights into consideration in the decision-making process.

In this section, we first apply the inputs of those papers into our own algorithm. We then compare the results obtained via our proposed algorithm with their results, with the aim of justifying the effectiveness of our algorithm. The different methods and their algorithms are analyzed below:

- (i) The algorithms in [10,11,39] all use the data given below as inputs

$$S = \left\{ \begin{array}{l} [0.4, 0.2, 0.3], [0.4, 0.2, 0.3], [0.2, 0.2, 0.5] \\ [0.6, 0.1, 0.2], [0.6, 0.1, 0.2], [0.5, 0.2, 0.2] \\ [0.3, 0.2, 0.3], [0.5, 0.2, 0.3], [0.5, 0.3, 0.2] \\ [0.7, 0.0, 0.1], [0.6, 0.1, 0.2], [0.4, 0.3, 0.2] \end{array} \right\}$$

The subjective weights w_j of the attributes are given by $w_1 = 0.35$, $w_2 = 0.25$, $w_3 = 0.40$. All the five algorithms from papers [10,11,39] yields either one of the following rankings:

$$A_4 > A_2 > A_3 > A_1 \quad \text{or} \quad A_2 > A_4 > A_3 > A_1$$

Our algorithm yields the ranking $A_4 > A_2 > A_3 > A_1$ which is consistent with the results obtained through the methods given above.

- (ii) The method proposed in [44] also uses the data given in S above as inputs but ignores the opinions of the decision makers as it does not take into account the subjective weights of the attributes. The algorithm from this paper yields the ranking of $A_4 > A_2 > A_3 > A_1$. To fit this data into our algorithm, we randomly assigned the subjective weights of the attributes as $w_j = \frac{1}{3}$ for $j = 1, 2, 3$. A ranking of $A_4 > A_2 > A_3 > A_1$ was nonetheless obtained from our algorithm.
- (iii) The methods introduced in [14,43,45] all use the data given below as input values:

$$S = \left\{ \begin{array}{l} [0.5, 0.1, 0.3], [0.5, 0.1, 0.4], [0.7, 0.1, 0.2], [0.3, 0.2, 0.1] \\ [0.4, 0.2, 0.3], [0.3, 0.2, 0.4], [0.9, 0.0, 0.1], [0.5, 0.3, 0.2] \\ [0.4, 0.3, 0.1], [0.5, 0.1, 0.3], [0.5, 0.0, 0.4], [0.6, 0.2, 0.2] \\ [0.6, 0.1, 0.2], [0.2, 0.2, 0.5], [0.4, 0.3, 0.2], [0.7, 0.2, 0.1] \end{array} \right\}$$

The subjective weights w_j of the attributes are given by $w_1 = 0.30$, $w_2 = 0.25$, $w_3 = 0.25$ and $w_4 = 0.20$.

In this case, all of the three algorithms produces a ranking of $A_1 > A_3 > A_2 > A_4$.

This result is however not very reliable as all of these methods only considered the subjective weights of the attributes and ignored the objective weight which is a vital measurement of the relative importance of an attribute e_j relative to the other attributes in an objective manner i.e., without “prejudice”.

When we calculated the objective weights using our own algorithm we have the following objective weights:

$$a_j = [0.203909, 0.213627, 0.357796, 0.224667]$$

In fact, it is indeed $\langle 0.9, 0.0, 0.1 \rangle$ that mainly contributes to the largeness of the objective weight of attribute e_3 compared to the other values of e_j . Hence, when we calculate the integrated weight, the weight of attribute e_3 is still the largest.

Since $[0.9, 0.0, 0.1]$ is in the second row, our algorithm yields a ranking of $A_2 > A_1 > A_3 > A_4$ as a result.

We therefore conclude that our algorithm is more effective and the results obtained via our algorithm is more reliable than the ones obtained in [14,43,45], as we consider both the objective and subjective weights.

- (iv) It can be observed that for the methods introduced in [10,11,39,44], we have $0.8 \leq T_{ij} + I_{ij} + F_{ij} \leq 1$ for all the entries. A similar trend can be observed in [14,43,45], where $0.6 \leq T_{ij} + I_{ij} + F_{ij} \leq 1$ for all the entries. Therefore, we are not certain about the results obtained through the decision making algorithms in these papers when the value of $T_{ij} + I_{ij} + F_{ij}$ deviates very far from 1.

Another aspect to be considered is the weighting method that is used in the decision making process. As mentioned above, most of the current decision making methods involving SVNSe use subjective weighting, a few use objective weighting and only two methods introduced in [15] uses an integrated weighting method to arrive at the final decision. In view of this, we proceeded to investigate if all of the algorithms that were compared in this section are able to produce reliable results when both the subjective and objective weights are taken into consideration. Specifically, we investigate if these algorithms are able to perform effectively in situations where the subjective weights clearly prioritize over the objective weights, and vice-versa. To achieve this, we tested all of the algorithms with three sets of inputs as given below:

Test 1: A scenario containing a very small value of $T_{ij} + I_{ij} + F_{ij}$.

$$S_1 = \left\{ \begin{array}{l} A_1 = ([0.5, 0.5, 0.5], [0.9999, 0.0001, 0.000]) \\ A_2 = ([0.5, 0.5, 0.5], [0.9999, 0.0001, 0.0001]) \\ A_3 = ([0.5, 0.5, 0.5], [0.9999, 0.0000, 0.0001]) \\ A_4 = ([0.5, 0.5, 0.5], [0.0001, 0.0000, 0.000]) \end{array} \right\}$$

The subjective weight in this case is assigned as: $a_j = [0.5, 0.5]$.

By observation alone, it is possible to tell that an effective algorithm should produce A_4 as the least favoured alternative, and A_2 should be second least-favoured alternative.

Test 2: A scenario where subjective weights *prioritize* over objective weight.

$$S_2 = \left\{ \begin{array}{l} A_1 = ([0.80, 0.10, 0.10], [0.19, 0.50, 0.50]) \\ A_2 = ([0.20, 0.50, 0.50], [0.81, 0.10, 0.10]) \end{array} \right\}$$

The subjective weight in this case is assigned as: $a_j = [0.99, 0.01]$.

By observation alone, we can tell that an effective algorithm should produce a ranking of $A_1 > A_2$.

Test 3: This test is based on a real-life situation.

Suppose a procurement committee is looking to select the best supplier to supply two raw materials e_1 and e_2 . In this context, the triplet $[T, I, F]$ represents the following:

T : the track record of the suppliers that is approved by the committee

I : the track record of the suppliers that the committee feels is questionable

F : the track record of the suppliers that is rejected by the committee

Based on their experience, the committee is of the opinion that raw material e_1 is slightly more important than raw material e_2 , and assigned subjective weights of $w_1^{sub} = 0.5001$ and $w_2^{sub} = 0.4999$.

After an intensive search around the country, the committee shortlisted 20 candidates (A_1 to A_{20}). After checking all of the candidates' track records and analyzing their past performances, the committee assigned the following values for each of the suppliers.

$$S_3 = \left\{ \begin{array}{l} A_1 = ([0.90, 0.00, 0.10], [0.80, 0.00, 0.10]), A_2 = ([0.80, 0.00, 0.10], [0.90, 0.00, 0.10]) \\ A_3 = ([0.50, 0.50, 0.50], [0.00, 0.90, 0.90]), A_4 = ([0.50, 0.50, 0.50], [0.10, 0.90, 0.80]) \\ A_5 = ([0.50, 0.50, 0.50], [0.20, 0.90, 0.70]), A_6 = ([0.50, 0.50, 0.50], [0.30, 0.90, 0.60]) \\ A_7 = ([0.50, 0.50, 0.50], [0.40, 0.90, 0.50]), A_8 = ([0.50, 0.50, 0.50], [0.50, 0.90, 0.40]) \\ A_9 = ([0.50, 0.50, 0.50], [0.60, 0.90, 0.30]), A_{10} = ([0.50, 0.50, 0.50], [0.70, 0.30, 0.90]) \\ A_{11} = ([0.50, 0.50, 0.50], [0.70, 0.90, 0.30]), A_{12} = ([0.50, 0.50, 0.50], [0.00, 0.30, 0.30]) \\ A_{13} = ([0.50, 0.50, 0.50], [0.70, 0.90, 0.90]), A_{14} = ([0.50, 0.50, 0.50], [0.70, 0.30, 0.30]) \\ A_{15} = ([0.50, 0.50, 0.50], [0.60, 0.40, 0.30]), A_{16} = ([0.50, 0.50, 0.50], [0.50, 0.50, 0.30]) \\ A_{17} = ([0.50, 0.50, 0.50], [0.40, 0.60, 0.30]), A_{18} = ([0.50, 0.50, 0.50], [0.30, 0.70, 0.30]) \\ A_{19} = ([0.50, 0.50, 0.50], [0.20, 0.80, 0.30]), A_{20} = ([0.50, 0.50, 0.50], [0.10, 0.90, 0.30]) \end{array} \right\}$$

The objective weights for this scenario was calculated based on our algorithm and the values are $w_1^{obj} = 0.1793$ and $w_2^{obj} = 0.8207$.

Now it can be observed that suppliers A_1 and A_2 are the ones that received the best evaluation scores from the committee. Supplier A_1 received better evaluation scores from the committee compared to supplier A_2 for attribute e_1 . Attribute e_1 was deemed to be more important than attribute e_2 by the committee, and hence had a higher subjective weight. However, the objective weight of attribute e_2 is much higher than e_1 . This resulted in supplier A_2 ultimately being chosen as the best supplier. This is an example of a scenario where the objective weights are prioritized over the subjective weights, and has a greater influence on the decision-making process.

Therefore, in the scenario described above, an effective algorithm should select A_2 as the optimal supplier, followed by A_1 . All of the remaining choices have values of $T < 0.8$, $I > 0.0$ and $F > 0.1$. As such, an effective algorithm should rank all of these remaining 18 choices behind A_1 .

We applied the three tests mentioned above and the data set for S_3 given above to the decision-making methods introduced in the 11 papers that were compared in the previous section. The results obtained are given in Table 4.

Thus it can be concluded that our proposed algorithm is the most effective algorithm and the one that yields the most reliable results in all the different types of scenario. Hence, our proposed algorithm provides a robust framework that can be used to handle any type of situation and data, and produce accurate and reliable results for any type of situation and data.

Finally, we look at the context of the scenario described in Example 1. The structure of our data (given in Table 2) is more generalized, by theory, having $0 \leq T_{ij} + I_{ij} + F_{ij} \leq 1$ and $0 \leq T_{ij} + I_{ij} + F_{ij} \leq 3$, and is similar to the structure of the data used in [15,40–42]. Hence, our choice of input data serves as a more faithful indicator of how each algorithm works under all sorts of possible conditions.

Table 4. Compliance to Tests 1, 2, and 3.

Paper		Test 1 Compliance	Test 2 Compliance	Test 3 Compliance
Ye [39]	WAAO *	Y	Y	N
	WGAO *	N	Y	N
Ye [10]	Weighted correlation coefficient	Y	Y	N
	Weighted cosine similarity measure	N	Y	N
Ye [11]		Y	Y	N
Huang [14]		Y	Y	N
Peng et al. [40]	GSNNWA **	Y	Y	N
	GSNNWG **	Y	Y	N
Peng & Liu [15]	EDAS	Y	Y	N
	Similarity measure	N	Y	Y
Maji [41]		N	N	N
Karaaslan [42]		Y	Y	N
Ye [43]		Y	Y	N
Biswas et al. [44]		Y	N	Y
Ye [45]		Y	Y	N
Adaptation of our proposed algorithm (objective weights only)		Y	N	Y
Adaptation of our proposed algorithm (subjective weights only)		Y	Y	N
Our proposed algorithm		Y	Y	Y

Remarks: Y = Yes (which indicates compliance to Test); N = No (which indicates non-compliance to Test); * WAAO = weighted arithmetic average operator; * WGAO = weighted geometric average operator; ** GSNNWA = generalized simplified neutrosophic number weighted averaging operator; ** GSNNWG = generalized simplified neutrosophic number weighted geometric operator.

6. Conclusions

The concluding remarks and the significant contributions that were made in this paper are expounded below.

- (i) A novel TOPSIS method for the SVNS model is introduced, with the maximizing deviation method used to determine the objective weight of the attributes. Through thorough analysis, we have proven that our algorithm is compliant with all of the three tests that were discussed in Section 5.3. This clearly indicates that our proposed decision-making algorithm is not only an effective algorithm but one that produces the most reliable and accurate results in all the different types of situation and data inputs.
- (ii) Unlike other methods in the existing literature which reduces the elements from single-valued neutrosophic numbers (SVNNs) to fuzzy numbers, or interval neutrosophic numbers (INNs) to neutrosophic numbers or fuzzy numbers, in our version of the TOPSIS method the input data is in the form of SVNNs and this form is maintained throughout the decision-making process. This prevents information loss and enables the original information to be retained, thereby ensuring a higher level of accuracy for the results that are obtained.
- (iii) The objective weighting method (e.g., the ones used in [10,11,14,39,40,43,45]) only takes into consideration the values of the membership functions while ignoring the preferences of the decision makers. Through the subjective weighting method (e.g., the ones used in [42,44]), the attribute weights are given by the decision makers based on their individual preferences and experiences. Very few approaches in the existing literature (e.g., [15]) consider both the objective and subjective weighting methods. Our proposed method uses an integrated weighting model that considers both the objective and subjective weights of the attributes, and this accurately reflects the input values of the alternatives as well as the preferences and risk attitude of the decision makers.

Funding: This research was funded by the Ministry of Education, Malaysia under grant no. FRGS/1/2017/STG06/UCSI/03/1.

References

1. Zadeh, L.A. Fuzzy sets. *Inf. Control* **1965**, *8*, 338–353. [CrossRef]
2. Atanassov, K.T. Intuitionistic fuzzy sets. *Fuzzy Sets Syst.* **1986**, *20*, 87–96. [CrossRef]
3. Gorzalczany, M.B. A method of inference in approximate reasoning based on interval-valued fuzzy sets. *Fuzzy Sets Syst.* **1987**, *21*, 1–17. [CrossRef]
4. Gau, W.L.; Buehrer, D.J. Vague sets. *IEEE Trans. Syst. Man Cybern.* **1993**, *23*, 610–614. [CrossRef]
5. Torra, V. Hesitant fuzzy sets. *Int. J. Intell. Syst.* **2010**, *25*, 529–539. [CrossRef]
6. Atanassov, K.; Gargov, G. Interval valued intuitionistic fuzzy sets. *Fuzzy Sets Syst.* **1989**, *31*, 343–349. [CrossRef]
7. Ezhilmaran, D.; Sankar, K. Morphism of bipolar intuitionistic fuzzy graphs. *J. Discret. Math. Sci. Cryptogr.* **2015**, *18*, 605–621. [CrossRef]
8. Smarandache, F. *Neutrosophy. Neutrosophic Probability, Set, and Logic*; ProQuest Information & Learning: Ann Arbor, MI, USA, 1998; 105p. Available online: <http://fs.gallup.unm.edu/eBook-neutrosophics6.pdf> (accessed on 7 June 2018).
9. Wang, H.; Smarandache, F.; Zhang, Y.Q.; Sunderraman, R. Single valued neutrosophic sets. *Multisp. Multistruct.* **2010**, *4*, 410–413.
10. Ye, J. Multicriteria decision-making method using the correlation coefficient under single-valued neutrosophic environment. *Int. J. Gen. Syst.* **2013**, *42*, 386–394. [CrossRef]
11. Ye, J. Improved correlation coefficients of single valued neutrosophic sets and interval neutrosophic sets for multiple attribute decision making. *J. Intell. Fuzzy Syst.* **2014**, *27*, 2453–2462.
12. Ye, J. Clustering methods using distance-based similarity measures of single-valued neutrosophic sets. *J. Intell. Fuzzy Syst.* **2014**, *23*, 379–389. [CrossRef]
13. Ye, J. Multiple attribute group decision-making method with completely unknown weights based on similarity measures under single valued neutrosophic environment. *J. Intell. Fuzzy Syst.* **2014**, *27*, 2927–2935.
14. Huang, H.L. New distance measure of single-valued neutrosophic sets and its application. *Int. J. Gen. Syst.* **2016**, *31*, 1021–1032. [CrossRef]
15. Peng, X.; Liu, C. Algorithms for neutrosophic soft decision making based on EDAS, new similarity measure and level soft set. *J. Intell. Fuzzy Syst.* **2017**, *32*, 955–968. [CrossRef]
16. Yang, H.L.; Guo, Z.L.; She, Y.H.; Liao, X.W. On single valued neutrosophic relations. *J. Intell. Fuzzy Syst.* **2016**, *30*, 1045–1056. [CrossRef]
17. Broumi, S.; Smarandache, F.; Talea, M.; Bakali, A. Single valued neutrosophic graph: Degree, order and size. In Proceedings of the IEEE International Conference on Fuzzy Systems, Vancouver, BC, Canada, 24–29 July 2016; pp. 2444–2451.
18. Broumi, S.; Bakali, A.; Talea, M.; Smarandache, F. Isolated single valued neutrosophic graphs. *Neutrosophic Sets Syst.* **2016**, *11*, 74–78.
19. Broumi, S.; Talea, M.; Bakali, A.; Smarandache, F. Single valued neutrosophic graphs. *J. New Theory* **2016**, *10*, 86–101.
20. Broumi, S.; Smarandache, F.; Talea, M.; Bakali, A. An introduction to bipolar single valued neutrosophic graph theory. *Appl. Mech. Mater.* **2016**, *841*, 184–191. [CrossRef]
21. Broumi, S.; Talea, M.; Bakali, A.; Smarandache, F. On bipolar single valued neutrosophic graphs. *J. New Theory* **2016**, *11*, 84–102.
22. Hassan, A.; Malik, M.A.; Broumi, S.; Bakali, A.; Talea, M.; Smarandache, F. Special types of bipolar single valued neutrosophic graphs. *Ann. Fuzzy Math. Inform.* **2017**, *14*, 55–73.
23. Tian, Z.P.; Wang, J.; Zhang, H.Y.; Wang, J.Q. Multi-criteria decision-making based on generalized prioritized aggregation operators under simplified neutrosophic uncertain linguistic environment. *Int. J. Mach. Learn. Cybern.* **2016**. [CrossRef]

24. Wu, X.H.; Wang, J.; Peng, J.J.; Chen, X.H. Cross-entropy and prioritized aggregation operator with simplified neutrosophic sets and their application in multi-criteria decision-making problems. *Int. J. Fuzzy Syst.* **2016**, *18*, 1104–1116. [[CrossRef](#)]
25. Sahin, R.; Kucuk, A. Subsethood measure for single valued neutrosophic sets. *J. Intell. Fuzzy Syst.* **2015**, *29*, 525–530. [[CrossRef](#)]
26. Ye, J. An extended TOPSIS method for multiple attribute group decision making based on single valued neutrosophic linguistic numbers. *J. Intell. Fuzzy Syst.* **2015**, *28*, 247–255.
27. Biswas, P.; Pramanik, S.; Giri, B.C. TOPSIS method for multi-attribute group decision-making under single-valued neutrosophic environment. *Neural Comput. Appl.* **2016**, *27*, 727–737. [[CrossRef](#)]
28. Majumdar, P.; Samanta, S.K. On similarity and entropy of neutrosophic sets. *J. Intell. Fuzzy Syst.* **2014**, *26*, 1245–1252.
29. Wang, Y.M. Using the method of maximizing deviations to make decision for multiindices. *Syst. Eng. Electron.* **1997**, *8*, 21–26.
30. Hwang, C.L.; Yoon, K. *Multiple Attribute Decision Making: Methods and Applications*; Springer-Verlag: New York, NY, USA, 1981.
31. Chen, M.F.; Tzeng, G.H. Combining grey relation and TOPSIS concepts for selecting an expatriate host country. *Math. Comput. Model.* **2004**, *40*, 1473–1490. [[CrossRef](#)]
32. Shaw, K.; Shankar, R.; Yadav, S.S.; Thakur, L.S. Supplier selection using fuzzy AHP and fuzzy multi-objective linear programming for developing low carbon supply chain. *Expert Syst. Appl.* **2012**, *39*, 8182–8192. [[CrossRef](#)]
33. Rouyendegh, B.D.; Saputro, T.E. Supplier selection using fuzzy TOPSIS and MCGP: A case study. *Procedia Soc. Behav. Sci.* **2014**, *116*, 3957–3970. [[CrossRef](#)]
34. Dargi, A.; Anjomshoae, A.; Galankashi, M.R.; Memari, A.; Tap, M.B.M. Supplier selection: A fuzzy-ANP approach. *Procedia Comput. Sci.* **2014**, *31*, 691–700. [[CrossRef](#)]
35. Kaur, P. Selection of vendor based on intuitionistic fuzzy analytical hierarchy process. *Adv. Oper. Res.* **2014**, *2014*. [[CrossRef](#)]
36. Kaur, P.; Rachana, K.N.L. An intuitionistic fuzzy optimization approach to vendor selection problem. *Perspect. Sci.* **2016**, *8*, 348–350. [[CrossRef](#)]
37. Dweiri, F.; Kumar, S.; Khan, S.A.; Jain, V. Designing an integrated AHP based decision support system for supplier selection in automotive industry. *Expert Syst. Appl.* **2016**, *62*, 273–283. [[CrossRef](#)]
38. Junior, F.R.L.; Osiro, L.; Carpinetti, L.C.R. A comparison between fuzzy AHP and fuzzy TOPSIS methods to supplier selection. *Appl. Soft Comput.* **2014**, *21*, 194–209. [[CrossRef](#)]
39. Ye, J. A multicriteria decision-making method using aggregation operators for simplified neutrosophic sets. *J. Intell. Fuzzy Syst.* **2014**, *26*, 2459–2466.
40. Peng, J.J.; Wang, J.; Wang, J.; Zhang, H.; Chen, X.H. Simplified neutrosophic sets and their applications in multi-criteria group decision-making problems. *Int. J. Syst. Sci.* **2016**, *47*, 2342–2358. [[CrossRef](#)]
41. Maji, P.K. A neutrosophic soft set approach to a decision making problem. *Ann. Fuzzy Math. Inform.* **2012**, *3*, 313–319.
42. Karaaslan, F. Neutrosophic soft sets with applications in decision making. *Int. J. Inf. Sci. Intell. Syst.* **2015**, *4*, 1–20.
43. Ye, J. Single valued neutrosophic cross-entropy for multicriteria decision making problems. *Appl. Math. Model.* **2014**, *38*, 1170–1175. [[CrossRef](#)]
44. Biswas, P.; Pramanik, S.; Giri, B.C. Entropy based grey relational analysis method for multi-attribute decision making under single valued neutrosophic assessments. *Neutrosophic Sets Syst.* **2014**, *2*, 102–110.
45. Ye, J. Improved cross entropy measures of single valued neutrosophic sets and interval neutrosophic sets and their multicriteria decision making methods. *Cybern. Inf. Technol.* **2015**, *15*, 13–26. [[CrossRef](#)]

Multi-Granulation Neutrosophic Rough Sets on a Single Domain and Dual Domains with Applications

Chunxin Bo, Xiaohong Zhang, Songtao Shao, Florentin Smarandache

Chunxin Bo, Xiaohong Zhang, Songtao Shao, Florentin Smarandache (2018). Multi-Granulation Neutrosophic Rough Sets on a Single Domain and Dual Domains with Applications. *Symmetry* 10, 296; DOI: 10.3390/sym10070296

Abstract: It is an interesting direction to study rough sets from a multi-granularity perspective. In rough set theory, the multi-particle structure was represented by a binary relation. This paper considers a new neutrosophic rough set model, multi-granulation neutrosophic rough set (MGNRS). First, the concept of MGNRS on a single domain and dual domains was proposed. Then, their properties and operators were considered. We obtained that MGNRS on dual domains will degenerate into MGNRS on a single domain when the two domains are the same. Finally, a kind of special multi-criteria group decision making (MCGDM) problem was solved based on MGNRS on dual domains, and an example was given to show its feasibility.

Keywords: neutrosophic rough set; MGNRS; dual domains; inclusion relation; decision-making

1. Introduction

As we all know, Pawlak first proposed a rough set in 1982, which was a useful tool of granular computing. The relation is an equivalent in Pawlak's rough set. After that, many researchers proposed other types of rough set theory (see the work by the following authors [1–8]).

In 1965, Zadeh presented a new concept of the fuzzy set. After that, a lot of scholars studied it and made extensions. For example, Atanassov introduced an intuitionistic fuzzy set, which gives two degrees of membership of an element; it is a generalization of the fuzzy set. Smarandache introduced a neutrosophic set in 1998 [9,10], which was an extension of the intuitionistic fuzzy set. It gives three degrees of membership of an element (T.I.F). Smarandache and Wang [11] proposed the definition of a single valued neutrosophic set and studied its operators. Ye [12] proposed the definition of simplified neutrosophic sets and studied their operators. Zhang et al. [13] introduced a new inclusion relation of the neutrosophic set and told us when it was used by an example, and its lattice structure was studied. Garg and Nancy proposed neutrosophic operators and applied them to decision-making problems [14–16]. Now, some researchers have combined the fuzzy set and rough set and have achieved many running results, such as the fuzzy rough set [17] and rough fuzzy set. Broumi and Smarandache [18] proposed the definition of a rough neutrosophic set and studied their operators and properties. In 2016, Yang et al. [19] proposed the definition of single valued neutrosophic rough sets and studied their operators and properties.

Under the perspective of granular computing [20], the concept of a rough set is shown by the upper and lower approximations of granularity. In other words, the concept is represented by the

known knowledge, which is defined by a single relationship. In fact, to meet the user's needs or achieve the goal of solving the problem, it is sometimes necessary to use multiple relational representation concepts on the domain, such as illustrated by the authors of [21]. In a grain calculation, an equivalence relation in the domain is a granularity, and a partition is considered as a granularity space [22]. The approximation that is defined by multiple equivalence relationships is a multi-granularity approximation and multiple partitions are considered as multi-granularity spaces; the resulting rough set is named a multi-granularity rough set, which has been proposed by Qian and Liang [23]. Recently, many scholars [24,25] have studied it and made extensions. Huang et al. [26] proposed the notion of intuitionistic fuzzy multi-granulation rough sets and studied their operators. Zhang et al. [27] introduced two new multi-granulation rough set models and investigated their operators. Yao et al. [28] made a summary about the rough set models on the multi-granulation spaces.

Although there have been many studies regarding multi-granulation rough set theory, there have been fewer studies about the multi-granulation rough set model on dual domains. Moreover, a multi-granulation rough set on dual domains is more convenient, for example, medical diagnosis in clinics [22,29]. The symptoms are the uncertainty index sets and the diseases are the decision sets. They are associated with each other, but they belong to two different domains. Therefore, it is necessary to use two different domains when solving the MCGDM problems. Sun et al. [29] discussed the multi-granulation rough set models based on dual domains; their properties were also obtained.

Although neutrosophic sets and multi-granulation rough sets are both useful tools to solve uncertainty problems, there are few research regarding their combination. In this paper, we proposed the definition of MGNRS as a rough set generated by multi-neutrosophic relations. It is useful to solve a kind of special group decision-making problem. We studied their properties and operations and then built a way to solve MCGDM problems based on the MGNRS theory on dual domains.

The structure of the article is as follows. In Section 2, some basic notions and operations are introduced. In Section 3, the notion of MGNRS is proposed and their properties are studied. In Section 4, the model of MGNRS on dual domains is proposed and their properties are obtained. Also, we obtained that MGNRS on dual domains will degenerate into MGNRS on a single domain when the two domains are same. In Section 5, an application of the MGNRS to solve a MCGDM problem was proposed. Finally, Section 6 concludes this paper and provides an outlook.

2. Preliminary

In this section, we review several basic concepts and operations of the neutrosophic set and multi-granulation rough set.

Definition 1 ([11]). A single valued neutrosophic set B is denoted by $\forall y \in Y$, as follows:

$$B(y) = (T_B(y), I_B(y), F_B(y))$$

$T_B(y), I_B(y), F_B(y) \in [0,1]$ and satisfies $0 \leq T_B(y) + I_B(y) + F_B(y) \leq 3$.

As a matter of convenience, 'single valued neutrosophic set' is abbreviated to 'neutrosophic set' later. In this paper, $NS(Y)$ denotes the set of all single valued neutrosophic sets in Y , and $NR(Y \times Z)$ denotes the set of all of the neutrosophic relations in $Y \times Z$.

Definition 2 ([11]). If A and C are two neutrosophic sets, then the inclusion relation, union, intersection, and complement operations are defined as follows:

- (1) $A \subseteq C$ iff $\forall y \in Y, T_A(y) \leq T_C(y), I_A(y) \geq I_C(y)$ and $F_A(y) \geq F_C(y)$
- (2) $A^c = \{(y, F_A(y), 1 - I_A(y), T_A(y)) \mid y \in Y\}$
- (3) $A \cap C = \{(y, T_A(y) \wedge T_C(y), I_A(y) \vee I_C(y), F_A(y) \vee F_C(y)) \mid y \in Y\}$
- (4) $A \cup C = \{(y, T_A(y) \vee T_C(y), I_A(y) \wedge I_C(y), F_A(y) \wedge F_C(y)) \mid y \in Y\}$

Definition 3 ([19]). If (U, R) is a single valued neutrosophic approximation space. Then $\forall B \in SVNS(U)$, the lower approximation $\underline{N}(B)$ and upper approximation $\overline{N}(B)$ of B are defined as follows:

$$\begin{aligned} T_{\underline{N}(B)}(y) &= \min_{z \in U} [\max(F_R(y, z), T_B(z))], & I_{\underline{N}(B)}(y) &= \max_{z \in U} [\min((1 - I_R(y, z)), I_B(z))], \\ F_{\underline{N}(B)}(y) &= \max_{z \in U} [\min(T_R(y, z), F_B(z))] \\ T_{\overline{N}(B)}(y) &= \max_{z \in U} [\min(T_R(y, z), T_B(z))], & I_{\overline{N}(B)}(y) &= \min_{z \in U} [\max(I_R(y, z), I_B(z))], \\ F_{\overline{N}(B)}(y) &= \min_{z \in U} [\max(F_R(y, z), F_B(z))] \end{aligned}$$

The pair $(\underline{N}(B), \overline{N}(B))$ is called the single valued neutrosophic rough set of B , with respect to (U, R) .

According to the operation of neutrosophic number in [16], the sum of two neutrosophic sets in U is defined as follows.

Definition 4. If C and D are two neutrosophic sets in U , then the sum of C and D is defined as follows:

$$C + D = \{ \langle y, C(y) \oplus D(y) \rangle \mid y \in U \}.$$

Definition 5 ([30]). If $b = (T_b, I_b, F_b)$ is a neutrosophic number, $b^* = (T_{b^*}, I_{b^*}, F_{b^*}) = (1, 0, 0)$ is an ideal neutrosophic number. Then, the cosine similarity measure is defined as follows:

$$S(b, b^*) = \frac{T_b \cdot T_{b^*} + I_b \cdot I_{b^*} + F_b \cdot F_{b^*}}{\sqrt{T_b^2 + I_b^2 + F_b^2} \cdot \sqrt{(T_{b^*})^2 + (I_{b^*})^2 + (F_{b^*})^2}}$$

3. Multi-Granulation Neutrosophic Rough Sets

In this part, we propose the concept of MGNRS and study their characterizations. MGNRS is a rough set generated by multi-neutrosophic relations, and when all neutrosophic relations are same, MGNRS will degenerated to neutrosophic rough set.

Definition 6. Assume U is a non-empty finite domain, and R_i ($1 \leq i \leq n$) is the binary neutrosophic relation on U . Then, (U, R_i) is called the multi-granulation neutrosophic approximation space (MGNAS).

Next, we present the multi-granulation rough approximation of a neutrosophic concept in an approximation space.

Definition 7. Let the tuple ordered set (U, R_i) ($1 \leq i \leq n$) be a MGNAS. For any $B \in NS(U)$, the three memberships of the optimistic lower approximation $\underline{M}^o(B)$ and optimistic upper approximation $\overline{M}^o(B)$ in (U, R_i) are defined, respectively, as follows:

$$\begin{aligned} T_{\underline{M}^o(B)}(y) &= \max_{i=1}^n \min_{z \in U} (\max(F_{R_i}(y, z), T_B(z))), & I_{\underline{M}^o(B)}(y) &= \min_{i=1}^n \max_{z \in U} (\min((1 - I_{R_i}(y, z)), I_B(z))), \\ F_{\underline{M}^o(B)}(y) &= \min_{i=1}^n \max_{z \in U} (\min(T_{R_i}(y, z), F_B(z))), & T_{\overline{M}^o(B)}(y) &= \min_{i=1}^n \max_{z \in U} (\min(T_{R_i}(y, z), T_B(z))), \\ I_{\overline{M}^o(B)}(y) &= \max_{i=1}^n \min_{z \in U} (\max(I_{R_i}(y, z), I_B(z))), & F_{\overline{M}^o(B)}(y) &= \max_{i=1}^n \min_{z \in U} (\max(F_{R_i}(y, z), F_B(z))). \end{aligned}$$

Then, $\underline{M}^o(B), \overline{M}^o(B) \in NS(U)$. In addition, B is called a definable neutrosophic set on (U, R_i) when $\underline{M}^o(B) = \overline{M}^o(B)$. Otherwise, the pair $(\underline{M}^o(B), \overline{M}^o(B))$ is called an optimistic MGNRS.

Definition 8. Let the tuple ordered set (U, R_i) ($1 \leq i \leq n$) be a MGNAS. For any $B \in NS(U)$, the three memberships of pessimistic lower approximation $\underline{M}^p(B)$ and pessimistic upper approximation $\overline{M}^p(B)$ in (U, R_i) are defined, respectively, as follows:

$$T_{\underline{M}^p(B)}(y) = \min_{i=1}^n \min_{z \in U} (\max(F_{R_i}(y, z), T_B(z))), I_{\underline{M}^p(B)}(y) = \max_{i=1}^n \max_{z \in U} (\min((1 - I_{R_i}(y, z)), I_B(z))),$$

$$F_{\underline{M}^p(B)}(y) = \max_{i=1}^n \max_{z \in U} (\min(T_{R_i}(y, z), F_B(z))), T_{\overline{M}^p(B)}(y) = \max_{i=1}^n \max_{z \in U} (\min(T_{R_i}(y, z), T_B(z))),$$

$$I_{\overline{M}^p(B)}(y) = \min_{i=1}^n \min_{z \in U} (\max(I_{R_i}(y, z), I_B(z))), F_{\overline{M}^p(B)}(y) = \min_{i=1}^n \min_{z \in U} (\max(F_{R_i}(y, z), F_B(z))).$$

Similarly, B is called a definable neutrosophic set on (U, R_i) when $\underline{M}^p(B) = \overline{M}^p(B)$. Otherwise, the pair $(\underline{M}^p(B), \overline{M}^p(B))$ is called a pessimistic MGNRS.

Example 1. Define MGNAS (U, R_i) , where $U = \{z_1, z_2, z_3\}$ and R_i ($1 \leq i \leq 3$) are given in Tables 1–3

Table 1. Neutrosophic relation R_1 .

R_1	z_1	z_2	z_3
z_1	(0.4, 0.5, 0.4)	(0.5, 0.7, 0.1)	(1, 0.8, 0.8)
z_2	(0.5, 0.6, 1)	(0.2, 0.6, 0.4)	(0.9, 0.2, 0.4)
z_3	(1, 0.2, 0)	(0.8, 0.9, 1)	(0.6, 1, 0)

Table 2. Neutrosophic relation R_2 .

R_2	z_1	z_2	z_3
z_1	(0.9, 0.2, 0.4)	(0.3, 0.9, 0.1)	(0.1, 0.7, 0)
z_2	(0.4, 0.5, 0.1)	(0, 0.1, 0.7)	(1, 0.8, 0.8)
z_3	(1, 0.5, 0)	(0.4, 0.4, 0.2)	(0.1, 0.5, 0.4)

Table 3. Neutrosophic relation R_3 .

R_3	z_1	z_2	z_3
z_1	(0.7, 0.7, 0)	(0.4, 0.8, 0.9)	(1, 0.4, 0.5)
z_2	(0.8, 0.2, 0.1)	(1, 0.1, 0.8)	(0.1, 0.3, 0.5)
z_3	(0, 0.8, 1)	(1, 0, 1)	(1, 1, 0)

Suppose a neutrosophic set on U is as follows: $C(z_1) = (0.2, 0.6, 0.4)$, $C(z_2) = (0.5, 0.4, 1)$, $C(z_3) = (0.7, 0.1, 0.5)$; by Definitions 7 and 8, we can get the following:

$$\underline{M}^o(C)(z_1) = (0.4, 0.3, 0.4), \underline{M}^o(C)(z_2) = (0.5, 0.4, 0.5), \underline{M}^o(C)(z_3) = (0.7, 0.4, 0.4)$$

$$\overline{M}^o(C)(z_1) = (0.3, 0.6, 0.4), \overline{M}^o(C)(z_2) = (0.5, 0.4, 0.5), \overline{M}^o(C)(z_3) = (0.4, 0.6, 0.5)$$

$$\underline{M}^p(C)(z_1) = (0.2, 0.6, 0.5), \underline{M}^p(C)(z_2) = (0.2, 0.6, 0.1), \underline{M}^p(C)(z_3) = (0.2, 0.6, 0.1)$$

$$\overline{M}^p(C)(z_1) = (0.7, 0.4, 0.4), \overline{M}^p(C)(z_2) = (0.7, 0.2, 0.4), \overline{M}^p(C)(z_3) = (0.7, 0.4, 0.4)$$

Proposition 1. Assume (U, R_i) is MGNAS, R_i ($1 \leq i \leq n$) is the neutrosophic relations. $\forall C \in NS(U)$, $\underline{M}^o(C)$ and $\overline{M}^o(C)$ are the optimistic lower and upper approximation of C . Then,

$$\underline{M}^o(C) = \bigcup_{i=1}^n \underline{N}(C) \overline{M}^o(C) = \bigcap_{i=1}^n \overline{N}(C)$$

where

$$\underline{N}(C)(y) = \bigcap_{z \in U} (R_i^c(y, z) \cup C(z)), \overline{N}(C)(y) = \bigcup_{z \in U} (R_i(y, z) \cap C(z))$$

Proof. They can be proved by Definitions 7.

Proposition 2. Assume (U, R_i) be MGNAS, R_i ($1 \leq i \leq n$) be neutrosophic relations. $\forall C \in NS(U)$, $\underline{M}^p(C)$ and $\overline{M}^p(C)$ are the pessimistic lower and upper approximation of C . Then

$$\underline{M}^p(C) = \bigcap_{i=1}^n \underline{N}(C) \overline{M}^p(C) = \bigcup_{i=1}^n \overline{N}(C)$$

where

$$\underline{N}(C)(y) = \bigcap_{z \in U} (R_i^c(y, z) \cup C(z)), \overline{N}(C)(y) = \bigcup_{z \in U} (R_i(y, z) \cap C(z))$$

Proof. Proposition 2 can be proven by Definition 8.

Proposition 3. Assume (U, R_i) is MGNAS, R_i ($1 \leq i \leq n$) is the neutrosophic relations. $\forall C, D \in NS(U)$, we have the following:

- (1) $\underline{M}^o(C) = \sim \overline{M}^o(\sim C)$, $\underline{M}^p(C) = \sim \overline{M}^p(\sim C)$;
- (2) $\overline{M}^o(C) = \sim \underline{M}^o(\sim C)$, $\overline{M}^p(C) = \sim \underline{M}^p(\sim C)$;
- (3) $\underline{M}^o(C \cap D) = \underline{M}^o(C) \cap \underline{M}^o(D)$, $\underline{M}^p(C \cap D) = \underline{M}^p(C) \cap \underline{M}^p(D)$;
- (4) $\overline{M}^o(C \cup D) = \overline{M}^o(C) \cup \overline{M}^o(D)$, $\overline{M}^p(C \cup D) = \overline{M}^p(C) \cup \overline{M}^p(D)$;
- (5) $C \subseteq D \Rightarrow \underline{M}^o(C) \subseteq \underline{M}^o(D)$, $\underline{M}^p(C) \subseteq \underline{M}^p(D)$;
- (6) $C \subseteq D \Rightarrow \overline{M}^o(C) \subseteq \overline{M}^o(D)$, $\overline{M}^p(C) \subseteq \overline{M}^p(D)$;
- (7) $\underline{M}^o(C \cup D) \supseteq \underline{M}^o(C) \cup \underline{M}^o(D)$, $\underline{M}^p(C \cup D) \supseteq \underline{M}^p(C) \cup \underline{M}^p(D)$;
- (8) $\overline{M}^o(C \cap D) \subseteq \overline{M}^o(C) \cap \overline{M}^o(D)$, $\overline{M}^p(C \cap D) \subseteq \overline{M}^p(C) \cap \overline{M}^p(D)$.

Proof. (1), (2), (5), and (6) can be taken directly from Definitions 7 and 8. We only show (3), (4), (7), and (8).

(3) From Proposition 1, we have the following:

$$\begin{aligned} \underline{M}^o(C \cap D)(y) &= \bigcup_{i=1}^n \left(\bigcap_{z \in U} (R_i^c(y, z) \cup (C \cap D)(z)) \right) \\ &= \bigcup_{i=1}^n \left(\bigcap_{z \in U} ((R_i^c(y, z) \cup C(z)) \cap (R_i^c(y, z) \cup D(z))) \right) \\ &= \left(\bigcup_{i=1}^n \left(\bigcap_{z \in U} (R_i^c(y, z) \cup C(z)) \right) \right) \cap \left(\bigcup_{i=1}^n \left(\bigcap_{z \in U} (R_i^c(y, z) \cup D(z)) \right) \right) \\ &= \underline{M}^o C(y) \cap \underline{M}^o D(y). \end{aligned}$$

Similarly, from Proposition 2, we can get the following:

$$\underline{M}^p(C \cap D)(y) = \underline{M}^p C(y) \cap \underline{M}^p D(y).$$

(4) According to Propositions 1 and 2, in the same way as (3), we can get the proof.

(7) From Definition 7, we have the following:

$$\begin{aligned} T_{\underline{M}^o(C \cup D)}(y) &= \max_{i=1}^n \min_{z \in U} \{ \max [F_{R_i}(y, z), (\max(T_C(z), T_D(z)))] \} \\ &= \max_{i=1}^n \min_{z \in U} \{ \max [(\max(F_{R_i}(y, z), T_C(z))), (\max(F_{R_i}(y, z), T_D(z)))] \} \\ &\geq \max \left\{ \left[\max_{i=1}^n \min_{z \in U} (\max(F_{R_i}(y, z), T_C(z))) \right], \left[\max_{i=1}^n \min_{z \in U} (\max(F_{R_i}(y, z), T_D(z))) \right] \right\} \\ &= \max(T_{\underline{M}^o(C)}(y), T_{\underline{M}^o(D)}(y)). \end{aligned}$$

$$\begin{aligned}
 I_{\underline{M}^o(C \cup D)}(y) &= \min_{i=1}^n \max_{z \in U} \{ \min [(1 - I_{R_i}(y, z)), (\min(I_C(z), I_D(z)))] \} \\
 &= \min_{i=1}^n \max_{z \in U} \{ \min [(\min((1 - I_{R_i}(y, z)), I_C(z))), (\min((1 - I_{R_i}(y, z)), I_D(z)))] \} \\
 &\leq \min \left\{ \left[\min_{i=1}^n \max_{z \in U} (\min((1 - I_{R_i}(y, z)), I_C(z))) \right], \left[\min_{i=1}^n \max_{z \in U} (\min((1 - I_{R_i}(y, z)), I_D(z))) \right] \right\} \\
 &= \min \left(I_{\underline{M}^o(C)}(y), I_{\underline{M}^o(D)}(y) \right). \\
 F_{\underline{M}^o(C \cup D)}(y) &= \min_{i=1}^n \max_{z \in U} \{ \min [T_{R_i}(y, z), (\min(F_C(z), F_D(z)))] \} \\
 &= \min_{i=1}^n \max_{z \in U} \{ \min [\min(T_{R_i}(y, z), F_C(z)), [\min(T_{R_i}(y, z), F_D(z))]] \} \\
 &\leq \min \left\{ \left[\min_{i=1}^n \max_{z \in U} (\min(T_{R_i}(y, z), F_C(z))) \right], \left[\min_{i=1}^n \max_{z \in U} (\min(T_{R_i}(y, z), F_D(z))) \right] \right\} \\
 &= \min \left(F_{\underline{M}^o(C)}(y), F_{\underline{M}^o(D)}(y) \right).
 \end{aligned}$$

Hence, $\underline{M}^o(C \cup D) \supseteq \underline{M}^o(C) \cup \underline{M}^o(D)$.

Also, according to Definition 8, we can get $\underline{M}^p(C \cup D) \supseteq \underline{M}^p(C) \cup \underline{M}^p(D)$.

(8) From Definition 7, we have the following:

$$\begin{aligned}
 T_{\overline{M}^o(C \cap D)}(y) &= \min_{i=1}^n \max_{z \in U} \{ \min [T_{R_i}(y, z), (\min(T_C(z), T_D(z)))] \} \\
 &= \min_{i=1}^n \max_{z \in U} \{ \min [(\min(T_{R_i}(y, z), T_C(z))), (\min(T_{R_i}(y, z), T_D(z)))] \} \\
 &\leq \min \left\{ \left[\min_{i=1}^n \max_{z \in U} (\min(T_{R_i}(y, z), T_C(z))) \right], \left[\min_{i=1}^n \max_{z \in U} (\min(T_{R_i}(y, z), T_D(z))) \right] \right\} \\
 &= \min \left(T_{\overline{M}^o(C)}(y), T_{\overline{M}^o(D)}(y) \right).
 \end{aligned}$$

$$\begin{aligned}
 I_{\overline{M}^o(C \cap D)}(y) &= \max_{i=1}^n \min_{z \in U} \{ \max [I_{R_i}(y, z), (\max(I_C(z), I_D(z)))] \} \\
 &= \max_{i=1}^n \min_{z \in U} \{ \max [(\max(I_{R_i}(y, z), I_C(z))), (\max(I_{R_i}(y, z), I_D(z)))] \} \\
 &\leq \min \left\{ \left[\max_{i=1}^n \min_{z \in U} (\max(I_{R_i}(y, z), I_C(z))) \right], \left[\max_{i=1}^n \min_{z \in U} (\max(I_{R_i}(y, z), I_D(z))) \right] \right\} \\
 &= \min \left(I_{\overline{M}^o(C)}(y), I_{\overline{M}^o(D)}(y) \right).
 \end{aligned}$$

$$\begin{aligned}
 F_{\overline{M}^o(C \cap D)}(y) &= \max_{i=1}^n \min_{z \in U} [F_{R_i}(y, z) \vee (F_C(z) \vee F_D(z))] \\
 &= \max_{i=1}^n \min_{z \in U} [(F_{R_i}(y, z) \vee F_C(z)) \vee (F_{R_i}(y, z) \vee F_D(z))] \\
 &\geq \left[\max_{i=1}^n \min_{z \in U} (F_{R_i}(y, z) \vee F_C(z)) \right] \vee \left[\max_{i=1}^n \min_{z \in U} (F_{R_i}(y, z) \vee F_D(z)) \right] \\
 &= \max \left(F_{\overline{M}^o(C)}(y), F_{\overline{M}^o(D)}(y) \right).
 \end{aligned}$$

Hence, $\overline{M}^o(C \cap D) \subseteq \overline{M}^o(C) \cap \overline{M}^o(D)$.

Similarly, according Definition 8, we can get $\overline{M}^p(C \cap D) \subseteq \overline{M}^p(C) \cap \overline{M}^p(D)$.

Next, we will give an example to show that maybe $\underline{M}^o(C \cup D) \neq \underline{M}^o(C) \cup \underline{M}^o(D)$.

Example 2. Define MGNAS (U, R_i) , where $U = \{z_1, z_2, z_3\}$ and R_i ($1 \leq i \leq 3$) are given in Example 1.

Suppose there are two neutrosophic sets on universe U , as follows: $C(z_1) = (0.5, 0.1, 0.2)$, $C(z_2) = (0.5, 0.3, 0.2)$, $C(z_3) = (0.6, 0.2, 0.1)$, $D(z_1) = (0.7, 0.2, 0.1)$, $D(z_2) = (0.4, 0.2, 0.1)$, $D(z_3) = (0.2, 0.2, 0.5)$, we have $(C \cup D)(z_1) = (0.7, 0.1, 0.1)$, $(C \cup D)(z_2) = (0.5, 0.2, 0.1)$, $(C \cup D)(z_3) = (0.6, 0.2, 0.1)$, $(C \cap D)(z_1) = (0.5, 0.1,$

0.2), $(C \cap D)(z_2) = (0.4, 0.2, 0.2)$, $(C \cap D)(z_3) = (0.2, 0.2, 0.5)$. Then, from Definitions 7 and 8, we can get the following:

$$\begin{aligned} \underline{M}^o(C)(z_1) &= (0.5, 0, 0.2), \underline{M}^o(C)(z_2) = (0.5, 0.1, 0.2), \underline{M}^o(C)(z_3) = (0.5, 0.1, 0.2); \\ \underline{M}^o(D)(z_1) &= (0.4, 0, 0.1), \underline{M}^o(D)(z_2) = (0.2, 0.1, 0.2), \underline{M}^o(D)(z_3) = (0.4, 0.1, 0.2); \\ \underline{M}^o(C \cup D)(z_1) &= (0.5, 0, 0.1), \underline{M}^o(C \cup D)(z_2) = (0.5, 0.1, 0.1), \underline{M}^o(C \cup D)(z_3) = (0.5, 0.1, 0.1) \\ (\underline{M}^o(C) \cup \underline{M}^o(D))(z_1) &= (0.5, 0, 0.1), (\underline{M}^o(C) \cup \underline{M}^o(D))(z_2) = (0.5, 0.1, 0.2), \\ &(\underline{M}^o(C) \cup \underline{M}^o(D))(z_3) = (0.5, 0.1, 0.2) \end{aligned}$$

So, $\underline{M}^o(C \cup D) \neq \underline{M}^o(C) \cup \underline{M}^o(D)$.

Also, there are examples to show that maybe $\underline{M}^p(C \cup D) \neq \underline{M}^p(C) \cup \underline{M}^p(D)$, $\overline{M}^o(C \cap D) \neq \overline{M}^o(C) \cap \overline{M}^o(D)$, $\overline{M}^p(C \cap D) \neq \overline{M}^p(C) \cap \overline{M}^p(D)$. We do not say anymore here.

4. Multi-Granulation Neutrosophic Rough Sets on Dual Domains

In this section, we propose the concept of MGNRS on dual domains and study their characterizations. Also, we obtain that the MGNRS on dual domains will degenerate into MGNRS, defined in Section 3, when the two domains are same.

Definition 9. Assume that U and V are two domains, and $R_i \in NS(U \times V)$ ($1 \leq i \leq n$) is the binary neutrosophic relations. The triple ordered set (U, V, R_i) is called the (two-domain) MGNAS.

Next, we present the multi-granulation rough approximation of a neutrosophic concept in an approximation space on dual domains.

Definition 10. Let (U, V, R_i) ($1 \leq i \leq n$) be (two-domain) MGNAS. $\forall B \in NS(V)$ and $y \in U$, the three memberships of the optimistic lower and upper approximation $\underline{M}^o(B)$, $\overline{M}^o(B)$ in (U, V, R_i) are defined, respectively, as follows:

$$\begin{aligned} T_{\underline{M}^o(B)}(y) &= \max_{i=1}^n \min_{z \in V} [\max(F_{R_i}(y, z), T_B(z))] \quad I_{\underline{M}^o(B)}(y) = \min_{i=1}^n \max_{z \in V} [\min((1 - I_{R_i}(y, z)), I_B(z))] \\ F_{\underline{M}^o(B)}(y) &= \min_{i=1}^n \max_{z \in V} [\min(T_{R_i}(y, z), F_B(z))] \quad T_{\overline{M}^o(B)}(y) = \min_{i=1}^n \max_{z \in V} [\min(T_{R_i}(y, z), T_B(z))] \\ I_{\overline{M}^o(B)}(y) &= \max_{i=1}^n \min_{z \in V} [\max(I_{R_i}(y, z), I_B(z))] \quad F_{\overline{M}^o(B)}(y) = \max_{i=1}^n \min_{z \in V} [\max(F_{R_i}(y, z), F_B(z))] \end{aligned}$$

Then $\underline{M}^o(B)$, $\overline{M}^o(B) \in NS(U)$. In addition, B is called a definable neutrosophic set on (U, V, R_i) on dual domains when $\underline{M}^o(B) = \overline{M}^o(B)$. Otherwise, the pair $(\underline{M}^o(B), \overline{M}^o(B))$ is called an optimistic MGNRS on dual domains.

Definition 11. Assume (U, V, R_i) ($1 \leq i \leq n$) is (two-domain) MGNAS. $\forall B \in NS(V)$ and $y \in U$, the three memberships of the pessimistic lower and upper approximation $\underline{M}^p(B)$, $\overline{M}^p(B)$ in (U, V, R_i) are defined, respectively, as follows:

$$\begin{aligned} T_{\underline{M}^p(B)}(y) &= \min_{i=1}^n \min_{z \in V} [\max(F_{R_i}(y, z), T_B(z))], \quad I_{\underline{M}^p(B)}(y) = \max_{i=1}^n \max_{z \in V} [\min((1 - I_{R_i}(y, z)), I_B(z))], \\ F_{\underline{M}^p(B)}(y) &= \max_{i=1}^n \max_{z \in V} [\min(T_{R_i}(y, z), F_B(z))], \quad T_{\overline{M}^p(B)}(y) = \max_{i=1}^n \max_{z \in V} [\min(T_{R_i}(y, z), T_B(z))], \\ I_{\overline{M}^p(B)}(y) &= \min_{i=1}^n \min_{z \in V} [\max(I_{R_i}(y, z), I_B(z))], \quad F_{\overline{M}^p(B)}(y) = \min_{i=1}^n \min_{z \in V} [\max(F_{R_i}(y, z), F_B(z))]. \end{aligned}$$

Then, B is called a definable neutrosophic set on (U, V, R_i) when $\underline{M}^p(B) = \overline{M}^p(B)$. Otherwise, the pair $(\underline{M}^p(B), \overline{M}^p(B))$ is called a pessimistic MGNRS on dual domains.

Remark 1. Note that if $U = V$, then the optimistic and pessimistic MGNRS on the dual domains will be the same with the optimistic and pessimistic MGNRS on a single domain, which is defined in Section 3

Proposition 4. Assume (U, V, R_i) ($1 \leq i \leq n$) is (two-domain) MGNAS, R_i ($1 \leq i \leq n$) is the neutrosophic relations. $\forall C, D \in NS(U)$, we have the following:

- (1) $\underline{M}^o(C) = \sim \overline{M}^o(\sim C), \underline{M}^p(C) = \sim \overline{M}^p(\sim C);$
- (2) $\overline{M}^o(C) = \sim \underline{M}^o(\sim C), \overline{M}^p(C) = \sim \underline{M}^p(\sim C);$
- (3) $\underline{M}^o(C \cap D) = \underline{M}^o(C) \cap \underline{M}^o(D), \underline{M}^p(C \cap D) = \underline{M}^p(C) \cap \underline{M}^p(D);$
- (4) $\overline{M}^o(C \cup D) = \overline{M}^o(C) \cup \overline{M}^o(D), \overline{M}^p(C \cup D) = \overline{M}^p(C) \cup \overline{M}^p(D);$
- (5) $C \subseteq D \Rightarrow \underline{M}^o(C) \subseteq \underline{M}^o(D), \underline{M}^p(C) \subseteq \underline{M}^p(D);$
- (6) $C \subseteq D \Rightarrow \overline{M}^o(C) \subseteq \overline{M}^o(D), \overline{M}^p(C) \subseteq \overline{M}^p(D);$
- (7) $\underline{M}^o(C \cup D) \supseteq \underline{M}^o(C) \cup \underline{M}^o(D), \underline{M}^p(C \cup D) \supseteq \underline{M}^p(C) \cup \underline{M}^p(D);$
- (8) $\overline{M}^o(C \cap D) \subseteq \overline{M}^o(C) \cap \overline{M}^o(D), \overline{M}^p(C \cap D) \subseteq \overline{M}^p(C) \cap \overline{M}^p(D).$

Proof. These propositions can be directly proven from Definitions 10 and 11.

5. An Application of Multi-Granulation Neutrosophic Rough Set on Dual Domains

Group decision making [31] is a useful way to solve uncertainty problems. It has developed rapidly since it was first proposed. Its essence is that in the decision-making process, multiple decision makers (experts) are required to participate and negotiate in order to settle the corresponding decision-making problems. However, with the complexity of the group decision-making problems, what we need to deal with is the multi-criteria problems, that is, multi-criteria group decision making (MCGDM). The MCGDM problem is to select or rank all of the feasible alternatives in multiple, interactive, and conflicting standards.

In this section, we build a neo-way to solve a kind of special MCGDM problem using the MGNRS theory. We generated the rough set according the multi-neutrosophic relations and then used it to solve the decision-making problems. We show the course and methodology of it.

5.1. Problem Description

Firstly, we describe the considered problem and we show it using a MCGDM example of houses selecting.

Let $U = \{x_1, x_2, \dots, x_m\}$ be the decision set, where x_1 represents very good, x_2 represents good, x_3 represents less good, \dots , and x_m represents not good. Let $V = \{y_1, y_2, \dots, y_n\}$ be the criteria set to describe the given house, where y_1 represents texture, y_2 represents geographic location, y_3 represents price, \dots , and y_n represents solidity. Suppose there are k evaluation experts and all of the experts give their own evaluation for criteria set y_j ($y_j \in V$) ($j = 1, 2, \dots, n$), regarding the decision set elements x_i ($x_i \in U$) ($i = 1, 2, \dots, m$). In this paper, let the evaluation relation R_1, R_2, \dots, R_k between V and U given by the experts, be the neutrosophic relation, $R_1, R_2, \dots, R_k \in SNS(U \times V)$. That is, $R_l(x_i, y_j)$ ($l = 1, 2, \dots, k$) represents the relation of the criteria set y_j and the decision set element x_i , which is given by expert l , based on their own specialized knowledge and experience. For a given customer, the criterion of the customer is shown using a neutrosophic set, C , in V , according to an expert's opinion. Then, the result of this problem is to get the opinion of the given house for the customer.

Then, we show the method to solve the above problem according to the theory of optimistic and pessimistic MGNRS on dual domains.

5.2. New Method

In the first step, we propose the multi-granulation neutrosophic decision information system based on dual domains for the above problem.

According to Section 5.1's description, we can get the evaluation of each expert as a neutrosophic relation. Then, all of the binary neutrosophic relations R_l given by all of the experts construct a relation set \mathcal{R} (i.e., $R_l \in \mathcal{R}$). Then, we get the multi-granulation neutrosophic decision information systems based on dual domains, denoted by (U, V, \mathcal{R}) .

Secondly, we compute $\underline{M}^o(C), \overline{M}^o(C), \underline{M}^p(C), \overline{M}^p(C)$ for the given customer, regarding (U, V, \mathcal{R}) .

Thirdly, according to Definition 4, we computed the sum of the optimistic and pessimistic multi-granulation neutrosophic lower and upper approximation.

Next, according Definition 5, we computed the cosine similarity measure. Define the choice x^* with the idea characteristics value $\alpha^* = (1, 0, 0)$ as the ideal choice. The bigger the value of $S(\alpha_{x_i}, \alpha^*)$ is, the closer the choice x_i with the ideal alternative x^* , so the better choice x_i is.

Finally, we compared $S(\alpha_{x_i}, \alpha^*)$ and ranked all of the choices that the given customer can choose from and we obtained the optimal choice.

5.3. Algorithm and Pseudo-Code

In this section, we provide the algorithm and pseudo-code given in table Algorithm 1.

Algorithm 1. Multi-granulation neutrosophic decision algorithm.

Input Multi-granulation neutrosophic decision information systems (U, V, \mathcal{R}) .

Output The optimal choice for the client.

Step 1 Computing $\underline{M}^o(C), \overline{M}^o(C), \underline{M}^p(C), \overline{M}^p(C)$ of neutrosophic set C about (U, V, \mathcal{R}) ;

Step 2 From Definition 4., we get $\underline{M}^o(C) + \overline{M}^o(C)$ and $\underline{M}^p(C) + \overline{M}^p(C)$;

Step 3 From Definition 5., we computer $S^o(\alpha_{x_i}, \alpha^*)$ and $S^p(\alpha_{x_i}, \alpha^*)$ ($i = 1, 2, \dots, m$);

Step 4 The optimal decision-making is to choose x_h if

$$S(\alpha_{x_h}, \alpha^*) = \max_{i \in \{1, 2, \dots, m\}} (S(\alpha_{x_i}, \alpha^*)).$$

pseudo-code

Begin

Input (U, V, \mathcal{R}) , where U is the decision set, V is the criteria set, and \mathcal{R} denotes the binary neutrosophic relation between criteria set and decision set.

Calculate $\underline{M}^o(C), \overline{M}^o(C), \underline{M}^p(C), \overline{M}^p(C)$. Where $\underline{M}^o(C), \overline{M}^o(C), \underline{M}^p(C), \overline{M}^p(C)$, which represents the optimistic and pessimistic multi-granulation lower and upper approximation of C , which is defined in Section 4.

Calculate $\underline{M}^o(C) + \overline{M}^o(C)$ and $\underline{M}^p(C) + \overline{M}^p(C)$, which is defined in Definition 4.

Calculate $S^o(\underline{M}^o(C) + \overline{M}^o(C), \alpha^*)$ and $S^p(\underline{M}^p(C) + \overline{M}^p(C), \alpha^*)$, which is defined in Definition 5.

For $i = 1, 2, \dots, m; j = 1, 2, \dots, n; l = 1, 2, \dots, k$;

If $S^o(\alpha_{x_i}, \alpha^*) < S^o(\alpha_{x_j}, \alpha^*)$, then $S^o(\alpha_{x_i}, \alpha^*) \rightarrow \text{Max}$,

 else $S^o(\alpha_{x_i}, \alpha^*) \rightarrow \text{Max}$,

 If $S^o(\alpha_{x_i}, \alpha^*) > \text{Max}$, then $S^o(\alpha_{x_i}, \alpha^*) \rightarrow \text{Max}$;

Print Max;

End

5.4. An Example

In this section, we used Section 5.2's way of solving a MCGDM problem, using the example of buying houses.

Let $V = \{y_1, y_2, y_3, y_4\}$ be the criteria set, where y_1 represents the texture, y_2 represents the geographic location, y_3 represents the price, and y_4 represents the solidity. Let $U = \{z_1, z_2, z_3, z_4\}$ be a decision set, where z_1 represents very good, z_2 represents good, z_3 represents less good, and z_4 represents not good.

Assume that there are three experts. They provide their opinions about all of the criteria sets y_j ($y_j \in V$) ($j = 1, 2, 3, 4$) regarding the decision set elements z_i ($x_i \in U$) ($i = 1, 2, 3, 4$). Like the discussion in Section 5.1, the experts give three evaluation relations, R_1, R_2 , and R_3 , which are neutrosophic relations between V and U , that is, $R_1, R_2, R_3 \in NR(U \times V)$. $T_{Rk}(z_i, y_j)$ shows the expert, k , give the truth membership of y_j to z_i ; $I_{Rk}(z_i, y_j)$ shows the expert, k , give the indeterminacy membership of y_j to z_i ; $F_{Rk}(z_i, y_j)$ shows the expert, k , give the falsity membership of y_j to z_i . For example, the first value (0.2, 0.3, 0.4) in Table 4, of 0.2 shows that the truth membership of the texture for the given house is very good, 0.3 shows that the indeterminacy membership of the texture for the given house is very good, and 0.4 shows that the falsity membership of the texture for the given house is very good.

Table 4. Neutrosophic relation R_1 .

R_1	y_1	y_2	y_3	y_4
z_1	(0.2, 0.3, 0.4)	(0.3, 0.5, 0.4)	(0.4, 0.6, 0.2)	(0.1, 0.3, 0.5)
z_2	(0.8, 0.7, 0.1)	(0.2, 0.5, 0.6)	(0.6, 0.6, 0.7)	(0.4, 0.6, 0.3)
z_3	(0.5, 0.7, 0.2)	(0.6, 0.2, 0.1)	(1, 0.9, 0.4)	(0.5, 0.4, 0.3)
z_4	(0.4, 0.6, 0.3)	(0.5, 0.5, 0.4)	(0.3, 0.8, 0.4)	(0.2, 0.9, 0.8)

So, we build the multi-granulation neutrosophic decision information system (U, V, \mathcal{R}) for the example.

Assume that the three experts give three evaluation relations, the results are given in Tables 4–6.

Table 5. Neutrosophic relation R_2 .

R_2	y_1	y_2	y_3	y_4
z_1	(0.3, 0.4, 0.5)	(0.6, 0.7, 0.2)	(0.1, 0.8, 0.3)	(0.5, 0.3, 0.4)
z_2	(0.5, 0.5, 0.4)	(1, 0, 1)	(0.8, 0.1, 0.8)	(0.7, 0.8, 0.5)
z_3	(0.7, 0.2, 0.1)	(0.3, 0.5, 0.4)	(0.6, 0.1, 0.4)	(1, 0, 0)
z_4	(1, 0.2, 0)	(0.8, 0.1, 0.5)	(0.1, 0.2, 0.7)	(0.2, 0.2, 0.8)

Table 6. Neutrosophic relation R_3 .

R_3	y_1	y_2	y_3	y_4
z_1	(0.6, 0.2, 0.2)	(0.3, 0.1, 0.7)	(0, 0.2, 0.9)	(0.8, 0.3, 0.2)
z_2	(0.1, 0.1, 0.7)	(0.2, 0.3, 0.8)	(0.7, 0.1, 0.2)	(0, 0, 1)
z_3	(0.8, 0.4, 0.1)	(0.9, 0.5, 0.3)	(0.2, 0.1, 0.6)	(0.7, 0.2, 0.3)
z_4	(0.6, 0.2, 0.2)	(0.2, 0.2, 0.8)	(1, 1, 0)	(0.5, 0.3, 0.1)

Assume C is the customer’s evaluation for each criterion in V , and is given by the following:

$$C(y_1) = (0.6, 0.5, 0.5), C(y_2) = (0.7, 0.3, 0.2), C(y_3) = (0.4, 0.5, 0.9), C(y_4) = (0.3, 0.2, 0.6).$$

From Definitions 10 and 11, we can compute the following:

$$\begin{aligned} \underline{M}^o(C)(z_1) &= (0.4, 0.5, 0.4), \underline{M}^o(C)(z_2) = (0.5, 0.4, 0.6), \underline{M}^o(C)(z_3) = (0.3, 0.3, 0.6), \\ &\underline{M}^o(C)(z_4) = (0.6, 0.4, 0.4) \\ \overline{M}^o(C)(z_1) &= (0.4, 0.3, 0.5), \overline{M}^o(C)(z_2) = (0.4, 0.5, 0.7), \overline{M}^o(C)(z_3) = (0.6, 0.3, 0.4), \\ &\overline{M}^o(C)(z_4) = (0.5, 0.5, 0.5) \\ \underline{M}^p(C)(z_1) &= (0.3, 0.5, 0.6), \underline{M}^p(C)(z_2) = (0.3, 0.5, 0.8), \underline{M}^p(C)(z_3) = (0.3, 0.5, 0.9), \\ &\underline{M}^p(C)(z_4) = (0.3, 0.5, 0.9) \\ \overline{M}^o(C)(z_1) &= (0.6, 0.3, 0.2), \overline{M}^o(C)(z_2) = (0.7, 0.2, 0.5), \overline{M}^o(C)(z_3) = (0.7, 0.2, 0.2), \\ &\overline{M}^o(C)(z_4) = (0.7, 0.2, 0.4) \end{aligned}$$

According Definition 4, we have the following:

$$\begin{aligned} (\underline{M}^o(C) + \overline{M}^o(C))(z_1) &= (0.64, 0.15, 0.2), (\underline{M}^o(C) + \overline{M}^o(C))(z_2) = (0.7, 0.2, 0.42), \\ (\underline{M}^o(C) + \overline{M}^o(C))(z_3) &= (0.72, 0.09, 0.24), (\underline{M}^o(C) + \overline{M}^o(C))(z_4) = (0.8, 0.2, 0.2) \\ (\underline{M}^p(C) + \overline{M}^p(C))(z_1) &= (0.72, 0.15, 0.12), (\underline{M}^p(C) + \overline{M}^p(C))(z_2) = (0.79, 0.1, 0.4), \\ (\underline{M}^p(C) + \overline{M}^p(C))(z_3) &= (0.79, 0.1, 0.18), (\underline{M}^p(C) + \overline{M}^p(C))(z_4) = (0.79, 0.1, 0.36) \end{aligned}$$

Then, according Definition 5, we have the following:

$$S^o(\alpha_{z_1}, \alpha^*) = 0.9315, S^o(\alpha_{z_2}, \alpha^*) = 0.8329, S^o(\alpha_{z_3}, \alpha^*) = 0.8588, S^o(\alpha_{z_4}, \alpha^*) = 0.9428. \quad (1)$$

$$S^p(\alpha_{z_1}, \alpha^*) = 0.9662, S^p(\alpha_{z_2}, \alpha^*) = 0.8865, S^p(\alpha_{z_3}, \alpha^*) = 0.9677, S^p(\alpha_{z_4}, \alpha^*) = 0.9040. \quad (2)$$

Then, we have the following:

$$S^o(\alpha_{z_4}, \alpha^*) > S^o(\alpha_{z_1}, \alpha^*) > S^o(\alpha_{z_3}, \alpha^*) > S^o(\alpha_{z_2}, \alpha^*). \quad (3)$$

$$S^p(\alpha_{z_3}, \alpha^*) > S^p(\alpha_{z_1}, \alpha^*) > S^p(\alpha_{z_4}, \alpha^*) = S^p(\alpha_{z_2}, \alpha^*). \quad (4)$$

So, the optimistic optimal choice is to choose x_4 , that is, this given house is “not good” for the customer; the pessimistic optimal choice is to choose x_3 , that is, this given house is “less good” for the customer.

6. Conclusions

In this paper, we propose the concept of MGNRS on a single domain and dual domains, and obtain their properties. In addition, we obtain that MGNRS on dual domains will be the same as the MGNRS on a single domain when the two domains are same. Then, we solve a kind of special group decision-making problem (based on neutrosophic relation) using MGNRS on dual domains, and we show the algorithm and give an example to show its feasibility.

In terms of the future direction, we will study other types of combinations of multi-granulation rough sets and neutrosophic sets and obtain their properties. At the same time, exploring the application of MGNRS in totally dependent-neutrosophic sets (see [32]) and related algebraic systems (see [33–35]), and a new aggregation operator, similarity measure, and distance measure (see [36–39]), are also meaningful research directions for the future.

Acknowledgments: This work was supported by the National Natural Science Foundation of China (Grant No. 61573240, 61473239) and the Graduate Student Innovation Project of Shanghai Maritime University 2017ycx082.

References

1. Chen, H.; Li, T.; Luo, C.; Horng, S.-J.; Wang, G. A decision-theoretic rough set approach for dynamic data mining. *IEEE Trans. Fuzzy Syst.* **2015**, *23*, 1958–1970. [[CrossRef](#)]
2. Cheng, Y.; Miao, D.Q.; Feng, Q.R. Positive approximation and converse approximation in interval-valued fuzzy rough sets. *Inf. Sci.* **2011**, *181*, 2086–2110. [[CrossRef](#)]
3. Dai, J.H.; Wang, W.T.; Xu, Q.; Tian, H.W. Uncertainty measurement for interval-valued decision systems based on extended conditional entropy. *Knowl.-Based Syst.* **2012**, *27*, 443–450. [[CrossRef](#)]
4. Greco, S.; Slowinski, R.; Zielniewicz, P. Putting dominance-based rough set approach and robust ordinal regression together. *Decis. Support Syst.* **2013**, *54*, 91–903. [[CrossRef](#)]

5. Jia, X.; Shang, L.; Zhou, B.; Yao, Y. Generalized attribute reduct in rough set theory. *Knowl.-Based Syst.* **2016**, *91*, 204–218. [[CrossRef](#)]
6. Li, J.H.; Mei, C.L.; Lv, Y.J. Incomplete decision contexts: Approximate concept construction, rule acquisition and knowledge reduction. *Int. J. Approx. Reason.* **2013**, *54*, 149–165. [[CrossRef](#)]
7. Qian, Y.; Liang, X.; Wang, Q.; Liang, J.; Liu, B.; Skowron, A.; Yao, Y.; Ma, J.; Dang, C. Local rough set: A solution to rough data analysis in big data. *Int. J. Approx. Reason.* **2018**, *97*, 38–63. [[CrossRef](#)]
8. Zhan, J.; Malik, H.; Akram, M. Novel decision-making algorithms based on intuitionistic fuzzy rough environment. *Int. J. Mach. Learn. Cyber.* **2018**, 1–27. [[CrossRef](#)]
9. Smarandache, F. *Neutrosophy: Neutrosophic Probability, Set and Logic*; American Research Press: Rehoboth, NM, USA, 1998.
10. Smarandache, F. Neutrosophic set—A generalization of the intuitionistic fuzzy sets. *Int. J. Pure Appl. Math.* **2005**, *24*, 287–297.
11. Wang, H.; Smarandache, F.; Sunderraman, R.; Zhang, Y.Q. *Interval Neutrosophic Sets and Logic: Theory and Applications in Computing*; Infinite Study (Cornell University): Ithaca, NY, USA, 2005.
12. Ye, J. A multicriteria decision-making method using aggregation operators for simplified neutrosophic sets. *J. Intell. Fuzzy Syst.* **2014**, *26*, 2459–2466.
13. Zhang, X.; Bo, C.; Smarandache, F.; Dai, J. New inclusion relation of neutrosophic sets with applications and related lattice structure. *Int. J. Mach. Learn. Cybern.* **2018**, 1–11. [[CrossRef](#)]
14. Garg, H.; Nancy, G.H. Linguistic single-valued neutrosophic prioritized aggregation operators and their applications to multiple-attribute group decision-making. *J. Ambient Intell. Humaniz. Comput.* **2018**, 1–23. [[CrossRef](#)]
15. Garg, H.; Nancy, G.H. Non-linear programming method for multi-criteria decision making problems under interval neutrosophic set environment. *Appl. Intell.* **2018**, *48*, 2199–2213. [[CrossRef](#)]
16. Nancy, G.H.; Garg, H. Novel single-valued neutrosophic decision making operators under frank norm operations and its application. *Int. J. Uncertain. Quantif.* **2016**, *6*, 361–375. [[CrossRef](#)]
17. Dubois, D.; Prade, H. Rough fuzzy sets and fuzzy rough sets. *Int. J. Gen. Syst.* **1990**, *17*, 191–209. [[CrossRef](#)]
18. Broumi, S.; Smarandache, F.; Dhar, M. Rough neutrosophic sets. *Neutrosophic Sets Syst.* **2014**, *3*, 62–67.
19. Yang, H.L.; Zhang, C.L.; Guo, Z.L.; Liu, Y.L.; Liao, X. A hybrid model of single valued neutrosophic sets and rough sets: Single valued neutrosophic rough set model. *Soft Comput.* **2017**, *21*, 6253–6267. [[CrossRef](#)]
20. Bargiela, A.; Pedrycz, W. Granular computing. In *Handbook on Computational Intelligence: Fuzzy Logic, Systems, Artificial Neural Networks, and Learning Systems*; World Scientific: Singapore, 2016; Volume 1, pp. 43–66.
21. Qian, Y.; Liang, J.Y.; Yao, Y.Y.; Dang, C.Y. MGRS: A multi-granulation rough set. *Inf. Sci.* **2010**, *180*, 949–970. [[CrossRef](#)]
22. Skowron, A.; Stepaniuk, J.; Swiniarski, R. Modeling rough granular computing based on approximation spaces. *Inf. Sci.* **2012**, *184*, 20–43. [[CrossRef](#)]
23. Qian, Y.; Liang, J.Y.; Pedrycz, W.; Dang, C.Y. An efficient accelerator for attribute reduction from incomplete data in rough set framework. *Pattern Recognit.* **2011**, *44*, 1658–1670. [[CrossRef](#)]
24. AbuDonia, H.M. Multi knowledge based rough approximations and applications. *Knowl.-Based Syst.* **2012**, *26*, 20–29. [[CrossRef](#)]
25. Wang, H.B.; Smarandache, F.; Zhang, Y.; Sunderraman, R. Single Valued Neutrosophic Sets. *Multispace Multistruct.* **2010**, *4*, 410–413.
26. Huang, B.; Guo, C.; Zhuang, Y.; Li, H.; Zhou, X. Intuitionistic fuzzy multi-granulation rough sets. *Inf. Sci.* **2014**, *277*, 299–320. [[CrossRef](#)]
27. Zhang, X.; Miao, D.; Liu, C.; Le, M. Constructive methods of rough approximation operators and multi-granulation rough sets. *Knowl.-Based Syst.* **2016**, *91*, 114–125. [[CrossRef](#)]
28. Yao, Y.; She, Y. Rough set models in multi-granulation spaces. *Inf. Sci.* **2016**, *327*, 40–56. [[CrossRef](#)]
29. Sun, B.; Ma, W.; Qian, Y. Multigranulation fuzzy rough set over two universes and its application to decision making. *Knowl.-Based Syst.* **2017**, *123*, 61–74. [[CrossRef](#)]
30. Ye, J. Multicriteria decision-making method using the correlation coefficient under single-valued neutrosophic environment. *Int. J. Gen. Syst.* **2013**, *42*, 386–394. [[CrossRef](#)]
31. Altuzarra, A.; Moreno-Jiménez, J.; Salvador, M. Consensus building in AHP-group decision making: A Bayesian approach. *Oper. Res.* **2010**, *58*, 1755–1773. [[CrossRef](#)]

32. Zhang, X.H.; Bo, C.X.; Smarandache, F.; Park, C. New operations of totally dependent-neutrosophic sets and totally dependent-neutrosophic soft sets. *Symmetry* **2018**, *10*, 187. [[CrossRef](#)]
33. Zhang, X.H.; Smarandache, F.; Liang, X.L. Neutrosophic duplet semi-group and cancellable neutrosophic triplet groups. *Symmetry* **2017**, *9*, 275. [[CrossRef](#)]
34. Zhang, X.H. Fuzzy anti-grouped filters and fuzzy normal filters in pseudo-BCI algebras. *J. Intell. Fuzzy Syst.* **2017**, *33*, 1767–1774. [[CrossRef](#)]
35. Zhang, X.H.; Park, C.; Wu, S.P. Soft set theoretical approach to pseudo-BCI algebras. *J. Intell. Fuzzy Syst.* **2018**, *34*, 559–568. [[CrossRef](#)]
36. Garg, H.; Arora, R. Dual Hesitant Fuzzy soft aggregation operators and their application in decision-making. *Cogn. Comput.* **2018**, 1–21. [[CrossRef](#)]
37. Garg, H.; Kumar, K. An advanced study on the similarity measures of intuitionistic fuzzy sets based on the set pair analysis theory and their application in decision making. *Soft Comput.* **2018**, *22*, 4959–4970. [[CrossRef](#)]
38. Selvachandran, G.; Garg, H.; Quek, S.G. Vague entropy measure for complex vague soft sets. *Entropy* **2018**, *20*, 403. [[CrossRef](#)]
39. Garg, H. Some new biparametric distance measures on single-valued neutrosophic sets with applications to pattern recognition and medical diagnosis. *Information* **2017**, *8*, 162. [[CrossRef](#)]

Some Linguistic Neutrosophic Cubic Mean Operators and Entropy with Applications in a Corporation to Choose an Area Supervisor

**Muhammad Gulistan, Hafiz Abdul Wahab, Florentin Smarandache, Salma Khan,
Sayed Inayat Ali Shah**

Muhammad Gulistan, Hafiz Abdul Wahab, Florentin Smarandache, Salma Khan, Sayed Inayat Ali Shah (2018). Some Linguistic Neutrosophic Cubic Mean Operators and Entropy with Applications in a Corporation to Choose an Area Supervisor. *Symmetry* 10, 428; DOI: 10.3390/sym1010042

Abstract: In this paper, we combined entropy with linguistic neutrosophic cubic numbers and used it in daily life problems related to a corporation that is going to choose an area supervisor, which is the main target of our proposed model. For this, we first develop the theory of linguistic neutrosophic cubic numbers, which explains the indeterminate and incomplete information by truth, indeterminacy and falsity linguistic variables (LVs) for the past, present, as well as for the future time very effectively. After giving the definitions, we initiate some basic operations and properties of linguistic neutrosophic cubic numbers. We also define the linguistic neutrosophic cubic Hamy mean operator and weighted linguistic neutrosophic cubic Hamy mean (WLNCHM) operator with some properties, which can handle multi-input agents with respect to the different time frame. Finally, as an application, we give a numerical example in order to test the applicability of our proposed model.

Keywords: neutrosophic set; neutrosophic cubic set; linguistic neutrosophic cubic numbers; linguistic neutrosophic cubic weighted averaging operator; entropy of linguistic neutrosophic cubic numbers; application; multiple attribute decision making problem

1. Introduction

In 1965, Zadeh [1] introduced the notion of fuzzy sets, which became a significant tool of studying many vague and uncertain concepts. It has a large number of applications in social, medicine and computer sciences. Atanassov [2] generalized the theme of a fuzzy set (FS) by initiating the idea of intuitionistic fuzzy sets (IFS) by introducing the idea of non membership of an element in a certain set. Jun et al. [3] initiated the idea of cubic sets, in which there are two representations: one is used for the membership/certain value and the other one is used for the non membership/uncertain value. The membership function is handled in the form of an interval, and the non membership is handled by the ordinary fuzzy set. Cubic sets have been considered by many authors in other areas of mathematics, for instance KU subalgebras [4,5], graph theory [6], left almost Γ -semihypergroups [7], LA-semihypergroups [8–11], semigroups [12,13] and Hv-LA-semigroups [14,15]. Smarandache [16,17] presented the new idea of the neutrosophic set (NS) and neutrosophic logic, which the generalized fuzzy set and intuitionistic fuzzy set. The neutrosophic set (NS) is defined by truth, indeterminacy and falsity membership degrees. For applications in physical, technical and different engineering regions, Wang et al. [18] suggested the concept of a single-valued neutrosophic set (SVNS) in 2010. After this, many researchers used neutrosophic sets in different research directions such as De and Beg [19] and Gulistan et al. [20]. Jun et al. [21,22] extended the idea of cubic sets to

neutrosophic cubic sets and defined different properties of external and internal neutrosophic cubic sets. Recently, Gulistan et al. [23] combined neutrosophic cubic sets with graphs. In multi-criteria decision making problems, the application of neutrosophic cubic sets was proposed by Zhan et al. [24]. In [25], Hashim et al. used neutrosophic bipolar fuzzy sets in the HOPE foundation with different types of similarity measures. For the aspects of real-life objectives, the human desire of judgment can be used for linguistic expression rather than numerical expression to better suit the thinking of people. Therefore, Zadeh [26] introduced the concept of linguistic variable and applied it to fuzzy reasoning. The idea of aggregation operators was presented by many researchers in decision making problems; see for example [27–29]. The concept of linguistic intuitionistic fuzzy numbers (LIFN) was introduced by Chen et al. [30]. After that, some researchers also gave the idea of linguistic intuitionistic multi-criteria group decision-making problems [31]. The theme of LNN_S was initiated by Fang et al. [32]. Besides, a multi-criteria decision making problem like the linguistic intuitionistic multi-criteria decision-making problem was also introduced [33]. Ye in 2016 presented the concept of an LNN_S and also gave the idea of different aggregation operators in multiple attribute group decision making problems [34]. Then, the concept of a linguistic neutrosophic number was proposed to solve multiple attribute group decision making problems by Li et al. in [35]. In [36], Hara et al. proposed some inequalities for certain bivariate means. A useful tool known as entropy is used to determine the uncertainty in sets, like the fuzzy set (FS) and intuitionistic fuzzy set (IFS), where LNCSs defined by managing uncertain information about truth, indeterminacy and falsity membership functions. In 1965, Zadeh [37] first defined the entropy of FS to determine the ambiguity in a quantitative manner. In the same way, the non-probabilistic entropy was axiomatized by De Luca-Termini [38]. He also analyzed mathematical properties of this functional and gave the considerations of and applicability to pattern analysis. A distance entropy measure was proposed by Kaufmann [39]. A new non-probabilistic entropy measure was introduced by Kosko [40]. In [41], Majumdar and Samanta introduced the notion of two single-valued neutrosophic sets, their properties and also defined the distance between these two sets. They also investigated the measure of entropy of a single-valued neutrosophic set. The entropy of IFSs was introduced by Szmidt and Kacprzyk [42]. This entropy measure was consistent with the considerations of fuzzy sets. Afterward, the measurement of fuzziness in terms of distance between the fuzzy set and its complement was put forward by Yager [43]; see also [37,44] for more details. The entropy in terms of neutrosophic sets was discussed by Patrascu in [45]. The of linguistic neutrosophic numbers (LNNs) and the linguistic neutrosophic Hamy mean (HM) (LNHM) operator was investigated by Liu et al., in [46]. Ye discussed linguistic neutrosophic cubic numbers and their multiple attribute decision making method in [47].

The present study proposes a new notion of linguistic neutrosophic cubic numbers (LNCNs), where the undetermined LNN_S agrees with the truth, indeterminacy and falsity membership. Besides that, we define the different operations on LNCNs, the linguistic neutrosophic cubic Hamy mean operator and the weighted linguistic neutrosophic cubic Hamy mean (WLNCHM) operator with some properties that can handle multi-input agents with respect to the different time frames. We define score, accuracy and certain functions of LNCNs. At the end, we use the developed approach in a decision making problem related to a corporation choosing an area supervisor.

2. Preliminaries

In this section, we give some helpful material from the existing literature.

Definition 1. [35] LNN_S (linguistic neutrosophic numbers): Let U be a universal set and $\hat{p} = (\hat{p}_0, \hat{p}_1, \dots, \hat{p}_t)$ be a linguistic term set (LT^S). An $LNS\hat{A}$ in U is specified by the truth, indeterminacy and falsity membership functions $\hat{\alpha}_{\hat{A}}, \hat{\beta}_{\hat{A}}$ and $\hat{\gamma}_{\hat{A}}$, where $\hat{\alpha}_{\hat{A}}, \hat{\beta}_{\hat{A}}, \hat{\gamma}_{\hat{A}} : U \rightarrow [0, t]$, and $\forall u \in U, \hat{g} = (\hat{p}_{\hat{\alpha}_{\hat{A}}(u)}, \hat{p}_{\hat{\beta}_{\hat{A}}(u)}, \hat{p}_{\hat{\gamma}_{\hat{A}}(u)}) \in \hat{A}$ is called an LNN of \hat{A} .

Remark 1. [35] Let \mathring{A} be the set of LNN_S , then its complement is represented by \mathring{A}^C , which is denoted as $\mathring{\alpha}_{\mathring{A}} = \mathring{\gamma}_{\mathring{A}}; \mathring{\beta}_{\mathring{A}} = t - \mathring{\beta}_{\mathring{A}}; \mathring{\gamma}_{\mathring{A}} = \mathring{\alpha}_{\mathring{A}}$.

Definition 2. [35] Let $\mathring{g} = (\mathring{p}_{\mathring{\alpha}}, \mathring{p}_{\mathring{\beta}}, \mathring{p}_{\mathring{\gamma}}), \mathring{g}_1 = (\mathring{p}_{\mathring{\alpha}_1}, \mathring{p}_{\mathring{\beta}_1}, \mathring{p}_{\mathring{\gamma}_1}), \mathring{g}_2 = (\mathring{p}_{\mathring{\alpha}_2}, \mathring{p}_{\mathring{\beta}_2}, \mathring{p}_{\mathring{\gamma}_2})$ be any LNN_S and $\lambda > 0$. Then (i):

$$\mathring{g}_1 \oplus \mathring{g}_2 = (\mathring{p}_{\mathring{\alpha}_1}, \mathring{p}_{\mathring{\beta}_1}, \mathring{p}_{\mathring{\gamma}_1}) \oplus (\mathring{p}_{\mathring{\alpha}_2}, \mathring{p}_{\mathring{\beta}_2}, \mathring{p}_{\mathring{\gamma}_2}) = \left(\mathring{p}_{\mathring{\alpha}_1 + \mathring{\alpha}_2 - \frac{\mathring{\alpha}_1 \mathring{\alpha}_2}{t}, \mathring{p}_{\mathring{\beta}_1 \mathring{\beta}_2}, \mathring{p}_{\mathring{\gamma}_1 \mathring{\gamma}_2} \right) \tag{1}$$

(ii):

$$\mathring{g}_1 \otimes \mathring{g}_2 = (\mathring{p}_{\mathring{\alpha}_1}, \mathring{p}_{\mathring{\beta}_1}, \mathring{p}_{\mathring{\gamma}_1}) \otimes (\mathring{p}_{\mathring{\alpha}_2}, \mathring{p}_{\mathring{\beta}_2}, \mathring{p}_{\mathring{\gamma}_2}) = \left(\mathring{p}_{\frac{\mathring{\alpha}_1 \mathring{\alpha}_2}{t}, \mathring{p}_{\mathring{\beta}_1 + \mathring{\beta}_2 - \frac{\mathring{\beta}_1 \mathring{\beta}_2}{t}}, \mathring{p}_{\mathring{\gamma}_1 + \mathring{\gamma}_2 - \frac{\mathring{\gamma}_1 \mathring{\gamma}_2}{t}} \right) \tag{2}$$

(iii):

$$\lambda \mathring{g} = \lambda (\mathring{p}_{\mathring{\alpha}}, \mathring{p}_{\mathring{\beta}}, \mathring{p}_{\mathring{\gamma}}) = \left(\mathring{p}_{t - t(1 - \frac{\mathring{\alpha}}{t})\lambda}, \mathring{p}_{t(\frac{\mathring{\beta}}{t})\lambda}, \mathring{p}_{t(\frac{\mathring{\gamma}}{t})\lambda} \right); \tag{3}$$

(iv)

$$\mathring{g}^\lambda = (\mathring{p}_{\mathring{\alpha}}, \mathring{p}_{\mathring{\beta}}, \mathring{p}_{\mathring{\gamma}})^\lambda = \left(\mathring{p}_{t(\frac{\mathring{\alpha}}{t})\lambda}, \mathring{p}_{t - t(1 - \frac{\mathring{\beta}}{t})\lambda}, \mathring{p}_{t - t(1 - \frac{\mathring{\gamma}}{t})\lambda} \right). \tag{4}$$

Definition 3. [35] Let $\mathring{g} = (\mathring{p}_{\mathring{\alpha}}, \mathring{p}_{\mathring{\beta}}, \mathring{p}_{\mathring{\gamma}})$ be an LNN . The following are the score and accuracy function of LNN ,

$$\hat{S}(\mathring{g}) = \frac{2t + \mathring{\alpha} - \mathring{\beta} - \mathring{\gamma}}{3t}, \tag{5}$$

$$\hat{H}(\mathring{g}) = \frac{\mathring{\alpha} - \mathring{\gamma}}{t}. \tag{6}$$

Definition 4. [35] Let $\mathring{g}_1 = (\mathring{p}_{\mathring{\alpha}_1}, \mathring{p}_{\mathring{\beta}_1}, \mathring{p}_{\mathring{\gamma}_1}), \mathring{g}_2 = (\mathring{p}_{\mathring{\alpha}_2}, \mathring{p}_{\mathring{\beta}_2}, \mathring{p}_{\mathring{\gamma}_2})$ be $LNNs$. Then: (1) If $\hat{S}(\mathring{g}_1) < \hat{S}(\mathring{g}_2)$, then $\mathring{g}_1 \prec \mathring{g}_2$. (2) If $\hat{S}(\mathring{g}_1) = \hat{S}(\mathring{g}_2)$, (a) and $\hat{H}(\mathring{g}_1) < \hat{H}(\mathring{g}_2)$, then $\mathring{g}_1 \prec \mathring{g}_2$, (b) and $\hat{H}(\mathring{g}_1) = \hat{H}(\mathring{g}_2)$, then $\mathring{g}_1 \approx \mathring{g}_2$.

Definition 5. [36] Suppose $u_{\hat{i}} (\hat{i} = 1, 2, \dots, n)$ is an assortment of non-negative real numbers and parameter $\hat{k} = 1, 2, \dots, n$. The Hamy mean (HM) is defined as:

$$HM^{\hat{k}}(x_1, x_2, \dots, x_n) = \frac{\sum_{1 \leq \hat{i}_1 < \dots < \hat{i}_{\hat{k}} \leq n} \left(\prod_{j=1}^{\hat{k}} u_{i_j} \right)^{\frac{1}{\hat{k}}}}{\binom{n}{\hat{k}}} \tag{7}$$

where $(\hat{i}_1, \hat{i}_2, \dots, \hat{i}_{\hat{k}})$ navigate all the k -tuple arrangements of $(1, 2, \dots, n)$, $\binom{n}{\hat{k}}$ is the binomial coefficient and $\binom{n}{\hat{k}} = \frac{n!}{\hat{k}!(n-\hat{k})!}$. The following are some properties of HM:

(1) $HM^{(\hat{k})}(0, 0, \dots, 0) = 0, HM^{(\hat{k})}(u, u, \dots, u) = u$, (2) $HM^{(\hat{k})}(u_1, u_2, \dots, u_n) \leq HM^{(\hat{k})}(v_1, v_2, \dots, v_n)$, if $u_{\hat{i}} \leq v_{\hat{i}}$ for all \hat{i} , (3) $\min\{u_{\hat{i}}\} \leq HM^{(\hat{k})}(u_1, u_2, \dots, u_n) \leq \max\{u_{\hat{i}}\}$.

Definition 6. [17] (Neutrosophic set) Let U be a non-empty set. A neutrosophic set in U is a structure of the form $A := \{u; A_{Tru}(u), A_{\hat{i}nd}(u), A_{Fal}(u) | u \in U\}$, is characterized by a truth membership Tru , indeterminacy membership $\hat{i}nd$ and falsity membership Fal , where $A_{Tru}, A_{\hat{i}nd}, A_{Fal} : U \rightarrow [0, 1]$.

Definition 7. [21] (Neutrosophic cubic set) Let X be a non-empty set; an NCS in U is defined in the form of a pair $\Omega = (\mathring{A}, \Lambda)$ where $\mathring{A} = \{(x; \mathring{A}_{Tru}(u), \mathring{A}_{\hat{i}nd}(u), \mathring{A}_{Fal}(u)) | u \in U\}$ is an interval neutrosophic set in U and $\Lambda = \{(u; \Lambda_{Tru}(u), \Lambda_{\hat{i}nd}(u), \Lambda_{Fal}(u)) | u \in U\}$ is a neutrosophic set in U .

3. Linguistic Neutrosophic Cubic Numbers and Operators

In this section, we define the linguistic neutrosophic cubic numbers and also discuss different operations and properties related to linguistic neutrosophic cubic numbers. We define the cubic Hamy mean operator, LNCHM operator and WLNCHM operator and discuss their properties.

Definition 8. LNCNs (linguistic neutrosophic cubic numbers): Let U be a universal set and $\mathring{p} = (\mathring{p}_0, \mathring{p}_1, \dots, \mathring{p}_t)$ be a LT^S . An LNCN \mathring{A} in U is determined by truth membership function $(\mathring{\alpha}_{\mathring{A}}, \mathring{\alpha}_{\mathring{A}})$, an indeterminacy membership function $(\mathring{\beta}_{\mathring{A}}, \mathring{\beta}_{\mathring{A}})$ and a falsity membership function $(\mathring{\gamma}_{\mathring{A}}, \mathring{\gamma}_{\mathring{A}})$, where $\mathring{\alpha}_{\mathring{A}}, \mathring{\beta}_{\mathring{A}}, \mathring{\gamma}_{\mathring{A}} : U \rightarrow D[0, t]$ and $\mathring{\alpha}_{\mathring{A}}, \mathring{\beta}_{\mathring{A}}, \mathring{\gamma}_{\mathring{A}} : U \rightarrow [0, t], \forall u \in U$, and it is denoted by $\mathring{g} = (\mathring{p}_{(\mathring{\alpha}_{\mathring{A}}, \mathring{\alpha}_{\mathring{A}})}(u), \mathring{p}_{(\mathring{\beta}_{\mathring{A}}, \mathring{\beta}_{\mathring{A}})}(u), \mathring{p}_{(\mathring{\gamma}_{\mathring{A}}, \mathring{\gamma}_{\mathring{A}})}(u)) \in \mathring{A}$.

Remark 2. Suppose A is a set of LNCNs, then its complement is represented by A^c and defined as $\{(\mathring{\alpha}_{\mathring{A}}, \mathring{\alpha}_{\mathring{A}})^c = (\mathring{\gamma}_{\mathring{A}}, \mathring{\gamma}_{\mathring{A}}), (\mathring{\beta}_{\mathring{A}}, \mathring{\beta}_{\mathring{A}})^c = (t - \mathring{\beta}_{\mathring{A}}, t - \mathring{\beta}_{\mathring{A}}), (\mathring{\gamma}_{\mathring{A}}, \mathring{\gamma}_{\mathring{A}})^c = (\mathring{\alpha}_{\mathring{A}}, \mathring{\alpha}_{\mathring{A}})\}$.

Definition 9. Let $\mathring{g} = (\mathring{p}_{(\mathring{\alpha}, \mathring{\alpha})}, \mathring{p}_{(\mathring{\beta}, \mathring{\beta})}, \mathring{p}_{(\mathring{\gamma}, \mathring{\gamma})})$, $\mathring{g}_1 = (\mathring{p}_{(\mathring{\alpha}_1, \mathring{\alpha}_1)}, \mathring{p}_{(\mathring{\beta}_1, \mathring{\beta}_1)}, \mathring{p}_{(\mathring{\gamma}_1, \mathring{\gamma}_1)})$, $\mathring{g}_2 = (\mathring{p}_{(\mathring{\alpha}_2, \mathring{\alpha}_2)}, \mathring{p}_{(\mathring{\beta}_2, \mathring{\beta}_2)}, \mathring{p}_{(\mathring{\gamma}_2, \mathring{\gamma}_2)})$ be any LNCNs and $\lambda > 0$. Then, we define:

(i):

$$\begin{aligned} \mathring{g}_1 \oplus \mathring{g}_2 &= (\mathring{p}_{(\mathring{\alpha}_1, \mathring{\alpha}_1)}, \mathring{p}_{(\mathring{\beta}_1, \mathring{\beta}_1)}, \mathring{p}_{(\mathring{\gamma}_1, \mathring{\gamma}_1)}) \oplus (\mathring{p}_{(\mathring{\alpha}_2, \mathring{\alpha}_2)}, \mathring{p}_{(\mathring{\beta}_2, \mathring{\beta}_2)}, \mathring{p}_{(\mathring{\gamma}_2, \mathring{\gamma}_2)}) \\ &= \left(\mathring{p}_{(\mathring{\alpha}_1 + \mathring{\alpha}_2, \mathring{\alpha}_1 + \mathring{\alpha}_2)} - \left(\frac{\mathring{\alpha}_1 \cdot \mathring{\alpha}_2}{t}, \frac{\mathring{\alpha}_1 \cdot \mathring{\alpha}_2}{t} \right), \mathring{p}_{\left(\frac{\mathring{\beta}_1 \cdot \mathring{\beta}_2}{t}, \frac{\mathring{\beta}_1 \cdot \mathring{\beta}_2}{t} \right)}, \mathring{p}_{\left(\frac{\mathring{\gamma}_1 \cdot \mathring{\gamma}_2}{t}, \frac{\mathring{\gamma}_1 \cdot \mathring{\gamma}_2}{t} \right)} \right); \end{aligned} \tag{8}$$

(ii):

$$\begin{aligned} \mathring{g}_1 \otimes \mathring{g}_2 &= (\mathring{p}_{(\mathring{\alpha}_1, \mathring{\alpha}_1)}, \mathring{p}_{(\mathring{\beta}_1, \mathring{\beta}_1)}, \mathring{p}_{(\mathring{\gamma}_1, \mathring{\gamma}_1)}) \otimes (\mathring{p}_{(\mathring{\alpha}_2, \mathring{\alpha}_2)}, \mathring{p}_{(\mathring{\beta}_2, \mathring{\beta}_2)}, \mathring{p}_{(\mathring{\gamma}_2, \mathring{\gamma}_2)}) \\ &= \left(\mathring{p}_{\left(\frac{\mathring{\alpha}_1 \cdot \mathring{\alpha}_2}{t}, \frac{\mathring{\alpha}_1 \cdot \mathring{\alpha}_2}{t} \right)}, \mathring{p}_{(\mathring{\beta}_1 + \mathring{\beta}_2, \mathring{\beta}_1 + \mathring{\beta}_2)} - \left(\frac{\mathring{\beta}_1 \cdot \mathring{\beta}_2}{t}, \frac{\mathring{\beta}_1 \cdot \mathring{\beta}_2}{t} \right), \mathring{p}_{(\mathring{\gamma}_1 + \mathring{\gamma}_2, \mathring{\gamma}_1 + \mathring{\gamma}_2)} - \left(\frac{\mathring{\gamma}_1 \cdot \mathring{\gamma}_2}{t}, \frac{\mathring{\gamma}_1 \cdot \mathring{\gamma}_2}{t} \right) \right); \end{aligned} \tag{9}$$

(iii):

$$\begin{aligned} \lambda \mathring{g} &= \lambda \left((\mathring{p}_{(\mathring{\alpha}_1, \mathring{\alpha}_1)}, \mathring{p}_{(\mathring{\beta}_1, \mathring{\beta}_1)}, \mathring{p}_{(\mathring{\gamma}_1, \mathring{\gamma}_1)}) \oplus (\mathring{p}_{(\mathring{\alpha}_2, \mathring{\alpha}_2)}, \mathring{p}_{(\mathring{\beta}_2, \mathring{\beta}_2)}, \mathring{p}_{(\mathring{\gamma}_2, \mathring{\gamma}_2)}) \right) \\ &= \left(\mathring{p}_{t-t(1-\frac{\mathring{\alpha}}{t}, 1-\frac{\mathring{\alpha}}{t})^\lambda}, \mathring{p}_t \left(\frac{\mathring{\beta}}{t}, \frac{\mathring{\beta}}{t} \right)^\lambda, \mathring{p}_t \left(\frac{\mathring{\gamma}}{t}, \frac{\mathring{\gamma}}{t} \right)^\lambda \right) \end{aligned} \tag{10}$$

(iv):

$$\begin{aligned} \mathring{g}^\lambda &= \left((\mathring{p}_{(\mathring{\alpha}_1, \mathring{\alpha}_1)}, \mathring{p}_{(\mathring{\beta}_1, \mathring{\beta}_1)}, \mathring{p}_{(\mathring{\gamma}_1, \mathring{\gamma}_1)}) \oplus (\mathring{p}_{(\mathring{\alpha}_2, \mathring{\alpha}_2)}, \mathring{p}_{(\mathring{\beta}_2, \mathring{\beta}_2)}, \mathring{p}_{(\mathring{\gamma}_2, \mathring{\gamma}_2)}) \right)^\lambda \\ &= \left(\mathring{p}_{t \left(\frac{\mathring{\alpha}}{t}, \frac{\mathring{\alpha}}{t} \right)^\lambda}, \mathring{p}_{t-t \left(1-\frac{\mathring{\beta}}{t}, 1-\frac{\mathring{\beta}}{t} \right)^\lambda}, \mathring{p}_{t-t \left(1-\frac{\mathring{\gamma}}{t}, 1-\frac{\mathring{\gamma}}{t} \right)^\lambda} \right) \end{aligned} \tag{11}$$

It is clear that these operational result are still LNCNs.

Definition 10. Let $\mathring{g} = (\mathring{p}_{(\mathring{\alpha}, \mathring{\alpha})}, \mathring{p}_{(\mathring{\beta}, \mathring{\beta})}, \mathring{p}_{(\mathring{\gamma}, \mathring{\gamma})})$, be an LNCN that depends on LT^S , \mathring{p} . Then, the score function, accuracy function and certain function of the LNCN, \mathring{g} , are defined as follows:

(i):

$$\begin{aligned} \varphi(\mathring{g}) &= \varphi\left(\mathring{p}_{(\mathring{\alpha}, \mathring{\alpha})}, \mathring{p}_{(\mathring{\beta}, \mathring{\beta})}, \mathring{p}_{(\mathring{\gamma}, \mathring{\gamma})}\right) \\ &= \frac{1}{9t} \left[(4t + \mathring{p}_{\mathring{\alpha}} - \mathring{p}_{\mathring{\beta}} - \mathring{p}_{\mathring{\gamma}}) + (2t + \mathring{p}_{\mathring{\alpha}} - \mathring{p}_{\mathring{\beta}} - \mathring{p}_{\mathring{\gamma}}) \right], \text{ for } \varphi(\mathring{g}) \in [0, 1] \end{aligned} \tag{12}$$

(ii):

$$\Phi(\mathring{g}) = \frac{1}{3t} [(\mathring{p}_{\mathring{\alpha}} - \mathring{p}_{\mathring{\gamma}}) + (\mathring{p}_{\mathring{\alpha}} - \mathring{p}_{\mathring{\gamma}})], \text{ for } \Phi(\mathring{g}) \in [-1, 1] \tag{13}$$

(iii):

$$\Psi(\mathring{g}) = \frac{\mathring{p}_{\mathring{\alpha}} + \mathring{p}_{\mathring{\alpha}}}{3t} \text{ for } \Psi(\mathring{g}) \in [0, 1]. \tag{14}$$

Now, with the help of the above-defined function, we introduce a ranking method for these function.

Definition 11. Let two LNCNs be $\mathring{g}_1 = \left(\mathring{p}_{(\mathring{\alpha}_1, \mathring{\alpha}_1)}, \mathring{p}_{(\mathring{\beta}_1, \mathring{\beta}_1)}, \mathring{p}_{(\mathring{\gamma}_1, \mathring{\gamma}_1)}\right)$ and $\mathring{g}_2 = \left(\mathring{p}_{(\mathring{\alpha}_2, \mathring{\alpha}_2)}, \mathring{p}_{(\mathring{\beta}_2, \mathring{\beta}_2)}, \mathring{p}_{(\mathring{\gamma}_2, \mathring{\gamma}_2)}\right)$. Then, their ranking method is defined as:

1. If $\varphi(\mathring{g}_1) > \varphi(\mathring{g}_2)$, then $\mathring{g}_1 \succ \mathring{g}_2$,
2. If $\varphi(\mathring{g}_1) = \varphi(\mathring{g}_2)$ and $\Phi(\mathring{g}_1) > \Phi(\mathring{g}_2)$, then $\mathring{g}_1 \succ \mathring{g}_2$,
3. If $\varphi(\mathring{g}_1) = \varphi(\mathring{g}_2)$, $\Phi(\mathring{g}_1) = \Phi(\mathring{g}_2)$ and $\Psi(\mathring{g}_1) > \Psi(\mathring{g}_2)$, then $\mathring{g}_1 \succ \mathring{g}_2$,
4. If $\varphi(\mathring{g}_1) = \varphi(\mathring{g}_2)$, $\Phi(\mathring{g}_1) = \Phi(\mathring{g}_2)$ and $\Psi(\mathring{g}_1) = \Psi(\mathring{g}_2)$, then $\mathring{g}_1 \sim \mathring{g}_2$.

Example 1. Let $\mathring{g}_1 = \left(\mathring{p}_{(\mathring{\alpha}_1, \mathring{\alpha}_1)}, \mathring{p}_{(\mathring{\beta}_1, \mathring{\beta}_1)}, \mathring{p}_{(\mathring{\gamma}_1, \mathring{\gamma}_1)}\right)$, $\mathring{g}_2 = \left(\mathring{p}_{(\mathring{\alpha}_2, \mathring{\alpha}_2)}, \mathring{p}_{(\mathring{\beta}_2, \mathring{\beta}_2)}, \mathring{p}_{(\mathring{\gamma}_2, \mathring{\gamma}_2)}\right)$ and $\mathring{g}_3 = \left(\mathring{p}_{(\mathring{\alpha}_3, \mathring{\alpha}_3)}, \mathring{p}_{(\mathring{\beta}_3, \mathring{\beta}_3)}, \mathring{p}_{(\mathring{\gamma}_3, \mathring{\gamma}_3)}\right)$ be three LNCNs in the linguistic term set $\varphi = \{\varphi_{\mathring{g}} \mid \mathring{g} \in [0, 8]\}$ where $\mathring{g}_1 = ([0.2, 0.3], [0.4, 0.5], [0.3, 0.5], (0.1, 0.2, 0.3))$, $\mathring{g}_2 = ([0.3, 0.4], [0.4, 0.5], [0.5, 0.6], (0.2, 0.4, 0.6))$, $\mathring{g}_3 = ([0.4, 0.5], [0.4, 0.6], [0.5, 0.7], (0.2, 0.3, 0.5))$, then we will find the values of their score, accuracy and certain function as follows:

(i) Score functions:

$$\begin{aligned} \varphi(\mathring{g}) &= \frac{1}{9t} \left[(4t + \mathring{p}_{\mathring{\alpha}} - \mathring{p}_{\mathring{\beta}} - \mathring{p}_{\mathring{\gamma}}) + (2t + \mathring{p}_{\mathring{\alpha}} - \mathring{p}_{\mathring{\beta}} - \mathring{p}_{\mathring{\gamma}}) \right], \text{ for } \varphi(\mathring{g}) \in [0, 1] \\ \varphi(\mathring{g}_1) &= \frac{[32 + 0.2 + 0.3 - (0.4 + 0.5 + 0.3 + 0.5) + 16 + 0.1 - (0.2 + 0.3)]}{72} \\ &= 0.644 \end{aligned}$$

$$\begin{aligned} \varphi(\mathring{g}_2) &= \frac{[32 + 0.3 + 0.4 - (0.4 + 0.5 + 0.5 + 0.6) + 16 + 0.2 - (0.4 + 0.6)]}{72} \\ &= 0.6375 \end{aligned}$$

$$\begin{aligned} \varphi(\mathring{g}_3) &= \frac{[32 + 0.4 + 0.5 - (0.4 + 0.6 + 0.5 + 0.7) + 16 + 0.2 - (0.3 + 0.5)]}{72} \\ &= 0.638 \end{aligned}$$

(ii) Accuracy functions:

$$\begin{aligned} \Phi(\mathring{g}) &= \frac{1}{3t} [(\mathring{p}_{\hat{\alpha}} - \mathring{p}_{\hat{\gamma}}) + (\mathring{p}_{\hat{\alpha}} - \mathring{p}_{\hat{\gamma}})], \text{ for } \Phi(\mathring{g}) \in [-1, 1] \\ \Phi(\mathring{g}_1) &= \frac{[0.2 + 0.3 - (0.3 + 0.5) + 0.1 - 0.3]}{24} \\ &= -0.0208 \\ \Phi(\mathring{g}_2) &= \frac{[0.3 + 0.4 - (0.5 + 0.6) + 0.2 - 0.6]}{24} \\ &= -0.0333 \\ \Phi(\mathring{g}_3) &= \frac{[0.4 + 0.5 - (0.6 + 0.7) + 0.3 - 0.5]}{24} \\ &= -0.0292 \end{aligned}$$

(iii) Certain functions:

$$\begin{aligned} \Psi(\mathring{g}) &= \frac{\mathring{p}_{\hat{\alpha}} + \mathring{p}_{\hat{\alpha}}}{3t} \text{ for } \Psi(\mathring{g}) \in [0, 1] \\ \Psi(\mathring{g}_1) &= \frac{[0.2 + 0.3 + 0.1]}{24} \\ &= 0.025 \\ \Psi(\mathring{g}_2) &= \frac{[0.3 + 0.4 + 0.2]}{24} \\ &= 0.0375 \\ \Psi(\mathring{g}_3) &= \frac{[0.4 + 0.5 + 0.2]}{24} \\ &= 0.0416 \end{aligned}$$

Definition 12. Suppose $(\tilde{u}_{\hat{i}}, u_{\hat{i}})$ where $\hat{i} = 1, 2, \dots, n$ is an assortment of non-negative real numbers and parameter $\hat{k} = 1, 2, \dots, n$. Then, the cubic Hamy mean (CHM) is defined as follows:

$$CHM^{\hat{k}}(\tilde{u}_{\hat{i}}, u_{\hat{i}}) = \frac{\sum_{1 \leq \hat{i}_1 < \dots < \hat{i}_{\hat{k}} \leq n} \left(\prod_{j=1}^{\hat{k}} \tilde{u}_{\hat{i}_j}, \prod_{j=1}^{\hat{k}} u_{\hat{i}_j} \right)^{\frac{1}{\hat{k}}}}{\binom{n}{\hat{k}}} \tag{15}$$

where $(\hat{i}_1, \hat{i}_2, \dots, \hat{i}_{\hat{k}})$ navigate all the \hat{k} -tuple arrangements of $(1, 2, \dots, n)$, $\binom{n}{\hat{k}}$ is the binomial coefficient and $\binom{n}{\hat{k}} = \frac{n!}{\hat{k}!(n-\hat{k})!}$.

Example 2. Let $(\tilde{u}_{\hat{i}}, u_{\hat{i}}) = ((\tilde{u}_1, u_1), (\tilde{u}_2, u_2))$ $i = 1, 2$ and $\hat{k} = 1$, where $u_1 = ([0.2, 0.4], (0.6))$, $u_2 = ([0.3, 0.5], (0.7))$.

$$\begin{aligned}
 &CHM^1((\tilde{u}_1, u_1), (\tilde{u}_2, u_2)) \\
 &= \frac{\sum((\tilde{u}_{11}, u_{11})(\tilde{u}_{22}, u_{22}))^1}{\binom{2}{1}} \\
 &= \frac{((\tilde{u}_{11}, u_{11})(\tilde{u}_{22}, u_{22}))^1 + ((\tilde{u}_{11}, u_{11})(\tilde{u}_{22}, u_{22}))^1}{\binom{2}{1}} \\
 &= \frac{\sum \left(\begin{array}{l} (([0.2, 0.4], (0.6)) ([0.2, 0.4], (0.6))) \\ (([0.3, 0.5], (0.7)) ([0.3, 0.5], (0.7))) \end{array} \right)^1}{\binom{2}{1}} \\
 &= \frac{\left(\begin{array}{l} (([0.2, 0.4], (0.6)) ([0.2, 0.4], (0.6))) \\ (([0.3, 0.5], (0.7)) ([0.3, 0.5], (0.7))) \end{array} \right)^1 + \left(\begin{array}{l} (([0.2, 0.4], (0.6)) ([0.2, 0.4], (0.6))) \\ (([0.3, 0.5], (0.7)) ([0.3, 0.5], (0.7))) \end{array} \right)^1}{\binom{2}{1}} \\
 &= \frac{(([0.04, 0.16], (0.84)) ([0.09, 0.25], (0.91))) + (([0.04, 0.16], (0.84)) ([0.09, 0.25], (0.91)))}{\binom{2}{1}} \\
 &= \frac{\left(\begin{array}{l} ([0.004, 0.04], (0.98)) \\ + ([0.004, 0.04], (0.98)) \end{array} \right)}{\binom{2}{1}} \\
 &= \frac{([0.008, 0.08], (0.96))}{\binom{2}{1}} \\
 &= ([0.004, 0.04], (0.48))
 \end{aligned}$$

Definition 13. Suppose (\tilde{g}_i, \hat{g}_i) where $i = 1, 2, \dots, n$. is an assortment of linguistic neutrosophic cubic numbers and parameter $k = 1, 2, \dots, n$. Then, the LNCHM operator is defined as follows:

$$LNCHM^k(\tilde{g}_i, \hat{g}_i) = \frac{\sum_{1 \leq \hat{i}_1 < \dots < \hat{i}_k \leq n} \left(\prod_{j=1}^k \tilde{g}_{\hat{i}_j}, \prod_{j=1}^k \hat{g}_{\hat{i}_j} \right)^{\frac{1}{k}}}{\binom{n}{k}} \tag{16}$$

where $(\hat{i}_1, \hat{i}_2, \dots, \hat{i}_k)$ navigate all the k -tuple arrangements of $(1, 2, \dots, n)$, $\binom{n}{k}$ is the binomial coefficient and $\binom{n}{k} = \frac{n!}{k!(n-k)!}$.

Example 3. Let $(\tilde{g}_i, \hat{g}_i) = ((\tilde{g}_1, \hat{g}_2), (\tilde{g}_2, \hat{g}_2))$ $i = 1, 2$ and $k = 1$, where $\tilde{g}_1 = ([0.2, 0.4], [0.3, 0.4], [0.4, 0.6], (0.6, 0.5, 0.8))$, $\tilde{g}_2 = ([0.3, 0.5], [0.4, 0.7], [0.2, 0.4], (0.7, 0.8, 0.6))$,

$$\begin{aligned}
 & LNCHM^1((\tilde{g}_1, \hat{g}_2), (\tilde{g}_2, \hat{g}_2)) \\
 &= \frac{\sum (((\tilde{g}_{11}, \hat{g}_{11}), (\tilde{g}_{22}, \hat{g}_{22})))^1}{\binom{2}{1}} \\
 &= \frac{(((\tilde{g}_{11}, \hat{g}_{11})(\tilde{g}_{22}, \hat{g}_{22})))^1 + (((\tilde{g}_{11}, \hat{g}_{11})(\tilde{g}_{22}, \hat{g}_{22})))^1}{\binom{2}{1}} \\
 &= \frac{\sum \left(\left(\begin{array}{l} ([0.2, 0.4], [0.3, 0.4], [0.4, 0.6], (0.6, 0.5, 0.8)) \\ ([0.2, 0.4], [0.3, 0.4], [0.4, 0.6], (0.6, 0.5, 0.8)) \\ ([0.3, 0.5], [0.4, 0.7], [0.2, 0.4], (0.7, 0.8, 0.6)) \\ ([0.3, 0.5], [0.4, 0.7], [0.2, 0.4], (0.7, 0.8, 0.6)) \end{array} \right) \right)^1}{\binom{2}{1}} \\
 &= \frac{\left(\left(\begin{array}{l} ([0.2, 0.4], [0.3, 0.4], [0.4, 0.6], (0.6, 0.5, 0.8)) \\ ([0.2, 0.4], [0.3, 0.4], [0.4, 0.6], (0.6, 0.5, 0.8)) \\ ([0.3, 0.5], [0.4, 0.7], [0.2, 0.4], (0.7, 0.8, 0.6)) \\ ([0.3, 0.5], [0.4, 0.7], [0.2, 0.4], (0.7, 0.8, 0.6)) \end{array} \right) \right)^1 + \left(\left(\begin{array}{l} ([0.2, 0.4], [0.3, 0.4], [0.4, 0.6], (0.6, 0.5, 0.8)) \\ ([0.2, 0.4], [0.3, 0.4], [0.4, 0.6], (0.6, 0.5, 0.8)) \\ ([0.3, 0.5], [0.4, 0.7], [0.2, 0.4], (0.7, 0.8, 0.6)) \\ ([0.3, 0.5], [0.4, 0.7], [0.2, 0.4], (0.7, 0.8, 0.6)) \end{array} \right) \right)^1}{\binom{2}{1}} \\
 &= \frac{\left(\begin{array}{l} ([0.04, 0.16], [0.09, 0.16], [0.16, 0.36], (0.84, 0.75, 0.96)) \\ ([0.09, 0.25], [0.16, 0.49], [0.04, 0.16], (0.91, 0.96, 0.84)) \end{array} \right) + \left(\begin{array}{l} ([0.04, 0.16], [0.09, 0.16], [0.16, 0.36], (0.84, 0.75, 0.96)) \\ ([0.09, 0.25], [0.16, 0.49], [0.04, 0.16], (0.91, 0.96, 0.84)) \end{array} \right)}{\binom{2}{1}} \\
 &= \frac{\left(\begin{array}{l} ([0.004, 0.04], [0.014, 0.08], [0.006, 0.06], (0.98, 0.99, 0.99)) \\ + ([0.004, 0.04], [0.014, 0.08], [0.006, 0.06], (0.98, 0.99, 0.99)) \end{array} \right)}{\binom{2}{1}} \\
 &= \frac{([0.008, 0.08], [0.03, 0.2], [0.012, 0.12], (0.96, 0.98, 0.98))}{\binom{2}{1}} \\
 &= ([0.004, 0.04], [0.02, 0.1], [0.006, 0.06], (0.48, 0.49, 0.49))
 \end{aligned}$$

Theorem 1. Let $(\tilde{g}_i, \hat{g}_i) = (\hat{p}(\tilde{\alpha}_i, \hat{\alpha}_i), \hat{p}(\tilde{\beta}_i, \hat{\beta}_i), \hat{p}(\tilde{\gamma}_i, \hat{\gamma}_i))$ ($i = 1, 2, \dots, n$) be an arrangement of LNCNs, then the accumulated value from Definition 13 is obviously an LNCN, and:

$$LNCHM^k(\tilde{g}_i, \hat{g}_i) \tag{17}$$

$$= \left(\begin{array}{l} \hat{p} \\ \left(\prod_{1 \leq i_1 < \dots < i_k \leq n} \left(1 - \left(\frac{\prod_{j=1}^k \tilde{\alpha}_{ij}}{t^k}, \frac{\prod_{j=1}^k \hat{\alpha}_{ij}}{t^k} \right) \right)^{\frac{1}{k}} \right)^{\frac{1}{k}}, \hat{p} \\ \left(\prod_{1 \leq i_1 < \dots < i_k \leq n} \left(1 - \left(\prod_{j=1}^k \left(1 - \frac{\tilde{\beta}_{ij}}{t}, 1 - \frac{\hat{\beta}_{ij}}{t} \right) \right) \right)^{\frac{1}{k}} \right)^{\frac{1}{k}}, \\ \hat{p} \\ \left(\prod_{1 \leq i_1 < \dots < i_k \leq n} \left(1 - \left(\prod_{j=1}^k \left(1 - \frac{\tilde{\gamma}_{ij}}{t}, 1 - \frac{\hat{\gamma}_{ij}}{t} \right) \right) \right)^{\frac{1}{k}} \right)^{\frac{1}{k}} \end{array} \right)$$

Proof. According to Equations (1)–(4), we have:

$$\begin{aligned} \left(\prod_{j=1}^k \tilde{g}_{i_j}, \prod_{j=1}^k \hat{g}_{i_j} \right) &= \left(\begin{matrix} \hat{p} & \hat{p} \\ \prod_{j=1}^k \frac{\tilde{a}_{i_j}}{t^k-1}, \prod_{j=1}^k \frac{\hat{a}_{i_j}}{t^k-1} & t-t \prod_{j=1}^k \left(1 - \frac{\tilde{\beta}_{i_j}}{t}, 1 - \frac{\hat{\beta}_{i_j}}{t} \right) & \hat{p} & t-t \prod_{j=1}^k \left(1 - \frac{\tilde{\gamma}_{i_j}}{t}, 1 - \frac{\hat{\gamma}_{i_j}}{t} \right) \end{matrix} \right) \\ \left(\prod_{j=1}^k \tilde{g}_{i_j}, \prod_{j=1}^k \hat{g}_{i_j} \right)^{\frac{1}{k}} &= \left(\begin{matrix} \hat{p} & \hat{p} \\ \prod_{j=1}^k \frac{\tilde{a}_{i_j}}{t^k}, \prod_{j=1}^k \frac{\hat{a}_{i_j}}{t^k} & t-t \left(\prod_{j=1}^k \left(1 - \frac{\tilde{\beta}_{i_j}}{t}, 1 - \frac{\hat{\beta}_{i_j}}{t} \right) \right)^{\frac{1}{k}} & \hat{p} & t-t \left(\prod_{j=1}^k \left(1 - \frac{\tilde{\gamma}_{i_j}}{t}, 1 - \frac{\hat{\gamma}_{i_j}}{t} \right) \right)^{\frac{1}{k}} \end{matrix} \right) \\ \sum_{1 \leq i_1 < \dots < i_k \leq n} \left(\prod_{j=1}^k \tilde{g}_{i_j}, \prod_{j=1}^k \hat{g}_{i_j} \right)^{\frac{1}{k}} &= \left(\begin{matrix} \hat{p} & \hat{p} \\ t-t \prod_{1 \leq i_1 < \dots < i_k \leq n} \left(1 - \left(\prod_{j=1}^k \frac{\tilde{a}_{i_j}}{t^k}, \prod_{j=1}^k \frac{\hat{a}_{i_j}}{t^k} \right)^{\frac{1}{k}} \right) & t \prod_{1 \leq i_1 < \dots < i_k \leq n} \left(1 - \left(\prod_{j=1}^k \left(1 - \frac{\tilde{\beta}_{i_j}}{t}, 1 - \frac{\hat{\beta}_{i_j}}{t} \right) \right)^{\frac{1}{k}} \right) & \hat{p} & t \prod_{1 \leq i_1 < \dots < i_k \leq n} \left(1 - \left(\prod_{j=1}^k \left(1 - \frac{\tilde{\gamma}_{i_j}}{t}, 1 - \frac{\hat{\gamma}_{i_j}}{t} \right) \right)^{\frac{1}{k}} \right) \end{matrix} \right) \end{aligned}$$

Then, we obtain:

$$\begin{aligned} \frac{1}{\binom{n}{k}} \sum_{1 \leq i_1 < \dots < i_k \leq n} \left(\prod_{j=1}^k \tilde{g}_{i_j}, \prod_{j=1}^k \hat{g}_{i_j} \right)^{\frac{1}{k}} &= \left(\begin{matrix} \hat{p} & \hat{p} \\ t-t \left(\prod_{1 \leq i_1 < \dots < i_k \leq n} \left(1 - \left(\prod_{j=1}^k \frac{\tilde{a}_{i_j}}{t^k}, \prod_{j=1}^k \frac{\hat{a}_{i_j}}{t^k} \right)^{\frac{1}{k}} \right) \right)^{\frac{1}{k}} & t \left(\prod_{1 \leq i_1 < \dots < i_k \leq n} \left(1 - \left(\prod_{j=1}^k \left(1 - \frac{\tilde{\beta}_{i_j}}{t}, 1 - \frac{\hat{\beta}_{i_j}}{t} \right) \right)^{\frac{1}{k}} \right) \right)^{\frac{1}{k}} & \hat{p} & t \left(\prod_{1 \leq i_1 < \dots < i_k \leq n} \left(1 - \left(\prod_{j=1}^k \left(1 - \frac{\tilde{\gamma}_{i_j}}{t}, 1 - \frac{\hat{\gamma}_{i_j}}{t} \right) \right)^{\frac{1}{k}} \right) \right)^{\frac{1}{k}} \end{matrix} \right) \end{aligned}$$

Therefore,

$$LNCHM^k(\mathring{g}_i, \mathring{g}_i) = \left(\begin{array}{c} \mathring{p} \\ t-t \left(\prod_{1 \leq \hat{i}_1 < \dots < \hat{i}_k \leq n} \left(1 - \left(\frac{\prod_{j=1}^k \tilde{\alpha}_{\hat{i}_j}}{t^k}, \frac{\prod_{j=1}^k \hat{\alpha}_{\hat{i}_j}}{t^k} \right)^{\frac{1}{k}} \right) \right)^{\frac{1}{k}}, \mathring{p} \\ t \left(\prod_{1 \leq \hat{i}_1 < \dots < \hat{i}_k \leq n} \left(1 - \left(\prod_{j=1}^k \left(1 - \frac{\tilde{\beta}_{\hat{i}_j}}{t}, 1 - \frac{\hat{\beta}_{\hat{i}_j}}{t} \right) \right)^{\frac{1}{k}} \right) \right)^{\frac{1}{k}}, \\ \mathring{p} \\ t \left(\prod_{1 \leq \hat{i}_1 < \dots < \hat{i}_k \leq n} \left(1 - \left(\prod_{j=1}^k \left(1 - \frac{\tilde{\gamma}_{\hat{i}_j}}{t}, 1 - \frac{\hat{\gamma}_{\hat{i}_j}}{t} \right) \right)^{\frac{1}{k}} \right) \right)^{\frac{1}{k}} \end{array} \right)$$

In addition, since:

$$\begin{aligned} 0 &\leq t-t \left(\prod_{1 \leq \hat{i}_1 < \dots < \hat{i}_k \leq n} \left(1 - \left(\frac{\prod_{j=1}^k \tilde{\alpha}_{\hat{i}_j}}{t^k}, \frac{\prod_{j=1}^k \hat{\alpha}_{\hat{i}_j}}{t^k} \right)^{\frac{1}{k}} \right) \right)^{\frac{1}{k}} \leq t, \\ 0 &\leq t \left(\prod_{1 \leq \hat{i}_1 < \dots < \hat{i}_k \leq n} \left(1 - \left(\prod_{j=1}^k \left(1 - \frac{\tilde{\beta}_{\hat{i}_j}}{t}, 1 - \frac{\hat{\beta}_{\hat{i}_j}}{t} \right) \right)^{\frac{1}{k}} \right) \right)^{\frac{1}{k}} \leq t, \\ 0 &\leq t \left(\prod_{1 \leq \hat{i}_1 < \dots < \hat{i}_k \leq n} \left(1 - \left(\prod_{j=1}^k \left(1 - \frac{\tilde{\gamma}_{\hat{i}_j}}{t}, 1 - \frac{\hat{\gamma}_{\hat{i}_j}}{t} \right) \right)^{\frac{1}{k}} \right) \right)^{\frac{1}{k}} \leq t, \end{aligned}$$

Therefore,

$$\left(\begin{array}{c} \mathring{p} \\ t-t \left(\prod_{1 \leq \hat{i}_1 < \dots < \hat{i}_k \leq n} \left(1 - \left(\frac{\prod_{j=1}^k \tilde{\alpha}_{\hat{i}_j}}{t^k}, \frac{\prod_{j=1}^k \hat{\alpha}_{\hat{i}_j}}{t^k} \right)^{\frac{1}{k}} \right) \right)^{\frac{1}{k}}, \\ \mathring{p} \\ t \left(\prod_{1 \leq \hat{i}_1 < \dots < \hat{i}_k \leq n} \left(1 - \left(\prod_{j=1}^k \left(1 - \frac{\tilde{\beta}_{\hat{i}_j}}{t}, 1 - \frac{\hat{\beta}_{\hat{i}_j}}{t} \right) \right)^{\frac{1}{k}} \right) \right)^{\frac{1}{k}}, \\ \mathring{p} \\ t \left(\prod_{1 \leq \hat{i}_1 < \dots < \hat{i}_k \leq n} \left(1 - \left(\prod_{j=1}^k \left(1 - \frac{\tilde{\gamma}_{\hat{i}_j}}{t}, 1 - \frac{\hat{\gamma}_{\hat{i}_j}}{t} \right) \right)^{\frac{1}{k}} \right) \right)^{\frac{1}{k}} \end{array} \right)$$

is also an LNCN. \square

Example 4. Let $\mathring{p} = \{\mathring{p}_0, \mathring{p}_1, \mathring{p}_2, \mathring{p}_3, \mathring{p}_4\}$ be an LT^S with odd cardinality $t + 1$ and $\mathring{g}_1 = (\mathring{p}_3, \mathring{p}_2, \mathring{p}_1)$, $\mathring{g}_2 = (\mathring{p}_4, \mathring{p}_3, \mathring{p}_1)$, be two LNCNsbased on \mathring{p} . Then, we can use the suggested LNCHM operator to aggregate these

two LNCNs (suppose $\mathring{k} = 2$) and to produce an inclusive value $LNCHM^{(\mathring{k})}(\mathring{g}_1, \mathring{g}_2) = \left(\mathring{p}_{(\tilde{\alpha}, \hat{\alpha})}, \mathring{p}_{(\tilde{\beta}, \hat{\beta})}, \mathring{p}_{(\tilde{\gamma}, \hat{\gamma})} \right)$ described as follows; where:

$$(\mathring{g}_1, \mathring{g}_2) = \left(\begin{array}{l} ([0.2, 0.3], [0.2, 0.5], [0.2, 0.5], (0.9, 0.7, 0.9)), \\ ([0.4, 0.5], [0.3, 0.5], [0.3, 0.5], (0.8, 0.8, 0.6)) \end{array} \right)$$

(i):

$$\frac{1}{\binom{n}{\mathring{k}}} = \frac{\mathring{k}!(n - \mathring{k})!}{n!} = \frac{2!(2 - 2)!}{2!} = 1$$

(ii):

$$t - t \left(\prod_{1 \leq \hat{i}_1 < \dots < \hat{i}_{\mathring{k}} \leq n} \left(1 - \left(\frac{\prod_{j=1}^{\mathring{k}} \tilde{\alpha}_{\hat{i}_j}}{t^{\mathring{k}}}, \frac{\prod_{j=1}^{\mathring{k}} \hat{\alpha}_{\hat{i}_j}}{t^{\mathring{k}}} \right)^{\frac{1}{\mathring{k}}} \right) \right)^{\frac{1}{\binom{n}{\mathring{k}}}}$$

$$= ([0.28, 0.39], 0.17)$$

(iii):

$$t \left(\prod_{1 \leq \hat{i}_1 < \dots < \hat{i}_{\mathring{k}} \leq n} \left(1 - \left(\prod_{j=1}^{\mathring{k}} \left(1 - \frac{\tilde{\beta}_{\hat{i}_j}}{t}, 1 - \frac{\hat{\beta}_{\hat{i}_j}}{t} \right) \right)^{\frac{1}{\mathring{k}}} \right) \right)^{\frac{1}{\binom{n}{\mathring{k}}}}$$

$$= ([0.3, 0.5], 0.75)$$

(iv):

$$t \left(\prod_{1 \leq \hat{i}_1 < \dots < \hat{i}_{\mathring{k}} \leq n} \left(1 - \left(\prod_{j=1}^{\mathring{k}} \left(1 - \frac{\tilde{\gamma}_{\hat{i}_j}}{t}, 1 - \frac{\hat{\gamma}_{\hat{i}_j}}{t} \right) \right)^{\frac{1}{\mathring{k}}} \right) \right)^{\frac{1}{\binom{n}{\mathring{k}}}}$$

$$= ([0.3, 0.5], 0.74)$$

Therefore, we get:

$$LNCHM^2(\mathring{g}_1, \mathring{g}_2) = \left(\mathring{p}_{(\tilde{\alpha}, \hat{\alpha})}, \mathring{p}_{(\tilde{\beta}, \hat{\beta})}, \mathring{p}_{(\tilde{\gamma}, \hat{\gamma})} \right)$$

$$= ([0.28, 0.39], [0.3, 0.5], [0.3, 0.5], (0.17, 0.75, 0.74)).$$

Now, we will study some of the ideal properties of LNCNs.

Property 1. (Idempotency) If $(\tilde{g}_{\hat{i}}, \hat{g}_{\hat{i}}) = (\tilde{g}, \hat{g}) = \left(\mathring{p}_{(\tilde{\alpha}, \hat{\alpha})}, \mathring{p}_{(\tilde{\beta}, \hat{\beta})}, \mathring{p}_{(\tilde{\gamma}, \hat{\gamma})} \right) \forall (\hat{i} = 1, 2, \dots, n)$, then:

$$LNCHM^{\mathring{k}}(\tilde{g}, \hat{g}) = \left(\mathring{p}_{(\tilde{\alpha}, \hat{\alpha})}, \mathring{p}_{(\tilde{\beta}, \hat{\beta})}, \mathring{p}_{(\tilde{\gamma}, \hat{\gamma})} \right) \tag{18}$$

Proof. Since $(\tilde{g}, \hat{g}) = (\mathring{p}_{(\tilde{\alpha}, \hat{\alpha})}, \mathring{p}_{(\tilde{\beta}, \hat{\beta})}, \mathring{p}_{(\tilde{\gamma}, \hat{\gamma})})$, based on Theorem 1, we have:

$$\begin{aligned} & LNCHM^k(\tilde{g}, \hat{g}) \\ &= \left(\begin{array}{c} \mathring{p} \\ t-t \left(\prod_{1 \leq \hat{i}_1 < \dots < \hat{i}_k \leq n} \left(1 - \left(\frac{\tilde{\alpha}^k}{t^k}, \frac{\hat{\alpha}^k}{t^k} \right)^{\frac{1}{k}} \right) \right)^{\frac{1}{k}}, \mathring{p} \\ t \left(\prod_{1 \leq \hat{i}_1 < \dots < \hat{i}_k \leq n} \left(1 - \left(\left(1 - \frac{\tilde{\beta}}{t}, 1 - \frac{\hat{\beta}}{t} \right)^k \right)^{\frac{1}{k}} \right) \right)^{\frac{1}{k}}, \mathring{p} \\ t \left(\prod_{1 \leq \hat{i}_1 < \dots < \hat{i}_k \leq n} \left(1 - \left(\left(1 - \frac{\tilde{\gamma}}{t}, 1 - \frac{\hat{\gamma}}{t} \right)^k \right)^{\frac{1}{k}} \right) \right)^{\frac{1}{k}} \end{array} \right) \\ &= \left(\begin{array}{c} \mathring{p} \\ t-t \left(\left(1 - \left(\frac{\tilde{\alpha}}{t}, \frac{\hat{\alpha}}{t} \right) \right)^{\binom{n}{k}} \right)^{\frac{1}{k}}, \mathring{p} \\ t \left(\left(1 - \left(1 - \frac{\tilde{\beta}}{t}, 1 - \frac{\hat{\beta}}{t} \right) \right)^{\binom{n}{k}} \right)^{\frac{1}{k}}, \mathring{p} \\ t \left(\left(1 - \left(1 - \frac{\tilde{\gamma}}{t}, 1 - \frac{\hat{\gamma}}{t} \right) \right)^{\binom{n}{k}} \right)^{\frac{1}{k}} \end{array} \right) \\ &= \left(\mathring{p}_{t-t \left(1 - \left(\frac{\tilde{\alpha}}{t}, \frac{\hat{\alpha}}{t} \right) \right)}, \mathring{p}_{t \left(1 - \left(1 - \frac{\tilde{\beta}}{t}, 1 - \frac{\hat{\beta}}{t} \right) \right)}, \mathring{p}_{t \left(1 - \left(1 - \frac{\tilde{\gamma}}{t}, 1 - \frac{\hat{\gamma}}{t} \right) \right)} \right) \\ &= \left(\mathring{p}_{(\tilde{\alpha}, \hat{\alpha})}, \mathring{p}_{(\tilde{\beta}, \hat{\beta})}, \mathring{p}_{(\tilde{\gamma}, \hat{\gamma})} \right) = (\tilde{g}, \hat{g}) \end{aligned}$$

□

Property 2. (Commutativity) Let (\tilde{g}_i, \hat{g}_i) for all $(i = 1, 2, \dots, n)$ be an assortment of LNCNs and $(\tilde{g}'_i, \hat{g}'_i)$ be any permutation of (\tilde{g}_i, \hat{g}_i) , then:

$$LNCHM^k(\tilde{g}'_i, \hat{g}'_i) = LNCHM^k(\tilde{g}_i, \hat{g}_i) \tag{19}$$

Proof. The conclusion is obvious, because Property 2 depends on Definition 13.

$$\begin{aligned} LNCHM^k(\tilde{g}'_i, \hat{g}'_i) &= \frac{\sum_{1 \leq \hat{i}_1 < \dots < \hat{i}_k \leq n} \left(\prod_{j=1}^k \tilde{g}_{\hat{i}_j}, \prod_{j=1}^k \hat{g}'_{\hat{i}_j} \right)^{\frac{1}{k}}}{\binom{n}{k}} \\ &= \frac{\sum_{1 \leq \hat{i}_1 < \dots < \hat{i}_k \leq n} \left(\prod_{j=1}^k \tilde{g}_{\hat{i}_j}, \prod_{j=1}^k \hat{g}_{\hat{i}_j} \right)^{\frac{1}{k}}}{\binom{n}{k}} \\ &= LNCHM^k(\tilde{g}_i, \hat{g}_i) \end{aligned}$$

□

Property 3. (Monotonicity) Let

$(\tilde{g}_i, \hat{g}_i) = (\mathring{p}_{(\tilde{\alpha}_i, \hat{\alpha}_i)}, \mathring{p}_{(\tilde{\beta}_i, \hat{\beta}_i)}, \mathring{p}_{(\tilde{\gamma}_i, \hat{\gamma}_i)})$, $(\tilde{f}_i, \hat{f}_i) = (\mathring{p}_{(\tilde{q}_i, \hat{q}_i)}, \mathring{p}_{(\tilde{r}_i, \hat{r}_i)}, \mathring{p}_{(\tilde{s}_i, \hat{s}_i)})$ ($i = 1, 2, \dots, n$) be two collections of LNCNs; if $(\tilde{\alpha}_i, \hat{\alpha}_i) \leq (\tilde{q}_i, \hat{q}_i)$, $(\tilde{\beta}_i, \hat{\beta}_i) \geq (\tilde{r}_i, \hat{r}_i)$, $(\tilde{\gamma}_i, \hat{\gamma}_i) \leq (\tilde{s}_i, \hat{s}_i)$ for all i , then:

$$LNCHM^k(\hat{g}_i, \tilde{g}_i) \leq LNCHM^k(\hat{f}_i, \tilde{f}_i) \tag{20}$$

Proof. Since $0 \leq (\tilde{\alpha}_i, \hat{\alpha}_i) \leq (\tilde{q}_i, \hat{q}_i)$, $(\tilde{\beta}_i, \hat{\beta}_i) \geq (\tilde{r}_i, \hat{r}_i) \geq 0$, $(\tilde{\gamma}_i, \hat{\gamma}_i) \geq (\tilde{s}_i, \hat{s}_i) \geq 0$, $t \geq 0$ and according to Theorem 1, we get:

$$\begin{aligned}
 & t - t \left(\prod_{1 \leq \hat{i}_1 < \dots < \hat{i}_k \leq n} \left(1 - \left(\frac{\prod_{j=1}^k \tilde{\alpha}_{i_j}}{t^k}, \frac{\prod_{j=1}^k \hat{\alpha}_{i_j}}{t^k} \right)^{\frac{1}{k}} \right) \right)^{\frac{1}{(k)}} \\
 & \leq t - t \left(\prod_{1 \leq \hat{i}_1 < \dots < \hat{i}_k \leq n} \left(1 - \left(\frac{\prod_{j=1}^k \tilde{q}_{i_j}}{t^k}, \frac{\prod_{j=1}^k \hat{q}_{i_j}}{t^k} \right)^{\frac{1}{k}} \right) \right)^{\frac{1}{(k)}} , \\
 & - t \left(\prod_{1 \leq \hat{i}_1 < \dots < \hat{i}_k \leq n} \left(1 - \left(\prod_{j=1}^k \left(1 - \frac{\tilde{\beta}_{i_j}}{t}, 1 - \frac{\hat{\beta}_{i_j}}{t} \right) \right)^{\frac{1}{k}} \right) \right)^{\frac{1}{(k)}} \\
 & \leq -t \left(\prod_{1 \leq \hat{i}_1 < \dots < \hat{i}_k \leq n} \left(1 - \left(\prod_{j=1}^k \left(1 - \frac{\tilde{r}_{i_j}}{t}, 1 - \frac{\hat{r}_{i_j}}{t} \right) \right)^{\frac{1}{k}} \right) \right)^{\frac{1}{(k)}} , \\
 & - t \left(\prod_{1 \leq \hat{i}_1 < \dots < \hat{i}_k \leq n} \left(1 - \left(\prod_{j=1}^k \left(1 - \frac{\tilde{\gamma}_{i_j}}{t}, 1 - \frac{\hat{\gamma}_{i_j}}{t} \right) \right)^{\frac{1}{k}} \right) \right)^{\frac{1}{(k)}} \\
 & \leq -t \left(\prod_{1 \leq \hat{i}_1 < \dots < \hat{i}_k \leq n} \left(1 - \left(\prod_{j=1}^k \left(1 - \frac{\tilde{s}_{i_j}}{t}, 1 - \frac{\hat{s}_{i_j}}{t} \right) \right)^{\frac{1}{k}} \right) \right)^{\frac{1}{(k)}} .
 \end{aligned}$$

□

Let $(\tilde{g}, \hat{g}) = LNCHM^{\hat{k}}(\tilde{g}_i, \hat{g}_i)$, $(\tilde{f}, f) = LNCHM^{\hat{k}}(\tilde{f}_i, f_i)$ and $\psi(\hat{g})$ and $\Psi(f)$ be the score functions of \hat{g} and f . According to the score value in Definition 11 and the above inequality, we can simply have $\psi(\hat{g}) \leq \Psi(f)$. Then, in the following, we argue some cases:

1. If $\psi(\hat{g}) \leq \Psi(f)$, we can obtain $LNCHM^{\hat{k}}(\tilde{g}_i, \hat{g}_i) \leq LNCHM^{\hat{k}}(\tilde{f}_i, f_i)$;
2. if $\psi(\hat{g}) = \Psi(f)$, then:

$$\begin{aligned}
 & 2t + t - t \left(\prod_{1 \leq \hat{i}_1 < \dots < \hat{i}_k \leq n} \left(1 - \left(\frac{\prod_{j=1}^k \tilde{\alpha}_{i_j}}{t^k}, \frac{\prod_{j=1}^k \hat{\alpha}_{i_j}}{t^k} \right)^{\frac{1}{k}} \right) \right)^{\frac{1}{(k)}} \\
 & - t \left(\prod_{1 \leq \hat{i}_1 < \dots < \hat{i}_k \leq n} \left(1 - \left(\prod_{j=1}^k \left(1 - \frac{\tilde{\beta}_{i_j}}{t}, 1 - \frac{\hat{\beta}_{i_j}}{t} \right) \right)^{\frac{1}{k}} \right) \right)^{\frac{1}{(k)}} \\
 & - t \left(\prod_{1 \leq \hat{i}_1 < \dots < \hat{i}_k \leq n} \left(1 - \left(\prod_{j=1}^k \left(1 - \frac{\tilde{\gamma}_{i_j}}{t}, 1 - \frac{\hat{\gamma}_{i_j}}{t} \right) \right)^{\frac{1}{k}} \right) \right)^{\frac{1}{(k)}} \\
 & \hline
 & 3t \\
 & 2t + t - t \left(\prod_{1 \leq \hat{i}_1 < \dots < \hat{i}_k \leq n} \left(1 - \left(\frac{\prod_{j=1}^k \tilde{q}_{i_j}}{t^k}, \frac{\prod_{j=1}^k \hat{q}_{i_j}}{t^k} \right)^{\frac{1}{k}} \right) \right)^{\frac{1}{(k)}} \\
 & - t \left(\prod_{1 \leq \hat{i}_1 < \dots < \hat{i}_k \leq n} \left(1 - \left(\prod_{j=1}^k \left(1 - \frac{\tilde{r}_{i_j}}{t}, 1 - \frac{\hat{r}_{i_j}}{t} \right) \right)^{\frac{1}{k}} \right) \right)^{\frac{1}{(k)}} \\
 & - t \left(\prod_{1 \leq \hat{i}_1 < \dots < \hat{i}_k \leq n} \left(1 - \left(\prod_{j=1}^k \left(1 - \frac{\tilde{s}_{i_j}}{t}, 1 - \frac{\hat{s}_{i_j}}{t} \right) \right)^{\frac{1}{k}} \right) \right)^{\frac{1}{(k)}} \\
 & \hline
 & 3t
 \end{aligned}$$

Since $0 \leq (\hat{\alpha}_i, \hat{\alpha}_i) \leq (\tilde{q}_i, q_i), (\hat{\beta}_i, \hat{\beta}_i) \geq (\tilde{r}_i, r_i) \geq 0, (\hat{\gamma}_i, \hat{\gamma}_i) \geq (\tilde{s}_i, s_i) \geq 0, t \geq 0$, we can assume that:

$$\begin{aligned} & t - t \left(\prod_{1 \leq \hat{i}_1 < \dots < \hat{i}_k \leq n} \left(1 - \left(\frac{\prod_{j=1}^k \tilde{\alpha}_{\hat{i}_j}}{t^k}, \frac{\prod_{j=1}^k \hat{\alpha}_{\hat{i}_j}}{t^k} \right)^{\frac{1}{k}} \right) \right)^{\frac{1}{k}} \\ &= t - t \left(\prod_{1 \leq \hat{i}_1 < \dots < \hat{i}_k \leq n} \left(1 - \left(\frac{\prod_{j=1}^k \tilde{q}_{\hat{i}_j}}{t^k}, \frac{\prod_{j=1}^k q_{\hat{i}_j}}{t^k} \right)^{\frac{1}{k}} \right) \right)^{\frac{1}{k}} \\ &= t \left(\prod_{1 \leq \hat{i}_1 < \dots < \hat{i}_k \leq n} \left(1 - \left(\prod_{j=1}^k \left(1 - \frac{\tilde{\gamma}_{\hat{i}_j}}{t}, 1 - \frac{\hat{\gamma}_{\hat{i}_j}}{t} \right) \right)^{\frac{1}{k}} \right) \right)^{\frac{1}{k}} \\ &= -t \left(\prod_{1 \leq \hat{i}_1 < \dots < \hat{i}_k \leq n} \left(1 - \left(\prod_{j=1}^k \left(1 - \frac{\tilde{s}_{\hat{i}_j}}{t}, 1 - \frac{s_{\hat{i}_j}}{t} \right) \right)^{\frac{1}{k}} \right) \right)^{\frac{1}{k}}, \end{aligned}$$

and based on the accuracy value in Definition 11, then $\Phi(\hat{g}) = \Phi(f)$. Finally, we get:

$$LNCHM^k(\tilde{g}_i, \hat{g}_i) \leq LNCHM^k(\tilde{f}_i, f_i)$$

Property 4. (Boundedness) Let $(\tilde{g}_i, \hat{g}_i) = (\hat{p}_{\tilde{\alpha}_i}, \hat{p}_{\tilde{\beta}_i}, \hat{p}_{\tilde{\gamma}_i}, \hat{p}_{\tilde{\alpha}_i}, \hat{p}_{\tilde{\beta}_i}, \hat{p}_{\tilde{\gamma}_i})(i = 1, 2, \dots, n)$ be the collection of LNCNs and:

$$\begin{aligned} \hat{g}^+ &= \max(\hat{p}_{\max(\tilde{\alpha}_i)}, \hat{p}_{\min(\tilde{\beta}_i)}, \hat{p}_{\min(\tilde{\gamma}_i)}, \hat{p}_{\max(\hat{\alpha}_i)}, \hat{p}_{\min(\hat{\beta}_i)}, \hat{p}_{\min(\hat{\gamma}_i)}), \\ \hat{g}^- &= \min(\tilde{g}_i, \hat{g}_i) = (\hat{p}_{\min(\tilde{\alpha}_i)}, \hat{p}_{\max(\tilde{\beta}_i)}, \hat{p}_{\max(\tilde{\gamma}_i)}, \\ & \hat{p}_{\min(\hat{\alpha}_i)}, \hat{p}_{\max(\hat{\beta}_i)}, \hat{p}_{\max(\hat{\gamma}_i)}), \end{aligned}$$

then

$$\hat{g}^- \leq LNCHM^k(\tilde{g}_i, \hat{g}_i) \leq \hat{g}^+ \tag{21}$$

Proof. Based on Properties 1 and 3, we have:

$$\begin{aligned} LNCHM^k(\tilde{g}_i, \hat{g}_i) &\geq LNCHM^k(\hat{g}_i^-, \hat{g}_i^-) = \hat{g}^- \\ LNCHM^k(\tilde{g}_i, \hat{g}_i) &\leq LNCHM^k(\hat{g}_i^+, \hat{g}_i^+) = \hat{g}^+. \end{aligned}$$

The proof is completed. \square

In addition, we will deliberate about some desirable cases of the LNCHM operator for the parameter k .

1. When $\hat{k} = 1$, the LNCHM operator in (16) will be reduced to the LNCHA (linguistic neutrosophic cubic Hamy averaging) operator:

$$\begin{aligned}
 LNCHM^1(\tilde{g}_i, \hat{g}_i) &= \frac{\sum_{1 \leq \hat{i}_1 \leq n} \left(\prod_{j=1}^1 \tilde{g}_{i_j}, \prod_{j=1}^1 \hat{g}_{i_j} \right)^{\frac{1}{1}}}{\binom{n}{1}} \\
 &= \left(\begin{array}{c} \hat{p} \\ t-t \left(\prod_{1 \leq \hat{i}_1 \leq n} \left(1 - \left(\prod_{j=1}^1 \tilde{\alpha}_{i_j}, \prod_{j=1}^1 \hat{\alpha}_{i_j} \right)^{\frac{1}{1}} \right) \right)^{\frac{1}{1}}, \hat{p} \\ t \left(\prod_{1 \leq \hat{i}_1 \leq n} \left(1 - \left(\prod_{j=1}^1 \left(1 - \frac{\tilde{\beta}_{i_j}}{t}, 1 - \frac{\hat{\beta}_{i_j}}{t} \right) \right)^{\frac{1}{1}} \right) \right)^{\frac{1}{1}}, \hat{p} \\ \hat{p} \\ t \left(\prod_{1 \leq \hat{i}_1 \leq n} \left(1 - \left(\prod_{j=1}^1 \left(1 - \frac{\tilde{\gamma}_{i_j}}{t}, 1 - \frac{\hat{\gamma}_{i_j}}{t} \right) \right)^{\frac{1}{1}} \right) \right)^{\frac{1}{1}} \end{array} \right) \quad (22) \\
 &= \left(\begin{array}{c} \hat{p} \\ t-t \left(\prod_{j=1}^1 (1 - \tilde{\alpha}_i, 1 - \hat{\alpha}_i) \right)^{\frac{1}{n}}, \hat{p} \\ t \left(\prod_{j=1}^1 \left(\frac{\tilde{\beta}_i}{t}, \frac{\hat{\beta}_i}{t} \right) \right)^{\frac{1}{n}}, \hat{p} \\ t \left(\prod_{j=1}^1 \left(\frac{\tilde{\gamma}_i}{t}, \frac{\hat{\gamma}_i}{t} \right) \right)^{\frac{1}{n}} \end{array} \right) \\
 &\quad (\text{let } \hat{i}_1 = i) = \frac{1}{n} \sum_{i=1}^n \hat{g}_i = LNCA(\tilde{g}_i, \hat{g}_i)
 \end{aligned}$$

2. When $\hat{k} = n$, the LNCHM operator in (16) will reduce to the LNCHA (linguistic neutrosophic cubic Hamy averaging) operator:

$$\begin{aligned}
 LNCHM^n(\tilde{g}_i, \hat{g}_i) &= \frac{\sum_{1 \leq \hat{i}_1 < \dots < \hat{i}_k \leq n} \left(\prod_{j=1}^n \tilde{g}_{i_j}, \prod_{j=1}^n \hat{g}_{i_j} \right)^{\frac{1}{n}}}{\binom{n}{n}} \\
 &= \left(\begin{array}{c} \hat{p} \\ t-t \left(\prod_{1 \leq \hat{i}_1 < \dots < \hat{i}_k \leq n} \left(1 - \left(\prod_{j=1}^n \frac{\tilde{\alpha}_{i_j}}{t^n}, \prod_{j=1}^n \frac{\hat{\alpha}_{i_j}}{t^n} \right) \right)^{\frac{1}{n}} \right)^{\frac{1}{n}}, \hat{p} \\ t \left(\prod_{1 \leq \hat{i}_1 < \dots < \hat{i}_k \leq n} \left(1 - \left(\prod_{j=1}^n \left(1 - \frac{\tilde{\beta}_{i_j}}{t}, 1 - \frac{\hat{\beta}_{i_j}}{t} \right) \right)^{\frac{1}{n}} \right) \right)^{\frac{1}{n}}, \hat{p} \\ \hat{p} \\ t \left(\prod_{1 \leq \hat{i}_1 < \dots < \hat{i}_k \leq n} \left(1 - \left(\prod_{j=1}^n \left(1 - \frac{\tilde{\gamma}_{i_j}}{t}, 1 - \frac{\hat{\gamma}_{i_j}}{t} \right) \right)^{\frac{1}{n}} \right) \right)^{\frac{1}{n}} \end{array} \right) \quad (23)
 \end{aligned}$$

$$\begin{aligned}
 &= \left(\begin{array}{c} \mathring{p} \\ t-t \left(1 - \left(\prod_{j=1}^n \frac{\mathring{\alpha}_{ij}}{t^n}, \prod_{j=1}^n \frac{\mathring{\alpha}_{ij}}{t^n} \right)^{\frac{1}{n}}, \mathring{p} \left(1 - \left(\prod_{j=1}^n \left(1 - \frac{\mathring{\beta}_{ij}}{t}, 1 - \frac{\mathring{\beta}_{ij}}{t} \right) \right)^{\frac{1}{n}} \right) \right) \\ \\ \mathring{p} \\ t \left(1 - \left(\prod_{j=1}^n \left(1 - \frac{\mathring{\gamma}_{ij}}{t}, 1 - \frac{\mathring{\gamma}_{ij}}{t} \right) \right)^{\frac{1}{n}} \right) \end{array} \right) \\
 &= \left(\begin{array}{c} \mathring{p} \\ t \left(\prod_{j=1}^n \frac{\mathring{\alpha}_{ij}}{t^n}, \prod_{j=1}^n \frac{\mathring{\alpha}_{ij}}{t^n} \right)^{\frac{1}{n}}, \mathring{p} \\ t-t \left(\prod_{j=1}^n \left(1 - \frac{\mathring{\beta}_{ij}}{t}, 1 - \frac{\mathring{\beta}_{ij}}{t} \right) \right)^{\frac{1}{n}}, \mathring{p} \\ t-t \left(\prod_{j=1}^n \left(1 - \frac{\mathring{\gamma}_{ij}}{t}, 1 - \frac{\mathring{\gamma}_{ij}}{t} \right) \right)^{\frac{1}{n}} \end{array} \right) \\
 &\quad \text{let } (\hat{i}_j = \hat{i}) = \prod_{\hat{i}=1}^n \mathring{g}_{\hat{i}}^{\frac{1}{n}} = LNG(\mathring{g}_{\hat{i}}, \mathring{g}_{\hat{i}})
 \end{aligned}$$

Definition 14. Suppose $(\mathring{g}_{\hat{i}}, \mathring{g}_{\hat{i}})$ where $\hat{i} = 1, 2, \dots, n$. is an assortment of linguistic neutrosophic cubic numbers and parameter $\mathring{k} = 1, 2, \dots, n$. and $\mathring{w} = (\mathring{w}_1, \mathring{w}_2, \dots, \mathring{w}_n)^T$ the weight vector of \hat{i}_i with $\mathring{w}_i \in [0, 1]$ and $\sum_{i=1}^n \mathring{w}_i = 1$, then the WLNCHM operator is defined as:

$$WLNCHM^{\mathring{k}}(\mathring{g}_{\hat{i}}, \mathring{g}_{\hat{i}}) = \frac{\sum_{1 \leq \hat{i}_1 < \dots < \hat{i}_k \leq n} \left(\prod_{j=1}^{\mathring{k}} \mathring{w}_{\hat{i}_j} \mathring{g}_{\hat{i}_j}, \prod_{j=1}^{\mathring{k}} \mathring{w}_{\hat{i}_j} \mathring{g}_{\hat{i}_j} \right)^{\frac{1}{\mathring{k}}}}{\binom{n}{\mathring{k}}} \tag{24}$$

where $(\hat{i}_1, \hat{i}_2, \dots, \hat{i}_k)$ navigate all the k -tuple arrangements of $(1, 2, \dots, n)$, $\binom{n}{k}$ is the binomial coefficient and $\binom{n}{k} = \frac{n!}{k!(n-k)!}$.

Example 5. Let $(\mathring{g}_{\hat{i}}, \mathring{g}_{\hat{i}}) = ((\mathring{g}_1, \mathring{g}_1), (\mathring{g}_2, \mathring{g}_2))$ $i = 1, 2$ and $k = 1$, where $\mathring{g}_1 = ([0.2, 0.4], [0.3, 0.4], [0.4, 0.6], (0.6, 0.5, 0.8))$, $\mathring{g}_2 = ([0.3, 0.5], [0.4, 0.7], [0.2, 0.4], (0.7, 0.8, 0.6))$ and $\mathring{w} = (0.5, 0.5)$:

$$\begin{aligned}
 &WLNCHM^1((\tilde{g}_1, \hat{g}_2), (\tilde{g}_2, \hat{g}_2)) \\
 &= \frac{\sum_{(1)}^2 (((\hat{w}_{11}\tilde{g}_{11}, \hat{w}_{11}\hat{g}_{11})(\hat{w}_{22}\tilde{g}_{22}, \hat{w}_{22}\hat{g}_{22})))^1}{\binom{2}{1}} \\
 &= \frac{(((\hat{w}_{11}\tilde{g}_{11}, \hat{w}_{11}\hat{g}_{11}), (\hat{w}_{22}\tilde{g}_{22}, \hat{w}_{22}\hat{g}_{22})))^1 + (((\hat{w}_{11}\tilde{g}_{11}, \hat{w}_{11}\hat{g}_{11}), (\hat{w}_{22}\tilde{g}_{22}, \hat{w}_{22}\hat{g}_{22})))^1}{\binom{2}{1}} \\
 &= \frac{\sum \left(\begin{matrix} (0.5) (0.5) \left(\begin{matrix} ([0.2, 0.4], [0.3, 0.4], [0.4, 0.6], (0.6, 0.5, 0.8)) \\ ([0.2, 0.4], [0.3, 0.4], [0.4, 0.6], (0.6, 0.5, 0.8)) \end{matrix} \right) \\ (0.5) (0.5) \left(\begin{matrix} ([0.3, 0.5], [0.4, 0.7], [0.2, 0.4], (0.7, 0.8, 0.6)) \\ ([0.3, 0.5], [0.4, 0.7], [0.2, 0.4], (0.7, 0.8, 0.6)) \end{matrix} \right) \end{matrix} \right)^1}{\binom{2}{1}} \\
 &= \frac{\left(\begin{matrix} (0.5) (0.5) \left(\begin{matrix} ([0.2, 0.4], [0.3, 0.4], [0.4, 0.6], (0.6, 0.5, 0.8)) \\ ([0.2, 0.4], [0.3, 0.4], [0.4, 0.6], (0.6, 0.5, 0.8)) \end{matrix} \right) \\ (0.5) (0.5) \left(\begin{matrix} ([0.3, 0.5], [0.4, 0.7], [0.2, 0.4], (0.7, 0.8, 0.6)) \\ ([0.3, 0.5], [0.4, 0.7], [0.2, 0.4], (0.7, 0.8, 0.6)) \end{matrix} \right) \end{matrix} \right)^1 + \left(\begin{matrix} (0.5) (0.5) \left(\begin{matrix} ([0.2, 0.4], [0.3, 0.4], [0.4, 0.6], (0.6, 0.5, 0.8)) \\ ([0.2, 0.4], [0.3, 0.4], [0.4, 0.6], (0.6, 0.5, 0.8)) \end{matrix} \right) \\ (0.5) (0.5) \left(\begin{matrix} ([0.3, 0.5], [0.4, 0.7], [0.2, 0.4], (0.7, 0.8, 0.6)) \\ ([0.3, 0.5], [0.4, 0.7], [0.2, 0.4], (0.7, 0.8, 0.6)) \end{matrix} \right) \end{matrix} \right)^1}{\binom{2}{1}} \\
 &= \frac{\left(\begin{matrix} ([0.003, 0.01], [0.006, 0.01], [0.01, 0.023], (0.3, 0.23, 0.2)) \\ ([0.006, 0.02], [0.01, 0.034], [0.03, 0.01], (0.32, 0.2, 0.3)) \end{matrix} \right) + \left(\begin{matrix} ([0.003, 0.01], [0.006, 0.01], [0.01, 0.023], (0.3, 0.23, 0.2)) \\ ([0.006, 0.02], [0.01, 0.034], [0.03, 0.01], (0.32, 0.2, 0.3)) \end{matrix} \right)}{\binom{2}{1}} \\
 &= \frac{\left(\begin{matrix} ([0.00002, 0.0002], [0.00006, 0.00034], [0.0003, 0.0023], (0.52, 0.4, 0.44)) \\ + ([0.00002, 0.0002], [0.00006, 0.00034], [0.0003, 0.0023], (0.52, 0.4, 0.44)) \end{matrix} \right)}{\binom{2}{1}} \\
 &= \frac{([0.00004, 0.0004], [0.00012, 0.0007], [0.0006, 0.005], (0.3, 0.2, 0.23))}{\binom{2}{1}} \\
 &= ([0.00002, 0.0002], [0.00006, 0.0004], [0.0003, 0.003], (0.2, 0.1, 0.12))
 \end{aligned}$$

Depending on the operations of LNCNs that were given in the above Equations (1)–(4), with the help of Equation (24), we can formulate the following theorem.

Theorem 2. Let $(\tilde{g}_i, \hat{g}_i) = (\hat{p}_{(\tilde{\alpha}, \hat{\alpha})}, \hat{p}_{(\tilde{\beta}, \hat{\beta})}, \hat{p}_{(\tilde{\gamma}, \hat{\gamma})})(i = 1, 2, \dots, n)$ be the collection of LNCNs, $\hat{w} = (\hat{w}_1, \hat{w}_2, \dots, \hat{w}_n)^T$ be the weight vector of \hat{w}_i with $\hat{w}_i \in [0, 1], i = 1, 2, \dots, n$ and $\sum_{i=1}^n \hat{w}_i = 1$. Then, the accumulated value acquired from the WLNCHM operator in Equation (24) is obviously an LNCN, and:

$$\begin{aligned}
 & WLNCM(\tilde{g}_t, \hat{g}_t) \tag{25} \\
 &= \left(\begin{array}{l} \hat{p} \\ t-t \left(\prod_{1 \leq i_1 < \dots < i_k \leq n} \left(1 - \left(\prod_{j=1}^k \left(1 - \left(1 - \frac{\tilde{\alpha}_{ij}}{t}, 1 - \frac{\hat{\alpha}_{ij}}{t} \right)^{w_{ij}} \right) \right)^{\frac{1}{k}} \right) \right)^{\frac{1}{k}}, \\ \hat{p} \\ t \left(\prod_{1 \leq i_1 < \dots < i_k \leq n} \left(1 - \left(\prod_{j=1}^k \left(1 - \left(\frac{\tilde{\beta}_{ij}}{t}, \frac{\hat{\beta}_{ij}}{t} \right)^{w_{ij}} \right) \right)^{\frac{1}{k}} \right) \right)^{\frac{1}{k}}, \\ \hat{p} \\ t \left(\prod_{1 \leq i_1 < \dots < i_k \leq n} \left(1 - \left(\prod_{j=1}^k \left(1 - \left(\frac{\tilde{\gamma}_{ij}}{t}, \frac{\hat{\gamma}_{ij}}{t} \right)^{w_{ij}} \right) \right)^{\frac{1}{k}} \right) \right)^{\frac{1}{k}} \end{array} \right)
 \end{aligned}$$

Proof. According to the operational law of LNCNs, we have:

$$\hat{w}_{ij} \hat{g}_{ij} = \left(\hat{p}_{t-t \left(1 - \frac{\tilde{\alpha}_{ij}}{t}, 1 - \frac{\hat{\alpha}_{ij}}{t} \right)^{w_{ij}}}, \hat{p}_{t \left(\frac{\tilde{\beta}_{ij}}{t}, \frac{\hat{\beta}_{ij}}{t} \right)^{w_{ij}}}, \hat{p}_{t \left(\frac{\tilde{\gamma}_{ij}}{t}, \frac{\hat{\gamma}_{ij}}{t} \right)^{w_{ij}}} \right),$$

$$\begin{aligned}
 & \prod_{j=1}^k \hat{w}_{ij} \hat{g}_{ij} \\
 &= \left(\hat{p}_{t \prod_{j=1}^k \left(1 - \left(1 - \frac{\tilde{\alpha}_{ij}}{t}, 1 - \frac{\hat{\alpha}_{ij}}{t} \right)^{w_{ij}} \right)}, \hat{p}_{t-t \prod_{j=1}^k \left(1 - \left(\frac{\tilde{\beta}_{ij}}{t}, \frac{\hat{\beta}_{ij}}{t} \right)^{w_{ij}} \right)}, \hat{p}_{t-t \prod_{j=1}^k \left(1 - \left(\frac{\tilde{\gamma}_{ij}}{t}, \frac{\hat{\gamma}_{ij}}{t} \right)^{w_{ij}} \right)} \right)
 \end{aligned}$$

and:

$$\begin{aligned}
 & \left(\prod_{j=1}^k \hat{w}_{ij} \hat{g}_{ij} \right)^{\frac{1}{k}} \\
 &= \left(\hat{p}_{t \left(\prod_{j=1}^k \left(1 - \left(1 - \frac{\tilde{\alpha}_{ij}}{t}, 1 - \frac{\hat{\alpha}_{ij}}{t} \right)^{w_{ij}} \right) \right)^{\frac{1}{k}}}, \hat{p}_{t-t \left(\prod_{j=1}^k \left(1 - \left(\frac{\tilde{\beta}_{ij}}{t}, \frac{\hat{\beta}_{ij}}{t} \right)^{w_{ij}} \right) \right)^{\frac{1}{k}}}, \hat{p}_{t-t \left(\prod_{j=1}^k \left(1 - \left(\frac{\tilde{\gamma}_{ij}}{t}, \frac{\hat{\gamma}_{ij}}{t} \right)^{w_{ij}} \right) \right)^{\frac{1}{k}}} \right)
 \end{aligned}$$

then:

$$\begin{aligned}
 & \sum_{1 \leq i_1 < \dots < i_k \leq n} \left(\prod_{j=1}^k \hat{g}_{ij} \right)^{\frac{1}{k}} \\
 &= \left(\hat{p}_{t-t \prod_{1 \leq i_1 < \dots < i_k \leq n} \left(1 - \left(\prod_{j=1}^k \left(1 - \left(1 - \frac{\tilde{\alpha}_{ij}}{t}, 1 - \frac{\hat{\alpha}_{ij}}{t} \right)^{w_{ij}} \right) \right)^{\frac{1}{k}}}, \hat{p}_{t \prod_{1 \leq i_1 < \dots < i_k \leq n} \left(1 - \left(\prod_{j=1}^k \left(1 - \left(\frac{\tilde{\beta}_{ij}}{t}, \frac{\hat{\beta}_{ij}}{t} \right)^{w_{ij}} \right) \right)^{\frac{1}{k}}}, \right. \\
 & \quad \left. \hat{p}_{t \prod_{1 \leq i_1 < \dots < i_k \leq n} \left(1 - \left(\prod_{j=1}^k \left(1 - \left(\frac{\tilde{\gamma}_{ij}}{t}, \frac{\hat{\gamma}_{ij}}{t} \right)^{w_{ij}} \right) \right)^{\frac{1}{k}} \right)} \right)
 \end{aligned}$$

$$\frac{1}{\binom{n}{k}} \sum_{1 \leq i_1 < \dots < i_k \leq n} \left(\prod_{j=1}^k \tilde{g}_{ij} \right)^{\frac{1}{k}}$$

$$= \left(\begin{array}{l} \hat{p} \\ t-t \left(\prod_{1 \leq i_1 < \dots < i_k \leq n} \left(1 - \left(\prod_{j=1}^k \left(1 - \left(1 - \frac{\tilde{a}_{ij}}{t}, 1 - \frac{\tilde{a}_{ij}}{t} \right)^{w_{ij}} \right) \right)^{\frac{1}{k}} \right) \right)^{\frac{1}{k}'} \\ \hat{p} \\ t \left(\prod_{1 \leq i_1 < \dots < i_k \leq n} \left(1 - \left(\prod_{j=1}^k \left(1 - \left(\frac{\tilde{b}_{ij}}{t}, \frac{\tilde{b}_{ij}}{t} \right)^{w_{ij}} \right) \right)^{\frac{1}{k}} \right) \right)^{\frac{1}{k}'} \\ \hat{p} \\ t \left(\prod_{1 \leq i_1 < \dots < i_k \leq n} \left(1 - \left(\prod_{j=1}^k \left(1 - \left(\frac{\tilde{\gamma}_{ij}}{t}, \frac{\tilde{\gamma}_{ij}}{t} \right)^{w_{ij}} \right) \right)^{\frac{1}{k}} \right) \right)^{\frac{1}{k}'} \end{array} \right)$$

Therefore,

$$WLNCHM(\tilde{g}_i, \hat{g}_i)$$

$$= \left(\begin{array}{l} \hat{p} \\ t-t \left(\prod_{1 \leq i_1 < \dots < i_k \leq n} \left(1 - \left(\prod_{j=1}^k \left(1 - \left(1 - \frac{\tilde{a}_{ij}}{t}, 1 - \frac{\tilde{a}_{ij}}{t} \right)^{w_{ij}} \right) \right)^{\frac{1}{k}} \right) \right)^{\frac{1}{k}'} \\ \hat{p} \\ t \left(\prod_{1 \leq i_1 < \dots < i_k \leq n} \left(1 - \left(\prod_{j=1}^k \left(1 - \left(\frac{\tilde{b}_{ij}}{t}, \frac{\tilde{b}_{ij}}{t} \right)^{w_{ij}} \right) \right)^{\frac{1}{k}} \right) \right)^{\frac{1}{k}'} \\ \hat{p} \\ t \left(\prod_{1 \leq i_1 < \dots < i_k \leq n} \left(1 - \left(\prod_{j=1}^k \left(1 - \left(\frac{\tilde{\gamma}_{ij}}{t}, \frac{\tilde{\gamma}_{ij}}{t} \right)^{w_{ij}} \right) \right)^{\frac{1}{k}} \right) \right)^{\frac{1}{k}'} \end{array} \right)$$

which proves Theorem. \square

According to the operating rules of the LNCNs, the WLNCHM operators also have the same properties in the following:

Property 5. (Commutativity) Let (\hat{g}_i, \tilde{g}_i) for all $(i = 1, 2, \dots, n)$, be an assortment of LNCNs and $(\tilde{g}'_i, \hat{g}'_i)$ be any permutation of (\tilde{g}_i, \hat{g}_i) , then:

$$WLNCHM^k(\tilde{g}'_i, \hat{g}'_i) = LNCHM^k(\tilde{g}_i, \hat{g}_i) \tag{26}$$

Based on Definition (13), the conclusion is obvious,

$$WLNCHM^k(\hat{w}_{ij}\tilde{g}'_i, \hat{w}_{ij}\hat{g}'_i)$$

$$= \frac{\sum_{1 \leq i_1 < \dots < i_k \leq n} \left(\prod_{j=1}^k \hat{w}_{ij}\tilde{g}'_{ij}, \prod_{j=1}^k \hat{w}_{ij}\hat{g}'_{ij} \right)^{\frac{1}{k}}}{\binom{n}{k}}$$

$$= \frac{\sum_{1 \leq i_1 < \dots < i_k \leq n} \left(\prod_{j=1}^k \hat{w}_{ij}\tilde{g}_{ij}, \prod_{j=1}^k \hat{w}_{ij}\hat{g}_{ij} \right)^{\frac{1}{k}}}{\binom{n}{k}}$$

$$= WLNCHM^k(\tilde{g}_i, \hat{g}_i)$$

Property 6. (Monotonicity) Let $(\tilde{g}_i, \hat{g}_i) = (\hat{p}_{(\tilde{\alpha}_i, \hat{\alpha}_i)}, \hat{p}_{(\tilde{\beta}_i, \hat{\beta}_i)}, \hat{p}_{(\tilde{\gamma}_i, \hat{\gamma}_i)}), (\tilde{f}_i, f_i) = (\hat{p}_{(\tilde{p}_i, p_i)}, \hat{p}_{(\tilde{q}_i, q_i)}, \hat{p}_{(\tilde{r}_i, r_i)})$ ($i = 1, 2, \dots, n$) be two collections of LNCNs; if $\tilde{\alpha}_i \leq \tilde{p}_i, \tilde{\beta}_i \leq \tilde{q}_i, \tilde{\gamma}_i \leq \tilde{r}_i$, and $\hat{\alpha}_i \leq \hat{p}_i, \hat{\beta}_i \leq \hat{q}_i, \hat{\gamma}_i \leq \hat{r}_i$ for all i , then:

$$WLNCHM^k(\tilde{g}_i, \hat{g}_i) \leq WLNCHM^k(\tilde{f}_i, f_i) \tag{27}$$

Property 7. (Idempotency) If $(\tilde{g}_i, \hat{g}_i) = (\tilde{g}, \hat{g}) = (\hat{p}_{(\tilde{\alpha}, \hat{\alpha})}, \hat{p}_{(\tilde{\beta}, \hat{\beta})}, \hat{p}_{(\tilde{\gamma}, \hat{\gamma})})$ for all $(i = 1, 2, \dots, n)$, then:

$$WLNCHM^k(\tilde{g}, \hat{g}) = (\hat{p}_{(\tilde{\alpha}, \hat{\alpha})}, \hat{p}_{(\tilde{\beta}, \hat{\beta})}, \hat{p}_{(\tilde{\gamma}, \hat{\gamma})}) \tag{28}$$

Property 8. (Boundedness) Let $(\tilde{g}_i, \hat{g}_i) (i = 1, 2, \dots, n)$ be an assortment of LNCNs and $\hat{g}^+ = \max(\tilde{g}_i, \hat{g}_i), \hat{g}^- = \min(\tilde{g}_i, \hat{g}_i)$, then:

$$\hat{g}^- \leq WLNCHM^k(\tilde{g}_i, \hat{g}_i) \leq \hat{g}^+ \tag{29}$$

Based on Properties 5 and 6, we have,

$$WLNCHM^k(\tilde{g}_i, \hat{g}_i) \geq WLNCHM^k(\hat{g}_i^-, \hat{g}_i^-) = \hat{g}^-$$

$$WLNCHM^k(\tilde{g}_i, \hat{g}_i) \leq WLNCHM^k(\hat{g}_i^+, \hat{g}_i^+) = \hat{g}^+.$$

4. Entropy of LNCs

Entropy is used to control the unpredictability in different sets like the fuzzy set (FS), intuitionistic fuzzy set (IFS), etc. In 1965, Zadeh [37] first defined the entropy of FS to determine the ambiguity in a quantitative manner. This notion of fuzziness plays a significant role in system optimization, pattern classification, control and some other areas. He also gave some points of its effects in system theory. Recently, the non-probabilistic entropy was axiomatized by Luca et al. [38]. The intuitionistic fuzzy sets are intuitive and have been widely used in the fuzzy literature. The entropy G of a fuzzy set H satisfies the following conditions,

1. $G(H) = 0$ if and only if $H \in 2^X$;
2. $G(H) = 1$ if and only if $\mu_A(x) = 0.5, \forall x \in X$;
3. $G(H) \leq G(\hat{i})$ if and only if H is less fuzzy than \hat{i} , i.e., if $\mu_H(x) \leq \mu_i(x) \leq 0.5, \forall x \in X$ or if $\mu_H(x) \geq \mu_i(x) \geq 0.5, \forall x \in X$;
4. $G(H^C) = G(H)$.

Axioms 1–4 were expressed for fuzzy sets (known only by their membership functions), and they are stated for the intuitionistic fuzzy sets as follows:

1. $G(H) = 0$ if and only if $H \in 2^X$; (H non-fuzzy)
2. $G(H) = 1$ if and only if $\mu_H(x) = \nu_H(x), \forall x \in X$;
3. $G(H) \leq G(\hat{i})$ if and only if H is less than \hat{i} , i.e., if $\mu_H(x) \leq \mu_i(x)$ and $\nu_H(x) \geq \nu_i(x)$ for $\mu_i(x) \leq \nu_i(x)$ or if $\mu_H(x) \geq \mu_i(x)$ and $\nu_H(x) \leq \nu_i(x)$ for $\mu_i(x) \geq \nu_i(x)$,
4. $G(H^C) = G(H)$.

Differences occur in Axiom 2 and 3.

Kaufmann [39] suggested a distance measure of soft entropy. A new non-probabilistic entropy measure was introduced by Kosko [40]. In [41] Majumdar and Samanta introduced the notion of two single-valued neutrosophic sets, their properties and also defined the distance between these two sets. They also investigated the measure of entropy of a single-valued neutrosophic set. The entropy of IFSs was introduced by Szmidt and Kacprzyk [42]. The fuzziness measure in terms of distance between the fuzzy set and its compliment was put forward by Yager [43].

The LNCS was examined by managing undetermined data with the truth, indeterminacy and falsity membership function. For the neutrosophic entropy, we will trace the Kosko idea for fuzziness calculation [40]. Kosko proposed to measure this information feature by a similarity function between the distance to the nearest crisp element and the distance to the farthest crisp element. For neutrosophic information, we refer the work by Patrascu [45] where he has given the following definition including from Equation (30) to (33). It states that: the two crisp elements are $(1, 0, 0)$ and $(0, 0, 1)$. We consider the following vector: $B = (\mu - \nu, \mu + \nu - 1, w)$. For $(1, 0, 0)$ and $(0, 0, 1)$, it results in $B_{Tru} = (1, 0, 0)$ and $B_{Fal} = (-1, 0, 0)$. We will now compute the distances as follows:

$$D(B, B_{Tru}) = |\mu - \nu - 1| + |\mu + \nu - 1| + w \tag{30}$$

$$D(B, B_{Fal}) = |\mu - \nu + 1| + |\mu + \nu - 1| + w \tag{31}$$

The neutrosophic entropy will be defined by the similarity between these two distances. The similarity E_c and neutrosophic entropy V_c are defined as follows:

$$E_c = 1 - \frac{|D(B, B_{Tru}) - D(B, B_{Fal})|}{D(B, B_{Tru}) + D(B, B_{Fal})} \tag{32}$$

$$V_c = 1 - \frac{|\mu - \nu|}{1 + |\mu + \nu - 1| + w} \tag{33}$$

Definition 15. Suppose that $H = \left\{ \left(x_i, \hat{P}_{(\tilde{\alpha}H, \hat{\alpha}H)(x_i)}, \hat{P}_{(\tilde{\beta}H, \hat{\beta}H)(x_i)}, \hat{P}_{(\tilde{\gamma}H, \hat{\gamma}H)(x_i)} \right) \mid x_i \in X \right\}$ is an LNCS; we define the entropy of LNCS as a function $G_{\hat{k}} : \hat{k}(X) \rightarrow [0, t]$, where t is an odd cardinality with $t + 1$. The following are some conditions.

1. $G_{\hat{k}}(H) = 0$ if H is a crisp set;
2. $G_{\hat{k}}(H) = [1, 1]$ if and only if $\frac{\tilde{\alpha}H(x)}{t} = \frac{\tilde{\beta}H(x)}{t} = \frac{\tilde{\gamma}H(x)}{t} = [0.5, 0.5]$ and $G_{\hat{k}}(H) = 1$ if and only if $\frac{\hat{\alpha}H(x)}{t} = \frac{\hat{\beta}H(x)}{t} = \frac{\hat{\gamma}H(x)}{t} = 0.5, \forall x \in X$;
3. $G_{\hat{k}}(H) \leq G_{\hat{k}}(\hat{t})$ if and only if H is less indeterminable than \hat{t} , i.e., if $\frac{\tilde{\alpha}H(x)}{t} + \frac{\tilde{\gamma}H(x)}{t} \geq \frac{\tilde{\alpha}\hat{t}(x)}{t} + \frac{\tilde{\gamma}\hat{t}(x)}{t}$, $\frac{\hat{\alpha}H(x)}{t} + \frac{\hat{\gamma}H(x)}{t} \geq \frac{\hat{\alpha}\hat{t}(x)}{t} + \frac{\hat{\gamma}\hat{t}(x)}{t}$ and $\left| \frac{\tilde{\beta}H(x)}{t} - \frac{\tilde{\beta}_{HC}(x)}{t} \right| \geq \left| \frac{\tilde{\beta}\hat{t}(x)}{t} - \frac{\tilde{\beta}_{HC}\hat{t}(x)}{t} \right|, \left| \frac{\hat{\beta}H(x)}{t} - \frac{\hat{\beta}_{HC}(x)}{t} \right| \geq \left| \frac{\hat{\beta}\hat{t}(x)}{t} - \frac{\hat{\beta}_{HC}\hat{t}(x)}{t} \right|$;
4. $G_{\hat{k}}(H^C) = G_{\hat{k}}(H)$.

We need to consider three factors for the uncertain measure of LNCS; one is the truth membership and false membership, and the other is the indeterminacy term. We define the entropy measure of $G_{\hat{k}}$ of an LNCS H , which depends on the following terms:

$$G_{\hat{k}}(H) = 1 - \frac{1}{n} \sum_{x \in X} \left(\frac{\tilde{\alpha}H(x)}{t} + \frac{\tilde{\gamma}H(x)}{t} \right) \cdot \left| \frac{\tilde{\beta}H(x)}{t} - \frac{\tilde{\beta}_{HC}(x)}{t} \right| \tag{34}$$

Then, we prove that Equation (34) can meet the condition of Definition 15.

Proof. 1. For a crisp set H , there is no indeterminacy function for any LNCS of H . Hence, $G_{\hat{k}}(H) = 0$ is satisfied.

2. If H is such that $\frac{\tilde{\alpha}H(x)}{t} = \frac{\tilde{\beta}H(x)}{t} = \frac{\tilde{\gamma}H(x)}{t} = [0.5, 0.5], \frac{\hat{\alpha}H(x)}{t}, \frac{\hat{\beta}H(x)}{t}, \frac{\hat{\gamma}H(x)}{t} = 0.5, \forall x \in X$, then $\frac{\tilde{\alpha}H(x)}{t} + \frac{\tilde{\gamma}H(x)}{t} = [1, 1], \frac{\hat{\alpha}H(x)}{t} + \frac{\hat{\gamma}H(x)}{t} = 1$ and $\frac{\tilde{\beta}H(x)}{t} - \frac{\tilde{\beta}_{HC}(x)}{t} = [0.5, 0.5] - [0.5, 0.5] = 0, \frac{\hat{\beta}H(x)}{t} - \frac{\hat{\beta}_{HC}(x)}{t} = 0.5 - 0.5 = 0, \forall x \in X \Rightarrow G_{\hat{k}}(H) = 1$.

3. H is less uncertain than I ; we assume $\frac{\tilde{\alpha}_H(x)}{t} + \frac{\tilde{\gamma}_H(x)}{t} \geq \frac{\tilde{\alpha}_I(x)}{t} + \frac{\tilde{\gamma}_I(x)}{t}, \frac{\hat{\alpha}_H(x)}{t} + \frac{\hat{\gamma}_H(x)}{t} \geq \frac{\hat{\alpha}_I(x)}{t} + \frac{\hat{\gamma}_I(x)}{t}$ and $\left| \frac{\tilde{\beta}_H(x)}{t} - \frac{\tilde{\beta}_{HC}(x)}{t} \right| \geq \left| \frac{\tilde{\beta}_I(x)}{t} - \frac{\tilde{\beta}_{IC}(x)}{t} \right|, \left| \frac{\hat{\beta}_H(x)}{t} - \frac{\hat{\beta}_{HC}(x)}{t} \right| \geq \left| \frac{\hat{\beta}_I(x)}{t} - \frac{\hat{\beta}_{IC}(x)}{t} \right|$. Depending on the entropy value in Equation (34), we can obtain $G_k(H) \leq G_k(I)$.
4. $H^C = \left\{ \left(x_i, \hat{p}_{\tilde{\gamma}_H(x_i)}, \hat{p}_{t-\tilde{\beta}_H(x_i)}, \hat{p}_{\tilde{\alpha}_H(x_i)}, \hat{p}_{\hat{\gamma}_H(x_i)}, \hat{p}_{t-\hat{\beta}_H(x_i)}, \hat{p}_{\hat{\alpha}_H(x_i)} \right) \mid x_i \in X \right\}$,
 $G_k(H^C) = 1 - \frac{1}{n} \sum_{x \in X} \left(\frac{\tilde{\gamma}_H(x)}{t} + \frac{\tilde{\alpha}_H(x)}{t} \right) \cdot \left| \frac{\tilde{\beta}_{HC}(x)}{t} - \frac{\tilde{\beta}_H(x)}{t} \right| = G_k(H)$.
 \square

Example 6. Let $\hat{p} = \{\hat{p}_0, \hat{p}_1, \hat{p}_2, \hat{p}_3, \hat{p}_4\}$ be a linguistic term set with cardinality $t + 1$, $\hat{g}_1 = (\hat{p}_3, \hat{p}_2, \hat{p}_1)$, $\hat{g}_2 = (\hat{p}_4, \hat{p}_3, \hat{p}_1)$, be two LNCNs based on \hat{p} and U be the universal set where:

$$H = \left\{ \begin{array}{l} ([0.1, 0.3], [0.4, 0.5], [0.4, 0.6], (0.4, 0.6, 0.7)), \\ ([0.1, 0.2], [0.2, 0.5], [0.1, 0.4], (0.4, 0.6, 0.5)) \end{array} \right\}$$

is an LNCS in U . Then, the entropy of U will be:

$$G_k(H) = 1 - \frac{1}{2} \left(\begin{array}{l} \left(\frac{[0.1,0.3]}{5} + \frac{[0.4,0.6]}{5} \right) \cdot \left| \frac{[0.4,0.5]}{5} - \frac{5-[0.4,0.5]}{5} \right| \\ + \left(\frac{[0.1,0.2]}{5} + \frac{[0.1,0.4]}{5} \right) \cdot \left| \frac{[0.1,0.4]}{5} - \frac{5-[0.1,0.4]}{5} \right| \end{array} \right) \\ = [0.89, 0.93]$$

5. The Method for MAGDM Based on the WLNCHM Operator

In this section, we discuss MAGDM, based on the WLNCHM operator with LNCN.

Let $U = \{U_1, U_2, \dots, U_m\}$ be the set of alternatives, $V = \{V_1, V_2, \dots, V_n\}$ be the set of attributes and $\hat{w} = (\hat{w}_1, \hat{w}_2, \dots, \hat{w}_n)^T$ be the weight vector. Then, by LNCNs and from the predefined linguistic term set $\varphi = \{\varphi_j \mid j \in [0, t]\}$ (where $t + 1$ is an odd cardinality), the decision makers are invited to evaluate the alternatives $U_i (\hat{i} = 1, 2, \dots, m)$ over the attributes $V_j (j = 1, 2, \dots, n)$. The DMs can assign the uncertain LT^S to the truth, indeterminacy and falsity linguistic terms and the certain LT^S to the truth, indeterminacy and falsity linguistic terms in each LNCNs, which is based on the LT^S in the evaluation process of the linguistic evaluation of each attribute $V_j (j = 1, 2, \dots, n)$ on each alternative $U_i (\hat{i} = 1, 2, \dots, m)$. Thus, we obtain the decision matrix $S = (s_{ij})_{m \times n}$, $(\hat{g}_{ij}, \hat{g}_{ij}) = (\hat{p}_{\tilde{\alpha}_{ij}}, \hat{p}_{\tilde{\beta}_{ij}}, \hat{p}_{\tilde{\gamma}_{ij}}, \hat{p}_{\hat{\alpha}_{ij}}, \hat{p}_{\hat{\beta}_{ij}}, \hat{p}_{\hat{\gamma}_{ij}})$ ($\hat{i} = 1, 2, \dots, m; j = 1, 2, \dots, n$) as an LNCN.

Based on the above information, the MAGDM on the WLNCHM operator is described as follows:

Step 1: Regulate the decision making problem.

Step 2: Calculate $\hat{g}_{ij} = WLNCHM(s_{i1}, s_{i2}, \dots, s_{in})$ to obtain the collective approximation value for alternatives U_i with respect to attribute V_j .

Step 3: In this step, we operate the entropy of LNCSs to find out the weight of the elements.
 $\hat{g}_j = (\hat{p}_{(\tilde{\alpha}_j, \hat{\alpha}_j)}, \hat{p}_{(\tilde{\beta}_j, \hat{\beta}_j)}, \hat{p}_{(\tilde{\gamma}_j, \hat{\gamma}_j)})$

$$G_k(\hat{g}_j) = 1 - \frac{1}{m} \sum_{x \in X} \left(\frac{\tilde{\alpha}_{R_j}(x)}{t} + \frac{\tilde{\gamma}_{R_j}(x)}{t} \right) \cdot \left| \frac{\tilde{\beta}_{R_j}(x)}{t} - \frac{\tilde{\beta}_{R_j^c}(x)}{t} \right| \\ \omega = G_k(\hat{g}_j) / \sum_{j=1}^n G_k(\hat{g}_j) \tag{35}$$

Step 4: In this step, we calculate the values of the score function $\varphi(S)$, accuracy function $\Phi(S)$ and certain function $\Psi(S)$ based on Equations (12)–(14).

Step 5: In this step, we find out the sequence of the alternatives $U_i(i = 1, 2, \dots, m)$. According to the ranking order of Definition 8, with a greater score function $\varphi(S)$, the ranking order of alternatives U_i is the best. If the score functions are the same, then the accuracy function of alternatives U_i is larger, and then, the ranking order of alternatives U_i is better. Furthermore, if the score and accuracy function both are the same, then the certain function of alternatives U_i is larger, and then, the ranking order of alternatives U_i is best.

Step 6: End.

6. Numerical Applications

A corporation intends to choose one person to be the area supervisor from five candidates ($U_1 - U_4$), to be further evaluated according to the three attributes, which are shown as follows: ideological and moral quality (V_1), professional ability (V_2) and creative ability (V_3). The weights of the indicators are $\hat{w} = (0.5, 0.3, 0.2)$.

6.1. Procedure

Case 1: If the weights of the element are absolutely unidentified, then we use the suggested technique to solve the above problem in which the decision making steps are as follows:

Step 1: Let $U = \{U_1, U_2, \dots, U_4\}$ be a set of alternatives and $V = \{V_1, V_2, V_3\}$ be a set of attributes. Let $S = (s_{ij})_{4 \times 3}$ be a set of decision matrices. A decision matrix evaluates each alternative based on the given attributes;

$$S_1 = \begin{matrix} & \begin{matrix} V_1 \\ V_2 \\ V_3 \end{matrix} \\ \begin{matrix} U_1 \\ U_2 \\ U_3 \\ U_4 \end{matrix} & \left\{ \begin{matrix} ([0.4, 0.5], \\ [0.1, 0.2], \\ [0.3, 0.6], \\ (0.6, 0.3, 0.7)) \end{matrix} \right\} & \left\{ \begin{matrix} ([0.3, 0.5], \\ [0.6, 0.7], \\ [0.4, 0.6], \\ (0.6, 0.8, 0.7)) \end{matrix} \right\} & \left\{ \begin{matrix} ([0.2, 0.5], \\ [0.4, 0.7], \\ [0.7, 0.8], \\ (0.6, 0.8, 0.9)) \end{matrix} \right\} \end{matrix}$$

$$S_2 = \begin{matrix} & V_1 & & V_2 & & V_3 \\ U_1 & \left\{ \begin{array}{l} ([0.4, 0.6], \\ [0.1, 0.3], \\ [0.3, 0.5], \\ (0.7, 0.4, 0.6)) \end{array} \right\} & & \left\{ \begin{array}{l} ([0.3, 0.4], \\ [0.6, 0.7], \\ [0.5, 0.6], \\ (0.5, 0.8, 0.7)) \end{array} \right\} & & \left\{ \begin{array}{l} ([0.2, 0.3], \\ [0.4, 0.5], \\ [0.7, 0.8], \\ (0.4, 0.6, 0.9)) \end{array} \right\} \\ U_2 & \left\{ \begin{array}{l} ([0.3, 0.7], \\ [0.7, 0.8], \\ [0.6, 0.8], \\ (0.8, 0.9, 1.0)) \end{array} \right\} & & \left\{ \begin{array}{l} ([0.4, 0.5], \\ [0.7, 0.9], \\ [0.1, 0.4], \\ (0.6, 1.0, 0.8)) \end{array} \right\} & & \left\{ \begin{array}{l} ([0.3, 0.4], \\ [0.1, 0.8], \\ [0.6, 0.9], \\ (0.5, 0.9, 1.0)) \end{array} \right\} \\ U_3 & \left\{ \begin{array}{l} ([0.2, 0.4], \\ [0.5, 0.6], \\ [0.1, 0.3], \\ (0.5, 0.7, 0.7)) \end{array} \right\} & & \left\{ \begin{array}{l} ([0.5, 0.6], \\ [0.3, 0.6], \\ [0.3, 0.7], \\ (0.7, 0.8, 0.9)) \end{array} \right\} & & \left\{ \begin{array}{l} ([0.1, 0.3], \\ [0.4, 0.6], \\ [0.2, 0.5], \\ (0.4, 0.7, 0.6)) \end{array} \right\} \\ U_4 & \left\{ \begin{array}{l} ([0.4, 0.7], \\ [0.3, 0.5], \\ [0.4, 0.6], \\ (0.8, 0.6, 0.7)) \end{array} \right\} & & \left\{ \begin{array}{l} ([0.1, 0.4], \\ [0.2, 0.6], \\ [0.6, 0.7], \\ (0.5, 0.7, 0.8)) \end{array} \right\} & & \left\{ \begin{array}{l} ([0.2, 0.7], \\ [0.2, 0.8], \\ [0.1, 0.5], \\ (0.8, 0.9, 0.7)) \end{array} \right\} \end{matrix}$$

$$S_3 = \begin{matrix} & V_1 & & V_2 & & V_3 \\ U_1 & \left\{ \begin{array}{l} ([0.4, 0.5], \\ [0.1, 0.2], \\ [0.3, 0.6], \\ (0.6, 0.3, 0.7)) \end{array} \right\} & & \left\{ \begin{array}{l} ([0.3, 0.4], \\ [0.5, 0.7], \\ [0.4, 0.5], \\ (0.5, 0.8, 0.6)) \end{array} \right\} & & \left\{ \begin{array}{l} ([0.2, 0.4], \\ [0.4, 0.6], \\ [0.7, 0.9], \\ (0.5, 0.7, 1.0)) \end{array} \right\} \\ U_2 & \left\{ \begin{array}{l} ([0.4, 0.5], \\ [0.7, 0.9], \\ [0.4, 0.9], \\ (0.6, 1.0, 1.1)) \end{array} \right\} & & \left\{ \begin{array}{l} ([0.4, 0.6], \\ [0.7, 0.9], \\ [0.1, 0.4], \\ (0.7, 1.0, 0.5)) \end{array} \right\} & & \left\{ \begin{array}{l} ([0.1, 0.4], \\ [0.1, 0.7], \\ [0.7, 0.8], \\ (0.5, 0.8, 0.9)) \end{array} \right\} \\ U_3 & \left\{ \begin{array}{l} ([0.2, 0.6], \\ [0.5, 0.8], \\ [0.1, 0.7], \\ (0.7, 0.9, 0.8)) \end{array} \right\} & & \left\{ \begin{array}{l} ([0.5, 0.6], \\ [0.4, 0.6], \\ [0.6, 0.8], \\ (0.7, 0.8, 0.9)) \end{array} \right\} & & \left\{ \begin{array}{l} ([0.1, 0.4], \\ [0.4, 0.8], \\ [0.6, 0.8], \\ (0.5, 0.9, 1.0)) \end{array} \right\} \\ U_4 & \left\{ \begin{array}{l} ([0.3, 0.9], \\ [0.4, 0.7], \\ [0.5, 0.9], \\ (1.1, 0.8, 1.0)) \end{array} \right\} & & \left\{ \begin{array}{l} ([0.1, 0.2], \\ [0.2, 0.5], \\ [0.6, 0.7], \\ (0.3, 0.6, 0.8)) \end{array} \right\} & & \left\{ \begin{array}{l} ([0.2, 0.5], \\ [0.2, 0.4], \\ [0.1, 0.9], \\ (0.7, 0.8, 1.0)) \end{array} \right\} \end{matrix}$$

Step 2: Calculate $s_{ij} = WLNCHM(s_{i1}, s_{i2}, \dots, s_{im})$ to obtain the overall assessment value for alternatives U_i with respect to attribute V_j .

	V_1	V_2	V_3
U_1	$\left\{ \begin{array}{l} ([0.110, 0.127], \\ [0.055, 0.084], \\ [0.095, 0.131], \\ (0.139, 0.101, \\ 0.142)) \end{array} \right\}$	$\left\{ \begin{array}{l} ([0.101, 0.119], \\ [0.115, 0.127], \\ [0.110, 0.135], \\ (0.127, 0.156, \\ 0.142)) \end{array} \right\}$	$\left\{ \begin{array}{l} ([0.078, 0.110], \\ [0.110, 0.135], \\ [0.146, 0.159], \\ (0.123, 0.110, \\ 0.169)) \end{array} \right\}$
U_2	$\left\{ \begin{array}{l} ([0.105, 0.139], \\ [0.146, 0.159], \\ [0.119, 0.159], \\ (0.149, 0.169, \\ 0.175)) \end{array} \right\}$	$\left\{ \begin{array}{l} ([0.110, 0.135], \\ [0.146, 0.162], \\ [0.055, 0.115], \\ (0.146, 0.172, \\ 0.142)) \end{array} \right\}$	$\left\{ \begin{array}{l} ([0.071, 0.110], \\ [0.055, 0.149], \\ [0.142, 0.162], \\ (0.123, 0.159, \\ 0.172)) \end{array} \right\}$
U_3	$\left\{ \begin{array}{l} ([0.078, 0.131], \\ [0.123, 0.146], \\ [0.055, 0.135], \\ (0.142, 0.156, \\ 0.156)) \end{array} \right\}$	$\left\{ \begin{array}{l} ([0.123, 0.131], \\ [0.105, 0.135], \\ [0.123, 0.153], \\ (0.142, 0.153, \\ 0.165)) \end{array} \right\}$	$\left\{ \begin{array}{l} ([0.055, 0.110], \\ [0.110, 0.153], \\ [0.101, 0.110], \\ (0.123, 0.162, \\ 0.159)) \end{array} \right\}$
U_4	$\left\{ \begin{array}{l} ([0.105, 0.159], \\ [0.101, 0.139], \\ [0.115, 0.156], \\ (0.172, 0.149, \\ 0.169)) \end{array} \right\}$	$\left\{ \begin{array}{l} ([0.055, 0.095], \\ [0.078, 0.135], \\ [0.139, 0.146], \\ (0.110, 0.146, \\ 0.159)) \end{array} \right\}$	$\left\{ \begin{array}{l} ([0.078, 0.135], \\ [0.078, 0.139], \\ [0.055, 0.149], \\ (0.149, 0.159, \\ 0.165)) \end{array} \right\}$

Step 3: We utilize the entropy of LNCSs to calculate the weight of the attributes, i.e., let $s_j = (\mathring{p}_{(\tilde{\alpha}_j, \hat{\alpha}_j)}, \mathring{p}_{(\tilde{\beta}_j, \hat{\beta}_j)}, \mathring{p}_{(\tilde{\gamma}_j, \hat{\gamma}_j)})$ be the LNCN and $G_k(s_j)$ be the weight of attributes, i.e.,

$$\begin{aligned}
 G_k(s_j) &= 1 - \frac{1}{m} \sum_{x \in X} \left(\frac{\tilde{\alpha}_{S_j}(x)}{t} + \frac{\tilde{\gamma}_{S_j}(x)}{t} \right) \cdot \left| \frac{\tilde{\beta}_{S_j}(x)}{t} - \frac{\tilde{\beta}_{S_j^c}(x)}{t} \right| \\
 G_k(s_1) &= 1 - \frac{1}{4} \left(\begin{aligned} & \left(\frac{[0.110,0.127]}{7} + \frac{[0.095,0.131]}{7} \right) \cdot \left| \frac{[0.055,0.084]}{7} - \frac{7-[0.055,0.084]}{7} \right| \\ & + \left(\frac{[0.105,0.139]}{7} + \frac{[0.119,0.159]}{7} \right) \cdot \left| \frac{[0.146,0.159]}{7} - \frac{7-[0.146,0.159]}{7} \right| \\ & + \left(\frac{[0.078,0.131]}{7} + \frac{[0.055,0.135]}{7} \right) \cdot \left| \frac{[0.123,0.146]}{7} - \frac{7-[0.123,0.146]}{7} \right| \\ & + \left(\frac{[0.105,0.159]}{7} + \frac{[0.115,0.156]}{7} \right) \cdot \left| \frac{[0.101,0.139]}{7} - \frac{7-[0.101,0.139]}{7} \right| \end{aligned} \right) \\
 &= [0.975, 0.976] \\
 G_k(s_2) &= 1 - \frac{1}{4} \left(\begin{aligned} & \left(\frac{[0.101,0.119]}{7} + \frac{[0.110,0.135]}{7} \right) \cdot \left| \frac{[0.115,0.127]}{7} - \frac{7-[0.115,0.127]}{7} \right| \\ & + \left(\frac{[0.110,0.135]}{7} + \frac{[0.055,0.115]}{7} \right) \cdot \left| \frac{[0.146,0.162]}{7} - \frac{7-[0.146,0.162]}{7} \right| \\ & + \left(\frac{[0.123,0.131]}{7} + \frac{[0.123,0.153]}{7} \right) \cdot \left| \frac{[0.105,0.135]}{7} - \frac{7-[0.105,0.135]}{7} \right| \\ & + \left(\frac{[0.055,0.095]}{7} + \frac{[0.139,0.146]}{7} \right) \cdot \left| \frac{[0.078,0.135]}{7} - \frac{7-[0.078,0.135]}{7} \right| \end{aligned} \right) \\
 &= [0.975, 0.994] \\
 G_k(s_3) &= 1 - \frac{1}{4} \left(\begin{aligned} & \left(\frac{[0.078,0.110]}{7} + \frac{[0.146,0.159]}{7} \right) \cdot \left| \frac{[0.110,0.135]}{7} - \frac{7-[0.110,0.135]}{7} \right| \\ & + \left(\frac{[0.071,0.110]}{7} + \frac{[0.142,0.162]}{7} \right) \cdot \left| \frac{[0.055,0.149]}{7} - \frac{7-[0.055,0.149]}{7} \right| \\ & + \left(\frac{[0.055,0.110]}{7} + \frac{[0.101,0.110]}{7} \right) \cdot \left| \frac{[0.110,0.153]}{7} - \frac{7-[0.110,0.153]}{7} \right| \\ & + \left(\frac{[0.078,0.135]}{7} + \frac{[0.055,0.149]}{7} \right) \cdot \left| \frac{[0.078,0.139]}{7} - \frac{7-[0.078,0.139]}{7} \right| \end{aligned} \right) \\
 &= [0.935, 0.982]
 \end{aligned}$$

$$\omega = G_k(s_j) / \sum_{j=1}^n G_k(s_j)$$

$$\begin{aligned}
 \omega_1 &= \frac{[0.957, 0.976]}{[2.883, 2.952]} \\
 &= [0.338, 0.330]
 \end{aligned}$$

$$\begin{aligned}
 \omega_2 &= \frac{[0.973, 0.994]}{[2.883, 2.952]} \\
 &= [0.337, 0.336]
 \end{aligned}$$

$$\begin{aligned}
 \omega_3 &= \frac{[0.935, 0.982]}{[2.883, 2.952]} \\
 &= [0.324, 0.332]
 \end{aligned}$$

Step 4: By the WLNCHM operator, we calculate the comprehensive evaluation value of each alternative as:

$$\begin{aligned}
 U_1 &= ([0.132, 0.182], [0.140, 0.174], [0.127, 0.192], (0.199, 0.189, 0.212)) \\
 U_2 &= ([0.128, 0.186], [0.147, 0.184], [0.141, 0.187], (0.174, 0.207, 0.199)) \\
 U_3 &= ([0.093, 0.153], [0.117, 0.190], [0.147, 0.191], (0.200, 0.195, 0.205)) \\
 U_4 &= ([0.103, 0.121], [0.133, 0.162], [0.152, 0.171], (0.160, 0.181, 0.175))
 \end{aligned}$$

Step 5: We find the values of score function $\varphi(S)$ as:

$$\varphi(S) = \frac{1}{9t} [(4t + \hat{\alpha} - \hat{\beta} - \hat{\gamma}) + (2t + \hat{\alpha} - \hat{\beta} - \hat{\gamma})], \text{ for } \varphi(S) \in [0, 1]$$

$$\begin{aligned} \varphi(S_1) &= \frac{1}{45} [20 + 0.13 + 0.2 - (0.14 + 0.2 + 0.13 + 0.2) \\ &\quad + 10 + 0.2 - (0.2 + 0.21)] \\ &= 654 \end{aligned}$$

$$\begin{aligned} \varphi(S_2) &= \frac{1}{45} [20 + 0.2 + 0.2 - (0.15 + 0.2 + 0.14 + 0.2) \\ &\quad + 10 + 0.2 - (0.2 + 0.2)] \\ &= 0.656 \end{aligned}$$

$$\begin{aligned} \varphi(S_3) &= \frac{1}{45} [20 + 0.1 + 0.2 - (0.12 + 0.2 + 0.15 + 0.2) \\ &\quad + 10 + 0.2 - (0.2 + 0.21)] \\ &= 0.653 \end{aligned}$$

$$\begin{aligned} \varphi(S_4) &= \frac{1}{45} [20 + 0.1 + 0.1 - (0.1 + 0.2 + 0.2 + 0.2) \\ &\quad + 10 + 0.2 - (0.2 + 0.2)] \\ &= 0.657 \end{aligned}$$

Step 6: According to the value of the score function, the ranking of the candidates can be confirmed, i.e., $S_4 \succ S_2 \succ S_1 \succ S_3$, so S_4 is the best alternatives.

Case 2: If the DM gives the information about the attributes and weight and the weight vector is $\hat{w} = (0.1, 0.5, 0.4)$, then the score function $\varphi(S_i)$ ($i = 1, 2, 3, 4$) of Case 2 can be obtained as follows; $\varphi(S_1) = 0.451$, $\varphi(S_2) = 0.435$, $\varphi(S_3) = 0.504$, $\varphi(S_4) = 0.492$. The ranking of these score functions is $S_3 \succ S_4 \succ S_1 \succ S_2$. Thus, due to the diverse weights of attributes, the ranking of Case 2 is different from that of Case 1.

In the MADM method, the attribute weights can return relative values in the decision method. However, due to the issues such as data loss, time pressure and incomplete field knowledge of the DMs, the information about attribute weights is not fully known or completely unknown. Through some methods, we should derive the weight vector of attributes to get possible alternatives. In Case 2, the attribute weights are usually determined based on DMs' opinions or preferences, while Case 1 uses the entropy concepts to determine weight values of attributes to successfully balance the manipulation of subjective factors. Therefore, the entropy of LNCS is applied in the decision process to give each attribute a more objective and reasonable weight.

6.2. Comparison Analysis

From the comparison analysis, one can see that the advanced method is more appropriate for articulating and handling the indeterminate and inconsistent information in linguistic decision making problems to overcome the insufficiency of several linguistic decision making methods in the existing work. In fact, most of the decision making problems based on different linguistic variables in the literature not only express inconsistent and indeterminate linguistic results, but the linguistic method suggested in the study is a generalization of existing linguistic methods and can handle and represent linguistic decision making problems with LNN information. We also see that the advanced method has much more information than the existing method in [26,32,44]. In addition, the literature [26,32,44] is the same as the best and worst and different from our methods. The reason for the difference between the given literature and our method may be the decision thought process.

Some initial information may be missing during the aggregation process. Moreover, the conclusions are different. Different aggregation operators may appear [32], and our methods are consistent with the aggregation operator and receive a different order. However, [32] may have some limitations because of the attributes. The weight vector is given directly, and the positive and negative ideal solutions are absolute. Other than this, the ranking in the literature [26,32,44] is different from the proposed method. The reason for the difference may be uncertainty in LNN membership since the information is inevitably distorted in LIFN. Our method develops the neutrosophic cubic theory and decision making method under a linguistic environment and provides a new way for solving linguistic MAGDM problems with indeterminate and inconsistent information.

7. Conclusions

In this paper, we work out the idea of *LNCNs*, their operational laws and also some properties and define the score, accuracy and certain functions of *LNCNs* for ranking *LNCNs*. Then, we define the LNCHM and WLNCHM operators. After that, we demonstrate the entropy of *LNCNs* and relate it to determine the weights. Next, we develop MAGDM based on WLNCHM operators to solve multi-attribute group decision making problems with *LNCN* information. Finally, we provide an example of the developed method.

References

1. Zadeh, L.A. Fuzzy sets. *Inform. Control* **1965**, *8*, 338–353. [[CrossRef](#)]
2. Atanassov, K.T. Intuitionistic fuzzy sets. *Fuzzy Sets Syst.* **1986**, *20*, 87–96. [[CrossRef](#)]
3. Jun, Y.B.; Kim, C.S.; Yang, K.O. Cubic sets. *Ann. Fuzzy Math. Inform.* **2012**, *4*, 83–98.
4. Akram, M.; Yaqoob, N.; Gulistan, M. Cubic KU-subalgebras. *Int. J. Pure Appl. Math.* **2013**, *89*, 659–665. [[CrossRef](#)]
5. Yaqoob, N.; Mostafa, S.M.; Ansari, M.A. On cubic KU-ideals of KU-algebras. *ISRN Algebra* **2013**, doi10.1155/2013/935905. [[CrossRef](#)]
6. Rashid, S.; Yaqoob, N.; Akram, M.; Gulistan, M. Cubic graphs with application. *Int. J. Anal. Appl.* **2018**, *16*, 733–750.
7. Aslam, M.; Aroob, T.; Yaqoob, N. On cubic Γ -hyperideals in left almost Γ -semihypergroups. *Ann. Fuzzy Math. Inform.* **2013**, *5*, 169–182.
8. Gulistan, M.; Yaqoob, N.; Vougiouklis, T.; Wahab, H.A. Extensions of cubic ideals in weak left almost semihypergroups. *J. Intell. Fuzzy Syst.* **2018**, *34*, 4161–4172. [[CrossRef](#)]
9. Gulistan, M.; Khan, M.; Yaqoob, N.; Shahzad, M. Structural properties of cubic sets in regular LA-semihypergroups. *Fuzzy Inf. Eng.* **2017**, *9*, 93–116. [[CrossRef](#)]
10. Khan, M.; Gulistan, M.; Yaqoob, N.; Hussain, F. General cubic hyperideals of LA-semihypergroups. *Afr. Mat.* **2016**, *27*, 731–751. [[CrossRef](#)]
11. Yaqoob, N.; Gulistan, M.; Leoreanu-Fotea, V.; Hila, K. Cubic hyperideals in LA-semihypergroups. *J. Intell. Fuzzy Syst.* **2018**, *34*, 2707–2721. [[CrossRef](#)]
12. Khan, M.; Jun, Y.B.; Gulistan, M.; Yaqoob, N. The generalized version of Jun's cubic sets in semigroups. *J. Intell. Fuzzy Syst.* **2015**, *28*, 947–960.
13. Khan, M.; Gulistan, M.; Yaqoob, N.; Shabir, M. Neutrosophic cubic (α, β) -ideals in semigroups with application. *J. Intell. Fuzzy Syst.* **2018**, *35*, 2469–2483. [[CrossRef](#)]
14. Ma, X.L.; Zhan, J.; Khan, M.; Gulistan, M.; Yaqoob, N. Generalized cubic relations in Hv-LA-semigroups. *J. Discret. Math. Sci. Cryptogr.* **2018**, *21*, 607–630. [[CrossRef](#)]

15. Gulistan, M.; Khan, M.; Yaqoob, N.; Shahzad, M.; Ashraf, U. Direct product of generalized cubic sets in Hv-LA-semigroups. *Sci. Int.* **2016**, *28*, 767–779.
16. Smarandache, F. *A Unifying Field in Logics: Neutrosophic Logic. Neutrosophy, Neutrosophic Set, Neutrosophic Probability*; American Research Press: Rehoboth, NM, USA, 1999.
17. Smarandache, F. Neutrosophic set, a generalization of the intuitionistic fuzzy set. *Int. J. Pure Appl. Math.* **2005**, *24*, 287–297.
18. Wang, H.; Smarandache, F.; Zhang, Q.Y.; Sunderraman, R. *Single Valued Neutrosophic Sets*; Infinite Study: New Delhi, India, 2010.
19. De, S.K.; Beg, I. Triangular dense fuzzy neutrosophic sets. *Neutrosophic Sets Syst.* **2016**, *13*, 25–38.
20. Gulistan, M.; Khan, A.; Abdullah, A.; Yaqoob, N. Complex neutrosophic subsemigroups and ideals. *Int. J. Anal. Appl.* **2018**, *16*, 97–116.
21. Jun, Y.B.; Smarandache, F.; Kim, C.S. Neutrosophic cubic sets. *New Math. Nat. Comput.* **2017**, *13*, 41–54. [[CrossRef](#)]
22. Jun, Y.B.; Smarandache, F.; Kim, C.S. P-union and P-intersection of neutrosophic cubic sets. *Anal. Univ. Ovidius Constanta* **2017**, *25*, 99–115. [[CrossRef](#)]
23. Gulistan, M.; Yaqoob, N.; Rashid, Z.; Smarandache, F.; Wahab, H. A study on neutrosophic cubic graphs with real life applications in industries. *Symmetry* **2018**, *10*, 203. [[CrossRef](#)]
24. Zhan, J.; Khan, M.; Gulistan, M.; Ali, A. Applications of neutrosophic cubic sets in multi-criteria decision-making. *Int. J. Uncertain. Quantif.* **2017**, *7*, 377–394. [[CrossRef](#)]
25. Hashim, R.M.; Gulistan, M.; Smrandache, F. Applications of neutrosophic bipolar fuzzy sets in HOPE foundation for planning to build a children hospital with different types of similarity measures. *Symmetry* **2018**, *10*, 331. [[CrossRef](#)]
26. Zadeh, L.A. The concept of a linguistic variable and its application to approximate reasoning Part I. *Inf. Sci.* **1975**, *8*, 199–249. [[CrossRef](#)]
27. Herrera, F.; Herrera-Viedma, E.; Verdegay, L. A model of consensus in group decision making under linguistic assessments. *Fuzzy Sets Syst.* **1996**, *79*, 73–87. [[CrossRef](#)]
28. Herrera, F.; Herrera-Viedma, E. linguistic decision analysis: Steps for solving decision problems under linguistic information. *Fuzzy Sets Syst.* **2000**, *115*, 67–82. [[CrossRef](#)]
29. Xu, Z.S. A method based on linguistic aggregation operators for group decision making with linguistic preference relations. *Inf. Sci.* **2004**, *166*, 19–30. [[CrossRef](#)]
30. Chen, Z.C.; Liu, P.H.; Pei, Z. An approach to multiple attribute group decision making based on linguistic intuitionistic fuzzy numbers. *Int. J. Comput. Intell. Syst.* **2015**, *8*, 747–760. [[CrossRef](#)]
31. Zhang, H. Linguistic intuitionistic fuzzy sets and application in MAGDM. *J. Appl. Math.* **2014**. [[CrossRef](#)]
32. Fang, Z.B.; Ye, J. Multiple attribute group decision-making method based on linguistic neutrosophic numbers. *Symmetry* **2017**, *9*, 111. [[CrossRef](#)]
33. Peng, H.G.; Wang, J.Q.; Cheng, P.F. A linguistic intuitionistic multi-criteria decision-making method based on the Frank Heronian mean operator and its application in evaluating coal mine safety. *Int. J. Mach. Learn. Cybern.* **2017**, *9*, 1053–1068. [[CrossRef](#)]
34. Ye, J. Aggregation operators of neutrosophic linguistic numbers for multiple attribute group decision making. *SpringerPlus* **2016**, *5*, 1691. [[CrossRef](#)] [[PubMed](#)]
35. Li, Y.Y.; Zhang, H.; Wang, J.Q. Linguistic neutrosophic sets and their application in multicriteria decision-making problems. *Int. J. Uncertain. Quantif.* **2017**, *7*. [[CrossRef](#)]
36. Hara, T.; Uchiyama, M.; Takahasi, S.E. A refinement of various mean inequalities. *J. Inequal. Appl.* **1998**, *4*, 932025. [[CrossRef](#)]
37. Zadeh, L.A. Fuzzy sets and systems. *Int. J. Gen. Syst.* **1990**, *17*, 129–138. [[CrossRef](#)]
38. De Luca, A.; Termini, S. A definition of a nonprobabilistic entropy in the setting of fuzzy sets theory. *Inf. Control* **1972**, *20*, 301–312. [[CrossRef](#)]
39. Kaufmann, A.; Bonaert, A.P. Introduction to the theory of fuzzy subsets-vol. 1: Fundamental theoretical elements. *IEEE Trans. Syst. Man Cybern.* **1977**, *7*, 495–496. [[CrossRef](#)]
40. Kosoko, B. Fuzzy entropy and conditioning. *Inf. Sci.* **1986**, *40*, 165–174. [[CrossRef](#)]
41. Majumdar, P.; Samanta, S.K. Softness of a soft set: Soft set entropy. *Ann. Fuzzy Math. Inf.* **2013**, *6*, 59–68.
42. Szmjdt, E.; Kacprzyk, J. Entropy for intuitionistic fuzzy sets. *Fuzzy Sets Syst.* **2001**, *118*, 467–477. [[CrossRef](#)]

43. Yager, R.R. On the measure of fuzziness and negation, Part I: Membership in the unit interval. *Int. J. Gen. Syst.* **1979**, *5*, 189–200. [[CrossRef](#)]
44. Ye, J. An extended TOPSIS method for multiple attribute group decision making based on single valued neutrosophic linguistic numbers. *J. Intell. Fuzzy Syst.* **2015**, *28*, 247–255.
45. Patrascu, V. The neutrosophic entropy and its five components. *Neutrosophic Sets. Syst.* **2015**, *7*, 40–46.
46. Liu, P.; You, X. Some linguistic neutrosophic Hamy mean operators and their application to multi-attribute group decision making. *PLoS ONE* **2018**, *13*, e0193027. [[CrossRef](#)] [[PubMed](#)]
47. Ye, J. Linguistic neutrosophic cubic numbers and their multiple attribute decision-making method. *Information* **2017**, *8*, 110. [[CrossRef](#)]

An Application of Complex Neutrosophic Sets to The Theory of Groups

Muhammad Gulistan, Florentin Smarandache, Amir Abdullah

Muhammad Gulistan, Florentin Smarandache, Amir Abdullah (2018). An Application of Complex Neutrosophic Sets to The Theory of Groups. *International Journal of Algebra and Statistics* 7: 1-2, 94–112; DOI :10.20454/ijas.2018.1455

Abstract. In this article we introduce the concept of complex neutrosophic subgroups (normal subgroups). We define the notion of alpha-cut of complex neutrosophic set, give examples and study some of its related results. We also define the Cartesian product of complex neutrosophic subgroups. Furthermore, we introduce the concept of image and preimage of complex neutrosophic set and prove some of its properties.

Keywords. Complex fuzzy sets; Complex neutrosophic sets; Neutrosophic subgroups; Complex neutrosophic subgroups; Complex neutrosophic normal subgroups.

1. Introduction

[1], In 1965, Zadeh presented the idea of a fuzzy set. [2], Atanassov's in 1986, initiated the notion of intuitionistic fuzzy set which is the generalization of a fuzzy set. Neutrosophic set was first proposed by Smarandache in 1999 [5], which is the generalization of fuzzy set and intuitionistic fuzzy set. Neutrosophic set is characterized by a truth membership function, an indeterminacy membership function and a falsity membership function. In 2002, the Ramot et al. [8], generalized the concept of fuzzy set and introduced the notion of complex fuzzy set. There are many researchers which have worked on complex fuzzy set for instance, Buckley [6], Nguyen et al. [7] and Zhang et al. [9]. In contrast, Ramot et al. [8] presented an innovative concept that is totally different from other researchers, in which the author extended the range of membership function to the unit circle in the complex plane, unlike the others who limited to. Furthermore to solve enigma they also added an extra term which is called phase term in translating human language to complex valued functions on physical terms and vice versa. Abd Uazeez et al. in 2012 [10], added the non-membership term to the idea of complex fuzzy set which is known as complex intuitionistic fuzzy sets, the range of values are extended to the unit circle in complex plan for both membership and non-membership functions instead of $[0, 1]$. In 2016, Mumtaz Ali et al. [12], extended the concept of complex fuzzy set, complex intuitionistic fuzzy set, and introduced the concept of complex neutrosophic sets which is a collection of complex-valued truth membership function, complex-valued indeterminacy membership function and complex-valued falsity membership function. Further in 1971, Rosenfeld [3], applied the concept of fuzzy set to groups and introduced the concept of fuzzy groups. The author defined fuzzy subgroups and studied some of its related properties. Vildan and Halis in 2017 [13], extended the concept of fuzzy subgroups on the base of neutrosophic sets and initiated the notion of neutrosophic subgroups.

Due to the motivation and inspiration of the above discussion. In this paper we introduce the concept of a complex neutrosophic subgroups (normal subgroups). We have give examples and study some related results. We also study the concept of Cartesian product of complex neutrosophic subgroups, image and preimage of complex neutrosophic set and alpha-cut of complex neutrosophic set with the help of examples and prove some of its properties.

2. Preliminaries

Here in this part we gathered some basic helping materials.

Definition 2.1. [1] A function f is defined from a universe X to a closed interval $[0, 1]$ is called a fuzzy set, i.e., a mapping:

$$f : X \longrightarrow [0, 1].$$

Definition 2.2. [8] A complex fuzzy set (CFS) \mathbb{C} over the universe X , is defined an object of the form:

$$\mathbb{C} = \{(x, \mu_{\mathbb{C}}(x)) : x \in X\}$$

where $\mu_{\mathbb{C}}(x) = r_{\mathbb{C}}(x) \cdot e^{i\omega_{\mathbb{C}}(x)}$, here the amplitude term $r_{\mathbb{C}}(x)$ and phase term $\omega_{\mathbb{C}}(x)$, are real valued functions, for every $x \in X$, the amplitude term $\mu_{\mathbb{C}}(x) : X \rightarrow [0, 1]$ and phase term $\omega_{\mathbb{C}}(x)$ lying in the interval $[0, 2\pi]$.

Definition 2.3. [11] Let \mathbb{C}_1 and \mathbb{C}_2 be any two complex Atanassov's intuitionistic fuzzy sets (CAIFSs) over the universe X , where

$$\mathbb{C}_1 = \left\{ \left\langle x, r_{\mathbb{C}_1}(x) \cdot e^{iv_{\mathbb{C}_1}(x)}, k_{\mathbb{C}_1}(x) \cdot e^{i\omega_{\mathbb{C}_1}(x)} \right\rangle : x \in X \right\}$$

and

$$\mathbb{C}_2 = \left\{ \left\langle x, r_{\mathbb{C}_2}(x) \cdot e^{iv_{\mathbb{C}_2}(x)}, k_{\mathbb{C}_2}(x) \cdot e^{i\omega_{\mathbb{C}_2}(x)} \right\rangle : x \in X \right\}.$$

Then

1. Containment:

$$\mathbb{C}_1 \subseteq \mathbb{C}_2 \Leftrightarrow r_{\mathbb{C}_1}(x) \leq r_{\mathbb{C}_2}(x), k_{\mathbb{C}_1}(x) \geq k_{\mathbb{C}_2}(x) \text{ and } v_{\mathbb{C}_1}(x) \leq v_{\mathbb{C}_2}(x), \omega_{\mathbb{C}_1}(x) \geq \omega_{\mathbb{C}_2}(x).$$

2. Equal:

$$\mathbb{C}_1 = \mathbb{C}_2 \Leftrightarrow r_{\mathbb{C}_1}(x) = r_{\mathbb{C}_2}(x), k_{\mathbb{C}_1}(x) = k_{\mathbb{C}_2}(x) \text{ and } v_{\mathbb{C}_1}(x) = v_{\mathbb{C}_2}(x), \omega_{\mathbb{C}_1}(x) = \omega_{\mathbb{C}_2}(x).$$

Definition 2.4. [12] Let X be a universe of discourse, and $x \in X$. A complex neutrosophic set (CNS) \mathbb{C} in X is characterized by a complex truth membership function $\mathbb{C}_T(x) = p_{\mathbb{C}}(x) \cdot e^{i\mu_{\mathbb{C}}(x)}$, a complex indeterminacy membership function $\mathbb{C}_I(x) = q_{\mathbb{C}}(x) \cdot e^{iv_{\mathbb{C}}(x)}$ and a complex falsity membership function $\mathbb{C}_F(x) = r_{\mathbb{C}}(x) \cdot e^{i\omega_{\mathbb{C}}(x)}$. The values $\mathbb{C}_T(x), \mathbb{C}_I(x), \mathbb{C}_F(x)$ may lies all within the unit circle in the complex plane, where $p_{\mathbb{C}}(x), q_{\mathbb{C}}(x), r_{\mathbb{C}}(x)$ and $\mu_{\mathbb{C}}(x), v_{\mathbb{C}}(x), \omega_{\mathbb{C}}(x)$ are amplitude terms and phase terms, respectively, and where $p_{\mathbb{C}}(x), q_{\mathbb{C}}(x), r_{\mathbb{C}}(x) \in [0, 1]$, such that, $0 \leq p_{\mathbb{C}}(x) + q_{\mathbb{C}}(x) + r_{\mathbb{C}}(x) \leq 3$ and $\mu_{\mathbb{C}}(x), v_{\mathbb{C}}(x), \omega_{\mathbb{C}}(x) \in [0, 2\pi]$.

The complex neutrosophic set can be represented in the form as:

$$\mathbb{C} = \left\{ \left\langle x, \mathbb{C}_T(x) = p_{\mathbb{C}}(x) \cdot e^{i\mu_{\mathbb{C}}(x)}, \mathbb{C}_I(x) = q_{\mathbb{C}}(x) \cdot e^{iv_{\mathbb{C}}(x)}, \mathbb{C}_F(x) = r_{\mathbb{C}}(x) \cdot e^{i\omega_{\mathbb{C}}(x)} \right\rangle : x \in X \right\}.$$

Example 2.5. Let $X = \{x_1, x_2, x_3\}$ be the universe set and \mathbb{C} be a complex neutrosophic set which is given by:

$$\mathbb{C} = \left\{ \left\langle x_1, 0.2e^{0.5\pi i}, 0.3e^{0.6\pi i}, 0.4e^{0.8\pi i} \right\rangle, \left\langle x_2, 0.4e^{0.6\pi i}, 0.5e^{1.3\pi i}, 0.1e^{0.6\pi i} \right\rangle, \left\langle x_3, 0.1e^{0.6\pi i}, 0.3e^{0.9\pi i}, 0.9e^{0.7\pi i} \right\rangle \right\}.$$

Definition 2.6. [3] Let \mathcal{G} be any group with multiplication and \mathcal{F} be a fuzzy subset of a group \mathcal{G} , then \mathcal{F} is called a fuzzy subgroup (FSG) of \mathcal{G} , if the following axioms are hold:

$$(FSG1): \mathcal{F}(x \cdot y) \geq \min\{\mathcal{F}(x), \mathcal{F}(y)\}.$$

$$(FSG2): \mathcal{F}(x^{-1}) \geq \mathcal{F}(x), \forall x, y \in \mathcal{G}.$$

Definition 2.7. [13] Let \mathcal{G} be any group with multiplication and \mathcal{N} be a neutrosophic set on a group \mathcal{G} . Then \mathcal{N} is called a neutrosophic subgroup (NSG) of \mathcal{G} , if its satisfy the following conditions:

$$(NSG1): \mathcal{N}(x \cdot y) \geq \mathcal{N}(x) \wedge \mathcal{N}(y), \text{ i.e.,}$$

$$T_{\mathcal{N}}(x \cdot y) \geq T_{\mathcal{N}}(x) \wedge T_{\mathcal{N}}(y), I_{\mathcal{N}}(x \cdot y) \geq I_{\mathcal{N}}(x) \wedge I_{\mathcal{N}}(y) \text{ and } F_{\mathcal{N}}(x \cdot y) \leq F_{\mathcal{N}}(x) \vee F_{\mathcal{N}}(y).$$

$$(NSG2): \mathcal{N}(x^{-1}) \geq \mathcal{N}(x), \text{ i.e.,}$$

$$T_{\mathcal{N}}(x^{-1}) \geq T_{\mathcal{N}}(x), I_{\mathcal{N}}(x^{-1}) \geq I_{\mathcal{N}}(x) \text{ and } F_{\mathcal{N}}(x^{-1}) \leq F_{\mathcal{N}}(x), \text{ for all } x \text{ and } y \text{ in } \mathcal{G}.$$

3. Complex Neutrosophic Subgroup

Note: It should be noted that through out in this section we use a capital letter \mathbb{C} to denote a complex neutrosophic set:

$$\mathbb{C} = \left\{ \left\langle T_{\mathbb{C}} = p_{\mathbb{C}} \cdot e^{i\mu_{\mathbb{C}}}, I_{\mathbb{C}} = q_{\mathbb{C}} \cdot e^{i\nu_{\mathbb{C}}}, F_{\mathbb{C}} = r_{\mathbb{C}} \cdot e^{i\omega_{\mathbb{C}}} \right\rangle \right\}.$$

Definition 3.1. A complex neutrosophic set $\mathbb{C} = \left\{ \left\langle T_{\mathbb{C}} = p_{\mathbb{C}} \cdot e^{i\mu_{\mathbb{C}}}, I_{\mathbb{C}} = q_{\mathbb{C}} \cdot e^{i\nu_{\mathbb{C}}}, F_{\mathbb{C}} = r_{\mathbb{C}} \cdot e^{i\omega_{\mathbb{C}}} \right\rangle \right\}$ on a group (\mathcal{G}, \cdot) is known as a complex neutrosophic subgroup (CNSG) of \mathcal{G} , if for all elements $x, y \in \mathcal{G}$, the following conditions are satisfied:

$$(CNSG1): \mathbb{C}(xy) \geq \min\{\mathbb{C}(x), \mathbb{C}(y)\} \text{ i.e.,}$$

$$(i) p_{\mathbb{C}}(xy) \cdot e^{i\mu_{\mathbb{C}}(xy)} \geq \min\{p_{\mathbb{C}}(x) \cdot e^{i\mu_{\mathbb{C}}(x)}, p_{\mathbb{C}}(y) \cdot e^{i\mu_{\mathbb{C}}(y)}\}$$

$$(ii) q_{\mathbb{C}}(xy) \cdot e^{i\nu_{\mathbb{C}}(xy)} \geq \min\{q_{\mathbb{C}}(x) \cdot e^{i\nu_{\mathbb{C}}(x)}, q_{\mathbb{C}}(y) \cdot e^{i\nu_{\mathbb{C}}(y)}\}$$

$$(iii) r_{\mathbb{C}}(xy) \cdot e^{i\omega_{\mathbb{C}}(xy)} \leq \max\{r_{\mathbb{C}}(x) \cdot e^{i\omega_{\mathbb{C}}(x)}, r_{\mathbb{C}}(y) \cdot e^{i\omega_{\mathbb{C}}(y)}\}$$

$$(CNSG2): \mathbb{C}(x^{-1}) \geq \mathbb{C}(x) \text{ i.e.,}$$

$$(iv) p_{\mathbb{C}}(x^{-1}) \cdot e^{i\mu_{\mathbb{C}}(x^{-1})} \geq p_{\mathbb{C}}(x) \cdot e^{i\mu_{\mathbb{C}}(x)}$$

$$(v) q_{\mathbb{C}}(x^{-1}) \cdot e^{i\nu_{\mathbb{C}}(x^{-1})} \geq q_{\mathbb{C}}(x) \cdot e^{i\nu_{\mathbb{C}}(x)}$$

$$(vi) r_{\mathbb{C}}(x^{-1}) \cdot e^{i\omega_{\mathbb{C}}(x^{-1})} \leq r_{\mathbb{C}}(x) \cdot e^{i\omega_{\mathbb{C}}(x)}.$$

Example 3.2. Let $\mathcal{G} = \{1, -1, i, -i\}$ be a group under multiplication, and

$$\mathbb{C} = \left\{ \left\langle 1, 0.7e^{0.6\pi i}, 0.6e^{0.5\pi i}, 0.5e^{0.2\pi i} \right\rangle, \left\langle -1, 0.6e^{0.5\pi i}, 0.5e^{0.4\pi i}, 0.4e^{0.2\pi i} \right\rangle, \right. \\ \left. \left\langle i, 0.5e^{0.3\pi i}, 0.4e^{0.2\pi i}, 0.1e^{0.2\pi i} \right\rangle, \left\langle -i, 0.5e^{0.3\pi i}, 0.4e^{0.2\pi i}, 0.1e^{0.2\pi i} \right\rangle \right\}$$

be a complex neutrosophic set on \mathcal{G} . Clearly \mathbb{C} is a complex neutrosophic subgroup of \mathcal{G} .

3.1. Cartesian Product of Complex Neutrosophic Subgroups

Definition 3.3. Let $\mathbf{C}_1 = \langle \mathbf{C}_{1T}(x), \mathbf{C}_{1I}(x), \mathbf{C}_{1F}(x) \rangle$ and $\mathbf{C}_2 = \langle \mathbf{C}_{2T}(x), \mathbf{C}_{2I}(x), \mathbf{C}_{2F}(x) \rangle$ be any two complex neutrosophic subgroups of the groups \mathcal{G}_1 and \mathcal{G}_2 , respectively. Then the Cartesian product of \mathbf{C}_1 and \mathbf{C}_2 , represented by $\mathbf{C}_1 \times \mathbf{C}_2$ and define as:

$$\mathbf{C}_1 \times \mathbf{C}_2 = \left\{ \begin{array}{l} \langle (x, y), (\mathbf{C}_1 \times \mathbf{C}_2)_T(x, y), (\mathbf{C}_1 \times \mathbf{C}_2)_I(x, y), (\mathbf{C}_1 \times \mathbf{C}_2)_F(x, y) \rangle \\ / \forall x \in \mathcal{G}_1, y \in \mathcal{G}_2 \end{array} \right\}$$

where

$$(\mathbf{C}_1 \times \mathbf{C}_2)_T(x, y) = \min \{ \mathbf{C}_{1T}(x), \mathbf{C}_{2T}(y) \},$$

$$(\mathbf{C}_1 \times \mathbf{C}_2)_I(x, y) = \min \{ \mathbf{C}_{1I}(x), \mathbf{C}_{2I}(y) \},$$

$$(\mathbf{C}_1 \times \mathbf{C}_2)_F(x, y) = \max \{ \mathbf{C}_{1F}(x), \mathbf{C}_{2F}(y) \}.$$

Example 3.4. Let $\mathcal{G}_1 = \{1, -1, i, -i\}$ and $\mathcal{G}_2 = \{1, \omega, \omega^2\}$ are two groups under multiplication.

Consider,

$$\mathbf{C}_1 = \left\{ \begin{array}{l} \langle 1, 0.7e^{0.6\pi i}, 0.6e^{0.5\pi i}, 0.5e^{0.2\pi i} \rangle, \langle -1, 0.6e^{0.5\pi i}, 0.5e^{0.4\pi i}, 0.4e^{0.2\pi i} \rangle, \\ \langle i, 0.5e^{0.3\pi i}, 0.4e^{0.2\pi i}, 0.1e^{0.2\pi i} \rangle, \langle -i, 0.5e^{0.3\pi i}, 0.4e^{0.2\pi i}, 0.1e^{0.2\pi i} \rangle \end{array} \right\}$$

and

$$\mathbf{C}_2 = \left\{ \begin{array}{l} \langle 1, 0.8e^{0.6\pi i}, 0.6e^{0.5\pi i}, 0.3e^{0.2\pi i} \rangle, \langle \omega, 0.7e^{0.6\pi i}, 0.5e^{0.4\pi i}, 0.3e^{0.2\pi i} \rangle, \\ \langle \omega^2, 0.7e^{0.6\pi i}, 0.5e^{0.4\pi i}, 0.3e^{0.2\pi i} \rangle \end{array} \right\}$$

are two complex neutrosophic subgroups of \mathcal{G}_1 and \mathcal{G}_2 , respectively.

Now let $x = 1$ and $y = \omega$, then

$$\begin{aligned} \mathbf{C}_1 \times \mathbf{C}_2 &= \{ \langle (\mathbf{C}_1 \times \mathbf{C}_2)_T(1, \omega), (\mathbf{C}_1 \times \mathbf{C}_2)_I(1, \omega), (\mathbf{C}_1 \times \mathbf{C}_2)_F(1, \omega) \rangle, \dots \} \\ &= \{ \langle \min \{ \mathbf{C}_{1T}(1), \mathbf{C}_{2T}(\omega) \}, \min \{ \mathbf{C}_{1I}(1), \mathbf{C}_{2I}(\omega) \}, \max \{ \mathbf{C}_{1F}(1), \mathbf{C}_{2F}(\omega) \} \rangle, \dots \} \\ &= \{ \langle \min \{ 0.7e^{0.6\pi i}, 0.7e^{0.6\pi i} \}, \min \{ 0.6e^{0.5\pi i}, 0.5e^{0.4\pi i} \}, \max \{ 0.5e^{0.2\pi i}, 0.3e^{0.2\pi i} \} \rangle, \dots \} \\ &= \{ \langle 0.7e^{0.6\pi i}, 0.5e^{0.4\pi i}, 0.5e^{0.2\pi i} \rangle, \dots \}. \end{aligned}$$

Theorem 3.5. If \mathbf{C}_1 and \mathbf{C}_2 are any two complex neutrosophic subgroups of the groups \mathcal{G}_1 and \mathcal{G}_2 respectively, then $\mathbf{C}_1 \times \mathbf{C}_2$ is a complex neutrosophic subgroup of $\mathcal{G}_1 \times \mathcal{G}_2$.

Proof: Assume that $\mathbf{C}_1 = \langle \mathbf{C}_{1T}, \mathbf{C}_{1I}, \mathbf{C}_{1F} \rangle$ and $\mathbf{C}_2 = \langle \mathbf{C}_{2T}, \mathbf{C}_{2I}, \mathbf{C}_{2F} \rangle$ be any two complex neutrosophic subgroups of the groups \mathcal{G}_1 and \mathcal{G}_2 , respectively. Let any arbitrary elements $x_1, x_2 \in \mathcal{G}_1$ and $y_1, y_2 \in \mathcal{G}_2$, then $(x_1, y_1), (x_2, y_2) \in \mathcal{G}_1 \times \mathcal{G}_2$.

Consider,

$$\begin{aligned} (\mathbf{C}_1 \times \mathbf{C}_2)_T((x_1, y_1), (x_2, y_2)) &= (\mathbf{C}_1 \times \mathbf{C}_2)_T(x_1x_2, y_1y_2) \\ &= \min \{ \mathbf{C}_{1T}(x_1x_2), \mathbf{C}_{2T}(y_1y_2) \} \\ &\geq \mathbf{C}_{1T}(x_1) \wedge \mathbf{C}_{1T}(x_2) \wedge \mathbf{C}_{2T}(y_1) \wedge \mathbf{C}_{2T}(y_2) \\ &= \mathbf{C}_{1T}(x_1) \wedge \mathbf{C}_{2T}(y_1) \wedge \mathbf{C}_{1T}(x_2) \wedge \mathbf{C}_{2T}(y_2) \\ &= (\mathbf{C}_1 \times \mathbf{C}_2)_T(x_1, y_1) \wedge (\mathbf{C}_1 \times \mathbf{C}_2)_T(x_2, y_2). \end{aligned}$$

Similarly,

$$(\mathbf{C}_1 \times \mathbf{C}_2)_I((x_1, y_1), (x_2, y_2)) \geq (\mathbf{C}_1 \times \mathbf{C}_2)_I(x_1, y_1) \wedge (\mathbf{C}_1 \times \mathbf{C}_2)_I(x_2, y_2),$$

and

$$\begin{aligned} (\mathbf{C}_1 \times \mathbf{C}_2)_F((x_1, y_1), (x_2, y_2)) &= (\mathbf{C}_1 \times \mathbf{C}_2)_F(x_1 x_2, y_1 y_2) \\ &= \max\{\mathbf{C}_{1F}(x_1 x_2), \mathbf{C}_{2F}(y_1 y_2)\} \\ &\leq \mathbf{C}_{1F}(x_1) \vee \mathbf{C}_{1F}(x_2) \vee \mathbf{C}_{2F}(y_1) \vee \mathbf{C}_{2F}(y_2) \\ &= \mathbf{C}_{1F}(x_1) \vee \mathbf{C}_{2F}(y_1) \vee \mathbf{C}_{1F}(x_2) \vee \mathbf{C}_{2F}(y_2) \\ &= (\mathbf{C}_1 \times \mathbf{C}_2)_F(x_1, y_1) \vee (\mathbf{C}_1 \times \mathbf{C}_2)_F(x_2, y_2). \end{aligned}$$

Also,

$$\begin{aligned} (\mathbf{C}_1 \times \mathbf{C}_2)_T(x_1, y_1)^{-1} &= (\mathbf{C}_1 \times \mathbf{C}_2)_T(x_1^{-1}, y_1^{-1}) \\ &= \mathbf{C}_{1T}(x_1^{-1}) \wedge \mathbf{C}_{2T}(y_1^{-1}) \\ &\geq \mathbf{C}_{1T}(x) \wedge \mathbf{C}_{2T}(y) \\ &= (\mathbf{C}_1 \times \mathbf{C}_2)_T(x, y). \end{aligned}$$

Similarly,

$$(\mathbf{C}_1 \times \mathbf{C}_2)_I(x_1, y_1)^{-1} \geq (\mathbf{C}_1 \times \mathbf{C}_2)_I(x, y).$$

And

$$\begin{aligned} (\mathbf{C}_1 \times \mathbf{C}_2)_F(x_1, y_1)^{-1} &= (\mathbf{C}_1 \times \mathbf{C}_2)_F(x_1^{-1}, y_1^{-1}) \\ &= \mathbf{C}_{1F}(x_1^{-1}) \vee \mathbf{C}_{2F}(y_1^{-1}) \\ &\leq \mathbf{C}_{1F}(x) \vee \mathbf{C}_{2F}(y) \\ &= (\mathbf{C}_1 \times \mathbf{C}_2)_F(x, y). \end{aligned}$$

Hence $\mathbf{C}_1 \times \mathbf{C}_2$ is a complex neutrosophic subgroup of $\mathcal{G}_1 \times \mathcal{G}_2$. \square

Theorem 3.6. Let \mathbf{C} be a CNSG of a group \mathcal{G} . Then the following properties are satisfied:

- (a) $\mathbf{C}(\hat{e}) \cdot e^{i\mathbf{C}(\hat{e})} \geq \mathbf{C}(x) \cdot e^{i\mathbf{C}(x)} \forall x \in \mathcal{G}$, where \hat{e} is the unit element of \mathcal{G} .
- (b) $\mathbf{C}(x^{-1}) \cdot e^{i\mathbf{C}(x^{-1})} = \mathbf{C}(x) \cdot e^{i\mathbf{C}(x)}$ for each $x \in \mathcal{G}$.

Proof: (a) Let \hat{e} be the unit element of \mathcal{G} and $x \in \mathcal{G}$ be arbitrary element, then by (CNSG1), (CNSG2) of Definition 3.1,

$$\begin{aligned} p_{\mathbf{C}}(\hat{e}) \cdot e^{i\mu_{\mathbf{C}}(\hat{e})} &= p_{\mathbf{C}}(x \cdot x^{-1}) \cdot e^{i\mu_{\mathbf{C}}(x \cdot x^{-1})} \\ &\geq p_{\mathbf{C}}(x) \cdot e^{i\mu_{\mathbf{C}}(x)} \wedge p_{\mathbf{C}}(x^{-1}) \cdot e^{i\mu_{\mathbf{C}}(x^{-1})} \\ &= p_{\mathbf{C}}(x) \cdot e^{i\mu_{\mathbf{C}}(x)} \wedge p_{\mathbf{C}}(x) \cdot e^{i\mu_{\mathbf{C}}(x)} \\ &= p_{\mathbf{C}}(x) \cdot e^{i\mu_{\mathbf{C}}(x)} \\ p_{\mathbf{C}}(\hat{e}) \cdot e^{i\mu_{\mathbf{C}}(\hat{e})} &\geq p_{\mathbf{C}}(x) \cdot e^{i\mu_{\mathbf{C}}(x)}, \end{aligned}$$

Similarly,

$$q_{\mathbf{C}}(\hat{e}) \cdot e^{i\nu_{\mathbf{C}}(\hat{e})} \geq q_{\mathbf{C}}(x) \cdot e^{i\nu_{\mathbf{C}}(x)}.$$

And

$$\begin{aligned} r_{\mathbb{C}}(\hat{e}) \cdot e^{i\omega_{\mathbb{C}}(\hat{e})} &= r_{\mathbb{C}}(x \cdot x^{-1}) \cdot e^{i\omega_{\mathbb{C}}(x \cdot x^{-1})} \\ &\leq r_{\mathbb{C}}(x) \cdot e^{i\omega_{\mathbb{C}}(x)} \vee r_{\mathbb{C}}(x^{-1}) \cdot e^{i\omega_{\mathbb{C}}(x^{-1})} \\ &= r_{\mathbb{C}}(x) \cdot e^{i\omega_{\mathbb{C}}(x)} \vee r_{\mathbb{C}}(x) \cdot e^{i\omega_{\mathbb{C}}(x)} \\ &= r_{\mathbb{C}}(x) \cdot e^{i\omega_{\mathbb{C}}(x)} \\ r_{\mathbb{C}}(\hat{e}) \cdot e^{i\omega_{\mathbb{C}}(\hat{e})} &\leq r_{\mathbb{C}}(x) \cdot e^{i\omega_{\mathbb{C}}(x)}. \end{aligned}$$

Hence $\mathbb{C}(\hat{e}) \cdot e^{i\mathbb{C}(\hat{e})} \geq \mathbb{C}(x) \cdot e^{i\mathbb{C}(x)}$ is satisfied, for all $x \in \mathcal{G}$.

(b) Let $x \in \mathcal{G}$. Since \mathbb{C} is a complex neutrosophic subgroup of \mathcal{G} ,

so $\mathbb{C}(x^{-1}) \cdot e^{i\mathbb{C}(x^{-1})} \geq \mathbb{C}(x) \cdot e^{i\mathbb{C}(x)}$ is clear from (CNSG2) of Definition 3.1.

Again by applying (CNSG2) of Definition 3.1, and using group structure of \mathcal{G} , the other side of the inequality is proved as follows;

$$\begin{aligned} p_{\mathbb{C}}(x) \cdot e^{i\mu_{\mathbb{C}}(x)} &= p_{\mathbb{C}}(x^{-1})^{-1} \cdot e^{i\mu_{\mathbb{C}}(x^{-1})^{-1}} \geq p_{\mathbb{C}}(x^{-1}) \cdot e^{i\mu_{\mathbb{C}}(x^{-1})}, \\ q_{\mathbb{C}}(x) \cdot e^{i\nu_{\mathbb{C}}(x)} &= q_{\mathbb{C}}(x^{-1})^{-1} \cdot e^{i\nu_{\mathbb{C}}(x^{-1})^{-1}} \geq q_{\mathbb{C}}(x^{-1}) \cdot e^{i\nu_{\mathbb{C}}(x^{-1})}, \\ r_{\mathbb{C}}(x) \cdot e^{i\omega_{\mathbb{C}}(x)} &= r_{\mathbb{C}}(x^{-1})^{-1} \cdot e^{i\omega_{\mathbb{C}}(x^{-1})^{-1}} \leq r_{\mathbb{C}}(x^{-1}) \cdot e^{i\omega_{\mathbb{C}}(x^{-1})}. \end{aligned}$$

Therefore,

$$\mathbb{C}(x) \cdot e^{i\mathbb{C}(x)} \geq \mathbb{C}(x^{-1}) \cdot e^{i\mathbb{C}(x^{-1})}.$$

Thus,

$$\mathbb{C}(x^{-1}) \cdot e^{i\mathbb{C}(x^{-1})} = \mathbb{C}(x) \cdot e^{i\mathbb{C}(x)}.$$

Hence $\mathbb{C}(x^{-1}) \cdot e^{i\mathbb{C}(x^{-1})} = \mathbb{C}(x) \cdot e^{i\mathbb{C}(x)}$ is satisfied, for all $x \in \mathcal{G}$. \square

Theorem 3.7. Let \mathbb{C} be a complex neutrosophic set on a group \mathcal{G} . Then \mathbb{C} is a CNSG of \mathcal{G} if and only if $\mathbb{C}(x \cdot y^{-1}) \cdot e^{i\mathbb{C}(x \cdot y^{-1})} \geq \mathbb{C}(x) \cdot e^{i\mathbb{C}(x)} \wedge \mathbb{C}(y) \cdot e^{i\mathbb{C}(y)}$ for each $x, y \in \mathcal{G}$.

Proof: Let \mathbb{C} be a complex neutrosophic subgroup of \mathcal{G} and $x, y \in \mathcal{G}$, So, it is clear that,

$$\begin{aligned} p_{\mathbb{C}}(xy^{-1}) \cdot e^{i\mu_{\mathbb{C}}(xy^{-1})} &\geq p_{\mathbb{C}}(x) \cdot e^{i\mu_{\mathbb{C}}(x)} \wedge p_{\mathbb{C}}(y^{-1}) \cdot e^{i\mu_{\mathbb{C}}(y^{-1})} \\ &\geq p_{\mathbb{C}}(x) \cdot e^{i\mu_{\mathbb{C}}(x)} \wedge p_{\mathbb{C}}(y) \cdot e^{i\mu_{\mathbb{C}}(y)}. \end{aligned}$$

Similarly,

$$q_{\mathbb{C}}(xy^{-1}) \cdot e^{i\nu_{\mathbb{C}}(xy^{-1})} \geq q_{\mathbb{C}}(x) \cdot e^{i\nu_{\mathbb{C}}(x)} \wedge q_{\mathbb{C}}(y) \cdot e^{i\nu_{\mathbb{C}}(y)}.$$

And

$$\begin{aligned} r_{\mathbb{C}}(xy^{-1}) \cdot e^{i\omega_{\mathbb{C}}(xy^{-1})} &\leq r_{\mathbb{C}}(x) \cdot e^{i\omega_{\mathbb{C}}(x)} \vee r_{\mathbb{C}}(y^{-1}) \cdot e^{i\omega_{\mathbb{C}}(y^{-1})} \\ &\leq r_{\mathbb{C}}(x) \cdot e^{i\omega_{\mathbb{C}}(x)} \vee r_{\mathbb{C}}(y) \cdot e^{i\omega_{\mathbb{C}}(y)}. \end{aligned}$$

Hence

$$\begin{aligned}
 \mathbb{C}(x \cdot y^{-1}) \cdot e^{i\mathbb{C}(x \cdot y^{-1})} &= (p_{\mathbb{C}}(xy^{-1}) \cdot e^{i\mu_{\mathbb{C}}(xy^{-1})}, q_{\mathbb{C}}(xy^{-1}) \cdot e^{i\nu_{\mathbb{C}}(xy^{-1})}, \\
 &\quad r_{\mathbb{C}}(xy^{-1}) \cdot e^{i\omega_{\mathbb{C}}(xy^{-1})}) \\
 &\geq (p_{\mathbb{C}}(x) \cdot e^{i\mu_{\mathbb{C}}(x)} \wedge p_{\mathbb{C}}(y) \cdot e^{i\mu_{\mathbb{C}}(y)}, q_{\mathbb{C}}(x) \cdot e^{i\nu_{\mathbb{C}}(x)} \\
 &\quad \wedge q_{\mathbb{C}}(y) \cdot e^{i\nu_{\mathbb{C}}(y)}, r_{\mathbb{C}}(x) \cdot e^{i\omega_{\mathbb{C}}(x)} \vee r_{\mathbb{C}}(y) \cdot e^{i\omega_{\mathbb{C}}(y)}) \\
 &= (p_{\mathbb{C}}(x) \cdot e^{i\mu_{\mathbb{C}}(x)}, q_{\mathbb{C}}(x) \cdot e^{i\nu_{\mathbb{C}}(x)}, r_{\mathbb{C}}(x) \cdot e^{i\omega_{\mathbb{C}}(x)}) \\
 &\quad \wedge (p_{\mathbb{C}}(y) \cdot e^{i\mu_{\mathbb{C}}(y)}, q_{\mathbb{C}}(y) \cdot e^{i\nu_{\mathbb{C}}(y)}, r_{\mathbb{C}}(y) \cdot e^{i\omega_{\mathbb{C}}(y)}) \\
 &= \mathbb{C}(x) \cdot e^{i\mathbb{C}(x)} \wedge \mathbb{C}(y) \cdot e^{i\mathbb{C}(y)}.
 \end{aligned}$$

Thus,

$$\mathbb{C}(x \cdot y^{-1}) \cdot e^{i\mathbb{C}(x \cdot y^{-1})} \geq \mathbb{C}(x) \cdot e^{i\mathbb{C}(x)} \wedge \mathbb{C}(y) \cdot e^{i\mathbb{C}(y)}.$$

Conversely, Suppose the condition

$$\mathbb{C}(x \cdot y^{-1}) \cdot e^{i\mathbb{C}(x \cdot y^{-1})} \geq \mathbb{C}(x) \cdot e^{i\mathbb{C}(x)} \wedge \mathbb{C}(y) \cdot e^{i\mathbb{C}(y)}$$

is hold.

Let \hat{e} be the unit of \mathcal{G} , since \mathcal{G} is a group,

$$\begin{aligned}
 p_{\mathbb{C}}(x^{-1}) \cdot e^{i\mu_{\mathbb{C}}(x^{-1})} &= p_{\mathbb{C}}(\hat{e} \cdot x^{-1}) \cdot e^{i\mu_{\mathbb{C}}(\hat{e} \cdot x^{-1})} \\
 &\geq p_{\mathbb{C}}(\hat{e}) \cdot e^{i\mu_{\mathbb{C}}(\hat{e})} \wedge p_{\mathbb{C}}(x) \cdot e^{i\mu_{\mathbb{C}}(x)} \\
 &= p_{\mathbb{C}}(x \cdot x^{-1}) \cdot e^{i\mu_{\mathbb{C}}(x \cdot x^{-1})} \wedge p_{\mathbb{C}}(x) \cdot e^{i\mu_{\mathbb{C}}(x)} \\
 &\geq p_{\mathbb{C}}(x) \cdot e^{i\mu_{\mathbb{C}}(x)} \wedge p_{\mathbb{C}}(x) \cdot e^{i\mu_{\mathbb{C}}(x)} \wedge p_{\mathbb{C}}(x) \cdot e^{i\mu_{\mathbb{C}}(x)} \\
 &= p_{\mathbb{C}}(x) \cdot e^{i\mu_{\mathbb{C}}(x)} \\
 p_{\mathbb{C}}(x^{-1}) \cdot e^{i\mu_{\mathbb{C}}(x^{-1})} &\geq p_{\mathbb{C}}(x) \cdot e^{i\mu_{\mathbb{C}}(x)}.
 \end{aligned}$$

Similarly,

$$q_{\mathbb{C}}(x^{-1}) \cdot e^{i\nu_{\mathbb{C}}(x^{-1})} \geq q_{\mathbb{C}}(x) \cdot e^{i\nu_{\mathbb{C}}(x)}.$$

And

$$\begin{aligned}
 r_{\mathbb{C}}(x^{-1}) \cdot e^{i\omega_{\mathbb{C}}(x^{-1})} &= r_{\mathbb{C}}(\hat{e} \cdot x^{-1}) \cdot e^{i\omega_{\mathbb{C}}(\hat{e} \cdot x^{-1})} \\
 &\leq r_{\mathbb{C}}(\hat{e}) \cdot e^{i\omega_{\mathbb{C}}(\hat{e})} \vee r_{\mathbb{C}}(x) \cdot e^{i\omega_{\mathbb{C}}(x)} \\
 &= r_{\mathbb{C}}(x \cdot x^{-1}) \cdot e^{i\omega_{\mathbb{C}}(x \cdot x^{-1})} \vee r_{\mathbb{C}}(x) \cdot e^{i\omega_{\mathbb{C}}(x)} \\
 &\leq r_{\mathbb{C}}(x) \cdot e^{i\omega_{\mathbb{C}}(x)} \vee r_{\mathbb{C}}(x) \cdot e^{i\omega_{\mathbb{C}}(x)} \vee r_{\mathbb{C}}(x) \cdot e^{i\omega_{\mathbb{C}}(x)} \\
 &= \vee r_{\mathbb{C}}(x) \cdot e^{i\omega_{\mathbb{C}}(x)}.
 \end{aligned}$$

So, the condition (CNSG2) of Definition 3.1 is satisfied.

Now let us show the condition (CNSG1) of Definition 3.1,

$$\begin{aligned}
 p_{\mathbb{C}}(x \cdot y) \cdot e^{i\mu_{\mathbb{C}}(x \cdot y)} &= p_{\mathbb{C}}(x \cdot (y^{-1})^{-1}) \cdot e^{i\mu_{\mathbb{C}}(x \cdot (y^{-1})^{-1})} \\
 &\geq p_{\mathbb{C}}(x) \cdot e^{i\mu_{\mathbb{C}}(x)} \wedge p_{\mathbb{C}}(y^{-1}) \cdot e^{i\mu_{\mathbb{C}}(y^{-1})} \\
 &\geq p_{\mathbb{C}}(x) \cdot e^{i\mu_{\mathbb{C}}(x)} \wedge p_{\mathbb{C}}(y) \cdot e^{i\mu_{\mathbb{C}}(y)}.
 \end{aligned}$$

Similarly,

$$q_{\mathbb{C}}(x \cdot y) \cdot e^{iv_{\mathbb{C}}(x \cdot y)} \geq q_{\mathbb{C}}(x) \cdot e^{iv_{\mathbb{C}}(x)} \wedge q_{\mathbb{C}}(y) \cdot e^{iv_{\mathbb{C}}(y)}$$

and

$$\begin{aligned} r_{\mathbb{C}}(x \cdot y) \cdot e^{i\omega_{\mathbb{C}}(x \cdot y)} &= r_{\mathbb{C}}(x \cdot (y^{-1})^{-1}) \cdot e^{i\omega_{\mathbb{C}}(x \cdot (y^{-1})^{-1})} \\ &\leq r_{\mathbb{C}}(x) \cdot e^{i\omega_{\mathbb{C}}(x)} \vee r_{\mathbb{C}}(y^{-1}) \cdot e^{i\omega_{\mathbb{C}}(y^{-1})} \\ &\leq r_{\mathbb{C}}(x) \cdot e^{i\omega_{\mathbb{C}}(x)} \vee r_{\mathbb{C}}(y) \cdot e^{i\omega_{\mathbb{C}}(y)}. \end{aligned}$$

Therefore (CNSG1) of Definition 3.1 is also satisfied. Thus \mathbb{C} is a complex neutrosophic subgroup of \mathcal{G} . \square

★ Based on Theorem 3.7, we define complex neutrosophic subgroup as follows:

Definition 3.8. Let \mathcal{G} be any group with multiplication. A complex neutrosophic set

$$\mathbb{C} = \left\{ \left\langle T_{\mathbb{C}} = p_{\mathbb{C}} \cdot e^{i\mu_{\mathbb{C}}}, I_{\mathbb{C}} = q_{\mathbb{C}} \cdot e^{iv_{\mathbb{C}}}, F_{\mathbb{C}} = r_{\mathbb{C}} \cdot e^{i\omega_{\mathbb{C}}} \right\rangle \right\}$$

on group \mathcal{G} is known as a complex neutrosophic subgroup (CNSG) of \mathcal{G} , if

$\mathbb{C}(x^{-1}y) \geq \min \{ \mathbb{C}(x), \mathbb{C}(y) \}$ i.e.,

$$(i) \ p_{\mathbb{C}}(x^{-1}y) \cdot e^{i\mu_{\mathbb{C}}(x^{-1}y)} \geq \min \{ p_{\mathbb{C}}(x) \cdot e^{i\mu_{\mathbb{C}}(x)}, p_{\mathbb{C}}(y) \cdot e^{i\mu_{\mathbb{C}}(y)} \}$$

$$(ii) \ q_{\mathbb{C}}(x^{-1}y) \cdot e^{iv_{\mathbb{C}}(x^{-1}y)} \geq \min \{ q_{\mathbb{C}}(x) \cdot e^{iv_{\mathbb{C}}(x)}, q_{\mathbb{C}}(y) \cdot e^{iv_{\mathbb{C}}(y)} \}$$

$$(iii) \ r_{\mathbb{C}}(x^{-1}y) \cdot e^{i\omega_{\mathbb{C}}(x^{-1}y)} \leq \max \{ r_{\mathbb{C}}(x) \cdot e^{i\omega_{\mathbb{C}}(x)}, r_{\mathbb{C}}(y) \cdot e^{i\omega_{\mathbb{C}}(y)} \}, \forall x, y \in \mathcal{G}.$$

Example 3.9. Let $\mathcal{G} = \{1, -1, i, -i\}$ be a group under multiplication, and $\mathbb{C} = \langle T_{\mathbb{C}}, I_{\mathbb{C}}, F_{\mathbb{C}} \rangle$ be complex neutrosophic set on \mathcal{G} , such that

$$T_{\mathbb{C}}(1) = 0.8e^{0.6\pi i}, T_{\mathbb{C}}(-1) = 0.7e^{0.5\pi i}, T_{\mathbb{C}}(i) = T_{\mathbb{C}}(-i) = 0.3e^{0.2\pi i}$$

$$I_{\mathbb{C}}(1) = 0.7e^{0.5\pi i}, I_{\mathbb{C}}(-1) = 0.6e^{0.4\pi i}, I_{\mathbb{C}}(i) = I_{\mathbb{C}}(-i) = 0.2e^{0.2\pi i}$$

$$F_{\mathbb{C}}(1) = 0.5e^{0.4\pi i}, F_{\mathbb{C}}(-1) = 0.1e^{0.2\pi i}, F_{\mathbb{C}}(i) = F_{\mathbb{C}}(-i) = 0.1e^{0.2\pi i}.$$

Clearly, \mathbb{C} is a complex neutrosophic subgroup of \mathcal{G} .

Theorem 3.10. If \mathbb{C}_1 and \mathbb{C}_2 are two complex neutrosophic subgroups of a group \mathcal{G} , then the intersection $\mathbb{C}_1 \cap \mathbb{C}_2$ is a complex neutrosophic subgroup of \mathcal{G} .

Proof: Let $x, y \in \mathcal{G}$ be any arbitrary elements. By Theorem 3.7, it is enough to show that

$$(\mathbb{C}_1 \cap \mathbb{C}_2)(x \cdot y^{-1}) \geq (\mathbb{C}_1 \cap \mathbb{C}_2)(x) \wedge (\mathbb{C}_1 \cap \mathbb{C}_2)(y).$$

First consider the truth-membership degree of the intersection

$$\begin{aligned} p_{\mathbb{C}_1 \cap \mathbb{C}_2}(x \cdot y^{-1}) \cdot e^{i\mu_{\mathbb{C}_1 \cap \mathbb{C}_2}(x \cdot y^{-1})} &= p_{\mathbb{C}_1}(x \cdot y^{-1}) \cdot e^{i\mu_{\mathbb{C}_1}(x \cdot y^{-1})} \\ &\wedge p_{\mathbb{C}_2}(x \cdot y^{-1}) \cdot e^{i\mu_{\mathbb{C}_2}(x \cdot y^{-1})} \\ &\geq p_{\mathbb{C}_1}(x) \cdot e^{i\mu_{\mathbb{C}_1}(x)} \wedge p_{\mathbb{C}_1}(y) \cdot e^{i\mu_{\mathbb{C}_1}(y)} \\ &\wedge p_{\mathbb{C}_2}(x) \cdot e^{i\mu_{\mathbb{C}_2}(x)} \wedge p_{\mathbb{C}_2}(y) \cdot e^{i\mu_{\mathbb{C}_2}(y)} \\ &= (p_{\mathbb{C}_1}(x) \cdot e^{i\mu_{\mathbb{C}_1}(x)} \wedge p_{\mathbb{C}_2}(x) \cdot e^{i\mu_{\mathbb{C}_2}(x)}) \\ &\wedge (p_{\mathbb{C}_1}(y) \cdot e^{i\mu_{\mathbb{C}_1}(y)} \wedge p_{\mathbb{C}_2}(y) \cdot e^{i\mu_{\mathbb{C}_2}(y)}) \\ &= p_{\mathbb{C}_1 \cap \mathbb{C}_2}(x) \cdot e^{i\mu_{\mathbb{C}_1 \cap \mathbb{C}_2}(x)} \\ &\wedge p_{\mathbb{C}_1 \cap \mathbb{C}_2}(y) \cdot e^{i\mu_{\mathbb{C}_1 \cap \mathbb{C}_2}(y)}. \end{aligned}$$

Similarly,

$$q_{\mathbb{C}_1 \cap \mathbb{C}_2}(x \cdot y^{-1}) \cdot e^{iv_{\mathbb{C}_1 \cap \mathbb{C}_2}(x \cdot y^{-1})} \geq q_{\mathbb{C}_1 \cap \mathbb{C}_2}(x) \cdot e^{iv_{\mathbb{C}_1 \cap \mathbb{C}_2}(x)} \\ \wedge q_{\mathbb{C}_1 \cap \mathbb{C}_2}(y) \cdot e^{iv_{\mathbb{C}_1 \cap \mathbb{C}_2}(y)}.$$

And

$$r_{\mathbb{C}_1 \cup \mathbb{C}_2}(x \cdot y^{-1}) \cdot e^{i\omega_{\mathbb{C}_1 \cup \mathbb{C}_2}(x \cdot y^{-1})} = r_{\mathbb{C}_1}(x \cdot y^{-1}) \cdot e^{i\omega_{\mathbb{C}_1}(x \cdot y^{-1})} \\ \vee r_{\mathbb{C}_2}(x \cdot y^{-1}) \cdot e^{i\omega_{\mathbb{C}_2}(x \cdot y^{-1})} \\ \leq r_{\mathbb{C}_1}(x) \cdot e^{i\omega_{\mathbb{C}_1}(x)} \vee r_{\mathbb{C}_1}(y) \cdot e^{i\omega_{\mathbb{C}_1}(y)} \\ \vee r_{\mathbb{C}_2}(x) \cdot e^{i\omega_{\mathbb{C}_2}(x)} \vee r_{\mathbb{C}_2}(y) \cdot e^{i\omega_{\mathbb{C}_2}(y)} \\ = r_{\mathbb{C}_1}(x) \cdot e^{i\omega_{\mathbb{C}_1}(x)} \vee r_{\mathbb{C}_2}(x) \cdot e^{i\omega_{\mathbb{C}_2}(x)} \\ \vee r_{\mathbb{C}_1}(y) \cdot e^{i\omega_{\mathbb{C}_1}(y)} \vee r_{\mathbb{C}_2}(y) \cdot e^{i\omega_{\mathbb{C}_2}(y)} \\ = r_{\mathbb{C}_1 \cup \mathbb{C}_2}(x) \cdot e^{i\omega_{\mathbb{C}_1 \cup \mathbb{C}_2}(x)} \\ \vee r_{\mathbb{C}_1 \cup \mathbb{C}_2}(y) \cdot e^{i\omega_{\mathbb{C}_1 \cup \mathbb{C}_2}(y)}.$$

Hence $\mathbb{C}_1 \cap \mathbb{C}_2$ is a complex neutrosophic subgroup of \mathcal{G} . \square

Theorem 3.11. *If \mathbb{C}_1 and \mathbb{C}_2 are two complex neutrosophic subgroups of a group \mathcal{G} , then the union $\mathbb{C}_1 \cup \mathbb{C}_2$ is a complex neutrosophic subgroup of \mathcal{G} .*

Proof: Let $x, y \in \mathcal{G}$ be any arbitrary elements. By Theorem 3.7, it is enough to show that

$$(\mathbb{C}_1 \cup \mathbb{C}_2)(x \cdot y^{-1}) \geq \min\{(\mathbb{C}_1 \cup \mathbb{C}_2)(x), (\mathbb{C}_1 \cup \mathbb{C}_2)(y)\}.$$

Consider,

$$p_{\mathbb{C}_1 \cup \mathbb{C}_2}(x \cdot y^{-1}) \cdot e^{i\mu_{\mathbb{C}_1 \cup \mathbb{C}_2}(x \cdot y^{-1})} = p_{\mathbb{C}_1}(x \cdot y^{-1}) \cdot e^{i\mu_{\mathbb{C}_1}(x \cdot y^{-1})} \\ \vee p_{\mathbb{C}_2}(x \cdot y^{-1}) \cdot e^{i\mu_{\mathbb{C}_2}(x \cdot y^{-1})} \\ \geq p_{\mathbb{C}_1}(x) \cdot e^{i\mu_{\mathbb{C}_1}(x)} \wedge p_{\mathbb{C}_1}(y) \cdot e^{i\mu_{\mathbb{C}_1}(y)} \\ \vee p_{\mathbb{C}_2}(x) \cdot e^{i\mu_{\mathbb{C}_2}(x)} \wedge p_{\mathbb{C}_2}(y) \cdot e^{i\mu_{\mathbb{C}_2}(y)} \\ = (p_{\mathbb{C}_1}(x) \cdot e^{i\mu_{\mathbb{C}_1}(x)} \vee p_{\mathbb{C}_2}(x) \cdot e^{i\mu_{\mathbb{C}_2}(x)}) \\ \wedge (p_{\mathbb{C}_1}(y) \cdot e^{i\mu_{\mathbb{C}_1}(y)} \vee p_{\mathbb{C}_2}(y) \cdot e^{i\mu_{\mathbb{C}_2}(y)}) \\ = \min\{p_{\mathbb{C}_1 \cup \mathbb{C}_2}(x) \cdot e^{i\mu_{\mathbb{C}_1 \cup \mathbb{C}_2}(x)}, \\ p_{\mathbb{C}_1 \cup \mathbb{C}_2}(y) \cdot e^{i\mu_{\mathbb{C}_1 \cup \mathbb{C}_2}(y)}\}.$$

And

$$r_{\mathbb{C}_1 \cap \mathbb{C}_2}(x \cdot y^{-1}) \cdot e^{i\omega_{\mathbb{C}_1 \cap \mathbb{C}_2}(x \cdot y^{-1})} = r_{\mathbb{C}_1}(x \cdot y^{-1}) \cdot e^{i\omega_{\mathbb{C}_1}(x \cdot y^{-1})} \\ \wedge r_{\mathbb{C}_2}(x \cdot y^{-1}) \cdot e^{i\omega_{\mathbb{C}_2}(x \cdot y^{-1})} \\ \leq r_{\mathbb{C}_1}(x) \cdot e^{i\omega_{\mathbb{C}_1}(x)} \vee r_{\mathbb{C}_1}(y) \cdot e^{i\omega_{\mathbb{C}_1}(y)} \\ \wedge r_{\mathbb{C}_2}(x) \cdot e^{i\omega_{\mathbb{C}_2}(x)} \vee r_{\mathbb{C}_2}(y) \cdot e^{i\omega_{\mathbb{C}_2}(y)} \\ = r_{\mathbb{C}_1}(x) \cdot e^{i\omega_{\mathbb{C}_1}(x)} \wedge r_{\mathbb{C}_2}(x) \cdot e^{i\omega_{\mathbb{C}_2}(x)} \\ \vee r_{\mathbb{C}_1}(y) \cdot e^{i\omega_{\mathbb{C}_1}(y)} \wedge r_{\mathbb{C}_2}(y) \cdot e^{i\omega_{\mathbb{C}_2}(y)} \\ = \max\{r_{\mathbb{C}_1 \cap \mathbb{C}_2}(x) \cdot e^{i\omega_{\mathbb{C}_1 \cap \mathbb{C}_2}(x)}, \\ r_{\mathbb{C}_1 \cap \mathbb{C}_2}(y) \cdot e^{i\omega_{\mathbb{C}_1 \cap \mathbb{C}_2}(y)}\}.$$

Thus, $\mathbb{C}_1 \cup \mathbb{C}_2$ is a complex neutrosophic subgroup of \mathcal{G} . \square

4. Alpha-Cut of Complex Neutrosophic Set

Definition 4.1. Let $\mathbb{C} = \langle \mathbb{C}_T = p_{\mathbb{C}}e^{i\mu_{\mathbb{C}}}, \mathbb{C}_I = q_{\mathbb{C}}e^{i\nu_{\mathbb{C}}}, \mathbb{C}_F = r_{\mathbb{C}}e^{i\omega_{\mathbb{C}}} \rangle$ be a complex neutrosophic set on \mathcal{X} and $\alpha = \beta \cdot e^{i\gamma}$, where $\beta \in [0, 1], \gamma \in [0, 2\pi]$.

Define the α -level set of \mathbb{C} as follows:

$\mathbb{C}_{\alpha} = \{x \in \mathcal{X} \mid \mathbb{C}(x) \geq \alpha\}$ i.e.,

$$\begin{aligned} (p_{\mathbb{C}}(x) \cdot e^{i\mu_{\mathbb{C}}(x)})_{\alpha} &= \{x \in \mathcal{X} \mid p_{\mathbb{C}}(x) \cdot e^{i\mu_{\mathbb{C}}(x)} \geq \beta \cdot e^{i\gamma}\}, \\ (q_{\mathbb{C}}(x) \cdot e^{i\nu_{\mathbb{C}}(x)})_{\alpha} &= \{x \in \mathcal{X} \mid q_{\mathbb{C}}(x) \cdot e^{i\nu_{\mathbb{C}}(x)} \geq \beta \cdot e^{i\gamma}\}, \\ (r_{\mathbb{C}}(x) \cdot e^{i\omega_{\mathbb{C}}(x)})_{\alpha} &= \{x \in \mathcal{X} \mid r_{\mathbb{C}}(x) \cdot e^{i\omega_{\mathbb{C}}(x)} \leq \beta \cdot e^{i\gamma}\}. \end{aligned}$$

It is easy to verify that,

(1) If $\mathbb{C}_1 \subseteq \mathbb{C}_2$ and $\alpha = \beta \cdot e^{i\gamma}$, where, $\beta \in [0, 1], \gamma \in [0, 2\pi]$, then,

$$\begin{aligned} (p_{\mathbb{C}_1}(x) \cdot e^{i\mu_{\mathbb{C}_1}(x)})_{\alpha} &\subseteq (p_{\mathbb{C}_2}(x) \cdot e^{i\mu_{\mathbb{C}_2}(x)})_{\alpha} \\ (q_{\mathbb{C}_1}(x) \cdot e^{i\nu_{\mathbb{C}_1}(x)})_{\alpha} &\subseteq (q_{\mathbb{C}_2}(x) \cdot e^{i\nu_{\mathbb{C}_2}(x)})_{\alpha} \\ (r_{\mathbb{C}_1}(x) \cdot e^{i\omega_{\mathbb{C}_1}(x)})_{\alpha} &\supseteq (r_{\mathbb{C}_2}(x) \cdot e^{i\omega_{\mathbb{C}_2}(x)})_{\alpha}. \end{aligned}$$

(2) $\alpha_1 \leq \alpha_2$ where, $\alpha_1 = \beta_1 \cdot e^{i\gamma_1}, \alpha_2 = \beta_2 \cdot e^{i\gamma_2}$ implies that

$$\begin{aligned} (p_{\mathbb{C}_1}(x) \cdot e^{i\mu_{\mathbb{C}_1}(x)})_{\alpha_1} &\supseteq (p_{\mathbb{C}_1}(x) \cdot e^{i\mu_{\mathbb{C}_1}(x)})_{\alpha_2} \\ (q_{\mathbb{C}_1}(x) \cdot e^{i\nu_{\mathbb{C}_1}(x)})_{\alpha_1} &\supseteq (q_{\mathbb{C}_1}(x) \cdot e^{i\nu_{\mathbb{C}_1}(x)})_{\alpha_2} \\ (r_{\mathbb{C}_1}(x) \cdot e^{i\omega_{\mathbb{C}_1}(x)})_{\alpha_1} &\subseteq (r_{\mathbb{C}_1}(x) \cdot e^{i\omega_{\mathbb{C}_1}(x)})_{\alpha_2}. \end{aligned}$$

Example 4.2. Let

$$\mathbb{C} = \left\{ \left\langle x_1, 0.2e^{0.4\pi i}, 0.3e^{0.5\pi i}, 0.7e^{0.1\pi i} \right\rangle, \left\langle x_2, 0.7e^{0.1\pi i}, 0.6e^{0.5\pi i}, 0.7e^{0.4\pi i} \right\rangle, \left\langle x_3, 0.6e^{0.4\pi i}, 0.4e^{0.5\pi i}, 0.1e^{0.4\pi i} \right\rangle \right\}$$

be a complex neutrosophic set of \mathcal{X} , and $\alpha = 0.4e^{0.4\pi i}$. Then the α -level set as: $\mathbb{C}_{\alpha} = \{x_3\}$.

Proposition 4.3. \mathbb{C} is a complex neutrosophic subgroup of \mathcal{G} if and only if for all $\alpha = \beta e^{i\gamma}$ where, $\beta \in [0, 1], \gamma \in [0, 2\pi]$, α -level sets of \mathbb{C} , $(p_{\mathbb{C}} \cdot e^{i\mu_{\mathbb{C}}})_{\alpha}$, $(q_{\mathbb{C}} \cdot e^{i\nu_{\mathbb{C}}})_{\alpha}$ and $(r_{\mathbb{C}} \cdot e^{i\omega_{\mathbb{C}}})_{\alpha}$ are classical subgroups of \mathcal{G} .

Proof: Let \mathbb{C} be a CNSG of \mathcal{G} , $\alpha = \beta e^{i\gamma}$ where $\beta \in [0, 1], \gamma \in [0, 2\pi]$ and $x, y \in (p_{\mathbb{C}} \cdot e^{i\mu_{\mathbb{C}}})_{\alpha}$ (similarly $x, y \in (q_{\mathbb{C}} \cdot e^{i\nu_{\mathbb{C}}})_{\alpha}, (r_{\mathbb{C}} \cdot e^{i\omega_{\mathbb{C}}})_{\alpha}$).

By the assumption,

$$\begin{aligned} p_{\mathbb{C}}(x \cdot y^{-1}) \cdot e^{i\mu_{\mathbb{C}}(x \cdot y^{-1})} &\geq p_{\mathbb{C}}(x) \cdot e^{i\mu_{\mathbb{C}}(x)} \wedge p_{\mathbb{C}}(y) \cdot e^{i\mu_{\mathbb{C}}(y)} \\ &\geq \alpha \wedge \alpha = \alpha. \end{aligned}$$

Similarly,

$$q_{\mathbb{C}}(x \cdot y^{-1}) \cdot e^{i\nu_{\mathbb{C}}(x \cdot y^{-1})} \geq \alpha.$$

And

$$\begin{aligned} r_{\mathbb{C}}(x \cdot y^{-1}) \cdot e^{i\omega_{\mathbb{C}}(x \cdot y^{-1})} &\leq r_{\mathbb{C}}(x) \cdot e^{i\omega_{\mathbb{C}}(x)} \vee r_{\mathbb{C}}(y) \cdot e^{i\omega_{\mathbb{C}}(y)} \\ &\leq \alpha \vee \alpha = \alpha. \end{aligned}$$

Hence $x \cdot y^{-1} \in (p_{\mathbb{C}} \cdot e^{i\mu_{\mathbb{C}}})_{\alpha}, (q_{\mathbb{C}} \cdot e^{i\nu_{\mathbb{C}}})_{\alpha}, (r_{\mathbb{C}} \cdot e^{i\omega_{\mathbb{C}}})_{\alpha}$ for each α .

This means that $(p_{\mathbb{C}}(x) \cdot e^{i\mu_{\mathbb{C}}(x)})_{\alpha}, (q_{\mathbb{C}}(x) \cdot e^{i\nu_{\mathbb{C}}(x)})_{\alpha}$ and $(r_{\mathbb{C}}(x) \cdot e^{i\omega_{\mathbb{C}}(x)})_{\alpha}$ is a classical subgroup of \mathcal{G} for each α .

Conversely, let $(p_{\mathbb{C}} \cdot e^{i\mu_{\mathbb{C}}})_{\alpha}$ be a classical subgroup of \mathcal{G} , for each $\alpha = \beta e^{i\gamma}$ where $\beta \in [0, 1], \gamma \in [0, 2\pi]$.

Let $x, y \in \mathcal{G}, \alpha = p_{\mathbb{C}}(x) \cdot e^{i\mu_{\mathbb{C}}(x)} \wedge p_{\mathbb{C}}(y) \cdot e^{i\mu_{\mathbb{C}}(y)}$ and $\delta = p_{\mathbb{C}}(x) \cdot e^{i\mu_{\mathbb{C}}(x)}$. Since $(p_{\mathbb{C}} \cdot e^{i\mu_{\mathbb{C}}})_{\alpha}$ and $(p_{\mathbb{C}} \cdot e^{i\mu_{\mathbb{C}}})_{\delta}$ are classical subgroup of $\mathcal{G}, x \cdot y \in (p_{\mathbb{C}} \cdot e^{i\mu_{\mathbb{C}}})_{\alpha}$ and $x^{-1} \in (p_{\mathbb{C}} \cdot e^{i\mu_{\mathbb{C}}})_{\delta}$. Thus,

$$p_{\mathbb{C}}(x \cdot y) \cdot e^{i\mu_{\mathbb{C}}(x \cdot y)} \geq \alpha = p_{\mathbb{C}}(x) \cdot e^{i\mu_{\mathbb{C}}(x)} \wedge p_{\mathbb{C}}(y) \cdot e^{i\mu_{\mathbb{C}}(y)},$$

and

$$p_{\mathbb{C}}(x^{-1}) \cdot e^{i\mu_{\mathbb{C}}(x^{-1})} \geq \delta = p_{\mathbb{C}}(x) \cdot e^{i\mu_{\mathbb{C}}(x)}.$$

Similarly,

$$q_{\mathbb{C}}(x \cdot y) \cdot e^{i\nu_{\mathbb{C}}(x \cdot y)} \geq q_{\mathbb{C}}(x) \cdot e^{i\nu_{\mathbb{C}}(x)} \wedge q_{\mathbb{C}}(y) \cdot e^{i\nu_{\mathbb{C}}(y)},$$

$$q_{\mathbb{C}}(x^{-1}) \cdot e^{i\nu_{\mathbb{C}}(x^{-1})} \geq q_{\mathbb{C}}(x) \cdot e^{i\nu_{\mathbb{C}}(x)}.$$

And

$$r_{\mathbb{C}}(x \cdot y) \cdot e^{i\omega_{\mathbb{C}}(x \cdot y)} \leq r_{\mathbb{C}}(x) \cdot e^{i\omega_{\mathbb{C}}(x)} \vee r_{\mathbb{C}}(y) \cdot e^{i\omega_{\mathbb{C}}(y)},$$

$$r_{\mathbb{C}}(x^{-1}) \cdot e^{i\omega_{\mathbb{C}}(x^{-1})} \leq r_{\mathbb{C}}(x) \cdot e^{i\omega_{\mathbb{C}}(x)}.$$

So, the conditions of Definition 3.1 are satisfied. Hence \mathcal{G} is a complex neutrosophic subgroup. \square

5. Image and Preimage of Complex Neutrosophic Set

Definition 5.1. Let $f : \mathcal{G}_1 \rightarrow \mathcal{G}_2$ be a function and \mathbb{C}_1 and \mathbb{C}_2 be the complex neutrosophic sets of \mathcal{G}_1 and \mathcal{G}_2 , respectively. Then the image of a complex neutrosophic set \mathbb{C}_1 is a complex neutrosophic set of \mathcal{G}_2 and it is defined as follows:

$$\begin{aligned} f(\mathbb{C}_1)(y) &= (p_f(\mathbb{C}_1)(y) \cdot e^{i\mu_f(\mathbb{C}_1)(y)}, q_f(\mathbb{C}_1)(y) \cdot e^{i\nu_f(\mathbb{C}_1)(y)}, \\ &\quad r_f(\mathbb{C}_1)(y) \cdot e^{i\omega_f(\mathbb{C}_1)(y)}) \\ &= (f(p_{\mathbb{C}_1})(y) \cdot e^{if(\mu_{\mathbb{C}_1})(y)}, f(q_{\mathbb{C}_1})(y) \cdot e^{if(\nu_{\mathbb{C}_1})(y)}, \\ &\quad f(r_{\mathbb{C}_1})(y) \cdot e^{if(\omega_{\mathbb{C}_1})(y)}), \forall y \in \mathcal{G}_2 \end{aligned}$$

where,

$$\begin{aligned} f(p_{\mathbb{C}_1})(y) \cdot e^{if(\mu_{\mathbb{C}_1})(y)} &= \begin{cases} \vee p_{\mathbb{C}_1}(x) \cdot e^{i\mu_{\mathbb{C}_1}(x)}, & \text{if } x \in f^{-1}(y) \\ 0 & \text{otherwise} \end{cases} \\ f(q_{\mathbb{C}_1})(y) \cdot e^{if(\nu_{\mathbb{C}_1})(y)} &= \begin{cases} \vee q_{\mathbb{C}_1}(x) \cdot e^{i\nu_{\mathbb{C}_1}(x)}, & \text{if } x \in f^{-1}(y) \\ 0 & \text{otherwise} \end{cases} \\ f(r_{\mathbb{C}_1})(y) \cdot e^{if(\omega_{\mathbb{C}_1})(y)} &= \begin{cases} \wedge r_{\mathbb{C}_1}(x) \cdot e^{i\omega_{\mathbb{C}_1}(x)}, & \text{if } x \in f^{-1}(y) \\ 1 \cdot e^{i2\pi} & \text{otherwise} \end{cases} . \end{aligned}$$

And the preimage of a complex neutrosophic set \mathbf{C}_2 is a complex neutrosophic set of \mathcal{G}_1 and it is defined as follows: for all $x \in \mathcal{G}_1$,

$$\begin{aligned} f^{-1}(\mathbf{C}_2)(x) &= \left(p_{f^{-1}(\mathbf{C}_2)}(x) \cdot e^{i\mu_{f^{-1}(\mathbf{C}_2)}(x)}, q_{f^{-1}(\mathbf{C}_2)}(x) \cdot e^{i\nu_{f^{-1}(\mathbf{C}_2)}(x)}, \right. \\ &\quad \left. r_{f^{-1}(\mathbf{C}_2)}(x) \cdot e^{i\omega_{f^{-1}(\mathbf{C}_2)}(x)} \right) \\ &= \left(p_{\mathbf{C}_2}(f(x)) \cdot e^{i\mu_{\mathbf{C}_2}(f(x))}, q_{\mathbf{C}_2}(f(x)) \cdot e^{i\nu_{\mathbf{C}_2}(f(x))}, \right. \\ &\quad \left. r_{\mathbf{C}_2}(f(x)) \cdot e^{i\omega_{\mathbf{C}_2}(f(x))} \right) \\ &= \mathbf{C}_2(f(x)). \end{aligned}$$

Theorem 5.2. Let \mathcal{G}_1 and \mathcal{G}_2 be two groups and $f : \mathcal{G}_1 \rightarrow \mathcal{G}_2$ be a group homomorphism. If \mathbf{C} is a complex neutrosophic subgroup of \mathcal{G}_1 , then the image of \mathbf{C} , $f(\mathbf{C})$ is a complex neutrosophic subgroup of \mathcal{G}_2 .

Proof: Let \mathbf{C} be a CNSG of \mathcal{G}_1 and $y_1, y_2 \in \mathcal{G}_2$. if $f^{-1}(y_1) = \phi$ or $f^{-1}(y_2) = \phi$, then it is obvious that $f(\mathbf{C})$ is a CNSG of \mathcal{G}_2 . Let us assume that there exist $x_1, x_2 \in \mathcal{G}_1$ such that $f(x_1) = y_1$ and $f(x_2) = y_2$. Since f is a group homomorphism,

$$\begin{aligned} f(p_{\mathbf{C}}(y_1 \cdot y_2^{-1})) \cdot e^{if(\mu_{\mathbf{C}}(y_1 \cdot y_2^{-1}))} &= \bigvee_{y_1 \cdot y_2^{-1} = f(x)} p_{\mathbf{C}}(x) \cdot e^{i\mu_{\mathbf{C}}(x)} \\ &\geq p_{\mathbf{C}}(x_1 \cdot x_2^{-1}) \cdot e^{i\mu_{\mathbf{C}}(x_1 \cdot x_2^{-1})}, \end{aligned}$$

$$\begin{aligned} f(q_{\mathbf{C}}(y_1 \cdot y_2^{-1})) \cdot e^{if(\nu_{\mathbf{C}}(y_1 \cdot y_2^{-1}))} &= \bigvee_{y_1 \cdot y_2^{-1} = f(x)} q_{\mathbf{C}}(x) \cdot e^{i\nu_{\mathbf{C}}(x)} \\ &\geq q_{\mathbf{C}}(x_1 \cdot x_2^{-1}) \cdot e^{i\nu_{\mathbf{C}}(x_1 \cdot x_2^{-1})}, \end{aligned}$$

$$\begin{aligned} f(r_{\mathbf{C}}(y_1 \cdot y_2^{-1})) \cdot e^{if(\omega_{\mathbf{C}}(y_1 \cdot y_2^{-1}))} &= \bigwedge_{y_1 \cdot y_2^{-1} = f(x)} r_{\mathbf{C}}(x) \cdot e^{i\omega_{\mathbf{C}}(x)} \\ &\leq r_{\mathbf{C}}(x_1 \cdot x_2^{-1}) \cdot e^{i\omega_{\mathbf{C}}(x_1 \cdot x_2^{-1})}. \end{aligned}$$

By using the above inequalities let us prove that

$$f(\mathbf{C})(y_1 \cdot y_2^{-1}) \geq f(\mathbf{C})(y_1) \wedge f(\mathbf{C})(y_2).$$

$$\begin{aligned} f(\mathbf{C})(y_1 \cdot y_2^{-1}) &= \left(f(p_{\mathbf{C}}(y_1 \cdot y_2^{-1})) \cdot e^{if(\mu_{\mathbf{C}}(y_1 \cdot y_2^{-1}))}, f(q_{\mathbf{C}}(y_1 \cdot y_2^{-1})) \cdot e^{if(\nu_{\mathbf{C}}(y_1 \cdot y_2^{-1}))}, \right. \\ &\quad \left. f(r_{\mathbf{C}}(y_1 \cdot y_2^{-1})) \cdot e^{if(\omega_{\mathbf{C}}(y_1 \cdot y_2^{-1}))} \right) \end{aligned}$$

$$= \left(\bigvee_{y_1 \cdot y_2^{-1} = f(x)} p_{\mathbf{C}}(x) \cdot e^{i\mu_{\mathbf{C}}(x)}, \bigvee_{y_1 \cdot y_2^{-1} = f(x)} q_{\mathbf{C}}(x) \cdot e^{i\nu_{\mathbf{C}}(x)}, \right. \\ \left. \bigwedge_{y_1 \cdot y_2^{-1} = f(x)} r_{\mathbf{C}}(x) \cdot e^{i\omega_{\mathbf{C}}(x)} \right)$$

$$\geq \left(p_{\mathbf{C}}(x_1 \cdot x_2^{-1}) \cdot e^{i\mu_{\mathbf{C}}(x_1 \cdot x_2^{-1})}, q_{\mathbf{C}}(x_1 \cdot x_2^{-1}) \cdot e^{i\nu_{\mathbf{C}}(x_1 \cdot x_2^{-1})}, \right. \\ \left. r_{\mathbf{C}}(x_1 \cdot x_2^{-1}) \cdot e^{i\omega_{\mathbf{C}}(x_1 \cdot x_2^{-1})} \right)$$

$$\begin{aligned} &\geq (p_{\mathbb{C}}(x_1) \cdot e^{i\mu_{\mathbb{C}}(x_1)} \wedge p_{\mathbb{C}}(x_2) \cdot e^{i\mu_{\mathbb{C}}(x_2)}, q_{\mathbb{C}}(x_1) \cdot e^{i\nu_{\mathbb{C}}(x_1)} \\ &\wedge q_{\mathbb{C}}(x_2) \cdot e^{i\nu_{\mathbb{C}}(x_2)}, r_{\mathbb{C}}(x_1) \cdot e^{i\omega_{\mathbb{C}}(x_1)} \vee r_{\mathbb{C}}(x_2) \cdot e^{i\omega_{\mathbb{C}}(x_2)}) \\ &= (p_{\mathbb{C}}(x_1) \cdot e^{i\mu_{\mathbb{C}}(x_1)}, q_{\mathbb{C}}(x_1) \cdot e^{i\nu_{\mathbb{C}}(x_1)}, r_{\mathbb{C}}(x_1) \cdot e^{i\omega_{\mathbb{C}}(x_1)} \\ &\wedge p_{\mathbb{C}}(x_2) \cdot e^{i\mu_{\mathbb{C}}(x_2)}, q_{\mathbb{C}}(x_2) \cdot e^{i\nu_{\mathbb{C}}(x_2)}, r_{\mathbb{C}}(x_2) \cdot e^{i\omega_{\mathbb{C}}(x_2)}) \\ &= f(\mathbb{C})(y_1) \wedge f(\mathbb{C})(y_2). \end{aligned}$$

This is satisfied for each $x_1, x_2 \in \mathcal{G}_1$ with $f(x_1) = y_1$ and $f(x_2) = y_2$, then it is obvious that

$$\begin{aligned} f(\mathbb{C})(y_1 \cdot y_2^{-1}) &\geq \left(\bigvee_{y_1=f(x_1)} p_{\mathbb{C}}(x_1) \cdot e^{i\mu_{\mathbb{C}}(x_1)}, \bigvee_{y_1=f(x_1)} q_{\mathbb{C}}(x_1) \cdot e^{i\nu_{\mathbb{C}}(x_1)}, \right. \\ &\quad \left. \bigwedge_{y_1=f(x_1)} r_{\mathbb{C}}(x_1) \cdot e^{i\omega_{\mathbb{C}}(x_1)} \right) \wedge \left(\bigvee_{y_2=f(x_2)} p_{\mathbb{C}}(x_2) \cdot e^{i\mu_{\mathbb{C}}(x_2)}, \right. \\ &\quad \left. \bigvee_{y_2=f(x_2)} q_{\mathbb{C}}(x_2) \cdot e^{i\nu_{\mathbb{C}}(x_2)}, \bigwedge_{y_2=f(x_2)} r_{\mathbb{C}}(x_2) \cdot e^{i\omega_{\mathbb{C}}(x_2)} \right) \\ &= (f(p_{\mathbb{C}}(y_1)) \cdot e^{if(\mu_{\mathbb{C}}(y_1))}, f(q_{\mathbb{C}}(y_1)) \cdot e^{if(\nu_{\mathbb{C}}(y_1))}, f(r_{\mathbb{C}}(x_1)) \cdot e^{if(\omega_{\mathbb{C}}(x_1))}) \\ &\quad \wedge (f(p_{\mathbb{C}}(y_2)) \cdot e^{if(\mu_{\mathbb{C}}(y_2))}, f(q_{\mathbb{C}}(y_2)) \cdot e^{if(\nu_{\mathbb{C}}(y_2))}, f(r_{\mathbb{C}}(x_2)) \cdot e^{if(\omega_{\mathbb{C}}(x_2))}) \\ &= f(\mathbb{C})(y_1) \wedge f(\mathbb{C})(y_2). \end{aligned}$$

Hence the image of a CNSG is also a CNSG. \square

Theorem 5.3. Let \mathcal{G}_1 and \mathcal{G}_2 be the two groups and $f : \mathcal{G}_1 \rightarrow \mathcal{G}_2$ be a group homomorphism. If \mathbb{C}_2 is a complex neutrosophic subgroup of \mathcal{G}_2 , then the preimage of $f^{-1}(\mathbb{C}_2)$ is a complex neutrosophic subgroup of \mathcal{G}_1 .

Proof: Let \mathbb{C}_2 be a complex neutrosophic subgroup of \mathcal{G}_2 , and $x_1, x_2 \in \mathcal{G}_1$. Since f is a group homomorphism, the following inequalities is obtained.

$$\begin{aligned} f^{-1}(\mathbb{C}_2)(x_1 \cdot x_2^{-1}) &= (p_{\mathbb{C}_2}(f(x_1 \cdot x_2^{-1})) \cdot e^{i\mu_{\mathbb{C}_2}(f(x_1 \cdot x_2^{-1}))}, \\ &\quad q_{\mathbb{C}_2}(f(x_1 \cdot x_2^{-1})) \cdot e^{i\nu_{\mathbb{C}_2}(f(x_1 \cdot x_2^{-1}))}, \\ &\quad r_{\mathbb{C}_2}(f(x_1 \cdot x_2^{-1})) \cdot e^{i\omega_{\mathbb{C}_2}(f(x_1 \cdot x_2^{-1}))}) \\ &= (p_{\mathbb{C}_2}(f(x_1) \cdot f(x_2)^{-1}) \cdot e^{i\mu_{\mathbb{C}_2}(f(x_1) \cdot f(x_2)^{-1})}, \\ &\quad q_{\mathbb{C}_2}(f(x_1) \cdot f(x_2)^{-1}) \cdot e^{i\nu_{\mathbb{C}_2}(f(x_1) \cdot f(x_2)^{-1})}, \\ &\quad r_{\mathbb{C}_2}(f(x_1) \cdot f(x_2)^{-1}) \cdot e^{i\omega_{\mathbb{C}_2}(f(x_1) \cdot f(x_2)^{-1})}) \\ &\geq (p_{\mathbb{C}_2}(f(x_1) \wedge f(x_2)) \cdot e^{i\mu_{\mathbb{C}_2}(f(x_1) \wedge f(x_2))}, \\ &\quad q_{\mathbb{C}_2}(f(x_1) \wedge f(x_2)) \cdot e^{i\nu_{\mathbb{C}_2}(f(x_1) \wedge f(x_2))}, \\ &\quad r_{\mathbb{C}_2}(f(x_1) \vee f(x_2)) \cdot e^{i\omega_{\mathbb{C}_2}(f(x_1) \vee f(x_2))}) \\ &= (p_{\mathbb{C}_2}(f(x_1)) \cdot e^{i\mu_{\mathbb{C}_2}(f(x_1))}, q_{\mathbb{C}_2}(f(x_1)) \cdot e^{i\nu_{\mathbb{C}_2}(f(x_1))}, \\ &\quad r_{\mathbb{C}_2}(f(x_1) \cdot e^{i\omega_{\mathbb{C}_2}(f(x_1))}) \wedge (p_{\mathbb{C}_2}(f(x_2)) \cdot e^{i\mu_{\mathbb{C}_2}(f(x_2))}, \\ &\quad q_{\mathbb{C}_2}(f(x_2)) \cdot e^{i\nu_{\mathbb{C}_2}(f(x_2))}, r_{\mathbb{C}_2}(f(x_2)) \cdot e^{i\omega_{\mathbb{C}_2}(f(x_2))}) \\ &= f^{-1}(\mathbb{C}_2)(x_1) \wedge f^{-1}(\mathbb{C}_2)(x_2). \end{aligned}$$

Hence $f^{-1}(\mathbb{C}_2)$ is a CNSG of \mathcal{G}_1 . \square

Theorem 5.4. Let $f : \mathcal{G}_1 \rightarrow \mathcal{G}_2$ be a homomorphism of groups, \mathbb{C} is a CNSG of \mathcal{G}_1 and define $\mathbb{C}^{-1} : \mathcal{G}_1 \rightarrow [0, 1] \cdot e^{i[0,2\pi]} \times [0, 1] \cdot e^{i[0,2\pi]} \times [0, 1] \cdot e^{i[0,2\pi]}$ as $\mathbb{C}^{-1}(x) = \mathbb{C}(x^{-1})$ for arbitrary $x \in \mathcal{G}_1$. Then the following properties are valid.

(1) \mathbb{C}^{-1} is a CNSG of \mathcal{G}_1 .

(2) $(f(\mathbb{C}))^{-1} = f(\mathbb{C}^{-1})$.

Proof: (1) Let \mathbb{C} is a complex neutrosophic subgroup of \mathcal{G}_1 .

Since $\mathbb{C}^{-1} : \mathcal{G}_1 \rightarrow [0, 1] \cdot e^{i[0,2\pi]} \times [0, 1] \cdot e^{i[0,2\pi]} \times [0, 1] \cdot e^{i[0,2\pi]}$.

Let for all $x \in \mathcal{G}_1$, this implies that, $\mathbb{C}^{-1}(x) = (x_T, x_I, x_F)$ where $x_T \in [0, 1] \cdot e^{i[0,2\pi]}$, $x_I \in [0, 1] \cdot e^{i[0,2\pi]}$ and $x_F \in [0, 1] \cdot e^{i[0,2\pi]}$.

So \mathbb{C}^{-1} is a complex neutrosophic subgroup of \mathcal{G}_1 .

(2) Given that $\mathbb{C}^{-1}(x) = \mathbb{C}(x^{-1}) \forall x \in \mathcal{G}_1$.

Since $f : \mathcal{G}_1 \rightarrow \mathcal{G}_2$ be a homomorphism. As \mathbb{C} is a CNSG of \mathcal{G}_1 this implies that \mathbb{C}^{-1} is a CNSG of \mathcal{G}_1 by part (1), so $f(\mathbb{C}^{-1}) \in \mathcal{G}_2$ and $f(\mathbb{C}) \in \mathcal{G}_2$. Now by (1), $(f(\mathbb{C}))^{-1} \in \mathcal{G}_2$ as \mathcal{G}_2 is a group homomorphism.

So $f(\mathbb{C}^{-1}) = (f(\mathbb{C}))^{-1}$ by uniqueness of inverse of an element. \square

Corollary 5.5. Let $f : \mathcal{G}_1 \rightarrow \mathcal{G}_2$ be an isomorphism on of groups, \mathbb{C} is complex neutrosophic subgroup of \mathcal{G}_1 , then $f^{-1}(f(\mathbb{C})) = \mathbb{C}$.

Corollary 5.6. Let $f : \mathcal{G} \rightarrow \mathcal{G}$ be an isomorphism on a group \mathcal{G} , \mathbb{C} is complex neutrosophic subgroup of \mathcal{G} , then $f(\mathbb{C}) = \mathbb{C}$ if and only if $f^{-1}(\mathbb{C}) = \mathbb{C}$.

6. Complex Neutrosophic Normal Subgroup

Definition 6.1. Let \mathbb{C} be a complex neutrosophic subgroup of a group \mathcal{G} is known as a complex neutrosophic normal subgroup (CNNSG) of \mathcal{G} , if

$\mathbb{C}(xyx^{-1}) \geq \mathbb{C}(y)$ i.e.,

- (i) $p_{\mathbb{C}}(xyx^{-1}) \cdot e^{i\mu_{\mathbb{C}}(xyx^{-1})} \geq p_{\mathbb{C}}(y) \cdot e^{i\mu_{\mathbb{C}}(y)}$
- (ii) $q_{\mathbb{C}}(xyx^{-1}) \cdot e^{i\nu_{\mathbb{C}}(xyx^{-1})} \geq q_{\mathbb{C}}(y) \cdot e^{i\nu_{\mathbb{C}}(y)}$
- (iii) $r_{\mathbb{C}}(xyx^{-1}) \cdot e^{i\omega_{\mathbb{C}}(xyx^{-1})} \leq r_{\mathbb{C}}(y) \cdot e^{i\omega_{\mathbb{C}}(y)}, \forall x, y \in \mathcal{G}$.

Example 6.2. Let $\mathcal{G} = S_3 = \{1, a, a^2, b, ab, a^2b\}$ be a group and $\mathbb{C} = \langle T_{\mathbb{C}}, I_{\mathbb{C}}, F_{\mathbb{C}} \rangle$ be a complex neutrosophic set of \mathcal{G} such that,

$$T_{\mathbb{C}}(1) = 0.8e^{0.6\pi i}, T_{\mathbb{C}}(a) = T_{\mathbb{C}}(a^2) = 0.6e^{0.6\pi i}$$

$$T_{\mathbb{C}}(b) = T_{\mathbb{C}}(ab) = T_{\mathbb{C}}(a^2b) = 0.5e^{0.4\pi i}$$

$$I_{\mathbb{C}}(1) = 0.7e^{0.5\pi i}, I_{\mathbb{C}}(a) = I_{\mathbb{C}}(a^2) = 0.6e^{0.5\pi i}$$

$$I_{\mathbb{C}}(b) = I_{\mathbb{C}}(ab) = I_{\mathbb{C}}(a^2b) = 0.4e^{0.3\pi i}$$

$$F_{\mathbb{C}}(1) = 0.5e^{0.4\pi i}, F_{\mathbb{C}}(a) = F_{\mathbb{C}}(a^2) = 0.3e^{0.2\pi i}$$

$$F_{\mathbb{C}}(b) = F_{\mathbb{C}}(ab) = F_{\mathbb{C}}(a^2b) = 0.3e^{0.2\pi i}.$$

Then clearly \mathbb{C} is a complex neutrosophic normal subgroup of \mathcal{G} .

Theorem 6.3. If \mathbb{C}_1 and \mathbb{C}_2 are any two complex neutrosophic normal subgroups of the groups \mathcal{G}_1 and \mathcal{G}_2 respectively, then $\mathbb{C}_1 \times \mathbb{C}_2$ is also a complex neutrosophic normal subgroup of $\mathcal{G}_1 \times \mathcal{G}_2$.

Proof: Similarly to the proof of Theorem 3.5. \square

Theorem 6.4. Let \mathcal{G} be a group, and \mathbb{C}_1 and \mathbb{C}_2 be two CNNSGs of \mathcal{G} , then $\mathbb{C}_1 \cap \mathbb{C}_2$ is also a complex neutrosophic normal subgroup of \mathcal{G} .

Proof: Since \mathbb{C}_1 and \mathbb{C}_2 are CNNSGs of \mathcal{G} , then

$$p_{\mathbb{C}_1}(x \cdot y \cdot x^{-1}) \cdot e^{i\mu_{\mathbb{C}_1}(x \cdot y \cdot x^{-1})} \geq p_{\mathbb{C}_1}(y) \cdot e^{i\mu_{\mathbb{C}_1}(y)},$$

and

$$p_{\mathbb{C}_2}(x \cdot y \cdot x^{-1}) \cdot e^{i\mu_{\mathbb{C}_2}(x \cdot y \cdot x^{-1})} \geq p_{\mathbb{C}_2}(y) \cdot e^{i\mu_{\mathbb{C}_2}(y)}.$$

So, by the definition of the intersection,

$$\begin{aligned} p_{\mathbb{C}_1 \cap \mathbb{C}_2}(x \cdot y \cdot x^{-1}) \cdot e^{i\mu_{\mathbb{C}_1 \cap \mathbb{C}_2}(x \cdot y \cdot x^{-1})} &= p_{\mathbb{C}_1}(x \cdot y \cdot x^{-1}) \cdot e^{i\mu_{\mathbb{C}_1}(x \cdot y \cdot x^{-1})} \\ &\quad \wedge p_{\mathbb{C}_2}(x \cdot y \cdot x^{-1}) \cdot e^{i\mu_{\mathbb{C}_2}(x \cdot y \cdot x^{-1})} \\ &\geq p_{\mathbb{C}_1}(y) \cdot e^{i\mu_{\mathbb{C}_1}(y)} \wedge p_{\mathbb{C}_2}(y) \cdot e^{i\mu_{\mathbb{C}_2}(y)} \\ &= p_{\mathbb{C}_1 \cap \mathbb{C}_2}(y) \cdot e^{i\mu_{\mathbb{C}_1 \cap \mathbb{C}_2}(y)}. \end{aligned}$$

By the similar way,

$$q_{\mathbb{C}_1 \cap \mathbb{C}_2}(x \cdot y \cdot x^{-1}) \cdot e^{i\nu_{\mathbb{C}_1 \cap \mathbb{C}_2}(x \cdot y \cdot x^{-1})} \geq q_{\mathbb{C}_1 \cap \mathbb{C}_2}(y) \cdot e^{i\nu_{\mathbb{C}_1 \cap \mathbb{C}_2}(y)}.$$

And

$$\begin{aligned} r_{\mathbb{C}_1 \cup \mathbb{C}_2}(x \cdot y \cdot x^{-1}) \cdot e^{i\omega_{\mathbb{C}_1 \cup \mathbb{C}_2}(x \cdot y \cdot x^{-1})} &= r_{\mathbb{C}_1}(x \cdot y \cdot x^{-1}) \cdot e^{i\omega_{\mathbb{C}_1}(x \cdot y \cdot x^{-1})} \\ &\quad \vee r_{\mathbb{C}_2}(x \cdot y \cdot x^{-1}) \cdot e^{i\omega_{\mathbb{C}_2}(x \cdot y \cdot x^{-1})} \\ &\leq r_{\mathbb{C}_1}(y) \cdot e^{i\omega_{\mathbb{C}_1}(y)} \vee r_{\mathbb{C}_2}(y) \cdot e^{i\omega_{\mathbb{C}_2}(y)} \\ &= r_{\mathbb{C}_1 \cup \mathbb{C}_2}(y) \cdot e^{i\omega_{\mathbb{C}_1 \cup \mathbb{C}_2}(y)}. \end{aligned}$$

Hence the intersection of two CNNSGs is also a CNNSG. \square

Theorem 6.5. If \mathbb{C}_1 and \mathbb{C}_2 be two CNNSGs of \mathcal{G} , then $\mathbb{C}_1 \cup \mathbb{C}_2$ is a complex neutrosophic normal subgroup of \mathcal{G} .

Proof: Similarly to the proof of Theorem 3.11. \square

Proposition 6.6. Let \mathbb{C} be a complex neutrosophic subgroup of a group \mathcal{G} . Then the following are correspondent:

- (1) \mathbb{C} is a CNNSG of \mathcal{G} .
- (2) $\mathbb{C}(x \cdot y \cdot x^{-1}) = \mathbb{C}(y), \forall x, y \in \mathcal{G}$.
- (3) $\mathbb{C}(x \cdot y) = \mathbb{C}(y \cdot x), \forall x, y \in \mathcal{G}$.

Proof: (1) \Rightarrow (2) : Let \mathbb{C} be a complex neutrosophic normal subgroup of \mathcal{G} . Take $x, y \in \mathcal{G}$, then by Definition 6.1,

$$\begin{aligned} p_{\mathbb{C}}(x \cdot y \cdot x^{-1}) \cdot e^{i\mu_{\mathbb{C}}(x \cdot y \cdot x^{-1})} &\geq p_{\mathbb{C}}(y) \cdot e^{i\mu_{\mathbb{C}}(y)}, \\ q_{\mathbb{C}}(x \cdot y \cdot x^{-1}) \cdot e^{i\nu_{\mathbb{C}}(x \cdot y \cdot x^{-1})} &\geq q_{\mathbb{C}}(y) \cdot e^{i\nu_{\mathbb{C}}(y)}, \\ r_{\mathbb{C}}(x \cdot y \cdot x^{-1}) \cdot e^{i\omega_{\mathbb{C}}(x \cdot y \cdot x^{-1})} &\leq r_{\mathbb{C}}(y) \cdot e^{i\omega_{\mathbb{C}}(y)}. \end{aligned}$$

Thus taking arbitrary element x , the following is got for the truth membership of \mathbb{C} ,

$$\begin{aligned} p_{\mathbb{C}}(x^{-1} \cdot y \cdot x) \cdot e^{i\mu_{\mathbb{C}}(x^{-1} \cdot y \cdot x)} &= p_{\mathbb{C}}(x^{-1} \cdot y \cdot (x^{-1})^{-1}) \cdot e^{i\mu_{\mathbb{C}}(x^{-1} \cdot y \cdot (x^{-1})^{-1})} \\ &\geq p_{\mathbb{C}}(y) \cdot e^{i\mu_{\mathbb{C}}(y)}. \end{aligned}$$

Therefore,

$$\begin{aligned} p_{\mathbb{C}}(y) \cdot e^{i\mu_{\mathbb{C}}(y)} &= p_{\mathbb{C}}(x^{-1} \cdot (x \cdot y \cdot x^{-1}) \cdot x) \cdot e^{i\mu_{\mathbb{C}}(x^{-1} \cdot (x \cdot y \cdot x^{-1}) \cdot x)} \\ &\geq p_{\mathbb{C}}(x \cdot y \cdot x^{-1}) \cdot e^{i\mu_{\mathbb{C}}(x \cdot y \cdot x^{-1})}. \end{aligned}$$

Thus, $p_{\mathbb{C}}(x \cdot y \cdot x^{-1}) \cdot e^{i\mu_{\mathbb{C}}(x \cdot y \cdot x^{-1})} = p_{\mathbb{C}}(y) \cdot e^{i\mu_{\mathbb{C}}(y)}$.

Similarly, $q_{\mathbb{C}}(x \cdot y \cdot x^{-1}) \cdot e^{i\nu_{\mathbb{C}}(x \cdot y \cdot x^{-1})} = q_{\mathbb{C}}(y) \cdot e^{i\nu_{\mathbb{C}}(y)}$.

For falsity membership,

$$\begin{aligned} r_{\mathbb{C}}(x^{-1} \cdot y \cdot x) \cdot e^{i\omega_{\mathbb{C}}(x^{-1} \cdot y \cdot x)} &= r_{\mathbb{C}}(x^{-1} \cdot y \cdot (x^{-1})^{-1}) \cdot e^{i\omega_{\mathbb{C}}(x^{-1} \cdot y \cdot (x^{-1})^{-1})} \\ &\leq r_{\mathbb{C}}(y) \cdot e^{i\omega_{\mathbb{C}}(y)}. \end{aligned}$$

Therefore,

$$\begin{aligned} r_{\mathbb{C}}(y) \cdot e^{i\omega_{\mathbb{C}}(y)} &= r_{\mathbb{C}}(x^{-1} \cdot (x \cdot y \cdot x^{-1}) \cdot x) \cdot e^{i\omega_{\mathbb{C}}(x^{-1} \cdot (x \cdot y \cdot x^{-1}) \cdot x)} \\ &\leq r_{\mathbb{C}}(x \cdot y \cdot x^{-1}) \cdot e^{i\omega_{\mathbb{C}}(x \cdot y \cdot x^{-1})}. \end{aligned}$$

This implies that

$$r_{\mathbb{C}}(x \cdot y \cdot x^{-1}) \cdot e^{i\omega_{\mathbb{C}}(x \cdot y \cdot x^{-1})} = r_{\mathbb{C}}(y) \cdot e^{i\omega_{\mathbb{C}}(y)}.$$

Hence $\mathbb{C}(x \cdot y \cdot x^{-1}) = \mathbb{C}(y)$ for all $x, y \in \mathcal{G}$.

(2) \Rightarrow (3) : Substituting $y = y \cdot x$ in (2), the condition (3) is shown easily.

(3) \Rightarrow (1) : According to $\mathbb{C}(y \cdot x) = \mathbb{C}(x \cdot y)$, the equality

$$\mathbb{C}(x \cdot y \cdot x^{-1}) = \mathbb{C}(y \cdot x \cdot x^{-1}) = \mathbb{C}(y) \geq \mathbb{C}(y)$$

is satisfied. Hence \mathbb{C} is a CNNSG of \mathcal{G} . \square

Theorem 6.7. Let \mathbb{C} is a complex neutrosophic subgroup of a group \mathcal{G} . Then \mathbb{C} is a complex neutrosophic normal subgroup of \mathcal{G} if and only if for arbitrary $\alpha = \beta e^{i\gamma}$ where $\beta \in [0, 1], \gamma \in [0, 2\pi]$, if α -level sets of \mathbb{C} are non-empty, then $(p_{\mathbb{C}} \cdot e^{i\mu_{\mathbb{C}}})_{\alpha}, (q_{\mathbb{C}} \cdot e^{i\nu_{\mathbb{C}}})_{\alpha}$ and $(r_{\mathbb{C}} \cdot e^{i\omega_{\mathbb{C}}})_{\alpha}$ are classical subgroups of \mathcal{G} .

Proof: Similarly to the proof of Proposition 4.3. \square

Theorem 6.8. Let \mathbb{C} is a complex neutrosophic normal subgroup of a group \mathcal{G} . Let $\mathcal{G}_{\mathbb{C}} = \{x \in \mathcal{G} \mid \mathbb{C}(x)e^{i\mathbb{C}(x)} = \mathbb{C}(\hat{e})e^{i\mathbb{C}(\hat{e})}\}$, where \hat{e} is the unit of \mathcal{G} . Then the classical subset $\mathcal{G}_{\mathbb{C}}$ of \mathcal{G} is a normal subgroup of \mathcal{G} .

Proof: Let \mathbb{C} be a CNNSG of \mathcal{G} . First it is necessary to show that the classical subset $\mathcal{G}_{\mathbb{C}}$ is a subgroup of \mathcal{G} . Let us take $x, y \in \mathcal{G}_{\mathbb{C}}$, then by Theorem 3.7,

$$\begin{aligned} \mathbb{C}(x \cdot y^{-1})e^{i\mathbb{C}(x \cdot y^{-1})} &\geq \mathbb{C}(x)e^{i\mathbb{C}(x)} \wedge \mathbb{C}(y)e^{i\mathbb{C}(y)} \\ &= \mathbb{C}(\hat{e})e^{i\mathbb{C}(\hat{e})} \wedge \mathbb{C}(\hat{e})e^{i\mathbb{C}(\hat{e})} \\ &= \mathbb{C}(\hat{e})e^{i\mathbb{C}(\hat{e})} \end{aligned}$$

and always $\mathbf{C}(\hat{\rho})e^{i\mathbf{C}(\hat{\rho})} \geq \mathbf{C}(x \cdot y^{-1})e^{i\mathbf{C}(x \cdot y^{-1})}$.

Hence $x \cdot y^{-1} \in \mathcal{G}_{\mathbf{C}}$, i.e., $\mathcal{G}_{\mathbf{C}}$ is a subgroup of \mathcal{G} .

Now we will be shown that $\mathcal{G}_{\mathbf{C}}$ is normal. Take arbitrary $x \in \mathcal{G}_{\mathbf{C}}$ and $y \in \mathcal{G}$. Therefore, $\mathbf{C}(x)e^{i\mathbf{C}(x)} = \mathbf{C}(\hat{\rho})e^{i\mathbf{C}(\hat{\rho})}$. Since $\mathbf{C} \in \text{CNNSG}(\mathcal{G})$, the following is obtained,

$$\begin{aligned} \mathbf{C}(y \cdot x \cdot y^{-1})e^{i\mathbf{C}(y \cdot x \cdot y^{-1})} &= \mathbf{C}(y^{-1} \cdot y \cdot x)e^{i\mathbf{C}(y^{-1} \cdot y \cdot x)} \\ &= \mathbf{C}(x)e^{i\mathbf{C}(x)} = \mathbf{C}(\hat{\rho})e^{i\mathbf{C}(\hat{\rho})}. \end{aligned}$$

Hence, $y \cdot x \cdot y^{-1} \in \mathcal{G}_{\mathbf{C}}$, So $\mathcal{G}_{\mathbf{C}}$ is a normal subgroup of \mathcal{G} .

Theorem 6.9. Let $f : \mathcal{G}_1 \rightarrow \mathcal{G}_2$ be a group homomorphism and \mathbf{C}_2 is a CNNSG of \mathcal{G}_2 . Then the preimage $f^{-1}(\mathbf{C}_2)$ is a CNNSG of \mathcal{G}_1 .

Proof: From the Theorem 5.3, it is known that $f^{-1}(\mathbf{C}_2)$ is a complex neutrosophic subgroup of \mathcal{G}_1 . Hence it is sufficient to show that normality property of $f^{-1}(\mathbf{C}_2)$. For arbitrary $x_1, x_2 \in \mathcal{G}_1$, by homomorphism of f and by the normality of \mathbf{C}_2 ,

$$\begin{aligned} f^{-1}(\mathbf{C}_2)(x_1 \cdot x_2)e^{if^{-1}(\mathbf{C}_2)(x_1 \cdot x_2)} &= \mathbf{C}_2(f(x_1 \cdot x_2))e^{i\mathbf{C}_2(f(x_1 \cdot x_2))} \\ &= \mathbf{C}_2(f(x_1) \cdot f(x_2))e^{i\mathbf{C}_2(f(x_1) \cdot f(x_2))} \\ &= \mathbf{C}_2(f(x_2) \cdot f(x_1))e^{i\mathbf{C}_2(f(x_2) \cdot f(x_1))} \\ &= \mathbf{C}_2(f(x_2 \cdot x_1))e^{i\mathbf{C}_2(f(x_2 \cdot x_1))} \\ &= f^{-1}(\mathbf{C}_2)(x_2 \cdot x_1)e^{if^{-1}(\mathbf{C}_2)(x_2 \cdot x_1)}. \end{aligned}$$

Hence, from the Proposition 6.6, $f^{-1}(\mathbf{C}_2)$ is a CNNSG of \mathcal{G}_1 . \square

Theorem 6.10. Let $f : \mathcal{G}_1 \rightarrow \mathcal{G}_2$ be a surjective homomorphism of groups \mathcal{G}_1 and \mathcal{G}_2 . if \mathbf{C} is a CNNSG of \mathcal{G}_1 , then $f(\mathbf{C})$ is a CNNSG of \mathcal{G}_2 .

Proof: Since $f(\mathbf{C})$ is a complex neutrosophic subgroup of \mathcal{G}_2 is clear from the Theorem 5.2, it is sufficient only to show that the normality condition by using Proposition 6.6 (3). Take $y_1, y_2 \in \mathcal{G}_2$ such that $f^{-1}(y_1) \neq \phi$, $f^{-1}(y_2) \neq \phi$ and $f^{-1}(y_1 \cdot y_2^{-1}) \neq \phi$. So it is inferred that

$$f(p_{\mathbf{C}}(y_1 \cdot y_2 \cdot y_1^{-1}))e^{if(\mu_{\mathbf{C}}(y_1 \cdot y_2 \cdot y_1^{-1}))} = \bigvee_{l \in f^{-1}(y_1 \cdot y_2 \cdot y_1^{-1})} p_{\mathbf{C}}(l)e^{i\mu_{\mathbf{C}}(l)}$$

and

$$f(p_{\mathbf{C}}(y_2))e^{if(\mu_{\mathbf{C}}(y_2))} = \bigvee_{l \in f^{-1}(y_2)} p_{\mathbf{C}}(l)e^{i\mu_{\mathbf{C}}(l)}.$$

For all $x_2 \in f^{-1}(y_2)$, $x_1 \in f^{-1}(y_1)$ and $x_1^{-1} \in f^{-1}(y_1^{-1})$, since \mathbf{C} is normal,

$$\begin{aligned} p_{\mathbf{C}}(x_1 \cdot x_2 \cdot x_1^{-1})e^{i\mu_{\mathbf{C}}(x_1 \cdot x_2 \cdot x_1^{-1})} &\geq p_{\mathbf{C}}(x_2)e^{i\mu_{\mathbf{C}}(x_2)}, \\ q_{\mathbf{C}}(x_1 \cdot x_2 \cdot x_1^{-1})e^{i\nu_{\mathbf{C}}(x_1 \cdot x_2 \cdot x_1^{-1})} &\geq q_{\mathbf{C}}(x_2)e^{i\nu_{\mathbf{C}}(x_2)}, \\ r_{\mathbf{C}}(x_1 \cdot x_2 \cdot x_1^{-1})e^{i\omega_{\mathbf{C}}(x_1 \cdot x_2 \cdot x_1^{-1})} &\leq r_{\mathbf{C}}(x_2)e^{i\omega_{\mathbf{C}}(x_2)} \end{aligned}$$

are obtained.

Since f is a homomorphism, it follows that

$$f(x_1 \cdot x_2 \cdot x_1^{-1}) = f(x_1) \cdot f(x_2) \cdot f(x_1)^{-1} = y_1 \cdot y_2 \cdot y_1^{-1}.$$

So, $x_1 \cdot x_2 \cdot x_1^{-1} \in f^{-1}(y_1 \cdot y_2 \cdot y_1^{-1})$. Hence

$$\begin{aligned} \bigvee_{l \in f^{-1}(y_1 \cdot y_2 \cdot y_1^{-1})} p_{\mathbb{C}}(l)e^{i\mu_{\mathbb{C}}(l)} &\geq \bigvee_{x_1 \in f^{-1}(y_1), x_2 \in f^{-1}(y_2)} p_{\mathbb{C}}(x_1 \cdot x_2 \cdot x_1^{-1})e^{i\mu_{\mathbb{C}}(x_1 \cdot x_2 \cdot x_1^{-1})} \\ &\geq \bigvee_{x_2 \in f^{-1}(y_2)} p_{\mathbb{C}}(x_2)e^{i\mu_{\mathbb{C}}(x_2)}. \end{aligned}$$

This means that,

$$f(p_{\mathbb{C}}(y_1 \cdot y_2 \cdot y_1^{-1}))e^{if(\mu_{\mathbb{C}}(y_1 \cdot y_2 \cdot y_1^{-1}))} \geq f(p_{\mathbb{C}}(y_2))e^{if(\mu_{\mathbb{C}}(y_2))}.$$

On the other hand, the following inequalities are obtained in a similar observation.

$$f(q_{\mathbb{C}}(y_1 \cdot y_2 \cdot y_1^{-1}))e^{if(v_{\mathbb{C}}(y_1 \cdot y_2 \cdot y_1^{-1}))} \geq f(q_{\mathbb{C}}(y_2))e^{if(v_{\mathbb{C}}(y_2))},$$

$$f(r_{\mathbb{C}}(y_1 \cdot y_2 \cdot y_1^{-1}))e^{if(\omega_{\mathbb{C}}(y_1 \cdot y_2 \cdot y_1^{-1}))} \geq f(r_{\mathbb{C}}(y_2))e^{if(\omega_{\mathbb{C}}(y_2))}.$$

So the desired inequality,

$$\begin{aligned} f(\mathbb{C})(y_1 \cdot y_2 \cdot y_1^{-1})e^{if(\mathbb{C})(y_1 \cdot y_2 \cdot y_1^{-1})} &= (f(p_{\mathbb{C}}(y_1 \cdot y_2 \cdot y_1^{-1}))e^{if(\mu_{\mathbb{C}}(y_1 \cdot y_2 \cdot y_1^{-1}))}, \\ &\quad f(q_{\mathbb{C}}(y_1 \cdot y_2 \cdot y_1^{-1}))e^{if(v_{\mathbb{C}}(y_1 \cdot y_2 \cdot y_1^{-1}))}, \\ &\quad f(r_{\mathbb{C}}(y_1 \cdot y_2 \cdot y_1^{-1}))e^{if(\omega_{\mathbb{C}}(y_1 \cdot y_2 \cdot y_1^{-1}))}) \\ &\geq (f(p_{\mathbb{C}}(y_2))e^{if(\mu_{\mathbb{C}}(y_2))}, f(q_{\mathbb{C}}(y_2))e^{if(v_{\mathbb{C}}(y_2))}, \\ &\quad f(r_{\mathbb{C}}(y_2))e^{if(\omega_{\mathbb{C}}(y_2))}) \\ &= (p_{f(\mathbb{C})}(y_2)e^{i\mu_{f(\mathbb{C})}(y_2)}, q_{f(\mathbb{C})}(y_2)e^{iv_{f(\mathbb{C})}(y_2)}, \\ &\quad r_{f(\mathbb{C})}(y_2)e^{i\omega_{f(\mathbb{C})}(y_2)}) \\ &= f(\mathbb{C})(y_2)e^{if(\mathbb{C})(y_2)}, \end{aligned}$$

is satisfied. \square

7. Conclusion

In this paper we presented the concept of complex neutrosophic subgroups (normal subgroups) and alpha-cut of complex neutrosophic set, and studied some of its motivating results. We have also defined the Cartesian product of complex neutrosophic subgroups and discussed some its related results. Furthermore, we have also defined the concept of image and preimage of complex neutrosophic set and studied some of its properties. In future, we will generalized the study to soft set theory and will initiate the concept of soft complex neutrosophic subgroups (normal subgroups).

References

- [1] Zadeh, L. A. 1965. Fuzzy Sets. *Inform and Control*, 8; 338-353.
- [2] Atanassov, K. T. 1986. Intuitionistic Fuzzy Sets, *Fuzzy Sets and Systems*, 20; 87-96.
- [3] Rosenfeld, A. 1971. Fuzzy Groups. *J. Math. Anal. Appl.*, 35; 512-517.
- [4] Wang, H. et al., 2005. Single Valued Neutrosophic Sets. *Proc of 10th Int Conf on Fuzzy Theory and Technology*, Salt Lake City, Utah.
- [5] Smarandache, F. 1999. A Unifying Field in Logics. *Neutrosophy: Neutrosophic Probability, Set and logic*, Rehoboth; American Research Press.
- [6] Buckley, J. J. 1989. Fuzzy Complex Numbers. *Fuzzy Sets and Systems*. 33; 333-345.
- [7] Nguyen, H. T. Kandel, A. and Kreinovich, V. 2000. Complex Fuzzy Sets. *Towards New Foundations*, IEEE. 7803-5877.
- [8] Ramot, D. Milo, R. Friedman, M. Kandel, A. 2002. Complex fuzzy sets. *IEEE Transactionson Fuzzy Systems*. 10; 171-186.
- [9] Zhang, G. Dillon, T. S. Cai, K. Y. Ma, J. and Lu, J. 2009. Operation Properties and δ -Equalities of Complex Fuzzy Sets. *International Journal of Approximate Reasoning*, 50; 1227-1249.
- [10] Abd Ulazeez, M. Alkouri, S. and Salleh, A. R. 2012. Complex Intuitionistic Fuzzy Sets. *International Conference on Fundamental and Applied Sciences*, AIP Conference Proceedings, 1482; 464-470.
- [11] Abd Ulazeez, M. Alkouri, S. and Salleh, A. R. 2013. Complex Atanassov's Intuitionistic Fuzzy Relation. *Hindawi Publishing Corporation Abstract and Applied Analysis*, Volume 2013, Article ID 287382, 18pages.
- [12] Ali, M and Smarandache, F. 2016. Complex Neutrosophic Set. *Neural Comput & Applic*. DOI 10.1007/s00521-015-2154-y.
- [13] Cetkin, V. and Aygun, H. 2017. An Approach to Neutrosophic Subgroup and its Fundamental Properties. *Journal of Intelligent & Fuzzy Systems*, (In Press).
- [14] Turksen, I. B. (1986). Interval-Valued Fuzzy Sets Based on Normal Forms. *Fuzzy Sets and Systems* 20; 191-210.
- [15] Yaqoob, N. Akram, M. and Aslam, M. (2013). Intuitionistic fuzzy soft groups induced by (t,s) -norm. *Indian Journal of Science and Technology* 6(4); 4282-4289.

Cross Entropy Measures of Bipolar and Interval Bipolar Neutrosophic Sets and Their Application for Multi-Attribute Decision-Making

Surapati Pramanik, Partha Pratim Dey, Florentin Smarandache, Jun Ye

Surapati Pramanik, Partha Pratim Dey, Florentin Smarandache, Jun Ye (2018). Cross Entropy Measures of Bipolar and Interval Bipolar Neutrosophic Sets and Their Application for Multi-Attribute Decision-Making. *Axioms* 7, 21; DOI: 10.3390/axioms7020021

Abstract: The bipolar neutrosophic set is an important extension of the bipolar fuzzy set. The bipolar neutrosophic set is a hybridization of the bipolar fuzzy set and neutrosophic set. Every element of a bipolar neutrosophic set consists of three independent positive membership functions and three independent negative membership functions. In this paper, we develop cross entropy measures of bipolar neutrosophic sets and prove their basic properties. We also define cross entropy measures of interval bipolar neutrosophic sets and prove their basic properties. Thereafter, we develop two novel multi-attribute decision-making strategies based on the proposed cross entropy measures. In the decision-making framework, we calculate the weighted cross entropy measures between each alternative and the ideal alternative to rank the alternatives and choose the best one. We solve two illustrative examples of multi-attribute decision-making problems and compare the obtained result with the results of other existing strategies to show the applicability and effectiveness of the developed strategies. At the end, the main conclusion and future scope of research are summarized.

Keywords: neutrosophic set; bipolar neutrosophic set; interval bipolar neutrosophic set; multi-attribute decision-making; cross entropy measure

1. Introduction

Shannon and Weaver [1] and Shannon [2] proposed the entropy measure which dealt formally with communication systems at its inception. According to Shannon and Weaver [1] and Shannon [2], the entropy measure is an important decision-making apparatus for computing uncertain information. Shannon [2] introduced the concept of the cross entropy strategy in information theory.

The measure of a quantity of fuzzy information obtained from a fuzzy set or fuzzy system is termed fuzzy entropy. However, the meaning of fuzzy entropy is quite different from the classical Shannon entropy because it is defined based on a nonprobabilistic concept [3–5], while Shannon entropy is defined based on a randomness (probabilistic) concept. In 1968, Zadeh [6] extended the Shannon entropy to fuzzy entropy on a fuzzy subset with respect to the concerned probability distribution. In 1972, De Luca and Termini [7] proposed fuzzy entropy based on Shannon's function and introduced the axioms with which the fuzzy entropy should comply. Sander [8] presented Shannon fuzzy entropy and proved that the properties sharpness, valuation, and general additivity have to

be imposed on fuzzy entropy. Xie and Bedrosian [9] proposed another form of total fuzzy entropy. To overcome the drawbacks of total entropy [8,9], Pal and Pal [10] introduced hybrid entropy that can be used as an objective measure for a proper defuzzification of a certain fuzzy set. Hybrid entropy [10] considers both probabilistic entropies in the absence of fuzziness. In the same study, Pal and Pal [10] defined higher-order entropy. Kaufmann and Gupta [11] studied the degree of fuzziness of a fuzzy set by a metric distance between its membership function and the membership function (characteristic function) of its nearest crisp set. Yager [12,13] introduced a fuzzy entropy card as a fuzziness measure by observing that the intersection of a fuzzy set and its complement is not the void set. Kosko [14,15] studied the fuzzy entropy of a fuzzy set based on the fuzzy set geometry and distances between them. Parkash et al. [16] proposed two new measures of weighted fuzzy entropy.

Burillo and Bustince [17] presented an axiomatic definition of an intuitionistic fuzzy entropy measure. Szmidski and Kacprzyk [18] developed a new entropy measure based on a geometric interpretation of the intuitionistic fuzzy set (IFS). Wei et al. [19] proposed an entropy measure for interval-valued intuitionistic fuzzy sets (IVIFSs) and employed it in pattern recognition and multi criteria decision-making (MCDM). Li [20] presented a new multi-attribute decision-making (MADM) strategy combining entropy and technique for order of preference by similarity to ideal solution (TOPSIS) in the IVIFS environment.

Shang and Jiang [21] developed cross entropy in the fuzzy environment. Vlachos and Sergiadis [22] presented intuitionistic fuzzy cross entropy by extending fuzzy cross entropy [21]. Ye [23] proposed a new cross entropy in the IVIFS environment and developed an optimal decision-making strategy. Xia and Xu [24] defined a new entropy and a cross entropy and presented multi-attribute group decision-making (MAGDM) strategy in the IFS environment. Tong and Yu [25] defined cross entropy in the IVIFS environment and employed it to solve MADM problems.

Smarandache [26] introduced the neutrosophic set, which is a generalization of the fuzzy set [27] and intuitionistic fuzzy set [28]. The single-valued neutrosophic set (SVNS) [29], an instance of the neutrosophic set, has caught the attention of researchers due to its applicability in decision-making [30–61], conflict resolution [62], educational problems [63,64], image processing [65–67], cluster analysis [68,69], social problems [70,71], etc.

Majumdar and Samanta [72] proposed an entropy measure and presented an MCDM strategy in the SVNS environment. Ye [73] defined cross entropy for SVNS and proposed an MCDM strategy which bears undefined phenomena. To overcome the undefined phenomena, Ye [74] defined improved cross entropy measures for SVNSs and interval neutrosophic sets (INSs) [75], which are straightforward symmetric, and employed them to solve MADM problems. Since MADM strategies [73,74] are suitable for single-decision-maker-oriented problems, Pramanik et al. [76] defined NS-cross entropy and developed an MAGDM strategy which is straightforward symmetric and free from undefined phenomena and suitable for group decision making problem. Şahin [77] proposed two techniques to convert the interval neutrosophic information to single-valued neutrosophic information and fuzzy information. In the same study, Şahin [77] defined an interval neutrosophic cross entropy measure by utilizing two reduction methods and an MCDM strategy. Tian et al. [78] developed a transformation operator to convert interval neutrosophic numbers to single-valued neutrosophic numbers and defined cross entropy measures for two SVNSs. In the same study, Tian et al. [78] developed an MCDM strategy based on cross entropy and TOPSIS [79] where the weight of the criterion is incomplete. Tian et al. [78] defined a cross entropy for INSs and developed an MCDM strategy based on the cross entropy and TOPSIS. The MCDM strategies proposed by Şahin [77] and Tian et al. [78] are applicable for a single decision maker only. Therefore, multiple decision-makers cannot participate in the strategies in [77,78]. To tackle the problem, Dalapati et al. [80] proposed IN-cross entropy and weighted IN-cross entropy and developed an MAGDM strategy.

Deli et al. [81] proposed bipolar neutrosophic set (BNS) by hybridizing the concept of bipolar fuzzy sets [82,83] and neutrosophic sets [26]. A BNS has two fully independent parts, which are positive membership degree $T^+ \rightarrow [0, 1]$, $I^+ \rightarrow [0, 1]$, $F^+ \rightarrow [0, 1]$, and negative membership degree $T^- \rightarrow [-1, 0]$,

$I^- \rightarrow [-1, 0]$, $F^- \rightarrow [-1, 0]$, where the positive membership degrees T^+ , I^+ , F^+ represent truth membership degree, indeterminacy membership degree, and false membership degree, respectively, of an element and the negative membership degrees T^- , I^- , F^- represent truth membership degree, indeterminacy membership degree, and false membership degree, respectively, of an element to some implicit counter property corresponding to a BNS. Deli et al. [81] defined some operations, namely, score, accuracy, and certainty functions, to compare BNSs and provided some operators in order to aggregate BNSs. Deli and Subas [84] defined a correlation coefficient similarity measure for dealing with MCDM problems in a single-valued bipolar neutrosophic setting. Şahin et al. [85] proposed a Jaccard vector similarity measure for MCDM problems with single-valued neutrosophic information. Uluçay et al. [86] introduced a Dice similarity measure, weighted Dice similarity measure, hybrid vector similarity measure, and weighted hybrid vector similarity measure for BNSs and established an MCDM strategy. Dey et al. [87] investigated a TOPSIS strategy for solving multi-attribute decision-making (MADM) problems with bipolar neutrosophic information where the weights of the attributes are completely unknown to the decision-maker. Pramanik et al. [88] defined projection, bidirectional projection, and hybrid projection measures for BNSs and proved their basic properties. In the same study, Pramanik et al. [88] developed three new MADM strategies based on the proposed projection, bidirectional projection, and hybrid projection measures with bipolar neutrosophic information. Wang et al. [89] defined Frank operations of bipolar neutrosophic numbers (BNNs) and proposed Frank bipolar neutrosophic Choquet Bonferroni mean operators by combining Choquet integral operators and Bonferroni mean operators based on Frank operations of BNNs. In the same study, Wang et al. [89] established an MCDM strategy based on Frank Choquet Bonferroni operators of BNNs in a bipolar neutrosophic environment. Pramanik et al. [90] developed a Tomada de decisao interativa e multicritério (TODIM) strategy for MAGDM in a bipolar neutrosophic environment. An MADM strategy based on cross entropy for BNSs is yet to appear in the literature.

Mahmood et al. [91] and Deli et al. [92] introduced the hybridized structure called interval bipolar neutrosophic sets (IBNSs) by combining BNSs and INNs and defined some operations and operators for IBNSs. An MADM strategy based on cross entropy for IBNSs is yet to appear in the literature.

Research gap:

An MADM strategy based on cross entropy for BNSs and an MADM strategy based on cross entropy for IBNSs.

This paper answers the following research questions:

- i. Is it possible to define a new cross entropy measure for BNSs?
- ii. Is it possible to define a new weighted cross entropy measure for BNSs?
- iii. Is it possible to develop a new MADM strategy based on the proposed cross entropy measure in a BNS environment?
- iv. Is it possible to develop a new MADM strategy based on the proposed weighted cross entropy measure in a BNS environment?
- v. Is it possible to define a new cross entropy measure for IBNSs?
- vi. Is it possible to define a new weighted cross entropy measure for IBNSs?
- vii. Is it possible to develop a new MADM strategy based on the proposed cross entropy measure in an IBNS environment?
- viii. Is it possible to develop a new MADM strategy based on the proposed weighted cross entropy measure in an IBNS environment?

Motivation:

The above-mentioned analysis presents the motivation behind proposing a cross-entropy-based strategy for tackling MADM in BNS and IBNS environments. This study develops two novel cross-entropy-based MADM strategies.

The objectives of the paper are:

1. To define a new cross entropy measure and prove its basic properties.
2. To define a new weighted cross measure and prove its basic properties.
3. To develop a new MADM strategy based on the weighted cross entropy measure in a BNS environment.
4. To develop a new MADM strategy based on the weighted cross entropy measure in an IBNS environment.

To fill the research gap, we propose a cross-entropy-based MADM strategy in the BNS environment and the IBNS environment.

The main contributions of this paper are summarized below:

1. We propose a new cross entropy measure in the BNS environment and prove its basic properties.
2. We propose a new weighted cross entropy measure in the IBNS environment and prove its basic properties.
3. We develop a new MADM strategy based on weighted cross entropy to solve MADM problems in a BNS environment.
4. We develop a new MADM strategy based on weighted cross entropy to solve MADM problems in an IBNS environment.
5. Two illustrative numerical examples are solved and a comparison analysis is provided.

The rest of the paper is organized as follows. In Section 2, we present some concepts regarding SVNSSs, INSSs, BNSs, and IBNSs. Section 3 proposes cross entropy and weighted cross entropy measures for BNSs and investigates their properties. In Section 4, we extend the cross entropy measures for BNSs to cross entropy measures for IBNSs and discuss their basic properties. Two novel MADM strategies based on the proposed cross entropy measures in bipolar and interval bipolar neutrosophic settings are presented in Section 5. In Section 6, two numerical examples are solved and a comparison with other existing methods is provided. In Section 7, conclusions and the scope of future work are provided.

2. Preliminary

In this section, we provide some basic definitions regarding SVNSSs, INSSs, BNSs, and IBNSs.

2.1. Single-Valued Neutrosophic Sets

An SVNSS [29] S in U is characterized by a truth membership function $T_S(x)$, an indeterminate membership function $I_S(x)$, and a falsity membership function $F_S(x)$. An SVNSS S over U is defined by

$$S = \{x, \langle T_S(x), I_S(x), F_S(x) \rangle | x \in U\}$$

where, $T_S(x), I_S(x), F_S(x): U \rightarrow [0, 1]$ and $0 \leq T_S(x) + I_S(x) + F_S(x) \leq 3$ for each point $x \in U$.

2.2. Interval Neutrosophic Set

An interval neutrosophic set [75] P in U is expressed as given below:

$$P = \{x, \langle T_P(x), I_P(x), F_P(x) \rangle | x \in U\}$$

$$= \{x, [\inf T_P(x), \sup T_P(x)]; [\inf I_P(x), \sup I_P(x)]; [\inf F_P(x), \sup F_P(x)] | x \in U\}$$

where $T_P(x), I_P(x), F_P(x)$ are the truth membership function, indeterminacy membership function, and falsity membership function, respectively. For each point x in U , $T_P(x), I_P(x), F_P(x) \subseteq [0, 1]$ satisfying the condition $0 \leq \sup T_P(x) + \sup I_P(x) + \sup F_P(x) \leq 3$.

2.3. Bipolar Neutrosophic Set

A BNS [81] E in U is presented as given below:

$$E = \{x, \langle T_E^+(x), I_E^+(x), F_E^+(x), T_E^-(x), I_E^-(x), F_E^-(x) \rangle | x \in U\}$$

where $T_E^+(x), I_E^+(x), F_E^+(x): U \rightarrow [0, 1]$ and $T_E^-(x), I_E^-(x), F_E^-(x): U \rightarrow [-1, 0]$. Here, $T_E^+(x), I_E^+(x), F_E^+(x)$ denote the truth membership, indeterminate membership, and falsity membership functions corresponding to BNS E on an element $x \in U$, and $T_E^-(x), I_E^-(x), F_E^-(x)$ denote the truth membership, indeterminate membership, and falsity membership of an element $x \in U$ to some implicit counter property corresponding to E .

Definition 1. Ref. [81]: Let, $E_1 = \{x, \langle T_{E_1}^+(x), I_{E_1}^+(x), F_{E_1}^+(x), T_{E_1}^-(x), I_{E_1}^-(x), F_{E_1}^-(x) \rangle | x \in U\}$ and $E_2 = \{x, \langle T_{E_2}^+(x), I_{E_2}^+(x), F_{E_2}^+(x), T_{E_2}^-(x), I_{E_2}^-(x), F_{E_2}^-(x) \rangle | x \in X\}$ be any two BNSs. Then

- $E_1 \subseteq E_2$ if, and only if,

$T_{E_1}^+(x) \leq T_{E_2}^+(x), I_{E_1}^+(x) \leq I_{E_2}^+(x), F_{E_1}^+(x) \geq F_{E_2}^+(x); T_{E_1}^-(x) \geq T_{E_2}^-(x), I_{E_1}^-(x) \geq I_{E_2}^-(x), F_{E_1}^-(x) \leq F_{E_2}^-(x)$ for all $x \in U$.

- $E_1 = E_2$ if, and only if,

$T_{E_1}^+(x) = T_{E_2}^+(x), I_{E_1}^+(x) = I_{E_2}^+(x), F_{E_1}^+(x) = F_{E_2}^+(x); T_{E_1}^-(x) = T_{E_2}^-(x), I_{E_1}^-(x) = I_{E_2}^-(x), F_{E_1}^-(x) = F_{E_2}^-(x)$ for all $x \in U$.

- The complement of E is $E^c = \{x, \langle T_{E^c}^+(x), I_{E^c}^+(x), F_{E^c}^+(x), T_{E^c}^-(x), I_{E^c}^-(x), F_{E^c}^-(x) \rangle | x \in U\}$

where

$$\begin{aligned} T_{E^c}^+(x) &= F_E^+(x), I_{E^c}^+(x) = 1 - I_E^+(x), F_{E^c}^+(x) = T_E^+(x); \\ T_{E^c}^-(x) &= F_E^-(x), I_{E^c}^-(x) = -1 - I_E^-(x), F_{E^c}^-(x) = T_E^-(x). \end{aligned}$$

- The union $E_1 \cup E_2$ is defined as follows:

$E_1 \cup E_2 = \{Max (T_{E_1}^+(x), T_{E_2}^+(x)), Min (I_{E_1}^+(x), I_{E_2}^+(x)), Min (F_{E_1}^+(x), F_{E_2}^+(x)), Min (T_{E_1}^-(x), T_{E_2}^-(x)), Max (I_{E_1}^-(x), I_{E_2}^-(x)), Max (F_{E_1}^-(x), F_{E_2}^-(x))\}, \forall x \in U$.

- The intersection $E_1 \cap E_2$ [88] is defined as follows:

$E_1 \cap E_2 = \{Min (T_{E_1}^+(x), T_{E_2}^+(x)), Max (I_{E_1}^+(x), I_{E_2}^+(x)), Max (F_{E_1}^+(x), F_{E_2}^+(x)), Max (T_{E_1}^-(x), T_{E_2}^-(x)), Min (I_{E_1}^-(x), I_{E_2}^-(x)), Min (F_{E_1}^-(x), F_{E_2}^-(x))\}, \forall x \in U$.

2.4. Interval Bipolar Neutrosophic Sets

An IBNS [91,92] $R = \{x, \langle [infT_R^+(x), supT_R^+(x)]; [infI_R^+(x), supI_R^+(x)]; [infF_R^+(x), supF_R^+(x)]; [infT_R^-(x), supT_R^-(x)]; [infI_R^-(x), supI_R^-(x)]; [infF_R^-(x), supF_R^-(x)] \rangle | x \in U\}$ is characterized by positive and negative truth membership functions $T_R^+(x), T_R^-(x)$, respectively; positive and negative indeterminacy membership functions $I_R^+(x), I_R^-(x)$, respectively; and positive and negative falsity membership functions $F_R^+(x), F_R^-(x)$, respectively. Here, for any $x \in U, T_R^+(x), I_R^+(x), F_R^+(x) \subseteq [0, 1]$ and $T_R^-(x), I_R^-(x), F_R^-(x) \subseteq [-1, 0]$ with the conditions $0 \leq supT_R^+(x) + supI_R^+(x) + supF_R^+(x) \leq 3$ and $-3 \leq supT_R^-(x) + supI_R^-(x) + supF_R^-(x) \leq 0$.

Definition 2. Ref. [91,92]: Let $R = \{x, \langle [infT_R^+(x), supT_R^+(x)]; [infI_R^+(x), supI_R^+(x)]; [infF_R^+(x), supF_R^+(x)]; [infT_R^-(x), supT_R^-(x)]; [infI_R^-(x), supI_R^-(x)]; [infF_R^-(x), supF_R^-(x)] \rangle | x \in U\}$ and $S = \{x, \langle [infT_S^+(x), supT_S^+(x)]; [infI_S^+(x), supI_S^+(x)]; [infF_S^+(x), supF_S^+(x)]; [infT_S^-(x), supT_S^-(x)]; [infI_S^-(x), supI_S^-(x)]; [infF_S^-(x), supF_S^-(x)] \rangle | x \in U\}$ be two IBNSs in U . Then

- $R \subseteq S$ if, and only if,

$$\inf T_R^+(x) \leq \inf T_S^+(x), \sup T_R^+(x) \leq \sup T_S^+(x),$$

$$\inf I_R^+(x) \geq \inf I_S^+(x), \sup I_R^+(x) \geq \sup I_S^+(x),$$

$$\inf F_R^+(x) \geq \inf F_S^+(x), \sup F_R^+(x) \geq \sup F_S^+(x),$$

$$\inf T_R^-(x) \geq \inf T_S^-(x), \sup T_R^-(x) \geq \sup T_S^-(x),$$

$$\inf I_R^-(x) \leq \inf I_S^-(x), \sup I_R^-(x) \leq \sup I_S^-(x),$$

$$\inf F_R^-(x) \leq \inf F_S^-(x), \sup F_R^-(x) \leq \sup F_S^-(x),$$

for all $x \in U$.
- $R = S$ if, and only if,

$$\inf T_R^+(x) = \inf T_S^+(x), \sup T_R^+(x) = \sup T_S^+(x), \inf I_R^+(x) = \inf I_S^+(x), \sup I_R^+(x) = \sup I_S^+(x),$$

$$\inf F_R^+(x) = \inf F_S^+(x), \sup F_R^+(x) = \sup F_S^+(x), \inf T_R^-(x) = \inf T_S^-(x), \sup T_R^-(x) = \sup T_S^-(x),$$

$$\inf I_R^-(x) = \inf I_S^-(x), \sup I_R^-(x) = \sup I_S^-(x), \inf F_R^-(x) = \inf F_S^-(x), \sup F_R^-(x) = \sup F_S^-(x),$$

for all $x \in U$.
- The complement of R is defined as $R^C = \{x, < [\inf T_{R^C}^+(x), \sup T_{R^C}^+(x)]; [\inf I_{R^C}^+(x), \sup I_{R^C}^+(x)]; [\inf F_{R^C}^+(x), \sup F_{R^C}^+(x)]; [\inf T_{R^C}^-(x), \sup T_{R^C}^-(x)]; [\inf I_{R^C}^-(x), \sup I_{R^C}^-(x)]; [\inf F_{R^C}^-(x), \sup F_{R^C}^-(x)] > | x \in U\}$ where

$$\inf T_{R^C}^+(x) = \inf F_R^+(x), \sup T_{R^C}^+(x) = \sup F_R^+(x)$$

$$\inf I_{R^C}^+(x) = 1 - \sup I_R^+(x), \sup I_{R^C}^+(x) = 1 - \inf I_R^+(x)$$

$$\inf F_{R^C}^+(x) = \inf T_R^+, \sup F_{R^C}^+(x) = \sup T_R^+$$

$$\inf T_{R^C}^-(x) = \inf F_R^-, \sup T_{R^C}^-(x) = \sup F_R^-$$

$$\inf I_{R^C}^-(x) = -1 - \sup I_R^-(x), \sup I_{R^C}^-(x) = -1 - \inf I_R^-(x)$$

$$\inf F_{R^C}^-(x) = \inf T_R^-(x), \sup F_{R^C}^-(x) = \sup T_R^-(x)$$

for all $x \in U$.

3. Cross Entropy Measures of Bipolar Neutrosophic Sets

In this section we define a cross entropy measure between two BNSs and establish some of its basic properties.

Definition 3. For any two BNSs M and N in U , the cross entropy measure can be defined as follows.

$$C_B(M, N) = \sum_{i=1}^n \left[\begin{aligned} & \sqrt{\frac{T_M^+(x_i) + T_N^+(x_i)}{2}} - \left(\frac{\sqrt{T_M^+(x_i)} + \sqrt{T_N^+(x_i)}}{2} \right) + \sqrt{\frac{I_M^+(x_i) + I_N^+(x_i)}{2}} - \left(\frac{\sqrt{I_M^+(x_i)} + \sqrt{I_N^+(x_i)}}{2} \right) + \\ & \sqrt{\frac{(1-I_M^+(x_i)) + (1-I_N^+(x_i))}{2}} - \left(\frac{\sqrt{(1-I_M^+(x_i))} + \sqrt{(1-I_N^+(x_i))}}{2} \right) + \sqrt{\frac{F_M^+(x_i) + F_N^+(x_i)}{2}} - \left(\frac{\sqrt{F_M^+(x_i)} + \sqrt{F_N^+(x_i)}}{2} \right) + \\ & \sqrt{\frac{-(T_M^-(x_i) + T_N^-(x_i))}{2}} - \left(\frac{\sqrt{-(T_M^-(x_i))} + \sqrt{-(T_N^-(x_i))}}{2} \right) + \sqrt{\frac{-(I_M^-(x_i) + I_N^-(x_i))}{2}} - \left(\frac{\sqrt{-(I_M^-(x_i))} + \sqrt{-(I_N^-(x_i))}}{2} \right) + \\ & \sqrt{\frac{(1+I_M^-(x_i)) + (1+I_N^-(x_i))}{2}} - \left(\frac{\sqrt{1+I_M^-(x_i)} + \sqrt{1+I_N^-(x_i)}}{2} \right) + \sqrt{\frac{-(F_M^-(x_i) + F_N^-(x_i))}{2}} - \left(\frac{\sqrt{-(F_M^-(x_i))} + \sqrt{-(F_N^-(x_i))}}{2} \right) \end{aligned} \right] \quad (1)$$

Theorem 1. If $M = \langle T_M^+(x_i), I_M^+(x_i), F_M^+(x_i), T_M^-(x_i), I_M^-(x_i), F_M^-(x_i) \rangle$ and $N = \langle T_N^+(x_i), I_N^+(x_i), F_N^+(x_i), T_N^-(x_i), I_N^-(x_i), F_N^-(x_i) \rangle$ are two BNSs in U , then the cross entropy measure $C_B(M, N)$ satisfies the following properties:

- (1) $C_B(M, N) \geq 0$;
- (2) $C_B(M, N) = 0$ if, and only if, $T_M^+(x_i) = T_N^+(x_i), I_M^+(x_i) = I_N^+(x_i), F_M^+(x_i) = F_N^+(x_i), T_M^-(x_i) = T_N^-(x_i), I_M^-(x_i) = I_N^-(x_i), F_M^-(x_i) = F_N^-(x_i), \forall x \in U$;
- (3) $C_B(M, N) = C_B(N, M)$;
- (4) $C_B(M, N) = C_B(M^C, N^C)$.

Proof

- (1) We have the inequality $\left(\frac{a+b}{2}\right)^{\frac{1}{2}} \geq \frac{a^{\frac{1}{2}}+b^{\frac{1}{2}}}{2}$ for all positive numbers a and b . From the inequality we can easily obtain $C_B(M, N) \geq 0$.
- (2) The inequality $\left(\frac{a+b}{2}\right)^{\frac{1}{2}} \geq \frac{a^{\frac{1}{2}}+b^{\frac{1}{2}}}{2}$ becomes the equality $\left(\frac{a+b}{2}\right)^{\frac{1}{2}} = \frac{a^{\frac{1}{2}}+b^{\frac{1}{2}}}{2}$ if, and only if, $a = b$ and therefore $C_B(M, N) = 0$ if, and only if, $M = N$, i.e., $T_M^+(x_i) = T_N^+(x_i), I_M^+(x_i) = I_N^+(x_i), F_M^+(x_i) = F_N^+(x_i), T_M^-(x_i) = T_N^-(x_i), I_M^-(x_i) = I_N^-(x_i), F_M^-(x_i) = F_N^-(x_i) \forall x \in U$.

$$\begin{aligned}
 (3) \quad C_B(M, N) &= \sum_{i=1}^n \left[\begin{aligned} &\sqrt{\frac{T_M^+(x_i)+T_N^+(x_i)}{2}} - \left(\frac{\sqrt{T_M^+(x_i)}+\sqrt{T_N^+(x_i)}}{2} \right) + \sqrt{\frac{I_M^+(x_i)+I_N^+(x_i)}{2}} - \left(\frac{\sqrt{I_M^+(x_i)}+\sqrt{I_N^+(x_i)}}{2} \right) + \\ &\sqrt{\frac{(1-I_M^+(x_i))+(1-I_N^+(x_i))}{2}} - \left(\frac{\sqrt{(1-I_M^+(x_i))}+\sqrt{(1-I_N^+(x_i))}}{2} \right) + \sqrt{\frac{F_M^+(x_i)+F_N^+(x_i)}{2}} - \left(\frac{\sqrt{F_M^+(x_i)}+\sqrt{F_N^+(x_i)}}{2} \right) + \\ &\sqrt{\frac{-(T_M^-(x_i)+T_N^-(x_i))}{2}} - \left(\frac{\sqrt{-(T_M^-(x_i))}+\sqrt{-(T_N^-(x_i))}}{2} \right) + \sqrt{\frac{-(I_M^-(x_i)+I_N^-(x_i))}{2}} - \left(\frac{\sqrt{-(I_M^-(x_i))}+\sqrt{-(I_N^-(x_i))}}{2} \right) + \\ &\sqrt{\frac{(1+I_M^-(x_i))+(1+I_N^-(x_i))}{2}} - \left(\frac{\sqrt{1+I_M^-(x_i)}+\sqrt{1+I_N^-(x_i)}}{2} \right) + \sqrt{\frac{-(F_M^-(x_i)+F_N^-(x_i))}{2}} - \left(\frac{\sqrt{-(F_M^-(x_i))}+\sqrt{-(F_N^-(x_i))}}{2} \right) \end{aligned} \right] \\
 &= \sum_{i=1}^n \left[\begin{aligned} &\sqrt{\frac{T_N^+(x_i)+T_M^+(x_i)}{2}} - \left(\frac{\sqrt{T_N^+(x_i)}+\sqrt{T_M^+(x_i)}}{2} \right) + \sqrt{\frac{I_N^+(x_i)+I_M^+(x_i)}{2}} - \left(\frac{\sqrt{I_N^+(x_i)}+\sqrt{I_M^+(x_i)}}{2} \right) + \\ &\sqrt{\frac{(1-I_N^+(x_i))+(1-I_M^+(x_i))}{2}} - \left(\frac{\sqrt{(1-I_N^+(x_i))}+\sqrt{(1-I_M^+(x_i))}}{2} \right) + \sqrt{\frac{F_N^+(x_i)+F_M^+(x_i)}{2}} - \left(\frac{\sqrt{F_N^+(x_i)}+\sqrt{F_M^+(x_i)}}{2} \right) + \\ &\sqrt{\frac{-(T_N^-(x_i)+T_M^-(x_i))}{2}} - \left(\frac{\sqrt{-(T_N^-(x_i))}+\sqrt{-(T_M^-(x_i))}}{2} \right) + \sqrt{\frac{-(I_N^-(x_i)+I_M^-(x_i))}{2}} - \left(\frac{\sqrt{-(I_N^-(x_i))}+\sqrt{-(I_M^-(x_i))}}{2} \right) + \\ &\sqrt{\frac{(1+I_N^-(x_i))+(1+I_M^-(x_i))}{2}} - \left(\frac{\sqrt{1+I_N^-(x_i)}+\sqrt{1+I_M^-(x_i)}}{2} \right) + \sqrt{\frac{-(F_N^-(x_i)+F_M^-(x_i))}{2}} - \left(\frac{\sqrt{-(F_N^-(x_i))}+\sqrt{-(F_M^-(x_i))}}{2} \right) \end{aligned} \right] = C_B(N, M).
 \end{aligned}$$

$$\begin{aligned}
 (4) \quad C_B(M^C, N^C) &= \sum_{i=1}^n \left[\begin{aligned} &\sqrt{\frac{F_M^+(x_i)+F_N^+(x_i)}{2}} - \left(\frac{\sqrt{F_M^+(x_i)}+\sqrt{F_N^+(x_i)}}{2} \right) + \sqrt{\frac{(1-I_M^+(x_i))+(1-I_N^+(x_i))}{2}} - \left(\frac{\sqrt{(1-I_M^+(x_i))}+\sqrt{(1-I_N^+(x_i))}}{2} \right) + \\ &\sqrt{\frac{1-(1-I_M^+(x_i))+1-(1-I_N^+(x_i))}{2}} - \left(\frac{\sqrt{1-(1-I_M^+(x_i))}+\sqrt{1-(1-I_N^+(x_i))}}{2} \right) + \sqrt{\frac{T_M^+(x_i)+T_N^+(x_i)}{2}} - \left(\frac{\sqrt{T_M^+(x_i)}+\sqrt{T_N^+(x_i)}}{2} \right) + \\ &\sqrt{\frac{-(F_M^-(x_i)+F_N^-(x_i))}{2}} - \left(\frac{\sqrt{-(F_M^-(x_i))}+\sqrt{-(F_N^-(x_i))}}{2} \right) + \sqrt{\frac{-(-1-I_M^-(x_i))-(-1-I_N^-(x_i))}{2}} - \left(\frac{\sqrt{-(-1-I_M^-(x_i))}+\sqrt{-(-1-I_N^-(x_i))}}{2} \right) + \\ &\sqrt{\frac{1+(-1-I_M^-(x_i))+1+(-1-I_N^-(x_i))}{2}} - \left(\frac{\sqrt{1+(-1-I_M^-(x_i))}+\sqrt{1+(-1-I_N^-(x_i))}}{2} \right) + \sqrt{\frac{-(T_M^-(x_i)+T_N^-(x_i))}{2}} - \left(\frac{\sqrt{-(T_M^-(x_i))}+\sqrt{-(T_N^-(x_i))}}{2} \right) \end{aligned} \right] \\
 &= \sum_{i=1}^n \left[\begin{aligned} &\sqrt{\frac{T_M^+(x_i)+T_N^+(x_i)}{2}} - \left(\frac{\sqrt{T_M^+(x_i)}+\sqrt{T_N^+(x_i)}}{2} \right) + \sqrt{\frac{I_M^+(x_i)+I_N^+(x_i)}{2}} - \left(\frac{\sqrt{I_M^+(x_i)}+\sqrt{I_N^+(x_i)}}{2} \right) + \\ &\sqrt{\frac{(1-I_M^+(x_i))+(1-I_N^+(x_i))}{2}} - \left(\frac{\sqrt{(1-I_M^+(x_i))}+\sqrt{(1-I_N^+(x_i))}}{2} \right) + \sqrt{\frac{F_M^+(x_i)+F_N^+(x_i)}{2}} - \left(\frac{\sqrt{F_M^+(x_i)}+\sqrt{F_N^+(x_i)}}{2} \right) + \\ &\sqrt{\frac{-(T_M^-(x_i)+T_N^-(x_i))}{2}} - \left(\frac{\sqrt{-(T_M^-(x_i))}+\sqrt{-(T_N^-(x_i))}}{2} \right) + \sqrt{\frac{-(I_M^-(x_i)+I_N^-(x_i))}{2}} - \left(\frac{\sqrt{-(I_M^-(x_i))}+\sqrt{-(I_N^-(x_i))}}{2} \right) + \\ &\sqrt{\frac{(1+I_M^-(x_i))+(1+I_N^-(x_i))}{2}} - \left(\frac{\sqrt{1+I_M^-(x_i)}+\sqrt{1+I_N^-(x_i)}}{2} \right) + \sqrt{\frac{-(F_M^-(x_i)+F_N^-(x_i))}{2}} - \left(\frac{\sqrt{-(F_M^-(x_i))}+\sqrt{-(F_N^-(x_i))}}{2} \right) \end{aligned} \right] = C_B(M, N).
 \end{aligned}$$

The proof is completed. \square

Example 1. Suppose that $M = \langle 0.7, 0.3, 0.4, -0.3, -0.5, -0.1 \rangle$ and $N = \langle 0.5, 0.2, 0.5, -0.3, -0.3, -0.2 \rangle$ are two BNSs; then the cross entropy between M and N is calculated as follows:

$$C_B(M, N) = \left[\begin{aligned} & \sqrt{\frac{0.7+0.5}{2}} - \left(\frac{\sqrt{0.7}+\sqrt{0.5}}{2} \right) + \sqrt{\frac{0.3+0.2}{2}} - \left(\frac{\sqrt{0.3}+\sqrt{0.2}}{2} \right) + \sqrt{\frac{(1-0.3)+(1-0.2)}{2}} - \left(\frac{\sqrt{1-0.3}+\sqrt{1-0.2}}{2} \right) + \sqrt{\frac{0.4+0.5}{2}} - \\ & \left(\frac{\sqrt{0.4}+\sqrt{0.5}}{2} \right) + \sqrt{\frac{-(-0.3-0.3)}{2}} - \left(\frac{\sqrt{-(-0.3)}+\sqrt{-(-0.3)}}{2} \right) + \sqrt{\frac{-(-0.5-0.3)}{2}} - \left(\frac{\sqrt{-(-0.5)}+\sqrt{-(-0.3)}}{2} \right) \\ & + \sqrt{\frac{(1-0.5)+(1-0.3)}{2}} - \left(\frac{\sqrt{1-0.5}+\sqrt{1-0.3}}{2} \right) + \sqrt{\frac{-(-0.1-0.2)}{2}} - \left(\frac{\sqrt{-(-0.1)}+\sqrt{-(-0.2)}}{2} \right) \end{aligned} \right] = 0.01738474.$$

Definition 4. Suppose that w_i is the weight of each element $x_i, i = 1, 2, \dots, n$, where $w_i \in [0, 1]$ and $\sum_{i=1}^n w_i = 1$; then the weighted cross entropy measure between any two BNSs M and N in U can be defined as follows.

$$C_B(M, N)_w = \sum_{i=1}^n w_i \left[\begin{aligned} & \sqrt{\frac{T_M^+(x_i)+T_N^+(x_i)}{2}} - \left(\frac{\sqrt{T_M^+(x_i)}+\sqrt{T_N^+(x_i)}}{2} \right) + \sqrt{\frac{I_M^+(x_i)+I_N^+(x_i)}{2}} - \left(\frac{\sqrt{I_M^+(x_i)}+\sqrt{I_N^+(x_i)}}{2} \right) + \\ & \sqrt{\frac{(1-I_M^+(x_i))+ (1-I_N^+(x_i))}{2}} - \left(\frac{\sqrt{1-I_M^+(x_i)}+\sqrt{1-I_N^+(x_i)}}{2} \right) + \sqrt{\frac{F_M^+(x_i)+F_N^+(x_i)}{2}} - \left(\frac{\sqrt{F_M^+(x_i)}+\sqrt{F_N^+(x_i)}}{2} \right) + \\ & \sqrt{\frac{(-T_M^-(x_i))+(-T_N^-(x_i))}{2}} - \left(\frac{\sqrt{-T_M^-(x_i)}+\sqrt{-T_N^-(x_i)}}{2} \right) + \sqrt{\frac{(-I_M^-(x_i))+(-I_N^-(x_i))}{2}} - \left(\frac{\sqrt{-I_M^-(x_i)}+\sqrt{-I_N^-(x_i)}}{2} \right) + \\ & \sqrt{\frac{(1+I_M^-(x_i))+ (1+I_N^-(x_i))}{2}} - \left(\frac{\sqrt{1+I_M^-(x_i)}+\sqrt{1+I_N^-(x_i)}}{2} \right) + \sqrt{\frac{(-F_M^-(x_i))+(-F_N^-(x_i))}{2}} - \left(\frac{\sqrt{-F_M^-(x_i)}+\sqrt{-F_N^-(x_i)}}{2} \right) \end{aligned} \right] \quad (2)$$

Theorem 2. If $M = \langle T_M^+(x_i), I_M^+(x_i), F_M^+(x_i), T_M^-(x_i), I_M^-(x_i), F_M^-(x_i) \rangle$ and $N = \langle T_N^+(x_i), I_N^+(x_i), F_N^+(x_i), T_N^-(x_i), I_N^-(x_i), F_N^-(x_i) \rangle$ are two BNSs in U , then the weighted cross entropy measure $C_B(M, N)_w$ satisfies the following properties:

- (1) $C_B(M, N)_w \geq 0$;
- (2) $C_B(M, N)_w = 0$ if, and only if, $T_M^+(x_i) = T_N^+(x_i), I_M^+(x_i) = I_N^+(x_i), F_M^+(x_i) = F_N^+(x_i), T_M^-(x_i) = T_N^-(x_i), I_M^-(x_i) = I_N^-(x_i), F_M^-(x_i) = F_N^-(x_i), \forall x \in U$;
- (3) $C_B(M, N)_w = C_B(N, M)_w$;
- (4) $C_B(M^C, N^C)_w = C_B(M, N)_w$.

Proof is given in Appendix A.

Example 2. Suppose that $M = \langle 0.7, 0.3, 0.4, -0.3, -0.5, -0.1 \rangle$ and $N = \langle 0.5, 0.2, 0.5, -0.3, -0.3, -0.2 \rangle$ are two BNSs and $w = 0.4$; then the weighted cross entropy between M and N is calculated as given below.

$$C_B(M, N)_w = 0.4 \times \left[\begin{aligned} & \sqrt{\frac{0.7+0.5}{2}} - \left(\frac{\sqrt{0.7}+\sqrt{0.5}}{2} \right) + \sqrt{\frac{0.3+0.2}{2}} - \left(\frac{\sqrt{0.3}+\sqrt{0.2}}{2} \right) + \sqrt{\frac{(1-0.3)+(1-0.2)}{2}} - \left(\frac{\sqrt{1-0.3}+\sqrt{1-0.2}}{2} \right) \\ & + \sqrt{\frac{0.4+0.5}{2}} - \left(\frac{\sqrt{0.4}+\sqrt{0.5}}{2} \right) + \sqrt{\frac{-(-0.3-0.3)}{2}} - \left(\frac{\sqrt{-(-0.3)}+\sqrt{-(-0.3)}}{2} \right) + \sqrt{\frac{-(-0.5-0.3)}{2}} - \left(\frac{\sqrt{-(-0.5)}+\sqrt{-(-0.3)}}{2} \right) \\ & + \sqrt{\frac{(1-0.5)+(1-0.3)}{2}} - \left(\frac{\sqrt{1-0.5}+\sqrt{1-0.3}}{2} \right) + \sqrt{\frac{-(-0.1-0.2)}{2}} - \left(\frac{\sqrt{-(-0.1)}+\sqrt{-(-0.2)}}{2} \right) \end{aligned} \right] = 0.006953896.$$

4. Cross Entropy Measure of IBNSs

This section extends the concepts of cross entropy and weighted cross entropy measures of BNSs to IBNSs.

Definition 5. The cross entropy measure between any two IBNSs $R = \langle [\inf T_R^+(x_i), \sup T_R^+(x_i)], [\inf I_R^+(x_i), \sup I_R^+(x_i)], [\inf F_R^+(x_i), \sup F_R^+(x_i)], [\inf T_R^-(x_i), \sup T_R^-(x_i)], [\inf I_R^-(x_i), \sup I_R^-(x_i)], [\inf F_R^-(x_i), \sup F_R^-(x_i)] \rangle$

$supF_R^-(x_i)] >$ and $S = \langle [infT_S^+(x_i), supT_S^+(x_i)], [infI_S^+(x_i), supI_S^+(x_i)], [infF_S^+(x_i), supF_S^+(x_i)], [infT_S^-(x_i), supT_S^-(x_i)], [infI_S^-(x_i), supI_S^-(x_i)], [infF_S^-(x_i), supF_S^-(x_i)] \rangle$ in U can be defined as follows.

$$C_{IB}(R, S) = \frac{1}{2} \sum_{i=1}^n \left[\begin{aligned} & \sqrt{\frac{infT_R^+(x_i) + infT_S^+(x_i)}{2}} - \left(\frac{\sqrt{infT_R^+(x_i)} + \sqrt{infT_S^+(x_i)}}{2} \right) + \sqrt{\frac{supT_R^+(x_i) + supT_S^+(x_i)}{2}} - \left(\frac{\sqrt{supT_R^+(x_i)} + \sqrt{supT_S^+(x_i)}}{2} \right) + \\ & \sqrt{\frac{infI_R^+(x_i) + infI_S^+(x_i)}{2}} - \left(\frac{\sqrt{infI_R^+(x_i)} + \sqrt{infI_S^+(x_i)}}{2} \right) + \sqrt{\frac{supI_R^+(x_i) + supI_S^+(x_i)}{2}} - \left(\frac{\sqrt{supI_R^+(x_i)} + \sqrt{supI_S^+(x_i)}}{2} \right) + \\ & \sqrt{\frac{(1 - infT_R^+(x_i)) + (1 - infT_S^+(x_i))}{2}} - \left(\frac{\sqrt{1 - infT_R^+(x_i)} + \sqrt{1 - infT_S^+(x_i)}}{2} \right) + \sqrt{\frac{(1 - supT_R^+(x_i)) + (1 - supT_S^+(x_i))}{2}} - \\ & \left(\frac{\sqrt{1 - supT_R^+(x_i)} + \sqrt{1 - supT_S^+(x_i)}}{2} \right) + \sqrt{\frac{infF_R^+(x_i) + infF_S^+(x_i)}{2}} - \left(\frac{\sqrt{infF_R^+(x_i)} + \sqrt{infF_S^+(x_i)}}{2} \right) + \\ & \sqrt{\frac{supF_R^+(x_i) + supF_S^+(x_i)}{2}} - \left(\frac{\sqrt{supF_R^+(x_i)} + \sqrt{supF_S^+(x_i)}}{2} \right) + \sqrt{\frac{-(infT_R^-(x_i)) + -(infT_S^-(x_i))}{2}} - \\ & \left(\frac{\sqrt{-(infT_R^-(x_i))} + \sqrt{-(infT_S^-(x_i))}}{2} \right) + \sqrt{\frac{-(supT_R^-(x_i)) + -(supT_S^-(x_i))}{2}} - \left(\frac{\sqrt{-(supT_R^-(x_i))} + \sqrt{-(supT_S^-(x_i))}}{2} \right) + \\ & \sqrt{\frac{-(infI_R^-(x_i)) + -(infI_S^-(x_i))}{2}} - \left(\frac{\sqrt{-(infI_R^-(x_i))} + \sqrt{-(infI_S^-(x_i))}}{2} \right) + \sqrt{\frac{-(supI_R^-(x_i)) + -(supI_S^-(x_i))}{2}} - \\ & \left(\frac{\sqrt{-(supI_R^-(x_i))} + \sqrt{-(supI_S^-(x_i))}}{2} \right) + \sqrt{\frac{(1 + infI_R^-(x_i)) + (1 + infI_S^-(x_i))}{2}} - \left(\frac{\sqrt{1 + infI_R^-(x_i)} + \sqrt{1 + infI_S^-(x_i)}}{2} \right) + \\ & \sqrt{\frac{(1 + supI_R^-(x_i)) + (1 + supI_S^-(x_i))}{2}} - \left(\frac{\sqrt{1 + supI_R^-(x_i)} + \sqrt{1 + supI_S^-(x_i)}}{2} \right) + \sqrt{\frac{-(infF_R^-(x_i)) + -(infF_S^-(x_i))}{2}} - \\ & \left(\frac{\sqrt{-(infF_R^-(x_i))} + \sqrt{-(infF_S^-(x_i))}}{2} \right) + \sqrt{\frac{-(supF_R^-(x_i)) + -(supF_S^-(x_i))}{2}} - \left(\frac{\sqrt{-(supF_R^-(x_i))} + \sqrt{-(supF_S^-(x_i))}}{2} \right) \end{aligned} \right] \quad (3)$$

Theorem 3. If $R = \langle [infT_R^+(x_i), supT_R^+(x_i)], [infI_R^+(x_i), supI_R^+(x_i)], [infF_R^+(x_i), supF_R^+(x_i)], [infT_R^-(x_i), supT_R^-(x_i)], [infI_R^-(x_i), supI_R^-(x_i)], [infF_R^-(x_i), supF_R^-(x_i)] \rangle$ and $S = \langle [infT_S^+(x_i), supT_S^+(x_i)], [infI_S^+(x_i), supI_S^+(x_i)], [infF_S^+(x_i), supF_S^+(x_i)], [infT_S^-(x_i), supT_S^-(x_i)], [infI_S^-(x_i), supI_S^-(x_i)], [infF_S^-(x_i), supF_S^-(x_i)] \rangle$ are two IBNSs in U , then the cross entropy measure $C_{IB}(R, S)$ satisfies the following properties:

- (1) $C_{IB}(R, S) \geq 0$;
- (2) $C_{IB}(R, S) = 0$ for $R = S$ i.e., $inf T_R^+(x_i) = inf T_S^+(x_i), sup T_R^+(x_i) = sup T_S^+(x_i), inf I_R^+(x_i) = inf I_S^+(x_i), sup I_R^+(x_i) = sup I_S^+(x_i), inf F_R^+(x_i) = inf F_S^+(x_i), sup F_R^+(x_i) = sup F_S^+(x_i), inf T_R^-(x_i) = inf T_S^-(x_i), sup T_R^-(x_i) = sup T_S^-(x_i), inf I_R^-(x_i) = inf I_S^-(x_i), sup I_R^-(x_i) = sup I_S^-(x_i), inf F_R^-(x_i) = inf F_S^-(x_i), sup F_R^-(x_i) = sup F_S^-(x_i) \forall x \in U$;
- (3) $C_{IB}(R, S) = C_{IB}(S, R)$;
- (4) $C_{IB}(R^C, S^C) = C_{IB}(R, S)$.

Proof

- (1) From the inequality stated in Theorem 1, we can easily get $C_{IB}(R, S) \geq 0$.
- (2) Since $infT_R^+(x_i) = infT_S^+(x_i), supT_R^+(x_i) = supT_S^+(x_i), infI_R^+(x_i) = infI_S^+(x_i), supI_R^+(x_i) = supI_S^+(x_i), infF_R^+(x_i) = infF_S^+(x_i), supF_R^+(x_i) = supF_S^+(x_i), infT_R^-(x_i) = infT_S^-(x_i), supT_R^-(x_i) = supT_S^-(x_i), infI_R^-(x_i) = infI_S^-(x_i), supI_R^-(x_i) = supI_S^-(x_i), infF_R^-(x_i) = infF_S^-(x_i), supF_R^-(x_i) = supF_S^-(x_i) \forall x \in U$, we have $C_{IB}(R, S) = 0$.

$$\begin{aligned}
 (3) \quad C_{IB}(R, S) &= \frac{1}{2} \sum_{i=1}^n \left[\begin{aligned}
 &\sqrt{\frac{\text{inf}T_R^+(x_i) + \text{inf}T_S^+(x_i)}{2}} - \left(\frac{\sqrt{\text{inf}T_R^+(x_i)} + \sqrt{\text{inf}T_S^+(x_i)}}{2} \right) + \sqrt{\frac{\text{sup}T_R^+(x_i) + \text{sup}T_S^+(x_i)}{2}} - \left(\frac{\sqrt{\text{sup}T_R^+(x_i)} + \sqrt{\text{sup}T_S^+(x_i)}}{2} \right) + \\
 &\sqrt{\frac{\text{inf}I_R^+(x_i) + \text{inf}I_S^+(x_i)}{2}} - \left(\frac{\sqrt{\text{inf}I_R^+(x_i)} + \sqrt{\text{inf}I_S^+(x_i)}}{2} \right) + \sqrt{\frac{\text{sup}I_R^+(x_i) + \text{sup}I_S^+(x_i)}{2}} - \left(\frac{\sqrt{\text{sup}I_R^+(x_i)} + \sqrt{\text{sup}I_S^+(x_i)}}{2} \right) + \\
 &\sqrt{\frac{(1 - \text{inf}I_R^+(x_i)) + (1 - \text{inf}I_S^+(x_i))}{2}} - \left(\frac{\sqrt{1 - \text{inf}I_R^+(x_i)} + \sqrt{1 - \text{inf}I_S^+(x_i)}}{2} \right) + \sqrt{\frac{(1 - \text{sup}I_R^+(x_i)) + (1 - \text{sup}I_S^+(x_i))}{2}} - \\
 &\left(\frac{\sqrt{1 - \text{sup}I_R^+(x_i)} + \sqrt{1 - \text{sup}I_S^+(x_i)}}{2} \right) + \sqrt{\frac{\text{inf}F_R^+(x_i) + \text{inf}F_S^+(x_i)}{2}} - \left(\frac{\sqrt{\text{inf}F_R^+(x_i)} + \sqrt{\text{inf}F_S^+(x_i)}}{2} \right) + \\
 &\sqrt{\frac{\text{sup}F_R^+(x_i) + \text{sup}F_S^+(x_i)}{2}} - \left(\frac{\sqrt{\text{sup}F_R^+(x_i)} + \sqrt{\text{sup}F_S^+(x_i)}}{2} \right) + \sqrt{\frac{-(\text{inf}T_R^-(x_i) + \text{inf}T_S^-(x_i))}{2}} - \\
 &\left(\frac{\sqrt{-(\text{inf}T_R^-(x_i))} + \sqrt{-(\text{inf}T_S^-(x_i))}}{2} \right) + \sqrt{\frac{-(\text{sup}T_R^-(x_i) + \text{sup}T_S^-(x_i))}{2}} - \left(\frac{\sqrt{-(\text{sup}T_R^-(x_i))} + \sqrt{-(\text{sup}T_S^-(x_i))}}{2} \right) + \\
 &\sqrt{\frac{-(\text{inf}I_R^-(x_i) + \text{inf}I_S^-(x_i))}{2}} - \left(\frac{\sqrt{-(\text{inf}I_R^-(x_i))} + \sqrt{-(\text{inf}I_S^-(x_i))}}{2} \right) + \sqrt{\frac{-(\text{sup}I_R^-(x_i) + \text{sup}I_S^-(x_i))}{2}} - \\
 &\left(\frac{\sqrt{-(\text{sup}I_R^-(x_i))} + \sqrt{-(\text{sup}I_S^-(x_i))}}{2} \right) + \sqrt{\frac{(1 + \text{inf}I_R^-(x_i)) + (1 + \text{inf}I_S^-(x_i))}{2}} - \left(\frac{\sqrt{1 + \text{inf}I_R^-(x_i)} + \sqrt{1 + \text{inf}I_S^-(x_i)}}{2} \right) + \\
 &\sqrt{\frac{(1 + \text{sup}I_R^-(x_i)) + (1 + \text{sup}I_S^-(x_i))}{2}} - \left(\frac{\sqrt{1 + \text{sup}I_R^-(x_i)} + \sqrt{1 + \text{sup}I_S^-(x_i)}}{2} \right) + \sqrt{\frac{-(\text{inf}F_R^-(x_i) + \text{inf}F_S^-(x_i))}{2}} - \\
 &\left(\frac{\sqrt{-(\text{inf}F_R^-(x_i))} + \sqrt{-(\text{inf}F_S^-(x_i))}}{2} \right) + \sqrt{\frac{-(\text{sup}F_R^-(x_i) + \text{sup}F_S^-(x_i))}{2}} - \left(\frac{\sqrt{-(\text{sup}F_R^-(x_i))} + \sqrt{-(\text{sup}F_S^-(x_i))}}{2} \right)
 \end{aligned} \right] \\
 &= \frac{1}{2} \sum_{i=1}^n \left[\begin{aligned}
 &\sqrt{\frac{\text{inf}T_S^+(x_i) + \text{inf}T_R^+(x_i)}{2}} - \left(\frac{\sqrt{\text{inf}T_S^+(x_i)} + \sqrt{\text{inf}T_R^+(x_i)}}{2} \right) + \sqrt{\frac{\text{sup}T_S^+(x_i) + \text{sup}T_R^+(x_i)}{2}} - \left(\frac{\sqrt{\text{sup}T_S^+(x_i)} + \sqrt{\text{sup}T_R^+(x_i)}}{2} \right) + \\
 &\sqrt{\frac{\text{inf}I_S^+(x_i) + \text{inf}I_R^+(x_i)}{2}} - \left(\frac{\sqrt{\text{inf}I_S^+(x_i)} + \sqrt{\text{inf}I_R^+(x_i)}}{2} \right) + \sqrt{\frac{\text{sup}I_S^+(x_i) + \text{sup}I_R^+(x_i)}{2}} - \left(\frac{\sqrt{\text{sup}I_S^+(x_i)} + \sqrt{\text{sup}I_R^+(x_i)}}{2} \right) + \\
 &\sqrt{\frac{(1 - \text{inf}I_S^+(x_i)) + (1 - \text{inf}I_R^+(x_i))}{2}} - \left(\frac{\sqrt{1 - \text{inf}I_S^+(x_i)} + \sqrt{1 - \text{inf}I_R^+(x_i)}}{2} \right) + \sqrt{\frac{(1 - \text{sup}I_S^+(x_i)) + (1 - \text{sup}I_R^+(x_i))}{2}} - \\
 &\left(\frac{\sqrt{1 - \text{sup}I_S^+(x_i)} + \sqrt{1 - \text{sup}I_R^+(x_i)}}{2} \right) + \sqrt{\frac{\text{inf}F_S^+(x_i) + \text{inf}F_R^+(x_i)}{2}} - \left(\frac{\sqrt{\text{inf}F_S^+(x_i)} + \sqrt{\text{inf}F_R^+(x_i)}}{2} \right) + \\
 &\sqrt{\frac{\text{sup}F_S^+(x_i) + \text{sup}F_R^+(x_i)}{2}} - \left(\frac{\sqrt{\text{sup}F_S^+(x_i)} + \sqrt{\text{sup}F_R^+(x_i)}}{2} \right) + \sqrt{\frac{-(\text{inf}T_S^-(x_i) + \text{inf}T_R^-(x_i))}{2}} - \\
 &\left(\frac{\sqrt{-(\text{inf}T_S^-(x_i))} + \sqrt{-(\text{inf}T_R^-(x_i))}}{2} \right) + \sqrt{\frac{-(\text{sup}T_S^-(x_i) + \text{sup}T_R^-(x_i))}{2}} - \left(\frac{\sqrt{-(\text{sup}T_S^-(x_i))} + \sqrt{-(\text{sup}T_R^-(x_i))}}{2} \right) + \\
 &\sqrt{\frac{-(\text{inf}I_S^-(x_i) + \text{inf}I_R^-(x_i))}{2}} - \left(\frac{\sqrt{-(\text{inf}I_S^-(x_i))} + \sqrt{-(\text{inf}I_R^-(x_i))}}{2} \right) + \sqrt{\frac{-(\text{sup}I_S^-(x_i) + \text{sup}I_R^-(x_i))}{2}} - \\
 &\left(\frac{\sqrt{-(\text{sup}I_S^-(x_i))} + \sqrt{-(\text{sup}I_R^-(x_i))}}{2} \right) + \sqrt{\frac{(1 + \text{inf}I_S^-(x_i)) + (1 + \text{inf}I_R^-(x_i))}{2}} - \left(\frac{\sqrt{1 + \text{inf}I_S^-(x_i)} + \sqrt{1 + \text{inf}I_R^-(x_i)}}{2} \right) + \\
 &\sqrt{\frac{(1 + \text{sup}I_S^-(x_i)) + (1 + \text{sup}I_R^-(x_i))}{2}} - \left(\frac{\sqrt{1 + \text{sup}I_S^-(x_i)} + \sqrt{1 + \text{sup}I_R^-(x_i)}}{2} \right) + \sqrt{\frac{-(\text{inf}F_S^-(x_i) + \text{inf}F_R^-(x_i))}{2}} - \\
 &\left(\frac{\sqrt{-(\text{inf}F_S^-(x_i))} + \sqrt{-(\text{inf}F_R^-(x_i))}}{2} \right) + \sqrt{\frac{-(\text{sup}F_S^-(x_i) + \text{sup}F_R^-(x_i))}{2}} - \left(\frac{\sqrt{-(\text{sup}F_S^-(x_i))} + \sqrt{-(\text{sup}F_R^-(x_i))}}{2} \right)
 \end{aligned} \right] \\
 &= C_{IB}(S, R).
 \end{aligned}$$

$$\begin{aligned}
 (4) \quad C_{IB}(R^C, S^C) &= \left[\begin{aligned} & \sqrt{\frac{\text{inf}_R^+(x_i) + \text{inf}_S^+(x_i)}{2}} - \left(\sqrt{\frac{\text{inf}_R^+(x_i)}{2}} + \sqrt{\frac{\text{inf}_S^+(x_i)}{2}} \right) + \sqrt{\frac{\text{sup}_R^+(x_i) + \text{sup}_S^+(x_i)}{2}} - \left(\sqrt{\frac{\text{sup}_R^+(x_i)}{2}} + \sqrt{\frac{\text{sup}_S^+(x_i)}{2}} \right) + \\ & \sqrt{\frac{(1 - \text{inf}_R^+(x_i)) + (1 - \text{inf}_S^+(x_i))}{2}} - \left(\sqrt{\frac{(1 - \text{inf}_R^+(x_i))}{2}} + \sqrt{\frac{(1 - \text{inf}_S^+(x_i))}{2}} \right) + \sqrt{\frac{(1 - \text{sup}_R^+(x_i)) + (1 - \text{sup}_S^+(x_i))}{2}} - \left(\sqrt{\frac{(1 - \text{sup}_R^+(x_i))}{2}} + \sqrt{\frac{(1 - \text{sup}_S^+(x_i))}{2}} \right) + \\ & \sqrt{\frac{(1 - \text{inf}_R^+(x_i)) + (1 - \text{inf}_S^+(x_i))}{2}} - \left(\sqrt{\frac{(1 - \text{inf}_R^+(x_i))}{2}} + \sqrt{\frac{(1 - \text{inf}_S^+(x_i))}{2}} \right) + \sqrt{\frac{(1 - \text{sup}_R^+(x_i)) + (1 - \text{sup}_S^+(x_i))}{2}} - \left(\sqrt{\frac{(1 - \text{sup}_R^+(x_i))}{2}} + \sqrt{\frac{(1 - \text{sup}_S^+(x_i))}{2}} \right) - \\ & \left(\sqrt{\frac{(1 - \text{inf}_R^+(x_i)) + (1 - \text{inf}_S^+(x_i))}{2}} + \sqrt{\frac{\text{inf}_R^+(x_i) + \text{inf}_S^+(x_i)}{2}} - \left(\sqrt{\frac{\text{inf}_R^+(x_i)}{2}} + \sqrt{\frac{\text{inf}_S^+(x_i)}{2}} \right) + \sqrt{\frac{\text{sup}_R^+(x_i) + \text{sup}_S^+(x_i)}{2}} - \left(\sqrt{\frac{\text{sup}_R^+(x_i)}{2}} + \sqrt{\frac{\text{sup}_S^+(x_i)}{2}} \right) \right) \\ & + \sqrt{\frac{-(\text{inf}_R^-(x_i) + \text{inf}_S^-(x_i))}{2}} - \left(\sqrt{\frac{-(\text{inf}_R^-(x_i))}{2}} + \sqrt{\frac{-(\text{inf}_S^-(x_i))}{2}} \right) + \sqrt{\frac{-(\text{sup}_R^-(x_i) + \text{sup}_S^-(x_i))}{2}} - \left(\sqrt{\frac{-(\text{sup}_R^-(x_i))}{2}} + \sqrt{\frac{-(\text{sup}_S^-(x_i))}{2}} \right) + \\ & \sqrt{\frac{-((1 - \text{inf}_R^-(x_i)) + (1 - \text{inf}_S^-(x_i)))}{2}} - \left(\sqrt{\frac{-((1 - \text{inf}_R^-(x_i))}{2}} + \sqrt{\frac{-((1 - \text{inf}_S^-(x_i))}{2}} \right) + \sqrt{\frac{-((1 - \text{sup}_R^-(x_i)) + (1 - \text{sup}_S^-(x_i)))}{2}} - \left(\sqrt{\frac{-((1 - \text{sup}_R^-(x_i))}{2}} + \sqrt{\frac{-((1 - \text{sup}_S^-(x_i))}{2}} \right) - \\ & \left(\sqrt{\frac{-((1 - \text{sup}_R^-(x_i)) + (1 - \text{sup}_S^-(x_i)))}{2}} + \sqrt{\frac{-(1 - \text{inf}_R^-(x_i)) + (1 - \text{inf}_S^-(x_i))}{2}} - \left(\sqrt{\frac{-(1 - \text{inf}_R^-(x_i))}{2}} + \sqrt{\frac{-(1 - \text{inf}_S^-(x_i))}{2}} \right) + \\ & \sqrt{\frac{-(1 - \text{sup}_R^-(x_i)) + (1 - \text{sup}_S^-(x_i))}{2}} - \left(\sqrt{\frac{-(1 - \text{sup}_R^-(x_i))}{2}} + \sqrt{\frac{-(1 - \text{sup}_S^-(x_i))}{2}} \right) + \sqrt{\frac{-(\text{inf}_R^-(x_i) + \text{inf}_S^-(x_i))}{2}} - \left(\sqrt{\frac{-(\text{inf}_R^-(x_i))}{2}} + \sqrt{\frac{-(\text{inf}_S^-(x_i))}{2}} \right) \\ & \left(\sqrt{\frac{-(\text{inf}_R^-(x_i)) + (1 - \text{inf}_S^-(x_i))}{2}} + \sqrt{\frac{-(\text{sup}_R^-(x_i) + \text{sup}_S^-(x_i))}{2}} - \left(\sqrt{\frac{-(\text{sup}_R^-(x_i))}{2}} + \sqrt{\frac{-(\text{sup}_S^-(x_i))}{2}} \right) \right) \end{aligned} \right] \\
 &= \frac{1}{2} \sum_{i=1}^n \left[\begin{aligned} & \sqrt{\frac{\text{inf}_R^+(x_i) + \text{inf}_S^+(x_i)}{2}} - \left(\sqrt{\frac{\text{inf}_R^+(x_i)}{2}} + \sqrt{\frac{\text{inf}_S^+(x_i)}{2}} \right) + \sqrt{\frac{\text{sup}_R^+(x_i) + \text{sup}_S^+(x_i)}{2}} - \left(\sqrt{\frac{\text{sup}_R^+(x_i)}{2}} + \sqrt{\frac{\text{sup}_S^+(x_i)}{2}} \right) + \\ & \sqrt{\frac{\text{inf}_R^+(x_i) + \text{inf}_S^+(x_i)}{2}} - \left(\sqrt{\frac{\text{inf}_R^+(x_i)}{2}} + \sqrt{\frac{\text{inf}_S^+(x_i)}{2}} \right) + \sqrt{\frac{\text{sup}_R^+(x_i) + \text{sup}_S^+(x_i)}{2}} - \left(\sqrt{\frac{\text{sup}_R^+(x_i)}{2}} + \sqrt{\frac{\text{sup}_S^+(x_i)}{2}} \right) + \\ & \sqrt{\frac{(1 - \text{inf}_R^+(x_i)) + (1 - \text{inf}_S^+(x_i))}{2}} - \left(\sqrt{\frac{1 - \text{inf}_R^+(x_i)}{2}} + \sqrt{\frac{1 - \text{inf}_S^+(x_i)}{2}} \right) + \sqrt{\frac{(1 - \text{sup}_R^+(x_i)) + (1 - \text{sup}_S^+(x_i))}{2}} - \left(\sqrt{\frac{1 - \text{sup}_R^+(x_i)}{2}} + \sqrt{\frac{1 - \text{sup}_S^+(x_i)}{2}} \right) - \\ & \left(\sqrt{\frac{1 - \text{sup}_R^+(x_i)}{2}} + \sqrt{\frac{1 - \text{sup}_S^+(x_i)}{2}} \right) + \sqrt{\frac{\text{inf}_R^+(x_i) + \text{inf}_S^+(x_i)}{2}} - \left(\sqrt{\frac{\text{inf}_R^+(x_i)}{2}} + \sqrt{\frac{\text{inf}_S^+(x_i)}{2}} \right) + \\ & \sqrt{\frac{\text{sup}_R^+(x_i) + \text{sup}_S^+(x_i)}{2}} - \left(\sqrt{\frac{\text{sup}_R^+(x_i)}{2}} + \sqrt{\frac{\text{sup}_S^+(x_i)}{2}} \right) + \sqrt{\frac{-(\text{inf}_R^-(x_i) + \text{inf}_S^-(x_i))}{2}} - \left(\sqrt{\frac{-(\text{inf}_R^-(x_i))}{2}} + \sqrt{\frac{-(\text{inf}_S^-(x_i))}{2}} \right) - \\ & \left(\sqrt{\frac{-(\text{inf}_R^-(x_i)) + (1 - \text{inf}_S^-(x_i))}{2}} + \sqrt{\frac{-(\text{sup}_R^-(x_i) + \text{sup}_S^-(x_i))}{2}} - \left(\sqrt{\frac{-(\text{sup}_R^-(x_i))}{2}} + \sqrt{\frac{-(\text{sup}_S^-(x_i))}{2}} \right) \right) + \\ & \sqrt{\frac{-(\text{inf}_R^-(x_i) + \text{inf}_S^-(x_i))}{2}} - \left(\sqrt{\frac{-(\text{inf}_R^-(x_i))}{2}} + \sqrt{\frac{-(\text{inf}_S^-(x_i))}{2}} \right) + \sqrt{\frac{-(\text{sup}_R^-(x_i) + \text{sup}_S^-(x_i))}{2}} - \left(\sqrt{\frac{-(\text{sup}_R^-(x_i))}{2}} + \sqrt{\frac{-(\text{sup}_S^-(x_i))}{2}} \right) + \\ & \sqrt{\frac{-((\text{inf}_R^-(x_i) + \text{inf}_S^-(x_i)))}{2}} - \left(\sqrt{\frac{-((\text{inf}_R^-(x_i))}{2}} + \sqrt{\frac{-((\text{inf}_S^-(x_i))}{2}} \right) + \sqrt{\frac{-((\text{sup}_R^-(x_i) + \text{sup}_S^-(x_i)))}{2}} - \left(\sqrt{\frac{-((\text{sup}_R^-(x_i))}{2}} + \sqrt{\frac{-((\text{sup}_S^-(x_i))}{2}} \right) - \\ & \left(\sqrt{\frac{-((\text{sup}_R^-(x_i)) + (1 - \text{sup}_S^-(x_i)))}{2}} + \sqrt{\frac{(1 + \text{inf}_R^-(x_i)) + (1 + \text{inf}_S^-(x_i))}{2}} - \left(\sqrt{\frac{1 + \text{inf}_R^-(x_i)}{2}} + \sqrt{\frac{1 + \text{inf}_S^-(x_i)}{2}} \right) + \\ & \sqrt{\frac{(1 + \text{sup}_R^-(x_i)) + (1 + \text{sup}_S^-(x_i))}{2}} - \left(\sqrt{\frac{1 + \text{sup}_R^-(x_i)}{2}} + \sqrt{\frac{1 + \text{sup}_S^-(x_i)}{2}} \right) + \sqrt{\frac{-(\text{inf}_R^-(x_i) + \text{inf}_S^-(x_i))}{2}} - \left(\sqrt{\frac{-(\text{inf}_R^-(x_i))}{2}} + \sqrt{\frac{-(\text{inf}_S^-(x_i))}{2}} \right) - \\ & \left(\sqrt{\frac{-(\text{inf}_R^-(x_i)) + (1 - \text{inf}_S^-(x_i))}{2}} + \sqrt{\frac{-(\text{sup}_R^-(x_i) + \text{sup}_S^-(x_i))}{2}} - \left(\sqrt{\frac{-(\text{sup}_R^-(x_i))}{2}} + \sqrt{\frac{-(\text{sup}_S^-(x_i))}{2}} \right) \right) \end{aligned} \right] \\
 &= C_{IB}(R, S). \quad \square
 \end{aligned}$$

Example 3. Suppose that $R = \langle [0.5, 0.8], [0.4, 0.6], [0.2, 0.6], [-0.3, -0.1], [-0.5, -0.1], [-0.5, -0.2] \rangle$ and $S = \langle [0.5, 0.9], [0.4, 0.5], [0.1, 0.4], [-0.5, -0.3], [-0.7, -0.3], [-0.6, -0.3] \rangle$ are two IBNSs; the cross entropy between R and S is computed as follows:

$$C_{IB}(R, S) = \frac{1}{2} \left[\begin{aligned} & \sqrt{\frac{0.5+0.5}{2}} - \left(\sqrt{\frac{0.5}{2}} + \sqrt{\frac{0.5}{2}} \right) + \sqrt{\frac{0.8+0.9}{2}} - \left(\sqrt{\frac{0.8}{2}} + \sqrt{\frac{0.9}{2}} \right) + \sqrt{\frac{0.4+0.4}{2}} - \left(\sqrt{\frac{0.4}{2}} + \sqrt{\frac{0.4}{2}} \right) + \sqrt{\frac{0.6+0.5}{2}} - \left(\sqrt{\frac{0.6}{2}} + \sqrt{\frac{0.5}{2}} \right) + \\ & \sqrt{\frac{[1-0.4] + [1-0.4]}{2}} - \left(\sqrt{\frac{1-0.4}{2}} + \sqrt{\frac{1-0.4}{2}} \right) + \sqrt{\frac{[1-0.6] + [1-0.5]}{2}} - \left(\sqrt{\frac{1-0.6}{2}} + \sqrt{\frac{1-0.5}{2}} \right) + \sqrt{\frac{0.2+0.1}{2}} - \left(\sqrt{\frac{0.2}{2}} + \sqrt{\frac{0.1}{2}} \right) + \\ & \sqrt{\frac{0.6+0.4}{2}} - \left(\sqrt{\frac{0.6}{2}} + \sqrt{\frac{0.4}{2}} \right) + \sqrt{\frac{-(-0.3-0.5)}{2}} - \left(\sqrt{\frac{-(-0.3)}{2}} + \sqrt{\frac{-(-0.5)}{2}} \right) + \sqrt{\frac{-(-0.1-0.3)}{2}} - \left(\sqrt{\frac{-(-0.1)}{2}} + \sqrt{\frac{-(-0.3)}{2}} \right) + \\ & \sqrt{\frac{-(-0.5-0.7)}{2}} - \left(\sqrt{\frac{-(-0.5)}{2}} + \sqrt{\frac{-(-0.7)}{2}} \right) + \sqrt{\frac{-(-0.1-0.3)}{2}} - \left(\sqrt{\frac{-(-0.1)}{2}} + \sqrt{\frac{-(-0.3)}{2}} \right) + \sqrt{\frac{[1-0.5] + [1-0.7]}{2}} - \left(\sqrt{\frac{1-0.5}{2}} + \sqrt{\frac{1-0.7}{2}} \right) - \\ & \left(\sqrt{\frac{-(\text{inf}_R^-(x_i) + \text{inf}_S^-(x_i))}{2}} + \sqrt{\frac{-(\text{sup}_R^-(x_i) + \text{sup}_S^-(x_i))}{2}} - \left(\sqrt{\frac{-(\text{sup}_R^-(x_i))}{2}} + \sqrt{\frac{-(\text{sup}_S^-(x_i))}{2}} \right) \right) + \\ & \sqrt{\frac{-(-0.2-0.3)}{2}} - \left(\sqrt{\frac{-(-0.2)}{2}} + \sqrt{\frac{-(-0.3)}{2}} \right) \end{aligned} \right] = 0.02984616.$$

Definition 6. Let w_i be the weight of each element $x_i, i = 1, 2, \dots, n$, and $w_i \in [0, 1]$ with $\sum_{i=1}^n w_i = 1$; then the weighted cross entropy measure between any two IBNSs $R = \langle [infT_R^+(x_i), supT_R^+(x_i)], [infI_R^+(x_i), supI_R^+(x_i)], [infF_R^+(x_i), supF_R^+(x_i)], [infT_R^-(x_i), supT_R^-(x_i)], [infI_R^-(x_i), supI_R^-(x_i)], [infF_R^-(x_i), supF_R^-(x_i)] \rangle$ and $S = \langle [infT_S^+(x_i), supT_S^+(x_i)], [infI_S^+(x_i), supI_S^+(x_i)], [infF_S^+(x_i), supF_S^+(x_i)], [infT_S^-(x_i), supT_S^-(x_i)], [infI_S^-(x_i), supI_S^-(x_i)], [infF_S^-(x_i), supF_S^-(x_i)] \rangle$ in U can be defined as follows.

$$C_{IB}(R,S)_w = \frac{1}{2} \sum_{i=1}^n w_i \left(\begin{aligned} & \left[\sqrt{\frac{infT_R^+(x_i)+infT_S^+(x_i)}{2}} - \left(\frac{\sqrt{infT_R^+(x_i)}+\sqrt{infT_S^+(x_i)}}{2} \right) + \sqrt{\frac{supT_R^+(x_i)+supT_S^+(x_i)}{2}} - \left(\frac{\sqrt{supT_R^+(x_i)}+\sqrt{supT_S^+(x_i)}}{2} \right) + \right. \\ & \left. \sqrt{\frac{infI_R^+(x_i)+infI_S^+(x_i)}{2}} - \left(\frac{\sqrt{infI_R^+(x_i)}+\sqrt{infI_S^+(x_i)}}{2} \right) + \sqrt{\frac{supI_R^+(x_i)+supI_S^+(x_i)}{2}} - \left(\frac{\sqrt{supI_R^+(x_i)}+\sqrt{supI_S^+(x_i)}}{2} \right) + \right. \\ & \left. \sqrt{\frac{(1-infI_R^+(x_i))+ (1-infI_S^+(x_i))}{2}} - \left(\frac{\sqrt{1-infI_R^+(x_i)}+\sqrt{1-infI_S^+(x_i)}}{2} \right) + \sqrt{\frac{(1-supI_R^+(x_i))+ (1-supI_S^+(x_i))}{2}} - \right. \\ & \left. \left(\frac{\sqrt{1-supI_R^+(x_i)}+\sqrt{1-supI_S^+(x_i)}}{2} \right) + \sqrt{\frac{infF_R^+(x_i)+infF_S^+(x_i)}{2}} - \left(\frac{\sqrt{infF_R^+(x_i)}+\sqrt{infF_S^+(x_i)}}{2} \right) + \right. \\ & \left. \sqrt{\frac{supF_R^+(x_i)+supF_S^+(x_i)}{2}} - \left(\frac{\sqrt{supF_R^+(x_i)}+\sqrt{supF_S^+(x_i)}}{2} \right) + \sqrt{\frac{-(infT_R^-(x_i))+infT_S^-(x_i)}{2}} - \right. \\ & \left. \left(\frac{\sqrt{-(infT_R^-(x_i))}+\sqrt{-(infT_S^-(x_i))}}{2} \right) + \sqrt{\frac{-(supT_R^-(x_i))+supT_S^-(x_i)}{2}} - \left(\frac{\sqrt{-(supT_R^-(x_i))}+\sqrt{-(supT_S^-(x_i))}}{2} \right) + \right. \\ & \left. \sqrt{\frac{-(infI_R^-(x_i))+infI_S^-(x_i)}{2}} - \left(\frac{\sqrt{-(infI_R^-(x_i))}+\sqrt{-(infI_S^-(x_i))}}{2} \right) + \sqrt{\frac{-(supI_R^-(x_i))+supI_S^-(x_i)}{2}} - \right. \\ & \left. \left(\frac{\sqrt{-(supI_R^-(x_i))}+\sqrt{-(supI_S^-(x_i))}}{2} \right) + \sqrt{\frac{(1+infI_R^-(x_i))+ (1+infI_S^-(x_i))}{2}} - \left(\frac{\sqrt{1+infI_R^-(x_i)}+\sqrt{1+infI_S^-(x_i)}}{2} \right) + \right. \\ & \left. \sqrt{\frac{(1+supI_R^-(x_i))+ (1+supI_S^-(x_i))}{2}} - \left(\frac{\sqrt{1+supI_R^-(x_i)}+\sqrt{1+supI_S^-(x_i)}}{2} \right) + \sqrt{\frac{-(infF_R^-(x_i))+infF_S^-(x_i)}{2}} - \right. \\ & \left. \left(\frac{\sqrt{-(infF_R^-(x_i))}+\sqrt{-(infF_S^-(x_i))}}{2} \right) + \sqrt{\frac{-(supF_R^-(x_i))+supF_S^-(x_i)}{2}} - \left(\frac{\sqrt{-(supF_R^-(x_i))}+\sqrt{-(supF_S^-(x_i))}}{2} \right) \right] \end{aligned} \right) \quad (4)$$

Theorem 4. For any two IBNSs $R = \langle [infT_R^+(x_i), supT_R^+(x_i)], [infI_R^+(x_i), supI_R^+(x_i)], [infF_R^+(x_i), supF_R^+(x_i)], [infT_R^-(x_i), supT_R^-(x_i)], [infI_R^-(x_i), supI_R^-(x_i)], [infF_R^-(x_i), supF_R^-(x_i)] \rangle$ and $S = \langle [infT_S^+(x_i), supT_S^+(x_i)], [infI_S^+(x_i), supI_S^+(x_i)], [infF_S^+(x_i), supF_S^+(x_i)], [infT_S^-(x_i), supT_S^-(x_i)], [infI_S^-(x_i), supI_S^-(x_i)], [infF_S^-(x_i), supF_S^-(x_i)] \rangle$ in U , the weighted cross entropy measure $C_{IB}(R, S)_w$ also satisfies the following properties:

- (1) $C_{IB}(R, S)_w \geq 0$;
- (2) $C_{IB}(R, S)_w = 0$ if, and only if, $R = S$ i.e., $infT_R^+(x_i) = infT_S^+(x_i), supT_R^+(x_i) = supT_S^+(x_i), infI_R^+(x_i) = infI_S^+(x_i), supI_R^+(x_i) = supI_S^+(x_i), infF_R^+(x_i) = infF_S^+(x_i), supF_R^+(x_i) = supF_S^+(x_i), infT_R^-(x_i) = infT_S^-(x_i), supT_R^-(x_i) = supT_S^-(x_i), infI_R^-(x_i) = infI_S^-(x_i), supI_R^-(x_i) = supI_S^-(x_i), infF_R^-(x_i) = infF_S^-(x_i), supF_R^-(x_i) = supF_S^-(x_i) \forall x \in U$;
- (3) $C_{IB}(R, S)_w = C_{IB}(S, R)_w$;
- (4) $C_{IB}(R^C, S^C)_w = C_{IB}(R, S)_w$.

The proofs are presented in Appendix B.

Example 4. Consider the two IBNSs $R = \langle [0.5, 0.8], [0.4, 0.6], [0.2, 0.6], [-0.3, -0.1], [-0.5, -0.1], [-0.5, -0.2] \rangle$ and $S = \langle [0.5, 0.9], [0.4, 0.5], [0.1, 0.4], [-0.5, -0.3], [-0.7, -0.3], [-0.6, -0.3] \rangle$, and let $w = 0.3$; then the weighted cross entropy between R and S is calculated as follows:

$$C_{IB}(R,S) = \frac{1}{2} \times 0.3 \times \left[\begin{aligned} & \sqrt{\frac{0.5+0.5}{2}} - \left(\frac{\sqrt{0.5} + \sqrt{0.5}}{2} \right) + \sqrt{\frac{0.8+0.9}{2}} - \left(\frac{\sqrt{0.8} + \sqrt{0.9}}{2} \right) + \sqrt{\frac{0.4+0.4}{2}} - \left(\frac{\sqrt{0.4} + \sqrt{0.4}}{2} \right) + \sqrt{\frac{0.6+0.5}{2}} - \left(\frac{\sqrt{0.6} + \sqrt{0.5}}{2} \right) + \\ & \sqrt{\frac{[1-0.4]+[1-0.4]}{2}} - \left(\frac{\sqrt{1-0.4} + \sqrt{1-0.4}}{2} \right) + \sqrt{\frac{[1-0.6]+[1-0.5]}{2}} - \left(\frac{\sqrt{1-0.6} + \sqrt{1-0.5}}{2} \right) + \sqrt{\frac{0.2+0.1}{2}} - \left(\frac{\sqrt{0.2} + \sqrt{0.1}}{2} \right) + \\ & \sqrt{\frac{0.6+0.4}{2}} - \left(\frac{\sqrt{0.6} + \sqrt{0.4}}{2} \right) + \sqrt{\frac{-(-0.3-0.5)}{2}} - \left(\frac{\sqrt{-(-0.3)} + \sqrt{-(-0.5)}}{2} \right) + \sqrt{\frac{-(-0.1-0.3)}{2}} - \left(\frac{\sqrt{-(-0.1)} + \sqrt{-(-0.3)}}{2} \right) + \\ & \sqrt{\frac{-(-0.5-0.7)}{2}} - \left(\frac{\sqrt{-(-0.5)} + \sqrt{-(-0.7)}}{2} \right) + \sqrt{\frac{-(-0.1-0.3)}{2}} - \left(\frac{\sqrt{-(-0.1)} + \sqrt{-(-0.3)}}{2} \right) + \sqrt{\frac{[1-0.5]+[1-0.7]}{2}} - \\ & \left(\frac{\sqrt{1-0.5} + \sqrt{1-0.7}}{2} \right) + \sqrt{\frac{[1-0.1]+[1-0.3]}{2}} - \left(\frac{\sqrt{1-0.1} + \sqrt{1-0.3}}{2} \right) + \sqrt{\frac{-(-0.5-0.6)}{2}} - \left(\frac{\sqrt{-(-0.5)} + \sqrt{-(-0.6)}}{2} \right) + \\ & \sqrt{\frac{-(-0.2-0.3)}{2}} - \left(\frac{\sqrt{-(-0.2)} + \sqrt{-(-0.3)}}{2} \right) \end{aligned} \right] = 0.00895385.$$

5. MADM Strategies Based on Cross Entropy Measures

In this section, we propose two new MADM strategies based on weighted cross entropy measures in bipolar neutrosophic and interval bipolar neutrosophic environments. Let $B = \{B_1, B_2, \dots, B_m\}$ ($m \geq 2$) be a discrete set of m feasible alternatives which are to be evaluated based on n attributes $C = \{C_1, C_2, \dots, C_n\}$ ($n \geq 2$) and let w_j be the weight vector of the attributes such that $0 \leq w_j \leq 1$ and $\sum_{j=1}^n w_j = 1$.

5.1. MADM Strategy Based on Weighted Cross Entropy Measures of BNS

The procedure for solving MADM problems in a bipolar neutrosophic environment is presented in the following steps:

Step 1. The rating of the performance value of alternative B_i ($i = 1, 2, \dots, m$) with respect to the predefined attribute C_j ($j = 1, 2, \dots, n$) can be expressed in terms of bipolar neutrosophic information as follows:

$$B_i = \{C_j, \langle T_{B_i}^+(C_j), I_{B_i}^+(C_j), F_{B_i}^+(C_j), T_{B_i}^-(C_j), I_{B_i}^-(C_j), F_{B_i}^-(C_j) \rangle \mid C_j \in C_j, j = 1, 2, \dots, n\},$$

where $0 \leq T_{B_i}^+(C_j) + I_{B_i}^+(C_j) + F_{B_i}^+(C_j) \leq 3$ and $-3 \leq T_{B_i}^-(C_j) + I_{B_i}^-(C_j) + F_{B_i}^-(C_j) \leq 0, i = 1, 2, \dots, m; j = 1, 2, \dots, n$.

Assume that $\tilde{d}_{ij} = \langle T_{ij}^+, I_{ij}^+, F_{ij}^+, T_{ij}^-, I_{ij}^-, F_{ij}^- \rangle$ is the bipolar neutrosophic decision matrix whose entries are the rating values of the alternatives with respect to the attributes provided by the expert or decision-maker. The bipolar neutrosophic decision matrix $[\tilde{d}_{ij}]_{m \times n}$ can be expressed as follows:

$$[\tilde{d}_{ij}]_{m \times n} = \begin{matrix} & & C_1 & C_2 & \dots & C_n \\ \begin{matrix} B_1 \\ B_2 \\ \vdots \\ \vdots \\ B_m \end{matrix} & \left(\begin{matrix} d_{11} & d_{12} & \dots & d_{1n} \\ d_{21} & d_{22} & \dots & d_{2n} \\ \vdots & \vdots & \dots & \vdots \\ \vdots & \vdots & \dots & \vdots \\ d_{m1} & d_{m2} & \dots & d_{mn} \end{matrix} \right) \end{matrix}.$$

Step 2. The positive ideal solution (PIS) $\langle p^* = (d_1^*, d_2^*, \dots, d_n^*) \rangle$ of the bipolar neutrosophic information is obtained as follows:

$$\begin{aligned}
 p_j^* = \langle & T_j^{*+}, I_j^{*+}, F_j^{*+}, T_j^{*-}, I_j^{*-}, F_j^{*-} \rangle = \langle \{ \text{Max}(T_{ij}^+) | j \in H_1 \}; \{ \text{Min}(T_{ij}^+) | j \in H_2 \} \rangle, \\
 & \{ \text{Min}(I_{ij}^+) | j \in H_1 \}; \{ \text{Max}(I_{ij}^+) | j \in H_2 \} \rangle, \{ \text{Min}(F_{ij}^+) | j \in H_1 \}; \{ \text{Max}(F_{ij}^+) | j \in H_2 \} \rangle, \\
 & \{ \text{Min}(T_{ij}^-) | j \in H_1 \}; \{ \text{Max}(T_{ij}^-) | j \in H_2 \} \rangle, \{ \text{Min}(I_{ij}^-) | j \in H_1 \}; \{ \text{Max}(I_{ij}^-) | j \in H_2 \} \rangle, \\
 & \{ \text{Min}(F_{ij}^-) | j \in H_1 \}; \{ \text{Max}(F_{ij}^-) | j \in H_2 \} \rangle \rangle, j = 1, 2, \dots, n;
 \end{aligned}$$

where H_1 and H_2 represent benefit and cost type attributes, respectively.

Step 3. The weighted cross entropy between an alternative $B_i, i = 1, 2, \dots, m$, and the ideal alternative p^* is determined by

$$C_B(B_i, p^*)_w = \sum_{i=1}^n w_i \left[\begin{aligned} & \sqrt{\frac{T_{ij}^+ + T_j^{*+}}{2}} - \left(\frac{\sqrt{T_{ij}^+} + \sqrt{T_j^{*+}}}{2} \right) + \sqrt{\frac{I_{ij}^+ + I_j^{*+}}{2}} - \left(\frac{\sqrt{I_{ij}^+} + \sqrt{I_j^{*+}}}{2} \right) + \sqrt{\frac{[1 - I_{ij}^+] + [1 - I_j^{*+}]}{2}} - \\ & \left(\frac{\sqrt{1 - I_{ij}^+} + \sqrt{1 - I_j^{*+}}}{2} \right) + \sqrt{\frac{F_{ij}^+ + F_j^{*+}}{2}} - \left(\frac{\sqrt{F_{ij}^+} + \sqrt{F_j^{*+}}}{2} \right) + \sqrt{\frac{-(T_{ij}^- + T_j^{*-})}{2}} - \\ & \left(\frac{\sqrt{-(T_{ij}^-)} + \sqrt{-(T_j^{*-})}}{2} \right) + \sqrt{\frac{-(I_{ij}^- + I_j^{*-})}{2}} - \left(\frac{\sqrt{-(I_{ij}^-)} + \sqrt{-(I_j^{*-})}}{2} \right) + \sqrt{\frac{[1 + I_{ij}^-] + [1 + I_j^{*-}]}{2}} - \\ & \left(\frac{\sqrt{1 + I_{ij}^-} + \sqrt{1 + I_j^{*-}}}{2} \right) + \sqrt{\frac{-(F_{ij}^- + F_j^{*-})}{2}} - \left(\frac{\sqrt{-(F_{ij}^-)} + \sqrt{-(F_j^{*-})}}{2} \right) \end{aligned} \right]. \tag{5}$$

Step 4. A smaller value of $C_B(B_i, p^*)_w, i = 1, 2, \dots, m$ represents that an alternative $B_i, i = 1, 2, \dots, m$ is closer to the PIS p^* . Therefore, the alternative with the smallest weighted cross entropy measure is the best alternative.

5.2. MADM Strategy Based on Weighted Cross Entropy Measures of IBNSs

The steps for solving MADM problems with interval bipolar neutrosophic information are presented as follows.

Step 1. In an interval bipolar neutrosophic environment, the rating of the performance value of alternative $B_i (i = 1, 2, \dots, m)$ with respect to the predefined attribute $C_j (j = 1, 2, \dots, n)$ can be represented as follows:

$$\begin{aligned}
 B_i = \{ & C_j, \langle [\text{inf}T_{B_i}^+(C_j), \text{sup}T_{B_i}^+(C_j)], [\text{inf}I_{B_i}^+(C_j), \text{sup}I_{B_i}^+(C_j)], [\text{inf}F_{B_i}^+(C_j), \text{sup}F_{B_i}^+(C_j)], \\ & [\text{inf}T_{B_i}^-(C_j), \text{sup}T_{B_i}^-(C_j)], [\text{inf}I_{B_i}^-(C_j), \text{sup}I_{B_i}^-(C_j)], [\text{inf}F_{B_i}^-(C_j), \text{sup}F_{B_i}^-(C_j)] \rangle | C_j \in C_j, \\ & j = 1, 2, \dots, n \}
 \end{aligned}$$

where $0 \leq \text{sup}T_{B_i}^+(C_j) + \text{sup}I_{B_i}^+(C_j) + \text{sup}F_{B_i}^+(C_j) \leq 3$ and $-3 \leq \text{sup}T_{B_i}^-(C_j) + \text{sup}I_{B_i}^-(C_j) + \text{sup}F_{B_i}^-(C_j) \leq 0$; $j = 1, 2, \dots, n$. Let $\tilde{g}_{ij} = \langle [{}^L T_{ij}^+, {}^U T_{ij}^+], [{}^L I_{ij}^+, {}^U I_{ij}^+], [{}^L F_{ij}^+, {}^U F_{ij}^+], [{}^L T_{ij}^-, {}^U T_{ij}^-], [{}^L I_{ij}^-, {}^U I_{ij}^-], [{}^L F_{ij}^-, {}^U F_{ij}^-] \rangle$ be the bipolar neutrosophic decision matrix whose entries are the rating values of the alternatives with respect to the attributes provided by the expert or decision-maker. The interval bipolar neutrosophic decision matrix $[\tilde{g}_{ij}]_{m \times n}$ can be presented as follows:

$$[\tilde{g}_{ij}]_{m \times n} = \begin{matrix} & & C_1 & C_2 & \dots & C_n \\ \begin{matrix} B_1 \\ B_2 \\ \vdots \\ \vdots \\ B_m \end{matrix} & \left(\begin{matrix} g_{11} & g_{12} & \dots & g_{1n} \\ g_{21} & g_{22} & \dots & g_{2n} \\ \vdots & \vdots & \dots & \vdots \\ \vdots & \vdots & \dots & \vdots \\ g_{m1} & g_{m2} & \dots & g_{mn} \end{matrix} \right) \end{matrix} .$$

Step 2. The PIS $\langle q^* = (g_1^*, g_2^*, \dots, g_n^*) \rangle$ of the interval bipolar neutrosophic information is obtained as follows:

$$\begin{aligned}
 q_j^* &= \langle [{}^L T_{ij}^{*+}, {}^U T_{ij}^{*+}], [{}^L I_{ij}^{*+}, {}^U I_{ij}^{*+}], [{}^L F_{ij}^{*+}, {}^U F_{ij}^{*+}], [{}^L T_{ij}^{*-}, {}^U T_{ij}^{*-}], [{}^L I_{ij}^{*-}, {}^U I_{ij}^{*-}], [{}^L F_{ij}^{*-}, {}^U F_{ij}^{*-}] \rangle, \\
 &= \langle [\{ \text{Max}_i ({}^L T_{ij}^+) | j \in H_1 \}; \{ \text{Min}_i ({}^L T_{ij}^+) | j \in H_2 \}, \{ \text{Max}_i ({}^U T_{ij}^+) | j \in H_1 \}; \{ \text{Min}_i ({}^U T_{ij}^+) | j \in H_2 \}], \\
 &[\{ \text{Min}_i ({}^L I_{ij}^+) | j \in H_1 \}; \{ \text{Max}_i ({}^L I_{ij}^+) | j \in H_2 \}, \{ \text{Min}_i ({}^U I_{ij}^+) | j \in H_1 \}; \{ \text{Max}_i ({}^U I_{ij}^+) | j \in H_2 \}], \\
 &[\{ \text{Min}_i ({}^L F_{ij}^+) | j \in H_1 \}; \{ \text{Max}_i ({}^L F_{ij}^+) | j \in H_2 \}, \{ \text{Min}_i ({}^U F_{ij}^+) | j \in H_1 \}; \{ \text{Max}_i ({}^U F_{ij}^+) | j \in H_2 \}], \\
 &[\{ \text{Min}_i ({}^L T_{ij}^-) | j \in H_1 \}; \{ \text{Max}_i ({}^L T_{ij}^-) | j \in H_2 \}, \{ \text{Min}_i ({}^U T_{ij}^-) | j \in H_1 \}; \{ \text{Max}_i ({}^U T_{ij}^-) | j \in H_2 \}], \\
 &[\{ \text{Min}_i ({}^L I_{ij}^-) | j \in H_1 \}; \{ \text{Max}_i ({}^L I_{ij}^-) | j \in H_2 \}, \{ \text{Min}_i ({}^U I_{ij}^-) | j \in H_1 \}; \{ \text{Max}_i ({}^U I_{ij}^-) | j \in H_2 \}], \\
 &[\{ \text{Max}_i ({}^L F_{ij}^-) | j \in H_1 \}; \{ \text{Min}_i ({}^L F_{ij}^-) | j \in H_2 \}, \{ \text{Max}_i ({}^U F_{ij}^-) | j \in H_1 \}; \{ \text{Min}_i ({}^U F_{ij}^-) | j \in H_2 \}] \rangle, \\
 &j = 1, 2, \dots, n
 \end{aligned}$$

where H_1 and H_2 stand for benefit and cost type attributes, respectively.

Step 3. The weighted cross entropy between an alternative $B_i, i = 1, 2, \dots, m$, and the ideal alternative q^* under an interval bipolar neutrosophic setting is computed as follows:

$$C_{IB}(B_i, q^*)_w = \frac{1}{2} \times \sum_{i=1}^m \left[\begin{aligned} &\sqrt{\frac{{}^L \tau_i^+ + {}^L \tau_i^{*+}}{2}} - \left(\sqrt{\frac{{}^L \tau_i^+ + {}^L \tau_i^{*+}}{2}} + \sqrt{\frac{{}^U \tau_i^+ + {}^U \tau_i^{*+}}{2}} \right) - \left(\sqrt{\frac{{}^L \tau_i^+ + {}^L \tau_i^{*+}}{2}} + \sqrt{\frac{{}^U \tau_i^+ + {}^U \tau_i^{*+}}{2}} \right) + \sqrt{\frac{{}^L \tau_i^+ + {}^L \tau_i^{*+}}{2}} - \left(\sqrt{\frac{{}^L \tau_i^+ + {}^L \tau_i^{*+}}{2}} + \sqrt{\frac{{}^U \tau_i^+ + {}^U \tau_i^{*+}}{2}} \right) + \\ &\sqrt{\frac{{}^L \tau_i^+ + {}^L \tau_i^{*+}}{2}} - \left(\sqrt{\frac{{}^L \tau_i^+ + {}^L \tau_i^{*+}}{2}} + \sqrt{\frac{{}^U \tau_i^+ + {}^U \tau_i^{*+}}{2}} \right) + \sqrt{\frac{{}^L \tau_i^+ + {}^L \tau_i^{*+}}{2}} - \left(\sqrt{\frac{{}^L \tau_i^+ + {}^L \tau_i^{*+}}{2}} + \sqrt{\frac{{}^U \tau_i^+ + {}^U \tau_i^{*+}}{2}} \right) + \sqrt{\frac{{}^L \tau_i^+ + {}^L \tau_i^{*+}}{2}} - \left(\sqrt{\frac{{}^L \tau_i^+ + {}^L \tau_i^{*+}}{2}} + \sqrt{\frac{{}^U \tau_i^+ + {}^U \tau_i^{*+}}{2}} \right) + \\ &\left(\sqrt{\frac{{}^L \tau_i^+ + {}^L \tau_i^{*+}}{2}} + \sqrt{\frac{{}^U \tau_i^+ + {}^U \tau_i^{*+}}{2}} \right) + \sqrt{\frac{{}^L \tau_i^+ + {}^L \tau_i^{*+}}{2}} - \left(\sqrt{\frac{{}^L \tau_i^+ + {}^L \tau_i^{*+}}{2}} + \sqrt{\frac{{}^U \tau_i^+ + {}^U \tau_i^{*+}}{2}} \right) + \sqrt{\frac{{}^L \tau_i^+ + {}^L \tau_i^{*+}}{2}} - \left(\sqrt{\frac{{}^L \tau_i^+ + {}^L \tau_i^{*+}}{2}} + \sqrt{\frac{{}^U \tau_i^+ + {}^U \tau_i^{*+}}{2}} \right) + \sqrt{\frac{{}^L \tau_i^+ + {}^L \tau_i^{*+}}{2}} - \left(\sqrt{\frac{{}^L \tau_i^+ + {}^L \tau_i^{*+}}{2}} + \sqrt{\frac{{}^U \tau_i^+ + {}^U \tau_i^{*+}}{2}} \right) - \\ &\left(\sqrt{\frac{{}^L \tau_i^- + {}^L \tau_i^{*-}}{2}} \right) + \sqrt{\frac{{}^L \tau_i^- + {}^L \tau_i^{*-}}{2}} - \left(\sqrt{\frac{{}^L \tau_i^- + {}^L \tau_i^{*-}}{2}} + \sqrt{\frac{{}^U \tau_i^- + {}^U \tau_i^{*-}}{2}} \right) + \sqrt{\frac{{}^L \tau_i^- + {}^L \tau_i^{*-}}{2}} - \left(\sqrt{\frac{{}^L \tau_i^- + {}^L \tau_i^{*-}}{2}} + \sqrt{\frac{{}^U \tau_i^- + {}^U \tau_i^{*-}}{2}} \right) + \sqrt{\frac{{}^L \tau_i^- + {}^L \tau_i^{*-}}{2}} - \left(\sqrt{\frac{{}^L \tau_i^- + {}^L \tau_i^{*-}}{2}} + \sqrt{\frac{{}^U \tau_i^- + {}^U \tau_i^{*-}}{2}} \right) + \\ &\sqrt{\frac{{}^L \tau_i^- + {}^L \tau_i^{*-}}{2}} - \left(\sqrt{\frac{{}^L \tau_i^- + {}^L \tau_i^{*-}}{2}} + \sqrt{\frac{{}^U \tau_i^- + {}^U \tau_i^{*-}}{2}} \right) + \sqrt{\frac{{}^L \tau_i^- + {}^L \tau_i^{*-}}{2}} - \left(\sqrt{\frac{{}^L \tau_i^- + {}^L \tau_i^{*-}}{2}} + \sqrt{\frac{{}^U \tau_i^- + {}^U \tau_i^{*-}}{2}} \right) + \sqrt{\frac{{}^L \tau_i^- + {}^L \tau_i^{*-}}{2}} - \left(\sqrt{\frac{{}^L \tau_i^- + {}^L \tau_i^{*-}}{2}} + \sqrt{\frac{{}^U \tau_i^- + {}^U \tau_i^{*-}}{2}} \right) - \\ &\left(\sqrt{\frac{{}^L \tau_i^- + {}^L \tau_i^{*-}}{2}} + \sqrt{\frac{{}^U \tau_i^- + {}^U \tau_i^{*-}}{2}} \right) + \sqrt{\frac{{}^L \tau_i^- + {}^L \tau_i^{*-}}{2}} - \left(\sqrt{\frac{{}^L \tau_i^- + {}^L \tau_i^{*-}}{2}} + \sqrt{\frac{{}^U \tau_i^- + {}^U \tau_i^{*-}}{2}} \right) + \sqrt{\frac{{}^L \tau_i^- + {}^L \tau_i^{*-}}{2}} - \left(\sqrt{\frac{{}^L \tau_i^- + {}^L \tau_i^{*-}}{2}} + \sqrt{\frac{{}^U \tau_i^- + {}^U \tau_i^{*-}}{2}} \right) - \left(\sqrt{\frac{{}^L \tau_i^- + {}^L \tau_i^{*-}}{2}} + \sqrt{\frac{{}^U \tau_i^- + {}^U \tau_i^{*-}}{2}} \right) \end{aligned} \right] \quad (6)$$

Step 4. A smaller value of $C_{IB}(B_i, p^*)_w, i = 1, 2, \dots, m$ indicates that an alternative $B_i, i = 1, 2, \dots, m$ is closer to the PIS q^* . Hence, the alternative with the smallest weighted cross entropy measure will be identified as the best alternative.

A conceptual model of the proposed strategy is shown in Figure 1.

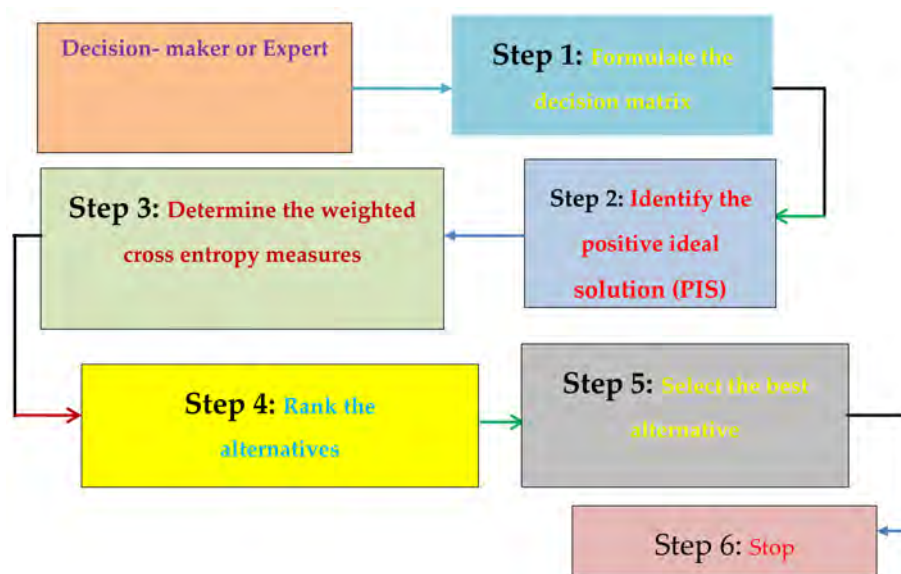

Figure 1. Conceptual model of the proposed strategy.

6. Illustrative Example

In this section we solve two numerical MADM problems and a comparison with other existing strategies is presented to verify the applicability and effectiveness of the proposed strategies in bipolar neutrosophic and interval bipolar neutrosophic environments.

6.1. Car Selection Problem with Bipolar Neutrosophic Information

Consider the problem discussed in [81,86–88] where a buyer wants to purchase a car based on some predefined attributes. Suppose that four types of cars (alternatives) B_i , ($i = 1, 2, 3, 4$) are available in the market. Four attributes are taken into consideration in the decision-making environment, namely, Fuel economy (C_1), Aerod (C_2), Comfort (C_3), Safety (C_4), to select the most desirable car. Assume that the weight vector for the four attributes is known and given by $w = (w_1, w_2, w_3, w_4) = (0.5, 0.25, 0.125, 0.125)$. Therefore, the bipolar neutrosophic decision matrix $\langle \tilde{d}_{ij} \rangle_{4 \times 4}$ can be obtained as given below.

The bipolar neutrosophic decision matrix $[\tilde{d}_{ij}]_{4 \times 4} =$

	C_1	C_2	C_3	C_4
B_1	$\langle 0.5, 0.7, 0.2, -0.7, -0.3, -0.6 \rangle$	$\langle 0.4, 0.4, 0.5, -0.7, -0.8, -0.4 \rangle$	$\langle 0.7, 0.7, 0.5, -0.8, -0.7, -0.6 \rangle$	$\langle 0.1, 0.5, 0.7, -0.5, -0.2, -0.8 \rangle$
B_2	$\langle 0.9, 0.7, 0.5, -0.7, -0.7, -0.1 \rangle$	$\langle 0.7, 0.6, 0.8, -0.7, -0.5, -0.1 \rangle$	$\langle 0.9, 0.4, 0.6, -0.1, -0.7, -0.5 \rangle$	$\langle 0.5, 0.2, 0.7, -0.5, -0.1, -0.9 \rangle$
B_3	$\langle 0.3, 0.4, 0.2, -0.6, -0.3, -0.7 \rangle$	$\langle 0.2, 0.2, 0.2, -0.4, -0.7, -0.4 \rangle$	$\langle 0.9, 0.5, 0.5, -0.6, -0.5, -0.2 \rangle$	$\langle 0.7, 0.5, 0.3, -0.4, -0.2, -0.2 \rangle$
B_4	$\langle 0.9, 0.7, 0.2, -0.8, -0.6, -0.1 \rangle$	$\langle 0.3, 0.5, 0.2, -0.5, -0.5, -0.2 \rangle$	$\langle 0.5, 0.4, 0.5, -0.1, -0.7, -0.2 \rangle$	$\langle 0.2, 0.4, 0.8, -0.5, -0.5, -0.6 \rangle$

The positive ideal bipolar neutrosophic solutions are computed from $[\tilde{d}_{ij}]_{4 \times 4}$ as follows:

$$p^* = [\langle 0.9, 0.4, 0.2, -0.8, -0.3, -0.1 \rangle, \langle 0.7, 0.2, 0.2, -0.7, -0.5, -0.1 \rangle, \langle 0.9, 0.4, 0.5, -0.8, -0.5, -0.2 \rangle, \langle 0.7, 0.2, 0.3, -0.5, -0.1, -0.2 \rangle].$$

Using Equation (5), the weighted cross entropy measure $C_B(B_i, p^*)_w$ is obtained as follows:

$$C_B(B_1, p^*)_w = 0.0734, C_B(B_2, p^*)_w = 0.0688, C_B(B_3, p^*)_w = 0.0642, C_B(B_4, p^*)_w = 0.0516. \tag{7}$$

According to the weighted cross entropy measure $C_B(B_i, p^*)_w$, the order of the four alternatives is $B_4 < B_3 < B_2 < B_1$; therefore, B_4 is the best car.

We compare our obtained result with the results of other existing strategies (see Table 1), where the known weight of the attributes is given by $w = (w_1, w_2, w_3, w_4) = (0.5, 0.25, 0.125, 0.125)$. It is to be noted that the ranking results obtained from the other existing strategies are different from the result of the proposed strategies in some cases. The reason is that the different authors adopted different decision-making strategies and thereby obtained different ranking results. However, the proposed strategies are simple and straightforward and can effectively solve decision-making problems with bipolar neutrosophic information.

Table 1. The results of the car selection problem obtained from different methods.

Methods	Ranking Results	Best Option
The proposed weighted cross entropy measure	$B_4 < B_3 < B_2 < B_1$	B_4
Dey et al.'s TOPSIS strategy [87]	$B_1 < B_3 < B_2 < B_4$	B_4
Deli et al.'s strategy [81]	$B_1 < B_2 < B_4 < B_3$	B_3
Projection measure [88]	$B_3 < B_4 < B_1 < B_2$	B_2
Bidirectional projection measure [88]	$B_2 < B_1 < B_4 < B_3$	B_3
Hybrid projection measure [88] with $\rho = 0.25$	$B_2 < B_1 < B_3 < B_4$	B_4
Hybrid projection measure [88] with $\rho = 0.50$	$B_3 < B_2 < B_1 < B_4$	B_4
Hybrid projection measure [88] with $\rho = 0.75$	$B_1 < B_3 < B_4 < B_2$	B_2
Hybrid projection measure [88] with $\rho = 0.90$	$B_3 < B_4 < B_2 < B_1$	B_1
Hybrid similarity measure [88] with $\rho = 0.25$	$B_2 < B_4 < B_1 < B_3$	B_3
Hybrid similarity measure [88] with $\rho = 0.30$	$B_2 < B_4 < B_1 < B_3$	B_3
Hybrid similarity measure [88] with $\rho = 0.60$	$B_2 < B_4 < B_1 < B_3$	B_3
Hybrid similarity measure [88] with $\rho = 0.90$	$B_2 < B_4 < B_3 < B_1$	B_1

6.2. Interval Bipolar Neutrosophic MADM Investment Problem

Consider an interval bipolar neutrosophic MADM problem studied in [91] with four possible alternatives with the aim to invest a sum of money in the best choice. The four alternatives are:

- > a food company (B_1),
- > a car company (B_2),
- > an arms company (B_3), and
- > a computer company (B_4).

The investment company selects the best option based on three predefined attributes, namely, growth analysis (C_1), risk analysis (C_2), and environment analysis (C_3). We consider C_1 and C_2 to be benefit type attributes and C_3 to be a cost type attribute based on Ye [93]. Assume that the weight vector [91] of C_1 , C_2 , and C_3 is given by $w = (w_1, w_2, w_3) = (0.35, 0.25, 0.4)$. The interval bipolar neutrosophic decision matrix $[\tilde{g}_{ij}]_{4 \times 3}$ presented by the decision-maker or expert is as follows.

Interval bipolar neutrosophic decision matrix $[\tilde{g}_{ij}]_{4 \times 3} =$

C_1

$$\begin{pmatrix} B_1 & [[0.4, 0.5], [0.2, 0.3], [0.3, 0.4], [-0.3, -0.2], [-0.4, -0.3], [-0.5, -0.4]] \\ B_2 & [[0.6, 0.7], [0.1, 0.2], [0.2, 0.3], [-0.2, -0.1], [-0.3, -0.2], [-0.7, -0.6]] \\ B_3 & [[0.3, 0.6], [0.2, 0.3], [0.3, 0.4], [-0.3, -0.2], [-0.4, -0.3], [-0.6, -0.3]] \\ B_4 & [[0.7, 0.8], [0.0, 0.1], [0.1, 0.2], [-0.1, -0.0], [-0.2, -0.1], [-0.8, -0.7]] \end{pmatrix}$$

C_2

$$\begin{pmatrix} B_1 & [[0.4, 0.6], [0.1, 0.3], [0.2, 0.4], [-0.3, -0.1], [-0.4, -0.2], [-0.6, -0.4]] \\ B_2 & [[0.6, 0.7], [0.1, 0.2], [0.2, 0.3], [-0.2, -0.1], [-0.3, -0.2], [-0.7, -0.6]] \\ B_3 & [[0.5, 0.6], [0.2, 0.3], [0.3, 0.4], [-0.3, -0.2], [-0.4, -0.3], [-0.6, -0.5]] \\ B_4 & [[0.6, 0.7], [0.1, 0.2], [0.1, 0.3], [-0.2, -0.1], [-0.3, -0.1], [-0.7, -0.6]] \end{pmatrix}$$

C_3

$$\begin{pmatrix} B_1 & [[0.7, 0.9], [0.2, 0.3], [0.4, 0.5], [-0.3, -0.2], [-0.5, -0.4], [-0.9, -0.7]] \\ B_2 & [[0.3, 0.6], [0.3, 0.5], [0.8, 0.9], [-0.5, -0.3], [-0.9, -0.8], [-0.6, -0.3]] \\ B_3 & [[0.4, 0.5], [0.2, 0.4], [0.7, 0.9], [-0.4, -0.2], [-0.9, -0.7], [-0.5, -0.4]] \\ B_4 & [[0.6, 0.7], [0.3, 0.4], [0.8, 0.9], [-0.4, -0.3], [-0.9, -0.8], [-0.7, -0.6]] \end{pmatrix}$$

From the matrix $[\tilde{g}_{ij}]_{4 \times 3}$, we determine the positive ideal interval bipolar neutrosophic solution (q^*) by using Equation (6) as follows:

$$\begin{aligned} q^* &= \langle [0.7, 0.8], [0.0, 0.1], [0.1, 0.2], [-0.3, -0.2], [-0.2, -0.1], [-0.5, -0.3] \rangle; \\ &\langle [0.6, 0.7], [0.1, 0.2], [0.1, 0.3], [-0.3, -0.2], [-0.3, -0.1], [-0.6, -0.4] \rangle; \\ &\langle [0.3, 0.5], [0.3, 0.5], [0.8, 0.9], [-0.3, -0.2], [-0.9, -0.8], [-0.9, -0.7] \rangle. \end{aligned}$$

The weighted cross entropy between an alternative $B_i, i = 1, 2, \dots, m$, and the ideal alternative q^* can be obtained as given below:

$$C_{IB}(B_1, q^*)_w = 0.0606, C_{IB}(B_2, q^*)_w = 0.0286, C_{IB}(B_3, q^*)_w = 0.0426, C_{IB}(B_4, q^*)_w = 0.0423.$$

On the basis of the weighted cross entropy measure $C_{IB}(B_i, q^*)_w$, the order of the four alternatives is $B_2 < B_4 < B_3 < B_1$; therefore, B_2 is the best choice.

Next, the comparison of the results obtained from different methods is presented in Table 2 where the weight vector of the attribute is given by $w = (w_1, w_2, w_3) = (0.35, 0.25, 0.4)$. We observe that B_2 is the best option obtained using the proposed method and B_4 is the best option obtained using the method of Mahmood et al. [91]. The reason for this may be that we use the interval bipolar neutrosophic

cross entropy method whereas Mahmood et al. [91] derived the most desirable alternative based on a weighted arithmetic average operator in an interval bipolar neutrosophic setting.

Table 2. The results of the investment problem obtained from different methods.

Methods	Ranking Results	Best Option
The proposed weighted cross entropy measure	$B_2 < B_4 < B_3 < B_1$	B_2
Mahmood et al.'s strategy [91]	$B_2 < B_3 < B_1 < B_4$	B_4

7. Conclusions

In this paper we defined cross entropy and weighted cross entropy measures for bipolar neutrosophic sets and proved their basic properties. We also extended the proposed concept to the interval bipolar neutrosophic environment and proved its basic properties. The proposed cross entropy measures were then employed to develop two new multi-attribute decision-making strategies. Two illustrative numerical examples were solved and comparisons with existing strategies were provided to demonstrate the feasibility, applicability, and efficiency of the proposed strategies. We hope that the proposed cross entropy measures can be effective in dealing with group decision-making, data analysis, medical diagnosis, selection of a suitable company to build power plants [94], teacher selection [95], quality brick selection [96], weaver selection [97,98], etc. In future, the cross entropy measures can be extended to other neutrosophic hybrid environments, such as bipolar neutrosophic soft expert sets, bipolar neutrosophic refined sets, etc.

Author Contributions: Surapati Pramanik and Partha Pratim Dey conceived and designed the experiments; Surapati Pramanik performed the experiments; Jun Ye and Florentin Smarandache analyzed the data; Surapati Pramanik and Partha Pratim Dey wrote the paper.

Conflicts of Interest: The authors declare no conflict of interest.

Appendix A

Proof of Theorem 2

- (1) From the inequality stated in Theorem 1, we can easily obtain $C_B(M, N)_w \geq 0$.
- (2) $C_B(M, N)_w = 0$ if, and only if, $M = N$, i.e., $T_M^+(x_i) = T_N^+(x_i)$, $I_M^+(x_i) = I_N^+(x_i)$, $F_M^+(x_i) = F_N^+(x_i)$, $T_M^-(x_i) = T_N^-(x_i)$, $I_M^-(x_i) = I_N^-(x_i)$, $F_M^-(x_i) = F_N^-(x_i) \forall x \in U$.

$$\begin{aligned}
 (3) \quad C_B(M, N)_w &= \sum_{i=1}^n w_i i \left[\begin{aligned} &\sqrt{\frac{T_M^+(x_i)+T_N^+(x_i)}{2}} - \left(\sqrt{\frac{T_M^+(x_i)}{2}} + \sqrt{\frac{T_N^+(x_i)}{2}} \right) + \sqrt{\frac{I_M^+(x_i)+I_N^+(x_i)}{2}} - \left(\sqrt{\frac{I_M^+(x_i)}{2}} + \sqrt{\frac{I_N^+(x_i)}{2}} \right) + \\ &\sqrt{\frac{(1-I_M^+(x_i))+(1-I_N^+(x_i))}{2}} - \left(\sqrt{\frac{1-I_M^+(x_i)}{2}} + \sqrt{\frac{1-I_N^+(x_i)}{2}} \right) + \sqrt{\frac{F_M^+(x_i)+F_N^+(x_i)}{2}} - \left(\sqrt{\frac{F_M^+(x_i)}{2}} + \sqrt{\frac{F_N^+(x_i)}{2}} \right) + \\ &\sqrt{\frac{-(T_M^-(x_i)+T_N^-(x_i))}{2}} - \left(\sqrt{\frac{-(T_M^-(x_i))}{2}} + \sqrt{\frac{-(T_N^-(x_i))}{2}} \right) + \sqrt{\frac{-(I_M^-(x_i)+I_N^-(x_i))}{2}} - \left(\sqrt{\frac{-(I_M^-(x_i))}{2}} + \sqrt{\frac{-(I_N^-(x_i))}{2}} \right) + \\ &\sqrt{\frac{(1+I_M^-(x_i))+(1+I_N^-(x_i))}{2}} - \left(\sqrt{\frac{1+I_M^-(x_i)}{2}} + \sqrt{\frac{1+I_N^-(x_i)}{2}} \right) + \sqrt{\frac{-(F_M^-(x_i)+F_N^-(x_i))}{2}} - \left(\sqrt{\frac{-(F_M^-(x_i))}{2}} + \sqrt{\frac{-(F_N^-(x_i))}{2}} \right) \end{aligned} \right] \\
 &= \sum_{i=1}^n w_i \left[\begin{aligned} &\sqrt{\frac{T_N^+(x_i)+T_M^+(x_i)}{2}} - \left(\sqrt{\frac{T_N^+(x_i)}{2}} + \sqrt{\frac{T_M^+(x_i)}{2}} \right) + \sqrt{\frac{I_N^+(x_i)+I_M^+(x_i)}{2}} - \left(\sqrt{\frac{I_N^+(x_i)}{2}} + \sqrt{\frac{I_M^+(x_i)}{2}} \right) + \\ &\sqrt{\frac{(1-I_N^+(x_i))+(1-I_M^+(x_i))}{2}} - \left(\sqrt{\frac{1-I_N^+(x_i)}{2}} + \sqrt{\frac{1-I_M^+(x_i)}{2}} \right) + \sqrt{\frac{F_N^+(x_i)+F_M^+(x_i)}{2}} - \left(\sqrt{\frac{F_N^+(x_i)}{2}} + \sqrt{\frac{F_M^+(x_i)}{2}} \right) + \\ &\sqrt{\frac{-(T_N^-(x_i)+T_M^-(x_i))}{2}} - \left(\sqrt{\frac{-(T_N^-(x_i))}{2}} + \sqrt{\frac{-(T_M^-(x_i))}{2}} \right) + \sqrt{\frac{-(I_N^-(x_i)+I_M^-(x_i))}{2}} - \left(\sqrt{\frac{-(I_N^-(x_i))}{2}} + \sqrt{\frac{-(I_M^-(x_i))}{2}} \right) + \\ &\sqrt{\frac{(1+I_N^-(x_i))+(1+I_M^-(x_i))}{2}} - \left(\sqrt{\frac{1+I_N^-(x_i)}{2}} + \sqrt{\frac{1+I_M^-(x_i)}{2}} \right) + \sqrt{\frac{-(F_N^-(x_i)+F_M^-(x_i))}{2}} - \left(\sqrt{\frac{-(F_N^-(x_i))}{2}} + \sqrt{\frac{-(F_M^-(x_i))}{2}} \right) \end{aligned} \right] \\
 &= C_B(N, M)_w.
 \end{aligned}$$

$$\begin{aligned}
 (4) \quad C_B(M^C, N^C)_w &= \\
 & \sum_{i=1}^n \left[\begin{aligned}
 & \sqrt{\frac{F_M^+(x_i)+F_N^+(x_i)}{2}} - \left(\frac{\sqrt{F_M^+(x_i)}+\sqrt{F_N^+(x_i)}}{2} \right) + \sqrt{\frac{(1-I_M^+(x_i))+(1-I_N^+(x_i))}{2}} - \left(\frac{\sqrt{1-I_M^+(x_i)}+\sqrt{1-I_N^+(x_i)}}{2} \right) + \\
 & \sqrt{\frac{1-(1-I_M^+(x_i))+1-(1-I_N^+(x_i))}{2}} - \left(\frac{\sqrt{1-(1-I_M^+(x_i))}+\sqrt{1-(1-I_N^+(x_i))}}{2} \right) + \sqrt{\frac{T_M^+(x_i)+T_N^+(x_i)}{2}} - \left(\frac{\sqrt{T_M^+(x_i)}+\sqrt{T_N^+(x_i)}}{2} \right) + \\
 & \sqrt{\frac{-(F_M^-(x_i)+F_N^-(x_i))}{2}} - \left(\frac{\sqrt{-(F_M^-(x_i))}+\sqrt{-(F_N^-(x_i))}}{2} \right) + \sqrt{\frac{-(-1-I_M^-(x_i))-(-1-I_N^-(x_i))}{2}} - \left(\frac{\sqrt{-(-1-I_M^-(x_i))}+\sqrt{-(-1-I_N^-(x_i))}}{2} \right) + \\
 & \sqrt{\frac{1+(-1-I_M^-(x_i))+1+(-1-I_N^-(x_i))}{2}} - \left(\frac{\sqrt{1+(-1-I_M^-(x_i))}+\sqrt{1+(-1-I_N^-(x_i))}}{2} \right) + \sqrt{\frac{-(T_M^-(x_i)+T_N^-(x_i))}{2}} - \left(\frac{\sqrt{-(T_M^-(x_i))}+\sqrt{-(T_N^-(x_i))}}{2} \right)
 \end{aligned} \right] \\
 & = \sum_{i=1}^n w_i i \left[\begin{aligned}
 & \sqrt{\frac{T_M^+(x_i)+T_N^+(x_i)}{2}} - \left(\frac{\sqrt{T_M^+(x_i)}+\sqrt{T_N^+(x_i)}}{2} \right) + \sqrt{\frac{I_M^+(x_i)+I_N^+(x_i)}{2}} - \left(\frac{\sqrt{I_M^+(x_i)}+\sqrt{I_N^+(x_i)}}{2} \right) + \\
 & \sqrt{\frac{(1-I_M^+(x_i))+(1-I_N^+(x_i))}{2}} - \left(\frac{\sqrt{1-I_M^+(x_i)}+\sqrt{1-I_N^+(x_i)}}{2} \right) + \sqrt{\frac{F_M^+(x_i)+F_N^+(x_i)}{2}} - \left(\frac{\sqrt{F_M^+(x_i)}+\sqrt{F_N^+(x_i)}}{2} \right) + \\
 & \sqrt{\frac{-(T_M^-(x_i)+T_N^-(x_i))}{2}} - \left(\frac{\sqrt{-(T_M^-(x_i))}+\sqrt{-(T_N^-(x_i))}}{2} \right) + \sqrt{\frac{-(I_M^-(x_i)+I_N^-(x_i))}{2}} - \left(\frac{\sqrt{-(I_M^-(x_i))}+\sqrt{-(I_N^-(x_i))}}{2} \right) + \\
 & \sqrt{\frac{(1+I_M^-(x_i))+1+I_N^-(x_i)}{2}} - \left(\frac{\sqrt{1+I_M^-(x_i)}+\sqrt{1+I_N^-(x_i)}}{2} \right) + \sqrt{\frac{-(F_M^-(x_i)+F_N^-(x_i))}{2}} - \left(\frac{\sqrt{-(F_M^-(x_i))}+\sqrt{-(F_N^-(x_i))}}{2} \right)
 \end{aligned} \right] \\
 & = C_B(M^C, N^C)_w. \quad \square
 \end{aligned}$$

Appendix B

Proof of Theorem 4

- (1) Obviously, we can easily get $C_{IB}(R, S)_w \geq 0$.
- (2) If $C_{IB}(R, S)_w = 0$ then $R = S$, and if $\inf T_R^+(x_i) = \inf T_S^+(x_i)$, $\sup T_R^+(x_i) = \sup T_S^+(x_i)$, $\inf I_R^+(x_i) = \inf I_S^+(x_i)$, $\sup I_R^+(x_i) = \sup I_S^+(x_i)$, $\inf F_R^+(x_i) = \inf F_S^+(x_i)$, $\sup F_R^+(x_i) = \sup F_S^+(x_i)$, $\inf T_R^-(x_i) = \inf T_S^-(x_i)$, $\sup T_R^-(x_i) = \sup T_S^-(x_i)$, $\inf I_R^-(x_i) = \inf I_S^-(x_i)$, $\sup I_R^-(x_i) = \sup I_S^-(x_i)$, $\inf F_R^-(x_i) = \inf F_S^-(x_i)$, $\sup F_R^-(x_i) = \sup F_S^-(x_i) \forall x \in U$, then we obtain $C_{IB}(R, S)_w = 0$.

$$(3) \quad C_{IB}(R, S)_w = \frac{1}{2} \sum_{i=1}^n w_i \left[\begin{aligned}
 & \sqrt{\frac{\inf T_R^+(x_i)+\inf T_S^+(x_i)}{2}} - \left(\frac{\sqrt{\inf T_R^+(x_i)}+\sqrt{\inf T_S^+(x_i)}}{2} \right) + \sqrt{\frac{\sup T_R^+(x_i)+\sup T_S^+(x_i)}{2}} - \left(\frac{\sqrt{\sup T_R^+(x_i)}+\sqrt{\sup T_S^+(x_i)}}{2} \right) + \\
 & \sqrt{\frac{\inf I_R^+(x_i)+\inf I_S^+(x_i)}{2}} - \left(\frac{\sqrt{\inf I_R^+(x_i)}+\sqrt{\inf I_S^+(x_i)}}{2} \right) + \sqrt{\frac{\sup I_R^+(x_i)+\sup I_S^+(x_i)}{2}} - \left(\frac{\sqrt{\sup I_R^+(x_i)}+\sqrt{\sup I_S^+(x_i)}}{2} \right) + \\
 & \sqrt{\frac{(1-\inf T_R^+(x_i))+(1-\inf T_S^+(x_i))}{2}} - \left(\frac{\sqrt{1-\inf T_R^+(x_i)}+\sqrt{1-\inf T_S^+(x_i)}}{2} \right) + \sqrt{\frac{(1-\sup T_R^+(x_i))+(1-\sup T_S^+(x_i))}{2}} - \left(\frac{\sqrt{1-\sup T_R^+(x_i)}+\sqrt{1-\sup T_S^+(x_i)}}{2} \right) - \\
 & \left(\frac{\sqrt{1-\sup T_R^+(x_i)}+\sqrt{1-\sup T_S^+(x_i)}}{2} \right) + \sqrt{\frac{\inf F_R^+(x_i)+\inf F_S^+(x_i)}{2}} - \left(\frac{\sqrt{\inf F_R^+(x_i)}+\sqrt{\inf F_S^+(x_i)}}{2} \right) + \\
 & \sqrt{\frac{\sup F_R^+(x_i)+\sup F_S^+(x_i)}{2}} - \left(\frac{\sqrt{\sup F_R^+(x_i)}+\sqrt{\sup F_S^+(x_i)}}{2} \right) + \sqrt{\frac{-(\inf T_R^-(x_i)+\inf T_S^-(x_i))}{2}} - \left(\frac{\sqrt{-(\inf T_R^-(x_i))}+\sqrt{-(\inf T_S^-(x_i))}}{2} \right) - \\
 & \left(\frac{\sqrt{-(\inf T_R^-(x_i))}+\sqrt{-(\inf T_S^-(x_i))}}{2} \right) + \sqrt{\frac{-(\sup T_R^-(x_i)+\sup T_S^-(x_i))}{2}} - \left(\frac{\sqrt{-(\sup T_R^-(x_i))}+\sqrt{-(\sup T_S^-(x_i))}}{2} \right) + \\
 & \sqrt{\frac{-(\inf I_R^-(x_i)+\inf I_S^-(x_i))}{2}} - \left(\frac{\sqrt{-(\inf I_R^-(x_i))}+\sqrt{-(\inf I_S^-(x_i))}}{2} \right) + \sqrt{\frac{-(\sup I_R^-(x_i)+\sup I_S^-(x_i))}{2}} - \left(\frac{\sqrt{-(\sup I_R^-(x_i))}+\sqrt{-(\sup I_S^-(x_i))}}{2} \right) - \\
 & \left(\frac{\sqrt{-(\sup I_R^-(x_i))}+\sqrt{-(\sup I_S^-(x_i))}}{2} \right) + \sqrt{\frac{(1+\inf I_R^-(x_i))+(1+\inf I_S^-(x_i))}{2}} - \left(\frac{\sqrt{1+\inf I_R^-(x_i)}+\sqrt{1+\inf I_S^-(x_i)}}{2} \right) + \\
 & \sqrt{\frac{(1+\sup I_R^-(x_i))+(1+\sup I_S^-(x_i))}{2}} - \left(\frac{\sqrt{1+\sup I_R^-(x_i)}+\sqrt{1+\sup I_S^-(x_i)}}{2} \right) + \sqrt{\frac{-(\inf F_R^-(x_i)+\inf F_S^-(x_i))}{2}} - \left(\frac{\sqrt{-(\inf F_R^-(x_i))}+\sqrt{-(\inf F_S^-(x_i))}}{2} \right) - \\
 & \left(\frac{\sqrt{-(\inf F_R^-(x_i))}+\sqrt{-(\inf F_S^-(x_i))}}{2} \right) + \sqrt{\frac{-(\sup F_R^-(x_i)+\sup F_S^-(x_i))}{2}} - \left(\frac{\sqrt{-(\sup F_R^-(x_i))}+\sqrt{-(\sup F_S^-(x_i))}}{2} \right)
 \end{aligned} \right]$$

$$\begin{aligned}
 &= \frac{1}{2} \sum_{i=1}^n w_i \left[\begin{aligned}
 &\sqrt{\frac{\inf T_S^+(x_i) + \inf T_R^+(x_i)}{2}} - \left(\sqrt{\frac{\inf T_S^+(x_i)}{2}} + \sqrt{\frac{\inf T_R^+(x_i)}{2}} \right) + \sqrt{\frac{\sup T_S^+(x_i) + \sup T_R^+(x_i)}{2}} - \left(\sqrt{\frac{\sup T_S^+(x_i)}{2}} + \sqrt{\frac{\sup T_R^+(x_i)}{2}} \right) + \\
 &\sqrt{\frac{\inf I_S^+(x_i) + \inf I_R^+(x_i)}{2}} - \left(\sqrt{\frac{\inf I_S^+(x_i)}{2}} + \sqrt{\frac{\inf I_R^+(x_i)}{2}} \right) + \sqrt{\frac{\sup I_S^+(x_i) + \sup I_R^+(x_i)}{2}} - \left(\sqrt{\frac{\sup I_S^+(x_i)}{2}} + \sqrt{\frac{\sup I_R^+(x_i)}{2}} \right) + \\
 &\sqrt{\frac{(1 - \inf I_S^+(x_i)) + (1 - \inf I_R^+(x_i))}{2}} - \left(\sqrt{\frac{1 - \inf I_S^+(x_i)}{2}} + \sqrt{\frac{1 - \inf I_R^+(x_i)}{2}} \right) + \sqrt{\frac{(1 - \sup I_S^+(x_i)) + (1 - \sup I_R^+(x_i))}{2}} - \\
 &\left(\sqrt{\frac{1 - \sup I_S^+(x_i)}{2}} + \sqrt{\frac{1 - \sup I_R^+(x_i)}{2}} \right) + \sqrt{\frac{\inf F_S^+(x_i) + \inf F_R^+(x_i)}{2}} - \left(\sqrt{\frac{\inf F_S^+(x_i)}{2}} + \sqrt{\frac{\inf F_R^+(x_i)}{2}} \right) + \\
 &\sqrt{\frac{\sup F_S^+(x_i) + \sup F_R^+(x_i)}{2}} - \left(\sqrt{\frac{\sup F_S^+(x_i)}{2}} + \sqrt{\frac{\sup F_R^+(x_i)}{2}} \right) + \sqrt{\frac{-(\inf T_S^-(x_i) + \inf T_R^-(x_i))}{2}} - \\
 &\left(\sqrt{\frac{-(\inf T_S^-(x_i))}{2}} + \sqrt{\frac{-(\inf T_R^-(x_i))}{2}} \right) + \sqrt{\frac{-(\sup T_S^-(x_i) + \sup T_R^-(x_i))}{2}} - \left(\sqrt{\frac{-(\sup T_S^-(x_i))}{2}} + \sqrt{\frac{-(\sup T_R^-(x_i))}{2}} \right) + \\
 &\sqrt{\frac{-(\inf I_S^-(x_i) + \inf I_R^-(x_i))}{2}} - \left(\sqrt{\frac{-(\inf I_S^-(x_i))}{2}} + \sqrt{\frac{-(\inf I_R^-(x_i))}{2}} \right) + \sqrt{\frac{-(\sup I_S^-(x_i) + \sup I_R^-(x_i))}{2}} - \\
 &\left(\sqrt{\frac{-(\sup I_S^-(x_i))}{2}} + \sqrt{\frac{-(\sup I_R^-(x_i))}{2}} \right) + \sqrt{\frac{(1 + \inf I_S^-(x_i)) + (1 + \inf I_R^-(x_i))}{2}} - \left(\sqrt{\frac{1 + \inf I_S^-(x_i)}{2}} + \sqrt{\frac{1 + \inf I_R^-(x_i)}{2}} \right) + \\
 &\sqrt{\frac{(1 + \sup I_S^-(x_i)) + (1 + \sup I_R^-(x_i))}{2}} - \left(\sqrt{\frac{1 + \sup I_S^-(x_i)}{2}} + \sqrt{\frac{1 + \sup I_R^-(x_i)}{2}} \right) + \sqrt{\frac{-(\inf F_S^-(x_i) + \inf F_R^-(x_i))}{2}} - \\
 &\left(\sqrt{\frac{-(\inf F_S^-(x_i))}{2}} + \sqrt{\frac{-(\inf F_R^-(x_i))}{2}} \right) + \sqrt{\frac{-(\sup F_S^-(x_i) + \sup F_R^-(x_i))}{2}} - \left(\sqrt{\frac{-(\sup F_S^-(x_i))}{2}} + \sqrt{\frac{-(\sup F_R^-(x_i))}{2}} \right)
 \end{aligned} \right]
 \end{aligned}$$

= $C_{IB}(S, R)_w$.

(4) $C_{IB}(R^C, S^C)_w =$

$$\begin{aligned}
 &\frac{1}{2} \sum_{i=1}^n w_i \left[\begin{aligned}
 &\sqrt{\frac{\sup I_S^+(c) + \sup I_R^+(c)}{2}} - \left(\sqrt{\frac{\sup I_S^+(c)}{2}} + \sqrt{\frac{\sup I_R^+(c)}{2}} \right) + \sqrt{\frac{\sup T_S^+(c) + \sup T_R^+(c)}{2}} - \left(\sqrt{\frac{\sup T_S^+(c)}{2}} + \sqrt{\frac{\sup T_R^+(c)}{2}} \right) + \\
 &\sqrt{\frac{-(\inf I_S^+(c) + \inf I_R^+(c))}{2}} - \left(\sqrt{\frac{-(\inf I_S^+(c))}{2}} + \sqrt{\frac{-(\inf I_R^+(c))}{2}} \right) + \sqrt{\frac{-(\sup I_S^+(c) + \sup I_R^+(c))}{2}} - \left(\sqrt{\frac{-(\sup I_S^+(c))}{2}} + \sqrt{\frac{-(\sup I_R^+(c))}{2}} \right) + \\
 &\sqrt{\frac{-(\inf T_S^+(c) + \inf T_R^+(c))}{2}} - \left(\sqrt{\frac{-(\inf T_S^+(c))}{2}} + \sqrt{\frac{-(\inf T_R^+(c))}{2}} \right) + \sqrt{\frac{-(\sup T_S^+(c) + \sup T_R^+(c))}{2}} - \left(\sqrt{\frac{-(\sup T_S^+(c))}{2}} + \sqrt{\frac{-(\sup T_R^+(c))}{2}} \right) - \\
 &\left(\sqrt{\frac{-(\inf I_S^+(c) + \inf I_R^+(c))}{2}} + \sqrt{\frac{-(\inf T_S^+(c) + \inf T_R^+(c))}{2}} - \left(\sqrt{\frac{-(\inf I_S^+(c))}{2}} + \sqrt{\frac{-(\inf T_S^+(c))}{2}} \right) + \sqrt{\frac{-(\sup I_S^+(c) + \sup I_R^+(c))}{2}} - \left(\sqrt{\frac{-(\sup I_S^+(c))}{2}} + \sqrt{\frac{-(\sup T_S^+(c))}{2}} \right) \right) \\
 &+ \sqrt{\frac{-(\inf I_S^-(c) + \inf I_R^-(c))}{2}} - \left(\sqrt{\frac{-(\inf I_S^-(c))}{2}} + \sqrt{\frac{-(\inf I_R^-(c))}{2}} \right) + \sqrt{\frac{-(\sup I_S^-(c) + \sup I_R^-(c))}{2}} - \left(\sqrt{\frac{-(\sup I_S^-(c))}{2}} + \sqrt{\frac{-(\sup I_R^-(c))}{2}} \right) + \\
 &\sqrt{\frac{-(\inf T_S^-(c) + \inf T_R^-(c))}{2}} - \left(\sqrt{\frac{-(\inf T_S^-(c))}{2}} + \sqrt{\frac{-(\inf T_R^-(c))}{2}} \right) + \sqrt{\frac{-(\sup T_S^-(c) + \sup T_R^-(c))}{2}} - \left(\sqrt{\frac{-(\sup T_S^-(c))}{2}} + \sqrt{\frac{-(\sup T_R^-(c))}{2}} \right) - \\
 &\left(\sqrt{\frac{-(\inf I_S^-(c) + \inf I_R^-(c))}{2}} + \sqrt{\frac{-(\inf T_S^-(c) + \inf T_R^-(c))}{2}} - \left(\sqrt{\frac{-(\inf I_S^-(c))}{2}} + \sqrt{\frac{-(\inf T_S^-(c))}{2}} \right) + \sqrt{\frac{-(\sup I_S^-(c) + \sup I_R^-(c))}{2}} - \left(\sqrt{\frac{-(\sup I_S^-(c))}{2}} + \sqrt{\frac{-(\sup T_S^-(c))}{2}} \right) \right) \\
 &\sqrt{\frac{-(\inf I_S^-(c) + \inf I_R^-(c))}{2}} + \sqrt{\frac{-(\inf T_S^-(c) + \inf T_R^-(c))}{2}} - \left(\sqrt{\frac{-(\inf I_S^-(c))}{2}} + \sqrt{\frac{-(\inf T_S^-(c))}{2}} \right) + \sqrt{\frac{-(\sup I_S^-(c) + \sup I_R^-(c))}{2}} - \\
 &\left(\sqrt{\frac{-(\sup I_S^-(c))}{2}} + \sqrt{\frac{-(\sup T_S^-(c))}{2}} \right) + \sqrt{\frac{-(\inf F_S^-(c) + \inf F_R^-(c))}{2}} - \\
 &\left(\sqrt{\frac{-(\inf F_S^-(c))}{2}} + \sqrt{\frac{-(\inf F_R^-(c))}{2}} \right) + \sqrt{\frac{-(\sup F_S^-(c) + \sup F_R^-(c))}{2}} - \left(\sqrt{\frac{-(\sup F_S^-(c))}{2}} + \sqrt{\frac{-(\sup F_R^-(c))}{2}} \right)
 \end{aligned} \right]
 \end{aligned}$$

$$\begin{aligned}
 &= \frac{1}{2} \sum_{i=1}^n w_i \left[\begin{aligned}
 &\sqrt{\frac{\text{inf}I_R^+(x_i) + \text{inf}I_S^+(x_i)}{2}} - \left(\frac{\sqrt{\text{inf}I_R^+(x_i)} + \sqrt{\text{inf}I_S^+(x_i)}}{2} \right) + \sqrt{\frac{\text{sup}I_R^+(x_i) + \text{sup}I_S^+(x_i)}{2}} - \left(\frac{\sqrt{\text{sup}I_R^+(x_i)} + \sqrt{\text{sup}I_S^+(x_i)}}{2} \right) + \\
 &\sqrt{\frac{\text{inf}I_R^+(x_i) + \text{inf}I_S^+(x_i)}{2}} - \left(\frac{\sqrt{\text{inf}I_R^+(x_i)} + \sqrt{\text{inf}I_S^+(x_i)}}{2} \right) + \sqrt{\frac{\text{sup}I_R^+(x_i) + \text{sup}I_S^+(x_i)}{2}} - \left(\frac{\sqrt{\text{sup}I_R^+(x_i)} + \sqrt{\text{sup}I_S^+(x_i)}}{2} \right) + \\
 &\sqrt{\frac{(1 - \text{inf}I_R^+(x_i)) + (1 - \text{inf}I_S^+(x_i))}{2}} - \left(\frac{\sqrt{1 - \text{inf}I_R^+(x_i)} + \sqrt{1 - \text{inf}I_S^+(x_i)}}{2} \right) + \sqrt{\frac{(1 - \text{sup}I_R^+(x_i)) + (1 - \text{sup}I_S^+(x_i))}{2}} - \\
 &\left(\frac{\sqrt{1 - \text{sup}I_R^+(x_i)} + \sqrt{1 - \text{sup}I_S^+(x_i)}}{2} \right) + \sqrt{\frac{\text{inf}F_R^+(x_i) + \text{inf}F_S^+(x_i)}{2}} - \left(\frac{\sqrt{\text{inf}F_R^+(x_i)} + \sqrt{\text{inf}F_S^+(x_i)}}{2} \right) + \\
 &\sqrt{\frac{\text{sup}F_R^+(x_i) + \text{sup}F_S^+(x_i)}{2}} - \left(\frac{\sqrt{\text{sup}F_R^+(x_i)} + \sqrt{\text{sup}F_S^+(x_i)}}{2} \right) + \sqrt{\frac{-(\text{inf}I_R^-(x_i) + \text{inf}I_S^-(x_i))}{2}} - \\
 &\left(\frac{\sqrt{-(\text{inf}I_R^-(x_i))} + \sqrt{-(\text{inf}I_S^-(x_i))}}{2} \right) + \sqrt{\frac{-(\text{sup}I_R^-(x_i) + \text{sup}I_S^-(x_i))}{2}} - \left(\frac{\sqrt{-(\text{sup}I_R^-(x_i))} + \sqrt{-(\text{sup}I_S^-(x_i))}}{2} \right) + \\
 &\sqrt{\frac{-(\text{inf}I_R^-(x_i) + \text{inf}I_S^-(x_i))}{2}} - \left(\frac{\sqrt{-(\text{inf}I_R^-(x_i))} + \sqrt{-(\text{inf}I_S^-(x_i))}}{2} \right) + \sqrt{\frac{-(\text{sup}I_R^-(x_i) + \text{sup}I_S^-(x_i))}{2}} - \\
 &\left(\frac{\sqrt{-(\text{sup}I_R^-(x_i))} + \sqrt{-(\text{sup}I_S^-(x_i))}}{2} \right) + \sqrt{\frac{(1 + \text{inf}I_R^-(x_i)) + (1 + \text{inf}I_S^-(x_i))}{2}} - \left(\frac{\sqrt{1 + \text{inf}I_R^-(x_i)} + \sqrt{1 + \text{inf}I_S^-(x_i)}}{2} \right) + \\
 &\sqrt{\frac{(1 + \text{sup}I_R^-(x_i)) + (1 + \text{sup}I_S^-(x_i))}{2}} - \left(\frac{\sqrt{1 + \text{sup}I_R^-(x_i)} + \sqrt{1 + \text{sup}I_S^-(x_i)}}{2} \right) + \sqrt{\frac{-(\text{inf}F_R^-(x_i) + \text{inf}F_S^-(x_i))}{2}} - \\
 &\left(\frac{\sqrt{-(\text{inf}F_R^-(x_i))} + \sqrt{-(\text{inf}F_S^-(x_i))}}{2} \right) + \sqrt{\frac{-(\text{sup}F_R^-(x_i) + \text{sup}F_S^-(x_i))}{2}} - \left(\frac{\sqrt{-(\text{sup}F_R^-(x_i))} + \sqrt{-(\text{sup}F_S^-(x_i))}}{2} \right)
 \end{aligned} \right] \\
 &= C_{IB}(R, S)_w.
 \end{aligned}$$

This completes the proof. □

References

1. Shannon, C.E.; Weaver, W. *The Mathematical Theory of Communications*; The University of Illinois Press: Urbana, IL, USA, 1949.
2. Shannon, C.E. A mathematical theory of communications. *Bell Syst. Tech. J.* **1948**, *27*, 379–423. [CrossRef]
3. Criado, F.; Gachechiladze, T. Entropy of fuzzy events. *Fuzzy Sets Syst.* **1997**, *88*, 99–106. [CrossRef]
4. Herencia, J.; Lamta, M. Entropy measure associated with fuzzy basic probability assignment. In Proceedings of the IEEE International Conference on Fuzzy Systems, Barcelona, Spain, 5 July 1997; Volume 2, pp. 863–868.
5. Rudas, I.; Kaynak, M. Entropy based operations on fuzzy sets. *IEEE Trans. Fuzzy Syst.* **1998**, *6*, 33–39. [CrossRef]
6. Zadeh, L.A. Probability measures of fuzzy events. *J. Math. Anal. Appl.* **1968**, *23*, 421–427. [CrossRef]
7. Luca, A.D.; Termini, S. A definition of non-probabilistic entropy in the setting of fuzzy set theory. *Inf. Control* **1972**, *20*, 301–312. [CrossRef]
8. Sander, W. On measure of fuzziness. *Fuzzy Sets Syst.* **1989**, *29*, 49–55. [CrossRef]
9. Xie, W.; Bedrosian, S. An information measure for fuzzy sets. *IEEE Trans. Syst. Man Cybern.* **1984**, *14*, 151–156. [CrossRef]
10. Pal, N.; Pal, S. Higher order fuzzy entropy and hybrid entropy of a fuzzy set. *Inf. Sci.* **1992**, *61*, 211–221. [CrossRef]
11. Kaufmann, A.; Gupta, M. *Introduction of Fuzzy Arithmetic: Theory and Applications*; Van Nostrand Reinhold Co.: New York, NY, USA, 1985.
12. Yager, R. On the measure of fuzziness and negation. Part I: Membership in the unit interval. *Int. J. Gen. Syst.* **1979**, *5*, 221–229. [CrossRef]
13. Yager, R. On the measure of fuzziness and negation. Part II: Lattice. *Inf. Control* **1980**, *44*, 236–260. [CrossRef]
14. Kosko, B. Fuzzy entropy and conditioning. *Inf. Sci.* **1986**, *40*, 165–174. [CrossRef]
15. Kosko, B. Concepts of fuzzy information measure on continuous domains. *Int. J. Gen. Syst.* **1990**, *17*, 211–240. [CrossRef]
16. Prakash, O.; Sharma, P.K.; Mahajan, R. New measures of weighted fuzzy entropy and their applications for the study of maximum weighted fuzzy entropy principle. *Inf. Sci.* **2008**, *178*, 2389–2395. [CrossRef]

17. Burillo, P.; Bustince, H. Entropy on intuitionistic fuzzy sets and on interval-valued fuzzy sets. *Fuzzy Sets Syst.* **1996**, *78*, 305–316. [[CrossRef](#)]
18. Szmidt, E.; Kacprzyk, J. Entropy for intuitionistic fuzzy sets. *Fuzzy Sets Syst.* **2001**, *118*, 467–477. [[CrossRef](#)]
19. Wei, C.P.; Wang, P.; Zhang, Y.Z. Entropy, similarity measure of interval-valued intuitionistic fuzzy sets and their applications. *Inf. Sci.* **2011**, *181*, 4273–4286. [[CrossRef](#)]
20. Li, X.Y. Interval-valued intuitionistic fuzzy continuous cross entropy and its application in multi-attribute decision-making. *Comput. Eng. Appl.* **2013**, *49*, 234–237.
21. Shang, X.G.; Jiang, W.S. A note on fuzzy information measures. *Pattern Recognit. Lett.* **1997**, *18*, 425–432. [[CrossRef](#)]
22. Vlachos, I.K.; Sergiadis, G.D. Intuitionistic fuzzy information applications to pattern recognition. *Pattern Recognit. Lett.* **2007**, *28*, 197–206. [[CrossRef](#)]
23. Ye, J. Fuzzy cross entropy of interval-valued intuitionistic fuzzy sets and its optimal decision-making method based on the weights of the alternatives. *Expert Syst. Appl.* **2011**, *38*, 6179–6183. [[CrossRef](#)]
24. Xia, M.M.; Xu, Z.S. Entropy/cross entropy-based group decision making under intuitionistic fuzzy sets. *Inf. Fusion* **2012**, *13*, 31–47. [[CrossRef](#)]
25. Tong, X.; Yu, L.A. A novel MADM approach based on fuzzy cross entropy with interval-valued intuitionistic fuzzy sets. *Math. Probl. Eng.* **2015**, *2015*, 1–9. [[CrossRef](#)]
26. Smarandache, F. *A Unifying Field of Logics. Neutrosophy: Neutrosophic Probability, Set and Logic*; American Research Press: Rehoboth, DE, USA, 1998.
27. Zadeh, L.A. Fuzzy sets. *Inf. Control* **1965**, *8*, 338–353. [[CrossRef](#)]
28. Atanassov, K.T. Intuitionistic fuzzy sets. *Fuzzy Sets Syst.* **1986**, *20*, 87–96. [[CrossRef](#)]
29. Wang, H.; Smarandache, F.; Zhang, Y.Q.; Sunderraman, R. Single valued neutrosophic sets. *Multispace Multistruct.* **2010**, *4*, 410–413.
30. Pramanik, S.; Biswas, P.; Giri, B.C. Hybrid vector similarity measures and their applications to multi-attribute decision making under neutrosophic environment. *Neural Comput. Appl.* **2017**, *28*, 1163–1176. [[CrossRef](#)]
31. Biswas, P.; Pramanik, S.; Giri, B.C. Entropy based grey relational analysis method for multi-attribute decision making under single valued neutrosophic assessments. *Neutrosophic Sets Syst.* **2014**, *2*, 102–110.
32. Biswas, P.; Pramanik, S.; Giri, B.C. A new methodology for neutrosophic multi-attribute decision making with unknown weight information. *Neutrosophic Sets Syst.* **2014**, *3*, 42–52.
33. Biswas, P.; Pramanik, S.; Giri, B.C. TOPSIS method for multi-attribute group decision-making under single valued neutrosophic environment. *Neural Comput. Appl.* **2015**. [[CrossRef](#)]
34. Biswas, P.; Pramanik, S.; Giri, B.C. Aggregation of triangular fuzzy neutrosophic set information and its application to multi-attribute decision making. *Neutrosophic Sets Syst.* **2016**, *12*, 20–40.
35. Biswas, P.; Pramanik, S.; Giri, B.C. Value and ambiguity index based ranking method of single-valued trapezoidal neutrosophic numbers and its application to multi-attribute decision making. *Neutrosophic Sets Syst.* **2016**, *12*, 127–138.
36. Biswas, P.; Pramanik, S.; Giri, B.C. Multi-attribute group decision making based on expected value of neutrosophic trapezoidal numbers. In *New Trends in Neutrosophic Theory and Applications*; Smarandache, F., Pramanik, S., Eds.; Pons Editions: Brussels, Belgium, 2017; Volume II, in press.
37. Biswas, P.; Pramanik, S.; Giri, B.C. Non-linear programming approach for single-valued neutrosophic TOPSIS method. *New Math. Nat. Comput.* **2017**, in press.
38. Deli, I.; Subas, Y. A ranking method of single valued neutrosophic numbers and its applications to multi-attribute decision making problems. *Int. J. Mach. Learn. Cybern.* **2016**. [[CrossRef](#)]
39. Ji, P.; Wang, J.Q.; Zhang, H.Y. Frank prioritized Bonferroni mean operator with single-valued neutrosophic sets and its application in selecting third-party logistics providers. *Neural Comput. Appl.* **2016**. [[CrossRef](#)]
40. Kharal, A. A neutrosophic multi-criteria decision making method. *New Math. Nat. Comput.* **2014**, *10*, 143–162. [[CrossRef](#)]
41. Liang, R.X.; Wang, J.Q.; Li, L. Multi-criteria group decision making method based on interdependent inputs of single valued trapezoidal neutrosophic information. *Neural Comput. Appl.* **2016**. [[CrossRef](#)]
42. Liang, R.X.; Wang, J.Q.; Zhang, H.Y. A multi-criteria decision-making method based on single-valued trapezoidal neutrosophic preference relations with complete weight information. *Neural Comput. Appl.* **2017**. [[CrossRef](#)]

43. Liu, P.; Chu, Y.; Li, Y.; Chen, Y. Some generalized neutrosophic number Hamacher aggregation operators and their application to group decision making. *Int. J. Fuzzy Syst.* **2014**, *16*, 242–255.
44. Liu, P.D.; Li, H.G. Multiple attribute decision-making method based on some normal neutrosophic Bonferroni mean operators. *Neural Comput. Appl.* **2017**, *28*, 179–194. [[CrossRef](#)]
45. Liu, P.; Wang, Y. Multiple attribute decision-making method based on single-valued neutrosophic normalized weighted Bonferroni mean. *Neural Comput. Appl.* **2014**, *25*, 2001–2010. [[CrossRef](#)]
46. Peng, J.J.; Wang, J.Q.; Wang, J.; Zhang, H.Y.; Chen, X.H. Simplified neutrosophic sets and their applications in multi-criteria group decision-making problems. *Int. J. Syst. Sci.* **2016**, *47*, 2342–2358. [[CrossRef](#)]
47. Peng, J.; Wang, J.; Zhang, H.; Chen, X. An outranking approach for multi-criteria decision-making problems with simplified neutrosophic sets. *Appl. Soft Comput.* **2014**, *25*, 336–346. [[CrossRef](#)]
48. Pramanik, S.; Banerjee, D.; Giri, B.C. Multi-criteria group decision making model in neutrosophic refined set and its application. *Glob. J. Eng. Sci. Res. Manag.* **2016**, *3*, 12–18.
49. Pramanik, S.; Dalapati, S.; Roy, T.K. Logistics center location selection approach based on neutrosophic multi-criteria decision making. In *New Trends in Neutrosophic Theory and Applications*; Smarandache, F., Pramanik, S., Eds.; Pons Asbl: Brussels, Belgium, 2016; Volume 1, pp. 161–174, ISBN 978-1-59973-498-9.
50. Sahin, R.; Karabacak, M. A multi attribute decision making method based on inclusion measure for interval neutrosophic sets. *Int. J. Eng. Appl. Sci.* **2014**, *2*, 13–15.
51. Sahin, R.; Kucuk, A. Subsethood measure for single valued neutrosophic sets. *J. Intell. Fuzzy Syst.* **2014**. [[CrossRef](#)]
52. Sahin, R.; Liu, P. Maximizing deviation method for neutrosophic multiple attribute decision making with incomplete weight information. *Neural Comput. Appl.* **2016**, *27*, 2017–2029. [[CrossRef](#)]
53. Sodenkamp, M. Models, Strategies and Applications of Group Multiple-Criteria Decision Analysis in Complex and Uncertain Systems. Ph.D. Thesis, University of Paderborn, Paderborn, Germany, 2013.
54. Ye, J. Multicriteria decision-making method using the correlation coefficient under single-valued neutrosophic environment. *Int. J. Gen. Syst.* **2013**, *42*, 386–394. [[CrossRef](#)]
55. Ye, J. Another form of correlation coefficient between single valued neutrosophic sets and its multiple attribute decision making method. *Neutrosophic Sets Syst.* **2013**, *1*, 8–12.
56. Ye, J. A multi criteria decision-making method using aggregation operators for simplified neutrosophic sets. *J. Intell. Fuzzy Syst.* **2014**, *26*, 2459–2466.
57. Ye, J. Trapezoidal neutrosophic set and its application to multiple attribute decision-making. *Neural Comput. Appl.* **2015**, *26*, 1157–1166. [[CrossRef](#)]
58. Ye, J. Bidirectional projection method for multiple attribute group decision making with neutrosophic number. *Neural Comput. Appl.* **2015**. [[CrossRef](#)]
59. Ye, J. Projection and bidirectional projection measures of single valued neutrosophic sets and their decision—Making method for mechanical design scheme. *J. Exp. Theor. Artif. Intell.* **2016**. [[CrossRef](#)]
60. Nancy, G.H. Novel single-valued neutrosophic decision making operators under Frank norm operations and its application. *Int. J. Uncertain. Quant.* **2016**, *6*, 361–375. [[CrossRef](#)]
61. Nancy, G.H. Some new biparametric distance measures on single-valued neutrosophic sets with applications to pattern recognition and medical diagnosis. *Information* **2017**, *8*, 162. [[CrossRef](#)]
62. Pramanik, S.; Roy, T.K. Neutrosophic game theoretic approach to Indo-Pak conflict over Jammu-Kashmir. *Neutrosophic Sets Syst.* **2014**, *2*, 82–101.
63. Mondal, K.; Pramanik, S. Multi-criteria group decision making approach for teacher recruitment in higher education under simplified Neutrosophic environment. *Neutrosophic Sets Syst.* **2014**, *6*, 28–34.
64. Mondal, K.; Pramanik, S. Neutrosophic decision making model of school choice. *Neutrosophic Sets Syst.* **2015**, *7*, 62–68.
65. Cheng, H.D.; Guo, Y. A new neutrosophic approach to image thresholding. *New Math. Nat. Comput.* **2008**, *4*, 291–308. [[CrossRef](#)]
66. Guo, Y.; Cheng, H.D. New neutrosophic approach to image segmentation. *Pattern Recognit.* **2009**, *42*, 587–595. [[CrossRef](#)]
67. Guo, Y.; Sengur, A.; Ye, J. A novel image thresholding algorithm based on neutrosophic similarity score. *Measurement* **2014**, *58*, 175–186. [[CrossRef](#)]
68. Ye, J. Single valued neutrosophic minimum spanning tree and its clustering method. *J. Intell. Syst.* **2014**, *23*, 311–324. [[CrossRef](#)]

69. Ye, J. Clustering strategies using distance-based similarity measures of single-valued neutrosophic sets. *J. Intell. Syst.* **2014**, *23*, 379–389.
70. Mondal, K.; Pramanik, S. A study on problems of Hijras in West Bengal based on neutrosophic cognitive maps. *Neutrosophic Sets Syst.* **2014**, *5*, 21–26.
71. Pramanik, S.; Chakrabarti, S. A study on problems of construction workers in West Bengal based on neutrosophic cognitive maps. *Int. J. Innov. Res. Sci. Eng. Technol.* **2013**, *2*, 6387–6394.
72. Majumdar, P.; Samanta, S.K. On similarity and entropy of neutrosophic sets. *J. Intell. Fuzzy Syst.* **2014**, *26*, 1245–1252.
73. Ye, J. Single valued neutrosophic cross-entropy for multi criteria decision making problems. *Appl. Math. Model.* **2014**, *38*, 1170–1175. [[CrossRef](#)]
74. Ye, J. Improved cross entropy measures of single valued neutrosophic sets and interval neutrosophic sets and their multi criteria decision making strategies. *Cybern. Inf. Technol.* **2015**, *15*, 13–26. [[CrossRef](#)]
75. Wang, H.; Smarandache, F.; Zhang, Y.Q.; Sunderraman, R. *Interval Neutrosophic Sets and Logic: Theory and Applications in Computing*; Hexis: Phoenix, AZ, USA, 2005.
76. Pramanik, S.; Dalapati, S.; Alam, S.; Smarandache, F.; Roy, T.K. NS-cross entropy-based MAGDM under single-valued neutrosophic set environment. *Information* **2018**, *9*, 37. [[CrossRef](#)]
77. Sahin, R. Cross-entropy measure on interval neutrosophic sets and its applications in multi criteria decision making. *Neural Comput. Appl.* **2015**. [[CrossRef](#)]
78. Tian, Z.P.; Zhang, H.Y.; Wang, J.; Wang, J.Q.; Chen, X.H. Multi-criteria decision-making method based on a cross-entropy with interval neutrosophic sets. *Int. J. Syst. Sci.* **2015**. [[CrossRef](#)]
79. Hwang, C.L.; Yoon, K. *Multiple Attribute Decision Making: Methods and Applications*; Springer: New York, NY, USA, 1981.
80. Dalapati, S.; Pramanik, S.; Alam, S.; Smarandache, S.; Roy, T.K. IN-cross entropy based magdm strategy under interval neutrosophic set environment. *Neutrosophic Sets Syst.* **2017**, *18*, 43–57. [[CrossRef](#)]
81. Deli, I.; Ali, M.; Smarandache, F. Bipolar neutrosophic sets and their application based on multi-criteria decision making problems. In Proceedings of the 2015 International Conference on Advanced Mechatronic Systems (ICAMechS), Beijing, China, 22–24 August 2015; pp. 249–254.
82. Zhang, W.R. Bipolar fuzzy sets. In Proceedings of the IEEE World Congress on Computational Science (FuzzIEEE), Anchorage, AK, USA, 4–9 May 1998; pp. 835–840. [[CrossRef](#)]
83. Zhang, W.R. Bipolar fuzzy sets and relations: A computational framework for cognitive modeling and multiagent decision analysis. In Proceedings of the IEEE Industrial Fuzzy Control and Intelligent Systems Conference, and the NASA Joint Technology Workshop on Neural Networks and Fuzzy Logic, Fuzzy Information Processing Society Biannual Conference, San Antonio, TX, USA, 18–21 December 1994; pp. 305–309. [[CrossRef](#)]
84. Deli, I.; Subas, Y.A. Multiple criteria decision making method on single valued bipolar neutrosophic set based on correlation coefficient similarity measure. In Proceedings of the International Conference on Mathematics and Mathematics Education (ICMME-2016), Elazg, Turkey, 12–14 May 2016.
85. Şahin, M.; Deli, I.; Uluçay, V. Jaccard vector similarity measure of bipolar neutrosophic set based on multi-criteria decision making. In Proceedings of the International Conference on Natural Science and Engineering (ICNASE'16), Killis, Turkey, 19–20 March 2016.
86. Uluçay, V.; Deli, I.; Şahin, M. Similarity measures of bipolar neutrosophic sets and their application to multiple criteria decision making. *Neural Comput. Appl.* **2016**. [[CrossRef](#)]
87. Dey, P.P.; Pramanik, S.; Giri, B.C. TOPSIS for solving multi-attribute decision making problems under bi-polar neutrosophic environment. In *New Trends in Neutrosophic Theory and Applications*; Smarandache, F., Pramanik, S., Eds.; Pons Asbl: Brussels, Belgium, 2016; pp. 65–77, ISBN 978-1-59973-498-9.
88. Pramanik, S.; Dey, P.P.; Giri, B.C.; Smarandache, F. Bipolar neutrosophic projection based models for solving multi-attribute decision making problems. *Neutrosophic Sets Syst.* **2017**, *15*, 74–83. [[CrossRef](#)]
89. Wang, L.; Zhang, H.; Wang, J. Frank Choquet Bonferroni operators of bipolar neutrosophic sets and their applications to multi-criteria decision-making problems. *Int. J. Fuzzy Syst.* **2017**. [[CrossRef](#)]
90. Pramanik, S.; Dalapati, S.; Alam, S.; Smarandache, F.; Roy, T.K. TODIM Method for Group Decision Making under Bipolar Neutrosophic Set Environment. In *New Trends in Neutrosophic Theory and Applications*; Smarandache, F., Pramanik, S., Eds.; Pons Editions: Brussels, Belgium, 2016; Volume II, in press.

91. Mahmood, T.; Ye, J.; Khan, Q. Bipolar Interval Neutrosophic Set and Its Application in Multicriteria Decision Making. Available online: <https://archive.org/details/BipolarIntervalNeutrosophicSet> (accessed on 9 October 2017).
92. Deli, I.; Şubaş, Y.; Smarandache, F.; Ali, M. Interval Valued Bipolar Neutrosophic Sets and Their Application in Pattern Recognition. Available online: <https://www.researchgate.net/publication/289587637> (accessed on 9 October 2017).
93. Ye, J. Similarity measures between interval neutrosophic sets and their applications in multicriteria decision-making. *J. Intell. Fuzzy Syst.* **2014**, *26*, 165–172. [[CrossRef](#)]
94. Garg, H. Non-linear programming method for multi-criteria decision making problems under interval neutrosophic set environment. *Appl. Intell.* **2017**, 1–15. [[CrossRef](#)]
95. Pramanik, S.; Mukhopadhyaya, D. Grey relational analysis-based intuitionistic fuzzy multi-criteria group decision-making approach for teacher selection in higher education. *Int. J. Comput. Appl.* **2011**, *34*, 21–29. [[CrossRef](#)]
96. Mondal, K.; Pramanik, S. Intuitionistic fuzzy multi criteria group decision making approach to quality-brick selection problem. *J. Appl. Quant. Methods* **2014**, *9*, 35–50.
97. Dey, P.P.; Pramanik, S.; Giri, B.C. Multi-criteria group decision making in intuitionistic fuzzy environment based on grey relational analysis for weaver selection in Khadi institution. *J. Appl. Quant. Methods* **2015**, *10*, 1–14.
98. Dey, P.P.; Pramanik, S.; Giri, B.C. An extended grey relational analysis based interval neutrosophic multi-attribute decision making for weaver selection. *J. New Theory* **2015**, *9*, 82–93.

Decision-Making Approach Based on Neutrosophic Rough Information

Muhammad Akram, Nabeela Ishfaq, Sidra Sayed, Florentin Smarandache

Muhammad Akram, Nabeela Ishfaq, Sidra Sayed, Florentin Smarandache (2018). Decision-Making Approach Based on Neutrosophic Rough Information. *Algorithms* 11, 59; DOI: 10.3390/a11050059

Abstract: Rough set theory and neutrosophic set theory are mathematical models to deal with incomplete and vague information. These two theories can be combined into a framework for modeling and processing incomplete information in information systems. Thus, the neutrosophic rough set hybrid model gives more precision, flexibility and compatibility to the system as compared to the classic and fuzzy models. In this research study, we develop neutrosophic rough digraphs based on the neutrosophic rough hybrid model. Moreover, we discuss regular neutrosophic rough digraphs, and we solve decision-making problems by using our proposed hybrid model. Finally, we give a comparison analysis of two hybrid models, namely, neutrosophic rough digraphs and rough neutrosophic digraphs.

Keywords: neutrosophic rough hybrid model; regular neutrosophic rough digraphs; decision-making method

1. Introduction

The concept of a neutrosophic set, which generalizes fuzzy sets [1] and intuitionistic fuzzy sets [2], was proposed by Smarandache [3] in 1998, and it is defined as a set about the degree of truth, indeterminacy, and falsity. A neutrosophic set A in a universal set X is characterized independently by a truth-membership function ($T_A(x)$), an indeterminacy-membership function ($I_A(x)$), and a falsity-membership function ($F_A(x)$). To apply neutrosophic sets in real-life problems more conveniently, Smarandache [3] and Wang et al., [4] defined single-valued neutrosophic sets which take the value from the subset of $[0, 1]$.

Rough set theory was proposed by Pawlak [5] in 1982. Rough set theory is useful to study the intelligence systems containing incomplete, uncertain or inexact information. The lower and upper approximation operators of rough sets are used for managing hidden information in a system. Therefore, many hybrid models have been built such as soft rough sets, rough fuzzy sets, fuzzy rough sets, soft fuzzy rough sets, neutrosophic rough sets and rough neutrosophic sets for handling uncertainty and incomplete information effectively. Dubois and Prade [6] introduced the notions of rough fuzzy sets and fuzzy rough sets. Liu and Chen [7] have studied different decision-making methods. Mordeson and Peng [8] presented operations on fuzzy graphs. Akram et al., [9–12] considered several new concepts of neutrosophic graphs with applications. Rough fuzzy digraphs with applications are presented in [13,14]. To get the extended notion of neutrosophic sets and rough sets, many attempts have been made. Broumi et al., [15] introduced the concept of rough neutrosophic sets. Yang et al., [16] proposed single valued neutrosophic rough sets by combining single valued neutrosophic sets and rough sets, and established an algorithm for the decision-making problem based on single valued neutrosophic rough sets on two universes. Nabeela et al., [17]

and Sayed et al., [18] introduced rough neutrosophic digraphs, in which they have approximated neutrosophic set under the influence of a crisp equivalence relation. In this research article, we apply another hybrid set model, neutrosophic rough, to graph theory. We deal with regular neutrosophic rough digraphs and then solve the decision-making problem by using our proposed hybrid model.

Our paper is organized as follows: Firstly, we develop the notion of neutrosophic rough digraphs and present some numerical examples. Secondly, we explore basic properties of neutrosophic rough digraphs. In particular, we investigate the regularity of neutrosophic rough digraphs. We describe novel applications of our proposed hybrid decision-making method. To compare the two notions, rough neutrosophic digraphs and neutrosophic rough digraphs, we give a comparison analysis. Finally, we end the paper by concluding remarks.

2. Neutrosophic Rough Information

Definition 1. [4] Let Z be a nonempty universe. A neutrosophic set N on Z is defined as follows:

$$N = \{ \langle x : T_N(x), I_N(x), F_N(x) \rangle : x \in Z \},$$

where the functions $T, I, F: Z \rightarrow [0, 1]$ represent the degree of membership, the degree of indeterminacy and the degree of falsity.

Definition 2. [5] Let Z be a nonempty universe and R an equivalence relation on Z . A pair (Z, R) is called an approximation space. Let N^* be a subset of Z and the lower and upper approximations of N^* in the approximation space (Z, R) denoted by $\underline{R}N^*$ and $\overline{R}N^*$ are defined as follows:

$$\begin{aligned} \underline{R}N^* &= \{ x \in Z \mid [x]_R \subseteq N^* \}, \\ \overline{R}N^* &= \{ x \in Z \mid [x]_R \cap N^* \neq \emptyset \}, \end{aligned}$$

where $[x]_R$ denotes the equivalence class of R containing x . A pair $(\underline{R}N^*, \overline{R}N^*)$ is called a rough set.

For other notations and applications, readers are referred to [19–32].

Definition 3. [16] Let X^* be a nonempty universe and R a neutrosophic relation on X^* . Let X be a neutrosophic set on X^* , defined as

$$X = \{ \langle x, T_X(x), I_X(x), F_X(x) \rangle : x \in X^* \}.$$

Then the lower and upper approximations of X represented by $\underline{R}X$ and $\overline{R}X$, respectively, are characterized as neutrosophic sets in X^* such that, $\forall x \in X^*$

$$\begin{aligned} \underline{R}X &= \{ \langle x, T_{\underline{R}(X)}(x), I_{\underline{R}(X)}(x), F_{\underline{R}(X)}(x) \rangle : x \in X^* \}, \\ \overline{R}X &= \{ \langle x, T_{\overline{R}(X)}(x), I_{\overline{R}(X)}(x), F_{\overline{R}(X)}(x) \rangle : x \in X^* \}, \end{aligned}$$

where

$$\begin{aligned} T_{\underline{R}X}(x) &= \bigwedge_{y \in X} (F_R(x, y) \vee T_X(y)), \\ I_{\underline{R}X}(x) &= \bigvee_{y \in X} (1 - I_R(x, y) \wedge I_X(y)), \\ F_{\underline{R}X}(x) &= \bigvee_{y \in X} (T_R(x, y) \wedge F_X(y)), \end{aligned}$$

and

$$\begin{aligned}
 T_{\overline{RX}}(x) &= \bigvee_{y \in X} (T_R(x, y) \wedge T_X(y)), \\
 I_{\overline{RX}}(x) &= \bigwedge_{y \in X} (I_R(x, y) \vee I_X(y)), \\
 F_{\overline{RX}}(x) &= \bigwedge_{y \in X} (F_R(x, y) \vee F_X(y)).
 \end{aligned}$$

A pair $(\underline{RX}, \overline{RX})$ is called a neutrosophic rough set.

Definition 4. Let X^* be a nonempty set and R a neutrosophic tolerance relation on X^* . Let X be a neutrosophic set on X^* defined as:

$$X = \{ \langle x, T_X(x), I_X(x), F_X(x) \rangle : x \in X^* \}.$$

Then the lower and upper approximations of X represented by \underline{RX} and \overline{RX} , respectively, are characterized as neutrosophic sets in X^* such that, $\forall x \in X^*$

$$\begin{aligned}
 \underline{RX} &= \{ \langle x, T_{\underline{RX}}(x), I_{\underline{RX}}(x), F_{\underline{RX}}(x) \rangle : x \in X^* \}, \\
 \overline{RX} &= \{ \langle x, T_{\overline{RX}}(x), I_{\overline{RX}}(x), F_{\overline{RX}}(x) \rangle : x \in X^* \},
 \end{aligned}$$

where

$$\begin{aligned}
 T_{\underline{RX}}(x) &= \bigwedge_{y \in X^*} (F_R(x, y) \vee T_X(y)), \\
 I_{\underline{RX}}(x) &= \bigwedge_{y \in X^*} (1 - I_R(x, y) \vee I_X(y)), \\
 F_{\underline{RX}}(x) &= \bigvee_{y \in X^*} (T_R(x, y) \wedge F_X(y)),
 \end{aligned}$$

and

$$\begin{aligned}
 T_{\overline{RX}}(x) &= \bigvee_{y \in X^*} (T_R(x, y) \wedge T_X(y)), \\
 I_{\overline{RX}}(x) &= \bigvee_{y \in X^*} (I_R(x, y) \wedge I_X(y)), \\
 F_{\overline{RX}}(x) &= \bigwedge_{y \in X^*} (F_R(x, y) \vee F_X(y)).
 \end{aligned}$$

Let $Y^* \subseteq X^* \times X^*$ and S a neutrosophic tolerance relation on Y^* such that

$$\begin{aligned}
 T_S((x_1, x_2)(y_1, y_2)) &= \min\{T_R(x_1, y_1), T_R(x_2, y_2)\}, \\
 I_S((x_1, x_2)(y_1, y_2)) &= \min\{I_R(x_1, y_1), I_R(x_2, y_2)\}, \\
 F_S((x_1, x_2)(y_1, y_2)) &= \max\{F_R(x_1, y_1), F_R(x_2, y_2)\}.
 \end{aligned}$$

Let Y be a neutrosophic set on Y^* defined as:

$$Y = \{ \langle xy, T_Y(xy), I_Y(xy), F_Y(xy) \rangle : xy \in Y^* \},$$

such that

$$\begin{aligned}
 T_Y(xy) &\leq \min\{T_{\underline{RX}}(x), T_{\underline{RX}}(y)\}, \\
 I_Y(xy) &\leq \min\{I_{\underline{RX}}(x), I_{\underline{RX}}(y)\}, \\
 F_Y(xy) &\leq \max\{F_{\overline{RX}}(x), F_{\overline{RX}}(y)\} \quad \forall x, y \in X^*.
 \end{aligned}$$

Then the lower and the upper approximations of Y represented by $\underline{S}Y$ and $\overline{S}Y$, are defined as follows:

$$\begin{aligned} \underline{S}Y &= \{ \langle xy, T_{\underline{S}Y}(xy), I_{\underline{S}Y}(xy), F_{\underline{S}Y}(xy) \rangle : xy \in Y^* \}, \\ \overline{S}Y &= \{ \langle xy, T_{\overline{S}Y}(xy), I_{\overline{S}Y}(xy), F_{\overline{S}Y}(xy) \rangle : xy \in Y^* \}, \end{aligned}$$

where

$$\begin{aligned} T_{\underline{S}Y}(xy) &= \bigwedge_{wz \in Y^*} (F_S((xy), (wz)) \vee T_Y(wz)), \\ I_{\underline{S}Y}(xy) &= \bigwedge_{wz \in Y^*} ((1 - I_S((xy), (wz))) \vee I_Y(wz)), \\ F_{\underline{S}Y}(xy) &= \bigvee_{wz \in Y^*} (T_S((xy), (wz)) \wedge F_Y(wz)), \end{aligned}$$

and

$$\begin{aligned} T_{\overline{S}Y}(xy) &= \bigvee_{wz \in Y^*} (T_S((xy), (wz)) \wedge T_Y(wz)), \\ I_{\overline{S}Y}(xy) &= \bigvee_{wz \in Y^*} (I_S((xy), (wz)) \wedge I_Y(wz)), \\ F_{\overline{S}Y}(xy) &= \bigwedge_{wz \in Y^*} (F_S((xy), (wz)) \vee F_Y(wz)). \end{aligned}$$

A pair $SY = (\underline{S}Y, \overline{S}Y)$ is called neutrosophic rough relation.

Definition 5. A neutrosophic rough digraph on a nonempty set X^* is a 4-ordered tuple $G = (R, RX, S, SY)$ such that

- (a) R is a neutrosophic tolerance relation on X^* ,
- (b) S is a neutrosophic tolerance relation on $Y^* \subseteq X^* \times X^*$,
- (c) $RX = (\underline{R}X, \overline{R}X)$ is a neutrosophic rough set on X^* ,
- (d) $SY = (\underline{S}Y, \overline{S}Y)$ is a neutrosophic rough relation on X^* ,
- (e) (RX, SY) is a neutrosophic rough digraph where $\underline{G} = (\underline{R}X, \underline{S}Y)$ and $\overline{G} = (\overline{R}X, \overline{S}Y)$ are lower and upper approximate neutrosophic digraphs of G such that

$$\begin{aligned} T_{\underline{S}Y}(xy) &\leq \min\{T_{\underline{R}X}(x), T_{\underline{R}X}(y)\}, \\ I_{\underline{S}Y}(xy) &\leq \min\{I_{\underline{R}X}(x), I_{\underline{R}X}(y)\}, \\ F_{\underline{S}Y}(xy) &\leq \max\{F_{\underline{R}X}(x), F_{\underline{R}X}(y)\}, \\ \\ T_{\overline{S}Y}(xy) &\leq \min\{T_{\overline{R}X}(x), T_{\overline{R}X}(y)\}, \\ I_{\overline{S}Y}(xy) &\leq \min\{I_{\overline{R}X}(x), I_{\overline{R}X}(y)\}, \\ F_{\overline{S}Y}(xy) &\leq \max\{F_{\overline{R}X}(x), F_{\overline{R}X}(y)\} \quad \forall x, y \in X^*. \end{aligned}$$

Example 1. Let $X^* = \{p, q, r, s, t\}$ be a nonempty set and R a neutrosophic tolerance relation on X^* is given as:

R	p	q	r	s	t
p	(1,1,0)	(0.5,0.2,0.3)	(0.1,0.9,0.4)	(0.6,0.5,0.2)	(0.2,0.1,0.8)
q	(0.5,0.2,0.3)	(1,1,0)	(0.3,0.7,0.5)	(0.1,0.9,0.6)	(0.6,0.5,0.1)
r	(0.1,0.9,0.4)	(0.3,0.7,0.5)	(1,1,0)	(0.2,0.8,0.7)	(0.1,0.9,0.6)
s	(0.6,0.5,0.2)	(0.1,0.9,0.6)	(0.2,0.8,0.7)	(1,1,0)	(0.2,0.1,0.8)
t	(0.2,0.1,0.8)	(0.6,0.5,0.1)	(0.1,0.9,0.6)	(0.2,0.3,0.1)	(1,1,0)

Let $X_1 = \{p, q, r, s, t\} \subseteq X^*$ be a neutrosophic set on X^* . The lower and upper approximations of X_1 are given as:

$\underline{RX}_1 = \{(p, 0.2, 0.1, 0.7), (q, 0.4, 0.5, 0.6), (r, 0.7, 0.8, 0.9), (s, 0.2, 0.9, 0.1), (t, 0.6, 0.8, 0.4)\}$ be a neutrosophic set on X^* . The lower and upper approximations of X_1 are given as:

$\underline{RX}_1 = \{(p, 0.4, 0.2, 0.8), (q, 0.6, 0.9, 0.4), (r, 0.7, 0.8, 0.6), (s, 0.2, 0.9, 0.1), (t, 0.6, 0.8, 0.1)\}$.

$\overline{RX}_1 = \{(p, 0.2, 0.1, 0.7), (q, 0.3, 0.5, 0.6), (r, 0.4, 0.1, 0.9), (s, 0.2, 0.5, 0.6), (t, 0.2, 0.5, 0.6)\}$,

Let $Y = \{pr, qs, rt, sp, tq\} \subseteq X^* \times X^*$ and S a neutrosophic tolerance relation which is given as:

Let $Y^* = \{pr, qs, rt, sp, tq\} \subseteq Y$ and S a neutrosophic tolerance relation which is given as:

pr	(1,1,0)	(0.2,0.2,0.7)	(0.1,0.9,0.6)	(0.1,0.5,0.4)	(0.2,0.1,0.8)
qs	(0.2,0.2,0.7)	(1,1,0)	(0.2,0.3,0.5)	(0.1,0.5,0.6)	(0.1,0.5,0.6)
rt	(0.1,0.9,0.6)	(0.2,0.3,0.5)	(1,1,0)	(0.1,0.9,0.4)	(0.2,0.1,0.8)
sp	(0.1,0.5,0.4)	(0.1,0.5,0.6)	(0.2,0.3,0.5)	(1,1,0)	(0.1,0.5,0.6)
tq	(0.2,0.1,0.8)	(0.1,0.5,0.6)	(0.1,0.9,0.4)	(0.1,0.5,0.6)	(1,1,0)

Let $Y_1 = \{(pr, 0.2, 0.1, 0.5), (qs, 0.1, 0.3, 0.3), (rt, 0.2, 0.1, 0.4), (sp, 0.1, 0.1, 0.2), (tq, 0.1, 0.4, 0.3)\}$ be a neutrosophic set on Y^* . The lower and upper approximations of Y_1 are given as:

$\underline{SY}_1 = \{(pr, 0.2, 0.1, 0.5), (qs, 0.1, 0.3, 0.3), (rt, 0.2, 0.1, 0.4), (sp, 0.1, 0.1, 0.2), (tq, 0.1, 0.4, 0.3)\}$,

$\overline{SY}_1 = \{(pr, 0.2, 0.2, 0.4), (qs, 0.2, 0.4, 0.3), (rt, 0.2, 0.4, 0.4), (sp, 0.2, 0.3, 0.2), (tq, 0.2, 0.4, 0.3)\}$.

Thus, $\underline{G} = (\underline{RX}_1, \underline{SY}_1)$ and $\overline{G} = (\overline{RX}_1, \overline{SY}_1)$ are neutrosophic digraphs as shown in Figure 1.

Thus, $\underline{G} = (\underline{RX}_1, \underline{SY}_1)$ and $\overline{G} = (\overline{RX}_1, \overline{SY}_1)$ are neutrosophic digraphs as shown in Fig. 1.

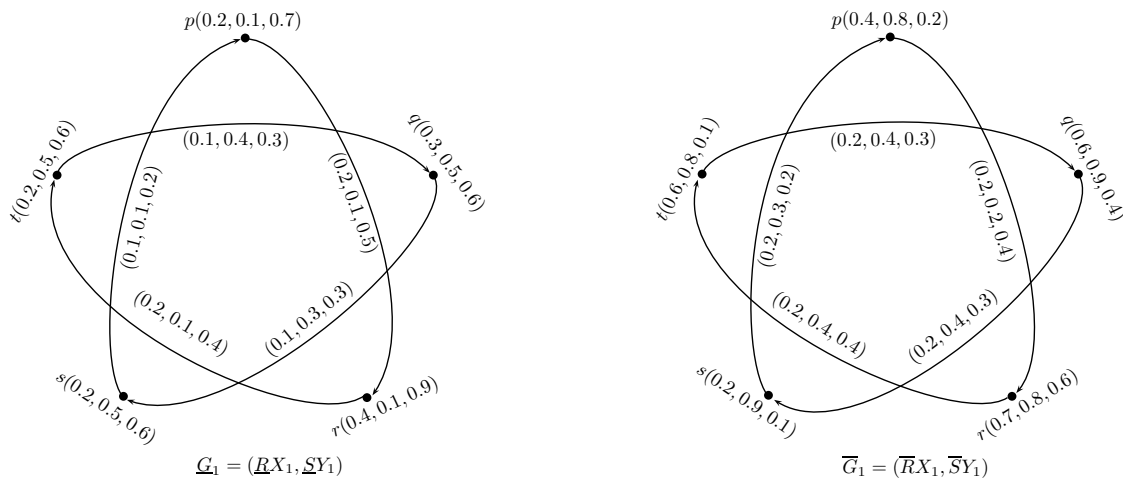
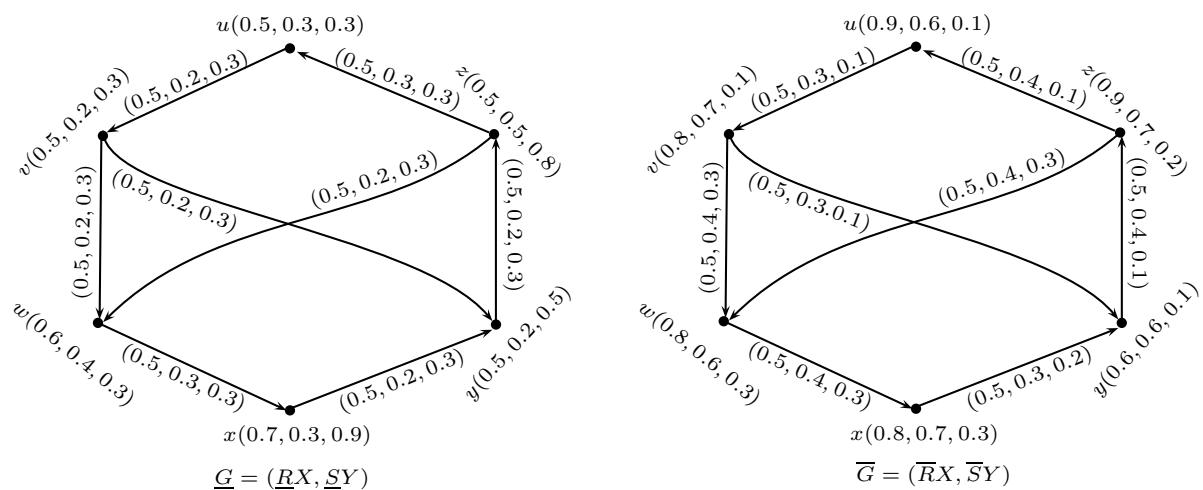

Figure 1: Neutrosophic Rough Digraph $G = (G_1, G_2)$

Example 2.2 Let $X^* = \{u, v, w, x, y, z\}$ be a crisp set and R a neutrosophic tolerance relation on X^* given by

R	u	v	w	x	y	z
u	(1,1,0)	(0.2,0.3,0.5)	(0.5,0.6,0.9)	(0.3,0.8,0.3)	(0.3,0.2,0.1)	(0.1,0.1,0.5)
v	(0.2,0.3,0.5)	(1,1,0)	(0.9,0.5,0.6)	(0.1,0.5,0.7)	(0.8,0.9,0.1)	(0.8,0.9,0.1)
w	(0.5,0.6,0.9)	(0.9,0.5,0.6)	(1,1,0)	(0.3,0.6,0.8)	(0.2,0.3,0.6)	(0.7,0.6,0.6)
x	(0.3,0.8,0.3)	(0.1,0.5,0.7)	(0.3,0.6,0.8)	(1,1,0)	(0.5,0.1,0.9)	(0.8,0.7,0.2)
y	(0.3,0.2,0.1)	(0.8,0.9,0.1)	(0.2,0.3,0.6)	(0.5,0.1,0.9)	(1,1,0)	(0.6,0.5,0.9)
z	(0.1,0.1,0.5)	(0.8,0.9,0.1)	(0.7,0.6,0.6)	(0.8,0.7,0.2)	(0.6,0.5,0.9)	(1,1,0)

Thus, $\underline{G} = (RX, \underline{SY})$ and $\overline{G} = (\overline{RX}, \overline{SY})$ are the neutrosophic digraphs as shown in Figure 2.



Now we discuss regular neutrosophic rough digraphs.

Definition 6. Let $G = (\underline{G}, \overline{G})$ be a neutrosophic rough digraph on a nonempty set X^* . The indegree of a vertex $x \in G$ is the sum of membership degree, indeterminacy and falsity of all edges towards x from other vertices in \underline{G} and \overline{G} , respectively, represented by $id_G(x)$ and defined by

$$id_G(x) = id_{\underline{G}}(x) + id_{\overline{G}}(x),$$

where

$$id_{\underline{G}}(x) = (\sum_{x,y \in \underline{SY}} T_{\underline{G}}(yx), \sum_{x,y \in \underline{SY}} I_{\underline{G}}(yx), \sum_{x,y \in \underline{SY}} F_{\underline{G}}(yx)),$$

$$id_{\overline{G}}(x) = (\sum_{x,y \in \overline{SY}} T_{\overline{G}}(yx), \sum_{x,y \in \overline{SY}} I_{\overline{G}}(yx), \sum_{x,y \in \overline{SY}} F_{\overline{G}}(yx)).$$

The outdegree of a vertex $x \in G$ is the sum of membership degree, indeterminacy and falsity of all edges outward from x to other vertices in \underline{G} and \overline{G} , respectively, represented by $od_G(x)$ and defined by

$$od_G(x) = od_{\underline{G}}(x) + od_{\overline{G}}(x),$$

where

$$od_{\underline{G}}(x) = (\sum_{x,y \in \underline{SY}} T_{\underline{G}}(xy), \sum_{x,y \in \underline{SY}} I_{\underline{G}}(xy), \sum_{x,y \in \underline{SY}} F_{\underline{G}}(xy)),$$

$$od_{\overline{G}}(x) = (\sum_{x,y \in \overline{SY}} T_{\overline{G}}(xy), \sum_{x,y \in \overline{SY}} I_{\overline{G}}(xy), \sum_{x,y \in \overline{SY}} F_{\overline{G}}(xy)).$$

$d_G(x) = id_G(x) + od_G(x)$ is called degree of vertex x .

Definition 7. A neutrosophic rough digraph is called a regular neutrosophic rough digraph of degree (m_1, m_2, m_3) if

$$d_G(x) = (m_1, m_2, m_3), \forall x \in X.$$

Example 3. Let $X^* = \{p, q, r, s\}$ be a nonempty set and R a neutrosophic tolerance relation on X^* is given as:

R	p	q	r	s
p	(1,1,0)	(0.1,0.9,0.8)	(0.7,0.5,0.8)	(0.1,0.9,0.8)
q	(0.9,0.8,0.1)	(1,1,0)	(0.1,0.9,0.8)	(0.4,0.3,0.9)
r	(0.7,0.5,0.8)	(0.1,0.9,0.8)	(1,1,0)	(0.1,0.9,0.8)
s	(0.1,0.9,0.8)	(0.4,0.3,0.9)	(0.1,0.9,0.8)	(1,1,0)

Let $X_1 = \{(p, 0.1, 0.4, 0.8), (q, 0.2, 0.3, 0.9), (r, 0.1, 0.6, 0.8), (s, 0.9, 0.6, 0.3)\}$ be a neutrosophic set on X^* . The lower and upper approximations of X_1 are given as:

$$\underline{RX}_1 = \{(p, 0.1, 0.3, 0.8), (q, 0.2, 0.3, 0.9), (r, 0.1, 0.3, 0.8), (s, 0.8, 0.4, 0.4)\},$$

$$\overline{RX}_1 = \{(p, 0.1, 0.6, 0.8), (q, 0.4, 0.6, 0.8), (r, 0.1, 0.6, 0.8), (s, 0.9, 0.6, 0.3)\}.$$

Let $Y^* = \{pq, qr, rs, sp\} \subseteq X^* \times X^*$ and S a neutrosophic tolerance relation on Y^* which is given as:

S	pq	qr	rs	sp
pq	(1,1,0)	(0.1,0.9,0.8)	(0.4,0.3,0.9)	(0.1,0.9,0.8)
qr	(0.1,0.9,0.8)	(1,1,0)	(0.1,0.9,0.8)	(0.4,0.3,0.9)
rs	(0.4,0.3,0.9)	(0.1,0.9,0.8)	(1,1,0)	(0.1,0.9,0.8)
sp	(0.1,0.9,0.8)	(0.4,0.3,0.9)	(0.1,0.9,0.8)	(1,1,0)

Let $Y_1 = \{(pq, 0.1, 0.3, 0.8), (qr, 0.1, 0.3, 0.3), (rs, 0.1, 0.3, 0.8), (sp, 0.1, 0.3, 0.8)\}$ be a neutrosophic set on Y^* . The lower and upper approximations of Y_1 are given as:

$$\underline{SY}_1 = \{(pq, 0.1, 0.3, 0.8), (qr, 0.1, 0.3, 0.3), (rs, 0.1, 0.3, 0.8), (sp, 0.1, 0.3, 0.8)\},$$

$$\overline{SY}_1 = \{(pq, 0.1, 0.3, 0.8), (qr, 0.1, 0.3, 0.3), (rs, 0.1, 0.3, 0.8), (sp, 0.1, 0.3, 0.8)\}.$$

Thus, $G_1 = (\underline{G}_1, \overline{G}_1)$ is a regular neutrosophic rough digraph as shown in Figure 3.

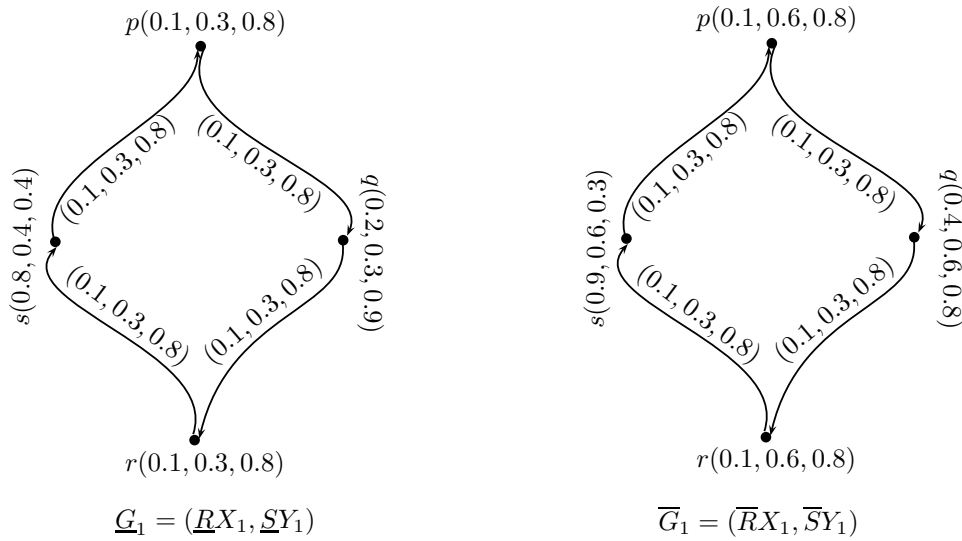

Figure 2.8. Regular neutrosophic rough digraphs $G_1 \in \underline{C}_1(\underline{G}_1, \overline{G}_1)$

Definition 2.8. Let $G_1 = (\underline{G}_1, \overline{G}_1)$ and $G_2 = (\underline{G}_2, \overline{G}_2)$ be two neutrosophic rough digraphs. Then the direct sum of G_1 and G_2 is a neutrosophic rough digraph $G = G_1 \oplus G_2 = (\underline{G}_1 \oplus \underline{G}_2, \overline{G}_1 \oplus \overline{G}_2)$, where $\underline{G}_1 \oplus \underline{G}_2 = (\underline{RX}_1 \oplus \underline{RX}_2, \underline{SY}_1 \oplus \underline{SY}_2)$ and $\overline{G}_1 \oplus \overline{G}_2 = (\overline{RX}_1 \oplus \overline{RX}_2, \overline{SY}_1 \oplus \overline{SY}_2)$ are neutrosophic digraphs.

Definition 2.8. Let $G_1 = (\underline{G}_1, \overline{G}_1)$ and $G_2 = (\underline{G}_2, \overline{G}_2)$ be two neutrosophic rough digraphs. Then the direct sum of G_1 and G_2 is a neutrosophic rough digraph $G = G_1 \oplus G_2 = (\underline{G}_1 \oplus \underline{G}_2, \overline{G}_1 \oplus \overline{G}_2)$, where $\underline{G}_1 \oplus \underline{G}_2 = (\underline{RX}_1 \oplus \underline{RX}_2, \underline{SY}_1 \oplus \underline{SY}_2)$ and $\overline{G}_1 \oplus \overline{G}_2 = (\overline{RX}_1 \oplus \overline{RX}_2, \overline{SY}_1 \oplus \overline{SY}_2)$ are neutrosophic digraphs.

$$(1) \quad \begin{aligned}
 T_{\underline{RX}_1 \oplus \underline{RX}_2}(x) &= \begin{cases} T_{\underline{RX}_1}(x), & \text{if } x \in \underline{RX}_1 - \underline{RX}_2 \\ T_{\underline{RX}_2}(x), & \text{if } x \in \underline{RX}_2 - \underline{RX}_1 \\ \max(T_{\underline{RX}_1}(x), T_{\underline{RX}_2}(x)), & \text{if } x \in \underline{RX}_1 \cap \underline{RX}_2 \end{cases} \\
 T_{\overline{RX}_1 \oplus \overline{RX}_2}(x) &= \begin{cases} \max(T_{\overline{RX}_1}(x), T_{\overline{RX}_2}(x)), & \text{if } x \in \overline{RX}_1 \cap \overline{RX}_2 \\ T_{\overline{RX}_2}(x), & \text{if } x \in \overline{RX}_2 - \overline{RX}_1 \\ T_{\overline{RX}_1}(x), & \text{if } x \in \overline{RX}_1 - \overline{RX}_2 \end{cases} \\
 I_{\underline{RX}_1 \oplus \underline{RX}_2}(x) &= \begin{cases} \min(I_{\underline{RX}_1}(x), I_{\underline{RX}_2}(x)), & \text{if } x \in \underline{RX}_1 \cap \underline{RX}_2 \\ I_{\underline{RX}_2}(x), & \text{if } x \in \underline{RX}_2 - \underline{RX}_1 \\ I_{\underline{RX}_1}(x), & \text{if } x \in \underline{RX}_1 - \underline{RX}_2 \end{cases} \\
 I_{\overline{RX}_1 \oplus \overline{RX}_2}(x) &= \begin{cases} \min(I_{\overline{RX}_1}(x), I_{\overline{RX}_2}(x)), & \text{if } x \in \overline{RX}_1 \cap \overline{RX}_2 \\ I_{\overline{RX}_1}(x), & \text{if } x \in \overline{RX}_1 - \overline{RX}_2 \\ I_{\overline{RX}_2}(x), & \text{if } x \in \overline{RX}_2 - \overline{RX}_1 \end{cases} \\
 F_{\underline{RX}_1 \oplus \underline{RX}_2}(x) &= \begin{cases} \max(F_{\underline{RX}_1}(x), F_{\underline{RX}_2}(x)), & \text{if } x \in \underline{RX}_1 \cap \underline{RX}_2 \\ F_{\underline{RX}_1}(x), & \text{if } x \in \underline{RX}_1 - \underline{RX}_2 \\ F_{\underline{RX}_2}(x), & \text{if } x \in \underline{RX}_2 - \underline{RX}_1 \end{cases} \\
 F_{\overline{RX}_1 \oplus \overline{RX}_2}(x) &= \begin{cases} \max(F_{\overline{RX}_1}(x), F_{\overline{RX}_2}(x)), & \text{if } x \in \overline{RX}_1 \cap \overline{RX}_2 \\ F_{\overline{RX}_2}(x), & \text{if } x \in \overline{RX}_2 - \overline{RX}_1 \\ F_{\overline{RX}_1}(x), & \text{if } x \in \overline{RX}_1 - \overline{RX}_2 \end{cases} \\
 T_{\underline{SY}_1 \oplus \underline{SY}_2}(x, y) &= \begin{cases} T_{\underline{SY}_1}(x, y), & \text{if } (x, y) \in \underline{SY}_1 \\ T_{\underline{SY}_2}(x, y), & \text{if } (x, y) \in \underline{SY}_2 \\ \min(T_{\underline{SY}_1}(x, y), T_{\underline{SY}_2}(x, y)), & \text{if } (x, y) \in \underline{SY}_1 \cap \underline{SY}_2 \end{cases} \\
 T_{\overline{SY}_1 \oplus \overline{SY}_2}(x, y) &= \begin{cases} \min(T_{\overline{SY}_1}(x, y), T_{\overline{SY}_2}(x, y)), & \text{if } (x, y) \in \overline{SY}_1 \cap \overline{SY}_2 \\ T_{\overline{SY}_2}(x, y), & \text{if } (x, y) \in \overline{SY}_2 - \overline{SY}_1 \\ T_{\overline{SY}_1}(x, y), & \text{if } (x, y) \in \overline{SY}_1 - \overline{SY}_2 \end{cases} \\
 I_{\underline{SY}_1 \oplus \underline{SY}_2}(x, y) &= \begin{cases} \max(I_{\underline{SY}_1}(x, y), I_{\underline{SY}_2}(x, y)), & \text{if } (x, y) \in \underline{SY}_1 \cap \underline{SY}_2 \\ I_{\underline{SY}_2}(x, y), & \text{if } (x, y) \in \underline{SY}_2 - \underline{SY}_1 \\ I_{\underline{SY}_1}(x, y), & \text{if } (x, y) \in \underline{SY}_1 - \underline{SY}_2 \end{cases} \\
 I_{\overline{SY}_1 \oplus \overline{SY}_2}(x, y) &= \begin{cases} \max(I_{\overline{SY}_1}(x, y), I_{\overline{SY}_2}(x, y)), & \text{if } (x, y) \in \overline{SY}_1 \cap \overline{SY}_2 \\ I_{\overline{SY}_1}(x, y), & \text{if } (x, y) \in \overline{SY}_1 - \overline{SY}_2 \\ I_{\overline{SY}_2}(x, y), & \text{if } (x, y) \in \overline{SY}_2 - \overline{SY}_1 \end{cases} \\
 F_{\underline{SY}_1 \oplus \underline{SY}_2}(x, y) &= \begin{cases} \min(F_{\underline{SY}_1}(x, y), F_{\underline{SY}_2}(x, y)), & \text{if } (x, y) \in \underline{SY}_1 \cap \underline{SY}_2 \\ F_{\underline{SY}_1}(x, y), & \text{if } (x, y) \in \underline{SY}_1 - \underline{SY}_2 \\ F_{\underline{SY}_2}(x, y), & \text{if } (x, y) \in \underline{SY}_2 - \underline{SY}_1 \end{cases} \\
 F_{\overline{SY}_1 \oplus \overline{SY}_2}(x, y) &= \begin{cases} \min(F_{\overline{SY}_1}(x, y), F_{\overline{SY}_2}(x, y)), & \text{if } (x, y) \in \overline{SY}_1 \cap \overline{SY}_2 \\ F_{\overline{SY}_2}(x, y), & \text{if } (x, y) \in \overline{SY}_2 - \overline{SY}_1 \\ F_{\overline{SY}_1}(x, y), & \text{if } (x, y) \in \overline{SY}_1 - \overline{SY}_2 \end{cases}
 \end{aligned}$$

(2)

$$\begin{aligned}
 T_{\overline{RX}_1 \oplus \overline{RX}_2}(x) &= \begin{cases} T_{\overline{RX}_1}(x), & \text{if } x \in \overline{RX}_1 - \overline{RX}_2 \\ T_{\overline{RX}_2}(x), & \text{if } x \in \overline{RX}_2 - \overline{RX}_1 \\ \max(T_{\overline{RX}_1}(x), T_{\overline{RX}_2}(x)), & \text{if } x \in \overline{RX}_1 \cap \overline{RX}_2 \end{cases} \\
 I_{\overline{RX}_1 \oplus \overline{RX}_2}(x) &= \begin{cases} I_{\overline{RX}_1}(x), & \text{if } x \in \overline{RX}_1 - \overline{RX}_2 \\ I_{\overline{RX}_2}(x), & \text{if } x \in \overline{RX}_2 - \overline{RX}_1 \\ \min(I_{\overline{RX}_1}(x), I_{\overline{RX}_2}(x)), & \text{if } x \in \overline{RX}_1 \cap \overline{RX}_2 \end{cases} \\
 F_{\overline{RX}_1 \oplus \overline{RX}_2}(x) &= \begin{cases} F_{\overline{RX}_1}(x), & \text{if } x \in \overline{RX}_1 - \overline{RX}_2 \\ F_{\overline{RX}_2}(x), & \text{if } x \in \overline{RX}_2 - \overline{RX}_1 \\ \min(F_{\overline{RX}_1}(x), F_{\overline{RX}_2}(x)), & \text{if } x \in \overline{RX}_1 \cap \overline{RX}_2 \end{cases} \\
 T_{\overline{SY}_1 \oplus \overline{SY}_2}(x, y) &= \begin{cases} T_{\overline{SY}_1}(x, y), & \text{if } (x, y) \in \overline{SY}_1 - \overline{SY}_2 \\ T_{\overline{SY}_2}(x, y), & \text{if } (x, y) \in \overline{SY}_2 - \overline{SY}_1 \\ \max(T_{\overline{SY}_1}(x, y), T_{\overline{SY}_2}(x, y)), & \text{if } (x, y) \in \overline{SY}_1 \cap \overline{SY}_2 \end{cases} \\
 I_{\overline{SY}_1 \oplus \overline{SY}_2}(x, y) &= \begin{cases} I_{\overline{SY}_1}(x, y), & \text{if } (x, y) \in \overline{SY}_1 - \overline{SY}_2 \\ I_{\overline{SY}_2}(x, y), & \text{if } (x, y) \in \overline{SY}_2 - \overline{SY}_1 \\ \min(I_{\overline{SY}_1}(x, y), I_{\overline{SY}_2}(x, y)), & \text{if } (x, y) \in \overline{SY}_1 \cap \overline{SY}_2 \end{cases} \\
 F_{\overline{SY}_1 \oplus \overline{SY}_2}(x, y) &= \begin{cases} F_{\overline{SY}_1}(x, y), & \text{if } (x, y) \in \overline{SY}_1 - \overline{SY}_2 \\ F_{\overline{SY}_2}(x, y), & \text{if } (x, y) \in \overline{SY}_2 - \overline{SY}_1 \\ \min(F_{\overline{SY}_1}(x, y), F_{\overline{SY}_2}(x, y)), & \text{if } (x, y) \in \overline{SY}_1 \cap \overline{SY}_2 \end{cases}
 \end{aligned}$$

Example 2.4. Let $X^* = \{p, q, r, s, t\}$ be a set. Let $G_1 = (\underline{G}_1, \overline{G}_1)$ and $G_2 = (\underline{G}_2, \overline{G}_2)$ be two neutrosophic rough digraphs on X^* as shown in Figures 1 and 4. The direct sum of G_1 and G_2 is $\overline{G} = (\underline{G}_1 \oplus \underline{G}_2, \overline{G}_1 \oplus \overline{G}_2)$, where $\underline{G}_1 \oplus \underline{G}_2 = (\underline{RX}_1 \oplus \underline{RX}_2, \underline{SY}_1 \oplus \underline{SY}_2)$ and $\overline{G}_1 \oplus \overline{G}_2 = (\overline{RX}_1 \oplus \overline{RX}_2, \overline{SY}_1 \oplus \overline{SY}_2)$ are neutrosophic digraphs as shown in Figure 5.

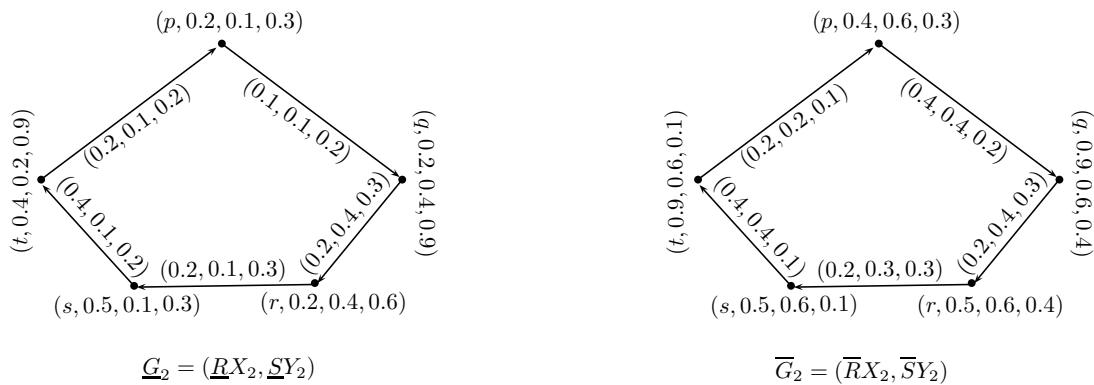

Figure 4. Neutrosophic Rough Digraph $G = (\underline{G}_2, \overline{G}_2)$

Remark 2.1. The direct sum of two regular neutrosophic rough digraphs may not be regular neutrosophic rough digraph as it can be seen in the following example.

Example 2.5. Consider the two regular neutrosophic rough digraphs $G_1 = (\underline{G}_1, \overline{G}_1)$ and $G_2 = (\underline{G}_2, \overline{G}_2)$ as shown in Fig.3 and Fig.6, respectively, then the direct sum $G = (\underline{G}_1 \oplus \underline{G}_2, \overline{G}_1 \oplus \overline{G}_2)$ of G_1 and G_2 as shown in Fig.7 is not a regular neutrosophic rough digraph.

Remark 2.2. If $G_1 = (\underline{G}_1, \overline{G}_1)$ and $G_2 = (\underline{G}_2, \overline{G}_2)$ are two regular neutrosophic rough digraphs with degree (m_1, m_2, m_3) and (n_1, n_2, n_3) on X_1^*, X_2^* , respectively, and $X_1^* \cap X_2^* = \phi$, then $G_1 \oplus G_2$ is a regular neutrosophic rough digraph if and only if $(m_1, m_2, m_3) = (n_1, n_2, n_3)$.

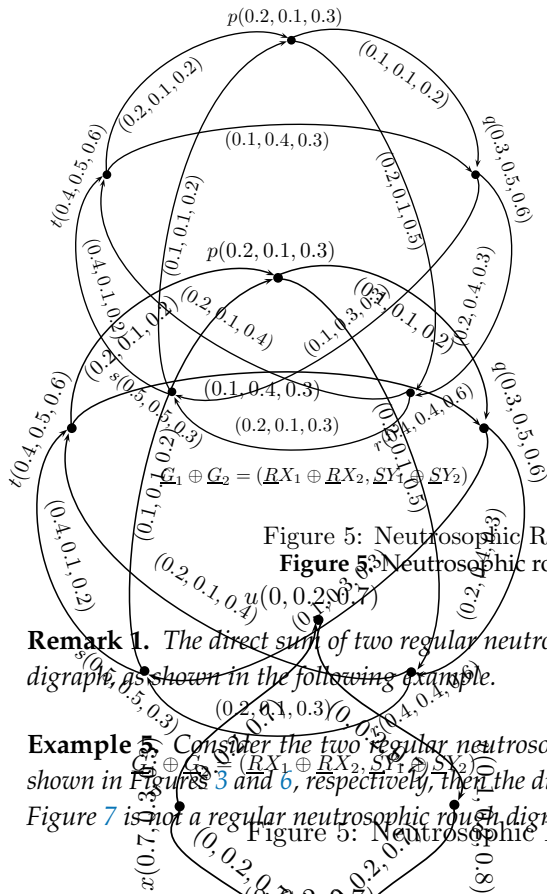

Figure 5: Neutrosophic Rough Digraph $G = (\underline{G}_1 \oplus \underline{G}_2, \overline{G}_1 \oplus \overline{G}_2)$
 Figure 5: Neutrosophic rough digraph $G = (\underline{G}_1 \oplus \underline{G}_2, \overline{G}_1 \oplus \overline{G}_2)$.

Remark 1. The direct sum of two regular neutrosophic rough digraphs may not be regular neutrosophic rough digraph, as shown in the following example.

Example 5. Consider the two regular neutrosophic rough digraphs $G_1 = (\underline{G}_1, \overline{G}_1)$ and $G_2 = (\underline{G}_2, \overline{G}_2)$ as shown in Figures 3 and 6, respectively, then the direct sum $G = (\underline{G}_1 \oplus \underline{G}_2, \overline{G}_1 \oplus \overline{G}_2)$ of G_1 and G_2 as shown in Figure 7 is not a regular neutrosophic rough digraph.

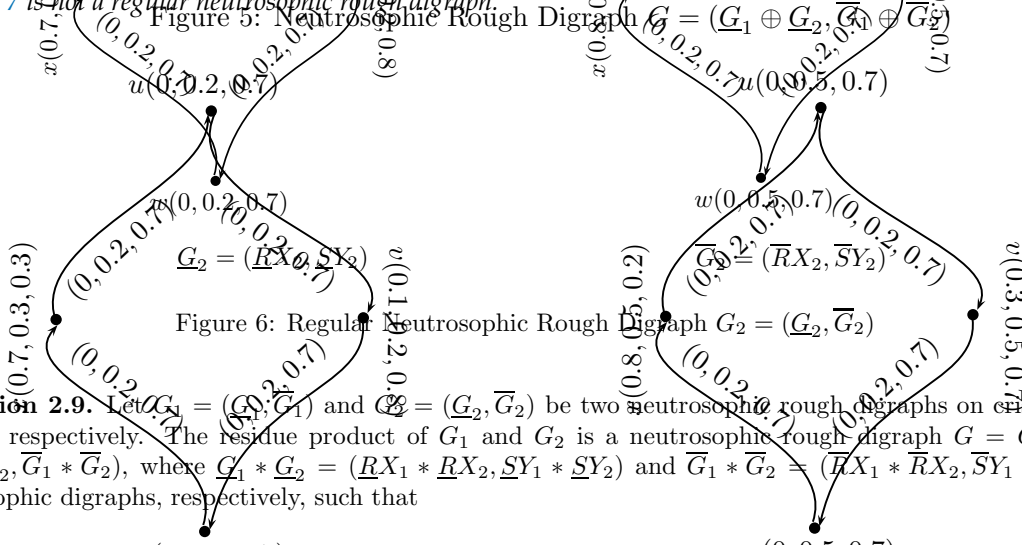

Figure 6: Regular Neutrosophic Rough Digraph $G_2 = (\underline{G}_2, \overline{G}_2)$

Definition 2.9. Let $G_1 = (\underline{G}_1, \overline{G}_1)$ and $G_2 = (\underline{G}_2, \overline{G}_2)$ be two neutrosophic rough digraphs on crisp sets X_1^* and X_2^* respectively. The residue product of G_1 and G_2 is a neutrosophic rough digraph $G = G_1 * G_2 = (\underline{G}_1 * \underline{G}_2, \overline{G}_1 * \overline{G}_2)$, where $\underline{G}_1 * \underline{G}_2 = (\underline{RX}_1 * \underline{RX}_2, \underline{SY}_1 * \underline{SY}_2)$ and $\overline{G}_1 * \overline{G}_2 = (\overline{RX}_1 * \overline{RX}_2, \overline{SY}_1 * \overline{SY}_2)$ are neutrosophic digraphs, respectively, such that

$$(1) \quad \begin{aligned} T_{\underline{RX}_1 * \underline{RX}_2}(x_1, x_2) &= \max\{T_{\underline{RX}_1}(x_1), T_{\underline{RX}_2}(x_2)\}, & \overline{G}_2 &= (\overline{RX}_2, \overline{SY}_2) \\ I_{\underline{RX}_1 * \underline{RX}_2}(x_1, x_2) &= \max\{I_{\underline{RX}_1}(x_1), I_{\underline{RX}_2}(x_2)\}, \\ F_{\underline{RX}_1 * \underline{RX}_2}(x_1, x_2) &= \min\{F_{\underline{RX}_1}(x_1), F_{\underline{RX}_2}(x_2)\}, \quad \forall (x_1, x_2) \in \underline{RX}_1 \times \underline{RX}_2 \end{aligned}$$

Figure 6: Regular Neutrosophic Rough Digraph $G_2 = (\underline{G}_2, \overline{G}_2)$

Definition 2.9. Let $G_1 = (\underline{G}_1, \overline{G}_1)$ and $G_2 = (\underline{G}_2, \overline{G}_2)$ be two neutrosophic rough digraphs on crisp sets X_1^* and X_2^* respectively. The residue product of G_1 and G_2 is a neutrosophic rough digraph $G = G_1 * G_2 = (\underline{G}_1 * \underline{G}_2, \overline{G}_1 * \overline{G}_2)$, where $\underline{G}_1 * \underline{G}_2 = (\underline{RX}_1 * \underline{RX}_2, \underline{SY}_1 * \underline{SY}_2)$ and $\overline{G}_1 * \overline{G}_2 = (\overline{RX}_1 * \overline{RX}_2, \overline{SY}_1 * \overline{SY}_2)$ are neutrosophic digraphs, respectively, such that

$$(1) \quad \begin{aligned} T_{\underline{RX}_1 * \underline{RX}_2}(x_1, x_2) &= \max\{T_{\underline{RX}_1}(x_1), T_{\underline{RX}_2}(x_2)\}, \\ I_{\underline{RX}_1 * \underline{RX}_2}(x_1, x_2) &= \max\{I_{\underline{RX}_1}(x_1), I_{\underline{RX}_2}(x_2)\}, \\ F_{\underline{RX}_1 * \underline{RX}_2}(x_1, x_2) &= \min\{F_{\underline{RX}_1}(x_1), F_{\underline{RX}_2}(x_2)\}, \quad \forall (x_1, x_2) \in \underline{RX}_1 \times \underline{RX}_2 \end{aligned}$$

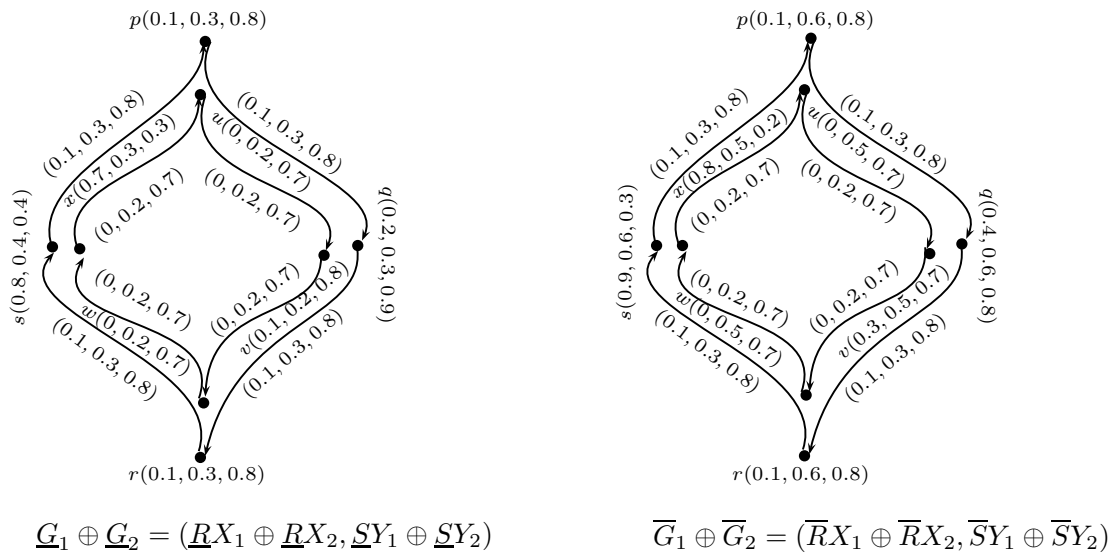

Figure 7: Neutrosophic Rough Digraph $G = (G_1 \oplus G_2, \bar{G}_1 \oplus \bar{G}_2)$
Figure 7. Neutrosophic rough digraph $G = (G_1 \oplus G_2, \bar{G}_1 \oplus \bar{G}_2)$.

Remark 2. If $G_1 = (\underline{G}_1, \bar{G}_1)$ and $G_2 = (\underline{G}_2, \bar{G}_2)$ are two m -regular neutrosophic rough digraphs with degree (m_1, m_2, m_3) and (n_1, n_2, n_3) respectively, and $X_1^* \cap X_2^* = \emptyset$, then $G_1 \oplus G_2$ is a regular neutrosophic rough digraph if and only if, if $(m_1, m_2, m_3) = (n_1, n_2, n_3)$.

Definition 9. Let $G_1 = (\underline{G}_1, \bar{G}_1)$ and $G_2 = (\underline{G}_2, \bar{G}_2)$ be two neutrosophic rough digraphs on crisp sets X_1^* and X_2^* respectively. The residue product of G_1 and G_2 is a neutrosophic rough digraph $G = G_1 * G_2 = (\underline{G}_1 * \underline{G}_2, \bar{G}_1 * \bar{G}_2)$, where $\underline{G}_1 * \underline{G}_2 = (\underline{RX}_1 * \underline{RX}_2, \underline{SY}_1 * \underline{SY}_2)$ and $\bar{G}_1 * \bar{G}_2 = (\bar{RX}_1 * \bar{RX}_2, \bar{SY}_1 * \bar{SY}_2)$ are neutrosophic digraphs, respectively, such that

$$(1) \quad \begin{aligned} I_{\bar{RX}_1 * \bar{RX}_2}(x_1, x_2) &= \max\{I_{\bar{RX}_1}(x_1), I_{\bar{RX}_2}(x_2)\}, \\ F_{\bar{RX}_1 * \bar{RX}_2}(x_1, x_2) &= \min\{F_{\bar{RX}_1}(x_1), F_{\bar{RX}_2}(x_2)\}, \quad \forall (x_1, x_2) \in \bar{RX}_1 \times \bar{RX}_2 \end{aligned}$$

$$\begin{aligned} T_{\bar{RX}_1 * \bar{RX}_2}(x_1, x_2) &= \max\{T_{\bar{RX}_1}(x_1), T_{\bar{RX}_2}(x_2)\}, \\ I_{\bar{SY}_1 * \bar{SY}_2}(x_1, x_2)(y_1, y_2) &= \max\{I_{\bar{SY}_1}(x_1, y_1), I_{\bar{SY}_2}(x_2, y_2)\}, \\ F_{\bar{SY}_1 * \bar{SY}_2}(x_1, x_2)(y_1, y_2) &= \min\{F_{\bar{SY}_1}(x_1, y_1), F_{\bar{SY}_2}(x_2, y_2)\}, \quad \forall (x_1, x_2) \in \bar{RX}_1 \times \bar{RX}_2 \\ F_{\bar{SY}_1 * \bar{SY}_2}(x_1, x_2)(y_1, y_2) &= F_{\bar{SY}_1}(x_1, y_1), \quad \forall (x_1, y_1) \in \bar{SY}_1, x_1 \neq y_2 \end{aligned}$$

Example 2.6. Let $G_1 = (\underline{G}_1, \bar{G}_1)$ and $G_2 = (\underline{G}_2, \bar{G}_2)$ be two neutrosophic rough digraphs on the two crisp sets $X_1^* = \{p, q\}$ and $X_2^* = \{u, v, w, x\}$ as shown in Fig. 8 and Fig. 9. Then the residue product of G_1 and G_2 is a neutrosophic rough digraph $G = G_1 * G_2 = (\underline{G}_1 * \underline{G}_2, \bar{G}_1 * \bar{G}_2)$ where $\underline{G}_1 * \underline{G}_2 = (\underline{RX}_1 * \underline{RX}_2, \underline{SY}_1 * \underline{SY}_2)$ and $\bar{G}_1 * \bar{G}_2 = (\bar{RX}_1 * \bar{RX}_2, \bar{SY}_1 * \bar{SY}_2)$ and the respective figures are shown in Fig. 10 and Fig. 11.

Theorem 2.1. If $G_1 = (\underline{G}_1, \bar{G}_1)$ and $G_2 = (\underline{G}_2, \bar{G}_2)$ are two neutrosophic rough digraph such that $|X_2^*| > 1$, then their residue product is regular if and only if G_1 is regular.

Proof. Let $G_1 * G_2$ be a regular neutrosophic rough digraph. Then, for any two vertices (x_1, x_2) and (y_1, y_2) in $X_1^* \times X_2^*$,

$$\begin{aligned} F_{\bar{RX}_1 * \bar{RX}_2}(x_1, x_2) &= \min\{F_{\bar{RX}_1}(x_1), F_{\bar{RX}_2}(x_2)\}, \\ &\Rightarrow d_{G_1}(x_1) = d_{G_1}(y_1) \end{aligned}$$

This is true for all vertices in X_1^* . Hence G_1 is a regular neutrosophic rough digraph.

$$\begin{aligned} T_{\bar{SY}_1 * \bar{SY}_2}(x_1, x_2)(y_1, y_2) &= T_{\bar{SY}_1}(x_1, y_1), \\ I_{\bar{SY}_1 * \bar{SY}_2}(x_1, x_2)(y_1, y_2) &= I_{\bar{SY}_1}(x_1, y_1), \\ F_{\bar{SY}_1 * \bar{SY}_2}(x_1, x_2)(y_1, y_2) &= F_{\bar{SY}_1}(x_1, y_1), \quad \forall (x_1, y_1) \in \bar{SY}_1, x_1 \neq y_2 \end{aligned}$$

Example 6. Let $G_1 = (\underline{G}_1, \overline{G}_1)$ and $G_2 = (\underline{G}_2, \overline{G}_2)$ be two neutrosophic rough digraphs on the two crisp sets $X_1^* = \{p, q\}$ and $X_2^* = \{u, v, w, x\}$ as shown in Figures 8 and 9. Then the residue product of G_1 and G_2 is a neutrosophic rough digraph $G = G_1 * G_2 = (\underline{G}_1 * \underline{G}_2, \overline{G}_1 * \overline{G}_2)$ where $\underline{G}_1 * \underline{G}_2 = (\underline{RX}_1 * \underline{RX}_2, \underline{SY}_1 * \underline{SY}_2)$ and $\overline{G}_1 * \overline{G}_2 = (\overline{RX}_1 * \overline{RX}_2, \overline{SY}_1 * \overline{SY}_2)$ and the respective figures are shown in Figure 10.

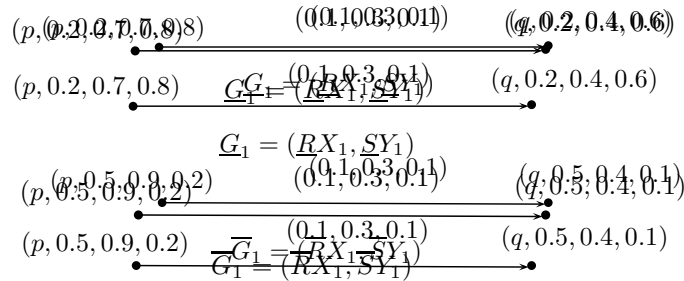

Figure 8: Neutrosophic Rough Digraph $G_1 = (\underline{G}_1, \overline{G}_1)$.

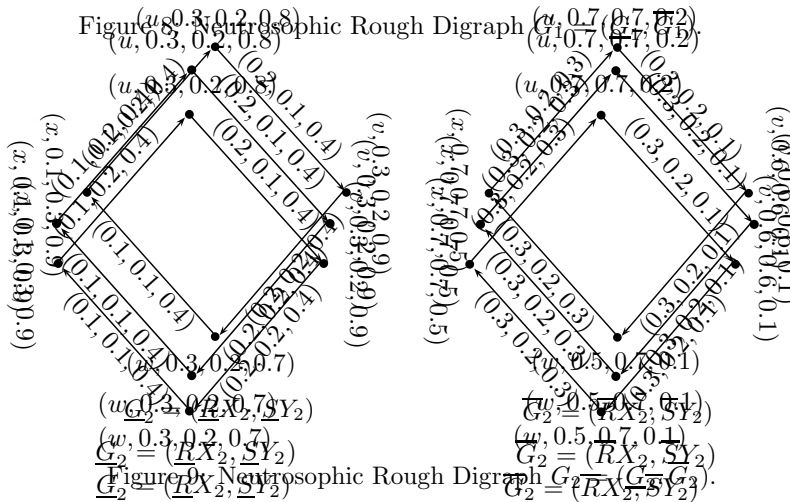

Figure 9: Neutrosophic Rough Digraph $G_2 = (\underline{G}_2, \overline{G}_2)$.

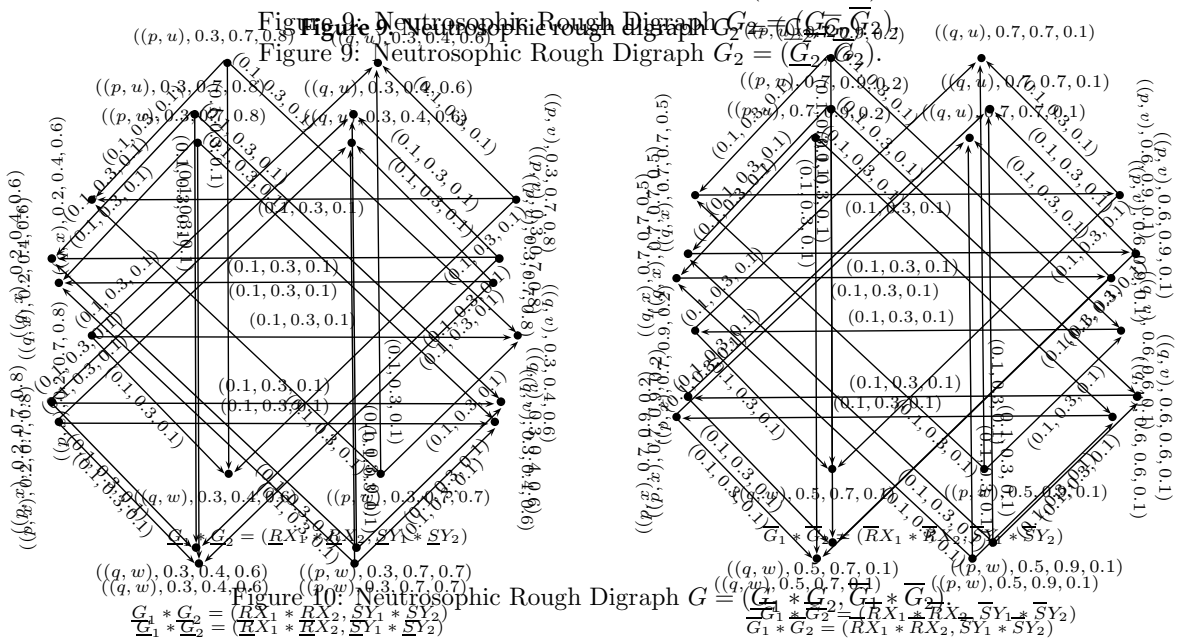

Figure 10: Neutrosophic Rough Digraph $G = (\underline{G}_1 * \underline{G}_2, \overline{G}_1 * \overline{G}_2)$.

Theorem 1. If $G_1 = (\underline{G}_1, \overline{G}_1)$ and $G_2 = (\underline{G}_2, \overline{G}_2)$ are two neutrosophic rough digraph such that $|X_2^*| > 1$, then their residue product is regular if and only if G_1 is regular.

Proof. Let $G_1 * G_2$ be a regular neutrosophic rough digraph.

Then, for any two vertices (x_1, x_2) and (y_1, y_2) in $X_1^* \times X_2^*$,

$$d_{G_1 * G_2}(x_1, x_2) = d_{G_1 * G_2}(y_1, y_2) \Rightarrow d_{G_1}(x_1) = d_{G_1}(y_1).$$

This is true for all vertices in X_1^* . Hence G_1 is a regular neutrosophic rough digraph.

Conversely, suppose that $G_1 = (\underline{G}_1, \overline{G}_1)$ is a (m_1, m_2, m_3) -regular neutrosophic rough digraph and $G_2 = (\underline{G}_2, \overline{G}_2)$ is any neutrosophic rough digraph with $|X_2^*| > 1$. If $|X_2^*| > 1$, then $d_{G_1 * G_2}(x_1, x_2) = d_{G_1}(x_1) = (m_1, m_2, m_3)$. This is a constant ordered-triplet for all vertices in $X_1^* \times X_2^*$. Hence $G_1 * G_2$ is a regular neutrosophic rough digraph. \square

3. Applications to Decision-Making

In this section, we present some real life applications of neutrosophic rough digraphs in decision making. In decision-making, the selection is facilitated by evaluating each choice on the set of criteria. The criteria must be measurable and their outcomes must be measured for every decision alternative.

3.1. Online Reviews and Ratings

Customer reviews are increasingly available online for a wide range of products and services. As customers search online for product information and to evaluate product alternatives, they often have access to dozens or hundreds of product reviews from other customers. These reviews are very helpful in product selection. However, only considering the good reviews about a product is not very helpful in decision-making. The customer should keep in mind bad and neutral reviews as well. We use percentages of good reviews, bad reviews and neutral reviews of a product as truth membership, false membership and indeterminacy respectively.

Mrs. Sadia wants to purchase a refrigerator. For this purpose she visits web sites of different refrigerator companies. The refrigerator companies and their ratings by other customers are shown in Table 1.

Table 1. Companies and their ratings.

X^*	Good Reviews	Neutral	Bad Reviews
PEL	45%	29%	37%
Dawlance	52%	25%	49%
Haier	51%	43%	45%
Waves	47%	41%	38%
Orient	51%	35%	48%

Here $X^* = \{Pel(P),Dawlance(D),Haier(H),Waves(W),Orient(O)\}$ and the neutrosophic set on X^* according to the reviews will be $X = \{(P, 0.45, 0.29, 0.37), (D, 0.52, 0.25, 0.49), (H, 0.51, 0.43, 0.45), (W, 0.47, 0.41, 0.38)(O, 0.51, 0.35, 0.48)\}$. The neutrosophic tolerance relation on X^* is given below

R	P	D	H	W	O
P	(1,1,0)	(0.5,0.6,0.9)	(0.2,0.3,0.6)	(0.1,0.2,0.3)	(0.4,0.6,0.8)
D	(0.5,0.6,0.9)	(1,1,0)	(0.1,0.6,0.9)	(0.4,0.5,0.9)	(0.9,0.8,0.2)
H	(0.2,0.3,0.6)	(0.1,0.6,0.9)	(1,1,0)	(0.2,0.9,0.6)	(0.1,0.9,0.7)
W	(0.1,0.2,0.3)	(0.4,0.5,0.9)	(0.2,0.9,0.6)	(1,1,0)	(0.2,0.5,0.9)
O	(0.4,0.6,0.8)	(0.9,0.8,0.2)	(0.1,0.9,0.7)	(0.2,0.5,0.9)	(1,1,0)

The lower and upper approximations of X are as follows:

$$\begin{aligned} \underline{RX} &= \{(P, 0.45, 0.29, 0.49), (D, 0.51, 0.25, 0.49), (H, 0.51, 0.35, 0.45), \\ &\quad (W, 0.45, 0.41, 0.40), (O, 0.51, 0.25, 0.49)\}, \\ \overline{RX} &= \{(P, 0.50, 0.35, 0.37), (D, 0.52, 0.43, 0.48), (H, 0.51, 0.43, 0.45), \\ &\quad (W, 0.47, 0.43, 0.37), (O, 0.52, 0.43, 0.48)\}. \end{aligned}$$

Let $Y^* = \{(P, D), (P, H), (D, H), (D, W), (H, W), (H, O), (W, P), (W, O), (O, P), (O, D)\}$ be the subset of $X^* \times X^*$ and the tolerance relation S on Y^* is given as follows:

S	(P,D)	(P,H)	(D,H)	(D,W)	(H,W)
(P,D)	(1,1,0)	(0.1,0.6,0.9)	(0.1,0.6,0.9)	(0.4,0.5,0.9)	(0.2,0.3,0.9)
(P,H)	(0.1,0.6,0.9)	(1,1,0)	(0.5,0.6,0.9)	(0.2,0.6,0.9)	(0.2,0.3,0.6)
(D,H)	(0.1,0.6,0.9)	(0.5,0.6,0.9)	(1,1,0)	(0.2,0.9,0.6)	(0.1,0.6,0.9)
(D,W)	(0.4, 5, .9)	(0.2,0.6,0.9)	(0.2,0.6,0.9)	(1,1,0)	(0.1,0.6,0.9)
(H,W)	(0.2,0.3,0.9)	(0.2,0.3,0.6)	(0.1,0.6,0.9)	(0.1,0.6, .9)	(1,1,0)
(H,O)	(0.2,0.3,0.6)	(0.1,0.3,0.7)	(0.1,0.6,0.9)	(0.1,0.5,0.9)	(0.2,0.5,0.9)
(W,P)	(0.1,0.2,0.9)	(0.1,0.2,0.6)	(0.2,0.3,0.9)	(0.1,0.2,0.9)	(0.1,0.2,0.6)
(W,O)	(0.1,0.2,0.3)	(0.1,0.2,0.7)	(0.1,0.5,0.9)	(0.2,0.5,0.9)	(0.2,0.5,0.9)
(O,P)	(0.4,0.6,0.9)	(0.2,0.3,0.8)	(0.2,0.3,0.6)	(0.1,0.2,0.3)	(0.1,0.2,0.7)
(O,D)	(0.4,0.6,0.8)	(0.1,0.6,0.9)	(0.1,0.6,0.9)	(0.4,0.5,0.9)	(0.1,0.5,0.9)
S	(H,O)	(W,P)	(W,O)	(O,P)	(O,D)
(P,D)	(0.2,0.3,0.6)	(0.1,0.2,0.9)	(0.1,0.2,0.3)	(0.4,0.6,0.9)	(0.4,0.6,0.8)
(P,H)	(0.1,0.3,0.7)	(0.1,0.2,0.6)	(0.1,0.2,0.7)	(0.2,0.3,0.8)	(0.1,0.6,0.9)
(D,H)	(0.2,0.3,0.9)	(0.1,0.5,0.9)	(0.2,0.3,0.6)	(0.1,0.6,0.9)	(0.1,0.6,0.9)
(D,W)	(0.1,0.2,0.9)	(0.2,0.5,0.9)	(0.1,0.2,0.3)	(0.4,0.5,0.9)	(0.1,0.5,0.9)
(H,W)	(0.1,0.2,0.6)	(0.2,0.5,0.9)	(0.1,0.2,0.7)	(0.1,0.5,0.9)	(0.2,0.5,0.9)
(H,O)	(1,1,0)	(0.2,0.6,0.8)	(0.2,0.9,0.6)	(0.1,0.6,0.8)	(0.1,0.8,0.7)
(W,P)	(0.2,0.6,0.8)	(1,1,0)	(0.4,0.6,0.8)	(0.2,0.5,0.9)	(0.2,0.5,0.9)
(W,O)	(0.2,0.9,0.6)	(0.4,0.6,0.8)	(1,1,0)	(0.2,0.5,0.9)	(0.2,0.5,0.9)
(O,P)	(0.1,0.6,0.8)	(0.2,0.5,0.9)	(0.2,0.5,0.9)	(1,1,0)	(0.5,0.6,0.9)
(O,D)	(0.1,0.8,0.7)	(0.2,0.5,0.9)	(0.2,0.5,0.9)	(0.5,0.6,0.9)	(1,1,0)

Thus, the lower and upper approximations of Y are calculated as follows:

$$\begin{aligned} \underline{SY} &= \{((P, D), 0.42, 0.23, 0.47), ((P, H), 0.45, 0.28, 0.45), ((D, H), 0.50, 0.21, 0.45), \\ &\quad ((D, W), 0.43, 0.22, 0.45), ((H, W), 0.41, 0.30, 0.44), ((H, O), 0.51, 0.22, 0.46), \\ &\quad ((W, P), 0.42, 0.26, 0.40), ((W, O), 0.42, 0.23, 0.44), ((O, P), 0.43, 0.25, 0.48), \\ &\quad ((O, D), 0.50, 0.22, 0.48)\} \\ \overline{SY} &= \{((P, D), 0.42, 0.30, 0.44), ((P, H), 0.50, 0.30, 0.41), ((D, H), 0.50, 0.30, 0.45), \\ &\quad ((D, W), 0.43, 0.30, 0.45), ((H, W), 0.41, 0.30, 0.44), ((H, O), 0.51, 0.30, 0.46), \\ &\quad ((W, P), 0.42, 0.26, 0.37), ((W, O), 0.45, 0.30, 0.44), ((O, P), 0.50, 0.28, 0.45), \\ &\quad ((O, D), 0.50, 0.30, 0.47)\}. \end{aligned}$$

Thus, $\underline{G} = (\underline{RX}, \underline{SY})$ and $\overline{G} = (\overline{RX}, \overline{SY})$ are the neutrosophic digraphs as shown in Figure 11. To find the best company, we use the following formula:

$$S(v_i) = \sum_{v_i \in X^*} \frac{(T_{\underline{RX}}(v_i) \times T_{\overline{RX}}(v_i)) + (I_{\underline{RX}}(v_i) \times I_{\overline{RX}}(v_i)) - (F_{\underline{RX}}(v_i) \times F_{\overline{RX}}(v_i))}{1 - \{T(v_i; v_j) + I(v_i; v_j) - F(v_i; v_j)\}}$$

where

$$T(v_i v_j) = \max_{v_j \in X^*} T_{SY}(v_i v_j) \times \max_{v_j \in X^*} T_{\bar{S}Y}(v_i v_j),$$

$$I(v_i v_j) = \max_{v_j \in X^*} I_{SY}(v_i v_j) \times \max_{v_j \in X^*} I_{\bar{S}Y}(v_i v_j),$$

$$F(v_i v_j) = \min_{v_j \in X^*} F_{SY}(v_i v_j) \times \min_{v_j \in X^*} F_{\bar{S}Y}(v_i v_j).$$

By direct calculations we have

$$S(P) = 0.167, S(D) = 0.156, S(H) = 0.268, S(W) = 0.272, S(O) = 0.155.$$

From the above calculations it is clear that Waves is the best company for refrigerator.

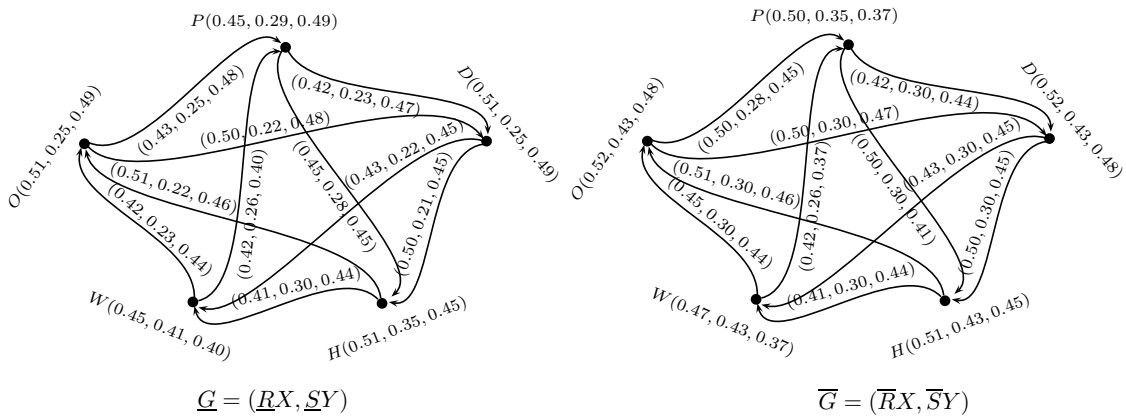

Figure 11. $G \in (G, \bar{G})$

3.2. Context of Recruitment

$$T(v_i v_j) = \max_{v_j \in X^*} T_{SY}(v_i v_j) \times \max_{v_j \in X^*} T_{\bar{S}Y}(v_i v_j),$$

$$I(v_i v_j) = \max_{v_j \in X^*} I_{SY}(v_i v_j) \times \max_{v_j \in X^*} I_{\bar{S}Y}(v_i v_j),$$

$$F(v_i v_j) = \min_{v_j \in X^*} F_{SY}(v_i v_j) \times \min_{v_j \in X^*} F_{\bar{S}Y}(v_i v_j).$$

Choosing the right candidate for the position available is not something that should be left to chance or guesswork.

How to choose the right candidate?

In any recruitment process the ability of the candidate is weighed against the suitability of the candidate. Pakistan Telecommunication Company Limited (PTCL) wants to recruit a person for the post of administrator. To keep the procedure simple, the company wants to appoint the employee on the basis of education (Edu) and experience (Exp).

Let $X^* = \{(C1, Edu), (C1, Exp), (C2, Edu), (C2, Exp), (C3, Edu), (C3, Exp)\}$ be the set of candidates who applied for the post and their corresponding attributes. Let R be a neutrosophic tolerance on X^* given as follows:

(C1, Edu)	(1,1,0)	(0.3,0.6,0.1)	(0.6,0.7,0.2)	(0.6,0.5,0.8)	(0.3,0.2,0.1)	(0.9,0.1,0.1)
(C1, Exp)	(0.3,0.6,0.1)	(1,1,0)	(0.9,0.9,0.3)	(0.8,0.7,0.6)	(0.4,0.5,0.9)	(0.3,0.1,0.1)
(C2, Edu)	(0.6,0.7,0.2)	(0.9,0.9,0.3)	(1,1,0)	(0.6,0.5,0.1)	(0.3,0.2,0.1)	(0.4,0.8,0.7)
(C2, Exp)	(0.6,0.5,0.8)	(0.8,0.7,0.6)	(0.6,0.5,0.1)	(1,1,0)	(0.1,0.1,0.2)	(0.5,0.6,0.7)
(C3, Edu)	(0.3,0.2,0.1)	(0.4,0.5,0.9)	(0.3,0.2,0.1)	(0.1,0.1,0.2)	(1,1,0)	(0.2,0.1,0.2)
(C3, Exp)	(0.9,0.1,0.1)	(0.3,0.1,0.1)	(0.4,0.8,0.7)	(0.5,0.6,0.7)	(0.2,0.1,0.2)	(1,1,0)

Let $X = \{((C1, Edu), 0.9, 0.1, 0.5), ((C1, Exp), 0.2, 0.6, 0.5), ((C2, Edu), 0.7, 0.2, 0.3), ((C2, Exp), 0.1, 0.3, 0.9), ((C3, Edu), 0.4, 0.6, 0.8), ((C3, Exp), 0.8, 0.1, 0.2)\}$ be a neutrosophic set define on X^* . Then the

Let $X = \{((C1, Edu), 0.9, 0.1, 0.5), ((C1, Exp), 0.2, 0.6, 0.5), ((C2, Edu), 0.7, 0.2, 0.3), ((C2, Exp), 0.1, 0.3, 0.9), ((C3, Edu), 0.4, 0.6, 0.8), ((C3, Exp), 0.8, 0.1, 0.2)\}$ be a neutrosophic set define on X^* . Then the lower and upper approximations of X are given as:

$$\begin{aligned} \underline{R}X &= \{((C1, Edu), 0.2, 0.1, 0.6), ((C1, Exp), 0.2, 0.2, 0.8), ((C2, Edu), 0.1, 0.2, 0.6), \\ &\quad ((C2, Exp), 0.1, 0.3, 0.9), ((C3, Edu), 0.2, 0.6, 0.8), ((C3, Exp), 0.2, 0.1, 0.5)\}, \\ \overline{R}X &= \{((C1, Edu), 0.9, 0.6, 0.2), ((C1, Exp), 0.7, 0.6, 0.2), ((C2, Edu), 0.7, 0.6, 0.3), \\ &\quad ((C2, Exp), 0.6, 0.6, 0.3), ((C3, Edu), 0.4, 0.6, 0.2), ((C3, Exp), 0.9, 0.3, 0.2)\}. \end{aligned}$$

Let $Y^* = \{(C1, Edu)(C1, Exp), (C1, Exp)(C2, Edu), (C1, Edu)(C3, Exp), (C3, Exp)(C1, Exp), (C1, Exp)(C2, Exp), (C2, Exp)(C2, Edu), (C3, Exp)(C3, Edu), (C3, Edu)(C2, Exp), (C3, Exp)(C2, Exp)\} \subseteq X^* \times X^*$ and S be a neutrosophic tolerance relation on Y^* given as follows:

S	(C1,Edu)(C1,Exp)	(C1,Exp)(C2,Edu)	(C1,Edu)(C3,Exp)	(C3,Exp)(C1,Exp)	(C1,Exp)(C2,Exp)
(C1,Edu)(C1,Exp)	(1,1,0)	(0.3,0.6,0.3)	(0.3,0.1,0.1)	(0.9,0.1,0.1)	(0.3,0.6,0.6)
(C1,Exp)(C2,Edu)	(0.3,0.6,0.3)	(1,1,0)	(0.3,0.6,0.7)	(0.3,0.1,0.3)	(0.6,0.5,0.1)
(C1,Edu)(C3,Exp)	(0.3,0.1,0.1)	(0.3,0.6,0.7)	(1,1,0)	(0.3,0.1,0.1)	(0.3,0.6,0.7)
(C3,Exp)(C1,Exp)	(0.9,0.1,0.1)	(0.3,0.1,0.3)	(0.3,0.1,0.1)	(1,1,0)	(0.3,0.1,0.6)
(C1,Exp)(C2,Exp)	(0.3,0.6,0.6)	(0.6,0.5,0.1)	(0.3,0.6,0.7)	(0.3,0.1,0.6)	(1,1,0)
(C2,Exp)(C2,Edu)	(0.6,0.5,0.8)	(0.8,0.7,0.6)	(0.4,0.5,0.8)	(0.5,0.6,0.7)	(0.6,0.5,0.6)
(C3,Exp)(C2,Exp)	(0.8,0.1,0.6)	(0.3,0.1,0.1)	(0.5,0.1,0.7)	(0.8,0.7,0.6)	(0.3,0.1,0.1)
(C3,Exp)(C3,Edu)	(0.4,0.1,0.9)	(0.3,0.1,0.1)	(0.2,0.1,0.2)	(0.4,0.5,0.9)	(0.1,0.1,0.2)
(C3,Edu)(C2,Exp)	(0.3,0.2,0.6)	(0.4,0.5,0.9)	(0.3,0.2,0.7)	(0.2,0.1,0.6)	(0.4,0.5,0.9)

S	(C2,Exp)(C2,Edu)	(C3,Exp)(C2,Exp)	(C3,Exp)(C3,Edu)	(C3,Edu)(C2,Exp)
(C1,Edu)(C1,Exp)	(0.6,0.5,0.8)	(0.8,0.1,0.6)	(0.4,0.1,0.9)	(0.3,0.2,0.6)
(C1,Exp)(C2,Edu)	(0.8,0.7,0.6)	(0.3,0.1,0.1)	(0.3,0.1,0.1)	(0.4,0.5,0.9)
(C1,Edu)(C3,Exp)	(0.4,0.5,0.8)	(0.5,0.1,0.7)	(0.2,0.1,0.2)	(0.3,0.2,0.7)
(C3,Exp)(C1,Exp)	(0.5,0.6,0.7)	(0.8,0.7,0.6)	(0.4,0.5,0.9)	(0.2,0.1,0.6)
(C1,Exp)(C2,Exp)	(0.6,0.5,0.6)	(0.3,0.1,0.1)	(0.1,0.1,0.2)	(0.4,0.5,0.9)
(C2,Exp)(C2,Edu)	(1,1,0)	(0.5,0.5,0.7)	(0.3,0.2,0.7)	(0.1,0.1,0.2)
(C3,Exp)(C2,Exp)	(0.5,0.5,0.7)	(1,1,0)	(0.1,0.1,0.2)	(0.2,0.1,0.2)
(C3,Exp)(C3,Edu)	(0.3,0.2,0.7)	(0.1,0.1,0.2)	(1,1,0)	(0.1,0.1,0.2)
(C3,Edu)(C2,Exp)	(0.1,0.1,0.2)	(0.2,0.1,0.2)	(0.1,0.1,0.2)	(1,1,0)

Let $Y = \{((C1, Edu)(C1, Exp), 0.2, 0.1, 0.1), ((C1, Exp)(C2, Edu), 0.1, 0.1, 0.3), ((C1, Edu)(C3, Exp), 0.2, 0.1, 0.2), ((C3, Exp)(C1, Exp), 0.2, 0.1, 0.2), ((C1, Exp)(C2, Exp), 0.1, 0.2, 0.3), ((C2, Exp)(C2, Edu), 0.1, 0.2, 0.3), ((C3, Exp)(C2, Exp), 0.1, 0.1, 0.3), ((C3, Exp)(C3, Edu), 0.2, 0.1, 0.2), ((C3, Edu)(C2, Exp), 0.1, 0.3, 0.3)\}$ be neutrosophic rough set on Y^* . Then the lower and upper approximations of Y are given as follows:

$$\begin{aligned} \underline{S}Y &= \{((C1, Edu)(C1, Exp), 0.2, 0.1, 0.3), ((C1, Exp)(C2, Edu), 0.1, 0.1, 0.3), \\ &\quad ((C1, Edu)(C3, Exp), 0.2, 0.1, 0.3), ((C3, Exp)(C1, Exp), 0.2, 0.1, 0.3), \\ &\quad ((C1, Exp)(C2, Exp), 0.1, 0.2, 0.3), ((C2, Exp)(C2, Edu), 0.1, 0.2, 0.3), \\ &\quad ((C3, Exp)(C2, Exp), 0.1, 0.1, 0.3), ((C3, Exp)(C3, Edu), 0.1, 0.1, 0.3), \\ &\quad ((C3, Edu)(C2, Exp), 0.1, 0.3, 0.3)\}, \\ \overline{S}Y &= \{((C1, Edu)(C1, Exp), 0.2, 0.2, 0.1), ((C1, Exp)(C2, Edu), 0.2, 0.3, 0.2), \\ &\quad ((C1, Edu)(C3, Exp), 0.2, 0.2, 0.1), ((C3, Exp)(C1, Exp), 0.2, 0.2, 0.1), \\ &\quad ((C1, Exp)(C2, Exp), 0.2, 0.2, 0.1), ((C2, Exp)(C2, Edu), 0.2, 0.2, 0.3), \\ &\quad ((C3, Exp)(C2, Exp), 0.2, 0.2, 0.2), ((C3, Exp)(C3, Edu), 0.2, 0.2, 0.2), \\ &\quad ((C3, Edu)(C2, Exp), 0.2, 0.3, 0.2)\} \end{aligned}$$

Thus, $\underline{G} = (\underline{RX}, \underline{SY})$ and $\overline{G} = (\overline{RX}, \overline{SY})$ are the neutrosophic digraphs as shown in Figures 12 and 13.

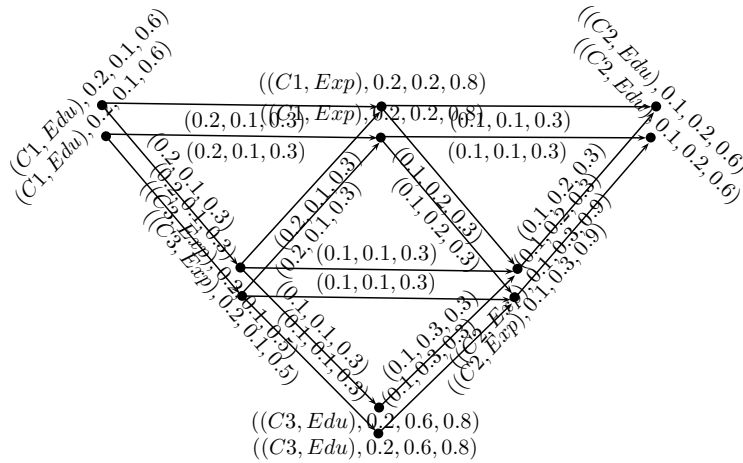

Figure 12. Neutrosophic Digraph $G = (RX, SY)$
 Figure 12: Neutrosophic Digraph $\underline{G} = (\underline{RX}, \underline{SY})$
 Figure 12: Neutrosophic Digraph $\underline{G} = (\underline{RX}, \underline{SY})$

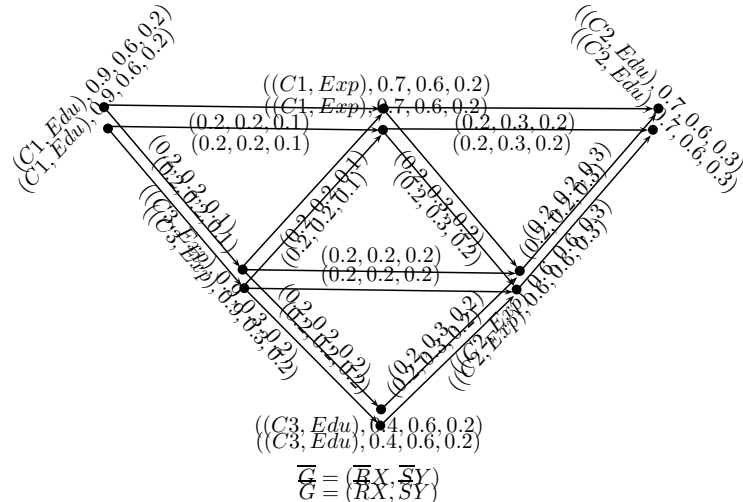

Figure 13. Neutrosophic Digraph $\overline{G} = (\overline{RX}, \overline{SY})$
 Figure 13: Neutrosophic Digraph $\overline{G} = (\overline{RX}, \overline{SY})$

To find the best employee using the following calculations, we have
 $\max\{I_{\overline{RY}}(C1), I_{\overline{RY}}(C2), I_{\overline{RY}}(C3)\} = \max\{0.8, 0.65, 0.65\} = 0.8$
 Thus, C1 is best employee for the post under consideration. So, PTCL can hire C1 for the post of administrator.

$$I_{\overline{RY}}(C1) = \frac{I_{\overline{RY}}(C1, Edu) + I_{\overline{RY}}(C1, Exp)}{2} = \frac{0.9 + 0.7}{2} = 0.8$$

$$I_{\overline{RY}}(C2) = \frac{I_{\overline{RY}}(C2, Edu) + I_{\overline{RY}}(C2, Exp)}{2} = \frac{0.7 + 0.6}{2} = 0.65$$

$$I_{\overline{RY}}(C3) = \frac{I_{\overline{RY}}(C3, Edu) + I_{\overline{RY}}(C3, Exp)}{2} = \frac{0.4 + 0.9}{2} = 0.65$$

$$\max\{I_{\overline{RY}}(C1), I_{\overline{RY}}(C2), I_{\overline{RY}}(C3)\} = \max\{0.8, 0.65, 0.65\} = 0.8$$

Thus, C1 is the best employee for the post under consideration. So, PTCL can hire C1 for the post of administrator.

4. Comparative Analysis of Rough Neutrosophic Digraphs and Neutrosophic Rough Digraphs

Rough neutrosophic digraphs and neutrosophic rough digraphs are two different notions on the basis of their construction and approach. In rough neutrosophic digraphs, the relation defined on the universe of discourse is a crisp equivalence relation that only classifies the elements which are related. On the other hand, in neutrosophic rough digraphs the relation defined on the set is

neutrosophic tolerance relation. The neutrosophic tolerance relation not only classifies the elements of the set which are related but also expresses their relation in terms of three components, namely truth membership (T), Indeterminacy (I) and falsity (F). This approach leaves room for indeterminacy and incompleteness. Below, we apply the method of rough neutrosophic digraphs to the above presented application (online reviews and ratings).

Here $X^* = \{Pel(P), Dawlance(D), Haier(H), Waves(W), Orient(O)\}$ and the neutrosophic set on X^* according to the reviews will be $X = \{(P, 0.45, 0.29, 0.37), (D, 0.52, 0.25, 0.49), (H, 0.51, 0.43, 0.45), (W, 0.47, 0.41, 0.38), (O, 0.51, 0.35, 0.48)\}$. The equivalence relation on X^* is given below

R	P	D	H	W	O
P	1	0	1	0	1
D	0	1	0	0	0
H	1	0	1	0	1
W	0	0	0	1	0
O	1	0	1	0	1

The lower and upper approximations of X are as follows:

$$\underline{R}X = \{(P, 0.45, 0.29, 0.48), (D, 0.52, 0.25, 0.49), (H, 0.45, 0.29, 0.48), (W, 0.47, 0.41, 0.38), (O, 0.45, 0.29, 0.48)\},$$

$$\overline{R}X = \{(P, 0.51, 0.43, 0.37), (D, 0.52, 0.25, 0.49), (H, 0.51, 0.43, 0.37), (W, 0.47, 0.41, 0.38), (O, 0.51, 0.43, 0.37)\}.$$

Let $Y^* = \{(P, D), (P, H), (D, H), (D, W), (H, W), (H, O), (W, P), (W, O), (O, P), (O, D)\}$ be the subset of $X^* \times X^*$ and the equivalence relation S on Y^* is given as follows:

S	(P,D)	(P,H)	(D,H)	(D,W)	(H,W)	(H,O)	(W,P)	(W,O)	(O,P)	(O,D)
(P,D)	1	0	0	0	0	0	0	0	0	0
(P,H)	0	1	0	0	0	1	0	0	1	1
(D,H)	0	0	1	0	0	0	0	0	0	0
(D,W)	0	0	0	1	0	0	0	0	0	0
(H,W)	0	0	0	0	1	0	0	0	0	0
(H,O)	0	1	0	0	0	1	0	0	1	1
(W,P)	0	0	0	0	0	0	1	1	0	0
(W,O)	0	0	0	0	0	0	1	1	0	0
(O,P)	0	1	0	0	0	1	0	0	1	1
(O,D)	0	1	0	0	0	1	0	0	1	1

Thus, the lower and upper approximations of Y are calculated as follows:

$$\underline{S}Y = \{((P, D), 0.45, 0.25, 0.48), ((P, H), 0.42, 0.24, 0.37), ((D, H), 0.45, 0.25, 0.47), ((D, W), 0.45, 0.24, 0.48), ((H, W), 0.45, 0.29, 0.38), ((H, O), 0.42, 0.24, 0.37), ((W, P), 0.42, 0.22, 0.37), ((W, O), 0.42, 0.22, 0.37), ((O, P), 0.42, 0.24, 0.37), ((O, D), 0.42, 0.24, 0.37)\}$$

$$\overline{S}Y = \{((P, D), 0.45, 0.25, 0.48), ((P, H), 0.45, 0.29, 0.37), ((D, H), 0.45, 0.25, 0.47), ((D, W), 0.45, 0.24, 0.48), ((H, W), 0.45, 0.29, 0.38), ((H, O), 0.45, 0.29, 0.37), ((W, P), 0.45, 0.29, 0.35), ((W, O), 0.45, 0.29, 0.35), ((O, P), 0.45, 0.29, 0.37), ((O, D), 0.45, 0.29, 0.37)\}.$$

To find the best company ratings, we use the following formula:

$$S(v_i) = \sum_{v_i \in X^*} \frac{(T_{RX}(v_i) \times T_{\overline{RX}}(v_i)) + (I_{RX}(v_i) \times I_{\overline{RX}}(v_i)) - (F_{RX}(v_i) \times F_{\overline{RX}}(v_i))}{1 - \{T(v_i v_j) + I(v_i v_j) - F(v_i v_j)\}}$$

where

$$\begin{aligned} T(v_i v_j) &= \max_{v_j \in X^*} T_{\underline{SY}}(v_i v_j) \times \max_{v_j \in X^*} T_{\overline{SY}}(v_i v_j), \\ I(v_i v_j) &= \max_{v_j \in X^*} I_{\underline{SY}}(v_i v_j) \times \max_{v_j \in X^*} I_{\overline{SY}}(v_i v_j), \\ F(v_i v_j) &= \min_{v_j \in X^*} F_{\underline{SY}}(v_i v_j) \times \min_{v_j \in X^*} F_{\overline{SY}}(v_i v_j). \end{aligned}$$

By direct calculations, we have

$$S(P) = 0.20, S(D) = 0.0971, S(H) = 0.2077, S(W) = 0.2790, S(O) = 0.2011.$$

From the above calculations, we have Waves as the best choice and Dawlance as the least choice for refrigerator. This is because the relation applied in this method is crisp equivalence relation which does not consider the uncertainty between the companies of the same equivalence class. Whereas in our proposed method, least choice for refrigerator is different. So, the results may vary when we apply the method of rough neutrosophic digraphs and neutrosophic rough digraphs on the same application. This means that rough neutrosophic digraphs and neutrosophic rough digraphs have a different approach.

5. Conclusions

Neutrosophic set and rough set are two different theories to deal with uncertainty and imprecise and incomplete information. Due to the limitation of human knowledge to understand the complex problems, it is very difficult to apply only a single type of uncertainty method to deal with such problems. Therefore, it is necessary to develop hybrid models by incorporating the advantages of many other different mathematical models dealing with uncertainty. Thus, by combining these two mathematical tools, we have presented a new hybrid model, namely, neutrosophic rough digraphs. We have escribed regular neutrosophic rough digraphs and we have presented novel applications of our proposed hybrid in decision-making. We have given a comparison of both models, rough neutrosophic digraphs and neutrosophic rough digraphs. We plan to extend our research work to (1) Neutrosophic rough hypergraphs; (2) Bipolar neutrosophic rough hypergraphs; (3) Soft rough neutrosophic graphs; (4) Decision support systems based on neutrosophic rough information.

References

1. Zadeh, L.A. Fuzzy sets. *Inf. Control* **1965**, *8*, 338–353. [[CrossRef](#)]
2. Atanassov, K.T. Intuitionistic fuzzy sets. *Fuzzy Sets Syst.* **1986**, *20*, 87–96. [[CrossRef](#)]
3. Smarandache, F. *Neutrosophy: Neutrosophic Probability, Set, and Logic*; American Research Press: Santa Fe, NM, USA, 1998.
4. Wang, H.; Smarandache, F.; Zhang, Y.; Sunderraman, R. Single-valued neutrosophic sets. *Multispace Multistructure* **2010**, *4*, 410–413.
5. Pawlak, Z. Rough sets. *Int. J. Comput. Inf. Sci.* **1982**, *11*, 341–356. [[CrossRef](#)]
6. Dubois, D.; Prade, H. Rough fuzzy sets and fuzzy rough sets. *Int. J. Gen. Syst.* **1990**, *17*, 191–209. [[CrossRef](#)]

7. Liu, P.; Chen, S.M. Group decision-making based on Heronian aggregation operators of intuitionistic fuzzy numbers. *IEEE Trans. Cybern.* **2017**, *47*, 2514–2530. [[CrossRef](#)] [[PubMed](#)]
8. Mordeson, J.N.; Peng, C.S. Operations on fuzzy graphs. *Inf. Sci.* **1994**, *79*, 159–170. [[CrossRef](#)]
9. Akram, M.; Shahzadi, S. Neutrosophic soft graphs with applicatin. *J. Intell. Fuzzy Syst.* **2017**, *32*, 841–858. [[CrossRef](#)]
10. Akram, M.; Sarwar, M. Novel multiple criteria decision-making methods based on bipolar neutrosophic sets and bipolar neutrosophic graphs. *Ital. J. Pure Appl. Math.* **2017**, *38*, 368–389.
11. Akram, M.; Siddique, S. Neutrosophic competition graphs with applications. *J. Intell. Fuzzy Syst.* **2017**, *33*, 921–935. [[CrossRef](#)]
12. Akram, M.; Sitara, M. Interval-valued neutrosophic graph structures. *Punjab Univ. J. Math.* **2018**, *50*, 113–137.
13. Akram, M.; Zafar, F. Rough fuzzy digraphs with application. *J. Appl. Math. Comput.* **2018**. [[CrossRef](#)]
14. Zafer, F.; Akram, M. A novel decision-making method based on rough fuzzy information. *Int. J. Fuzzy Syst.* **2018**, *20*, 1000–1014. [[CrossRef](#)]
15. Broumi, S.; Smarandache, F.; Dhar, M. Rough neutrosophic sets. *Neutrosophic Sets Syst.* **2014**, *3*, 62–67.
16. Yang, H.L.; Zhang, C.L.; Guo, Z.L.; Liu, Y.; Liao, X. A hybrid model of single valued neutrosophic sets and rough sets: Single valued neutrosophic rough set model. *Soft Comput.* **2016**. [[CrossRef](#)]
17. Nabeela, I.; Sayed, S.; Akram, M.; Smarandache, F. Notions of Rough Neutrosophic Digraphs. *Mathematics* **2018**, *6*, 18.
18. Sidra, S.; Ishfaq, N.; Akram, M.; Smarandache, F. Rough Neutrosophic Digraphs with Application. *Axioms* **2018**, *7*, 5.
19. Akram, M.; Shum, K.P. Bipolar neutrosophic planar graphs. *J. Math. Res. Appl.* **2017**, *36*, 631–648.
20. Peng, H.G.; Zhang, H.Y.; Wang, J.Q. Probability multi-valued neutrosophic sets and its application in multi-criteria group decision-making problems. *Neural Comput. Appl.* **2016**. [[CrossRef](#)]
21. Ye, J. Multicriteria decision-making method using the correlation coefficient under single-valued neutrosophic environment. *Int. J. General Syst.* **2013**, *42*, 386–394. [[CrossRef](#)]
22. Ye, J. Improved correlation coefficients of single valued neutrosophic sets and interval neutrosophic sets for multiple attribute decision-making. *J. Intell. Fuzzy Syst.* **2014**, *27*, 2453–2462.
23. Smarandache, F. A Unifying Field in Logics: Neutrosophic Logic. In *Neutrosophy*; American Research Press: Santa Fe, NM, USA, 1999.
24. Akram, M.; Malik, H.M.; Shahzadi, S.; Smarandache, F. Neutrosophic Soft Rough Graphs with Application. *Axioms* **2018**, *7*, 14. [[CrossRef](#)]
25. Banerjee, M.; Pal, S.K. Roughness of a fuzzy set. *Inf. Sci.* **1996**, *93*, 235–246. [[CrossRef](#)]
26. Liu, P.; Chen, S.M.; Junlin, L. Some intuitionistic fuzzy interaction partitioned Bonferroni mean operators and their application to multi-attribute group decision-making. *Inf. Sci.* **2017**, *41*, 98–121. [[CrossRef](#)]
27. Liu, P. Multiple attribute group decision-making method based on interval-valued intuitionistic fuzzy power Heronian aggregation operators. *Comput. Ind. Eng.* **2017**, *18*, 199–212. [[CrossRef](#)]
28. Liang, R.X.; Wang, J.Q.; Zhang, H.Y. A multi-criteria decision-making method based on single-valued trapezoidal neutrosophic preference relations with complete weight information. *Neural Comput. Appl.* **2017**. [[CrossRef](#)]
29. Nie, R.X.; Wang, J.Q.; Zhang, H.Y. Solving solar-wind power station location problem using an extended weighted aggregated sum product assessment (WASPAS) technique with interval neutrosophic sets. *Symmetry* **2017**, *9*, 106. [[CrossRef](#)]
30. Luo, S.Z.; Cheng, P.F.; Wang, J.Q.; Huang, Y.J. Selecting project delivery systems based on simplified neutrosophic linguistic preference relations. *Symmetry* **2017**, *9*, 151. [[CrossRef](#)]
31. Zhang, X.; Dai, J.; Yu, Y. On the union and intersection operations of rough sets based on various approximation spaces. *Inf. Sci.* **2015**, *292*, 214–229. [[CrossRef](#)]
32. Bao, Y.L.; Yang, H.L. On single valued neutrosophic refined rough set model and its application. *J. Intell. Fuzzy Syst.* **2017**, *33*, 1235–1248. [[CrossRef](#)]

Inverse Properties in Neutrosophic Triplet Loop and Their Application to Cryptography

Temitope Gbolahan Jaiyeola, Florentin Smarandache

Temitope Gbolahan Jaiyeola, Florentin Smarandache (2018). Inverse Properties in Neutrosophic Triplet Loop and Their Application to Cryptography. *Algorithms* 11, 32; DOI: 10.3390/a11030032

Abstract: This paper is the first study of the neutrosophic triplet loop (NTL) which was originally introduced by Florentin Smarandache. NTL originated from the neutrosophic triplet set X : a collection of triplets $(x, neut(x), anti(x))$ for an $x \in X$ which obeys some axioms (existence of neutral(s) and opposite(s)). NTL can be informally said to be a neutrosophic triplet group that is not associative. That is, a neutrosophic triplet group is an NTL that is associative. In this study, NTL with inverse properties such as: right inverse property (RIP), left inverse property (LIP), right cross inverse property (RCIP), left cross inverse property (LCIP), right weak inverse property (RWIP), left weak inverse property (LWIP), automorphic inverse property (AIP), and anti-automorphic inverse property are introduced and studied. The research was carried out with the following assumptions: the inverse property (IP) is the RIP and LIP, cross inverse property (CIP) is the RCIP and LCIP, weak inverse property (WIP) is the RWIP and LWIP. The algebraic properties of neutrality and opposite in the aforementioned inverse property NTLs were investigated, and they were found to share some properties with the neutrosophic triplet group. The following were established: (1) In a CIPNTL (IPNTL), RIP (RCIP) and LIP (LCIP) were equivalent; (2) In an RIPNTL (LIPNTL), the CIP was equivalent to commutativity; (3) In a commutative NTL, the RIP, LIP, RCIP, and LCIP were found to be equivalent; (4) In an NTL, IP implied anti-automorphic inverse property and WIP, RCIP implied AIP and RWIP, while LCIP implied AIP and LWIP; (5) An NTL has the IP (CIP) if and only if it has the WIP and anti-automorphic inverse property (AIP); (6) A CIPNTL or an IPNTL was a quasigroup; (7) An LWIPNTL (RWIPNTL) was a left (right) quasigroup. The algebraic behaviours of an element, its neutral and opposite in the associator and commutator of a CIPNTL or an IPNTL were investigated. It was shown that $(\mathbb{Z}_p, *)$ where $x * y = (p - 1)(x + y)$, for any prime p , is a non-associative commutative CIPNTL and IPNTL. The application of some of these varieties of inverse property NTLs to cryptography is discussed.

Keywords: neutrosophic; triplet loop; quasigroup; loop; generalized group; neutrosophic triplet group; group; cryptography

1. Introduction

1.1. Generalized Group

A generalized group is an algebraic structure which has a deep physical background in the unified gauge theory and has direct relation with isotopies. Mathematicians and physicists have been trying to construct a suitable unified theory for twistor theory, isotopies theory, and so on. It was known that generalized groups are tools for constructions in unified geometric theory and electroweak theory. Electroweak theories are essentially structured on Minkowskian axioms, and gravitational theories are

constructed on Riemannian axioms. According to Araujo et. al. [1], the generalized group is equivalent to the notion of a completely simple semigroup.

Some of the structures and properties of generalized groups have been studied by Vagner [2], Molaei [3], [4], Mehrabi, Molaei, and Oloomi [5], Agboola [6], Adeniran et al. [7], and Fatehi and Molaei [8]. Smooth generalized groups were introduced in Agboola [9], and later Agboola [10] also presented smooth generalized subgroups while Molaei [11], Molaei and Tahmoresi [12] considered the notion of topological generalized groups, and Maleki and Molaei [13] studied the quotient space of generalized groups.

Definition 1. (*Generalized Group*)

A generalized group G is a non-empty set admitting a binary operation called multiplication, subject to the set of rules given below.

- (i) $(xy)z = x(yz)$ for all $x, y, z \in G$.
- (ii) For each $x \in G$, there exists a unique $e(x) \in G$ such that $xe(x) = e(x)x = x$ (existence and uniqueness of identity element).
- (iii) For each $x \in G$, there exists $x^{-1} \in G$ such that $xx^{-1} = x^{-1}x = e(x)$ (existence of inverse element).

Definition 2. Let L be a non-empty set. Define a binary operation (\cdot) on L . If $x \cdot y \in L$ for all $x, y \in L$, (L, \cdot) is called a groupoid.

If the equation $a \cdot x = b$ (resp. $y \cdot a = b$) has a unique solution relative to x (resp. y) (i.e., obeys the left (resp. right) cancellation law), then (L, \cdot) is called a left (resp. right) quasigroup. If a groupoid (L, \cdot) is both a left quasigroup and right quasigroup, then it is called a quasigroup. If there exists an element $e \in L$ called the identity element such that for all $x \in L$, $x \cdot e = e \cdot x = x$, then a quasigroup (L, \cdot) is called a loop.

For more on quasigroups and loops, readers should check [14–20].

Definition 3. (*Generalized loop*)

A generalized loop is the pair (G, \cdot) where G is a non-empty set and \cdot a binary operation such that the following are true.

- (i) (G, \cdot) is a groupoid.
- (ii) For each $x \in G$, there exists a unique $e(x) \in G$ such that $xe(x) = e(x)x = x$.
- (iii) For each $x \in G$, there exists $x^{-1} \in G$ such that $xx^{-1} = x^{-1}x = e(x)$.

A generalized group G exhibits the following properties:

- (i) For each $x \in G$, there exists a unique $x^{-1} \in G$.
- (ii) $e(e(x)) = e(x)$ and $e(x^{-1}) = e(x)$ whenever $x \in G$.
- (iii) If G is commutative, then G is a group.

1.2. Neutrosophic Triplet Group

Neutrosophy is a new branch of philosophy which studies the nature, origin, and scope of neutralities as well as their interaction with ideational spectra. In 1995, Florentin Smarandache [21] first introduced the concept of neutrosophic logic and neutrosophic sets where each proposition in neutrosophic logic is approximated to have the percentage of truth in a subset T , the percentage of indeterminacy in a subset I , and the percentage of falsity in a subset F so that this neutrosophic logic is called an extension of fuzzy logic, especially to intuitionistic fuzzy logic. In fact, the neutrosophic set is the generalization of classical sets [22], fuzzy sets [23], intuitionistic fuzzy sets [22,24] and interval valued fuzzy sets [22], to mention a few. This mathematical tool is used to handle problems consisting of uncertainty, imprecision, indeterminacy, inconsistency, incompleteness, and falsity. The development process of neutrosophic sets, fuzzy sets, and intuitionistic fuzzy sets are still growing, with various

applications; here are some recent research works in these directions [25–32]. By utilizing the idea of neutrosophic theory, Vasantha Kandasamy and Florentin Smarandache studied neutrosophic algebraic structures in [33–35] by introducing an indeterminate element “ I ” in the algebraic structure and then combining “ I ” with each element of the structure with respect to the corresponding binary operation $*$. This was called a neutrosophic element, and the generated algebraic structure was termed a neutrosophic algebraic structure. They further studied several neutrosophic algebraic structures, such as neutrosophic fields, neutrosophic vector spaces, neutrosophic groups, neutrosophic bigroups, neutrosophic N-groups, neutrosophic semigroups, neutrosophic bisemigroups, neutrosophic N-semigroups, neutrosophic loops, neutrosophic biloops, neutrosophic N-loops, neutrosophic groupoids, neutrosophic bigroupoids, and so on.

Smarandache and Ali [36] for the first time introduced the idea of the neutrosophic triplet, which they had previously discussed in [37]. They used these neutrosophic triplets to introduce the neutrosophic triplet group, which is different from the classical group both in structural and fundamental properties. They gave distinction and comparison of neutrosophic triplet group with the classical generalized group. They also drew a brief sketch of the possible applications of the neutrosophic triplet group in some other research areas. Jaiyéolá [38] studied new algebraic properties of the neutrosophic triplet group with new applications. Some new applications of neutrosophy were announced in Okpako and Asagba [39], Sahin and Kargin [40], Vasantha Kandasamy et al. [41], and Smarandache [42]. Agboola et al. [43] and Zhang et al. [44] are some recent works on neutrosophic triplet groups, neutrosophic quadruple, and neutrosophic duplet of algebraic structures.

Definition 4. (*Neutrosophic Triplet Set*)

Let X be a set together with a binary operation $*$ defined on it. Then, X is called a neutrosophic triplet set if for any $x \in X$, there exists a neutral of “ x ” denoted by $neut(x)$ (not necessarily the identity element) and an opposite of “ x ” denoted by $anti(x)$ or x], with $neut(x), anti(x) \in X$ such that:

$$x * neut(x) = neut(x) * x = x \quad \text{and} \quad x * anti(x) = anti(x) * x = neut(x).$$

The elements $x, neut(x)$, and $anti(x)$ are collectively referred to as a neutrosophic triplet, and denoted by $(x, neut(x), anti(x))$.

Remark 1. For the same $x \in X$, each $neut(x)$ and $anti(x)$ may not be unique. In a neutrosophic triplet set $(X, *)$, an element y (resp. z) is the second (resp. third) component of a neutrosophic triplet if there exist $x, z \in X$ ($x, y \in X$) such that $x * y = y * x = x$ and $x * z = z * x = y$. Thus, (x, y, z) is the neutrosophic triplet.

Example 1. (*Smarandache and Ali [36]*)

Consider (\mathbb{Z}_6, \times_6) where $\mathbb{Z}_6 = \{0, 1, 2, 3, 4, 5\}$ and \times_6 is multiplication in modulo 6. $(2, 4, 2), (4, 4, 4)$, and $(0, 0, 0)$ are neutrosophic triplets, but 3 does not give rise to a neutrosophic triplet.

Definition 5. (*Neutrosophic Triplet Group*)

Let $(X, *)$ be a neutrosophic triplet set. Then, $(X, *)$ is called a neutrosophic triplet group if $(X, *)$ is a semigroup. If in addition, $(X, *)$ obeys the commutativity law, then $(X, *)$ is called a commutative neutrosophic triplet group.

Remark 2. A neutrosophic triplet group is not a group in general, but a group is a neutrosophic triplet group where $neut(x) = e$ the general identity element for all $x \in X$ and $anti(x)$ is unique for each $x \in X$.

1. A generalized loop is a generalized group if and only if it is associative.
2. A neutrosophic triplet loop (NTL) is a neutrosophic triplet group if and only if it is associative.
3. An NTL is a generalized loop if and only if $neut(x) = e(x)$ is unique for each x .
4. An NTL is a loop if and only if it is a quasigroup and $neut(x) = neut(y)$ for all x, y .

Example 2. (Smarandache and Ali [36])

Consider $(\mathbb{Z}_{10}, \otimes)$ where $x \otimes y = 3xy \pmod{10}$. $(\mathbb{Z}_{10}, \otimes)$ is a commutative neutrosophic triplet group but neither a classical group nor a generalized group.

Example 3. (Smarandache and Ali [36])

Consider (\mathbb{Z}_{10}, \star) where $x \star y = 5x + y \pmod{10}$. (\mathbb{Z}_{10}, \star) is a non-commutative neutrosophic triplet group, but not a classical group.

Theorem 1. (Smarandache and Ali [36])

Let (X, \ast) be a neutrosophic triplet group. The following are true for all $x, y, z \in X$.

1. $x \ast y = x \ast z \Leftrightarrow \text{neut}(x) \ast y = \text{neut}(x) \ast z$.
2. $y \ast x = z \ast x \Leftrightarrow y \ast \text{neut}(x) = z \ast \text{neut}(x)$.
3. $\text{anti}(x) \ast y = \text{anti}(x) \ast z \Rightarrow \text{neut}(x) \ast y = \text{neut}(x) \ast z$.
4. $y \ast \text{anti}(x) = z \ast \text{anti}(x) \Rightarrow y \ast \text{neut}(x) = z \ast \text{neut}(x)$.
5. $\text{neut}(x) \ast \text{neut}(x) = \text{neut}(x)$ i.e., $\text{neut}(\text{neut}(x)) = \text{neut}(x)$.
6. $\text{neut}(x)^n = \text{neut}(x)$ for any $n \in \mathbb{N}$; $\text{anti}(\text{neut}(x)) = \text{neut}(x)$.
7. $\text{neut}(x) \ast \text{anti}(x) = \text{anti}(x) \ast \text{neut}(x) = \text{anti}(x)$ i.e. $\text{neut}(\text{anti}(x)) = \text{neut}(x)$.

Definition 6. (Neutrosophic Triplet Loop—NTL)

Let (X, \ast) be a neutrosophic triplet set. Then, (X, \ast) is called a neutrosophic triplet loop if (X, \ast) is a groupoid. If in addition, (X, \ast) obeys the commutativity law, then (X, \ast) is called a commutative neutrosophic triplet loop.

Let (X, \ast) be a neutrosophic triplet loop. If $\text{neut}(xy) = \text{neut}(x)\text{neut}(y)$ for all $x, y \in X$, then X is called normal.

Remark 3. An NTL is a neutrosophic triplet group if and only if it is associative. Thus, an NTL is a generalization of a neutrosophic triplet group, and it is interesting to study an NTL that obeys weak associative law. NTL was originally introduced by Florentin Smarandache.

Example 4. Let $(\mathbb{Z}_{10}, +, \cdot)$ be the field of integers modulo 10. Consider (\mathbb{Z}_{10}, \ast) , where for all $x, y \in \mathbb{Z}_{10}$, $x \ast y = 2x + 2y$. The following are neutrosophic triplets:

$$(0, 0, 0), (0, 0, 5), (2, 4, 0), (2, 4, 5), (4, 8, 0), (4, 8, 5), (6, 2, 0), (6, 2, 5), (8, 6, 0), (8, 6, 5)$$

in (\mathbb{Z}_{10}, \ast) . Thus, $\{0, 2, 4, 5, 6, 8\}$ is a neutrosophic triplet set. (\mathbb{Z}_{10}, \ast) is non-associative because $(x \ast y) \ast z = 4x + 4y + 2z \neq x \ast (y \ast z) = 2x + 4y + 4z$. (\mathbb{Z}_{10}, \ast) is a non-associative NTL (i.e., not a neutrosophic triplet group) with $2 \ast \text{neut}(x) = 9x$ and $4 \ast \text{anti}(x) = 5x$.

Definition 7. (Inverse Properties and Neutrosophic Triplet Loop)

(X, \ast) will be called a right inverse property neutrosophic triplet loop (RIPNTL) if it obeys the right inverse property (RIP)

$$(y \ast x) \ast \text{anti}(x) = y \tag{1}$$

(X, \ast) will be called a left inverse property neutrosophic triplet loop (LIPNTL) if it obeys the left inverse property (LIP)

$$\text{anti}(x) \ast (x \ast y) = y \tag{2}$$

(X, \ast) will be called an inverse property neutrosophic triplet loop if it obeys both (1) and (2).

(X, \ast) will be called a left cross inverse property neutrosophic triplet loop (LCIPNTL) if it obeys the left cross inverse property (LCIP)

$$\text{anti}(x) \ast (y \ast x) = y \tag{3}$$

$(X, *)$ will be called a right cross inverse property neutrosophic triplet loop (RCIPNTL) if it obeys the right cross inverse property (RCIP)

$$(x * y) * anti(x) = y \tag{4}$$

$(X, *)$ will be called a cross inverse property neutrosophic triplet loop (CIPNTL) if it obeys both (3) and (4).

$(X, *)$ will be called a right weak inverse property neutrosophic triplet loop (RWIPNTL) if it obeys the right weak inverse property (RWIP)

$$x * anti(y * x) = anti(y) \tag{5}$$

$(X, *)$ will be called a left weak inverse property neutrosophic triplet loop (LWIPNTL) if it obeys the left weak inverse property (LWIP)

$$anti(x * y) * x = anti(y) \tag{6}$$

$(X, *)$ will be called a weak inverse property neutrosophic triplet loop (WIPNTL) if it obeys both (5) and (6).

$(X, *)$ will be called an automorphic inverse property neutrosophic triplet loop (AIPNTL) if it obeys the automorphic inverse property (AIP)

$$anti(x * y) = anti(x) * anti(y) \tag{7}$$

$(X, *)$ will be called an antiautomorphic inverse property neutrosophic triplet loop (AAIPNTL) if it obeys the antiautomorphic inverse property (AAIP)

$$anti(x * y) = anti(y) * anti(x) \tag{8}$$

$(X, *)$ will be called a semi-automorphic inverse property neutrosophic triplet loop (SAIPNTL) if it obeys the semi-automorphic inverse property (SAIP)

$$anti((x * y) * x) = (anti(x) * anti(y)) * anti(x) \tag{9}$$

Definition 8. (Associators and Commutators of Neutrosophic Triplet Loop)

Let $(X, *)$ be an NTL. For any $x, y, z \in X$,

1. $(x, y, z) \in X$ is called the right associator of x, y, z if $xy * z = (x * yz)(x, y, z)$.
2. $[x, y, z] \in X$ is called the left associator of x, y, z if $xy * z = [x, y, z](x * yz)$.
3. $(x, y) \in X$ is called the right commutator of x, y if $x * y = (y * x)(x, y)$.
4. $[x, y] \in X$ is called the right commutator of x, y if $x * y = [x, y](y * x)$.

This paper is the first study of a class of neutrosophic triplet loop (NTL) containing varieties of inverse property NTLs and the application of some of them to cryptography. The second section contains the main results on the varieties of inverse property NTLs in Definition 7 and the interrelationships. The algebraic properties of their neutrality and opposite were investigated, and were found to share some properties with the neutrosophic triplet group. An example of these varieties of NTL is given. Summaries of the results in the second section are exhibited as two Hasse diagrams in Figure 1. The third section discusses the application of some of these varieties of inverse property NTLs to cryptography.

2. Main Results

Lemma 1. Let X be a CIPNTL. Then:

1. $neut(x) = neut(anti(x)), anti(anti(x)) = x$ and $J^2 = I$.
2. $L_x R_{anti(x)} = I = R_x L_{anti(x)}$.

3. X is an RIPNTL if and only X is an LIPNTL.
4. $neut(x) = anti(neut(x))$ and $neut(neut(x)) = neut(x)neut(x)$.

Proof.

1. Put $y = anti(x)$ in (4) to get $x anti(x) * anti(x) = anti(x) \Rightarrow$

$$neut(x)anti(x) = anti(x) \quad (10)$$

Put $y = anti(x)$ in (3) to get $anti(x) * anti(x)x = anti(x) \Rightarrow$

$$anti(x)neut(x) = anti(x) \quad (11)$$

By (10) and (11), we have $neut(x) = neut(anti(x))$. By this, $anti(x)x = x anti(x) = neut(x) \Rightarrow anti(anti(x)) = x$ and $J^2 = I$.

2. These are just (3) and (4) put in translation forms.
3. From 2., $L_x R_{anti(x)} R_x L_{anti(x)} = I$. So, $R_{anti(x)} R_x = I \Rightarrow L_x R_{anti(x)} \Leftrightarrow y anti(x) * x = y \Rightarrow anti(x) * xy = y \Leftrightarrow y anti(anti(x)) * anti(x) = y \Rightarrow anti(x) * xy = y \Leftrightarrow yx * anti(x) = y \Rightarrow anti(x) * xy = y \Leftrightarrow X$ has the RIP, which implies that X has the LIP. Similarly, since by 2., $R_x L_{anti(x)} L_x R_{anti(x)} = I$, then we get X has the LIP implies X has the RIP.
4. Let $x \in X$. Recall that $x neut(x) = x = neut(x)x$. So, by the RCIP, $neut(x)x * anti(neut(x)) = x anti(neut(x)) \Rightarrow$

$$x anti(neut(x)) = x. \quad (12)$$

Similarly, by the LCIP,

$$anti(neut(x))x = x. \quad (13)$$

Thus, by (12) and (13), $neut(x) = anti(neut(x))$. Furthermore, $neut(x)neut(x) = anti(neut(x))neut(x) = neut(x)anti(neut(x)) \Rightarrow neut(neut(x)) = neut(x)neut(x)$.

□

Lemma 2. Let X be a CIPNTL or an IPLNTL. Then:

1. Equations $a * x = b$ and $y * c = d$ have solutions for $x, y \in X$ and these solutions are unique for all $a, b, c, d \in X$. (unique solvability)
2. The cancellation laws hold.
3. The right and left translation maps R_a and L_a are bijections for all $a \in X$.

Proof. For CIPNTL.

1. $a * x = b \Rightarrow (a * x)anti(a) = b anti(a) \Rightarrow x = b anti(a) \in X$. Similarly, $y * c = d \Rightarrow anti(c)(y * c) = anti(c)d \Rightarrow y = anti(c)d$.

Let $x_1, x_2 \in X$ such that $a * x_1 = b = a * x_2 \Rightarrow (a * x_1)anti(a) = (a * x_2)anti(a) \Rightarrow x_1 = x_2$.

2. This follows from 1.
3. $R_a : X \rightarrow X$ given by $xR_a = x * a$. R_a is a bijection if and only if the equation $x * a = b$ is uniquely solvable for x for all $a, b \in X$. $L_a : X \rightarrow X$ given by $xL_a = a * x$. L_a is a bijection if and only if the equation $a * x = b$ is uniquely solvable for x for all $a, b \in X$.

For IPNTL.

1. $a * x = b \Rightarrow anti(a)(a * x) = anti(a)b \Rightarrow x = anti(a)b \in X$. Similarly, $y * c = d \Rightarrow (y * c)anti(c) = d anti(c) \Rightarrow y = d anti(c)$.

Let $x_1, x_2 \in X$ such that $a * x_1 = b = a * x_2 \Rightarrow anti(a)(a * x_1) = anti(a)(a * x_2) \Rightarrow x_1 = x_2$.

2. This follows from above.
3. $R_a : X \rightarrow X$ given by $xR_a = x * a$. R_a is a bijection if and only if the equation $x * a = b$ is uniquely solvable for x for all $a, b \in X$. $L_a : X \rightarrow X$ given by $xL_a = a * x$. L_a is a bijection if and only if the equation $a * x = b$ is uniquely solvable for x for all $a, b \in X$.

□

Theorem 2. *Let X be an NTL.*

1. X is an RCIPNTL if and only if $x * y \text{ anti}(x) = y$.
2. X is an LCIPNTL if and only if $\text{anti}(x)y * x = y$.
3. X is a CIPNTL if and only if $x * y \text{ anti}(x) = y = \text{anti}(x)y * x$.

Proof.

1. By Lemma 2, if X is an RCIPNTL, then it is a left quasigroup and L_a is a bijection for $a \in X$. Consider an NTL which has the property $x * y \text{ anti}(x) = y$. Put $y = \text{neut}(\text{anti}(x))$ to get $x * \text{neut}(\text{anti}(x))\text{anti}(x) = \text{neut}(\text{anti}(x)) \Rightarrow x * \text{anti}(x) = \text{neut}(\text{anti}(x)) \Rightarrow \text{neut}(x) = \text{neut}(\text{anti}(x)) \Rightarrow \text{anti}(\text{anti}(x)) = x$. Thus, $x * a = b \Rightarrow x * \text{anti}(\text{anti}(a)) = b \Rightarrow \text{anti}(a)(x * \text{anti}(\text{anti}(a))) = \text{anti}(a)b \Rightarrow x = \text{anti}(a)b$. Let $x_1, x_2 \in X$. Then, $x_1 * a = x_2 * a \Rightarrow x_1 * \text{anti}(\text{anti}(a)) = x_2 * \text{anti}(\text{anti}(a)) \Rightarrow \text{anti}(a)(x_1 * \text{anti}(\text{anti}(a))) = \text{anti}(a)(x_2 * \text{anti}(\text{anti}(a))) \Rightarrow x_1 = x_2$. So, $x * a = b$ is uniquely solvable for x that R_a is bijective.

RCIP implies $L_x R_{\text{anti}(x)} = I \Rightarrow R_{\text{anti}(x)} = L_x^{-1} \Rightarrow R_{\text{anti}(x)} L_x = I \Rightarrow x * y \text{ anti}(x) = y$. Conversely, $x * y \text{ anti}(x) = y \Rightarrow R_{\text{anti}(x)} L_x = I \Rightarrow L_x = R_{\text{anti}(x)}^{-1} \Rightarrow L_x R_{\text{anti}(x)} = I \Rightarrow \text{RCIP}$.

2. By Lemma 2, if X is an LCIPNTL, then it is a right quasigroup and R_a is a bijection for $a \in X$. Consider an NTL which has the property $\text{anti}(x)y * x = y$. Put $y = \text{neut}(\text{anti}(x))$ to get $\text{anti}(x)\text{neut}(\text{anti}(x)) * x = \text{neut}(\text{anti}(x)) \Rightarrow \text{anti}(x) * x = \text{neut}(\text{anti}(x)) \Rightarrow \text{neut}(x) = \text{neut}(\text{anti}(x)) \Rightarrow \text{anti}(\text{anti}(x)) = x$. Thus, $a * x = b \Rightarrow \text{anti}(\text{anti}(a)) * x = b \Rightarrow (\text{anti}(\text{anti}(a)) * x)\text{anti}(a) = b \text{ anti}(a) \Rightarrow x = b \text{ anti}(a)$. Let $x_1, x_2 \in X$. Then, $a * x_1 = a * x_2 \Rightarrow \text{anti}(\text{anti}(a)) * x_1 = \text{anti}(\text{anti}(a)) * x_2 \Rightarrow (\text{anti}(\text{anti}(a)) * x_1)\text{anti}(a) = (\text{anti}(\text{anti}(a)) * x_2)\text{anti}(a) \Rightarrow x_1 = x_2$. So, $a * x = b$ is uniquely solvable for x that L_a is bijective.

LCIP implies $R_x L_{\text{anti}(x)} = I \Rightarrow R_x^{-1} = L_{\text{anti}(x)} \Rightarrow L_{\text{anti}(x)} R_x = I \Rightarrow \text{anti}(x)y * x = y$. Conversely, $\text{anti}(x)y * x = y \Rightarrow L_{\text{anti}(x)} R_x = I \Rightarrow L_{\text{anti}(x)}^{-1} = R_x \Rightarrow R_x L_{\text{anti}(x)} = I \Rightarrow \text{LCIP}$.

3. This follows from 1. and 2.

□

Lemma 3. *Let X be an IPNL. Then:*

1. $\text{neut}(x) = \text{neut}(\text{anti}(x))$, $\text{anti}(\text{anti}(x)) = x$ and $J^2 = I$.
2. $R_x R_{\text{anti}(x)} = I = L_x L_{\text{anti}(x)}$.
3. X is an RCIPNL if and only if X is an LCIPNL.
4. $\text{neut}(x) = \text{anti}(\text{neut}(x))$ and $\text{neut}(\text{neut}(x)) = \text{neut}(x)\text{neut}(x)$.

Proof.

1. Put $y = \text{anti}(x)$ in (1) to get $\text{anti}(x)x * \text{anti}(x) = \text{anti}(x) \Rightarrow$

$$\text{neut}(x)\text{anti}(x) = \text{anti}(x) \tag{14}$$

Put $y = \text{anti}(x)$ in (2) to get $\text{anti}(x) * x \text{ anti}(x) = \text{anti}(x) \Rightarrow$

$$\text{anti}(x)\text{neut}(x) = \text{anti}(x) \tag{15}$$

By (14) and (15), we have $neut(x) = neut(anti(x))$. By this, $anti(x)x = x anti(x) = neut(x) \Rightarrow anti(anti(x)) = x$ and $J^2 = I$.

2. These are just (1) and (2) put in translation forms.
3. Keep Theorem 2 in mind. From 2., $R_x R_{anti(x)} L_x L_{anti(x)} = I$. So, $R_{anti(x)} L_x = I \Rightarrow R_x L_{anti(x)} \Leftrightarrow x * y anti(x) = y \Rightarrow anti(x) * yx = y \Leftrightarrow X$ has the RCIP implies X has the LCIP. Similarly, since by 2., $L_x L_{anti(x)} R_x R_{anti(x)} = I$, then we get X has the LCIP implies X has the RCIP.
4. Let $x \in X$. Recall that $x neut(x) = x = neut(x)x$. So, by the RIP, $x neut(x) * anti(neut(x)) = x anti(neut(x)) \Rightarrow$

$$x anti(neut(x)) = x. \quad (16)$$

Similarly, by the LIP,

$$anti(neut(x))x = x. \quad (17)$$

Thus, by (16) and (17), $neut(x) = anti(neut(x))$. Furthermore, $neut(x)neut(x) = anti(neut(x))neut(x) = neut(x)anti(neut(x)) \Rightarrow neut(neut(x)) = neut(x)neut(x)$.

□

Theorem 3. Let X be a CIPNTL. For all $x, y \in X$,

1. $(x, x, anti(x)) = neut(x) = [x, x, anti(x)]$.
2. $(x, y, anti(x)) = neut(y) = [x, y, anti(x)]$.
3. $(anti(x), x, x) = neut(x) = [anti(x), x, x]$.
4. $(anti(x), y, x) = neut(y) = [anti(x), y, x]$.
5. $(x, neut(x)) = neut(x) = [x, neut(x)]$.
6. $(neut(x), x) = neut(x) = [neut(x), x]$.
7. $(x, x) = neut(xx) = [x, x]$.
8. $(x, anti(x)) = neut(neut(x)) = [x, anti(x)]$.
9. $(anti(x), x) = neut(neut(x)) = [anti(x), x]$.
10. $(x, y) = (xy)anti(yx)$ and $[x, y] = anti(yx)(xy)$.
11. X is commutative if and only if $(x, y) = neut(yx)$ if and only if $[x, y] = neut(yx)$.
12. If X is commutative, then X is normal if and only if $(x, y) = (x, neut(x))(y, neut(y))$ if and only if $[x, y] = [x, neut(x)][y, neut(y)]$.
13. X is normal if and only if $(x, y)anti(xy) * (yx) = neut(y)neut(x)$ if and only if $(yx) * (x, y)anti(xy) = neut(y)neut(x)$ if and only if $anti(xy)[x, y] * yx = neut(y)neut(x)$ if and only if $(yx) * anti(xy)[x, y] = neut(y)neut(x)$.
14. $(x, neut(x), anti(x)) = neut(neut(x)) = (anti(x), neut(x), x)$.
15. $(neut(x), x, anti(x)) = (anti(x), x, neut(x)) = (x, anti(x), neut(x)) = (neut(x), anti(x), x) = neut(x)$.

Proof.

1 and 2 From the right associator, $xy * anti(x) = (x * y anti(x))(x, y, anti(x)) \Rightarrow y = y(x, y, anti(x)) \Rightarrow y anti(y) = y(x, y, anti(x)) * anti(y) \Rightarrow (x, y, anti(x)) = neut(y)$. Hence, $(x, x, anti(x)) = neut(x)$.

From the left associator, $xy * anti(x) = [x, y, anti(x)](x * y anti(x)) \Rightarrow y = [x, y, anti(x)]y \Rightarrow anti(y)y = anti(y) * [x, y, anti(x)]y \Rightarrow [x, y, anti(x)] = neut(y)$. Hence, $[x, x, anti(x)] = neut(x)$.

3 and 4 From the right associator, $anti(x)y * x = (anti(x) * yx)(anti(x), y, x) \Rightarrow y = y(anti(x), y, x) \Rightarrow y anti(y) = y(anti(x), y, x) * anti(y) \Rightarrow (anti(x), y, x) = neut(y)$. Hence, $(anti(x), x, x) = neut(x)$.

From the left associator, $anti(x)y * x = [anti(x), y, x](anti(x) * yx) \Rightarrow y = [anti(x), y, x]y \Rightarrow$

$anti(y)y = anti(y) * [anti(x), y, x]y \Rightarrow [anti(x), y, x] = neut(y)$. Hence, $[anti(x), x, x] = neut(x)$.

5 and 6 From the right commutator, $x * neut(x) = (neut(x) * x)(x, neut(x)) \Rightarrow x = x(x, neut(x)) \Rightarrow x anti(x) = x(x, neut(x)) * anti(x) \Rightarrow (x, neut(x)) = neut(x)$. Similarly, $(neut(x), x) = neut(x)$.

From the left commutator, $x * neut(x) = [x, neut(x)](neut(x) * x) \Rightarrow x = [x, neut(x)]x \Rightarrow anti(x)x = anti(x) * x(x, neut(x)) \Rightarrow [x, neut(x)] = neut(x)$. Similarly, $[neut(x), x] = neut(x)$.

7 From the right commutator, $x * x = (xx)(x, x) \Rightarrow xx * anti(xx) = (xx)(x, x) * anti(xx) \Rightarrow neut(xx) = (x, x)$. From the left commutator, $x * x = [x, x](xx) \Rightarrow anti(xx) * xx = anti(xx) * [x, x](xx) \Rightarrow neut(xx) = [x, x]$.

8 and 9 From the right commutator, $x * anti(x) = (anti(x) * x)(x, anti(x)) \Rightarrow neut(x) = neut(x)(x, anti(x)) \Rightarrow neut(x)anti(neut(x)) = neut(x)(x, anti(x)) * anti(neut(x)) \Rightarrow big(x, anti(x)) = neut(neut(x))$. Similarly, $(anti(x), x) = neut(neut(x))$.

From the left commutator, $anti(x) * x = [x, anti(x)](x * anti(x)) \Rightarrow neut(x) = [x, anti(x)]neut(x) \Rightarrow anti(neut(x))neut(x) = anti(neut(x)) * [x, anti(x)]neut(x) \Rightarrow [x, anti(x)] = neut(neut(x))$. Similarly, $[anti(x), x] = neut(neut(x))$.

10 From the right commutator, $xy = yx * (x, y) \Rightarrow xy * anti(yx) = (yx)(x, y) * anti(yx) \Rightarrow (x, y) = (xy)anti(yx)$. From the left commutator, $xy = [x, y] * yx \Rightarrow anti(yx) * xy = anti(yx) * [x, y](yx) \Rightarrow [x, y] = anti(yx)(xy)$.

11 This follows from 10.

12 This follows from 6 and 10.

13 We shall use 10.

X is normal if and only if $(x, y)anti(xy) = (xy)anti(yx) * anti(yx) \Leftrightarrow (x, y)anti(xy) = anti(yx) \Leftrightarrow$

$$\begin{aligned} (x, y)anti(xy) * (yx) &= anti(yx)(yx) \text{ or } (yx) * (x, y)anti(xy) = (yx)anti(yx) \Leftrightarrow \\ (x, y)anti(xy) * (yx) &= neut(yx) \text{ or } (yx) * (x, y)anti(xy) = neut(yx) \Leftrightarrow \\ (x, y)anti(xy) * (yx) &= neut(y)neut(x) \text{ or } (yx) * (x, y)anti(xy) = neut(y)neut(x). \end{aligned}$$

X is normal if and only if $anti(xy)[x, y] = anti(xy) * anti(yx)(xy) \Leftrightarrow anti(xy)[x, y] = anti(yx) \Leftrightarrow$

$$\begin{aligned} anti(xy)[x, y] * (yx) &= anti(yx)(yx) \text{ or } (yx) * anti(xy)[x, y] = (yx)anti(yx) \Leftrightarrow \\ anti(xy)[x, y] * (yx) &= neut(yx) \text{ or } (yx) * anti(xy)[x, y] = neut(yx) \Leftrightarrow \\ anti(xy)[x, y] * (yx) &= neut(y)neut(x) \text{ or } (yx) * anti(xy)[x, y] = neut(y)neut(x). \end{aligned}$$

14 Apply the right and left associators.

15 Apply the right and left associators.

□

Lemma 4. Let X be an NTL.

1. Let X be an RIPNL. X is a CIPNTL if and only if X is commutative.
2. Let X be an LIPNL. X is a CIPNTL if and only if X is commutative.
3. Let X be commutative. The following are equivalent:

- (a) RIP.
- (b) LIP.
- (c) RCIP.
- (d) LCIP.

Proof.

1. Let X be an RIPNL. Then, $yx * anti(x) = y$. RCIP implies $xy * anti(x) = y \Rightarrow xy * anti(x) = yx * anti(x) \Rightarrow xy = yx$. Conversely, RIP and commutativity imply $xy * anti(x) = y$ and $anti(x) * yx = y$ imply RCIP and LCIP.
 2. Let X be an LIPNL. Then, $anti(x) * xy = y$. LCIP implies $anti(x) * yx = y \Rightarrow anti(x) * yx = anti(x) * xy = y \Rightarrow xy = yx$. Conversely, LIP and commutativity imply $xy * anti(x) = y$ and $anti(x) * yx = y$ imply RCIP and LCIP.
 3. This follows from 1 and 2.
 4. Let X be commutative. X has the RIP iff $yx * anti(x) = y \Leftrightarrow anti(x) * xy = y$ iff X has the LIP. X has the RIP iff $yx * anti(x) = y \Leftrightarrow xy * anti(x) = y$ iff X has the RCIP. X has the RIP iff $yx * anti(x) = y \Leftrightarrow anti(x) * yx = y$ iff X has the LCIP.
-

Theorem 4. Let X be an IPNTL. For all $x, y \in X$,

1. $(x, y, anti(y)) = anti(x neut(y))x, (x, x, anti(x)) = neut(x)$.
2. $(anti(y), y, x) = anti(x) * neut(y)x, (anti(x), x, x) = neut(x)$.
3. $[x, y, anti(y)] = x anti(x neut(y)), [x, x, anti(x)] = neut(x)$.
4. $[anti(y), y, x] = neut(y), [anti(x), x, x] = neut(x)$.
5. $(x, y) = anti(yx)(xy)$ and $[x, y] = (xy)anti(yx)$.
6. $(x, y, anti(y)) = [x, y, anti(y)] \Leftrightarrow x * anti(neut(y))anti(x) = anti(neut(y))$.
7. $(anti(y), y, x) = [anti(y), y, x] \Leftrightarrow x neut(y) = neut(y)x$.
8. $anti(x [anti(y), y, x])x = (x, y, anti(y))$.
9. $anti(x) * [anti(y), y, x]x = (anti(y), y, x)$.
10. $x anti(x [anti(y), y, x])x = [x, y, anti(y)]$.
11. $(neut(x), x) = neut(x) = [neut(x), x]$ and $(x, x) = neut(xx) = [x, x]$.
12. $(x, neut(x), anti(x)) = neut(neut(x)) = (anti(x), neut(x), x)$.
13. $(neut(x), x, anti(x)) = (anti(x), x, neut(x)) = (x, anti(x), neut(x)) = (neut(x), anti(x), x) = neut(x)$.

Proof.

1. From the right associator, $xy * anti(y) = (x * y anti(y))(x, y, anti(y)) \Rightarrow x = x neut(y) * (x, y, anti(y)) \Rightarrow anti(x neut(y))x = anti(x neut(y)) [x neut(y) * (x, y, anti(y))] \Rightarrow (x, y, anti(y)) = anti(x neut(y))x$. Hence, $(x, x, anti(x)) = neut(x)$.
2. From the right associator, $anti(y)y * x = (anti(y) * yx)(anti(y), y, x) \Rightarrow neut(y)x = x(anti(y), y, x) \Rightarrow anti(x) * neut(y)x = anti(x) * x(anti(y), y, x) \Rightarrow (anti(y), y, x) = anti(x) * neut(y)x$. Hence, $(anti(x), x, x) = neut(x)$.
3. From the left associator, $xy * anti(y) = [x, y, anti(y)](x * y anti(y)) \Rightarrow x = [x, y, anti(y)](x neut(y)) \Rightarrow x anti(x neut(y)) = [x, y, anti(y)](x neut(y)) * anti(x neut(y)) \Rightarrow [x, y, anti(y)] = x anti(x neut(y))$. Hence, $[x, x, anti(x)] = neut(x)$.
4. From the left associator, $anti(y)y * x = [anti(y), y, x](anti(y) * yx) \Rightarrow neut(y)x = [anti(y), y, x]x \xrightarrow{\text{Lemma 2}} [anti(y), y, x] = neut(y)$. Hence, $[anti(x), x, x] = neut(x)$.
5. From the right commutator, $x * y = (y * x)(x, y) \Rightarrow anti(yx) * xy = anti(yx) * (yx)(x, y) \Rightarrow (x, y) = anti(yx)(xy)$. From the left commutator, $x * y = [x, y](y * x) \Rightarrow xy * anti(yx) = [x, y](yx) * anti(yx) \Rightarrow [x, y] = (xy)anti(yx)$.
6. By 1 and 3, $(x, y, anti(y)) = [x, y, anti(y)] \Leftrightarrow anti(x neut(y))x = x anti(x neut(y)) \xrightarrow{\text{Theorem 5 AAIP}} anti(neut(y))anti(x) * x = x * anti(neut(y))anti(x) \Leftrightarrow anti(neut(y)) = x * anti(neut(y))anti(x)$.
7. By 2 and 4, $(anti(y), y, x) = [anti(y), y, x] \Leftrightarrow anti(x) * neut(y)x = neut(y) \Leftrightarrow x(anti(x) * neut(y)x) = x neut(y) \Leftrightarrow x neut(y) = neut(y)x$.

8. This follows combining by 1 and 4.
 9. This follows combining by 2 and 4.
 10. This follows combining by 3 and 4.
 11. Apply 5.
 12. Apply the right and left associators.
 13. Apply the right and left associators.
-

Lemma 5. *Let X be a CIPNTL or an IPLNTL. Then:*

1. $neut(x)$ is unique for each $x \in X$.
2. $anti(x)$ is unique for each $x \in X$.
3. X is a generalized loop and a quasigroup.
4. X is a loop if and only if $neut(x) = neut(y)$ for all $x, y \in X$.
5. If X is associative, then X is a loop and group.
6. X is a group if and only if X is associative.

Proof.

1. By Lemma 2(2), $neut(x)x = x = neut(x)' \Rightarrow neut(x) = neut(x)'$.
 2. By Lemma 2(2), $anti(x)x = x = anti(x)' \Rightarrow anti(x) = x = anti(x)'$.
 3. These follow by 1. and Lemma 2(1).
 4. By the definition of NTL and loop, and 2.
 5. An associative quasigroup is a loop and a group.
 6. A loop is a group if and only it is associative.
-

Theorem 5. *Let X be an NTL.*

1. *If X is an IPNTL, then for all $x \in X$:*
 - (a) X is an AAIPNL.
 - (b) $R_x^{-1} = R_{anti(x)}$ and $L_x^{-1} = L_{anti(x)}$.
 - (c) $JR_xJ = L_x^{-1}$ and $JL_xJ = R_x^{-1}$.
 - (d) X is a WIPNTL.
2. *If X is a CIPNTL, then for all $x \in X$:*
 - (a) X is an AIPNTL.
 - (b) $L_xR_{anti(x)} = I = R_{anti(x)}L_x$ and $R_xL_{anti(x)} = I = L_{anti(x)}R_x$.
 - (c) $JR_xJ = R_{anti(x)}$ and $JL_xJ = L_{anti(x)}$.
 - (d) X is a WIPNTL.
3. *If X is an RCIPNTL, then for all $x \in X$:*
 - (a) X is an AIPNTL.
 - (b) $L_xR_{anti(x)} = I = R_{anti(x)}L_x$.
 - (c) $JR_xJ = R_{anti(x)}$ and $JL_xJ = L_{anti(x)}$ if and only if $anti(anti(x)) = x$.
 - (d) X is an RWIPNTL.
4. *If X is an LCIPNTL, then for all $x \in X$:*
 - (a) X is an AIPNL.

- (b) $R_x L_{anti(x)} = I = L_{anti(x)} R_x$.
 (c) $JR_x J = R_{anti(x)}$ and $JL_x J = L_{anti(x)}$ if and only if $anti(anti(x)) = x$.
 (d) X is an LWIPNTL.

Proof.

1. Let X be an IPNTL.

- (a) $xy = z \Rightarrow x = z anti(y) \Rightarrow anti(y) = anti(z)x \Rightarrow anti(z) = anti(y)anti(x) \Rightarrow anti(y)anti(x) = anti(xy) \Rightarrow$ AAIP. So, X is an AAIPNL.
 (b) RIP implies $xy * anti(y) = x \Rightarrow R_y R_{anti(y)} = I \Rightarrow R_y^{-1} = R_{anti(y)}$. LIP implies $anti(y) * yx = x \Rightarrow L_y L_{anti(y)} = I \Rightarrow L_y^{-1} = L_{anti(y)}$.
 (c) $yJR_x J = anti(anti(y)x) = anti(x)anti(anti(y)) = anti(x)y = yL_{anti(x)} = yL_x^{-1} \Rightarrow JR_x J = L_x^{-1}$. Also, $yJL_x J = anti(x anti(y)) = anti(anti(y))anti(x) = yanti(x) = yR_{anti(x)} = yR_x^{-1} \Rightarrow JL_x J = R_x^{-1}$.
 (d) $anti(xy)x = anti(y)anti(x) * x = anti(y) \Rightarrow$ LWIP. Also, $x anti(yx) = x * anti(x)anti(y) * x = anti(y) \Rightarrow$ RWIP. So, X is a WIPNTL.

2. Let X be a CIPNTL.

- (a) $xy = z \Rightarrow y = z anti(x) \Rightarrow anti(x) = y anti(z) \Rightarrow anti(z) = anti(x)anti(y) \Rightarrow anti(x)anti(y) = anti(xy) \Rightarrow$ AIP. So, X is an AIPNL.
 (b) By Theorem 2: RCIP implies that $L_x R_{anti(x)} = I = R_{anti(x)} L_x$ and LCIP implies that $R_x L_{anti(x)} = I = L_{anti(x)} R_x$.
 (c) $yJR_x J = anti(anti(y)x) = anti(anti(y))anti(x) = y anti(x) = yR_{anti(x)} \Rightarrow JR_x J = R_{anti(x)}$. Also, $yJL_x J = anti(x anti(y)) = anti(x)anti(anti(y)) = anti(x)y = yL_{anti(x)} \Rightarrow JL_x J = L_{anti(x)}$.
 (d) $anti(xy)x = anti(x)anti(y) * x = anti(y) \Rightarrow$ LWIP. Also, $x anti(yx) = x * anti(y)anti(x) * x = anti(y) \Rightarrow$ RWIP. So, X is a WIPNTL.

3. Let X be an RCIPNTL.

- (a) $xy = z \Rightarrow y = z anti(x) \Rightarrow anti(x) = y anti(z) \Rightarrow anti(z) = anti(x)anti(y) \Rightarrow anti(x)anti(y) = anti(xy) \Rightarrow$ AIP. So, X is an AIPNL.
 (b) By Theorem 2: RCIP implies that $L_x R_{anti(x)} = I = R_{anti(x)} L_x$.
 (c) $yJR_x J = anti(anti(y)x) = anti(anti(y))anti(x)$. So, $JR_x J = R_{anti(x)} \Leftrightarrow anti(anti(y))anti(x) = y anti(x) \Leftrightarrow anti(anti(y)) = y$.
 Also, $yJL_x J = anti(x anti(y)) = anti(x)anti(anti(y))$. So, $JL_x J = L_{anti(x)} \Leftrightarrow anti(x)anti(anti(y)) = anti(x)y \Leftrightarrow anti(anti(y)) = y$.
 (d) $x anti(yx) = x * anti(y)anti(x) = anti(y) \Rightarrow$ RWIP. So, X is an RWIPNTL.

4. Let X be an LCIPNTL.

- (a) $xy = z \Rightarrow x = anti(y)z \Rightarrow anti(y) = anti(z)x \Rightarrow anti(z) = anti(x)anti(y) \Rightarrow anti(x)anti(y) = anti(xy) \Rightarrow$ AIP. So, X is an AIPNL.
 (b) By Theorem 2: LCIP implies that $R_x L_{anti(x)} = I = L_{anti(x)} R_x$.
 (c) $yJR_x J = anti(anti(y)x) = anti(anti(y))anti(x)$. So, $JR_x J = R_{anti(x)} \Leftrightarrow anti(anti(y))anti(x) = y anti(x) \Leftrightarrow anti(anti(y)) = y$.
 Also, $yJL_x J = anti(x anti(y)) = anti(x)anti(anti(y))$. So, $JL_x J = L_{anti(x)} \Leftrightarrow anti(x)anti(anti(y)) = anti(x)y \Leftrightarrow anti(anti(y)) = y$.
 (d) $anti(xy)x = anti(x)anti(y) * x = anti(y) \Rightarrow$ LWIP. So, X is an LWIPNTL.

□

Theorem 6. *Let X be an NTL.*

1. *If X is an LWIPNTL, then for all $x \in X$:*

- (a) $neut(x) = anti(neut(x))$.
- (b) $neut(neut(x)) = neut(x)neut(x)$.
- (c) $anti(anti(x)) = x$ and $J^2 = I$.
- (d) $neut(x) = neut(anti(x))$.
- (e) J is a bijection.
- (f) X is a left quasigroup.
- (g) L_x is a bijection.

2. *If X is an RWIPNTL, then for all $x \in X$:*

- (a) $neut(x) = anti(neut(x))$.
- (b) $neut(neut(x)) = neut(x)neut(x)$.
- (c) $anti(anti(x)) = x$ and $J^2 = I$.
- (d) $neut(x) = neut(anti(x))$.
- (e) J is a bijection.
- (f) X is a right quasigroup.
- (g) R_x is a bijection.

3. *The following are equivalent.*

- (a) X is an LWIPNTL and R_x is bijective.
- (b) X is an RWIPNTL and L_x is bijective.
- (c) X is an LWIPNTL and X is a right quasigroup.
- (d) X is an RWIPNTL and X is a left quasigroup.

4. *If X is a WIPNTL, then $L_x^2 = I \Leftrightarrow R_x^2 = I$.*

5. *If X is an LCIPNTL, then X is a right quasigroup.*

6. *If X is an RCIPNTL, then X is a left quasigroup.*

Proof.

1. Let X be an LWIPNTL, then $anti(xy)x = anti(y)$.

Put $y = anti(x)$ to get $anti(x anti(x))x = anti(anti(x)) \Rightarrow$

$$anti(neut(x))x = anti(anti(x)) \quad (18)$$

Put $y = neut(x)$ to get $anti(x neut(x))x = anti(neut(x)) \Rightarrow x anti(x) = anti(neut(x)) \Rightarrow$

$$neut(x) = anti(neut(x)) \quad (19)$$

(19) implies $neut(x)neut(x) = anti(neut(x))neut(x) \Rightarrow$

$$neut(x)neut(x) = neut(neut(x)) \quad (20)$$

From (18) and (19), $neut(x)x = anti(anti(x)) \Rightarrow \boxed{x = anti(anti(x))}$ and so, $J^2 = I$

Put $x = neut(y)$ to get $anti(neut(y) y)neut(y) = anti(y) \Rightarrow$

$$anti(y)neut(y) = anti(y) \quad (21)$$

Put $x = anti(y)$ to get $anti(anti(y) y) anti(y) = anti(y) \Rightarrow anti(neut(y)) anti(y) = anti(y) \Rightarrow$

$$neut(y) anti(y) = anti(y) \tag{22}$$

By (21) and (22), $neut(anti(y)) = neut(y)$

Let $J : X \rightarrow X \uparrow xJ = anti(x)$. Then, $x_1J = x_2J \Rightarrow anti(x_1) = anti(x_2) \Rightarrow anti(anti(x_1)) = anti(anti(x_2)) \Rightarrow x_1 = x_2$. So, J is 1-1. For all $y \in X$, there exists $x \in X$ such that $xJ = y$ because $anti(x) = y \Rightarrow anti(anti(x)) = anti(y) \Rightarrow x = anti(y) \in X$.

Consider $L_a : X \rightarrow X \uparrow xL_a = ax$. Let $x_1L_a = x_2L_a \Rightarrow ax_1 = ax_2 \Rightarrow anti(ax_1) = anti(ax_2) \Rightarrow anti(ax_1) * a = anti(ax_2) * a \Rightarrow anti(x_1) = anti(x_2) \Rightarrow anti(anti(x_1)) = anti(anti(x_2)) \Rightarrow x_1 = x_2$. For all $y \in X$, there exists $x \in X$ such that $xL_a = y$ because $ax = y \Rightarrow anti(ax) = anti(y) \Rightarrow anti(ax) * a = anti(y) * a \Rightarrow anti(x) = anti(y) a \Rightarrow anti(anti(x)) = anti(anti(y) a) \Rightarrow x = anti(anti(y) a)$.

2. Let X be an RWIPNTL, then $x anti(yx) = anti(y)$.

Put $y = anti(x)$ to get $x anti(anti(x)x) = anti(anti(x)) \Rightarrow$

$$x anti(neut(x)) = anti(anti(x)). \tag{23}$$

Put $y = neut(x)$ to get $x anti(neut(x)x) = anti(neut(x)) \Rightarrow x anti(x) = anti(neut(x)) \Rightarrow$

$$neut(x) = anti(neut(x)). \tag{24}$$

(24) implies $neut(x)neut(x) = anti(neut(x))neut(x) \Rightarrow$

$$neut(x)neut(x) = neut(neut(x)). \tag{25}$$

From (23) and (24), $xneut(x) = anti(anti(x)) \Rightarrow x = anti(anti(x))$ and so, $J^2 = I$.

Put $x = neut(y)$ to get $neut(y) anti(y neut(y)) = anti(y) \Rightarrow$

$$neut(y) anti(y) = anti(y). \tag{26}$$

Put $x = anti(y)$ to get $anti(y) anti(y anti(y)) = anti(y) \Rightarrow anti(y) anti(neut(y)) = anti(y) \Rightarrow$

$$anti(y) neut(y) = anti(y). \tag{27}$$

By (26) and (27), $neut(anti(y)) = neut(y)$.

Let $J : X \rightarrow X \uparrow xJ = anti(x)$. Then, $x_1J = x_2J \Rightarrow anti(x_1) = anti(x_2) \Rightarrow anti(anti(x_1)) = anti(anti(x_2)) \Rightarrow x_1 = x_2$. So, J is 1-1. For all $y \in X$, there exists $x \in X$ such that $xJ = y$ because $anti(x) = y \Rightarrow anti(anti(x)) = anti(y) \Rightarrow x = anti(y) \in X$.

Consider $R_a : X \rightarrow X \uparrow xR_a = xa$. Let $x_1R_a = x_2R_a \Rightarrow x_1a = x_2a \Rightarrow anti(x_1a) = anti(x_2a) \Rightarrow a * anti(x_1a) = a * anti(x_2a) \Rightarrow anti(x_1) = anti(x_2) \Rightarrow anti(anti(x_1)) = anti(anti(x_2)) \Rightarrow x_1 = x_2$. For all $y \in X$, there exists $x \in X$ such that $xR_a = y$ because $xa = y \Rightarrow anti(xa) = anti(y) \Rightarrow a * anti(xa) = a * anti(y) \Rightarrow anti(x) = a anti(y) \Rightarrow anti(anti(x)) = anti(a anti(y)) \Rightarrow x = anti(a anti(y))$.

3. X is an LWIPNTL if and only if $anti(xy)x = anti(y) \Leftrightarrow L_xJR_x = J$ and X is an RWIPNTL if and only if $x anti(yx) = anti(y) \Leftrightarrow R_xJL_x = J$.

X is an LWIPNTL and R_x is bijective if and only if $(L_xJR_x)^{-1} = J^{-1}$ and R_x is bijective if and only if $R_x^{-1}J^{-1}L_x^{-1} = J^{-1} \Leftrightarrow R_x^{-1}JL_x^{-1} = J \Leftrightarrow R_xJL_x = J$ and L_x is bijective if and only if X is an RWIPNTL and L_x is bijective.

For a groupoid X : L_x is bijective for all $x \in X$ if and only if X is a left quasigroup and R_x is bijective for all $x \in X$ if and only if X is a right quasigroup. Hence, (a) to (d) are equivalent.

4. If X is a WIPNTL, then it is both an LWIPNTL and RWIPNTL which implies that $L_xJR_x = J$ and $R_xJL_x = J$. Consequently, $L_xJR_x^2JL_x = J^2$ and $R_xJL_x^2JR_x = J^2$. Thus, $L_x^2 = I \Leftrightarrow R_x^2 = I$.
5. This follows from Lemma 2.
6. This follows from Lemma 2.

□

Theorem 7. *Let X be an NTL.*

1. X has the LWIP and AAIP, then X has the RIP.
2. X has the RWIP and AAIP, then X has the LIP.
3. X has the LWIP and AIP, then X has the RCIP.
4. X has the RWIP and AIP, then X has the LCIP.
5. X is an IPNTL if and only if X is a WIPNTL and an AAIPNTL.
6. X is a CIPNTL if and only if X is a WIPNTL and an AIPNTL.

Proof. Let X be an NTL.

1. LWIP implies $anti(xy)x = anti(y) \xrightarrow{AAIP} anti(y)anti(x) * x = anti(y) \begin{matrix} y \mapsto anti(y) \\ \Rightarrow \\ x \mapsto anti(x) \end{matrix} anti(anti(y))anti(anti(x)) * anti(x) = anti(anti(y)) \Rightarrow yx * anti(x) = y \Rightarrow \text{RIP}$.
2. RWIP implies $x anti(yx) = anti(y) \xrightarrow{AAIP} x * anti(x)anti(y) = anti(y) \begin{matrix} y \mapsto anti(y) \\ \Rightarrow \\ x \mapsto anti(x) \end{matrix} anti(x) * anti(anti(x))anti(anti(y)) = anti(anti(y)) \Rightarrow anti(x) * xy = y \Rightarrow \text{LIP}$.
3. LWIP implies $anti(xy)x = anti(y) \xrightarrow{AIP} anti(x)anti(y) * x = anti(y) \begin{matrix} y \mapsto anti(y) \\ \Rightarrow \\ x \mapsto anti(x) \end{matrix} anti(anti(x))anti(anti(y)) * anti(x) = anti(anti(y)) \Rightarrow xy * anti(x) = y \Rightarrow \text{RCIP}$.
4. RWIP implies $x anti(yx) = anti(y) \xrightarrow{AIP} x * anti(y)anti(x) = anti(y) \begin{matrix} y \mapsto anti(y) \\ \Rightarrow \\ x \mapsto anti(x) \end{matrix} anti(x) * anti(anti(y))anti(anti(x)) = anti(anti(y)) \Rightarrow anti(x) * yx = y \Rightarrow \text{LCIP}$.
5. This backward of the statement follows by 1 and 2, while the forward of the statement follows by 1 of Theorem 5.
6. This backward of the statement follows by 3 and 4, while the forward of the statement follows by 2 of Theorem 5.

□

Lemma 6. *Let X be an NTL.*

1. If X is an AIPNTL, then
 - (a) $neut(anti(x)) = anti(neut(x))$.
 - (b) $anti(neut(x)neut(y)) = neut(anti(x))neut(anti(y))$.
2. If X is an AAIPNTL, then
 - (a) $neut(anti(x)) = anti(neut(x))$.
 - (b) $anti(neut(x)neut(y)) = neut(anti(y))neut(anti(x))$.
3. If X is an AIPNTL (AAIPNTL), then X is an AAIPNTL (AIPNTL) if and only if $anti(x)anti(y) = anti(y)anti(x)$.
4. Let X be an AIPNTL (AAIPNTL), then X is an AAIPNTL (AIPNTL) if
 - (a) $(anti(x), anti(y)) = neut(anti(y)anti(x))$ or
 - (b) $[anti(x), anti(y)] = neut(anti(y)anti(x))$.

Proof.

1. Let X be an AIPNTL. Then, $anti(xy) = anti(x)anti(y)$.

(a) Put $y = neut(x)$ to get $anti(x neut(x)) = anti(x)anti(neut(x)) \Rightarrow$

$$anti(x) = anti(x)anti(neut(x)). \tag{28}$$

Do the replacement $x \mapsto neut(x)$ and put $y = x$ to get $anti(neut(x)x) = anti(neut(x))anti(x) \Rightarrow$

$$anti(x) = anti(neut(x))anti(x). \tag{29}$$

Combining (28) and (29), we get $neut(anti(x)) = anti(neut(x))$.

(b) Do the replacements $x \mapsto neut(x)$ and $y \mapsto neut(y)$ to get

$$anti(neut(x)neut(y)) = anti(neut(x))anti(neut(y)) = neut(anti(x))neut(anti(y)).$$

2. Let X be an AAIPNTL. Then, $anti(xy) = anti(y)anti(x)$.

(a) Put $y = neut(x)$ to get $anti(x neut(x)) = anti(neut(x))anti(x) \Rightarrow$

$$anti(x) = anti(neut(x))anti(x). \tag{30}$$

Do the replacement $x \mapsto neut(x)$ and put $y = x$ to get $anti(neut(x)x) = anti(x)anti(neut(x)) \Rightarrow$

$$anti(x) = anti(x)anti(neut(x)) \tag{31}$$

Combining (30) and (31), we get $neut(anti(x)) = anti(neut(x))$.

(b) Do the replacements $x \mapsto neut(x)$ and $y \mapsto neut(y)$ to get

$$anti(neut(x)neut(y)) = anti(neut(y))anti(neut(x)) = neut(anti(y))neut(anti(x)).$$

3. This follows from the AIP and AAIP.

4. This follows from the AIP and AAIP.

□

Theorem 8. Let $(\mathbb{Z}_p, +, \cdot)$ be the field of integers modulo p , where p is prime. Define $*$ on \mathbb{Z}_p as follows: $x * y = ax + ay$ for a fixed $0, 1 \neq a \in \mathbb{Z}_p$. Then:

1. $(\mathbb{Z}_p, +, \cdot)$ is a non-associative commutative NTL.
2. The following are equivalent.

- (a) $(\mathbb{Z}_p, *)$ is a CIPNTL.
- (b) $(\mathbb{Z}_p, *)$ is an IPNTL.
- (c) $a^2 \equiv 1 \pmod p$.

Proof.

1. $(\mathbb{Z}_p, *)$ is a groupoid by the definition of $*$.

Commutativity $x * y = ax + ay = ay + ax = y * x$. So, $(\mathbb{Z}_p, *)$ is commutative.

Neutrality $x * neut(x) = x \Leftrightarrow ax + a neut(x) = x \Leftrightarrow a neut(x) = x - ax = (1 - a)x \Leftrightarrow neut(x) = a^{-1}(1 - a)x$. Similarly, $neut(x) * x = x \Leftrightarrow neut(x) * x = a^{-1}(1 - a)x$.

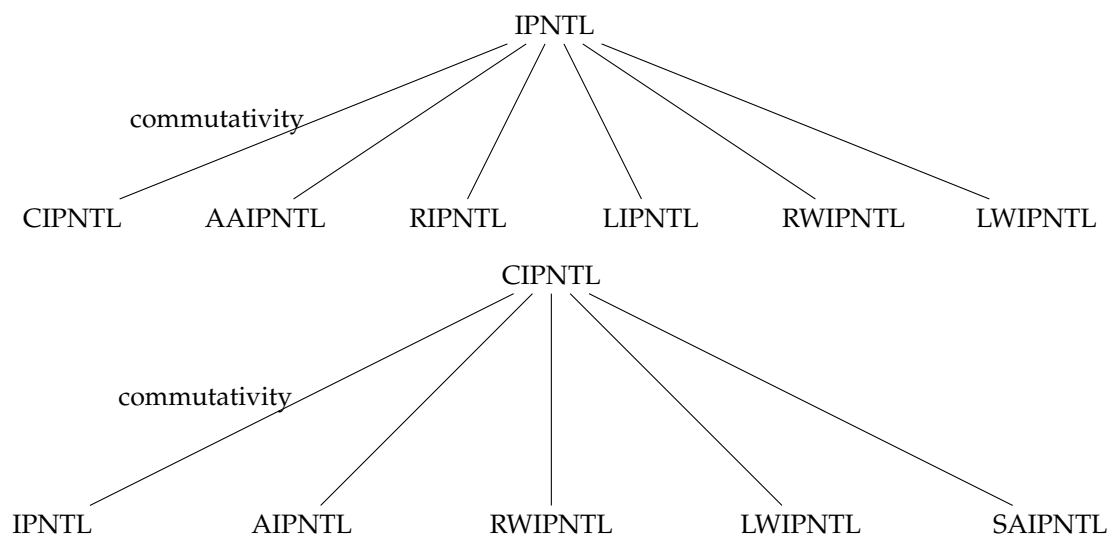

Figure 1. Inverse property neutrosophic triplet loop (NTL) Hasse diagrams. AAIP: antiautomorphic inverse property; AIP: automorphic inverse property; CIP: cross inverse property; LCIP: left cross inverse property; LIP: left inverse property; LWIP: left weak inverse property; RCIP: right cross inverse property; RIP: right inverse property; RWIP: right weak inverse property; SAIP: semi-automorphic inverse property; WIP: weak inverse property.

Opposite $x * anti(x) = neut(x) \Leftrightarrow ax + a anti(x) = neut(x) \Leftrightarrow ax + a anti(x) = a^{-1}(1 - a)x \Leftrightarrow anti(x) = a^{-1}(1 - a)x - ax = a^{-1}[a^{-1}(1 - a) - a]x \Leftrightarrow anti(x) = [a^{-2}(1 - a) - 1]x$. Similarly, $anti(x) * x = neut(x) \Leftrightarrow anti(x) = [a^{-2}(1 - a) - 1]x$. So, $(\mathbb{Z}_p, *)$ is a NTL. So, $(\mathbb{Z}_p, *)$ is an NTL.

Non-Associativity $x * (y * z) = ax + a(ay + az) = ax + a^2y + a^2z$ and $(x * y) * z = a(ax + ay) + az = a^2x + a^2y + az$. So, $x * (y * z) \neq (x * y) * z$.

$\therefore (\mathbb{Z}_p, *)$ is a non-associative commutative NTL.

2. Going by 3. of Lemma 4, it suffices to only show that $(\mathbb{Z}_p, *)$ is a RIPL. $(\mathbb{Z}_p, *)$ has the RIP if and only if $(y * x) * anti(x) = y \Leftrightarrow (ay + ax) * anti(x) = y \Leftrightarrow a(ay + ax) + a anti(x) = y \Leftrightarrow a^2y + a^2x + a[a^{-2}(1 - a) - 1]x = y \Leftrightarrow a^2y + [a^{-1}(1 - a) - a + a^2]x = 1y + 0x \Leftrightarrow a^2 \equiv 1 \pmod p$. □

Remark 4. In Theorem 8, $a^2 \equiv 1 \pmod p \Leftrightarrow p|a^2 - 1 \Leftrightarrow \exists k \in \mathbb{Z} \ni a^2 - 1 = pk \Leftrightarrow a = \sqrt{pk + 1}$ for some $k \in \mathbb{Z}$ with $a < p$. Hence, with the requirements that $a^2 = pk + 1$ and $a < p$, $k = p - 2$, so that $a = p - 1$.

Example 5. $(\mathbb{Z}_p, *)$ where $x * y = (p - 1)(x + y)$, for any prime p is a non-associative commutative CIPNTL and IPNTL.

3. Application to Cryptography

Keedwell [45], Keedwell and Shcherbacov [46–49], Jaiyéolá [50–55], and Jaiyéolá and Adéníran [56] are of great significance in the study of quasigroups and loop with the WIP, AIP, CIP, their generalizations (i.e., m -inverse loops and quasigroups, (r,s,t) -inverse quasigroups) and applications to cryptography.

Cross inverse property quasigroups have been found appropriate for cryptography because they give rise to what is called ‘cycle of inverses’ or ‘inverse cycles’ or simply ‘cycles’.

After Jaiyéolá [57] studied the universality of Osborn loops; a class of loop which includes universal WIP loops, some of the identities established in Jaiyéolá and Adéníran [58] were singled out and christened ‘cryptographic identities’, and their applications to cryptography have been reported in Jaiyéolá [59,60], Jaiyéolá and Adéníran [61].

Going by Lemma 1, Lemma 3, and Theorem 6, a CIPNTL, IPNTL, LWIPNTL, or RWIPNTL X obeys the property $anti(anti(x)) = x$ for any $x \in X$. Additionally, by Lemma 4, a commutative NTL X with RIP or LIP or RCIP or LCIP also has the property $anti(anti(x)) = x$ for any $x \in X$. Hence, long inverse cycles which naturally arise in CIP quasigroup will not be feasible for such NTLs. However, for an RCIPNTL, LCIPNTL, RIPNTL, or LRIPNTL X that is non-commutative, long inverse cycles will be feasible (this makes an attack on the system more difficult). Thus, such a non-commutative NTL which is not a CIPNTL, IPNTL, RWIPNTL, or RWIPNTL will be appropriate for cryptography. The procedure for applying any of them is described below.

RCIPNTL Assume that the message to be transmitted can be represented as a single element $x \in X$.

Then, this is enciphered by pre-multiplying by another element $y \in X$ so that the cipher text is $yx \in X$. At the receiving end, the cipher text is deciphered by post-multiplying by $anti(y) \in X$ to get the plain text.

LCIPNTL Assume that the message to be transmitted can be represented as a single element $x \in X$.

Then, this is enciphered by post-multiplying by another element $y \in X$ so that the cipher text is $xy \in X$. At the receiving end, the cipher text is deciphered by pre-multiplying by $anti(y) \in X$ to get the plain text.

RIPNTL Assume that the message to be transmitted can be represented as a single element $x \in X$.

Then, this is enciphered by post-multiplying by another element $y \in X$ so that the cipher text is $xy \in X$. At the receiving end, the cipher text is deciphered by post-multiplying by $anti(y) \in X$ to get the plain text.

LIPNTL Assume that the message to be transmitted can be represented as a single element $x \in X$.

Then, this is enciphered by pre-multiplying by another element $y \in X$ so that the cipher text is $yx \in X$. At the receiving end, the cipher text is deciphered by pre-multiplying by $anti(y) \in X$ to get the plain text.

Note that these four procedures can alternatively be carried out using Theorem 2.

References

1. Araujo, J.; Konieczny, J. Molaei’s Generalized Groups are Completely Simple Semigroups. *Bul. Inst. Polytech. Jassy Sect. I. Mat. Mec. Teor. Fiz.* **2002**, *48*, 1–5.
2. Vagner, V. Generalized Groups. *Dokl. Akad. Nauk SSSR* **1952**, *84*, 1119–1122. (In Russian)
3. Molaei, M.R. Generalized actions. In Proceedings of the First International Conference on Geometry, Integrability and Quantization, Varna, Bulgaria, 1–10 September 1999; pp. 175–180.
4. Molaei, M.R. Generalized groups. *Bull. Inst. Polit. Di. Iase Fasc.* **1999**, *3*, 21–24.
5. Mehrabi, M.; Molaei, M.R.; Oloomi, A. Generalized subgroups and homomorphisms. *Arab J. Math. Sci.* **2000**, *6*, 1–7.
6. Agboola, A.A.A. Certain properties of generalized groups. *Proc. Jangjeon Math. Soc.* **2004**, *7*, 137–148.
7. Adeniran, J.O.; Akinmoyewa, J.T.; Solarin, A.R.T.; Jaiyeola T.G. On some algebraic properties of generalized groups. *Acta Math. Acad. Paedagog. Nyhazi.* **2011**, *27*, 23–30.

8. Fatehi, F.; Molaei, M.R. On Completely Simple Semigroups. *Acta Math. Acad. Paedagog. Nyhazi.* **2012**, *28*, 95–102.
9. Agboola, A.A.A. Smooth generalized groups. *J. Niger. Math. Soc.* **2004**, *23*, 6–76.
10. Agboola, A.A.A. Smooth generalized subgroups and homomorphisms. *Adv. Stud. Contemp. Math.* **2004**, *9*, 183–193.
11. Molaei, M.R. Topological generalized groups. *Int. J. Appl. Math.* **2000**, *2*, 1055–1060.
12. Molaei, M.R.; Tahmoresi, A. Connected topological generalized groups. *Gen. Math.* **2004**, *12*, 13–22.
13. Maleki, H.; Molaei, H. On the quotient space of a generalized action of a generalized group. *arXiv* **2014**, arXiv:1402.3408.
14. Bruck, R.H. *A Survey of Binary Systems*; Springer: Berlin/Göttingen/Heidelberg, Germany, 1966.
15. Chein, O.; Pflugfelder, H.O.; Smith, J.D.H. *Quasigroups and Loops: Theory and Applications*; Sigma Series in Pure Mathematics 8; Heldermann: Berlin, Germany, 1990; ISBN 3-88538-008-0.
16. Dene, J.; Keedwell, A.D. *Latin Squares and Their Applications*; Elsevier/North-Holland: Amsterdam, The Netherlands, 2015; ISBN 978-0-444-63555-6.
17. Goodaire, E.G.; Jespers, E.; Milies, C.P. *Alternative Loop Rings*; North-Holland Mathematics Studies 184; North-Holland: Amsterdam, The Netherlands, 1996.
18. Jaiyéolá, T.G. *A Study of New Concepts in Smarandache Quasigroups and Loops*; Books on Demand, ProQuest Information and Learning: Ann Arbor, MI, USA, 2009.
19. Pflugfelder, H.O. *Quasigroups and Loops: Introduction*; Sigma Series in Pure Math. 7; Heldermann: Berlin, Germany, 1990.
20. Vasantha Kandasamy, W.B. *Smarandache Loops*; Department of Mathematics, Indian Institute of Technology: Madras, India, 2002.
21. Smarandache, F. *A Unifying Field in Logics. Neutrosophy: Neutrosophic Probability, Set and Logic*; American Research Press (ARP): Rehoboth, NM, USA, 2003; ISBN 1-879585-76-6.
22. Smarandache, F. Neutrosophic set, a generalization of the intuitionistic fuzzy set. In Proceedings of the 2006 IEEE International Conference on Granular Computing, Atlanta, GA, USA, 10–12 May 2006; pp. 38–42, doi:10.1109/ GRC.2006.1635754.
23. Zadeh, L.A. Information and control. *Fuzzy Sets* **1965**, *8*, 338–353.
24. Atanassov, A.K. Intuitionistic fuzzy sets. *Fuzzy Sets Syst.* **1986**, *20*, 87–96.
25. Liu, P.; Liu, J.; Chen, S.M. Some intuitionistic fuzzy Dombi Bonferroni mean operators and their application to multi-attribute group decision making. *J. Oper. Res. Soc.* **2018**, *69*, 1–24, doi:10.1057/s41274-017-0190-y.
26. Liu, P.; Chen, S.M. Group decision making based on Heronian aggregation operators of intuitionistic fuzzy numbers. *IEEE Trans. Cybern.* **2017**, *47*, 2514–2530, doi:10.1109/TCYB.2016.2634599.
27. Liu, P.; Chen, S.M. Multiattribute Group Decision Making Based on Intuitionistic 2-Tuple Linguistic Information. *Inf. Sci.* **2018**, *430–431*, 599–619, doi:10.1016/j.ins.2017.11.059.
28. Liu, P. Multiple attribute group decision making method based on interval-valued intuitionistic fuzzy power Heronian aggregation operators. *Comput. Ind. Eng.* **2017**, *108*, 199–212, doi:10.1016/j.cie.2017.04.033.
29. Liu, P.; Li, H. Interval-valued intuitionistic fuzzy power Bonferroni aggregation operators and their application to group decision making. *Cognit. Comput.* **2017**, *9*, 494–512, doi:10.1007/s12559-017-9453-9.
30. Liu, P.; Liu, J.; Merigo, J.M. Partitioned Heronian means based on linguistic intuitionistic fuzzy numbers for dealing with multi-attribute group decision making. *Appl. Soft Comput.* **2018**, *62*, 395–422, doi:10.1016/j.asoc.2017.10.017.
31. Liu, P.; Shi, L. Some Neutrosophic uncertain linguistic number Heronian mean operators and their application to multi-attribute group decision making. *Neural Comput. Appl.* **2017**, *28*, 1079–1093, doi:10.1007/s00521-015-2122-6.
32. Liu, P.; Zhang, L.; Liu, X.; Wang, P. Multi-valued Neutrosophic number Bonferroni mean operators and their application in multiple attribute group decision making. *Int. J. Inf. Technol. Decis. Mak.* **2016**, *15*, 1181–1210, doi:10.1142/S0219622016500346.
33. Vasantha Kandasamy, W.B.; Smarandache, F. *Some Neutrosophic Algebraic Structures and Neutrosophic n-Algebraic Structures*; Hexis: Frontigan, France, 2006.
34. Vasantha Kandasamy, W.B.; Smarandache, F. *N-Algebraic Structures and s-n-Algebraic Structures*; Hexis: Phoenix, AZ, USA, 2006.
35. Vasantha Kandasamy, W.B.; Smarandache, F. *Basic Neutrosophic Algebraic Structures and Their Applications to Fuzzy and Neutro-Sophic Models*; Hexis: Frontigan, France, 2004.
36. Smarandache, F.; Ali, M. Neutrosophic triplet group. *Neural Comput. Appl.* **2016**, doi:10.1007/s00521-016-2535-x.

37. Smarandache, F.; Ali, M. Neutrosophic triplet as extension of matter plasma, unmatter plasma, and antimatter plasma. In Proceedings of the 69th Annual Gaseous Electronics Conference, Bochum, Germany, 10–14 October 2016. Available online: <http://meetings.aps.org/Meeting/GEC16/Session/HT6.111>. (accessed on 14 March 2018).
38. Jaiyéólá, T.G. Some Results on Neutrosophic Triplet Group, in press.
39. Okpako, A.E.; Asagba, P.O. A Framework for Diagnosing Confusable Diseases using Neutrosophic based Neural Network. *Int. J. Comput. Appl.* **2017**, *167*, 1–7.
40. Sahin, M.; Kargin, A. Neutrosophic Triplet Normed Space. *Open Phys.* **2017**, *15*, 697–704.
41. Vasantha Kandasamy, W.B.; Ilanthenral, K.; Smarandache, F. *Neutrosophic Triplet Groups and Their Applications to Mathematical Modelling*; EuropaNova ASBL: Bruxelles, Belgium, 2017.
42. Smarandache, F. *Neutrosophic Perspectives: Triplets, Duplets, Multisets, Hybrid Operators, Modal Logic, Hedge Algebras and Applications*; Pons Publishing House: Brussels, Belgium, 2017.
43. Agboola, A.A.A.; Davvaz, B.; Smarandache, F. Neutrosophic quadruple algebraic hyperstructures. *Ann. Fuzzy Math. Inform.* **2017**, *14*, 29–42.
44. Zhang, X.; Smarandache, F.; Liang, X. Neutrosophic Duplet Semi-Group and Cancellable Neutrosophic Triplet Groups. *Symmetry* **2017**, *9*, 275, doi:10.3390/sym9110275.
45. Keedwell, A.D. Crossed-inverse quasigroups with long inverse cycles and applications to cryptography. *Australas. J. Comb.* **1999**, *20*, 241–250.
46. Keedwell, A.D.; Shcherbacov, V.A. On m -inverse loops and quasigroups with a long inverse cycle. *Australas. J. Comb.* **2002**, *26*, 99–119.
47. Keedwell, A.D.; Shcherbacov, V.A. Construction and properties of (r, s, t) -inverse quasigroups I. *Discret. Math.* **2003**, *266*, 275–291.
48. Keedwell, A.D.; Shcherbacov, V.A. Construction and properties of (r, s, t) -inverse quasigroups II. *Discret. Math.* **2004**, *288*, 61–71.
49. Keedwell, A.D.; Shcherbacov, V.A. Quasigroups with an inverse property and generalized parastrophic identities. *Quasigroups Relat. Syst.* **2005**, *13*, 109–124.
50. Jaiyéólá, T.G. An holomorphic study of Smarandache automorphic and cross inverse property loops. *Sci. Magna J.* **2008**, *4*, 102–108.
51. Jaiyéólá, T.G. A double cryptography using the Smarandache Keedwell cross inverse quasigroup. *Int. J. Math. Comb.* **2008**, *3*, 28–33.
52. Jaiyéólá, T.G. Some isotopy-isomorphy conditions for m -inverse quasigroups and loops. *Analele Stiintifice Univ. Ovidius Constanta Ser. Mat.* **2008**, *16*, 57–66.
53. Jaiyéólá, T.G. On a pair of universal weak inverse property loops. *NUMTA Bull.* **2009**, *3*, 22–40.
54. Jaiyéólá, T.G. On middle universal weak and cross inverse property loops with equal length of inverse cycles. *Rev. Colomb. Mat.* **2010**, *44*, 79–89.
55. Jaiyéólá, T.G. On middle universal m -inverse quasigroups and their applications to cryptography. *Analele Univ. Vest Timis. Ser. Mat.-Inform.* **2011**, *49*, 69–87.
56. Jaiyéólá, T.G.; Adéníran J.O. Weak inverse property loops and some isotopy-isomorphy properties. *Analele Univ. Vest Timis. Ser. Mat.-Inform.* **2009**, *49*, 69–87.
57. Jaiyéólá, T.G. The Study of the Universality of Osborn Loops. Ph.D. Thesis, University of Agriculture, Abeokuta, Nigeria, 2009.
58. Jaiyéólá, T.G.; Adéníran, J.O. New identities in universal Osborn loops. *Quasigroups Relat. Syst.* **2009**, *17*, 55–76.
59. Jaiyéólá, T.G. On three cryptographic identities in left universal Osborn loops. *J. Discret. Math. Sci. Cryptogr.* **2011**, *14*, 33–50, doi:10.1080/09720529.2011.10698322.
60. Jaiyéólá, T.G. On two cryptographic identities in universal Osborn loops. *J. Discret. Math. Sci. Cryptogr.* **2013**, *16*, 95–116, doi:10.1080/09720529.2013.821371.
61. Jaiyéólá, T.G.; Adéníran, J.O. On another two cryptographic identities in universal Osborn loops. *Surv. Math. Its Appl.* **2010**, *5*, 17–34.

A Novel Neutrosophic Data Analytic Hierarchy Process for Multi-Criteria Decision-Making Method: A Case Study in Kuala Lumpur Stock Exchange

Desmond Jun Yi Tey, Yee Fei Gan, Ganeshsree Selvachandran, Shio Gai Quek,
Florentin Smarandache, Le Hoang Son, Mohamed Abdel-Basset, Hoang Viet Long

Desmond Jun Yi Tey, Yee Fei Gan, Ganeshsree Selvachandran, Shio Gai Quek, Florentin Smarandache, Le Hoang Son, Mohamed Abdel-Basset, Hoang Viet Long (2018). A Novel Neutrosophic Data Analytic Hierarchy Process for Multi-Criteria Decision-Making Method: A Case Study in Kuala Lumpur Stock Exchange. *IEEE Access* 7: 53687-53697, DOI: 10.1109/ACCESS.2019.2912913

ABSTRACT This paper proposes a multi-criteria decision making method called the neutrosophic data analytical hierarchy process (NDAHP) for the single-valued neutrosophic set (SVNS). This method is an extension of the neutrosophic analytic hierarchy process (NAHP) but was designed to handle actual datasets which consists of crisp values. Our proposed NDAHP method uses an objective weighting mechanism whereas all other existing versions of the AHP, fuzzy AHP and other fuzzy based AHP method in literature such as the NAHP and picture fuzzy AHP uses a subjective weighting mechanism to arrive at the decision. This makes our proposed NDAHP method a very objective one as the weightage of the criteria which forms the input of the evaluation matrix are determined in an objective manner using actual data collected for the problem, and hence will not change according to the opinions of the different decision makers which are subjective. The proposed NDAHP method is applied to a multi-criteria decision making problem related to the ranking of the financial performance of five public listed petrochemical companies trading in the main board of the Kuala Lumpur Stock Exchange (KLSE). Actual dataset of 15 financial indices for the five petrochemical companies for 2017 obtained from Yahoo! Finance were used in this study. Following this, a brief comparative study is conducted to evaluate the performance of our NDAHP algorithm against the results of other existing SVNS based decision making methods in literature. The results are compared against actual results obtained from KLSE. To further verify the rankings obtained through each method, the Spearman and Pearson ranking tests are carried out on each of the decision making methods that are studied. It is proved that our proposed NDAHP method produces the most accurate results, and this was further verified from the results of the Spearman and Pearson ranking tests.

KEYWORDS: Single-valued neutrosophic set; analytic hierarchy process (AHP); multi-criteria decision making; neutrosophic AHP; neutrosophic decision making

1. INTRODUCTION

Fuzzy set theory [1] is an extension of classical set theory which was developed as a tool to deal with the uncertainty and vagueness that exists in most of the situations that we

encounter on a daily basis. Fuzzy sets are characterized by a single membership value which indicates the degree of belongingness of the elements to a set. The fuzzy set model provided solutions when solving problems where the information is imprecise due to the non-sharply determined

criteria of the membership classes. Developments made in the application of fuzzy set theory led to a greater demand for advanced studies in this area. This and the deficiencies in fuzzy set theory led to the development of many similar models with the most commonly used ones being the intuitionistic fuzzy set [2], interval-valued fuzzy set [3], interval-valued intuitionistic fuzzy set [4], vague set [5], neutrosophic set [6], hesitant fuzzy set [7] and picture fuzzy set [8].

The inability of fuzzy sets and intuitionistic fuzzy sets (IFSs) in dealing with the inconsistency and indeterminacy components of any information, both of which are inevitably present in most real world situations was one of the factors that led to the introduction of the neutrosophic set in 1995. The neutrosophic set (NS) is an extension of the IFS model, and was introduced to solve problems with inconsistent, incomplete and indeterminate information. The NS model has a triple membership structure that consists of a truth, indeterminacy and falsity membership function, each of which expresses the degree of belongingness, degree of indeterminacy and degree of non-belongingness of an object to a set, respectively. Another significant difference between the NS and other fuzzy based models is the independent nature of the three membership functions in the NS model. Although the initial NS model was developed to take on values in the non-standard subinterval of $] -0,1+[$ which was fine in the study of philosophy, it was found to be unsuitable to be used in solving real-life problems related to engineering and science. This shortcoming of the NS model led to the inception of the single-valued neutrosophic set (SVNS) by Wang et al. [9] which is a special case of the NS with membership values in the standard unit interval of $[0, 1]$. This makes the SVNS model more suitable and convenient to be used in problem solving as it is more compatible with the structure of fuzzy sets and other fuzzy-based models whose membership functions are also defined in the interval of $[0, 1]$ (see [51-63] for details). This paper is concerned with developing a decision making method for the SVNS model based on the analytic hierarchy process (AHP).

The analytic hierarchy process (AHP) was first introduced by Saaty [10] as a mathematical tool that is used to make a decision from several alternatives, by taking their criteria into consideration. After the evaluation process is done using AHP, decision makers can then obtain the results which ranks the alternatives from the most desirable to the least desirable. Nowadays, AHP had been widely accepted as an effective tool to handle multi-criteria decision making (MCDM) problems. The AHP method is a relatively simple and practical tool to be used as it does not involve advanced mathematical theory, but rather converts the thinking process

of the decision maker into quantitative and qualitative data, and subsequently analyses the multi-criteria data by using simple mathematical tools. Also, the pair-wise comparison between different criteria and construction of a matrix does not require advanced mathematical knowledge [11]. AHP also requires lesser quantitative data compared to other MCDM methods as it is more focused on the criteria involved in the evaluation process, and the evaluation of the importance of these criteria by the decision makers. However, this lack of numerical data also poses a problem as the entire decision making process is dependent on the subjective opinions of the decision makers which can be inconsistent and may vary from one decision maker to another depending on their prior experiences and personal opinions. As such, the results obtained for a problem using the opinions of a set of decision makers may not be convincing for other decision makers. Although, we can compute the consistency ratio and use this to determine the consistency of the opinions (i.e. weightage of the criteria) given by the decision makers, it is still not reliable enough and actually lengthens the decision making process. This is because we need to continuously modify the opinions given by the decision makers until a consistency index of zero or at least a sufficiently small value close to zero is reached. This may also increase the chances of getting erroneous results and lead to the decision makers making a wrong decision. These disadvantages of the traditional AHP methods can be overcome by modifying the algorithm of the AHP to use actual datasets as the input for the AHP method instead of using the subjective opinions of the decision makers as the input for the AHP method. This is the feature of our proposed AHP method based on SVNSs which will be expounded in the subsequent sections.

Another major disadvantage of the AHP method is its inability to handle the subjectivity and vagueness of human judgment or behavior [12]. The fuzzy set model and other fuzzy based models on the other hand, have the advantage of being able to capture the fuzziness of the criteria and other decision parameters in an efficient manner. This led to the introduction of the fuzzy analytic hierarchy process (FAHP) method by Van Laarhoven and Pedrycz [13]. A lot of studies had been done to examine the reliability and credibility of the FAHP. Some of the recent studies in this area are due to Nguyen et al. [14] who used FAHP to determine the ranking of the importance of parameters in a transportation project. Ruiz-Padillo et al. [15] applied FAHP to study the factors that contributed to traffic noise problem in a region, whereas Calabrese et al. [16] applied FAHP in the selection of criteria that affects the performance of a company.

Xu and Liao [17] proposed the intuitionistic fuzzy analytic hierarchy process (IFAHF) by combining the AHP

method and the IFS model to improve the capability of FAHP without affecting its originality and inherent characteristics. Many researchers have acknowledged the advantages of IFAHP and have applied it in various problems in different areas. Abdullah, Jaafar and Taib [18, 19] studied the ranking of Human Capital Indicators using IFAHP, and evaluated the criteria involved in sustainable energy technology in Malaysia, respectively. Kaur [20] applied IFAHP to evaluate and select the best vendor for a company, while Nguyen [21] employed the IFAHP method to estimate and subsequently eliminate the potential risks faced by a shipping system.

Apart from the above, other fuzzy based AHP methods have been introduced in literature. These include the interval-valued fuzzy analytic hierarchy process (IVFAHP) by Mirzaei [22] and the interval-valued intuitionistic fuzzy analytic hierarchy process (IVIFAHP) by Abdullah and Najib [23]. Mirzaei [22] applied his proposed IVFAHP to select the best cargo terminals for a logistics problem, whereas Fahmi, Derakhshan and Kahraman [24] applied the IVIFAHP to a human resource management problem to select the best candidate for university position. The rapid development in neutrosophic theory led to the introduction of the neutrosophic analytic hierarchy process (NAHP) by Radwan, Senousy and Riad [25] who then applied this method to the selection of the most suitable learning management system for an educational institution.

The remainder of this paper is organized as follows. In Section 2, we recapitulate some of the fundamental concepts related to SVNSs and the NAHP method. In Section 3, we introduce our proposed neutrosophic data analytic hierarchy process (NDAHP) based on the SVNS model. In Section 4, the proposed decision-making method is then applied to a problem related to the evaluation of the performance of a company based on 15 financial parameters. Actual data for the five companies that were studied were obtained from Yahoo! Finance for the year 2017. In Section 5, a comprehensive comparative analysis of the results obtained via our proposed method and other recent SVNS based decision making methods are presented. We further verify the results obtained via our proposed NDAHP method using the Pearson and Spearman rank tests. It is proved that our proposed NDAHP method is more effective and produces more reliable results compared to the other SVNS based decision making method. Concluding remarks are given in Section 6, followed by the acknowledgements and list of references.

2. PRELIMINARIES

In this section, we recapitulate some important concepts pertaining to the theory of SVNSs, and some of the recent developments related to SVNS based decision making. We

refer the readers to [6, 9] for further details pertaining to the NS and SVNS theory, respectively.

The single-valued neutrosophic set (SVNS) model [9] is a special case of the general neutrosophic set where the range of each of the three membership functions are in the standard unit of interval of $[0, 1]$, instead of the non-standard interval of $] -0, 1+[$. The SVNS model is one of the most commonly used versions of the NS model, and a lot of research related to SVNS based decision making can be found in literature [26-44].

The formal definition of the classical NS introduced by Smarandache [6] is given below.

Let U be a universe of discourse, with a class of elements in U denoted by x .

Definition 2.1. [6] A neutrosophic set A is an object having the form $A = \{ \langle x, T_A(x), I_A(x), F_A(x) \rangle : x \in U \}$, where the functions $T, I, F : U \rightarrow] -0, 1+[$ denote the truth, indeterminacy, and falsity membership functions, respectively, of the element $x \in U$ with respect to A . The membership functions must satisfy the condition

$$-0 \leq T_A(x) + I_A(x) + F_A(x) \leq 3^+.$$

Definition 2.2. [6] A neutrosophic set A is contained in another neutrosophic set B , if $T_A(x) \leq T_B(x)$, $I_A(x) \geq I_B(x)$, and $F_A(x) \geq F_B(x)$, for all $x \in U$. This relationship is denoted as $A \subseteq B$.

The SVNS [9] is a specific form of the NS with values of the membership functions defined in the standard interval of $[0, 1]$. The formal definition of the SVNS is presented below, and this is followed by the definitions of some of the important concepts and set theoretic operations of the SVNS.

Definition 2.3. [9] A SVNS A is a neutrosophic set that is characterized by a truth-membership function $T_A(x)$, an indeterminacy-membership function $I_A(x)$, and a falsity-membership function $F_A(x)$, where $T_A(x), I_A(x), F_A(x) \in [0, 1]$. This set A can thus be written as

$$A = \{ \langle x, T_A(x), I_A(x), F_A(x) \rangle : x \in U \}. \quad (1)$$

The sum of $T_A(x)$, $I_A(x)$ and $F_A(x)$ must fulfill the condition $0 \leq T_A(x) + I_A(x) + F_A(x) \leq 3$. For a SVNS A in U , the triplet $(T_A(x), I_A(x), F_A(x))$ is called a single-valued neutrosophic number (SVNN). For the sake of convenience, we simply let $x = (T_x, I_x, F_x)$ to represent a SVNN as an element in the SVNS A .

Definition 2.4. [9] Let A and B be two SVNSs over a universe U .

- (i) A is contained in B , if $T_A(x) \leq T_B(x), I_A(x) \geq I_B(x)$, and $F_A(x) \geq F_B(x)$, for all $x \in U$. This relationship is denoted as $A \subseteq B$.
- (ii) A and B are said to be equal if $A \subseteq B$ and $B \subseteq A$.
- (iii) $A^c = (x, (F_A(x), 1 - I_A(x), T_A(x)))$, for all $x \in U$.
- (iv) $A \cup B = (x, (\max(T_A, T_B), \min(I_A, I_B), \min(F_A, F_B)))$, for all $x \in U$.
- (v) $A \cap B = (x, (\min(T_A, T_B), \max(I_A, I_B), \max(F_A, F_B)))$, for all $x \in U$.

Definition 2.5. [9] Let $x = (T_x, I_x, F_x)$ and $y = (T_y, I_y, F_y)$ be two SVNNs. The operations for SVNNs can be defined as follows:

- (i) The Hamming distance between A and B are defined as:

$$d_H(A, B) = \sum_{i=1}^n \{|T_A(x_i) - T_B(x_i)| + |I_A(x_i) - I_B(x_i)| + |F_A(x_i) - F_B(x_i)|\} \quad (2)$$

- (ii) The normalized Hamming distance between A and B are defined as:

$$d_H^N(A, B) = \frac{1}{3n} \sum_{i=1}^n \{|T_A(x_i) - T_B(x_i)| + |I_A(x_i) - I_B(x_i)| + |F_A(x_i) - F_B(x_i)|\} \quad (3)$$

- (iii) The Euclidean distance between A and B are defined as:

$$d_E(A, B) = \sqrt{\sum_{i=1}^n \{(T_A(x_i) - T_B(x_i))^2 + (I_A(x_i) - I_B(x_i))^2 + (F_A(x_i) - F_B(x_i))^2\}} \quad (4)$$

- (iv) The normalized Euclidean distance between A and B are defined as:

$$d_E^N(A, B) = \sqrt{\frac{1}{3n} \sum_{i=1}^n \{(T_A(x_i) - T_B(x_i))^2 + (I_A(x_i) - I_B(x_i))^2 + (F_A(x_i) - F_B(x_i))^2\}} \quad (5)$$

3. THE PROPOSED NDAHP METHOD BASED ON SVNS

In this section, we present the decision making algorithm for our proposed neutrosophic data analytic hierarchy process (NDAHP). The important components of our proposed NDAHP method such as the formula for the pairwise comparison step and the formula to convert the crisp data to SVNN are also presented and explained.

Neutrosophic data analytic hierarchy process (NDAHP)

Previous research related to NAHP (Radwan, Senousy & Riad [25], Abdel-Basset, Mohamed and Smarandache [46], and Alava et al. [47]) highlighted the practicality of NAHP by applying it to solve various MCDM problems. However, all of these research only considers experts' opinions which can be very subjective and the importance of a criterion evaluated by an expert may be subverted by actual data. Besides, the experts' may not have consensus with each other, as one expert may not necessarily agree with the importance of a criteria as determined by another expert.

- (i) $x \oplus y = (T_x + T_y - T_x * T_y, I_x * I_y, F_x * F_y)$
- (ii) $x \otimes y = (T_x * T_y, I_x + I_y - I_x * I_y, F_x + F_y - F_x * F_y)$
- (iii) $\lambda x = (1 - (1 - T_x)^\lambda, (I_x)^\lambda, (F_x)^\lambda)$, where $\lambda > 0$
- (iv) $x^\lambda = ((T_x)^\lambda, 1 - (1 - I_x)^\lambda, 1 - (1 - F_x)^\lambda)$, where $\lambda > 0$.

Definition 2.6. [45] Let A and B be two SVNSs over a finite universe $U = \{x_1, x_2, \dots, x_n\}$. Then the various distance measures between A and B are defined as follows:

To overcome this problem, we propose a new AHP method based on the SVNS model called the neutrosophic data analytic hierarchy process (NDAHP). The main difference between our NDAHP method and the NAHP method is that the NDAHP uses actual data to obtain the weightage of the criteria, instead of relying on experts' opinion to obtain the weightage of the criteria. Hence, the results obtained through the NDAHP model will be more accurate as the weightage and importance of each criteria and alternative is determined objectively by using actual datasets. Therefore, our proposed method produces input and output values that better reflect the actual situation as per the law of input argument.

The decision making method for the NDAHP method and the procedure to apply in MCDM problems is described as follows:

Step 1: Construct hierarchical model

The framework of the application need to be constructed in order to give the decision maker a clearer idea about the application. First, the objective need to be determined because

that is important for the decision maker to determine the criteria and alternatives of the problem. Next, the decision maker needs to select the criteria and alternatives that are related to the objective. Involvement of unrelated criteria and alternatives will result in inaccurate results being obtained.



Figure 1: An example of a NDAHP structure

Step 2: Obtain actual datasets for the problem from reliable source(s)

The necessary data need to be exported from reliable and verified source(s). Any datasets sourced from unverified sources may contain wrong information and this will affect the accuracy of the results obtained.

Step 3: Convert crisp data into single-valued neutrosophic numbers (SVNN)

The crisp data needs to be converted into single-valued neutrosophic number (SVNN) using Eq. (6) and (7) that was introduced by Nirmal and Bhatt [48].

Beneficial criteria:

$$R_{ij} = \frac{X_{ij} - \text{Min}X_{ij}}{\text{Max}X_{ij} - \text{Min}X_{ij}} \quad (6)$$

Non-beneficial criteria:

$$R_{ij} = \frac{\text{Max}X_{ij} - X_{ij}}{\text{Max}X_{ij} - \text{Min}X_{ij}} \quad (7)$$

Beneficial criteria refers to criteria which are preferable when the value is higher, for example, revenue and quality. Non-beneficial criteria refers to criteria which are preferable when the value is lower, for example cost and debt.

After obtaining the value of R_{ij} , the corresponding SVNNs are then computed using Eq. (8) and (9) which are also due to Nirmal and Bhatt [48].

Beneficial criteria:

$$(t_p, i_p, f_p) = (R_{ij}, 1 - R_{ij}, 1 - R_{ij}) \quad (8)$$

Non-beneficial criteria:

$$(t_p, i_p, f_p) = (1 - R_{ij}, R_{ij}, R_{ij}) \quad (9)$$

Step 4: Pairwise comparison

In this step, the SVNN of each criteria need to be compared to the other criteria to determine their relative importance. Here we introduce a formula to calculate the comparison values in the pairwise comparison matrix. Eq. (10) is proposed as no other formula are available in the existing literature for the purpose of calculating the comparison values in the comparison matrix using actual data.

$$a_{ij} = \frac{\theta_i - \theta_j + 1}{2} \quad (10)$$

where θ_i , θ_j and a_{ij} denotes the SVNN of the criteria i , SVNN of the criteria j and the SVNN in the comparison matrix, respectively.

The comparison values obtained are to be placed in a comparison matrix in the form given in Table 1.

Table 1: Comparison matrix

Criteria	θ_1	θ_2	...	θ_n
θ_1	$\frac{\theta_1 - \theta_1 + 1}{2}$	$\frac{\theta_1 - \theta_2 + 1}{2}$...	$\frac{\theta_1 - \theta_n + 1}{2}$
θ_2	$\frac{\theta_2 - \theta_1 + 1}{2}$	$\frac{\theta_2 - \theta_2 + 1}{2}$...	$\frac{\theta_2 - \theta_n + 1}{2}$
\vdots	\vdots	\vdots	...	\vdots
θ_n	$\frac{\theta_n - \theta_1 + 1}{2}$	$\frac{\theta_n - \theta_2 + 1}{2}$...	$\frac{\theta_n - \theta_n + 1}{2}$

Step 5: Consistency checking

The purpose of this step is to check the consistency of the matrix and determine the acceptability of the matrix.

Given a SVNS $A = (a_{ij})_{n \times n}$, where each a_{ij} represents a neutrosophic number (T_{ij}, I_{ij}, F_{ij}) and a consistency matrix $C = (c_{ij})_{n \times n} = (T'_{ij}, I'_{ij}, F'_{ij})_{n \times n}$. The procedure to determine the consistency is as outlined below.

- (i) For $j > i + 1$,

$$T'_{ij} = \frac{j^{-i-1} \sqrt{T_{ik} \times T_{kj} \times T_{i(j-1)} \times T_{(j-1)j}}}{j^{-i-1} \sqrt{T_{ik} \times T_{kj} \times T_{i(j-1)} \times T_{(j-1)j}} + j^{-i-1} \sqrt{(1 - T_{ik}) \times (1 - T_{kj}) \times (1 - T_{i(j-1)}) \times (1 - T_{(j-1)j})}}$$

$$I'_{ij} = \frac{j^{-i-1} \sqrt{I_{ik} \times I_{kj} \times I_{i(j-1)} \times I_{(j-1)j}}}{j^{-i-1} \sqrt{I_{ik} \times I_{kj} \times I_{i(j-1)} \times I_{(j-1)j}} + j^{-i-1} \sqrt{(1 - I_{ik}) \times (1 - I_{kj}) \times (1 - I_{i(j-1)}) \times (1 - I_{(j-1)j})}}$$

$$F'_{ij} = \frac{j^{-i-1} \sqrt{F_{ik} \times F_{kj} \times F_{i(j-1)} \times F_{(j-1)j}}}{j^{-i-1} \sqrt{F_{ik} \times F_{kj} \times F_{i(j-1)} \times F_{(j-1)j}} + j^{-i-1} \sqrt{(1 - F_{ik}) \times (1 - F_{kj}) \times (1 - F_{i(j-1)}) \times (1 - F_{(j-1)j})}},$$

where $k = i + 1$.

- (ii) For $j = i + 1$, $c_{ij} = (T_{ij}, I_{ij}, F_{ij})$, where $k = i + 1$.
- (iii) For $j < i$, $c_{ij} = (F'_{ji}, 1 - I'_{ji}, T'_{ji})$, where $k = i + 1$.

By applying the above formula, the consistency index (CI) of the data will be obtained in the form of a matrix. The decision maker will then need to apply Eq. (11) to obtain the consistency ratio (CR):

$$CR = \frac{1}{2(n-1)(n-2)} \sum_{i=1}^n \sum_{j=1}^n (|T'_{ij} - T_{ij}| + |I'_{ij} - I_{ij}| + |F'_{ij} - F_{ij}|) \tag{11}$$

The matrix is said to be acceptable and can be further processed if the value of the CR is less than 0.1, otherwise, the data is considered inconsistent and requires reconstruction.

Remarks: This consistency checking step is done to examine the validity of the alternatives' preference when the comparison matrix is constructed. The consistency ratio tends to be large when the relative importance is determined by the subjective opinions of human experts and, as a result the comparison matrix tends to become inconsistent. As our proposed NDAHP method uses actual datasets to obtain the weightage and pairwise comparison values which is very objective, this consistency checking step is not necessary to be carried out.

Step 6: Compute relative weightage

After the consistency is checked, and found to be acceptable, the weightage of criteria is calculated. Since the weightage of the criteria are in the form SVNNs, some of the properties and concepts pertaining to SVNS given in Eqs. (12) to (16) need to be used. These formula are due to Radwan, Senousy and

Riad [25]; here A_1, A_2 denote SVNSs, and N denotes the number of alternatives or criteria.

(i) $A_1 + A_2 = (t_1 + t_2 - t_1 t_2, i_1 i_2, f_1 f_2)$ (12)

(ii) $A_1 \times A_2 = (t_1 t_2, i_1 + i_2 - i_1 i_2, f_1 + f_2 - f_1 f_2)$ (13)

(iii) $\frac{A_1}{A_2} = (\frac{t_1}{t_2}, \frac{i_1 - i_2}{1 - i_2}, \frac{f_1 - f_2}{1 - f_2})$ (14)

(iv) $A_1 \times N = (1 - (1 - t_1)^N, i_1^N, f_1^N)$ (15)

(v) $\frac{A_1}{N} = (1 - (1 - t_1)^{\frac{1}{N}}, i_1^{\frac{1}{N}}, f_1^{\frac{1}{N}})$ (16)

These operations are going to be used in the computation of weightage for the criteria. A pairwise comparison matrix is constructed, and each of the element in the matrix is a SVNN. The procedure to obtain the weightage is as described below.

First, sum up the SVNN in the column using Eq. (12). The result of the summation of the SVNNs forms a new matrix of dimension $(1 \times n)$. Next, divide every element in the matrix by the corresponding element in matrix B using Eq. (15). As a result, a matrix A' of dimension $(n \times n)$ is formed. Lastly, the weightage is obtained by calculating the average value of the SVNNs that represent the different criteria row by row using Eq. (12) and Eq. (16).

Step 7: Obtain overall ranking

In this step, the decision maker needs to repeat step 3 to step 6 described above to calculate the weightage of the sub-criteria and alternatives. After the weightage of the criteria, sub-criteria and alternatives have been obtained, the overall weightage can be calculated. The concept of the method to obtain the overall weightage is the same as the method used to calculate the overall weightage in the AHP method. The procedure to obtain the overall weightage are shown in Table 2.

From Table 2, the notation θ_i denotes the weightage of criteria i while W_{X_i} denotes the weightage of alternative X with respect to criteria i . Note that the overall weightage obtained is in SVNN form. Eq. (17) is then used to convert the SVNNs to crisp values.

$$S(A_j) = \frac{3 + t_j - 2i_j - f_j}{4} \quad (17)$$

where t_j, i_j and f_j denotes the truth, indeterminacy and falsity membership value for alternative A_j .

Table 2: Procedure to obtain the overall weightage

Criteria	Alternatives	Weightage A	Weightage B	Weightage C
θ_1	W_{A_1}	$\theta_1 W_{A_1}$	$\theta_1 W_{B_1}$	$\theta_1 W_{C_1}$
	W_{B_1}			
	W_{C_1}			
θ_2	W_{A_2}	$\theta_2 W_{A_2}$	$\theta_2 W_{B_2}$	$\theta_2 W_{C_2}$
	W_{B_2}			
	W_{C_2}			
θ_3	W_{A_3}	$\theta_3 W_{A_3}$	$\theta_3 W_{B_3}$	$\theta_3 W_{C_3}$
	W_{B_3}			
	W_{C_3}			
Total		$\sum_{i=1}^n \theta_i W_{A_i}$	$\sum_{i=1}^n \theta_i W_{B_i}$	$\sum_{i=1}^n \theta_i W_{C_i}$

Step 8: Determine overall ranking

At the end of step 7, a weightage is obtained for every alternative. At this final step, the decision maker has to arrange the weightage obtained for each alternative in descending order, and subsequently make a decision.

4. APPLICATION OF THE NDAHP METHOD IN A MCDM PROBLEM

In this section, the utility and practicality of our proposed NDAHP method are demonstrated by applying the NDAHP method to a MCDM problem related to the ranking of the financial performance of five selected petrochemical companies in Malaysia.

4.1 Ranking the financial performance of petrochemical companies in Malaysia

The performance of a company is measured using the financial indicators of the company, and this is an important factor that contributes to investor confidence and the performance of the company in the stock market. Here, we consider five public listed petrochemical companies that are

trading in the main board of the Kuala Lumpur Stock Exchange (KLSE). The companies are Hengyuan Refining Company Berhad (HENGYUAN), Petron Malaysia Refining and Marketing Berhad (PETRONM), Barakah Offshore Petroleum Berhad (BARAKAH), Sapura Energy Berhad (SAPURA) and Perdana Petroleum Berhad (PERDANA), and these companies form the set of alternatives for this problem. The objective of the study is to rank the five companies based on their financial performance in the year 2017. To examine this, 15 financial ratios and financial indicators for the five companies are considered. These are the sales growth, asset growth, shareholder’s equity growth, accounts receivable turnover, fixed assets turnover, equity turnover, total asset turnover, debt ratio, debt to equity ratio, ROA, ROE, net profit margin, current ratio, quick ratio and cash ratio, and these form the set of criteria for this problem. Actual datasets for the financial ratios for the financial year 2017 for these five companies were used in this study. These datasets were obtained from the official annual reports of the respective companies that were obtained from the Securities Commission of Malaysia and/or the official websites of the companies.

The above-mentioned datasets were applied to our proposed NDAHP method and the results obtained are as given in Table 3.

Table 3: Results obtained from our proposed NDAHP method

Petrochemical company	Weightage	Ranking
HENGYUAN	0.223344084	1
PETRONM	0.218360145	2
BARAKAH	0.186326396	3
SAPURA	0.186265568	4
PERDANA	0.185703807	5

4.2 Discussion of results

The consistency of the comparison between alternatives and criteria was examined and the average consistency ratio is 1.88494×10^{-16} which means that the comparison matrices will not be affected by the consistency and can be further processed.

Financial ratio is a useful tool for investors and analysts to evaluate the financial performance of a company. In this study, we propose the use of the NDAHP method to evaluate the financial performance of five petrochemical companies in the year 2017 by taking into consideration 15 financial ratios namely sales growth, asset growth,

shareholder’s equity growth, accounts receivable turnover, fixed asset turnover, equity turnover, total assets turnover, debt ratio, debt to equity ratio, ROA, ROE, net profit margin, current ratio, quick ratio and cash ratio.

The results obtained corroborates the actual results obtained from the Edge financial newspaper. In the following, we provide explanations to support our results. It was found that HENGYUAN has the best financial performance among the five petrochemical companies with a weightage of 0.223344084. HENGYUAN performed well in the growth ratios, liquidity ratios and profitability ratios components in the petrochemical sector. The net profit of HENGYUAN in the financial year 2017 is RM930 million, which is a triple of the RM335 million net profit recorded in the previous financial year. This was mainly contributed by the 38.47% growth in revenue of the company from RM8.37 billion in 2016 to RM11.58 billion in 2017. HENGYUAN also recorded a higher production output thanks to the higher level of plant reliability in 2017. Several major hurricane and fire incidents that happened in the US had caused a number of major refineries in the US and Netherlands to shut down, and this had eventually caused an increase in global product prices. This higher profit margins for the refining was fully capitalized by HENGYUAN.

PETRONM recorded the second best financial performance among the five selected petrochemical companies with a weightage of 0.218360145. PETRONM is good in managing the financial leverage ratio in which the debt to equity ratio was constantly maintained at below one. A low debt to equity ratio indicates that the assets in PETRONM was fund by their equities instead of debt. The increase in oil prices and sales volume had contributed a RM405.2 million net profit in the financial year 2017. The sales volume increased by 9% from 2016 to 2017 which was contributed by the high demand of aviation and industrial sector sales of their Turbo Diesel Euro 5 and Blaze 100 Euro 4M products.

BARAKAH had a net loss of RM217 million in financial year 2017 compared with a RM14.53 million net profit made in financial year 2016. The revenue was decreased a lot in the fourth quarter of financial year 2017 due to the cost overruns in their on-going projects. Besides these, BARAKAH also had a major financial concern as their loan of RM38.53 million taken in 2017 had to be settled within 12 months, and overall there was a RM71.83 million negative cash flow recorded. All in all, BARAKAH had a negative growth ratio and profitability ratio for 2017, and the company was incurring losses.

SAPURA suffered from financial problems which were mainly due to material uncertainties which meant that

the company was not confident enough to maintain its solvency. The current liabilities exceeded the current assets for the financial period ending June 30, 2017, and some major impairment needed to be made on their plants and equipment.

PERDANA was re-listed on the main board of the KLSE since the middle of August 2017. Their goal was to improve offshore support vessel (OSV) utilization rate in 2017, which was affected by decreasing oil prices in 2016, thus resulting in a low vessel utilization rate. This issue negatively impacted the financial performance of PERDANA, ad resulted in PERDANA having a negative growth ratio and profitability ratio. To improve on this situation and cut down on their recurring losses, PERDANA began having joint ventures with some major players in the petrochemical sector such as Petronas and Shell.

5. COMPARATIVE STUDIES

In this section, we present a brief but comprehensive comparative analysis of some of the recent works in this area and our proposed method. These recent approaches are applied to our case study related to the evaluation of financial performance of the five petrochemical companies done in Section 4.1. The existing methods that were chosen for this comparative studies are the neutrosophic Technique for Order Preference by Similarity to an Ideal Solution (NTOPSIS) by Biswas, Pramanik and Giri [43], neutrosophic correlation coefficient (NCC) by Ye [26], neutrosophic cross-entropy (NCE) by Pramanik et al. [49], neutrosophic Evaluation based on Distance from Average Solution (NEDAS) by Peng and Liu [31] and the improved single valued neutrosophic weighted averaging geometric aggregation operator (ISVNWAGAO) by Mandal and Basu [50]. These five methods will be applied to our case study and the results obtained will be compared to the results obtained from our proposed NDAH method in a bid to verify the effectiveness of our proposed MCDM method.

5.1 Comparison of results obtained through different methods

Table 4: The results obtained using different methods for the case study in Section 4.1

Method	The final ranking
NTOPSIS [43]	HENGYUAN ≻ PETRONM ≻ PERDANA ≻ BARAKAH ≻SAPURA
NCC [26]	HENGYUAN ≻ PETRONM ≻ SAPURA ≻ BARAKAH ≻ PERDANA
NCE [49]	HENGYUAN ≻ PETRONM ≻ BARAKAH ≻ PERDANA ≻ SAPURA
NEDAS [31]	PETRONM ≻ HENGYUAN ≻ SAPURA ≻ PERDANA ≻ BARAKAH

[50]	HENGYUAN ≻ PETRONM ≻ SAPURA ≻ BARAKAH ≻ PERDANA
Our proposed NDAHP method	HENGYUAN ≻ PETRONM ≻ BARAKAH ≻ SAPURA ≻ PERDANA
Actual ranking	HENGYUAN ≻ PETRONM ≻ BARAKAH ≻ SAPURA ≻ PERDANA

5.2 Discussion of results

From the results obtained in Table 4, it can be observed that different rankings and optimal alternatives were obtained from the different methods that were compared. These differences are due to a number of reasons which are summarized briefly below:

(i) In the NDAHP method, we use the hierarchical principal in which we compare the pairwise values between the criteria and between the alternatives. The criteria weights are needed to be determined to rank the alternatives. However, we use the distance principal for NEDAS method in which the distance is between the alternatives and the average solution. This is the reason for the difference in the results obtained via the NDAHP and NEDAS methods.

(ii) The NDAHP method provides the weightage of different criteria under different alternatives. For example, in our case study related to the ranking of the financial performance of five selected petrochemical companies, the NDAHP method provides the weightage of the different criteria for the companies HENGYUAN, PETRONM, BARAKAH, SAPURA and PERDANA. Decision makers can observe the comparative advantage of a company through the differences in the weightage of the different criteria. For examples, the weightage of sales growth under HENGYUAN is 0.20507543 which is much higher than the other companies, which makes it clear to the decision makers that HENGYUAN has the highest sales growth among the five petrochemical companies that are studied.

5.3 Further verification of results using Spearman’s rank and Pearson coefficient correlation

Correlation is an analysis that examine the strength of the relationship between two variables. A rank test can help users to examine how strong are the relationship between two variables. The result obtained from the rank test is range from between -1 to 1. A value of -1 indicates that the two variables are negatively correlated, i.e. for every increase in the first variable, there will a certain amount of decrease in the second variable. A value of 1 indicates that the two variables are positively correlated, i.e. for every increase in the first variable, there will be a certain amount of increase in the second variable. When the result obtained is 0, it means that there is no relationship between the two variables.

Here, the correlation between the results obtained from the decision making methods used in Table 4 and the actual ranking will be examined to determine how strong is the relationship between the result obtained by decision making method and the actual ranking. The rank test used here will be the Spearman’s rank correlation coefficient and Pearson correlation coefficient. The result of Spearman’s rank correlation coefficient is determined by using the ranking while the Pearson correlation coefficient is determined by using weightage or the value used to determine the ranking. The formula used to determine the correlation between the two variables are as given below:

i) Spearman’s rank correlation coefficient

$$\text{Correlation} = 1 - \frac{6 \sum_{i=1}^n d_i^2}{n(n^2 - 1)} \tag{18}$$

ii) Pearson correlation coefficient

$$\text{Correlation} = \frac{n \sum_{i=1}^n x_i y_i - \sum_{i=1}^n x_i \sum_{i=1}^n y_i}{\sqrt{n \sum_{i=1}^n x_i^2 - (\sum_{i=1}^n x_i)^2} \sqrt{n \sum_{i=1}^n y_i^2 - (\sum_{i=1}^n y_i)^2}} \tag{19}$$

The results obtained from the rank test are presented in Table 5.

Table 5: Correlation between the results of the ranking of financial performance

Ranking	Spearman’s rank correlation coefficient		Pearson correlation coefficient	
	1	1.0	NDAHP	0.922317
2	0.9	NCC	0.91458	ISVNWA GAO
3	0.9	NCE	0.906758	NDAHP
4	0.9	ISVNWA GAO	0.888549	NTOPSIS
5	0.7	NTOPSIS	0.556343	NEDAS
6	0.6	NEDAS	-0.88332	NCE

From the results obtained from Spearman’s rank correlation coefficient, it can be clearly seen that our proposed NDAHP method is perfectly correlated with the actual ranking while the NCC, NCE and ISVNWAGAO are slightly less correlated to the actual ranking compared to the NDAHP method, whereas the NTOPSIS and NEDAS methods have the worst correlation with the actual ranking.

From the results obtained from Pearson coefficient correlation, the results obtained from decision making

methods of NDAHP, NCC, ISVNWAGAO and NTOPSIS are strongly correlated with the actual ranking. However, the results obtained from the NEDAS method has a very low consistency with the actual ranking, whereas the results obtained from the NCE method is negatively correlated with the actual ranking with a Pearson correlation coefficient of -0.88332.

It is therefore clearly proven that our proposed NDAHP method is the approach that produces results that are most consistent with the actual ranking.

6. CONCLUSION AND REMARKS

The concluding remarks and the significant contributions that were made by the work in this paper are summarized below:

- (i) A novel AHP method for the single-valued neutrosophic set (SVNS) model called the neutrosophic data analytic hierarchy process (NDAHP) is introduced. Our proposed NDAHP method holds the distinction of being the only AHP based method in literature that is designed to handle actual datasets i.e. data in the form of crisp values. This makes it novel and more comprehensive compared to existing AHP methods in literature as these are only able to handle subjective information in the form of opinions collected from the users and decision makers based on their individual opinions and experiences.
- (ii) The NAHP method uses the opinions of experts to determine the relative importance of each criteria, whereas our proposed NDAHP method has a step incorporated into it which is able to convert the crisp values in actual datasets. Therefore, our proposed NDAHP method uses an objective weighting mechanism whereas all other existing versions of the AHP, fuzzy AHP and other fuzzy based AHP method in literature such as the NAHP and picture fuzzy AHP uses a subjective weighting method in the process of determining the weights of the criteria. Furthermore, the formula used in our method to convert the crisp values in the real-life datasets to single-valued neutrosophic numbers is also able to differentiate between the beneficial and non-beneficial criteria. This makes our proposed NDAHP method a very objective one as the weightage of the criteria and evaluation matrix are determined in an objective manner using the actual data collected for the problem, and hence will not change according to the opinions of the different decision makers which are subjective. This also makes it unnecessary to determine the consistency of the evaluation matrix as our method uses an objective weighting mechanism.
- (iii) Through thorough analysis using the Spearman's rank correlation coefficient and Pearson's correlation coefficient tests, we have proven that our proposed NDAHP method produces results that are consistent with the actual results.

This clearly indicates that our proposed method is not only an effective decision making algorithm but one that is also highly reliable and accurate.

Funding: This research was funded by the Ministry of Education, Malaysia under grant no. FRGS/1/2017/STG06/UCSI/03/1.

REFERENCES

- [1] Zadeh, L.A. 1965. Fuzzy sets, *Information and Control*, 8, 338-353.
- [2] Atanassov, K.T. 1986. Intuitionistic fuzzy sets, *Fuzzy Sets and Systems*, 20(1), 87-96.
- [3] Gorzalczany, M.B. 1987. A method of inference in approximate reasoning based on interval-valued fuzzy sets, *Fuzzy Sets and Systems*, 21, 1-17.
- [4] Atanassov, K. & Gargov, G. 1989. Interval valued intuitionistic fuzzy sets, *Fuzzy Sets and Systems*, 31(3), 343-349.
- [5] Gau, W.L. & Buehrer, D.J. 1993. Vague sets, *IEEE Transactions on Systems, Man and Cybernetics*, 23(2), 610-614.
- [6] Smarandache, F. 1999. *A unifying field in logics, neutrosophy: Neutrosophic probability, set and logic*, American Research Press.
- [7] Torra, V. 2010. Hesitant fuzzy sets, *International Journal of Intelligent Systems*, 25(6), 529-539.
- [8] Cuong, B. C. 2014. Picture Fuzzy Sets. *Journal of Computer Science and Cybernetics*, 30(4), 409 - 420.
- [9] Wang, H., Smarandache, F., Zhang, Y.Q. & Sunderraman, R. 2010. Single valued neutrosophic sets, *Multispace Multistructure*, 4, 410-413.
- [10] Saaty, T. L. 1990. How to make a decision: the Analytic Hierarchy Process. *European Journal of Operational Research*, 48, 9-26.
- [11] Vargas, R.V. 2010. Using the analytic hierarchy process (AHP) to select and prioritize projects in a portfolio. North America, Washington, DC. Newtown Square: Project Management Institute.
- [12] Ishizaka, A. 2014. Comparison of fuzzy logic, AHP, FAHP and hybrid fuzzy AHP for new supplier selection and its performance analysis. *International Journal of Integrated Supply Management*, 9(1/2), 1-22.

- [13] Van Laarhoven, P. & Pedrycz, W. 1983. A fuzzy extension of Saaty's priority theory. *Fuzzy Sets and Systems*, 11(3), 199-227.
- [14] Nguyen, A.T., Nguyen, L.D., Le-Hoai, L. & Dang, C.N. 2015. Quantifying the complexity of transportation projects using the fuzzy analytic hierarchy process. *International Journal of Project Management*, 33(6), 1364-1376.
- [15] Ruiz-Padillo, A., Ruiz, D.P., Torija, A.J. & Ramos-Ridao, A. 2016. Selection of suitable alternatives to reduce the environmental impact of road traffic noise using a fuzzy multi-criteria decision model. *Environmental Impact Assessment Review*, 61, 8-18.
- [16] Calabrese, A., Costa, R., Levaldi, N. & Menichini, T. 2016. A fuzzy analytic hierarchy process method to support materiality assessment in sustainability reporting. *Journal of Cleaner Production*, 121, 248-264.
- [17] Xu, Z. & Liao, H. 2014. Intuitionistic fuzzy analytic hierarchy process. *IEEE Transactions on Fuzzy Systems*, 22(4), 749-761.
- [18] Abdullah, L., Jaafar, S. & Taib, I. 2013. Intuitionistic fuzzy analytic hierarchy process approach in ranking of human capital indicators. *Journal of Applied Sciences*, 13(3), 423-429.
- [19] Abdullah, L. & Najib, L. 2016. Sustainable energy planning decision using the intuitionistic fuzzy analytic hierarchy process: choosing energy technology in Malaysia. *International Journal of Sustainable Energy*, 35(4), 360-377.
- [20] Kaur, P. 2014. Selection of vendor based on intuitionistic fuzzy analytical hierarchy process, *Advances in Operations Research*, 2014, 1-10, <http://dx.doi.org/10.1155/2014/987690>.
- [21] Nguyen, H. 2016. An application of intuitionistic fuzzy analytic hierarchy process in ship system risk estimation. *Journal of KONES Powertrain and Transport*, 23(3), 365-372.
- [22] Mirzaei, E., Minatour, Y., Bonakdari, H. & Javadi, A. 2015. Application of interval-valued fuzzy analytic hierarchy process approach. *International Journal of Engineering*, 28(3), 387-395.
- [23] Abdullah, L. & Najib, L. 2016. A new preference scale MCDM method based on interval-valued intuitionistic fuzzy sets and the analytic hierarchy process. *Soft Computing*, 20(2), 511-523.
- [24] Fahmi, A., Derakhshan, A. & Kahraman, C. 2015. Human resources management using interval valued intuitionistic fuzzy analytic hierarchy process. *Proceedings of the 2015 IEEE International Conference on Fuzzy Systems (FUZZ-IEEE)*, 1-5.
- [25] Radwan, N.M., Senousy, M.B. & Riad, A.E.D.M. 2016. Neutrosophic AHP multi criteria decision making method applied on the selection of learning management system. *International Journal of Advancements in Computing Technology*, 8(5), 95 - 105.
- [26] Ye, J. 2013. Multicriteria decision-making method using the correlation coefficient under single-valued neutrosophic environment. *International Journal of General Systems* 42, 386-394.
- [27] Ye, J. 2014. Improved correlation coefficients of single valued neutrosophic sets and interval neutrosophic sets for multiple attribute decision making. *Journal of Intelligent Fuzzy System* 27, 2453-2462.
- [28] Ye, J. 2014. Clustering methods using distance-based similarity measures of single-valued neutrosophic sets. *Journal of Intelligent Systems*, 23, 379-389.
- [29] Ye, J. 2014. Multiple attribute group decision-making method with completely unknown weights based on similarity measures under single valued neutrosophic environment. *Journal of Intelligent and Fuzzy Systems*, 27, 2927-2935.
- [30] Huang, H.L. 2016. New distance measure of single-valued neutrosophic sets and its application. *International Journal of Intelligent Systems*, 31(10), 1021-1032.
- [31] Peng, X. & Liu, C. 2017. Algorithms for neutrosophic soft decision making based on EDAS, new similarity measure and level soft set. *Journal of Intelligent and Fuzzy Systems*, 32, 955-968.
- [32] Yang, H.L., Guo, Z.L., She, Y.H. & Liao, X.W. 2016. On single valued neutrosophic relations. *Journal of Intelligent and Fuzzy Systems*, 30, 1045-1056.
- [33] Broumi, S., Smarandache, F., Talea, M. & Bakali, A. 2016. Single valued neutrosophic graph: Degree, order and size, *Proceedings of the 2016 IEEE International Conference on Fuzzy Systems*, 2444-2451.
- [34] Broumi, S., Bakali, A., Talea, M. & Smarandache, F. 2016. Isolated single valued neutrosophic graphs. *Neutrosophic Sets and Systems*, 11, 74-78.
- [35] Broumi, S., Talea, M., Bakali, A. & Smarandache, F. 2016. Single valued neutrosophic graphs. *Journal of New Theory*, 10, 86-101.
- [36] Broumi, S., Smarandache, F., Talea, M. & Bakali, A. 2016. An introduction to bipolar single valued neutrosophic graph theory. *Applied Mechanics and Materials*, 841, 184-191.

- [37] Broumi, S., Talea, M., Bakali, A. & Smarandache, F. 2016. On bipolar single valued neutrosophic graphs. *Journal of New Theory*, 11, 84-102.
- [38] Hassan, A., Malik, M.A., Broumi, S., Bakali, A., Talea, M. & Smarandache, F. 2017. Special types of bipolar single valued neutrosophic graphs. *Annals of Fuzzy Mathematics and Informatics*, 14(1), 55-73.
- [39] Tian, Z.P. Wang, J., Zhang, H.Y. & Wang, J.Q. 2018. Multi-criteria decision-making based on generalized prioritized aggregation operators under simplified neutrosophic uncertain linguistic environment. *International Journal of Machine Learning and Cybernetics*, 9(3), 523-539.
- [40] Wu, X.H., Wang, J., Peng, J.J. & Chen, X.H. 2016. Cross-entropy and prioritized aggregation operator with simplified neutrosophic sets and their application in multi-criteria decision- making problems. *International Journal of Fuzzy Systems*, 18(6), 1104-1116.
- [41] Sahin, R. & Kucuk, A. 2015. Subsethood measure for single valued neutrosophic sets. *Journal of Intelligent and Fuzzy Systems*, 29(2), 525-530.
- [42] Ye, J. 2015. An extended TOPSIS method for multiple attribute group decision making based on single valued neutrosophic linguistic numbers. *Journal of Intelligent and Fuzzy Systems*, 28(1), 247-255.
- [43] Biswas, P., Pramanik, S. & Giri, B.C. 2016. TOPSIS method for multi-attribute group decision-making under single-valued neutrosophic environment. *Neural Computing and Applications*, 27(3), 727-737.
- [44] Selvachandran, G., Quek, S.G., Smarandache, F. & Broumi, S. 2018. An extended technique for order preference by similarity to an ideal solution (TOPSIS) with maximizing deviation method based on integrated weight measure for single-valued neutrosophic sets. *Symmetry*, 10(7), 236-252.
- [45] P. Majumdar & S.K. Samanta, On similarity and entropy of neutrosophic sets, *Journal of Intelligent and Fuzzy Systems*, 26(3) (2014) 1245-1252.
- [46] Abdel-Basset, M., Mohamed, M. & Smarandache, F. 2018. An extension of neutrosophic AHP-SWOT analysis for strategic planning and decision-making. *Symmetry*, 10(4), 116-133.
- [47] Alava, M. V., Figueroa, D., Alcivar, B. & Vazquez, M. L., 2018. Single valued neutrosophic numbers and analytic. *Neutrosophic Sets and Systems*, 21, 122 - 130.
- [48] Nirmal, N.P. & Bhatt, M.G. 2016. Selection of automated guided vehicle using single valued neutrosophic entropy based on novel multi attribute decision making technique. *New Trends in Neutrosophic Theory and Applications*, 105-114.
- [49] Pramanik, S., Dalapati, S., Alam, S., Smarandache, F. & Roy, T.K. 2018. NS-Cross Entropy-Based MAGDM under Single-Valued Neutrosophic Set Environment. *Information*, 9(2), 37-57.
- [50] Mandal, K. & Basu, K. 2016. Multi criteria decision making method in neutrosophic environment using a new aggregation operator, score and certainty function. *New Trends in Neutrosophic Theory and Applications*, 141-159.
- [51] Sudan Jha, Le Hoang Son, Raghvendra Kumar, Ishaani Priyadarshini, Florentin Smarandache, Hoang Viet Long (2019), “Neutrosophic Image Segmentation with Dice Coefficients”, *Measurement*, 134, pp. 762-772.
- [52] Gia Nhu Nguyen, Le Hoang Son, Amira S. Ashour, Nilanjan Dey (2019), “A survey of the State-of-the-arts on Neutrosophic Sets in Biomedical Diagnoses”, *International Journal of Machine Learning and Cybernetics*, 10(1), pp. 1-13.
- [53] Sudan Jha, Raghvendra Kumar, Le Hoang Son, Jyotir Moy Chatterjee, Manju Khari, Navneet Yadav, Florentin Smarandache (2019), “Neutrosophic soft set decision making for stock trending analysis”, *Evolving Systems*, in press.
- [54] Tran Manh Tuan, Pham Minh Chuan, Mumtaz Ali, Tran Thi Ngan, Mamta Mittal, Le Hoang Son (2019), “Fuzzy and neutrosophic modeling for link prediction in social networks”, *Evolving Systems*, in press.
- [55] Hoang Viet Long, Mumtaz Ali, Le Hoang Son, Mohsin Khan, Doan Ngoc Tu (2019), “A novel approach for Fuzzy Clustering based on Neutrosophic Association Matrix”, *Computers & Industrial Engineering*, 127, pp. 687-697.
- [56] Nguyen Tho Thong, Luu Quoc Dat, Le Hoang Son, Nguyen Dinh Hoa, Mumtaz Ali, Florentin Smarandache (2019), “Dynamic Interval Valued Neutrosophic Set: Modeling Decision Making in Dynamic Environments”, *Computers in Industry*, 108, pp. 45 – 52.
- [57] Sudan Jha, Raghvendra Kumar, Le Hoang Son, Francisco Chiclana, Vikram Puri, Ishaani Priyadarshini (2019), “Neutrosophic Approach for Enhancing Quality of Signals”, *Multimedia Tools and Applications*, DOI = <http://dx.doi.org/10.1007/s11042-019-7375-0>.
- [58] Nguyen Thi Kim Son, Nguyen Phuong Dong, Le Hoang Son, Hoang Viet Long (2019), “Towards granular calculus of single-valued neutrosophic functions under granular computing”, *Multimedia Tools and Applications*, DOI = <http://dx.doi.org/10.1007/s11042-019-7388-8>.
- [59] Luu Quoc Dat, Nguyen Tho Thong, Le Hoang Son, Mumtaz Ali, Florentin Smarandache, Mohamed Abdel-Basset, Hoang Viet Long (2019), “Linguistic Approaches to Interval Complex Neutrosophic Sets in Decision Making”, *IEEE Access*, DOI 10.1109/ACCESS.2019.2902841.

- [60] Mumtaz Ali, Le Hoang Son, Mohsin Khan, Nguyen Thanh Tung (2018), "Segmentation of Dental X-ray Images in Medical Imaging using Neutrosophic Orthogonal Matrices", *Expert Systems With Applications*, 91, pp. 434-441
- [61] Mumtaz Ali, Luu Quoc Dat, Le Hoang Son, Florentin Smarandache (2018), "Interval Complex Neutrosophic Set: Formulation and Applications in Decision-Making", *International Journal of Fuzzy Systems*, 20(3), pp. 986 – 999.
- [62] Mumtaz Ali, Le Hoang Son, Nguyen Dang Thanh, Nguyen Van Minh (2018), "A Neutrosophic Recommender System for Medical Diagnosis Based on Algebraic Neutrosophic Measures", *Applied Soft Computing*, 71, pp. 1054-1071.
- [63] Mohsin Khan, Le Hoang Son, Mumtaz Ali, Hoang Thi Minh Chau, Nguyen Thi Nhu Na, Florentin Smarandache (2018), "Systematic Review of Decision Making Algorithms in Extended Neutrosophic Sets", *Symmetry-Basel*, 10, pp. 314–342.
- [64] Pu Ji ; Hong-Yu Zhang ; Jian-Qiang Wang A Fuzzy Decision Support Model With Sentiment Analysis for Items Comparison in e-Commerce: The Case Study of PConline.com, *IEEE Transactions on Systems, Man, and Cybernetics: Systems*. DOI: 10.1109/TSMC.2018.2875163
- [65] Ying-ying Li, Jian-qiang Wang, Tie-li Wang, A linguistic neutrosophic multi-criteria group decision-making approach with EDAS method, *Arabian Journal for Science and Engineering*, 44(3): 2737-2749
- [66] Pu Ji, Hong-yu Zhang, Jian-qiang Wang, Selecting an outsourcing provider based on the combined MABAC-ELECTRE method using single-valued neutrosophic linguistic sets, *Computers & Industrial Engineering*, 120: 429-441,2018
- [67] Pu Ji, Hong-yu Zhang & Jian-qiang Wang, Fuzzy decision-making framework for treatment selection based on the combined QUALIFLEX-TODIM method, *International Journal of Systems Science*,48(14):3072-3086
- [68] Jian Li, Jian-qiang Wang, Jun-hua Hu, Multi-criteria decision-making method based on dominance degree and BWM with probabilistic hesitant fuzzy information, *International Journal of Machine Learning and Cybernetics* , <https://doi.org/10.1007/s13042-018-0845-2>
- [69] S. M. Mousavi; H. Gitinavard ; A. Siadat, View All Authors A new hesitant fuzzy analytical hierarchy process method for decision-making problems under uncertainty." 2014 IEEE International Conference on Industrial Engineering and Engineering Management. IEEE, 2014.
- [70] H. Gitinavard; M. Akbarpour Shirazi, An extended intuitionistic fuzzy modified group complex proportional assessment approach." *Journal of Industrial and Systems Engineering* 11.3 (2018): 229-246
- [71] S. Ebrahimnejad, H. Gitinavard and S. Sohrabvandi, A New Extended Analytical Hierarchy Process Technique with Incomplete Interval-valued Information for Risk Assessment in IT Outsourcing." *International Journal of Engineering* 30.5 (2017): 739-748.
- [72] Hossein Gitinavard, Mir Saman Pishvaei , Fatemeh Jalalvand, A hierarchical multi-criteria group decision-making method based on TOPSIS and hesitant fuzzy information." *International Journal of Applied Decision Sciences* 10.3 (2017): 213-232

Multi-Attribute Decision-Making Method Based on Neutrosophic Soft Rough Information

Muhammad Akram, Sundas Shahzadi, Florentin Smarandache

Muhammad Akram, Sundas Shahzadi, Florentin Smarandache (2018). Multi-Attribute Decision-Making Method Based on Neutrosophic Soft Rough Information. *Axioms* 7, 19; DOI: 10.3390/axioms7010019

Abstract: Soft sets (SSs), neutrosophic sets (NSs), and rough sets (RSs) are different mathematical models for handling uncertainties, but they are mutually related. In this research paper, we introduce the notions of soft rough neutrosophic sets (SRNSs) and neutrosophic soft rough sets (NSRSs) as hybrid models for soft computing. We describe a mathematical approach to handle decision-making problems in view of NSRSs. We also present an efficient algorithm of our proposed hybrid model to solve decision-making problems.

Keywords: soft rough neutrosophic sets; neutrosophic soft rough sets; decision-making; algorithm

1. Introduction

Smarandache [1] initiated the concept of neutrosophic set (NS). Smarandache's NS is characterized by three parts: truth, indeterminacy, and falsity. Truth, indeterminacy and falsity membership values behave independently and deal with the problems of having uncertain, indeterminate and imprecise data. Wang et al. [2] gave a new concept of single valued neutrosophic set (SVNS) and defined the set of theoretic operators in an instance of NS called SVNS. Ye [3–5] studied the correlation coefficient and improved correlation coefficient of NSs, and also determined that, in NSs, the cosine similarity measure is a special case of the correlation coefficient. Peng et al. [6] discussed the operations of simplified neutrosophic numbers and introduced an outranking idea of simplified neutrosophic numbers.

Molodtsov [7] introduced the notion of soft set as a novel mathematical approach for handling uncertainties. Molodtsov's soft sets give us new technique for dealing with uncertainty from the viewpoint of parameters. Maji et al. [8–10] introduced neutrosophic soft sets (NSSs), intuitionistic fuzzy soft sets (IFSSs) and fuzzy soft sets (FSSs). Babitha and Sunil gave the idea of soft set relations [11]. In [12], Sahin and Kucuk presented NSS in the form of neutrosophic relation.

Rough set theory was initiated by Pawlak [13] in 1982. Rough set theory is used to study the intelligence systems containing incomplete, uncertain or inexact information. The lower and upper approximation operators of RSs are used for managing hidden information in a system. Therefore, many hybrid models have been built such as soft rough sets (SRSs), rough fuzzy sets (RFSs), fuzzy rough sets (FRSs), soft fuzzy rough sets (SFRSs), soft rough fuzzy sets (SRFSs), intuitionistic fuzzy soft rough sets (IFSRs), neutrosophic rough sets (NRSs), and rough neutrosophic sets (RNSs) for handling uncertainty and incomplete information effectively. Soft set theory and RS theory are two different mathematical tools to deal with uncertainty. Evidently, there is no direct relationship between these two mathematical tools, but efforts have been made to define some kind of relation [14,15]. Feng et al. [15] took a significant step to introduce parametrization tools in RSs. They introduced SRSs,

in which parameterized subsets of universal sets are elementary building blocks for approximation operators of a subset. Shabir et al. [16] introduced another approach to study roughness through SSs, and this approach is known as modified SRSs (MSR-sets). In MSR-sets, some results proved to be valid that failed to hold in SRSs. Feng et al. [17] introduced a modification of Pawlak approximation space known as soft approximation space (SAS) in which SAS SRSs were proposed. Moreover, they introduced soft rough fuzzy approximation operators in SAS and initiated a idea of SRFs, which is an extension of RFSs introduced by Dubois and Prade [18]. Meng et al. [19] provide further discussion of the combination of SSs, RSs and FSs. In various decision-making problems, RSs have been used. The existing results of RSs and other extended RSs such as RFSs, generalized RFSs, SFRSs and IFRSs based decision-making models have their advantages and limitations [20,21]. In a different way, RS approximations have been constructed into the IF environment and are known as IFRSs, RIFs and generalized IFRSs [22–24]. Zhang et al. [25,26] presented the notions of SRSs, SRIFs, and IFSRSs, its application in decision-making, and also introduced generalized IFSRSs. Broumi et al. [27,28] developed a hybrid structure by combining RSs and NSs, called RNSs. They also presented interval valued neutrosophic soft rough sets by combining interval valued neutrosophic soft sets and RSs. Yang et al. [29] proposed single valued neutrosophic rough sets (SVNRSs) by combining SVNNSs and RSs, and established an algorithm for decision-making problems based on SVNRSs in two universes. For some papers related to NSs and multi-criteria decision-making (MCDM), the readers are referred to [30–38]. The notion of SRNSs is a extension of SRSs, SRIFs, IFSRSs, introduced by Zhang et al. motivated by the idea of single valued neutrosophic rough sets (SVNRSs) introduced, we extend the single valued neutrosophic rough sets' lower and upper approximations to the case of a neutrosophic soft rough set. The concept of a neutrosophic soft rough set is introduced by coupling both the neutrosophic soft sets and rough sets. In this research paper, we introduce the notions of SRNSs and NSRSs as hybrid models for soft computing. Approximation operators of SRNSs and NSRSs are described and their relevant properties are investigated in detail. We describe a mathematical approach to handle decision-making problems in view of NSRSs. We also present an efficient algorithm of our proposed hybrid model to solve decision-making problems.

2. Construction of Soft Rough Neutrosophic Sets

In this section, we introduce the notions of SRNSs by combining soft sets with RNSs and soft rough neutrosophic relations (SRNRs). Soft rough neutrosophic sets consist of two basic components, namely neutrosophic sets and soft relations, which are the mathematical basis of SRNSs. The basic idea of soft rough neutrosophic sets is based on the approximation of sets by a couple of sets known as the lower soft rough neutrosophic approximation and the upper soft rough neutrosophic approximation of a set. Here, the lower and upper approximation operators are based on an arbitrary soft relation. The concept of soft rough neutrosophic sets is an extension of the crisp set, rough set for the study of intelligent systems characterized by inexact, uncertain or insufficient information. It is a useful tool for dealing with uncertainty or imprecision information. The concept of neutrosophic soft sets is powerful logic to handle indeterminate and inconsistent situations, and the theory of rough neutrosophic sets is also powerful mathematical logic to handle incompleteness. We introduce the notions of soft rough neutrosophic sets (SRNSs) and neutrosophic soft rough sets (NSRSs) as hybrid models for soft computing. The rating of all alternatives is expressed with the upper soft rough neutrosophic approximation and lower soft rough neutrosophic approximation operator and the pair of neutrosophic sets that are characterized by truth-membership degree, indeterminacy-membership degree, and falsity-membership degree from the view point of parameters.

Definition 1. Let Y be an initial universal set and M a universal set of parameters. For an arbitrary soft relation P over $Y \times M$, let $P_s : Y \rightarrow \mathcal{N}(M)$ be a set-valued function defined as $P_s(u) = \{k \in M \mid (u, k) \in P\}, u \in Y$.

Let (Y, M, P) be an SAS. For any NS $C = \{(k, T_C(k), I_C(k), F_C(k)) \mid k \in M\} \in \mathcal{N}(M)$, where $\mathcal{N}(M)$ is a neutrosophic power set of parameter set M , the lower soft rough neutrosophic approximation (LSRNA) and

the upper soft rough neutrosophic approximation (USRNA) operators of C w.r.t (Y, M, P) denoted by $\underline{P}(C)$ and $\overline{P}(C)$, are, respectively, defined as follows:

$$\overline{P}(C) = \{(u, T_{\overline{P}(C)}(u), I_{\overline{P}(C)}(u), F_{\overline{P}(C)}(u)) \mid u \in Y\},$$

$$\underline{P}(C) = \{(u, T_{\underline{P}(C)}(u), I_{\underline{P}(C)}(u), F_{\underline{P}(C)}(u)) \mid u \in Y\},$$

where

$$T_{\overline{P}(C)}(u) = \bigvee_{k \in P_s(u)} T_C(k), \quad I_{\overline{P}(C)}(u) = \bigwedge_{k \in P_s(u)} I_C(k), \quad F_{\overline{P}(C)}(u) = \bigwedge_{k \in P_s(u)} F_C(k),$$

$$T_{\underline{P}(C)}(u) = \bigwedge_{k \in P_s(u)} T_C(k), \quad I_{\underline{P}(C)}(u) = \bigvee_{k \in P_s(u)} I_C(k), \quad F_{\underline{P}(C)}(u) = \bigvee_{k \in P_s(u)} F_C(k).$$

It is observed that $\overline{P}(C)$ and $\underline{P}(C)$ are two NSs on Y , $\underline{P}(C), \overline{P}(C) : \mathcal{N}(M) \rightarrow \mathcal{P}(Y)$ are referred to as the LSRNA and the USRNA operators, respectively. The pair $(\underline{P}(C), \overline{P}(C))$ is called SRNS of C w.r.t (Y, M, P) .

Remark 1. Let (Y, M, P) be an SAS. If $C \in IF(M)$ and $C \in \mathcal{P}(M)$, where $IF(M)$ and $\mathcal{P}(M)$ are intuitionistic fuzzy power set and crisp power set of M , respectively. Then, the above SRNA operators $\underline{P}(C)$ and $\overline{P}(C)$ degenerate to SRIFA and SRA operators, respectively. Hence, SRNA operators are an extension of SRIFA and SRA operators.

Example 1. Suppose that $Y = \{w_1, w_2, w_3, w_4, w_5\}$ is the set of five careers under observation, and Mr. X wants to select best suitable career. Let $M = \{k_1, k_2, k_3, k_4\}$ be a set of decision parameters. The parameters k_1, k_2, k_3 and k_4 stand for ‘‘aptitude’’, ‘‘work value’’, ‘‘skill’’ and ‘‘recent advancement’’, respectively. Mr. X describes the ‘‘most suitable career’’ by defining a soft relation P from Y to M , which is a crisp soft set as shown in Table 1.

Table 1. Crisp soft relation P .

P	w_1	w_2	w_3	w_4	w_5
k_1	1	1	0	1	0
k_2	0	1	1	0	1
k_3	0	1	0	0	0
k_4	1	1	1	0	1

$P_s : Y \rightarrow \mathcal{N}(M)$ is a set valued function, and we have $P_s(w_1) = \{k_1, k_4\}, P_s(w_2) = \{k_1, k_2, k_3, k_4\}, P_s(w_3) = \{k_2, k_4\}, P_s(w_4) = \{k_1\}$ and $P_s(w_5) = \{k_2, k_4\}$. Mr. X gives most the favorable parameter object C , which is an NS defined as follows:

$$C = \{(k_1, 0.2, 0.5, 0.6), (k_2, 0.4, 0.3, 0.2), (k_3, 0.2, 0.4, 0.5), (k_4, 0.6, 0.2, 0.1)\}.$$

From the Definition 1, we have

$$T_{\overline{P}(C)}(w_1) = \bigvee_{k \in P_s(w_1)} T_C(k) = \bigvee \{0.2, 0.6\} = 0.6,$$

$$I_{\overline{P}(C)}(w_1) = \bigwedge_{k \in P_s(w_1)} I_C(k) = \bigwedge \{0.5, 0.2\} = 0.2,$$

$$F_{\overline{P}(C)}(w_1) = \bigwedge_{k \in P_s(w_1)} F_C(k) = \bigwedge \{0.6, 0.1\} = 0.1,$$

$$T_{\overline{P}(C)}(w_2) = 0.6, \quad I_{\overline{P}(C)}(w_2) = 0.2, \quad F_{\overline{P}(C)}(w_2) = 0.1,$$

$$T_{\overline{P}(C)}(w_3) = 0.6, \quad I_{\overline{P}(C)}(w_3) = 0.2, \quad F_{\overline{P}(C)}(w_3) = 0.1,$$

$$T_{\overline{P}(C)}(w_4) = 0.2, \quad I_{\overline{P}(C)}(w_4) = 0.5, \quad F_{\overline{P}(C)}(w_4) = 0.6,$$

$$T_{\overline{P}(C)}(w_5) = 0.6, \quad I_{\overline{P}(C)}(w_5) = 0.2, \quad F_{\overline{P}(C)}(w_5) = 0.1.$$

Similarly,

$$T_{\underline{P}(C)}(w_1) = \bigwedge_{k \in P_s(w_1)} T_C(k) = \bigwedge \{0.2, 0.6\} = 0.2,$$

$$I_{\underline{P}(C)}(w_1) = \bigvee_{k \in P_s(w_1)} I_C(k) = \bigvee \{0.5, 0.2\} = 0.5,$$

$$F_{\underline{P}(C)}(w_1) = \bigvee_{k \in P_s(w_1)} F_C(k) = \bigvee \{0.6, 0.1\} = 0.6,$$

$$T_{\underline{P}(C)}(w_2) = 0.2, \quad I_{\underline{P}(C)}(w_2) = 0.5, \quad F_{\underline{P}(C)}(w_2) = 0.6,$$

$$T_{\underline{P}(C)}(w_3) = 0.4, \quad I_{\underline{P}(C)}(w_3) = 0.3, \quad F_{\underline{P}(C)}(w_3) = 0.2,$$

$$T_{\underline{P}(C)}(w_4) = 0.2, \quad I_{\underline{P}(C)}(w_4) = 0.5, \quad F_{\underline{P}(C)}(w_4) = 0.6,$$

$$T_{\underline{P}(C)}(w_5) = 0.4, \quad I_{\underline{P}(C)}(w_5) = 0.3, \quad F_{\underline{P}(C)}(w_5) = 0.2.$$

Thus, we obtain

$$\overline{P}(C) = \{(w_1, 0.6, 0.2, 0.1), (w_2, 0.6, 0.2, 0.1), (w_3, 0.6, 0.2, 0.1), (w_4, 0.2, 0.5, 0.6), (w_5, 0.6, 0.2, 0.1)\},$$

$$\underline{P}(C) = \{(w_1, 0.2, 0.5, 0.6), (w_2, 0.2, 0.5, 0.6), (w_3, 0.4, 0.3, 0.2), (w_4, 0.2, 0.5, 0.6), (w_5, 0.4, 0.3, 0.2)\}.$$

Hence, $(\underline{P}(C), \overline{P}(C))$ is an SRNS of C .

Theorem 1. Let (Y, M, P) be an SAS. Then, the LSRNA and the USRNA operators $\underline{P}(C)$ and $\overline{P}(C)$ satisfy the following properties for all $C, D \in \mathcal{N}(M)$:

- (i) $\overline{P}(C) = \sim \underline{P}(\sim C)$,
- (ii) $\underline{P}(C \cap D) = \underline{P}(C) \cap \underline{P}(D)$,
- (iii) $C \subseteq D \Rightarrow \underline{P}(C) \subseteq \underline{P}(D)$,
- (iv) $\underline{P}(C \cup D) \supseteq \underline{P}(C) \cup \underline{P}(D)$,
- (v) $\underline{P}(C) = \sim \overline{P}(\sim C)$,
- (vi) $\overline{P}(C \cup D) = \overline{P}(C) \cup \overline{P}(D)$,
- (vii) $C \subseteq D \Rightarrow \overline{P}(C) \subseteq \overline{P}(D)$,
- (viii) $\overline{P}(C \cap D) \subseteq \overline{P}(C) \cap \overline{P}(D)$,

where $\sim C$ is the complement of C .

Proof. (i) By definition of SRNS, we have

$$\sim C = \{(k, F_C(k), 1 - I_C(k), T_C(k))\},$$

$$\underline{P}(\sim C) = \{(u, T_{\underline{P}(\sim C)}(u), I_{\underline{P}(\sim C)}(u), F_{\underline{P}(\sim C)}(u)) \mid u \in Y\},$$

$$\sim \underline{P}(\sim C) = \{(u, F_{\underline{P}(\sim C)}(u), 1 - I_{\underline{P}(\sim C)}(u), T_{\underline{P}(\sim C)}(u)) \mid u \in Y\},$$

where

$$F_{\underline{P}(\sim C)}(u) = \bigvee_{k \in P_s(u)} T_C(k), \quad I_{\underline{P}(\sim C)}(u) = \bigvee_{k \in P_s(u)} (1 - I_C(k)), \quad T_{\underline{P}(\sim C)}(u) = \bigwedge_{k \in P_s(u)} F_C(k).$$

Hence, $\sim \underline{P}(\sim C) = \overline{P}(C)$.

(ii)

$$\begin{aligned}
 \underline{P}(C \cap D) &= \{(u, T_{\underline{P}(C \cap D)}(u), I_{\underline{P}(C \cap D)}(u), F_{\underline{P}(C \cap D)}(u)) \mid u \in Y\} \\
 &= \{(u, \bigwedge_{k \in P_s(u)} T_{(C \cap D)}(k), \bigvee_{k \in P_s(u)} I_{(C \cap D)}(k), \bigvee_{k \in P_s(u)} F_{(C \cap D)}(k)) \mid u \in Y\} \\
 &= \{(u, \bigwedge_{k \in P_s(u)} (T_C(k) \wedge T_D(k)), \bigvee_{k \in P_s(u)} (I_C(k) \vee I_D(k)), \\
 &\quad \bigvee_{k \in P_s(u)} (F_C(k) \vee F_D(k)) \mid u \in Y\} \\
 &= \{(u, T_{\underline{P}(C)}(u) \wedge T_{\underline{P}(D)}(u), I_{\underline{P}(C)}(u) \vee I_{\underline{P}(D)}(u), F_{\underline{P}(C)}(u) \vee F_{\underline{P}(D)}(u)) \mid u \in Y\} \\
 &= \underline{P}(C) \cap \underline{P}(D).
 \end{aligned}$$

(iii) It can be easily proved by Definition 1.

(iv)

$$\begin{aligned}
 T_{\underline{P}(C \cup D)}(u) &= \bigwedge_{k \in P_s(u)} T_{C \cup D}(k) \\
 &= \bigwedge_{k \in P_s(u)} (T_C(k) \vee T_D(k)) \\
 &\geq (\bigwedge_{k \in P_s(u)} T_C(k) \vee \bigwedge_{k \in P_s(u)} T_D(k)) \\
 &\geq (T_{\underline{P}(C)}(u) \vee T_{\underline{P}(D)}(u)), \\
 T_{\underline{P}(C \cup D)}(u) &\geq T_{\underline{P}(C)}(u) \cup T_{\underline{P}(D)}(u).
 \end{aligned}$$

Similarly, we can prove that

$$\begin{aligned}
 I_{\underline{P}(C \cup D)}(u) &\leq I_{\underline{P}(C)}(u) \cup I_{\underline{P}(D)}(u), \\
 F_{\underline{P}(C \cup D)}(u) &\leq F_{\underline{P}(C)}(u) \cup F_{\underline{P}(D)}(u).
 \end{aligned}$$

Thus, $\underline{P}(C \cup D) \supseteq \underline{P}(C) \cup \underline{P}(D)$.

The properties (v)–(viii) of the USRNA $\bar{P}(C)$ can be easily proved similarly. \square

Example 2. Considering Example 1, we have

$$\begin{aligned}
 \sim C &= \{(k_1, 0.6, 0.5, 0.2), (k_2, 0.2, 0.7, 0.4), (k_3, 0.5, 0.6, 0.2), (k_4, 0.1, 0.8, 0.6)\}, \\
 \bar{P}(\sim C) &= \{(w_1, 0.6, 0.5, 0.2), (w_2, 0.6, 0.5, 0.2), (w_3, 0.2, 0.7, 0.4), (w_4, 0.6, 0.5, 0.2), \\
 &\quad (w_5, 0.2, 0.7, 0.4)\}, \\
 \sim \bar{P}(\sim C) &= \{(w_1, 0.2, 0.5, 0.6), (w_2, 0.2, 0.5, 0.6), (w_3, 0.4, 0.3, 0.2), (w_4, 0.2, 0.5, 0.6), \\
 &\quad (w_5, 0.4, 0.3, 0.2)\}, \\
 &= \underline{P}(C). \\
 \text{Let } D &= \{(k_1, 0.4, 0.2, 0.6), (k_2, 0.5, 0.3, 0.2), (k_3, 0.5, 0.5, 0.1), (k_4, 0.6, 0.4, 0.7)\}, \\
 \underline{P}(D) &= \{(w_1, 0.4, 0.4, 0.7), (w_2, 0.4, 0.5, 0.6), (w_3, 0.5, 0.4, 0.7), (w_4, 0.4, 0.2, 0.6), \\
 &\quad (w_5, 0.5, 0.4, 0.7)\}, \\
 C \cap D &= \{(k_1, 0.2, 0.5, 0.6), (k_2, 0.4, 0.3, 0.2), (k_3, 0.2, 0.5, 0.5), (k_4, 0.6, 0.4, 0.7)\},
 \end{aligned}$$

$$\begin{aligned}
 \underline{P}(C \cap D) &= \{(w_1, 0.2, 0.5, 0.7), (w_2, 0.2, 0.5, 0.6), (w_3, 0.4, 0.4, 0.7), (w_4, 0.2, 0.5, 0.6), \\
 &\quad (w_5, 0.4, 0.4, 0.7)\}, \\
 \underline{P}(C) \cap \underline{P}(D) &= \{(w_1, 0.2, 0.5, 0.7), (w_2, 0.2, 0.5, 0.6), (w_3, 0.4, 0.4, 0.7), (w_4, 0.2, 0.5, 0.6), \\
 &\quad (w_5, 0.4, 0.4, 0.7)\}, \\
 \underline{P}(C \cap D) &= \underline{P}(C) \cap \underline{P}(D), \\
 C \cup D &= \{(k_1, 0.4, 0.2, 0.6), (k_2, 0.5, 0.3, 0.2), (k_3, 0.5, 0.4, 0.1), (k_4, 0.6, 0.2, 0.1)\}, \\
 \underline{P}(C \cup D) &= \{(w_1, 0.4, 0.2, 0.6), (w_2, 0.4, 0.4, 0.6), (w_3, 0.5, 0.3, 0.2), (w_4, 0.4, 0.2, 0.6), \\
 &\quad (w_5, 0.5, 0.3, 0.2)\}, \\
 \underline{P}(C) \cup \underline{P}(D) &= \{(w_1, 0.4, 0.4, 0.6), (w_2, 0.4, 0.5, 0.6), (w_3, 0.5, 0.3, 0.2), (w_4, 0.4, 0.2, 0.6), \\
 &\quad (w_5, 0.5, 0.3, 0.2)\}.
 \end{aligned}$$

Clearly, $\underline{P}(C \cup D) \supseteq \underline{P}(C) \cup \underline{P}(D)$. Hence, properties of the LSRNA operator hold, and we can easily verify the properties of the USRNA operator.

The conventional soft set is a mapping from a parameter to the subset of universe and let (P, M) be a crisp soft set. In [11], Babitha and Sunil introduced the concept of soft set relation. Now, we present the constructive definition of SRNR by using a soft relation R from $M \times M = \hat{M}$ to $\mathcal{P}(Y \times Y = \hat{Y})$, where Y is a universal set and M is a set of parameter.

Definition 2. A SRNR $(\underline{R}(D), \bar{R}(D))$ on Y is a SRNS, $R : \hat{M} \rightarrow \mathcal{P}(\hat{Y})$ is a soft relation on Y defined by

$$R(k_i k_j) = \{u_i u_j \mid \exists u_i \in P(k_i), u_j \in P(k_j)\}, u_i u_j \in \hat{Y}.$$

Let $R_s : \hat{Y} \rightarrow \mathcal{P}(\hat{M})$ be a set-valued function by

$$R_s(u_i u_j) = \{k_i k_j \in \hat{M} \mid (u_i u_j, k_i k_j) \in R\}, u_i u_j \in \hat{Y}.$$

For any $D \in \mathcal{N}(\hat{M})$, the USRNA and the LSRNA operators of D w.r.t (\hat{Y}, \hat{M}, R) defined as follows:

$$\begin{aligned}
 \bar{R}(D) &= \{(u_i u_j, T_{\bar{R}(D)}(u_i u_j), I_{\bar{R}(D)}(u_i u_j), F_{\bar{R}(D)}(u_i u_j)) \mid u_i u_j \in \hat{Y}\}, \\
 \underline{R}(D) &= \{(u_i u_j, T_{\underline{R}(D)}(u_i u_j), I_{\underline{R}(D)}(u_i u_j), F_{\underline{R}(D)}(u_i u_j)) \mid u_i u_j \in \hat{Y}\},
 \end{aligned}$$

where

$$\begin{aligned}
 T_{\bar{R}(D)}(u_i u_j) &= \bigvee_{k_i k_j \in R_s(u_i u_j)} T_D(k_i k_j), & I_{\bar{R}(D)}(u_i u_j) &= \bigwedge_{k_i k_j \in R_s(u_i u_j)} I_D(k_i k_j), \\
 F_{\bar{R}(D)}(u_i u_j) &= \bigwedge_{k_i k_j \in R_s(u_i u_j)} F_D(k_i k_j), \\
 T_{\underline{R}(D)}(u_i u_j) &= \bigwedge_{k_i k_j \in R_s(u_i u_j)} T_D(k_i k_j), & I_{\underline{R}(D)}(u_i u_j) &= \bigvee_{k_i k_j \in R_s(u_i u_j)} I_D(k_i k_j), \\
 F_{\underline{R}(D)}(u_i u_j) &= \bigvee_{k_i k_j \in R_s(u_i u_j)} F_D(k_i k_j).
 \end{aligned}$$

The pair $(\underline{R}(D), \bar{R}(D))$ is called SRNR and $\underline{R}, \bar{R} : \mathcal{N}(\hat{M}) \rightarrow \mathcal{P}(\hat{Y})$ are called the LSRNA and the USRNA operators, respectively.

Remark 2. For an NS D on \acute{M} and an NS C on M ,

$$\begin{aligned} T_D(k_i k_j) &\leq \min_{k_i \in M} \{T_C(k_i)\}, \\ I_D(k_i k_j) &\leq \min_{k_i \in M} \{I_C(k_i)\}, \\ F_D(k_i k_j) &\leq \min_{k_i \in M} \{F_C(k_i)\}. \end{aligned}$$

According to the definition of SRNR, we get

$$\begin{aligned} T_{\overline{R}(D)}(u_i u_j) &\leq \min\{T_{\overline{R}(C)}(u_i), T_{\overline{R}(C)}(u_j)\}, \\ I_{\overline{R}(D)}(u_i u_j) &\leq \max\{I_{\overline{R}(C)}(u_i), I_{\overline{R}(C)}(u_j)\}, \\ F_{\overline{R}(D)}(u_i u_j) &\leq \max\{F_{\overline{R}(C)}(u_i), F_{\overline{R}(C)}(u_j)\}. \end{aligned}$$

Similarly, for the LSRNA operator $\underline{R}(D)$,

$$\begin{aligned} T_{\underline{R}(D)}(u_i u_j) &\leq \min\{T_{\underline{R}(C)}(u_i), T_{\underline{R}(C)}(u_j)\}, \\ I_{\underline{R}(D)}(u_i u_j) &\leq \max\{I_{\underline{R}(C)}(u_i), I_{\underline{R}(C)}(u_j)\}, \\ F_{\underline{R}(D)}(u_i u_j) &\leq \max\{F_{\underline{R}(C)}(u_i), F_{\underline{R}(C)}(u_j)\}. \end{aligned}$$

Example 3. Let $Y = \{u_1, u_2, u_3\}$ be a universal set and $M = \{k_1, k_2, k_3\}$ be a set of parameters. A soft set (P, M) on Y can be defined in tabular form (see Table 2) as follows:

Table 2. Soft set (P, M) .

P	u_1	u_2	u_3
k_1	1	1	0
k_2	0	0	1
k_3	1	1	1

Let $E = \{u_1 u_2, u_2 u_3, u_2 u_2, u_3 u_2\} \subseteq \acute{Y}$ and $L = \{k_1 k_3, k_2 k_1, k_3 k_2\} \subseteq \acute{M}$. Then, a soft relation R on E (from L to E) can be defined in tabular form (see Table 3) as follows:

Table 3. Soft relation R .

R	$u_1 u_2$	$u_2 u_3$	$u_2 u_2$	$u_3 u_2$
$k_1 k_3$	1	1	1	0
$k_2 k_1$	0	0	0	1
$k_3 k_2$	0	1	0	0

Now, we can define set-valued function R_s such that

$$R_s(u_1 u_2) = \{k_1 k_3\}, R_s(u_2 u_3) = \{k_1 k_3, k_3 k_2\}, R_s(u_2 u_2) = \{k_1 k_3\}, R_s(u_3 u_2) = \{k_2 k_1\}.$$

Let $C = \{(k_1, 0.2, 0.4, 0.6), (k_2, 0.4, 0.5, 0.2), (k_3, 0.1, 0.2, 0.4)\}$ be an NS on M , then

$$\overline{R}(C) = \{(u_1, 0.2, 0.2, 0.4), (u_2, 0.2, 0.4, 0.4), (u_3, 0.4, 0.2, 0.2)\},$$

$$\underline{R}(C) = \{(u_1, 0.1, 0.4, 0.6), (u_2, 0.1, 0.4, 0.6), (u_3, 0.1, 0.5, 0.4)\},$$

Let $D = \{(k_1 k_3, 0.1, 0.2, 0.2), (k_2 k_1, 0.1, 0.1, 0.2), (k_3 k_2, 0.1, 0.2, 0.1)\}$ be an NS on L , then

$$\overline{R}(D) = \{(u_1 u_2, 0.1, 0.2, 0.2), (u_2 u_3, 0.1, 0.2, 0.1), (u_2 u_2, 0.1, 0.2, 0.2), (u_3 u_2, 0.1, 0.1, 0.2)\},$$

$$\underline{R}(D) = \{(u_1 u_2, 0.1, 0.2, 0.2), (u_2 u_3, 0.1, 0.2, 0.1), (u_2 u_2, 0.1, 0.2, 0.2), (u_3 u_2, 0.1, 0.1, 0.2)\}.$$

Hence, $R(D) = (\underline{R}(D), \overline{R}(D))$ is SRNR.

3. Construction of Neutrosophic Soft Rough Sets

In this section, we will introduce the notions of NSRSs, neutrosophic soft rough relations (NSRRs).

Definition 3. Let Y be an initial universal set and M a universal set of parameters. For an arbitrary neutrosophic soft relation \tilde{P} from Y to M , (Y, M, \tilde{P}) is called neutrosophic soft approximation space (NSAS). For any NS $C \in \mathcal{N}(M)$, we define the upper neutrosophic soft approximation (UNSA) and the lower neutrosophic soft approximation (LNSA) operators of C with respect to (Y, M, \tilde{P}) denoted by $\overline{\tilde{P}}(C)$ and $\underline{\tilde{P}}(C)$, respectively as follows:

$$\begin{aligned} \overline{\tilde{P}}(C) &= \{(u, T_{\overline{\tilde{P}}(C)}(u), I_{\overline{\tilde{P}}(C)}(u), F_{\overline{\tilde{P}}(C)}(u)) \mid u \in Y\}, \\ \underline{\tilde{P}}(C) &= \{(u, T_{\underline{\tilde{P}}(C)}(u), I_{\underline{\tilde{P}}(C)}(u), F_{\underline{\tilde{P}}(C)}(u)) \mid u \in Y\}, \end{aligned}$$

where

$$\begin{aligned} T_{\overline{\tilde{P}}(C)}(u) &= \bigvee_{k \in M} (T_{\tilde{P}(C)}(u, k) \wedge T_C(k)), & I_{\overline{\tilde{P}}(C)}(u) &= \bigwedge_{k \in M} (I_{\tilde{P}(C)}(u, k) \vee I_C(k)), \\ F_{\overline{\tilde{P}}(C)}(u) &= \bigwedge_{k \in M} (F_{\tilde{P}(C)}(u, k) \vee F_C(k)), \\ T_{\underline{\tilde{P}}(C)}(u) &= \bigwedge_{k \in M} (F_{\tilde{P}(C)}(u, k) \vee T_C(k)), & I_{\underline{\tilde{P}}(C)}(u) &= \bigvee_{k \in M} ((1 - I_{\tilde{P}(C)}(u, k)) \wedge I_C(k)), \\ F_{\underline{\tilde{P}}(C)}(u) &= \bigvee_{k \in M} (T_{\tilde{P}(C)}(u, k) \wedge F_C(k)). \end{aligned}$$

The pair $(\underline{\tilde{P}}(C), \overline{\tilde{P}}(C))$ is called NSRS of C w.r.t (Y, M, \tilde{P}) , and $\underline{\tilde{P}}$ and $\overline{\tilde{P}}$ are referred to as the LNSRA and the UNSRA operators, respectively.

Remark 3. A neutrosophic soft relation over $Y \times M$ is actually a neutrosophic soft set on Y . The NSRA operators are defined over two distinct universes Y and M . As we know, universal set Y and parameter set M are two different universes of discourse but have solid relations. These universes can not be considered as identical universes; therefore, the reflexive, symmetric and transitive properties of neutrosophic soft relations from Y to M do not exist.

Let \tilde{P} be a neutrosophic soft relation from Y to M , if, for each $u \in Y$, there exists $k \in M$ such that $T_{\tilde{P}}(u, k) = 1, I_{\tilde{P}}(u, k) = 0, F_{\tilde{P}}(u, k) = 0$. Then, \tilde{P} is referred to as a serial neutrosophic soft relation from Y to parameter set M .

Example 4. Suppose that $Y = \{w_1, w_2, w_3, w_4\}$ is the set of careers under consideration, and Mr. X wants to select the most suitable career. $M = \{k_1, k_2, k_3\}$ is a set of decision parameters. Mr. X describes the "most suitable career" by defining a neutrosophic soft set (\tilde{P}, M) on Y that is a neutrosophic relation from Y to M as shown in Table 4.

Table 4. Neutrosophic soft relation \tilde{P} .

\tilde{P}	w_1	w_2	w_3	w_4
k_1	(0.3, 0.4, 0.5)	(0.4, 0.2, 0.3)	(0.1, 0.5, 0.4)	(0.2, 0.3, 0.4)
k_2	(0.1, 0.5, 0.4)	(0.3, 0.4, 0.6)	(0.4, 0.4, 0.3)	(0.5, 0.3, 0.8)
k_3	(0.3, 0.4, 0.4)	(0.4, 0.6, 0.7)	(0.3, 0.5, 0.4)	(0.5, 0.4, 0.6)

Now, Mr. X gives the most favorable decision object C , which is an NS on M defined as follows:
 $C = \{(k_1, 0.5, 0.2, 0.4), (k_2, 0.2, 0.3, 0.1), (k_3, 0.2, 0.4, 0.6)\}$. By Definition 3, we have

$$\begin{aligned} T_{\bar{P}(C)}(w_1) &= \bigvee_{k \in M} (T_{\bar{P}(C)}(w_1, k) \wedge T_C(k)) = \bigvee \{0.3, 0.1, 0.2\} = 0.3, \\ I_{\bar{P}(C)}(w_1) &= \bigwedge_{k \in M} (I_{\bar{P}(C)}(w_1, k) \vee I_C(k)) = \bigwedge \{0.4, 0.5, 0.4\} = 0.4, \\ F_{\bar{P}(C)}(w_1) &= \bigwedge_{k \in M} (F_{\bar{P}(C)}(w_1, k) \vee F_C(k)) = \bigwedge \{0.5, 0.4, 0.6\} = 0.4, \\ T_{\bar{P}(C)}(w_2) &= 0.4, \quad I_{\bar{P}(C)}(w_2) = 0.2, \quad F_{\bar{P}(C)}(w_2) = 0.4, \\ T_{\bar{P}(C)}(w_3) &= 0.2, \quad I_{\bar{P}(C)}(w_3) = 0.4, \quad F_{\bar{P}(C)}(w_3) = 0.3, \\ T_{\bar{P}(C)}(w_4) &= 0.2, \quad I_{\bar{P}(C)}(w_4) = 0.3, \quad F_{\bar{P}(C)}(w_4) = 0.4. \end{aligned}$$

Similarly,

$$\begin{aligned} T_{\underline{P}(C)}(w_1) &= \bigwedge_{k \in M} (F_{\underline{P}(C)}(w_1, k) \vee T_C(k)) = \bigwedge \{0.5, 0.4, 0.4\} = 0.4, \\ I_{\underline{P}(C)}(w_1) &= \bigvee_{k \in M} ((1 - I_{\underline{P}(C)}(w_1, k)) \wedge I_C(k)) = \bigvee \{0.2, 0.3, 0.4\} = 0.4, \\ F_{\underline{P}(C)}(w_1) &= \bigvee_{k \in M} (T_{\underline{P}(C)}(w_1, k) \wedge F_C(k)) = \bigvee \{0.3, 0.1, 0.3\} = 0.3, \\ T_{\underline{P}(C)}(w_2) &= 0.5, \quad I_{\underline{P}(C)}(w_2) = 0.4, \quad F_{\underline{P}(C)}(w_2) = 0.4, \\ T_{\underline{P}(C)}(w_3) &= 0.4, \quad I_{\underline{P}(C)}(w_3) = 0.4, \quad F_{\underline{P}(C)}(w_3) = 0.3, \\ T_{\underline{P}(C)}(w_4) &= 0.5, \quad I_{\underline{P}(C)}(w_4) = 0.4, \quad F_{\underline{P}(C)}(w_4) = 0.5. \end{aligned}$$

Thus, we obtain

$$\begin{aligned} \bar{P}(C) &= \{(w_1, 0.3, 0.4, 0.4), (w_2, 0.4, 0.2, 0.4), (w_3, 0.2, 0.4, 0.3), (w_4, 0.2, 0.3, 0.4)\}, \\ \underline{P}(C) &= \{(w_1, 0.4, 0.4, 0.3), (w_2, 0.5, 0.4, 0.4), (w_3, 0.4, 0.4, 0.3), (w_4, 0.5, 0.4, 0.5)\}. \end{aligned}$$

Hence, $(\underline{P}(C), \bar{P}(C))$ is an NSRS of C .

Theorem 2. Let (Y, M, \tilde{P}) be an NSAS. Then, the UNSRA and the LNSRA operators $\bar{P}(C)$ and $\underline{P}(C)$ satisfy the following properties for all $C, D \in \mathcal{N}(M)$:

- (i) $\underline{P}(C) = \sim \bar{P}(\sim A)$,
- (ii) $\underline{P}(C \cap D) = \underline{P}(C) \cap \underline{P}(D)$,
- (iii) $C \subseteq D \Rightarrow \underline{P}(C) \subseteq \underline{P}(D)$,
- (iv) $\underline{P}(C \cup D) \supseteq \underline{P}(C) \cup \underline{P}(D)$,
- (v) $\bar{P}(C) = \sim \underline{P}(\sim C)$,
- (vi) $\bar{P}(C \cup D) = \bar{P}(C) \cup \bar{P}(D)$,
- (vii) $C \subseteq D \Rightarrow \bar{P}(C) \subseteq \bar{P}(D)$,
- (viii) $\bar{P}(C \cap D) \subseteq \bar{P}(C) \cap \bar{P}(D)$.

Proof. (i)

$$\sim C = \{(k, F_C(k), 1 - I_C(k), T_C(k)) \mid k \in M\}.$$

By definition of NSRS, we have

$$\begin{aligned} \tilde{P}(\sim C) &= \{(u, T_{\tilde{P}(\sim C)}(u), I_{\tilde{P}(\sim C)}(u), F_{\tilde{P}(\sim C)}(u)) \mid u \in Y\}, \\ \sim \tilde{P}(\sim C) &= \{(u, F_{\tilde{P}(\sim C)}(u), 1 - I_{\tilde{P}(\sim C)}(u), T_{\tilde{P}(\sim C)}(u)) \mid u \in Y\}, \\ F_{\tilde{P}(\sim C)}(u) &= \bigwedge_{k \in M} (F_{\tilde{P}}(u, k) \vee T_C(k)) \\ &= T_{\underline{\tilde{P}}(C)}(u), \\ 1 - I_{\tilde{P}(\sim C)}(u) &= 1 - \left(\bigwedge_{k \in M} [I_{\tilde{P}}(u, k) \vee I_{\sim C}(k)] \right) \\ &= \bigvee_{k \in M} \left((1 - I_{\tilde{P}}(u, k)) \wedge (1 - I_{\sim C}(k)) \right) \\ &= \bigvee_{k \in M} \left((1 - I_{\tilde{P}}(u, k)) \wedge (1 - (1 - I_C(k))) \right) \\ &= \bigvee_{k \in M} \left((1 - I_{\tilde{P}}(u, k)) \wedge I_C(k) \right) \\ &= I_{\underline{\tilde{P}}(C)}(u), \\ T_{\tilde{P}(\sim C)}(u) &= \bigvee_{k \in M} (T_{\tilde{P}}(u, k) \wedge T_{\sim C}(k)) \\ &= \bigvee_{k \in M} (T_{\tilde{P}}(u, k) \wedge F_C(k)) \\ &= F_{\underline{\tilde{P}}(C)}(u). \end{aligned}$$

Thus, $\underline{\tilde{P}}(C) = \sim \overline{\tilde{P}}(\sim C).$

(ii)

$$\begin{aligned} \underline{\tilde{P}}(C \cap D) &= \{(u, T_{\underline{\tilde{P}}(C \cap D)}(u), I_{\underline{\tilde{P}}(C \cap D)}(u), F_{\underline{\tilde{P}}(C \cap D)}(u))\}, \\ \underline{\tilde{P}}(C) \cap \underline{\tilde{P}}(D) &= \{(u, T_{\underline{\tilde{P}}(C)}(u) \wedge T_{\underline{\tilde{P}}(D)}(u), I_{\underline{\tilde{P}}(C)}(u) \vee I_{\underline{\tilde{P}}(D)}(u), F_{\underline{\tilde{P}}(C)}(u) \vee F_{\underline{\tilde{P}}(D)}(u))\}. \end{aligned}$$

Now, consider

$$\begin{aligned} T_{\underline{\tilde{P}}(C \cap D)}(u) &= \bigwedge_{k \in M} (F_{\underline{\tilde{P}}}(u, k) \vee T_{C \cap D}(k)) \\ &= \bigwedge_{k \in M} (F_{\underline{\tilde{P}}}(u, k) \vee (T_C(k) \wedge T_D(k))) \\ &= \bigwedge_{k \in M} (F_{\underline{\tilde{P}}}(u, k) \vee T_C(k)) \wedge \bigwedge_{k \in M} (F_{\underline{\tilde{P}}}(u, k) \vee T_D(k)) \\ &= T_{\underline{\tilde{P}}(C)}(u) \wedge T_{\underline{\tilde{P}}(D)}(u), \end{aligned}$$

$$\begin{aligned}
 I_{\underline{\tilde{P}}(C \cap D)}(u) &= \bigvee_{k \in M} ((1 - I_{\underline{\tilde{P}}}(u, k)) \wedge I_{C \cap D}(k)) \\
 &= \bigvee_{k \in M} ((1 - I_{\underline{\tilde{P}}}(u, k)) \wedge (I_C(k) \vee I_D(k))) \\
 &= \bigvee_{k \in M} ((1 - I_{\underline{\tilde{P}}}(u, k))) \wedge I_C(k) \vee \bigvee_{k \in M} ((1 - I_{\underline{\tilde{P}}}(u, k)) \vee I_D(k)) \\
 &= I_{\underline{\tilde{P}}(C)}(u) \vee I_{\underline{\tilde{P}}(D)}(u), \\
 F_{\underline{\tilde{P}}(C \cap D)}(u) &= \bigvee_{k \in M} (T_{\underline{\tilde{P}}}(u, k) \wedge F_{C \cap D}(k)) \\
 &= \bigvee_{k \in M} (T_{\underline{\tilde{P}}}(u, k) \wedge (F_C(k) \vee F_D(k))) \\
 &= \bigvee_{k \in M} (T_{\underline{\tilde{P}}}(u, k) \wedge F_C(k)) \vee \bigvee_{k \in M} (T_{\underline{\tilde{P}}}(u, k) \wedge F_D(k)) \\
 &= F_{\underline{\tilde{P}}(C)}(u) \vee F_{\underline{\tilde{P}}(D)}(u). \\
 \text{Thus, } \underline{\tilde{P}}(C \cap D) &= \underline{\tilde{P}}(C) \cap \underline{\tilde{P}}(D).
 \end{aligned}$$

(iii) It can be easily proven by Definition 3.

(iv)

$$\begin{aligned}
 \underline{\tilde{P}}(C \cup D) &= \{(u, T_{\underline{\tilde{P}}(C \cup D)}(u), I_{\underline{\tilde{P}}(C \cup D)}(u), F_{\underline{\tilde{P}}(C \cup D)}(u))\}, \\
 \underline{\tilde{P}}(C) \cup \underline{\tilde{P}}(D) &= \{(u, T_{\underline{\tilde{P}}(C)}(u) \vee T_{\underline{\tilde{P}}(D)}(u), I_{\underline{\tilde{P}}(C)}(u) \wedge I_{\underline{\tilde{P}}(D)}(u), F_{\underline{\tilde{P}}(C)}(u) \wedge F_{\underline{\tilde{P}}(D)}(u))\}, \\
 T_{\underline{\tilde{P}}(C \cup D)}(u) &= \bigwedge_{k \in M} (F_{\underline{\tilde{P}}}(u, k) \vee T_{C \cup D}(k)) \\
 &= \bigwedge_{k \in M} (F_{\underline{\tilde{P}}}(u, k) \vee [T_C(k) \vee T_D(k)]) \\
 &= \bigwedge_{k \in M} ([F_{\underline{\tilde{P}}}(u, k) \vee T_C(k)] \vee [F_{\underline{\tilde{P}}}(u, k) \vee T_D(k)]) \\
 &\geq \bigwedge_{k \in M} (F_{\underline{\tilde{P}}}(u, k) \vee T_C(k)) \vee \bigwedge_{k \in M} (F_{\underline{\tilde{P}}}(u, k) \vee T_D(k)) \\
 &= T_{\underline{\tilde{P}}(C)}(u) \vee T_{\underline{\tilde{P}}(D)}(u), \\
 I_{\underline{\tilde{P}}(C \cup D)}(u) &= \bigvee_{k \in M} ((1 - I_{\underline{\tilde{P}}}(u, k)) \wedge I_{C \cup D}(k)) \\
 &= \bigvee_{k \in M} ((1 - I_{\underline{\tilde{P}}}(u, k)) \wedge [I_C(k) \wedge I_D(k)]) \\
 &= \bigvee_{k \in M} ([1 - I_{\underline{\tilde{P}}}(u, k)] \wedge I_C(k)) \wedge [(1 - I_{\underline{\tilde{P}}}(u, k)) \wedge I_D(k)] \\
 &\leq \bigvee_{k \in M} ((1 - I_{\underline{\tilde{P}}}(u, k)) \wedge I_C(k)) \wedge \bigvee_{k \in M} ((1 - I_{\underline{\tilde{P}}}(u, k)) \wedge I_D(k)) \\
 &= I_{\underline{\tilde{P}}(C)}(u) \wedge I_{\underline{\tilde{P}}(D)}(u), \\
 F_{\underline{\tilde{P}}(C \cup D)}(u) &= \bigvee_{k \in M} (T_{\underline{\tilde{P}}}(u, k) \wedge F_{C \cup D}(k)) \\
 &= \bigvee_{k \in M} (T_{\underline{\tilde{P}}}(u, k) \wedge [F_C(k) \wedge F_D(k)]) \\
 &= \bigvee_{k \in M} ([T_{\underline{\tilde{P}}}(u, k) \wedge F_C(k)] \wedge [T_{\underline{\tilde{P}}}(u, k) \wedge F_D(k)]) \\
 &\leq \bigvee_{k \in M} (T_{\underline{\tilde{P}}}(u, k) \wedge F_C(k)) \wedge \bigvee_{k \in M} (T_{\underline{\tilde{P}}}(u, k) \wedge F_D(k)) \\
 &= F_{\underline{\tilde{P}}(C)}(u) \wedge F_{\underline{\tilde{P}}(D)}(u).
 \end{aligned}$$

(vii)

$$\begin{aligned}
 \bar{P}(C \cap D) &= \{(u, T_{\bar{P}(C \cap D)}(u), I_{\bar{P}(C \cap D)}(u), F_{\bar{P}(C \cap D)}(u))\}, \\
 \bar{P}(C) \cap \bar{P}(D) &= \{(u, T_{\bar{P}(C)}(u) \wedge T_{\bar{P}(D)}(u), I_{\bar{P}(C)}(u) \vee I_{\bar{P}(D)}(u), F_{\bar{P}(C)}(u) \vee F_{\bar{P}(D)}(u))\}, \\
 T_{\bar{P}(C \cap D)}(u) &= \bigvee_{k \in M} (T_{\bar{P}}(u, k) \wedge T_{C \cap D}(k)) \\
 &= \bigvee_{k \in M} (T_{\bar{P}}(u, k) \wedge [T_C(k) \wedge T_D(k)]) \\
 &= \bigvee_{k \in M} ([T_{\bar{P}}(u, k) \wedge T_C(k)] \wedge [T_{\bar{P}}(u, k) \wedge T_D(k)]) \\
 &\leq \bigvee_{k \in M} (T_{\bar{P}}(u, k) \wedge T_C(k)) \wedge \bigvee_{k \in M} (T_{\bar{P}}(u, k) \wedge T_D(k)) \\
 &= T_{\bar{P}(C)}(u) \wedge T_{\bar{P}(D)}(u), \\
 I_{\bar{P}(C \cap D)}(u) &= \bigwedge_{k \in M} (I_{\bar{P}}(u, k) \vee I_{C \cap D}(k)) \\
 &= \bigwedge_{k \in M} (I_{\bar{P}}(u, k) \vee [I_C(k) \vee I_D(k)]) \\
 &= \bigwedge_{k \in M} ([I_{\bar{P}}(u, k) \vee I_C(k)] \vee [I_{\bar{P}}(u, k) \vee I_D(k)]) \\
 &\geq \bigwedge_{k \in M} ((I_{\bar{P}}(u, k) \vee I_C(k)) \vee \bigwedge_{k \in M} ((I_{\bar{P}}(u, k) \vee I_D(k))) \\
 &= I_{\bar{P}(C)}(u) \vee I_{\bar{P}(D)}(u), \\
 F_{\bar{P}(C \cap D)}(u) &= \bigwedge_{k \in M} (F_{\bar{P}}(u, k) \vee F_{C \cap D}(k)) \\
 &= \bigwedge_{k \in M} (F_{\bar{P}}(u, k) \vee [F_C(k) \vee F_D(k)]) \\
 &= \bigwedge_{k \in M} ([F_{\bar{P}}(u, k) \vee F_C(k)] \vee [F_{\bar{P}}(u, k) \vee F_D(k)]) \\
 &\geq \bigwedge_{k \in M} (F_{\bar{P}}(u, k) \vee F_C(k)) \vee \bigwedge_{k \in M} (F_{\bar{P}}(u, k) \vee F_D(k)) \\
 &= F_{\bar{P}(C)}(u) \vee F_{\bar{P}(D)}(u).
 \end{aligned}$$

Thus, $\bar{P}(C \cap D) \subseteq \bar{P}(C) \cap \bar{P}(D)$.

The properties (v)–(vii) of the UNSRA operator $\bar{P}(C)$ can be easily proved similarly. \square

Theorem 3. Let (Y, M, \bar{P}) be an NSAS. The UNSRA and the LNSRA operators \bar{P} and \underline{P} satisfy the following properties for all $C, D \in \mathcal{N}(M)$:

- (i) $\underline{P}(C - D) \supseteq \underline{P}(C) - \bar{P}(D)$,
- (ii) $\bar{P}(C - D) \subseteq \bar{P}(C) - \underline{P}(D)$.

Proof. (i) By Definition 3 and definition of difference of two NSs, for all $u \in Y$,

$$\begin{aligned}
 T_{\underline{\tilde{P}}(C-D)}(u) &= \bigwedge_{k \in M} (F_{\tilde{P}}(u, k) \vee T_{C-D}(k)) \\
 &= \bigwedge_{k \in M} (F_{\tilde{P}}(u, k) \vee (T_C(k) \wedge F_D(k))) \\
 &= \bigwedge_{k \in M} \left([F_{\tilde{P}}(u, k) \vee T_C(k)] \wedge [F_{\tilde{P}}(u, k) \vee F_D(k)] \right) \\
 &= \bigwedge_{k \in M} (F_{\tilde{P}}(u, k) \vee T_C(k)) \wedge \bigwedge_{k \in M} (F_{\tilde{P}}(u, k) \vee F_D(k)) \\
 &= T_{\underline{\tilde{P}}(C)}(u) \wedge F_{\overline{\tilde{P}}(D)}(u) \\
 &= T_{\underline{\tilde{P}}(C) - \overline{\tilde{P}}(D)}(u), \\
 I_{\underline{\tilde{P}}(C-D)}(u) &= \bigvee_{k \in M} ((1 - I_{\tilde{P}}(u, k)) \wedge I_{C-D}(k)) \\
 &= \bigvee_{k \in M} ((1 - I_{\tilde{P}}(u, k)) \wedge (I_C(k) \wedge (1 - I_D(k)))) \\
 &= \bigvee_{k \in M} \left([(1 - I_{\tilde{P}}(u, k)) \wedge I_C(k)] \wedge [(1 - I_{\tilde{P}}(u, k)) \wedge (1 - I_D(k))] \right) \\
 &= \bigvee_{k \in M} \left([(1 - I_{\tilde{P}}(u, k)) \wedge I_C(k)] \wedge [1 - (I_{\tilde{P}}(u, k) \vee I_D(k))] \right) \\
 &\leq \bigvee_{k \in M} ((1 - I_{\tilde{P}}(u, k)) \wedge I_C(k)) \wedge \bigvee_{k \in M} (1 - (I_{\tilde{P}}(u, k) \vee I_D(k))) \\
 &\leq \bigvee_{k \in M} ((1 - I_{\tilde{P}}(u, k)) \wedge I_C(k)) \wedge \left(1 - \bigwedge_{k \in M} (I_{\tilde{P}}(u, k) \vee I_D(k)) \right) \\
 &= I_{\underline{\tilde{P}}(C)}(u) \wedge (1 - I_{\overline{\tilde{P}}(D)}(u)) \\
 &= I_{\underline{\tilde{P}}(C) - \overline{\tilde{P}}(D)}(u), \\
 F_{\underline{\tilde{P}}(C-D)}(u) &= \bigvee_{k \in M} (T_{\tilde{P}}(u, k) \wedge F_{C-D}(k)) \\
 &= \bigvee_{k \in M} (T_{\tilde{P}}(u, k) \wedge (F_C(k) \wedge T_D(k))) \\
 &= \bigvee_{k \in M} \left([T_{\tilde{P}}(u, k) \wedge F_C(k)] \wedge [T_{\tilde{P}}(u, k) \wedge T_D(k)] \right) \\
 &\leq \bigvee_{k \in M} (T_{\tilde{P}}(u, k) \wedge F_C(k)) \wedge \bigvee_{k \in M} (T_{\tilde{P}}(u, k) \wedge T_D(k)) \\
 &= F_{\underline{\tilde{P}}(C)}(u) \wedge T_{\overline{\tilde{P}}(D)}(u) \\
 &= F_{\underline{\tilde{P}}(C) - \overline{\tilde{P}}(D)}(u).
 \end{aligned}$$

Thus, $\underline{\tilde{P}}(C - D) \subseteq \underline{\tilde{P}}(C) - \overline{\tilde{P}}(D)$.

(ii) By Definition 3 and definition of difference of two NSs, for all $u \in Y$,

$$\begin{aligned}
 T_{\overline{\tilde{P}}(C-D)}(u) &= \bigvee_{k \in M} (T_{\tilde{P}}(u, k) \wedge T_{C-D}(k)) \\
 &= \bigvee_{k \in M} (T_{\tilde{P}}(u, k) \wedge (T_C(k) \wedge F_D(k))) \\
 &= \bigvee_{k \in M} ([T_{\tilde{P}}(u, k) \wedge T_C(k)] \wedge [T_{\tilde{P}}(u, k) \wedge F_D(k)]) \\
 &\leq \bigvee_{k \in M} (T_{\tilde{P}}(u, k) \wedge T_C(k)) \wedge \bigvee_{k \in M} (T_{\tilde{P}}(u, k) \wedge F_D(k)) \\
 &= T_{\overline{\tilde{P}}(C)}(u) \wedge F_{\underline{\tilde{P}}(D)}(u) \\
 &= T_{\overline{\tilde{P}}(C) - \underline{\tilde{P}}(D)}(u), \\
 I_{\overline{\tilde{P}}(C-D)}(u) &= \bigwedge_{k \in M} (I_{\tilde{P}}(u, k) \vee I_{C-D}(k)) \\
 &= \bigwedge_{k \in M} (I_{\tilde{P}}(u, k) \vee (I_C(k) \wedge (1 - I_D(k)))) \\
 &= \bigwedge_{k \in M} ([I_{\tilde{P}}(u, k) \vee I_C(k)] \wedge [I_{\tilde{P}}(u, k) \vee (1 - I_D(k))]) \\
 &= \bigwedge_{k \in M} ([I_{\tilde{P}}(u, k) \vee I_C(k)] \wedge [1 - (1 - I_{\tilde{P}}(u, k)) \vee (1 - I_D(k))]) \\
 &= \bigwedge_{k \in M} (I_{\tilde{P}}(u, k) \vee I_C(k)) \wedge \left(1 - \bigvee_{k \in M} ((1 - I_{\tilde{P}}(u, k)) \wedge I_D(k))\right) \\
 &= I_{\overline{\tilde{P}}(C)}(u) \wedge (1 - I_{\underline{\tilde{P}}(D)}(u)) \\
 &= I_{\overline{\tilde{P}}(C) - \underline{\tilde{P}}(D)}(u), \\
 F_{\overline{\tilde{P}}(C-D)}(u) &= \bigwedge_{k \in M} (F_{\tilde{P}}(u, k) \vee F_{C-D}(k)) \\
 &= \bigwedge_{k \in M} (F_{\tilde{P}}(u, k) \vee (F_C(k) \wedge T_D(k))) \\
 &= \bigwedge_{k \in M} ([F_{\tilde{P}}(u, k) \vee F_C(k)] \wedge [F_{\tilde{P}}(u, k) \vee T_D(k)]) \\
 &= \bigwedge_{k \in M} (F_{\tilde{P}}(u, k) \vee F_C(k)) \wedge \bigwedge_{k \in M} (F_{\tilde{P}}(u, k) \vee T_D(k)) \\
 &= F_{\overline{\tilde{P}}(C)}(u) \wedge T_{\underline{\tilde{P}}(D)}(u) \\
 &= F_{\overline{\tilde{P}}(C) - \underline{\tilde{P}}(D)}(u).
 \end{aligned}$$

Thus, $\overline{\tilde{P}}(C - D) \subseteq \overline{\tilde{P}}(C) - \underline{\tilde{P}}(D)$.

□

Theorem 4. Let (Y, M, \tilde{P}) be an NSAS. If \tilde{P} is serial, then the UNSA and the LNSA operators $\overline{\tilde{P}}$ and $\underline{\tilde{P}}$ satisfy the following properties for all $\emptyset, M, C \in \mathcal{N}(M)$:

- (i) $\overline{\tilde{P}}(\emptyset) = \emptyset, \underline{\tilde{P}}(M) = Y,$
- (ii) $\underline{\tilde{P}}(C) \subseteq \overline{\tilde{P}}(C).$

Proof. (i)

$$\begin{aligned} \bar{P}(\emptyset) &= \{(u, T_{\bar{P}(\emptyset)}(u), I_{\bar{P}(\emptyset)}(u), F_{\bar{P}(\emptyset)}(u)) \mid u \in Y\}, \\ T_{\bar{P}(\emptyset)}(u) &= \bigvee_{k \in M} (T_{\bar{P}}(u, k) \wedge T_{\emptyset}(k)), \\ I_{\bar{P}(\emptyset)}(u) &= \bigwedge_{k \in M} (I_{\bar{P}}(u, k) \vee I_{\emptyset}(k)), \\ F_{\bar{P}(\emptyset)}(u) &= \bigwedge_{k \in M} (F_{\bar{P}}(u, k) \vee F_{\emptyset}(k)). \end{aligned}$$

Since \emptyset is a null NS on M , $T_{\emptyset}(k) = 0$, $I_{\emptyset}(k) = 1$, $F_{\emptyset}(k) = 1$, and this implies $T_{\bar{P}(\emptyset)}(u) = 0$, $I_{\bar{P}(\emptyset)}(u) = 1$, $F_{\bar{P}(\emptyset)}(u) = 1$. Thus, $\bar{P}(\emptyset) = \emptyset$.

Now,

$$\begin{aligned} \tilde{P}(M) &= \{(u, T_{\tilde{P}(M)}(u), I_{\tilde{P}(M)}(u), F_{\tilde{P}(M)}(u)) \mid u \in Y\}, \\ T_{\tilde{P}(M)}(u) &= \bigwedge_{k \in M} (F_{\tilde{P}}(u, k) \vee T_M(k)), \quad I_{\tilde{P}(M)}(u) = \bigvee_{k \in M} ((1 - I_{\tilde{P}}(u, k)) \wedge I_M(k)), \\ F_{\tilde{P}(M)}(u) &= \bigvee_{k \in M} (T_{\tilde{P}}(u, k) \wedge F_M(k)). \end{aligned}$$

Since M is full NS on M , $T_M(k) = 1$, $I_M(k) = 0$, $F_M(k) = 0$, for all $k \in M$, and this implies $T_{\tilde{P}(M)}(u) = 1$, $I_{\tilde{P}(M)}(u) = 0$, $F_{\tilde{P}(M)}(u) = 0$. Thus, $\tilde{P}(M) = Y$.

(ii) Since (Y, M, \tilde{P}) is an NSAS and \tilde{P} is a serial neutrosophic soft relation, then, for each $u \in Y$, there exists $k \in M$, such that $T_{\tilde{P}}(u, k) = 1$, $I_{\tilde{P}}(u, k) = 0$, and $F_{\tilde{P}}(u, k) = 0$. The UNSRA and LNSRA operators $\bar{P}(C)$, and $\tilde{P}(C)$ of an NS C can be defined as:

$$\begin{aligned} T_{\bar{P}(C)}(u) &= \bigvee_{k \in M} T_C(k), \quad I_{\bar{P}(C)}(u) = \bigwedge_{k \in M} I_C(k), \\ F_{\bar{P}(C)}(u) &= \bigwedge_{k \in M} F_C(k), \\ T_{\tilde{P}(C)}(u) &= \bigwedge_{k \in M} T_C(k), \quad I_{\tilde{P}(C)}(u) = \bigvee_{k \in M} I_C(k), \\ F_{\tilde{P}(C)}(u) &= \bigvee_{k \in M} F_C(k). \end{aligned}$$

Clearly, $T_{\tilde{P}(C)}(u) \leq T_{\bar{P}(C)}(u)$, $I_{\tilde{P}(C)}(u) \geq I_{\bar{P}(C)}(u)$, $F_{\tilde{P}(C)}(u) \geq F_{\bar{P}(C)}(u)$ for all $u \in Y$. Thus, $\tilde{P}(C) \subseteq \bar{P}(C)$.

□

The conventional NSS is a mapping from a parameter to the neutrosophic subset of universe and let (\tilde{P}, M) be NSS. Now, we present the constructive definition of neutrosophic soft rough relation by using a neutrosophic soft relation \tilde{R} from $M \times M = \tilde{M}$ to $\mathcal{N}(Y \times Y = \tilde{Y})$, where Y is a universal set and M is a set of parameters.

Definition 4. A neutrosophic soft rough relation $(\tilde{R}(D), \bar{R}(D))$ on Y is an NSRS, $\tilde{R} : \tilde{M} \rightarrow \mathcal{N}(\tilde{Y})$ is a neutrosophic soft relation on Y defined by

$$\tilde{R}(k_i k_j) = \{u_i u_j \mid \exists u_i \in \tilde{P}(k_i), u_j \in \tilde{P}(k_j)\}, u_i u_j \in \tilde{Y},$$

such that

$$\begin{aligned} T_{\bar{R}}(u_i u_j, k_i k_j) &\leq \min\{T_{\bar{P}}(u_i, k_i), T_{\bar{P}}(u_j, k_j)\}, \\ I_{\bar{R}}(u_i u_j, k_i k_j) &\leq \max\{I_{\bar{P}}(u_i, k_i), I_{\bar{P}}(u_j, k_j)\}, \\ F_{\bar{R}}(u_i u_j, k_i k_j) &\leq \max\{F_{\bar{P}}(u_i, k_i), F_{\bar{P}}(u_j, k_j)\}. \end{aligned}$$

For any $D \in \mathcal{N}(\acute{M})$, the UNSA and the LNSA of B w.r.t $(\acute{Y}, \acute{M}, \bar{R})$ are defined as follows:

$$\bar{\bar{R}}(D) = \{(u_i u_j, T_{\bar{\bar{R}}(D)}(u_i u_j), I_{\bar{\bar{R}}(D)}(u_i u_j), F_{\bar{\bar{R}}(D)}(u_i u_j)) \mid u_i u_j \in \acute{Y}\},$$

$$\bar{\underline{R}}(D) = \{(u_i u_j, T_{\bar{\underline{R}}(D)}(u_i u_j), I_{\bar{\underline{R}}(D)}(u_i u_j), F_{\bar{\underline{R}}(D)}(u_i u_j)) \mid u_i u_j \in \acute{Y}\},$$

where

$$\begin{aligned} T_{\bar{\bar{R}}(D)}(u_i u_j) &= \bigvee_{k_i k_j \in \acute{M}} (T_{\bar{R}}(u_i u_j, k_i k_j) \wedge T_D(k_i k_j)), \\ I_{\bar{\bar{R}}(D)}(u_i u_j) &= \bigwedge_{k_i k_j \in \acute{M}} (I_{\bar{R}}(u_i u_j, k_i k_j) \vee I_D(k_i k_j)), \\ F_{\bar{\bar{R}}(D)}(u_i u_j) &= \bigwedge_{k_i k_j \in \acute{M}} (F_{\bar{R}}(u_i u_j, k_i k_j) \vee F_D(k_i k_j)), \end{aligned}$$

$$\begin{aligned} T_{\bar{\underline{R}}(D)}(u_i u_j) &= \bigwedge_{k_i k_j \in \acute{M}} (F_{\bar{R}}(u_i u_j, k_i k_j) \vee T_D(k_i k_j)), \\ I_{\bar{\underline{R}}(D)}(u_i u_j) &= \bigvee_{k_i k_j \in \acute{M}} ((1 - I_{\bar{R}}(u_i u_j, k_i k_j)) \wedge I_D(k_i k_j)), \\ F_{\bar{\underline{R}}(D)}(u_i u_j) &= \bigvee_{k_i k_j \in \acute{M}} (T_{\bar{R}}(u_i u_j, k_i k_j) \wedge F_D(k_i k_j)). \end{aligned}$$

The pair $(\bar{\underline{R}}(D), \bar{\bar{R}}(D))$ is called NSRR and $\bar{\underline{R}}, \bar{\bar{R}} : \mathcal{N}(\acute{M}) \rightarrow \mathcal{N}(\acute{Y})$ are called the LNSRA and the UNSRA operators, respectively.

Remark 4. Consider an NS D on \acute{M} and an NS C on M ,

$$\begin{aligned} T_D(k_i k_j) &\leq \min\{T_C(k_i), T_C(k_j)\}, \\ I_D(k_i k_j) &\leq \max\{I_C(k_i), I_C(k_j)\}, \\ F_D(k_i k_j) &\leq \max\{F_C(k_i), F_C(k_j)\}. \end{aligned}$$

According to the definition of NSRR, we get

$$\begin{aligned} T_{\bar{\bar{R}}(D)}(u_i u_j) &\leq \min\{T_{\bar{\bar{R}}(C)}(u_i), T_{\bar{\bar{R}}(C)}(u_j)\}, \\ I_{\bar{\bar{R}}(D)}(u_i u_j) &\leq \max\{I_{\bar{\bar{R}}(C)}(u_i), I_{\bar{\bar{R}}(C)}(u_j)\}, \\ F_{\bar{\bar{R}}(D)}(u_i u_j) &\leq \max\{F_{\bar{\bar{R}}(C)}(u_i), F_{\bar{\bar{R}}(C)}(u_j)\}. \end{aligned}$$

Similarly, for LNSRA operator $\tilde{R}(D)$,

$$\begin{aligned} T_{\tilde{R}(D)}(u_i u_j) &\leq \min\{T_{\tilde{R}(C)}(u_i), T_{\tilde{R}(C)}(u_j)\}, \\ I_{\tilde{R}(D)}(u_i u_j) &\leq \max\{I_{\tilde{R}(C)}(u_i), I_{\tilde{R}(C)}(u_j)\}, \\ F_{\tilde{R}(D)}(u_i u_j) &\leq \max\{F_{\tilde{R}(C)}(u_i), F_{\tilde{R}(C)}(u_j)\}. \end{aligned}$$

Example 5. Let $Y = \{u_1, u_2, u_3\}$ be a universal set and $M = \{k_1, k_2, k_3\}$ a set of parameters. A neutrosophic soft set (\tilde{P}, M) on Y can be defined in tabular form (see Table 5) as follows:

Table 5. Neutrosophic soft set (\tilde{P}, M) .

\tilde{P}	u_1	u_2	u_3
k_1	(0.4, 0.5, 0.6)	(0.7, 0.3, 0.2)	(0.6, 0.3, 0.4)
k_2	(0.5, 0.3, 0.6)	(0.3, 0.4, 0.3)	(0.7, 0.2, 0.3)
k_3	(0.7, 0.2, 0.3)	(0.6, 0.5, 0.4)	(0.7, 0.2, 0.4)

Let $E = \{u_1 u_2, u_2 u_3, u_2 u_2, u_3 u_2\} \subseteq \dot{Y}$ and $L = \{k_1 k_3, k_2 k_1, k_3 k_2\} \subseteq \dot{M}$.

Then, a soft relation \tilde{R} on E (from L to E) can be defined in tabular form (see Table 6) as follows:

Table 6. Neutrosophic soft relation \tilde{R} .

\tilde{R}	$u_1 u_2$	$u_2 u_3$	$u_2 u_2$	$u_3 u_2$
$k_1 k_3$	(0.4, 0.4, 0.5)	(0.6, 0.3, 0.4)	(0.5, 0.4, 0.2)	(0.5, 0.4, 0.3)
$k_2 k_1$	(0.3, 0.3, 0.4)	(0.3, 0.2, 0.3)	(0.2, 0.3, 0.3)	(0.7, 0.2, 0.2)
$k_3 k_2$	(0.3, 0.3, 0.2)	(0.5, 0.3, 0.2)	(0.2, 0.4, 0.4)	(0.3, 0.4, 0.4)

Let $C = \{(k_1, 0.2, 0.4, 0.6), (k_2, 0.4, 0.5, 0.2), (k_3, 0.1, 0.2, 0.4)\}$ be an NS on M , then

$$\tilde{R}(C) = \{(u_1, 0.4, 0.2, 0.4), (u_2, 0.3, 0.4, 0.3), (u_3, 0.4, 0.2, 0.3)\},$$

$$\underline{\tilde{R}}(C) = \{(u_1, 0.3, 0.5, 0.4), (u_2, 0.2, 0.5, 0.6), (u_3, 0.4, 0.5, 0.6)\},$$

Let $B = \{(k_1 k_3, 0.1, 0.3, 0.5), (k_2 k_1, 0.2, 0.4, 0.3), (k_3 k_2, 0.1, 0.2, 0.3)\}$ be an NS on L , then

$$\tilde{R}(D) = \{(u_1 u_2, 0.2, 0.3, 0.3), (u_2 u_3, 0.2, 0.3, 0.3), (u_2 u_2, 0.2, 0.4, 0.3), (u_3 u_2, 0.2, 0.4, 0.3)\},$$

$$\underline{\tilde{R}}(D) = \{(u_1 u_2, 0.2, 0.4, 0.4), (u_2 u_3, 0.2, 0.4, 0.5), (u_2 u_2, 0.3, 0.4, 0.5), (u_3 u_2, 0.2, 0.4, 0.5)\}.$$

Hence, $\tilde{R}(D) = (\tilde{R}(D), \underline{\tilde{R}}(D))$ is NSRR.

Theorem 5. Let \tilde{P}_1, \tilde{P}_2 be two NSRRs from universal Y to a parameter set M ; for all $C \in \mathcal{N}(M)$, we have

(i) $\underline{\tilde{P}_1 \cup \tilde{P}_2}(C) = \underline{\tilde{P}_1}(C) \cap \underline{\tilde{P}_2}(C),$

(ii) $\tilde{P}_1 \cup \tilde{P}_2(C) = \tilde{P}_1(C) \cup \tilde{P}_2(C).$

Theorem 6. Let \tilde{P}_1, \tilde{P}_2 be two neutrosophic soft relations from universal Y to a parameter set M ; for all $C \in \mathcal{N}(M)$, we have

(i) $\underline{\tilde{P}_1 \cap \tilde{P}_2}(C) \supseteq \underline{\tilde{P}_1}(C) \cup \underline{\tilde{P}_2}(C) \supseteq \underline{\tilde{P}_1}(C) \cap \underline{\tilde{P}_2}(C),$

(ii) $\tilde{P}_1 \cap \tilde{P}_2(C) \subseteq \tilde{P}_1(C) \cap \tilde{P}_2(C).$

4. Application

In this section, we apply the concept of NSRSs to a decision-making problem. In recent times, the object recognition problem has gained considerable importance. The object recognition problem can be considered as a decision-making problem, in which final identification of object is founded on a given amount of information. A detailed description of the algorithm for the selection of the most suitable object based on an available set of alternatives is given, and the proposed decision-making method can be used to calculate lower and upper approximation operators to address deep concerns of the problem. The presented algorithms can be applied to avoid lengthy calculations when dealing with a large number of objects. This method can be applied in various domains for multi-criteria selection of objects. A multicriteria decision making (MCDM) can be modeled using neutrosophic soft rough sets and is ideally suited for solving problems.

In the pharmaceutical industry, different pharmaceutical companies develop, produce and discover pharmaceutical medicines (drugs) for use as medication. These pharmaceutical companies deal with “brand name medicine” and “generic medicine”. Brand name medicine and generic medicine are bioequivalent, have a generic medicine rate and element of absorption. Brand name medicine and generic medicine have the same active ingredients, but the inactive ingredients may differ. The most important difference is cost. Generic medicine is less expensive as compared to brand names in comparison. Usually, generic drug manufacturers have competition to produce products that cost less. The product may possibly be slightly dissimilar in color, shape, or markings. The major difference is cost. We consider a brand name drug “ $u = \text{Claritin (loratadink)}$ ” with an ideal neutrosophic value number $n_u = (1, 0, 0)$ used for seasonal allergy medication. Consider

$$Y = \{u_1 = \text{Nasacort Aq (Triamcinolone)}, u_2 = \text{Zyrtec D (Cetirizine/Pseudoephedrine)}, \\ u_3 = \text{Sudafed (Pseudoephedrine)}, u_4 = \text{Claritin-D (loratadine/pseudoephedrine)}, \\ u_5 = \text{Flonase (Fluticasone)}\}$$

is a set of generic versions of “Clarition”. We want to select the most suitable generic version of Claritin on the basis of parameters $e_1 = \text{Highly soluble}$, $e_2 = \text{Highly permeable}$, $e_3 = \text{Rapidly dissolving}$. $M = \{e_1, e_2, e_3\}$ be a set of paraments. Let \tilde{P} be a neutrosophic soft relation from Y to parameter set M as shown in Table 7.

Table 7. Neutrosophic soft set (\tilde{P}, M) .

\tilde{P}	e_1	e_2	e_3
u_1	(0.4, 0.5, 0.6)	(0.7, 0.3, 0.2)	(0.6, 0.3, 0.4)
u_2	(0.5, 0.3, 0.6)	(0.3, 0.4, 0.3)	(0.7, 0.2, 0.3)
u_3	(0.7, 0.2, 0.3)	(0.6, 0.5, 0.4)	(0.7, 0.2, 0.4)
u_4	(0.5, 0.7, 0.5)	(0.8, 0.4, 0.6)	(0.8, 0.7, 0.6)
u_5	(0.6, 0.5, 0.4)	(0.7, 0.8, 0.5)	(0.7, 0.3, 0.5)

Suppose $C = \{(e_1, 0.2, 0.4, 0.5), (e_2, 0.5, 0.6, 0.4), (e_3, 0.7, 0.5, 0.4)\}$ is the most favorable object that is an NS on the parameter set M under consideration. Then, $(\underline{\tilde{P}}(C), \overline{\tilde{P}}(C))$ is an NSRS in NSAS (Y, M, \tilde{P}) , where

$$\overline{\tilde{P}}(C) = \{(u_1, 0.6, 0.5, 0.4), (u_2, 0.7, 0.4, 0.4), (u_3, 0.7, 0.4, 0.4), (u_4, 0.7, 0.6, 0.5), (u_5, 0.7, 0.5, 0.5)\}, \\ \underline{\tilde{P}}(C) = \{(u_1, 0.5, 0.6, 0.4), (u_2, 0.5, 0.6, 0.5), (u_3, 0.3, 0.3, 0.5), (u_4, 0.5, 0.6, 0.5), (u_5, 0.4, 0.5, 0.5)\}.$$

In [6], the sum of two neutrosophic numbers is defined. The sum of LNSRA and the UNSRA operators $\bar{P}(C)$ and $\underline{P}(C)$ is an NS $\bar{P}(C) \oplus \underline{P}(C)$ defined by

$$\bar{P}(C) \oplus \underline{P}(C) = \{(u_1, 0.8, 0.3, 0.16), (u_2, 0.85, 0.24, 0.2), (u_3, 0.79, 0.2, 0.2), (u_4, 0.85, 0.36, 0.25), (u_5, 0.82, 0.25, 0.25)\}.$$

Let $n_{u_i} = (T_{n_{u_i}}, I_{n_{u_i}}, F_{n_{u_i}})$ be a neutrosophic value number of generic versions medicine u_i . We can calculate the cosine similarity measure $S(n_{u_i}, n_u)$ between each neutrosophic value number n_{u_i} of generic version u_i and ideal value number n_u of brand name drug u , and the grading of all generic version medicines of Y can be determined. The cosine similarity measure is calculated as the inner product of two vectors divided by the product of their lengths. It is the cosine of the angle between the vector representations of two neutrosophic soft rough sets. The cosine similarity measure is a fundamental measure used in information technology. In [3], the cosine similarity is measured between neutrosophic numbers and demonstrates that the cosine similarity measure is a special case of the correlation coefficient in SVNS. Then, a decision-making method is proposed by the use of the cosine similarity measure of SVNSs, in which the evaluation information for alternatives with respect to criteria is carried out by truth-membership degree, indeterminacy-membership degree, and falsity-membership degree under single-valued neutrosophic environment. It defined as follows:

$$S(n_u, n_{u_i}) = \frac{T_{n_u} \cdot T_{n_{u_i}} + I_{n_u} \cdot I_{n_{u_i}} + F_{n_u} \cdot F_{n_{u_i}}}{\sqrt{T_{n_u}^2 + T_{n_{u_i}}^2 + F_{n_u}^2 + F_{n_{u_i}}^2}}. \tag{1}$$

Through the cosine similarity measure between each object and the ideal object, the ranking order of all objects can be determined and the best object can be easily identified as well. The advantage is that the proposed MCDM approach has some simple tools and concepts in the neutrosophic similarity measure approach among the existing ones. An illustrative application shows that the proposed method is simple and effective.

The generic version medicine u_i with the larger similarity measure $S(n_{u_i}, n_u)$ is the most suitable version u_i because it is close to the brand name drug u . By comparing the cosine similarity measure values, the grading of all generic medicines can be determined, and we can find the most suitable generic medicine after selection of suitable NS of parameters. By Equation (1), we can calculate the cosine similarity measure between neutrosophic value numbers n_u of u and n_{u_i} of u_i as follows:

$$\begin{aligned} S(n_u, n_{u_1}) &= 0.9203, S(n_u, n_{u_2}) = 0.9386, S(n_u, n_{u_3}) = 0.9415, \\ S(n_u, n_{u_4}) &= 0.8888 S(n_u, n_{u_5}) = 0.9183. \end{aligned}$$

We get $S(n_u, n_{u_3}) > S(n_u, n_{u_2}) > S(n_u, n_{u_1}) > S(n_u, n_{u_5}) > S(n_u, n_{u_4})$. Thus, the optimal decision is u_3 , and the most suitable generic version of Claritin is Sudafed (Pseudoephedrine). We have used software MATLAB (version 7, MathWorks, Natick, MA, USA) for calculations in the application. The flow chart of the algorithm is general for any number of objects with respect to certain parameters. The flow chart of our proposed method is given in Figure 1. The method is presented as an algorithm in Algorithm 1.

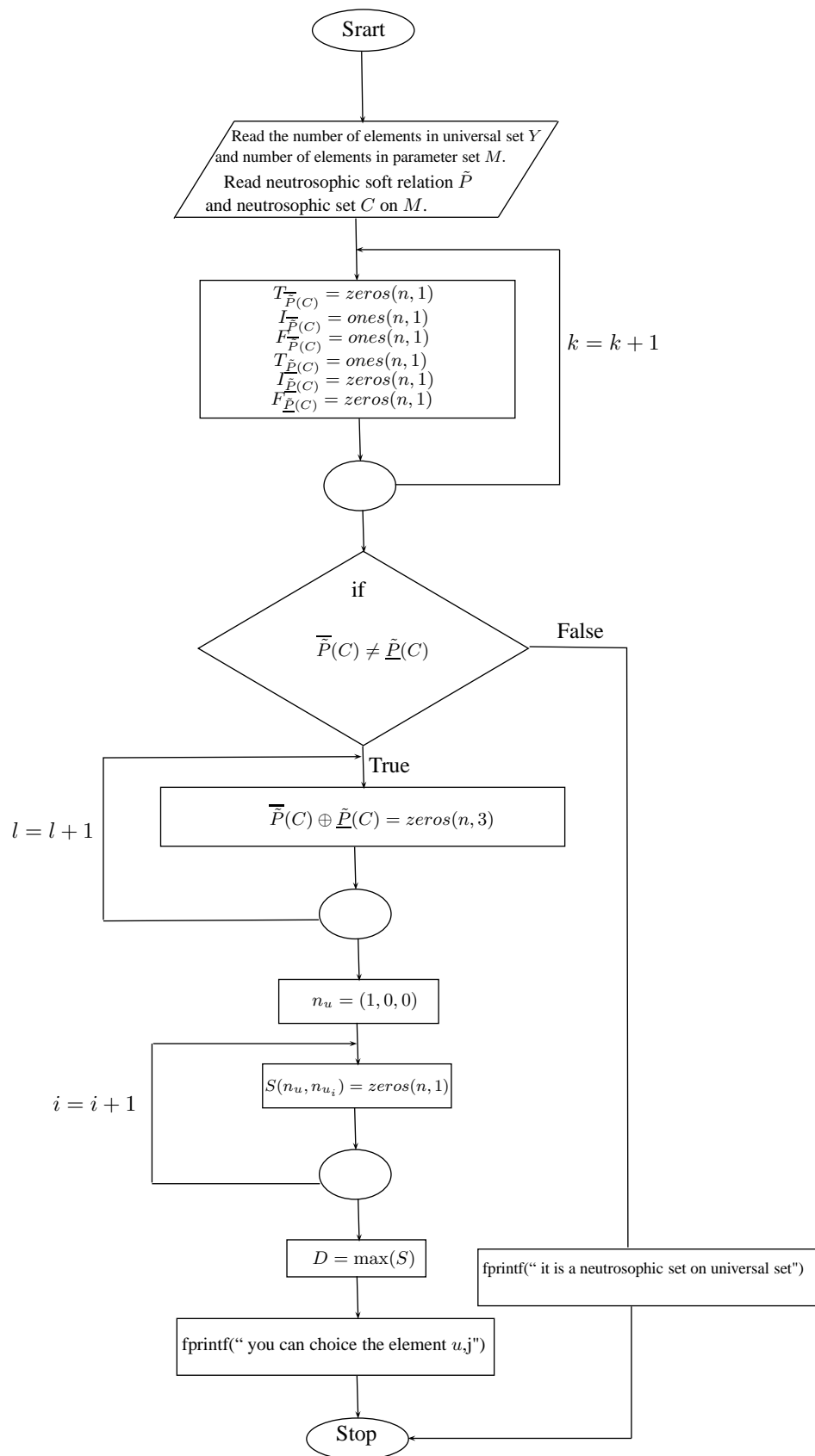

Figure 11. Flowchart for selection of most suitable objects

Algorithm 1: Algorithm for selection of the most suitable objects

```

1. Begin
2.  Input the number of elements in universal set  $Y = \{u_1, u_2, \dots, u_n\}$ .
3.  Input the number of elements in parameter set  $M = \{e_1, e_2, \dots, e_m\}$ .
4.  Input a neutrosophic soft relation  $\tilde{P}$  from  $Y$  to  $M$ .
5.  Input an NS  $C$  on  $M$ .
6.  if  $size(\tilde{P}) \neq [n, 3 * m]$ 
7.    fprintf(\ size of neutrosophic soft relation from universal set to parameter
           set is not correct, it should be of order %dx%d; ', n, 3 * m)
8.    error(\ Dimemsion of neutrosophic soft relation on vertex set is not correct. ')
9.  end
10. if  $size(C) \neq [m, 3]$ 
11.  fprintf(\ size of NS on parameter set is not correct,
           it should be of order %dx3; ', m)
12.  error('Dimemsion of NS on parameter set is not correct.')
13. end
14.  $T_{\tilde{P}(C)} = zeros(n, 1);$ 
15.  $I_{\tilde{P}(C)} = ones(n, 1);$ 
16.  $F_{\tilde{P}(C)} = ones(n, 1);$ 
17.  $T_{\underline{\tilde{P}}(C)} = ones(n, 1);$ 
18.  $I_{\underline{\tilde{P}}(C)} = zeros(n, 1);$ 
19.  $F_{\underline{\tilde{P}}(C)} = zeros(n, 1);$ 
20.  if  $size(\tilde{P}) == [n, 3 * m]$ 
21.    if  $size(C) == [m, 3]$ 
22.      if  $\tilde{P} \geq 0 \ \&\& \ \tilde{P} \leq 1$ 
23.        if  $C \geq 0 \ \&\& \ C \leq 1$ 
24.          for  $i = 1 : n$ 
25.            for  $k = 1 : m$ 
26.               $j = 3 * k - 2;$ 
27.               $T_{\tilde{P}(C)}(i, 1) = \max(T_{\tilde{P}(C)}(i, 1), \min(\tilde{P}(i, j), C(k, 1)));$ 
28.               $I_{\tilde{P}(C)}(i, 1) = \min(I_{\tilde{P}(C)}(i, 1), \max(\tilde{P}(i, j + 1), C(k, 2)));$ 
29.               $F_{\tilde{P}(C)}(i, 1) = \min(F_{\tilde{P}(C)}(i, 1), \max(\tilde{P}(i, j + 2), C(k, 3)));$ 
30.               $T_{\underline{\tilde{P}}(C)}(i, 1) = \min(T_{\underline{\tilde{P}}(C)}(i, 1), \max(\tilde{P}(i, j + 2), C(k, 1)));$ 
31.               $I_{\underline{\tilde{P}}(C)}(i, 1) = \max(I_{\underline{\tilde{P}}(C)}(i, 1), \min((1 - \tilde{P}(i, j + 1)), C(k, 2)));$ 
32.               $F_{\underline{\tilde{P}}(C)}(i, 1) = \max(F_{\underline{\tilde{P}}(C)}(i, 1), \min(\tilde{P}(i, j), C(k, 3)));$ 
33.            end
34.          end
35.           $\bar{\tilde{P}}(C) = (T_{\tilde{P}(C)}, I_{\tilde{P}(C)}, F_{\tilde{P}(C)})$ 
36.           $\underline{\tilde{P}}(C) = (T_{\underline{\tilde{P}}(C)}, I_{\underline{\tilde{P}}(C)}, F_{\underline{\tilde{P}}(C)})$ 
37.          if  $\bar{\tilde{P}}(C) == \underline{\tilde{P}}(C)$ 
38.            fprintf(\ it is a neutrosophic set on universal set. ')
39.          else
40.            fprintf(\ it is an NSRS on universal set. ')
41.             $\bar{\tilde{P}}(C) \oplus \underline{\tilde{P}}(C) = zeros(n, 3);$ 

```

```

42.          for i=1:n
43.               $T_{\bar{P}(C)}(i) \oplus T_{\underline{P}(C)}(i) = T_{\bar{P}(C)}(i) + T_{\underline{P}(C)}(i)$ 
44.                   $- T_{\bar{P}(C)}(i) \cdot T_{\underline{P}(C)}(i);$ 
45.               $I_{\bar{P}(C)}(i) \oplus I_{\underline{P}(C)}(i) = I_{\bar{P}(C)}(i) \cdot I_{\underline{P}(C)}(i);$ 
46.               $F_{\bar{P}(C)}(i) \oplus F_{\underline{P}(C)}(i) = F_{\bar{P}(C)}(i) \cdot F_{\underline{P}(C)}(i);$ 
47.          end
48.           $n_u = (1, 0, 0);$ 
49.           $S(n_u, n_{u_i}) = \text{zeros}(n, 1);$ 
50.          for i=1:n
51.               $S(n_u, n_{u_i}) = \frac{T_{n_u} \cdot T_{n_{u_i}} + I_{n_u} \cdot I_{n_{u_i}} + F_{n_u} \cdot F_{n_{u_i}}}{\sqrt{T_{n_u}^2 + T_{n_{u_i}}^2 + F_{n_u}^2} + \sqrt{T_{n_{u_i}}^2 + T_{n_u}^2 + F_{n_{u_i}}^2}};$ 
52.          end
53.           $S(n_u, n_{u_i})$ 
54.           $D = \max(S);$ 
55.           $l = 0;$ 
56.           $m = \text{zeros}(n, 1);$ 
57.           $D2 = \text{zeros}(n, 1);$ 
58.          for j=1:n
59.              if  $S(j, 1) == D$ 
60.                   $l = l + 1;$ 
61.                   $D2(j, 1) = S(j, 1);$ 
62.                   $m(j) = j;$ 
63.              end
64.          end
65.          for  $j = 1 : n$ 
66.              if  $m(j) = 0$ 
67.                   $\text{fprintf}(\backslash \text{ you can choice the element } u_{\%d} \backslash j);$ 
68.              end
69.          end
70.      end
71.  end
72.  end
73.  end
74. End

```

5. Conclusions and Future Directions

Rough set theory can be considered as an extension of classical set theory. Rough set theory is a very useful mathematical model to handle vagueness. NS theory, RS theory and SS theory are three useful distinguished approaches to deal with vagueness. NS and RS models are used to handle uncertainty, and combining these two models with another remarkable model of SSs gives more precise results for decision-making problems. In this paper, we have first presented the notion of SRNSs. Furthermore, we have introduced NSRSs and investigated some properties of NSRSs in detail. The notion of NSRS can be utilized as a mathematical tool to deal with imprecise and unspecified information. In addition, a decision-making method based on NSRSs has been proposed. This research work can be extended to (1) rough bipolar neutrosophic soft sets; (2) bipolar neutrosophic soft rough sets; (3) interval-valued bipolar neutrosophic rough sets; and (4) neutrosophic soft rough graphs.

References

1. Smarandache, F. *Neutrosophy: Neutrosophic Probability, Set, and Logic*; American Research Press: Rehoboth, DE, USA, 1998; 105p.
2. Wang, H.; Smarandache, F.; Zhang, Y.; Sunderraman, R. Single-valued neutrosophic sets. *Multispace Multistruct.* **2010**, *4*, 410–413.
3. Ye, J. Multicriteria decision-making method using the correlation coefficient under single-valued neutrosophic environment. *Int. J. Gen. Syst.* **2013**, *42*, 386–394.
4. Ye, J. Improved correlation coefficients of single valued neutrosophic sets and interval neutrosophic sets for multiple attribute decision making. *J. Intell. Fuzzy Syst.* **2014**, *27*, 2453–2462.
5. Ye, J.; Fu, J. Multi-period medical diagnosis method using a single valued neutrosophic similarity measure based on tangent function. *Comput. Methods Prog. Biomed.* **2016**, *123*, 142–149.
6. Peng, J.J.; Wang, J.Q.; Zhang, H.Y.; Chen, X.H. An outranking approach for multi-criteria decision-making problems with simplified neutrosophic sets. *Appl. Soft Comput.* **2014**, *25*, 336–346.
7. Molodtsov, D.A. Soft set theory—first results. *Comput. Math. Appl.* **1999**, *37*, 19–31.
8. Maji, P.K.; Biswas, R.; Roy, A.R. Fuzzy soft sets. *J. Fuzzy Math.* **2001**, *9*, 589–602.
9. Maji, P.K.; Biswas, R.; Roy, A.R. Intuitionistic fuzzy soft sets. *J. Fuzzy Math.* **2001**, *9*, 677–692.
10. Maji, P.K. Neutrosophic soft set. *Ann. Fuzzy Math. Inform.* **2013**, *5*, 157–168.
11. Babitha, K.V.; Sunil, J.J. Soft set relations and functions. *Comput. Math. Appl.* **2010**, *60*, 1840–1849.
12. Sahin, R.; Kucuk, A. On similarity and entropy of neutrosophic soft sets. *J. Intell. Fuzzy Syst. Appl. Eng. Technol.* **2014**, *27*, 2417–2430.
13. Pawlak, Z. Rough sets. *Int. J. Comput. Inf. Sci.* **1982**, *11*, 341–356.
14. Ali, M. A note on soft sets, rough sets and fuzzy soft sets. *Appl. Soft Comput.* **2011**, *11*, 3329–3332.
15. Feng, F.; Liu, X.; Leoreanu-Fotea, B.; Jun, Y.B. Soft sets and soft rough sets. *Inf. Sci.* **2011**, *181*, 1125–1137.
16. Shabir, M.; Ali, M.I.; Shaheen, T. Another approach to soft rough sets. *Knowl.-Based Syst.* **2013**, *40*, 72–80.
17. Feng, F.; Li, C.; Davvaz, B.; Ali, M.I. Soft sets combined with fuzzy sets and rough sets: A tentative approach. *Soft Comput.* **2010**, *14*, 899–911.
18. Dubois, D.; Prade, H. Rough fuzzy sets and fuzzy rough sets. *Int. J. Gen. Syst.* **1990**, *17*, 191–209.
19. Meng, D.; Zhang, X.; Qin, K. Soft rough fuzzy sets and soft fuzzy rough sets. *Comput. Math. Appl.* **2011**, *62*, 4635–4645.
20. Sun, B.Z.; Ma, W.; Liu, Q. An approach to decision making based on intuitionistic fuzzy rough sets over two universes. *J. Oper. Res. Soc.* **2013**, *64*, 1079–1089.
21. Sun, B.Z.; Ma, W. Soft fuzzy rough sets and its application in decision making. *Artif. Intell. Rev.* **2014**, *41*, 67–80.
22. Zhang, X.; Dai, J.; Yu, Y. On the union and intersection operations of rough sets based on various approximation spaces. *Inf. Sci.* **2015**, *292*, 214–229.
23. Zhang, H.; Shu, L. Generalized intuitionistic fuzzy rough set based on intuitionistic fuzzy covering. *Inf. Sci.* **2012**, *198*, 186–206.
24. Zhang, X.; Zhou, B.; Li, P. A general frame for intuitionistic fuzzy rough sets. *Inf. Sci.* **2012**, *216*, 34–49.
25. Zhang, H.; Shu, L.; Liao, S. Intuitionistic fuzzy soft rough set and its application in decision making. *Abstr. Appl. Anal.* **2014**, *2014*, 13.
26. Zhang, H.; Xiong, L.; Ma, W. Generalized intuitionistic fuzzy soft rough set and its application in decision making. *J. Comput. Anal. Appl.* **2016**, *20*, 750–766.
27. Broumi, S.; Smarandache, F. Interval-valued neutrosophic soft rough sets. *Int. J. Comput. Math.* **2015**, *2015*, 232919.
28. Broumi, S.; Smarandache, F.; Dhar, M. Rough Neutrosophic sets. *Neutrosophic Sets Syst.* **2014**, *3*, 62–67.
29. Yang, H.L.; Zhang, C.L.; Guo, Z.L.; Liu, Y.L.; Liao, X. A hybrid model of single valued neutrosophic sets and rough sets: Single valued neutrosophic rough set model. *Soft Comput.* **2016**, *21*, 6253–6267.

30. Faizi, S.; Salabun, W.; Rashid, T.; Watrbski, J.; Zafar, S. Group decision-making for hesitant fuzzy sets based on characteristic objects method. *Symmetry* **2017**, *9*, 136.
31. Faizi, S.; Rashid, T.; Salabun, W.; Zafar, S.; Watrbski, J. Decision making with uncertainty using hesitant fuzzy sets. *Int. J. Fuzzy Syst.* **2018**, *20*, 93–103.
32. Mardani, A.; Nilashi, M.; Antucheviciene, J.; Tavana, M.; Bausys, R.; Ibrahim, O. Recent Fuzzy Generalisations of Rough Sets Theory: A Systematic Review and Methodological Critique of the Literature. *Complexity* **2017**, *2017*, 33.
33. Liang, R.X.; Wang, J.Q.; Zhang, H.Y. A multi-criteria decision-making method based on single-valued trapezoidal neutrosophic preference relations with complete weight information. *Neural Comput. Appl.* **2017**, 1–16, doi:10.1007/s00521-017-2925-8.
34. Liang, R.; Wang, J.; Zhang, H. Evaluation of e-commerce websites: An integrated approach under a single-valued trapezoidal neutrosophic environment. *Knowl.-Based Syst.* **2017**, *135*, 44–59.
35. Peng, H.G.; Zhang, H.Y.; Wang, J.Q. Probability multi-valued neutrosophic sets and its application in multi-criteria group decision-making problems. *Neural Comput. Appl.* **2016**, 1–21, doi:10.1007/s00521-016-2702-0.
36. Wang, L.; Zhang, H.Y.; Wang, J.Q. Frank Choquet Bonferroni mean operators of bipolar neutrosophic sets and their application to multi-criteria decision-making problems. *Int. J. Fuzzy Syst.* **2018**, *20*, 13–28.
37. Zavadskas, E.K.; Bausys, R.; Kaklauskas, A.; Ubarte, I.; Kuzminske, A.; Gudiene, N. Sustainable market valuation of buildings by the single-valued neutrosophic MAMVA method. *Appl. Soft Comput.* **2017**, *57*, 74–87.
38. Li, Y.; Liu, P.; Chen, Y. Some single valued neutrosophic number heronian mean operators and their application in multiple attribute group decision making. *Informatica* **2016**, *27*, 85–110.

Decision-Making with Bipolar Neutrosophic TOPSIS and Bipolar Neutrosophic ELECTRE-I

Muhammad Akram, Shumaiza, Florentin Smarandache

Muhammad Akram, Shumaiza, Florentin Smarandache (2018). Decision-Making with Bipolar Neutrosophic TOPSIS and Bipolar Neutrosophic ELECTRE-I. *Axioms* 7, 33; DOI: 10.3390/axioms7020033

Abstract: Technique for the order of preference by similarity to ideal solution (TOPSIS) and elimination and choice translating reality (ELECTRE) are widely used methods to solve multi-criteria decision making problems. In this research article, we present bipolar neutrosophic TOPSIS method and bipolar neutrosophic ELECTRE-I method to solve such problems. We use the revised closeness degree to rank the alternatives in our bipolar neutrosophic TOPSIS method. We describe bipolar neutrosophic TOPSIS method and bipolar neutrosophic ELECTRE-I method by flow charts. We solve numerical examples by proposed methods. We also give a comparison of these methods.

Keywords: neutrosophic sets; bipolar neutrosophic TOPSIS; bipolar neutrosophic ELECTRE-I; normalized Euclidean distance

1. Introduction

The theory of fuzzy sets was introduced by Zadeh [1]. Fuzzy set theory allows objects to be members of the set with a degree of membership, which can take any value within the unit closed interval $[0, 1]$. Smarandache [2] originally introduced neutrosophy, a branch of philosophy which examines the origin, nature, and scope of neutralities, as well as their connections with different intellectual spectra. To apply neutrosophic set in real-life problems more conveniently, Smarandache [2] and Wang et al. [3] defined single-valued neutrosophic sets which takes the value from the subset of $[0, 1]$. Thus, a single-valued neutrosophic set is an instance of neutrosophic set, and can be used feasibly to deal with real-world problems, especially in decision support. Deli et al. [4] dealt with bipolar neutrosophic sets, which is an extension of bipolar fuzzy sets [5].

Multi-criteria decision making (MCDM) is a process to make an ideal choice that has the highest degree of achievement from a set of alternatives that are characterized in terms of multiple conflicting criteria. Hwang and Yoon [6] developed the TOPSIS method, which is one of the most favorable and effective MCDM methods to solve MCDM problems. In classical MCDM methods, the attribute values and weights are determined precisely. To deal with problems consisting of incomplete and vague information, in 2000 Chen [7] conferred the fuzzy version of TOPSIS method for the first time. Chung and Chu [8] presented fuzzy TOPSIS method under group decision for facility location selection problem. Hadi et al. [9] proposed the fuzzy inferior ratio method for multiple attribute decision making problems. Joshi and Kumar [10] discussed the TOPSIS method based on intuitionistic fuzzy entropy and distance measure for multi criteria decision making. A comparative study of multiple criteria decision making methods under stochastic inputs is described by Kolios et al. [11]. Akram et al. [12–14] considered decision support systems based on bipolar fuzzy graphs. Applications of bipolar fuzzy sets to graphs have been discussed in [15,16]. Faizi et al. [17] presented group decision making for

hesitant fuzzy sets based on characteristic objects method. Recently, Alghamdi et al. [18] have studied multi-criteria decision-making methods in bipolar fuzzy environment. Dey et al. [19] considered TOPSIS method for solving the decision making problem under bipolar neutrosophic environment.

On the other hand, the ELECTRE is one of the useful MCDM methods. This outranking method was proposed by Benayoun et al. [20], which was later referred to as ELECTRE-I method. Different versions of ELECTRE method have been developed as ELECTRE-I, II, III, IV and TRI. Hatami-Marbini and Tavana [21] extended the ELECTRE-I method and gave an alternative fuzzy outranking method to deal with uncertain and linguistic information. Aytac et al. [22] considered fuzzy ELECTRE-I method for evaluating catering firm alternatives. Wu and Chen [23] proposed the multi-criteria analysis approach ELECTRE based on intuitionistic fuzzy sets. In this research article, we present bipolar neutrosophic TOPSIS method and bipolar neutrosophic ELECTRE-I method to solve MCDM problems. We use the revised closeness degree to rank the alternatives in our bipolar neutrosophic TOPSIS method. We describe bipolar neutrosophic TOPSIS method and bipolar neutrosophic ELECTRE-I method by flow charts. We solve numerical examples by proposed methods. We also give a comparison of these methods. For other notions and applications that are not mentioned in this paper, the readers are referred to [24–29].

2. Bipolar Neutrosophic TOPSIS Method

Definition 1. Ref. [4] Let C be a nonempty set. A bipolar neutrosophic set (BNS) \tilde{B} on C is defined as follows

$$\tilde{B} = \{c, \langle T_{\tilde{B}}^+(c), I_{\tilde{B}}^+(c), F_{\tilde{B}}^+(c), T_{\tilde{B}}^-(c), I_{\tilde{B}}^-(c), F_{\tilde{B}}^-(c) \rangle \mid c \in C\},$$

where, $T_{\tilde{B}}^+(c), I_{\tilde{B}}^+(c), F_{\tilde{B}}^+(c) : C \rightarrow [0, 1]$ and $T_{\tilde{B}}^-(c), I_{\tilde{B}}^-(c), F_{\tilde{B}}^-(c) : C \rightarrow [-1, 0]$.

We now describe our proposed bipolar neutrosophic TOPSIS method.

Let $S = \{S_1, S_2, \dots, S_m\}$ be a set of m favorable alternatives and let $T = \{T_1, T_2, \dots, T_n\}$ be a set of n attributes. Let $W = [w_1 \ w_2 \ \dots \ w_n]^T$ be the weight vector such that $0 \leq w_j \leq 1$ and $\sum_{j=1}^n w_j = 1$. Suppose that the rating value of each alternative $S_i, (i = 1, 2, \dots, m)$ with respect to the attributes $T_j, (j = 1, 2, \dots, n)$ is given by decision maker in the form of bipolar neutrosophic sets (BNSs). The steps of bipolar neutrosophic TOPSIS method are described as follows:

- (i) Each value of alternative is estimated with respect to n criteria. The value of each alternative under each criterion is given in the form of BNSs and they can be expressed in the decision matrix as

$$K = [k_{ij}]_{m \times n} = \begin{bmatrix} k_{11} & k_{12} & \dots & k_{1n} \\ k_{21} & k_{22} & \dots & k_{2n} \\ \cdot & \cdot & \dots & \cdot \\ \cdot & \cdot & \dots & \cdot \\ k_{m1} & k_{m2} & \dots & k_{mn} \end{bmatrix}.$$

Each entry $k_{ij} = \langle T_{ij}^+, I_{ij}^+, F_{ij}^+, T_{ij}^-, I_{ij}^-, F_{ij}^- \rangle$, where, T_{ij}^+, I_{ij}^+ and F_{ij}^+ represent the degree of positive truth, indeterminacy and falsity membership, respectively, whereas, T_{ij}^-, I_{ij}^- and F_{ij}^- represent the degree of negative truth, indeterminacy and falsity membership, respectively, such that $T_{ij}^+, I_{ij}^+, F_{ij}^+ \in [0, 1], T_{ij}^-, I_{ij}^-, F_{ij}^- \in [-1, 0]$ and $0 \leq T_{ij}^+ + I_{ij}^+ + F_{ij}^+ - T_{ij}^- - I_{ij}^- - F_{ij}^- \leq 6, i = 1, 2, 3, \dots, m; j = 1, 2, 3, \dots, n$.

- (ii) Suppose that the weights of the criteria are not equally assigned and they are totally unknown to the decision maker. We use the maximizing deviation method [30] to determine the unknown weights of the criteria. Therefore, the weight of the attribute T_j is given as

$$w_j = \frac{\sum_{i=1}^m \sum_{l=1}^m |k_{ij} - k_{lj}|}{\sqrt{\sum_{j=1}^n \left(\sum_{i=1}^m \sum_{l=1}^m |k_{ij} - k_{lj}| \right)^2}},$$

and the normalized weight of the attribute T_j is given as

$$w_j^* = \frac{\sum_{i=1}^m \sum_{l=1}^m |k_{ij} - k_{lj}|}{\sum_{j=1}^n \left(\sum_{i=1}^m \sum_{l=1}^m |k_{ij} - k_{lj}| \right)}.$$

- (iii) The accumulated weighted bipolar neutrosophic decision matrix is computed by multiplying the weights of the attributes to aggregated decision matrix as follows:

$$K \otimes W = [k_{ij}^{w_j}]_{m \times n} = \begin{bmatrix} k_{11}^{w_1} & k_{12}^{w_2} & \dots & k_{1n}^{w_n} \\ k_{21}^{w_1} & k_{22}^{w_2} & \dots & k_{2n}^{w_n} \\ \cdot & \cdot & \dots & \cdot \\ \cdot & \cdot & \dots & \cdot \\ k_{m1}^{w_1} & k_{m2}^{w_2} & \dots & k_{mn}^{w_n} \end{bmatrix}.$$

where

$$k_{ij}^{w_j} = \langle T_{ij}^{w_j^+}, I_{ij}^{w_j^+}, F_{ij}^{w_j^+}, T_{ij}^{w_j^-}, I_{ij}^{w_j^-}, F_{ij}^{w_j^-} \rangle \\ = \langle 1 - (1 - T_{ij}^+)^{w_j}, (I_{ij}^+)^{w_j}, (F_{ij}^+)^{w_j}, -(-T_{ij}^-)^{w_j}, -(-I_{ij}^-)^{w_j}, -(1 - (1 - (-F_{ij}^-))^{w_j}) \rangle,$$

- (iv) Two types of attributes, benefit type attributes and cost type attributes, are mostly applicable in real life decision making. The bipolar neutrosophic relative positive ideal solution (BNRPIS) and bipolar neutrosophic relative negative ideal solution (BNRNIS) for both type of attributes are defined as follows:

$$BNRPIS = \left(\langle {}^+T_1^{w_1^+}, {}^+I_1^{w_1^+}, {}^+F_1^{w_1^+}, {}^+T_1^{w_1^-}, {}^+I_1^{w_1^-}, {}^+F_1^{w_1^-} \rangle, \langle {}^+T_2^{w_2^+}, {}^+I_2^{w_2^+}, {}^+F_2^{w_2^+}, {}^+T_2^{w_2^-}, \right. \\ \left. {}^+I_2^{w_2^-}, {}^+F_2^{w_2^-} \rangle, \dots, \langle {}^+T_n^{w_n^+}, {}^+I_n^{w_n^+}, {}^+F_n^{w_n^+}, {}^+T_n^{w_n^-}, {}^+I_n^{w_n^-}, {}^+F_n^{w_n^-} \rangle \right), \\ BNRNIS = \left(\langle {}^-T_1^{w_1^+}, {}^-I_1^{w_1^+}, {}^-F_1^{w_1^+}, {}^-T_1^{w_1^-}, {}^-I_1^{w_1^-}, {}^-F_1^{w_1^-} \rangle, \langle {}^-T_2^{w_2^+}, {}^-I_2^{w_2^+}, {}^-F_2^{w_2^+}, {}^-T_2^{w_2^-}, \right. \\ \left. {}^-I_2^{w_2^-}, {}^-F_2^{w_2^-} \rangle, \dots, \langle {}^-T_n^{w_n^+}, {}^-I_n^{w_n^+}, {}^-F_n^{w_n^+}, {}^-T_n^{w_n^-}, {}^-I_n^{w_n^-}, {}^-F_n^{w_n^-} \rangle \right),$$

such that, for benefit type criteria, $j = 1, 2, \dots, n$

$$\begin{aligned} \langle {}^+T_j^{w_j^+}, {}^+I_j^{w_j^+}, {}^+F_j^{w_j^+}, {}^+T_j^{w_j^-}, {}^+I_j^{w_j^-}, {}^+F_j^{w_j^-} \rangle &= \langle \max(T_{ij}^{w_j^+}), \min(I_{ij}^{w_j^+}), \min(F_{ij}^{w_j^+}), \\ &\quad \min(T_{ij}^{w_j^-}), \max(I_{ij}^{w_j^-}), \max(F_{ij}^{w_j^-}) \rangle, \\ \langle {}^-T_j^{w_j^+}, {}^-I_j^{w_j^+}, {}^-F_j^{w_j^+}, {}^-T_j^{w_j^-}, {}^-I_j^{w_j^-}, {}^-F_j^{w_j^-} \rangle &= \langle \min(T_{ij}^{w_j^+}), \max(I_{ij}^{w_j^+}), \max(F_{ij}^{w_j^+}), \\ &\quad \max(T_{ij}^{w_j^-}), \min(I_{ij}^{w_j^-}), \min(F_{ij}^{w_j^-}) \rangle. \end{aligned}$$

Similarly, for cost type criteria, $j = 1, 2, \dots, n$

$$\begin{aligned} \langle {}^+T_j^{w_j^+}, {}^+I_j^{w_j^+}, {}^+F_j^{w_j^+}, {}^+T_j^{w_j^-}, {}^+I_j^{w_j^-}, {}^+F_j^{w_j^-} \rangle &= \langle \min(T_{ij}^{w_j^+}), \max(I_{ij}^{w_j^+}), \max(F_{ij}^{w_j^+}), \\ &\quad \max(T_{ij}^{w_j^-}), \min(I_{ij}^{w_j^-}), \min(F_{ij}^{w_j^-}) \rangle, \\ \langle {}^-T_j^{w_j^+}, {}^-I_j^{w_j^+}, {}^-F_j^{w_j^+}, {}^-T_j^{w_j^-}, {}^-I_j^{w_j^-}, {}^-F_j^{w_j^-} \rangle &= \langle \max(T_{ij}^{w_j^+}), \min(I_{ij}^{w_j^+}), \min(F_{ij}^{w_j^+}), \\ &\quad \min(T_{ij}^{w_j^-}), \max(I_{ij}^{w_j^-}), \max(F_{ij}^{w_j^-}) \rangle. \end{aligned}$$

- (v) The normalized Euclidean distance of each alternative $\langle T_{ij}^{w_j^+}, I_{ij}^{w_j^+}, F_{ij}^{w_j^+}, T_{ij}^{w_j^-}, I_{ij}^{w_j^-}, F_{ij}^{w_j^-} \rangle$ from the BNRPIS $\langle {}^+T_j^{w_j^+}, {}^+I_j^{w_j^+}, {}^+F_j^{w_j^+}, {}^+T_j^{w_j^-}, {}^+I_j^{w_j^-}, {}^+F_j^{w_j^-} \rangle$ can be calculated as

$$d_N(S_i, BNRPIS) = \sqrt{\frac{1}{6n} \sum_{j=1}^n \left\{ (T_{ij}^{w_j^+} - {}^+T_j^{w_j^+})^2 + (I_{ij}^{w_j^+} - {}^+I_j^{w_j^+})^2 + (F_{ij}^{w_j^+} - {}^+F_j^{w_j^+})^2 + (T_{ij}^{w_j^-} - {}^+T_j^{w_j^-})^2 + (I_{ij}^{w_j^-} - {}^+I_j^{w_j^-})^2 + (F_{ij}^{w_j^-} - {}^+F_j^{w_j^-})^2 \right\}}$$

and the normalized Euclidean distance of each alternative $\langle T_{ij}^{w_j^+}, I_{ij}^{w_j^+}, F_{ij}^{w_j^+}, T_{ij}^{w_j^-}, I_{ij}^{w_j^-}, F_{ij}^{w_j^-} \rangle$ from the BNRNIS $\langle {}^-T_j^{w_j^+}, {}^-I_j^{w_j^+}, {}^-F_j^{w_j^+}, {}^-T_j^{w_j^-}, {}^-I_j^{w_j^-}, {}^-F_j^{w_j^-} \rangle$ can be calculated as

$$d_N(S_i, BNRNIS) = \sqrt{\frac{1}{6n} \sum_{j=1}^n \left\{ (T_{ij}^{w_j^+} - {}^-T_j^{w_j^+})^2 + (I_{ij}^{w_j^+} - {}^-I_j^{w_j^+})^2 + (F_{ij}^{w_j^+} - {}^-F_j^{w_j^+})^2 + (T_{ij}^{w_j^-} - {}^-T_j^{w_j^-})^2 + (I_{ij}^{w_j^-} - {}^-I_j^{w_j^-})^2 + (F_{ij}^{w_j^-} - {}^-F_j^{w_j^-})^2 \right\}}$$

- (vi) Revised closeness degree of each alternative to BNRPIS represented as ρ_i and it is calculated using formula

$$\rho(S_i) = \frac{d_N(S_i, BNRNIS)}{\max\{d_N(S_i, BNRNIS)\}} - \frac{d_N(S_i, BNRPIS)}{\min\{d_N(S_i, BNRPIS)\}}, \quad i = 1, 2, \dots, m.$$

- (vii) By using the revised closeness degrees, the inferior ratio to each alternative is determined as follows:

$$IR(i) = \frac{\rho(S_i)}{\min_{1 \leq i \leq m} (\rho(S_i))}.$$

It is clear that each value of $IR(i)$ lies in the closed unit interval $[0,1]$.

- (viii) The alternatives are ranked according to the ascending order of inferior ratio values and the best alternative with minimum choice value is chosen.

Geometric representation of the procedure of our proposed bipolar neutrosophic TOPSIS method is shown in Figure 1.

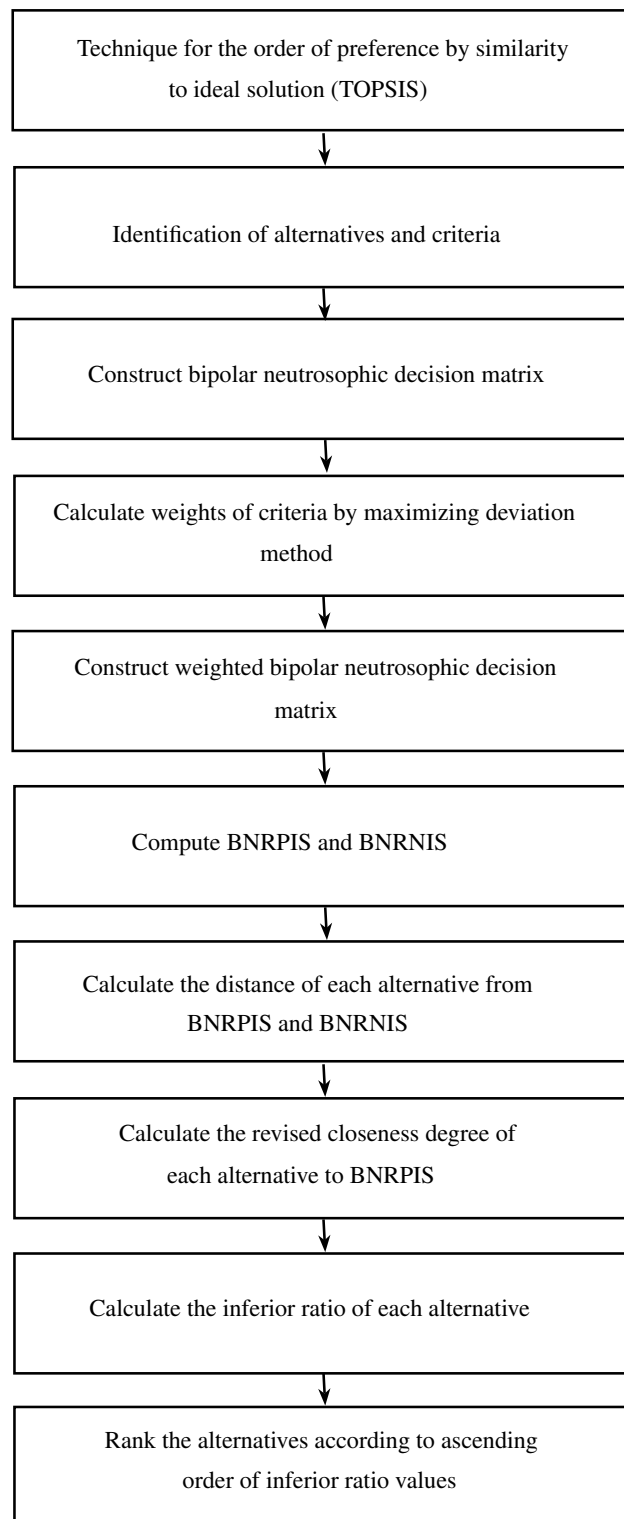

Figure 2.2: ~~Figure 1.~~ Flow chart of bipolar neutrosophic TOPSIS method

3. Applications

Step 3. The weighted bipolar neutrosophic decision matrix is constructed by multiplying the weights to decision matrix as given in Table 2. In this section, we apply bipolar neutrosophic TOPSIS method to solve real life problems: the best electronic commerce web site, heart surgeon and employee were chosen.

3.1. Electronic Commerce Web Site

Electronic Commerce (*e-commerce*, for short) is a process of trading the services and goods through electronic networks like computer structures as well as the internet. In recent times *e-commerce* has become a very fascinating and convenient choice for both the businesses and customers. Many companies are interested in advancing their online stores rather than the brick and mortar buildings, because of the appealing requirements of customers for online purchasing. Suppose that a person wants to launch his own online store for selling his products. He will choose the *e-commerce* web site that has comparatively better ratings and that is most popular among internet users. After initial screening four web sites, $S_1 = \text{Shopify}$, $S_2 = 3d \text{ Cart}$, $S_3 = \text{BigCommerce}$ and $S_4 = \text{Shopsite}$, are considered. Four attributes, $T_1 = \text{Customer satisfaction}$, $T_2 = \text{Comparative prices}$, $T_3 = \text{On-time delivery}$ and $T_4 = \text{Digital marketing}$, are designed to choose the best alternative.

Step 1. The decision matrix in the form of bipolar neutrosophic information is given as in Table 1:

Table 1. Bipolar neutrosophic decision matrix.

$S \setminus T$	T_1	T_2	T_3	T_4
S_1	(0.4, 0.2, 0.5, -0.6, -0.4, -0.4)	(0.5, 0.3, 0.3, -0.7, -0.2, -0.4)	(0.2, 0.7, 0.5, -0.4, -0.4, -0.3)	(0.4, 0.6, 0.5, -0.3, -0.7, -0.4)
S_2	(0.3, 0.6, 0.1, -0.5, -0.7, -0.5)	(0.2, 0.6, 0.1, -0.5, -0.3, -0.7)	(0.4, 0.2, 0.5, -0.6, -0.3, -0.1)	(0.2, 0.7, 0.5, -0.5, -0.3, -0.2)
S_3	(0.3, 0.5, 0.2, -0.4, -0.3, -0.7)	(0.4, 0.5, 0.2, -0.3, -0.8, -0.5)	(0.9, 0.5, 0.7, -0.3, -0.4, -0.3)	(0.3, 0.7, 0.6, -0.5, -0.5, -0.4)
S_4	(0.6, 0.7, 0.5, -0.2, -0.1, -0.3)	(0.8, 0.4, 0.6, -0.1, -0.3, -0.4)	(0.6, 0.3, 0.6, -0.1, -0.4, -0.2)	(0.8, 0.3, 0.2, -0.1, -0.3, -0.1)

Step 2. The normalized weights of the criteria are calculated by using maximizing deviation method as given below:

$$w_1 = 0.2567, w_2 = 0.2776, w_3 = 0.2179, w_4 = 0.2478, \text{ where } \sum_{j=1}^4 w_j = 1.$$

Step 3. The weighted bipolar neutrosophic decision matrix is constructed by multiplying the weights to decision matrix as given in Table 2:

Table 2. Weighted bipolar neutrosophic decision matrix.

$S \setminus T$	T_1	T_2	T_3	T_4
S_1	(0.123, 0.662, 0.837, -0.877, -0.79, -0.123)	(0.175, 0.716, 0.716, -0.906, -0.64, -0.132)	(0.047, 0.925, 0.86, -0.819, -0.819, -0.075)	(0.119, 0.881, 0.842, -0.742, -0.915, -0.119)
S_2	(0.087, 0.877, 0.554, -0.837, -0.913, -0.163)	(0.06, 0.868, 0.528, -0.825, -0.716, -0.284)	(0.105, 0.704, 0.86, -0.895, -0.769, -0.023)	(0.054, 0.915, 0.842, -0.842, -0.742, -0.054)
S_3	(0.087, 0.837, 0.662, -0.79, -0.734, -0.266)	(0.132, 0.825, 0.64, -0.716, -0.94, -0.175)	(0.395, 0.86, 0.925, -0.769, -0.819, -0.075)	(0.085, 0.915, 0.881, -0.842, -0.842, -0.119)
S_4	(0.21, 0.913, 0.837, -0.662, -0.554, -0.087)	(0.36, 0.775, 0.868, -0.528, -0.716, -0.132)	(0.181, 0.769, 0.895, -0.605, -0.819, -0.047)	(0.329, 0.742, 0.671, -0.565, -0.742, -0.026)

Step 4. The BNRPIs and BNRNIs are given by

$$\begin{aligned} \text{BNRPIS} = < (0.21, 0.662, 0.554, -0.877, -0.554, -0.087), \\ & (0.06, 0.868, 0.868, -0.528, -0.94, -0.284), \\ & (0.395, 0.704, 0.86, -0.895, -0.769, -0.023), \\ & (0.329, 0.742, 0.671, -0.842, -0.742, -0.062) >; \end{aligned}$$

$$\begin{aligned}
 BNRNIS = < (0.087, 0.913, 0.837, -0.662, -0.913, -0.266), \\
 & (0.36, 0.716, 0.528, -0.906, -0.64, -0.132), \\
 & (0.047, 0.925, 0.925, -0.605, -0.819, -0.075), \\
 & (0.054, 0.915, 0.881, -0.565, -0.915, -0.119) > .
 \end{aligned}$$

Step 5. The normalized Euclidean distances of each alternative from the BNRPISs and the BNRNISs are given as follows:

$$\begin{aligned}
 d_N(S_1, BNRPIS) &= 0.1805, & d_N(S_1, BNRNIS) &= 0.1125, \\
 d_N(S_2, BNRPIS) &= 0.1672, & d_N(S_2, BNRNIS) &= 0.1485, \\
 d_N(S_3, BNRPIS) &= 0.135, & d_N(S_3, BNRNIS) &= 0.1478, \\
 d_N(S_4, BNRPIS) &= 0.155, & d_N(S_4, BNRNIS) &= 0.1678.
 \end{aligned}$$

Step 6. The revised closeness degree of each alternative is given as

$$\rho(S_1) = -0.667, \rho(S_2) = -0.354, \rho(S_3) = -0.119, \rho(S_4) = -0.148.$$

Step 7. The inferior ratio to each alternative is given as

$$IR(1) = 1, IR(2) = 0.52, IR(3) = 0.18, IR(4) = 0.22.$$

Step 8. Ordering the web stores according to ascending order of alternatives, we obtain: $S_3 < S_4 < S_2 < S_1$. Therefore, the person will choose the BigCommerce for opening a web store.

3.2. Heart Surgeon

Suppose that a heart patient wants to select a best cardiac surgeon for heart surgery. After initial screening, five surgeons are considered for further evaluation. These surgeons represent the alternatives and are denoted by S_1, S_2, S_3, S_4 , and S_5 in our MCDM problem. Suppose that he concentrates on four characteristics, $T_1 =$ Availability of medical equipment, $T_2 =$ Surgeon reputation, $T_3 =$ Expenditure and $T_4 =$ Suitability of time, in order to select the best surgeon. These characteristics represent the criteria for this MCDM problem.

Step 1. The decision matrix in the form of bipolar neutrosophic information is given as in Table 3:

Table 3. Bipolar neutrosophic decision matrix.

$S \setminus T$	T_1	T_2	T_3	T_4
S_1	(0.6, 0.5, 0.3, -0.5, -0.7, -0.4)	(0.5, 0.7, 0.4, -0.6, -0.4, -0.5)	(0.3, 0.5, 0.5, -0.7, -0.3, -0.4)	(0.5, 0.3, 0.6, -0.4, -0.7, -0.5)
S_2	(0.9, 0.3, 0.2, -0.3, -0.6, -0.5)	(0.7, 0.4, 0.2, -0.4, -0.5, -0.7)	(0.4, 0.7, 0.6, -0.6, -0.3, -0.3)	(0.8, 0.3, 0.2, -0.2, -0.5, -0.7)
S_3	(0.4, 0.6, 0.6, -0.7, -0.4, -0.3)	(0.5, 0.3, 0.6, -0.6, -0.4, -0.4)	(0.7, 0.5, 0.3, -0.4, -0.4, -0.6)	(0.4, 0.6, 0.7, -0.5, -0.4, -0.4)
S_4	(0.8, 0.5, 0.3, -0.3, -0.4, -0.5)	(0.6, 0.4, 0.3, -0.5, -0.7, -0.8)	(0.4, 0.5, 0.7, -0.5, -0.4, -0.2)	(0.5, 0.4, 0.6, -0.6, -0.7, -0.3)
S_5	(0.6, 0.4, 0.6, -0.4, -0.7, -0.3)	(0.4, 0.7, 0.6, -0.7, -0.5, -0.6)	(0.6, 0.3, 0.5, -0.3, -0.7, -0.4)	(0.5, 0.7, 0.4, -0.3, -0.6, -0.5)

Step 2. The normalized weights of the criteria are calculated by using maximizing deviation method as given below:

$$w_1 = 0.2480, w_2 = 0.2424, w_3 = 0.2480, w_4 = 0.2616, \text{ where } \sum_{j=1}^4 w_j = 1.$$

Step 3. The weighted bipolar neutrosophic decision matrix is constructed by multiplying the weights to decision matrix as given in Table 4:

Table 4. Weighted bipolar neutrosophic decision matrix.

$S \setminus T$	T_1	T_2	T_3	T_4
S_1	(0.203, 0.842, 0.742, -0.842, -0.915, -0.119)	(0.155, 0.917, 0.801, -0.884, -0.801, -0.155)	(0.085, 0.842, 0.842, -0.915, -0.742, -0.119)	(0.166, 0.730, 0.875, -0.787, -0.911, -0.166)
S_2	(0.435, 0.742, 0.671, -0.742, -0.881, -0.158)	(0.253, 0.801, 0.677, -0.801, -0.845, -0.253)	(0.119, 0.915, 0.881, -0.881, -0.742, -0.085)	(0.344, 0.730, 0.656, -0.656, -0.834, -0.270)
S_3	(0.119, 0.881, 0.881, -0.915, -0.797, -0.085)	(0.155, 0.747, 0.884, -0.884, -0.801, -0.116)	(0.258, 0.842, 0.742, -0.797, -0.797, -0.203)	(0.125, 0.875, 0.911, -0.834, -0.787, -0.125)
S_4	(0.329, 0.842, 0.742, -0.742, -0.797, -0.158)	(0.199, 0.801, 0.747, -0.845, -0.917, -0.323)	(0.119, 0.842, 0.915, -0.842, -0.797, -0.054)	(0.166, 0.787, 0.875, -0.875, -0.911, -0.089)
S_5	(0.203, 0.797, 0.881, -0.797, -0.915, -0.085)	(0.116, 0.917, 0.884, -0.917, -0.845, -0.199)	(0.203, 0.742, 0.842, -0.742, -0.915, -0.119)	(0.166, 0.911, 0.787, -0.730, -0.875, -0.166)

Step 4. The BNRPIS and BNRNIS are given by

$$BNRPIS = \langle (0.435, 0.742, 0.671, -0.915, -0.797, -0.085), (0.253, 0.747, 0.677, -0.917, -0.801, -0.116), (0.085, 0.915, 0.915, -0.742, -0.915, -0.203), (0.344, 0.730, 0.656, -0.875, -0.787, -0.089) \rangle;$$

$$BNRNIS = \langle (0.119, 0.881, 0.881, -0.742, -0.915, -0.158), (0.116, 0.917, 0.884, -0.801, -0.917, -0.323), (0.258, 0.742, 0.742, -0.915, -0.742, -0.054), (0.125, 0.911, 0.911, -0.656, -0.911, -0.270) \rangle.$$

Step 5. The normalized Euclidean distances of each alternative from the BNRPISs and the BNRNISs are given as follows:

$$\begin{aligned} d_N(S_1, BNRPIS) &= 0.1176, & d_N(S_1, BNRNIS) &= 0.0945, \\ d_N(S_2, BNRPIS) &= 0.0974, & d_N(S_2, BNRNIS) &= 0.1402, \\ d_N(S_3, BNRPIS) &= 0.1348, & d_N(S_3, BNRNIS) &= 0.1043, \\ d_N(S_4, BNRPIS) &= 0.1089, & d_N(S_4, BNRNIS) &= 0.1093, \\ d_N(S_5, BNRPIS) &= 0.1292, & d_N(S_5, BNRNIS) &= 0.0837. \end{aligned}$$

Step 6. The revised closeness degree of each alternative is given as

$$\rho(S_1) = -0.553, \rho(S_2) = 0, \rho(S_3) = -0.64, \rho(S_4) = -0.338, \rho(S_5) = -0.729$$

Step 7. The inferior ratio to each alternative is given as

$$IR(1) = 0.73, IR(2) = 0, IR(3) = 0.88, IR(4) = 0.46, IR(5) = 1.$$

Step 8. Ordering the alternatives in ascending order, we obtain: $S_2 < S_4 < S_1 < S_3 < S_5$. Therefore, S_2 is best among all other alternatives.

3.3. Employee (Marketing Manager)

Process of employee selection has an analytical importance for any kind of business. According to firm hiring requirements and the job position, this process may vary from a very simple process to a complicated procedure. Suppose that a company wants to hire an employee for the post of marketing manager. After initial screening, four candidates are considered as alternatives and denoted by S_1, S_2, S_3 and S_4 in our MCDM problem. The requirements for this post, $T_1 =$ Confidence, $T_2 =$ Qualification, $T_3 =$ Leading skills and $T_4 =$ Communication skills, are considered as criteria in order to select the most relevant candidate.

Step 1. The decision matrix in the form of bipolar neutrosophic information is given as in Table 5:

Table 5. Bipolar neutrosophic decision matrix.

$S \setminus T$	T_1	T_2	T_3	T_4
S_1	(0.8, 0.5, 0.3, -0.3, -0.6, -0.5)	(0.7, 0.3, 0.2, -0.3, -0.5, -0.4)	(0.5, 0.4, 0.6, -0.5, -0.3, -0.4)	(0.9, 0.3, 0.2, -0.3, -0.4, -0.2)
S_2	(0.5, 0.7, 0.6, -0.4, -0.2, -0.4)	(0.4, 0.7, 0.5, -0.6, -0.2, -0.3)	(0.6, 0.8, 0.5, -0.3, -0.5, -0.7)	(0.5, 0.3, 0.6, -0.6, -0.4, -0.3)
S_3	(0.4, 0.6, 0.8, -0.7, -0.3, -0.4)	(0.6, 0.3, 0.5, -0.2, -0.4, -0.6)	(0.3, 0.5, 0.7, -0.8, -0.4, -0.2)	(0.5, 0.7, 0.4, -0.6, -0.3, -0.5)
S_4	(0.7, 0.3, 0.5, -0.4, -0.2, -0.5)	(0.5, 0.4, 0.6, -0.4, -0.5, -0.3)	(0.6, 0.4, 0.3, -0.3, -0.5, -0.7)	(0.4, 0.5, 0.7, -0.6, -0.5, -0.3)

Step 2. The normalized weights of the criteria are calculated by using maximizing deviation method as given below:

$$w_1 = 0.25, w_2 = 0.2361, w_3 = 0.2708, w_4 = 0.2431, \text{ where } \sum_{j=1}^4 w_j = 1.$$

Step 3. The weighted bipolar neutrosophic decision matrix is constructed by multiplying the weights to decision matrix as given in Table 6:

Table 6. Weighted bipolar neutrosophic decision matrix.

$S \setminus T$	T_1	T_2	T_3	T_4
S_1	(0.3313, 0.8409, 0.7401, -0.7401, -0.8801, -0.1591)	(0.2474, 0.7526, 0.6839, -0.7526, -0.8490, -0.1136)	(0.1711, 0.7803, 0.8708, -0.8289, -0.7218, -0.1292)	(0.4287, 0.7463, 0.6762, -0.7463, -0.8003, -0.0528)
S_2	(0.1591, 0.9147, 0.8801, -0.7953, -0.6687, -0.1199)	(0.1136, 0.9192, 0.8490, -0.8864, -0.6839, -0.0808)	(0.2197, 0.9414, 0.8289, -0.7218, -0.8289, -0.2782)	(0.1551, 0.7463, 0.8832, -0.8832, -0.8003, -0.0831)
S_3	(0.1199, 0.8801, 0.9457, -0.9147, -0.7401, -0.1199)	(0.1945, 0.7526, 0.8490, -0.6839, -0.8055, -0.1945)	(0.0921, 0.8289, 0.9079, -0.9414, -0.7803, -0.0586)	(0.1551, 0.9169, 0.8003, -0.8832, -0.7463, -0.1551)
S_4	(0.2599, 0.7401, 0.8409, -0.7953, -0.6687, -0.1591)	(0.1510, 0.8055, 0.8864, -0.8055, -0.8490, -0.0808)	(0.2197, 0.7803, 0.7218, -0.7218, -0.8289, -0.2782)	(0.1168, 0.8449, 0.9169, -0.8832, -0.8449, -0.0831)

Step 4. The BNRPIs and BNRNIs are given by

$$\begin{aligned} \text{BNRPIS} = & \langle (0.3313, 0.7401, 0.7401, -0.9147, -0.6687, -0.1199), \\ & (0.2474, 0.7526, 0.6839, -0.8864, -0.6839, -0.0808), \\ & (0.2197, 0.7803, 0.7218, -0.9414, -0.7218, -0.0586), \\ & (0.4287, 0.7463, 0.6762, -0.8832, -0.7463, -0.0528) \rangle; \end{aligned}$$

$$\begin{aligned}
 BNRNIS = < (0.1199, 0.9147, 0.9457, -0.7401, -0.8801, -0.1591), \\
 & (0.1136, 0.9192, 0.8864, -0.6839, -0.8490, -0.1945), \\
 & (0.0921, 0.9414, 0.9079, -0.7218, -0.8289, -0.2782), \\
 & (0.1168, 0.9169, 0.9169, -0.7463, -0.8449, -0.1551) > .
 \end{aligned}$$

Step 5. The normalized Euclidean distances of each alternative from the BNRPISs and the BNRNISs are given as follows:

$$\begin{aligned}
 d_N(S_1, BNRPIS) &= 0.0906, & d_N(S_1, BNRNIS) &= 0.1393, \\
 d_N(S_2, BNRPIS) &= 0.1344, & d_N(S_2, BNRNIS) &= 0.0953, \\
 d_N(S_3, BNRPIS) &= 0.1286, & d_N(S_3, BNRNIS) &= 0.1011, \\
 d_N(S_4, BNRPIS) &= 0.1293, & d_N(S_4, BNRNIS) &= 0.0999.
 \end{aligned}$$

Step 6. The revised closeness degree of each alternative is given as

$$\rho(S_1) = 0, \rho(S_2) = -0.799, \rho(S_3) = -0.694, \rho(S_4) = -0.780.$$

Step 7. The inferior ratio to each alternative is given as

$$IR(1) = 0, IR(2) = 1, IR(3) = 0.87, IR(4) = 0.98.$$

Step 8. Ordering the alternatives in ascending order, we obtain: $S_1 < S_3 < S_4 < S_2$. Therefore, the company will select the candidate S_1 for this post.

4. Bipolar Neutrosophic ELECTRE-I Method

In this section, we propose bipolar neutrosophic ELECTRE-I method to solve MCDM problems. Consider a set of alternatives, denoted by $S = \{S_1, S_2, S_3, \dots, S_m\}$ and the set of criteria, denoted by $T = \{T_1, T_2, T_3, \dots, T_n\}$ which are used to evaluate the alternatives.

- (i-iii) As in the section of bipolar neutrosophic TOPSIS, the rating values of alternatives with respect to the criteria are expressed in the form of matrix $[k_{ij}]_{m \times n}$. The weights w_j of the criteria T_j are evaluated by maximizing deviation method and the weighted bipolar neutrosophic decision matrix $[k_{ij}^{w_j}]_{m \times n}$ is constructed.
- (iv) The bipolar neutrosophic concordance sets E_{xy} and bipolar neutrosophic discordance sets F_{xy} are defined as follows:

$$\begin{aligned}
 E_{xy} &= \{1 \leq j \leq n \mid \rho_{xj} \geq \rho_{yj}\}, \quad x \neq y, \quad x, y = 1, 2, \dots, m, \\
 F_{xy} &= \{1 \leq j \leq n \mid \rho_{xj} \leq \rho_{yj}\}, \quad x \neq y, \quad x, y = 1, 2, \dots, m,
 \end{aligned}$$

where, $\rho_{ij} = T_{ij}^+ + I_{ij}^+ + F_{ij}^+ + T_{ij}^- + I_{ij}^- + F_{ij}^-$, $i = 1, 2, \dots, m, j = 1, 2, \dots, n$.

- (v) The bipolar neutrosophic concordance matrix E is constructed as follows:

$$E = \begin{bmatrix} - & e_{12} & \cdot & \cdot & \cdot & e_{1m} \\ e_{21} & - & \cdot & \cdot & \cdot & e_{2m} \\ \cdot & & & & & \\ \cdot & & & & & \\ \cdot & & & & & \\ e_{m1} & e_{m2} & \cdot & \cdot & \cdot & - \end{bmatrix},$$

where, the bipolar neutrosophic concordance indices e_{xy} 's are determined as

$$e_{xy} = \sum_{j \in E_{xy}} w_j.$$

(vi) The bipolar neutrosophic discordance matrix F is constructed as follows:

$$F = \begin{bmatrix} - & f_{12} & \cdot & \cdot & \cdot & f_{1m} \\ f_{21} & - & \cdot & \cdot & \cdot & f_{2m} \\ \cdot & & & & & \\ \cdot & & & & & \\ \cdot & & & & & \\ f_{m1} & f_{m2} & \cdot & \cdot & \cdot & - \end{bmatrix},$$

where, the bipolar neutrosophic discordance indices f_{xy} 's are determined as

$$f_{xy} = \frac{\max_{j \in F_{xy}} \sqrt{\frac{1}{6n} \left\{ (T_{xj}^{w_j^+} - T_{yj}^{w_j^+})^2 + (I_{xj}^{w_j^+} - I_{yj}^{w_j^+})^2 + (F_{xj}^{w_j^+} - F_{yj}^{w_j^+})^2 + (T_{xj}^{w_j^-} - T_{yj}^{w_j^-})^2 + (I_{xj}^{w_j^-} - I_{yj}^{w_j^-})^2 + (F_{xj}^{w_j^-} - F_{yj}^{w_j^-})^2 \right\}}}{\max_j \sqrt{\frac{1}{6n} \left\{ (T_{xj}^{w_j^+} - T_{yj}^{w_j^+})^2 + (I_{xj}^{w_j^+} - I_{yj}^{w_j^+})^2 + (F_{xj}^{w_j^+} - F_{yj}^{w_j^+})^2 + (T_{xj}^{w_j^-} - T_{yj}^{w_j^-})^2 + (I_{xj}^{w_j^-} - I_{yj}^{w_j^-})^2 + (F_{xj}^{w_j^-} - F_{yj}^{w_j^-})^2 \right\}}}$$

(vii) Concordance and discordance levels are computed to rank the alternatives. The bipolar neutrosophic concordance level \hat{e} is defined as the average value of the bipolar neutrosophic concordance indices as

$$\hat{e} = \frac{1}{m(m-1)} \sum_{\substack{x=1, y=1, \\ x \neq y, y \neq x}}^m \sum_{\substack{x=1, y=1, \\ x \neq y, y \neq x}}^m e_{xy},$$

similarly, the bipolar neutrosophic discordance level \hat{f} is defined as the average value of the bipolar neutrosophic discordance indices as

$$\hat{f} = \frac{1}{m(m-1)} \sum_{\substack{x=1, y=1, \\ x \neq y, y \neq x}}^m \sum_{\substack{x=1, y=1, \\ x \neq y, y \neq x}}^m f_{xy}.$$

(viii) The bipolar neutrosophic concordance dominance matrix ϕ on the basis of \hat{e} is determined as follows:

$$\phi = \begin{bmatrix} - & \phi_{12} & \cdot & \cdot & \cdot & \phi_{1m} \\ \phi_{21} & - & \cdot & \cdot & \cdot & \phi_{2m} \\ \cdot & & & & & \\ \cdot & & & & & \\ \cdot & & & & & \\ \phi_{m1} & \phi_{m2} & \cdot & \cdot & \cdot & - \end{bmatrix},$$

where, ϕ_{xy} is defined as

$$\phi_{xy} = \begin{cases} 1, & \text{if } e_{xy} \geq \hat{e}, \\ 0, & \text{if } e_{xy} < \hat{e}. \end{cases}$$

- (ix) The bipolar neutrosophic discordance dominance matrix ψ on the basis of \hat{f} is determined as follows:

$$\psi = \begin{bmatrix} - & \psi_{12} & \cdot & \cdot & \cdot & \psi_{1m} \\ \psi_{21} & - & \cdot & \cdot & \cdot & \psi_{2m} \\ \cdot & & & & & \\ \cdot & & & & & \\ \psi_{m1} & \psi_{m2} & \cdot & \cdot & \cdot & - \end{bmatrix},$$

where, ψ_{xy} is defined as

$$\psi_{xy} = \begin{cases} 1, & \text{if } f_{xy} \leq \hat{f}, \\ 0, & \text{if } f_{xy} > \hat{f}. \end{cases}$$

- (x) Consequently, the bipolar neutrosophic aggregated dominance matrix π is evaluated by multiplying the corresponding entries of ϕ and ψ , that is

$$\pi = \begin{bmatrix} - & \pi_{12} & \cdot & \cdot & \cdot & \pi_{1m} \\ \pi_{21} & - & \cdot & \cdot & \cdot & \pi_{2m} \\ \cdot & & & & & \\ \cdot & & & & & \\ \pi_{m1} & \pi_{m2} & \cdot & \cdot & \cdot & - \end{bmatrix},$$

where, π_{xy} is defined as

$$\pi_{xy} = \phi_{xy}\psi_{xy}.$$

- (xi) Finally, the alternatives are ranked according to the outranking values π_{xy} 's. That is, for each pair of alternatives S_x and S_y , an arrow from S_x to S_y exists if and only if $\pi_{xy} = 1$. As a result, we have three possible cases:
- (a) There exists a unique arrow from S_x into S_y .
 - (b) There exist two possible arrows between S_x and S_y .
 - (c) There is no arrow between S_x and S_y .

For case a, we decide that S_x is preferred to S_y . For the second case, S_x and S_y are indifferent, whereas, S_x and S_y are incomparable in case c.

Geometric representation of proposed bipolar neutrosophic ELECTRE-I method is shown in Figure 2.

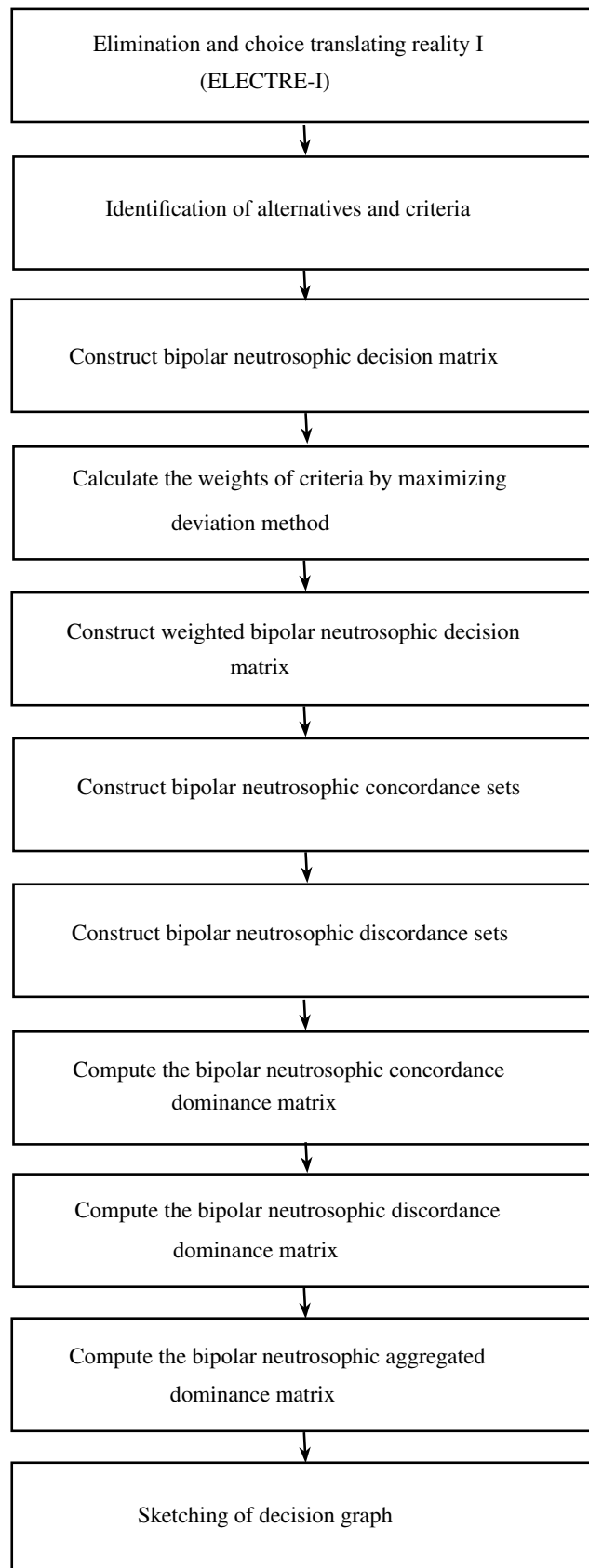

Figure 2.3: Flow chart of bipolar neutrosophic ELECTRE-I method

Numerical Example

In Section 3, MCDM problems are presented using the bipolar neutrosophic TOPSIS method. In this section, we apply our proposed bipolar neutrosophic ELECTRE-I method to select the “electronic commerce web site” to compare these two MCDM methods. Steps (1–3) have already been done in Section 3.1. So we move on to Step 4.

Step 4. The bipolar neutrosophic concordance sets E_{xy} 's are given as in Table 7:

Table 7. Bipolar neutrosophic concordance sets.

$E_{xy} \setminus y$	1	2	3	4
E_{1y}	-	{1, 2, 3}	{1, 2}	{}
E_{2y}	{4}	-	{4}	{}
E_{3y}	{3, 4}	{1, 2, 3}	-	{3}
E_{4y}	{1, 2, 3, 4}	{1, 2, 3, 4}	{1, 2, 4}	-

Step 5. The bipolar neutrosophic discordance sets F_{xy} 's are given as in Table 8.

Table 8. Bipolar neutrosophic discordance sets.

$F_{xy} \setminus y$	1	2	3	4
F_{1y}	-	{4}	{3, 4}	{1, 2, 3, 4}
F_{2y}	{1, 2, 3}	-	{1, 2, 3}	{1, 2, 3, 4}
F_{3y}	{1, 2}	{4}	-	{1, 2, 4}
F_{4y}	{}	{}	{3}	-

Step 6. The bipolar neutrosophic concordance matrix E is computed as follows

$$E = \begin{bmatrix} - & 0.7522 & 0.5343 & 0 \\ 0.2478 & - & 0.2478 & 0 \\ 0.4657 & 0.7522 & - & 0.2179 \\ 1 & 1 & 0.7821 & - \end{bmatrix}$$

Step 7. The bipolar neutrosophic discordance matrix F is computed as follows

$$F = \begin{bmatrix} - & 0.5826 & 0.9464 & 1 \\ 1 & - & 1 & 1 \\ 1 & 0.3534 & - & 1 \\ 0 & 0 & 0.6009 & - \end{bmatrix}$$

Step 8. The bipolar neutrosophic concordance level is $\hat{e} = 0.5003$ and bipolar neutrosophic discordance level is $\hat{f} = 0.7069$. The bipolar neutrosophic concordance dominance matrix ϕ and bipolar neutrosophic discordance dominance matrix ψ are as follows

$$\phi = \begin{bmatrix} - & 1 & 1 & 0 \\ 0 & - & 0 & 0 \\ 0 & 1 & - & 0 \\ 1 & 1 & 1 & - \end{bmatrix}, \psi = \begin{bmatrix} - & 1 & 0 & 0 \\ 0 & - & 0 & 0 \\ 0 & 1 & - & 0 \\ 0 & 0 & 0 & - \end{bmatrix}.$$

Step 9. The bipolar neutrosophic aggregated dominance matrix π is computed as

$$\pi = \begin{bmatrix} - & 1 & 0 & 0 \\ 0 & - & 0 & 0 \\ 0 & 1 & - & 0 \\ 0 & 0 & 0 & - \end{bmatrix}.$$

According to nonzero values of π_{xy} , we get the alternatives in the following sequence:

$$S_1 \rightarrow S_2 \leftarrow S_3$$

Therefore, the most favorable alternatives are S_3 and S_1 .

5. Comparison of Bipolar Neutrosophic TOPSIS and Bipolar Neutrosophic ELECTRE-I

TOPSIS and ELECTRE-I are the most commonly used MCDM methods to solve decision making problems, in which the best possible alternative is selected among others. The main idea of the TOPSIS method is that the chosen alternative has the shortest distance from positive ideal solution and the greatest distance from negative ideal solution, whereas the ELECTRE-I method is based on the binary comparison of alternatives. The proposed MCDM methods TOPSIS and ELECTRE-I are based on bipolar neutrosophic information. In the bipolar neutrosophic TOPSIS method, the normalized Euclidean distance is used to compute the revised closeness coefficient of alternatives to BNRPI and BNRNI. Alternatives are ranked in increasing order on the basis of inferior ratio values. Bipolar neutrosophic TOPSIS is an effective method because it has a simple process and is able to deal with any number of alternatives and criteria. Throughout history, one drawback of the TOPSIS method is that more rank reversals are created by increasing the number of alternatives. The proposed bipolar neutrosophic ELECTRE-I is an outranking relation theory that compares all pairs of alternatives and figures out which alternatives are preferred to the others by systematically comparing them for each criterion. The connection between different alternatives shows the bipolar neutrosophic concordance and bipolar neutrosophic discordance behavior of alternatives. The bipolar neutrosophic TOPSIS method gives only one possible alternative but the bipolar neutrosophic ELECTRE-I method sometimes provides a set of alternatives as a final selection to consider the MCDM problem. Despite all of the above comparisons, it is difficult to determine which method is most convenient, because both methods have their own importance and can be used according to the choice of the decision maker.

6. Conclusions

A single-valued neutrosophic set as an instance of a neutrosophic set provides an additional possibility to represent imprecise, uncertainty, inconsistent and incomplete information which exist in real situations. Single valued neutrosophic models are more flexible and practical than fuzzy and intuitionistic fuzzy models. We have presented the procedure, technique and implication of TOPSIS and ELECTRE-I methods under bipolar neutrosophic environment. The rating values of alternatives with respect to attributes are expressed in the form of BNSs. The unknown weights of the attributes are calculated by maximizing the deviation method to construct the weighted decision matrix. The normalized Euclidean distance is used to calculate the distance of each alternative from BNRPI and BNRNI. Revised closeness degrees are computed and then the inferior ratio method is used to rank the alternatives in bipolar neutrosophic TOPSIS. The concordance and discordance matrices are evaluated to rank the alternatives in bipolar neutrosophic ELECTRE-I. We have also presented some examples to explain these methods.

References

1. Zadeh, L.A. Fuzzy sets. *Inf. Control* **1965**, *8*, 338–353. [[CrossRef](#)]
2. Smarandache, F. *A Unifying Field of Logics, Neutrosophy: Neutrosophic Probability, Set and Logic*; American Research Press: Rehoboth, DE, USA, 1998.
3. Wang, H.; Smarandache, F.; Zhang, Y.; Sunderraman, R. Single valued neutrosophic sets. In *Multi-Space and Multi-Structure*; Infinite Study: New Delhi, India, 2010; Volume 4, pp. 410–413.
4. Deli, M.; Ali, F. Smarandache, Bipolar neutrosophic sets and their application based on multi-criteria decision making problems. In *Proceedings of the 2015 International Conference on Advanced Mechatronic Systems*, Beijing, China, 20–24 August 2015; pp. 249–254.
5. Zhang, W.R. Bipolar fuzzy sets and relations: A computational framework for cognitive modeling and multiagent decision analysis. In *Processing of the IEEE Conference, Fuzzy Information Processing Society Biannual Conference*, San Antonio, TX, USA, 81–21 December 1994; pp. 305–309.
6. Hwang, C.L.; Yoon, K. *Multi Attribute Decision Making: Methods and Applications*; Springer: New York, NY, USA, 1981.
7. Chen, C.-T. Extensions of the TOPSIS for group decision-making under fuzzy environment. *Fuzzy Sets Syst.* **2000**, *114*, 1–9. [[CrossRef](#)]
8. Chu, T.C. Facility location selection using fuzzy TOPSIS under group decisions. *Int. J. Uncertain. Fuzziness Knowl.-Based Syst.* **2002**, *10*, 687–701. [[CrossRef](#)]
9. Hadi-Vencheh, A.; Mirjaberi, M. Fuzzy inferior ratio method for multiple attribute decision making problems. *Inf. Sci.* **2014**, *277*, 263–272. [[CrossRef](#)]
10. Joshi, D.; Kumar, S. Intuitionistic fuzzy entropy and distance measure based TOPSIS method for multi-criteria decision making. *Egypt. Inform. J.* **2014**, *15*, 97–104. [[CrossRef](#)]
11. Kolios, A.; Mytilinou, V.; Lozano-Minguez, E.; Salonitis, K. A comparative study of multiple-criteria decision-making methods under stochastic inputs. *Energies* **2016**, *9*, 566. [[CrossRef](#)]
12. Akram, M.; Alshehri, N.O.; Davvaz, B.; Ashraf, A. Bipolar fuzzy digraphs in decision support systems. *J. Multiple-Valued Log. Soft Comput.* **2016**, *27*, 531–551.
13. Akram, M.; Feng, F.; Saeid, A.B.; Fotea, V. A new multiple criteria decision-making method based on bipolar fuzzy soft graphs. *Iran. J. Fuzzy Syst.* **2017**. [[CrossRef](#)]
14. Akram, M.; Waseem, N. Novel applications of bipolar fuzzy graphs to decision making problems. *J. Appl. Math. Comput.* **2018**, *56*, 73–91. [[CrossRef](#)]
15. Sarwar, M.; Akram, M. Certain algorithms for computing strength of competition in bipolar fuzzy graphs. *Int. J. Uncertain. Fuzziness Knowl.-Based Syst.* **2017**, *25*, 877–896. [[CrossRef](#)]
16. Sarwar, M.; Akram, M. Novel concepts of bipolar fuzzy competition graphs. *J. Appl. Math. Comput.* **2017**, *54*, 511–547. [[CrossRef](#)]
17. Faizi, S.; Salabun, W.; Rashid, T.; Watróbski, J.; Zafar, S. Group decision-making for hesitant fuzzy sets based on characteristic objects method. *Symmetry* **2017**, *9*, 136. [[CrossRef](#)]
18. Alghamdi, M.A.; Alshehri, N.O.; Akram, M. Multi-criteria decision-making methods in bipolar fuzzy environment. *Int. J. Fuzzy Syst.* **2018**. [[CrossRef](#)]
19. Dey, P.P.; Pramanik, S.; Giri, B.C. TOPSIS for solving multi-attribute decision making problems under bipolar neutrosophic environment. In *New Trends in Neutrosophic Theory and Applications*; Pons Editions: Brussels, Belgium, 2016; pp. 65–77.
20. Benayoun, R.; Roy, B.; Sussman, N. *Manual de Reference du Programme Electre*; Note de Synthèse et Formation, No. 25; Direction Scientific SEMA: Paris, France, 1966.
21. Hatami-Marbini, A.; Tavana, M. An extension of the ELECTRE method for group decision making under a fuzzy environment. *Omega* **2011**, *39*, 373–386. [[CrossRef](#)]
22. Aytac, E.; Isik, A.T.; Kundaki, N. Fuzzy ELECTRE I method for evaluating catering firm alternatives. *Ege Acad. Rev.* **2011**, *11*, 125–134.
23. Wu, M.-C.; Chen, T.-Y. The ELECTRE multicriteria analysis approach based on Attanssov's intuitionistic fuzzy sets. *Expert Syst. Appl.* **2011**, *38*, 12318–12327. [[CrossRef](#)]
24. Chu, T.-C. Selecting plant location via a fuzzy TOPSIS approach. *Int. J. Adv. Manuf. Technol.* **2002**, *20*, 859–864.
25. Guarini, M.R.; Battisti, F.; Chiovitti, A. A Methodology for the selection of multi-criteria decision analysis methods in real estate and land management processes. *Sustainability* **2018**, *10*, 507. [[CrossRef](#)]

26. Hatefi, S.M.; Tamošaitiene, J. Construction projects assessment based on the sustainable development criteria by an integrated fuzzy AHP and improved GRA model. *Sustainability* **2018**, *10*, 991. [[CrossRef](#)]
27. Huang, Y.P.; Basanta, H.; Kuo, H.C.; Huang, A. Health symptom checking system for elderly people using fuzzy analytic hierarchy process. *Appl. Syst. Innov.* **2018**, *1*, 10. [[CrossRef](#)]
28. Salabun, W.; Piegat, A. Comparative analysis of MCDM methods for the assessment of mortality in patients with acute coronary syndrome. *Artif. Intell. Rev.* **2017**, *48*, 557–571. [[CrossRef](#)]
29. Triantaphyllou, E. *Multi-Criteria Decision Making Methods, Multi-Criteria Decision Making Methods: A Comparative Study*; Springer: Boston, MA, USA, 2000; pp. 5–21.
30. Yang, Y.M. Using the method of maximizing deviations to make decision for multi-indices. *Syst. Eng. Electron.* **1998**, *7*, 24–31.

Neutrosophic Incidence Graphs with Application

Muhammad Akram, Sidra Sayed, Florentin Smarandache

Muhammad Akram, Sidra Sayed, Florentin Smarandache (2018). Neutrosophic Incidence Graphs with Application. *Axioms* 7, 47; DOI: 10.3390/axioms7030047

Abstract: In this research study, we introduce the notion of single-valued neutrosophic incidence graphs. We describe certain concepts, including bridges, cut vertex and blocks in single-valued neutrosophic incidence graphs. We present some properties of single-valued neutrosophic incidence graphs. We discuss the edge-connectivity, vertex-connectivity and pair-connectivity in neutrosophic incidence graphs. We also deal with a mathematical model of the situation of illegal migration from Pakistan to Europe.

Keywords: single-valued neutrosophic incidence graphs; edge-connectivity; vertex-connectivity and pair-connectivity; application

1. Introduction

The concept of graph theory was introduced by Euler. A crisp graph shows the relations between the elements of the vertex set. A weighted graph gives the extent of these relations. Many problems can be solved if proper weights are given. However, in many situations, the weights may not known, and the relationship is uncertain. Hence, a fuzzy relation can be used to handle such situations. Rosenfeld [1] developed the concept of a fuzzy graph. He also discussed several concepts like edges, paths, bridges and connectedness in a fuzzy graph. Most of the theoretical development of fuzzy graph theory is based on Rosenfeld's initial work. Bhutani et al. [2,3] introduced the advance concepts in fuzzy graphs.

Sometimes when the relationship between the elements of the vertex set is indeterminate, the fuzzy graph and its extension fails. This indeterminacy can be overcome by using single-valued neutrosophic graphs [4].

Dinesh, in [5], introduced the concept of unordered pairs of vertices which are not incident with end vertices. The fuzzy incidence graph not just shows the relations between vertices, but also provides information about the influence of a vertex on an edge. Dinesh extended the idea of the fuzzy incidence graph in [6] by introducing new concepts in this regard. Later, Methew et al. [7] discussed the connectivity concepts in fuzzy incidence graphs. Malik et al. [8] applied the notion of the fuzzy incidence graph in problems involving human trafficking. They discussed the role played by the vulnerability of countries and their government's response to human trafficking. Methew et al. [9] studied fuzzy incidence blocks and their applications in illegal migration problems. They used fuzzy incidence graphs as a model for a nondeterministic network with supporting links. They used fuzzy incidence blocks to avoid the vulnerable links in the network.

The paper is organized as follows: In Section 1, we give some preliminary notions and terminologies of fuzzy incidence graphs which are needed to understand the extended concept of the single-valued neutrosophic incidence graph. In Section 2, we present the definition of a single-valued neutrosophic incidence graph. We also discuss the edge-connectivity, vertex-connectivity and

pair-connectivity in neutrosophic incidence graphs. In Section 3, we give a mathematical model of the situation of illegal migration from Pakistan to Europe. Finally, the paper is concluded by some remarks in Section 4. Below we present some preliminary definitions from [6] and [4]. For further study on these topics, the readers are referred to references [1,7–16].

Let $G = (V, E)$ be a graph on a nonempty set, V . Then, $G' = (V, E, I)$ is called an incidence graph, where $I \subseteq V \times E$. The elements of I are called incidence pairs or simply, pairs.

A fuzzy incidence graph of an incidence graph, $G' = (V, E, I)$, is an ordered-triplet, $\tilde{G} = (\mu, \lambda, \psi)$, where μ is a fuzzy subset of V , λ is a fuzzy relation of V , and ψ is a fuzzy subset of I such that

$$\psi(x, xy) \leq \min\{\mu(x), \lambda(xy)\}, \forall x \in V, xy \in E.$$

We may compare elements of two neutrosophic sets A and B , that is

$$\begin{aligned} (T_A(x), I_A(x), F_A(x)) &< (T_B(x), I_B(x), F_B(x)) \\ \Rightarrow T_A(x) < T_B(x), I_A(x) < I_B(x), F_A(x) > F_B(x). \end{aligned}$$

2. Single-Valued Neutrosophic Incidence Graphs

Definition 1. A single-valued neutrosophic incidence graph of an incidence graph, $G' = (V, E, I)$, is an ordered-triplet, $\tilde{G} = (A, B, C)$, such that

1. A is a single-valued neutrosophic set on V .
2. B is a single-valued neutrosophic relation on V .
3. C is a single-valued neutrosophic subset of $V \times E$ such that

$$\begin{aligned} T_C(x, xy) &\leq \min\{T_A(x), T_B(xy)\}, \\ I_C(x, xy) &\leq \min\{I_A(x), I_B(xy)\}, \\ F_C(x, xy) &\leq \max\{F_A(x), F_B(xy)\}, \forall x \in V, xy \in E. \end{aligned}$$

Here, we discuss an example of a single-valued neutrosophic incidence graph (SVNIG).

Example 1. Consider an incidence graph, $G = (V, E, I)$, such that $V = \{a, b, c, d\}$, $E = \{ab, bc, bd, cd, ad\}$ and $I = \{(a, ab), (b, ab), (b, bc), (c, bc), (b, bd), (d, bd), (c, cd), (d, cd), (d, ad), (a, ad)\}$, as shown in Figure 1.

Let $\tilde{G} = (A, B, C)$ be a single-valued neutrosophic incidence graph associated with G , as shown in Figure 2, where

$$\begin{aligned} A &= \{(a, 0.2, 0.5, 0.8), (b, 0.3, 0.5, 0.1), (c, 0.9, 0.9, 0.1), (d, 0.8, 0.1, 0.2)\}, \\ B &= \{(ab, 0.2, 0.4, 0.7), (bc, 0.3, 0.4, 0.1), (bd, 0.1, 0.1, 0.1), (cd, 0.7, 0.1, 0.2), (ad, 0.1, 0.1, 0.5)\}, \\ C &= \{((a, ab), 0.2, 0.3, 0.7), ((b, ab), 0.1, 0.4, 0.6), ((b, bc), 0.3, 0.3, 0.1), ((c, bc), 0.2, 0.3, 0.1), \\ &\quad ((b, bd), 0.1, 0.1, 0.1), ((d, bd), 0.1, 0.1, 0.2), ((c, cd), 0.7, 0.1, 0.2), ((d, cd), 0.7, 0.1, 0.2) \\ &\quad ((d, ad), 0.1, 0.1, 0.4), ((a, ad), 0.1, 0.1, 0.5)\}. \end{aligned}$$

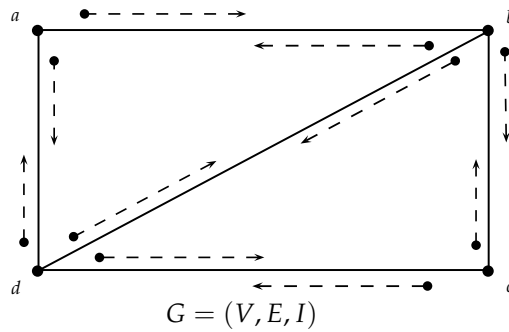

Figure 1. Incidence graph.

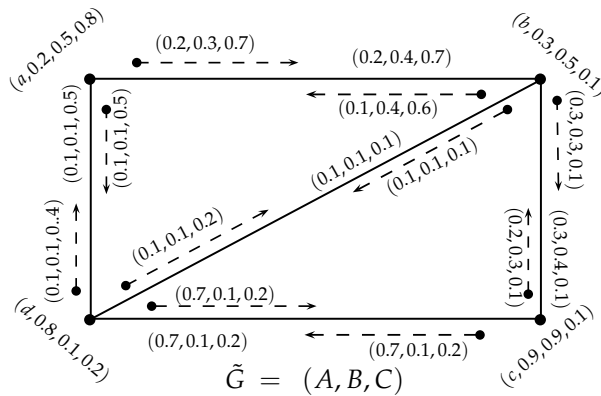

Figure 2. Single-valued neutrosophic incidence graph.

Definition 2. The support of an SVNIG $\tilde{G} = (A, B, C)$ is denoted by $G^* = (A^*, B^*, C^*)$ where

$$A^* = \text{support of } A = \{x \in V : T_A(x) > 0, I_A(x) > 0, F_A(x) > 0\},$$

$$B^* = \text{support of } B = \{xy \in E : T_B(xy) > 0, I_B(xy) > 0, F_B(xy) > 0\},$$

$$C^* = \text{support of } C = \{(x, xy) \in I : T_C(x, xy) > 0, I_C(x, xy) > 0, F_C(x, xy) > 0\}.$$

Now we introduce the concepts of edge, pair, walk, trail, path and connectedness in an SVNIG.

Definition 3. If $xy \in B^*$, then xy is an edge of the SVNIG $\tilde{G} = (A, B, C)$ and if $(x, xy), (y, xy) \in C^*$, then (x, xy) and (y, xy) are called pairs of \tilde{G} .

Definition 4. A sequence

$$P : u_0, (u_0, u_0u_1), u_0u_1, (u_1, u_0u_1), u_1, (u_1, u_1u_2), u_1u_2, (u_2, u_1u_2), u_2, \dots, \\ u_{n-1}, (u_{n-1}, u_{n-1}u_n), u_{n-1}u_n, (u_n, u_{n-1}u_n), u_n$$

of vertices, edges and pairs in \tilde{G} is a walk. It is a closed walk if $u_0 = u_n$.

In the above sequence, if all edges are distinct, then it is a trail, and if the pairs are distinct, then it is an incidence trail. P is called a path if the vertices are distinct. A path is called a cycle if the initial and end vertices of the path are same. Any two vertices of \tilde{G} are said to be connected if they are joined by a path.

Example 2. In the example presented earlier

$$P_1 : a, (a, ab), ab, (b, ab), b, (b, bd), bd, (d, bd), d, (d, da), da, (a, da), a$$

is a walk. It is a closed walk since the initial and final vertices are same, i.e., it is not a path, but it is a trail and an incidence trail.

$$P_2 : a, (a, ab), ab, (b, ab), b, (b, bd), bd, (d, bd), d$$

P_2 is a walk, path, trail and an incidence trail.

Definition 5. Let $\tilde{G} = (A, B, C)$ be a nSVNIG. Then, $\tilde{H} = (L, M, N)$ is a single-valued neutrosophic incidence subgraph of \tilde{G} if $L \subseteq A, M \subseteq B$ and $N \subseteq C$. \tilde{H} is a single-valued neutrosophic incidence spanning subgraph of \tilde{G} if $L^* = A^*$.

Definition 6. In an SVNIG, the strength of a path, P , is an ordered triplet denoted by $S(P) = (s_1, s_2, s_3)$, where

$$\begin{aligned} s_1 &= \min\{T_B(uv) : uv \in P\}, \\ s_2 &= \min\{I_B(uv) : uv \in P\}, \\ s_3 &= \max\{F_B(uv) : uv \in P\}. \end{aligned}$$

Similarly, the incidence strength of a path, P , in an SVNIG is denoted by $IS(P) = (is_1, is_2, is_3)$, where

$$\begin{aligned} is_1 &= \min\{T_C(u, uv) : (u, uv) \in P\}, \\ is_2 &= \min\{I_C(u, uv) : (u, uv) \in P\}, \\ is_3 &= \max\{F_C(u, uv) : (u, uv) \in P\}. \end{aligned}$$

Example 3. Let $G = (V, E, I)$ be an incidence graph, as shown in Figure 3, and $\tilde{G} = (A, B, C)$ is an SVNIG associated with G , which is shown in Figure 4.

Clearly, $P : u, (u, uv), uv, (v, uv), v, (v, vx), vx, (x, vx), x$ is a path in \tilde{G} .

The strength of the path, P , is $S(P) = (0.2, 0.1, 0.5)$, and the incidence strength of P is $IS(P) = (0.1, 0.1, 0.6)$.

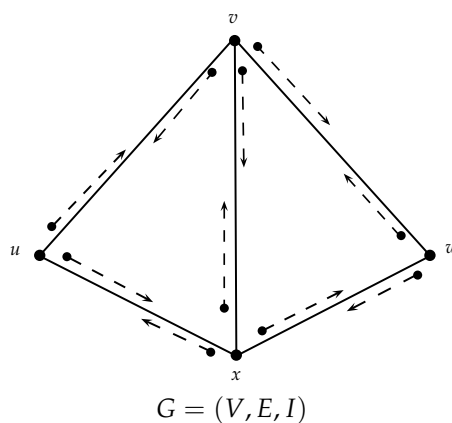

Figure 3. Incidence graph.

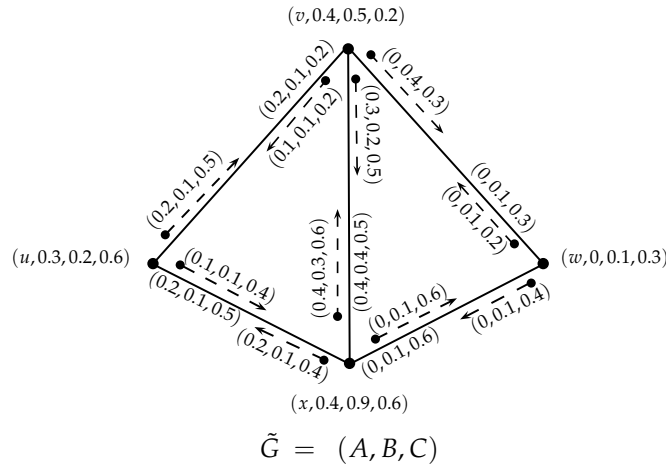

Figure 4. Single-valued neutrosophic incidence graph.

Definition 7. In an SVNIG, $\tilde{G} = (A, B, C)$ the greatest strength of the path from l to m , where $l, m \in A^* \cup B^*$ is the maximum of strength of all paths from l to m .

$$\begin{aligned}
 S^\infty(l, m) &= \max\{S(P_1), S(P_2), S(P_3), \dots\} \\
 &= (s_1^\infty, s_2^\infty, s_3^\infty) \\
 &= (\max(s_{11}, s_{12}, s_{13}, \dots), \max(s_{21}, s_{22}, s_{23}, \dots), \min(s_{31}, s_{32}, s_{33}, \dots)).
 \end{aligned}$$

$S^\infty(l, m)$ is sometimes called the connectedness between l and m .

Similarly, the greatest incidence strength of the path from l to m , where $l, m \in A^* \cup B^*$ is the maximum incidence strength of all paths from l to m .

$$\begin{aligned}
 IS^\infty(l, m) &= \max\{IS(P_1), IS(P_2), IS(P_3), \dots\} \\
 &= (is_1^\infty, is_2^\infty, is_3^\infty) \\
 &= (\max(is_{11}, is_{12}, is_{13}, \dots), \max(is_{21}, is_{22}, is_{23}, \dots), \min(is_{31}, is_{32}, is_{33}, \dots)),
 \end{aligned}$$

where $P_j, j = 1, 2, 3, \dots$ are different paths from l to m .

$IS^\infty(l, m)$ is sometimes referred as the incidence connectedness between l and m .

Example 4. In the SVNIG given in Figure 4, the total paths from vertex u to w are as follows:

- $P_1 : u, (u, ux), ux, (x, ux), x, (x, wx), wx, (w, wx), w.$
- $P_2 : u, (u, uv), uv, (v, uv), v, (v, vw), vw, (w, vw), w.$
- $P_3 : u, (u, uv), uv, (v, uv), v, (v, vx), vx, (x, vx), x, (x, wx), wx, (w, wx), w.$
- $P_4 : u, (u, ux), ux, (x, ux), x, (x, vx), vx, (v, vx), v, (v, vw), vw, (w, vw), w.$

The corresponding incidence strengths of each path are

$$\begin{aligned}
 IS(P_1) &= (s_{11}, s_{21}, s_{31}) = (0, 0.1, 0.6), \\
 IS(P_2) &= (s_{12}, s_{22}, s_{32}) = (0, 0.1, 0.5), \\
 IS(P_3) &= (s_{13}, s_{23}, s_{33}) = (0, 0.1, 0.6), \\
 IS(P_4) &= (s_{14}, s_{24}, s_{34}) = (0, 0.1, 0.6).
 \end{aligned}$$

Now, the greatest incidence strength of the path from u to w is calculated as follows:

$$\begin{aligned} IS^\infty(u, w) &= \max\{IS(P_1), IS(P_2), IS(P_3), IS(P_4)\} \\ &= (\max\{is_{11}, is_{12}, is_{13}, is_{14}\}, \max\{is_{21}, is_{22}, is_{23}, is_{24}\}, \min\{is_{31}, is_{32}, is_{33}, is_{34}\}) \\ &= (\max\{0, 0, 0, 0\}, \max\{0.1, 0.1, 0.1, 0.1\}, \min\{0.6, 0.5, 0.6, 0.6\}) \\ &= (0, 0.1, 0.5). \end{aligned}$$

Definition 8. An SVNIG, $\tilde{G} = (A, B, C)$, is a cycle if, and only if, the underlying graph, $G^* = (A^*, B^*, C^*)$, is a cycle.

Definition 9. The SVNIG $\tilde{G} = (A, B, C)$ is a neutrosophic cycle if, and only if, $G^* = (A^*, B^*, C^*)$ is a cycle and there exists no unique edge, $xy \in B^*$, such that

$$\begin{aligned} T_B(xy) &= \min\{T_B(uv) : uv \in B^*\}, \\ I_B(xy) &= \min\{I_B(uv) : uv \in B^*\}, \\ F_B(xy) &= \max\{F_B(uv) : uv \in B^*\}. \end{aligned}$$

Definition 10. The SVNIG $\tilde{G} = (A, B, C)$ is a neutrosophic incidence cycle if, and only if it is a neutrosophic cycle and there exists no unique pair, $(x, xy) \in C^*$, such that

$$\begin{aligned} T_C(x, xy) &= \min\{T_C(u, uv) : (u, uv) \in C^*\}, \\ I_C(x, xy) &= \min\{I_C(u, uv) : (u, uv) \in C^*\}, \\ F_C(x, xy) &= \max\{F_C(u, uv) : (u, uv) \in C^*\}. \end{aligned}$$

Example 5. Let $\tilde{G} = (A, B, C)$ be an SVNIG, as shown in Figure 5. \tilde{G} is a cycle, since $G = (A^*, B^*, C^*)$ (support of \tilde{G}) is clearly a cycle.

Also,

$$\begin{aligned} T_B(ab) &= 0.1 = \min\{T_B(ab), T_B(bc), T_B(cd), T_B(de), T_B(ea)\}, \\ I_B(ab) &= 0.1 = \min\{I_B(ab), I_B(bc), I_B(cd), I_B(de), I_B(ea)\}, \\ F_B(ab) &= 0.6 = \max\{F_B(ab), F_B(bc), F_B(cd), F_B(de), F_B(ea)\}, \end{aligned}$$

and

$$\begin{aligned} T_B(bc) &= 0.1 = \min\{T_B(ab), T_B(bc), T_B(cd), T_B(de), T_B(ea)\}, \\ I_B(bc) &= 0.1 = \min\{I_B(ab), I_B(bc), I_B(cd), I_B(de), I_B(ea)\}, \\ F_B(bc) &= 0.6 = \max\{F_B(ab), F_B(bc), F_B(cd), F_B(de), F_B(ea)\}. \end{aligned}$$

So, \tilde{G} is a neutrosophic cycle.

Furthermore, \tilde{G} is a neutrosophic incidence cycle since there is more than one pair, namely, (b, ab) and (d, de) , such that

$$\begin{aligned} T_C(b, ab) &= 0.1 = \min\{T_C(u, uv) : (u, uv) \in C^*\}, \\ I_C(b, ab) &= 0.1 = \min\{I_C(u, uv) : (u, uv) \in C^*\}, \\ F_C(b, ab) &= 0.7 = \max\{F_C(u, uv) : (u, uv) \in C^*\}, \end{aligned}$$

and

$$\begin{aligned} T_C(d, de) &= 0.1 = \min\{T_C(u, uv) : (u, uv) \in C^*\}, \\ I_C(d, de) &= 0.1 = \min\{I_C(u, uv) : (u, uv) \in C^*\}, \\ F_C(d, de) &= 0.7 = \max\{F_C(u, uv) : (u, uv) \in C^*\}. \end{aligned}$$

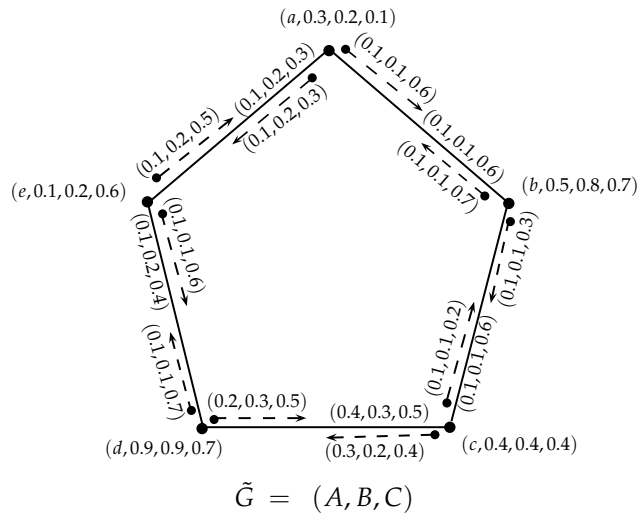

Figure 5. Single-valued neutrosophic incidence graph.

The concepts of bridges, cutvertices and cutpairs in SVNIG are defined as follows.

Definition 11. Let $\tilde{G} = (A, B, C)$ be an SVNIG. An edge uv , in \tilde{G} is called a bridge if, and only if, uv is a bridge in $G^* = (A^*, B^*, C^*)$ —that is, the removal of uv disconnects G^* .

An edge uv is called a neutrosophic bridge if

$$S'^{\infty}(x, y) < S^{\infty}(x, y), \quad \text{for some } x, y \in A^*,$$

$$(s'_1{}^{\infty}, s'_2{}^{\infty}, s'_3{}^{\infty}) < (s_1{}^{\infty}, s_2{}^{\infty}, s_3{}^{\infty})$$

$$\Rightarrow s'_1{}^{\infty} < s_1{}^{\infty}, s'_2{}^{\infty} < s_2{}^{\infty}, s'_3{}^{\infty} > s_3{}^{\infty}$$

where $S'^{\infty}(x, y)$ and $S^{\infty}(x, y)$ denote the connectedness between x and y in $G' = \tilde{G} - \{uv\}$ and \tilde{G} , respectively.

An edge, uv , is called a neutrosophic incidence bridge if

$$IS'^{\infty}(x, y) < IS^{\infty}(x, y), \quad \text{for some } x, y \in A^*,$$

$$(is'_1{}^{\infty}, is'_2{}^{\infty}, is'_3{}^{\infty}) < (is_1{}^{\infty}, is_2{}^{\infty}, is_3{}^{\infty})$$

$$\Rightarrow is'_1{}^{\infty} < is_1{}^{\infty}, is'_2{}^{\infty} < is_2{}^{\infty}, is'_3{}^{\infty} > is_3{}^{\infty}$$

where $IS'^{\infty}(x, y)$ and $IS^{\infty}(x, y)$ denote the incidence connectedness between x and y in $G' = \tilde{G} - \{uv\}$ and \tilde{G} , respectively.

Definition 12. Let $\tilde{G} = (A, B, C)$ be an SVNIG. A vertex, v , in \tilde{G} is a cutvertex if, and only if, it is a cutvertex in $G^* = (A^*, B^*, C^*)$ —that is $G^* - \{v\}$ is a disconnect graph.

A vertex, v , in an SVNIG is called a neutrosophic cutvertex if the connectedness between any two vertices in $G' = \tilde{G} - \{v\}$ is less than the connectedness between the same vertices in \tilde{G} —that is,

$$S'^{\infty}(x, y) < S^{\infty}(x, y), \quad \text{for some } x, y \in A^*.$$

A vertex, v , in SVNIG \tilde{G} is a neutrosophic incidence cutvertex if for any pair of vertices, x, y , other than v , the following condition holds:

$$IS'^{\infty}(x, y) < IS^{\infty}(x, y),$$

where $IS'^{\infty}(x, y)$ and $IS^{\infty}(x, y)$ denote the incidence connectedness between x and y in $G' = \tilde{G} - \{v\}$ and \tilde{G} , respectively.

Definition 13. Let $\tilde{G} = (A, B, C)$ be an SVNIG. A pair (u, uv) is called a cutpair if, and only if, (u, uv) is a cutpair in $G^* = (A^*, B^*, C^*)$ —that is, after removing the pair (u, uv) , there is no path between u and uv .

Let $\tilde{G} = (A, B, C)$ be an SVNIG. A pair (u, uv) is called a neutrosophic cutpair if deleting the pair (u, uv) reduces the connectedness between $u, uv \in A^* \cup B^*$, that is,

$$S'^{\infty}(u, uv) < S^{\infty}(u, uv),$$

where $S'^{\infty}(u, uv)$ and $S^{\infty}(u, uv)$ denote the connectedness between u and uv in $G' = \tilde{G} - \{(u, uv)\}$ and \tilde{G} , respectively.

A pair (u, uv) is called neutrosophic incidence cutpair if

$$IS'^{\infty}(u, uv) < IS^{\infty}(u, uv), \quad \text{for } u, uv \in A^* \cup B^*,$$

where $IS'^{\infty}(u, uv)$ and $IS^{\infty}(u, uv)$ denote the incidence connectedness between u and uv in $G' = \tilde{G} - \{(u, uv)\}$ and \tilde{G} , respectively.

Example 6. In the SVNIG, \tilde{G} , given in Figure 6, ab and bc are bridges, since their removal disconnects the underlying graph, G^* .

In \tilde{G} , ab, bc, cd and de are neutrosophic bridges, since, for $a, e \in A^*$,

$$S'^{\infty}(a, e) < S^{\infty}(a, e)$$

after the removal of each of the bridges. The edges— ab, bc, cd and de —are neutrosophic incidence bridges in \tilde{G} as well.

b and c are cutvertices. In addition, all the vertices of \tilde{G} are neutrosophic cutvertices, except for a , since the removal of a does not affect the connectedness of \tilde{G} . b, c, d and e are neutrosophic incidence cutvertices in \tilde{G} .

The pairs $(a, ab), (b, ab), (b, bc)$ and (c, bc) are the cutpairs, neutrosophic cutpairs and also neutrosophic incidence cutpairs in the given graph.

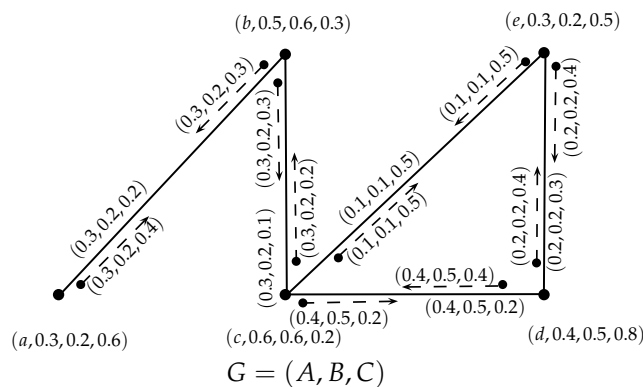

Figure 6. Single-valued neutrosophic incidence graph.

Theorem 1. Let $\tilde{G} = (A, B, C)$ be a SVNIG. If uv is a neutrosophic bridge, then uv is not a weakest edge in any cycle.

Proof. Let uv be a neutrosophic bridge and suppose, on the contrary, that uv is the weakest edge of a cycle. Then, in this cycle, we can find an alternative path, P_1 , from u to v that does not contain the edge uv , and $S(P_1)$ is greater than or equal to $S(P_2)$, where P_2 is the path involving the edge uv . Thus, removal of the edge uv from \tilde{G} does not affect the connectedness between u and v —a contradiction to our assumption. Hence, uv is not the weakest edge in any cycle. \square

Theorem 2. *If (u, uv) is a neutrosophic incidence cutpair, then (u, uv) is not the weakest pair in any cycle.*

Proof. Let (u, uv) be a neutrosophic incidence cutpair in \tilde{G} . On contrary suppose that (u, uv) is a weakest pair of a cycle. Then we can find an alternative path from u to uv having incidence strength greater than or equal to that of the path involving the pair (u, uv) . Thus, removal of the pair (u, uv) does not affect the incidence connectedness between u and uv but this is a contradiction to our assumption that (u, uv) is a neutrosophic incidence cutpair. Hence (u, uv) is not a weakest pair in any cycle. \square

Theorem 3. *Let $\tilde{G} = (A, B, C)$ be a SVNIG. If uv is a neutrosophic bridge in \tilde{G} , then*

$$S^\infty(u, v) = (s_1^\infty, s_2^\infty, s_3^\infty) = (T_B(uv), I_B(uv), F_B(uv)).$$

Proof. Let \tilde{G} be an SVNIG, and uv is a neutrosophic bridge in \tilde{G} . On the contrary, suppose that

$$S^\infty(u, v) > (T_B(uv), I_B(uv), F_B(uv)).$$

Then, there exists a u - v path, P , with

$$S(P) > (T_B(uv), I_B(uv), F_B(uv))$$

and

$$(T_B(xy), I_B(xy), F_B(xy)) > (T_B(uv), I_B(uv), F_B(uv)),$$

for all edges on path P . Now, P , together with the edge, uv , forms a cycle in which uv is the weakest edge, but it is a contradiction to the fact that uv is a neutrosophic bridge. Hence,

$$S^\infty(u, v) = (s_1^\infty, s_2^\infty, s_3^\infty) = (T_B(uv), I_B(uv), F_B(uv)).$$

\square

Theorem 4. *If (u, uv) is a neutrosophic incidence cutpair in an SVNIG $\tilde{G} = (A, B, C)$, then*

$$IS^\infty(u, uv) = (is_1^\infty, is_2^\infty, is_3^\infty) = (T_C(u, uv), I_C(u, uv), F_C(u, uv)).$$

Proof. The proof is on the same line as Theorem 3. \square

Theorem 5. *Let $\tilde{G} = (A, B, C)$ be an SVNIG and $G^* = (A^*, B^*, C^*)$ is a cycle. Then, an edge, uv , is a neutrosophic bridge of \tilde{G} if, and only if, it is an edge common to two neutrosophic incidence cutpairs.*

Proof. Suppose that uv is a neutrosophic bridge of \tilde{G} . Then, there exist vertices u and v with the uv edge lying on every path with the greatest incidence strength between u and v . Consequently, there exists only one path, P , (say) between u and v which contains a uv edge and has the greatest incidence strength. Any pair on P will be a neutrosophic incidence cutpair, since the removal of any one of them will disconnect P and reduce the incidence strength.

Conversely, let uv be an edge common to two neutrosophic incidence cutpairs (u, uv) and (v, uv) . Thus both (u, uv) and (v, uv) are not the weakest cutpairs of \tilde{G} . Now, $G^* = (A^*, B^*, C^*)$ being a cycle, there exist only two paths between any two vertices. Also the path P_1 from the vertex u to v not containing the pairs (u, uv) and (v, uv) has less incidence strength than the path containing them. Thus, the path with the greatest incidence strength from u to v is

$$P_2 : u, (u, uv), uv, (v, uv), v.$$

Also,

$$S^\infty(u, v) = S(P_2) = (T_B(uv), I_B(uv), F_B(uv)).$$

Therefore, uv is a neutrosophic bridge. \square

Definition 14. Let $\tilde{G} = (A, B, C)$ be an SVNIG. An edge, uv , of \tilde{G} is called a strong edge if

$$S'^\infty(u, v) \leq (T_B(uv), I_B(uv), F_B(uv)),$$

where $S'^\infty(u, v)$ represents the connectedness between u and v in $G' = \tilde{G} - \{uv\}$.

In particular, an edge, uv , is said to be an α -strong edge if

$$S'^\infty(u, v) < (T_B(uv), I_B(uv), F_B(uv)),$$

and it is called a β -strong edge if

$$S'^\infty(u, v) = (T_B(uv), I_B(uv), F_B(uv)).$$

Definition 15. A pair (u, uv) in an SVNIG, \tilde{G} , is called a strong pair if

$$IS'^\infty(u, uv) \leq (T_C(u, uv), I_C(u, uv), F_C(u, uv)),$$

where $IS'^\infty(u, uv)$ represents the incidence connectedness between u and uv in $G' = \tilde{G} - \{(u, uv)\}$.

In particular, (u, uv) is called α -strong pair if

$$IS'^\infty(u, uv) < (T_C(u, uv), I_C(u, uv), F_C(u, uv)),$$

and it is called β -strong pair if

$$IS'^\infty(u, uv) = (T_C(u, uv), I_C(u, uv), F_C(u, uv)).$$

It is not necessary for all edges and pairs to be strong. Edges and pairs exist which are not strong in an SVNIG. Such edges and pairs are given in the following definition.

Definition 16. Let $\tilde{G} = (A, B, C)$ be an SVNIG. An edge, uv , is said to be a δ -edge if

$$(T_B(uv), I_B(uv), F_B(uv)) < S'^\infty(u, v).$$

Similarly, a pair (u, uv) in \tilde{G} is called a δ -pair if

$$(T_C(u, uv), I_C(u, uv), F_C(u, uv)) < IS'^\infty(u, uv).$$

Theorem 6. In an SVNIG, every neutrosophic incidence cutpair is a strong pair.

Proof. Let $\tilde{G} = (A, B, C)$ be an SVNIG. Let $(u, uv) \in C^*$ be a neutrosophic incidence cutpair. Then, by Definition 13, we have

$$IS'^\infty(u, uv) < IS^\infty(u, uv).$$

On the contrary, suppose that (u, uv) is not a strong incidence pair. Then, it follows that

$$IS'^\infty(u, uv) > (T_C(u, uv), I_C(u, uv), F_C(u, uv)).$$

Let P be the path from u to uv in $G' = \tilde{G} - \{(u, uv)\}$ with the greatest incidence strength. Then, P together with (u, uv) , forms a cycle in \tilde{G} . Now, in this cycle, (u, uv) is the weakest pair, but, based on

Theorem 2, it is not possible, since (u, uv) is a neutrosophic incidence cutpair. Hence, our assumption is wrong, and (u, uv) is a strong incidence pair. \square

Theorem 7. *In an SVNIG $\tilde{G} = (A, B, C)$. The pair (u, uv) is a neutrosophic incidence cutpair if, and only if, it is α -strong.*

Proof. Let (u, uv) be a neutrosophic incidence cutpair in \tilde{G} . Then, according to the Definition 13 of cutpair,

$$IS^\infty(u, uv) > IS'^\infty(u, uv).$$

Then, based on Theorem 4, it follows that

$$(T_C(u, uv), I_C(u, uv), F_C(u, uv)) > IS'^\infty(u, uv),$$

which is the definition of α -strong pair. Hence, (u, uv) is an α -strong pair in \tilde{G} .

Conversely, let (u, uv) be an α -strong pair in \tilde{G} . Then, by definition

$$(T_C(u, uv), I_C(u, uv), F_C(u, uv)) > IS'^\infty(u, uv).$$

It follows that $P : u, (u, uv), uv$ is a unique path from u to uv which has the greatest incidence strength of all paths. Therefore, any other path from u to uv will have a lower incidence strength.

$$IS^\infty(u, uv) > IS'^\infty(u, uv).$$

Hence, (u, uv) is a neutrosophic incidence cutpair. \square

Definition 17. *Let $\tilde{G} = (A, B, C)$ be an SVNIG.*

- (i) \tilde{G} is called a block if $G^* = (A^*, B^*, C^*)$ is block. That is, there are no cutvertices in G^* .
- (ii) \tilde{G} is called a neutrosophic block if \tilde{G} has no neutrosophic cutvertices.
- (iii) \tilde{G} is called a neutrosophic incidence block if it has no neutrosophic incidence cutvertices.

Example 7. Consider the SVNIG $\tilde{G} = (A, B, C)$ shown in Figure 7 with $A^* = \{a, b, c\}$ and $B^* = \{ab, bc, ac\}$. \tilde{G} is a block, since the crisp graph, G^* , has no cutvertex and it is a neutrosophic incidence block. \tilde{G} is not a neutrosophic block, since it has a neutrosophic cutvertex, namely, a .

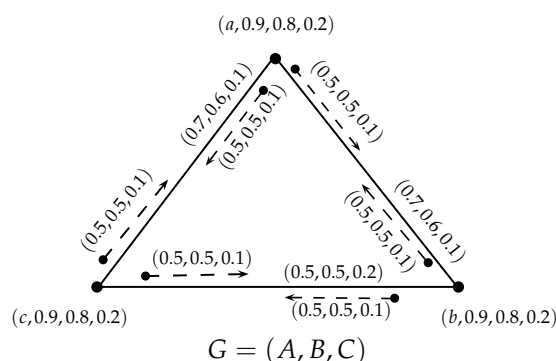

Figure 7. Single-valued neutrosophic incidence graph.

Theorem 8. *Let $\tilde{G} = (A, B, C)$ be a neutrosophic incidence block. A pair, (u, uv) , in \tilde{G} , such that*

$$(T_C(u, uv), I_C(u, uv), F_C(u, uv)) = (\max T_C(x, xy), \max I_C(x, xy), \min F_C(x, xy)),$$

for all $(x, xy) \in C^*$, is a strong pair.

Proof. Let \tilde{G} be a neutrosophic incidence block. By definition, there are no neutrosophic incidence cutvertices in \tilde{G} . Let (u, uv) be a pair in \tilde{G} , such that

$$(T_C(u, uv), I_C(u, uv), F_C(u, uv)) = (\max T_C(x, xy), \max I_C(x, xy), \min F_C(x, xy)).$$

We will prove that (u, uv) is a strong pair by showing that

$$(T_C(u, uv), I_C(u, uv), F_C(u, uv)) \geq IS'^{\infty}(u, uv).$$

The incidence strength of any path, P , from u to uv will be less than or equal to $(T_C(u, uv), I_C(u, uv), F_C(u, uv))$. If (u, uv) is the only pair in \tilde{G} with

$$(T_C(u, uv), I_C(u, uv), F_C(u, uv)) = (\max T_C(x, xy), \max I_C(x, xy), \min F_C(x, xy)),$$

then every other path from x to xy in \tilde{G} will have less incidence strength than $(T_C(u, uv), I_C(u, uv), F_C(u, uv))$, and hence,

$$(T_C(u, uv), I_C(u, uv), F_C(u, uv)) > IS'^{\infty}(u, uv).$$

Thus, (u, uv) is an α -strong pair.

If (u, uv) is not unique, then the maximum possible value for the incidence strength of any path in $G' = \tilde{G} - \{(u, uv)\}$ will be equal to $(T_C(u, uv), I_C(u, uv), F_C(u, uv))$. Therefore, there exists a path from u to uv with an incidence strength equal to $(T_C(u, uv), I_C(u, uv), F_C(u, uv))$, that is

$$(T_C(u, uv), I_C(u, uv), F_C(u, uv)) = IS'^{\infty}(u, uv).$$

Then, (u, uv) is β -strong. \square

3. Application

According to the Federal Investigation Agency (FIA), Pakistan is among the fourth largest country in terms of its citizens who illegally enter Europe. There is no formally declared policy of the Government of Pakistan for Migration and Pakistani Migrants. Every year, thousands of Pakistanis fleeing poverty, unemployment, law and other problems attempt to illegally enter Europe. A lot of them even die before reaching the destination. These illegal immigrants use land routes featuring Pakistan, Iran, Turkey and Greece to enter Europe. Greece is a gateway to the west, and roughly nine out of ten people illegally entering Europe follow this route. Below, we present a mathematical model of this phenomenon.

Consider SVNIG $\tilde{G} = (A, B, C)$ as shown in Figure 8, a mathematical model of the situation of illegal migration from Pakistan to European, where

$$A = \{(Pakistan, 0.9, 0.8, 0.7), (Iran, 0.8, 0.6, 0.8), (Turkey, 0.9, 0.8, 0.7), (Greece, 0.9, 0.8, 0.6)\}$$

is the set of countries under consideration,

$$B = \{((Pak, Iran), 0.7, 0.6, 0.4), ((Iran, Turkey), 0.5, 0.5, 0.5), ((Turkey, Greece), 0.6, 0.8, 0.5)\}$$

represents the flow of people traveling legally from country x to country y and

$$C = \{((Pak, (Pak, Iran)), 0.5, 0.6, 0.3), ((Iran, (Pak, Iran)), 0.4, 0.2, 0.8), ((Iran, (Iran, Turkey)), 0.5, 0.5, 0.4), ((Turkey, (Iran, Turkey)), 0.3, 0.5, 0.4), ((Turkey, (Turkey, Greece)), 0.6, 0.8, 0.2), ((Greece, (Turkey, Greece)), 0.2, 0.2, 0.6)\}$$

represents the flow of people traveling illegally from country x to the country y . It is clear that each pair in this model is a neutrosophic incidence cutpair. So, every government of the countries featuring in this path must make hard and fast rules to control illegal migration as it creates lot of problems for both sending and receiving countries. Policy makers and practitioners need to develop a comprehensive understanding of the phenomenon of illegal migration in order to manage it effectively. We present our proposed method in Algorithm 1.

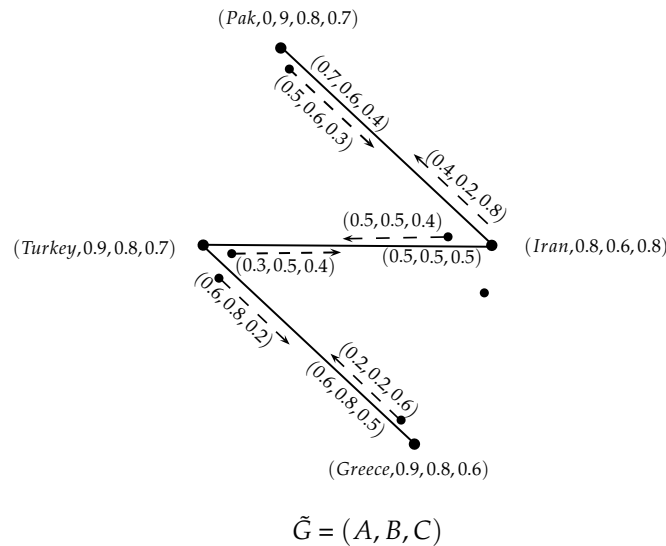

Figure 8. Model of the situation of illegal migration from Pakistan to Europe.

Algorithm 1 Method of Finding Neutrosophic Incidence Cutpair

1. Input the vertex set, V .
2. Input the edge set, $E \subseteq V \times V$.
3. Construct the single-valued neutrosophic set, A , on V .
4. Construct the single-valued neutrosophic relation, B , on E .
5. Construct the single-valued neutrosophic set, C , on $V \times E$.
6. Calculate the incidence strength, $IS(u_i, u_j)$, of all possible paths from u_i to u_j , such that

$$\begin{aligned}
 is_1 &= \min\{T_C(u_i, u_i u_{i+1}) : (u_i, u_i u_{i+1}) \in I\}, \\
 is_2 &= \min\{I_C(u_i, u_i u_{i+1}) : (u_i, u_i u_{i+1}) \in I\}, \\
 is_3 &= \max\{F_C(u_i, u_i u_{i+1}) : (u_i, u_i u_{i+1}) \in I\}.
 \end{aligned}$$

7. Calculate the greatest incidence strength, $IS^\infty(u_i, u_j)$, of paths from u_i to u_j .
8. Remove the pair $(u_i, u_i u_{i+1})$ from I .
9. Repeat step 6 and step 7 to calculate the incidence strength, $IS'^\infty(u_i, u_j)$ from u_i to u_j .
10. Compare the two greatest incidence strengths.
11. If $IS'^\infty(u_i, u_j) < IS^\infty(u_i, u_j)$, then $(u_i, u_i u_{i+1})$ is the required neutrosophic incidence cutpair.

4. Conclusions

Graph theory is a useful tool for analyzing and modeling different mathematical structures. However, its failure to determine relationships between vertices (nodes) and edge (arcs) led to the introduction of the fuzzy incidence graph. The single-valued neutrosophic incidence graph is an extension of fuzzy incidence graph, which can be used as a tool for constructing different mathematical models with indeterminate information and interconnected supporting links. In this paper, we discussed different properties of single-valued neutrosophic incidence graphs. We studied the block structure of single-valued neutrosophic incidence graphs. We aim to extend the application of single-valued neutrosophic incidence graphs to human trafficking.

References

1. Rosenfeld, A. Fuzzy graphs in Fuzzy Sets and Their Applications to Cognitive and Decision Processes. In Proceedings of the US—Japan Seminar on Fuzzy Sets and their Applications, Berkeley, CA, USA, 1–4 July 1974. [[CrossRef](#)]
2. Bhutani, K.R.; Mordeson, J.N.; Rosenfeld, A. On degrees of end nodes and cut nodes in fuzzy graphs. *Iran. J. Fuzzy Syst.* **2004**, *1*, 57–64.
3. Bhutani, K.R.; Rosenfeld, A. Strong arcs in fuzzy graphs. *Inf. Sci.* **2003**, *152*, 319–322. [[CrossRef](#)]
4. Broumi, S.; Talea, M.; Bakali, A.; Smarandache, F. Interval valued neutrosophic graphs. *Crit. Rev.* **2016**, *XII*, 5–33.
5. Dinesh, T. A Study on Graph Structures, Incidence Algebras and Their Fuzzy Analogues. Ph.D. Thesis, Kannur University, Kerala, India, 2012.
6. Dinesh, T. Fuzzy incidence graph—An introduction. *Adv. Fuzzy Sets Syst.* **2016**, *21*, 33. [[CrossRef](#)]
7. Mathew, S.; Mordeson, J.N. Connectivity concepts in fuzzy incidence graphs. *Inf. Sci.* **2017**, *382*, 326–333. [[CrossRef](#)]
8. Malik, D.S.; Mathew, S.; Mordeson, J.N. Fuzzy Incidence Graphs: Applications to Human Trafficking. *Inf. Sci.* **2018**, *447*, 244–255. [[CrossRef](#)]
9. Mathew, S.; Jordeson, J.N. Fuzzy incidence blocks and their applications in illegal migration problems. *New Math. Nat. Comput.* **2017**, *13*, 245–260. [[CrossRef](#)]
10. Methew, S.; Sunitha, M.S. Types of arcs in a fuzzy graph. *Inf. Sci.* **2009**, *179*, 1760–1768. [[CrossRef](#)]
11. Smarandache, F. *Neutrosophy: Neutrosophic Probability, Set, and Logic: Analytic Synthesis & Synthetic Analysis*; American Research Press: Washington, DC, USA, 1998.
12. Smarandache, F. *A Unifying Field in Logics. Neutrosophy: Neutrosophic Probability, Set and Logic*; American Research Press: Washington, DC, USA, 1999.
13. Sidra, S.; Ishfaq, N.; Akram, M.; Smarandache, F. Rough neutrosophic digraphs with application. *Axioms* **2018**, *7*, 5. [[CrossRef](#)]
14. Zhan, J.; Malik, H.M.; Akram, M. Novel decision-making algorithms based on intuitionistic fuzzy rough environment. *Int. J. Mach. Learn. Cybern.* **2018**, 1–27. [[CrossRef](#)]
15. Harary, F. *Graph Theory*; Narosa Publishing House: New Delhi, India, 1995.
16. Ishfaq, N.; Sayed, S.; Akram, M.; Smarandache, F. Notions of rough neutrosophic digraphs. *Mathematics* **2018**, *6*, 18.

Neutrosophic Nano $A\psi$ Closed Sets in Neutrosophic Nano Topological Spaces

Mani Parimala, R. Jeevitha, Saeid Jafari, Florentin Smarandache,
Karthika Muthusamy

Mani Parimala, R. Jeevitha, Saeid Jafari, Florentin Smarandache, Karthika Muthusamy (2018). Neutrosophic Nano $A\psi$ Closed Sets in Neutrosophic Nano Topological Spaces. *Journal of Advanced Research in Dynamical & Control Systems* 10: 523-531

Abstract- In this article we introduce the notation of neutrosophic nano semi closed, neutrosophic nano α closed, neutrosophic nano pre closed, neutrosophic nano semi pre closed and neutrosophic nano regular closed and investigate some of their properties. Further we study the concept of neutrosophic nano sg closed, neutrosophic nano ψ closed and neutrosophic nano $\alpha\psi$ closed and derive some of their properties.

Keywords and Phrases: neutrosophic nano semi closed, neutrosophic nano α closed, neutrosophic nano pre closed, neutrosophic nano semi pre closed, neutrosophic nano regular closed, neutrosophic nano sg closed, neutrosophic nano ψ closed and neutrosophic nano $\alpha\psi$ closed.

1. Introduction

The nation of α closed sets in topological spaces was introduced by O.Njastad[1]. M.K.R.S.Veerakumar [2] was explored the notion of ψ closed. The new concept of $\alpha\psi$ closed set in topology was introduced by R.Devi et.al [3]. Nanotopology was introduced by LellisThivagar et.al [4]. It contains approximations and boundary region. The open set contains only five set that is empty, universe, Lower and upper approximation, boundary region. Fuzzy and intuitionistic fuzzy were introduced by Zadeh [5] and K.Atanassav [6]. The new theory neutrosophic set described by membership, indeterminacy and non-membership were introduced by Smarandache [7]. The neutrosophic set in (X, τ_N) is having the form $S = \{ \langle x, M_S(x), I_S(x), N_S(x) \rangle : x \in (X, \tau_N) \}$, where the functions $M_S : S \rightarrow [0,1]$, $I_S : S \rightarrow [0,1]$, $N_S : S \rightarrow [0,1]$ denoted the degree of membership, indeterminacy, degree of non-membership. The neutrosophic set $S = \{ \langle x, M_S(x), I_S(x), N_S(x) \rangle : x \in (X, \tau_N) \}$ is called a subset of $T = \{ \langle x, M_T(x), I_T(x), N_T(x) \rangle : x \in (X, \tau_N) \}$ [in short $S \subset T$] if degree of membership and indeterminacy is minimum in S and degree of non-membership is maximum in S or degree of membership is minimum and degree of non-membership and indeterminacy is maximum in S. The complement on NTS $S = \{ \langle x, M_S(x), I_S(x), N_S(x) \rangle : x \in (X, \tau_N) \}$ is $S^c = \{ \langle x, N_S(x), I_S(x), M_S(x) \rangle : x \in (X, \tau_N) \}$. Parimala et.al [8] introduced and studied the concept of neutrosophic $\alpha\psi$ -closed sets.

Now LellisThivagar et.al [9] explored a new concept of neutrosophic nano topology. In that paper he discussed about neutrosophic nano interior and neutrosophic nano closure.

In this paper, basic properties of neutrosophic nano semi closed, neutrosophic nano α closed, neutrosophic nano pre closed, neutrosophic nano semi pre closed and neutrosophic nano regular closed were introduced. It also established the notion of neutrosophic nano sg closed, neutrosophic nano ψ closed and neutrosophic nano $\alpha\psi$ closed. Further, studied some of their related attributes were discussed.

2. Preliminaries

This section shows that some related definition and properties.

Definition 2.1.[4] Let U be a non-empty finite set of objects called the universe and R be an equivalence relation on U named as the indiscernibility relation. Then U is divided into disjoint equivalence classes. Let X is

a subset of U , then the lower approximation of X with respect to R is denoted by $\underline{R} = \bigcup_{x \in U} \{R(x) : R(x) \subseteq X\}$, where $R(x)$ denotes the equivalence class determined by $x \in U$.

Definition 2.2. [4] The upper approximation of X with respect to R is the set of all objects, which can be possibly classified as X with respect to R and its is denoted by $\overline{R} = \bigcup_{x \in U} \{R(x) : R(x) \cap X \neq \emptyset\}$.

Definition 2.3. [4] The boundary region of X with respect to R is the set of all objects, which can be possibly classified neither as X nor as not X with respect to R and its is denoted by $B_R = \overline{R} - \underline{R}$.

Definition 2.4. [4] If (U, R) is an approximation space and $X, Y \subseteq U$. Then

1. $\underline{R} \subseteq X \subseteq \overline{R}$
2. $\underline{R}(\emptyset) = \overline{R}(\emptyset) = \emptyset$ and $\underline{R}(U) = \overline{R}(U) = U$
3. $\overline{R}(X \cup Y) = \overline{R}(X) \cup \overline{R}(Y)$
4. $\overline{R}(X \cap Y) = \overline{R}(X) \cap \overline{R}(Y)$
5. $\underline{R}(X \cup Y) = \underline{R}(X) \cup \underline{R}(Y)$
6. $\underline{R}(X \cap Y) = \underline{R}(X) \cap \underline{R}(Y)$
7. $\overline{R}(X) \subseteq \overline{R}(Y)$ and $\underline{R}(X) \subseteq \underline{R}(Y)$ whenever $X \subseteq Y$
8. $\overline{R}(X^c) = (\underline{R})^c$ and $\underline{R}(X^c) = (\overline{R})^c$
9. $\underline{R}(\underline{R}) = \overline{R}(\underline{R}) = \underline{R}$
10. $\overline{R}(\overline{R}) = \underline{R}(\overline{R}) = \overline{R}$

Definition 2.5. [9] Let U be an universe and R be an equivalence relation on U and Let S be a neutrosophic subset of U . Then the neutrosophic nano topology is defined by $\tau_N(S) = \{0_N, 1_N, \underline{N}(S), \overline{N}(S), B_N(S)\}$, where

1. $\underline{N}(S) = \{ \langle y, M_{\underline{R}(y)}, I_{\underline{R}(y)}, N_{\underline{R}(y)} \rangle / z \in [y]_R, y \in U \}$
2. $\overline{N}(S) = \{ \langle y, M_{\overline{R}(y)}, I_{\overline{R}(y)}, N_{\overline{R}(y)} \rangle / z \in [y]_R, y \in U \}$
3. $B_N(S) = \overline{N} - \underline{N}$

Wher $M_{\underline{R}(y)} = \bigwedge_{z \in [y]_R} M_S(z), I_{\underline{R}(y)} = \bigwedge_{z \in [y]_R} I_S(z), N_{\underline{R}(y)} = \bigvee_{z \in [y]_R} N_S(z),$
 $M_{\overline{R}(y)} = \bigvee_{z \in [y]_R} M_S(z), I_{\overline{R}(y)} = \bigvee_{z \in [y]_R} I_S(z), N_{\overline{R}(y)} = \bigwedge_{z \in [y]_R} N_S(z)$.

Definition 2.6. [9] Let $(U, \tau_N(S))$ be a neutrosophic nano topological spaces,

where $S \subseteq U$. Assume S and T be neutrosophic subset of U . Then the following hold:

1. $S \subseteq N_{Ncl}(S)$.
2. S is neutrosophic nano closed iff $N_{Ncl}(S) = S$.
3. $N_{Ncl}(0_N) = 0_N$ and $N_{Ncl}(1_N) = 1$.

4. $S \subseteq T$ implies $N_{Ncl}(S) \subseteq N_{Ncl}(T)$.

5. $N_{Ncl}(S \cup T) = N_{Ncl}(S) \cup N_{Ncl}(T)$.

6. $N_{Ncl}(S \cap T) \subseteq N_{Ncl}(S) \cap N_{Ncl}(T)$.

7. $N_{Ncl}(N_{Ncl}(A)) = N_{Ncl}(S)$.

Definition 2.7. [9] Let $(U, \tau_N(S))$ be a neutrosophic nano topological spaces, where $S \subseteq U$. Assume S and T be neutrosophic subset of U. Then the following hold:

1. $N_{Nint}(S) \subseteq S$.

2. S is neutrosophic nano open iff $N_{Nint}(S) = S$.

3. $N_{Nint}(0_N) = 0_N$ and $N_{Nint}(1_N) = 1_N$.

4. $S \subseteq T$ implies $N_{Nint}(S) \subseteq N_{Nint}(T)$.

5. $N_{Nint}(S) \cup N_{Nint}(T) \subseteq N_{Nint}(S \cup T)$.

6. $N_{Nint}(S \cap T) = N_{Nint}(S) \cap N_{Nint}(T)$.

7. $N_{Nint}(N_{Nint}(A)) = N_{Nint}(S)$.

Definition 2.8. [10] Let (X, τ_N) be a non-empty fixed set. A neutrosophic set A is an object having the form $S = \{ \langle x, M_S(x), I_S(x), N_S(x) \rangle : x \in (X, \tau_N) \}$. Where $M_S(x)$, $I_S(x)$, $N_S(x)$ which represent the degree of membership, the degree of indeterminacy, and the degree of non-membership of each element $x \in (X, \tau_N)$ to the set S.

Definition 2.9. [11] Let S and T be NS of the form $S = \{ \langle x, M_S(x), I_S(x), N_S(x) \rangle : x \in (X, \tau_N) \}$ and $T = \{ \langle x, M_T(x), I_T(x), N_T(x) \rangle : x \in (X, \tau_N) \}$. Then

(1) $S \subseteq T$ if and only if $M_S(x) \leq M_T(x)$, $I_S(x) \geq I_T(x)$ and $N_S(x) \geq N_T(x)$ for all $x \in (X, \tau_N)$ or $M_S(x) \geq M_T(x)$, $I_S(x) \leq I_T(x)$ and $N_S(x) \leq N_T(x)$ for all $x \in (X, \tau_N)$.

(2) $S = T$ if and only if $S \subseteq T$ and $T \subseteq S$.

(3) $S^c = \{ \langle x, N_S(x), I_S(x), M_S(x) \rangle : x \in (X, \tau_N) \}$.

(4) $S \cup T = \{ \langle x, M_S(x) \vee M_T(x), I_S(x) \wedge I_T(x), N_S(x) \wedge N_T(x) \rangle : x \in (X, \tau_N) \}$.

(5) $S \cap T = \{ \langle x, M_S(x) \wedge M_T(x), I_S(x) \vee I_T(x), N_S(x) \vee N_T(x) \rangle : x \in (X, \tau_N) \}$.

Definition 2.10. [11] Let (X, τ_N) be NTS and $S = \{ \langle x, M_S(x), I_S(x), N_S(x) \rangle : x \in (X, \tau_N) \}$ be a NS in X. Then the neutrosophic closure and neutrosophic interior of S are defined by

(1) $Ncl(S) = \bigcap \{ K : K \text{ is an NCS in } X \text{ and } S \subseteq K \}$

$$(2) \text{Nint}(S) = \bigcup \{K: K \text{ is an NOS in } X \text{ and } K \subseteq S\}$$

3. Neutrosophic Nano $A\psi$ Closed Sets

Definition 3.1. Let $(U, \tau_N(S))$ be a neutrosophic nano topological space. Then

A neutrosophic nano subset S in $(U, \tau_N(S))$ is said to be:

- (a) Neutrosophic nano semi closed (NNSC) if $N_N\text{int}(N_N\text{cl}(S)) \subseteq S$.
- (b) Neutrosophic nano α closed (NN α C) if $N_N\text{cl}(N_N\text{int}(N_N\text{cl}(S))) \subseteq S$.
- (c) Neutrosophic nano pre closed (NNPC) if $N_N\text{cl}(N_N\text{int}(S)) \subseteq S$.
- (d) Neutrosophic nano semi pre closed (NNSPC) if $N_N\text{int}(N_N\text{cl}(N_N\text{int}(S))) \subseteq S$.
- (e) Neutrosophic nano regular closed (NNRC) if $N_N\text{cl}(N_N\text{int}(S)) = S$.
- (f) Neutrosophic nano sg closed set (NNSGC) if $N_N\text{scl}(S) \subseteq V$ whenever $S \subseteq V$ and V is neutrosophic nano semi open.
- (g) neutrosophic nano ψ closed set (NN ψ C) if $N_N\text{scl}(S) \subseteq V$ whenever $S \subseteq V$ and V is neutrosophic nanosg open.
- (h) neutrosophic nano $\alpha\psi$ closed set (NN $\alpha\psi$ C) if $N_N\text{cl}(S) \subseteq V$ whenever $S \subseteq V$ and V is neutrosophic nano α open.

This shows that the following example.

Example 3.2. Assume $U = \{n_1, n_2, n_3\}$ be the universe set and the equivalence relation is $U/R = \{\{n_1\}, \{n_2, n_3\}\}$ Let $S = \left\{ \left\langle \frac{n_1}{(0.3,0.4,0.3)} \right\rangle, \left\langle \frac{n_2}{(0.6,0.3,0.1)} \right\rangle, \left\langle \frac{n_3}{(0.2,0.6,0.2)} \right\rangle \right\}$ be neutrosophic nano subset of U . Then $N_*(S) = \left\{ \left\langle \frac{n_1}{(0.2,0.3,0.3)} \right\rangle, \left\langle \frac{n_2}{(0.5,0.3,0.2)} \right\rangle, \left\langle \frac{n_3}{(0.2,0.5,0.3)} \right\rangle \right\}$ and $N^*(S) = \left\{ \left\langle \frac{n_1}{(0.3,0.5,0.2)} \right\rangle, \left\langle \frac{n_2}{(0.6,0.4,0.1)} \right\rangle, \left\langle \frac{n_3}{(0.3,0.5,0.2)} \right\rangle \right\}$ $B_N(S) = \left\{ \left\langle \frac{n_1}{(0.2,0.3,0.4)} \right\rangle, \left\langle \frac{n_2}{(0.5,0.4,0.2)} \right\rangle, \left\langle \frac{n_3}{(0.3,0.4,0.2)} \right\rangle \right\}$. Here $\tau_N(S) = \{0_N, 1_N, N_*(S), N^*(S), B_N(S)\}$ be a neutrosophic nano open set and a neutrosophic nano closed set is $[\tau_N(S)]^c = \{0_N, 1_N, N_*^c(S), N^{*c}(S), B_N(S)\}$ where $N_*^c(S) = \left\{ \left\langle \frac{n_1}{(0.3,0.3,0.2)} \right\rangle, \left\langle \frac{n_2}{(0.2,0.3,0.5)} \right\rangle, \left\langle \frac{n_3}{(0.3,0.5,0.2)} \right\rangle \right\}$, $N^{*c}(S) = \left\{ \left\langle \frac{n_1}{(0.2,0.5,0.3)} \right\rangle, \left\langle \frac{n_2}{(0.1,0.4,0.6)} \right\rangle, \left\langle \frac{n_3}{(0.2,0.5,0.3)} \right\rangle \right\}$ and $B_N^c(S) = \left\{ \left\langle \frac{n_1}{(0.4,0.3,0.2)} \right\rangle, \left\langle \frac{n_2}{(0.2,0.4,0.5)} \right\rangle, \left\langle \frac{n_3}{(0.2,0.4,0.3)} \right\rangle \right\}$. Assume $R = \left\{ \left\langle \frac{n_1}{(0.2,0.3,0.2)} \right\rangle, \left\langle \frac{n_2}{(0.2,0.2,0.6)} \right\rangle, \left\langle \frac{n_3}{(0.3,0.2,0.3)} \right\rangle \right\}$ be a neutrosophic nano semi closed because $N_N\text{int}(N_N\text{cl}(R)) = N_N(N_N\text{cl}(R)) = N_N(N_*^c) = 0_N \subseteq R$. Similarly, R is also neutrosophic nano α closed, neutrosophic nano pre closed and neutrosophic nano semi pre closed.

Example 3.3. Assume $U = \{n_1, n_2, n_3\}$ be the universe set and the equivalence relation is $U/R = \{\{n_1\}, \{n_2, n_3\}\}$ Let $S = \left\{ \left\langle \frac{n_1}{(0.3,0.3,0.2)} \right\rangle, \left\langle \frac{n_2}{(0.2,0.3,0.1)} \right\rangle, \left\langle \frac{n_3}{(0.3,0.2,0.3)} \right\rangle \right\}$ be neutrosophic nano subset of U . Then $N_*(S) = \left\{ \left\langle \frac{n_1}{(0.2,0.3,0.2)} \right\rangle, \left\langle \frac{n_2}{(0.2,0.3,0.2)} \right\rangle, \left\langle \frac{n_3}{(0.3,0.5,0.3)} \right\rangle \right\}$, $N^*(S) = \left\{ \left\langle \frac{n_1}{(0.3,0.3,0.2)} \right\rangle, \left\langle \frac{n_2}{(0.3,0.4,0.3)} \right\rangle, \left\langle \frac{n_3}{(0.3,0.5,0.3)} \right\rangle \right\}$ and $B_N(S) = N_*(S)$. Here $\tau_N(S) = \{0_N, 1_N, N_*(S), N^*(S), B_N(S)\}$ be a neutrosophic nano open set and a neutrosophic nano closed

set is $[\tau_N(S)]^C = \{0_N, 1_N, N_*^C(S), N^{*C}(S), B_N(S)\}$ where $N_*^C(S) = \left\{ \left\langle \frac{n_1}{(0.2,0.3,0.2)} \right\rangle, \left\langle \frac{n_2}{(0.2,0.3,0.2)} \right\rangle, \left\langle \frac{n_3}{(0.3,0.5,0.3)} \right\rangle \right\}$
 $N^{*C}(S) = \left\{ \left\langle \frac{n_1}{(0.3,0.3,0.2)} \right\rangle, \left\langle \frac{n_2}{(0.3,0.4,0.3)} \right\rangle, \left\langle \frac{n_3}{(0.3,0.5,0.3)} \right\rangle \right\}$

. Assume $R = \left\{ \left\langle \frac{n_1}{(0.2,0.3,0.2)} \right\rangle, \left\langle \frac{n_2}{(0.2,0.2,0.6)} \right\rangle, \left\langle \frac{n_3}{(0.3,0.2,0.3)} \right\rangle \right\}$ be a neutrosophic nano regular

closed because $N_{Ncl}(N_{Nint}(R)) = R$.

Example 3.4. Assume $U = \{n_1, n_2, n_3\}$ be the universe set and the equivalence relation is $U/R = \{\{n_1\}, \{n_2, n_3\}\}$ Let $S = \left\{ \left\langle \frac{n_1}{(0.3,0.3,0.2)} \right\rangle, \left\langle \frac{n_2}{(0.2,0.3,0.1)} \right\rangle, \left\langle \frac{n_3}{(0.3,0.2,0.3)} \right\rangle \right\}$ be neutrosophic nano subset of U. Then

$N_*(S) = \left\{ \left\langle \frac{n_1}{(0.3,0.3,0.4)} \right\rangle, \left\langle \frac{n_2}{(0.1,0.3,0.5)} \right\rangle, \left\langle \frac{n_3}{(0.1,0.2,0.5)} \right\rangle \right\}$, $N^*(S) = \left\{ \left\langle \frac{n_1}{(0.4,0.3,0.2)} \right\rangle, \left\langle \frac{n_2}{(0.3,0.4,0.1)} \right\rangle, \left\langle \frac{n_3}{(0.4,0.3,0.2)} \right\rangle \right\}$ and

$B_N(S) = \left\{ \left\langle \frac{n_1}{(0.3,0.3,0.3)} \right\rangle, \left\langle \frac{n_2}{(0.3,0.3,0.2)} \right\rangle, \left\langle \frac{n_3}{(0.3,0.3,0.4)} \right\rangle \right\}$. Here $\tau_N(S) = \{0_N, 1_N, N_*(S), N^*(S), B_N(S)\}$ be a

neutrosophic nano open set and a neutrosophic nano closed set is $[\tau_N(S)]^C = \{0_N, 1_N, N_*^C(S), N^{*C}(S), B_N(S)\}$ where $N_*^C(S) = \left\{ \left\langle \frac{n_1}{(0.4,0.3,0.3)} \right\rangle, \left\langle \frac{n_2}{(0.5,0.3,0.1)} \right\rangle, \left\langle \frac{n_3}{(0.5,0.2,0.1)} \right\rangle \right\}$, $N^{*C}(S) = \left\{ \left\langle \frac{n_1}{(0.2,0.3,0.4)} \right\rangle, \left\langle \frac{n_2}{(0.1,0.4,0.3)} \right\rangle, \left\langle \frac{n_3}{(0.2,0.3,0.4)} \right\rangle \right\}$ and

$B_N^C(S) = \left\{ \left\langle \frac{n_1}{(0.3,0.3,0.3)} \right\rangle, \left\langle \frac{n_2}{(0.2,0.3,0.3)} \right\rangle, \left\langle \frac{n_3}{(0.4,0.3,0.3)} \right\rangle \right\}$

. Assume $R = \left\{ \left\langle \frac{n_1}{(0.3,0.3,0.3)} \right\rangle, \left\langle \frac{n_2}{(0.1,0.3,0.5)} \right\rangle, \left\langle \frac{n_3}{(0.1,0.2,0.5)} \right\rangle \right\}$ be a neutrosophic nano sg closed and

$C = \left\{ \left\langle \frac{n_1}{(0.3,0.3,0.3)} \right\rangle, \left\langle \frac{n_2}{(0.1,0.3,0.2)} \right\rangle, \left\langle \frac{n_3}{(0.3,0.2,0.4)} \right\rangle \right\}$ be a neutrosophic nano ψ closed and also neutrosophic nano $\alpha\psi$

closed.

Theorem 3.5. Let $(U, \tau_N(S))$ be a neutrosophic nano topological space. Then

the following are hold:

- (a) Every neutrosophic nano closed set is neutrosophic nano semi closed set.
- (b) Every neutrosophic nano closed set is neutrosophic nano α closed set.
- (c) Every neutrosophic nano closed set is neutrosophic nano pre closed.
- (d) Every neutrosophic nano closed set is neutrosophic nano semi pre closed set.
- (e) Every neutrosophic nano regular closed set is neutrosophic nano closed set.
- (f) Every neutrosophic nano closed set is neutrosophic nano semi closed set.
- (g) Every neutrosophic nano α closed set is neutrosophic nano pre closed set.

Proof.

(a) Let S be a neutrosophic nano closed set then $N_{Ncl}(S) = S$. This implies

$N_{Nint}(N_{Ncl}(S)) \subseteq N_{Nint}(S) = S$. Therefore $N_{Nint}(N_{Ncl}(S)) \subseteq S$. Then neutrosophic nano closed set is neutrosophic nano semi closed set.

(b) Let S be a neutrosophic nano closed set then $N_{Ncl}(S) = S$. This implies $N_{Nint}(N_{Ncl}(S)) \subseteq N_{Nint}(S) \subseteq S$ implies that $N_{Ncl}(N_{Nint}(N_{Ncl}(S))) \subseteq N_{Ncl}(S) = S$. Therefore $N_{Ncl}(N_{Nint}(N_{Ncl}(S))) \subseteq S$. Then S is neutrosophic nano α closed set.

(c) Let S be a neutrosophic nano closed set then $N_{Ncl}(S) = S$. We know that $N_{Nint}(S) \subseteq S$. This implies $N_{Ncl}(N_{Nint}(S)) \subseteq N_{Ncl}(S) = S$. Therefore $N_{Ncl}(N_{Nint}(S)) \subseteq S$. Then S is neutrosophic nano pre closed.

(d) Let S be a neutrosophic nano closed set then $N_{Ncl}(S) = S$. We know that $N_{Nint}(S) \subseteq S$. This implies $N_{Ncl}(N_{Nint}(S)) \subseteq N_{Ncl}(S) = S$ implies that $N_{Nint}(N_{Ncl}(N_{Nint}(S))) \subseteq N_{Nint}(S) \subseteq S$. Then S is neutrosophic nano semi pre closed set.

(e) Let S be a neutrosophic nano regular closed set then $N_{Ncl}(N_{Nint}(S)) = S$. This implies $N_{Ncl}(N_{Ncl}(N_{Nint}(S))) = N_{Ncl}(S)$ implies that $N_{Ncl}(N_{Nint}(S)) = N_{Ncl}(S) = S$. Therefore S is neutrosophic nano closed set.

(f) Let S be a neutrosophic nano α closed set then $N_{Ncl}(N_{Nint}(N_{Ncl}(S))) \subseteq S$ implies that $N_{Nint}(N_{Ncl}(S)) \subseteq S$. Hence S is neutrosophic nano semi closed set

(g) Let S be a neutrosophic nano α closed set then $N_{Ncl}(N_{Nint}(N_{Ncl}(S))) \subseteq S$. We know that S is neutrosophic nano closed set so $N_{Ncl}(S) = S$ implies that $N_{Ncl}(N_{Nint}(S)) \subseteq S$. Hence S is neutrosophic nano pre closed set

The inverse part not true by the following examples.

Example 3.6. By using Example [3.2],

(a) Let us take $R = \left\{ \left\langle \frac{n_1}{(0.2,0.3,0.2)} \right\rangle, \left\langle \frac{n_2}{(0.2,0.2,0.6)} \right\rangle, \left\langle \frac{n_3}{(0.3,0.2,0.3)} \right\rangle \right\}$ be a neutrosophic nano semi closed but it is not neutrosophic nano closed.

(b) Let us take $R = \left\{ \left\langle \frac{n_1}{(0.2,0.3,0.2)} \right\rangle, \left\langle \frac{n_2}{(0.2,0.2,0.6)} \right\rangle, \left\langle \frac{n_3}{(0.3,0.2,0.3)} \right\rangle \right\}$ be a neutrosophic nano α closed but it is not neutrosophic nano closed.

(c) Let us take $R = \left\{ \left\langle \frac{n_1}{(0.2,0.3,0.2)} \right\rangle, \left\langle \frac{n_2}{(0.2,0.2,0.6)} \right\rangle, \left\langle \frac{n_3}{(0.3,0.2,0.3)} \right\rangle \right\}$ be a neutrosophic nano pre closed but it is not neutrosophic nano closed.

(d) Let us take $R = \left\{ \left\langle \frac{n_1}{(0.2,0.3,0.2)} \right\rangle, \left\langle \frac{n_2}{(0.2,0.2,0.6)} \right\rangle, \left\langle \frac{n_3}{(0.3,0.2,0.3)} \right\rangle \right\}$ be a neutrosophic nano semi pre closed but it is not neutrosophic nano closed.

(e) Let us take $R = \left\{ \left\langle \frac{n_1}{(0.2,0.3,0.2)} \right\rangle, \left\langle \frac{n_2}{(0.2,0.2,0.6)} \right\rangle, \left\langle \frac{n_3}{(0.3,0.2,0.3)} \right\rangle \right\}$ be a neutrosophic nano closed but it is not neutrosophic nano regular closed.

(f) Assume $U = \{n_1, n_2, n_3\}$ be the universe set and the equivalence relation is $U / R = \{\{n_1\}, \{n_2, n_3\}\}$ Let $S = \left\{ \left\langle \frac{n_1}{(0.3,0.4,0.3)} \right\rangle, \left\langle \frac{n_2}{(0.6,0.3,0.1)} \right\rangle, \left\langle \frac{n_3}{(0.2,0.6,0.2)} \right\rangle \right\}$ be neutrosophic nano subset of U . Then

$N_*(S) = \left\{ \left\langle \frac{n_1}{(0.3,0.3,0.4)} \right\rangle, \left\langle \frac{n_2}{(0.1,0.3,0.5)} \right\rangle, \left\langle \frac{n_3}{(0.1,0.2,0.5)} \right\rangle \right\}$, $N^*(S) = \left\{ \left\langle \frac{n_1}{(0.4,0.3,0.2)} \right\rangle, \left\langle \frac{n_2}{(0.3,0.4,0.1)} \right\rangle, \left\langle \frac{n_3}{(0.4,0.3,0.2)} \right\rangle \right\}$ and

$B_N(S) = \left\{ \left\langle \frac{n_1}{(0.3,0.3,0.3)} \right\rangle, \left\langle \frac{n_2}{(0.2,0.3,0.3)} \right\rangle, \left\langle \frac{n_3}{(0.3,0.3,0.4)} \right\rangle \right\}$. Here $\tau_N(S) = \{0_N, 1_N, N_*(S), N^*(S), B_N(S)\}$ be a

neutrosophic nano open set and a neutrosophic nano closed set is $[\tau_N(S)]^C = \{0_N, 1_N, N_*^C(S), N^{*C}(S), B_N(S)\}$

where $N_*^C(S) = \left\{ \left\langle \frac{n_1}{(0.4,0.3,0.3)} \right\rangle, \left\langle \frac{n_2}{(0.5,0.3,0.1)} \right\rangle, \left\langle \frac{n_3}{(0.5,0.2,0.1)} \right\rangle \right\}$, $N^{*C}(S) = \left\{ \left\langle \frac{n_1}{(0.2,0.3,0.4)} \right\rangle, \left\langle \frac{n_2}{(0.1,0.4,0.3)} \right\rangle, \left\langle \frac{n_3}{(0.2,0.3,0.4)} \right\rangle \right\}$ and

$B^c_N(S) = \left\{ \left\langle \frac{n_1}{(0.3,0.3,0.3)} \right\rangle, \left\langle \frac{n_2}{(0.2,0.3,0.3)} \right\rangle, \left\langle \frac{n_3}{(0.4,0.3,0.3)} \right\rangle \right\}$. Assume $R = \left\{ \left\langle \frac{n_1}{(0.3,0.3,0.3)} \right\rangle, \left\langle \frac{n_2}{(0.1,0.3,0.4)} \right\rangle, \left\langle \frac{n_3}{(0.2,0.2,0.4)} \right\rangle \right\}$ be a neutrosophic nano semi closed but it is not neutrosophic nano α closed.

(g) Assume $U = \{n_1, n_2, n_3\}$ be the universe set and the equivalence relation is $U / R = \{\{n_1\}, \{n_2, n_3\}\}$ Let

$S = \left\{ \left\langle \frac{n_1}{(0.3,0.4,0.3)} \right\rangle, \left\langle \frac{n_2}{(0.6,0.3,0.1)} \right\rangle, \left\langle \frac{n_3}{(0.2,0.6,0.2)} \right\rangle \right\}$ be neutrosophic nano subset of U . Then

$N_*(S) = \left\{ \left\langle \frac{n_1}{(0.4,0.3,0.3)} \right\rangle, \left\langle \frac{n_2}{(0.5,0.3,0.1)} \right\rangle, \left\langle \frac{n_3}{(0.5,0.2,0.1)} \right\rangle \right\}$, $N^*(S) = \left\{ \left\langle \frac{n_1}{(0.2,0.3,0.4)} \right\rangle, \left\langle \frac{n_2}{(0.1,0.4,0.3)} \right\rangle, \left\langle \frac{n_3}{(0.2,0.3,0.4)} \right\rangle \right\}$ and

$B_N(S) = \left\{ \left\langle \frac{n_1}{(0.3,0.3,0.3)} \right\rangle, \left\langle \frac{n_2}{(0.2,0.3,0.3)} \right\rangle, \left\langle \frac{n_3}{(0.4,0.3,0.3)} \right\rangle \right\}$. Here $\tau_N(S) = \{0_N, 1_N, N_*(S), N^*(S), B_N(S)\}$ be a

neutrosophic nano open set and a neutrosophic nano closed set is $[\tau_N(S)]^C = \{0_N, 1_N, N_*^C(S), N^{*C}(S), B_N(S)\}$ where

$$N_*^C(S) = \left\{ \left\langle \frac{n_1}{(0.3,0.3,0.4)} \right\rangle, \left\langle \frac{n_2}{(0.1,0.3,0.5)} \right\rangle, \left\langle \frac{n_3}{(0.1,0.2,0.5)} \right\rangle \right\}, \quad N^{*C}(S) = \left\{ \left\langle \frac{n_1}{(0.4,0.3,0.2)} \right\rangle, \left\langle \frac{n_2}{(0.3,0.4,0.1)} \right\rangle, \left\langle \frac{n_3}{(0.4,0.3,0.2)} \right\rangle \right\}$$
 and

$B^c_N(S) = \left\{ \left\langle \frac{n_1}{(0.3,0.3,0.3)} \right\rangle, \left\langle \frac{n_2}{(0.2,0.3,0.3)} \right\rangle, \left\langle \frac{n_3}{(0.3,0.3,0.4)} \right\rangle \right\}$. Assume $R = \left\{ \left\langle \frac{n_1}{(0.4,0.3,0.3)} \right\rangle, \left\langle \frac{n_2}{(0.5,0.3,0.2)} \right\rangle, \left\langle \frac{n_3}{(0.5,0.2,0.4)} \right\rangle \right\}$ be a neutrosophic nano semi closed but it is not neutrosophic nano α closed.

Theorem 3.7. Let $(U, \tau_N(S))$ be a neutrosophic topological space. Then the following are hold:

- (a) Every neutrosophic nano closed set is neutrosophic nano $\alpha\psi$ closed set.
- (b) Every neutrosophic nano α closed set is neutrosophic nano $\alpha\psi$ closed set.
- (c) Every neutrosophic nano semi closed set is neutrosophic nano sg closed.
- (d) Every neutrosophic nano ψ closed set is neutrosophic nano $\alpha\psi$ closed set.

Proof.

(a) Let S be a neutrosophic nano closed set. This implies $N_{Ncl}(S) = S$. Now assume that T be a neutrosophic nano α open set and $S \subseteq T$, then $N_N cl(S) \subseteq N_{Ncl}(S) = S \subseteq T$. Therefore $N_N cl(S) \subseteq T$. Hence S is neutrosophic nano $\alpha\psi$ closed.

(b) Let S be a neutrosophic nano α closed set then $N_{Ncl}(S) = S$. Now assume that $S \subseteq T$ and T be a neutrosophic nano $\alpha\psi$ open set, then $N_N cl(S) \subseteq N_{Ncl}(S) \subseteq T$. Therefore it is neutrosophic nano $\alpha\psi$ closed set.

(c) Let S be a neutrosophic nano semi closed then $N_N scl(S) = S$. Assume that $S \subseteq T$, T is neutrosophic nano semi open, then $N_N scl(S) \subseteq T$. Then S is neutrosophic nano sg closed set.

(d) Let S be a neutrosophic nano α closed. Every neutrosophic nano α open set is neutrosophic nano semi open and neutrosophic nano semi open is neutrosophic nano sg open. Assume that $S \subseteq T$, T is neutrosophic nano sg open, then $N_N cl(N_N scl(S)) \subseteq T$. Then S is neutrosophic nano $\alpha\psi$ closed set.

The inverse part not true by the following examples.

Example 3.8. By using Example [3.5 (f)]

(a) Let $C = \left\{ \left\langle \frac{n_1}{(0.3,0.3,0.3)} \right\rangle, \left\langle \frac{n_2}{(0.1,0.3,0.2)} \right\rangle, \left\langle \frac{n_3}{(0.3,0.2,0.4)} \right\rangle \right\}$ be a neutrosophic nano semi open and also neutrosophic nano

α open. Here $R = \left\{ \left\langle \frac{n_1}{(0.3,0.3,0.3)} \right\rangle, \left\langle \frac{n_2}{(0.1,0.3,0.5)} \right\rangle, \left\langle \frac{n_3}{(0.1,0.2,0.5)} \right\rangle \right\}$ be a neutrosophic nanosg closed and

$V = \left\{ \left\langle \frac{n_1}{(0.3,0.3,0.3)} \right\rangle, \left\langle \frac{n_2}{(0.5,0.3,0.1)} \right\rangle, \left\langle \frac{n_3}{(0.5,0.2,0.1)} \right\rangle \right\}$ be a neutrosophic nanosg open and $C \subseteq V$. Hence C is neutrosophic

nano $\alpha\psi$ closed but it is not neutrosophic nano closed set.

(b) Let $C = \left\{ \left\langle \frac{n_1}{(0.3,0.3,0.3)} \right\rangle, \left\langle \frac{n_2}{(0.1,0.3,0.2)} \right\rangle, \left\langle \frac{n_3}{(0.3,0.2,0.4)} \right\rangle \right\}$ be a neutrosophic nano semi open and also neutrosophic nano α open. Here $R = \left\{ \left\langle \frac{n_1}{(0.3,0.3,0.3)} \right\rangle, \left\langle \frac{n_2}{(0.1,0.3,0.5)} \right\rangle, \left\langle \frac{n_3}{(0.1,0.2,0.5)} \right\rangle \right\}$ be a neutrosophic nano sg closed and $V = \left\{ \left\langle \frac{n_1}{(0.3,0.3,0.3)} \right\rangle, \left\langle \frac{n_2}{(0.5,0.3,0.1)} \right\rangle, \left\langle \frac{n_3}{(0.5,0.2,0.1)} \right\rangle \right\}$ be a neutrosophic nanosg open and $C \subseteq V$. Hence C is neutrosophic nano $\alpha\psi$ closed but it is not neutrosophic nano α closed set.

(c) Let $U = \left\{ \left\langle \frac{n_1}{(0.3,0.3,0.3)} \right\rangle, \left\langle \frac{n_2}{(0.1,0.3,0.2)} \right\rangle, \left\langle \frac{n_3}{(0.3,0.2,0.4)} \right\rangle \right\}$ be a neutrosophic nano semi open .Here $C = \left\{ \left\langle \frac{n_1}{(0.2,0.3,0.3)} \right\rangle, \left\langle \frac{n_2}{(0.3,0.3,0.4)} \right\rangle, \left\langle \frac{n_3}{(0.2,0.3,0.4)} \right\rangle \right\}$. Hence C is neutrosophic nano sg closed but it is not neutrosophic nano semi closed set.

(d) Let $C = \left\{ \left\langle \frac{n_1}{(0.3,0.3,0.3)} \right\rangle, \left\langle \frac{n_2}{(0.1,0.3,0.2)} \right\rangle, \left\langle \frac{n_3}{(0.3,0.2,0.4)} \right\rangle \right\}$ be a neutrosophic nano semi open and also neutrosophic nano α open. Here $R = \left\{ \left\langle \frac{n_1}{(0.3,0.3,0.3)} \right\rangle, \left\langle \frac{n_2}{(0.1,0.3,0.4)} \right\rangle, \left\langle \frac{n_3}{(0.2,0.2,0.4)} \right\rangle \right\}$ is not neutrosophic nano sg closed and $V = \left\{ \left\langle \frac{n_1}{(0.3,0.3,0.3)} \right\rangle, \left\langle \frac{n_2}{(0.4,0.3,0.1)} \right\rangle, \left\langle \frac{n_3}{(0.4,0.2,0.2)} \right\rangle \right\}$ is not neutrosophic nano sg open and $C \subseteq U$. Hence C is neutrosophic nano $\alpha\psi$ closed but it is not neutrosophic nano ψ closed set.

Theorem 3.9. The union of two neutrosophic nano $\alpha\psi$ closed set is also neutrosophic nano $\alpha\psi$ closed set.

Proof. Let us assume that S and T be two neutrosophic nano $\alpha\psi$ closed sets. Let $S \cup T \subseteq V$, V is neutrosophic nano α open. By definition of neutrosophic nano $\alpha\psi$ closed set, $N_N\psi cl(S) \subseteq V$ and $N_N\psi cl(T) \subseteq V$. This implies that $N_N\psi cl(S \cup T) \subseteq V$. Hence $S \cup T$ is neutrosophic nano $\alpha\psi$ closed set.

Theorem3.10. Let S is neutrosophic nano $\alpha\psi$ closed set if S is both neutrosophic nano α open and neutrosophic nano ψ closedset.

Proof.Let us assume that S is both neutrosophic nano α open and neutrosophic nano ψ closed set, then by definition of neutrosophic nano ψ closed set, $N_Nscl(S) \subseteq T$ this implies that $N_N\psi cl(S) \subseteq N_Nscl(S) \subseteq T$. Therefore $N_N\psi cl(S) \subseteq T$. Hence S is neutrosophic nano $\alpha\psi$ closed set.

Theorem 3.11. Assume S be a neutrosophic nano $\alpha\psi$ closed set in neutrosophic nano topological spaces U. Then $N_N\psi cl(S) - S$ does not contain any non-empty neutrosophic nano α closed set.

Proof. Let us assume T be non-empty neutrosophic nano α closed subset of $N_N\psi cl(S) - S$. Then $S \subset U - T$, where $U - T$ is neutrosophic nano α open. Thus $N_N\psi cl(S) \subset U - T$ or equivalently $T \subset U - N_N\psi cl(S)$. This is contradiction by assumption. Hence $N_N\psi cl(S) - S$ does not contain any non-empty neutrosophic nano α closed s topological space.

Theorem 3.12. Let S be neutrosophic nano $\alpha\psi$ closed subset of neutrosophic topological spaces such that $S \subset T \subset N_N\psi cl(S)$, then T is also neutrosophic nano $\alpha\psi$ closed subset of neutrosophic nano topological space.

Proof. Let S be a neutrosophic nano $\alpha\psi$ closed set, by definition $S \subseteq W$ and W is neutrosophic nano α open set in neutrosophic nano topological spaces then $N_N\psi cl(S) \subset W$. Now assume that $T \subset W$ and W is neutrosophic nano α open set. Here $N_N\psi cl(S)$ is neutrosophic nano ψ closed set. Therefore $N_N\psi cl(T) \subseteq N_N\psi cl(N_N\psi cl(S)) = N_N\psi cl(S) \subset W$. Hence $N_N\psi cl(S) \subset W$. Therefore S is also neutrosophic nano $\alpha\psi$ closed subset of neutrosophic nano topological space.

Theorem 3.13. Let S be a subset of neutrosophic nano topological space then the following conditions are equivalent

- (i) S is neutrosophic nano semi open and neutrosophic nano ψ closed.
- (ii) S is neutrosophic nano regular open.

Proof. (i) \Rightarrow (ii) Let us assume that S is neutrosophic nano semi open and neutrosophic nano ψ closed sets. Every neutrosophic nano semi open is neutrosophic nanosg open. Then $N_{Nscl}(S) \subseteq S \Rightarrow N_{Ncl}(N_{Nint}(S)) \subseteq S \Rightarrow N_{Nint}(N_{Ncl}(N_{Nint}(S))) \subseteq N_{Nint}(S)$. As S is neutrosophic nano open sets then it is neutrosophic nano α open and so $S \subseteq N_{Nint}(N_{Ncl}(N_{Nint}(S)))$. Then $N_{Nint}(N_{Ncl}(S)) \subseteq S \subseteq N_{Nint}(N_{Ncl}(S))$. Therefore $S = N_{Nint}(N_{Ncl}(S))$. Hence S is neutrosophic nano regular open set.

(ii) \Rightarrow (i) Each neutrosophic nano regular open set is neutrosophic nano open and every neutrosophic nano open set is neutrosophic nano semi open. By assumption S is neutrosophic nano semi open and by definition of neutrosophic nano regular open set, $S = N_{Nint}(N_{Ncl}(S))$ then $N_{Nint}(N_{Ncl}(S)) \subseteq S$, therefore it is also neutrosophic nano semi closed. Hence it is also neutrosophic nano ψ closed set.

4. Conclusion

In this paper it is discussed about the new concept of neutrosophic nano semi closed, neutrosophic nano α closed, neutrosophic nano pre closed, neutrosophic nano semi pre closed and neutrosophic nano regular closed and investigate some of their properties. Also the work is extended as neutrosophic nano sg closed, neutrosophic nano ψ closed and neutrosophic nano $\alpha\psi$ closed and derive some of their properties and theorems.

References

- [1] O.Njastad, On some classes of nearly open sets, Pacific J.Math., 15(1965), 961-970.
- [2] M.K.R.S. Veerakumar, Between semi closed sets and semi pre closed sets, Rend.Istit.Mat.Univ.Trieste XXXII, (2000), 25-41.
- [3] R. Devi and M. Parimala, On Quasi $\alpha\psi$ -Open Functions in Topological Spaces, Applied Mathematical Sciences, Volume 3, No 58, (2009), 2881 - 2886.
- [4] M.LellisThivagar, Carmel Richard, On nano forms of weakly open sets, International journal of mathematics and statistics invention, Volume 1, Issue 1, August 2013, 31-37.
- [5] L.A.Zadeh, Fuzzy set, Inform. and Control 8(1965), 338-353.
- [6] K.T.Atanassov, Intuitionistic fuzzy sets, Fuzzy sets and systems, 20(1986), 87-96.
- [7] Smarandache.F, A unifying field in logics neutrosophic probability, set and logic, Rehoboth American Research Press 1999.
- [8] M. Parimala, F. Smarandache, S. Jafari and R. Udhayakumar, On Neutrosophic $\alpha\psi$ -Closed Sets, Information,9(2018), 103, 1-7.
- [9] M.LellisThivagar, SaeidJafari, V.Sudhadevi and V.Antonyamy, A novel approach to nano topology via neutrosophic sets, Neutrosophic sets and systems, Vol 20, 2018.
- [10] F.G.Lupianez, On Neutrosophic sets and topology, Kybernetes, 37(2008), 797-800.

Neutrosophic Soft Rough Graphs with Application

Muhammad Akram, Hafsa M. Malik, Sundas Shahzadi, Florentin Smarandache

Muhammad Akram, Hafsa M. Malik, Sundas Shahzadi, Florentin Smarandache (2018). Neutrosophic Soft Rough Graphs with Application. *Axioms* 7, 14; DOI: 10.3390/axioms7010014

Abstract: Neutrosophic sets (NSs) handle uncertain information while fuzzy sets (FSs) and intuitionistic fuzzy sets (IFs) fail to handle indeterminate information. Soft set theory, neutrosophic set theory, and rough set theory are different mathematical models for handling uncertainties and they are mutually related. The neutrosophic soft rough set (NSRS) model is a hybrid model by combining neutrosophic soft sets with rough sets. We apply neutrosophic soft rough sets to graphs. In this research paper, we introduce the idea of neutrosophic soft rough graphs (NSRGs) and describe different methods of their construction. We consider the application of NSRG in decision-making problems. In particular, we develop efficient algorithms to solve decision-making problems.

Keywords: neutrosophic soft rough sets; neutrosophic soft rough graphs; decision-making; algorithm

1. Introduction

Smarandache [1] initiated the concept of neutrosophic set (NS). Smarandache's NS is characterized by three parts: truth, indeterminacy, and falsity. Truth, indeterminacy and falsity membership values behave independently and deal with problems having uncertain, indeterminate and imprecise data. Wang et al. [2] gave a new concept of single valued neutrosophic sets (SVNSs) and defined the set theoretic operators on an instance of NS called SVNS. Peng et al. [3] discussed the operations of simplified neutrosophic numbers and introduced an outranking idea of simplified neutrosophic numbers.

Molodtsov [4] introduced the notion of soft set (SS) as a novel mathematical approach for handling uncertainties. Molodtsov's SSs gave us a new technique for dealing with uncertainty from the viewpoint of parameters. Maji et al. [5–7] introduced neutrosophic soft sets (NSSs), intuitionistic fuzzy soft sets and fuzzy soft sets (FSSs). In [8], Sahin and Kucuk presented NSS in the form of neutrosophic relations.

Theory of rough set (RS) was proposed by Pawlak [9] in 1982. Rough set theory is used to study the intelligence systems containing incomplete, uncertain or inexact information. The lower and upper approximation operators of RSs are used for managing hidden information in a system. Feng et al. [10] took a significant step to introduce parametrization tools in RSs. Meng et al. [11] provide further discussion of the combination of SSs, RSs and FSs. The existing results of RSs and other extended RSs such as rough fuzzy sets, generalized rough fuzzy sets, soft fuzzy rough sets and intuitionistic fuzzy rough sets based decision-making models have their advantages and limitations [12,13]. In a different way, rough set approximations have been constructed into the intuitionistic fuzzy environment and are known as intuitionistic fuzzy rough sets and rough intuitionistic fuzzy sets [14,15]. Zhang et al. [16,17] presented the notions of soft rough sets, soft rough intuitionistic fuzzy sets, intuitionistic fuzzy soft rough sets, its application in decision-making, and also introduced generalized intuitionistic fuzzy soft rough sets. Broumi et al. [18,19] developed a hybrid structure by combining

RSs and NSs, called RNSs, they also presented interval valued neutrosophic soft rough sets by combining interval valued neutrosophic soft sets and RSs. Yang et al. [20] proposed single valued neutrosophic rough sets (SVNRSs) by combining SVNNSs and RSs and defined SVNRSs on two universes and established an algorithm for a decision-making problem based on SVNRSs on two universes. Akram and Nawaz [21] have introduced the concept of soft graphs and some operation on soft graphs. Certain concepts of fuzzy soft graphs and intuitionistic fuzzy soft graphs are discussed in [22–24]. Akram and Shahzadi [25] have introduced neutrosophic soft graphs. Zafar and Akram [26] introduced a rough fuzzy digraph and several basic notions concerning rough fuzzy digraphs. In this research paper, a neutrosophic soft rough set is a generalization of a neutrosophic rough set, and we introduce the idea of neutrosophic soft rough graphs (NSRGs) that are made by combining NSRSs with graphs and describe different methods of their construction. We consider the application of NSRG in decision-making problems and resolve the problem. In particular, we develop efficient algorithms to solve decision-making problems.

For other notations, terminologies and applications not mentioned in the paper, the readers are referred to [27–35].

2. Neutrosophic Soft Rough Information

In this section, we will introduce the notions of neutrosophic soft rough relation (NSRR), and NSRGs.

Definition 1. Let Y be an initial universal set, \mathbb{P} a universal set of parameters and $\mathbb{M} \subseteq \mathbb{P}$. For an arbitrary neutrosophic soft relation Q over $Y \times \mathbb{M}$, (Y, \mathbb{M}, Q) is called neutrosophic soft approximation space (NSAS).

For any NS $A \in \mathcal{N}(\mathbb{M})$, we define the upper neutrosophic soft rough approximation (UNNSRA) and the lower neutrosophic soft rough approximation (LNSRA) operators of A with respect to (Y, \mathbb{M}, Q) denoted by $\overline{Q}(A)$ and $\underline{Q}(A)$, respectively as follows:

$$\begin{aligned} \overline{Q}(A) &= \{(u, T_{\overline{Q}(A)}(u), I_{\overline{Q}(A)}(u), F_{\overline{Q}(A)}(u)) \mid u \in Y\}, \\ \underline{Q}(A) &= \{(u, T_{\underline{Q}(A)}(u), I_{\underline{Q}(A)}(u), F_{\underline{Q}(A)}(u)) \mid u \in Y\}, \end{aligned}$$

where

$$\begin{aligned} T_{\overline{Q}(A)}(u) &= \bigvee_{e \in \mathbb{M}} (T_{Q(A)}(u, e) \wedge T_A(e)), & I_{\overline{Q}(A)}(u) &= \bigwedge_{e \in \mathbb{M}} (I_{Q(A)}(u, e) \vee I_A(e)), \\ F_{\overline{Q}(A)}(u) &= \bigwedge_{e \in \mathbb{M}} (F_{Q(A)}(u, e) \vee F_A(e)); & T_{\underline{Q}(A)}(u) &= \bigwedge_{e \in \mathbb{M}} (F_{Q(A)}(u, e) \vee T_A(e)), \\ I_{\underline{Q}(A)}(u) &= \bigvee_{e \in \mathbb{M}} ((1 - I_{Q(A)}(u, e)) \wedge I_A(e)), & F_{\underline{Q}(A)}(u) &= \bigvee_{e \in \mathbb{M}} (T_{Q(A)}(u, e) \wedge F_A(e)). \end{aligned}$$

The pair $(\underline{Q}(A), \overline{Q}(A))$ is called NSRS of A w.r.t (Y, \mathbb{M}, Q) , \underline{Q} and \overline{Q} are referred to as the LNSRA and the UNNSRA operators, respectively.

Example 1. Suppose that $Y = \{w_1, w_2, w_3, w_4\}$ is the set of careers under consideration, and Mr. X wants to select the best suitable career. $\mathbb{M} = \{e_1, e_2, e_3\}$ is a set of decision parameters. Mr. X describes the “most suitable career” by defining a neutrosophic soft set (Q, \mathbb{M}) on Y that is a neutrosophic relation from Y to \mathbb{M} as shown in Table 1.

Table 1. Neutrosophic soft relation Q .

Q	w_1	w_2	w_3	w_4
e_1	(0.3, 0.4, 0.5)	(0.4, 0.2, 0.3)	(0.1, 0.5, 0.4)	(0.2, 0.3, 0.4)
e_2	(0.1, 0.5, 0.4)	(0.3, 0.4, 0.6)	(0.4, 0.4, 0.3)	(0.5, 0.3, 0.8)
e_3	(0.3, 0.4, 0.4)	(0.4, 0.6, 0.7)	(0.3, 0.5, 0.4)	(0.5, 0.4, 0.6)

Now, Mr. X gives the most favorable decision object A, which is an NS on \mathbb{M} defined as follows: $A = \{(e_1, 0.5, 0.2, 0.4), (e_2, 0.2, 0.3, 0.1), (e_3, 0.2, 0.4, 0.6)\}$. By Definition 1, we have

$$\begin{aligned} T_{\overline{Q}(A)}(w_1) &= 0.3, & I_{\overline{Q}(A)}(w_1) &= 0.4, & F_{\overline{Q}(A)}(w_1) &= 0.4, \\ T_{\overline{Q}(A)}(w_2) &= 0.4, & I_{\overline{Q}(A)}(w_2) &= 0.2, & F_{\overline{Q}(A)}(w_2) &= 0.4, \\ T_{\overline{Q}(A)}(w_3) &= 0.2, & I_{\overline{Q}(A)}(w_3) &= 0.4, & F_{\overline{Q}(A)}(w_3) &= 0.3, \\ T_{\overline{Q}(A)}(w_4) &= 0.2, & I_{\overline{Q}(A)}(w_4) &= 0.3, & F_{\overline{Q}(A)}(w_4) &= 0.4. \end{aligned}$$

Similarly,

$$\begin{aligned} T_{\underline{Q}(A)}(w_1) &= 0.4, & I_{\underline{Q}(A)}(w_1) &= 0.4, & F_{\underline{Q}(A)}(w_1) &= 0.3, \\ T_{\underline{Q}(A)}(w_2) &= 0.5, & I_{\underline{Q}(A)}(w_2) &= 0.4, & F_{\underline{Q}(A)}(w_2) &= 0.4, \\ T_{\underline{Q}(A)}(w_3) &= 0.4, & I_{\underline{Q}(A)}(w_3) &= 0.4, & F_{\underline{Q}(A)}(w_3) &= 0.3, \\ T_{\underline{Q}(A)}(w_4) &= 0.5, & I_{\underline{Q}(A)}(w_4) &= 0.4, & F_{\underline{Q}(A)}(w_4) &= 0.5. \end{aligned}$$

Thus, we obtain

$$\begin{aligned} \overline{Q}(A) &= \{(w_1, 0.3, 0.4, 0.4), (w_2, 0.4, 0.2, 0.4), (w_3, 0.2, 0.4, 0.3), (w_4, 0.2, 0.3, 0.4)\}, \\ \underline{Q}(A) &= \{(w_1, 0.4, 0.4, 0.3), (w_2, 0.5, 0.4, 0.4), (w_3, 0.4, 0.4, 0.3), (w_4, 0.5, 0.4, 0.5)\}. \end{aligned}$$

Hence, $(\underline{Q}(A), \overline{Q}(A))$ is an NSRS of A.

The conventional neutrosophic soft set is a mapping from a parameter to the neutrosophic subset of the universe and letting (Q, \mathbb{M}) be neutrosophic soft set. Now, we present the constructive definition of neutrosophic soft rough relation by using a neutrosophic soft relation S from $\mathbb{M} \times \mathbb{M} = \hat{\mathbb{M}}$ to $\mathcal{N}(Y \times Y = \hat{Y})$, where Y is a universal set and \mathbb{M} be a set of parameters.

Definition 2. A neutrosophic soft rough relation $(\underline{S}(B), \overline{S}(B))$ on Y is an NSRS, $S : \hat{\mathbb{M}} \rightarrow \mathcal{N}(\hat{Y})$ is a neutrosophic soft relation on Y defined by

$$\begin{aligned} S(e_i e_j) &= \{u_i u_j \mid \exists u_i \in Q(e_i), u_j \in Q(e_j)\}, u_i u_j \in \hat{Y}, \text{ such that} \\ T_S(u_i u_j, e_i e_j) &\leq \min\{T_Q(u_i, e_i), T_Q(u_j, e_j)\} \\ I_S(u_i u_j, e_i e_j) &\leq \max\{I_Q(u_i, e_i), I_Q(u_j, e_j)\} \\ F_S(u_i u_j, e_i e_j) &\leq \max\{F_Q(u_i, e_i), F_Q(u_j, e_j)\}. \end{aligned}$$

For any $B \in \mathcal{N}(\hat{\mathbb{M}})$, $B = \{(e_i e_j, T_B(e_i e_j), I_B(e_i e_j), F_B(e_i e_j)) \mid u_i u_j \in \hat{\mathbb{M}}\}$,

$$\begin{aligned} T_B(e_i e_j) &\leq \min\{T_A(e_i), T_A(e_j)\}, \\ I_B(e_i e_j) &\leq \max\{I_A(e_i), I_A(e_j)\}, \\ F_B(e_i e_j) &\leq \max\{F_A(e_i), F_A(e_j)\}. \end{aligned}$$

The UNSA and the LNSA of B w.r.t $(\hat{Y}, \hat{\mathbb{M}}, S)$ are defined as follows:

$$\begin{aligned} \overline{S}(B) &= \{(u_i u_j, T_{\overline{S}(B)}(u_i u_j), I_{\overline{S}(B)}(u_i u_j), F_{\overline{S}(B)}(u_i u_j)) \mid u_i u_j \in \hat{Y}\}, \\ \underline{S}(B) &= \{(u_i u_j, T_{\underline{S}(B)}(u_i u_j), I_{\underline{S}(B)}(u_i u_j), F_{\underline{S}(B)}(u_i u_j)) \mid u_i u_j \in \hat{Y}\}, \end{aligned}$$

where

$$T_{\overline{S}(B)}(u_i u_j) = \bigvee_{e_i e_j \in \check{\mathbb{M}}} (T_S(u_i u_j, e_i e_j) \wedge T_B(e_i e_j)),$$

$$I_{\overline{S}(B)}(u_i u_j) = \bigwedge_{e_i e_j \in \check{\mathbb{M}}} (I_S(u_i u_j, e_i e_j) \vee I_B(e_i e_j)),$$

$$F_{\overline{S}(B)}(u_i u_j) = \bigwedge_{e_i e_j \in \check{\mathbb{M}}} (F_S(u_i u_j, e_i e_j) \vee F_B(e_i e_j));$$

$$T_{\underline{S}(B)}(u_i u_j) = \bigwedge_{e_i e_j \in \check{\mathbb{M}}} (F_S(u_i u_j, e_i e_j) \vee T_B(e_i e_j)),$$

$$I_{\underline{S}(B)}(u_i u_j) = \bigvee_{e_i e_j \in \check{\mathbb{M}}} ((1 - I_S(u_i u_j, e_i e_j)) \wedge I_B(e_i e_j)),$$

$$F_{\underline{S}(B)}(u_i u_j) = \bigvee_{e_i e_j \in \check{\mathbb{M}}} (T_S(u_i u_j, e_i e_j) \wedge F_B(e_i e_j)).$$

The pair $(\underline{S}(B), \overline{S}(B))$ is called NSRR and $\underline{S}, \overline{S} : \mathcal{N}(\check{\mathbb{M}}) \rightarrow \mathcal{N}(\check{Y})$ are called the LNSRA and the UNSRA operators, respectively.

Remark 1. Consider an NS B on $\check{\mathbb{M}}$ and an NS A on \mathbb{M} , according to the definition of NSRR, we get

$$T_{\overline{S}(B)}(u_i u_j) \leq \min\{T_{\overline{S}(A)}(u_i), T_{\overline{S}(A)}(u_j)\},$$

$$I_{\overline{S}(B)}(u_i u_j) \leq \max\{I_{\overline{S}(A)}(u_i), I_{\overline{S}(A)}(u_j)\},$$

$$F_{\overline{S}(B)}(u_i u_j) \leq \max\{F_{\overline{S}(A)}(u_i), F_{\overline{S}(A)}(u_j)\}.$$

Similarly, for LNSRA operator $\underline{S}(B)$,

$$T_{\underline{S}(B)}(u_i u_j) \leq \min\{T_{\underline{S}(A)}(u_i), T_{\underline{S}(A)}(u_j)\},$$

$$I_{\underline{S}(B)}(u_i u_j) \leq \max\{I_{\underline{S}(A)}(u_i), I_{\underline{S}(A)}(u_j)\},$$

$$F_{\underline{S}(B)}(u_i u_j) \leq \max\{F_{\underline{S}(A)}(u_i), F_{\underline{S}(A)}(u_j)\}.$$

Example 2. Let $Y = \{u_1, u_2, u_3\}$ be a universal set and $\mathbb{M} = \{e_1, e_2, e_3\}$ a set of parameters. A neutrosophic soft set (Q, \mathbb{M}) on Y can be defined in tabular form in Table 2 as follows:

Table 2. Neutrosophic soft set (Q, \mathbb{M}) .

Q	u_1	u_2	u_3
e_1	(0.4, 0.5, 0.6)	(0.7, 0.3, 0.2)	(0.6, 0.3, 0.4)
e_2	(0.5, 0.3, 0.6)	(0.3, 0.4, 0.3)	(0.7, 0.2, 0.3)
e_3	(0.7, 0.2, 0.3)	(0.6, 0.5, 0.4)	(0.7, 0.2, 0.4)

Let $E = \{u_1 u_2, u_2 u_3, u_2 u_2, u_3 u_2\} \subseteq \check{Y}$ and $L = \{e_1 e_3, e_2 e_1, e_3 e_2\} \subseteq \check{\mathbb{M}}$.

Then, a soft relation S on E (from L to E) can be defined in Table 3 as follows:

Table 3. Neutrosophic soft relation S .

S	u_1u_2	u_2u_3	u_2u_2	u_3u_2
e_1e_3	(0.4, 0.4, 0.5)	(0.6, 0.3, 0.4)	(0.5, 0.4, 0.2)	(0.5, 0.4, 0.3)
e_2e_1	(0.3, 0.3, 0.4)	(0.3, 0.2, 0.3)	(0.2, 0.3, 0.3)	(0.7, 0.2, 0.2)
e_3e_2	(0.3, 0.3, 0.2)	(0.5, 0.3, 0.2)	(0.2, 0.4, 0.4)	(0.3, 0.4, 0.4)

Let $A = \{(e_1, 0.2, 0.4, 0.6), (e_2, 0.4, 0.5, 0.2), (e_3, 0.1, 0.2, 0.4)\}$ be an NS on \mathbb{M} , then

$$\bar{S}(A) = \{(u_1, 0.4, 0.2, 0.4), (u_2, 0.3, 0.4, 0.3), (u_3, 0.4, 0.2, 0.3)\},$$

$$\underline{S}(A) = \{(u_1, 0.3, 0.5, 0.4), (u_2, 0.2, 0.5, 0.6), (u_3, 0.4, 0.5, 0.6)\}.$$

Let $B = \{(e_1e_3, 0.1, 0.3, 0.5), (e_2e_1, 0.2, 0.4, 0.3), (e_3e_2, 0.1, 0.2, 0.3)\}$ be an NS on L , then

$$\bar{S}(B) = \{(u_1u_2, 0.2, 0.3, 0.3), (u_2u_3, 0.2, 0.3, 0.3), (u_2u_2, 0.2, 0.4, 0.3), (u_3u_2, 0.2, 0.4, 0.3)\},$$

$$\underline{S}(B) = \{(u_1u_2, 0.2, 0.4, 0.4), (u_2u_3, 0.2, 0.4, 0.5), (u_2u_2, 0.3, 0.4, 0.5), (u_3u_2, 0.2, 0.4, 0.5)\}.$$

Hence, $S(B) = (\underline{S}(B), \bar{S}(B))$ is NSRR.

Definition 3. A neutrosophic soft rough graph (NSRG) on a non-empty V is an 4-ordered tuple $(V, \mathbb{M}, Q(A), S(B))$ such that

- (i) \mathbb{M} is a set of parameters,
- (ii) Q is an arbitrary neutrosophic soft relation over $V \times \mathbb{M}$,
- (iii) S is an arbitrary neutrosophic soft relation over $\hat{V} \times \hat{\mathbb{M}}$,
- (iv) $Q(A) = (\underline{Q}A, \bar{Q}A)$ is an NSRS of A ,
- (v) $S(B) = (\underline{S}B, \bar{S}B)$ is an NSRR on $\hat{V} \subset V \times V$,
- (vi) $G = (Q(A), S(B))$ is a neutrosophic soft rough graph, where $\underline{G} = (\underline{Q}A, \underline{S}B)$ and $\bar{G} = (\bar{Q}A, \bar{S}B)$ are lower neutrosophic approximate graph (LNAG) and upper neutrosophic approximate graph (UNAG), respectively of neutrosophic soft rough graph (NSRG) $G = (Q(A), S(B))$.

Example 3. Let $V = \{v_1, v_2, v_3, v_4, v_5, v_6\}$ be a vertex set and $\mathbb{M} = \{e_1, e_2, e_3\}$ a set of parameters. A neutrosophic soft relation over $V \times \mathbb{M}$ can be defined in tabular form in Table 4 as follows:

Table 4. Neutrosophic soft relation Q .

Q	v_1	v_2	v_3	v_4	v_5	v_6
e_1	(0.4, 0.5, 0.6)	(0.7, 0.3, 0.5)	(0.6, 0.2, 0.3)	(0.4, 0.4, 0.2)	(0.5, 0.5, 0.6)	(0.4, 0.5, 0.6)
e_2	(0.5, 0.4, 0.2)	(0.6, 0.4, 0.5)	(0.7, 0.3, 0.4)	(0.5, 0.3, 0.2)	(0.4, 0.5, 0.4)	(0.6, 0.5, 0.4)
e_3	(0.5, 0.4, 0.1)	(0.6, 0.3, 0.2)	(0.5, 0.4, 0.3)	(0.6, 0.2, 0.3)	(0.5, 0.4, 0.4)	(0.7, 0.3, 0.5)

Let $A = \{(e_1, 0.5, 0.4, 0.6), (e_2, 0.7, 0.4, 0.5), (e_3, 0.6, 0.2, 0.5)\}$ be an NS on \mathbb{M} , then

$$\bar{S}(A) = \{(v_1, 0.5, 0.4, 0.5), (v_2, 0.6, 0.3, 0.5), (v_3, 0.7, 0.4, 0.5), (v_4, 0.6, 0.2, 0.5), (v_5, 0.5, 0.4, 0.5), (v_6, 0.6, 0.3, 0.5)\},$$

$$\underline{S}(A) = \{(v_1, 0.6, 0.4, 0.5), (v_2, 0.5, 0.4, 0.6), (v_3, 0.5, 0.4, 0.6), (v_4, 0.5, 0.4, 0.5), (v_5, 0.6, 0.4, 0.5), (v_6, 0.6, 0.4, 0.5)\}.$$

Let $E = \{v_1v_1, v_1v_2, v_2v_1, v_2v_3, v_4v_5, v_3v_4, v_5v_2, v_5v_6\} \subseteq \hat{V}$ and $L = \{e_1e_3, e_2e_1, e_3e_2\} \subseteq \hat{\mathbb{M}}$. Then, a neutrosophic soft relation S on E (from L to E) can be defined in Tables 5 and 6 as follows:

Table 5. Neutrosophic soft relation S .

S	v_1v_1	v_1v_2	v_2v_1	v_2v_3
e_1e_2	(0.4, 0.4, 0.2)	(0.4, 0.4, 0.5)	(0.4, 0.4, 0.5)	(0.6, 0.3, 0.4)
e_2e_3	(0.5, 0.4, 0.1)	(0.4, 0.3, 0.2)	(0.4, 0.3, 0.2)	(0.5, 0.3, 0.2)
e_1e_3	(0.4, 0.4, 0.1)	(0.4, 0.2, 0.2)	(0.4, 0.2, 0.2)	(0.5, 0.3, 0.3)

S	v_1v_1	v_1v_2	v_2v_1	v_2v_3
e_1e_2	(0.4, 0.4, 0.2)	(0.4, 0.4, 0.5)	(0.4, 0.4, 0.5)	(0.6, 0.3, 0.4)
e_2e_3	(0.5, 0.4, 0.1)	(0.4, 0.3, 0.2)	(0.4, 0.3, 0.2)	(0.5, 0.3, 0.2)
e_1e_3	(0.4, 0.4, 0.1)	(0.4, 0.2, 0.2)	(0.4, 0.2, 0.2)	(0.5, 0.3, 0.3)

Table 6. Neutrosophic soft relation S .

S	v_3v_4	v_4v_5	v_5v_2	v_5v_6
e_1e_2	(0.4, 0.2, 0.2)	(0.4, 0.4, 0.2)	(0.4, 0.3, 0.4)	(0.5, 0.2, 0.3)
e_2e_3	(0.6, 0.2, 0.4)	(0.3, 0.2, 0.1)	(0.4, 0.3, 0.2)	(0.4, 0.3, 0.4)
e_1e_3	(0.4, 0.2, 0.3)	(0.4, 0.3, 0.1)	(0.5, 0.3, 0.2)	(0.5, 0.3, 0.5)

Let $B = \{(e_1e_2, 0.4, 0.4, 0.5), (e_2e_3, 0.5, 0.4, 0.5), (e_1e_3, 0.5, 0.2, 0.5)\}$ be an NS on L , then
 Let $\bar{B} = \{(e_1e_2, 0.4, 0.4, 0.5), (e_2e_3, 0.5, 0.4, 0.5), (e_1e_3, 0.5, 0.2, 0.5)\}$ be a NS on L , then
 $\underline{SB} = \{(v_1v_1, 0.5, 0.4, 0.5), (v_1v_2, 0.4, 0.2, 0.5), (v_2v_1, 0.4, 0.2, 0.5), (v_2v_3, 0.5, 0.3, 0.5),$
 $(v_3v_4, 0.5, 0.2, 0.5), (v_4v_5, 0.4, 0.3, 0.5), (v_5v_2, 0.5, 0.3, 0.5), (v_5v_6, 0.5, 0.3, 0.5)\},$
 $\underline{SB} = \{(v_1v_1, 0.4, 0.4, 0.5), (v_1v_2, 0.5, 0.4, 0.4), (v_2v_1, 0.5, 0.4, 0.4), (v_2v_3, 0.4, 0.4, 0.5),$
 $(v_3v_4, 0.4, 0.4, 0.5), (v_4v_5, 0.4, 0.4, 0.4), (v_5v_2, 0.4, 0.4, 0.5), (v_5v_6, 0.4, 0.4, 0.5)\}.$

Hence $\underline{S(\bar{B})} = (\underline{SB}, \bar{SB})$ is NSRR on V .

Thus, $\bar{G} = (\bar{Q}A, \bar{SB})$ and $\underline{G} = (\underline{Q}A, \underline{SB})$ are LNAG and UNAG, respectively are shown in Figure 1.
 Hence, $G = (\underline{G}, \bar{G})$ is NSRG.

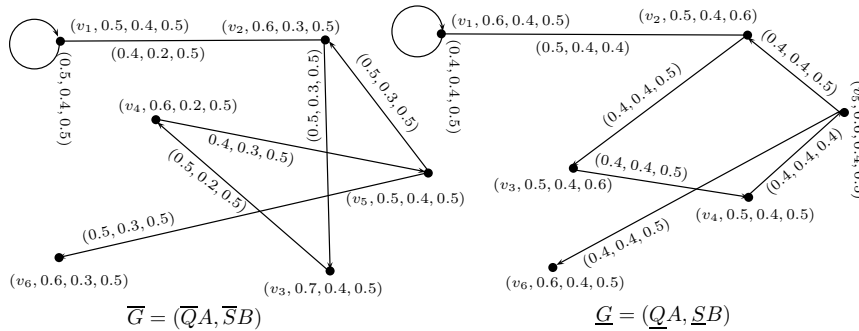

Figure 1: Neutrosophic soft rough graph $G = (\underline{G}, \bar{G})$

Definition 2.4. Let $\bar{G} = (\bar{Q}A, \bar{SB})$ be a neutrosophic soft rough graph on a non-empty set V . The order of \bar{G} can be denoted by $\mathbf{O}(\bar{G})$, defined by

Definition 4. Let $G = (\underline{Q}A, \underline{SB})$ be a neutrosophic soft rough graph on a non-empty set V . The order of G can be denoted by $\mathbf{O}(G)$, defined by

$$\mathbf{O}(\bar{G}) = \sum_{v \in V} \bar{Q}A(v), \mathbf{O}(G) = \sum_{v \in V} \underline{Q}A(v).$$

$$\mathbf{O}(G) = \mathbf{O}(\bar{G}) + \mathbf{O}(G), \text{ where } v \in V$$

The size of neutrosophic soft rough graph \bar{G} , denoted by $\mathbf{S}(\bar{G})$, defined by

$$\mathbf{S}(\bar{G}) = (\sum_{uv \in E} \bar{S}B(uv), \mathbf{S}(\bar{G})), \text{ where } uv \in E$$

The size of neutrosophic soft rough graph G , denoted by $\mathbf{S}(G)$, defined by

$$\mathbf{S}(G) = (\mathbf{S}(\bar{G}) + \mathbf{S}(G), \text{ where } uv \in E$$

$$\mathbf{S}(\bar{G}) = \sum_{uv \in E} \bar{S}B(uv), \mathbf{S}(G) = \sum_{uv \in E} \underline{S}B(uv).$$

Example 4. Let G be a neutrosophic soft rough graph as shown in Figure 1. Then,

$$\mathbf{O}(\bar{G}) = (3.5, 2.0, 3.0), \mathbf{O}(G) = (3.3, 2.4, 3.2),$$

$$\mathbf{O}(G) = \mathbf{O}(\bar{G}) + \mathbf{O}(G) = (6.8, 4.4, 6.2), \text{ and}$$

$$\mathbf{S}(\bar{G}) = (3.2, 1.8, 3.0) \mathbf{S}(G) = (2.5, 2.4, 2.8)$$

$$\mathbf{S}(G) = \mathbf{S}(\bar{G}) + \mathbf{S}(G) = (5.7, 4.2, 5.8).$$

Definition 5. Let $G_1 = (\underline{G}_1, \overline{G}_1)$ and $G_2 = (\underline{G}_2, \overline{G}_2)$ be two neutrosophic soft rough graphs on V . The union of G_1 and G_2 is a neutrosophic soft rough graph $G = G_1 \cup G_2 = (\underline{G}_1 \cup \underline{G}_2, \overline{G}_1 \cup \overline{G}_2)$, where $\underline{G}_1 \cup \underline{G}_2 = (\underline{QA}_1 \cup \underline{QA}_2, \underline{SB}_1 \cup \underline{SB}_2)$ and $\overline{G}_1 \cup \overline{G}_2 = (\overline{QA}_1 \cup \overline{QA}_2, \overline{SB}_1 \cup \overline{SB}_2)$ are neutrosophic graphs, such that

(i) $\forall v \in QA_1$ but $v \notin QA_2$.

$$\begin{aligned} T_{\overline{QA}_1 \cup \overline{QA}_2}(v) &= T_{\overline{QA}_1}(v), T_{\underline{QA}_1 \cup \underline{QA}_2}(v) = T_{\underline{QA}_1}(v), \\ I_{\overline{QA}_1 \cup \overline{QA}_2}(v) &= I_{\overline{QA}_1}(v), I_{\underline{QA}_1 \cup \underline{QA}_2}(v) = I_{\underline{QA}_1}(v), \\ F_{\overline{QA}_1 \cup \overline{QA}_2}(v) &= F_{\overline{QA}_1}(v), F_{\underline{QA}_1 \cup \underline{QA}_2}(v) = F_{\underline{QA}_1}(v). \end{aligned}$$

(ii) $\forall v \notin QA_1$ but $v \in QA_2$.

$$\begin{aligned} T_{\overline{QA}_1 \cup \overline{QA}_2}(v) &= T_{\overline{QA}_2}(v), T_{\underline{QA}_1 \cup \underline{QA}_2}(v) = T_{\underline{QA}_2}(v), \\ I_{\overline{QA}_1 \cup \overline{QA}_2}(v) &= I_{\overline{QA}_2}(v), I_{\underline{QA}_1 \cup \underline{QA}_2}(v) = I_{\underline{QA}_2}(v), \\ F_{\overline{QA}_1 \cup \overline{QA}_2}(v) &= F_{\overline{QA}_2}(v), F_{\underline{QA}_1 \cup \underline{QA}_2}(v) = F_{\underline{QA}_2}(v). \end{aligned}$$

(iii) $\forall v \in QA_1 \cap QA_2$

$$\begin{aligned} T_{\overline{QA}_1 \cup \overline{QA}_2}(v) &= \max\{T_{\overline{QA}_1}(v), T_{\overline{QA}_2}(v)\}, T_{\underline{QA}_1 \cup \underline{QA}_2}(v) = \max\{T_{\underline{QA}_1}(v), T_{\underline{QA}_2}(v)\}, \\ I_{\overline{QA}_1 \cup \overline{QA}_2}(v) &= \min\{I_{\overline{QA}_1}(v), I_{\overline{QA}_2}(v)\}, I_{\underline{QA}_1 \cup \underline{QA}_2}(v) = \min\{I_{\underline{QA}_1}(v), I_{\underline{QA}_2}(v)\}, \\ F_{\overline{QA}_1 \cup \overline{QA}_2}(v) &= \min\{F_{\overline{QA}_1}(v), F_{\overline{QA}_2}(v)\}, F_{\underline{QA}_1 \cup \underline{QA}_2}(v) = \min\{F_{\underline{QA}_1}(v), F_{\underline{QA}_2}(v)\}. \end{aligned}$$

(iv) $\forall vu \in SB_1$ but $vu \notin SB_2$.

$$\begin{aligned} T_{\overline{SB}_1 \cup \overline{SB}_2}(vu) &= T_{\overline{SB}_1}(vu), T_{\underline{SB}_1 \cup \underline{SB}_2}(vu) = T_{\underline{SB}_1}(vu), \\ I_{\overline{SB}_1 \cup \overline{SB}_2}(vu) &= I_{\overline{SB}_1}(vu), I_{\underline{SB}_1 \cup \underline{SB}_2}(vu) = I_{\underline{SB}_1}(vu), \\ F_{\overline{SB}_1 \cup \overline{SB}_2}(vu) &= F_{\overline{SB}_1}(vu), F_{\underline{SB}_1 \cup \underline{SB}_2}(vu) = F_{\underline{SB}_1}(vu). \end{aligned}$$

(v) $\forall vu \notin SB_1$ but $vu \in SB_2$

$$\begin{aligned} T_{\overline{SB}_1 \cup \overline{SB}_2}(vu) &= T_{\overline{SB}_2}(vu), T_{\underline{SB}_1 \cup \underline{SB}_2}(vu) = T_{\underline{SB}_2}(vu), \\ I_{\overline{SB}_1 \cup \overline{SB}_2}(vu) &= I_{\overline{SB}_2}(vu), I_{\underline{SB}_1 \cup \underline{SB}_2}(vu) = I_{\underline{SB}_2}(vu), \\ F_{\overline{SB}_1 \cup \overline{SB}_2}(vu) &= F_{\overline{SB}_2}(vu), F_{\underline{SB}_1 \cup \underline{SB}_2}(vu) = F_{\underline{SB}_2}(vu). \end{aligned}$$

(vi) $\forall vu \in SB_1 \cap SB_2$

$$\begin{aligned} T_{\overline{SB}_1 \cup \overline{SB}_2}(vu) &= \max\{T_{\overline{SB}_1}(vu), T_{\overline{SB}_2}(vu)\}, T_{\underline{SB}_1 \cup \underline{SB}_2}(vu) = \max\{T_{\underline{SB}_1}(vu), T_{\underline{SB}_2}(vu)\}, \\ I_{\overline{SB}_1 \cup \overline{SB}_2}(vu) &= \min\{I_{\overline{SB}_1}(vu), I_{\overline{SB}_2}(vu)\}, I_{\underline{SB}_1 \cup \underline{SB}_2}(vu) = \min\{I_{\underline{SB}_1}(vu), I_{\underline{SB}_2}(vu)\}, \\ F_{\overline{SB}_1 \cup \overline{SB}_2}(vu) &= \min\{F_{\overline{SB}_1}(vu), F_{\overline{SB}_2}(vu)\}, F_{\underline{SB}_1 \cup \underline{SB}_2}(vu) = \min\{F_{\underline{SB}_1}(vu), F_{\underline{SB}_2}(vu)\}. \end{aligned}$$

Example 5. Let $V = \{v_1, v_2, v_3, v_4\}$ be a set of universes, and $\mathbb{M} = \{e_1, e_2, e_3\}$ a set of parameters. Then, a neutrosophic soft relation over $V \times \mathbb{M}$ can be written as in Table 7.

Table 7. Neutrosophic soft relation Q .

Q	v_1	v_2	v_3	v_4
e_1	(0.5, 0.4, 0.3)	(0.7, 0.6, 0.5)	(0.7, 0.6, 0.4)	(0.5, 0.7, 0.4)
e_2	(0.3, 0.5, 0.6)	(0.4, 0.5, 0.1)	(0.3, 0.6, 0.5)	(0.4, 0.8, 0.2)
e_3	(0.7, 0.5, 0.8)	(0.2, 0.3, 0.8)	(0.7, 0.3, 0.5)	(0.6, 0.4, 0.3)

Let $A_1 = \{(e_1, 0.5, 0.7, 0.8), (e_2, 0.7, 0.5, 0.3), (e_3, 0.4, 0.5, 0.3)\}$, and $A_2 = \{(e_1, 0.6, 0.3, 0.5), (e_2, 0.5, 0.8, 0.2), (e_3, 0.5, 0.7, 0.2)\}$ are two neutrosophic sets on \mathbb{M} , Then, $Q(A_1) = (\underline{Q}(A_1), \overline{Q}(A_1))$ and $Q(A_2) = (\underline{Q}(A_2), \overline{Q}(A_2))$ are NSRSs, where

$$\begin{aligned} \underline{Q}(A_1) &= \{(v_1, 0.5, 0.6, 0.5), (v_2, 0.5, 0.5, 0.7), (v_3, 0.5, 0.5, 0.7), (v_4, 0.4, 0.5, 0.5)\}, \\ \overline{Q}(A_1) &= \{(v_1, 0.5, 0.5, 0.6), (v_2, 0.5, 0.5, 0.3), (v_3, 0.5, 0.5, 0.5), (v_4, 0.5, 0.5, 0.3)\}, \\ \underline{Q}(A_2) &= \{(v_1, 0.6, 0.5, 0.5), (v_2, 0.5, 0.7, 0.5), (v_3, 0.5, 0.7, 0.5), (v_4, 0.5, 0.6, 0.5)\}, \\ \overline{Q}(A_2) &= \{(v_1, 0.5, 0.4, 0.5), (v_2, 0.6, 0.6, 0.2), (v_3, 0.6, 0.6, 0.5), (v_4, 0.5, 0.7, 0.2)\}. \end{aligned}$$

Let $E = \{v_1v_2, v_1v_4, v_2v_2, v_2v_3, v_3v_3, v_3v_4\} \subseteq V \times V$, and $L = \{e_1e_2, e_1e_3, e_2e_3\} \subset \mathbb{M}$. Then, a neutrosophic soft relation on E can be written as in Table 8.

Table 8. Neutrosophic soft relation S.

S	v_1v_2	v_1v_4	v_2v_2	v_2v_3	v_3v_3	v_3v_4
e_1e_2	(0.3, 0.4, 0.1)	(0.4, 0.4, 0.2)	(0.4, 0.5, 0.1)	(0.3, 0.5, 0.4)	(0.3, 0.4, 0.4)	(0.4, 0.5, 0.2)
e_1e_3	(0.2, 0.3, 0.3)	(0.4, 0.3, 0.2)	(0.2, 0.3, 0.5)	(0.4, 0.3, 0.3)	(0.5, 0.3, 0.3)	(0.5, 0.4, 0.3)
e_2e_3	(0.2, 0.3, 0.5)	(0.3, 0.3, 0.3)	(0.2, 0.3, 0.1)	(0.4, 0.3, 0.1)	(0.3, 0.3, 0.5)	(0.3, 0.4, 0.3)

Let $B_1 = \{(e_1e_2, 0.5, 0.4, 0.5), (e_1e_3, 0.3, 0.4, 0.5), (e_2e_3, 0.4, 0.4, 0.3)\}$, and $B_2 = \{(e_1e_2, 0.5, 0.3, 0.2), (e_1e_3, 0.4, 0.3, 0.3), (e_2e_3, 0.4, 0.6, 0.2)\}$ are two neutrosophic sets on L , Then, $S(B_1) = (\underline{S}(B_1), \overline{S}(B_1))$ and $S(B_2) = (\underline{S}(B_2), \overline{S}(B_2))$ are NSRRs, where

$$\begin{aligned} \underline{S}(B_1) &= \{(v_1v_2, 0.3, 0.4, 0.3), (v_1v_4, 0.3, 0.4, 0.4), (v_2v_2, 0.4, 0.4, 0.4), (v_2v_3, 0.3, 0.4, 0.4), \\ &\quad (v_3v_3, 0.3, 0.4, 0.5), (v_3v_4, 0.3, 0.4, 0.5)\}, \\ \overline{S}(B_1) &= \{(v_1v_2, 0.3, 0.4, 0.5), (v_1v_4, 0.4, 0.4, 0.3), (v_2v_2, 0.4, 0.4, 0.3), (v_2v_3, 0.4, 0.4, 0.3), \\ &\quad (v_3v_3, 0.3, 0.4, 0.5), (v_3v_4, 0.4, 0.4, 0.3)\}; \\ \underline{S}(B_2) &= \{(v_1v_2, 0.4, 0.6, 0.2), (v_1v_4, 0.4, 0.6, 0.3), (v_2v_2, 0.4, 0.6, 0.2), (v_2v_3, 0.4, 0.6, 0.3), \\ &\quad (v_3v_3, 0.4, 0.6, 0.3), (v_3v_4, 0.4, 0.6, 0.3)\}, \\ \overline{S}(B_2) &= \{(v_1v_2, 0.3, 0.3, 0.2), (v_1v_4, 0.4, 0.3, 0.2), (v_2v_2, 0.4, 0.3, 0.2), (v_2v_3, 0.4, 0.3, 0.2), \\ &\quad (v_3v_3, 0.4, 0.3, 0.3), (v_3v_4, 0.4, 0.4, 0.2)\}. \end{aligned}$$

Thus, $G_1 = (\underline{G}_1, \overline{G}_1)$ and $G_2 = (\underline{G}_2, \overline{G}_2)$ are NSRGs, where $\underline{G}_1 = (\underline{Q}(A_1), \underline{S}(B_1))$, $\overline{G}_1 = (\overline{Q}(A_1), \overline{S}(B_1))$ as shown in Figure 2.

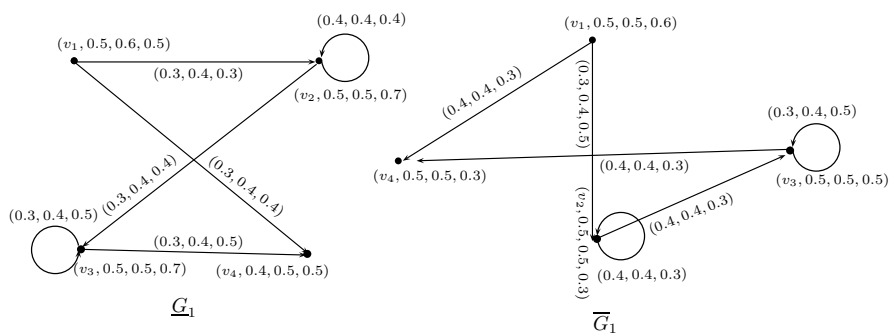

Figure 2. Neutrosophic soft rough graph $G_1 = (\underline{G}_1, \overline{G}_1)$

$G_2 \equiv (\underline{Q}(A_2), \underline{S}(B_2))$, $\overline{G}_2 \equiv (\overline{Q}(A_2), \overline{S}(B_2))$ as shown in Figure 3.

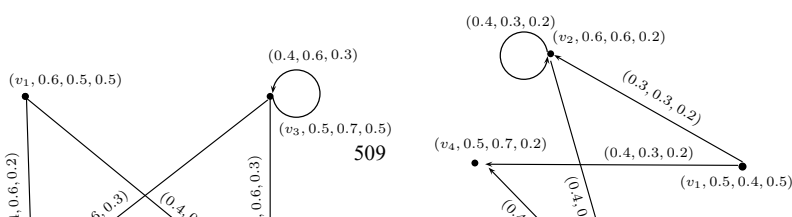

Figure 2: Neutrosophic soft rough graph $G_1 = (\underline{G}_1, \overline{G}_1)$

$\underline{G}_2 = (\underline{Q}(A_2), \underline{S}(B_2))$, $\overline{G}_2 = (\overline{Q}(A_2), \overline{S}(B_2))$ as shown in Figure 3.

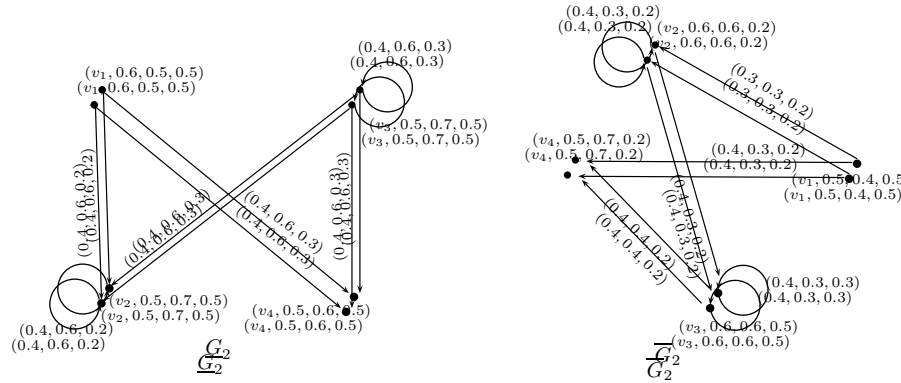

Figure 3: Neutrosophic soft rough graph $G_2 = (\underline{G}_2, \overline{G}_2)$

The union of $G_1 = (\underline{G}_1, \overline{G}_1)$ and $G_2 = (\underline{G}_2, \overline{G}_2)$ is NSRGG $G = G_1 \cup G_2 = (\underline{G}_1 \cup \underline{G}_2, \overline{G}_1 \cup \overline{G}_2)$ as shown in Figure 4.

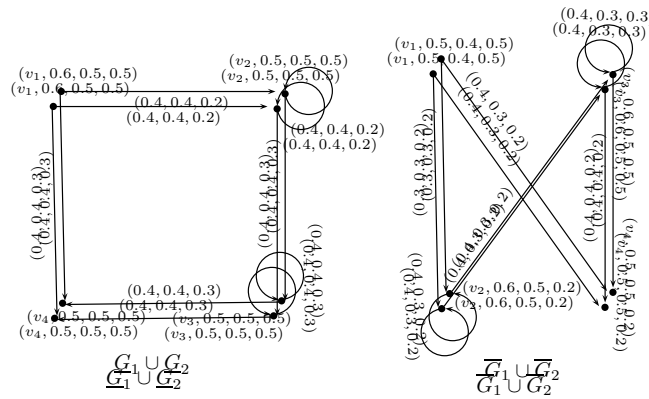

Figure 4: Neutrosophic soft rough graph $G_1 \cup G_2 = (\underline{G}_1 \cup \underline{G}_2, \overline{G}_1 \cup \overline{G}_2)$

Definition 2.6. Let $G_1 = (\underline{G}_1, \overline{G}_1)$ and $G_2 = (\underline{G}_2, \overline{G}_2)$ be two NSRGGs on V . The intersection of G_1 and G_2 is a neutrosophic soft rough graph $G = G_1 \cap G_2 = (\underline{G}_1 \cap \underline{G}_2, \overline{G}_1 \cap \overline{G}_2)$ where $\underline{G}_1 \cap \underline{G}_2 = (\underline{Q}(A_1 \cap A_2), \underline{S}(B_1 \cap B_2))$ and $\overline{G}_1 \cap \overline{G}_2 = (\overline{Q}(A_1 \cap A_2), \overline{S}(B_1 \cap B_2))$ are neutrosophic graphs, respectively, such that

(i) $\forall v \in QA_1$ but $v \notin QA_2$.

$$\begin{aligned} T_{\overline{Q}A_1 \cap \overline{Q}A_2}(v) &= T_{\overline{Q}A_1}(v), T_{QA_1 \cap QA_2}(v) = T_{QA_1}(v), \\ I_{\overline{Q}A_1 \cap \overline{Q}A_2}(v) &= I_{\overline{Q}A_1}(v), I_{QA_1 \cap QA_2}(v) = I_{QA_1}(v), \\ F_{\overline{Q}A_1 \cap \overline{Q}A_2}(v) &= F_{\overline{Q}A_1}(v), F_{QA_1 \cap QA_2}(v) = F_{QA_1}(v). \end{aligned}$$

(ii) $\forall v \notin QA_1$ but $v \in QA_2$.

$$\begin{aligned} T_{\overline{Q}A_1 \cap \overline{Q}A_2}(v) &= T_{\overline{Q}A_2}(v), T_{QA_1 \cap QA_2}(v) = T_{QA_2}(v), \\ I_{\overline{Q}A_1 \cap \overline{Q}A_2}(v) &= I_{\overline{Q}A_2}(v), I_{QA_1 \cap QA_2}(v) = I_{QA_2}(v), \\ F_{\overline{Q}A_1 \cap \overline{Q}A_2}(v) &= F_{\overline{Q}A_2}(v), F_{QA_1 \cap QA_2}(v) = F_{QA_2}(v). \end{aligned}$$

(iii) $\forall v \in QA_1 \cap QA_2$

$$\begin{aligned} T_{\overline{QA_1} \cap \overline{QA_2}}(v) &= \min\{T_{\overline{QA_1}}(v), T_{\overline{QA_2}}(v)\}, T_{\underline{QA_1} \cap \underline{QA_2}}(v) = \min\{T_{\underline{QA_1}}(v), T_{\underline{QA_2}}(v)\}, \\ I_{\overline{QA_1} \cap \overline{QA_2}}(v) &= \max\{I_{\overline{QA_1}}(v), I_{\overline{QA_2}}(v)\}, I_{\underline{QA_1} \cap \underline{QA_2}}(v) = \max\{I_{\underline{QA_1}}(v), I_{\underline{QA_2}}(v)\}, \\ F_{\overline{QA_1} \cap \overline{QA_2}}(v) &= \max\{F_{\overline{QA_1}}(v), F_{\overline{QA_2}}(v)\}, F_{\underline{QA_1} \cap \underline{QA_2}}(v) = \max\{F_{\underline{QA_1}}(v), F_{\underline{QA_2}}(v)\}. \end{aligned}$$

(iv) $\forall vu \in SB_1$ but $vu \notin SB_2$.

$$\begin{aligned} T_{\overline{SB_1} \cap \overline{SB_2}}(vu) &= T_{\overline{SB_1}}(vu), T_{\underline{SB_1} \cap \underline{SB_2}}(vu) = T_{\underline{SB_1}}(vu), \\ I_{\overline{SB_1} \cap \overline{SB_2}}(vu) &= I_{\overline{SB_1}}(vu), I_{\underline{SB_1} \cap \underline{SB_2}}(vu) = I_{\underline{SB_1}}(vu), \\ F_{\overline{SB_1} \cap \overline{SB_2}}(vu) &= F_{\overline{SB_1}}(vu), F_{\underline{SB_1} \cap \underline{SB_2}}(vu) = F_{\underline{SB_1}}(vu). \end{aligned}$$

(v) $\forall vu \notin SB_1$ but $vu \in SB_2$

$$\begin{aligned} T_{\overline{SB_1} \cap \overline{SB_2}}(vu) &= T_{\overline{SB_2}}(vu), T_{\underline{SB_1} \cap \underline{SB_2}}(vu) = T_{\underline{SB_2}}(vu), \\ I_{\overline{SB_1} \cap \overline{SB_2}}(vu) &= I_{\overline{SB_2}}(vu), I_{\underline{SB_1} \cap \underline{SB_2}}(vu) = I_{\underline{SB_2}}(vu), \\ F_{\overline{SB_1} \cap \overline{SB_2}}(vu) &= F_{\overline{SB_2}}(vu), F_{\underline{SB_1} \cap \underline{SB_2}}(vu) = F_{\underline{SB_2}}(vu). \end{aligned}$$

(vi) $\forall vu \in SB_1 \cap SB_2$

$$\begin{aligned} T_{\overline{SB_1} \cap \overline{SB_2}}(vu) &= \min\{T_{\overline{SB_1}}(vu), T_{\overline{SB_2}}(vu)\}, T_{\underline{SB_1} \cap \underline{SB_2}}(vu) = \min\{T_{\underline{SB_1}}(vu), T_{\underline{SB_2}}(vu)\}, \\ I_{\overline{SB_1} \cap \overline{SB_2}}(vu) &= \max\{I_{\overline{SB_1}}(vu), I_{\overline{SB_2}}(vu)\}, I_{\underline{SB_1} \cap \underline{SB_2}}(vu) = \max\{I_{\underline{SB_1}}(vu), I_{\underline{SB_2}}(vu)\}, \\ F_{\overline{SB_1} \cap \overline{SB_2}}(vu) &= \max\{F_{\overline{SB_1}}(vu), F_{\overline{SB_2}}(vu)\}, F_{\underline{SB_1} \cap \underline{SB_2}}(vu) = \max\{F_{\underline{SB_1}}(vu), F_{\underline{SB_2}}(vu)\}. \end{aligned}$$

Definition 7. Let $G_1 = (\underline{G}_1, \overline{G}_1)$ and $G_2 = (\underline{G}_2, \overline{G}_2)$ be two neutrosophic soft rough graphs on V . The join of G_1 and G_2 is a neutrosophic soft rough graph $G = G_1 + G_2 = (\underline{G}_1 + \underline{G}_2, \overline{G}_1 + \overline{G}_2)$, where $\underline{G}_1 + \underline{G}_2 = (\underline{QA_1} + \underline{QA_2}, \underline{SB_1} + \underline{SB_2})$ and $\overline{G}_1 + \overline{G}_2 = (\overline{QA_1} + \overline{QA_2}, \overline{SB_1} + \overline{SB_2})$ are neutrosophic graph, respectively, such that

(i) $\forall v \in QA_1$ but $v \notin QA_2$.

$$\begin{aligned} T_{\overline{QA_1} + \overline{QA_2}}(v) &= T_{\overline{QA_1}}(v), T_{\underline{QA_1} + \underline{QA_2}}(v) = T_{\underline{QA_1}}(v), \\ I_{\overline{QA_1} + \overline{QA_2}}(v) &= I_{\overline{QA_1}}(v), I_{\underline{QA_1} + \underline{QA_2}}(v) = I_{\underline{QA_1}}(v), \\ F_{\overline{QA_1} + \overline{QA_2}}(v) &= F_{\overline{QA_1}}(v), F_{\underline{QA_1} + \underline{QA_2}}(v) = F_{\underline{QA_1}}(v). \end{aligned}$$

(ii) $\forall v \notin QA_1$ but $v \in QA_2$.

$$\begin{aligned} T_{\overline{QA_1} + \overline{QA_2}}(v) &= T_{\overline{QA_2}}(v), T_{\underline{QA_1} + \underline{QA_2}}(v) = T_{\underline{QA_2}}(v), \\ I_{\overline{QA_1} + \overline{QA_2}}(v) &= I_{\overline{QA_2}}(v), I_{\underline{QA_1} + \underline{QA_2}}(v) = I_{\underline{QA_2}}(v), \\ F_{\overline{QA_1} + \overline{QA_2}}(v) &= F_{\overline{QA_2}}(v), F_{\underline{QA_1} + \underline{QA_2}}(v) = F_{\underline{QA_2}}(v). \end{aligned}$$

(iii) $\forall v \in QA_1 \cap QA_2$

$$\begin{aligned} T_{\overline{QA_1} + \overline{QA_2}}(v) &= \max\{T_{\overline{QA_1}}(v), T_{\overline{QA_2}}(v)\}, T_{\underline{QA_1} + \underline{QA_2}}(v) = \max\{T_{\underline{QA_1}}(v), T_{\underline{QA_2}}(v)\}, \\ I_{\overline{QA_1} + \overline{QA_2}}(v) &= \min\{I_{\overline{QA_1}}(v), I_{\overline{QA_2}}(v)\}, I_{\underline{QA_1} + \underline{QA_2}}(v) = \min\{I_{\underline{QA_1}}(v), I_{\underline{QA_2}}(v)\}, \\ F_{\overline{QA_1} + \overline{QA_2}}(v) &= \min\{F_{\overline{QA_1}}(v), F_{\overline{QA_2}}(v)\}, F_{\underline{QA_1} + \underline{QA_2}}(v) = \min\{F_{\underline{QA_1}}(v), F_{\underline{QA_2}}(v)\}. \end{aligned}$$

(iv) $\forall vu \in SB_1$ but $vu \notin SB_2$.

$$\begin{aligned} T_{\overline{SB_1+\overline{SB_2}}}(vu) &= T_{\overline{SB_1}}(vu), T_{\underline{SB_1+\underline{SB_2}}}(vu) = T_{\underline{SB_1}}(vu), \\ I_{\overline{SB_1+\overline{SB_2}}}(vu) &= I_{\overline{SB_1}}(vu), I_{\underline{SB_1+\underline{SB_2}}}(vu) = I_{\underline{SB_1}}(vu), \\ F_{\overline{SB_1+\overline{SB_2}}}(vu) &= F_{\overline{SB_1}}(vu), F_{\underline{SB_1+\underline{SB_2}}}(vu) = F_{\underline{SB_1}}(vu). \end{aligned}$$

(v) $\forall vu \notin SB_1$ but $vu \in SB_2$

$$\begin{aligned} T_{\overline{SB_1+\overline{SB_2}}}(vu) &= T_{\overline{SB_2}}(vu), T_{\underline{SB_1+\underline{SB_2}}}(vu) = T_{\underline{SB_2}}(vu), \\ I_{\overline{SB_1+\overline{SB_2}}}(vu) &= I_{\overline{SB_2}}(vu), I_{\underline{SB_1+\underline{SB_2}}}(vu) = I_{\underline{SB_2}}(vu), \\ F_{\overline{SB_1+\overline{SB_2}}}(vu) &= F_{\overline{SB_2}}(vu), F_{\underline{SB_1+\underline{SB_2}}}(vu) = F_{\underline{SB_2}}(vu). \end{aligned}$$

(vi) $\forall vu \in SB_1 \cap \underline{SB_2}$

$$\begin{aligned} T_{\overline{SB_1+\overline{SB_2}}}(vu) &= \max\{T_{\overline{SB_1}}(vu), T_{\overline{SB_2}}(vu)\}, T_{\underline{SB_1+\underline{SB_2}}}(vu) = \max\{T_{\underline{SB_1}}(vu), T_{\underline{SB_2}}(vu)\}, \\ I_{\overline{SB_1+\overline{SB_2}}}(vu) &= \min\{I_{\overline{SB_1}}(vu), I_{\overline{SB_2}}(vu)\}, I_{\underline{SB_1+\underline{SB_2}}}(vu) = \min\{I_{\underline{SB_1}}(vu), I_{\underline{SB_2}}(vu)\}, \\ F_{\overline{SB_1+\overline{SB_2}}}(vu) &= \min\{F_{\overline{SB_1}}(vu), F_{\overline{SB_2}}(vu)\}, F_{\underline{SB_1+\underline{SB_2}}}(vu) = \min\{F_{\underline{SB_1}}(vu), F_{\underline{SB_2}}(vu)\}. \end{aligned}$$

(vii) $\forall vu \in \tilde{E}$, where \tilde{E} is the set of edges joining vertices of QA_1 and QA_2 .

$$\begin{aligned} T_{\overline{SB_1+\overline{SB_2}}}(vu) &= \min\{T_{\overline{QA_1}}(v), T_{\overline{QA_2}}(u)\}, T_{\underline{SB_1+\underline{SB_2}}}(vu) = \min\{T_{\underline{QA_1}}(v), T_{\underline{QA_2}}(u)\}, \\ I_{\overline{SB_1+\overline{SB_2}}}(vu) &= \max\{I_{\overline{QA_1}}(v), I_{\overline{QA_2}}(u)\}, I_{\underline{SB_1+\underline{SB_2}}}(vu) = \max\{I_{\underline{QA_1}}(v), I_{\underline{QA_2}}(u)\}, \\ F_{\overline{SB_1+\overline{SB_2}}}(vu) &= \max\{F_{\overline{QA_1}}(v), F_{\overline{QA_2}}(u)\}, F_{\underline{SB_1+\underline{SB_2}}}(vu) = \max\{F_{\underline{QA_1}}(v), F_{\underline{QA_2}}(u)\}. \end{aligned}$$

Definition 8. The Cartesian product of G_1 and G_2 is a $G = G_1 \times G_2 = (\underline{G_1} \times \underline{G_2}, \overline{G_1} \times \overline{G_2})$, where $\underline{G_1} \times \underline{G_2} = (\underline{QA_1} \times \underline{QA_2}, \underline{SB_1} \times \underline{SB_2})$ and $\overline{G_1} \times \overline{G_2} = (\overline{QA_1} \times \overline{QA_2}, \overline{SB_1} \times \overline{SB_2})$ are neutrosophic digraph, such that

(i) $\forall (v_1, v_2) \in QA_1 \times QA_2$.

$$\begin{aligned} T_{(\overline{QA_1} \times \overline{QA_2})}(v_1, v_2) &= \min\{T_{\overline{QA_1}}(v_1), T_{\overline{QA_2}}(v_2)\}, T_{(\underline{QA_1} \times \underline{QA_2})}(v_1, v_2) = \min\{T_{\underline{QA_1}}(v_1), T_{\underline{QA_2}}(v_2)\}, \\ I_{(\overline{QA_1} \times \overline{QA_2})}(v_1, v_2) &= \max\{I_{\overline{QA_1}}(v_1), I_{\overline{QA_2}}(v_2)\}, I_{(\underline{QA_1} \times \underline{QA_2})}(v_1, v_2) = \max\{I_{\underline{QA_1}}(v_1), I_{\underline{QA_2}}(v_2)\}, \\ F_{(\overline{QA_1} \times \overline{QA_2})}(v_1, v_2) &= \max\{F_{\overline{QA_1}}(v_1), F_{\overline{QA_2}}(v_2)\}, F_{(\underline{QA_1} \times \underline{QA_2})}(v_1, v_2) = \max\{F_{\underline{QA_1}}(v_1), F_{\underline{QA_2}}(v_2)\}. \end{aligned}$$

(ii) $\forall v_1 v_2 \in SB_2, v \in QA_1$.

$$\begin{aligned} T_{(\overline{SB_1} \times \overline{SB_2})}((v, v_1)(v, v_2)) &= \min\{T_{\overline{QA_1}}(v), T_{\overline{SB_2}}(v_1 v_2)\}, \\ T_{(\underline{SB_1} \times \underline{SB_2})}((v, v_1)(v, v_2)) &= \min\{T_{\underline{QA_1}}(v), T_{\underline{SB_2}}(v_1 v_2)\}, \\ I_{(\overline{SB_1} \times \overline{SB_2})}((v, v_1)(v, v_2)) &= \max\{I_{\overline{QA_1}}(v), I_{\overline{SB_2}}(v_1 v_2)\}, \\ I_{(\underline{SB_1} \times \underline{SB_2})}((v, v_1)(v, v_2)) &= \max\{I_{\underline{QA_1}}(v), I_{\underline{SB_2}}(v_1 v_2)\}, \\ F_{(\overline{SB_1} \times \overline{SB_2})}((v, v_1)(v, v_2)) &= \max\{F_{\overline{QA_1}}(v), F_{\overline{SB_2}}(v_1 v_2)\}, \\ F_{(\underline{SB_1} \times \underline{SB_2})}((v, v_1)(v, v_2)) &= \max\{F_{\underline{QA_1}}(v), F_{\underline{SB_2}}(v_1 v_2)\}. \end{aligned}$$

(iii) $\forall v_1 v_2 \in SB_1, v \in QA_2$.

$$\begin{aligned} T_{(\underline{SB}_1 \times \underline{SB}_2)}((v_1, v)(v_2, v)) &= \min\{T_{\underline{SB}_1}(v_1 v_2), T_{\underline{QA}_2}(v)\}, \\ T_{(\overline{SB}_1 \times \overline{SB}_2)}((v_1, v)(v_2, v)) &= \min\{T_{\overline{SB}_1}(v_1 v_2), T_{\overline{QA}_2}(v)\}, \\ I_{(\overline{SB}_1 \times \overline{SB}_2)}((v_1, v)(v_2, v)) &= \max\{I_{\overline{SB}_1}(v_1 v_2), I_{\overline{QA}_2}(v)\}, \\ I_{(\underline{SB}_1 \times \underline{SB}_2)}((v_1, v)(v_2, v)) &= \max\{I_{\underline{SB}_1}(v_1 v_2), I_{\underline{QA}_2}(v)\}, \\ F_{(\overline{SB}_1 \times \overline{SB}_2)}((v_1, v)(v_2, v)) &= \max\{F_{\overline{SB}_1}(v_1 v_2), F_{\overline{QA}_2}(v)\}, \\ F_{(\underline{SB}_1 \times \underline{SB}_2)}((v_1, v)(v_2, v)) &= \max\{F_{\underline{SB}_1}(v_1 v_2), F_{\underline{QA}_2}(v)\}. \end{aligned}$$

Definition 9. The cross product of G_1 and G_2 is a neutrosophic soft rough graph $G = G_1 \odot G_2 = (\underline{G}_1 \odot \underline{G}_2, \overline{G}_1 \odot \overline{G}_2)$, where $\underline{G}_1 \odot \underline{G}_2 = (\underline{QA}_1 \odot \underline{QA}_2, \underline{SB}_1 \odot \underline{SB}_2)$ and $\overline{G}_1 \odot \overline{G}_2 = (\overline{QA}_1 \odot \overline{QA}_2, \overline{SB}_1 \odot \overline{SB}_2)$ are neutrosophic graphs, respectively, such that

(i) $\forall (v_1, v_2) \in QA_1 \times QA_2$.

$$\begin{aligned} T_{(\overline{QA}_1 \odot \overline{QA}_2)}(v_1, v_2) &= \min\{T_{\overline{QA}_1}(v_1), T_{\overline{QA}_2}(v_1)\}, T_{(\underline{QA}_1 \odot \underline{QA}_2)}(v_1, v_2) = \min\{T_{\underline{QA}_1}(v_1), T_{\underline{QA}_2}(v_1)\}, \\ I_{(\overline{QA}_1 \odot \overline{QA}_2)}(v_1, v_2) &= \max\{I_{\overline{QA}_1}(v_1), I_{\overline{QA}_2}(v_1)\}, I_{(\underline{QA}_1 \odot \underline{QA}_2)}(v_1, v_2) = \max\{I_{\underline{QA}_1}(v_1), I_{\underline{QA}_2}(v_1)\}, \\ F_{(\overline{QA}_1 \odot \overline{QA}_2)}(v_1, v_2) &= \max\{F_{\overline{QA}_1}(v_1), F_{\overline{QA}_2}(v_1)\}, F_{(\underline{QA}_1 \odot \underline{QA}_2)}(v_1, v_2) = \max\{F_{\underline{QA}_1}(v_1), F_{\underline{QA}_2}(v_1)\}. \end{aligned}$$

(ii) $\forall v_1 u_1 \in SB_1, v_2 u_2 \in SB_2$.

$$\begin{aligned} T_{(\overline{SB}_1 \odot \overline{SB}_2)}((v_1, v_2)(u_1, u_2)) &= \min\{T_{\overline{SB}_1}(v_1 u_1), T_{\overline{SB}_2}(v_1 u_2)\}, \\ T_{(\underline{SB}_1 \odot \underline{SB}_2)}((v_1, v_2)(u_1, u_2)) &= \min\{T_{\underline{SB}_1}(v_1 u_1), T_{\underline{SB}_2}(v_1 u_2)\}, \\ I_{(\overline{SB}_1 \odot \overline{SB}_2)}((v_1, v_2)(u_1, u_2)) &= \max\{I_{\overline{SB}_1}(v_1 u_1), I_{\overline{SB}_2}(v_1 u_2)\}, \\ I_{(\underline{SB}_1 \odot \underline{SB}_2)}((v_1, v_2)(u_1, u_2)) &= \max\{I_{\underline{SB}_1}(v_1 u_1), I_{\underline{SB}_2}(v_1 u_2)\}, \\ F_{(\overline{SB}_1 \odot \overline{SB}_2)}((v_1, v_2)(u_1, u_2)) &= \max\{F_{\overline{SB}_1}(v_1 u_1), F_{\overline{SB}_2}(v_1 u_2)\}, \\ F_{(\underline{SB}_1 \odot \underline{SB}_2)}((v_1, v_2)(u_1, u_2)) &= \max\{F_{\underline{SB}_1}(v_1 u_1), F_{\underline{SB}_2}(v_1 u_2)\}. \end{aligned}$$

Definition 10. The rejection of G_1 and G_2 is a neutrosophic soft rough graph $G = G_1 | G_2 = (\underline{G}_1 | \underline{G}_2, \overline{G}_1 | \overline{G}_2)$, where $\underline{G}_1 | \underline{G}_2 = (\underline{SA}_1 | \underline{SA}_2, \underline{SB}_1 | \underline{SB}_2)$ and $\overline{G}_1 | \overline{G}_2 = (\overline{SA}_1 | \overline{SA}_2, \overline{SB}_1 | \overline{SB}_2)$ are neutrosophic graphs such that

(i) $\forall (v_1, v_2) \in QA_1 \times QA_2$.

$$\begin{aligned} T_{(\overline{QA}_1 | \overline{QA}_2)}(v_1, v_2) &= \min\{T_{\overline{QA}_1}(v_1), T_{\overline{QA}_2}(v_2)\}, T_{(\underline{QA}_1 | \underline{QA}_2)}(v_1, v_2) = \min\{T_{\underline{QA}_1}(v_1), T_{\underline{QA}_2}(v_2)\}, \\ I_{(\overline{QA}_1 | \overline{QA}_2)}(v_1, v_2) &= \max\{I_{\overline{QA}_1}(v_1), I_{\overline{QA}_2}(v_2)\}, I_{(\underline{QA}_1 | \underline{QA}_2)}(v_1, v_2) = \max\{I_{\underline{QA}_1}(v_1), I_{\underline{QA}_2}(v_2)\}, \\ F_{(\overline{QA}_1 | \overline{QA}_2)}(v_1, v_2) &= \max\{F_{\overline{QA}_1}(v_1), F_{\overline{QA}_2}(v_2)\}, F_{(\underline{QA}_1 | \underline{QA}_2)}(v_1, v_2) = \max\{F_{\underline{QA}_1}(v_1), F_{\underline{QA}_2}(v_2)\}. \end{aligned}$$

(ii) $\forall v_2 u_2 \notin SB_2, v \in QA_1$.

$$\begin{aligned} T_{(\overline{SB}_1 | \overline{SB}_2)}((v, v_2)(v, u_2)) &= \min\{T_{\overline{QA}_1}(v), T_{\overline{QA}_2}(v_2), T_{\overline{QA}_2}(u_2)\}, \\ T_{(\underline{SB}_1 | \underline{SB}_2)}((v, v_2)(v, u_2)) &= \min\{T_{\underline{QA}_1}(v), T_{\underline{QA}_2}(v_2), T_{\underline{QA}_2}(u_2)\}, \\ I_{(\overline{SB}_1 | \overline{SB}_2)}((v, v_2)(v, u_2)) &= \max\{I_{\overline{QA}_1}(v), I_{\overline{QA}_2}(v_2), I_{\overline{QA}_2}(u_2)\}, \\ I_{(\underline{SB}_1 | \underline{SB}_2)}((v, v_2)(v, u_2)) &= \max\{I_{\underline{QA}_1}(v), I_{\underline{QA}_2}(v_2), I_{\underline{QA}_2}(u_2)\}, \\ F_{(\overline{SB}_1 | \overline{SB}_2)}((v, v_2)(v, u_2)) &= \max\{F_{\overline{QA}_1}(v), F_{\overline{QA}_2}(v_2), F_{\overline{QA}_2}(u_2)\}, \\ F_{(\underline{SB}_1 | \underline{SB}_2)}((v, v_2)(v, u_2)) &= \max\{F_{\underline{QA}_1}(v), F_{\underline{QA}_2}(v_2), F_{\underline{QA}_2}(u_2)\}. \end{aligned}$$

(iii) $\forall v_1 u_1 \notin SB_1, v \in QA_2,$

$$\begin{aligned}
 T_{(\underline{SB}_1|\underline{SB}_2)}((v_1, v)(u_1, v)) &= \min\{T_{\underline{QA}_1}(v_1), T_{\underline{QA}_1}(u_1), T_{\underline{QA}_2}(v)\}, \\
 I_{(\underline{SB}_1|\underline{SB}_2)}((v_1, v)(u_1, v)) &= \max\{I_{\underline{QA}_1}(v_1), I_{\underline{QA}_1}(u_1), I_{\underline{QA}_2}(v)\}, \\
 F_{(\underline{SB}_1|\underline{SB}_2)}((v_1, v)(u_1, v)) &= \max\{F_{\underline{QA}_1}(v_1), F_{\underline{QA}_1}(u_1), F_{\underline{QA}_2}(v)\}, \\
 T_{(\overline{SB}_1|\overline{SB}_2)}((v_1, v)(u_1, v)) &= \min\{T_{\overline{QA}_1}(v_1), T_{\overline{QA}_1}(u_1), T_{\overline{QA}_2}(v)\}, \\
 I_{(\overline{SB}_1|\overline{SB}_2)}((v_1, v)(u_1, v)) &= \max\{I_{\overline{QA}_1}(v_1), I_{\overline{QA}_1}(u_1), I_{\overline{QA}_2}(v)\}, \\
 F_{(\overline{SB}_1|\overline{SB}_2)}((v_1, v)(u_1, v)) &= \max\{F_{\overline{QA}_1}(v_1), F_{\overline{QA}_1}(u_1), F_{\overline{QA}_2}(v)\}.
 \end{aligned}$$

(iv) $\forall v_1 u_1 \notin \overline{SB}_1, v_2 u_2 \notin \overline{SB}_2, v_1 = u_1.$

$$\begin{aligned}
 T_{(\underline{SB}_1|\underline{SB}_2)}((v_1, v_2)(u_1, u_2)) &= \min\{T_{\underline{QA}_1}(v_1), T_{\underline{QA}_1}(u_1), T_{\underline{QA}_2}(v_2), T_{\underline{QA}_2}(u_2)\}, \\
 I_{(\underline{SB}_1|\underline{SB}_2)}((v_1, v_2)(u_1, u_2)) &= \max\{I_{\underline{QA}_1}(v_1), I_{\underline{QA}_1}(u_1), I_{\underline{QA}_2}(v_2), I_{\underline{QA}_2}(u_2)\}, \\
 F_{(\underline{SB}_1|\underline{SB}_2)}((v_1, v_2)(u_1, u_2)) &= \max\{F_{\underline{QA}_1}(v_1), F_{\underline{QA}_1}(u_1), F_{\underline{QA}_2}(v_2), F_{\underline{QA}_2}(u_2)\}, \\
 T_{(\overline{SB}_1|\overline{SB}_2)}((v_1, v_2)(u_1, u_2)) &= \min\{T_{\overline{QA}_1}(v_1), T_{\overline{QA}_1}(u_1), T_{\overline{QA}_2}(v_2), T_{\overline{QA}_2}(u_2)\}, \\
 I_{(\overline{SB}_1|\overline{SB}_2)}((v_1, v_2)(u_1, u_2)) &= \max\{I_{\overline{QA}_1}(v_1), I_{\overline{QA}_1}(u_1), I_{\overline{QA}_2}(v_2), I_{\overline{QA}_2}(u_2)\}, \\
 F_{(\overline{SB}_1|\overline{SB}_2)}((v_1, v_2)(u_1, u_2)) &= \max\{F_{\overline{QA}_1}(v_1), F_{\overline{QA}_1}(u_1), F_{\overline{QA}_2}(v_2), F_{\overline{QA}_2}(u_2)\},
 \end{aligned}$$

Example 6. Let $G_1 = (\underline{G}_1, \overline{G}_1)$ and $G_2 = (\underline{G}_2, \overline{G}_2)$ be two neutrosophic soft rough graphs on V , where $\underline{G}_1 = (\underline{QA}_1, \underline{SB}_1)$ and $\overline{G}_1 = (\overline{QA}_1, \overline{SB}_1)$ are neutrosophic graphs as shown in Figure 2 and $\underline{G}_2 = (\underline{QA}_2, \underline{SB}_2)$ and $\overline{G}_2 = (\overline{QA}_2, \overline{SB}_2)$ are neutrosophic graphs as shown in Figure 3. The Cartesian product of $G_1 = (\underline{G}_1, \overline{G}_1)$ and $G_2 = (\underline{G}_2, \overline{G}_2)$ is NSRG $G = G_1 \times G_2 = (\underline{G}_1 \times \underline{G}_2, \overline{G}_1 \times \overline{G}_2)$ as shown in Figure 5.

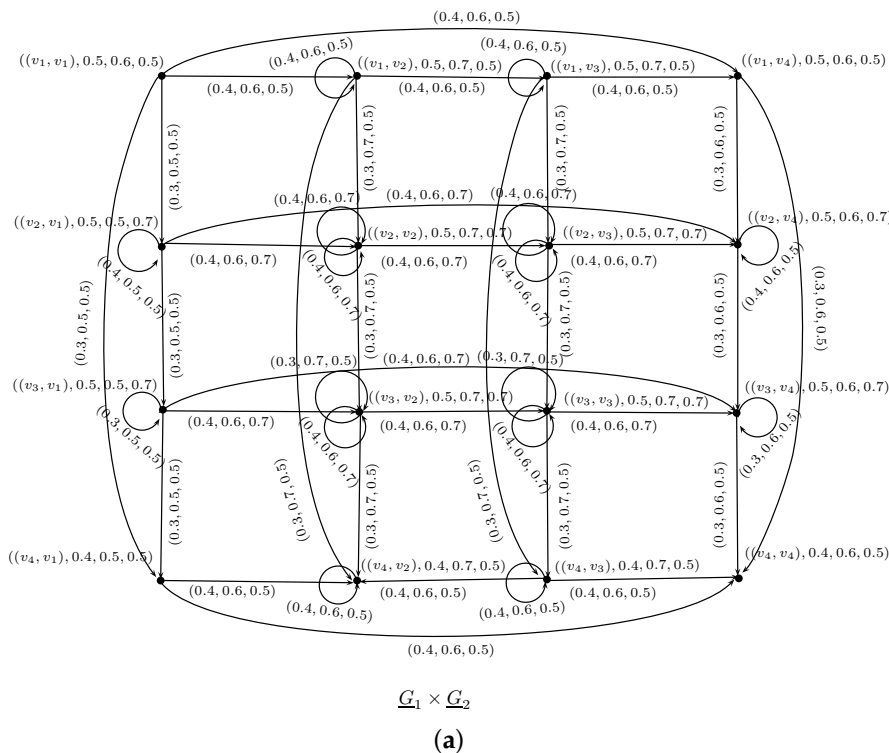
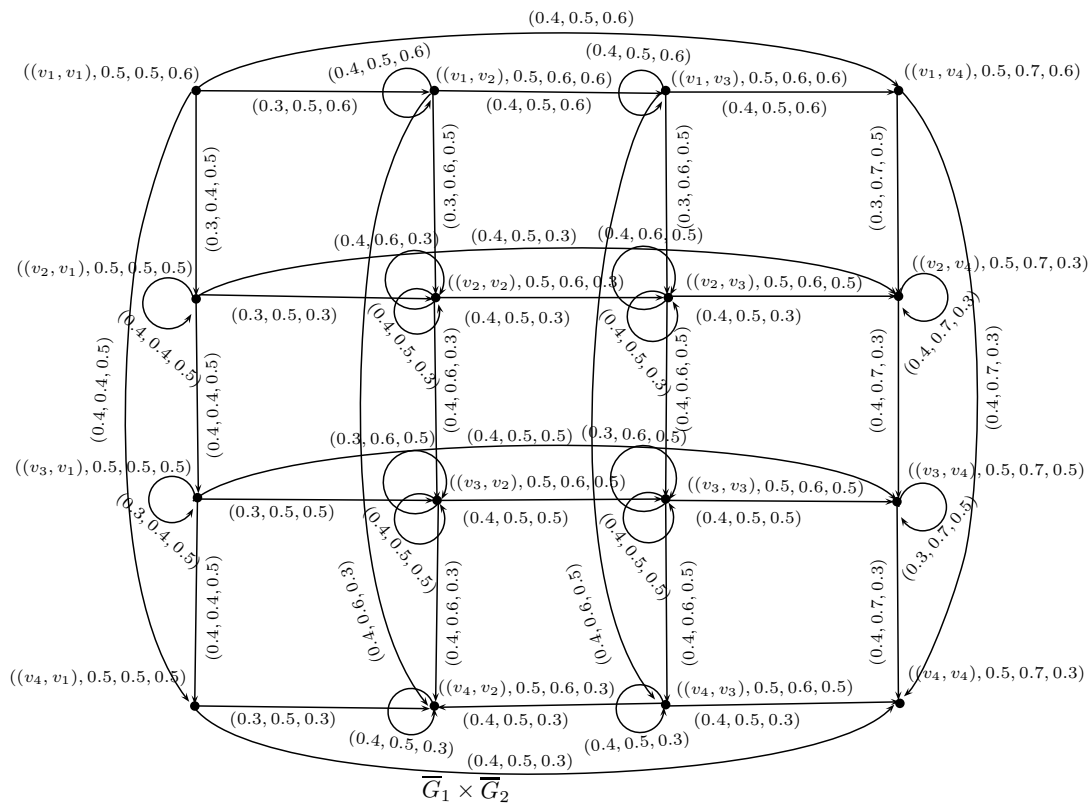

Figure 5. Cont.



(b)
Figure 5: Cartesian product of two neutrosophic soft rough graphs $G_1 \times G_2$

Figure 5. Cartesian product of two neutrosophic soft rough graphs $G_1 \times G_2$
Definition 2.11. The symmetric difference of G_1 and G_2 is a neutrosophic soft rough graph $G = G_1 \oplus G_2 = (\underline{G}_1 \oplus \underline{G}_2, \overline{G}_1 \oplus \overline{G}_2)$, where $\underline{G}_1 \oplus \underline{G}_2 = (\underline{QA}_1 \oplus \underline{QA}_2, \underline{SB}_1 \oplus \underline{SB}_2)$ and $\overline{G}_1 \oplus \overline{G}_2 = (\overline{QA}_1 \oplus \overline{QA}_2, \overline{SB}_1 \oplus \overline{SB}_2)$ are neutrosophic graphs, respectively, such that $G = \overline{G}_1 \oplus \overline{G}_2 = (\overline{G}_1 \oplus \overline{G}_2, \underline{G}_1 \oplus \underline{G}_2)$, where $\underline{G}_1 \oplus \underline{G}_2 = (\underline{QA}_1 \oplus \underline{QA}_2, \underline{SB}_1 \oplus \underline{SB}_2)$ and $\overline{G}_1 \oplus \overline{G}_2 = (\overline{QA}_1 \oplus \overline{QA}_2, \overline{SB}_1 \oplus \overline{SB}_2)$ are neutrosophic graphs, respectively, such that

$$(i) \quad \begin{aligned} T_{(\underline{QA}_1 \oplus \underline{QA}_2)}(v_1, v_2) &= \min\{T_{\underline{QA}_1}(v_1), T_{\underline{QA}_2}(v_2)\}, \quad T_{(\overline{QA}_1 \oplus \overline{QA}_2)}(v_1, v_2) = \min\{T_{\overline{QA}_1}(v_1), T_{\overline{QA}_2}(v_2)\}, \\ I_{(\underline{QA}_1 \oplus \underline{QA}_2)}(v_1, v_2) &= \max\{I_{\underline{QA}_1}(v_1), I_{\underline{QA}_2}(v_2)\}, \quad I_{(\overline{QA}_1 \oplus \overline{QA}_2)}(v_1, v_2) = \max\{I_{\overline{QA}_1}(v_1), I_{\overline{QA}_2}(v_2)\}, \\ F_{(\underline{QA}_1 \oplus \underline{QA}_2)}(v_1, v_2) &= \min\{F_{\underline{QA}_1}(v_1), F_{\underline{QA}_2}(v_2)\}, \quad F_{(\overline{QA}_1 \oplus \overline{QA}_2)}(v_1, v_2) = \min\{F_{\overline{QA}_1}(v_1), F_{\overline{QA}_2}(v_2)\}, \\ F_{(\underline{QA}_1 \oplus \underline{QA}_2)}(v_1, v_2) &= \max\{F_{\underline{QA}_1}(v_1), F_{\underline{QA}_2}(v_2)\}, \quad F_{(\overline{QA}_1 \oplus \overline{QA}_2)}(v_1, v_2) = \max\{F_{\overline{QA}_1}(v_1), F_{\overline{QA}_2}(v_2)\}, \\ I_{(\underline{QA}_1 \oplus \underline{QA}_2)}(v_1, v_2) &= \max\{I_{\underline{QA}_1}(v_1), I_{\underline{QA}_2}(v_2)\}, \quad I_{(\overline{QA}_1 \oplus \overline{QA}_2)}(v_1, v_2) = \max\{I_{\overline{QA}_1}(v_1), I_{\overline{QA}_2}(v_2)\}, \end{aligned}$$

$$(ii) \quad \forall v_1, v_2 \in \underline{SB}_2, v \in \underline{QA}_1, \quad \begin{aligned} T_{(\underline{SB}_1 \oplus \underline{SB}_2)}((v, v_1)(v, v_2)) &= \min\{T_{\underline{QA}_1}(v), T_{\underline{SB}_2}(v_1, v_2)\}, \\ T_{(\overline{SB}_1 \oplus \overline{SB}_2)}((v, v_1)(v, v_2)) &= \min\{T_{\overline{QA}_1}(v), T_{\overline{SB}_2}(v_1, v_2)\}, \\ I_{(\underline{SB}_1 \oplus \underline{SB}_2)}((v, v_1)(v, v_2)) &= \max\{I_{\underline{QA}_1}(v), I_{\underline{SB}_2}(v_1, v_2)\}, \\ I_{(\overline{SB}_1 \oplus \overline{SB}_2)}((v, v_1)(v, v_2)) &= \max\{I_{\overline{QA}_1}(v), I_{\overline{SB}_2}(v_1, v_2)\}, \\ F_{(\underline{SB}_1 \oplus \underline{SB}_2)}((v, v_1)(v, v_2)) &= \min\{F_{\underline{QA}_1}(v), F_{\underline{SB}_2}(v_1, v_2)\}, \\ F_{(\overline{SB}_1 \oplus \overline{SB}_2)}((v, v_1)(v, v_2)) &= \min\{F_{\overline{QA}_1}(v), F_{\overline{SB}_2}(v_1, v_2)\}, \\ F_{(\underline{SB}_1 \oplus \underline{SB}_2)}((v, v_1)(v, v_2)) &= \max\{F_{\underline{QA}_1}(v), F_{\underline{SB}_2}(v_1, v_2)\}, \\ F_{(\overline{SB}_1 \oplus \overline{SB}_2)}((v, v_1)(v, v_2)) &= \max\{F_{\overline{QA}_1}(v), F_{\overline{SB}_2}(v_1, v_2)\}. \end{aligned}$$

(iii) $\forall v_1 v_2 \in SB_1, v \in QA_2.$

(iii) $\forall v_1 v_2 \in SB_1, v \in QA_2.$

$$\begin{aligned} T_{(\overline{SB_1} \oplus \overline{SB_2})}((v_1, v)(v_2, v)) &= \min\{T_{\overline{SB_1}}(v_1 v_2), T_{\overline{QA_2}}(v)\}, \\ T_{(\overline{SB_1} \oplus \overline{SB_2})}((v_1, v)(v_2, v)) &\equiv \min\{T_{\overline{SB_1}}(v_1 v_2), T_{\overline{QA_2}}(v)\}, \\ I_{(\overline{SB_1} \oplus \overline{SB_2})}((v_1, v)(v_2, v)) &\equiv \max\{I_{\overline{SB_1}}(v_1 v_2), I_{\overline{QA_2}}(v)\}, \\ I_{(\overline{SB_1} \oplus \overline{SB_2})}((v_1, v)(v_2, v)) &\equiv \max\{I_{\overline{SB_1}}(v_1 v_2), I_{\overline{QA_2}}(v)\}, \\ F_{(\overline{SB_1} \oplus \overline{SB_2})}((v_1, v)(v_2, v)) &\equiv \max\{F_{\overline{SB_1}}(v_1 v_2), F_{\overline{QA_2}}(v)\}, \\ F_{(\overline{SB_1} \oplus \overline{SB_2})}((v_1, v)(v_2, v)) &\equiv \max\{F_{\overline{SB_1}}(v_1 v_2), F_{\overline{QA_2}}(v)\}. \\ F_{(SB_1 \oplus SB_2)}((v_1, v)(v_2, v)) &= \max\{F_{SB_1}(v_1 v_2), F_{QA_2}(v)\}. \end{aligned}$$

(iv) $\forall v_1 u_1 \notin SB_1, v_2 u_2 \in SB_2.$

(iv) $\forall v_1 u_1 \notin SB_1, v_2 u_2 \in SB_2.$

$$\begin{aligned} T_{(\overline{SB_1} \oplus \overline{SB_2})}((v_1, v_2)(u_1, u_2)) &= \min\{T_{\overline{SB_1}}(v_1 u_1), T_{\overline{QA_2}}(v_2), T_{\overline{QA_2}}(u_2)\}, \\ T_{(\overline{SB_1} \oplus \overline{SB_2})}((v_1, v_2)(u_1, u_2)) &= \min\{T_{\overline{SB_1}}(v_1 u_1), T_{\overline{QA_2}}(v_2), T_{\overline{QA_2}}(u_2)\}, \\ T_{(\overline{SB_1} \oplus \overline{SB_2})}((v_1, v_2)(u_1, u_2)) &= \min\{T_{\overline{SB_1}}(v_1 u_1), T_{\overline{QA_2}}(v_2), T_{\overline{QA_2}}(u_2)\}, \\ I_{(\overline{SB_1} \oplus \overline{SB_2})}((v_1, v_2)(u_1, u_2)) &= \max\{I_{\overline{SB_1}}(v_1 u_1), I_{\overline{QA_2}}(v_2), I_{\overline{QA_2}}(u_2)\}, \\ I_{(\overline{SB_1} \oplus \overline{SB_2})}((v_1, v_2)(u_1, u_2)) &= \max\{I_{\overline{SB_1}}(v_1 u_1), I_{\overline{QA_2}}(v_2), I_{\overline{QA_2}}(u_2)\}, \\ I_{(\overline{SB_1} \oplus \overline{SB_2})}((v_1, v_2)(u_1, u_2)) &= \max\{I_{\overline{SB_1}}(v_1 u_1), I_{\overline{QA_2}}(v_2), I_{\overline{QA_2}}(u_2)\}, \\ F_{(\overline{SB_1} \oplus \overline{SB_2})}((v_1, v_2)(u_1, u_2)) &= \max\{F_{\overline{SB_1}}(v_1 u_1), F_{\overline{QA_2}}(v_2), F_{\overline{QA_2}}(u_2)\}, \\ F_{(\overline{SB_1} \oplus \overline{SB_2})}((v_1, v_2)(u_1, u_2)) &= \max\{F_{\overline{SB_1}}(v_1 u_1), F_{\overline{QA_2}}(v_2), F_{\overline{QA_2}}(u_2)\}, \\ F_{(SB_1 \oplus SB_2)}((v_1, v_2)(u_1, u_2)) &= \max\{F_{SB_1}(v_1 u_1), F_{QA_2}(v_2), F_{QA_2}(u_2)\}. \end{aligned}$$

(v) $\forall v_1 u_1 \notin SB_1, v_2 u_2 \in SB_2.$

$$\begin{aligned} T_{(\overline{SB_1} \oplus \overline{SB_2})}((v_1, v_2)(u_1, u_2)) &= \min\{T_{\overline{QA_1}}(v_1), T_{\overline{QA_1}}(u_1), T_{\overline{SB_2}}(v_2 u_2)\}, \\ T_{(\overline{SB_1} \oplus \overline{SB_2})}((v_1, v_2)(u_1, u_2)) &= \min\{T_{\overline{QA_1}}(v_1), T_{\overline{QA_1}}(u_1), T_{\overline{SB_2}}(v_2 u_2)\}, \\ I_{(\overline{SB_1} \oplus \overline{SB_2})}((v_1, v_2)(u_1, u_2)) &= \max\{I_{\overline{QA_1}}(v_1), I_{\overline{QA_1}}(u_1), I_{\overline{SB_2}}(v_2 u_2)\}, \\ I_{(\overline{SB_1} \oplus \overline{SB_2})}((v_1, v_2)(u_1, u_2)) &= \max\{I_{\overline{QA_1}}(v_1), I_{\overline{QA_1}}(u_1), I_{\overline{SB_2}}(v_2 u_2)\}, \\ F_{(\overline{SB_1} \oplus \overline{SB_2})}((v_1, v_2)(u_1, u_2)) &= \max\{F_{\overline{QA_1}}(v_1), F_{\overline{QA_1}}(u_1), F_{\overline{SB_2}}(v_2 u_2)\}, \\ F_{(\overline{SB_1} \oplus \overline{SB_2})}((v_1, v_2)(u_1, u_2)) &= \max\{F_{\overline{QA_1}}(v_1), F_{\overline{QA_1}}(u_1), F_{\overline{SB_2}}(v_2 u_2)\}. \end{aligned}$$

Example 2.7. Let $G_1 \equiv (\underline{G}_1, \overline{G}_1)$ and $G_2 \equiv (\underline{G}_2, \overline{G}_2)$ be two neutrosophic soft rough graphs on V , where $\underline{G}_1 = (\underline{QA}_1, \underline{SB}_1)$ and $\overline{G}_1 = (\overline{QA}_1, \overline{SB}_1)$ are neutrosophic graphs as shown in Figure 6 and $\underline{G}_2 = (\underline{QA}_2, \underline{SB}_2)$ and $\overline{G}_2 = (\overline{QA}_2, \overline{SB}_2)$ are neutrosophic graphs as shown in Figure 7

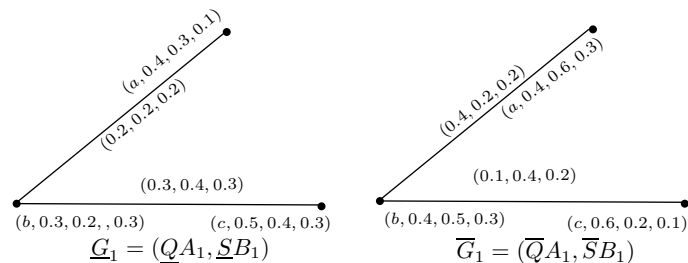

Figure 6: Neutrosophic soft rough graph $G_1 \equiv (\underline{G}_1, \overline{G}_1)$

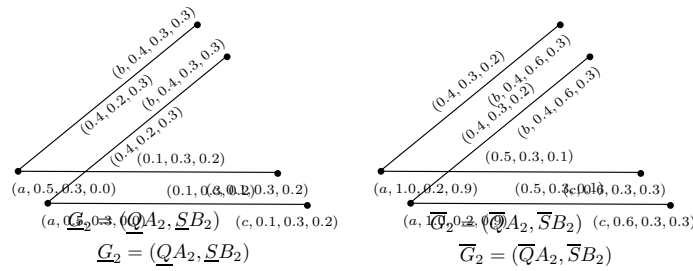

Figure 7: Neutrosophic soft rough graph $G_2 = (\underline{G}_2, \overline{G}_2)$

The symmetric difference of G_1 and G_2 is $G' = G_1 \oplus G_2 = (\underline{G} \oplus \underline{G}_2, \overline{G} \oplus \overline{G}_2)$, where $G_1 \oplus G_2 = (\underline{Q}A_1 \oplus \underline{Q}A_2, \overline{Q}A_1 \oplus \overline{Q}A_2)$ and $G_1 \oplus G_2 = (\underline{S}B_1 \oplus \underline{S}B_2, \overline{S}B_1 \oplus \overline{S}B_2)$ are neutrosophic graphs as shown in Figure 8.

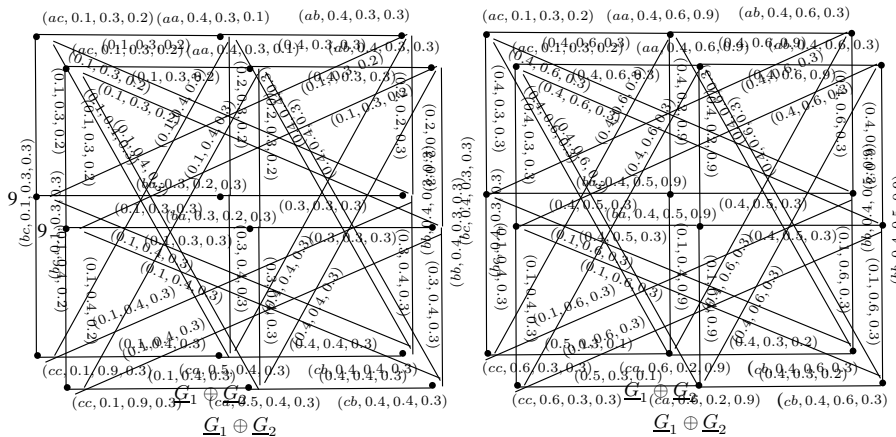

Figure 8: Neutrosophic soft rough graph $G_1 \oplus G_2 = (\underline{G}_1 \oplus \underline{G}_2, \overline{G}_1 \oplus \overline{G}_2)$

Definition 2.12. The lexicographic product of G_1 and G_2 is a neutrosophic soft rough graph $G = G_1 \circ G_2 = (\underline{Q}A_1 \circ \underline{Q}A_2, \overline{Q}A_1 \circ \overline{Q}A_2)$ and $G = G_1 \circ G_2 = (\underline{S}B_1 \circ \underline{S}B_2, \overline{S}B_1 \circ \overline{S}B_2)$ where $G_1 = (\underline{Q}A_1, \overline{Q}A_1)$ and $G_2 = (\underline{Q}A_2, \overline{Q}A_2)$ are neutrosophic graphs, respectively, such that

- (i) $\forall (v_1, v_2) \in \underline{Q}A_1 \times \underline{Q}A_2$,
 - $T_{(\underline{Q}A_1 \circ \underline{Q}A_2)}(v_1, v_2) = \min\{T_{\underline{Q}A_1}(v_1), T_{\underline{Q}A_2}(v_2)\}$,
 - $I_{(\underline{Q}A_1 \circ \underline{Q}A_2)}(v_1, v_2) = \max\{I_{\underline{Q}A_1}(v_1), I_{\underline{Q}A_2}(v_2)\}$,
 - $F_{(\underline{Q}A_1 \circ \underline{Q}A_2)}(v_1, v_2) = \max\{F_{\underline{Q}A_1}(v_1), F_{\underline{Q}A_2}(v_2)\}$,
- (ii) $\forall v_1, v_2 \in \underline{S}B_2, v \in \underline{Q}A_1$,
 - $T_{(\underline{S}B_1 \circ \underline{S}B_2)}((v, v_1)(v, v_2)) = \min\{T_{\underline{Q}A_1}(v), T_{\underline{S}B_2}(v_1 v_2)\}$,
 - $I_{(\underline{S}B_1 \circ \underline{S}B_2)}((v, v_1)(v, v_2)) = \max\{I_{\underline{Q}A_1}(v), I_{\underline{S}B_2}(v_1 v_2)\}$,
 - $F_{(\underline{S}B_1 \circ \underline{S}B_2)}((v, v_1)(v, v_2)) = \max\{F_{\underline{Q}A_1}(v), F_{\underline{S}B_2}(v_1 v_2)\}$,

(iii) $\forall v_1 u_1 \in SB_1, v_1 u_2 \in SB_2.$

$$\begin{aligned} T_{(\overline{SB}_1 \odot \overline{SB}_2)}((v_1, v_1)(u_1, u_2)) &= \min\{T_{\overline{SB}_1}(v_1 u_1), T_{\overline{SB}_2}(v_1 u_2)\}, \\ T_{(\underline{SB}_1 \odot \underline{SB}_2)}((v_1, v_1)(u_1, u_2)) &= \min\{T_{\underline{SB}_1}(v_1 u_1), T_{\underline{SB}_2}(v_1 u_2)\}, \\ I_{(\overline{SB}_1 \odot \overline{SB}_2)}((v_1, v_1)(u_1, u_2)) &= \max\{I_{\overline{SB}_1}(v_1 u_1), I_{\overline{SB}_2}(v_1 u_2)\}, \\ I_{(\underline{SB}_1 \odot \underline{SB}_2)}((v_1, v_1)(u_1, u_2)) &= \max\{I_{\underline{SB}_1}(v_1 u_1), I_{\underline{SB}_2}(v_1 u_2)\}, \\ F_{(\overline{SB}_1 \odot \overline{SB}_2)}((v_1, v_1)(u_1, u_2)) &= \max\{F_{\overline{SB}_1}(v_1 u_1), F_{\overline{SB}_2}(v_1 u_2)\}, \\ F_{(\underline{SB}_1 \odot \underline{SB}_2)}((v_1, v_1)(u_1, u_2)) &= \max\{F_{\underline{SB}_1}(v_1 u_1), F_{\underline{SB}_2}(v_1 u_2)\}. \end{aligned}$$

Definition 13. The strong product of G_1 and G_2 is a neutrosophic soft rough graph $G = G_1 \otimes G_2 = (G_{1*} \otimes G_{2*}, G_1^* \otimes G_2^*)$, where $G_{1*} \otimes G_{2*} = (\underline{QA}_1 \otimes \underline{QA}_2, \underline{SB}_1 \otimes \underline{SB}_2)$ and $G_1^* \otimes G_2^* = (\overline{QA}_1 \otimes \overline{QA}_2, \overline{SB}_1 \otimes \overline{SB}_2)$ are neutrosophic graphs, respectively, such that

(i) $\forall (v_1, v_2) \in QA_1 \times QA_2.$

$$\begin{aligned} T_{(\overline{QA}_1 \otimes \overline{QA}_2)}(v_1, v_2) &= \min\{T_{\overline{QA}_1}(v_1), T_{\overline{QA}_2}(v_2)\}, \quad T_{(\underline{QA}_1 \otimes \underline{QA}_2)}(v_1, v_2) = \min\{T_{\underline{QA}_1}(v_1), T_{\underline{QA}_2}(v_2)\}, \\ I_{(\overline{QA}_1 \otimes \overline{QA}_2)}(v_1, v_2) &= \max\{I_{\overline{QA}_1}(v_1), I_{\overline{QA}_2}(v_2)\}, \quad I_{(\underline{QA}_1 \otimes \underline{QA}_2)}(v_1, v_2) = \max\{I_{\underline{QA}_1}(v_1), I_{\underline{QA}_2}(v_2)\}, \\ F_{(\overline{QA}_1 \otimes \overline{QA}_2)}(v_1, v_2) &= \max\{F_{\overline{QA}_1}(v_1), F_{\overline{QA}_2}(v_2)\}, \quad F_{(\underline{QA}_1 \otimes \underline{QA}_2)}(v_1, v_2) = \max\{F_{\underline{QA}_1}(v_1), F_{\underline{QA}_2}(v_2)\}. \end{aligned}$$

(ii) $\forall v_1 v_2 \in SB_2, v \in QA_1.$

$$\begin{aligned} T_{(\overline{SB}_1 \otimes \overline{SB}_2)}((v, v_1)(v, v_2)) &= \min\{T_{\overline{QA}_1}(v), T_{\overline{SB}_2}(v_1 v_2)\}, \\ T_{(\underline{SB}_1 \otimes \underline{SB}_2)}((v, v_1)(v, v_2)) &= \min\{T_{\underline{QA}_1}(v), T_{\underline{SB}_2}(v_1 v_2)\}, \\ I_{(\overline{SB}_1 \otimes \overline{SB}_2)}((v, v_1)(v, v_2)) &= \max\{I_{\overline{QA}_1}(v), I_{\overline{SB}_2}(v_1 v_2)\}, \\ I_{(\underline{SB}_1 \otimes \underline{SB}_2)}((v, v_1)(v, v_2)) &= \max\{I_{\underline{QA}_1}(v), I_{\underline{SB}_2}(v_1 v_2)\}, \\ F_{(\overline{SB}_1 \otimes \overline{SB}_2)}((v, v_1)(v, v_2)) &= \max\{F_{\overline{QA}_1}(v), F_{\overline{SB}_2}(v_1 v_2)\}, \\ F_{(\underline{SB}_1 \otimes \underline{SB}_2)}((v, v_1)(v, v_2)) &= \max\{F_{\underline{QA}_1}(v), F_{\underline{SB}_2}(v_1 v_2)\}. \end{aligned}$$

(iii) $\forall v_1 v_2 \in SB_1, v \in QA_2.$

$$\begin{aligned} T_{(\overline{SB}_1 \otimes \overline{SB}_2)}((v_1, v)(v_2, v)) &= \min\{T_{\overline{SB}_1}(v_1 v_2), T_{\overline{QA}_2}(v)\}, \\ T_{(\underline{SB}_1 \otimes \underline{SB}_2)}((v_1, v)(v_2, v)) &= \min\{T_{\underline{SB}_1}(v_1 v_2), T_{\underline{QA}_2}(v)\}, \\ I_{(\overline{SB}_1 \otimes \overline{SB}_2)}((v_1, v)(v_2, v)) &= \max\{I_{\overline{SB}_1}(v_1 v_2), I_{\overline{QA}_2}(v)\}, \\ I_{(\underline{SB}_1 \otimes \underline{SB}_2)}((v_1, v)(v_2, v)) &= \max\{I_{\underline{SB}_1}(v_1 v_2), I_{\underline{QA}_2}(v)\}, \\ F_{(\overline{SB}_1 \otimes \overline{SB}_2)}((v_1, v)(v_2, v)) &= \max\{F_{\overline{SB}_1}(v_1 v_2), F_{\overline{QA}_2}(v)\}, \\ F_{(\underline{SB}_1 \otimes \underline{SB}_2)}((v_1, v)(v_2, v)) &= \max\{F_{\underline{SB}_1}(v_1 v_2), F_{\underline{QA}_2}(v)\}. \end{aligned}$$

(iv) $\forall v_1 u_1 \in SB_1, v_1 u_2 \in SB_2.$

$$\begin{aligned} T_{(\overline{SB}_1 \otimes \overline{SB}_2)}((v_1, v_1)(u_1, u_2)) &= \min\{T_{\overline{SB}_1}(v_1 u_1), T_{\overline{SB}_2}(v_1 u_2)\}, \\ T_{(\underline{SB}_1 \otimes \underline{SB}_2)}((v_1, v_1)(u_1, u_2)) &= \min\{T_{\underline{SB}_1}(v_1 u_1), T_{\underline{SB}_2}(v_1 u_2)\}, \\ I_{(\overline{SB}_1 \otimes \overline{SB}_2)}((v_1, v_1)(u_1, u_2)) &= \max\{I_{\overline{SB}_1}(v_1 u_1), I_{\overline{SB}_2}(v_1 u_2)\}, \\ I_{(\underline{SB}_1 \otimes \underline{SB}_2)}((v_1, v_1)(u_1, u_2)) &= \max\{I_{\underline{SB}_1}(v_1 u_1), I_{\underline{SB}_2}(v_1 u_2)\}, \\ F_{(\overline{SB}_1 \otimes \overline{SB}_2)}((v_1, v_1)(u_1, u_2)) &= \max\{F_{\overline{SB}_1}(v_1 u_1), F_{\overline{SB}_2}(v_1 u_2)\}, \\ F_{(\underline{SB}_1 \otimes \underline{SB}_2)}((v_1, v_1)(u_1, u_2)) &= \max\{F_{\underline{SB}_1}(v_1 u_1), F_{\underline{SB}_2}(v_1 u_2)\}. \end{aligned}$$

Definition 14. The composition of G_1 and G_2 is a neutrosophic soft rough graph $G = G_1[G_2] = (G_{1*}[G_{2*}], G_1^*[G_2^*])$, where $G_{1*}[G_{2*}] = (\underline{QA}_1[\underline{QA}_2], \underline{SB}_1[\underline{SB}_2])$ and $G_1^*[G_2^*] = (\overline{QA}_1[\overline{QA}_2], \overline{SB}_1[\overline{SB}_2])$ are neutrosophic graphs, respectively, such that

(i) $\forall (v_1, v_2) \in QA_1 \times QA_2.$

$$\begin{aligned} T_{(\overline{QA}_1 \times \overline{QA}_2)}(v_1, v_2) &= \min\{T_{\overline{QA}_1}(v_1), T_{\overline{QA}_2}(v_2)\}, \quad T_{(\underline{QA}_1 \times \underline{QA}_2)}(v_1, v_2) = \min\{T_{\underline{QA}_1}(v_1), T_{\underline{QA}_2}(v_2)\}, \\ I_{(\overline{QA}_1 \times \overline{QA}_2)}(v_1, v_2) &= \max\{I_{\overline{QA}_1}(v_1), I_{\overline{QA}_2}(v_2)\}, \quad I_{(\underline{QA}_1 \times \underline{QA}_2)}(v_1, v_2) = \max\{I_{\underline{QA}_1}(v_1), I_{\underline{QA}_2}(v_2)\}, \\ F_{(\overline{QA}_1 \times \overline{QA}_2)}(v_1, v_2) &= \max\{F_{\overline{QA}_1}(v_1), F_{\overline{QA}_2}(v_2)\}, \quad F_{(\underline{QA}_1 \times \underline{QA}_2)}(v_1, v_2) = \max\{F_{\underline{QA}_1}(v_1), F_{\underline{QA}_2}(v_2)\}. \end{aligned}$$

(ii) $\forall v_1 v_2 \in SB_2, v \in QA_1.$

$$\begin{aligned} T_{(\overline{SB}_1 \times \overline{SB}_2)}((v, v_1)(v, v_2)) &= \min\{T_{\overline{QA}_1}(v), T_{\overline{SB}_2}(v_1 v_2)\}, \\ T_{(\underline{SB}_1 \times \underline{SB}_2)}((v, v_1)(v, v_2)) &= \min\{T_{\underline{QA}_1}(v), T_{\underline{SB}_2}(v_1 v_2)\}, \\ I_{(\overline{SB}_1 \times \overline{SB}_2)}((v, v_1)(v, v_2)) &= \max\{I_{\overline{QA}_1}(v), I_{\overline{SB}_2}(v_1 v_2)\}, \\ I_{(\underline{SB}_1 \times \underline{SB}_2)}((v, v_1)(v, v_2)) &= \max\{I_{\underline{QA}_1}(v), I_{\underline{SB}_2}(v_1 v_2)\}, \\ F_{(\overline{SB}_1 \times \overline{SB}_2)}((v, v_1)(v, v_2)) &= \max\{F_{\overline{QA}_1}(v), F_{\overline{SB}_2}(v_1 v_2)\}, \\ F_{(\underline{SB}_1 \times \underline{SB}_2)}((v, v_1)(v, v_2)) &= \max\{F_{\underline{QA}_1}(v), F_{\underline{SB}_2}(v_1 v_2)\}. \end{aligned}$$

(iii) $\forall v_1 v_2 \in SB_1, v \in QA_2.$

$$\begin{aligned} T_{(\overline{SB}_1 \times \overline{SB}_2)}((v_1, v)(v_2, v)) &= \min\{T_{\overline{SB}_1}(v_1 v_2), T_{\overline{QA}_2}(v)\}, \\ T_{(\underline{SB}_1 \times \underline{SB}_2)}((v_1, v)(v_2, v)) &= \min\{T_{\underline{SB}_1}(v_1 v_2), T_{\underline{QA}_2}(v)\}, \\ I_{(\overline{SB}_1 \times \overline{SB}_2)}((v_1, v)(v_2, v)) &= \max\{I_{\overline{SB}_1}(v_1 v_2), I_{\overline{QA}_2}(v)\}, \\ I_{(\underline{SB}_1 \times \underline{SB}_2)}((v_1, v)(v_2, v)) &= \max\{I_{\underline{SB}_1}(v_1 v_2), I_{\underline{QA}_2}(v)\}, \\ F_{(\overline{SB}_1 \times \overline{SB}_2)}((v_1, v)(v_2, v)) &= \max\{F_{\overline{SB}_1}(v_1 v_2), F_{\overline{QA}_2}(v)\}, \\ F_{(\underline{SB}_1 \times \underline{SB}_2)}((v_1, v)(v_2, v)) &= \max\{F_{\underline{SB}_1}(v_1 v_2), F_{\underline{QA}_2}(v)\}. \end{aligned}$$

(iv) $\forall v_1 u_1 \in SB_1, v_1 \neq u_2 \in QA_2.$

$$\begin{aligned} T_{(\overline{SB_1} \times \overline{SB_2})}((v_1, v_1)(u_1, u_2)) &= \min\{T_{\overline{SB_1}}(v_1 u_1), T_{\overline{SB_2}}(v_1 u_2)\}, \\ T_{(\underline{SB_1} \times \underline{SB_2})}((v_1, v_1)(u_1, u_2)) &= \min\{T_{\underline{SB_1}}(v_1 u_1), T_{\underline{SB_2}}(v_1 u_2)\}, \\ I_{(\overline{SB_1} \times \overline{SB_2})}((v_1, v_1)(u_1, u_2)) &= \max\{I_{\overline{SB_1}}(v_1 u_1), I_{\overline{SB_2}}(v_1 u_2)\}, \\ I_{(\underline{SB_1} \times \underline{SB_2})}((v_1, v_1)(u_1, u_2)) &= \max\{I_{\underline{SB_1}}(v_1 u_1), I_{\underline{SB_2}}(v_1 u_2)\}, \\ F_{(\overline{SB_1} \times \overline{SB_2})}((v_1, v_1)(u_1, u_2)) &= \max\{F_{\overline{SB_1}}(v_1 u_1), F_{\overline{SB_2}}(v_1 u_2)\}, \\ F_{(\underline{SB_1} \times \underline{SB_2})}((v_1, v_1)(u_1, u_2)) &= \max\{F_{\underline{SB_1}}(v_1 u_1), F_{\underline{SB_2}}(v_1 u_2)\}. \end{aligned}$$

Definition 15. Let $G = (\underline{G}, \overline{G})$ be a neutrosophic soft rough graph. The complement of G , denoted by $\hat{G} = (\hat{\underline{G}}, \hat{\overline{G}})$ is a neutrosophic soft rough graph, where $\hat{\underline{G}} = (\underline{QA}, \underline{SB})$ and $\hat{\overline{G}} = (\overline{QA}, \overline{SB})$ are neutrosophic graphs such that

(i) $\forall v \in QA.$

$$\begin{aligned} T'_{\overline{QA}}(v) &= T_{\overline{QA}(v)}, \quad I'_{\overline{QA}}(v) = I_{\overline{QA}(v)}, \quad F'_{\overline{QA}}(v) = F_{\overline{QA}(v)}, \\ T'_{\underline{QA}}(v) &= T_{\underline{QA}(v)}, \quad I'_{\underline{QA}}(v) = I_{\underline{QA}(v)}, \quad F'_{\underline{QA}}(v) = F_{\underline{QA}(v)}. \end{aligned}$$

(ii) $\forall v, u \in QA.$
 (ii) $\forall v, u \in QA.$

$$\begin{aligned} T'_{\overline{SB}}(vu) &= \min\{T'_{\overline{QA}}(v), T'_{\overline{QA}}(u)\} - T_{\overline{SB}}(vu), \\ T'_{\underline{SB}}(vu) &= \min\{T'_{\underline{QA}}(v), T'_{\underline{QA}}(u)\} - T_{\underline{SB}}(vu), \\ I'_{\overline{SB}}(vu) &= \max\{I'_{\overline{QA}}(v), I'_{\overline{QA}}(u)\} - I_{\overline{SB}}(vu), \\ I'_{\underline{SB}}(vu) &= \max\{I'_{\underline{QA}}(v), I'_{\underline{QA}}(u)\} - I_{\underline{SB}}(vu), \\ F'_{\overline{SB}}(vu) &= \max\{F'_{\overline{QA}}(v), F'_{\overline{QA}}(u)\} - F_{\overline{SB}}(vu), \\ F'_{\underline{SB}}(vu) &= \max\{F'_{\underline{QA}}(v), F'_{\underline{QA}}(u)\} - F_{\underline{SB}}(vu), \\ T_{\overline{SB}}(vu) &= \min\{T_{\overline{QA}}(v), T_{\overline{QA}}(u)\} - T_{\overline{SB}}(vu), \\ T_{\underline{SB}}(vu) &= \min\{T_{\underline{QA}}(v), T_{\underline{QA}}(u)\} - T_{\underline{SB}}(vu), \\ I_{\overline{SB}}(vu) &= \max\{I_{\overline{QA}}(v), I_{\overline{QA}}(u)\} - I_{\overline{SB}}(vu), \\ I_{\underline{SB}}(vu) &= \max\{I_{\underline{QA}}(v), I_{\underline{QA}}(u)\} - I_{\underline{SB}}(vu), \\ F_{\overline{SB}}(vu) &= \max\{F_{\overline{QA}}(v), F_{\overline{QA}}(u)\} - F_{\overline{SB}}(vu), \\ F_{\underline{SB}}(vu) &= \max\{F_{\underline{QA}}(v), F_{\underline{QA}}(u)\} - F_{\underline{SB}}(vu). \end{aligned}$$

Example 2.8. Consider a NSRGS G as shown in Figure 9. The complement of G is $\hat{G} = (\hat{\underline{G}}, \hat{\overline{G}})$ is

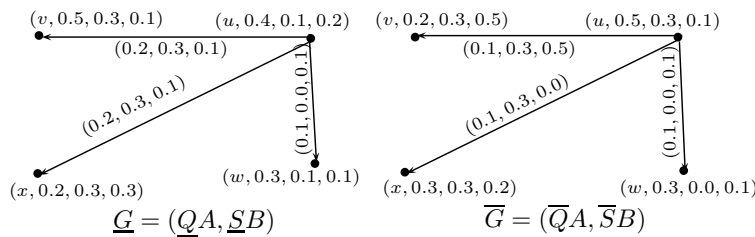

Figure 9: Neutrosophic soft rough graph $G = (\underline{G}, \overline{G})$

The complement of G is $\hat{G} = (\hat{\underline{G}}, \hat{\overline{G}})$ is obtained by using the Definition 2.15, where $\hat{\underline{G}} = (\underline{QA}, \underline{SB})$ and $\hat{\overline{G}} = (\overline{QA}, \overline{SB})$ are neutrosophic graphs as shown in Figure 10.

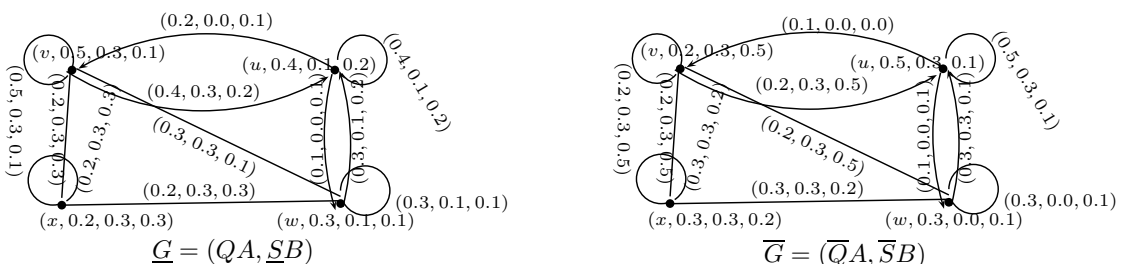

Figure 10: Neutrosophic soft rough graph $\hat{G} = (\hat{\underline{G}}, \hat{\overline{G}})$

Figure 9: Neutrosophic soft rough graph $G = (\underline{G}, \overline{G})$

obtained by using the Definition 2.15, where $\underline{G} = (\underline{QA}, \underline{SB})$ and $\overline{G} = (\overline{QA}, \overline{SB})$ are neutrosophic graphs as shown in Figure 10.

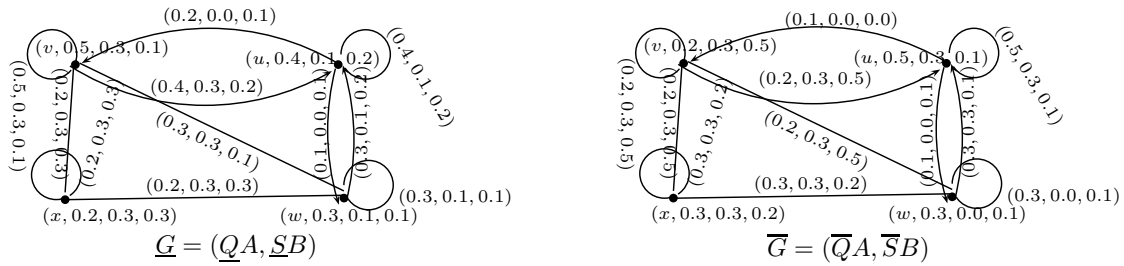

Figure 10: Neutrosophic soft rough graph $\underline{G} = (\underline{G}, \overline{G})$

Definition 16. A graph G is called self complement, if $G = \hat{G}$, i.e.,
Definition 2.16. A graph G is called self complement, if $G = \hat{G}$, i.e.,

(i) $\forall v \in QA$.

$$T'_{QA}(v) = T_{QA}(v), F'_{QA}(v) = F_{QA}(v), I'_{QA}(v) = I_{QA}(v), F'_{QA}(v) = F_{QA}(v), T'_{QA}(v) = T_{QA}(v), F'_{QA}(v) = F_{QA}(v), I'_{QA}(v) = I_{QA}(v), F'_{QA}(v) = F_{QA}(v).$$

(ii) $\forall v, u \in QA$.

$$T'_{SB}(vu) = T_{SB}(vu), I'_{SB}(vu) = I_{SB}(vu), F'_{SB}(vu) = F_{SB}(vu), T'_{SB}(vu) = T_{SB}(vu), I'_{SB}(vu) = I_{SB}(vu), F'_{SB}(vu) = F_{SB}(vu).$$

Definition 17. A neutrosophic soft rough graph G is called strong neutrosophic soft rough graph if $\forall uv \in SB$

$$T_{SB}(vu) = \min\{T_{QA}(v), T_{QA}(u)\}, I_{SB}(vu) = \max\{I_{QA}(v), I_{QA}(u)\}, F_{SB}(vu) = \max\{F_{QA}(v), F_{QA}(u)\}, T_{SB}(vu) = \min\{T_{QA}(v), T_{QA}(u)\}, I_{SB}(vu) = \max\{I_{QA}(v), I_{QA}(u)\}, F_{SB}(vu) = \max\{F_{QA}(v), F_{QA}(u)\}.$$

Example 9. Consider a graph G such that $V = \{u, v, w\}$ and $E = \{uv, vw, wu\}$, as shown in Figure 11. Let QA be a neutrosophic soft rough set of V and let SB be a neutrosophic soft rough set of E defined in the Tables 9 and 10, respectively.

Table 9. Neutrosophic soft rough set on V .

V	\overline{QA}	\underline{QA}
u	(0.8, 0.5, 0.2)	(0.7, 0.5, 0.2)
v	(0.9, 0.5, 0.1)	(0.7, 0.5, 0.2)
w	(0.7, 0.5, 0.1)	(0.7, 0.5, 0.2)

Table 10. Neutrosophic soft rough set on E .

E	\overline{SB}	\underline{SB}
uv	(0.8, 0.5, 0.2)	(0.7, 0.5, 0.2)
vw	(0.7, 0.5, 0.1)	(0.7, 0.5, 0.2)
wu	(0.7, 0.5, 0.2)	(0.7, 0.5, 0.2)

E	\overline{SB}	\underline{SB}
wv	(0.8, 0.5, 0.2)	(0.7, 0.5, 0.2)
vw	(0.7, 0.5, 0.1)	(0.7, 0.5, 0.2)
wu	(0.7, 0.5, 0.2)	(0.7, 0.5, 0.2)

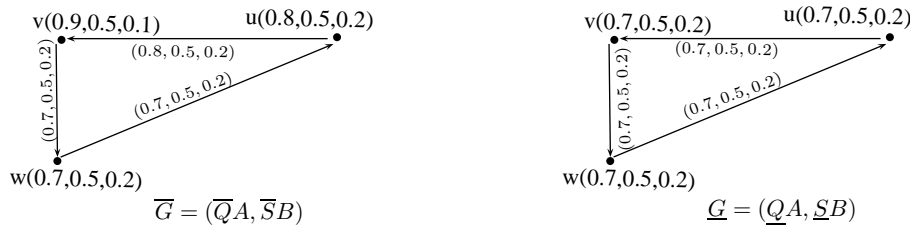

Figure 11: Strong neutrosophic soft rough graph $\overline{G} = (\overline{QA}, \overline{SB})$ (QA, SB)

Hence, $G = (QA, SB)$ is a strong neutrosophic soft rough graph.

Definition 2.18. A neutrosophic soft rough graph G is called a complete neutrosophic soft rough graph if $\forall vu \in QA$,

$$T_{\overline{SB}}(vu) = \min\{T_{\overline{QA}}(v), T_{\overline{QA}}(u)\}, I_{\overline{SB}}(vu) = \max\{I_{\overline{QA}}(v), I_{\overline{QA}}(u)\}, F_{\overline{SB}}(vu) = \max\{F_{\overline{QA}}(v), F_{\overline{QA}}(u)\},$$

$$T_{\underline{SB}}(vu) = \min\{T_{\underline{QA}}(v), T_{\underline{QA}}(u)\}, I_{\underline{SB}}(vu) = \max\{I_{\underline{QA}}(v), I_{\underline{QA}}(u)\}, F_{\underline{SB}}(vu) = \max\{F_{\underline{QA}}(v), F_{\underline{QA}}(u)\}.$$

Remark 2.2. Every complete neutrosophic soft rough graph is a strong neutrosophic soft rough graph. But the converse is not true.

Definition 2.19. A neutrosophic soft rough graph G is isolated, if $\forall x, y \in QA$.

Definition 19. A neutrosophic soft rough graph G is isolated, if $\forall x, y \in QA$.

$$T_{\overline{SB}}(vu) = 0, I_{\overline{SB}}(vu) = 0, F_{\overline{SB}}(vu) = 0, T_{\underline{SB}}(vu) = 0, I_{\underline{SB}}(vu) = 0, F_{\underline{SB}}(vu) = 0,$$

Theorem 2.1. The rejection of two neutrosophic soft rough graphs is a neutrosophic soft rough graph.

Theorem 1. The rejection of two neutrosophic soft rough graphs is a neutrosophic soft rough graph.

Proof. Let $G_1 = (\underline{G}_1, \overline{G}_1)$ and $G_2 = (\underline{G}_2, \overline{G}_2)$ be two NSRGs. Let $G = G_1|G_2 = (\underline{G}_1|\underline{G}_2, \overline{G}_1|\overline{G}_2)$ be the rejection of G_1 and G_2 where $(\underline{G}_1, \overline{G}_1)$ and $(\underline{G}_2, \overline{G}_2)$ be two NSRGs. Let $\underline{SB}_1| \underline{SB}_2$ and $\overline{SB}_1| \overline{SB}_2$ be the $\underline{SB}_1| \underline{SB}_2$ and $\overline{SB}_1| \overline{SB}_2$ of G where $\underline{SB}_1| \underline{SB}_2$ and $\overline{SB}_1| \overline{SB}_2$ are the $\underline{SB}_1| \underline{SB}_2$ and $\overline{SB}_1| \overline{SB}_2$ of G_1 and G_2 respectively. We show that $\underline{SB}_1| \underline{SB}_2$ and $\overline{SB}_1| \overline{SB}_2$ are neutrosophic relations on $QA_1|QA_2$ and $QA_1|QA_2$, respectively. First, we show that $\underline{SB}_1| \underline{SB}_2$ is a neutrosophic relation on $QA_1|QA_2$.

If $v \in \underline{QA}_1, v_1v_2 \notin \underline{SB}_2$, then

$$T_{(\underline{SB}_1|\underline{SB}_2)}((v, v_1)(v, v_2)) = (T_{\underline{QA}_1}(v) \wedge T_{\underline{QA}_2}(v_2)) \wedge T_{\underline{QA}_2}(v_2)$$

$$= (T_{\underline{QA}_1}(v) \wedge T_{\underline{QA}_2}(v_2)) \wedge (T_{\underline{QA}_1}(v) \wedge T_{\underline{QA}_2}(v_2))$$

$$= T_{(\underline{QA}_1|\underline{QA}_2)}(v, v_1) \wedge T_{(\underline{QA}_1|\underline{QA}_2)}(v, v_2)$$

$$T_{(\underline{SB}_1|\underline{SB}_2)}((v, v_1)(v, v_2)) = T_{(\underline{QA}_1|\underline{QA}_2)}(v, v_1) \wedge T_{(\underline{QA}_1|\underline{QA}_2)}(v, v_2)$$

Similarly, $I_{(\underline{SB}_1|\underline{SB}_2)}((v, v_1)(v, v_2)) = I_{(\underline{QA}_1|\underline{QA}_2)}(v, v_1) \vee I_{(\underline{QA}_1|\underline{QA}_2)}(v, v_2)$

$$F_{(\underline{SB}_1|\underline{SB}_2)}((v, v_1)(v, v_2)) = F_{(\underline{QA}_1|\underline{QA}_2)}(v, v_1) \vee F_{(\underline{QA}_1|\underline{QA}_2)}(v, v_2).$$

If $v_1v_2 \notin \underline{SB}_1, v \in \underline{QA}_2$, then

$$T_{(\underline{SB}_1|\underline{SB}_2)}((v_1, v)(v_2, v)) = ((T_{\underline{QA}_1}(v_1) \wedge T_{\underline{QA}_1}(v_2)) \wedge T_{\underline{QA}_2}(v))$$

$$= ((T_{\underline{QA}_1}(v_1) \wedge T_{\underline{QA}_2}(v)) \wedge (T_{\underline{QA}_1}(v_2) \wedge T_{\underline{QA}_2}(v)))$$

$$= T_{(\underline{QA}_1|\underline{QA}_2)}(v_1, v) \wedge T_{(\underline{QA}_1|\underline{QA}_2)}(v_2, v)$$

$$T_{(\underline{SB}_1|\underline{SB}_2)}((v_1, v)(v_2, v)) = T_{(\underline{QA}_1|\underline{QA}_2)}(v_1, v) \wedge T_{(\underline{QA}_1|\underline{QA}_2)}(v_2, v)$$

Similarly, $I_{(\underline{SB}_1|\underline{SB}_2)}((v_1, v)(v_2, v)) = I_{(\underline{QA}_1|\underline{QA}_2)}(v_1, v) \vee I_{(\underline{QA}_1|\underline{QA}_2)}(v_2, v)$

$$F_{(\underline{SB}_1|\underline{SB}_2)}((v_1, v)(v_2, v)) = F_{(\underline{QA}_1|\underline{QA}_2)}(v_1, v) \vee F_{(\underline{QA}_1|\underline{QA}_2)}(v_2, v).$$

If $v_1 v_2 \notin \underline{SB}_1, u_1, u_2 \notin \underline{SB}_2$, then

$$\begin{aligned} T_{(\underline{SB}_1|\underline{SB}_2)}((v_1, u_1)(v_2, u_2)) &= ((T_{\underline{QA}_1}(v_1) \wedge T_{\underline{QA}_1}(v_2)) \wedge (T_{\underline{QA}_2}(u_1) \wedge T_{\underline{QA}_2}(u_2))) \\ &= (T_{\underline{QA}_1}(v_1) \wedge T_{\underline{QA}_2}(u_1)) \wedge (T_{\underline{QA}_1}(v_2) \wedge T_{\underline{QA}_2}(u_2)) \\ &= T_{(\underline{QA}_1|\underline{QA}_2)}(v_1, u_1) \wedge T_{(\underline{QA}_1|\underline{QA}_2)}(v_2, u_2) \\ T_{(\underline{SB}_1|\underline{SB}_2)}((v_1, u_1)(v_2, u_2)) &= T_{(\underline{QA}_1|\underline{QA}_2)}(v_1, u_1) \wedge T_{(\underline{QA}_1|\underline{QA}_2)}(u_1, u_2) \\ \text{Similarly, } I_{(\underline{SB}_1|\underline{SB}_2)}((v_1, u_1)(v_2, u_2)) &= I_{(\underline{QA}_1|\underline{QA}_2)}(v_1, u_1) \vee I_{(\underline{QA}_1|\underline{QA}_2)}(u_1, u_2) \\ F_{(\underline{SB}_1|\underline{SB}_2)}((v_1, u_1)(v_2, u_2)) &= F_{(\underline{QA}_1|\underline{QA}_2)}(v_1, u_1) \vee F_{(\underline{QA}_1|\underline{QA}_2)}(u_1, u_2). \end{aligned}$$

Thus, $\underline{SB}_1|\underline{SB}_2$ is a neutrosophic relation on $\underline{QA}_1|\underline{QA}_2$. Similarly, we can show that $\bar{SB}_1|\bar{SB}_2$ is a neutrosophic relation on $\bar{QA}_1|\bar{QA}_2$. Hence, G is a neutrosophic soft rough graph. \square

Theorem 2. *The Cartesian product of two NSRGs is a neutrosophic soft rough graph.*

Proof. Let $G_1 = (\underline{G}_1, \bar{G}_1)$ and $G_2 = (\underline{G}_2, \bar{G}_2)$ be two NSRGs. Let $G = G_1 \times G_2 = (\underline{G}_1 \times \underline{G}_2, \bar{G}_1 \times \bar{G}_2)$ be the Cartesian product of G_1 and G_2 , where $\underline{G}_1 \times \underline{G}_2 = (\underline{QA}_1 \times \underline{QA}_2, \underline{SB}_1 \times \underline{SB}_2)$ and $\bar{G}_1 \times \bar{G}_2 = (\bar{QA}_1 \times \bar{QA}_2, \bar{SB}_1 \times \bar{SB}_2)$. We claim that $G = G_1 \times G_2$ is a neutrosophic soft rough graph. It is enough to show that $\underline{SB}_1 \times \underline{SB}_2$ and $\bar{SB}_1 \times \bar{SB}_2$ are neutrosophic relations on $\underline{QA}_1 \times \underline{QA}_2$ and $\bar{QA}_1 \times \bar{QA}_2$, respectively. We have to show that $\underline{SB}_1 \times \underline{SB}_2$ is a neutrosophic relation on $\underline{QA}_1 \times \underline{QA}_2$.

If $v \in \underline{QA}_1, v_1 u_1 \in \underline{SB}_2$, then

$$\begin{aligned} T_{(\underline{SB}_1 \times \underline{SB}_2)}((v, v_1)(v, u_1)) &= T_{(\underline{QA}_1)}(v) \wedge T_{(\underline{SB}_2)}(v_1 u_1) \\ &\leq T_{(\underline{QA}_1)}(v) \wedge (T_{(\underline{QA}_2)}(v_1) \wedge T_{(\underline{QA}_2)}(u_1)) \\ &= (T_{(\underline{QA}_1)}(v) \wedge T_{(\underline{QA}_2)}(v_1)) \wedge (T_{(\underline{QA}_1)}(v) \wedge T_{(\underline{QA}_2)}(u_1)) \\ &= T_{(\underline{QA}_1 \times \underline{QA}_2)}(v, v_1) \wedge T_{(\underline{QA}_1 \times \underline{QA}_2)}(v, u_1) \\ T_{(\underline{SB}_1 \times \underline{SB}_2)}((v, v_1)(v, u_1)) &\leq T_{(\underline{QA}_1 \times \underline{QA}_2)}(v, v_1) \wedge T_{(\underline{QA}_1 \times \underline{QA}_2)}(v, u_1) \\ \text{Similarly, } I_{(\underline{SB}_1 \times \underline{SB}_2)}((v, v_1)(v, u_1)) &\leq I_{(\underline{QA}_1 \times \underline{QA}_2)}(v, v_1) \vee I_{(\underline{QA}_1 \times \underline{QA}_2)}(v, u_1) \\ F_{(\underline{SB}_1 \times \underline{SB}_2)}((v, v_1)(v, u_1)) &\leq F_{(\underline{QA}_1 \times \underline{QA}_2)}(v, v_1) \vee F_{(\underline{QA}_1 \times \underline{QA}_2)}(v, u_1). \end{aligned}$$

If $v_1 u_1 \in \underline{SB}_1, z \in \underline{QA}_2$, then

$$\begin{aligned} T_{(\underline{SB}_1 \times \underline{SB}_2)}((v_1, z)(u_1, z)) &= T_{(\underline{SB}_1)}(v_1 u_1) \wedge T_{(\underline{QA}_2)}(z) \\ &\leq (T_{(\underline{QA}_1)}(v_1) \wedge T_{(\underline{QA}_1)}(u_1)) \wedge T_{(\underline{QA}_2)}(z) \\ &= T_{(\underline{QA}_1 \times \underline{QA}_2)}(v_1, z) \wedge T_{(\underline{QA}_1 \times \underline{QA}_2)}(u_1, z) \\ T_{(\underline{SB}_1 \times \underline{SB}_2)}((v_1, z)(u_1, z)) &\leq T_{(\underline{QA}_1 \times \underline{QA}_2)}(v_1, z) \wedge T_{(\underline{QA}_1 \times \underline{QA}_2)}(u_1, z) \\ \text{Similarly, } I_{(\underline{SB}_1 \times \underline{SB}_2)}((v_1, z)(u_1, z)) &\leq I_{(\underline{QA}_1 \times \underline{QA}_2)}(v_1, z) \vee I_{(\underline{QA}_1 \times \underline{QA}_2)}(u_1, z) \\ F_{(\underline{SB}_1 \times \underline{SB}_2)}((v_1, z)(u_1, z)) &\leq F_{(\underline{QA}_1 \times \underline{QA}_2)}(v_1, z) \vee F_{(\underline{QA}_1 \times \underline{QA}_2)}(u_1, z). \end{aligned}$$

Therefore, $\underline{SB}_1 \times \underline{SB}_2$ is a neutrosophic relation on $\underline{QA}_1 \times \underline{QA}_2$. Similarly, $\bar{SB}_1 \times \bar{SB}_2$ is a neutrosophic relation on $\bar{QA}_1 \times \bar{QA}_2$. Hence, G is a neutrosophic rough graph. \square

Theorem 3. *The cross product of two neutrosophic soft rough graphs is a neutrosophic soft rough graph.*

Proof. Let $G_1 = (\underline{G}_1, \bar{G}_1)$ and $G_2 = (\underline{G}_2, \bar{G}_2)$ be two NSRGs. Let $G = G_1 \odot G_2 = (\underline{G}_1 \odot \underline{G}_2, \bar{G}_1 \odot \bar{G}_2)$ be the cross product of G_1 and G_2 , where $\underline{G}_1 \odot \underline{G}_2 = (\underline{QA}_1 \odot \underline{QA}_2, \underline{SB}_1 \odot \underline{SB}_2)$ and $\bar{G}_1 \odot \bar{G}_2 = (\bar{QA}_1 \odot \bar{QA}_2, \bar{SB}_1 \odot \bar{SB}_2)$. We claim that $G = G_1 \odot G_2$ is a neutrosophic soft rough graph. It is enough to show that $\underline{SB}_1 \odot \underline{SB}_2$ and $\bar{SB}_1 \odot \bar{SB}_2$ are neutrosophic relations on $\underline{QA}_1 \odot \underline{QA}_2$ and $\bar{QA}_1 \odot \bar{QA}_2$, respectively. First, we show that $\underline{SB}_1 \odot \underline{SB}_2$ is a neutrosophic relation on $\underline{QA}_1 \odot \underline{QA}_2$.

If $v_1u_1 \in \underline{SB}_1, v_1u_2 \in \underline{SB}_2$, then

$$\begin{aligned}
 T_{(\underline{SB}_1 \odot \underline{SB}_2)}((v_1, v_1)(u_1, u_2)) &= T_{(\underline{SB}_1)}(v_1u_1) \wedge T_{(\underline{SB}_2)}(v_1u_2) \\
 &\leq (T_{(\underline{QA}_1)}(v_1) \wedge T_{(\underline{QA}_1)}(u_1) \wedge T_{(\underline{QA}_2)}(v_1) \wedge T_{(\underline{QA}_2)}(u_2)) \\
 &= (T_{(\underline{QA}_1)}(v_1) \wedge T_{(\underline{QA}_2)}(v_1)) \wedge (T_{(\underline{QA}_1)}(u_1) \wedge T_{(\underline{QA}_2)}(u_2)) \\
 &= T_{(\underline{QA}_1 \odot \underline{QA}_2)}(v_1, v_1) \wedge T_{(\underline{QA}_1 \odot \underline{QA}_2)}(u_1, u_2) \\
 T_{(\underline{SB}_1 \odot \underline{SB}_2)}((v_1, v_1)(u_1, u_2)) &\leq T_{(\underline{QA}_1 \odot \underline{QA}_2)}(v_1, v_1) \wedge T_{(\underline{QA}_1 \odot \underline{QA}_2)}(v, u_2) \\
 \text{Similarly, } I_{(\underline{SB}_1 \odot \underline{SB}_2)}((v_1, v_1)(u_1, u_2)) &\leq I_{(\underline{QA}_1 \odot \underline{QA}_2)}(v_1, v_1) \vee I_{(\underline{QA}_1 \odot \underline{QA}_2)}(v, u_2) \\
 F_{(\underline{SB}_1 \odot \underline{SB}_2)}((v_1, v_1)(u_1, u_2)) &\leq F_{(\underline{QA}_1 \odot \underline{QA}_2)}(v_1, v_1) \vee F_{(\underline{QA}_1 \odot \underline{QA}_2)}(v, u_2).
 \end{aligned}$$

Thus, $\underline{SB}_1 \odot \underline{SB}_2$ is a neutrosophic relation on $\underline{QA}_1 \odot \underline{QA}_2$. Similarly, we can show that $\overline{SB}_1 \odot \overline{SB}_2$ is a neutrosophic relation on $\overline{QA}_1 \odot \overline{QA}_2$. Hence, G is a neutrosophic soft rough graph. \square

3. Application

In this section, we apply the concept of NSRSs to a decision-making problem. In recent times, the object recognition problem has gained considerable importance. The object recognition problem can be considered as a decision-making problem, in which final identification of objects is founded on a given set of information. A detailed description of the algorithm for the selection of most suitable objects based on an available set of alternatives is given, and purposed decision-making method can be used to calculate lower and upper approximation operators to progress deep concerns of the problem. The presented algorithms can be applied to avoid lengthy calculations when dealing with large number of objects. This method can be applied in various domains for multi-criteria selection of objects.

Selection of Most Suitable Generic Version of Brand Name Medicine

In the pharmaceutical industry, different pharmaceutical companies develop, produce and discover pharmaceutical medicine (drugs) for use as medication. These pharmaceutical companies deals with “brand name medicine” and “generic medicine”. Brand name medicine and generic medicine are bioequivalent, and have a generic medicine rate and element of absorption. Brand name medicine and generic medicine have the same active ingredients, but the inactive ingredients may differ. The most important difference is cost. Generic medicine is less expensive as compared to brand name comparators. Usually, generic drug manufacturers face competition to produce cost less products. The product may possibly be slightly dissimilar in color, shape, or markings. The major difference is cost. We consider a brand name drug “ $u = \text{Loratadine}$ ” used for seasonal allergies medication. Consider

$$\begin{aligned}
 V &= \{u_1 = \text{Triamcinolone}, u_2 = \text{Cetirizine/Pseudoephedrine}, \\
 &\quad u_3 = \text{Pseudoephedrine}, u_4 = \text{loratadine/pseudoephedrine}, \\
 &\quad u_5 = \text{Fluticasone}\}
 \end{aligned}$$

is a set of generic versions of “Loratadine”. We want to select the most suitable generic version of Loratadine on the basis of parameters $e_1 = \text{Highly soluble}, e_2 = \text{Highly permeable}, e_3 = \text{Rapidly dissolving}$. $\mathbb{M} = \{e_1, e_2, e_3\}$ be a set of paraments. Let Q be a neutrosophic soft relation from V to parameter set M , and describe truth-membership, indeterminacy-membership and false-membership degrees of generic version medicine corresponding to the parameters as shown in Table 11.

Table 11. Neutrosophic soft set (Q, M) .

Q	u_1	u_2	u_3	u_4	u_5
e_1	(0.4, 0.5, 0.6)	(0.5, 0.3, 0.6)	(0.7, 0.2, 0.3)	(0.5, 0.7, 0.5)	(0.6, 0.5, 0.4)
e_2	(0.7, 0.3, 0.2)	(0.3, 0.4, 0.3)	(0.6, 0.5, 0.4)	(0.8, 0.4, 0.6)	(0.7, 0.8, 0.5)
e_3	(0.6, 0.3, 0.4)	(0.7, 0.2, 0.3)	(0.7, 0.2, 0.4)	(0.8, 0.7, 0.6)	(0.7, 0.3, 0.5)

Suppose $A = \{(e_1, 0.2, 0.4, 0.5), (e_2, 0.5, 0.6, 0.4), (e_3, 0.7, 0.5, 0.4)\}$ is the most favorable object that is an NS on the parameter set M under consideration. Then, $(\underline{Q}(A), \overline{Q}(A))$ is an NSRS in NSAS (V, M, Q) , where

$$\begin{aligned} \overline{Q}(A) &= \{(u_1, 0.6, 0.5, 0.4), (u_2, 0.7, 0.4, 0.4), (u_3, 0.7, 0.4, 0.4), (u_4, 0.7, 0.6, 0.5), (u_5, 0.7, 0.5, 0.5)\}, \\ \underline{Q}(A) &= \{(u_1, 0.5, 0.6, 0.4), (u_2, 0.5, 0.6, 0.5), (u_3, 0.3, 0.3, 0.5), (u_4, 0.5, 0.6, 0.5), (u_5, 0.4, 0.5, 0.5)\}. \end{aligned}$$

Let $E = \{u_1v_2, u_1u_3, u_4u_1, u_2u_3, u_5u_3, u_2u_4, u_2u_5\} \subseteq \hat{V}$ and $L = \{e_1e_3, e_2e_1, e_3e_2\} \subseteq \hat{M}$.

Then, a neutrosophic soft relation S on E (from L to E) can be defined as follows in Table 12:

Table 12. Neutrosophic soft relation S .

S	u_1u_2	u_1u_3	u_4u_1	u_2u_3	u_5u_3	u_2u_4	u_2u_5
e_1e_2	(0.3, 0.4, 0.2)	(0.4, 0.4, 0.5)	(0.4, 0.4, 0.5)	(0.6, 0.3, 0.4)	(0.4, 0.2, 0.2)	(0.4, 0.4, 0.2)	(0.4, 0.3, 0.4)
e_2e_3	(0.5, 0.4, 0.1)	(0.4, 0.3, 0.2)	(0.4, 0.3, 0.2)	(0.3, 0.3, 0.2)	(0.6, 0.2, 0.4)	(0.3, 0.2, 0.1)	(0.3, 0.3, 0.2)
e_1e_3	(0.4, 0.4, 0.1)	(0.4, 0.2, 0.2)	(0.4, 0.2, 0.2)	(0.5, 0.3, 0.3)	(0.4, 0.2, 0.3)	(0.4, 0.3, 0.1)	(0.5, 0.3, 0.2)

Let $B = \{(e_1e_2, 0.2, 0.4, 0.5), (e_2e_3, 0.5, 0.4, 0.4), (e_1e_3, 0.5, 0.2, 0.5)\}$ be an NS on L that describes some relationship between the parameters under consideration; then, $SB = (\underline{SB}, \overline{SB})$ is an NSRR, where

$$\begin{aligned} \overline{SB} &= \{(u_1u_2, 0.5, 0.4, 0.4), (u_1u_3, 0.4, 0.2, 0.4), (u_4u_1, 0.4, 0.2, 0.4), (u_2u_3, 0.5, 0.3, 0.4), \\ &\quad (u_5u_3, 0.5, 0.2, 0.4), (u_2u_4, 0.4, 0.3, 0.4), (u_2u_5, 0.5, 0.3, 0.4)\}, \\ \underline{SB} &= \{(u_1u_2, 0.2, 0.4, 0.4), (u_1u_3, 0.5, 0.4, 0.4), (u_4u_1, 0.5, 0.4, 0.4), (u_2u_3, 0.4, 0.4, 0.5), \\ &\quad (u_5u_3, 0.2, 0.4, 0.4), (u_2u_4, 0.2, 0.4, 0.4), (u_2u_5, 0.4, 0.4, 0.5)\}. \end{aligned}$$

Thus, $G = (\underline{G}, \overline{G})$ is an NSRG as shown in Figure 12.

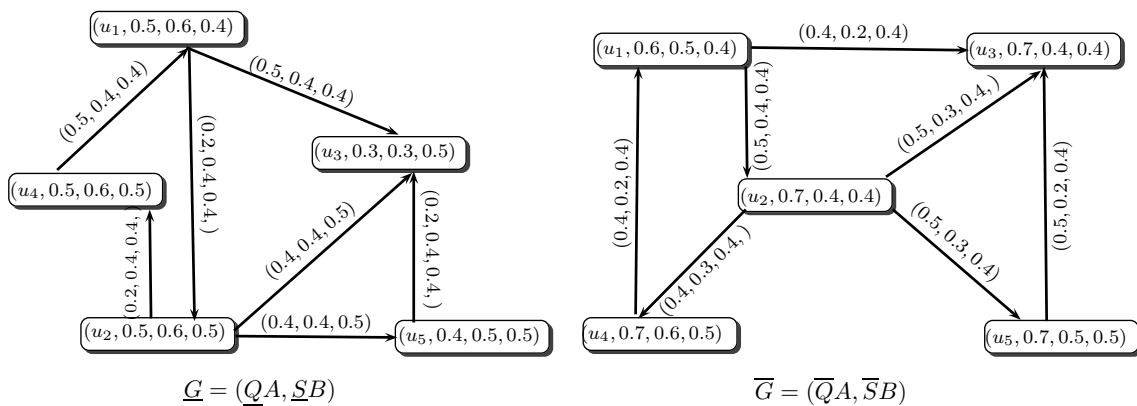

Definition 20. [3] Let C and D be two single valued neutrosophic numbers, and the sum of two single valued neutrosophic number is defined as follows:

$$C \oplus D = \langle T_C + T_D - T_C \times T_D, I_C \times I_D, F_C \times F_D \rangle. \tag{1}$$

Algorithm 1: Algorithm for selection of most suitable objects

1. Input the number of elements in vertex set $V = \{u_1, u_2, \dots, u_n\}$.
2. Input the number of elements in parameter set $\mathbb{M} = \{e_1, e_2, \dots, e_m\}$.
3. Input a neutrosophic soft relation Q from V to \mathbb{M} .
4. Input a neutrosophic set A on M .
5. Compute neutrosophic soft rough vertex set $QA = (\underline{QA}, \overline{Q(A)})$.
6. Input the number of elements in edge set $E = \{u_1u_1, u_1u_2, \dots, u_ku_1\}$.
7. Input the number of elements in parameter set $\mathbb{M}' = \{e_1e_1, e_1e_2, \dots, e_1e_1\}$.
8. Input a neutrosophic soft relation S from \mathbb{V} to \mathbb{M} .
9. Input a neutrosophic set B on \mathbb{M} .
10. Compute neutrosophic soft rough edge set $SB = (\underline{SB}, \overline{S(B)})$.
11. Compute neutrosophic set $\alpha = (T_\alpha(u_i), I_\alpha(u_i), F_\alpha(u_i))$, where

$$\begin{aligned} T_\alpha(u_i) &= T_{\overline{Q(A)}}(u_i) + T_{\underline{Q(A)}}(u_i) - T_{\overline{Q(A)}}(u_i) \times T_{\underline{Q(A)}}(u_i), \\ I_\alpha(u_i) &= T_{\overline{Q(A)}}(u_i) \times T_{\underline{Q(A)}}(u_i), \\ F_\alpha(u_i) &= F_{\overline{Q(A)}}(u_i) \times F_{\underline{Q(A)}}(u_i). \end{aligned}$$

12. Compute neutrosophic set $\beta = (T_\beta(u_iu_j), I_\beta(u_iu_j), F_\beta(u_iu_j))$, where

$$\begin{aligned} T_\beta(u_iu_j) &= T_{\overline{S(B)}}(u_iu_j) + T_{\underline{S(B)}}(u_iu_j) - T_{\overline{S(B)}}(u_iu_j) \times T_{\underline{S(B)}}(u_iu_j), \\ I_\beta(u_iu_j) &= T_{\overline{S(B)}}(u_iu_j) \times T_{\underline{S(B)}}(u_iu_j), \\ F_\beta(u_iu_j) &= F_{\overline{S(B)}}(u_iu_j) \times F_{\underline{S(B)}}(u_iu_j). \end{aligned}$$

13. Calculate the score values of each object u_i , and the score function is defined as follows:

$$\tilde{S}(u_i) = \sum_{u_iu_j \in E} \frac{T_\alpha(u_j) + I_\alpha(u_j) - F_\alpha(u_j)}{3 - (T_\beta(u_iu_j) + I_\beta(u_iu_j) - F_\beta(u_iu_j))}.$$

14. The decision is S_i if $S_i = \max_{i=1}^n \tilde{S}_i$.
 15. If i has more than one value, then any one of S_i may be chosen.
-

The sum of UNSRS \overline{QA} and the LNSRS \underline{QA} and sum of LNSRR \underline{SB} and the UNSRR \overline{SB} are NSs $\overline{QA} \oplus \underline{QA}$ and $\overline{SB} \oplus \underline{SB}$, respectively defined by

$$\begin{aligned} \alpha = \overline{QA} \oplus \underline{QA} &= \{(u_1, 0.8, 0.3, 0.16), (u_2, 0.85, 0.24, 0.2), (u_3, 0.79, 0.2, 0.2), (u_4, 0.85, 0.36, 0.25), \\ &\quad (u_5, 0.82, 0.25, 0.25)\}, \\ \beta = \overline{SB} \oplus \underline{SB} &= \{(u_1u_2, 0.6, 0.16, 0.16), (u_1u_3, 0.7, 0.8, 0.16), (u_4u_1, 0.7, 0.8, 0.16), (u_2u_3, 0.7, \\ &\quad 0.12, 0.2), (u_5u_3, 0.6, 0.08, 0.16), (u_2u_4, 0.52, 0.12, 0.16), (u_2u_5, 0.7, 0.12, 0.2)\}. \end{aligned}$$

The score function $\tilde{S}(u_k)$ defines for each generic version medicine $u_i \in V$,

$$\tilde{S}(u_i) = \sum_{u_iu_j \in E} \frac{T_\alpha(u_j) + I_\alpha(u_j) - F_\alpha(u_j)}{3 - (T_\beta(u_iu_j) + I_\beta(u_iu_j) - F_\beta(u_iu_j))} \tag{2}$$

and u_k with the larger score value $u_k = \max_i S(u_i)$ is the most suitable generic version medicine. By calculations, we have

$$\tilde{S}(u_1) = 0.88, \tilde{S}(u_2) = 0.69, \tilde{S}(u_3) = 0.26, \tilde{S}(u_4) = 0.57, \text{ and } \tilde{S}(u_5) = 0.33. \quad (3)$$

Here, u_1 is the optimal decision, and the most suitable generic version of “Loratadine” is “Triamcinolone”. We have used software MATLAB (version 7, MathWorks, Natick, MA, USA) for calculating the required results in the application. The algorithm is given in Algorithm 1. The algorithm of the program is general for any number of objects with respect to certain parameters.

4. Conclusions

Rough set theory can be considered as an extension of classical set theory. Rough set theory is a very useful mathematical model to handle vagueness. NS theory, RS theory and SS theory are three useful distinguished approaches to deal with vagueness. NS and RS models are used to handle uncertainty, and combining these two models with another remarkable model of SSSs gives more precise results for decision-making problems. In this paper, we have presented the notion of NSRGs and investigated some properties of NSRGs in detail. The notion of NSRGs can be utilized as a mathematical tool to deal with imprecise and unspecified information. In addition, a decision-making method based on NSRGs is proposed. This research work can be extended to (1) Rough bipolar neutrosophic soft sets; (2) Bipolar neutrosophic soft rough sets, (3) Interval-valued bipolar neutrosophic rough sets, and (4) Soft rough neutrosophic graphs.

References

1. Smarandache, F. Neutrosophic set, a generalisation of the Intuitionistic Fuzzy Sets. *Int. J. Pure Appl. Math.* **2010**, *24*, 289–297.
2. Wang, H.; Smarandache, F.; Zhang, Y.; Sunderraman, R. Single-valued neutrosophic sets. *Multispace Multistructure* **2010**, *4*, 410–413.
3. Peng, J.J.; Wang, J.Q.; Zhang, H.Y.; Chen, X.H. An outranking approach for multi-criteria decision-making problems with simplified neutrosophic sets. *Appl. Soft Comput.* **2014**, *25*, 336–346.
4. Molodtsov, D.A. Soft set theory—first results. *Comput. Math. Appl.* **1999**, *37*, 19–31.
5. Maji, P.K.; Biswas, R.; Roy, A.R. Fuzzy soft sets. *J. Fuzzy Math.* **2001**, *9*, 589–602.
6. Maji, P.K.; Biswas, R.; Roy, A.R. Intuitionistic fuzzy soft sets. *J. Fuzzy Math.* **2001**, *9*, 677–692.
7. Maji, P.K. Neutrosophic soft set. *Ann. Fuzzy Math. Inform.* **2013**, *5*, 157–168.
8. Sahin, R.; Kucuk, A. On similarity and entropy of neutrosophic soft sets. *J. Intell. Fuzzy Syst. Appl. Eng. Technol.* **2014**, *27*, 2417–2430.
9. Pawlak, Z. Rough sets. *Int. J. Comput. Inf. Sci.* **1982**, *11*, 341–356.
10. Feng, F.; Liu, X.; Leoreanu-Fotea, B.; Jun, Y.B. Soft sets and soft rough sets. *Inf. Sci.* **2011**, *181*, 1125–1137.
11. Meng, D.; Zhang, X.; Qin, K. Soft rough fuzzy sets and soft fuzzy rough sets. *Comput. Math. Appl.* **2011**, *62*, 4635–4645.
12. Sun, B.Z.; Ma, W. Soft fuzzy rough sets and its application in decision making. *Artif. Intell. Rev.* **2014**, *41*, 67–80.
13. Sun, B.Z.; Ma, W.; Liu, Q. An approach to decision making based on intuitionistic fuzzy rough sets over two universes. *J. Oper. Res. Soc.* **2013**, *64*, 1079–1089.
14. Zhang, X.; Zhou, B.; Li, Q. A general frame for intuitionistic fuzzy rough sets. *Inf. Sci.* **2012**, *216*, 34–49.
15. Zhang, X.; Dai, J.; Yu, Y. On the union and intersection operations of rough sets based on various approximation spaces. *Inf. Sci.* **2015**, *292*, 214–229.

16. Zhang, H.; Shu, L.; Liao, S. Intuitionistic fuzzy soft rough set and its application in decision making. *Abstr. Appl. Anal.* **2014**, *2014*, 287314.
17. Zhang, H.; Xiong, L.; Ma, W. Generalized intuitionistic fuzzy soft rough set and its application in decision making. *J. Comput. Anal. Appl.* **2016**, *20*, 750–766.
18. Broumi, S.; Smarandache, F. Interval-valued neutrosophic soft rough sets. *Int. J. Comput. Math.* **2015**, *2015*, 232919.
19. Broumi, S.; Smarandache, F.; Dhar, M. Rough neutrosophic sets. *Neutrosophic Sets Syst.* **2014**, *3*, 62–67.
20. Yang, H.L.; Zhang, C.L.; Guo, Z.L.; Liu, Y.L.; Liao, X. A hybrid model of single valued neutrosophic sets and rough sets: Single valued neutrosophic rough set model. *Soft Comput.* **2016**, doi:10.1007/s00500-016-2356-y .
21. Akram, M.; Nawaz, S. Operations on soft graphs. *Fuzzy Inf. Eng.* **2015**, *7*, 423–449.
22. Akram, M.; Nawaz, S. On fuzzy soft graphs. *Ital. J. Pure Appl. Math.* **2015**, *34*, 497–514.
23. Akram, M.; Shahzadi, S. Novel intuitionistic fuzzy soft multiple-attribute decision-making methods. *Neural Comput. Appl.* **2016**, doi:10.1007/s00521-016-2543-x 1–13.
24. Shahzadi, S.; Akram, M. Intuitionistic fuzzy soft graphs with applications. *J. Appl. Math. Comput.* **2016**, *55*, 369–392.
25. Akram, M.; Shahzadi, S. Neutrosophic soft graphs with application. *J. Intell. Fuzzy Syst.* **2017**, *2*, 841–858.
26. Zafar, F.; Akram, M. A novel decision-making method based on rough fuzzy information. *Int. J. Fuzzy Syst.* **2017**, 1–15, doi:10.1007/s40815-017-0368-0.
27. Peng, T.Z.; Qiang, W.J.; Yu, Z.H. Hybrid single-valued neutrosophic MCGDM with QFD for market segment evaluation and selection. *J. Intell. Fuzzy Syst.* **2018**, *34*, 177–187.
28. Qiang, W.J.; Xu, Z.; Yu, Z.H. Hotel recommendation approach based on the online consumer reviews using interval neutrosophic linguistic numbers. *J. Intell. Fuzzy Syst.* **2018**, *34*, 381–394.
29. Luo, S.Z.; Cheng, P.F.; Wang, J.Q.; Huang, Y.J. Selecting Project Delivery Systems Based on Simplified Neutrosophic Linguistic Preference Relations. *Symmetry* **2017**, *9*, 151, doi:10.3390/sym9070151.
30. Nie, R.X.; Wang, J.Q.; Zhang, H.Y. Solving solar-wind power station location problem using an extended WASPAS technique with Interval neutrosophic sets. *Symmetry* **2017**, *9*, 106, doi:10.3390/sym9070106.
31. Wu, X.; Wang, J.; Peng, J.; Qian, J. A novel group decision-making method with probability hesitant interval neutrosophic set and its application in middle level manager's selection. *Int. J. Uncertain. Quant.* **2018**, doi:10.1615/Int.J.UncertaintyQuantification.2017020671.
32. Medina, J.; Ojeda-Aciego, M. Multi-adjoint t-concept lattices. *Inf. Sci.* **2010**, *180*, 712–725.
33. Pozna, C.; Minculete, N.; Precup, R.E.; Kóczy, L.T.; Ballagi, Á. Signatures: Definitions, operators and applications to fuzzy modeling. *Fuzzy Sets Syst.* **2012**, *201*, 86–104.
34. Nowaková, J.; Prílepok, M.; Snášel, V. Medical image retrieval using vector quantization and fuzzy S-tree. *J. Med. Syst.* **2017**, *41*, 1–16.
35. Kumar, A.; Kumar, D.; Jarial, S.K. A hybrid clustering method based on improved artificial bee colony and fuzzy C-Means algorithm. *Int. J. Artif. Intell.* **2017**, *15*, 40–60.

NN-Harmonic Mean Aggregation Operators-Based MCGDM Strategy in a Neutrosophic Number Environment

Kalyan Mondal, Surapati Pramanik, Bibhas C. Giri, Florentin Smarandache

Kalyan Mondal, Surapati Pramanik, Bibhas C. Giri, Florentin Smarandache (2018). NN-Harmonic Mean Aggregation Operators-Based MCGDM Strategy in a Neutrosophic Number Environment. *Axioms* 7, 12; DOI: 10.3390/axioms7010012

Abstract: A neutrosophic number ($a + bI$) is a significant mathematical tool to deal with indeterminate and incomplete information which exists generally in real-world problems, where a and bI denote the determinate component and indeterminate component, respectively. We define score functions and accuracy functions for ranking neutrosophic numbers. We then define a cosine function to determine the unknown weight of the criteria. We define the neutrosophic number harmonic mean operators and prove their basic properties. Then, we develop two novel multi-criteria group decision-making (MCGDM) strategies using the proposed aggregation operators. We solve a numerical example to demonstrate the feasibility, applicability, and effectiveness of the two proposed strategies. Sensitivity analysis with the variation of “ I ” on neutrosophic numbers is performed to demonstrate how the preference ranking order of alternatives is sensitive to the change of “ I ”. The efficiency of the developed strategies is ascertained by comparing the results obtained from the proposed strategies with the results obtained from the existing strategies in the literature.

Keywords: neutrosophic number; neutrosophic number harmonic mean operator (NNHMO); neutrosophic number weighted harmonic mean operator (NNWHMO); cosine function; score function; multi-criteria group decision-making

1. Introduction

Multi-criteria decision-making (MCDM), and multi-criteria group decision-making (MCGDM) are significant branches of decision theories which have been commonly applied in many scientific fields. They have been developed in many directions, such as crisp environments [1,2], and uncertain environments, namely fuzzy environments [3–13], intuitionistic fuzzy environments [14–24], and neutrosophic set environments [25–45]. Smarandache [46,47] introduced another direction of uncertainty by defining neutrosophic numbers (NN), which represent indeterminate and incomplete information in a new way. A NN consists of a determinate component and an indeterminate component. Thus, the NNs are more applicable to deal with indeterminate and incomplete information in real world problems. The NN is expressed as the function $N = p + qI$ in which p is the determinate component and qI is the indeterminate component. If $N = qI$, i.e., the indeterminate part reaches the maximum label, the worst situation occurs. If $N = p$, i.e., the indeterminate part does not appear, the best situation occurs. Thus, the application of NNs is more

appropriate to deal with the indeterminate and incomplete information in real-world decision-making situations.

Information aggregation is an essential practice of accumulating relevant information from various sources. It is used to present aggregation between the min and max operators. The harmonic mean is usually used as a mathematical tool to accumulate the central tendency of information [48].

The harmonic mean (HM) is widely used in statistics to calculate the central tendency of a set of data. Park et al. [49] proposed multi-attribute group decision-making (MAGDM) strategy based on HM operators under uncertain linguistic environments. Wei [50] proposed a MAGDM strategy based on fuzzy-induced, ordered, weighted HM. In a fuzzy environment, Xu [48] studied a fuzzy-weighted HM operator, fuzzy ordered weighted HM operator, and a fuzzy hybrid HM operator, and employed them for MADM problems. Ye [51] proposed a multi-attribute decision-making (MADM) strategy based on harmonic averaging projection for a simplified neutrosophic sets (SNS) environment.

In a NN environment, Ye [52] proposed a MAGDM using de-neutrosophication strategy and a possibility degree ranking strategy for neutrosophic numbers. Liu and Liu [53] proposed a NN generalized weighted power averaging operator for MAGDM. Zheng et al. [54] proposed a MAGDM strategy based on a NN generalized hybrid weighted averaging operator. Pramanik et al. [55] studied a teacher selection strategy based on projection and bidirectional projection measures in a NN environment.

Only four [52–55] MCGDM strategies using NNs have been reported in the literature. Motivated from the works of Ye [52], Liu and Liu [53], Zheng et al. [54], and Pramanik et al. [55], we consider the proposed strategies to handle MCGDM problems in a NN environment.

The strategies [52–55] cannot deal with the situation when larger values other than arithmetic mean, geometric mean, and harmonic mean are necessary for experimental purposes. To fill the research gap, we propose two MCGDM strategies.

In this paper, we develop two new MCGDM strategies based on a NN harmonic mean operator (NNHMO) and a NN weighted harmonic mean operator (NNWHMO) to solve MCGDM problems. We define a cosine function to determine unknown weights of the criteria. To develop the proposed strategies, we define score and accuracy functions for ranking NNs for the first time in the literature.

The rest of the paper is structured as follows: Section 2 presents some preliminaries of NNs and score and accuracy functions of NNs. Section 3 devotes NN harmonic mean operator (NNHMO) and NN weighted harmonic mean operator (NNWHMO). Section 4 defines the cosine function to determine unknown criteria weights. Section 5 presents two novel decision-making strategies based on NNHMO and NNWHMO. In Section 6, a numerical example is presented to illustrate the proposed MCGDM strategies and the results show the feasibility of the proposed MCGDM strategies. Section 7 compares the obtained results derived from the proposed strategies and the existing strategies in NN environment. Finally, Section 8 concludes the paper with some remarks and future scope of research.

2. Preliminaries

In this section, definition of harmonic and weighted harmonic mean of positive real numbers, concepts of NNs, operations on NNs, score and accuracy functions of NNs are outlined.

2.1. Harmonic Mean and Weighted Harmonic Mean

Harmonic mean is a traditional average, which is generally used to determine central tendency of data. The harmonic mean is commonly considered as a fusion method of numerical data.

Definition 1. [48]: The harmonic mean H of the positive real numbers x_1, x_2, \dots, x_n is defined as:

$$H = \frac{n}{\frac{1}{x_1} + \frac{1}{x_2} + \dots + \frac{1}{x_n}} = \frac{n}{\sum_{i=1}^n \frac{1}{x_i}}; i = 1, 2, \dots, n.$$

Definition 2. [49]: The weighted harmonic mean H of the positive real numbers x_1, x_2, \dots, x_n is defined as

$$WH = \frac{1}{\frac{w_1}{x_1} + \frac{w_2}{x_2} + \dots + \frac{w_n}{x_n}} = \frac{1}{\sum_{i=1}^n \frac{w_i}{x_i}}; i = 1, 2, \dots, n.$$

Here, $\sum_{i=1}^n w_i = 1$.

2.2. NNs

A NN [46,47] consists of a determinate component x and an indeterminate component yI , and is mathematically expressed as $z = x + yI$ for $x, y \in R$, where I is indeterminacy interval and R is the set of real numbers. A NN z can be specified as a possible interval number, denoted by $z = [x + yI^L, x + yI^U]$ for $z \in Z$ (Z is set of all NNs) and $I \in [I^L, I^U]$. The interval $I \in [I^L, I^U]$ is considered as an indeterminate interval.

- If $yI = 0$, then z is degenerated to the determinate component $z = x$
- If $x = 0$, then z is degenerated to the indeterminate component $z = yI$
- If $I^L = I^U$, then z is degenerated to a real number.

Let two NNs be $z_1 = x_1 + y_1I$ and $z_2 = x_2 + y_2I$ for $z_1, z_2 \in Z$, and $I \in [I^L, I^U]$. Some basic operational rules for z_1 and z_2 are presented as follows:

- (1) $I^2 = I$
- (2) $I \cdot 0 = 0$
- (3) $I/I = \text{Undefined}$
- (4) $z_1 + z_2 = x_1 + x_2 + (y_1 + y_2)I = [x_1 + x_2 + (y_1 + y_2)I^L, x_1 + x_2 + (y_1 + y_2)I^U]$
- (5) $z_1 - z_2 = x_1 - x_2 + (y_1 - y_2)I = [x_1 - x_2 + (y_1 - y_2)I^L, x_1 - x_2 + (y_1 - y_2)I^U]$
- (6) $z_1 \times z_2 = x_1x_2 + (x_1y_2 + x_2y_1)I + y_1y_2I^2 = x_1x_2 + (x_1y_2 + x_2y_1 + y_1y_2)I$
- (7) $\frac{z_1}{z_2} = \frac{x_1 + y_1I}{x_2 + y_2I} = \frac{x_1}{x_2} + \frac{x_2y_1 - x_1y_2}{x_2(x_2 + y_2)}I; x_2 \neq 0, x_2 \neq -y_2$
- (8) $\frac{1}{z_1} = \frac{1 + 0 \cdot I}{x_1 + y_1I} = \frac{1}{x_1} + \frac{-y_1}{x_1(x_1 + y_1)}I; x_1 \neq 0, x_1 \neq -y_1$
- (9) $z_1^2 = x_1^2 + (2x_1y_1 + y_1^2)I$
- (10) $\lambda z_1 = \lambda x_1 + \lambda y_1I$

Theorem 1. If z is a neutrosophic number then, $\frac{1}{(z)^{-1}} = z, z \neq 0$.

Proof. Let $z = x + yI$. Then,

$$\begin{aligned} \frac{1}{z} = (z)^{-1} &= \frac{1}{x} + \frac{-y}{x(x+y)}I; x \neq 0, x \neq -y \\ \frac{1}{(z)^{-1}} &= \frac{1}{\frac{1}{x} + \frac{-y}{x(x+y)}I} = \frac{y}{1/x \left(1/x - \frac{y}{x(x+y)} \right)}I; x \neq 0, x \neq -y \\ &= x + yI = z. \end{aligned}$$

□

Definition 3. For any NN $z = x + yI = [x + yI^L, x + yI^U]$, (x and y not both zeroes), its score and accuracy functions are defined, respectively, as follows:

$$Sc(z) = \left| \frac{x + y(I^U - I^L)}{2\sqrt{x^2 + y^2}} \right| \tag{1}$$

$$Ac(z) = 1 - \exp\left\langle -\left|x + y(I^U - I^L)\right| \right\rangle \tag{2}$$

Theorem 2. Both score function $Sc(z)$ and accuracy function $Ac(z)$ are bounded.

Proof.

$$x, y \in R \text{ and } I \in [0, 1]$$

$$\Rightarrow 0 \leq \frac{x}{\sqrt{x^2 + y^2}} \leq 1, 0 \leq \frac{y(I^U - I^L)}{\sqrt{x^2 + y^2}} \leq 1$$

$$\Rightarrow 0 \leq \left| \frac{x + y(I^U - I^L)}{\sqrt{x^2 + y^2}} \right| \leq 2 \Rightarrow 0 \leq \left| \frac{x + y(I^U - I^L)}{2\sqrt{x^2 + y^2}} \right| \leq 1 \Rightarrow 0 \leq S(z) \leq 1.$$

Since $0 \leq Sc(z) \leq 1$, score function is bounded.

Again:

$$0 \leq \exp\left\langle -\left|x + y(I^U - I^L)\right| \right\rangle \leq 1$$

$$\Rightarrow -1 \leq -\exp\left\langle -\left|x + y(I^U - I^L)\right| \right\rangle \leq 0$$

$$\Rightarrow 0 \leq 1 - \exp\left\langle -\left|x + y(I^U - I^L)\right| \right\rangle \leq 1$$

Since $0 \leq Ac(z) \leq 1$, accuracy function is bounded. \square

Definition 4. Let two NNs be $z_1 = x_1 + y_1I = [x_1 + y_1I^L, x_1 + y_1I^U]$, and $z_2 = x_2 + y_2I = [x_2 + y_2I^L, x_2 + y_2I^U]$, then the following comparative relations hold:

- If $S(z_1) > S(z_2)$, then $z_1 > z_2$
- If $S(z_1) = S(z_2)$ and $A(z_1) < A(z_2)$, then $z_1 < z_2$
- If $S(z_1) = S(z_2)$ and $A(z_1) = A(z_2)$, then $z_1 = z_2$.

Example 1. Let three NNs be $z_1 = 10 + 2I$, $z_2 = 12$ and $z_3 = 12 + 5I$ and $I \in [0, 0.2]$. Then,

$$S(z_1) = 0.5099, S(z_2) = 0.5, S(z_3) = 0.5577, A(z_1) = 0.999969, A(z_2) = 0.999994, A(z_3) = 0.999997.$$

We see that, $S(z_1) \succ S(z_2) = S(z_3)$, and $A(z_3) \succ S(z_2)$.

Using Definition 2, we conclude that, $z_1 \succ z_3 \succ z_2$.

3. Harmonic Mean Operators for NNs

In this section, we define harmonic mean operator and weighted harmonic mean operator for neutrosophic numbers.

3.1. NN-Harmonic Mean Operator (NNHMO)

Definition 5. Let $z_i = x_i + y_iI$ ($i = 1, 2, \dots, n$) be a collection of NNs. Then the NNHMO is defined as follows:

$$NNHMO(z_1, z_2, \dots, z_n) = n \cdot \left(\sum_{i=1}^n (z_i)^{-1} \right)^{-1} \tag{3}$$

Theorem 3. Let $z_i = x_i + y_iI$ ($i = 1, 2, \dots, n$) be a collection of NNs. The aggregated value of the NNHMO(z_1, z_2, \dots, z_n) operator is also a NN.

Proof.

$$\begin{aligned} \text{NNHMO}(z_1, z_2, \dots, z_n) &= n \cdot \left(\sum_{i=1}^n (z_i)^{-1} \right)^{-1} \\ &= n \cdot \left(\sum_{i=1}^n \frac{1}{x_i} + \sum_{i=1}^n \frac{-y_i}{x_i(x_i + y_i)} I \right)^{-1}; x_i \neq 0, x_i \neq -y_i \\ &= \frac{n}{\sum_{i=1}^n \frac{1}{x_i}} + \frac{-n \cdot \sum_{i=1}^n \frac{-y_i}{x_i(x_i + y_i)}}{\left(\sum_{i=1}^n \frac{1}{x_i} \right) \left(\sum_{i=1}^n \frac{1}{x_i} + \sum_{i=1}^n \frac{-y_i}{x_i(x_i + y_i)} \right)} I; \sum_{i=1}^n \frac{1}{x_i} \neq 0, \sum_{i=1}^n \frac{1}{x_i} \neq - \sum_{i=1}^n \frac{-y_i}{x_i(x_i + y_i)} \end{aligned}$$

This shows that NNHMO is also a NN. □

3.2. NN-Weighted Harmonic Mean Operator (NNWHMO)

Definition 6. Let $z_i = x_i + y_iI$ ($i = 1, 2, \dots, n$) be a collection of NNs and w_i ($i = 1, 2, \dots, n$) is the weight of z_i ($i = 1, 2, \dots, n$) and $\sum_{i=1}^n w_i = 1$. Then the NN-weighted harmonic mean (NNWHMO) is defined as follows:

$$\text{NNWHMO}(z_1, z_2, \dots, z_n) = \left(\sum_{i=1}^n \frac{w_i}{z_i} \right)^{-1}, z_i \neq 0 \tag{4}$$

Theorem 4. Let $z_i = x_i + y_iI$ ($i = 1, 2, \dots, n$) be a collection of NNs. The aggregated value of the NNWHMO(z_1, z_2, \dots, z_n) operator is also a NN.

Proof.

$$\begin{aligned} \text{NNWHMO}(z_1, z_2, \dots, z_n) &= \left(\sum_{i=1}^n \frac{w_i}{z_i} \right)^{-1}, z_i \neq 0 \\ &= \left(\sum_{i=1}^n w_i \left(\frac{1}{x_i} + \frac{-y_i}{x_i(x_i + y_i)} I \right) \right)^{-1}; x_i \neq 0, x_i \neq -y_i \\ &= \left(w_i \cdot \sum_{i=1}^n \frac{1}{x_i} + w_i \cdot \sum_{i=1}^n \frac{-y_i}{x_i(x_i + y_i)} I \right)^{-1}; x_i \neq 0, x_i \neq -y_i \\ &= \frac{1}{w_i \cdot \sum_{i=1}^n \frac{1}{x_i}} + \frac{-w_i \cdot \sum_{i=1}^n \frac{-y_i}{x_i(x_i + y_i)}}{\left(w_i \cdot \sum_{i=1}^n \frac{1}{x_i} \right) \left(w_i \cdot \sum_{i=1}^n \frac{1}{x_i} + w_i \cdot \sum_{i=1}^n \frac{-y_i}{x_i(x_i + y_i)} \right)} I; w_i \cdot \sum_{i=1}^n \frac{1}{x_i} \neq 0, w_i \cdot \sum_{i=1}^n \frac{1}{x_i} \neq -w_i \cdot \sum_{i=1}^n \frac{-y_i}{x_i(x_i + y_i)}; \sum_{i=1}^n w_i = 1 \end{aligned}$$

This shows that NNWHMO is also a NN. □

Example 2. Let two NNs be $z_1 = 3 + 2I$ and $z_2 = 2 + I$ and $I \in [0, 0.2]$. Then:

$$\text{NNHMO}(z_1, z_2) = 2 \left(\frac{1}{z_1} + \frac{1}{z_2} \right)^{-1} = 2 \left(\frac{1}{3+2I} + \frac{1}{2+I} \right)^{-1} = 2.4 + 0.635I.$$

Example 3. Let two NNs be $z_1 = 3 + 2I$ and $z_2 = 2 + I$, $I \in [0, 0.2]$ and $w_1 = 0.4$, $w_2 = 0.6$, then:

$$\text{NNWHMO}(z_1, z_2) = \left(w_1 \frac{1}{z_1} + w_2 \frac{1}{z_2} \right)^{-1} = \left(0.4 \frac{1}{3+2I} + 0.6 \frac{1}{2+I} \right)^{-1} = 2.308 + 1.370I.$$

The NNHMO operator and the NNWHMO operator satisfy the following properties.

P1. Idempotent law: If $z_i = z$ for $i = 1, 2, \dots, n$ then, $\text{NNHMO}(z_1, z_2, \dots, z_n) = z$ and $\text{NNWHMO}(z_1, z_2, \dots, z_n) = z$.

Proof. For, $z_i = z$, $\sum_{i=1}^n w_i = 1$,

$$\text{NNHMO}(z_1, z_2, \dots, z_n) = n \cdot \left(\sum_{i=1}^n (z_i)^{-1} \right)^{-1} = n \cdot \left(\sum_{i=1}^n (z)^{-1} \right)^{-1} = \frac{n}{n \cdot z^{-1}} = z.$$

$$\text{NNWHMO}(z_1, z_2, \dots, z_n) = \left(\sum_{i=1}^n \frac{w_i}{z_i} \right)^{-1}, z_i \neq 0 = \left(\sum_{i=1}^n \frac{w_i}{z} \right)^{-1} = \left(\sum_{i=1}^n w_i \cdot \frac{1}{z} \right)^{-1} = z.$$

□

P2. Boundedness: Both the operators are bounded.

Proof. Let $z_{\min} = \min(z_1, z_2, \dots, z_n)$, $z_{\max} = \max(z_1, z_2, \dots, z_n)$ for $i = 1, 2, \dots, n$ then, $z_{\min} \leq \text{NNHMO}(z_1, z_2, \dots, z_n) \leq z_{\max}$ and $z_{\min} \leq \text{NNWHMO}(z_1, z_2, \dots, z_n) \leq z_{\max}$.

Hence, both the operators are bounded. □

P3. Monotonicity: If $z_i \leq z_i^*$ for $i = 1, 2, \dots, n$ then, $\text{NNHMO}(z_1, z_2, \dots, z_n) \leq \text{NNHMO}(z_1^*, z_2^*, \dots, z_n^*)$ and $\text{NNWHMO}(z_1, z_2, \dots, z_n) \leq \text{NNWHMO}(z_1^*, z_2^*, \dots, z_n^*)$.

Proof. $\text{NNHMO}(z_1, z_2, \dots, z_n) - \text{NNHMO}(z_1^*, z_2^*, \dots, z_n^*) = \frac{n}{\frac{1}{z_1} + \frac{1}{z_2} + \dots + \frac{1}{z_n}} - \frac{n}{\frac{1}{z_1^*} + \frac{1}{z_2^*} + \dots + \frac{1}{z_n^*}} \leq 0$,

since $z_i \leq z_i^*$ or $\frac{1}{z_i} \geq \frac{1}{z_i^*}$, for $i = 1, 2, \dots, n$.

Again,

$$\text{NNWHMO}(z_1, z_2, \dots, z_n) - \text{NNWHMO}(z_1^*, z_2^*, \dots, z_n^*) = \frac{1}{\frac{w_1}{z_1} + \frac{w_2}{z_2} + \dots + \frac{w_n}{z_n}} - \frac{1}{\frac{w_1}{z_1^*} + \frac{w_2}{z_2^*} + \dots + \frac{w_n}{z_n^*}} \leq 0$$
 ,

since $z_i \leq z_i^*$ or $\frac{1}{z_i} \geq \frac{1}{z_i^*}$, ≤ 0 , for $z_i \leq z_i^*$; $\sum_{i=1}^n w_i = 1$; ($i = 1, 2, \dots, n$).

This proves the monotonicity of the functions $\text{NNHMO}(z_1, z_2, \dots, z_n)$ and $\text{NNWHMO}(z_1, z_2, \dots, z_n)$. □

P4. Commutativity: If $(z_1^\circ, z_2^\circ, \dots, z_n^\circ)$ be any permutation of (z_1, z_2, \dots, z_n) then, $\text{NNHMO}(z_1, z_2, \dots, z_n) = \text{NNHMO}(z_1^\circ, z_2^\circ, \dots, z_n^\circ)$ and $\text{NNWHMO}(z_1, z_2, \dots, z_n) = \text{NNWHMO}(z_1^\circ, z_2^\circ, \dots, z_n^\circ)$.

Proof. $NNHMO(z_1, z_2, \dots, z_n) - NNHMO(z_1^{\circ}, z_2^{\circ}, \dots, z_n^{\circ}) = n \left(\sum_{i=1}^n (z_i)^{-1} \right)^{-1} - n \left(\sum_{i=1}^n (z_i^*)^{-1} \right)^{-1} = 0$, because, $(z_1^{\circ}, z_2^{\circ}, \dots, z_n^{\circ})$ is any permutation of (z_1, z_2, \dots, z_n) .

Hence, we have $NNHMO(z_1, z_2, \dots, z_n) = NNHMO(z_1^{\circ}, z_2^{\circ}, \dots, z_n^{\circ})$.

Again:

$NNWHMO(z_1, z_2, \dots, z_n) - NNWHMO(z_1^{\circ}, z_2^{\circ}, \dots, z_n^{\circ}) = \left(\sum_{i=1}^n w_i (z_i)^{-1} \right)^{-1} - \left(\sum_{i=1}^n w_i (z_i^*)^{-1} \right)^{-1} = 0$, because, $(z_1^{\circ}, z_2^{\circ}, \dots, z_n^{\circ})$ is any permutation of (z_1, z_2, \dots, z_n) .

Hence, we have $NNWHMO(z_1, z_2, \dots, z_n) = NNWHMO(z_1^{\circ}, z_2^{\circ}, \dots, z_n^{\circ})$. □

4. Cosine Function for Determining Unknown Criteria Weights

When criteria weights are completely unknown to decision-makers, the entropy measure [56] can be used to calculate criteria weights. Biswas et al. [57] employed entropy measure for MADM problems to determine completely unknown attribute weights of single valued neutrosophic sets (SVNSs). Literature review reflects that, strategy to determine unknown weights in the NN environment is yet to appear. In this paper, we propose a cosine function to determine unknown criteria weights.

Definition 7. The cosine function of a NN $P = x_{ij} + y_{ij}I = [x_{ij} + y_{ij}I^L, x_{ij} + y_{ij}I^U]$, $(i = 1, 2, \dots, m; j = 1, 2, \dots, n)$ is defined as follows:

$$COS_j(P) = \frac{1}{n} \sum_{i=1}^n \cos \frac{\pi}{2} \left(\frac{y_{ij}}{\sqrt{x_{ij}^2 + y_{ij}^2}} \right), \quad (x_{ij} \text{ and } y_{ij} \text{ are not both zeroes}) \tag{5}$$

The weight structure is defined as follows:

$$w_j = \frac{COS_j(P)}{\sum_{j=1}^n COS_j(P)}; j = 1, 2, \dots, n \ \& \ \sum_{j=1}^n w_j = 1 \tag{6}$$

The cosine function $COS_j(P)$ satisfies the following properties:

- P1. $COS_j(P) = 1$, if $y_{ij} = 0$ and $x_{ij} \neq 0$
- P2. $COS_j(P) = 0$, if $x_{ij} = 0$ and $y_{ij} \neq 0$.
- P3. $COS_j(P) \geq COS_j(Q)$, if x_{ij} of $P > x_{ij}$ of Q or y_{ij} of $P < y_{ij}$ of Q or both.

Proof.

- P1. $y_{ij} = 0 \Rightarrow COS_j(P) = \frac{1}{n} \sum_{i=1}^n [\cos 0] = 1$
- P2. $x_{ij} = 0 \Rightarrow COS_j(P) = \frac{1}{n} \sum_{i=1}^n \left[\cos \frac{\pi}{2} \right] = 0$
- P3. For, x_{ij} of $P > x_{ij}$ of Q
 \Rightarrow Determinate part of $P >$ Determinate part of Q
 $\Rightarrow COS_j(Q) < COS_j(P)$.
 For, y_{ij} of $P < y_{ij}$ of Q
 \Rightarrow Indeterminacy part of $P <$ Indeterminacy part of Q
 $\Rightarrow COS_j(Q) > COS_j(P)$.
 For, x_{ij} of $P > x_{ij}$ of Q and y_{ij} of $P < y_{ij}$ of Q

\Rightarrow (Real part of $P >$ Real part of Q) & (Indeterminacy part of $P <$ Indeterminacy part of Q)
 $\Rightarrow \text{COS}_j(Q) > \text{COS}_j(P) . \square$

Example 4. Let two NNs be $z_1 = 3 + 2I$, and $z_2 = 3 + 5I$, then, $\text{COS}(z_1) = 0.9066$, $\text{COS}(z_2) = 0.7817$.

Example 5. Let two NNs be $z_1 = 3 + I$, and $z_2 = 7 + I$, then, $\text{COS}(z_1) = 0.9693$, $\text{COS}(z_2) = 0.9938$.

Example 6. Let two NNs be $z_1 = 10 + 2I$, and $z_2 = 2 + 10I$, then, $\text{COS}(z_1) = 0.9882$, $\text{COS}(z_2) = 0.7178$.

5. Multi-Criteria Group Decision-Making Strategies Based on NNHMO and NNWHMO

Two MCGDM strategies using the NNHMO and NNWHMO respectively are developed in this section. Suppose that $A = \{A_1, A_2, \dots, A_m\}$ is a set of alternatives, $C = \{C_1, C_2, \dots, C_n\}$ is a set of criteria and $DM = \{DM_1, DM_2, \dots, DM_k\}$ is a set of decision-makers. Decision-makers' assessment for each alternative A_i will be based on each criterion C_j . All the assessment values are expressed by NNs. Steps of decision making strategies based on proposed NNHMO and NNWHMO to solve MCGDM problems are presented below.

5.1. MCGDM Strategy 1 (Based on NNHMO)

Strategy 1 is presented (see Figure 1) using the following six steps:

Step 1. Determine the relation between alternatives and criteria.

Each decision-maker forms a NN decision matrix. The relation between the alternative A_i ($i = 1, 2, \dots, m$) and the criterion C_j ($j = 1, 2, \dots, n$) is presented in Equation (7).

$$DM_k[A | C] = \begin{matrix} & \begin{matrix} C_1 & C_2 & \dots & C_n \end{matrix} \\ \begin{matrix} A_1 \\ A_2 \\ \vdots \\ A_m \end{matrix} & \begin{pmatrix} \langle x_{11} + y_{11}I \rangle_k & \langle x_{12} + y_{12}I \rangle_k & \dots & \langle x_{1n} + y_{1n}I \rangle_k \\ \langle x_{21} + y_{21}I \rangle_k & \langle x_{22} + y_{22}I \rangle_k & \dots & \langle x_{2n} + y_{2n}I \rangle_k \\ \vdots & \vdots & \ddots & \vdots \\ \langle x_{m1} + y_{m1}I \rangle_k & \langle x_{m2} + y_{m2}I \rangle_k & \dots & \langle x_{mn} + y_{mn}I \rangle_k \end{pmatrix} \end{matrix} \quad (7)$$

Note 1: Here, $\langle x_{ij} + y_{ij}I \rangle_k$ represents the NN rating value of the alternative A_i with respect to the criterion C_j for the decision-maker DM_k .

Step 2. Using Equation (3), determine the aggregation values ($DM_k^{aggr}(A_i)$), ($i = 1, 2, \dots, n$) for all decision matrices.

Step 3. To fuse all the aggregation values ($DM_k^{aggr}(A_i)$), corresponding to alternatives A_i , we define the averaging function as follows:

$$DM^{aggr}(A_i) = \sum_{t=1}^k w_t (DM_t^{aggr}(A_i)); \sum_{t=1}^k w_t = 1. (i = 1, 2, \dots, n; t = 1, 2, \dots, k) \quad (8)$$

Here, w_t ($t = 1, 2, \dots, k$) is the weight of the decision-maker DM_t .

Step 4. Determine the preference ranking order.

Using Equation (1), determine the score values $Sc(z_i)$ (accuracy degrees $Ac(z_i)$, if necessary) ($i = 1, 2, \dots, m$) of all alternatives A_i . All the score values are arranged in descending order. The alternative corresponding to the highest score value (accuracy values) reflects the best choice.

Step 5. Select the best alternative from the preference ranking order.

Step 6. End.

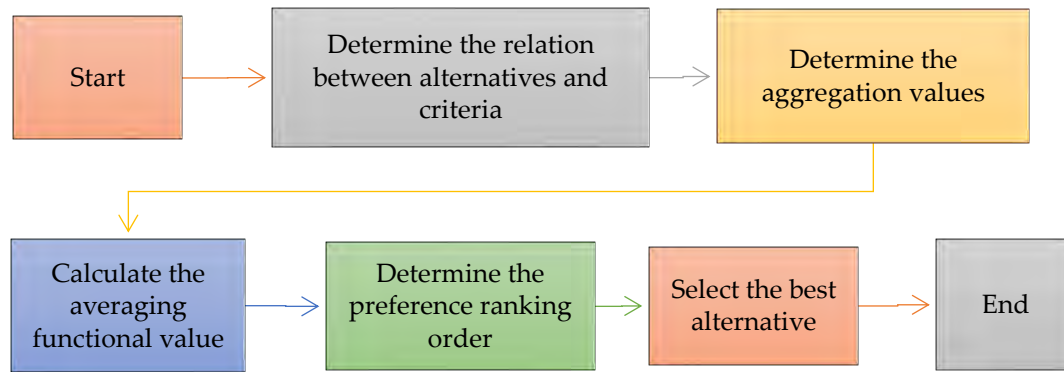

Figure 1. Steps of MCGDM Strategy 1 based on NNHMO.

5.2. MCGDM Strategy 2 (Based on NNWHMO)

Strategy 2 is presented (see Figure 2) using the following seven steps:

Step 1. This step is similar to the first step of Strategy 1.

Step 2. Determine the criteria weights.

Using Equation (6), determine the criteria weights from decision matrices $(DM_t[A|C])$, $(t = 1, 2, \dots, k)$.

Step 3. Determine the weighted aggregation values $(DM^{waggr}_k(A_i))$.

Using Equation (4), determine the weighted aggregation values $(DM^{waggr}_k(A_i))$, $(i = 1, 2, \dots, n)$ for all decision matrices.

Step 4. Determine the averaging values.

To fuse all the weighted aggregation values $(DM^{waggr}_k(A_i))$, corresponding to alternatives A_i , we define the averaging function as follows:

$$DM^{waggr}(A_i) = \sum_{t=1}^k w_t (DM^{waggr}_t(A_i)) \quad (i = 1, 2, \dots, n; t = 1, 2, \dots, k) \quad (9)$$

Here, w_t $(t = 1, 2, \dots, k)$ is the weight of the decision maker DM_t .

Step 5. Determine the ranking order.

Using Equation (1), determine the score values $S(z_i)$ (accuracy degrees $A(z_i)$, if necessary) $(i = 1, 2, \dots, m)$ of all alternatives A_i . All the score values are arranged in descending order. The alternative corresponding to the highest score value (accuracy values) reflects the best choice.

Step 6. Select the best alternative from the preference ranking order.

Step 7. End.

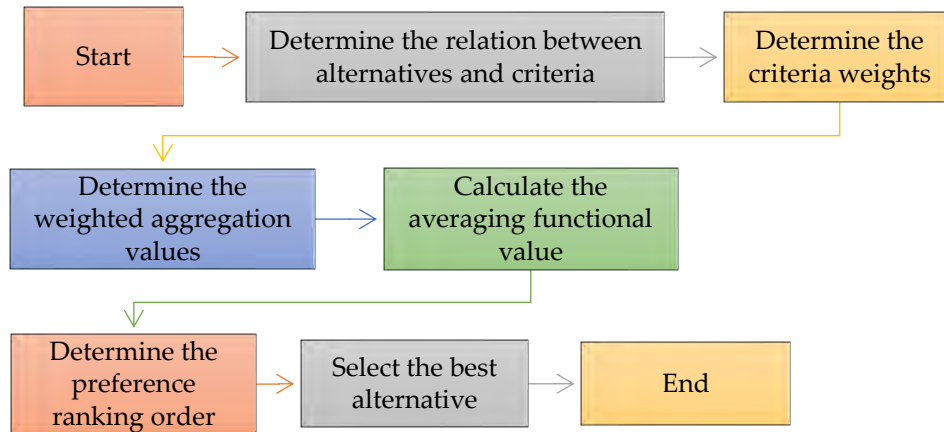

Figure 2. Steps of MCGDM strategy based on NNWHMO.

6. Simulation Results

We solve a numerical example studied by Zheng et al. [54]. An investment company desires to invest a sum of money in the best investment fund. There are four possible selection options to invest the money. Feasible selection options are namely, A_1 : Car company (CARC); A_2 : Food company (FOODC); A_3 : Computer company (COMC); A_4 : Arms company (ARMC). Decision-making must be based on the three criteria namely, risk analysis (C_1), growth analysis (C_2), environmental impact analysis (C_3). The four possible selection options/alternatives are to be selected under the criteria by the NN assessments provided by the three decision-makers DM_1 , DM_2 , and DM_3 .

6.1. Solution Using MCGDM Strategy 1

Step 1. Determine the relation between alternatives and criteria.

All assessment values are provided by the following three NN based decision matrices (shown in Equations (10)–(12).

$$DM_1[L | C] = \begin{matrix} & \begin{matrix} C_1 & C_2 & C_3 \end{matrix} \\ \begin{matrix} A_1 \\ A_2 \\ A_3 \\ A_4 \end{matrix} & \begin{pmatrix} 4+I & 5 & 3+I \\ 6 & 6 & 5 \\ 3 & 5+I & 6 \\ 7 & 6 & 4+I \end{pmatrix} \end{matrix} \quad (10)$$

$$DM_2[L | C] = \begin{matrix} & \begin{matrix} C_1 & C_2 & C_3 \end{matrix} \\ \begin{matrix} A_1 \\ A_2 \\ A_3 \\ A_4 \end{matrix} & \begin{pmatrix} 5 & 4 & 4 \\ 5+I & 6 & 6 \\ 4 & 5 & 5+I \\ 6+I & 6 & 5 \end{pmatrix} \end{matrix} \quad (11)$$

$$DM_3[L | C] = \begin{matrix} & \begin{matrix} C_1 & C_2 & C_3 \end{matrix} \\ \begin{matrix} A_1 \\ A_2 \\ A_3 \\ A_4 \end{matrix} & \begin{pmatrix} 4 & 5+I & 4 \\ 6 & 7 & 5+I \\ 4+I & 5 & 6 \\ 8 & 6 & 4+I \end{pmatrix} \end{matrix} \quad (12)$$

Note 2: Here, $DM_1[L | C]$, $DM_2[L | C]$ and $DM_3[L | C]$ are the decision matrices for the decision makers DM_1 , DM_2 and DM_3 respectively.

Step 2. Determine the weighted aggregation values ($DM_k^{agg}(A_i)$).

Using Equation (3), we calculate the aggregation values ($DM_k^{agg}(A_i)$) as follows:

$$DM_1^{agg}(A_1)=3.829+0.785I; DM_1^{agg}(A_2)=5.625; DM_1^{agg}(A_3)=4.285+0.214I; DM_1^{agg}(A_4)=5.362+0.514I;$$

$$DM_2^{agg}(A_1)=4.285; DM_2^{agg}(A_2)=5.206+0.415I; DM_2^{agg}(A_3)=4.196+0.532I; DM_2^{agg}(A_4)=5.234+0.618I;$$

$$DM_3^{agg}(A_1)=4.019+0.605I; DM_3^{agg}(A_2)=5.817+0.433I; DM_3^{agg}(A_3)=4.876+0.387I; DM_3^{agg}(A_4)=6.023+0.257I.$$

Step 3. Determine the averaging values.

Using Equation (8), we calculate the averaging values (Considering equal importance of all the decision makers) to fuse all the aggregation values corresponding to the alternative A_i .

$$DM^{agg}(A_1) = 4.044 + 0.463I; DM^{agg}(A_2) = 5.549 + 0.282I; DM^{agg}(A_3) = 4.452 + 0.378I; DM^{agg}(A_4) = 5.539 + 0.463I.$$

Step 4. Using Equation (1), we calculate the score values $Sc(A_i)$ ($i = 1, 2, 3, 4$). Sensitivity analysis and ranking order of alternatives are shown in Table 1 for different values of I .

Table 1. Sensitivity analysis and ranking order with variation of “ I ” on NNs for strategy 1.

I	$Sc(A_i)$	Ranking Order
$I = [0, 0]$	$S(A_1) = 0.4988, S(A_2) = 0.4993, S(A_3) = 0.4982, S(A_4) = 0.4983$	$A_2 \succ A_1 \succ A_4 \succ A_3$
$I \in [0, 0.2]$	$S(A_1) = 0.5081, S(A_2) = 0.5144, S(A_3) = 0.5067, S(A_4) = 0.5056$	$A_2 \succ A_1 \succ A_3 \succ A_4$
$I \in [0, 0.4]$	$S(A_1) = 0.5182, S(A_2) = 0.5195, S(A_3) = 0.5151, S(A_4) = 0.5249$	$A_2 \succ A_1 \succ A_4 \succ A_3$
$I \in [0, 0.6]$	$S(A_1) = 0.5289, S(A_2) = 0.5346, S(A_3) = 0.5236, S(A_4) = 0.5233$	$A_2 \succ A_1 \succ A_3 \succ A_4$
$I \in [0, 0.8]$	$S(A_1) = 0.5396, S(A_2) = 0.5497, S(A_3) = 0.5320, S(A_4) = 0.5316$	$A_2 \succ A_1 \succ A_3 \succ A_4$
$I \in [0, 1]$	$S(A_1) = 0.5503, S(A_2) = 0.5547, S(A_3) = 0.5405, S(A_4) = 0.5399$	$A_2 \succ A_1 \succ A_3 \succ A_4$

Step 5. Food company (FOODC) is the best alternative for investment.

Step 6. End.

Note 3: In Figure 3, we represent ranking order of alternatives with variation of “ I ” based on strategy 1. Figure 3 reflects that various values of I , ranking order of alternatives are different. However, the best choice is the same.

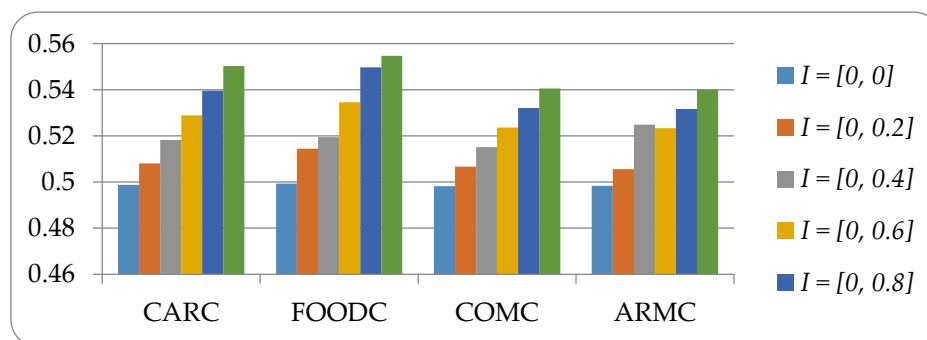

Figure 3. Ranking order with variation of ‘ I ’ based on strategy 1.

6.2. Solution Using MCGDM Strategy 2

Step 1. Determine the relation between alternatives and criteria.

This step is similar to the first step of strategy 1.

Step 2. Determine the criteria weights.

Using Equations (5) and (6), criteria weights are calculated as follows:

$$[w_1 = 0.3265, w_2 = 0.3430, w_3 = 0.3305] \text{ for } DM_1,$$

$$[w_1 = 0.3332, w_2 = 0.3334, w_3 = 0.3334] \text{ for } DM_2,$$

$$[w_1 = 0.3333, w_2 = 0.3335, w_3 = 0.3332] \text{ for } DM_3.$$

Step 3. Determine the weighted aggregation values ($DM^{wagg}_k(A_i)$).

Using Equation (4), we calculate the aggregation values ($DM^{agg}_k(A_i)$) as follows:

$$DM^{agg}_1(A_1)=3.861+0.774I; DM^{agg}_1(A_2)=6.006; DM^{agg}_1(A_3)=4.307+0.234I; DM^{agg}_1(A_4)=5.399+0.541I;$$

$$DM^{agg}_2(A_1)=4.288; DM^{agg}_2(A_2)=5.219+0.429I; DM^{agg}_2(A_3)=4.206+0.541I; DM^{agg}_2(A_4)=5.251+0.629I;$$

$$DM^{agg}_3(A_1)=4.024+0.616I; DM^{agg}_3(A_2)=5.824+0.445I; DM^{agg}_3(A_3)=4.889+0.393I; DM^{agg}_3(A_4)=6.029+0.265I.$$

Step 4. Determine the averaging values.

Using Equation (9), we calculate the averaging (Considering equal importance of all the decision makers to fuse all the aggregation values corresponding to the alternative A_i).

$$DM^{agg}(A_1) = 4.057 + 0.463I; DM^{agg}(A_2) = 5.568 + 0.291I; DM^{agg}(A_3) = 4.467 + 0.389I; DM^{agg}(A_4) = 5.559 + 0.478I.$$

Step 5. Determine the ranking order.

Using Equation (1), we calculate the score values $Sc(A_i)$ ($i = 1, 2, 3, 4$). Since scores values are different, accuracy values are not required. Sensitivity analysis and ranking order of alternatives are shown in Table 2 for different values of I .

Table 2. Sensitivity analysis and ranking order with variation of “ I ” on NNs for strategy 2.

I	$Sc(A_i)$	Ranking Order
$I = 0$	$S(A_1) = 0.4968, S(A_2) = 0.4993, S(A_3) = 0.4981, S(A_4) = 0.4982$	$A_2 \succ A_4 \succ A_3 \succ A_1$
$I \in [0, 0.2]$	$S(A_1) = 0.5081, S(A_2) = 0.5095, S(A_3) = 0.5068, S(A_4) = 0.5067$	$A_2 \succ A_1 \succ A_4 \succ A_3$
$I \in [0, 0.4]$	$S(A_1) = 0.5195, S(A_2) = 0.5198, S(A_3) = 0.5155, S(A_4) = 0.5153$	$A_2 \succ A_1 \succ A_3 \succ A_4$
$I \in [0, 0.6]$	$S(A_1) = 0.5308, S(A_2) = 0.5350, S(A_3) = 0.5241, S(A_4) = 0.5239$	$A_2 \succ A_1 \succ A_3 \succ A_4$
$I \in [0, 0.8]$	$S(A_1) = 0.5421, S(A_2) = 0.5502, S(A_3) = 0.5328, S(A_4) = 0.5324$	$A_2 \succ A_1 \succ A_3 \succ A_4$
$I \in [0, 1]$	$S(A_1) = 0.5535, S(A_2) = 0.5654, S(A_3) = 0.5415, S(A_4) = 0.5410$	$A_2 \succ A_1 \succ A_3 \succ A_4$

Step 6. Food company (FOODC) is the best alternative for investment.

Step 7. End.

Note 4: In Figure 4, we represent ranking order of alternatives with variation of “ I ” based on strategy 2. Figure 4 reflects that various values of I , ranking order of alternatives are different. However, the best choice is the same.

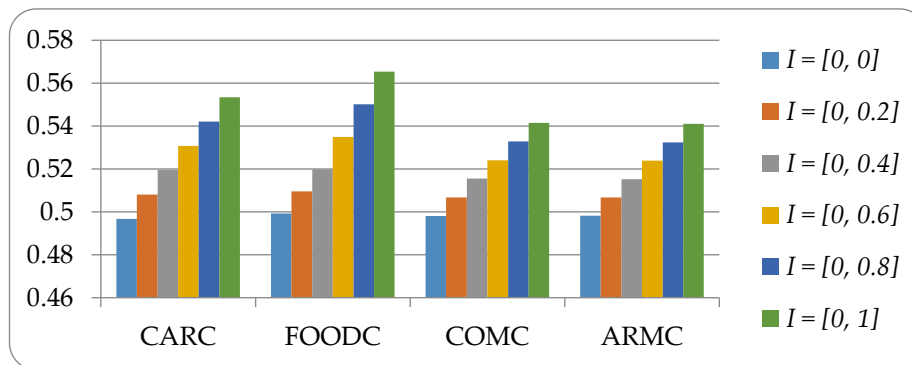

Figure 4. Ranking order with variation of ‘ I ’ on NNs for Strategy 2.

7. Comparison Analysis and Contributions of the Proposed Approach

7.1. Comparison Analysis

In this subsection, a comparison analysis is conducted between the proposed MCGDM strategies and the other existing strategies in the literature in NN environment. Table 1 reflects that A_2 is the best alternative for $I = 0$ and $I \neq 0$ i.e., for all cases considered. Table 2 reflects that A_2 is the best alternative for any values of I . Ranking order differs for different values of I .

The ranking results obtained from the existing strategies [52–54] are furnished in Table 3. The ranking orders of Ye [52] and Zheng et al. [54] are similar for all values of I considered. When I lies in $[0, 0]$, $[0, 0.2]$, $[0, 0.4]$, A_2 is the best alternative for [52–54] and the proposed strategies. When I lies in $[0, 0.6]$, $[0, 0.8]$, $[0, 1]$, A_4 is the best alternative for [52,54], whereas A_2 is the best alternative for [53], and the proposed strategies.

Table 3. Comparison of ranking preference order with variation of ‘ I ’ on NNs for different strategies.

I	Ye [52]	Zheng et al. [54]	Liu and Liu [53]	Proposed Strategy 1	Proposed Strategy 2
$[0, 0]$	$A_2 \succ A_4 \succ A_3 \succ A_1$	$A_2 \succ A_4 \succ A_3 \succ A_1$	$A_2 \succ A_4 \succ A_1 \succ A_3$	$A_2 \succ A_1 \succ A_4 \succ A_3$	$A_2 \succ A_4 \succ A_3 \succ A_1$
$[0, 0.2]$	$A_2 \succ A_4 \succ A_3 \succ A_1$	$A_2 \succ A_4 \succ A_3 \succ A_1$	$A_2 \succ A_3 \succ A_1 \succ A_4$	$A_2 \succ A_1 \succ A_3 \succ A_4$	$A_2 \succ A_1 \succ A_4 \succ A_3$
$[0, 0.4]$	$A_2 \succ A_4 \succ A_3 \succ A_1$	$A_2 \succ A_4 \succ A_3 \succ A_1$	$A_2 \succ A_3 \succ A_4 \succ A_1$	$A_2 \succ A_1 \succ A_4 \succ A_3$	$A_2 \succ A_1 \succ A_3 \succ A_4$
$[0, 0.6]$	$A_4 \succ A_2 \succ A_3 \succ A_1$	$A_4 \succ A_2 \succ A_3 \succ A_1$	$A_2 \succ A_3 \succ A_4 \succ A_1$	$A_2 \succ A_1 \succ A_3 \succ A_4$	$A_2 \succ A_1 \succ A_3 \succ A_4$
$[0, 0.8]$	$A_4 \succ A_2 \succ A_3 \succ A_1$	$A_4 \succ A_2 \succ A_3 \succ A_1$	$A_2 \succ A_3 \succ A_4 \succ A_1$	$A_2 \succ A_1 \succ A_3 \succ A_4$	$A_2 \succ A_1 \succ A_3 \succ A_4$
$[0, 1]$	$A_4 \succ A_2 \succ A_3 \succ A_1$	$A_4 \succ A_2 \succ A_3 \succ A_1$	$A_2 \succ A_4 \succ A_3 \succ A_1$	$A_2 \succ A_1 \succ A_3 \succ A_4$	$A_2 \succ A_1 \succ A_3 \succ A_4$

In strategy [52], deneutrosophication process is analyzed. It does not recognize the importance of the aggregation information. MCGDM due to Liu and Liu [53] is based on NN generalized weighted power averaging operator. This strategy cannot deal the situation when larger value other than arithmetic mean, geometric mean, and harmonic mean is necessary for experimental purpose.

The strategy proposed by Zheng et al. [54] cannot be used when few observations contribute disproportionate amount to the arithmetic mean. The proposed two MCGDM strategies are free from these shortcomings.

7.2. Contributions of the Proposed Approach

- NNHMO and NNWHMO in NN environment are firstly defined in the literature. We have also proved their basic properties.
- We have proposed score and accuracy functions of NN numbers for ranking. If two score values are same, then accuracy function can be used for ranking purpose.
- The proposed two strategies can also be used when observations/experiments contribute is disproportionate amount to the arithmetic mean. The harmonic mean is used when sample values contain fractions and/or extreme values (either too small or too big).
- To calculate unknown weights structure of criteria in NN environment, we have proposed cosine function.
- Steps and calculations of the proposed strategies are easy to use.
- We have solved a numerical example to show the feasibility, applicability, and effectiveness of the proposed two strategies.

8. Conclusions

In the study, we have proposed NNHMO and NNWHMO. We have developed two strategies of ranking NNs based on proposed score and accuracy functions. We have proposed a cosine function to determine unknown weights of the criteria in a NN environment. We have developed two novel MCGDM strategies based on the proposed aggregation operators. We have solved a hypothetical case study and compared the obtained results with other existing strategies to demonstrate the effectiveness of the proposed MCGDM strategies. Sensitivity analysis for different values of I is also conducted to show the influence of I in preference ranking of the alternatives. The proposed MCGDM strategies can be applied in supply selection, pattern recognition, cluster analysis, medical diagnosis, etc.

References

1. Hwang, L.; Lin, M.J. *Group Decision Making under Multiple Criteria: Methods and Applications*; Springer: Heidelberg, Germany, 1987.
2. Hwang, C.; Yoon, K. *Multiple Attribute Decision Making, Methods and Applications*; Springer: New York, NY, USA, 1981; Volume 186.
3. Chen, S.J.; Hwang, C.L. *Fuzzy Multiple Attribute Decision-Making, Methods and Applications*; Lecture Notes in Economics and Mathematical Systems; Springer: Berlin/Heidelberg, Germany, 1992; Volume 375.
4. Chang, T.H.; Wang, T.C. Using the fuzzy multi-criteria decision making approach for measuring the possibility of successful knowledge management. *Inf. Sci.* **2009**, *179*, 355–370.
5. Krohling, R.A.; De Souza, T.T.M. Combining prospect theory and fuzzy numbers to multi-criteria decision making. *Exp. Syst. Appl.* **2012**, *39*, 11487–11493.
6. Chen, C.T. Extension of the TOPSIS for group decision-making under fuzzy environment. *Fuzzy Sets Syst.* **2000**, *114*, 1–9.
7. Zhang, G.; Lu, J. An integrated group decision-making method dealing with fuzzy preferences for alternatives and individual judgments for selection criteria. *Group Decis. Negot.* **2003**, *12*, 501–515.
8. Krohling, R.A.; Campanharo, V.C. Fuzzy TOPSIS for group decision making: A case study for accidents with oil spill in the sea. *Exp. Syst. Appl.* **2011**, *38*, 4190–4197.
9. Xia, M.; Xu, Z. A novel method for fuzzy multi-criteria decision making. *Int. J. Inf. Technol. Decis. Mak.* **2014**, *13*, 497–519.
10. Mehlawat, M.K.; Gupta, P. A new fuzzy group multi-criteria decision making method with an application to the critical path selection. *Int. J. Adv. Manuf. Technol.* **2015**, doi:10.1007/s00170-015-7610-4.
11. Lin, L.; Yuan, X.H.; Xia, Z.Q. Multicriteria fuzzy decision-making based on intuitionistic fuzzy sets. *J. Comput. Syst. Sci.* **2007**, *73*, 84–88.
12. Liu, H.W.; Wang, G.J. Multi-criteria decision-making methods based on intuitionistic fuzzy sets. *Eur. J. Oper. Res.* **2007**, *179*, 220–233.
13. Pramanik, S.; Mondal, K. Weighted fuzzy similarity measure based on tangent function and its application to medical diagnosis. *Int. J. Innov. Res. Sci. Eng. Technol.* **2015**, *4*, 158–164.
14. Pramanik, S.; Mukhopadhyaya, D. Grey relational analysis based intuitionistic fuzzy multi-criteria group decision-making approach for teacher selection in higher education. *Int. J. Comput. Appl.* **2011**, *34*, 21–29, doi:10.5120/4138-5985.
15. Mondal, K.; Pramanik, S. Intuitionistic fuzzy multi criteria group decision making approach to quality-brick selection problem. *J. Appl. Quant. Methods* **2014**, *9*, 35–50.
16. Dey, P.P.; Pramanik, S.; Giri, B.C. Multi-criteria group decision making in intuitionistic fuzzy environment based on grey relational analysis for weaver selection in Khadi institution. *J. Appl. Quant. Methods* **2015**, *10*, 1–14.
17. Ye, J. Multicriteria fuzzy decision-making method based on the intuitionistic fuzzy cross-entropy. In Proceedings of the International Conference on Intelligent Human-Machine Systems and Cybernetics, Hangzhou, China, 26–27 August 2009.
18. Chen, S.M.; Chang, C.H. A novel similarity measure between Atanassov's intuitionistic fuzzy sets based on transformation techniques with applications to pattern recognition. *Inf. Sci.* **2015**, *291*, 96–114.
19. Chen, S.M.; Cheng, S.H.; Chiou, C.H. Fuzzy multi-attribute group decision making based on intuitionistic fuzzy sets and evidential reasoning methodology. *Inf. Fusion* **2016**, *27*, 215–227.

20. Wang, J.Q.; Han, Z.Q.; Zhang, H.Y. Multi-criteria group decision making method based on intuitionistic interval fuzzy information. *Group Decis. Negot.* **2014**, *23*, 715–733.
21. Yue, Z.L. TOPSIS-based group decision-making methodology in intuitionistic fuzzy setting. *Inf. Sci.* **2014**, *277*, 141–153.
22. He, X.; Liu, W.F. An intuitionistic fuzzy multi-attribute decision-making method with preference on alternatives. *Oper. Res Manag. Sci.* **2013**, *22*, 36–40.
23. Mondal, K.; Pramanik, S. Intuitionistic fuzzy similarity measure based on tangent function and its application to multi-attribute decision making. *Glob. J. Adv. Res.* **2015**, *2*, 464–471.
24. Peng, H.G.; Wang, J.Q.; Cheng, P.F. A linguistic intuitionistic multi-criteria decision-making method based on the Frank Heronian mean operator and its application in evaluating coal mine safety. *Int. J. Mach. Learn. Cybern.* **2016**, doi:10.1007/s13042-016-0630-z.
25. Liang, R.X.; Wang, J.Q.; Zhang, H.Y. A multi-criteria decision-making method based on single-valued trapezoidal neutrosophic preference relations with complete weight information. *Neural Comput. Appl.* **2017**, doi:10.1007/s00521-017-2925-8.
26. Wang, J.Q.; Yang, Y.; Li, L. Multi-criteria decision-making method based on single-valued neutrosophic linguistic Maclaurin symmetric mean operators. *Neural Comput. Appl.* **2016**, doi:10.1007/s00521-016-2747-0.
27. Kharal, A. A neutrosophic multi-criteria decision making method. *New Math. Nat. Comput.* **2014**, *10*, 143–162.
28. Ye, J. Multiple attribute group decision-making method with completely unknown weights based on similarity measures under single valued neutrosophic environment. *J. Intell. Fuzzy Syst.* **2014**, *27*, 2927–2935.
29. Mondal, K.; Pramanik, S. Multi-criteria group decision making approach for teacher recruitment in higher education under simplified neutrosophic environment. *Neutrosophic Sets Syst.* **2014**, *6*, 28–34.
30. Biswas, P.; Pramanik, S.; Giri, B.C. A new methodology for neutrosophic multi-attribute decision-making with unknown weight information. *Neutrosophic Sets Syst.* **2014**, *3*, 44–54.
31. Biswas, P.; Pramanik, S.; Giri, B.C. Cosine similarity measure based multi-attribute decision-making with trapezoidal fuzzy neutrosophic numbers. *Neutrosophic Sets Syst.* **2014**, *8*, 46–56.
32. Mondal, K.; Pramanik, S. Neutrosophic decision making model for clay-brick selection in construction field based on grey relational analysis. *Neutrosophic Sets Syst.* **2015**, *9*, 64–71.
33. Mondal, K.; Pramanik, S. Neutrosophic tangent similarity measure and its application to multiple attribute decision making. *Neutrosophic Sets Syst.* **2015**, *9*, 85–92.
34. Pramanik, S.; Biswas, P.; Giri, B.C. Hybrid vector similarity measures and their applications to multi-attribute decision making under neutrosophic environment. *Neural Comput. Appl.* **2015**, doi:10.1007/s00521-015-2125-3.
35. Sahin, R.; Küçük, A. Subsethood measure for single valued neutrosophic sets. *J. Intell. Fuzzy Syst.* **2015**, *29*, 525–530.
36. Mondal, K.; Pramanik, S. Neutrosophic decision making model of school choice. *Neutrosophic Sets Syst.* **2015**, *7*, 62–68.
37. Ye, J. An extended TOPSIS method for multiple attribute group decision making based on single valued neutrosophic linguistic numbers. *J. Intell. Fuzzy Syst.* **2015**, *28*, 247–255.
38. Biswas, P.; Pramanik, S.; Giri, B.C. TOPSIS method for multi-attribute group decision-making under single-valued neutrosophic environment. *Neural Comput. Appl.* **2016**, *27*, 727–737.
39. Biswas, P.; Pramanik, S.; Giri, B.C. Value and ambiguity index based ranking method of single-valued trapezoidal neutrosophic numbers and its application to multi-attribute decision making. *Neutrosophic Sets Syst.* **2016**, *12*, 127–138.
40. Biswas, P.; Pramanik, S.; Giri, B.C. Aggregation of triangular fuzzy neutrosophic set information and its application to multi-attribute decision making. *Neutrosophic Sets Syst.* **2016**, *12*, 20–40.
41. Smarandache, F.; Pramanik, S. (Eds.) *New Trends in Neutrosophic Theory and Applications*; Pons Editions: Brussels, Belgium, 2016; pp. 15–161, ISBN 978-1-59973-498-9.
42. Sahin, R.; Liu, P. Maximizing deviation method for neutrosophic multiple attribute decision making with incomplete weight information. *Neural Comput. Appl.* **2016**, *27*, 2017–2029.
43. Pramanik, S.; Dalapati, S.; Alam, S.; Smarandache, S.; Roy, T.K. NS-cross entropy based MAGDM under single valued neutrosophic set environment. *Preprints* **2018**, doi:10.20944/preprints201801.0006.v1.

44. Sahin, R.; Liu, P. Possibility-induced simplified neutrosophic aggregation operators and their application to multi-criteria group decision-making. *J. Exp. Theor. Artif. Intell.* **2017**, *29*, 769–785.
45. Biswas, P.; Pramanik, S.; Giri, B.C. Multi-attribute group decision making based on expected value of neutrosophic trapezoidal numbers. *New Math. Nat. Comput.* **2017**, in press.
46. Smarandache, F. *Introduction to Neutrosophic Measure, Neutrosophic Integral, and Neutrosophic, Probability*; Sitech & Education Publisher: Craiova, Romania, 2013.
47. Smarandache, F. *Introduction to Neutrosophic Statistics*; Sitech & Education Publishing: Columbus, OH, USA, 2014.
48. Xu, Z. Fuzzy harmonic mean operators. *Int. J. Intell. Syst.* **2009**, *24*, 152–172.
49. Park, J.H.; Gwak, M.G.; Kwun, Y.C. Uncertain linguistic harmonic mean operators and their applications to multiple attribute group decision making. *Computing* **2011**, *93*, 47–64.
50. Wei, G.W. FIOWHM operator and its application to multiple attribute group decision making. *Expert Syst. Appl.* **2011**, *38*, 2984–2989.
51. Ye, J. Simplified neutrosophic harmonic averaging projection-based strategy for multiple attribute decision-making problems. *Int. J. Mach. Learn. Cybern.* **2017**, *8*, 981–987.
52. Ye, J. Multiple attribute group decision making method under neutrosophic number environment. *J. Intell. Syst.* **2016**, *25*, 377–386.
53. Liu, P.; Liu, X. The neutrosophic number generalized weighted power averaging operator and its application in multiple attribute group decision making. *Int. J. Mach. Learn. Cybern.* **2016**, 1–12, doi:10.1007/s13042-016-0508-0.
54. Zheng, E.; Teng, F.; Liu, P. Multiple attribute group decision-making strategy based on neutrosophic number generalized hybrid weighted averaging operator. *Neural Comput. Appl.* **2017**, *28*, 2063–2074.
55. Pramanik, S.; Roy, R.; Roy, T.K. Teacher selection strategy based on bidirectional projection measure in neutrosophic number environment. In *Neutrosophic Operational Research*; Smarandache, F., Abdel-Basset, M., El-Henawy, I., Eds.; Pons Publishing House: Bruxelles, Belgium, 2017; Volume 2, ISBN 978-1-59973-537-5.
56. Majumdar, P.; Samanta, S.K. On similarity and entropy of neutrosophic sets. *J. Intell. Fuzzy Syst.* **2014**, *26*, 1245–1252.
57. Biswas, P.; Pramanik, S.; Giri, B.C. Entropy based grey relational analysis strategy for multi-attribute decision-making under single valued neutrosophic assessments. *Neutrosophic Sets. Syst.* **2014**, *2*, 102–110.

Rough Neutrosophic Digraphs with Application

Sidra Sayed, Nabeela Ishfaq, Muhammad Akram, Florentin Smarandache

Sidra Sayed, Nabeela Ishfaq, Muhammad Akram, Florentin Smarandache (2018). Rough Neutrosophic Digraphs with Application. *Axioms* 7, 5; DOI: 10.3390/axioms7010005

Abstract: A rough neutrosophic set model is a hybrid model which deals with vagueness by using the lower and upper approximation spaces. In this research paper, we apply the concept of rough neutrosophic sets to graphs. We introduce rough neutrosophic digraphs and describe methods of their construction. Moreover, we present the concept of self complementary rough neutrosophic digraphs. Finally, we consider an application of rough neutrosophic digraphs in decision-making.

Keywords: rough neutrosophic sets; rough neutrosophic digraphs; decision-making

1. Introduction

Smarandache [1] proposed the concept of neutrosophic sets as an extension of fuzzy sets [2]. A neutrosophic set has three components, namely, truth membership, indeterminacy membership and falsity membership, in which each membership value is a real standard or non-standard subset of the nonstandard unit interval $]0-, 1 + [$ ([3]), where $0^- = 0 - \epsilon$, $1^+ = 1 + \epsilon$, ϵ is an infinitesimal number > 0 . To apply neutrosophic set in real-life problems more conveniently, Smarandache [3] and Wang et al. [4] defined single-valued neutrosophic sets which takes the value from the subset of $[0, 1]$. Actually, the single valued neutrosophic set was introduced for the first time by Smarandache in 1998 in [3]. Ye [5] considered multicriteria decision-making method using the correlation coefficient under single-valued neutrosophic environment. Ye [6] also presented improved correlation coefficients of single valued neutrosophic sets and interval neutrosophic sets for multiple attribute decision making.

Rough set theory was proposed by Pawlak [7] in 1982. Rough set theory is useful to study the intelligence systems containing incomplete, uncertain or inexact information. The lower and upper approximation operators of rough sets are used for managing hidden information in a system. Therefore, many hybrid models have been built, such as soft rough sets, rough fuzzy sets, fuzzy rough sets, soft fuzzy rough sets, neutrosophic rough sets, and rough neutrosophic sets, for handling uncertainty and incomplete information effectively. Dubois and Prade [8] introduced the notions of rough fuzzy sets and fuzzy rough sets. Liu and Chen [9] have studied different decision-making methods. Broumi et al. [10] introduced the concept of rough neutrosophic sets. Yang et al. [11] proposed single valued neutrosophic rough sets by combining single valued neutrosophic sets and rough sets, and established an algorithm for decision-making problem based on single valued neutrosophic rough sets on two universes. Mordeson and Peng [12] presented operations on fuzzy graphs. Akram et al. [13–16] considered several new concepts of neutrosophic graphs with applications. Zafer and Akram [17] introduced a novel decision-making method based on rough fuzzy information. In this research study, we apply the concept of rough neutrosophic sets to graphs. We introduce rough neutrosophic digraphs and describe methods of their construction. Moreover,

we present the concept of self complementary rough neutrosophic digraphs. We also present an application of rough neutrosophic digraphs in decision-making.

We have used standard definitions and terminologies in this paper. For other notations, terminologies and applications not mentioned in the paper, the readers are referred to [18–22].

2. Rough Neutrosophic Digraphs

Definition 1. [4] Let Z be a nonempty universe. A neutrosophic set N on Z is defined as follows:

$$N = \{ \langle x : \mu_N(x), \sigma_N(x), \lambda_N(x) \rangle, x \in Z \}$$

where the functions $\mu, \sigma, \lambda : Z \rightarrow [0, 1]$ represent the degree of membership, the degree of indeterminacy and the degree of falsity.

Definition 2. [7] Let Z be a nonempty universe and R an equivalence relation on Z . A pair (Z, R) is called an approximation space. Let N^* be a subset of Z and the lower and upper approximations of N^* in the approximation space (Z, R) denoted by $\underline{R}N^*$ and $\overline{R}N^*$ are defined as follows:

$$\begin{aligned} \underline{R}N^* &= \{ x \in Z \mid [x]_R \subseteq N^* \}, \\ \overline{R}N^* &= \{ x \in Z \mid [x]_R \cap N^* \neq \emptyset \}, \end{aligned}$$

where $[x]_R$ denotes the equivalence class of R containing x . A pair $(\underline{R}N^*, \overline{R}N^*)$ is called a rough set.

Definition 3. [10] Let Z be a nonempty universe and R an equivalence relation on Z . Let N be a neutrosophic set (NS) on Z . The lower and upper approximations of N in the approximation space (Z, R) denoted by $\underline{R}N$ and $\overline{R}N$ are defined as follows:

$$\begin{aligned} \underline{R}N &= \{ \langle x, \mu_{\underline{R}(N)}(x), \sigma_{\underline{R}(N)}(x), \lambda_{\underline{R}(N)}(x) \rangle : y \in [x]_R, x \in Z \}, \\ \overline{R}N &= \{ \langle x, \mu_{\overline{R}(N)}(x), \sigma_{\overline{R}(N)}(x), \lambda_{\overline{R}(N)}(x) \rangle : y \in [x]_R, x \in Z \}, \end{aligned}$$

where,

$$\begin{aligned} \mu_{\underline{R}(N)}(x) &= \bigwedge_{y \in [x]_R} \mu_N(y), & \mu_{\overline{R}(N)}(x) &= \bigvee_{y \in [x]_R} \mu_N(y), \\ \sigma_{\underline{R}(N)}(x) &= \bigwedge_{y \in [x]_R} \sigma_N(y), & \sigma_{\overline{R}(N)}(x) &= \bigvee_{y \in [x]_R} \sigma_N(y), \\ \lambda_{\underline{R}(N)}(x) &= \bigvee_{y \in [x]_R} \lambda_N(y), & \lambda_{\overline{R}(N)}(x) &= \bigwedge_{y \in [x]_R} \lambda_N(y). \end{aligned}$$

A pair $(\underline{R}N, \overline{R}N)$ is called a rough neutrosophic set.

We now define the concept of rough neutrosophic digraph.

Definition 4. Let V^* be a nonempty set and R an equivalence relation on V^* . Let V be a NS on V^* , defined as

$$V = \{ \langle x, \mu_V(x), \sigma_V(x), \lambda_V(x) \rangle : x \in V^* \}.$$

Then, the lower and upper approximations of V represented by $\underline{R}V$ and $\overline{R}V$, respectively, are characterized as NSs in V^* such that $\forall x \in V^*$,

$$\begin{aligned} \underline{R}(V) &= \{ \langle x, \mu_{\underline{R}(V)}(x), \sigma_{\underline{R}(V)}(x), \lambda_{\underline{R}(V)}(x) \rangle : y \in [x]_R \}, \\ \overline{R}(V) &= \{ \langle x, \mu_{\overline{R}(V)}(x), \sigma_{\overline{R}(V)}(x), \lambda_{\overline{R}(V)}(x) \rangle : y \in [x]_R \}, \end{aligned}$$

where,

$$\begin{aligned} \mu_{\underline{R}(V)}(x) &= \bigwedge_{y \in [x]_R} \mu_V(y), & \mu_{\overline{R}(V)}(x) &= \bigvee_{y \in [x]_R} \mu_V(y), \\ \sigma_{\underline{R}(V)}(x) &= \bigwedge_{y \in [x]_R} \sigma_V(y), & \sigma_{\overline{R}(V)}(x) &= \bigvee_{y \in [x]_R} \sigma_V(y), \\ \lambda_{\underline{R}(V)}(x) &= \bigvee_{y \in [x]_R} \lambda_V(y), & \lambda_{\overline{R}(V)}(x) &= \bigwedge_{y \in [x]_R} \lambda_V(y). \end{aligned}$$

Let $E^* \subseteq V^* \times V^*$ and S an equivalence relation on E^* such that

$$((x_1, x_2), (y_1, y_2)) \in S \Leftrightarrow (x_1, y_1), (x_2, y_2) \in R.$$

Let E be a neutrosophic set on $E^* \subseteq V^* \times V^*$ defined as

$$E = \{ \langle xy, \mu_E(xy), \sigma_E(xy), \lambda_E(xy) \rangle : xy \in V^* \times V^* \},$$

such that

$$\begin{aligned} \mu_E(xy) &\leq \min\{\mu_{\underline{RV}}(x), \mu_{\underline{RV}}(y)\}, \\ \sigma_E(xy) &\leq \min\{\sigma_{\underline{RV}}(x), \sigma_{\underline{RV}}(y)\}, \\ \lambda_E(xy) &\leq \max\{\lambda_{\overline{RV}}(x), \lambda_{\overline{RV}}(y)\} \quad \forall x, y \in V^*. \end{aligned}$$

Then, the lower and upper approximations of E represented by \underline{SE} and \overline{SE} , respectively, are defined as follows

$$\begin{aligned} \underline{SE} &= \{ \langle xy, \mu_{\underline{SE}}(xy), \sigma_{\underline{SE}}(xy), \lambda_{\underline{SE}}(xy) \rangle : wz \in [xy]_S, xy \in V^* \times V^* \}, \\ \overline{SE} &= \{ \langle xy, \mu_{\overline{SE}}(xy), \sigma_{\overline{SE}}(xy), \lambda_{\overline{SE}}(xy) \rangle : wz \in [xy]_S, xy \in V^* \times V^* \}, \end{aligned}$$

where,

$$\begin{aligned} \mu_{\underline{SE}}(xy) &= \bigwedge_{wz \in [xy]_S} \mu_E(wz), & \mu_{\overline{SE}}(xy) &= \bigvee_{wz \in [xy]_S} \mu_E(wz), \\ \sigma_{\underline{SE}}(xy) &= \bigwedge_{wz \in [xy]_S} \sigma_E(wz), & \sigma_{\overline{SE}}(xy) &= \bigvee_{wz \in [xy]_S} \sigma_E(wz), \\ \lambda_{\underline{SE}}(xy) &= \bigvee_{wz \in [xy]_S} \lambda_E(wz), & \lambda_{\overline{SE}}(xy) &= \bigwedge_{wz \in [xy]_S} \lambda_E(wz). \end{aligned}$$

A pair $SE = (\underline{SE}, \overline{SE})$ is called a rough neutrosophic relation.

Definition 5. A rough neutrosophic digraph on a nonempty set V^* is a four-ordered tuple $G = (R, RV, S, SE)$ such that

- (a) R is an equivalence relation on V^* ;
- (b) S is an equivalence relation on $E^* \subseteq V^* \times V^*$;
- (c) $RV = (\underline{RV}, \overline{RV})$ is a rough neutrosophic set on V^* ;
- (d) $SE = (\underline{SE}, \overline{SE})$ is a rough neutrosophic relation on V^* and
- (e) (RV, SE) is a neutrosophic digraph where $\underline{G} = (\underline{RV}, \underline{SE})$ and $\overline{G} = (\overline{RV}, \overline{SE})$ are lower and upper approximate neutrosophic digraphs of G such that

$$\begin{aligned} \mu_{\underline{SE}}(xy) &\leq \min\{\mu_{\underline{RV}}(x), \mu_{\underline{RV}}(y)\}, \\ \sigma_{\underline{SE}}(xy) &\leq \min\{\sigma_{\underline{RV}}(x), \sigma_{\underline{RV}}(y)\}, \\ \lambda_{\underline{SE}}(xy) &\leq \max\{\lambda_{\overline{RV}}(x), \lambda_{\overline{RV}}(y)\}, \end{aligned}$$

and

$$\begin{aligned} \mu_{\overline{SE}}(xy) &\leq \min\{\mu_{\overline{RV}}(x), \mu_{\overline{RV}}(y)\}, \\ \sigma_{\overline{SE}}(xy) &\leq \min\{\sigma_{\overline{RV}}(x), \sigma_{\overline{RV}}(y)\}, \\ \lambda_{\overline{SE}}(xy) &\leq \max\{\lambda_{\overline{RV}}(x), \lambda_{\overline{RV}}(y)\} \quad \forall x, y \in V^*. \end{aligned}$$

Example 1. Let $V^* = \{a, b, c\}$ be a set and R an equivalence relation on V^*

$$R = \begin{bmatrix} 1 & 0 & 1 \\ 0 & 1 & 0 \\ 1 & 0 & 1 \end{bmatrix}.$$

Let $V = \{(a, 0.2, 0.3, 0.6), (b, 0.8, 0.6, 0.5), (c, 0.9, 0.1, 0.4)\}$ be a neutrosophic set on V^* . The lower and upper approximations of V are given by,

$$\underline{RV} = \{(a, 0.2, 0.1, 0.6), (b, 0.8, 0.6, 0.5), (c, 0.2, 0.1, 0.6)\},$$

$$\overline{RV} = \{(a, 0.9, 0.3, 0.4), (b, 0.8, 0.6, 0.5), (c, 0.9, 0.3, 0.4)\}.$$

Let $E^* = \{aa, ab, ac, bb, ca, cb\} \subseteq V^* \times V^*$ and S an equivalence relation on E^* defined as:

$$S = \begin{bmatrix} 1 & 0 & 1 & 0 & 1 & 0 \\ 0 & 1 & 0 & 0 & 0 & 1 \\ 1 & 0 & 1 & 0 & 1 & 0 \\ 0 & 0 & 0 & 1 & 0 & 0 \\ 1 & 0 & 1 & 0 & 1 & 0 \\ 0 & 1 & 0 & 0 & 0 & 1 \end{bmatrix}.$$

Let $E = \{(aa, 0.2, 0.1, 0.4), (ab, 0.2, 0.1, 0.5), (ac, 0.1, 0.1, 0.5), (bb, 0.7, 0.5, 0.5), (ca, 0.1, 0.1, 0.3), (cb, 0.2, 0.1, 0.5)\}$ be a neutrosophic set on E^* and $SE = (\underline{SE}, \overline{SE})$ a rough neutrosophic relation where \underline{SE} and \overline{SE} are given as

$$\underline{SE} = \{(aa, 0.1, 0.1, 0.5), (ab, 0.2, 0.1, 0.5), (ac, 0.1, 0.1, 0.5), (bb, 0.7, 0.5, 0.5), (ca, 0.1, 0.1, 0.5), (cb, 0.2, 0.1, 0.5)\},$$

$$\overline{SE} = \{(aa, 0.2, 0.1, 0.3), (ab, 0.2, 0.1, 0.5), (ac, 0.2, 0.1, 0.3), (bb, 0.7, 0.5, 0.5), (ca, 0.2, 0.1, 0.3), (cb, 0.2, 0.1, 0.5)\}.$$

Thus, $\underline{G} = (\underline{RV}, \underline{SE})$ and $\overline{G} = (\overline{RV}, \overline{SE})$ are neutrosophic digraphs as shown in Figure 1.

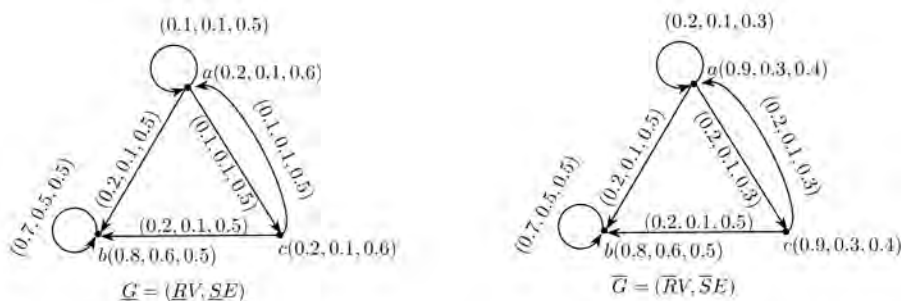

Figure 1. Rough neutrosophic digraph $G = (\underline{G}, \overline{G})$.

We now form new rough neutrosophic digraphs from old ones.

Definition 6. Let $G_1 = (\underline{G}_1, \overline{G}_1)$ and $G_2 = (\underline{G}_2, \overline{G}_2)$ be two rough neutrosophic digraphs on a set V^* . Then, the intersection of G_1 and G_2 is a rough neutrosophic digraph $G = G_1 \cap G_2 = (\underline{G}_1 \cap \underline{G}_2, \overline{G}_1 \cap \overline{G}_2)$, where $\underline{G}_1 \cap \underline{G}_2 = (\underline{RV}_1 \cap \underline{RV}_2, \underline{SE}_1 \cap \underline{SE}_2)$ and $\overline{G}_1 \cap \overline{G}_2 = (\overline{RV}_1 \cap \overline{RV}_2, \overline{SE}_1 \cap \overline{SE}_2)$ are neutrosophic digraphs, respectively, such that

$$\begin{aligned}
 (1) \quad & \mu_{\underline{RV}_1 \cap \underline{RV}_2}(x) = \min\{\mu_{\underline{RV}_1}(x), \mu_{\underline{RV}_2}(x)\}, \\
 & \sigma_{\underline{RV}_1 \cap \underline{RV}_2}(x) = \min\{\sigma_{\underline{RV}_1}(x), \sigma_{\underline{RV}_2}(x)\}, \\
 & \lambda_{\underline{RV}_1 \cap \underline{RV}_2}(x) = \max\{\lambda_{\underline{RV}_1}(x), \lambda_{\underline{RV}_2}(x)\} \quad \forall x \in \underline{RV}_1 \cap \underline{RV}_2, \\
 & \mu_{\underline{SE}_1 \cap \underline{SE}_2}(xy) = \min\{\mu_{\underline{SE}_1}(x), \mu_{\underline{SE}_2}(y)\}, \\
 & \sigma_{\underline{SE}_1 \cap \underline{SE}_2}(xy) = \min\{\sigma_{\underline{SE}_1}(x), \sigma_{\underline{SE}_2}(y)\} \\
 & \lambda_{\underline{SE}_1 \cap \underline{SE}_2}(xy) = \max\{\lambda_{\underline{SE}_1}(x), \lambda_{\underline{SE}_2}(y)\} \quad \forall xy \in \underline{SE}_1 \cap \underline{SE}_2, \\
 \\
 (2) \quad & \mu_{\overline{RV}_1 \cap \overline{RV}_2}(x) = \min\{\mu_{\overline{RV}_1}(x), \mu_{\overline{RV}_2}(x)\}, \\
 & \sigma_{\overline{RV}_1 \cap \overline{RV}_2}(x) = \min\{\sigma_{\overline{RV}_1}(x), \sigma_{\overline{RV}_2}(x)\}, \\
 & \lambda_{\overline{RV}_1 \cap \overline{RV}_2}(x) = \max\{\lambda_{\overline{RV}_1}(x), \lambda_{\overline{RV}_2}(x)\} \quad \forall x \in \overline{RV}_1 \cap \overline{RV}_2, \\
 & \mu_{\overline{SE}_1 \cap \overline{SE}_2}(xy) = \min\{\mu_{\overline{SE}_1}(x), \mu_{\overline{SE}_2}(y)\} \\
 & \sigma_{\overline{SE}_1 \cap \overline{SE}_2}(xy) = \min\{\sigma_{\overline{SE}_1}(x), \sigma_{\overline{SE}_2}(y)\} \\
 & \lambda_{\overline{SE}_1 \cap \overline{SE}_2}(xy) = \max\{\lambda_{\overline{SE}_1}(x), \lambda_{\overline{SE}_2}(y)\} \quad \forall xy \in \overline{SE}_1 \cap \overline{SE}_2.
 \end{aligned}$$

Example 2. Consider the two rough neutrosophic digraphs \underline{G}_1 and \overline{G}_2 as shown in Figures 1 and 2. The intersection of \underline{G}_1 and \overline{G}_2 is $G = \underline{G}_1 \cap \overline{G}_2 = (\underline{G}_1 \cap \underline{G}_2, \overline{G}_1 \cap \overline{G}_2)$ where $\underline{G}_1 \cap \underline{G}_2 = (\underline{RV}_1 \cap \underline{RV}_2, \underline{SE}_1 \cap \underline{SE}_2)$ and $\overline{G}_1 \cap \overline{G}_2 = (\overline{RV}_1 \cap \overline{RV}_2, \overline{SE}_1 \cap \overline{SE}_2)$ are neutrosophic digraphs as shown in Figure 3.

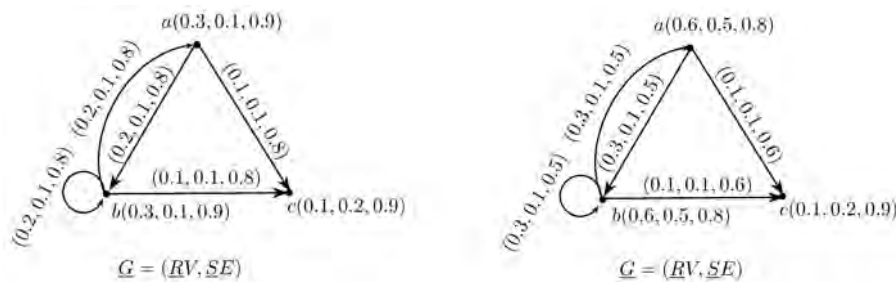

Figure 2. Rough neutrosophic digraph $G = (\underline{G}, \overline{G})$.

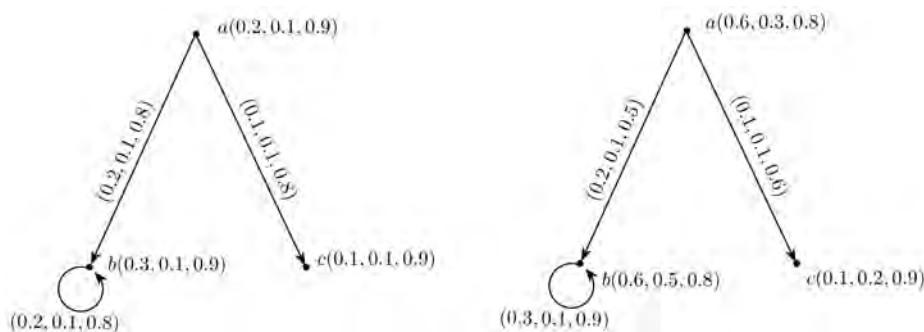

Figure 3. Rough neutrosophic digraph $G_1 \cap G_2 = (\underline{G}_1 \cap \underline{G}_2, \overline{G}_1 \cap \overline{G}_2)$.

Theorem 1. The intersection of two rough neutrosophic digraphs is a rough neutrosophic digraph.

Proof. Let $G_1 = (\underline{G}_1, \overline{G}_1)$ and $G_2 = (\underline{G}_2, \overline{G}_2)$ be two rough neutrosophic digraphs. Let $G = G_1 \cap G_2 = (\underline{G}_1 \cap \underline{G}_2, \overline{G}_1 \cap \overline{G}_2)$ be the intersection of G_1 and G_2 , where $\underline{G}_1 \cap \underline{G}_2 = (\underline{RV}_1 \cap \underline{RV}_2, \underline{SE}_1 \cap \underline{SE}_2)$ and $\overline{G}_1 \cap \overline{G}_2 = (\overline{RV}_1 \cap \overline{RV}_2, \overline{SE}_1 \cap \overline{SE}_2)$. To prove that $G = \underline{G}_1 \cap \overline{G}_2$ is a rough neutrosophic digraph, it is

enough to show that $\underline{SE}_1 \cap \underline{SE}_2$ and $\overline{SE}_1 \cap \overline{SE}_2$ are neutrosophic relation on $\underline{RV}_1 \cap \underline{RV}_2$ and $\overline{RV}_1 \cap \overline{RV}_2$, respectively. First, we show that $\underline{SE}_1 \cap \underline{SE}_2$ is a neutrosophic relation on $\underline{RV}_1 \cap \underline{RV}_2$.

$$\begin{aligned} \mu_{\underline{SE}_1 \cap \underline{SE}_2}(xy) &= \mu_{\underline{SE}_1}(xy) \wedge \mu_{\underline{SE}_2}(xy) \\ &\leq (\mu_{\underline{RV}_1}(x) \wedge \mu_{\underline{RV}_2}(y)) \wedge (\mu_{\underline{RV}_1}(x) \wedge \mu_{\underline{RV}_2}(y)) \\ &= (\mu_{\underline{RV}_1}(x) \wedge \mu_{\underline{RV}_2}(x)) \wedge (\mu_{\underline{RV}_1}(y) \wedge \mu_{\underline{RV}_2}(y)) \\ &= \mu_{\underline{RV}_1 \cap \underline{RV}_2}(x) \wedge \mu_{\underline{RV}_1 \cap \underline{RV}_2}(y) \\ \mu_{\underline{SE}_1 \cap \underline{SE}_2}(xy) &\leq \min\{\mu_{\underline{RV}_1 \cap \underline{RV}_2}(x), \mu_{\underline{RV}_1 \cap \underline{RV}_2}(y)\} \\ \sigma_{\underline{SE}_1 \cap \underline{SE}_2}(xy) &= \sigma_{\underline{SE}_1}(xy) \wedge \sigma_{\underline{SE}_2}(xy) \\ &\leq (\sigma_{\underline{RV}_1}(x) \wedge \sigma_{\underline{RV}_2}(y)) \wedge (\sigma_{\underline{RV}_1}(x) \wedge \sigma_{\underline{RV}_2}(y)) \\ &= (\sigma_{\underline{RV}_1}(x) \wedge \sigma_{\underline{RV}_2}(x)) \wedge (\sigma_{\underline{RV}_1}(y) \wedge \sigma_{\underline{RV}_2}(y)) \\ &= \sigma_{\underline{RV}_1 \cap \underline{RV}_2}(x) \wedge \sigma_{\underline{RV}_1 \cap \underline{RV}_2}(y) \\ \sigma_{\underline{SE}_1 \cap \underline{SE}_2}(xy) &\leq \min\{\sigma_{\underline{RV}_1 \cap \underline{RV}_2}(x), \sigma_{\underline{RV}_1 \cap \underline{RV}_2}(y)\} \\ \lambda_{\underline{SE}_1 \cap \underline{SE}_2}(xy) &= \lambda_{\underline{SE}_1}(xy) \wedge \lambda_{\underline{SE}_2}(xy) \\ &\leq (\lambda_{\underline{RV}_1}(x) \vee \lambda_{\underline{RV}_2}(y)) \wedge (\lambda_{\underline{RV}_1}(x) \vee \lambda_{\underline{RV}_2}(y)) \\ &= (\lambda_{\underline{RV}_1}(x) \wedge \lambda_{\underline{RV}_2}(x)) \vee (\lambda_{\underline{RV}_1}(y) \wedge \lambda_{\underline{RV}_2}(y)) \\ &= \lambda_{\underline{RV}_1 \cap \underline{RV}_2}(x) \vee \lambda_{\underline{RV}_1 \cap \underline{RV}_2}(y) \\ \lambda_{\underline{SE}_1 \cap \underline{SE}_2}(xy) &\leq \max\{\lambda_{\underline{RV}_1 \cap \underline{RV}_2}(x), \lambda_{\underline{RV}_1 \cap \underline{RV}_2}(y)\}. \end{aligned}$$

Thus, from above it is clear that $\underline{SE}_1 \cap \underline{SE}_2$ is a neutrosophic relation on $\underline{RV}_1 \cap \underline{RV}_2$.

Similarly, we can show that $\overline{SE}_1 \cap \overline{SE}_2$ is a neutrosophic relation on $\overline{RV}_1 \cap \overline{RV}_2$. Hence, G is a rough neutrosophic digraph. \square

Definition 7. The Cartesian product of two neutrosophic digraphs G_1 and G_2 is a rough neutrosophic digraph $G = G_1 \times G_2 = (\underline{G}_1 \times \underline{G}_2, \overline{G}_1 \times \overline{G}_2)$, where $\underline{G}_1 \times \underline{G}_2 = (\underline{R}_1 \times \underline{R}_2, \underline{SE}_1 \times \underline{SE}_2)$ and $\overline{G}_1 \times \overline{G}_2 = (\overline{RV}_1 \times \overline{RV}_2, \overline{SE}_1 \times \overline{SE}_2)$ such that

$$\begin{aligned} (1) \quad &\mu_{\underline{RV}_1 \times \underline{RV}_2}(x_1, x_2) = \min\{\mu_{\underline{RV}_1}(x_1), \mu_{\underline{RV}_2}(x_2)\}, \\ &\sigma_{\underline{RV}_1 \times \underline{RV}_2}(x_1, x_2) = \min\{\sigma_{\underline{RV}_1}(x_1), \sigma_{\underline{RV}_2}(x_2)\}, \\ &\lambda_{\underline{RV}_1 \times \underline{RV}_2}(x_1, x_2) = \max\{\lambda_{\underline{RV}_1}(x_1), \lambda_{\underline{RV}_2}(x_2)\}, \quad \forall (x_1, x_2) \in \underline{RV}_1 \times \underline{RV}_2, \\ &\mu_{\underline{SE}_1 \times \underline{SE}_2}(x, x_2)(x, y_2) = \min\{\mu_{\underline{RV}_1}(x), \mu_{\underline{SE}_2}(x_2, y_2)\}, \\ &\sigma_{\underline{SE}_1 \times \underline{SE}_2}(x, x_2)(x, y_2) = \min\{\sigma_{\underline{RV}_1}(x), \sigma_{\underline{SE}_2}(x_2, y_2)\}, \\ &\lambda_{\underline{SE}_1 \times \underline{SE}_2}(x, x_2)(x, y_2) = \max\{\lambda_{\underline{RV}_1}(x), \lambda_{\underline{SE}_2}(x_2, y_2)\} \quad \forall x \in \underline{RV}_1, x_2 y_2 \in \underline{SE}_2, \\ &\mu_{\underline{SE}_1 \times \underline{SE}_2}(x_1, z)(y_1, z) = \min\{\mu_{\underline{SE}_1}(x_1, y_1), \mu_{\underline{RV}_2}(z)\}, \\ &\sigma_{\underline{SE}_1 \times \underline{SE}_2}(x_1, z)(y_1, z) = \min\{\sigma_{\underline{SE}_1}(x_1, y_1), \sigma_{\underline{RV}_2}(z)\}, \\ &\lambda_{\underline{SE}_1 \times \underline{SE}_2}(x_1, z)(y_1, z) = \max\{\lambda_{\underline{SE}_1}(x_1, y_1), \lambda_{\underline{RV}_2}(z)\} \quad \forall x_1 y_1 \in \underline{SE}_1, z \in \underline{RV}_2, \\ (2) \quad &\mu_{\overline{RV}_1 \times \overline{RV}_2}(x_1, x_2) = \min\{\mu_{\overline{RV}_1}(x_1), \mu_{\overline{RV}_2}(x_2)\}, \\ &\sigma_{\overline{RV}_1 \times \overline{RV}_2}(x_1, x_2) = \min\{\sigma_{\overline{RV}_1}(x_1), \sigma_{\overline{RV}_2}(x_2)\}, \\ &\lambda_{\overline{RV}_1 \times \overline{RV}_2}(x_1, x_2) = \max\{\lambda_{\overline{RV}_1}(x_1), \lambda_{\overline{RV}_2}(x_2)\} \quad \forall (x_1, x_2) \in \overline{RV}_1 \times \overline{RV}_2, \\ &\mu_{\overline{SE}_1 \times \overline{SE}_2}(x, x_2)(x, y_2) = \min\{\mu_{\overline{RV}_1}(x), \mu_{\overline{SE}_2}(x_2, y_2)\}, \\ &\sigma_{\overline{SE}_1 \times \overline{SE}_2}(x, x_2)(x, y_2) = \min\{\sigma_{\overline{RV}_1}(x), \sigma_{\overline{SE}_2}(x_2, y_2)\}, \\ &\lambda_{\overline{SE}_1 \times \overline{SE}_2}(x, x_2)(x, y_2) = \max\{\lambda_{\overline{RV}_1}(x), \lambda_{\overline{SE}_2}(x_2, y_2)\} \quad \forall x \in \overline{RV}_1, x_2 y_2 \in \overline{SE}_2, \end{aligned}$$

$$\begin{aligned} \mu_{\bar{S}E_1 \times \bar{S}E_2}(x_1, z)(y_1, z) &= \min\{\mu_{\bar{S}E_1}(x_1, y_1), \mu_{\bar{R}V_2}(z)\}, \\ \sigma_{\bar{S}E_1 \times \bar{S}E_2}(x_1, z)(y_1, z) &= \min\{\sigma_{\bar{S}E_1}(x_1, y_1), \sigma_{\bar{R}V_2}(z)\}, \\ \lambda_{\bar{S}E_1 \times \bar{S}E_2}(x_1, z)(y_1, z) &= \max\{\lambda_{\bar{S}E_1}(x_1, y_1), \lambda_{\bar{R}V_2}(z)\} \quad \forall x_1, y_1 \in \bar{S}E_1, z \in \bar{R}V_2, \end{aligned}$$

Example 3. Let $V^* = \{a, b, c, d\}$ be a set. Let $G_1 = (\underline{G}_1, \overline{G}_1)$ and $G_2 = (\underline{G}_2, \overline{G}_2)$ be two rough neutrosophic digraphs on V^* , as shown in Figures 4 and 5. The cartesian product of G_1 and G_2 is $G = (\underline{G}_1 \times \underline{G}_2, \overline{G}_1 \times \overline{G}_2)$, where $\underline{G}_1 \times \underline{G}_2 = (\underline{R}N_1 \times \underline{R}N_2, \underline{S}E_1 \times \underline{S}E_2)$ and $\overline{G}_1 \times \overline{G}_2 = (\overline{R}N_1 \times \overline{R}N_2, \overline{S}E_1 \times \overline{S}E_2)$ are neutrosophic digraphs, as shown in Figures 6 and 7, respectively.

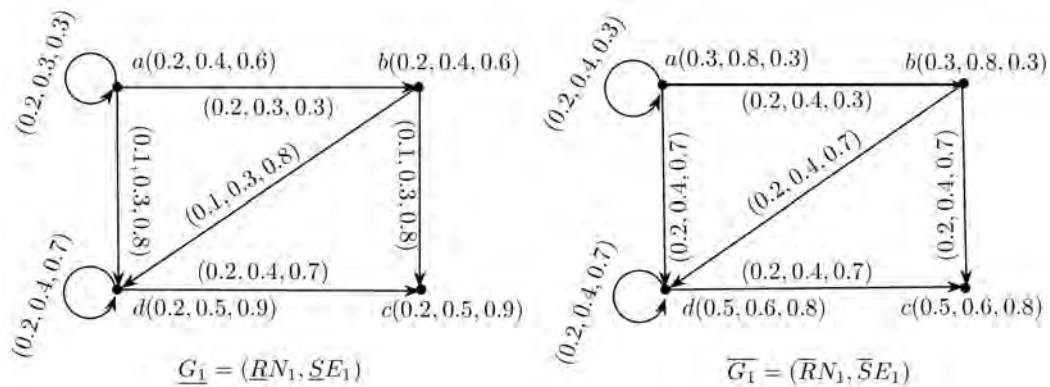

Figure 4. Rough neutrosophic digraph $G_1 = (\underline{G}_1, \overline{G}_1)$.

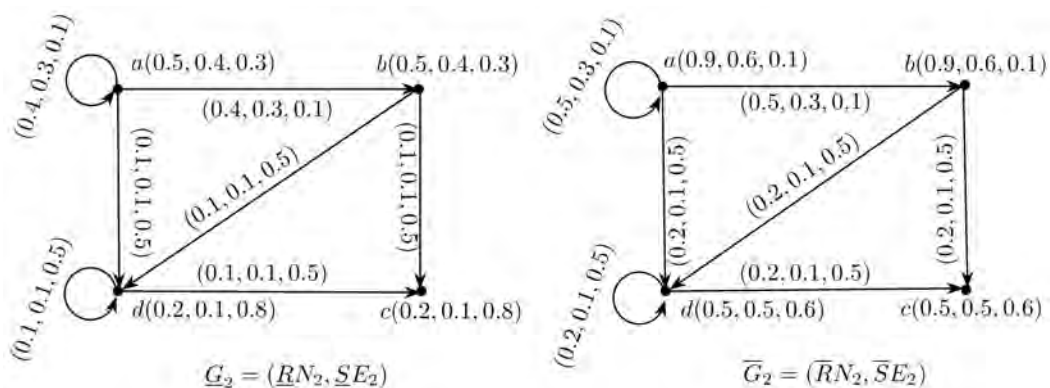

Figure 5. Rough neutrosophic digraph $G_2 = (\underline{G}_2, \overline{G}_2)$.

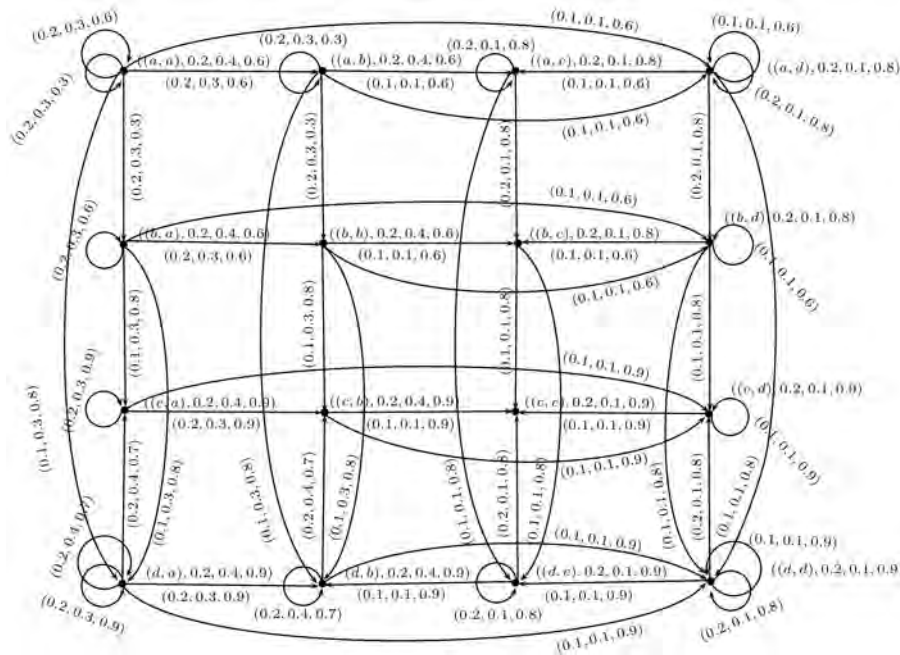

Figure 6. Neutrosophic digraph $\underline{G}_1 \times \underline{G}_2 = (\underline{RN}_1 \times \underline{RN}_2, \underline{SE}_1 \times \underline{SE}_2)$.

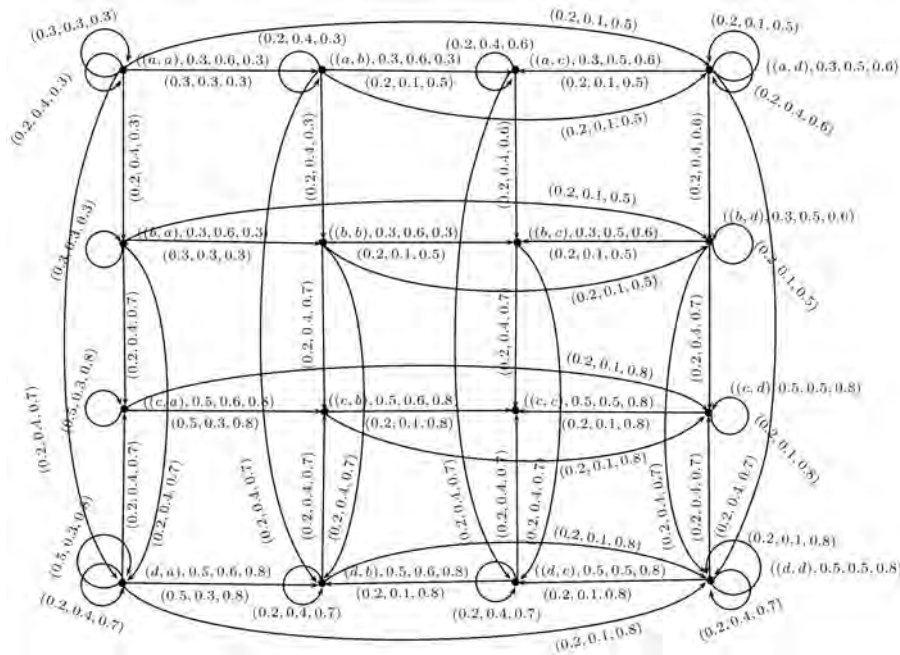

Figure 7. Neutrosophic digraph $\overline{G}_1 \times \overline{G}_2 = (\overline{RN}_1 \times \overline{RN}_2, \overline{SE}_1 \times \overline{SE}_2)$.

Theorem 2. *The Cartesian product of two rough neutrosophic digraphs is a rough neutrosophic digraph.*

Proof. Let $G_1 = (\underline{G}_1, \overline{G}_1)$ and $G_2 = (\underline{G}_2, \overline{G}_2)$ be two rough neutrosophic digraphs. Let $G = G_1 \times G_2 = (\underline{G}_1 \times \underline{G}_2, \overline{G}_1 \times \overline{G}_2)$ be the Cartesian product of G_1 and G_2 , where $\underline{G}_1 \times \underline{G}_2 = (\underline{RV}_1 \times \underline{RV}_2, \underline{SE}_1 \times \underline{SE}_2)$ and $\overline{G}_1 \times \overline{G}_2 = (\overline{RV}_1 \times \overline{RV}_2, \overline{SE}_1 \times \overline{SE}_2)$. To prove that $G = \underline{G}_1 \times \overline{G}_2$ is a rough neutrosophic digraph, it is enough to show that $\underline{SE}_1 \times \underline{SE}_2$ and $\overline{SE}_1 \times \overline{SE}_2$ are neutrosophic relation on $\underline{RV}_1 \times \underline{RV}_2$ and $\overline{RV}_1 \times \overline{RV}_2$, respectively. First, we show that $\underline{SE}_1 \times \underline{SE}_2$ is a neutrosophic relation on $\underline{RV}_1 \times \underline{RV}_2$.

If $x \in \underline{RV}_1, x_2y_2 \in \underline{SE}_2$, then

$$\begin{aligned} \mu_{\underline{SE}_1 \times \underline{SE}_2}(x, x_2)(x, y_2) &= \mu_{\underline{RV}_1}(x) \wedge \mu_{\underline{SE}_2}(x_2, y_2) \\ &\leq \mu_{\underline{RV}_1}(x) \wedge (\mu_{\underline{RV}_2}(x_2) \wedge \mu_{\underline{RV}_2}(y_2)) \\ &= (\mu_{\underline{RV}_1}(x) \wedge \mu_{\underline{RV}_2}(x_2)) \wedge (\mu_{\underline{RV}_1}(x) \wedge \mu_{\underline{RV}_2}(y_2)) \\ &= \mu_{\underline{RV}_1 \times \underline{RV}_2}(x, x_2) \wedge \mu_{\underline{RV}_1 \times \underline{RV}_2}(x, y_2) \\ \mu_{\underline{SE}_1 \times \underline{SE}_2}(x, x_2)(x, y_2) &\leq \min\{\mu_{\underline{RV}_1 \times \underline{RV}_2}(x, x_2), \mu_{\underline{RV}_1 \times \underline{RV}_2}(x, y_2)\}, \\ \sigma_{\underline{SE}_1 \times \underline{SE}_2}(x, x_2)(x, y_2) &= \sigma_{\underline{RV}_1}(x) \wedge \sigma_{\underline{SE}_2}(x_2, y_2) \\ &\leq \sigma_{\underline{RV}_1}(x) \wedge (\sigma_{\underline{RV}_2}(x_2) \wedge \sigma_{\underline{RV}_2}(y_2)) \\ &= (\sigma_{\underline{RV}_1}(x) \wedge \sigma_{\underline{RV}_2}(x_2)) \wedge (\sigma_{\underline{RV}_1}(x) \wedge \sigma_{\underline{RV}_2}(y_2)) \\ &= \sigma_{\underline{RV}_1 \times \underline{RV}_2}(x, x_2) \wedge \sigma_{\underline{RV}_1 \times \underline{RV}_2}(x, y_2) \\ \sigma_{\underline{SE}_1 \times \underline{SE}_2}(x, x_2)(x, y_2) &\leq \min\{\sigma_{\underline{RV}_1 \times \underline{RV}_2}(x, x_2), \sigma_{\underline{RV}_1 \times \underline{RV}_2}(x, y_2)\}, \\ \lambda_{\underline{SE}_1 \times \underline{SE}_2}(x, x_2)(x, y_2) &= \lambda_{\underline{RV}_1}(x) \vee \lambda_{\underline{SE}_2}(x_2, y_2) \\ &\leq \lambda_{\underline{RV}_1}(x) \vee (\lambda_{\underline{RV}_2}(x_2) \vee \lambda_{\underline{RV}_2}(y_2)) \\ &= (\lambda_{\underline{RV}_1}(x) \vee \lambda_{\underline{RV}_2}(x_2)) \vee (\lambda_{\underline{RV}_1}(x) \vee \lambda_{\underline{RV}_2}(y_2)) \\ &= \lambda_{\underline{RV}_1 \times \underline{RV}_2}(x, x_2) \vee \lambda_{\underline{RV}_1 \times \underline{RV}_2}(x, y_2) \\ \lambda_{\underline{SE}_1 \times \underline{SE}_2}(x, x_2, x, y_2) &\leq \max\{\lambda_{\underline{RV}_1 \times \underline{RV}_2}(x, x_2), \lambda_{\underline{RV}_1 \times \underline{RV}_2}(x, y_2)\}. \end{aligned}$$

If $x_1y_1 \in \underline{SE}_1, z \in \underline{RV}_2$, then

$$\begin{aligned} \mu_{\underline{SE}_1 \times \underline{SE}_2}(x_1, z)(y_1, z) &= \mu_{\underline{SE}_1}(x_1, y_1) \wedge \mu_{\underline{RV}_2}(z) \\ &\leq (\mu_{\underline{RV}_1}(x_1) \wedge \mu_{\underline{RV}_1}(y_1)) \wedge \mu_{\underline{RV}_2}(z) \\ &= (\mu_{\underline{RV}_1}(x_1) \wedge \mu_{\underline{RV}_2}(z)) \wedge (\mu_{\underline{RV}_1}(y_1) \wedge \mu_{\underline{RV}_2}(z)) \\ &= \mu_{\underline{RV}_1 \times \underline{RV}_2}(x_1, z) \wedge \mu_{\underline{RV}_1 \times \underline{RV}_2}(y_1, z) \\ \mu_{\underline{SE}_1 \times \underline{SE}_2}(x_1, z)(y_1, z) &\leq \min\{\mu_{\underline{RV}_1 \times \underline{RV}_2}(x_1, z), \mu_{\underline{RV}_1 \times \underline{RV}_2}(y_1, z)\}, \\ \sigma_{\underline{SE}_1 \times \underline{SE}_2}(x_1, z)(y_1, z) &= \sigma_{\underline{SE}_1}(x_1, y_1) \wedge \sigma_{\underline{RV}_2}(z) \\ &\leq (\sigma_{\underline{RV}_1}(x_1) \wedge \sigma_{\underline{RV}_1}(y_1)) \wedge \sigma_{\underline{RV}_2}(z) \\ &= (\sigma_{\underline{RV}_1}(x_1) \wedge \sigma_{\underline{RV}_2}(z)) \wedge (\sigma_{\underline{RV}_1}(y_1) \wedge \sigma_{\underline{RV}_2}(z)) \\ &= \sigma_{\underline{RV}_1 \times \underline{RV}_2}(x_1, z) \wedge \sigma_{\underline{RV}_1 \times \underline{RV}_2}(y_1, z) \\ \sigma_{\underline{SE}_1 \times \underline{SE}_2}(x_1, z)(y_1, z) &\leq \min\{\sigma_{\underline{RV}_1 \times \underline{RV}_2}(x_1, z), \sigma_{\underline{RV}_1 \times \underline{RV}_2}(y_1, z)\}, \\ \lambda_{\underline{SE}_1 \times \underline{SE}_2}(x_1, z)(y_1, z) &= \lambda_{\underline{SE}_1}(x_1, y_1) \vee \lambda_{\underline{RV}_2}(z) \\ &\leq (\lambda_{\underline{RV}_1}(x_1) \vee \lambda_{\underline{RV}_1}(y_1)) \vee \lambda_{\underline{RV}_2}(z) \\ &= (\lambda_{\underline{RV}_1}(x_1) \vee \lambda_{\underline{RV}_2}(z)) \vee (\lambda_{\underline{RV}_1}(y_1) \vee \lambda_{\underline{RV}_2}(z)) \\ &= \lambda_{\underline{RV}_1 \times \underline{RV}_2}(x_1, z) \vee \lambda_{\underline{RV}_1 \times \underline{RV}_2}(y_1, z) \\ \lambda_{\underline{SE}_1 \times \underline{SE}_2}(x_1, z)(y_1, z) &\leq \max\{\lambda_{\underline{RV}_1 \times \underline{RV}_2}(x_1, z), \lambda_{\underline{RV}_1 \times \underline{RV}_2}(y_1, z)\}. \end{aligned}$$

Thus, from above, it is clear that $\underline{SE}_1 \times \underline{SE}_2$ is a neutrosophic relation on $\underline{RV}_1 \times \underline{RV}_2$.

Similarly, we can show that $\overline{SE}_1 \times \overline{SE}_2$ is a neutrosophic relation on $\overline{RV}_1 \times \overline{RV}_2$. Hence, $G = (\underline{G}_1 \times \underline{G}_2, \overline{G}_1 \times \overline{G}_2)$ is a rough neutrosophic digraph. \square

Definition 8. The composition of two rough neutrosophic digraphs G_1 and G_2 is a rough neutrosophic digraph $G = G_1 \circ G_2 = (\underline{G}_1 \circ \underline{G}_2, \overline{G}_1 \circ \overline{G}_2)$, where $\underline{G}_1 \circ \underline{G}_2 = (\underline{RV}_1 \circ \underline{RV}_2, \underline{SE}_1 \circ \underline{SE}_2)$ and $\overline{G}_1 \circ \overline{G}_2 = (\overline{RV}_1 \circ \overline{RV}_2, \overline{SE}_1 \circ \overline{SE}_2)$ are neutrosophic digraphs, respectively, such that

$$(1) \quad \mu_{\underline{RV}_1 \circ \underline{RV}_2}(x_1, x_2) = \min\{\mu_{\underline{RV}_1}(x_1), \mu_{\underline{RV}_2}(x_2)\},$$

$$\begin{aligned}
 \sigma_{\underline{RV}_1 \circ \underline{RV}_2}(x_1, x_2) &= \min\{\sigma_{\underline{RV}_1}(x_1), \mu_{\underline{RV}_2}(x_2)\}, \\
 \lambda_{\underline{RV}_1 \circ \underline{RV}_2}(x_1, x_2) &= \max\{\lambda_{\underline{RV}_1}(x_1), \mu_{\underline{RV}_2}(x_2)\} \quad \forall (x_1, x_2) \in \underline{RV}_1 \times \underline{RV}_2, \\
 \mu_{\underline{SE}_1 \circ \underline{SE}_2}(x, x_2)(x, y_2) &= \min\{\mu_{\underline{RV}_1}(x), \mu_{\underline{SE}_2}(x_2, y_2)\}, \\
 \sigma_{\underline{SE}_1 \circ \underline{SE}_2}(x, x_2)(x, y_2) &= \min\{\sigma_{\underline{RV}_1}(x), \sigma_{\underline{SE}_2}(x_2, y_2)\}, \\
 \lambda_{\underline{SE}_1 \circ \underline{SE}_2}(x, x_2)(x, y_2) &= \max\{\lambda_{\underline{RV}_1}(x), \lambda_{\underline{SE}_2}(x_2, y_2)\} \quad \forall x \in \underline{RV}_1, x_2 y_2 \in \underline{SE}_2, \\
 \mu_{\underline{SE}_1 \circ \underline{SE}_2}(x_1, z)(y_1, z) &= \min\{\mu_{\underline{SE}_1}(x_1, y_1), \mu_{\underline{RV}_2}(z)\}, \\
 \sigma_{\underline{SE}_1 \circ \underline{SE}_2}(x_1, z)(y_1, z) &= \min\{\sigma_{\underline{SE}_1}(x_1, y_1), \sigma_{\underline{RV}_2}(z)\}, \\
 \lambda_{\underline{SE}_1 \circ \underline{SE}_2}(x_1, z)(y_1, z) &= \max\{\lambda_{\underline{SE}_1}(x_1, y_1), \lambda_{\underline{RV}_2}(z)\} \quad \forall x_1 y_1 \in \underline{SE}_1, z \in \underline{RV}_2, \\
 \mu_{\underline{SE}_1 \circ \underline{SE}_2}(x_1, x_2)(y_1, y_2) &= \min\{\mu_{\underline{SE}_1}(x_1, y_1), \mu_{\underline{RV}_2}(x_2), \mu_{\underline{RV}_2}(y_2)\}, \\
 \sigma_{\underline{SE}_1 \circ \underline{SE}_2}(x_1, x_2)(y_1, y_2) &= \min\{\sigma_{\underline{SE}_1}(x_1, y_1), \sigma_{\underline{RV}_2}(x_2), \sigma_{\underline{RV}_2}(y_2)\}, \\
 \lambda_{\underline{SE}_1 \circ \underline{SE}_2}(x_1, x_2)(y_1, y_2) &= \max\{\lambda_{\underline{SE}_1}(x_1, y_1), \lambda_{\underline{RV}_2}(x_2), \lambda_{\underline{RV}_2}(y_2)\} \\
 &\quad \forall x_1 y_1 \in \underline{SE}_1, x_2, y_2 \in \underline{RV}_2, x_2 \neq y_2.
 \end{aligned}$$

$$\begin{aligned}
 (2) \quad \mu_{\overline{RV}_1 \circ \overline{RV}_2}(x_1, x_2) &= \min\{\mu_{\overline{RV}_1}(x_1), \mu_{\overline{RV}_2}(x_2)\}, \\
 \sigma_{\overline{RV}_1 \circ \overline{RV}_2}(x_1, x_2) &= \min\{\sigma_{\overline{RV}_1}(x_1), \mu_{\overline{RV}_2}(x_2)\}, \\
 \lambda_{\overline{RV}_1 \circ \overline{RV}_2}(x_1, x_2) &= \max\{\lambda_{\overline{RV}_1}(x_1), \mu_{\overline{RV}_2}(x_2)\} \quad \forall (x_1, x_2) \in \overline{RV}_1 \times \overline{RV}_2, \\
 \mu_{\overline{SE}_1 \circ \overline{SE}_2}(x, x_2)(x, y_2) &= \min\{\mu_{\overline{RV}_1}(x), \mu_{\overline{SE}_2}(x_2, y_2)\}, \\
 \sigma_{\overline{SE}_1 \circ \overline{SE}_2}(x, x_2)(x, y_2) &= \min\{\sigma_{\overline{RV}_1}(x), \sigma_{\overline{SE}_2}(x_2, y_2)\}, \\
 \lambda_{\overline{SE}_1 \circ \overline{SE}_2}(x, x_2)(x, y_2) &= \max\{\lambda_{\overline{RV}_1}(x), \lambda_{\overline{SE}_2}(x_2, y_2)\} \quad \forall x \in \overline{RV}_1, x_2 y_2 \in \overline{SE}_2, \\
 \mu_{\overline{SE}_1 \circ \overline{SE}_2}(x_1, z)(y_1, z) &= \min\{\mu_{\overline{SE}_1}(x_1, y_1), \mu_{\overline{RV}_2}(z)\}, \\
 \sigma_{\overline{SE}_1 \circ \overline{SE}_2}(x_1, z)(y_1, z) &= \min\{\sigma_{\overline{SE}_1}(x_1, y_1), \sigma_{\overline{RV}_2}(z)\}, \\
 \lambda_{\overline{SE}_1 \circ \overline{SE}_2}(x_1, z)(y_1, z) &= \max\{\lambda_{\overline{SE}_1}(x_1, y_1), \lambda_{\overline{RV}_2}(z)\} \quad \forall x_1 y_1 \in \overline{SE}_1, z \in \overline{RV}_2, \\
 \mu_{\overline{SE}_1 \circ \overline{SE}_2}(x_1, x_2)(y_1, y_2) &= \min\{\mu_{\overline{SE}_1}(x_1, y_1), \mu_{\overline{RV}_2}(x_2), \mu_{\overline{RV}_2}(y_2)\}, \\
 \sigma_{\overline{SE}_1 \circ \overline{SE}_2}(x_1, x_2)(y_1, y_2) &= \min\{\sigma_{\overline{SE}_1}(x_1, y_1), \sigma_{\overline{RV}_2}(x_2), \sigma_{\overline{RV}_2}(y_2)\}, \\
 \lambda_{\overline{SE}_1 \circ \overline{SE}_2}(x_1, x_2)(y_1, y_2) &= \max\{\lambda_{\overline{SE}_1}(x_1, y_1), \lambda_{\overline{RV}_2}(x_2), \lambda_{\overline{RV}_2}(y_2)\} \\
 &\quad \forall x_1 y_1 \in \overline{SE}_1, x_2, y_2 \in \overline{RV}_2, x_2 \neq y_2
 \end{aligned}$$

Example 4. Let $V^* = \{p, q, r\}$ be a set. Let $G_1 = (\underline{G}_1, \overline{G}_1)$ and $G_2 = (\underline{G}_2, \overline{G}_2)$ be two RND on V^* , where $\underline{G}_1 = (\underline{RV}_1, \underline{SE}_1)$ and $\overline{G}_1 = (\overline{RV}_1, \overline{SE}_1)$ are ND, as shown in Figure 8. $\underline{G}_2 = (\underline{RV}_2, \underline{SE}_2)$ and $\overline{G}_2 = (\overline{RV}_2, \overline{SE}_2)$ are also ND, as shown in Figure 9.

The composition of G_1 and G_2 is $G = G_1 \circ G_2 = (\underline{G}_1 \circ \underline{G}_2, \overline{G}_1 \circ \overline{G}_2)$ where $\underline{G}_1 \circ \underline{G}_2 = (\underline{RV}_1 \circ \underline{RV}_2, \underline{SE}_1 \circ \underline{SE}_2)$ and $\overline{G}_1 \circ \overline{G}_2 = (\overline{RV}_1 \circ \overline{RV}_2, \overline{SE}_1 \circ \overline{SE}_2)$ are NDs, as shown in Figures 10 and 11.

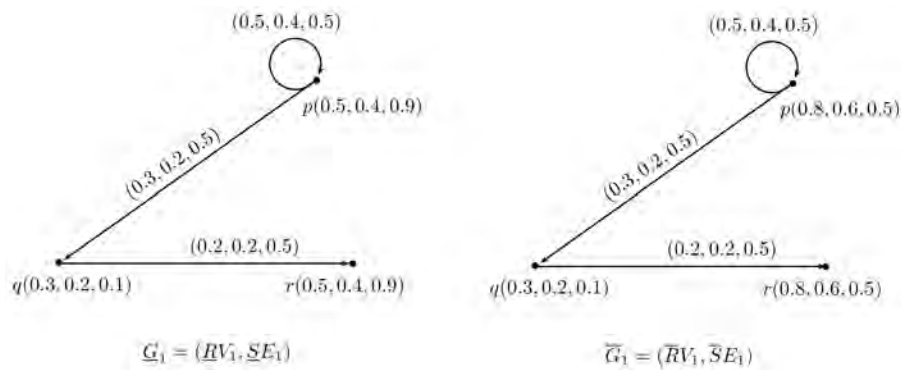

Figure 8. Rough neutrosophic digraph $G_1 = (\underline{G}_1, \overline{G}_1)$.

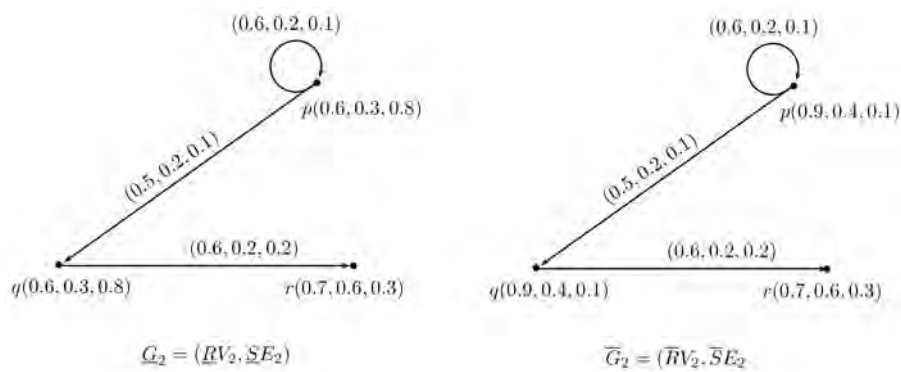

Figure 9. Rough neutrosophic digraph $G_2 = (\underline{G}_2, \overline{G}_2)$.

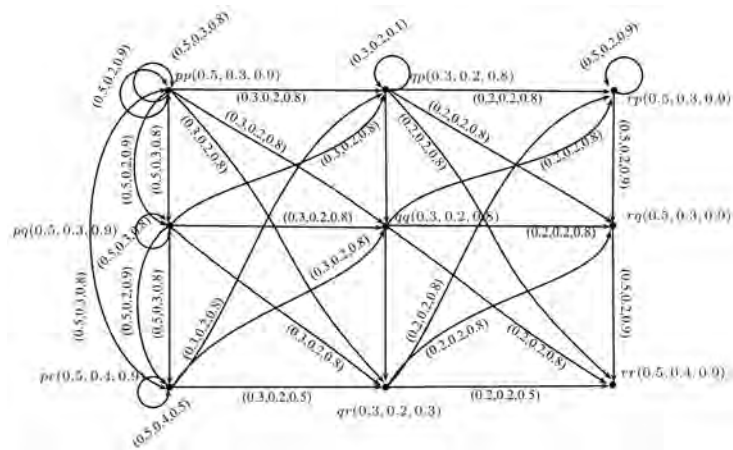

Figure 10. Neutrosophic digraph $\underline{G}_1 \circ \underline{G}_2 = (\underline{RV}_1 \circ \underline{RV}_2, \underline{SE}_1 \circ \underline{SE}_2)$.

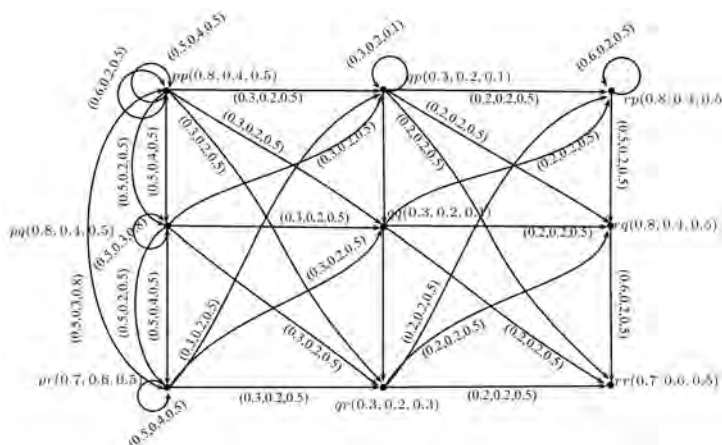

Figure 11. Neutrosophic digraph $\bar{G}_1 \circ \bar{G}_2 = (\underline{RV}_1 \circ \underline{RV}_2, \underline{SE}_1 \circ \underline{SE}_2)$.

Theorem 3. *The Composition of two rough neutrosophic digraphs is a rough neutrosophic digraph.*

Proof. Let $G_1 = (\underline{G}_1, \bar{G}_1)$ and $G_2 = (\underline{G}_2, \bar{G}_2)$ be two rough neutrosophic digraphs. Let $G = G_1 \circ G_2 = (\underline{G}_1 \circ \underline{G}_2, \bar{G}_1 \circ \bar{G}_2)$ be the Composition of G_1 and G_2 , where $\underline{G}_1 \circ \underline{G}_2 = (\underline{RV}_1 \circ \underline{RV}_2, \underline{SE}_1 \circ \underline{SE}_2)$ and $\bar{G}_1 \circ \bar{G}_2 = (\bar{RV}_1 \circ \bar{RV}_2, \bar{SE}_1 \circ \bar{SE}_2)$. To prove that $G = \underline{G}_1 \circ \bar{G}_2$ is a rough neutrosophic digraph, it is enough to show that $\underline{SE}_1 \circ \underline{SE}_2$ and $\bar{SE}_1 \circ \bar{SE}_2$ are neutrosophic relations on $\underline{RV}_1 \circ \underline{RV}_2$ and $\bar{RV}_1 \circ \bar{RV}_2$, respectively. First, we show that $\underline{SE}_1 \circ \underline{SE}_2$ is a neutrosophic relation on $\underline{RV}_1 \circ \underline{RV}_2$.

If $x \in \underline{RV}_1, x_2 y_2 \in \underline{SE}_2$, then

$$\begin{aligned} \mu_{\underline{SE}_1 \circ \underline{SE}_2}(x, x_2)(x, y_2) &= \mu_{\underline{RV}_1}(x) \wedge \mu_{\underline{SE}_2}(x_2, y_2) \\ &\leq \mu_{\underline{RV}_1}(x) \wedge (\mu_{\underline{RV}_2}(x_2) \wedge \mu_{\underline{RV}_2}(y_2)) \\ &= (\mu_{\underline{RV}_1}(x) \wedge \mu_{\underline{RV}_2}(x_2)) \wedge (\mu_{\underline{RV}_1}(x) \wedge \mu_{\underline{RV}_2}(y_2)) \\ &= \mu_{\underline{RV}_1 \circ \underline{RV}_2}(x, x_2) \wedge \mu_{\underline{RV}_1 \circ \underline{RV}_2}(x, y_2) \\ \mu_{\underline{SE}_1 \circ \underline{SE}_2}(x, x_2)(x, y_2) &\leq \min\{\mu_{\underline{RV}_1 \circ \underline{RV}_2}(x, x_2), \mu_{\underline{RV}_1 \circ \underline{RV}_2}(x, y_2)\}, \\ \sigma_{\underline{SE}_1 \circ \underline{SE}_2}(x, x_2)(x, y_2) &= \sigma_{\underline{RV}_1}(x) \wedge \sigma_{\underline{SE}_2}(x_2, y_2) \\ &\leq \sigma_{\underline{RV}_1}(x) \wedge (\sigma_{\underline{RV}_2}(x_2) \wedge \sigma_{\underline{RV}_2}(y_2)) \\ &= (\sigma_{\underline{RV}_1}(x) \wedge \sigma_{\underline{RV}_2}(x_2)) \wedge (\sigma_{\underline{RV}_1}(x) \wedge \sigma_{\underline{RV}_2}(y_2)) \\ &= \sigma_{\underline{RV}_1 \circ \underline{RV}_2}(x, x_2) \wedge \sigma_{\underline{RV}_1 \circ \underline{RV}_2}(x, y_2) \\ \sigma_{\underline{SE}_1 \circ \underline{SE}_2}(x, x_2)(x, y_2) &\leq \min\{\sigma_{\underline{RV}_1 \circ \underline{RV}_2}(x, x_2), \sigma_{\underline{RV}_1 \circ \underline{RV}_2}(x, y_2)\}, \\ \lambda_{\underline{SE}_1 \circ \underline{SE}_2}(x, x_2)(x, y_2) &= \lambda_{\underline{RV}_1}(x) \vee \lambda_{\underline{SE}_2}(x_2, y_2) \\ &\leq \lambda_{\underline{RV}_1}(x) \vee (\lambda_{\underline{RV}_2}(x_2) \vee \lambda_{\underline{RV}_2}(y_2)) \\ &= (\lambda_{\underline{RV}_1}(x) \vee \lambda_{\underline{RV}_2}(x_2)) \vee (\lambda_{\underline{RV}_1}(x) \vee \lambda_{\underline{RV}_2}(y_2)) \\ &= \lambda_{\underline{RV}_1 \circ \underline{RV}_2}(x, x_2) \vee \lambda_{\underline{RV}_1 \circ \underline{RV}_2}(x, y_2) \\ \lambda_{\underline{SE}_1 \circ \underline{SE}_2}(x, x_2, x, y_2) &\leq \max\{\lambda_{\underline{RV}_1 \circ \underline{RV}_2}(x, x_2), \lambda_{\underline{RV}_1 \circ \underline{RV}_2}(x, y_2)\}. \end{aligned}$$

If $x_1 y_1 \in \underline{SE}_1, z \in \underline{RV}_2$, then

$$\begin{aligned} \mu_{\underline{SE}_1 \circ \underline{SE}_2}(x_1, z)(y_1, z) &= \mu_{\underline{SE}_1}(x_1, y_1) \wedge \mu_{\underline{RV}_2}(z) \\ &\leq (\mu_{\underline{RV}_1}(x_1) \wedge \mu_{\underline{RV}_1}(y_1)) \wedge \mu_{\underline{RV}_2}(z) \\ &= (\mu_{\underline{RV}_1}(x_1) \wedge \mu_{\underline{RV}_2}(z)) \wedge (\mu_{\underline{RV}_1}(y_1) \wedge \mu_{\underline{RV}_2}(z)) \\ &= \mu_{\underline{RV}_1 \circ \underline{RV}_2}(x_1, z) \wedge \mu_{\underline{RV}_1 \circ \underline{RV}_2}(y_1, z) \\ \mu_{\underline{SE}_1 \circ \underline{SE}_2}(x_1, z)(y_1, z) &\leq \min\{\mu_{\underline{RV}_1 \circ \underline{RV}_2}(x_1, z), \mu_{\underline{RV}_1 \circ \underline{RV}_2}(y_1, z)\}, \end{aligned}$$

$$\begin{aligned}
 \sigma_{\underline{SE}_1 \circ \underline{SE}_2}(x_1, z)(y_1, z) &= \sigma_{\underline{SE}_1}(x_1, y_1) \wedge \sigma_{\underline{RV}_2}(z) \\
 &\leq (\sigma_{\underline{RV}_1}(x_1) \wedge \sigma_{\underline{RV}_1}(y_1)) \wedge \sigma_{\underline{RV}_2}(z) \\
 &= (\sigma_{\underline{RV}_1}(x_1) \wedge \sigma_{\underline{RV}_2}(z)) \wedge (\sigma_{\underline{RV}_1}(y_1) \wedge \sigma_{\underline{RV}_2}(z)) \\
 &= \sigma_{\underline{RV}_1 \circ \underline{RV}_2}(x_1, z) \wedge \sigma_{\underline{RV}_1 \circ \underline{RV}_2}(y_1, z) \\
 \sigma_{\underline{SE}_1 \circ \underline{SE}_2}(x_1, z)(y_1, z) &\leq \min\{\sigma_{\underline{RV}_1 \circ \underline{RV}_2}(x_1, z), \sigma_{\underline{RV}_1 \circ \underline{RV}_2}(y_1, z)\}, \\
 \lambda_{\underline{SE}_1 \circ \underline{SE}_2}(x_1, z)(y_1, z) &= \lambda_{\underline{SE}_1}(x_1, y_1) \vee \lambda_{\underline{RV}_2}(z) \\
 &\leq (\lambda_{\underline{RV}_1}(x_1) \vee \lambda_{\underline{RV}_1}(y_1)) \vee \lambda_{\underline{RV}_2}(z) \\
 &= (\lambda_{\underline{RV}_1}(x_1) \vee \lambda_{\underline{RV}_2}(z)) \vee (\lambda_{\underline{RV}_1}(y_1) \vee \lambda_{\underline{RV}_2}(z)) \\
 &= \lambda_{\underline{RV}_1 \circ \underline{RV}_2}(x_1, z) \vee \lambda_{\underline{RV}_1 \circ \underline{RV}_2}(y_1, z) \\
 \lambda_{\underline{SE}_1 \circ \underline{SE}_2}(x_1, z)(y_1, z) &\leq \max\{\lambda_{\underline{RV}_1 \circ \underline{RV}_2}(x_1, z), \lambda_{\underline{RV}_1 \circ \underline{RV}_2}(y_1, z)\}.
 \end{aligned}$$

If $x_1 y_1 \in \underline{SE}_1, x_2, y_2 \in \underline{RV}_2$ such that $x_2 \neq y_2$,

$$\begin{aligned}
 \mu_{\underline{SE}_1 \circ \underline{SE}_2}(x_1, x_2)(y_1, y_2) &= \mu_{\underline{SE}_1}(x_1 y_1) \wedge \mu_{\underline{RV}_2}(x_2) \wedge \mu_{\underline{RV}_2}(y_2) \\
 &\leq (\mu_{\underline{RV}_1}(x_1) \wedge \mu_{\underline{RV}_1}(y_1)) \wedge \mu_{\underline{RV}_2}(x_2) \wedge \mu_{\underline{RV}_2}(y_2) \\
 &= (\mu_{\underline{RV}_1}(x_1) \wedge \mu_{\underline{RV}_2}(x_2)) \wedge (\mu_{\underline{RV}_1}(y_1) \wedge \mu_{\underline{RV}_2}(y_2)) \\
 &= \mu_{\underline{RV}_1 \circ \underline{RV}_2}(x_1, x_2) \wedge \mu_{\underline{RV}_1 \circ \underline{RV}_2}(y_1, y_2) \\
 \mu_{\underline{SE}_1 \circ \underline{SE}_2}(x_1, x_2)(y_1, y_2) &\leq \min\{\mu_{\underline{RV}_1 \circ \underline{RV}_2}(x_1, x_2), \mu_{\underline{RV}_1 \circ \underline{RV}_2}(y_1, y_2)\} \\
 \sigma_{\underline{SE}_1 \circ \underline{SE}_2}(x_1, x_2)(y_1, y_2) &= \sigma_{\underline{SE}_1}(x_1 y_1) \wedge \sigma_{\underline{RV}_2}(x_2) \wedge \sigma_{\underline{RV}_2}(y_2) \\
 &\leq (\sigma_{\underline{RV}_1}(x_1) \wedge \sigma_{\underline{RV}_1}(y_1)) \wedge \sigma_{\underline{RV}_2}(x_2) \wedge \sigma_{\underline{RV}_2}(y_2) \\
 &= (\sigma_{\underline{RV}_1}(x_1) \wedge \sigma_{\underline{RV}_2}(x_2)) \wedge (\sigma_{\underline{RV}_1}(y_1) \wedge \sigma_{\underline{RV}_2}(y_2)) \\
 &= \sigma_{\underline{RV}_1 \circ \underline{RV}_2}(x_1, x_2) \wedge \sigma_{\underline{RV}_1 \circ \underline{RV}_2}(y_1, y_2) \\
 \sigma_{\underline{SE}_1 \circ \underline{SE}_2}(x_1, x_2)(y_1, y_2) &\leq \min\{\sigma_{\underline{RV}_1 \circ \underline{RV}_2}(x_1, x_2), \sigma_{\underline{RV}_1 \circ \underline{RV}_2}(y_1, y_2)\} \\
 \lambda_{\underline{SE}_1 \circ \underline{SE}_2}(x_1, x_2)(y_1, y_2) &= \lambda_{\underline{SE}_1}(x_1 y_1) \vee \lambda_{\underline{RV}_2}(x_2) \vee \lambda_{\underline{RV}_2}(y_2) \\
 &\leq (\lambda_{\underline{RV}_1}(x_1) \vee \lambda_{\underline{RV}_1}(y_1)) \vee \lambda_{\underline{RV}_2}(x_2) \vee \lambda_{\underline{RV}_2}(y_2) \\
 &= (\lambda_{\underline{RV}_1}(x_1) \vee \lambda_{\underline{RV}_2}(x_2)) \vee (\lambda_{\underline{RV}_1}(y_1) \vee \lambda_{\underline{RV}_2}(y_2)) \\
 &= \lambda_{\underline{RV}_1 \circ \underline{RV}_2}(x_1, x_2) \vee \lambda_{\underline{RV}_1 \circ \underline{RV}_2}(y_1, y_2) \\
 \lambda_{\underline{SE}_1 \circ \underline{SE}_2}(x_1, x_2)(y_1, y_2) &\leq \max\{\lambda_{\underline{RV}_1 \circ \underline{RV}_2}(x_1, x_2), \lambda_{\underline{RV}_1 \circ \underline{RV}_2}(y_1, y_2)\}.
 \end{aligned}$$

Thus, from above, it is clear that $\underline{SE}_1 \circ \underline{SE}_2$ is a neutrosophic relation on $\underline{RV}_1 \circ \underline{RV}_2$.

Similarly, we can show that $\overline{SE}_1 \circ \overline{SE}_2$ is a neutrosophic relation on $\overline{RV}_1 \circ \overline{RV}_2$. Hence, $G = (\underline{G}_1 \circ \underline{G}_2, \overline{G}_1 \circ \overline{G}_2)$ is a rough neutrosophic digraph. \square

Definition 9. Let $G = (\underline{G}, \overline{G})$ be a RND. The complement of G , denoted by $G' = (\underline{G}', \overline{G}')$ is a rough neutrosophic digraph, where $\underline{G}' = ((\underline{RV})', (\underline{SE})')$ and $\overline{G}' = ((\overline{RV})', (\overline{SE})')$ are neutrosophic digraph such that

$$\begin{aligned}
 \text{(1)} \quad \mu_{(\underline{RV})'}(x) &= \mu_{\underline{RV}}(x), \\
 \sigma_{(\underline{RV})'}(x) &= \sigma_{\underline{RV}}(x), \\
 \lambda_{(\underline{RV})'}(x) &= \lambda_{\underline{RV}}(x) \quad \forall x \in V^* \\
 \mu_{(\underline{SE})'}(x, y) &= \min\{\mu_{\underline{RV}}(x), \mu_{\underline{RV}}(y)\} - \mu_{\underline{SE}}(xy) \\
 \sigma_{(\underline{SE})'}(x, y) &= \min\{\sigma_{\underline{RV}}(x), \sigma_{\underline{RV}}(y)\} - \sigma_{\underline{SE}}(xy) \\
 \lambda_{(\underline{SE})'}(x, y) &= \max\{\lambda_{\underline{RV}}(x), \lambda_{\underline{RV}}(y)\} - \lambda_{\underline{SE}}(xy) \quad \forall x, y \in V^*.
 \end{aligned}$$

$$\begin{aligned}
 (2) \quad & \mu_{\underline{RV}'}(x) = \mu_{\underline{RV}}(x), \\
 & \sigma_{\underline{RV}'}(x) = \sigma_{\underline{RV}}(x), \\
 & \lambda_{\underline{RV}'}(x) = \lambda_{\underline{RV}}(x), \quad \forall x \in V^* \\
 & \mu_{(\underline{SE})'}(x, y) = \min\{\mu_{\underline{RV}}(x), \mu_{\underline{RV}}(y)\} - \mu_{\underline{SE}}(xy) \\
 & \sigma_{(\underline{SE})'}(x, y) = \min\{\sigma_{\underline{RV}}(x), \sigma_{\underline{RV}}(y)\} - \sigma_{\underline{SE}}(xy) \\
 & \lambda_{(\underline{SE})'}(x, y) = \max\{\lambda_{\underline{RV}}(x), \lambda_{\underline{RV}}(y)\} - \lambda_{\underline{SE}}(xy) \quad \forall x, y \in V^*.
 \end{aligned}$$

Example 5. Consider a rough neutrosophic digraph as shown in Figure 4. The lower and upper approximations of graph G are $\underline{G} = (\underline{RV}, \underline{SE})$ and $\overline{G} = (\overline{RV}, \overline{SE})$, respectively, where

$$\begin{aligned}
 \underline{RV} &= \{(a, 0.2, 0.4, 0.6), (b, 0.2, 0.4, 0.6), (c, 0.2, 0.5, 0.9), (d, 0.2, 0.5, 0.9)\}, \\
 \overline{RV} &= \{(a, 0.3, 0.8, 0.3), (b, 0.3, 0.8, 0.3), (c, 0.5, 0.6, 0.8), (d, 0.5, 0.6, 0.8)\}, \\
 \underline{SE} &= \{(aa, 0.2, 0.3, 0.3), (ab, 0.2, 0.3, 0.3), (ad, 0.1, 0.3, 0.8), (bc, 0.1, 0.3, 0.8), \\
 & \quad (bd, 0.1, 0.3, 0.8), (dc, 0.2, 0.4, 0.7), (dd, 0.2, 0.4, 0.7)\}, \\
 \overline{SE} &= \{(aa, 0.2, 0.4, 0.3), (ab, 0.2, 0.4, 0.3), (ad, 0.2, 0.4, 0.7), (bc, 0.2, 0.4, 0.7), \\
 & \quad (bd, 0.2, 0.4, 0.7), (dc, 0.2, 0.4, 0.7), (dd, 0.2, 0.4, 0.7)\}.
 \end{aligned}$$

The complement of G is $G' = (\underline{G}', \overline{G}')$. By calculations, we have

$$\begin{aligned}
 (\underline{RV})' &= \{(a, 0.2, 0.4, 0.6), (b, 0.2, 0.4, 0.6), (c, 0.2, 0.5, 0.9), (d, 0.2, 0.5, 0.9)\}, \\
 (\overline{RV})' &= \{(a, 0.3, 0.8, 0.3), (b, 0.3, 0.8, 0.3), (c, 0.5, 0.6, 0.8), (d, 0.5, 0.6, 0.8)\}, \\
 (\underline{SE})' &= \{(aa, 0, 0.1, 0.3), (ab, 0, 0.1, 0.3), (ac, 0.2, 0.4, 0.9), (ad, 0.1, 0.1, 0.1), (ba, 0.2, 0.4, 0.6), (bb, 0.2, 0.4, 0.6), \\
 & \quad (bc, 0.1, 0.1, 0.1), (bd, 0.1, 0.1, 0.1), (ca, 0.2, 0.4, 0.9), (cb, 0.2, 0.4, 0.9), (cc, 0.2, 0.5, 0.9), (cd, 0.2, 0.5, 0.9), \\
 & \quad (da, 0.2, 0.4, 0.9), (db, 0.2, 0.4, 0.9), (dc, 0, 0.1, 0.2), (dd, 0, 0.1, 0.2)\}, \\
 (\overline{SE})' &= \{(aa, 0.1, 0.4, 0), (ab, 0.1, 0.4, 0), (ac, 0.3, 0.6, 0.8), (ad, 0.1, 0.2, 0.1), (ba, 0.3, 0.8, 0.3), (bb, 0.3, 0.8, 0.3), \\
 & \quad (bc, 0.1, 0.2, 0.1), (bd, 0.1, 0.2, 0.1), (ca, 0.3, 0.6, 0.8), (cb, 0.3, 0.6, 0.8), (cc, 0.5, 0.6, 0.8), (cd, 0.5, 0.6, 0.8), \\
 & \quad (da, 0.3, 0.6, 0.8), (db, 0.3, 0.6, 0.8), (dc, 0.3, 0.2, 0.1), (dd, 0.3, 0.2, 0.1)\}.
 \end{aligned}$$

Thus, $\underline{G}' = ((\underline{RV})', (\underline{SE})')$ and $\overline{G}' = ((\overline{RV})', (\overline{SE})')$ are neutrosophic digraph, as shown in Figure 12.

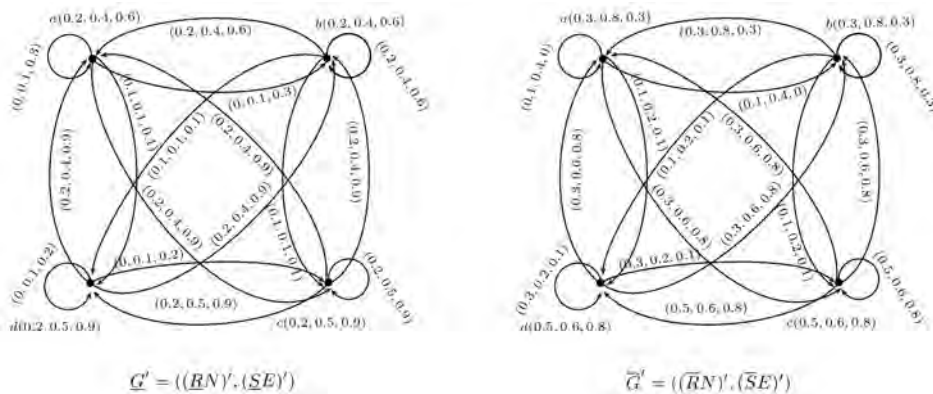

Figure 12. Rough neutrosophic digraph $G' = (\underline{G}', \overline{G}')$.

Definition 10. A rough neutrosophic digraph $G = (\underline{G}, \overline{G})$ is self complementary if G and G' are isomorphic, that is, $\underline{G} \cong \underline{G}'$ and $\overline{G} \cong \overline{G}'$.

Example 6. Let $V^* = \{a, b, c\}$ be a set and R an equivalence relation on V^* defined as:

$$R = \begin{bmatrix} 1 & 0 & 1 \\ 0 & 1 & 0 \\ 1 & 0 & 1 \end{bmatrix}.$$

Let $V = \{(a, 0.2, 0.4, 0.8), (b, 0.2, 0.4, 0.8), (c, 0.4, 0.6, 0.4)\}$ be a neutrosophic set on V^* . The lower and upper approximations of V are given as,

$$\underline{R}V = \{(a, 0.2, 0.4, 0.8), (b, 0.2, 0.4, 0.8), (c, 0.2, 0.4, 0.8)\},$$

$$\overline{R}V = \{(a, 0.4, 0.6, 0.4), (b, 0.2, 0.4, 0.8), (c, 0.4, 0.6, 0.4)\}.$$

Let $E^* = \{aa, ab, ac, ba\} \subseteq V^* \times V^*$ and S an equivalence relation on E^* defined as

$$S = \begin{bmatrix} 1 & 0 & 1 & 0 \\ 0 & 1 & 0 & 0 \\ 1 & 0 & 1 & 0 \\ 0 & 0 & 0 & 1 \end{bmatrix}.$$

Let $E = \{(aa, 0.1, 0.3, 0.2), (ab, 0.1, 0.2, 0.4), (ac, 0.2, 0.2, 0.4), (ba, 0.1, 0.2, 0.4)\}$ be a neutrosophic set on E^* and $SE = (\underline{SE}, \overline{SE})$ a RNR where \underline{SE} and \overline{SE} are given as

$$\underline{SE} = \{(aa, 0.1, 0.2, 0.4), (ab, 0.1, 0.2, 0.4), (ac, 0.1, 0.2, 0.4), (ba, 0.1, 0.2, 0.4)\},$$

$$\overline{SE} = \{(aa, 0.2, 0.3, 0.2), (ab, 0.1, 0.2, 0.4), (ac, 0.2, 0.3, 0.2), (ba, 0.1, 0.2, 0.4)\}.$$

Thus, $\underline{G} = (\underline{R}V, \underline{SE})$ and $\overline{G} = (\overline{R}V, \overline{SE})$ are neutrosophic digraphs, as shown in Figure 13. The complement of G is $G' = (\underline{G}', \overline{G}')$, where $\underline{G}' = \underline{G}$ and $\overline{G}' = \overline{G}$ are neutrosophic digraphs, as shown in Figure 13, and it can be easily shown that G and G' are isomorphic. Hence, $G = (\underline{G}, \overline{G})$ is a self complementary RND.

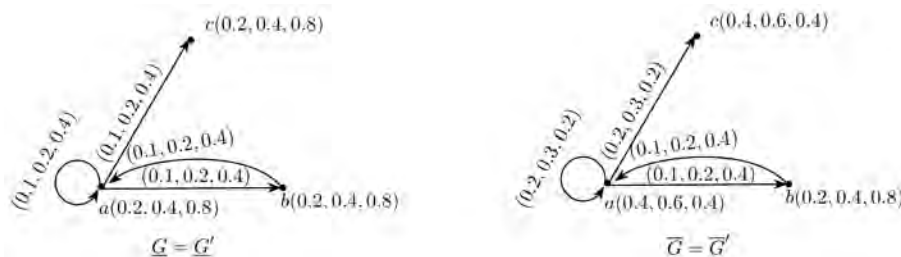

Figure 13. Self complementary RND $G = (\underline{G}, \overline{G})$.

Theorem 4. Let $G = (\underline{G}, \overline{G})$ be a self complementary rough neutrosophic digraph. Then,

$$\begin{aligned} \sum_{w,z \in V^*} \mu_{\underline{SE}}(wz) &= \frac{1}{2} \sum_{w,z \in V^*} (\mu_{\underline{R}V}(w) \wedge \mu_{\underline{R}V}(z)) \\ \sum_{w,z \in V^*} \sigma_{\underline{SE}}(wz) &= \frac{1}{2} \sum_{w,z \in V^*} (\sigma_{\underline{R}V}(w) \wedge \sigma_{\underline{R}V}(z)) \\ \sum_{w,z \in V^*} \lambda_{\underline{SE}}(wz) &= \frac{1}{2} \sum_{w,z \in V^*} (\lambda_{\underline{R}V}(w) \vee \lambda_{\underline{R}V}(z)) \\ \sum_{w,z \in V^*} \mu_{\overline{SE}}(wz) &= \frac{1}{2} \sum_{w,z \in V^*} (\mu_{\overline{R}V}(w) \wedge \mu_{\overline{R}V}(z)) \\ \sum_{w,z \in V^*} \sigma_{\overline{SE}}(wz) &= \frac{1}{2} \sum_{w,z \in V^*} (\sigma_{\overline{R}V}(w) \wedge \sigma_{\overline{R}V}(z)) \\ \sum_{w,z \in V^*} \lambda_{\overline{SE}}(wz) &= \frac{1}{2} \sum_{w,z \in V^*} (\lambda_{\overline{R}V}(w) \vee \lambda_{\overline{R}V}(z)). \end{aligned}$$

Proof. Let $G = (\underline{G}, \overline{G})$ be a self complementary rough neutrosophic digraph. Then, there exist two isomorphisms $\underline{g} : V^* \rightarrow V^*$ and $\overline{g} : V^* \rightarrow V^*$, respectively, such that

$$\begin{aligned} \mu_{(\underline{R}V)'}(\underline{g}(w)) &= \mu_{\underline{R}V}(w), \\ \sigma_{(\underline{R}V)'}(\underline{g}(w)) &= \sigma_{\underline{R}V}(w), \\ \lambda_{(\underline{R}V)'}(\underline{g}(w)) &= \lambda_{\underline{R}V}(w), \quad \forall w \in V^* \\ \mu_{(\underline{S}E)'}(\underline{g}(w)\underline{g}(z)) &= \mu_{(\underline{S}E)}(wz), \\ \sigma_{(\underline{S}E)'}(\underline{g}(w)\underline{g}(z)) &= \sigma_{(\underline{S}E)}(wz), \\ \lambda_{(\underline{S}E)'}(\underline{g}(w)\underline{g}(z)) &= \lambda_{(\underline{S}E)}(wz) \quad \forall w, z \in V^*. \end{aligned}$$

and

$$\begin{aligned} \mu_{(\overline{R}V)'}(\overline{g}(w)) &= \mu_{\overline{R}V}(w), \\ \sigma_{(\overline{R}V)'}(\overline{g}(w)) &= \sigma_{\overline{R}V}(w), \\ \lambda_{(\overline{R}V)'}(\overline{g}(w)) &= \lambda_{\overline{R}V}(w), \quad \forall w \in V^* \\ \mu_{(\overline{S}E)'}(\overline{g}(w)\overline{g}(z)) &= \mu_{(\overline{S}E)}(wz), \\ \sigma_{(\overline{S}E)'}(\overline{g}(w)\overline{g}(z)) &= \sigma_{(\overline{S}E)}(wz), \\ \lambda_{(\overline{S}E)'}(\overline{g}(w)\overline{g}(z)) &= \lambda_{(\overline{S}E)}(wz) \quad \forall w, z \in V^*. \end{aligned}$$

By Definition 7, we have

$$\begin{aligned} \mu_{(\underline{S}E)'}(\underline{g}(w)\underline{g}(z)) &= (\mu_{\underline{R}V}(w) \wedge \mu_{\underline{R}V}(z)) - \mu_{(\underline{S}E)}(wz) \\ \mu_{(\underline{S}E)}(wz) &= (\mu_{\underline{R}V}(w) \wedge \mu_{\underline{R}V}(z)) - \mu_{(\underline{S}E)}(wz) \\ \sum_{w,z \in V^*} \mu_{(\underline{S}E)}(wz) &= \sum_{w,z \in V^*} (\mu_{\underline{R}V}(w) \wedge \mu_{\underline{R}V}(z)) - \sum_{w,z \in V^*} \mu_{(\underline{S}E)}(wz) \\ 2 \sum_{w,z \in V^*} \mu_{(\underline{S}E)}(wz) &= \sum_{w,z \in V^*} (\mu_{\underline{R}V}(w) \wedge \mu_{\underline{R}V}(z)) \\ \sum_{w,z \in V^*} \mu_{(\underline{S}E)}(wz) &= \frac{1}{2} \sum_{w,z \in V^*} (\mu_{\underline{R}V}(w) \wedge \mu_{\underline{R}V}(z)) \\ \sigma_{(\underline{S}E)'}(\underline{g}(w)\underline{g}(z)) &= (\sigma_{\underline{R}V}(w) \wedge \sigma_{\underline{R}V}(z)) - \sigma_{(\underline{S}E)}(wz) \\ \sigma_{(\underline{S}E)}(wz) &= (\sigma_{\underline{R}V}(w) \wedge \sigma_{\underline{R}V}(z)) - \sigma_{(\underline{S}E)}(wz) \\ \sum_{w,z \in V^*} \sigma_{(\underline{S}E)}(wz) &= \sum_{w,z \in V^*} (\sigma_{\underline{R}V}(w) \wedge \sigma_{\underline{R}V}(z)) - \sum_{w,z \in V^*} \sigma_{(\underline{S}E)}(wz) \\ 2 \sum_{w,z \in V^*} \sigma_{(\underline{S}E)}(wz) &= \sum_{w,z \in V^*} (\sigma_{\underline{R}V}(w) \wedge \sigma_{\underline{R}V}(z)) \\ \sum_{w,z \in V^*} \sigma_{(\underline{S}E)}(wz) &= \frac{1}{2} \sum_{w,z \in V^*} (\sigma_{\underline{R}V}(w) \wedge \sigma_{\underline{R}V}(z)) \\ \lambda_{(\underline{S}E)'}(\underline{g}(w)\underline{g}(z)) &= (\lambda_{\underline{R}V}(w) \vee \lambda_{\underline{R}V}(z)) - \lambda_{(\underline{S}E)}(wz) \\ \lambda_{(\underline{S}E)}(wz) &= (\lambda_{\underline{R}V}(w) \vee \lambda_{\underline{R}V}(z)) - \lambda_{(\underline{S}E)}(wz) \\ \sum_{w,z \in V^*} \lambda_{(\underline{S}E)}(wz) &= \sum_{w,z \in V^*} (\lambda_{\underline{R}V}(w) \vee \lambda_{\underline{R}V}(z)) - \sum_{w,z \in V^*} \lambda_{(\underline{S}E)}(wz) \\ 2 \sum_{w,z \in V^*} \lambda_{(\underline{S}E)}(wz) &= \sum_{w,z \in V^*} (\lambda_{\underline{R}V}(w) \vee \lambda_{\underline{R}V}(z)) \\ \sum_{w,z \in V^*} \lambda_{(\underline{S}E)}(wz) &= \frac{1}{2} \sum_{w,z \in V^*} (\lambda_{\underline{R}V}(w) \vee \lambda_{\underline{R}V}(z)) \end{aligned}$$

Similarly, it can be shown that

$$\begin{aligned} \sum_{w,z \in V^*} \mu_{\bar{S}E}(wz) &= \frac{1}{2} \sum_{w,z \in V^*} (\mu_{\bar{R}V}(w) \wedge \mu_{\bar{R}V}(z)) \\ \sum_{w,z \in V^*} \sigma_{\bar{S}E}(wz) &= \frac{1}{2} \sum_{w,z \in V^*} (\sigma_{\bar{R}V}(w) \wedge \sigma_{\bar{R}V}(z)) \\ \sum_{w,z \in V^*} \lambda_{\bar{S}E}(wz) &= \frac{1}{2} \sum_{w,z \in V^*} (\lambda_{\bar{R}V}(w) \vee \lambda_{\bar{R}V}(z)). \end{aligned}$$

This completes the proof. \square

3. Application

Investment is a very good way of getting profit and wisely invested money surely gives certain profit. The most important factors that influence individual investment decision are: company’s reputation, corporate earnings and price per share. In this application, we combine these factors into one factor, i.e. company’s status in industry, to describe overall performance of the company. Let us consider an individual Mr. Shahid who wants to invest his money. For this purpose, he considers some private companies, which are Telecommunication company (*TC*), Carpenter company (*CC*), Real Estate business (*RE*), Vehicle Leasing company (*VL*), Advertising company (*AD*), and Textile Testing company (*TT*). Let $V^* = \{TC, CC, RE, VL, AD, TT\}$ be a set. Let *T* be an equivalence relation defined on V^* as follows:

$$T = \begin{bmatrix} 1 & 0 & 1 & 0 & 1 & 0 \\ 0 & 1 & 0 & 0 & 0 & 0 \\ 1 & 0 & 1 & 0 & 1 & 0 \\ 0 & 0 & 0 & 1 & 0 & 1 \\ 1 & 0 & 1 & 0 & 1 & 0 \\ 0 & 0 & 0 & 1 & 0 & 1 \end{bmatrix}.$$

Let $V = \{(TC, 0.3, 0.4, 0.1), (CC, 0.8, 0.1, 0.5), (RE, 0.1, 0.2, 0.6), (VL, 0.9, 0.6, 0.1), (AD, 0.2, 0.5, 0.2), (TT, 0.8, 0.6, 0.5)\}$ be a neutrosophic set on V^* with three components corresponding to each company, which represents its status in the industry and $TV = (\underline{TV}, \bar{TV})$ a rough neutrosophic set, where \underline{TV} and \bar{TV} are lower and upper approximations of *V*, respectively, as follows:

$$\underline{TV} = \{(TC, 0.1, 0.2, 0.6), (CC, 0.8, 0.1, 0.5), (RE, 0.1, 0.2, 0.6), (VL, 0.8, 0.6, 0.5), (AD, 0.1, 0.2, 0.6), (TT, 0.8, 0.6, 0.5)\},$$

$$\bar{TV} = \{(TC, 0.3, 0.5, 0.1), (CC, 0.8, 0.1, 0.5), (RE, 0.3, 0.5, 0.1), (VL, 0.9, 0.6, 0.1), (AD, 0.3, 0.5, 0.1), (TT, 0.9, 0.6, 0.1)\}.$$

$$\text{Let } E^* = \{(TC, CC), (TC, AD), (TC, RE), (CC, VL), (CC, TT), (AD, RE), (TT, VL)\},$$

be the set of edges and *S* an equivalence relation on E^* defined as follows:

$$S = \begin{bmatrix} 1 & 0 & 0 & 0 & 0 & 0 & 0 \\ 0 & 1 & 1 & 0 & 0 & 1 & 0 \\ 0 & 1 & 1 & 0 & 0 & 1 & 0 \\ 0 & 0 & 0 & 1 & 1 & 0 & 0 \\ 0 & 1 & 0 & 1 & 1 & 0 & 0 \\ 0 & 0 & 1 & 0 & 0 & 1 & 0 \\ 0 & 0 & 0 & 0 & 0 & 0 & 1 \end{bmatrix}.$$

$$\text{Let } E = \{((TC, CC), 0.1, 0.1, 0.1), ((TC, AD), 0.1, 0.2, 0.1), ((TC, RE), 0.1, 0.2, 0.1), ((CC, VL), 0.8, 0.1, 0.5), ((CC, TT), 0.8, 0.1, 0.5), ((AD, RE), 0.1, 0.2, 0.1), ((TT, VL), 0.8, 0.6, 0.1)\}$$

be a neutrosophic set on E^* which represents relationship between companies and $SE = (\underline{SE}, \overline{SE})$ a rough neutrosophic relation, where \underline{SE} and \overline{SE} are lower and upper upper approximations of E , respectively, as follows:

$$\begin{aligned} \underline{SE} &= \{((TC, CC), 0.1, 0.1, 0.1), ((TC, AD), 0.1, 0.2, 0.1), ((TC, RE), 0.1, 0.2, 0.1), ((CC, VL), 0.8, 0.1, 0.5), ((CC, TT), 0.8, 0.1, 0.5), ((AD, RE), 0.1, 0.2, 0.1), ((TT, VL), 0.8, 0.6, 0.1)\}, \\ \overline{SE} &= \{((TC, CC), 0.1, 0.1, 0.1), ((TC, AD), 0.1, 0.2, 0.1), ((TC, RE), 0.1, 0.2, 0.1), ((CC, VL), 0.8, 0.1, 0.5), ((CC, TT), 0.8, 0.1, 0.5), ((AD, RE), 0.1, 0.2, 0.1), ((TT, VL), 0.8, 0.6, 0.1)\}. \end{aligned}$$

Thus, $\underline{G} = (\underline{TV}, \underline{SE})$ and $\overline{G} = (\overline{TV}, \overline{SE})$ is a rough neutrosophic digraph as shown in Figure 14.

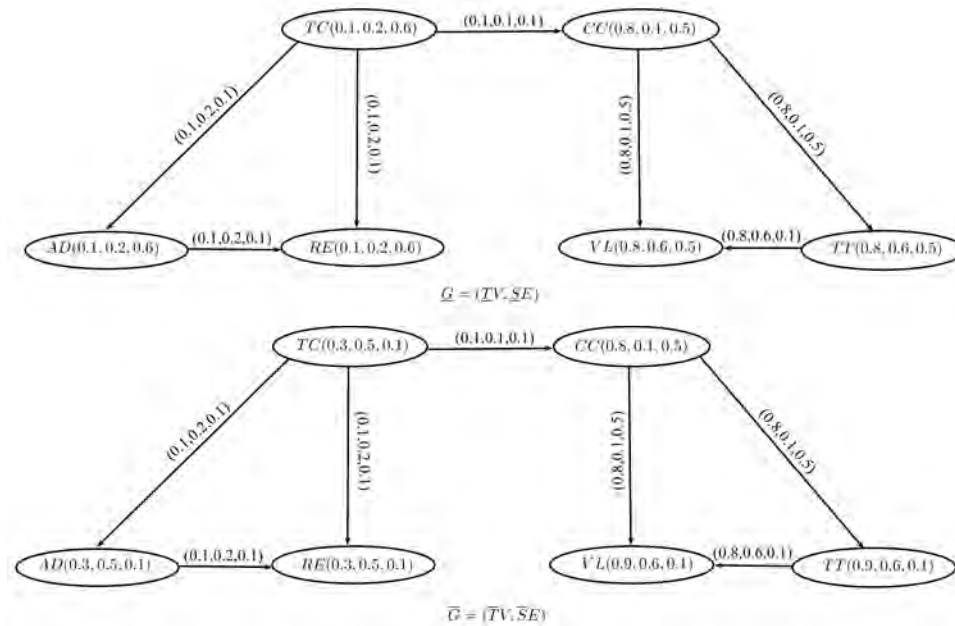

Figure 14. Rough neutrosophic digraph $G = (\underline{G}, \overline{G})$.

To find out the most suitable investment company, we define the score values

$$S(v_i) = \sum_{v_i, v_j \in E^*} \frac{T(v_j) + I(v_j) - F(v_j)}{3 - (T(v_i v_j) + I(v_i v_j) - F(v_i v_j))'}$$

where

$$\begin{aligned} T(v_j) &= \frac{\underline{I}(v_j) + \overline{I}(v_j)}{2}, \\ I(v_j) &= \frac{\underline{I}(v_j) + \overline{I}(v_j)}{2}, \\ F(v_j) &= \frac{\underline{F}(v_j) + \overline{F}(v_j)}{2}, \end{aligned}$$

and

$$\begin{aligned}
 T(v_i v_j) &= \frac{\underline{T}(v_i v_j) + \overline{T}(v_i v_j)}{2}, \\
 I(v_i v_j) &= \frac{\underline{I}(v_i v_j) + \overline{I}(v_i v_j)}{2}, \\
 F(v_i v_j) &= \frac{\underline{F}(v_i v_j) + \overline{F}(v_i v_j)}{2}.
 \end{aligned}$$

of each selected company and industry decision is v_k if $v_k = \max_i S(v_i)$. By calculation, we have $S(TC) = 0.4926$, $S(CC) = 1.4038$, $S(RE) = 0.0667$, $S(VL) = 0.3833$, $S(AD) = 0.1429$ and $S(TT) = 1.3529$. Clearly, CC is the optimal decision. Therefore, the carpenter company is selected to get maximum possible profit. We present our proposed method as an algorithm. This Algorithm 1 returns the optimal solution for the investment problem.

Algorithm 1 Calculation of Optimal decision

- 1: Input the vertex set V^* .
- 2: Construct an equivalence relation T on the set V^* .
- 3: Calculate the approximation sets $\underline{T}V$ and $\overline{T}V$.
- 4: Input the edge set $E^* \subseteq V^* \times V^*$.
- 5: Construct an equivalence relation S on E^* .
- 6: Calculate the approximation sets $\underline{S}E$ and $\overline{S}E$.
- 7: Calculate the score value, by using formula

$$S(v_i) = \sum_{v_i v_j \in E^*} \frac{T(v_j) + I(v_j) - F(v_j)}{3 - (T(v_i v_j) + I(v_i v_j) - F(v_i v_j))}.$$

- 8: The decision is $S(v_k) = \max_{v_i \in V^*} S(v_i)$.
 - 9: If v_k has more than one value, then any one of $S(v_k)$ may be chosen.
-

4. Conclusions and Future Directions

Neutrosophic sets and rough sets are very important models to handle uncertainty from two different perspectives. A rough neutrosophic model is a hybrid model which is made by combining two mathematical models, namely, rough sets and neutrosophic sets. This hybrid model deals with soft computing and vagueness by using the lower and upper approximation spaces. A rough neutrosophic set model gives more precise results for decision-making problems as compared to neutrosophic set model. In this paper, we have introduced the notion of rough neutrosophic digraphs. This research work can be extended to: (1) rough bipolar neutrosophic soft graphs; (2) bipolar neutrosophic soft rough graphs; (3) interval-valued bipolar neutrosophic rough graphs; and (4) neutrosophic soft rough graphs.

References

1. Smarandache, F. *A Unifying Field in Logics. Neutrosophy: Neutrosophic Probability, Set and Logic*; American Research Press: Rehoboth, NM, USA, 1999.
2. Zadeh, L.A. Fuzzy sets. *Inf. Control* **1965**, *8*, 338–353.
3. Smarandache, F. *Neutrosophy Neutrosophic Probability, Set, and Logic*; American Research Press: Rehoboth, NM, USA, 1998.
4. Wang, H.; Smarandache, F.; Zhang, Y.; Sunderraman, R. Single-valued neutrosophic sets. *Multispace Multistructure* **2010**, *4*, 410–413.
5. Ye, J. Multicriteria decision-making method using the correlation coefficient under single-valued neutrosophic environment. *Int. J. Gen. Syst.* **2013**, *42*, 386–394.
6. Ye, J. Improved correlation coefficients of single valued neutrosophic sets and interval neutrosophic sets for multiple attribute decision making. *J. Intell. Fuzzy Syst.* **2014**, *27*, 2453–2462.
7. Pawlak, Z. Rough sets. *Int. J. Comput. Inf. Sci.* **1982**, *11*, 341–356.
8. Dubois, D.; Prade, H. Rough fuzzy sets and fuzzy rough sets. *Int. J. Gen. Syst.* **1990**, *17*, 191–209.
9. Liu, P.; Chen, S.M. Group decision making based on Heronian aggregation operators of intuitionistic fuzzy numbers. *IEEE Trans. Cybern.* **2017**, *47*, 2514–2530.
10. Broumi, S.; Smarandache, F.; Dhar, M. Rough neutrosophic sets. *Neutrosophic Sets Syst.* **2014**, *3*, 62–67.
11. Yang, H.L.; Zhang, C.L.; Guo, Z.L.; Liu, Y.L.; Liao, X. A hybrid model of single valued neutrosophic sets and rough sets: Single valued neutrosophic rough set model. *Soft Comput.* **2016**, *21*, 6253–6267, doi:10.1007/s00500-016-2356-y.
12. Mordeson, J.N.; Peng, C.S. Operations on fuzzy graphs. *Inf. Sci.* **1994**, *79*, 159–170.
13. Akram, M.; Shahzadi, S. Neutrosophic soft graphs with applicatin. *J. Intell. Fuzzy Syst.* **2017**, *32*, 841–858.
14. Akram, M.; Sarwar, M. Novel multiple criteria decision making methods based on bipolar neutrosophic sets and bipolar neutrosophic graphs. *Ital. J. Pure Appl. Math.* **2017**, *38*, 368–389.
15. Akram, M.; Siddique, S. Neutrosophic competition graphs with applications. *J. Intell. Fuzzy Syst.* **2017**, *33*, 921–935.
16. Akram, M.; Sitara, M. Interval-valued neutrosophic graph structures. *Punjab Univ. J. Math.* **2018**, *50*, 113–137.
17. Zafer, F.; Akram, M. A novel decision-making method based on rough fuzzy information. *Int. J. Fuzzy Syst.* **2017**, doi:10.1007/s40815-017-0368-0.
18. Banerjee, M.; Pal, S.K. Roughness of a fuzzy set. *Inf. Sci.* **1996**, *93*, 235–246.
19. Liu, P.; Chen, S.M.; Junlin, L. Some intuitionistic fuzzy interaction partitioned Bonferroni mean operators and their application to multi-attribute group decision making. *Inf. Sci.* **2017**, *411*, 98–121.
20. Liu, P. Multiple attribute group decision making method based on interval-valued intuitionistic fuzzy power Heronian aggregation operators. *Comput. Ind. Eng.* **2017**, *108*, 199–212.
21. Zhang, X.; Dai, J.; Yu, Y. On the union and intersection operations of rough sets based on various approximation spaces. *Inf. Sci.* **2015**, *292*, 214–229.
22. Bao, Y.L.; Yang, H.L. On single valued neutrosophic refined rough set model and its application. *J. Intell. Fuzzy Syst.* **2017**, *33*, 1235–1248.

Spanning Tree Problem with Neutrosophic Edge Weights

**Said Broumi, Assia Bakali, Mohamed Talea, Florentin Smarandache, Arindam Dey,
Le Hoang Son**

Said Broumi, Assia Bakali, Mohamed Talea, Florentin Smarandache, Arindam Dey, Le Hoang Son (2018). Spanning Tree Problem with Neutrosophic Edge Weights. The First International Conference on Intelligent Computing in Data Sciences, *Procedia Computer Science* 127: 190–199; DOI: 10.1016/j.procs.2018.01.114

Abstract

Neutrosophic set and neutrosophic logic theory are renowned theories to deal with complex, not clearly explained and uncertain real life problems, in which classical fuzzy sets/models may fail to model properly. This paper introduces an algorithm for finding minimum spanning tree (MST) of an undirected neutrosophic weighted connected graph (abbr. UNWCG) where the arc/edge lengths are represented by a single valued neutrosophic numbers. To build the MST of UNWCG, a new algorithm based on matrix approach has been introduced. The proposed algorithm is compared to other existing methods and finally a numerical example is provided

1. Introduction

Smarandache [5] has proposed the idea of “Neutrosophic set” (abbr. NS) which can capture the natural phenomenon of the imprecision and uncertainty that exists in the real life scenarios. The idea of NS is direct extensions of the idea of the conventional set, type 1 fuzzy set and intuitionistic fuzzy set. The NSs are described by a truth membership function (t), an indeterminate membership function (i) and a false membership function (f) independently. The values of t , i and f are within the nonstandard unit interval $]^{-}0, 1^{+}[$. Moreover, for the sake of applying NSs in real-world problems efficiently, Smarandache [5] introduced the idea of single valued neutrosophic set (abbr. SVNS).

Then, Wang et al.[6] described some properties of SVNNSs. The NS model is an useful method for dealing with real world problems because it can capture the uncertainty (i.e., incomplete, inconsistent and indeterminate information) of the real world problem. The NSs is applied in various fields [24]. To make distinction between two single valued neutrosophic numbers, a series of score functions are presented by some scholars (see table 1). Many algorithms are available to find minimum spanning tree which has a large applications in divers fields of computers science and engineering. In classical graph theory, there are many algorithms for finding the MST [4], two most well know algorithms are Prim’s algorithm and Kruskal algorithm. In the literature, several types of spanning tree problems have been developed by many researchers when the weights of the edges are not precise and there is an uncertainty [1, 2, 3, 10, 28]. Recently using the idea of single valued neutrosophic sets on graph theory, a new theory is introduced and it is defined as single valued neutrosophic graph theory (abbr. SVNGT). The concept of SVNGT and their extensions finds its applications in diverse fields [12- 24]. However, to the best of our knowledge, there are only few studies in the literature to deal with the minimum spanning tree problem in neutrosophic environment. Ye [8] presented a method to design the MST of a graph where nodes (samples) are represented in the form of SVNS and distance between two nodes which represents the dissimilarity between the corresponding samples has been derived. Mullai et al. [27] studied the shortest path problem by minimal spanning tree algorithm using bipolar neutrosophic numbers. Kandasamy [7] proposed a double-valued neutrosophic Minimum Spanning Tree (abbr. DVN-MST) clustering algorithm, to cluster the data represented by double-valued neutrosophic information. Mandal and Basu [9] proposed a solution approach of the optimum spanning tree problems considering the inconsistency, incompleteness and indeterminacy of the information. The authors consider a network problem with multiple criteria which are represented by weight of each edge in neutrosophic sets. The approach proposed by the authors is based on similarity measure. It should be noted that the triangular fuzzy numbers and SVNNSs are similar in the mathematical notation, but totally different.

Table 1. Different types of score functions of SVNNS

References	Score function
27	$S_{RIDVAN}(A) = \frac{(1+T - 2I - F)}{2}$
11	$S_{NANCY}(A) = \frac{1+(1+T - 2I - F)(2 - T - F)}{2}$
25	$S_{ZHANG}(A) = \frac{(2+T - I - F)}{3}$

The main contribution of this manuscript is to extend the matrix approach for finding the cost minimum spanning tree of an undirected neutrosophic graph. Neutrosophic graphs give more precision, and compatibility to model the MST problem in neutrosophic environment when compared to the fuzzy MST.

The manuscript is organized as follows. We briefly introduce the ideas of NSs, SVNNS, and the score function of single valued neutrosophic number in Section 2. Section 3 present the formulation problem. Section 4 describes an algorithm for finding the minimum spanning tree of neutrosophic undirected graph. In Section 5, an example is presented to described the proposed method. In Section 6, A comparative study with others existing methods is presented. We present the conclusion of the paper in Section 7.

2. Preliminaries

Some of the important background knowledge for the materials that are presented in this paper is presented in this section. These results can be found in [5, 6, 25].

Definition 2.1 [5] Let ξ be an universal set. The neutrosophic set A on the universal set ξ categorized in to three membership functions called the true $T_A(x)$, indeterminate $I_A(x)$ and false $F_A(x)$ contained in real standard or non-standard subset of $]0, 1+[$ respectively.

$$0 \leq \sup T_A(x) + \sup I_A(x) + \sup F_A(x) \leq 3 \quad (1)$$

Definition 2.2 [6] Let ξ be a universal set. The single valued neutrosophic sets (SVNs) A on the universal ξ is denoted as following

$$A = \{ \langle x: T_A(x), I_A(x), F_A(x) \rangle \mid x \in \xi \} \quad (2)$$

The functions $T_A(x) \in [0, 1]$ is the degree of truth membership of x in A , $I_A(x) \in [0, 1]$ is the degree of indeterminacy of x in A and $F_A(x) \in [0, 1]$ degree of falsity membership of x in A . The $T_A(x)$, $I_A(x)$ and $F_A(x)$ satisfy the following condition:

$$0 \leq T_A(x) + I_A(x) + F_A(x) \leq 3 \quad (3)$$

To rank the single valued neutrosophic sets, Zhang [25] defined the score function and the relation order between two SVNs as follows.

Definition 2.3 [25] Let $A = (T, I, F)$ be a SVNs. Then a score function S is defined as follow

$$S_{ZHANG}(A) = \frac{(2 + T - I - F)}{3} \quad (4)$$

Here, T , I and F represent the degree of truth membership value, indeterminacy membership value and falsity membership values of A .

Remark 2.4: In neutrosophic mathematics, the zero sets are represented by the following form $0_N = \{ \langle x, (0, 1, 1) \rangle \mid x \in X \}$.

3. Problem formulation

A spanning tree of a connected neutrosophic graph G is an acyclic sub-graph which includes every node of neutrosophic graph G and it also is connected. Every neutrosophic spanning tree has exactly $n - 1$ arcs, where n represents the number of nodes of the neutrosophic graph. A neutrosophic minimum spanning tree (MST) problem is to find a neutrosophic spanning tree such that the sum of all its arc costs/ lengths is minimum. In crisp environment, the MST problem uses the exact costs/lengths associated with the edges of the graph. However, in real life scenarios the arc lengths may be imprecise/uncertain in nature. The decision maker takes their decision based on insufficient information due to lack of evidence or incompleteness. The effective way to work with this imprecision information is to consider a neutrosophic graph. In this paper, we have considered an undirected neutrosophic weighted connected graph. The arc weights of the neutrosophic graph are represented as neutrosophic instead of crisp value. To design the MST, we have introduced an algorithm to solve this problem.

4. Minimum spanning tree algorithm of neutrosophic undirected graph

In this section, a new version of minimum spanning tree problem based on matrix approach is presented and discussed on a graph with neutrosophic edge weight.

In the following, we propose a neutrosophic minimum spanning tree algorithm, whose computing steps are described below:

Algorithm m:

Input: Adjacency matrix $M = [W_{ij}]_{n \times n}$ for the undirected weighted neutrosophic graph G with their edge weight.

Output: MST T of graph G

Step 1: Input neutrosophic adjacency matrix A

Step 2: Using the score function (4), convert the neutrosophic matrix into a score matrix $[S_{ij}]_{n \times n}$.

Step 3: Iterate step 4 and step 5 until all (n-1) elements of matrix of S are either marked to 0 or all the nonzero ($\neq 0$) elements of the matrix are marked.

Step 4: Find the M either column wise or row wise to compute the unmarked minimum element S_{ij} , which is the cost of the corresponding arc e_{ij} in M.

Step 5: If the corresponding arc e_{ij} of chosen S_{ij} produce a cycle with the previous marked entries of the score matrix S then set $S_{ij} = 0$ else mark S_{ij} .

Step 6: Design the tree T including only the marked elements from the S which will be computed MST of G.

Step 7: Stop.

5. Practical example

Consider the graph $G = (V, E)$ depicted in figure 1 where V represents the vertices and E represent the edge of the graph. Each arc consists of neutrosophic edge's weight. Here $V = 6$ and edge = 9. The different steps involved in the design of the MST are presented as follows

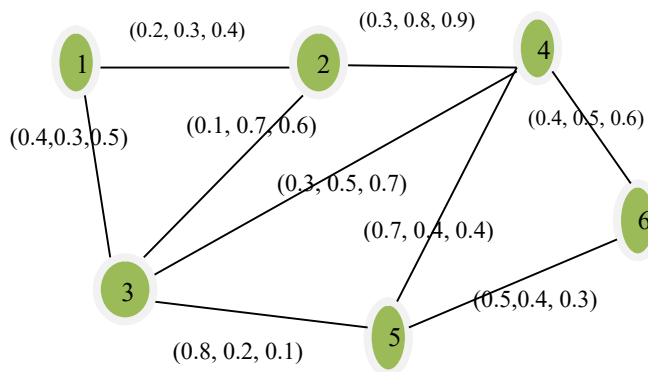

Fig 1. Undirected neutrosophic graphs

The neutrosophic adjacency matrix A of the undirected neutrosophic graph is given below:

$$\begin{bmatrix}
 0 & (0.2, 0.3, 0.4) & (0.4, 0.3, 0.5) & 0 & 0 & 0 \\
 (0.2, 0.3, 0.4) & 0 & (0.1, 0.7, 0.6) & (0.3, 0.8, 0.9) & 0 & 0 \\
 (0.4, 0.3, 0.5) & (0.1, 0.7, 0.6) & 0 & (0.3, 0.5, 0.7) & (0.8, 0.2, 0.1) & 0 \\
 0 & (0.3, 0.8, 0.9) & (0.3, 0.5, 0.7) & 0 & (0.7, 0.4, 0.4) & (0.4, 0.5, 0.6) \\
 0 & 0 & (0.8, 0.2, 0.1) & (0.7, 0.4, 0.4) & 0 & (0.5, 0.4, 0.3) \\
 0 & 0 & 0 & (0.4, 0.5, 0.6) & (0.5, 0.4, 0.3) & 0
 \end{bmatrix}$$

Thus, using the score function, we get the score matrix

$$S = \begin{bmatrix} 0 & .5 & 0.533 & 0 & 0 & 0 \\ .5 & 0 & 0.267 & 0.2 & 0 & 0 \\ 0.533 & 0.267 & 0 & 0.367 & 0.833 & 0 \\ 0 & 0.2 & 0.367 & 0 & 0.633 & 0.433 \\ 0 & 0 & 0.833 & 0.633 & 0 & 0.6 \\ 0 & 0 & 0 & 0.433 & 0.6 & 0 \end{bmatrix}$$

Fig. 2. Score matrix

By referring to the figure 2, the minimum entries 0.2 is selected and the corresponding edge (2, 4) is highlighted by red color in figure 3 . Repeat the procedure until the iteration will exist.

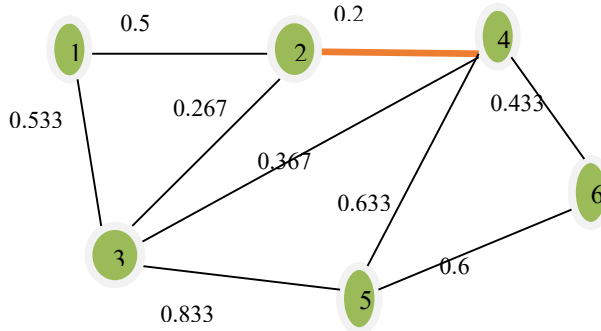

Fig. 3 Undirected neutrosophic graph where the edge (2, 4) is highlighted

By referring to the figure 4, the next non zero minimum entries 0.267 is marked and corresponding edge (2, 3) is highlighted with red color in figure 5.

$$S = \begin{bmatrix} 0 & .5 & 0.533 & 0 & 0 & 0 \\ .5 & 0 & 0.267 & 0.2 & 0 & 0 \\ 0.533 & 0.267 & 0 & 0.367 & 0.833 & 0 \\ 0 & 0.2 & 0.367 & 0 & 0.633 & 0.433 \\ 0 & 0 & 0.833 & 0.633 & 0 & 0.6 \\ 0 & 0 & 0 & 0.433 & 0.6 & 0 \end{bmatrix}$$

Fig. 4

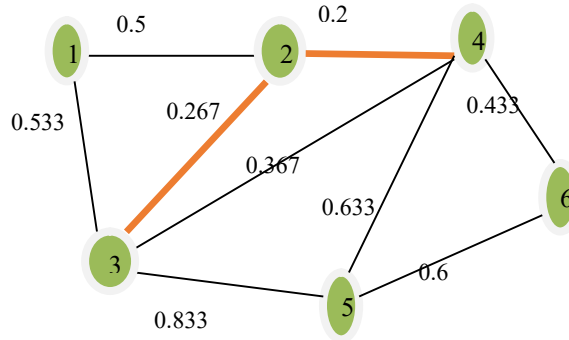

Fig. 5 Undirected neutrosophic graph where the edge (2,3) is highlighted

$$S = \begin{bmatrix} 0 & .5 & 0.533 & 0 & 0 & 0 \\ .5 & 0 & 0.267 & 0.2 & 0 & 0 \\ 0.533 & 0.267 & 0 & 0.367 & 0 & 0.833 \\ 0 & 0.2 & 0.367 & 0 & 0.633 & 0.433 \\ 0 & 0 & 0.833 & 0.633 & 0 & 0.6 \\ 0 & 0 & 0 & 0.433 & 0.6 & 0 \end{bmatrix}$$

Fig.6

By referring to the figure 6, the next minimum non zero element 0.367 is marked. But it produces the cycle so we delete and mark it as 0 instead of 0.367. The cycle {2, 3, 4} is shown in figure 7.

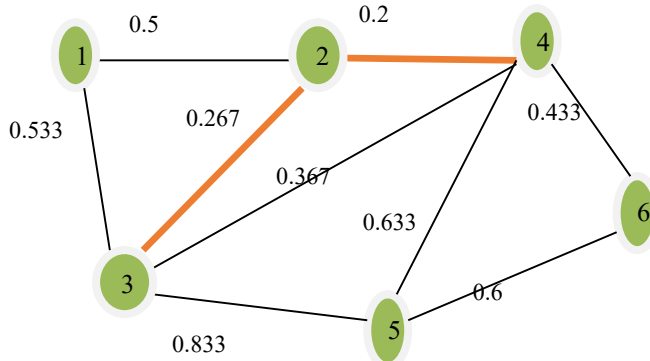

Fig 7. cycle {2, 3, 4}

The next non zero minimum element 0.433 is marked and it is shown in the figure 8. The corresponding marked arc is portrayed in figure 9.

$$S = \begin{bmatrix} 0 & .5 & 0.533 & 0 & 0 & 0 \\ .5 & 0 & 0.267 & 0.2 & 0 & 0 \\ 0.533 & 0.267 & 0 & 0.367 & 0.833 & 0 \\ 0 & 0.2 & 0.367 & 0 & 0.633 & 0.433 \\ 0 & 0 & 0.833 & 0.633 & 0 & 0.6 \\ 0 & 0 & 0 & 0.433 & 0.6 & 0 \end{bmatrix}$$

Fig.8

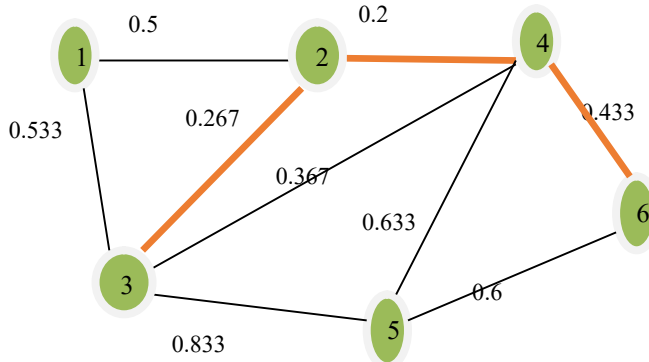

Fig.9. Undirected neutrosophic graph where the edge (4, 6) is highlighted

The next non zero minimum element 0.5 is marked and it is described in the figure 10. The corresponding marked arc is portrayed in figure 11.

$$S = \begin{bmatrix} 0 & .5 & 0.533 & 0 & 0 & 0 \\ .5 & 0 & 0.267 & 0.2 & 0 & 0 \\ 0.533 & 0.267 & 0 & 0.367 & 0.833 & 0 \\ 0 & 0.2 & 0.367 & 0 & 0.633 & 0.433 \\ 0 & 0 & 0.833 & 0.633 & 0 & 0.6 \\ 0 & 0 & 0 & 0.433 & 0.6 & 0 \end{bmatrix}$$

Fig. 10

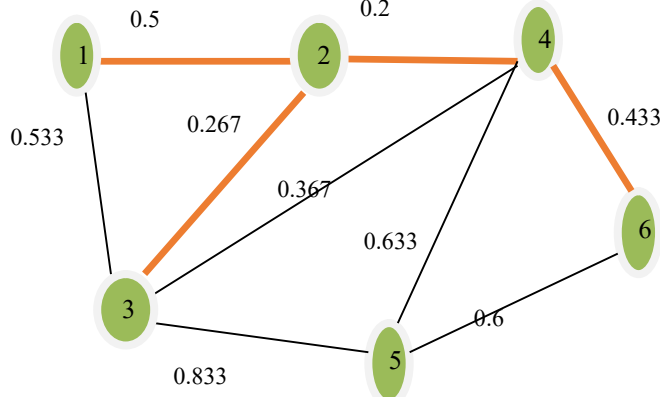

Fig. 11 Undirected neutrosophic graph where the edge (1,2) is highlighted

By referring to the figure 12. The next minimum non zero element 0.533 is now marked. But it produces the cycle so we delete it and mark it as 0 in the place of 0.533.

$$S = \begin{bmatrix} 0 & .5 & 0.533 & 0 & 0 & 0 \\ .5 & 0 & 0.267 & 0.2 & 0 & 0 \\ 0.533 & 0.267 & 0 & 0.367 & 0.833 & 0 \\ 0 & 0.2 & 0.367 & 0 & 0.633 & 0.433 \\ 0 & 0 & 0.833 & 0.633 & 0 & 0.6 \\ 0 & 0 & 0 & 0.433 & 0.6 & 0 \end{bmatrix}$$

Fig. 12

The next non zero minimum entries 0.6 is marked it is shown in the figure 13. The corresponding marked edge is portrayed in figure 14.

$$S = \begin{bmatrix} 0 & .5 & 0.533 & 0 & 0 & 0 \\ .5 & 0 & 0.267 & 0.2 & 0 & 0 \\ 0.533 & 0.267 & 0 & 0.367 & 0.833 & 0 \\ 0 & 0.2 & 0.367 & 0 & 0.633 & 0.433 \\ 0 & 0 & 0.833 & 0.633 & 0 & 0.6 \\ 0 & 0 & 0 & 0.433 & 0.6 & 0 \end{bmatrix}$$

Fig. 13

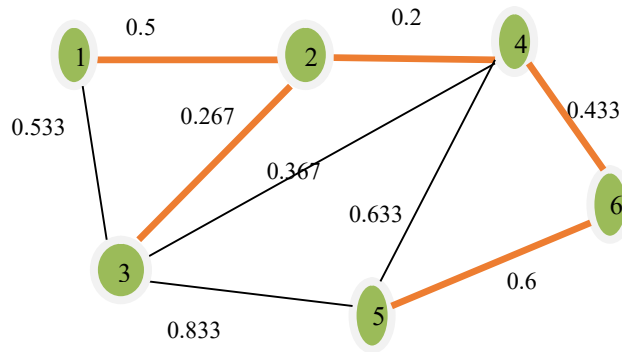

Fig .14 Undirected neutrosophic graph where the edge (5, 6) is highlighted

By referring to the figure 15. The next minimum non zero element 0.633 is marked. But this edge produces a cycle. So, we delete and mark it as 0 in the place of 0.633

$$S = \begin{bmatrix} 0 & .5 & \mathbf{0.533-0} & 0 & 0 & 0 \\ .5 & 0 & \mathbf{0.267} & 0.2 & 0 & 0 \\ \mathbf{0.533} & 0.267 & 0 & \mathbf{0.367} & 0.833 & 0 \\ 0 & 0.2 & 0.367 & 0 & \mathbf{0.633-0} & 0.433 \\ 0 & 0 & 0.833 & 0.633 & 0 & 0.6 \\ 0 & 0 & 0 & 0.433 & 0.6 & 0 \end{bmatrix}$$

Fig .15

By referring to the figure 16. The next minimum non zero element 0.833 is marked. But while drawing the edges it produces the cycle so we delete and mark it as 0 instead of 0.833

$$S = \begin{bmatrix} 0 & .5 & \mathbf{0.533-0} & 0 & 0 & 0 \\ .5 & 0 & \mathbf{0.267} & 0.2 & 0 & 0 \\ \mathbf{0.533} & 0.267 & 0 & \mathbf{0.367} & 0.833 & 0 \\ 0 & 0.2 & 0.367 & 0 & \mathbf{0.633-0} & 0.433 \\ 0 & 0 & \mathbf{0.833-0} & 0.633 & 0 & 0.6 \\ 0 & 0 & 0 & 0.433 & 0.6 & 0 \end{bmatrix}$$

Fig .16

After the above steps, the final path of MST of G is portrayed in figure 17.

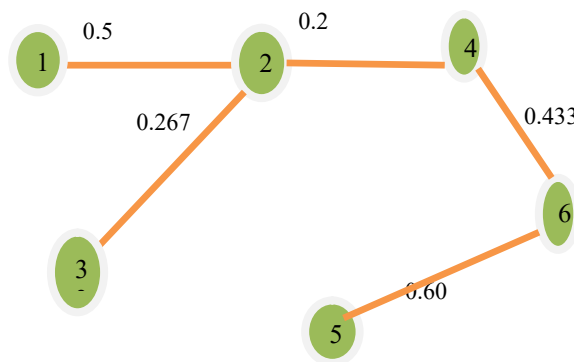

Fig .17. Final path of minimum cost of spanning tree of neutrosophic graph.

According to the procedure of matrix approach presented in section 4. Thus, the crisp minimum cost spanning tree is 2 and the final MST is {1, 2}, {2, 3}, {2, 4}, {4, 6}, {6, 5}

6. COMPARATIVE STUDY

In this section, the proposed method presented in section 4 is compared with other existing methods including the algorithm proposed by Mullai et al [27] as follow

Iteration 1: Let $C_1 = \{1\}$ and $\bar{C}_1 = \{2, 3, 4, 5\}$

Iteration 2: Let $C_2 = \{1, 4\}$ and $\bar{C}_2 = \{2, 3, 5\}$

Iteration 3: Let $C_3 = \{1, 4, 3\}$ and $\bar{C}_3 = \{2, 5\}$

Iteration 4: Let $C_4 = \{1, 3, 4, 5\}$ and $\bar{C}_4 = \{2\}$

Finally, the single valued neutrosophic minimal spanning tree is

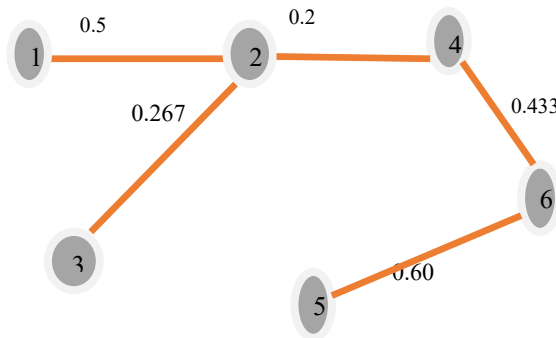

Fig .18 . Single valued neutrosophic minimal spanning tree obtained by Mullai’s algorithm.

So, using the score function (4), the SVN MST $\{1, 2\}, \{2, 3\}, \{2, 4\}, \{4, 6\}, \{6, 5\}$ obtained by Mullai’s algorithm is the same as the path obtained by the proposed algorithm.

The difference between the proposed algorithm and Mullai’s algorithm is that the proposed approach is based on matrix approach, which can be easily implemented in Matlab, whereas the Mullai’s algorithm is based on the comparison of edges in each iteration of the algorithm and this leads to high computation.

7. Conclusion

This paper deals with a MST problem under the neutrosophic environment. The edges of graph are represented by SVN. Numerical examples are used to describe the proposed algorithm. The main contribution of this study is to describe an algorithmic approach for MST in uncertain environment using neutrosophic set as edge weights. The proposed algorithm for MST is simple enough and efficient for real world problems. This work can be extended to the case of directed neutrosophic graphs and other structure of graphs including bipolar neutrosophic graphs, interval valued neutrosophic graphs, interval valued bipolar neutrosophic graphs.

8. Referen ces

[1] Pal A, and Majumder S. (2017) “Searching minimum spanning tree in a type-2 fuzzy graph.” Progress in Nonlinear Dynamics and Chaos 5(1): 43-58.
 [2] Janiak A, and Kasperski A. (2008)” The minimum spanning tree problem with fuzzy costs.” Fuzzy Optimization and Decision Making 7(2):105–118.

- [3] Dey A, and Pal A.(2016) "Prim's algorithm for solving minimum spanning tree problem in fuzzy environment." *Annals of Fuzzy Mathematics and Informatics* 12 (3):419-430.
- [4] Graham R. L and Hall P. (1985) "On the history of the minimum spanning tree problem." *Annals of the History of Computing* 7 (1):43-57.
- [5] Smarandache F.(1998)" Neutrosophy. Neutrosophic Probability, Set, and Logic." ProQuest Information & Learning, Ann Arbor, Michigan, USA, 105 p.
- [6] Wang H , Smarandache F, Zhang Y and Sunderraman R.(2010) "Single valued neutrosophic sets." *Multisspace and Multistructure* 4: 410-413.
- [7] Kandasamy I. (2016) "Double-Valued Neutrosophic Sets, their Minimum Spanning Trees, and clustering algorithm." *Journal of Intelligent system* pp.1-17.
- [8] Ye J. (2014) "Single valued neutrosophic minimum spanning tree and its clustering method." *Journal of Intelligent system* 23:311-324.
- [9] Mandal K, and Basu K.(2016) "Improved similarity measure in neutrosophic environment and its application in finding minimum spanning tree." *Journal of Intelligent & Fuzzy System* 31: 1721-1730.
- [10] Mohanty S. P, Biswal S, Pradhan G. (2012) "Minimum spanning tree in fuzzy weighted rough graph." *International Journal of Engineering Research and Development* 1(10) (June):23-28.
- [11] Nancy & Garg H.(2016) "An improved score function for ranking neutrosophic sets and its application to decision making process", *International Journal for Uncertainty Quantification* 6 (5):377-385 .
- [12] Broumi S, Bakali A, Talea M, Smarandache F, and Vladareanu L. (2016) "Computation of Shortest Path Problem in a Network with SV-Trapezoidal Neutrosophic Numbers." *Proceedings of the 2016 International Conference on Advanced Mechatronic Systems, Melbourne, Australia, 2016*, pp. 417-422.
- [13] Broumi S, Bakali A, Talea M, Smarandache F, and Vladareanu L. (2016) "Applying Dijkstra Algorithm for Solving Neutrosophic Shortest Path Problem." *Proceedings of the 2016 International Conference on Advanced Mechatronic Systems, Melbourne, Australia, November 30 - December 3*, 412-416.
- [14] Broumi S, Bakali A, Talea M, and Smarandache F, and Kishore Kumar P.K.(2017) "Shortest Path Problem on Single Valued Neutrosophic Graphs." *2017 International Symposium on Networks, Computers and Communications (ISNCC)*, (in press)
- [15] Broumi S, Bakali A, Talea M, Smarandache F, and Vladareanu L.(2016) "Shortest Path Problem Under Triangular Fuzzy Neutrosophic Information." *10th International Conference on Software, Knowledge, Information Management & Applications (SKIMA)*, pp.169-174.
- [16] Broumi S, Bakali A, Talea M, Smarandache F, and Ali M.(2016) "Shortest path problem under bipolar neutrosophic setting." *Applied Mechanics and Materials*, Vol. 859: 59-66.
- [17] Broumi S, Talea M, Bakali A, Smarandache F.(2016) "Single valued neutrosophic graphs." *Journal of New Theory* 10: 86-101.
- [18] Broumi S, Talea M, Bakali A, Smarandache F.(2016) "On bipolar single valued neutrosophic graphs." *Journal of New Theory* 11: pp.84-102.
- [19] Broumi S, Talea M, Bakali A, Smarandache F.(2016)"Interval valued neutrosophic graphs." *Critical Review*, XII:5-33.
- [20] Broumi S, Bakali A, Talea M, and Smarandache F.(2016) "Isolated single valued neutrosophic graphs." *Neutrosophic Sets and Systems* Vol. 11:74-78
- [21] Broumi S, Smarandache F, Talea M, and Bakali A. (2016) "An introduction to bipolar single valued neutrosophic graph theory." *Applied Mechanics and Materials* 841:184-191.
- [22] Broumi S, Talea M, Smarandache F, and Bakali A.(2016) "Single valued neutrosophic graphs: degree, order and size." *IEEE International Conference on Fuzzy Systems (FUZZ)*:2444-2451.
- [23] Broumi S, Smarandache F, Talea M and Bakali A. "Decision-making method based on the interval valued neutrosophic graph.", *Future Technologie*, 2016, IEEE, pp. 44-50.g.", chapter in book- *New Trends in Neutrosophic Theory and Applications- Florentin Smarandache and Surpati Pramanik (Editors)*, 2016, pp. 231-254. ISBN 978-1-59973-498-9
- [24] <http://fs.gallup.unm.edu/NSS/>.
- [25] Zhang H.Y, Wang J.Q, Chen X.H.(2014)"Interval neutrosophic sets and their application in multicriteria decision making problems." *Sci. World J.* 2014, 645953.
- [26] Şahin R. "Multi-criteria neutrosophic decision making method based on score and accuracy functions under neutrosophic environment." pp.1-9. arXiv:1412.5202
- [27] Mullai M, Broumi S, Stephen A. (2017) "Shortest path problem by minimal spanning tree algorithm using bipolar neutrosophic numbers." *International Journal of Mathematic Trends and Technology* 46(2):80-87.
- [28] Zhou J, Chen L, Wang K & Yang F. (2016)"Fuzzy α -minimum spanning tree problem: definition and solutions." *International Journal of General Systems*. doi: 10.1080/03081079.2015.1086578

Single-Valued Neutrosophic Clustering Algorithm Based on Tsallis Entropy Maximization

Qiaoyan Li, Yingcang Ma, Florentin Smarandache, Shuangwu Zhu

Qiaoyan Li, Yingcang Ma, Florentin Smarandache, Shuangwu Zhu (2018). Single-Valued Neutrosophic Clustering Algorithm Based on Tsallis Entropy Maximization. *Axioms* 7, 57; DOI: 10.3390/axioms7030057

Abstract: Data clustering is an important field in pattern recognition and machine learning. Fuzzy c -means is considered as a useful tool in data clustering. The neutrosophic set, which is an extension of the fuzzy set, has received extensive attention in solving many real-life problems of inaccuracy, incompleteness, inconsistency and uncertainty. In this paper, we propose a new clustering algorithm, the single-valued neutrosophic clustering algorithm, which is inspired by fuzzy c -means, picture fuzzy clustering and the single-valued neutrosophic set. A novel suitable objective function, which is depicted as a constrained minimization problem based on a single-valued neutrosophic set, is built, and the Lagrange multiplier method is used to solve the objective function. We do several experiments with some benchmark datasets, and we also apply the method to image segmentation using the Lena image. The experimental results show that the given algorithm can be considered as a promising tool for data clustering and image processing.

Keywords: single-valued neutrosophic set; fuzzy c -means; picture fuzzy clustering; Tsallis entropy

1. Introduction

Data clustering is one of the most important topics in pattern recognition, machine learning and data mining. Generally, data clustering is the task of grouping a set of objects in such a way that objects in the same group (cluster) are more similar to each other than to those in other groups (clusters). In the past few decades, many clustering algorithms have been proposed, such as k -means clustering [1], hierarchical clustering [2], spectral clustering [3], etc. The clustering technique has been used in many fields, including image analysis, bioinformatics, data compression, computer graphics and so on [4–6].

The k -means algorithm is one of the typical hard clustering algorithms that is widely used in real applications due to its simplicity and efficiency. Unlike hard clustering, the fuzzy c -means (FCM) algorithm [7] is one of the most popular soft clustering algorithms in which each data point belongs to a cluster to some degree that is specified by membership degrees in $[0, 1]$, and the sum of the clusters for each of the data should be equal to one. In recent years, many improved algorithms for FCM have been proposed. There are three main ways to build the clustering algorithm. First is extensions of the traditional fuzzy sets. In this way, numerous fuzzy clustering algorithms based on the extension fuzzy sets, such as the intuitionistic fuzzy set, the Type-2 fuzzy set, etc., are built. By replacing traditional fuzzy sets with intuitionistic fuzzy set, Chaira introduced the intuitionistic fuzzy clustering (IFC) method in [8], which integrated the intuitionistic fuzzy entropy with the objective function. Hwang and Rhee suggested deploying FCM on (interval) Type-2 fuzzy set sets in [9], which aimed to design and manage uncertainty for fuzzifier m . Thong and Son proposed picture fuzzy clustering based on the picture fuzzy set (PFS) in [10]. Second, the kernel-based method is applied to improve the fuzzy clustering quality. For example, Graves and Pedrycz presented a kernel version of the FCM algorithm,

namely KFCM in [11]. Ramathilagam et al. analyzed the Lung Cancer database by incorporating the hyper tangent kernel function [12]. Third, adding regularization terms to the objective function is used to improve the clustering quality. For example, Yasuda proposed an approach to FCM based on entropy maximization in [13]. Of course, we can use these together to obtain better clustering quality.

The neutrosophic set was proposed by Smarandache [14] in order to deal with real-world problems. Now, the neutrosophic set is gaining significant attention in solving many real-life problems that involve uncertainty, impreciseness, incompleteness, inconsistency and indeterminacy. A neutrosophic set has three membership functions, and each membership degree is a real standard or non-standard subset of the nonstandard unit interval $]0^-, 1^+[= 0^- \cup [0, 1] \cup 1^+$. Wang et al. [15] introduced single-valued neutrosophic sets (SVNSs), which are an extension of intuitionistic fuzzy sets. Moreover, the three membership functions are independent, and their values belong to the unit interval $[0, 1]$. In recent years, the studies of SVNSs have been rapidly developing. For example, Majumdar and Samanta [16] studied the similarity and entropy of SVNSs. Ye [17] proposed correlation coefficients of SVNSs and applied them to single-valued neutrosophic decision-making problems, etc. Zhang et al. in [18] proposed a new definition of the inclusion relation of neutrosophic sets (which is also called the Type-3 inclusion relation), and a new method of ranking neutrosophic sets was given. Zhang et al. in [19] studied neutrosophic duplet sets, neutrosophic duplet semi-groups and cancelable neutrosophic triplet groups.

The clustering methods by the neutrosophic set have been studied deeply. In [20], Ye proposed a single-valued neutrosophic minimum spanning tree (SVNMST) clustering algorithm, and he also introduced single-valued neutrosophic clustering methods based on similarity measures between SVNSs [21]. Guo and Sengur introduced the neutrosophic c -means clustering algorithm [22], which was inspired by FCM and the neutrosophic set framework. Thong and Son did significant work on clustering based on PFS. In [10], a picture fuzzy clustering algorithm, called FC-PFS, was proposed. In order to determine the number of clusters, they built an automatically determined most suitable number of clusters based on particle swarm optimization and picture composite cardinality for a dataset [23]. They also extended the picture fuzzy clustering algorithm for complex data [24]. Unlike the method in [10], Son presented a novel distributed picture fuzzy clustering method on the picture fuzzy set [25]. We can note that the basic ideas of the fuzzy set, the intuitionistic fuzzy set and the SVNS are consistent in the data clustering, but there are differences in the representation of the objects, so that the clustering objective functions are different. Thus, the more adequate description can be better used for clustering. Inspired by FCM, FC-PFS, SVNS and the maximization entropy method, we propose a new clustering algorithm, the single-valued neutrosophic clustering algorithm based on Tsallis entropy maximization (SVNCA-TEM), in this paper, and the experimental results show that the proposed algorithm can be considered as a promising tool for data clustering and image processing.

The rest of paper is organized as follows. Section 2 shows the related work on FCM, IFC and FC-PFS. Section 3 introduces the proposed method, using the Lagrange multiplier method to solve the objective function. In Section 4, the experiments on some benchmark UCI datasets indicate that the proposed algorithm can be considered as a useful tool for data clustering and image processing. The last section draws the conclusions.

2. Related Works

In general, suppose dataset $D = \{X_1, X_2, \dots, X_n\}$ includes n data points, each of the data $X_i = \{x_{i1}; x_{i2}; \dots; x_{id}\} \in R^d$ is a d -dim feature vector. The aim of clustering is to get k disjoint clusters $\{C_j | j = 1, 2, \dots, k\}$, satisfying $C_{j'} \cap_{j' \neq j} C_j = \emptyset$ and $D = \cup_{j=1}^k C_j$. In the following, we will briefly introduce three fuzzy clustering methods, which are FCM, IFC and FC-PFS.

2.1. Fuzzy c -Means

The FCM was proposed in 1984 [7]. FCM is a data clustering technique wherein each data point belongs to a cluster to some degree that is specified by a membership grade. A data point X_i of cluster

C_j is denoted by the term μ_{ij} , which shows the fuzzy membership degree of the i -th data point in the j -th cluster. We use $V = \{V_1, V_2, \dots, V_k\}$ to describe the cluster centroids of the clusters, and $V_j \in R^d$ is the cluster centroid of C_j . The FCM is based on the minimization of the following objective function:

$$J = \sum_{i=1}^n \sum_{j=1}^k u_{ij}^m \|x_i - V_j\|^2, \tag{1}$$

where m represents the fuzzy parameter and $m \geq 1$. The constraints for (1) are,

$$\sum_{l=1}^k \mu_{il} = 1, \mu_{ij} \in [0, 1], i = 1, 2, \dots, n, j = 1, 2, \dots, k. \tag{2}$$

Using the Lagrangian method, the iteration scheme to calculate cluster centroids V_j and the fuzzy membership degrees μ_{ij} of the objective function (1) is as follows:

$$V_j = \frac{\sum_{i=1}^n \mu_{ij}^m X_i}{\sum_{i=1}^n \mu_{ij}^m}, j = 1, 2, \dots, k. \tag{3}$$

$$\mu_{ij} = \left(\sum_{l=1}^k \left(\frac{\|X_i - V_j\|}{\|X_i - V_l\|} \right)^{\frac{2}{m-1}} \right)^{-1}. i = 1, 2, \dots, n. j = 1, 2, \dots, k. \tag{4}$$

The iteration will not stop until it reaches the maximum iterations or $|J^{(t)} - J^{(t-1)}| < \epsilon$, where $J^{(t)}$ and $J^{(t-1)}$ are the objection function value at (t) -th and $(t - 1)$ -th iterations, and ϵ is a termination criterion between zero and 0.1. This procedure converges to a local minimum or a saddle point of J . Finally, each data point is assigned to a different cluster according to the fuzzy membership value, that is X_i belongs to C_l if $\mu_{il} = \max(\mu_{i1}, \mu_{i2}, \dots, \mu_{ik})$.

2.2. Intuitionistic Fuzzy Clustering

The intuitionistic fuzzy set is an extension of fuzzy sets. Chaira proposed intuitionistic fuzzy clustering (IFC) [8], which integrates the intuitionistic fuzzy entropy with the objective function of FCM. The objective function of IFS is:

$$J = \sum_{i=1}^n \sum_{j=1}^k \mu_{ij}^m \|X_i - V_j\|^2 + \sum_{j=1}^k \pi_j^* e^{1-\pi_j^*}, \tag{5}$$

where $\pi_j^* = \frac{1}{n} \sum_{i=1}^n \pi_{ij}$, and π_{ij} is the hesitation degree of X_i for C_j . The constraints of IFC are similar to (2). Hesitation degree π_{ik} is initially calculated using the following form:

$$\pi_{ij} = 1 - \mu_{ij} - (1 - u_{ij}^\alpha)^{1/\alpha}, \text{ where } \alpha \in [0, 1], \tag{6}$$

and the intuitionistic fuzzy membership values are obtained as follows:

$$\mu_{ij}^* = \mu_{ij} + \pi_{ij}, \tag{7}$$

where $\mu_{ij}^*(\mu_{ij})$ denotes the intuitionistic (conventional) fuzzy membership of the i -th data in the j -th class. The modified cluster centroid is:

$$V_j = \frac{\sum_{i=1}^n \mu_{ij}^{*m} X_i}{\sum_{i=1}^n \mu_{ij}^{*m}}, j = 1, 2, \dots, k. \tag{8}$$

The iteration will not stop until it reaches the maximum iterations or the difference between $\mu_{ij}^{*(t)}$ and $\mu_{ij}^{*(t-1)}$ is not larger than a pre-defined threshold ϵ , that is $\max_{i,j} |\mu_{ij}^{*(t)} - \mu_{ij}^{*(t-1)}| < \epsilon$.

2.3. Picture Fuzzy Clustering

In [26], Cuong introduced the picture fuzzy set (which is also called the standard neutrosophic set [27]), which is defined on a non-empty set S , $\hat{A} = \{(x, \mu_{\hat{A}}(x), \eta_{\hat{A}}(x), \gamma_{\hat{A}}(x)) | x \in S\}$, where $\mu_{\hat{A}}(x)$ is the positive degree of each element $x \in X$, $\eta_{\hat{A}}(x)$ is the neutral degree and $\gamma_{\hat{A}}(x)$ is the negative degree satisfying the constraints,

$$\begin{cases} \mu_{\hat{A}}(x), \eta_{\hat{A}}(x), \gamma_{\hat{A}}(x) \in [0, 1], & \forall x \in S. \\ \mu_{\hat{A}}(x) + \eta_{\hat{A}}(x) + \gamma_{\hat{A}}(x) \leq 1, & \forall x \in S. \end{cases} \quad (9)$$

The refusal degree of an element is calculated as:

$$\xi_{\hat{A}}(x) = 1 - (\mu_{\hat{A}}(x) + \eta_{\hat{A}}(x) + \gamma_{\hat{A}}(x)), \forall x \in S. \quad (10)$$

In [10], Thong and Son proposed picture fuzzy clustering (FC-PFS), which is related to neutrosophic clustering. The objective function is:

$$J = \sum_{i=1}^n \sum_{j=1}^k (\mu_{ij}(2 - \xi_{ij}))^m \|X_i - V_j\|^2 + \sum_{i=1}^n \sum_{j=1}^k \eta_{ij}(\log \eta_{ij} + \xi_{ij}). \quad (11)$$

where $i = 1, \dots, n, j = 1, \dots, k$. μ_{ij}, η_{ij} and ξ_{ij} are the positive, neutral and refusal degrees, respectively, for which each data point X_i belongs to cluster C_j . Denote μ, η and ξ as the matrices whose elements are μ_{ij}, η_{ij} and ξ_{ij} , respectively. The constraints for FC-PFS are defined as follows:

$$\begin{cases} \mu_{ij}, \eta_{ij}, \xi_{ij} \in [0, 1], \\ \mu_{ij} + \eta_{ij} + \xi_{ij} \leq 1, \\ \sum_{l=1}^k (\mu_{il}(2 - \xi_{il})) = 1, \\ \sum_{l=1}^k (\eta_{il} + \xi_{il}/k) = 1. \end{cases} \quad (12)$$

Using the Lagrangian multiplier method, the iteration scheme to calculate $\mu_{ij}, \eta_{ij}, \xi_{ij}$ and V_j for the model (11,12) is as the following equations:

$$\xi_{ij} = 1 - (\mu_{ij} + \eta_{ij}) - (1 - (\mu_{ij} + \eta_{ij})^\alpha)^{1/\alpha}, \text{ where } \alpha \in [0, 1], (i = 1, \dots, n, j = 1, \dots, k), \quad (13)$$

$$\mu_{ij} = \frac{1}{\sum_{l=1}^k (2 - \xi_{il}) \left(\frac{\|X_i - V_j\|}{\|X_i - V_l\|} \right)^{\frac{2}{m-1}}}, (i = 1, \dots, n, j = 1, \dots, k), \quad (14)$$

$$\eta_{ij} = \frac{e^{-\xi_{ij}}}{\sum_{l=1}^k e^{-\xi_{il}}} \left(1 - \frac{1}{k} \sum_{l=1}^k \xi_{il} \right), (i = 1, \dots, n, j = 1, \dots, k), \quad (15)$$

$$V_j = \frac{\sum_{i=1}^n (\mu_{ij}(2 - \xi_{ij}))^m X_i}{\sum_{i=1}^n (\mu_{ij}(2 - \xi_{ij}))^m}, (j = 1, \dots, k). \quad (16)$$

The iteration will not stop until it reaches the maximum iterations or $\|\mu^{(t)} - \mu^{(t-1)}\| + \|\eta^{(t)} - \eta^{(t-1)}\| + \|\xi^{(t)} - \xi^{(t-1)}\| < \epsilon$.

3. The Proposed Model and Solutions

Definition 1. [15] Set U as a space of points (objects), with a generic element in U denoted by u . A SVN A in U is characterized by three membership functions, a truth membership function T_A , an indeterminacy

membership function I_A and a falsity-membership function F_A , where $\forall u \in U, T_A(u), I_A(u), F_A(u) \in [0, 1]$. That is, $T_A : U \rightarrow [0, 1], I_A : U \rightarrow [0, 1]$ and $F_A : U \rightarrow [0, 1]$. There is no restriction on the sum of $T_A(u), I_A(u)$ and $F_A(u)$; thus, $0 \leq T_A(u) + I_A(u) + F_A(u) \leq 3$.

Moreover, the hesitate membership function is defined as $H_A : U \rightarrow [0, 3]$ and $\forall u \in U, T_A(u) + I_A(u) + F_A(u) + H_A(u) = 3$.

Entropy is a key concept in the uncertainty field. It is a measure of the uncertainty of a system or a piece of information. It is an improvement of information entropy. The Tsallis entropy [28], which is a generalization of the standard Boltzmann–Gibbs entropy, is defined as follows.

Definition 2. [28] Let \mathcal{X} be a finite set and X be a random variable taking values $x \in \mathcal{X}$, with distribution $p(x)$. The Tsallis entropy is defined as $S_m(X) = \frac{1}{m-1}(1 - \sum_{x \in \mathcal{X}} p(x)^m)$, where $m > 0$ and $m \neq 1$.

For FCM, μ_{ij} denotes the fuzzy membership degree of X_i to C_j , and supports $\sum_{j=1}^k \mu_{ij} = 1$. From Definition 2, the Tsallis entropy of μ can be described by $S_m(\mu) = \sum_{i=1}^n \frac{1}{m-1}(1 - \sum_{j=1}^k \mu_{ij}^m)$. n being a fixed number, Yasuda [13] used the following formulary to describe the the Tsallis entropy of μ :

$$S_m(\mu) = -\frac{1}{m-1} \left(\sum_{i=1}^n \sum_{j=1}^k \mu_{ij}^m - 1 \right). \tag{17}$$

The maximum entropy principle has been widely applied in many fields, such as spectral estimation, image restoration, error handling of measurement theory, and so on. In the following, the maximum entropy principle is applied to the single-valued neutrosophic set clustering. After the objection function of clustering is built, the maximum fuzzy entropy is used to regularize variables.

Suppose that there is a dataset D consisting of n data points in d dimensions. Let $\mu_{ij}, \gamma_{ij}, \eta_{ij}$ and ξ_{ij} be the truth membership degree, falsity-membership degree, indeterminacy membership degree and hesitate membership degree, respectively, that each data point X_i belongs to cluster C_j . Denote μ, γ, η and ξ as the matrices, the elements of which are $\mu_{ij}, \gamma_{ij}, \eta_{ij}$ and ξ_{ij} , respectively, where $\xi_{ij} = 3 - \mu_{ij} - \gamma_{ij} - \eta_{ij}$. The single-valued neutrosophic clustering based on Tsallis entropy maximization (SVNC-TEM) is the minimization of the following objective function:

$$J = \sum_{i=1}^n \sum_{j=1}^k (\mu_{ij}(4 - \xi_{ij} - \gamma_{ij}))^m \|X_i - V_j\|^2 + \frac{\rho}{m-1} (\sum_{i=1}^n \sum_{j=1}^k (\mu_{ij}(4 - \gamma_{ij} - \xi_{ij}))^m - 1) + \sum_{i=1}^n \sum_{j=1}^k \eta_{ij}(\log \eta_{ij} + \xi_{ij}/3), \tag{18}$$

The constraints are given as follows:

$$\mu_{ij}, \gamma_{ij}, \eta_{ij} \in [0, 1], \xi_{ij} \in [0, 3], (i = 1, 2, \dots, n, j = 1, 2, \dots, k) \tag{19}$$

$$\sum_{l=1}^k (\mu_{il}(4 - \gamma_{il} - \xi_{il})) = 1, (i = 1, 2, \dots, n), \tag{20}$$

$$\sum_{l=1}^k (\eta_{il} + \xi_{il}/(3 * k)) = 1, (i = 1, 2, \dots, n) \tag{21}$$

The proposed model in Formulary (18)–(21) is applied to the maximum entropy principle of the SVNS. Now, let us summarize the major points of this model as follows.

- The first term of the objection function (18) describes the weighted distance sum of each data point X_i to the cluster center V_j . μ_{ij} being from the positive aspect and $(4 - \xi_{ij} - \gamma_{ij})$ (four is selected in order to guarantee $\mu_{ij} \in [0, 1]$ in the iterative calculation) from the negative aspect, denoting the membership degree for X_i to V_j , we use $\mu_{ij}(4 - \xi_{ij} - \gamma_{ij})$ to represent the “integrated true” membership of the i -th data point in the j -th cluster. From the maximum entropy principle,

the best to represent the current state of knowledge is the one with largest entropy, so the second term of the objection function (18) describes the negative Tsallis entropy of $\mu(4 - \gamma - \xi)$, which means that the minimization of (18) is the maximum Tsallis entropy. ρ is the regularization parameter. If $\gamma = \eta = \xi = 0$, the proposed model returns the FCM model.

- Formulary (19) guarantees the definition of the SVNS (Definition 1).
- Formulary (20) implies that the “integrated true” membership of a data point X_i to the cluster center V_j satisfies the sum-row constraint of memberships. For convenience, we set $T_{ij} = \mu_{ij}(4 - \xi_{ij} - \gamma_{ij})$, and X_i belongs to class C_l if $T_{il} = \max(T_{i1}, T_{i2}, \dots, T_{ik})$.
- Equation (21) guarantees the working of the SVNS since at least one of two uncertain factors, namely indeterminacy membership degree and hesitate membership degree, always exists in the model.

Theorem 1. *The optimal solutions of the systems (18–21) are:*

$$V_j = \frac{\sum_{i=1}^n (\mu_{ij}(4 - \gamma_{ij} - \xi_{ij}))^m X_i}{\sum_{i=1}^n (\mu_{ij}(4 - \gamma_{ij} - \xi_{ij}))^m}, \tag{22}$$

$$\mu_{ij} = \frac{1}{\sum_{l=1}^k (4 - \gamma_{ij} - \xi_{ij}) \left(\frac{\|X_i - V_j\|^2 + \frac{\rho}{m-1}}{\|X_i - V_l\|^2 + \frac{\rho}{m-1}} \right)^{\frac{1}{m-1}}}, \tag{23}$$

$$\gamma_{ij} = 4 - \xi_{ij} - \frac{1}{u_{ij} \sum_{l=1}^k \left(\frac{\|X_i - V_j\|^2 + \frac{\rho}{m-1}}{\|X_i - V_l\|^2 + \frac{\rho}{m-1}} \right)^{\frac{1}{m-1}}}, \tag{24}$$

$$\eta_{ij} = \left(1 - \frac{1}{3k} \sum_{l=1}^k \xi_{il} \right) \frac{e^{-\xi_{ij}}}{\sum_{l=1}^k e^{-\xi_{il}}}, \tag{25}$$

$$\xi_{ij} = 3 - \mu_{ij} - \gamma_{ij} - \eta_{ij}. \tag{26}$$

Proof. The Lagrangian multiplier of the optimization model (18–21) is:

$$J = \sum_{i=1}^n \sum_{j=1}^k (u_{ij}(4 - \gamma_{ij} - \xi_{ij}))^m \|X_i - V_j\|^2 + \frac{\rho}{m-1} (\sum_{i=1}^n \sum_{j=1}^k (u_{ij}(4 - \gamma_{ij} - \xi_{ij}))^m - 1) + \sum_{i=1}^n \sum_{j=1}^k \eta_{ij} (\log \eta_{ij} + \xi_{ij}/3) + \sum_{i=1}^n \lambda_i (\sum_{j=1}^k \mu_{ij}(4 - \gamma_{ij} - \xi_{ij})^m - 1) + \sum_{i=1}^n \chi_i (\sum_{j=1}^k (\eta_{ij} + \xi_{ij}/(3k)) - 1), \tag{27}$$

where λ_i and χ_i are Lagrangian multipliers.

In order to get V_j , taking the derivative of the objective function with respect to V_j , we have $\frac{\partial J}{\partial V_j} = \sum_{i=1}^n (\mu_{ij}(4 - \gamma_{ij} - \xi_{ij}))^m (-2X_i + 2V_j)$. Since $\frac{\partial J}{\partial V_j} = 0$, so $\sum_{i=1}^n (\mu_{ij}(4 - \eta_{ij} - \xi_{ij}))^m (-2X_i + 2V_j) = 0 \Leftrightarrow \sum_{i=1}^n (\mu_{ij}(4 - \eta_{ij} - \xi_{ij}))^m X_i = \sum_{i=1}^n (\mu_{ij}(4 - \eta_{ij} - \xi_{ij}))^m V_j \Leftrightarrow V_j = \frac{\sum_{i=1}^n (\mu_{ij}(4 - \eta_{ij} - \xi_{ij}))^m X_i}{\sum_{i=1}^n (\mu_{ij}(4 - \eta_{ij} - \xi_{ij}))^m}$.

Similarly, $\frac{\partial J}{\partial \mu_{ij}} = m\mu_{ij}^{m-1}(4 - \xi_{ij} - \eta_{ij})^m \|X_i - V_j\|^2 + \frac{\rho m}{m-1} \mu_{ij}^{m-1}(4 - \xi_{ij} - \eta_{ij})^m + \lambda_i(4 - \xi_{ij} - \eta_{ij}) = 0 \Leftrightarrow \mu_{ij}^{m-1}(4 - \gamma_{ij} - \xi_{ij})^{m-1} (m\|X_i - V_j\|^2 + \frac{\rho m}{m-1}) + \lambda_i = 0 \Leftrightarrow \mu_{ij} = \frac{1}{4 - \gamma_{ij} - \xi_{ij}} \left(\frac{\lambda_i}{m\|X_i - V_j\|^2 + \frac{\rho m}{m-1}} \right)^{\frac{1}{m-1}}$.

From (20), we can get $\sum_{l=1}^k \left(\frac{\lambda_i}{m\|X_i - V_l\|^2 + \frac{\rho m}{m-1}} \right)^{\frac{1}{m-1}} = 1$, that is $\lambda_i = \left(\frac{1}{\sum_{l=1}^k \frac{1}{\left(\frac{\lambda_i}{m\|X_i - V_l\|^2 + \frac{\rho m}{m-1}} \right)^{\frac{1}{m-1}}}} \right)^{m-1}$, so

$$\mu_{ij} = \frac{1}{\sum_{l=1}^k (4 - \xi_{ij} - \eta_{ij}) \left(\frac{\|X_i - V_j\|^2 + \frac{\rho}{m-1}}{\|X_i - V_l\|^2 + \frac{\rho}{m-1}} \right)^{\frac{1}{m-1}}}; \text{ thus, (23) holds.}$$

From (23), we can also get $\mu_{ij}(4 - \gamma_{ij} - \xi_{ij}) = \frac{1}{\sum_{l=1}^k \left(\frac{\|X_i - V_j\|^2 + \frac{\rho}{m-1}}{\|X_i - V_l\|^2 + \frac{\rho}{m-1}} \right)^{\frac{1}{m-1}}}$, so $\gamma_{ij} = 4 - \xi_{ij} -$

$$\frac{1}{u_{ij} \sum_{l=1}^k \left(\frac{\|X_i - V_j\|^2 + \frac{\rho}{m-1}}{\|X_i - V_l\|^2 + \frac{\rho}{m-1}} \right)^{\frac{1}{m-1}}}; \text{ thus, (24) holds.}$$

Similarly, $\frac{\partial L}{\partial \eta_{ij}} = \log \eta_{ij} + 1 - \chi_i + \xi_{ij} = 0 \Leftrightarrow \eta_{ij} = e^{(\chi_i - 1 - \xi_{ij})}$, From (21), we have $\sum_{l=1}^k e^{\chi_i - 1 - \xi_{il}} + \frac{1}{3k} \sum_{l=1}^k \xi_{il} = 1 \Leftrightarrow e^{\chi_i - 1} \sum_{l=1}^k e^{-\xi_{il}} = 1 - \frac{1}{3k} \sum_{l=1}^k \xi_{il} \Leftrightarrow e^{\chi_i - 1} = \frac{1 - \frac{1}{3k} \sum_{l=1}^k \xi_{il}}{\sum_{l=1}^k e^{-\xi_{il}}}$. Therefore, we have $\eta_{ij} = (1 - \frac{1}{3k} \sum_{l=1}^k \xi_{il}) \frac{e^{-\xi_{ij}}}{\sum_{l=1}^k e^{-\xi_{il}}}$.

Finally, from Definition 1, we can get $\xi_{ij} = 3 - \mu_{ij} - \gamma_{ij} - \eta_{ij}$. Thus, (26) holds. \square

Theorem 1 guarantees the convergence of the proposed method. The detailed descriptions of SVNC-TEM algorithm are presented in the following Algorithm 1:

Algorithm 1: SVNC-TEM

Input: Dataset $D = \{X_1, X_2, \dots, X_n\}$ (n elements, d dimensions), number of clusters k , maximal number of iterations (Max-Iter), parameters: m, ϵ, ρ

Output: Cluster result

- 1: $t = 0$;
 - 2: Initialize μ, γ, ξ , satisfies Constraints (19) and (20);
 - 3: Repeat
 - 4: $t = t + 1$;
 - 5: Update $V_j^{(t)}$, ($j = 1, 2, \dots, k$) using Equation (22);
 - 6: Update $\mu_{ij}^{(t)}$, ($i = 1, 2, \dots, n, j = 1, 2, \dots, k$) using Equation (23);
 - 7: Update $\gamma_{ij}^{(t)}$, ($i = 1, 2, \dots, n, j = 1, 2, \dots, k$) using Equation (24);
 - 8: Update $\eta_{ij}^{(t)}$, ($i = 1, 2, \dots, n, j = 1, 2, \dots, k$) using Equation (25);
 - 9: Update $\xi_{ij}^{(t)}$, ($i = 1, 2, \dots, n, j = 1, 2, \dots, k$) using Equation (26);
 - 10: Update $T_{ij}^{(t)} = \mu_{ij}^{(t)}(4 - \gamma_{ij}^{(t)} - \xi_{ij}^{(t)})$, ($i = 1, 2, \dots, n, j = 1, 2, \dots, k$);
 - 11: Update $J^{(t)}$ using Equation (18);
 - 12: Until $|J^{(t)} - J^{(t-1)}| < \epsilon$ or Max-Iter is reached.
 - 13: Assign X_i ($i = 1, 2, \dots, n$) to the l -th class if $T_{il} = \max(T_{i1}, T_{i2}, \dots, T_{ik})$.
-

Compared to FCM, the proposed algorithm needs additional time to calculate μ, γ, η and ξ in order to more precisely describe the object and get better performance. If the dimension of the given dataset is d , the number of objects is n , the number of clusters is c and the number of iterations is t , then the computational complexity of the proposed algorithm is $O(dnct)$. We can see that the computational complexity is very high if d and n are large.

4. Experimental Results

In this section, some experiments are intended to validate the effectiveness of the proposed algorithm SVNC-TEM for data clustering. Firstly, we used an artificial dataset to show that SVNC-TEM can cluster well. Secondly, the proposed clustering method was used in image segmentation using an example. Lastly, we selected five benchmark datasets, and SVNC-TEM was compared to four state-of-the-art clustering algorithms, which were: k -means, FCM, IFC and FS-PFS.

In the experiments, the parameter m was selected as two and $\epsilon = 10^{-5}$. The maximum iterations (Max-Iter) = 100. The selected datasets have class labels, so the number of cluster k was known in advance. All the codes in the experiments were implemented in MATLAB R2015b.

4.1. Artificial Data to Cluster by the SVNC-TEM Algorithm

The activities of the SVNC-TEM algorithm are illustrated to cluster artificial data, which was two-dimensional data and had 100 data points, into four classes. We use an example to show the clustering process of the proposed algorithm. The distribution of data points is illustrated in Figure 1a. Figure 1b–e shows the cluster results when the number of iterations was $t = 1, 5, 10, 20$, respectively. We can see that the clustering result was obtained when $t = 20$. Figure 1f shows the final results of

the clustering; the number of iterations was 32. We can see that the proposed algorithm gave correct clustering results from Figure 1.

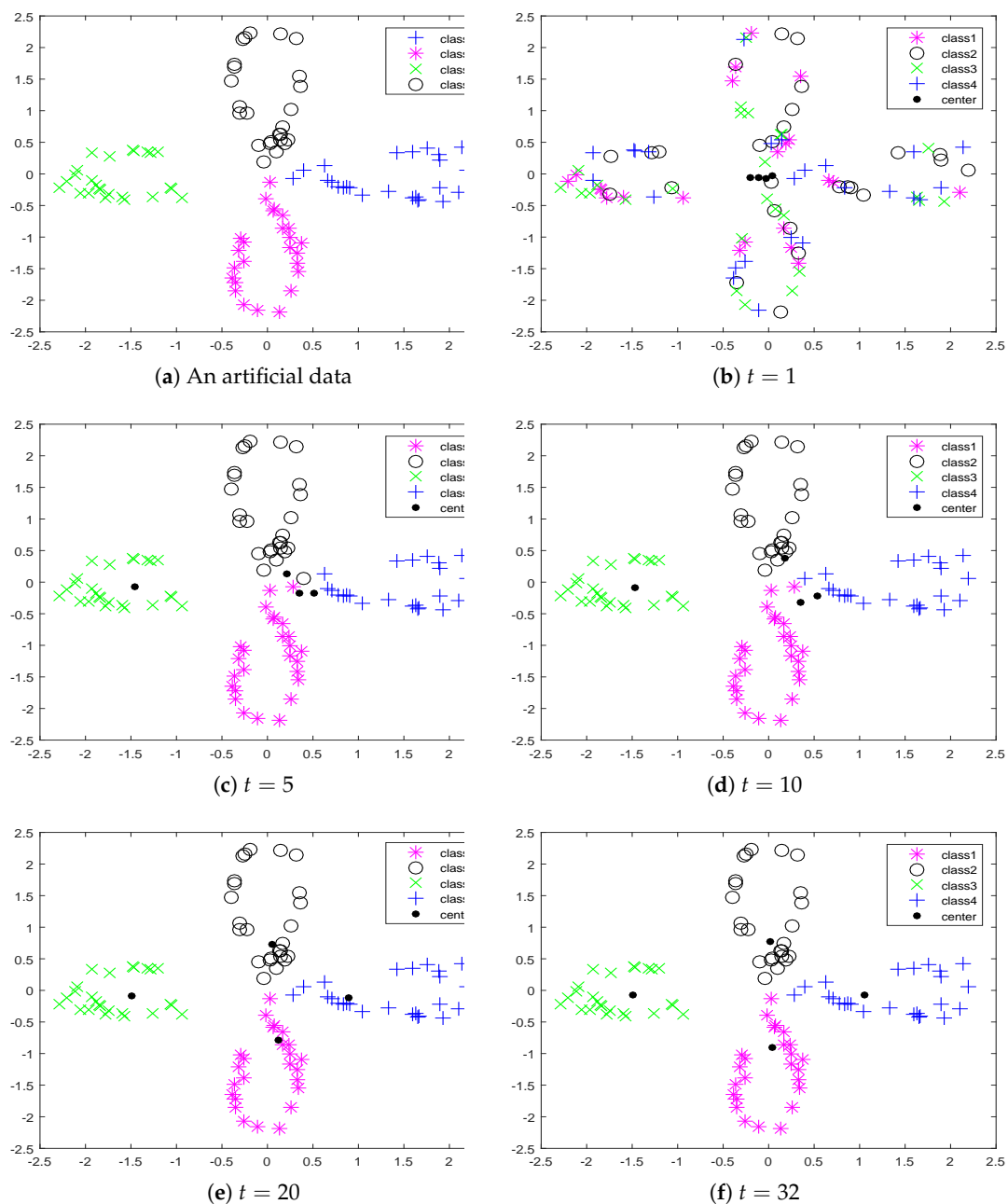

Figure 1. The demonstration figure of the clustering process for artificial data. (a) The original data. (b–e) The clustering figures when the number of iterations $t = 1, 5, 10, 20$, respectively. (f) The final clustering result.

4.2. Image Segmentation by the SVNC-TEM Algorithm

In this subsection, we use the proposed algorithm for image segmentation. As a simple example, the Lena image was used to test the proposed algorithm for image segmentation. Through this example, we wish to show that the proposed algorithm can be applied to image segmentation. Figure 2a is the original Lena image. Figure 2b shows the segmentation images when the number of clusters was $k = 2$, and we can see that the quality of the image was greatly reduced. Figure 2c–f shows the segmentation

images when the number of clusters was $k = 5, 8, 11$ and 20 , respectively. We can see that the quality of segmentation image was improved very much with the increase of the clustering number.



Figure 2. The image segmentation for the Lena image. (a) The original Lena image. (b–f) The clustering images when the number of clusters $k = 2, 5, 8, 11$ and 20 , respectively.

The above two examples demonstrate that the proposed algorithm can be effectively applied to clustering and image processing. Next, we will further compare the given algorithm to other state-of-art clustering algorithms on benchmark datasets.

4.3. Comparison Analysis Experiments

In order to verify the clustering performance, in this subsection, we experiment with five benchmark datasets of the UCI Machine Learning Repository, which are IRIS, CMC, GLASS, BALANCE and BREAST. These datasets were used to test the performance of the clustering algorithm. Table 1 shows the details of the characteristics of the datasets.

Table 1. Description of the experimental datasets.

Dataset	No. of Elements	No. of Attributes	No. of Classes	Elements in Each Classes
IRIS	150	4	3	[50, 50, 50]
CMC	1473	9	3	[629, 333, 511]
GLASS	214	9	6	[29, 76, 70, 17, 13, 9]
BALANCE	625	4	3	[49, 288, 288]
BREAST	277	9	2	[81, 196]

In order to compare the performance of the clustering algorithms, three evaluation criteria were introduced as follows.

Given one data point X_i , denote p_i as the truth class and q_i as the predicted clustering class. The clustering accuracy (ACC) measure is evaluated as follows:

$$ACC = \frac{\sum_{i=1}^n \delta(p_i, \text{map}(q_i))}{n}, \tag{28}$$

where n is the total number of data points, $\delta(x, y) = 1$ if $x = y$; otherwise, $\delta(x, y) = 0$. $map(\bullet)$ is the best permutation mapping function that matches the obtained clustering label to the equivalent label of the dataset. One of the best mapping functions is the Kuhn–Munkres algorithm [29]. The higher the ACC was, the better the clustering performance was.

Given two random variables X and Y , $MI(X; Y)$ is the mutual information of X and Y . $H(X)$ and $H(Y)$ are the entropies of P and Q , respectively. We use the normalized mutual information (NMI) as follows:

$$NMI(X; Y) = \frac{MI(X; Y)}{\sqrt{H(X)H(Y)}}. \tag{29}$$

The clustering results $\hat{C} = \{\hat{C}_j\}_{j=1}^{\hat{k}}$ and the ground truth classes $C = \{C_j\}_{j=1}^k$ are regarded as two discrete random variables. Therefore, NMI is specified as follows:

$$NMI(C; \hat{C}) = \frac{\sum_{i=1}^{\hat{k}} \sum_{j=1}^k |\hat{C}_i \cap C_j| \log \frac{n|\hat{C}_i \cap C_j|}{|\hat{C}_i||C_j|}}{\sqrt{(\sum_{i=1}^{\hat{k}} |\hat{C}_i| \log \frac{|\hat{C}_i|}{n}) (\sum_{j=1}^k |C_j| \log \frac{|C_j|}{n})}}. \tag{30}$$

The higher the NMI was, the better the clustering performance was.

The Rand index is defined as,

$$RI = \frac{2(a + d)}{n(n - 1)}, \tag{31}$$

where a is the number of pairs of data points belonging to the same class in C and to the same cluster in \hat{C} . d is the number of pairs of data points belonging to the different class and to the different cluster. n is the number of data points. The larger the Rand index is, the better the clustering performance is.

We did a series of experiments to indicate the performance of the proposed method for data clustering. In the experiments, we set the parameters of all approaches in the same way to make the experiments fair enough, that is for parameter ρ , we set $\rho = \{0.01, 0.05, 0.07, 0.1, 0.15, 0.5, 1, 2, 5, 8, 9, 15, 20, 50\}$. For α , we set $\alpha = \{0.1, 0.2, 0.3, 0.4, 0.5, 0.6, 0.7, 0.8, 0.9\}$. For each parameter, we ran the given method 50 times and selected the best mean value to report. Tables 2–4 show the results with the different evaluation measures. In these tables, we use bold font to indicate the best performance.

Table 2. The ACC for different algorithms on different datasets.

Dataset	<i>k</i> -Means	FCM	IFC	FC-PFS	SVNC-TEM
IRIS	0.8803	0.8933	0.9000	0.8933	0.9000
CMC	0.3965	0.3917	0.3958	0.3917	0.3985
GLASS	0.3219	0.2570	0.3636	0.2935	0.3681
BALANCE	0.5300	0.5260	0.5413	0.5206	0.5149
BREAST	0.6676	0.5765	0.6595	0.6585	0.6686

Bold format: the best performance.

Table 3. The NMI for different algorithms on different datasets.

Dataset	<i>k</i> -Means	FCM	IFC	FC-PFS	SVNC-TEM
IRIS	0.7514	0.7496	0.7102	0.7501	0.7578
CMC	0.0320	0.0330	0.0322	0.0334	0.0266
GLASS	0.0488	0.0387	0.0673	0.0419	0.0682
BALANCE	0.1356	0.1336	0.1232	0.1213	0.1437
BREAST	0.0623	0.0309	0.0285	0.0610	0.0797

Bold format: the best performance.

We analyze the results from the dataset firstly. For IRIS dataset, the proposed method obtained the best performance for ACC, NMI and RI. For the CMC dataset, the proposed method had the best performance for ACC and RI. For the GLASS and BREAST datasets, the proposed method obtained the best performance for ACC and NMI. For the BALANCE dataset, the proposed method had the best performance for NMI and RI. On the other hand, from the three evaluation criteria, for ACC and NMI, the proposed method beat the other methods for four datasets. For RI, SVNC-TEM beat the other methods for three datasets. From the experimental results, we can see that the proposed method had better clustering performance than the other algorithms.

Table 4. The RI for different algorithms on different datasets.

Dataset	<i>k</i> -Means	FCM	IFC	FC-PFS	SVNC-TEM
IRIS	0.8733	0.8797	0.8827	0.8797	0.8859
CMC	0.5576	0.5582	0.5589	0.5582	0.5605
GLASS	0.5373	0.6294	0.4617	0.5874	0.4590
BALANCE	0.5940	0.5928	0.5899	0.5904	0.5999
BREAST	0.5708	0.5159	0.5732	0.5656	0.5567

Bold format: the best performance.

5. Conclusions

In the paper, we consider the truth membership degree, the falsity-membership degree, the indeterminacy membership degree and hesitate membership degree in a comprehensive way for data clustering by the single-valued neutrosophic set. We propose a novel data clustering algorithm, SVNC-TEM, and the experimental results showed that the proposed algorithm can be considered as a promising tool for data clustering and image processing. The proposed algorithm had better clustering performance than the other algorithms such as *k*-means, FCM, IFC and FC-PFS. Next, we will consider the proposed method to deal with outliers. Moreover, we will consider the clustering algorithm combined with spectral clustering and other clustering methods.

References

1. MacQueen, J.B. Some methods for classification and analysis of multivariate observations. In *Proceedings of the 5th Berkeley Symposium on Mathematical Statistics and Probability*; University of California Press: Berkeley, CA, USA, 1967; pp. 281–297.
2. Johnson, S.C. Hierarchical clustering schemes. *Psychometrika* **1967**, *2*, 241–254. [[CrossRef](#)]
3. Ng, A.Y.; Jordan, M.I.; Weiss, Y. On spectral clustering: Analysis and an algorithm. *Adv. Neural Inf. Process. Syst.* **2002**, *14*, 849–856.
4. Andenberg, M.R. *Cluster Analysis for Applications*; Academic Press: New York, NY, USA, 1973.
5. Ménard, M.; Demko, C.; Loonis, P. The fuzzy $c + 2$ means: Solving the ambiguity rejection in clustering. *Pattern Recognit.* **2000**, *33*, 1219–1237.
6. Aggarwal, C.C.; Reddy, C.K. *Data Clustering: Algorithms and Applications*; CRC Press: Boca Raton, FL, USA, 2013.
7. Bezdek, J.C.; Ehrlich, R.; Full, W. FCM: The fuzzy c -means clustering algorithm. *Comput. Geosci.* **1984**, *10*, 191–203. [[CrossRef](#)]
8. Chaira, T. A novel intuitionistic fuzzy C means clustering algorithm and its application to medical images. *Appl. Soft Comput.* **2011**, *11*, 1711–1717. [[CrossRef](#)]
9. Hwang C.; Rhee F.C.H. Uncertain fuzzy clustering: interval type-2 fuzzy approach to c -means. *IEEE Trans. Fuzzy Syst.* **2007**, *15*, 107–120. [[CrossRef](#)]

10. Thong, P.H.; Son, L.H. Picture fuzzy clustering: A new computational intelligence method. *Soft Comput.* **2016**, *20*, 3549–3562. [[CrossRef](#)]
11. Graves, D.; Pedrycz, W. Kernel-based fuzzy clustering and fuzzy clustering: A comparative experimental study. *Fuzzy Sets Syst.* **2010**, *161*, 522–543. [[CrossRef](#)]
12. Ramathilagam, S.; Devi, R.; Kannan, S.R. Extended fuzzy c-means: An analyzing data clustering problems. *Clust. Comput.* **2013**, *16*, 389–406. [[CrossRef](#)]
13. Yasuda, M. Deterministic Annealing Approach to Fuzzy C-Means Clustering Based on Entropy Maximization. *Adv. Fuzzy Syst.* **2011**, *2011*, 960635. [[CrossRef](#)]
14. Smarandache, F. *A Unifying Field in Logics. Neutrosophy: Neutrosophic Probability, Set and Logic*; American Research Press: Rehoboth, TX, USA, 1998.
15. Wang, H.; Smarandache, F.; Zhang, Y.Q.; Sunderraman, R. Single Valued Neutrosophic Sets. *Multispace Multistruct* **2010**, *4*, 410–413.
16. Majumdar, P.; Samant, S.K. On similarity and entropy of neutrosophic sets. *J. Intell. Fuzzy Syst.* **2014**, *26*, 1245–1252.
17. Ye, J. Improved correlation coefficients of single valued neutrosophic sets and interval neutrosophic sets for multiple attribute decision making. *J. Intell. Fuzzy Syst.* **2014**, *27*, 2453–2462.
18. Zhang, X.; Bo, C.; Smarandache, F.; Dai, J. New Inclusion Relation of Neutrosophic Sets with Applications and Related Lattice Structure. *J. Mach. Learn. Cybern.* **2018**, *2018*, 1–11. [[CrossRef](#)]
19. Zhang, X.H.; Smarandache, F.; Liang, X.L. Neutrosophic duplet semi-group and cancelable neutrosophic triplet groups. *Symmetry* **2017**, *9*, 275. [[CrossRef](#)]
20. Ye, J. Single-Valued Neutrosophic Minimum Spanning Tree and Its Clustering Method. *J. Intell. Syst.* **2014**, *23*, 311–324. [[CrossRef](#)]
21. Ye, J. Clustering Methods Using Distance-Based Similarity Measures of Single-Valued Neutrosophic Sets. *J. Intell. Syst.* **2014**, *23*, 379–389. [[CrossRef](#)]
22. Guo, Y.; Sengur, A. NCM: Neutrosophic c-means clustering algorithm. *Pattern Recognit.* **2015**, *48*, 2710–2724. [[CrossRef](#)]
23. Thong, P.H.; Son, L.H. A novel automatic picture fuzzy clustering method based on particle swarm optimization and picture composite cardinality. *Knowl. Based Syst.* **2016**, *109*, 48–60. [[CrossRef](#)]
24. Thong, P.H.; Son, L.H. Picturefuzzyclusteringforcomplexdata. *Eng. Appl. Artif. Intell.* **2016**, *56*, 121–130. [[CrossRef](#)]
25. Son, L.H. DPFCM: A novel distributed picture fuzzy clustering method on picture fuzzy sets. *Expert Syst. Appl.* **2015**, *42*, 51–66. [[CrossRef](#)]
26. Cuong, B.C. Picture Fuzzy Sets. *J. Comput. Sci. Cybern.* **2014**, *30*, 409–420.
27. Cuong, B.C.; Phong, P.H. Smarandache, F. Standard Neutrosophic Soft Theory: Some First Results. *Neutrosophic Sets Syst.* **2016**, *12*, 80–91.
28. Tsallis, C. Possible generalization of Boltzmann-Gibbs statistics. *J. Stat. Phys.* **1988**, *52*, 479–487. [[CrossRef](#)]
29. Lovasz, L.; Plummer, M.D. *Matching Theory*; AMS Chelsea Publishing: Providence, RI, USA, 2009.

Correlation Coefficient Measures of Interval Bipolar Neutrosophic Sets for Solving Multi-Attribute Decision Making Problems

Surapati Pramanik, Partha Pratim Dey, Florentin Smarandache

Surapati Pramanik, Partha Pratim Dey, Florentin Smarandache (2018). Correlation Coefficient Measures of Interval Bipolar Neutrosophic Sets for Solving Multi-Attribute Decision Making Problems. *Neutrosophic Sets and Systems* 19: 70-79

Abstract. Interval bipolar neutrosophic set is a significant extension of interval neutrosophic set where every element of the set comprises of three independent positive membership functions and three independent negative membership functions. In this study, we first define correlation coefficient, and weighted correlation coefficient measures of interval bipolar neutrosophic sets and

prove their basic properties. Then, we develop a new multi-attribute decision making strategy based on the proposed weighted correlation coefficient measure. Finally, we solve an investment problem with interval bipolar neutrosophic information and comparison is given to demonstrate the applicability and effectiveness of the proposed strategy.

Keywords: Interval bipolar neutrosophic set, multi-attribute decision making, correlation coefficient measure.

1 Introduction

Correlation coefficient is an important decision making apparatus in statistics to evaluate the relation between two sets. In neutrosophic environment [1], Hanafy et al. [2] derived a formula for correlation coefficient between two neutrosophic sets (NSs). Hanafy et al. [3] obtained the correlation coefficient of NSs by using centroid strategy which lies in $[-1, 1]$. The correlation coefficient obtained from [3] provides the information about the degree of the relationship between two NSs and also informs us whether the NSs are positive or negatively related. In 2013, Ye [4] defined correlation, correlation coefficient, weighted correlation coefficient in single valued neutrosophic set (SVNS) [5] environment and established a multi-criteria decision making (MCDM) based on the proposed weighted correlation coefficient measure. Broumi and Smarandache [6] introduced the concept of correlation coefficient and weighted correlation coefficient between two interval neutrosophic sets (INSs) [7] and established some of their basic properties. Hanafy et al. [8] studied the notion of correlation and correlation coefficient of neutrosophic data under probability spaces. Ye [9] suggested an improved correlation coefficient between two SVNSs in order to overcome the drawbacks of the correlation coefficient discussed in [4] and investigated its properties. In the same

study, Ye [9] extended the concept of correlation coefficient measure of SVNS to correlation coefficient measure of INS environment. Furthermore, Ye [9] developed strategies for solving multi-attribute decision making (MADM) problems with single valued neutrosophic and interval neutrosophic environments based on the proposed correlation coefficient measures. Broumi and Deli [10] defined correlation measure of two neutrosophic refined (multi) sets [11] by extending the correlation measure of two intuitionistic fuzzy multi-sets proposed by Rajarajeswari and Uma [12] and proved some of its basis properties. Zhang et al. [13] defined an improved weighted correlation coefficient on the basis of integrated weight for INSs and a decision making strategy is developed. Karaaslan [14] proposed a strategy to compute correlation coefficient between possibility neutrosophic soft sets and presented several properties related to the proposed strategy. Karaaslan [15] defined a new mathematical structure called single-valued neutrosophic refined soft sets (SNRSSs) and presented its set theoretical operations such as union, intersection and complement and proved some of their basic properties. In the same study [15], two formulas to determine correlation coefficient between two SNRSSs are proposed and the developed strategy is used to solve a clustering analysis problem. Şahin and Liu [16] defined single valued

neutrosophic hesitant fuzzy sets (SVNHFSs) and established some basic properties and finally proposed a decision making strategy. Liu and Luo [17] defined correlation coefficient and weighted correlation coefficient for interval-valued neutrosophic hesitant fuzzy sets (INHFSS) due to Liu and Shi [18] and studied their properties. Then, Liu and Luo [17] developed a MADM strategy within the framework of INHFSSs based on weighted correlation coefficient. Ye [19] suggested a dynamic single valued neutrosophic multiset (DSVNM) based on dynamic information obtained from different time intervals in several practical situations in order to express dynamical data and operational relations of DSVNMs. In the same study [19], correlation coefficient and weighted correlation coefficient measures between DSVNMs are proposed and a MADM strategy is developed on the basis of the proposed weighted correlation coefficient under DSVNM setting. Recently, Ye [20] proposed two correlation coefficient between normal neutrosophic sets (NNSs) based on the score functions of normal neutrosophic numbers and investigated their essential properties. In the same study, Ye [20] formulated a MADM strategy by employing correlation coefficient of NNSs in normal neutrosophic environment. Pramanik et al. [21] defined correlation coefficient and weighted correlation coefficient between two rough neutrosophic sets and proved their basic properties. In the same study, Pramanik et al. [21] developed a multi-criteria decision making strategy based on the proposed correlation coefficient measure and solved an illustrative example in medical diagnosis.

In 2015, Deli et al. [22] introduced a novel concept called bipolar neutrosophic sets (BNSs) by generalizing the concepts of bipolar fuzzy sets [23, 24] and bipolar intuitionistic fuzzy sets [25]. In the same study, Deli et al. [22] defined score, accuracy and certainty functions to compare BNSs and formulated a MCDM approach based on the score, accuracy and certainty functions and bipolar neutrosophic weighted average operator (A_w) and bipolar neutrosophic weighted geometric operator (G_w). In bipolar neutrosophic environment, Dey et al. [26] developed a MADM approach based on technique for order of preference by similarity to ideal solution (TOPSIS) strategy. Deli and Subas [27] and Şahin et al. [28] developed MCDM strategies based on correlation coefficient and Jaccard similarity measures, respectively in BNS environment. Uluçay et al. [29] defined Dice, weighted Dice similarity measures, hybrid and weighted hybrid similarity measures for

MCDM problems with bipolar neutrosophic information. Pramanik et al. [30] defined projection, bidirectional projection and hybrid projection measures between BNSs and proved their basic properties and then, three new MADM models are developed based on proposed measures.

Mahmood et al. [31] and Deli et al. [32] incorporated the notion of interval bipolar neutrosophic sets (IBNSs) and defined some operations and operators for IBNSs. Recently, Pramanik et al. [33] defined new cross entropy and weighted cross entropy measures in BNS and IBNS environment and discussed some of their essential properties. In the same study, Pramanik et al. [33] developed two novel MADM strategies on the basis of the proposed weighted cross entropy measures.

Research gap:

MADM strategy based on correlation coefficient under IBNSs environment.

This paper answers the following research questions:

- i. Is it possible to introduce a novel correlation coefficient measure for IBNSs?
- ii. Is it possible to introduce a novel weighted correlation coefficient measure for IBNSs?
- iii. Is it feasible to formulate a novel MADM strategy based on the proposed correlation coefficient measure in IBNS environment?
- iv. Is it feasible to formulate a novel MADM strategy based on the proposed weighted correlation coefficient measure in IBNS environment?

Motivation:

The aforementioned analysis presents the motivation behind developing correlation coefficient -based strategy for handling MADM problems with IBNS information.

The objectives of the paper are as follows:

1. To define a new correlation coefficient measure and a new weighted correlation coefficient measure in IBNS environment and prove their basic properties.
2. To develop a new MADM strategy based on weighted correlation coefficient measure in IBNS environment.

In order to fill the research gap, we propose correlation coefficient-based MADM strategy in IBNS environment.

Rest of the article is organized as follows. Section 2 provides the preliminaries of bipolar fuzzy sets, bipolar intuitionistic fuzzy sets, BNSs and IBNSs. Section 3 defines the correlation coefficient and weighted correlation coefficient measures in IBNS environment and establishes their basic properties. In section 4, a new MADM strategy based on the proposed weighted correlation coefficient measure is developed. In section 5, we solve a numerical example and comparison analysis is given. Finally, in the last section, conclusions are presented.

2 Preliminaries

2.1 Bipolar fuzzy sets

A bipolar fuzzy set [23, 24] B in X is characterized by a positive membership function $\alpha_B^+(x)$ and a negative membership function $\alpha_B^-(x)$. A bipolar fuzzy set B is expressed in the following way.

$$B = \{x, \langle \alpha_B^+(x), \alpha_B^-(x) \rangle \mid x \in X\}$$

where $\alpha_B^+(x): X \rightarrow [0, 1]$ and $\alpha_B^-(x): X \rightarrow [-1, 0]$ for each point $x \in X$.

2.2 Bipolar intuitionistic fuzzy sets

Consider X be a non-empty set, then a BIFS [25] E is expressed in the following way.

$$E = \{x, \langle \alpha_E^+(x), \alpha_E^-(x), \beta_E^+(x), \beta_E^-(x) \rangle \mid x \in X\}$$

where $\alpha_E^+(x), \beta_E^+(x): X \rightarrow [0, 1]$ and $\alpha_E^-(x), \beta_E^-(x): X \rightarrow [-1, 0]$ for each point $x \in X$ such that $0 \leq \alpha_E^+(x) + \beta_E^+(x) \leq 1$ and $-1 \leq \alpha_E^-(x) + \beta_E^-(x) \leq 0$.

2.3 Bipolar neutrosophic sets

A BNS [22] M in X is presented as follows:

$$M = \{x, \langle \alpha_M^+(x), \beta_M^+(x), \gamma_M^+(x), \alpha_M^-(x), \beta_M^-(x), \gamma_M^-(x) \rangle \mid x \in X\}$$

where $\alpha_M^+(x), \beta_M^+(x), \gamma_M^+(x): X \rightarrow [0, 1]$ and $\alpha_M^-(x), \beta_M^-(x), \gamma_M^-(x): X \rightarrow [-1, 0]$. The positive membership degrees $\alpha_M^+(x), \beta_M^+(x), \gamma_M^+(x)$ denote the truth membership, indeterminate membership, and false membership functions of an object $x \in X$ corresponding to a BNS M and the negative membership degrees $\alpha_M^-(x), \beta_M^-(x), \gamma_M^-(x)$ denote the truth membership, indeterminate membership, and false membership of an object $x \in X$ to several implicit counter property associated with a BNS M .

Definition 2.3.1

Let, $M_1 = \{x, \langle \alpha_{M_1}^+(x), \beta_{M_1}^+(x), \gamma_{M_1}^+(x), \alpha_{M_1}^-(x), \beta_{M_1}^-(x), \gamma_{M_1}^-(x) \rangle \mid x \in X\}$ and $M_2 = \{x, \langle \alpha_{M_2}^+(x), \beta_{M_2}^+(x), \gamma_{M_2}^+(x), \alpha_{M_2}^-(x), \beta_{M_2}^-(x), \gamma_{M_2}^-(x) \rangle \mid x \in X\}$ be any two BNSs. Then, a BNS M_1 is contained in another BNS M_2 , represented by $M_1 \subseteq M_2$ if and only if $\alpha_{M_1}^+(x) \leq \alpha_{M_2}^+(x), \beta_{M_1}^+(x) \geq \beta_{M_2}^+(x), \gamma_{M_1}^+(x) \geq \gamma_{M_2}^+(x); \alpha_{M_1}^-(x) \geq \alpha_{M_2}^-(x), \beta_{M_1}^-(x) \leq \beta_{M_2}^-(x), \gamma_{M_1}^-(x) \leq \gamma_{M_2}^-(x)$ for all $x \in X$.

Definition 2.3.2

Let, $M_1 = \{x, \langle \alpha_{M_1}^+(x), \beta_{M_1}^+(x), \gamma_{M_1}^+(x), \alpha_{M_1}^-(x), \beta_{M_1}^-(x), \gamma_{M_1}^-(x) \rangle \mid x \in X\}$ and $M_2 = \{x, \langle \alpha_{M_2}^+(x), \beta_{M_2}^+(x), \gamma_{M_2}^+(x), \alpha_{M_2}^-(x), \beta_{M_2}^-(x), \gamma_{M_2}^-(x) \rangle \mid x \in X\}$ be any two BNSs [22], then $M_1 = M_2$ if and only if $\alpha_{M_1}^+(x) = \alpha_{M_2}^+(x), \beta_{M_1}^+(x) = \beta_{M_2}^+(x), \gamma_{M_1}^+(x) = \gamma_{M_2}^+(x), \alpha_{M_1}^-(x) = \alpha_{M_2}^-(x), \beta_{M_1}^-(x) = \beta_{M_2}^-(x), \gamma_{M_1}^-(x) = \gamma_{M_2}^-(x)$ for all $x \in X$.

Definition 2.3.3

The complement of a BNS [33] M is $M^c = \{x, \langle \alpha_{M^c}^+(x), \beta_{M^c}^+(x), \gamma_{M^c}^+(x), \alpha_{M^c}^-(x), \beta_{M^c}^-(x), \gamma_{M^c}^-(x) \rangle \mid x \in X\}$ where $\alpha_{M^c}^+(x) = \gamma_M^+(x), \beta_{M^c}^+(x) = 1 - \beta_M^+(x), \gamma_{M^c}^+(x) = \alpha_M^+(x); \alpha_{M^c}^-(x) = \gamma_M^-(x), \beta_{M^c}^-(x) = -1 - \beta_M^-(x), \gamma_{M^c}^-(x) = \alpha_M^-(x)$.

Definition 2.3.4

The union [30] of two BNSs M_1 and M_2 represented by $M_1 \cup M_2$ is defined as follows: $M_1 \cup M_2 = \{\text{Max}(T_{M_1}^+(x), T_{M_2}^+(x)), \text{Min}(I_{M_1}^+(x), I_{M_2}^+(x)), \text{Min}(F_{M_1}^+(x), F_{M_2}^+(x)), \text{Min}(T_{M_1}^-(x), T_{M_2}^-(x)), \text{Max}(I_{M_1}^-(x), I_{M_2}^-(x)), \text{Max}(F_{M_1}^-(x), F_{M_2}^-(x))\}, \forall x \in X$.

Definition 2.3.5

The intersection [30] of two BNSs M_1 and M_2 denoted by $M_1 \cap M_2$ is defined as follows: $M_1 \cap M_2 = \{\text{Min}(T_{M_1}^+(x), T_{M_2}^+(x)), \text{Max}(I_{M_1}^+(x), I_{M_2}^+(x)), \text{Max}(F_{M_1}^+(x), F_{M_2}^+(x)), \text{Max}(T_{M_1}^-(x), T_{M_2}^-(x)), \text{Min}(I_{M_1}^-(x), I_{M_2}^-(x)), \text{Min}(F_{M_1}^-(x), F_{M_2}^-(x))\}, \forall x \in X$.

2.4 Interval bipolar neutrosophic sets

Consider X be the space of objects, then an IBNS [31, 32] L in X is represented as follows:

$$L = \left\{ x, \left\langle \begin{array}{l} [\inf \alpha_L^+(x), \sup \alpha_L^+(x)], [\inf \beta_L^+(x), \sup \beta_L^+(x)], \\ [\inf \gamma_L^+(x), \sup \gamma_L^+(x)], [\inf \alpha_L^-(x), \sup \alpha_L^-(x)], \\ [\inf \beta_L^-(x), \sup \beta_L^-(x)], [\inf \gamma_L^-(x), \sup \gamma_L^-(x)] \end{array} \right\rangle \mid x \in X \right\}$$

where L is characterized by positive and negative truth-membership $\alpha_L^+(x)$, $\alpha_L^-(x)$; indeterminacy-membership $\beta_L^+(x)$, $\beta_L^-(x)$; falsity-membership $\gamma_L^+(x)$, $\gamma_L^-(x)$ functions respectively. Here, $\alpha_L^+(x)$, $\beta_L^+(x)$, $\gamma_L^+(x) \subseteq [0, 1]$; $\alpha_L^-(x)$, $\beta_L^-(x)$, $\gamma_L^-(x) \subseteq [-1, 0]$ for all $x \in X$ with the conditions $0 \leq \sup \alpha_L^+(x) + \sup \beta_L^+(x) + \sup \gamma_L^+(x) \leq 3$, and $-3 \leq \sup \alpha_L^-(x) + \sup \beta_L^-(x) + \sup \gamma_L^-(x) \leq 0$.

Definition 2.4.1 : Let $L_1 = \{x, < [\inf \alpha_{L_1}^+(x), \sup \alpha_{L_1}^+(x)]; [\inf \beta_{L_1}^+(x), \sup \beta_{L_1}^+(x)]; [\inf \gamma_{L_1}^+(x), \sup \gamma_{L_1}^+(x)]; [\inf \alpha_{L_1}^-(x), \sup \alpha_{L_1}^-(x)]; [\inf \beta_{L_1}^-(x), \sup \beta_{L_1}^-(x)]; [\inf \gamma_{L_1}^-(x), \sup \gamma_{L_1}^-(x)] > \mid x \in X\}$ and $L_2 = \{x, < [\inf \alpha_{L_2}^+(x), \sup \alpha_{L_2}^+(x)]; [\inf \beta_{L_2}^+(x), \sup \beta_{L_2}^+(x)]; [\inf \gamma_{L_2}^+(x), \sup \gamma_{L_2}^+(x)]; [\inf \alpha_{L_2}^-(x), \sup \alpha_{L_2}^-(x)]; [\inf \beta_{L_2}^-(x), \sup \beta_{L_2}^-(x)]; [\inf \gamma_{L_2}^-(x), \sup \gamma_{L_2}^-(x)] > \mid x \in X\}$ be two IBNSs [31]. Then $L_1 \subseteq L_2$ if and only if

$$\begin{aligned} \inf \alpha_{L_1}^+(x) &\leq \inf \alpha_{L_2}^+(x), & \sup \alpha_{L_1}^+(x) &\leq \sup \alpha_{L_2}^+(x), \\ \inf \beta_{L_1}^+(x) &\geq \inf \beta_{L_2}^+(x), & \sup \beta_{L_1}^+(x) &\geq \sup \beta_{L_2}^+(x), \\ \inf \gamma_{L_1}^+(x) &\geq \inf \gamma_{L_2}^+(x), & \sup \gamma_{L_1}^+(x) &\geq \sup \gamma_{L_2}^+(x), & \inf \alpha_{L_1}^-(x) &\geq \inf \alpha_{L_2}^-(x), \\ \sup \alpha_{L_1}^-(x) &\geq \sup \alpha_{L_2}^-(x), & \inf \beta_{L_1}^-(x) &\leq \inf \beta_{L_2}^-(x), & \sup \beta_{L_1}^-(x) &\leq \sup \beta_{L_2}^-(x), \\ \inf \gamma_{L_1}^-(x) &\leq \inf \gamma_{L_2}^-(x), & \sup \gamma_{L_1}^-(x) &\leq \sup \gamma_{L_2}^-(x), \end{aligned}$$

for all $x \in X$.

Definition 2.4.2: Consider $L_1 = \{x, < [\inf \alpha_{L_1}^+(x), \sup \alpha_{L_1}^+(x)]; [\inf \beta_{L_1}^+(x), \sup \beta_{L_1}^+(x)]; [\inf \gamma_{L_1}^+(x), \sup \gamma_{L_1}^+(x)]; [\inf \alpha_{L_1}^-(x), \sup \alpha_{L_1}^-(x)]; [\inf \beta_{L_1}^-(x), \sup \beta_{L_1}^-(x)]; [\inf \gamma_{L_1}^-(x), \sup \gamma_{L_1}^-(x)] > \mid x \in X\}$ and $L_2 = \{x, < [\inf \alpha_{L_2}^+(x), \sup \alpha_{L_2}^+(x)]; [\inf \beta_{L_2}^+(x), \sup \beta_{L_2}^+(x)]; [\inf \gamma_{L_2}^+(x), \sup \gamma_{L_2}^+(x)]; [\inf \alpha_{L_2}^-(x), \sup \alpha_{L_2}^-(x)]; [\inf \beta_{L_2}^-(x), \sup \beta_{L_2}^-(x)]; [\inf \gamma_{L_2}^-(x), \sup \gamma_{L_2}^-(x)] > \mid x \in X\}$ be two IBNSs [31]. Then $L_1 = L_2$ if and only if

$$\begin{aligned} \inf \alpha_{L_1}^+(x) &= \inf \alpha_{L_2}^+(x), & \sup \alpha_{L_1}^+(x) &= \sup \alpha_{L_2}^+(x), \\ \inf \beta_{L_1}^+(x) &= \inf \beta_{L_2}^+(x), & \sup \beta_{L_1}^+(x) &= \sup \beta_{L_2}^+(x), & \inf \gamma_{L_1}^+(x) &= \inf \gamma_{L_2}^+(x), \\ \sup \gamma_{L_1}^+(x) &= \sup \gamma_{L_2}^+(x), & \inf \alpha_{L_1}^-(x) &= \inf \alpha_{L_2}^-(x), \\ \sup \alpha_{L_1}^-(x) &= \sup \alpha_{L_2}^-(x), & \inf \beta_{L_1}^-(x) &= \inf \beta_{L_2}^-(x), \\ \sup \beta_{L_1}^-(x) &= \sup \beta_{L_2}^-(x), & \inf \gamma_{L_1}^-(x) &= \inf \gamma_{L_2}^-(x), \\ \sup \gamma_{L_1}^-(x) &= \sup \gamma_{L_2}^-(x), \end{aligned}$$

for all $x \in X$.

Definition 2.4.3: The complement [33] of $L = \{x, < [\inf \alpha_L^+(x), \sup \alpha_L^+(x)]; [\inf \beta_L^+(x), \sup \beta_L^+(x)]; [\inf \gamma_L^+(x), \sup \gamma_L^+(x)]; [\inf \alpha_L^-(x), \sup \alpha_L^-(x)]; [\inf \beta_L^-(x), \sup \beta_L^-(x)]; [\inf \gamma_L^-(x), \sup \gamma_L^-(x)] > \mid x \in X\}$ is defined as $L^c = \{x, < [\inf \alpha_{L^c}^+(x), \sup \alpha_{L^c}^+(x)]; [\inf \beta_{L^c}^+(x), \sup \beta_{L^c}^+(x)]; [\inf \gamma_{L^c}^+(x), \sup \gamma_{L^c}^+(x)]; [\inf \alpha_{L^c}^-(x), \sup \alpha_{L^c}^-(x)]; [\inf \beta_{L^c}^-(x), \sup \beta_{L^c}^-(x)]; [\inf \gamma_{L^c}^-(x), \sup \gamma_{L^c}^-(x)] > \mid x \in X\}$ where

$$\begin{aligned} \inf \alpha_{L^c}^+(x) &= \inf \gamma_L^+(x), & \sup \alpha_{L^c}^+(x) &= \sup \gamma_L^+(x), & \inf \beta_{L^c}^+(x) &= 1 - \sup \beta_L^+(x), \\ \sup \beta_{L^c}^+(x) &= 1 - \inf \beta_L^+(x), & \inf \gamma_{L^c}^+(x) &= \inf \alpha_L^+, & \sup \gamma_{L^c}^+(x) &= \sup \alpha_L^+, \\ \inf \alpha_{L^c}^-(x) &= \inf \gamma_L^-, & \sup \alpha_{L^c}^-(x) &= \sup \gamma_L^-, & \inf \beta_{L^c}^-(x) &= -1 - \sup \beta_L^-(x), \\ \sup \beta_{L^c}^-(x) &= -1 - \inf \beta_L^-(x), & \inf \gamma_{L^c}^-(x) &= \inf \alpha_L^-(x), \\ \sup \gamma_{L^c}^-(x) &= \sup \alpha_L^-(x) \end{aligned}$$

for all $x \in X$.

3 Correlation coefficient measures under IBNSs setting

Definition 3.1: Let L_1 and L_2 be two IBNSs in $X = \{x_1, x_2, \dots, x_n\}$, then the correlation between L_1 and L_2 is defined as follows:

$$R(L_1, L_2) = \sum_{i=1}^n \left(\begin{array}{l} \inf \alpha_{L_1}^+(x_i). \inf \alpha_{L_2}^+(x_i) + \sup \alpha_{L_1}^+(x_i). \sup \alpha_{L_2}^+(x_i) + \\ \inf \beta_{L_1}^+(x_i). \inf \beta_{L_2}^+(x_i) + \sup \beta_{L_1}^+(x_i). \sup \beta_{L_2}^+(x_i) + \\ \inf \gamma_{L_1}^+(x_i). \inf \gamma_{L_2}^+(x_i) + \sup \gamma_{L_1}^+(x_i). \sup \gamma_{L_2}^+(x_i) + \\ \inf \alpha_{L_1}^-(x_i). \inf \alpha_{L_2}^-(x_i) + \sup \alpha_{L_1}^-(x_i). \sup \alpha_{L_2}^-(x_i) + \\ \inf \beta_{L_1}^-(x_i). \inf \beta_{L_2}^-(x_i) + \sup \beta_{L_1}^-(x_i). \sup \beta_{L_2}^-(x_i) + \\ \inf \gamma_{L_1}^-(x_i). \inf \gamma_{L_2}^-(x_i) + \sup \gamma_{L_1}^-(x_i). \sup \gamma_{L_2}^-(x_i) \end{array} \right)$$

Definition 3.2: Consider L_1 and L_2 be two IBNSs in $X = \{x_1, x_2, \dots, x_n\}$, then the correlation coefficient between L_1 and L_2 is defined as follows:

$$Cor(L_1, L_2) = \frac{R(L_1, L_2)}{[R(L_1, L_1) \cdot R(L_2, L_2)]^{1/2}} \quad (1)$$

where

$$R(L_1, L_2) = \sum_{i=1}^n \begin{pmatrix} \inf \alpha_{L_1}^+(x_i) \cdot \inf \alpha_{L_2}^+(x_i) + \sup \alpha_{L_1}^+(x_i) \cdot \sup \alpha_{L_2}^+(x_i) + \\ \inf \beta_{L_1}^+(x_i) \cdot \inf \beta_{L_2}^+(x_i) + \sup \beta_{L_1}^+(x_i) \cdot \sup \beta_{L_2}^+(x_i) + \\ \inf \gamma_{L_1}^+(x_i) \cdot \inf \gamma_{L_2}^+(x_i) + \sup \gamma_{L_1}^+(x_i) \cdot \sup \gamma_{L_2}^+(x_i) + \\ \inf \alpha_{L_1}^-(x_i) \cdot \inf \alpha_{L_2}^-(x_i) + \sup \alpha_{L_1}^-(x_i) \cdot \sup \alpha_{L_2}^-(x_i) + \\ \inf \beta_{L_1}^-(x_i) \cdot \inf \beta_{L_2}^-(x_i) + \sup \beta_{L_1}^-(x_i) \cdot \sup \beta_{L_2}^-(x_i) + \\ \inf \gamma_{L_1}^-(x_i) \cdot \inf \gamma_{L_2}^-(x_i) + \sup \gamma_{L_1}^-(x_i) \cdot \sup \gamma_{L_2}^-(x_i) \end{pmatrix}$$

$$R(L_1, L_1) = \sum_{i=1}^n \begin{pmatrix} (\inf \alpha_{L_1}^+(x_i))^2 + (\sup \alpha_{L_1}^+(x_i))^2 + (\inf \beta_{L_1}^+(x_i))^2 + \\ (\sup \beta_{L_1}^+(x_i))^2 + (\inf \gamma_{L_1}^+(x_i))^2 + (\sup \gamma_{L_1}^+(x_i))^2 + \\ (\inf \alpha_{L_1}^-(x_i))^2 + (\sup \alpha_{L_1}^-(x_i))^2 + (\inf \beta_{L_1}^-(x_i))^2 + \\ (\sup \beta_{L_1}^-(x_i))^2 + (\inf \gamma_{L_1}^-(x_i))^2 + (\sup \gamma_{L_1}^-(x_i))^2 \end{pmatrix}$$

$$R(L_2, L_2) = \sum_{i=1}^n \begin{pmatrix} (\inf \alpha_{L_2}^+(x_i))^2 + (\sup \alpha_{L_2}^+(x_i))^2 + (\inf \beta_{L_2}^+(x_i))^2 + \\ (\sup \beta_{L_2}^+(x_i))^2 + (\inf \gamma_{L_2}^+(x_i))^2 + (\sup \gamma_{L_2}^+(x_i))^2 + \\ (\inf \alpha_{L_2}^-(x_i))^2 + (\sup \alpha_{L_2}^-(x_i))^2 + (\inf \beta_{L_2}^-(x_i))^2 + \\ (\sup \beta_{L_2}^-(x_i))^2 + (\inf \gamma_{L_2}^-(x_i))^2 + (\sup \gamma_{L_2}^-(x_i))^2 \end{pmatrix}$$

Theorem 1. The correlation coefficient measure $Cor(L_1, L_2)$ between two IBNSs L_1, L_2 satisfies the following properties:

- (C1) $Cor(L_1, L_2) = Cor(L_2, L_1)$;
- (C2) $0 \leq Cor(L_1, L_2) \leq 1$;
- (C3) $Cor(L_1, L_2) = 1$, if $L_1 = L_2$.

Proof:

$$(1) \quad Cor(L_1, L_2) = \frac{R(L_1, L_2)}{[R(L_1, L_1) \times R(L_2, L_2)]^{1/2}} \\ = \frac{R(L_2, L_1)}{[R(L_2, L_2) \times R(L_1, L_1)]^{1/2}} = Cor(L_2, L_1).$$

(2) Since, $R(L_1, L_2) \geq 0, R(L_1, L_1) \geq 0, R(L_2, L_2) \geq 0$ and using Cauchy-Schwarz inequality we can easily prove that $Cor(L_1, L_2) \leq 1$, therefore, $0 \leq Cor(L_1, L_2) \leq 1$.

(3) If $L_1 = L_2$, then $\inf \alpha_{L_1}^+(x) = \inf \alpha_{L_2}^+(x), \sup \alpha_{L_1}^+(x) = \sup \alpha_{L_2}^+(x), \inf \beta_{L_1}^+(x) = \inf \beta_{L_2}^+(x), \sup \beta_{L_1}^+(x) = \sup \beta_{L_2}^+(x), \inf \gamma_{L_1}^+(x) = \inf \gamma_{L_2}^+(x), \sup \gamma_{L_1}^+(x) = \sup \gamma_{L_2}^+(x), \inf \alpha_{L_1}^-(x) = \inf \alpha_{L_2}^-(x), \sup \alpha_{L_1}^-(x) = \sup \alpha_{L_2}^-(x), \inf \beta_{L_1}^-(x) = \inf \beta_{L_2}^-(x), \sup \beta_{L_1}^-(x) = \sup \beta_{L_2}^-(x), \inf \gamma_{L_1}^-(x) = \inf \gamma_{L_2}^-(x), \sup \gamma_{L_1}^-(x) = \sup \gamma_{L_2}^-(x)$

$\alpha_{L_2}^-(x), \sup \gamma_{L_1}^-(x) = \sup \gamma_{L_2}^-(x)$ for any $x \in X$ and therefore, $Cor(L_1, L_2) = 1$.

Definition 3.3: Let $w_i = (w_1, w_2, \dots, w_n) \in [0, 1]$ be the weight vector of the elements x_j ($j = 1, 2, \dots, n$), the weighted correlation coefficient between two IBNSs L_1, L_2 can be defined by the following formula

$$Cor_w(L_1, L_2) = \frac{R_w(L_1, L_2)}{[R_w(L_1, L_1) \cdot R_w(L_2, L_2)]^{1/2}} \quad (2)$$

where

$$R_w(L_1, L_2) = \sum_{i=1}^n w_i \begin{pmatrix} \inf \alpha_{L_1}^+(x_i) \cdot \inf \alpha_{L_2}^+(x_i) + \sup \alpha_{L_1}^+(x_i) \cdot \sup \alpha_{L_2}^+(x_i) + \\ \inf \beta_{L_1}^+(x_i) \cdot \inf \beta_{L_2}^+(x_i) + \sup \beta_{L_1}^+(x_i) \cdot \sup \beta_{L_2}^+(x_i) + \\ \inf \gamma_{L_1}^+(x_i) \cdot \inf \gamma_{L_2}^+(x_i) + \sup \gamma_{L_1}^+(x_i) \cdot \sup \gamma_{L_2}^+(x_i) + \\ \inf \alpha_{L_1}^-(x_i) \cdot \inf \alpha_{L_2}^-(x_i) + \sup \alpha_{L_1}^-(x_i) \cdot \sup \alpha_{L_2}^-(x_i) + \\ \inf \beta_{L_1}^-(x_i) \cdot \inf \beta_{L_2}^-(x_i) + \sup \beta_{L_1}^-(x_i) \cdot \sup \beta_{L_2}^-(x_i) + \\ \inf \gamma_{L_1}^-(x_i) \cdot \inf \gamma_{L_2}^-(x_i) + \sup \gamma_{L_1}^-(x_i) \cdot \sup \gamma_{L_2}^-(x_i) \end{pmatrix}$$

$$R_w(L_1, L_1) = \sum_{i=1}^n w_i \begin{pmatrix} (\inf \alpha_{L_1}^+(x_i))^2 + (\sup \alpha_{L_1}^+(x_i))^2 + (\inf \beta_{L_1}^+(x_i))^2 + \\ (\sup \beta_{L_1}^+(x_i))^2 + (\inf \gamma_{L_1}^+(x_i))^2 + (\sup \gamma_{L_1}^+(x_i))^2 + \\ (\inf \alpha_{L_1}^-(x_i))^2 + (\sup \alpha_{L_1}^-(x_i))^2 + (\inf \beta_{L_1}^-(x_i))^2 + \\ (\sup \beta_{L_1}^-(x_i))^2 + (\inf \gamma_{L_1}^-(x_i))^2 + (\sup \gamma_{L_1}^-(x_i))^2 \end{pmatrix}$$

$$R_w(L_2, L_2) = \sum_{i=1}^n w_i \begin{pmatrix} (\inf \alpha_{L_2}^+(x_i))^2 + (\sup \alpha_{L_2}^+(x_i))^2 + (\inf \beta_{L_2}^+(x_i))^2 + \\ (\sup \beta_{L_2}^+(x_i))^2 + (\inf \gamma_{L_2}^+(x_i))^2 + (\sup \gamma_{L_2}^+(x_i))^2 + \\ (\inf \alpha_{L_2}^-(x_i))^2 + (\sup \alpha_{L_2}^-(x_i))^2 + (\inf \beta_{L_2}^-(x_i))^2 + \\ (\sup \beta_{L_2}^-(x_i))^2 + (\inf \gamma_{L_2}^-(x_i))^2 + (\sup \gamma_{L_2}^-(x_i))^2 \end{pmatrix}$$

If $w = (1/n, 1/n, \dots, 1/n)^T$, the Eq. (2) is reduced to Eq. (1).

Theorem 2. The weighted correlation coefficient measure $Cor_w(L_1, L_2)$ between two IBNSs L_1, L_2 also satisfies the following properties:

- (C1) $Cor_w(L_1, L_2) = Cor_w(L_2, L_1)$;
- (C2) $0 \leq Cor_w(L_1, L_2) \leq 1$;
- (C3) $Cor_w(L_1, L_2) = 1$, if $L_1 = L_2$.

Proof:

$$(1) \quad Cor_w(L_1, L_2) = \frac{R_w(L_1, L_2)}{[R_w(L_1, L_1) \cdot R_w(L_2, L_2)]^{1/2}} \\ = \frac{R_w(L_2, L_1)}{[R_w(L_2, L_2) \cdot R_w(L_1, L_1)]^{1/2}} = Cor_w(L_2, L_1).$$

(2) Since, $R_w(L_1, L_2) \geq 0, R_w(L_1, L_1) \geq 0, R_w(L_2, L_2) \geq 0$ and using Cauchy-Schwarz inequality we can easily prove that $Cor_w(L_1, L_2) \leq 1$, so, $0 \leq Cor_w(L_1, L_2) \leq 1$.

(3) If $L_1 = L_2$, then $\inf \alpha_{L_1}^+(x) = \inf \alpha_{L_2}^+(x)$, $\sup \alpha_{L_1}^+(x) = \sup \alpha_{L_2}^+(x)$, $\inf \beta_{L_1}^+(x) = \inf \beta_{L_2}^+(x)$, $\sup \beta_{L_1}^+(x) = \sup \beta_{L_2}^+(x)$, $\inf \gamma_{L_1}^+(x) = \inf \gamma_{L_2}^+(x)$, $\sup \gamma_{L_1}^+(x) = \sup \gamma_{L_2}^+(x)$, $\inf \alpha_{L_1}^-(x) = \inf \alpha_{L_2}^-(x)$, $\sup \alpha_{L_1}^-(x) = \sup \alpha_{L_2}^-(x)$, $\inf \beta_{L_1}^-(x) = \inf \beta_{L_2}^-(x)$, $\sup \beta_{L_1}^-(x) = \sup \beta_{L_2}^-(x)$, $\inf \gamma_{L_1}^-(x) = \inf \gamma_{L_2}^-(x)$ for any $x \in X$ and hence, $Cor_w(L_1, L_2) = 1$.

Example 1. Suppose that $L_1 = < [0.3, 0.7], [0.3, 0.8], [0.5, 0.9], [-0.9, -0.3], [-0.6, -0.2], [-0.8, -0.4] >$ and $L_2 = < [0.1, 0.6], [0.2, 0.7], [0.3, 0.5], [-0.8, -0.2], [-0.8, -0.3], [-0.7, -0.4] >$ be two IBNSs, then correlation coefficient between L_1 and L_2 is obtain using Eq. (1) as follows:

$$Cor(L_1, L_2) = 0.4870391.$$

Example 2. If $w = 0.4$, then the weighted correlation coefficient between $L_1 = < [0.3, 0.7], [0.3, 0.8], [0.5, 0.9], [-0.9, -0.3], [-0.6, -0.2], [-0.8, -0.4] >$ and $L_2 = < [0.1, 0.6], [0.2, 0.7], [0.3, 0.5], [-0.8, -0.2], [-0.8, -0.3], [-0.7, -0.4] >$ is calculated by using Eq. (2) as follows.

$$Cor_w(L_1, L_2) = 0.5689123.$$

4. MADM strategy based on weighted correlation coefficient measure in IBNS environment

In this section, we have developed a novel MADM strategy based on weighted correlation coefficient measure in interval bipolar neutrosophic environment. Let, $F = \{F_1, F_2, \dots, F_m\}$, ($m \geq 2$) be a discrete set of m feasible alternatives, $G = \{G_1, G_2, \dots, G_n\}$, ($n \geq 2$) be a set of n predefined attributes and w_j be the weight vector of the attributes such that $0 \leq w_j \leq 1$ and $\sum_{j=1}^n w_j = 1$. The steps for solving MADM problems in IBNS environment are presented as follows.

Step 1. The evaluation of the performance value of alternative F_i ($i = 1, 2, \dots, m$) with regard to the predefined attribute G_j ($j = 1, 2, \dots, n$) provided by the decision maker or expert can be presented in terms of interval bipolar neutrosophic values $q_{ij} = < [\inf \alpha_{ij}^+, \sup \alpha_{ij}^+], [\inf \beta_{ij}^+, \sup \beta_{ij}^+], [\inf \gamma_{ij}^+, \sup \gamma_{ij}^+], [\inf \alpha_{ij}^-, \sup \alpha_{ij}^-], [\inf \beta_{ij}^-, \sup \beta_{ij}^-], [\inf \gamma_{ij}^-, \sup \gamma_{ij}^-] > = < c_{ij}, d_{ij}, e_{ij}, f_{ij}, g_{ij}, h_{ij}, r_{ij}, s_{ij}, t_{ij}, u_{ij}, v_{ij}, w_{ij} >$, $i = 1, 2, \dots, m$; $j = 1, 2, \dots, n$. The interval bipolar neutrosophic decision matrix $[\tilde{R}_{ij}]_{m \times n}$ is presented as given below.

$$[\tilde{R}_{ij}]_{m \times n} = \begin{matrix} & G_1 & G_2 & \dots & G_n \\ \begin{matrix} F_1 \\ F_2 \\ \dots \\ F_m \end{matrix} & \begin{pmatrix} q_{11} & q_{12} & \dots & q_{1n} \\ q_{21} & q_{22} & \dots & q_{2n} \\ \dots & \dots & \dots & \dots \\ q_{m1} & q_{m2} & \dots & q_{mn} \end{pmatrix} \end{matrix}$$

Step 2. The interval bipolar neutrosophic positive ideal solution (IBN-PIS) can be defined as follows: $Q^* = < c_j^+, d_j^+, e_j^+, f_j^+, g_j^+, h_j^+, r_j^+, s_j^+, t_j^+, u_j^+, v_j^+, w_j^+ > = < [\{\underset{i}{\text{Max}}(c_{ij}) | j \in J^+; \underset{i}{\text{Min}}(c_{ij}) | j \in J^-\}, \{\underset{i}{\text{Max}}(d_{ij}) | j \in J^+; \underset{i}{\text{Min}}(d_{ij}) | j \in J^-\}, [\{\underset{i}{\text{Min}}(e_{ij}) | j \in J^+; \underset{i}{\text{Max}}(e_{ij}) | j \in J^-\}, \{\underset{i}{\text{Min}}(f_{ij}) | j \in J^+; \underset{i}{\text{Max}}(f_{ij}) | j \in J^-\}, [\{\underset{i}{\text{Min}}(g_{ij}) | j \in J^+; \underset{i}{\text{Max}}(g_{ij}) | j \in J^-\}, \{\underset{i}{\text{Min}}(h_{ij}) | j \in J^+; \underset{i}{\text{Max}}(h_{ij}) | j \in J^-\}, [\{\underset{i}{\text{Min}}(r_{ij}) | j \in J^+; \underset{i}{\text{Max}}(r_{ij}) | j \in J^-\}, \{\underset{i}{\text{Min}}(s_{ij}) | j \in J^+; \underset{i}{\text{Max}}(s_{ij}) | j \in J^-\}, [\{\underset{i}{\text{Max}}(t_{ij}) | j \in J^+; \underset{i}{\text{Min}}(t_{ij}) | j \in J^-\}, \{\underset{i}{\text{Max}}(u_{ij}) | j \in J^+; \underset{i}{\text{Min}}(u_{ij}) | j \in J^-\}, [\{\underset{i}{\text{Max}}(v_{ij}) | j \in J^+; \underset{i}{\text{Min}}(v_{ij}) | j \in J^-\}, \{\underset{i}{\text{Max}}(w_{ij}) | j \in J^+; \underset{i}{\text{Min}}(w_{ij}) | j \in J^-\}] >$, $j = 1, 2, \dots, n$, where J^+, J^- denote the benefit and cost type attributes, respectively.

Step 3. The weighted correlation coefficient of IBNS between alternative F_i ($i = 1, 2, \dots, m$) and the ideal alternative Q^* can be derived as follows:

$$Cor_w(F_i, Q^*) = \frac{R_w(F_i, Q^*)}{[R_w(F_i, F_i) \cdot R_w(Q^*, Q^*)]^{1/2}}$$

where,

$$R_w(F_i, Q^*) = \sum_{j=1}^n w_j [c_{ij} \cdot c_j^+ + d_{ij} \cdot d_j^+ + e_{ij} \cdot e_j^+ + f_{ij} \cdot f_j^+ + g_{ij} \cdot g_j^+ + h_{ij} \cdot h_j^+ + r_{ij} \cdot r_j^+ + s_{ij} \cdot s_j^+ + t_{ij} \cdot t_j^+ + u_{ij} \cdot u_j^+ + v_{ij} \cdot v_j^+ + w_{ij} \cdot w_j^+]$$

$$R_w(F_i, F_i) = \sum_{j=1}^n w_j [(c_{ij})^2 + (d_{ij})^2 + (e_{ij})^2 + (f_{ij})^2 + (g_{ij})^2 + (h_{ij})^2 + (r_{ij})^2 + (s_{ij})^2 + (t_{ij})^2 + (u_{ij})^2 + (v_{ij})^2 + (w_{ij})^2]$$

$$R_w(Q^*, Q^*) = \sum_{i=1}^n w_j [(c_j^+)^2 + (d_j^+)^2 + (e_j^+)^2 + (f_j^+)^2 + (g_j^+)^2 + (h_j^+)^2 + (r_j^+)^2 + (s_j^+)^2 + (t_j^+)^2 + (u_j^+)^2 + (v_j^+)^2 + (w_j^+)^2]$$

Step 4: The biggest value of $Cor_w(F_i, Q^*)$, $i = 1, 2, \dots, m$ implies F_i , ($i = 1, 2, \dots, m$) is the better alternative.

In Fig 1. we represent the steps for solving MADM problems based on weighted correlation coefficient measure in IBNS environment.

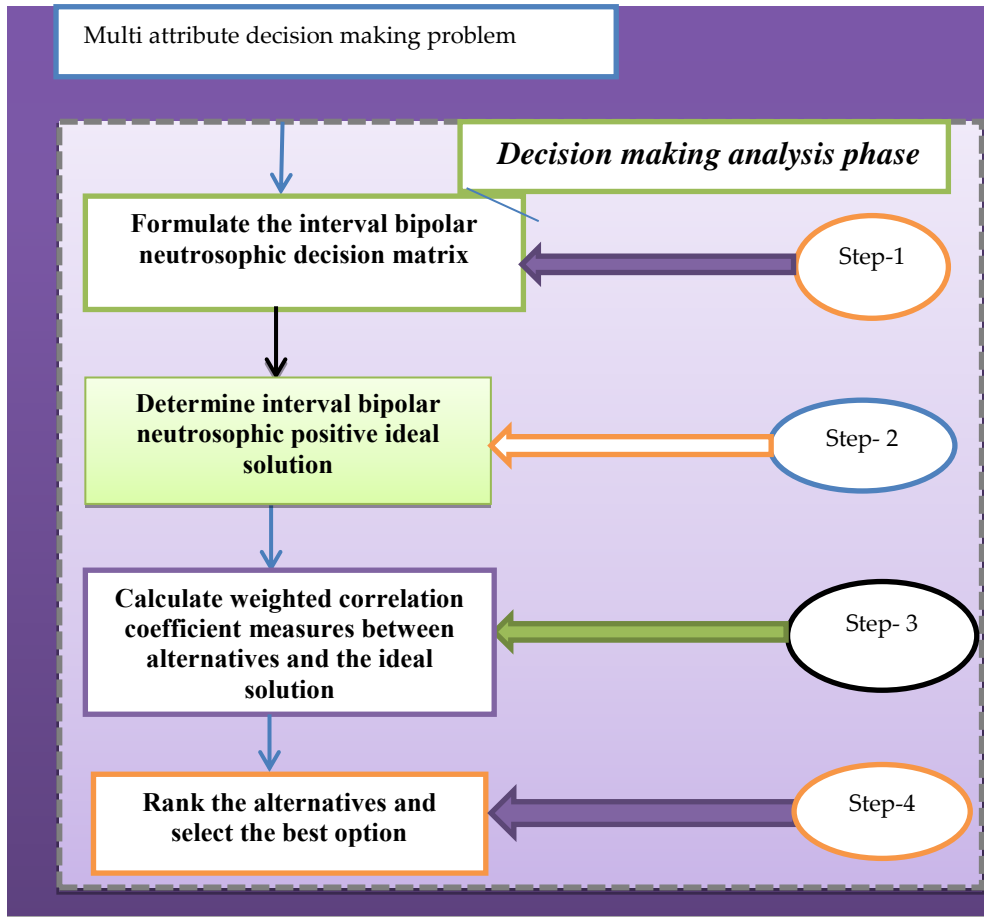

Figure.1 Decision making procedure of proposed MADM strategy

5. Numerical example

In this section, an illustrative numerical problem is solved to illustrate the proposed strategy. We consider an MADM studied in [31, 33] where there are four possible alternatives to invest money namely, a food company (F_1), a car company (F_2), a arm company (F_3), and a computer company (F_4). The investment company must take a decision based on the three predefined attributes namely growth analysis (G_1), risk analysis (G_2), and environment analysis (G_3) where G_1, G_2 are the benefit type and G_3 is the cost type attribute [34] and the weight vector of G_1, G_2 , and G_3 is given by $w = (w_1, w_2, w_3) = (0.35, 0.25, 0.4)$ [31].

The proposed strategy consisting of the following steps:

Step 1. The evaluation of performance value of the alternatives with respect to the attributes provided by the decision maker can be expressed by interval bipolar neutrosophic values and the decision matrix is presented as follows:

Interval bipolar neutrosophic decision matrix

G_1	
F_1	$[[0.4, 0.5], [0.2, 0.3], [0.3, 0.4], [-0.3, -0.2], [-0.4, -0.3], [-0.5, -0.4]]$
F_2	$[[0.6, 0.7], [0.1, 0.2], [0.2, 0.3], [-0.2, -0.1], [-0.3, -0.2], [-0.7, -0.6]]$
F_3	$[[0.3, 0.6], [0.2, 0.3], [0.3, 0.4], [-0.3, -0.2], [-0.4, -0.3], [-0.6, -0.3]]$
F_4	$[[0.7, 0.8], [0.0, 0.1], [0.1, 0.2], [-0.1, -0.0], [-0.2, -0.1], [-0.8, -0.7]]$

G_2	
F_1	$[[0.4, 0.6], [0.1, 0.3], [0.2, 0.4], [-0.3, -0.1], [-0.4, -0.2], [-0.6, -0.4]]$
F_2	$[[0.6, 0.7], [0.1, 0.2], [0.2, 0.3], [-0.2, -0.1], [-0.3, -0.2], [-0.7, -0.6]]$
F_3	$[[0.5, 0.6], [0.2, 0.3], [0.3, 0.4], [-0.3, -0.2], [-0.4, -0.3], [-0.6, -0.5]]$
F_4	$[[0.6, 0.7], [0.1, 0.2], [0.1, 0.3], [-0.2, -0.1], [-0.3, -0.1], [-0.7, -0.6]]$

G_3

$$\begin{pmatrix} F_1 & [[0.7, 0.9], [0.2, 0.3], [0.4, 0.5], [-0.3, -0.2], [-0.5, -0.4], [-0.9, -0.7]] \\ F_2 & [[0.3, 0.6], [0.3, 0.5], [0.8, 0.9], [-0.5, -0.3], [-0.9, -0.8], [-0.6, -0.3]] \\ F_3 & [[0.4, 0.5], [0.2, 0.4], [0.7, 0.9], [-0.4, -0.2], [-0.9, -0.7], [-0.5, -0.4]] \\ F_4 & [[0.6, 0.7], [0.3, 0.4], [0.8, 0.9], [-0.4, -0.3], [-0.9, -0.8], [-0.7, -0.6]] \end{pmatrix}$$

Step 2. Determine the IBN-PIS (Q^*) from interval bipolar neutrosophic decision matrix as follows:

$$\langle [c_1^+, d_1^+], [e_1^+, f_1^+], [g_1^+, h_1^+], [r_1^-, s_1^-], [t_1^-, u_1^-], [v_1^-, w_1^-] \rangle = < [0.7, 0.8], [0.0, 0.1], [0.1, 0.2], [-0.3, -0.2], [-0.2, -0.1], [-0.5, -0.3];$$

$$\langle [c_2^+, d_2^+], [e_2^+, f_2^+], [g_2^+, h_2^+], [r_2^-, s_2^-], [t_2^-, u_2^-], [v_2^-, w_2^-] \rangle = < [0.6, 0.7], [0.1, 0.2], [0.1, 0.3], [-0.3, -0.2], [-0.3, -0.1], [-0.6, -0.4];$$

$$\langle [c_3^+, d_3^+], [e_3^+, f_3^+], [g_3^+, h_3^+], [r_3^-, s_3^-], [t_3^-, u_3^-], [v_3^-, w_3^-] \rangle = < [0.3, 0.5], [0.3, 0.5], [0.8, 0.9], [-0.3, -0.2], [-0.9, -0.8], [-0.9, -0.7].$$

Step 3. The weighted correlation coefficient $Cor_w(F_i, Q^*)$ between alternative F_i ($i = 1, 2, \dots, m$) and IBN-PIS Q^* is obtained as given below.

$$R_w(F_1, Q^*) = 2.4465, R_w(F_1, F_1) = 2.585351, R_w(Q^*, Q^*) = 2.850693, Cor_w(F_1, Q^*) = 0.331952,$$

$$R_w(F_2, Q^*) = 2.9205, R_w(F_2, F_2) = 2.905408, Cor_w(F_2, Q^*) = 0.3526141,$$

$$R_w(F_3, Q^*) = 2.6625, R_w(F_3, F_3) = 2.701919, Cor_w(F_3, Q^*) = 0.3456741,$$

$$R_w(F_4, Q^*) = 3.098, R_w(F_4, F_4) = 3.048081, Cor_w(F_4, Q^*) = 0.3565369.$$

We observe that $Cor_w(F_4, Q^*) > Cor_w(F_2, Q^*) > Cor_w(F_3, Q^*) > Cor_w(F_1, Q^*)$.

Step 4. According to the weighted correlation coefficient values, the ranking order of the companies is presented as:

$$F_4 > F_2 > F_3 > F_1.$$

Hence, the most desirable investment company is F_4 .

In Fig 2. we represent the graphical representation of alternatives versus weighted correlation coefficient values.

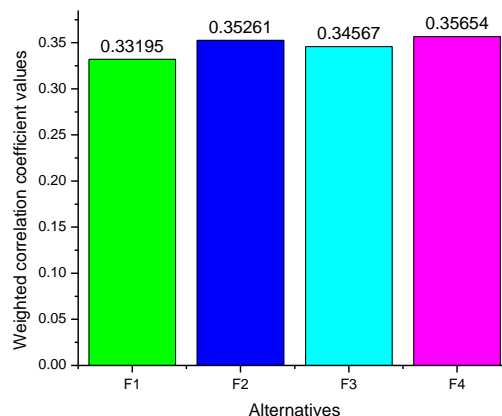

Fig 2. Graphical representation of alternatives versus weighted correlation coefficient values.

Next, we compare the obtained results with the results of Mahmood et al. [31] and Pramanik et al. [33] in Table 1 where the weight vector of the attributes is $w = (0.35, 0.25, 0.4)$ [31]. We see that ranking orders of alternatives derived by the proposed strategy and the strategies discussed by Mahmood et al. [31] and Pramanik et al. [33] are different. We also observe that F_4 is the best option obtained by the proposed strategy as well as the strategy discussed by Mahmood et al. [31]. However, Pramanik et al. [33] found that F_2 is the most desirable alternative based on weighted cross entropy measure.

Table 1. The results derived from different strategies

strategy	Ranking results	Best choice
The proposed weighted correlation coefficient strategy	$F_4 \succ F_2 \succ F_3 \succ F_1$	F_4
Mahmood et al.'s strategy [31]	$F_4 \succ F_1 \succ F_3 \succ F_2$	F_4
Weighted cross entropy measure [33]	$F_1 \prec F_3 \prec F_4 \prec F_2$	F_2

6 Conclusion

In the study, we have defined correlation coefficient and weighted correlation coefficient measures in interval bipolar neutrosophic environments and prove their basic properties. Using the proposed weighted correlation coefficient measure, we have developed a novel MADM strategy in interval bipolar neutrosophic environment. We have solved an investment problem with interval bipolar neutrosophic information. Comparison analysis with other existing strategies is presented to demonstrate the feasibility and applicability of the proposed strategy. We hope that the proposed correlation coefficient measures can be employed to tackle realistic multi attribute decision making problems such as clustering analysis [15], medical diagnosis [21], weaver selection [35-37], fault diagnosis [38], brick selection [39- 40], data mining [41], logistic centre location selection [42- 43], school selection [44], teacher selection [45-47], image processing, information fusion, etc. in interval bipolar neutrosophic environment. Using aggregation operators, the proposed strategy can be extended to multi attribute group decision making problem in interval bipolar neutrosophic set environment.

References

1. F. Smarandache. A unifying field in logics: Neutrosophic logic. Neutrosophy, neutrosophic set, neutrosophic probability, and neutrosophic statistics. American Research Press, Rehoboth, 1998.
2. I. M. Hanafy, A. A. Salama, and K. M. Hahfouz. Correlation of neutrosophic data. *International Refereed Journal of Engineering and Science*, 1(2) (2012), 39-43.
3. I. M. Hanafy, A. A. Salama, and K. M. Hahfouz. Correlation coefficients of neutrosophic sets by centroid method. *International Journal of Probability and Statistics*, 2(1) (2013), 9-12.
4. J. Ye. Multicriteria decision-making method using the correlation coefficient under single-valued neutrosophic environment. *International Journal of General Systems*, 42(4) (2013), 386-394.
5. H. Wang, F. Smarandache, Y. Q. Zhang, and R. Sundaraman. Single valued neutrosophic sets. *Multispace and Multistructure*, 4 (2010), 410-413.
6. S. Broumi, and F. Smarandache. Correlation coefficient of interval neutrosophic set. *Applied Mechanics and Materials*, 436 (2013), 511-517.
7. H. Wang, F. Smarandache, Y. Q. Zhang, and R. Sundaraman. Interval neutrosophic sets and logic: theory and applications in computing. Hexis, Arizona, 2005.
8. I. M. Hanafy, A. A. Salama, O. M. Khaled, and K. M. Hahfouz. Correlation of neutrosophic sets in probability spaces. *Journal of Applied Mathematics, Statistics and Informatics*, 10(1) (2014), 45-62.
9. J. Ye. Improved correlation coefficients of single value neutrosophic sets and interval neutrosophic sets for multiple attribute decision making. *Journal of Intelligent and Fuzzy Systems*, 27(5), (2014), 2453-2462.
10. S. Broumi, and I. Deli. Correlation measure for neutrosophic refined sets and its application medical diagnosis. *Palestine Journal of Mathematics*, 3(1) (2014), 11-19.
11. F. Smarandache. n – Valued refined neutrosophic logic and its application in physics. *Progress in Physics*, 4 (2013), 143-146.
12. P. Rajarajeswari, and N. Uma. Correlation measure for intuitionistic fuzzy multi sets. *International Journal of Research in Engineering and Technology*, 3(1) (2014), 611-617.
13. H. Zhang, P. Ji, J. Wang, and X. Chen. An improved weighted correlation coefficient based on integrated weight for interval neutrosophic sets and its application in multi-criteria decision making problems. *International Journal of Computational Intelligence Systems*, 8(6) (2015). doi: 10.1080/18756891.2015.1099917.
14. F. Karaaslan. Correlation coefficient between possibility neutrosophic soft sets. *Mathematics Science Letters*, 5(1) (2016), 71-74.
15. F. Karaaslan. Correlation coefficient of single-valued neutrosophic refined soft sets and their applications in clustering analysis. *Neural Computing and Applications*, (2016). doi: 10.1007/s00521-016-2209-8.
16. R. Şahin, and P. Liu. Correlation coefficient of single-valued neutrosophic hesitant fuzzy sets and their applications in decision making. *Neural Computing and Applications*, 28(6) (2017), 1387-1395.
17. C. Liu, and Y. Luo. Correlation coefficient for the interval-valued neutrosophic hesitant fuzzy sets and its use in multiple-attribute decision making. In *3rd International Conference on Engineering Technology and Application, (ICETA 2016)*, (2016), 222-227.
18. P. D. Liu, and L. L. Shi. The generalized hybrid weighted average operator based on interval neutrosophic hesitant set and its application to multiple attribute decision making. *Neural Computing and Applications*, 26 (2015), 457-471.
19. J. Ye. Correlation coefficient between dynamic single valued neutrosophic multisets and its multiple attribute decision-making method. *Information*, 8 (2017), 1-9. doi: 10.3390/info8020041.
20. J. Ye. Multiple attribute decision making method using correlation coefficients of normal neutrosophic sets. *Symmetry*, 9 (2017), 1-10. doi.: 10.3390/sym9060080.
21. S. Pramanik, R. Roy, T. K. Roy, and F. Smarandache. Multi criteria decision making using correlation coefficient under rough neutrosophic environment. *Neutrosophic Sets and Systems*, 17 (2017), 29-36. doi: 10.5281/zenodo.1012237.
22. I. Deli, M. Ali, and F. Smarandache, Bipolar neutrosophic sets and their application based on multi-criteria decision making problems. In *International conference on advanced mechatronic systems (ICAMechS)* (IEEE, August, 2015), 249-254.
23. W. R. Zhang, Bipolar fuzzy sets and relations: a computational framework for cognitive modeling and multiagent decision analysis. In *Proc. of IEEE Conf.* (1994), 305-309. doi 10.1109/IJCF.1994.375115.
24. W. R. Zhang. Bipolar fuzzy sets, in *Proc. of the IEEE World Congress on Computational Science (FuzzIEEE)* (Anchor-age, Alaska, 1998), 835-840. doi:10.1109/FUZZY.1998.687599.

25. D. Ezhilmaran, and K. Shankar. Morphism of bipolar intuitionistic fuzzy graphs. *Journal of Discrete Mathematical Sciences and Cryptography*, 18 (5) (2015), 605-621.
26. P. P. Dey, S. Pramanik, and B.C. Giri. TOPSIS for solving multi-attribute decision making problems under bi-polar neutrosophic environment. In F. Smarandache, & S. Pramanik (Eds.), *New Trends in Neutrosophic Theory and Applications*. Pons Edition, Brussels, 2016, 65-77.
27. I. Deli, and Y. A. Subas. Multiple criteria decision making method on single valued bipolar neutrosophic set based on correlation coefficient similarity measure. In *International Conference on mathematics and mathematics education (ICMME-2016)*, Frat University, Elazg, Turkey, 12-14 May 2016.
28. M. Şahin, I. Deli, and V. Uluçay, Jaccard vector similarity measure of bipolar neutrosophic set based on multi-criteria decision making. In *International Conference on Natural Science and Engineering (ICNASE'16)*, Killis, 19-20 March 2016.
29. V. Uluçay, I. Deli, and M.Şahin, Similarity measures of bipolar neutrosophic sets and their application to multiple criteria decision making. *Neural Computing & Applications*, (2016). doi:10.1007/s00521-016-2479-1.
30. S. Pramanik, P. P. Dey, B. C. Giri, and F. Smarandache. Bipolar neutrosophic projection based models for solving multi-attribute decision making problems. *Neutrosophic Sets and Systems*, 15 (2017), 74-83.
31. T. Mahmood, J. Ye, and Q. Khan, Bipolar interval neutrosophic set and its application in multicriteria decision making. <https://archive.org/details/BipolarIntervalNeutrosophicSet> et. Retrieved on October 9, 2017.
32. I. Deli, Y. A. Subas, F. Smarandache, and M. Ali. Interval valued bipolar neutrosophic sets and their application in pattern recognition. <https://www.researchgate.net/publication/289587637>. Retrieved on October 9, 2017.
33. S. Pramanik, P. P. Dey, F. Smarandache, and J. Ye. Cross entropy measures of bipolar and interval bipolar neutrosophic sets and their application for multi-attribute decision making. *Axioms*, 7 (2018), 1-24. doi: 10.3390/axioms7020021.
34. J. Ye. Similarity measures between interval neutrosophic sets and their applications in multicriteria decision-making. *Journal of Intelligent and Fuzzy Systems*, 26 (1) (2014), 165-172. doi: 10.3233/IFS-120724.
35. P. P. Dey, S. Pramanik, and B. C. Giri. Multi-criteria group decision making in intuitionistic fuzzy environment based on grey relational analysis for weaver selection in khadi institution. *Journal of Applied and Quantitative Methods*, 10 (4) (2015), 1-14.
36. P. P. Dey, S. Pramanik, and B. C. Giri. An extended grey relational analysis based interval neutrosophic multi-attribute decision making for weaver selection. *Journal of New Theory*, (9) (2015), 82-93.
37. P. P. Dey, S. Pramanik, and B.C. Giri. Extended projection based models for solving multiple attribute decision making problems with interval valued neutrosophic information. In F. Smarandache, & S. Pramanik (Eds.), *New Trends in Neutrosophic Theory and Applications*. Pons Edition, Brussels, 2016, 127-140.
38. L. Shi. Correlation coefficient of simplified neutrosophic sets for bearing fault diagnosis. *Shock and Vibration*, 2016 (2016), Article ID 5414361. doi: 10.1155/2016/5414361.
39. K. Mondal, S. Pramanik, and F. Smarandache. Intuitionistic fuzzy multi-criteria group decision making approach to quality-brick selection problem. *Journal of Applied and Quantitative Methods*, 9(2) (2014), 35-50.
40. K. Mondal, and S. Pramanik. Neutrosophic decision making model for clay-brick selection in construction field based on grey relational analysis. *Neutrosophic Sets and Systems*, 9 (2015), 72-79.
41. K. Mondal, S. Pramanik, and F. Smarandache. Role of neutrosophic logic in data mining. In F. Smarandache, & S. Pramanik (Eds.), *New Trends in Neutrosophic Theory and Application*. Pons Editions, Brussels, 2016, 15-23.
42. S. Pramanik, S. Dalapati, and T. K. Roy. Logistics center location selection approach based on neutrosophic multi-criteria decision making, In F. Smarandache, & S. Pramanik (Eds.), *New Trends in Neutrosophic Theory and Application*. Pons Editions, Brussels, 2016, 161-174.
43. S. Pramanik, S. Dalapati, and T. K. Roy. Neutrosophic multi-attribute group decision making strategy for logistic center location selection. In F. Smarandache, M. A. Basset & V. Chang (Eds.), *Neutrosophic Operational Research*, Vol. III. Pons Asbl, Brussels, 2018, 13-32.
44. K. Mondal, and S. Pramanik. Neutrosophic decision making model of school choice. *Neutrosophic Sets and Systems*, 7 (2015), 62-68.
45. S. Pramanik, P. P. Dey, and B. C. Giri. TOPSIS for single valued neutrosophic soft expert set based multi-attribute decision making problems. *Neutrosophic Sets and Systems*, 10 (2015), 88-95.
46. K. Mondal, and S. Pramanik. Multi-criteria group decision making approach for teacher recruitment in higher education under simplified neutrosophic environment. *Neutrosophic Sets and Systems*, 6 (2014), 28-34.
47. S. Pramanik, and D. Mukhopadhyaya. Grey relational analysis based intuitionistic fuzzy multi criteria group decision-making approach for teacher selection in higher education. *International Journal of Computer Applications*, 34(10) (2011), 21-29.
48. Abdel-Basset, M., Mohamed, M., Zhou, Y., & Hezam, I. (2017). Multi-criteria group decision making based on neutrosophic analytic hierarchy process. *Journal of Intelligent & Fuzzy Systems*, 33(6), 4055-4066.

Divergence Measure of Neutrosophic Sets and Applications

Nguyen Xuan Thao, Florentin Smarandache

Nguyen Xuan Thao, Florentin Smarandache (2018). Divergence Measure of Neutrosophic Sets and Applications. *Neutrosophic Sets and Systems* 21: 142-152

Abstract: In this paper, we first propose the concept of divergence measure on neutrosophic sets. We also provide some formulas for the divergence measure for neutrosophic sets. After that, we investigate the properties of proposed neutrosophic divergence measure. Finally, we also apply these formulas in medical problem and the classification problem.

Keywords: neutrosophic set, divergence measure, classification problem.

1 Introduction

The neutrosophic set [25] was first introduced by Smarandache as an extension of intuitionistic fuzzy set [1] and fuzzy set [36]. It is a useful mathematical tool for dealing with ambiguous and inaccurate problems [4-6, 10, 24, 26-35, 37]. So far, many theoretical and applied results have been exploited on neutrosophic sets as the similarity/distance measures of neutrosophic sets [7-9, 11, 17-19, 22]. Neutrosophic set is applied in the multi-criteria decision making (MCDM) problem [4-6, 10-16, 23]. A special case of neutrosophic set is Single valued neutrosophic set (SVNS) which introduced by Wang et al [29]. In 2014, Ye proposed distance-based similarity measures of single valued neutrosophic sets and their multiple attribute group decision making method [32]. In 2017, Ye studied cotangent similarity measures for single-valued neutrosophic sets and applied it in the MCDM problem and in the fault diagnosis of steam turbine [34].

In the study of the applications of fuzzy set theory, the measurements are focused heavily on research. Measurements are often used to measure the degree of similarity or dissimilarity between objects. One of the dissimilarity measures of fuzzy sets/intuitionistic fuzzy sets was recently investigated by investigators as a measure of the divergence of fuzzy sets [3, 12, 20, 21]. Divergence measures also have many applications in practical problem classes and give us interesting results [3, 12, 20, 21]. Some authors have applied divergence measure to determine the relationship between the patient and the treatment regimen based on symptoms, thereby selecting the most appropriate treatment regimen for each patient [3]. Divergence measure is also used in multi-criterion decision problems [3, 12, 20, 21].

In this paper, we introduce the concept of divergence measure of neutrosophic sets, called neutrosophic divergence measure. We also give some expressions that define the neutrosophic divergence measures. After that, we investigate the properties of them. Finally, we use these neutrosophic divergence measure to identify appropriate treatment regimens for each patient and use them in the sample recognition problem.

The article is organized as follows: In section 2, we recall the knowledge related to neutrosophic sets. In section 3, we introduce the concept of neutrosophic divergence measure and investigate their properties. We show some applications of neutrosophic divergence measures in section 4. In section 5, we give conclusion on neutrosophic divergence measure and its some development direction.

2 Preliminary

Definition 1. Neutrosophic set (NS) [28]:

$$A = \{(x, T_A(x), I_A(x), F_A(x)) \mid x \in U\} \tag{1}$$

where $T_A(x) \in [0,1]$ is a trust membership function, $I_A(x) \in [0,1]$ is indeterminacy membership function, $F_A(x) \in [0,1]$ is falsity-membership function of A .

We denote $NS(U)$ is a collection of neutrosophic set on U . In which

$$U = \{(u, 1, 1, 0) \mid u \in U\}$$

and

$$\emptyset = \{(u, 0, 0, 1) \mid u \in U\}$$

For two set $A, B \in NS(U)$ we have:

- Union of A and B :

$$A \cup B = \{(x, T_{A \cup B}(x), I_{A \cup B}(x), F_{A \cup B}(x))\}$$

where

$$T_{A \cup B}(x) = \max(T_A(x), T_B(x)),$$

$$I_{A \cup B}(x) = \min(I_A(x), I_B(x))$$

and

$$F_{A \cup B}(x) = \min(F_A(x), F_B(x))$$

for all $x \in X$.

- Intersection of A and B :

$$A \cap B = \{(x, T_{A \cap B}(x), I_{A \cap B}(x), F_{A \cap B}(x))\}$$

where

$$T_{A \cap B}(x) = \min(T_A(x), T_B(x)),$$

$$I_{A \cap B}(x) = \max(I_A(x), I_B(x))$$

and

$$F_{A \cap B}(x) = \max(F_A(x), F_B(x))$$

for all $x \in X$.

- Subset: $A \subseteq B$ if only if

$$T_A(x) \leq T_B(x), I_A(x) \geq I_B(x), F_A(x) \geq F_B(x)$$

for all $x \in X$.

- Equal set: $A = B$ if only if $A \subseteq B$ and $B \subseteq A$.

- Complement of A :

$$A^C = \{(x, F_A(x), 1 - I_A(x), T_A(x)) \mid x \in U\}$$

3 Divergence measures of neutrosophic sets

Definition 2. Let A and B be two neutrosophic sets on U . A function $D : NS(U) \times NS(U) \rightarrow R$ is a divergence measure of neutrosophic sets if it satisfies the following conditions:

Div1. $D(A, B) = D(B, A),$

Div2. $D(A, B) = 0$ iff $A = B$

Div3. $D(A \cap C, B \cap C) \leq D(A, B)$ for all $C \in NS(U)$,

Div4. $D(A \cup C, B \cup C) \leq D(A, B)$ for all $C \in NS(U)$.

We can easily verify that the divergence measures of neutrosophic sets are non-negative. Because, if we choose $C = \emptyset$ then conditions Div2 and Div3 in definition 2, then we have

$$D(A, B) \geq D(A \cap C, B \cap C) = D(\emptyset, \emptyset) = 0.$$

Now we give some divergence measures of Neutrosophic sets and their properties.

Definition 3. Let A and B be two neutrosophic sets on $U = \{u_1, u_2, \dots, u_n\}$. A function $D : NS(U) \times NS(U) \rightarrow R$ is defined as follows

$$D(A, B) = \frac{1}{n} \sum_{i=1}^n [D_T^i(A, B) + D_I^i(A, B) + D_F^i(A, B)] \tag{2}$$

where

$$D_T^i(A, B) = T_A(u_i) \ln \frac{2T_A(u_i)}{T_A(u_i) + T_B(u_i)} + T_B(u_i) \ln \frac{2T_B(u_i)}{T_A(u_i) + T_B(u_i)} \tag{3}$$

$$D_I^i(A, B) = I_A(u_i) \ln \frac{2I_A(u_i)}{I_A(u_i) + I_B(u_i)} + I_B(u_i) \ln \frac{2I_B(u_i)}{I_A(u_i) + I_B(u_i)} \tag{4}$$

and

$$D_F^i(A, B) = F_A(u_i) \ln \frac{2F_A(u_i)}{F_A(u_i) + F_B(u_i)} + F_B(u_i) \ln \frac{2F_B(u_i)}{F_A(u_i) + F_B(u_i)}. \tag{5}$$

To proof that $D(A, B)$ is a divergence measure of neutrosophic sets we need some following lemma.

Lemma 1. Given $a \in (0, 1]$. For all $z \in [0, 1 - a]$ then

$$f(z) = a \ln 2a + (a + z) \ln(2a + 2z) - (2a + z) \ln(2a + z) \tag{6}$$

is a non-decreasing function and $f(z) \geq 0$.

Proof.

We obtain $\frac{\partial f(z)}{\partial z} = \ln(2a + 2z) - \ln(2a + z) \geq 0$ for all $z \in [0, 1 - a]$. \square

Lemma 2. Given $b \in (0, 1]$. For all $z \in (0, b]$ then

$$f(z) = b \ln 2b + z \ln 2z - (b + z) \ln(b + z) \tag{7}$$

is a non-increasing function and $f(z) \geq 0$.

Proof.

We have $\frac{\partial f(z)}{\partial z} = \ln 2z - \ln(b + z) \leq 0$ for all $z \in (0, b]$. \square

Lemma 3. Given $a \in (0, 1]$. For all $z \in [a, 1]$ then

$$f(z) = a \ln 2a - (a + z) \ln(a + z) + z \ln 2z \tag{8}$$

is a non-decreasing function and $f(z) \geq 0$.

Proof.

We have $\frac{\partial f(z)}{\partial z} = \ln 2z - \ln(a + z) \geq 0$ for all $z \in [a, 1]$. \square

Theorem 1. The function $D(A, B)$ defined by eq (2, 3, 4, 5) (in definition 3) is a divergence measure of two Neutrosophic sets.

Proof.

We check the conditions of the definition. For two Neutrosophic sets A and B on U , we have:

- Div1: $D(A, B) = D(B, A)$,
- Div2:

+ If $A = B$ we have $D_T^i(A, B) = D_I^i(A, B) = D_F^i(A, B) = 0$. So that $D(A, B) = 0$.

+ Assume that

$$D(A, B) = \frac{1}{n} \sum_{i=1}^n [D_T^i(A, B) + D_I^i(A, B) + D_F^i(A, B)] = 0$$

For each $u_i \in U$ we have $T_A(u_i) \leq T_B(u_i)$ (or $T_A(u_i) \leq T_B(u_i)$). So that, using Lemma 1 with $a = T_A(u_i), z = T_B(u_i) - T_A(u_i)$ (if $T_A(u_i) \leq T_B(u_i)$) we have

$$\begin{aligned} f(z) &= a \ln 2a + (a+z) \ln(2a+2z) - (2a+z) \ln(2a+z) \\ &= a \ln \frac{2a}{2a+z} + (a+z) \ln \frac{2(a+z)}{2a+z} \geq 0 \end{aligned}$$

We obtain

$$D_T^i(A, B) = T_A(u_i) \ln \frac{2T_A(u_i)}{T_A(u_i) + T_B(u_i)} + T_B(u_i) \ln \frac{2T_B(u_i)}{T_A(u_i) + T_B(u_i)} \geq 0$$

and $D_T^i(A, B) = 0$ if only if $z = T_B(u_i) - T_A(u_i) = 0$ i.e. $T_B(u_i) = T_A(u_i)$.

By same way, we also obtain $D_I^i(A, B) \geq 0$ and $D_I^i(A, B) = 0$ if only if $I_B(u_i) = I_A(u_i)$; $D_F^i(A, B) \geq 0$ and $D_F^i(A, B) = 0$ if only if $F_B(u_i) = F_A(u_i)$. Those imply that $D(A, B) = 0$ if only if $A = B$.

- Div3. For all $C \in NS(U)$ and for all $u_i \in U, (i = 1, 2, \dots, n)$. Because of the symmetry of divergence measures, we can consider the following cases:
- With falsity-membership function we have:

+ If $T_A(u_i) \leq T_B(u_i) \leq T_C(u_i)$ then $T_{A \cap C}(u_i) = T_A(u_i)$ and $T_{B \cap C}(u_i) = T_B(u_i)$ so that

$$\begin{aligned} &D_T^i(A \cap C, B \cap C) \\ &= T_{A \cap C}(u_i) \ln \frac{2T_{A \cap C}(u_i)}{T_{A \cap C}(u_i) + T_{B \cap C}(u_i)} + T_{B \cap C}(u_i) \ln \frac{2T_{B \cap C}(u_i)}{T_{A \cap C}(u_i) + T_{B \cap C}(u_i)} \\ &= T_A(u_i) \ln \frac{2T_A(u_i)}{T_A(u_i) + T_B(u_i)} + T_B(u_i) \ln \frac{2T_B(u_i)}{T_A(u_i) + T_B(u_i)} \\ &= D_T^i(A, B) \end{aligned}$$

+ If $T_A(u_i) \leq T_C(u_i) \leq T_B(u_i)$ then $T_{A \cup C}(u_i) = T_C(u_i)$ and $T_{B \cup C}(u_i) = T_B(u_i)$. So that, according the lemma 3 with $a = T_A(u_i)$, we have

$$\begin{aligned} &D_T^i(A \cap C, B \cap C) \\ &= T_A(u_i) \ln \frac{2T_A(u_i)}{T_A(u_i) + T_C(u_i)} + T_C(u_i) \ln \frac{2T_C(u_i)}{T_A(u_i) + T_C(u_i)} \end{aligned}$$

$$\leq T_A(u_i) \ln \frac{2T_A(u_i)}{T_A(u_i) + T_B(u_i)} + T_C(u_i) \ln \frac{2T_B(u_i)}{T_A(u_i) + T_B(u_i)}$$

$$= D_T^i(A, B)$$

+ If $T_C(u_i) \leq T_A(u_i) \leq T_B(u_i)$ then $T_{A \cap C}(u_i) = T_{B \cap C}(u_i) = T_C(u_i)$ and $T_B(u_i) = T_C(u_i) + z$ with $z \in [0, 1 - T_A(u_i)]$ so that according the lemma 1 we have

$$D_T^i(A \cap C, B \cap C)$$

$$= T_C(u_i) \ln \frac{2T_C(u_i)}{T_C(u_i) + T_C(u_i)} + T_C(u_i) \ln \frac{2T_C(u_i)}{T_C(u_i) + T_C(u_i)} = 0$$

$$\leq T_A(u_i) \ln \frac{2T_A(u_i)}{2T_A(u_i) + z} + T_B(u_i) \ln \frac{2T_A(u_i) + 2z}{2T_A(u_i) + z}$$

$$= T_A(u_i) \ln \frac{2T_A(u_i)}{T_A(u_i) + T_B(u_i)} + T_B(u_i) \ln \frac{2T_B(u_i)}{T_A(u_i) + T_B(u_i)}$$

$$= D_T^i(A, B).$$

- With indeterminacy membership function: we prove similarly to the case of falsity-membership function.

- With falsity membership function, we have:

+ If $F_A(u_i) \leq F_B(u_i) \leq F_C(u_i)$ then $F_{A \cap C}(u_i) = F_C(u_i)$ and $F_{B \cap C}(u_i) = F_C(u_i)$ so that according lemma 1 we have

$$D_F^i(A \cap C, B \cap C)$$

$$= F_{A \cap C}(u_i) \ln \frac{2F_{A \cap C}(u_i)}{F_{A \cap C}(u_i) + F_{B \cap C}(u_i)} + F_{B \cap C}(u_i) \ln \frac{2F_{B \cap C}(u_i)}{F_{A \cap C}(u_i) + F_{B \cap C}(u_i)}$$

$$= F_C(u_i) \ln \frac{2F_C(u_i)}{F_C(u_i) + F_C(u_i)} + F_C(u_i) \ln \frac{2F_C(u_i)}{F_C(u_i) + F_C(u_i)} = 0$$

$$\leq F_A(u_i) \ln \frac{2F_B(u_i)}{F_A(u_i) + F_B(u_i)} + F_B(u_i) \ln \frac{2F_B(u_i)}{F_A(u_i) + F_B(u_i)}$$

$$= D_F^i(A, B)$$

+ If $F_A(u_i) \leq F_C(u_i) \leq F_B(u_i)$ then $F_{A \cup C}(u_i) = F_C(u_i)$ and $F_{B \cup C}(u_i) = F_B(u_i)$. So that, according the lemma 2 with $b = F_B(u_i)$ we have

$$D_F^i(A \cap C, B \cap C)$$

$$= F_C(u_i) \ln \frac{2F_C(u_i)}{F_C(u_i) + F_B(u_i)} + F_B(u_i) \ln \frac{2F_B(u_i)}{F_C(u_i) + F_B(u_i)}$$

$$\leq F_A(u_i) \ln \frac{2F_A(u_i)}{F_A(u_i) + F_B(u_i)} + F_B(u_i) \ln \frac{2F_B(u_i)}{F_A(u_i) + F_B(u_i)}$$

$$= D_F^i(A, B).$$

+ If $F_C(u_i) \leq F_A(u_i) \leq F_B(u_i)$ then according the lemma 1 we have

$$D_F^i(A \cap C, B \cap C)$$

$$= F_A(u_i) \ln \frac{2F_A(u_i)}{F_A(u_i) + F_B(u_i)} + F_B(u_i) \ln \frac{2F_B(u_i)}{F_A(u_i) + F_B(u_i)}$$

$$= D_F^i(A, B).$$

Now, we add that with respect to the respective components we have

$$\begin{aligned} & D(A \cap C, B \cap C) \\ &= \frac{1}{n} \sum_{i=1}^n [D_T^i(A \cap C, B \cap C) + D_I^i(A \cap C, B \cap C) + D_F^i(A \cap C, B \cap C)] \\ &\leq \frac{1}{n} \sum_{i=1}^n [D_T^i(A, B) + D_I^i(A, B) + D_F^i(A, B)] \\ &= D(A, B) \end{aligned}$$

- Div4. We perform as Div 3. □

Now we consider some properties of the divergence measures defined in definition 3.

Theorem 2. For all Neutrosophic set $A, B \in PFS(U)$. We have

(D1) For all $A \subseteq B$, or $B \subseteq A$ we have

$$D(A \cap B, B) = D(A, A \cup B) \leq D(A, B),$$

(D2) $D(A \cap B, A \cup B) = D(A, B)$,

(D3) For all $A \subseteq B \subseteq C$ we have

$$D(A, B) \leq D(A, C),$$

(D4) For all $A \subseteq B \subseteq C$ we have

$$D(B, C) \leq D(A, C).$$

Proof.

(D1). If $A \subseteq B$ then $D(A \cap B, B) = D(A, B)$ so that, we have

$$D(A, A \cup B) = D(A, B).$$

If $B \subseteq A$ then $D(A \cap B, B) = D(B, B) = 0$ so that, we have

$$D(A, A \cup B) = D(A, A) = 0.$$

It means that if $A \subseteq B$, or $B \subseteq A$ we have

$$D(A \cap B, B) = D(A, A \cup B) \leq D(A, B).$$

(D2). Because of the symmetry of the divergence measure. We consider the cases:

+ If $T_A(u_i) \leq T_B(u_i)$ then we have

$$\begin{aligned} & D_T^i(A \cup B, A \cap B) \\ &= T_B(u_i) \ln \frac{2T_B(u_i)}{T_A(u_i) + T_B(u_i)} + T_A(u_i) \ln \frac{2T_A(u_i)}{T_A(u_i) + T_B(u_i)} \\ &= D(A, B), \end{aligned}$$

+ if $T_B(u_i) \leq T_A(u_i)$ then we have

$$\begin{aligned} & D_T^i(A \cup B, A \cap B) \\ &= T_A(u_i) \ln \frac{2T_A(u_i)}{T_A(u_i) + T_B(u_i)} + T_B(u_i) \ln \frac{2T_B(u_i)}{T_A(u_i) + T_B(u_i)} \\ &= D(A, B). \end{aligned}$$

By the same consideration for indeterminacy membership function and falsity membership function, we obtain

$$D(A \cap B, A \cup B) = D(A, B),$$

(D3). For all $A \subseteq B \subseteq C$ and for all $u_i \in U$ we have:

- With the falsity-membership function:

From condition $T_A(u_i) \leq T_B(u_i) \leq T_C(u_i)$ and lemma 2 we have:

$$\begin{aligned} D_T^i(A, B) &= T_A(u_i) \ln \frac{2T_A(u_i)}{T_A(u_i) + T_B(u_i)} + T_B(u_i) \ln \frac{2T_B(u_i)}{T_A(u_i) + T_B(u_i)} \\ &= T_A(u_i) \ln \frac{2T_A(u_i)}{T_A(u_i) + T_C(u_i)} + T_C(u_i) \ln \frac{2T_C(u_i)}{T_C(u_i) + T_A(u_i)} \\ &= D_T^i(A, C), \end{aligned}$$

- With the indeterminacy membership function:

By the same way as falsity- membership function we have $D_I^i(A, B) \leq D_I^i(A, C)$,

- With the falsity- membership function:

From condition $F_A(u_i) \geq F_B(u_i) \geq F_C(u_i)$ and lemma 3 we have:

$$\begin{aligned} D_F^i(A, B) &= F_A(u_i) \ln \frac{2F_A(u_i)}{F_A(u_i) + F_B(u_i)} + F_B(u_i) \ln \frac{2F_B(u_i)}{F_A(u_i) + F_B(u_i)} \\ &\leq F_A(u_i) \ln \frac{2F_A(u_i)}{F_A(u_i) + F_C(u_i)} + F_C(u_i) \ln \frac{2F_C(u_i)}{F_A(u_i) + F_C(u_i)} \\ &= D_F^i(A, C). \end{aligned}$$

So that, we obtain the result $D(A, B) \leq D(A, C)$.

(D4). By the same way as (D4) using lemma 1, lemma 2 and lemma 3, it is easy to derive these results when considering specific cases. □

4 Applications of divergence measure of Neutrosophic set

In this section we apply the Neutrosophic divergence measures in the medical diagnosis and classification problems.

4.1 In the medical diagnosis

Now, we applied the Neutrosophic divergence measure for obtaining a proper diagnosis for the data given in Table 1 and Table 2. This data was modified from the data that introduced in [2]. Usage of diagnostic methods $D = \{\text{Viral fever } (A_1), \text{ Malaria } (A_2), \text{ Typhoid } (A_3), \text{ Stomach problem } (A_4), \text{ Chest problem } (A_5)\}$ for patients with given values of symptoms $S = \{\text{temperature } (s_1), \text{ headache } (s_2), \text{ stomach pain } (s_3), \text{ cough } (s_4), \text{ chest pain } (s_5)\}$. In this case, the neutrosophic set is useful to handle them. Here, for each $A_k \in D, (k = 1, 2, \dots, 5)$, is expressed in form that is a neutrosophic set on the universal set $S = \{s_1, s_2, s_3, s_4, s_5\}$, see Table 1. The information of symptoms characteristic for the considered patients is given in Table 2. In which, for each patient $B_j (j = 1, 2, 3, 4)$ is a neutrosophic set in the universal set $S = \{s_1, s_2, s_3, s_4, s_5\}$.

To select the appropriate diagnostic method we calculate the divergence measure between each patient and each diagnosis. After that, we chose the smallest value of them. This will be to give us the best diagnosis for each patient (Table 3).

The divergence measure of a diagnosis $A_k \in D (k = 1, 2, \dots, 5)$ for each patient $B_j (j = 1, 2, 3, 4)$ is computed by using the Eq.(2), Eq.(3), Eq.(4), Eq.(5) as follows:

$$D(A_k, B_j) = \frac{1}{n} \sum_{i=1}^n [D_T^i(A_k, B_j) + D_I^i(A_k, B_j) + D_F^i(A_k, B_j)]$$

where

$$D_T^j(A_k, B_j) = T_{A_k}(u_i) \ln \frac{2T_{A_k}(u_i)}{T_{A_k}(u_i) + T_{B_j}(u_i)} + T_{B_j}(u_i) \ln \frac{2T_{B_j}(u_i)}{T_{A_k}(u_i) + T_{B_j}(u_i)}$$

$$D_I^j(A_k, B_j) = I_{A_k}(u_i) \ln \frac{2I_{A_k}(u_i)}{I_{A_k}(u_i) + I_{B_j}(u_i)} + I_{B_j}(u_i) \ln \frac{2I_{B_j}(u_i)}{I_{A_k}(u_i) + I_{B_j}(u_i)}$$

and

$$D_F^j(A_k, B_j) = F_{A_k}(u_i) \ln \frac{2F_{A_k}(u_i)}{F_{A_k}(u_i) + F_{B_j}(u_i)} + F_{B_j}(u_i) \ln \frac{2F_{B_j}(u_i)}{F_{A_k}(u_i) + F_{B_j}(u_i)}.$$

Table 1. Symptoms Characteristics for the Diagnosis

	Viral fever	Malaria	Typhoid	Stomach Problem	Chest Problem
Temperature	(0.7,0.5,0.6)	(0.7,0.9,0.1)	(0.3,0.7,0.2)	(0.1,0.6,0.7)	(0.1,0.9,0.8)
Headache	(0.8,0.2,0.9)	(0.4,0.5, 0.5)	(0.6,0.9,0.2)	(0.7,0.4,0.3)	(0.1,0.6,0.7)
Somach pain	(0.8,1,0.1)	(0.5,0.9,0.2)	(0.2,0.5,0.5)	(0.7,0.7,0.8)	(0.5,0.7,0.6)
Cough	(0.45,0.8,0.7)	(0.7,0.8,0.6)	(0.2,0.5,0.5)	(0.2,0.8,0.65)	(0.2,0.8,0.6)
Chest pain	(0.2,0.6,0.5)	(0.1,0.6,0.8)	(0.1,0.8,0.8)	(0.5,0.8,0.6)	(0.8,0.8,0.2)

Table 2. Symptoms Characteristics for the Patients

	Temperature	Headache	Stomach pain	Cough	Chest pain
Al (B_1)	(0.7,0.6,0.5)	(0.6,0.3,0.5)	(0.5,0.5,0.75)	(0.8,0.75,0.5)	(0.7,0.2,0.6)
Bob (B_2)	(0.7,0.3,0.5)	(0.5,0.5,0.8)	(0.6,0.5,0.5)	(0.65,0.4,0.75)	(0.2,0.85,0.65)
Joe (B_3)	(0.75,0.5,0.5)	(0.2,0.85,0.7)	(0.7,0.6,0.4)	(0.7,0.55,0.5)	(0.5,0.9,0.64)
Ted (B_4)	(0.4,0.7,0.6)	(0.7,0.5,0.7)	(0.6,0.7,0.5)	(0.5,0.9,0.65)	(0.6,0.5,0.85)

The computed results of the divergence measures are listed in Table 3. From the results, we see that Al and Ted should use diagnostic methods corresponding to Stomach Problem, Bob use a Viral fever, Joe use a Malaria.

Table 3. Diagnosis results for the divergence measure using eq. (2)

	Viral fever	Malaria	Typhoid	Stomach Problem	Chest Problem
Al	0.81614	0.82946	1.14558	0.75326	1.10798
Bob	0.49750	0.59104	0.73430	0.79456	1.14038
Joe	0.75011	0.60603	0.89659	0.88206	0.79920
Ted	0.48722	0.61785	0.81009	0.36199	0.72614

4.2 In the classification problem

Assume that, we have m pattern $\{A_1, A_2, \dots, A_m\}$, in which each pattern is a Neutrosophic set on universal set $U = \{u_1, u_2, \dots, u_n\}$. Suppose that, we have a sample B with the given feature information. Our goal is to classify sample B into which sample. To solve this, we calculate the divergence measure of B with each pattern $A_i (i = 1, 2, \dots, m)$. Then we choose the smallest value. It gives us the class that B belongs to.

Example 1. Assume that three are three Neutrosophic patterns in $U = \{u_1, u_2, u_3\}$ as following

$$A_1 = \{(u_1, 0.7, 0.7, 0.2), (u_2, 0.7, 0.8, 0.4), (u_3, 0.6, 0.8, 0.2)\}$$

$$A_2 = \{(u_1, 0.5, 0.7, 0.3), (u_2, 0.7, 0.7, 0.5), (u_3, 0.8, 0.6, 0.1)\}$$

$$A_3 = \{(u_1, 0.9, 0.5, 0.1), (u_2, 0.7, 0.6, 0.4), (u_3, 0.8, 0.5, 0.2)\}$$

Assume that a sample

$$B = \{(u_1, 0.7, 0.8, 0.4), (u_2, 0.8, 0.5, 0.3), (u_3, 0.5, 0.8, 0.5)\}$$

Using the divergence measure in Eq.(2) we have $D(A_1, B) = 0.15372$, $D(A_2, B) = 0.26741$, $D(A_3, B) = 0.29516$.

So that we can classify that B belongs to class A_1 .

5 Conclusion

Neutrosophic set theory is more and more interested by researchers. There are many theoretical and applied results on Neutrosophic sets that are built and developed. In this paper, we study the divergence measure of Neutrosophic sets. Along with that, we offer some divergence formulas on Neutrosophic sets and give some properties of these measurements. Finally we apply the proposed measures in some cases.

In the future, we will continue to study this measure and offer some of their applications in other areas such as image segmentation or multi-criteria decision making.

References

- [1]. K. Atanassov. Intuitionistic Fuzzy Sets. Fuzzy set and systems. 20, 1986, 87-96.
- [2]. A. Aydođdu. On similarity and entropy of single valued neutrosophic sets. *Gen. Math. Notes*, 29(1), 2015, 67-74.
- [3]. S.K De, R. Biswas, A.R. Roy. An application of intuitionistic fuzzy sets in medical diagnosis. *Fuzzy sets and Systems*, 117(2), 209-213.
- [4]. P. Biswas, S. Pramanik, B.C. Giri. Entropy Based Grey Relational Analysis Method for Multi-Attribute Decision Making under Single Valued Neutrosophic Assessments, *Neutrosophic Sets and Systems*, vol. 2, 2014, pp. 102-110. doi.org/10.5281/zenodo.571363.
- [5]. P. Biswas, S. Pramanik, Bibhas C. Giri. A New Methodology for Neutrosophic Multi-Attribute Decision making with Unknown Weight Information, *Neutrosophic Sets and Systems*, vol. 3, 2014, pp. 42-50. doi.org/10.5281/zenodo.571212.
- [6]. P. Biswas, S. Pramanik, BC. Giri, (2016). TOPSIS method for multi-attribute group decision making under single-valued neutrosophic environment. *Neural computing and Applications*, 27 (3), 2016, 727-737.
- [7]. S. Broumi, F. Smarandache: Several Similarity Measures of Neutrosophic Sets, *Neutrosophic Sets and Systems*, vol. 1, 2013, pp. 54-62. doi.org/10.5281/zenodo.571755
- [8]. S. Broumi, F. Smarandache. New distance and similarity measures of interval neutrosophic sets. (2014). *Infinite Study*.
- [9]. S. Broumi, F. Smarandache. Extended hausdorff distance and similarity measures for neutrosophic refined sets and their application in medical diagnosis. *Journal of New Theory*, 7, 2015, 64-78.
- [10]. S. Dalapati, S. Pramanik, S. Alam, F. Smarandache, T. Roy. IN-cross Entropy Based MAGDM Strategy under Interval Neutrosophic Set Environment, *Neutrosophic Sets and Systems*, vol. 18, 2017, pp. 43-57. http://doi.org/10.5281/zenodo.1175162.
- [11]. H.L. Huang. New Distance Measure of Single-Valued Neutrosophic Sets and Its Application. *International Journal of Intelligent Systems*, 31(10), 2016, 1021-1032.
- [12]. A.R. Mishra, R. Kumari, D.K Sharma. Intuitionistic fuzzy divergence measure-based multi-criteria decision-making method. *Neural Computing and Application*, 2017, 1-16.
- [13]. K. Mondal, S. Pramanik. Multi-criteria Group Decision Making Approach for Teacher Recruitment in Higher Education under Simplified Neutrosophic Environment, *Neutrosophic Sets and Systems*, vol. 6, 2014, pp. 28-34. doi.org/10.5281/zenodo.571479.
- [14]. K. Mondal, S. Pramanik. Neutrosophic Decision Making Model of School Choice, *Neutrosophic Sets and Systems*, vol. 7, 2015, pp. 62-68. doi.org/10.5281/zenodo.571507.
- [15]. K. Mondal, S. Pramanik. Neutrosophic Tangent Similarity Measure and Its Application to Multiple Attribute Decision Making, *Neutrosophic Sets and Systems*, vol. 9, 2015, pp. 80-87. doi.org/10.5281/zenodo.571578.
- [16]. K. Mondal, S. Pramanik. Neutrosophic Decision Making Model for Clay-Brick Selection in Construction Field Based on Grey Relational Analysis, *Neutrosophic Sets and Systems*, vol. 9, 2015, pp. 64-71. doi.org/10.5281/zenodo.34864.
- [17]. K. Mondal, S. Pramanik, B.C. Giri. Interval Neutrosophic Tangent Similarity Measure Based MADM strategy and its Application to MADM Problems, *Neutrosophic Sets and Systems*, vol. 19, 2018, pp. 46-56. http://doi.org/10.5281/zenodo.1235201.
- [18]. K. Mondal, S. Pramanik, B.C. Giri: Single Valued Neutrosophic Hyperbolic Sine Similarity Measure Based MADM Strategy, *Neutrosophic Sets and Systems*, vol. 20, 2018, pp. 3-11. http://doi.org/10.5281/zenodo.1235383.

- [19]. K. Mondal, S. Pramanik, B.C. Giri: Hybrid Binary Logarithm Similarity Measure for MAGDM Problems under SVNS Assessments, *Neutrosophic Sets and Systems*, vol. 20, 2018, pp. 12-25. <http://doi.org/10.5281/zenodo.1235365>
- [20]. I. Montes, N.R. Pal, V. Jani, S. Montes. Divergence measures for intuitionistic fuzzy sets. *IEEE Transactions on Fuzzy Systems* 23(2), 2015, 444-456.
- [21]. A. Ohlan. A new generalized fuzzy divergence measure and applications. *Fuzzy Information and Engineering* 7(4), 2015, 507-523.
- [22]. S. Pramanik, P. Biswas, B.C. Giri. Hybrid Vector Similarity Measures and Their Applications to Multi-attribute Decision Making under Neutrosophic Environment. *Neural Computing and Applications* 28 (5), 2017, 1163-1176. DOI 10.1007/s00521-015-2125-3
- [23]. S. Pramanik, S. Dalapati, S. Alam, F. Smarandache, and T.K. Roy. NS-cross entropy based MAGDM under single valued neutrosophic set environment. *Information*, 9(2), 2018, 37. doi:10.3390/info9020037.
- [24]. G. Shahzadi, M. Akram, A. B. Saeid. An Application of Single-Valued Neutrosophic Sets in Medical Diagnosis, *Neutrosophic Sets and Systems*, vol. 18, 2017, pp. 80-88. <http://doi.org/10.5281/zenodo.1175158>
- [25]. F. Smarandache . *Neutrosophy. Neutrosophic Probability, Set, and Logic*, ProQuest Information & Learning, Ann Arbor, Michigan, USA, 105 p., 1998; <http://fs.gallup.unm.edu/eBook-neutrosophics6.pdf> (last edition online);
- [26]. F. Smarandache, S. Pramanik, (Eds). *New trends in neutrosophic theory and applications*. Brussels: Pons Editions, 2016.
- [27]. F. Smarandache, S. Pramanik, (Eds). *New trends in neutrosophic theory and applications. Vol. II*. Brussels: Pons Editions, 2018.
- [28]. H. Wang, F. Smarandache, Y.Q. Zhang, R. Sunderraman. Single valued neutrosophic sets. *Multispace and Multistructure*, 4, 2014, 410-413.
- [29]. J. Ye: Another Form of Correlation Coefficient between Single Valued Neutrosophic Sets and Its Multiple Attribute Decision Making Method, *Neutrosophic Sets and Systems*, Vol. 1, 2013, pp. 8-12. doi.org/10.5281/zenodo.571265
- [30]. J. Ye and Q. Zhang: Single Valued Neutrosophic Similarity Measures for Multiple Attribute Decision-Making, *Neutrosophic Sets and Systems*, vol. 2, 2014, pp. 48-54. doi.org/10.5281/zenodo.571756.
- [31]. J. Ye Clustering methods using distance-based similarity measures of single-valued neutrosophic sets. *Journal of Intelligent Systems*, 23(4), 2014, 379-389.
- [32]. J. Ye. Multiple attribute group decision-making method with completely unknown weights based on similarity measures under single valued neutrosophic environment. *Journal of Intelligent & Fuzzy Systems*, 27(6), 2014, 2927-2935.
- [33]. S. Ye, J. Fu, and J. Ye. Medical diagnosis using distance-based similarity measures of single valued neutrosophic multisets. *Neutrosophic Sets and Systems*, 7, 2015, 47-52.
- [34]. J. Ye. Single-valued neutrosophic similarity measures based on cotangent function and their application in the fault diagnosis of steam turbine. *Soft Computing*, 21(3), 2017, 817-825.
- [35]. J. Ye. Single-valued neutrosophic clustering algorithms based on similarity measures. *Journal of Classification*, 34(1), 2017, 148-162.
- [36]. L.A. Zadeh. Fuzzy sets, *Information and control* 8(3), 1965, 338-353.
- [37]. Z. Zhang, Chong Wu: A novel method for single-valued neutrosophic multi-criteria decision making with incomplete weight information, *Neutrosophic Sets and Systems*, vol. 4, 2014, pp. 35-49. doi.org/10.5281/zenodo.571269
- [38] Arindam Dey, Said Broumi, Le Hoang Son, Assia Bakali, Mohamed Talea, Florentin Smarandache, "A new algorithm for finding minimum spanning trees with undirected neutrosophic graphs", *Granular Computing* (Springer), pp.1-7, 2018.
- [39] S Broumi, A Dey, A Bakali, M Talea, F Smarandache, LH Son, D Koley, "Uniform Single Valued Neutrosophic Graphs", *Neutrosophic sets and systems*, 2017.
- [40] S Broumi, A Bakali, M Talea, F Smarandache, A. Dey, LH Son, "Spanning tree problem with Neutrosophic edge weights", in *Proceedings of the 3rd International Conference on intelligence computing in data science*, Elsevier, science direct, *Procedia computer science*, 2018.
- [41] Said Broumi; Arindam Dey; Assia Bakali; Mohamed Talea; Florentin Smarandache; Dipak Koley, "An algorithmic approach for computing the complement of intuitionistic fuzzy graphs" 2017 13th International Conference on Natural Computation, Fuzzy Systems and Knowledge Discovery (ICNC-FSKD)
- [42] Abdel-Basset, M., Mohamed, M., Smarandache, F., & Chang, V. (2018). Neutrosophic Association Rule Mining Algorithm for Big Data Analysis. *Symmetry*, 10(4), 106.
- [43] Abdel-Basset, M., & Mohamed, M. (2018). The Role of Single Valued Neutrosophic Sets and Rough Sets in Smart City: Imperfect and Incomplete Information Systems. Measurement. [Volume 124](#), August 2018, Pages 47-55
- [44] Abdel-Basset, M., Gunasekaran, M., Mohamed, M., & Smarandache, F. A novel method for solving the fully neutrosophic linear programming problems. *Neural Computing and Applications*, 1-11.
- [45] Abdel-Basset, M., Manogaran, G., Gamal, A., & Smarandache, F. (2018). A hybrid approach of neutrosophic sets and DEMATEL method for developing supplier selection criteria. *Design Automation for Embedded Systems*, 1- 22.

- [46] Abdel-Basset, M., Mohamed, M., & Chang, V. (2018). NMCDA: A framework for evaluating cloud computing services. *Future Generation Computer Systems*, 86, 12-29.
- [47] Abdel-Basset, M., Mohamed, M., Zhou, Y., & Hezam, I. (2017). Multi-criteria group decision making based on neutrosophic analytic hierarchy process. *Journal of Intelligent & Fuzzy Systems*, 33(6), 4055-4066.
- [48] Abdel-Basset, M.; Mohamed, M.; Smarandache, F. An Extension of Neutrosophic AHP–SWOT Analysis for Strategic Planning and Decision-Making. *Symmetry* 2018, 10, 116.
- [49] Abdel-Basset, Mohamed, et al. "A novel group decision-making model based on triangular neutrosophic numbers." *Soft Computing* (2017): 1-15. DOI: <https://doi.org/10.1007/s00500-017-2758-5>
- [50] Abdel-Baset, Mohamed, Ibrahim M. Hezam, and Florentin Smarandache. "Neutrosophic goal programming." *Neutrosophic Sets Syst* 11 (2016): 112-118.
- [51] El-Hefenawy, Nancy, et al. "A review on the applications of neutrosophic sets." *Journal of Computational and Theoretical Nanoscience* 13.1 (2016): 936-944.

Constant Single Valued Neutrosophic Graphs with Applications

Naeem Jan, Lemnaouar Zedam, Tahir Mahmood, Kifayat Ullah, Said Broumi,
Florentin Smarandache

Naeem Jan, Lemnaouar Zedam, Tahir Mahmood, Kifayat Ullah, Said Broumi, Florentin Smarandache (2019). Constant Single Valued Neutrosophic Graphs with Applications. *Neutrosophic Sets and Systems* 24: 77-89

Abstract. In this paper, we introduced a new concept of single valued neutrosophic graph (SVNG) known as constant single valued neutrosophic graph (CSVNG). Basically, SVNG is a generalization of intuitionistic fuzzy graph (IFG). More specifically, we described and explored some graph theoretic ideas related to the introduced concepts of CSVNG. An application of CSVNG in a Wi-Fi network system is discussed and a comparison of CSVNG with constant IFG is established showing the worth of the proposed work. Further, several terms like constant function and totally constant function are investigated in the frame-work of CSVNG and their characteristics are studied.

Keywords. Single valued neutrosophic graph. Constant single valued neutrosophic graph; constant function; totally constant function; Wi-Fi network.

1. Introduction

Dealing with uncertain situations and insufficient information requires some high potential mathematical tools. Graph theory is one of the mathematical tools which effectively deals with large data. If there are some of uncertainty factors, then fuzzy graph is the appropriate tool to be used. In addition to its ability of handling large data, graph theory has a special interest as it can be applied in several important areas including management sciences [19], social sciences [17], computer and information sciences [41], communication networks [18], description of group structures [39], database theory [26] and economics [25].

The concept of fuzzy set (FS) proposed by Zadeh [46] is among the famous tools dealing with uncertain situations and insufficient information. After, Kaufmann [20] introduced the notion of fuzzy graph. A comprehensive study on fuzzy graphs is done by Rosenfeld [40] in which he shown some of their basic properties. The work in the field of graph theory is exemplary during the past decades as its concepts are applied in many real-life problems such as cluster analysis [14,6,45,30], slicing [30], for solving fuzzy intersecting equations [31,29], in some theory of data base [26], in networking problems [27], in the structure of a group [43, 32], in chemistry [44], in air trafficking [35], in the control of traffic [34] etc. The worth of FG lies in its capability of handling with uncertainties and it has done so far better but Atanassov [1] proposed that FSs only deals with one sided uncertainties which is not enough as human nature isn't limited to only yes type or no type problems. Hence the logic of intuitionistic fuzzy set (IFS) have been developed sufficient to deal with uncertainties of both yes and no types. Atanassov's IFS gave rise to the theory of IFG proposed by Parvathi and Karunambigai [36]. The structure of IFG is advanced and is applied successfully social networks [13], clustering [23], radio coverage network [21] and shortest path problems [32] etc. Furthermore, Parvathi et al [36-28] did some work on constant IFGs and operations of IFGs. The concept of intuitionistic fuzzy hypergraphs (IFHG) was proposed by Parvathi et al. [37] which were applied in real life problems by Akram and Wieslaw [3]. NagoorGani and Shajitha [15] wrote about degree, order and size for IFG in 2010. Akram and Davvaz [2] gave the concept of strong IFG.

Smarandache in 1995 develop the neutrosophic logic which give rise to a novel theory of neutrosophic set (NS) [42] which give rise to the development of single/double and triple valued NSs [16,22,24]. Broumi et al initiated the concept of single-valued neutrosophic graph (SVNG) [7]. Work on the operations of SVNG can be found in [5]. Note on the degree, order and size of SVNG is present in [8]. Recently, Broumi et al [47] introduced a single-valued neutrosophic techniques for analysis of WIFI connection. The hypergraph i.e. single-valued neutrosophic hyper graph is introduced in [4]. Neutrosophic sets and graphs have ben widely studied in recent decades. Various

real life applications are discussed using neutrosophic techniques. For development in neutrosophic sets and graphs and their applications, one is refer to [9-12, 48-67,68-71].

In this paper, we introduced the concept of CSVNG and investigated some graph theoretic ideas related to this introduced concept. An application of CSVNG in a Wi-Fi network system is discussed and a comparison of CSVNG with constant IFG is established in order to show the worth of the proposed concept.

The rest of the paper is organized as follows. In Section 2, we recalled the necessary basic concepts and properties of IFG, CIFG and SVNG. In section 3, the concept of CSVNG is described and some related graph theoretic ideas are explored. In Section 4, we discussed the characteristic of CSVNGs, while section 5 deals with an application of CSVNGs in Wi-Fi network system. Finally, advantages and concluding remarks are discussed.

2 Preliminaries

This section is basically about some very basic definitions. The concepts of IFG, CIFG and SVNG are discussed and explained with the help of some examples. For undefined terms and notions, we refer to [5, 8, 35, 36].

Definition 1 [36]. A Pair $G = (\tilde{V}, \tilde{E})$ is said to be *IFG* if

- (i) $\tilde{V} = \{\tilde{v}_1, \tilde{v}_2, \tilde{v}_3, \dots, \tilde{v}_n\}$ are the set of vertices such that $\tilde{T}_1: \tilde{V} \rightarrow [0, 1]$ and $F_1: \tilde{V} \rightarrow [0, 1]$ represents the degree of membership and non-membership of the element $\tilde{v}_i \in \tilde{V}$ respectively with a condition that $0 \leq \tilde{T}_1(\tilde{v}_i) + F_1(\tilde{v}_i) \leq 1$ for all $\tilde{v}_i \in \tilde{V}, (i \in I)$.
- (ii) $\tilde{E} \subseteq \tilde{V} \times \tilde{V}$ where $\tilde{T}_2: \tilde{V} \times \tilde{V} \rightarrow [0, 1]$ and $F_2: \tilde{V} \times \tilde{V} \rightarrow [0, 1]$ represents the degree of membership and non-membership of the element $(\tilde{v}_i, \tilde{v}_j) \in \tilde{E}$ such that $\tilde{T}_2(\tilde{v}_i, \tilde{v}_j) \leq \min\{\tilde{T}_1(\tilde{v}_i), \tilde{T}_1(\tilde{v}_j)\}$ and $F_2(\tilde{v}_i, \tilde{v}_j) \leq \max\{F_1(\tilde{v}_i), F_1(\tilde{v}_j)\}$ with a condition $0 \leq \tilde{T}_2(\tilde{v}_i, \tilde{v}_j) + F_2(\tilde{v}_i, \tilde{v}_j) \leq 1$ for all $(\tilde{v}_i, \tilde{v}_j) \in \tilde{E} (i \in I)$.

Example 1. Let $G = (\tilde{V}, \tilde{E})$ be an IFG where $\tilde{V} = \{\tilde{v}_1, \tilde{v}_2, \tilde{v}_3\}$ be the set of vertices and $\tilde{E} = \{\tilde{v}_1\tilde{v}_2, \tilde{v}_1\tilde{v}_3, \tilde{v}_2\tilde{v}_3\}$ be the set of edges. Then

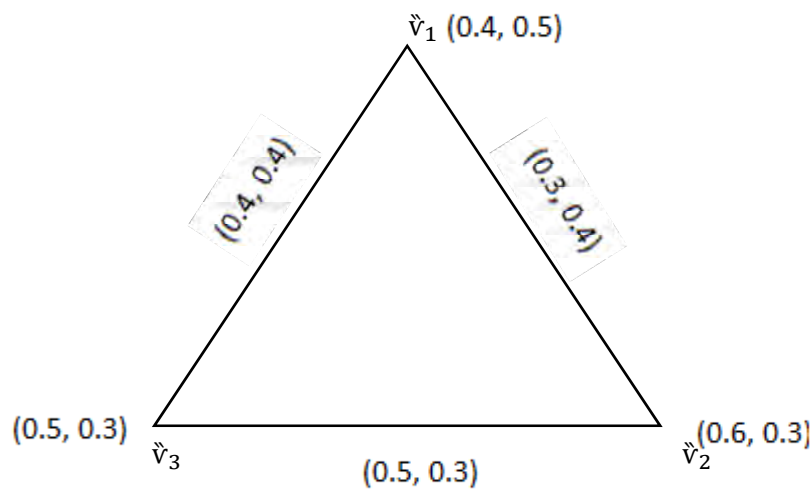

Figure 1 (IFG)

Definition 2 [28]. A pair $G = (\tilde{V}, \tilde{E})$ is said to be Constant-IFG of degree (k_i, k_j) or (k_i, k_j) - IFG. If

$$d_T(\tilde{v}_i) = k_i, d(F_j) = k_j \forall \tilde{v}_i, \tilde{v}_j \in \tilde{V}.$$

Example 2. Let $G = (\tilde{V}, \tilde{E})$ be an IFG where $\tilde{V} = \{\tilde{v}_1, \tilde{v}_2, \tilde{v}_3, \tilde{v}_4\}$ be the set of vertices and $\tilde{E} = \{\tilde{v}_1\tilde{v}_2, \tilde{v}_2\tilde{v}_3, \tilde{v}_3\tilde{v}_4, \tilde{v}_4\tilde{v}_1\}$ be the set of edges. Then

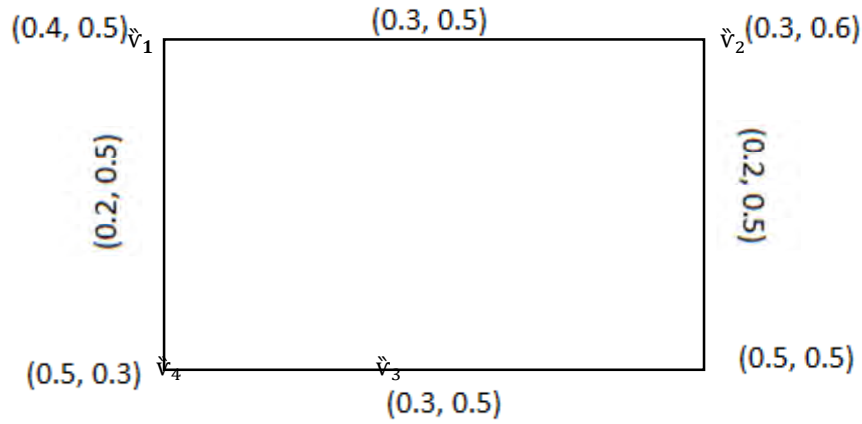

Figure 2 (Constant-IFG of degree (k_i, k_j))

The degree of $\check{v}_1, \check{v}_2, \check{v}_3, \check{v}_4$ is $(0.5, 1.0)$.

Definition 3 [7]. A pair $G = (\check{V}, \check{E})$ is said to be as *SVNG* if

- (i) $\check{V} = \{\check{v}_1, \check{v}_2, \check{v}_3, \dots, \check{v}_n\}$ are the set of vertices such that $\check{T}_1: \check{V} \rightarrow [0, 1]$, $\check{I}_1: \check{V} \rightarrow [0, 1]$ and $\check{F}_1: \check{V} \rightarrow [0, 1]$ denote the degree of membership, indeterminacy and non-membership of the element $\check{v}_i \in \check{V}$ respectively with a condition that $0 \leq \check{T}_1 + \check{I}_1 + \check{F}_1 \leq 3$ for all $\check{v}_i \in \check{V}$, $(i \in I)$.
- (ii) $\check{E} \subseteq \check{V} \times \check{V}$ where $\check{T}_2: \check{V} \times \check{V} \rightarrow [0, 1]$, $\check{I}_2: \check{V} \times \check{V} \rightarrow [0, 1]$ and $\check{F}_2: \check{V} \times \check{V} \rightarrow [0, 1]$ denote the degree of membership, abstinance and non-membership of the element $(\check{v}_i, \check{v}_j) \in \check{E}$ such that $\check{T}_2(\check{v}_i, \check{v}_j) \leq \min\{\check{T}_2(\check{v}_i), \check{T}_2(\check{v}_j)\}$, $\check{I}_2(\check{v}_i, \check{v}_j) \geq \max\{\check{I}_2(\check{v}_i), \check{I}_2(\check{v}_j)\}$ and $\check{F}_2(\check{v}_i, \check{v}_j) \geq \max\{\check{F}_2(\check{v}_i), \check{F}_2(\check{v}_j)\}$ with a condition $0 \leq \check{T}_2(\check{v}_i, \check{v}_j) + \check{I}_2(\check{v}_i, \check{v}_j) + \check{F}_2(\check{v}_i, \check{v}_j) \leq 3$ for all $(\check{v}_i, \check{v}_j) \in \check{E}$, $(i \in I)$.

Example 3. Let $G = (\check{V}, \check{E})$ be a *SVNG* where $\check{V} = \{\check{v}_1, \check{v}_2, \check{v}_3, \check{v}_4\}$ be the set of vertices and $\check{E} = \{\check{v}_1\check{v}_2, \check{v}_2\check{v}_3, \check{v}_3\check{v}_4, \check{v}_4\check{v}_1\}$ be the set of edges. Then

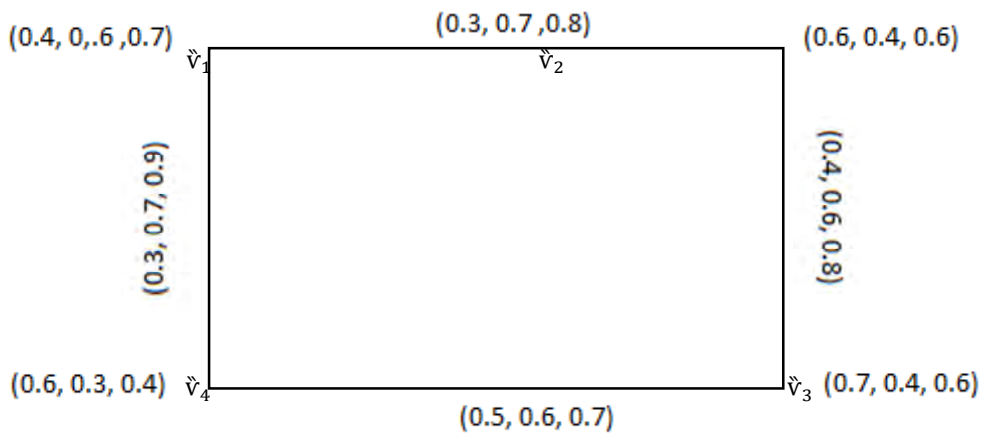

Figure 3 .SVNG

3 Constant single valued neutrosophic graph

In this section, the concept of CSVNG is introduced and supported with some examples. We discussed some related terms like completeness, total degree and constant function and exemplified them. Some results are also studied related to completeness and constant functions.

Definition 4. A pair $G = (\tilde{V}, \tilde{E})$ is said to be constant-SVNG of degree (k_i, k_j, k_k) or (k_i, k_j, k_k) -SVNG. If $d_T(\tilde{v}_i) = k_i, d_I(\tilde{v}_j) = k_j,$ and $d_F(\tilde{v}_k) = k_k \forall \tilde{v}_i, \tilde{v}_j, \tilde{v}_k \in \tilde{V}.$

Example 4. Let $G = (\tilde{V}, \tilde{E})$ be a SVNG where $\tilde{V} = \{\tilde{v}_1, \tilde{v}_2, \tilde{v}_3, \tilde{v}_4\}$ be the set of vertices and $\tilde{E} = \{\tilde{v}_1\tilde{v}_2, \tilde{v}_2\tilde{v}_3, \tilde{v}_3\tilde{v}_4, \tilde{v}_4\tilde{v}_1\}$ be the set of edges. Then CSVNG is shown in the below figure 4.

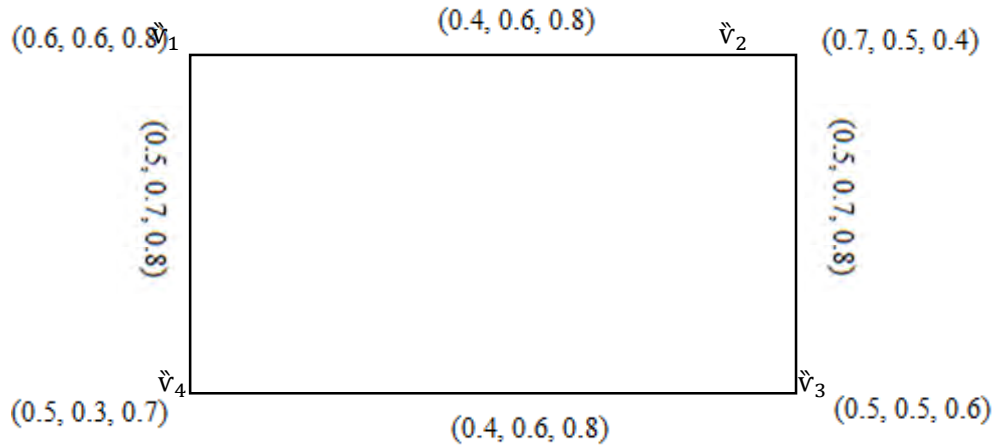

Figure 4 (Constant-SVNG of degree (k_i, k_j, k_k))

The degree of $\tilde{v}_1, \tilde{v}_2, \tilde{v}_3, \tilde{v}_4$ is $(0.9, 1.3, 1.6)$.

Remark 1. A complete SVNG may not be a constant-SVNG.

Example 5. Consider a graph $G = (\tilde{V}, \tilde{E})$ where $\tilde{V} = \{\tilde{v}_1, \tilde{v}_2, \tilde{v}_3, \tilde{v}_4\}$ be the set of vertices and $\tilde{E} = \{\tilde{v}_1\tilde{v}_2, \tilde{v}_2\tilde{v}_3, \tilde{v}_3\tilde{v}_4, \tilde{v}_4\tilde{v}_1, \tilde{v}_1\tilde{v}_3, \tilde{v}_2\tilde{v}_4, \tilde{v}_3\tilde{v}_1, \tilde{v}_4\tilde{v}_2\}$ be the set of edges. Then

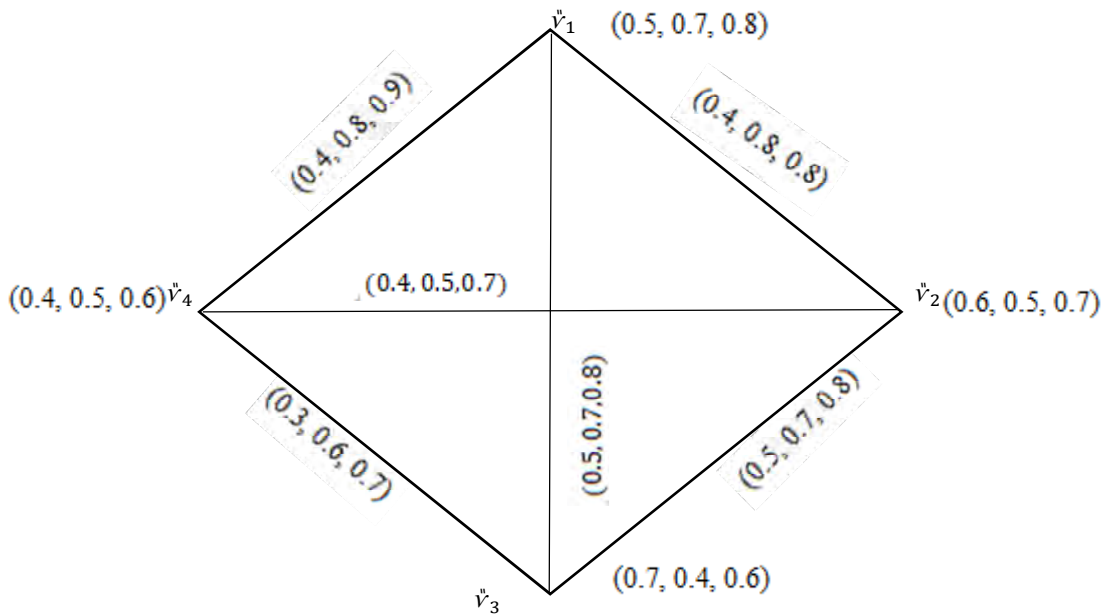

Figure 5 (G is complete but not Constant-SVNG)

Definition 5. The total degree of a vertex \check{v} in aSVNG is defined as

$$td(\check{v}) = \left[\sum_{\check{v} \in \check{E}} d_{T_2}(\check{v}) + \hat{T}_1(\check{v}), \sum_{\check{v} \in \check{E}} d_{I_2}(\check{v}) + \hat{I}_1(\check{v}), \sum_{\check{v} \in \check{E}} d_{F_2}(\check{v}) + F_1(\check{v}) \right]$$

If every vertex has the same total degree, then it is called SVNG of total degree or totally constant SVNG.

Example 6. Consider a graph $G = (\check{V}, \check{E})$ where $\check{V} = \{\check{v}_1, \check{v}_2, \check{v}_3, \check{v}_4\}$ be the set of vertices and $\check{E} = \{\check{v}_1\check{v}_2, \check{v}_2\check{v}_3, \check{v}_3\check{v}_4, \check{v}_4\check{v}_1\}$ be the set of edges. Then

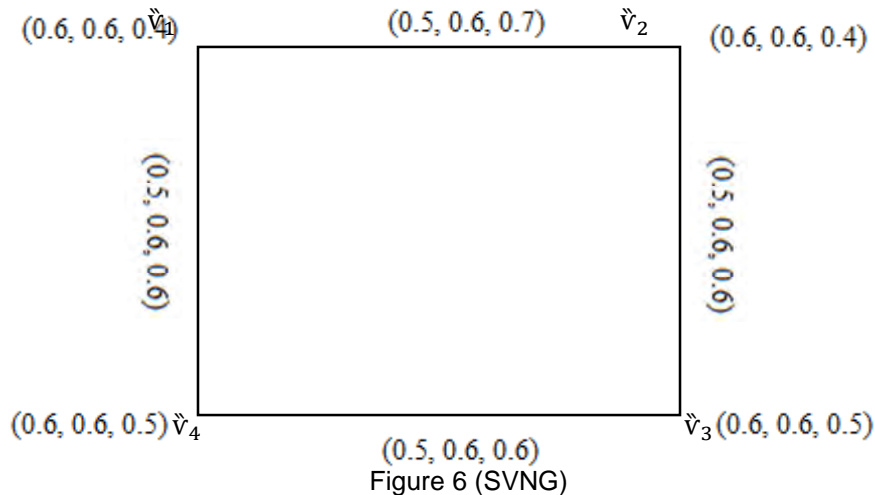

Figure 6 (SVNG)

Constant SVNG of total degree (1.6, 1.8, 1.7).

Theorem 1. If G be a SVNG. Then $(\hat{T}_1, \hat{I}_1, F_1)$ is a constant function iff the following are equivalent.

- (i) G is a constant SVNG.
- (ii) G is a totally constant SVNG.

Proof Let $(\hat{T}_1, \hat{I}_1, F_1)$ be a constant function and $\hat{T}_1(\check{v}) = \hat{c}_1, \hat{I}_1(\check{v}) = \hat{c}_2,$ and $F_1(\check{v}) = \hat{c}_3$ for all $\check{v}_i \in \check{V}$. Where \hat{c}_1, \hat{c}_2 and \hat{c}_3 are constants. Suppose that G is a (k_i, k_j, k_k) -CSVNG. Then $d_T(\check{v}_i) = k_1, d_I(\check{v}_i) = k_2$ and $d_F(\check{v}_i) = k_3$ for all $\check{v}_i \in \check{V}$. Therefore, $td_T(\check{v}_i) = d_T(\check{v}_i) + \hat{T}_1(\check{v}_i), td_I(\check{v}_i) = d_I(\check{v}_i) + \hat{I}_1(\check{v}_i)$ and $td_F(\check{v}_i) = d_F(\check{v}_i) + F_1(\check{v}_i)$ for all $\check{v}_i \in \check{V}, td_T(\check{v}_i) = k_1 + \hat{c}_1, td_I(\check{v}_i) = k_2 + \hat{c}_2$ and $td_F(\check{v}_i) = k_3 + \hat{c}_3$ for all $\check{v}_i \in \check{V}$. Hence G is a totally constant SVNG.

Now, Assume that G is a $(\hat{T}_1, \hat{I}_1, F_1)$ -totally constant SVNG. Then $td_T(\check{v}_i) = r_1, td_I(\check{v}_i) = r_2$ and $td_F(\check{v}_i) = r_3$ for all $\check{v}_i \in \check{V}$. $d_T(\check{v}_i) + \hat{T}_1(\check{v}_i) = r_1, d_I(\check{v}_i) + \hat{c}_1 = r_1, d_T(\check{v}_i) = r_1 - \hat{c}_1,$ similarly $d_I(\check{v}_i) + \hat{I}_1(\check{v}_i) = r_2, d_I(\check{v}_i) = r_2 - \hat{c}_2$ and $d_F(\check{v}_i) + F_1(\check{v}_i) = r_3, d_F(\check{v}_i) = r_3 - \hat{c}_3$. Therefore, G is a constant SVNG. Hence (i) and (ii) are equivalent.

Conversely, assume that (i) and (ii) are equivalent That is G is a constant SVNG iff G is a totally constant SVNG. Assume $(\hat{T}_1, \hat{I}_1, F_1)$ is not a constant function. Then $\hat{T}_1(\check{v}_1) \neq \hat{T}_1(\check{v}_2), \hat{I}_1(\check{v}_1) \neq \hat{I}_1(\check{v}_2)$ and $F_1(\check{v}_1) \neq F_1(\check{v}_2)$ for at least one pair of vertices $\check{v}_1, \check{v}_2 \in \check{V}$. Consider G be a (k_i, k_j, k_k) -SVNG. Then, $\hat{T}_1(\check{v}_1) = \hat{T}_1(\check{v}_2) = k_1, \hat{I}_1(\check{v}_1) = \hat{I}_1(\check{v}_2) = k_2$ and $F_1(\check{v}_1) = F_1(\check{v}_2) = k_3$. So, $td_T(\check{v}_1) = d_T(\check{v}_1) + \hat{T}_1(\check{v}_1) = k_1 + \hat{T}_1(\check{v}_1),$ and $td_T(\check{v}_2) = k_1 + \hat{T}_1(\check{v}_2)$. Similarly, $td_I(\check{v}_1) = k_2 + \hat{I}_1(\check{v}_1), td_I(\check{v}_2) = k_2 + \hat{I}_1(\check{v}_2)$ and $td_F(\check{v}_1) = k_3 + F_1(\check{v}_1), td_F(\check{v}_2) = k_3 + F_1(\check{v}_2)$. Since $\hat{T}_1(\check{v}_1) \neq \hat{T}_1(\check{v}_2), \hat{I}_1(\check{v}_1) \neq \hat{I}_1(\check{v}_2)$ and $F_1(\check{v}_1) \neq F_1(\check{v}_2)$. We have $td_T(\check{v}_1) \neq td_T(\check{v}_2), td_I(\check{v}_1) \neq td_I(\check{v}_2)$ and $td_F(\check{v}_1) \neq td_F(\check{v}_2)$. Therefore, G is not totally constant SVNG which is contradiction to our supposition.

Now, consider G be a totally constant SVNG. Then, $td_T(\check{v}_1) = td_T(\check{v}_2), d_T(\check{v}_1) + \hat{T}(\check{v}_1) = d_T(\check{v}_2) + \hat{T}(\check{v}_2), d_T(\check{v}_1) - d_T(\check{v}_2) = \hat{T}(\check{v}_2) - \hat{T}(\check{v}_1)$ (i.e. $\neq 0$) $d_T(\check{v}_1) \neq d_T(\check{v}_2)$. Similarly $d_I(\check{v}_1) \neq d_I(\check{v}_2)$ and $d_F(\check{v}_1) \neq d_F(\check{v}_2)$. G is not constant which is contradiction to our assumption. Hence $(\hat{T}_1, \hat{I}_1, F_1)$ is constant function.

Example 7. Consider a graph $G = (\check{V}, \check{E})$ where $\check{V} = \{\check{v}_1, \check{v}_2, \check{v}_3, \check{v}_4\}$ be the set of vertices and $\check{E} = \{\check{v}_1\check{v}_2, \check{v}_2\check{v}_3, \check{v}_3\check{v}_4, \check{v}_4\check{v}_1\}$ be the set of edges. Then

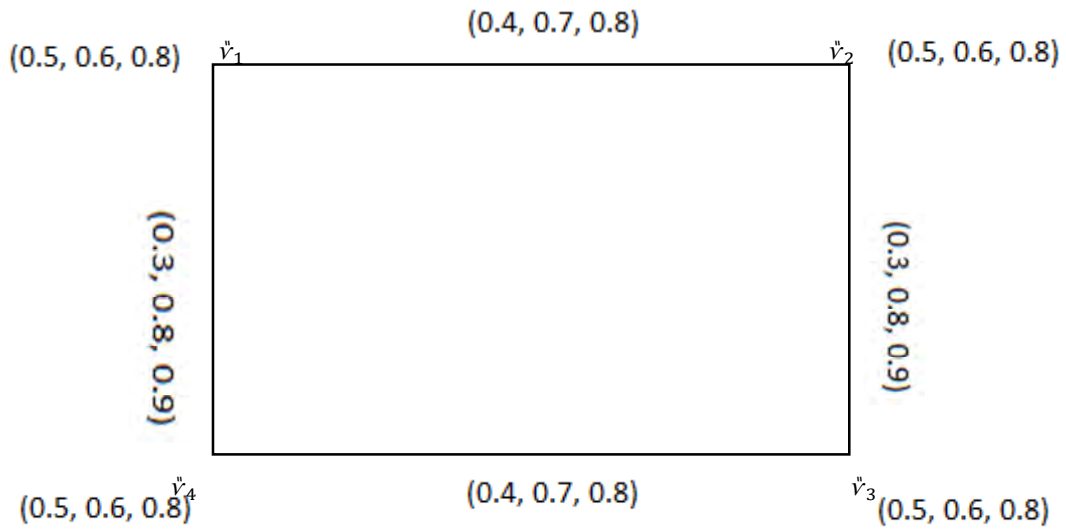

Figure 7. SVNG

$(\hat{T}_1, \hat{I}_1, F_1)$ is a constant function, then G is constant and totally constant.

Theorem 2. Let G is constant and totally constant then $(\hat{T}_1, \hat{I}_1, F_1)$ is a constant function.

Proof. Assume that G be a (k_i, k_j, k_k) –constant and (r_1, r_2, r_3) –totally constant SVNG. Therefore, $d_T(\check{v}_1) = k_1, d_I(\check{v}_1) = k_2$ and $d_F(\check{v}_1) = k_3$ for $\check{v}_1 \in \check{V}$ and $td_T(\check{v}_1) = r_1, td_I(\check{v}_1) = r_2$ and $td_F(\check{v}_1) = r_3$ for all $\check{v} \in \check{V}$. $\hat{T}_1(\check{v}) + k_1 = r_1$ for all $\check{v} \in \check{V}$. $\hat{T}_1(\check{v}) = r_1 - k_1$, for all $\check{v} \in \check{V}$. Hence $\hat{T}_1(\check{v}_1)$ is a constant function. Similarly $\hat{I}_1(\check{v}) = r_2 - k_2$ and $F_1(\check{v}) = r_3 - k_3$ for all $\check{v} \in \check{V}$.

Remark 2. Converse of the above theorem 2 is not true.

Example 8. Consider a graph $G = (\check{V}, \check{E})$ where $\check{V} = \{\check{v}_1, \check{v}_2, \check{v}_3, \check{v}_4\}$ be the set of vertices and $\check{E} = \{\check{v}_1\check{v}_2, \check{v}_2\check{v}_3, \check{v}_3\check{v}_4, \check{v}_4\check{v}_1\}$ be the set of edges. Then

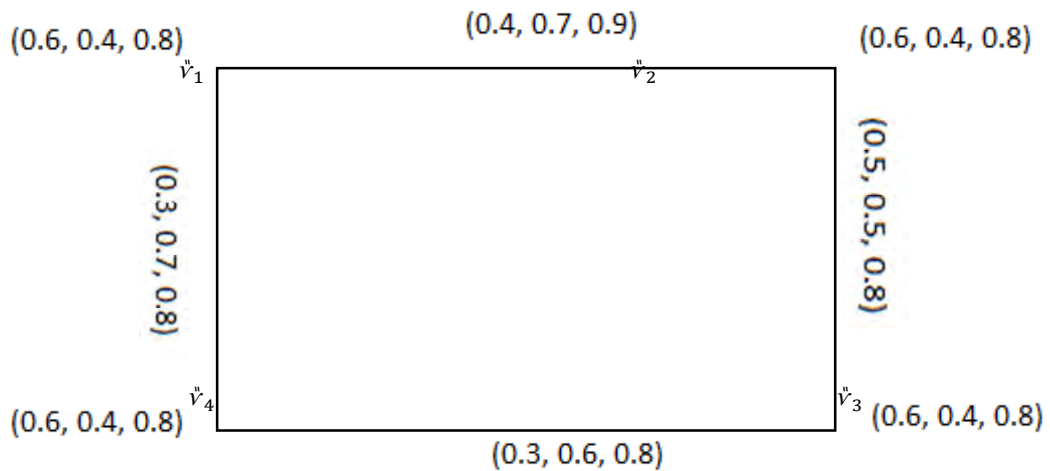

Figure 8. SVNG

$(\hat{T}_1, \hat{I}_1, F_1)$ is a constant function But neither constant SVNG nor totally constant SVNG.

4 Characterization of constant SVNG on a cycle

This section is based on some important results on even (odd) cycles, bridges in SVNGs and cut vertex of even (odd) cycle. The stated results are supported with some examples. .

Theorem 3. If G is an SVNG where crisp graph G is an odd cycle. Then G is constant SVNG iff $(\hat{T}_2, \hat{I}_2, F_2)$ is a constant function.

Proof. Suppose $(\hat{T}_2, \hat{I}_2, F_2)$ is constant function $\hat{T}_2 = \hat{c}_1, \hat{I}_2 = \hat{c}_2,$ and $F_2 = \hat{c}_3$ for all $(\check{v}_i, \check{v}_j) \in \check{E}$. Then $d_{\hat{T}}(\check{v}_i) = 2\hat{c}_1, d_{\hat{I}}(\check{v}_i) = 2\hat{c}_2$ and $d_{F_2}(\check{v}_i) = 2\hat{c}_3$ for all $\check{v}_i \in \check{V}$ SoG is constant SVNG.

Conversely, assume that G is (k_1, k_2, k_3) –regular SVNG. If $e_1, e_2, e_3 \dots e_{2n+1}$ be the edges of G in that order. If $\hat{T}_2(e_1) = \hat{c}_1, \hat{T}_2(e_2) = k_1 - \hat{c}_1, \hat{T}_2(e_3) = k_1 - (k_1 - \hat{c}_1) = \hat{c}_1, \hat{T}_2(e_4) = k_1 - \hat{c}_1$ and so on. Likewise, $\hat{I}_2(e_1) = \hat{c}_2, \hat{I}_2(e_2) = k_2 - \hat{c}_2, \hat{I}_2(e_3) = k_2 - (k_2 - \hat{c}_2) = \hat{c}_2, \hat{I}_2(e_4) = k_2 - \hat{c}_2$ and $F_2(e_1) = \hat{c}_3, F_2(e_2) = k_3 - \hat{c}_3, F_2(e_3) = k_3 - (k_3 - \hat{c}_3) = \hat{c}_3, F_2(e_4) = k_3 - \hat{c}_3$ and so on. Therefore

$$\hat{T}_2(e_i) = \begin{cases} \hat{c}_1, & \text{if } i \text{ is odd} \\ k_1 - \hat{c}_1, & \text{if } i \text{ is even} \end{cases}$$

Hence $\hat{T}_2(e_1) = \hat{T}_2(e_{2n+1}) = \hat{c}_1$. So, if e_1 and e_{2n+1} incident at a vertex \check{v}_1 , then $d_{\hat{T}}(\check{v}_1) = k_1, d(e_1) + d(e_{2n+1}) = k_1, \hat{c}_1 + \hat{c}_1 = k_1, 2\hat{c}_1 = k_1, \hat{c}_1 = \frac{k_1}{2}$.

Remark 3. The above theorem (3) is not true for totally constant SVNG.

Example 8. Consider a graph $G = (\check{V}, \check{E})$ where $\check{V} = \{\check{v}_1, \check{v}_2, \check{v}_3\}$ be the set of vertices and $\check{E} = \{\check{v}_1\check{v}_2, \check{v}_2\check{v}_3, \check{v}_3\check{v}_1\}$ be the set of edges. Then

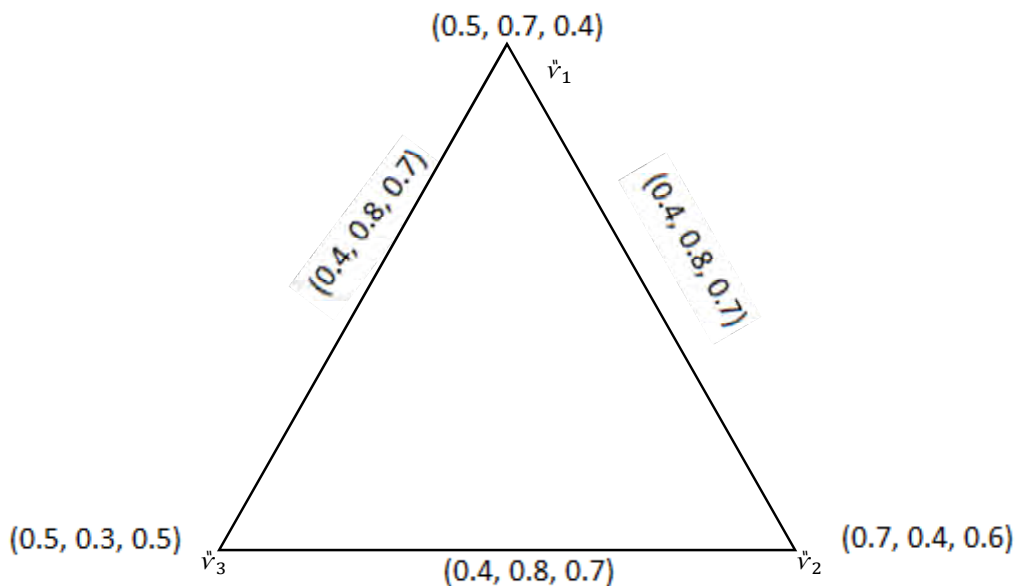

Figure 9. SVNG

$(\hat{T}_2, \hat{I}_2, F_2)$ is constant function but not totally constant.

Theorem 4. If G is an SVNG where crisp graph G is an even cycle. Then G is constant SVNG iff either $(\hat{T}_2, \hat{I}_2, F_2)$ is a constant function or alternative edges have same membership, indeterminacy and non-membership values.

Proof. If $(\hat{T}_2, \hat{I}_2, F_2)$ is a constant function then G is constant SVNG. Conversely, assume that G is (k_1, k_2, k_3) –constant SVNG. If $e_1, e_2, e_3 \dots e_{2n}$ be the edges of even cycle G in that order. By using the above theorem (3), $\hat{T}_2(e_i) = \begin{cases} \hat{c}_1, & \text{if } i \text{ is odd} \\ k_1 - \hat{c}_1, & \text{if } i \text{ is even} \end{cases}, \hat{I}_2(e_i) = \begin{cases} \hat{c}_2, & \text{if } i \text{ is odd} \\ k_2 - \hat{c}_2, & \text{if } i \text{ is even} \end{cases}$

And

$F_2(e_i) = \begin{cases} \hat{c}_3, & \text{if } i \text{ is odd} \\ k_3 - \hat{c}_3, & \text{if } i \text{ is even} \end{cases}$. If $\hat{c}_1 = k_1 - \hat{c}_1$, the $(\hat{T}_2, \hat{I}_2, F_2)$ is constant function. If $\hat{c}_1 \neq k_1 - \hat{c}_1$ then alternative edges have same membership, indeterminacy and non-membership values.

Remark 4. The above theorem (4) is not true for totally constant SVNG.

Example 9. Consider a graph $G = (\check{V}, \check{E})$ where $\check{V} = \{\check{v}_1, \check{v}_2, \check{v}_3, \check{v}_4\}$ be the set of vertices and $\check{E} = \{\check{v}_1\check{v}_2, \check{v}_2\check{v}_3, \check{v}_3\check{v}_4, \check{v}_4\check{v}_1\}$ be the set of edges. Then

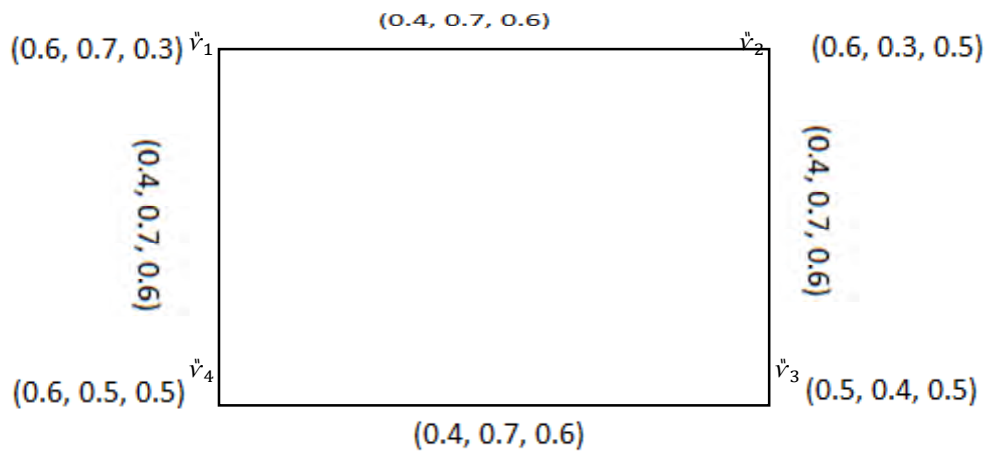

Figure 10.SVNG

$(\hat{T}_2, \hat{I}_2, F_2)$ is constant function, then G is constant SVNG. But not totally constant SVNG.

Theorem 5. If G is constant SVNG is an odd cycle does not have SVN bridge. Hence it does not have SVN cut-vertex.

Proof. Suppose G is constant SVNG is an odd cycle of its crisp graph. Then $(\hat{T}_2, \hat{I}_2, F_2)$ is constant function. Therefore removal any edge does not reduce the strength of connectedness between any pair of vertex. Therefore G has no SVN edge and Hence there is no SVN cut vertex.

Remark 5. For totally constant the above theorem (5) is not true.

Example 10. Consider a graph $G = (V, E)$ where $V = \{v_1, v_2, v_3\}$ be the set of vertices and $E = \{v_1v_2, v_2v_3, v_3v_1\}$ be the set of edges. Then

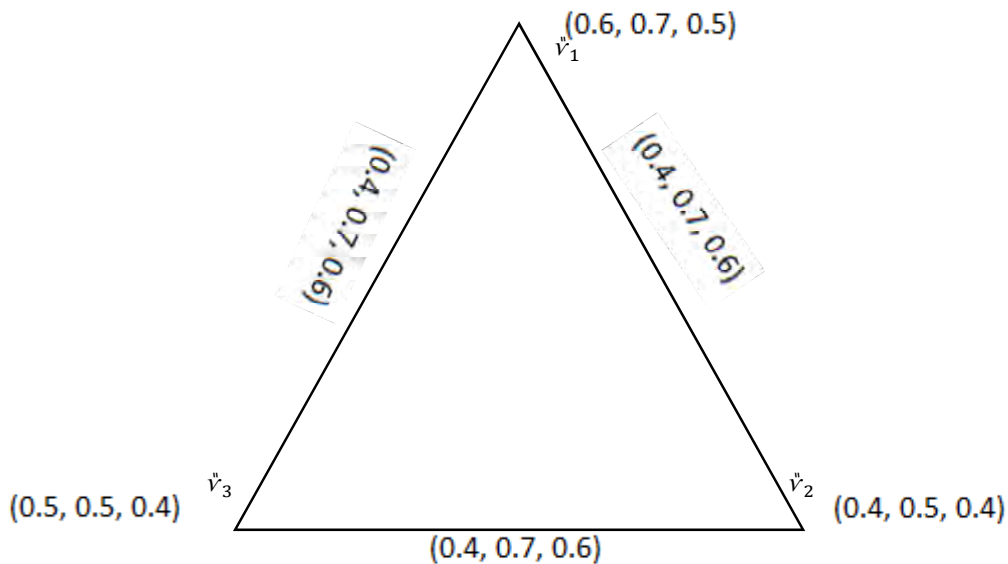

Figure 11 .SVNG

$(\hat{T}_2, \hat{I}_2, F_2)$ is constant function, but neither SVN bridge nor SVN cut vertex.

Theorem 6. If G is constant SVNG is an even cycle of its crisp graph. Then either G does not have SVN bridge also it does not have SVN cut vertex.

Proof. Straightforward.

Remark 6. For totally constant the above theorem (6) is not true.

Example 11. Consider a graph $G = (\check{V}, \check{E})$ where $\check{V} = \{\check{v}_1, \check{v}_2, \check{v}_3, \check{v}_4\}$ be the set of vertices and $\check{E} = \{\check{v}_1\check{v}_2, \check{v}_2\check{v}_3, \check{v}_3\check{v}_4, \check{v}_4\check{v}_1\}$ be the set of edges. Then

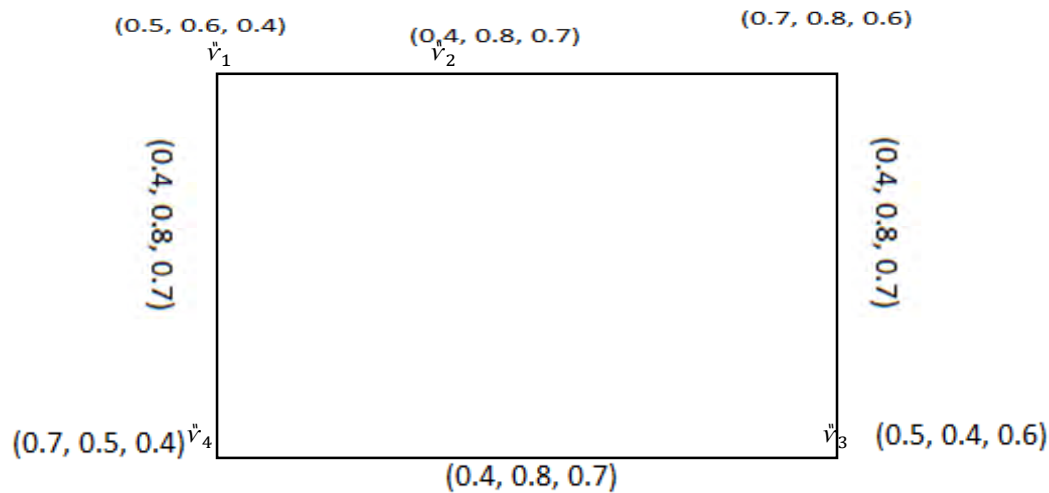

Figure 12.SVNG

$(\hat{T}_2, \hat{I}_2, F_2)$ is constant function, but neither SVN bridge nor SVN cut vertex.

5 Application

In this section, we applied the concept of CSVNG to model a Wi-Fi system. It is discussed how the concept of CSVNGs is useful in modelling such network.

The Wi-Fi technology that is connected to the internet can be employed to deliver access to devices which are within the range of a wireless networks. The coverage extension can be as small area as few rooms to large as many square kilometres among two or more interconnected access points. The dependency of Wi-Fi range is on frequency band, radio power production and modulation techniques. Paralleled to traditional wired network security which is wired networking, simplified access is basic problem with wireless network security, it is essential that one either gain access to building (connecting/ relating into interior web tangibly), or a break through an exterior firewall. To facilitate Wi-Fi, one essentially require to be within the range of Wi-Fi linkage. The solid Wi-Fi hotspot device is the internal coin Wi-Fi which is designed to aid all internal setting owners. Make available 100 meters Wi-Fi signal range to outdoor and 30 meters to indoor. With the help of CSVNG this type of Wi-Fi linkage is deliberated and demonstrated.

The CSVNG is useful to a Wi-Fi network. The purpose for doing this is that there are three values in aCSVNG. The first one signifies connectivity, the second one defined the technical error of the device such as device is in range but changes between the connected and disconnected state and the third value indicates the disconnectivity. The notion of IFG only permits us to model two states such as connected and disconnected, a Wi-Fi system cannot be demonstrated using this confined structure of IFG. Though the CSVNG deliberate more than these two similarities.

An outdoor Wi-Fi co-ordination, comprises four vertices which characterise the Wi-Fi devices in such a way that there is a block between each two routers and collectively both routers have been giving signals to the block, given away in figure (13). The devices can provide signal to each block with the help of CSVNG persistently.

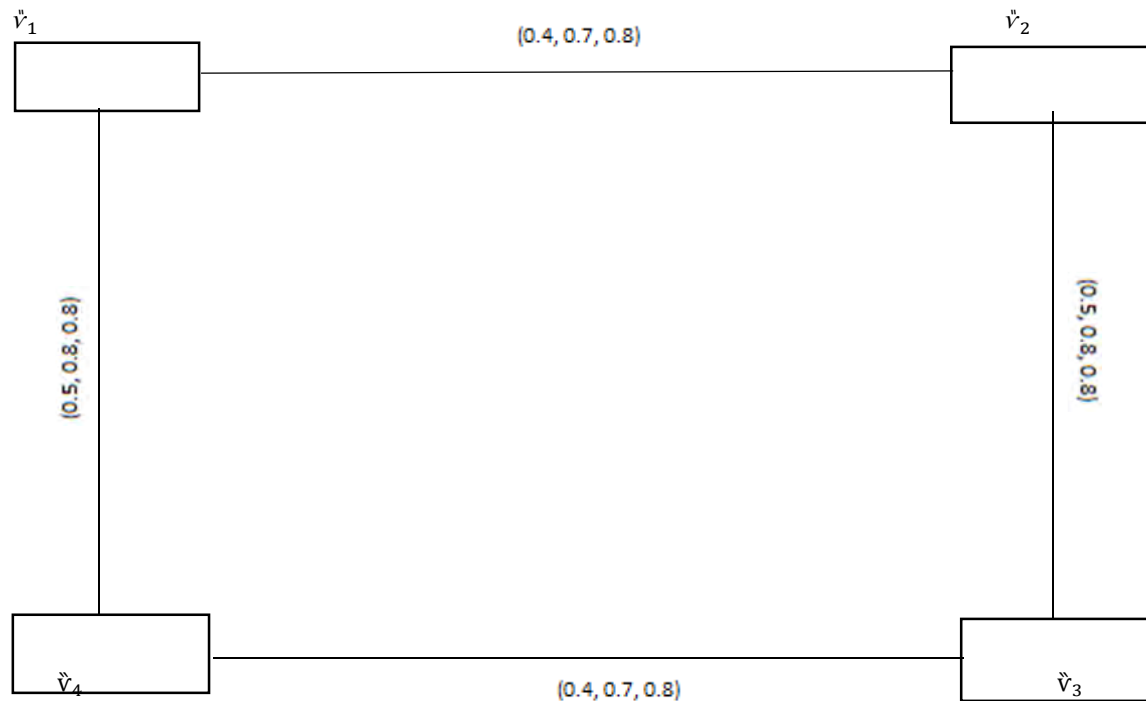

Figure 13.SVNG.

In figure 13, the four apexes denotes four different routers. The edge displays the signal strength of routers between each two routers. Each edge and apex take the single valued neutrosophic number form where the first value denotes the connectivity, the second one defined the technical error of the device, changes between the connected and disconnected state while the device is in range but, and the third value displays the disconnectivity. By using definition 4, the degree of every vertex is deliberated. In this situation which characterises that all router has been giving the same signal, so the degree of all routers is same. This also indicates that each router providing the same signal to the block. As a consequence, the concept of CSVNG displaying its importance, has been exercised to practical operations effectively.

Table 1 shows the degree of each vertex of figure 13.

vertex	Degree
\check{v}_1	(0.9, 1.5, 1.6)
\check{v}_2	(0.9, 1.5, 1.6)
\check{v}_3	(0.9, 1.5, 1.6)
\check{v}_4	(0.9, 1.5, 1.6)

Table 1 .vertex and its degree

Advantages:

The advantages of SVNGs over prevailing concepts of IFGs is due to the enhanced structure of SVNGs which allows us to deal with of more than two types ambiguous condition as it is done in the present situation of Wi-Fi

system. While the IFG allow only to deal with two states connected and disconnected which means that IFGs cannot be employed to model the Wi-Fi system.

Conclusion:

The conception of CSVNG has been developed in this paper. With the help of examples, basic graph theoretic ideas such as degree of CSVNG, constant functions, totally CSVNG and characterization of CSVNG on a cycle are proved. That notion of CSVNG have been applied to a real-world problem of Wi-Fi system and the consequences are deliberated. A comparison of CSVNG with CIFG have showed the worth of CSVNGs. Further, in the proposed frame work, implementations in the field of engineering and computer sciences can be considered in near future.

References

- [1] Atanassov, K. T. Intuitionistic fuzzy sets. *Fuzzy sets and Systems*.20(1), 1986, 87-96.
- [2] M.Akram and B.Davvaz. Strong intuitionistic fuzzy graphs.*Filomat*, 26, 2012, 177–196.
- [3] M.Akram and W. A.Dudek. Intuitionistic fuzzy hypergraphs with applications. *Information Sciences*, 218, 2013, 182–193.
- [4] M.Akram& S. Shahzadi andA.Borumandsaeid. Single-valued neutrosophichypergraphs. *TWMS Journal of Applied and Engineering Mathematics*. 2016.
- [5] M.Akram&G.Shahzadi.Operations on single-valued neutrosophic graphs. *Infinite Study* (2017).
- [6] J. C.Bezdek and J. D.Harris. Fuzzy partitions and relations an axiomatic basis for clustering. *Fuzzy Sets and Systems* 1, 1978, 111–127.
- [7] Broumi, S., Talea, M., Bakali, A., &Smarandache, F.Single valued neutrosophic graphs. *FlorentinSmarandache, SurapatiPramanik*, 2015, 187.
- [8] S.Broumi, F.Smarandache, M.Talea&A. Bakali, Single valued neutrosophic graphs: degree, order and size. In *Fuzzy Systems (FUZZ-IEEE)*, 2016 IEEE International Conference on, pp. 2444-2451.
- [9] S.Broumi,M.Talea,A.Bakali&F.Smarandache.Interval valued neutrosophic graphs. *Critical Review*, XII, 2016, 5-33.
- [10] S.Broumi, M.Talea,F.Smarandache&A. Bakali. Decision-making method based on the interval valued neutrosophic graph. In *Future Technologies Conference (FTC)*, 2016 pp. 44-50. IEEE.
- [11] S.Broumi,M.Talea, A.Bakali&F.Smarandache.On strong interval valued neutrosophic graphs. *Critical review*, 12, 2016, 49-71.
- [12] S.Broumi, A.Bakali,M. Talea, F.Smarandache& M. Ali.Shortest path problem under bipolar neutrosophic setting. In *Applied Mechanics and Materials*, Vol. 859, 2017, pp. 59-66
- [13] S. M.Chen, Randyanto and S. H.Cheng. Fuzzy queries processing based on intuitionistic fuzzy social relational networks. *Information Sciences*, 327, 2016, 110-24.
- [14] B.Ding, A clustering dynamic state method for maximal trees in fuzzy graph theory. *J. Numer. Methods Comput. Appl.* 13, 1992, 157–160.
- [15] A. N.Gani, S. S.Begum. Degree, order and size in intuitionistic fuzzy graphs. *International journal of algorithms, Computing and Mathematics*, 3(3), 2010, 11-6.
- [16] Pramanik, S., Dalapati, S., Alam, S., Smarandache, S., & Roy, T.K. (2018). NS-cross entropy based MAGDM under r single valued neutrosophic set environment. *Information*, 9(2), 37; doi:10.3390/info9020037.
- [17] F.Harary and R. Z.Norman, *Graph Theory as a Mathematical Model in Social Science*. Ann Arbor, Mich., Institute for Social Research, 1953.
- [18] F.Harary and I. C Ross. The Number of Complete Cycles in a Communication Network. *Journal of Social Psychology*, 40, 1953, 329–332.
- [19] F.Harary. Graph Theoretic Methods in the Management Sciences. *Management Science*, 5, 1959, 387–403.
- [20] A. Kaufmann, *Introduction à la Théorie des sous-ensembles flous*.I, Masson Paris, 1973. 41–189.
- [21] P.Karthick, and S.Narayanamoorthy. The Intuitionistic Fuzzy Line Graph Model to Investigate Radio Coverage Network. *International Journal of Pure and Applied Mathematics*, 109 (10), 2016, 79-87.
- [22] I.Kandasamy, and F. Smarandache. Triple Refined Indeterminate Neutrosophic Sets for Personality Classification. in *Computational Intelligence (SSCI)*, 2016 IEEE Symposium Series on. 2016. IEEE.
- [23] M. G Karunambigai, M. Akram, S. Sivasankar and K. Palanivel, *Int. J. Unc. Fuzz. Knowl. Based Syst.* 25, 2017, 367-383.
- [24] I.Kandasamy, and F. Smarandache. Multicriteria decision making using double refined indeterminacy neutrosophic cross entropy and indeterminacy based cross entropy. in *Applied Mechanics and Materials*. 2017. Trans Tech Publ.
- [25] A. A.Keller. Graph theory and economic models: from small to large size applications. *Electronic Notes in Discrete Mathematics*, 28, 2007, 469-476.
- [26] A.Kiss.An application of fuzzy graphs in database theory, *Automata. languages and programming systems* (Salgotarjan 1990) *Pure Math, Appl. Ser. A*, 1, 1991, 337–342.

- [27] L. T.Kóczy. Fuzzy graphs in the evaluation and optimization of networks. *Fuzzy Sets and Systems* 46, 1992, 307–319.
- [28] M.G. Karunambigai, R. Parvathi, R.Buvaswari. Constant Intuitionistic Fuzzy graphs NIFS (2011), 1, 37-47.
- [29] W. J.Liu. On some systems of simultaneous equations in a completely distributive lattice. *Inform. Sci.* **50**, 1990, 185–196.
- [30] D. W.Matula. k -components, clusters, and slicings in graphs. *SIAM J. Appl. Math.* 22, 1972, 459–480.
- [31] J. N.Mordeson and C-S.Peng. Fuzzy intersection equations, *Fuzzy Sets and Systems* 60, 1993, 77–81.
- [32] J. N.Mordeson & P. S. Nair. Applications of fuzzy graphs. In *Fuzzy Graphs and Fuzzy Hypergraphs Physica, Heidelberg*, 2000, pp. 83-133.
- [33] S.Mukherjee. Dijkstra's algorithm for solving the shortest path problem on networks under intuitionistic fuzzy environment. *Journal of Mathematical Modelling and Algorithms*, 11(4), 2012, 345-359.
- [34] R.Myna. Application of Fuzzy Graph in Traffic. *International Journal of Scientific & Engineering Research*, 2015, 1692-1696.
- [35] T .Neumann. Routing Planning as An Application of Graph Theory with Fuzzy Logic. *TransNav, the International Journal on Marine Navigation and Safety of Sea Transportation*, 10(4), 2016.
- [36] R.Parvathi & M. G. Karunambigai. Intuitionistic fuzzy graphs. In *Computational Intelligence, Theory and Applications*, Springer, Berlin, Heidelberg, 2006, pp. 139-150.
- [37] R.Parvathi, M. G.Karunambigai and K. T.Atanassov. Operations on intuitionistic fuzzy graphs. In: *Proceedings of the IEEE International Conference on Fuzzy Systems*, IEEE, 2009, 1396–1401.
- [38] R. Parvathi, S. Thilagavathi and M. G Karunambigai. Intuitionistic fuzzy hypergraphs. *Cybernetics and Information Technologies*, 9(2), 2009, 46-53.
- [39] I. C.Ross and F.Harary. A Description of Strengthening and Weakening Members of a Group. *Sociometry*, 22, 1959, 139–147.
- [40] A.Rosenfeld. Fuzzy graphs. In: L. A. Zadeh, K. S. Fu, M. Shimura, Eds., *Fuzzy Sets and Their Applications*, Academic Press, 1975, 77–95.
- [41] S. G.Shirininivas, S.Vetrivel and N. M.Elango. Applications of graph theory in computer science an overview. *International Journal of Engineering Science and Technology*, 2(9), 2010, 4610-4621.
- [42] Smarandache, F. & Pramanik, S. (Eds). (2018). *New trends in neutrosophic theory and applications*, Vol.2. Brussels: Pons Editions.
- [43] E.Takeda and T.Nishida. An application of fuzzy graph to the problem concerning group structure. *J. Operations Res. Soc. Japan* 19, 1976, 217–227.
- [44] J.Xu. The use of fuzzy graphs in chemical structure research. In: D.H. Rouvry, Ed., *Fuzzy Logic in Chemistry*, Academic Press, 1997, 249–282.
- [45] R.T.Yeh and S.Y.Bang. Fuzzy relations, fuzzy graphs, and their applications to clustering analysis. In: L. A. Zadeh, K. S. Fu, M. Shimura, Eds., *Fuzzy Sets and Their Applications*, Academic Press, 1975, 125–149.
- [46] L. A Zadeh. *Fuzzy Sets. Information and Control.* 8, 1965, 338–353.
- [47] S.Broumi, Rao V.Venkateswara, M.Talea, A. Bakali, P.K. Singh and F.Smarandache. Single-Valued Neutrosophic Techniques for Analysis of WIFI Connection. in *Proceedings Springer Books (Advances in Intelligent Systems and Computing)*, 2018, in press
- [48] Surapati Pramanik, Rama Mallick: VIKOR based MAGDM Strategy with Trapezoidal Neutrosophic Numbers, *Neutrosophic Sets and Systems*, vol. 22, 2018, pp. 118-130. DOI: 10.5281/zenodo.2160840
- [49] Dalapati, S., Pramanik, S., Alam, S., Smarandache, S., & Roy, T.K. (2017). IN-cross entropy based magdm strategy under interval neutrosophic set environment. *Neutrosophic Sets and Systems*, 18, 43-57. <http://doi.org/10.5281/zenodo.1175162>
- [50] Biswas, P., Pramanik, S., & Giri, B. C. (2018). Distance measure based MADM strategy with interval trapezoidal neutrosophic numbers. *Neutrosophic Sets and Systems*, 19, 40-46.
- [51] Biswas, P., Pramanik, S., & Giri, B. C. (2018). TOPSIS strategy for multi-attribute decision making with trapezoidal numbers. *Neutrosophic Sets and Systems*, 19, 29-39.
- [52] Biswas, P., Pramanik, S., & Giri, B. C. (2018). Multi-attribute group decision making based on expected value of neutrosophic trapezoidal numbers. In F. Smarandache, & S. Pramanik (Eds., vol.2), *New trends in neutrosophic theory and applications* (pp. 103-124). Brussels: Pons Editions.
- [53] Mondal, K., Pramanik, S., & Giri, B. C. (2018). Single valued neutrosophic hyperbolic sine similarity measure based MADM strategy. *Neutrosophic Sets and Systems*, 20, 3-11. <http://doi.org/10.5281/zenodo.1235383>
- [54] Mondal, K., Pramanik, S., & Giri, B. C. (2018). Hybrid binary logarithm similarity measure for MAGDM problems under SVNS assessments. *Neutrosophic Sets and Systems*, 20, 12-25. <http://doi.org/10.5281/zenodo.1235365>
- [55] Biswas, P, Pramanik, S. & Giri, B.C. (2016). Aggregation of triangular fuzzy neutrosophic set information and its application to multi-attribute decision making. *Neutrosophic Sets and Systems*, 12, 20-40.

- [56] Biswas, P, Pramanik, S. & Giri, B.C. (2016). Value and ambiguity index based ranking method of single-valued trapezoidal neutrosophic numbers and its application to multi-attribute decision making. *Neutrosophic Sets and Systems*, 12, 127-138.
- [57] Mondal, K., & Pramanik, S. (2015). Neutrosophic decision making model for clay-brick selection in construction field based on grey relational analysis. *Neutrosophic Sets and Systems*, 9, 64-71.
- [58] Mondal, K., & Pramanik, S. (2015). Neutrosophic tangent similarity measure and its application to multiple attribute decision making. *Neutrosophic Sets and Systems*, 9, 85-92.
- [59] Biswas, P., Pramanik, S., & Giri, B.C. (2015). Cosine similarity measure based multi-attribute decision-making with trapezoidal fuzzy neutrosophic numbers. *Neutrosophic Sets and Systems*, 8, 46-56.
- [60] Biswas, P, Pramanik, S. & Giri, B.C. (2014). A new methodology for neutrosophic multi-attribute decision-making with unknown weight information. *Neutrosophic Sets and Systems*, 3, 42-50.
- [61] Biswas, P, Pramanik, S. & Giri, B.C. (2014). Entropy based grey relational analysis method for multi-attribute decision making under single valued neutrosophic assessments. *Neutrosophic Sets and Systems*, 2, 102-110.
- [62] R. Dhavaseelan, S. Jafari, M. R. Farahani, S. Broumi: On single-valued co-neutrosophic graphs, *Neutrosophic Sets and Systems*, vol. 22, 2018, pp. 180-187. DOI: 10.5281/zenodo.2159886
- [63] S. Broumi, A. Dey, A. Bakali, M. Talea, F. Smarandache, L. H. Son, D. Koley: Uniform Single Valued Neutrosophic Graphs, *Neutrosophic Sets and Systems*, vol. 17, 2017, pp. 42-49. <http://doi.org/10.5281/zenodo.1012249>
- [64] Muhammad Aslam Malik, Ali Hassan, Said Broumi, Florentin Smarandache: Regular Single Valued Neutrosophic Hypergraphs, *Neutrosophic Sets and Systems*, vol. 13, 2016, pp. 18-23. doi.org/10.5281/zenodo.570865
- [65] Pramanik, S., Biswas, P., & Giri, B. C. (2017). Hybrid vector similarity measures and their applications to multi-attribute decision making under neutrosophic environment. *Neural Computing and Applications*, 28 (5), 1163-1176. DOI 10.1007/s00521-015-2125-3.
- [66] P. Biswas, S. Pramanik, B.C. Giri. (2016). TOPSIS method for multi-attribute group decision making under single-valued neutrosophic environment. *Neural Computing and Applications*, 27(3), 727-737. doi: 10.1007/s00521-015-1891-2.
- [67] Biswas, P., Pramanik, S., & Giri, B. C. (2018). Neutrosophic TOPSIS with group decision making. In C. Kahraman & I. Otay (Eds.): C. Kahraman and I. Otay (eds.), *Fuzzy Multicriteria Decision Making Using Neutrosophic Sets, Studies in Fuzziness and Soft Computing* 369. doi. https://doi.org/10.1007/978-3-030-00045-5_21
- [68] M. Abdel-Basset, M. Gunasekaran, M. Mohamed & F. Smarandache: A novel method for solving the fully neutrosophic linear programming problems. *Neural Computing and Applications*, 2018, pp. 1-11.
- [69] M. Abdel-Basset, M. Mohamed & V. Chang. NMCDA: A framework for evaluating cloud computing services. *Future Generation Computer Systems*, 86, 2018, pp. 12-29.
- [70] M. Abdel-Basset, Y. Zhou, M. Mohamed & V. Chang. A group decision making framework based on neutrosophic VIKOR approach for e-government website evaluation. *Journal of Intelligent & Fuzzy Systems*, 34(6), 2018, pp. 4213-4224.
- [71] M. Abdel-Basset, M. Mohamed, Y. Zhou & I. Hezam. Multi-criteria group decision making based on neutrosophic analytic hierarchy process. *Journal of Intelligent & Fuzzy Systems*, 33(6), 2017, pp. 4055-4066.

Shortest Path Problem using Bellman Algorithm under Neutrosophic Environment

Said Broumi, Arindam Dey, Mohamed Talea, Assia Bakali, Florentin Smarandache, Deivanayagampillai Nagarajan, Malayalan Lathamaheswari, Ranjan Kumar

Said Broumi, Arindam Dey, Mohamed Talea, Assia Bakali, Florentin Smarandache, Deivanayagampillai Nagarajan, Malayalan Lathamaheswari, Ranjan Kumar (2019). Shortest Path Problem using Bellman Algorithm under Neutrosophic Environment. *Complex & Intelligent Systems* 5: 409-416; DOI: 10.1007/s40747-019-0101-8

Abstract

An elongation of the single-valued neutrosophic set is an interval-valued neutrosophic set. It has been demonstrated to deal indeterminacy in a decision-making problem. Real-world problems have some kind of uncertainty in nature and among them; one of the influential problems is solving the shortest path problem (SPP) in interconnections. In this contribution, we consider SPP through Bellman's algorithm for a network using interval-valued neutrosophic numbers (IVNNs). We proposed a novel algorithm to obtain the neutrosophic shortest path between each pair of nodes. Length of all the edges is accredited an IVNN. Moreover, for the validation of the proposed algorithm, a numerical example has been offered. Also, a comparative analysis has been done with the existing methods which exhibit the advantages of the new algorithm.

Keywords Interval-valued neutrosophic numbers · Ranking methods · Shortest path problem · Bellman's algorithm · Directed graph network

Introduction and review of the literature

A tool which represents the partnership or relationship function is called a Fuzzy Set (FS) and handles the real-world problems in which generally some type of uncertainty exists [1]. This concept was generalized by Atanassov [2] to intuitionistic fuzzy set (IFS) which is determined in terms of membership (MS) and non-membership (NMS) functions,

the characteristic functions of the set. Beside this, several theories have been developed for uncertainties, including generalized orthopair FSs [3], Pythagorean FSs [4], picture FSs [5], hesitant interval-based neutrosophic linguistic sets [6], N-valued interval neutrosophic sets (NVINSs) [7], generalized interval-valued triangular intuitionistic FSs [8], interval-valued trapezoidal intuitionistic FSs [9],

interval-valued Pythagorean FSs [10], interval-valued IFSs [11], and interval type 2 FSs [12].

In 1995, Smarandache [13] premises the theme of neutrosophic sets (NS). The NS is to be a set of elements having a membership degree, indeterminate membership and also non-membership with the criterion less than or equal to 3. The neutrosophic number is an exceptional type of neutrosophic sets that extend the domain of numbers from those of real numbers to neutrosophic numbers. By generalizing SVN_Ss [14], Wang et al. premised the idea of IVNS. The IVNS [15] is a more general database to generalize the concept of different types of sets to express membership degrees' truth, indeterminacy, and a false degree in terms of intervals. Thus, several papers are published in the field of fuzzy and neutrosophic sets [46–62].

Harish [16] proposed and analyzed an extension of the score function by incorporating hesitance. The authors presented an algorithm for the function including qualitative examples. Jun et al. [17] discuss IN_Ss in algebra of BCK/BCI. Mehmet [18] put forward for analyzing the concept of the interval cut set (ICS) and strong ICS (α, β, γ) of IVNSs with proof and examples. Also, there are other several extensions of NSs described in the literature including interval-valued bipolar neutrosophic sets [19], hesitant interval neutrosophic linguistic set [20], and interval neutrosophic hesitant fuzzy sets [21]; for more details of neutrosophic set and their extensions, we refer the reader to [22–28].

Among humanistic problems of computer science, finding the shortest path is one of the significant problems. Many of the algorithms existing for optimization assumed the edge weights as the absolute real numbers. Despite this, we need to deal inexplicit parameters such as scope, costs, time and requirements in real-world problems. For example, a substantial length of any road is permanent; still, traveling time along the road varies according to weather and traffic conditions. An uncertain fact of those cases directs us to adopt fuzzy logic, fuzzy numbers, intuitionistic fuzzy and so on.

The SPP using fuzzy numbers is called fuzzy shortest path problem (FSPP). Several researchers are paying attention in fuzzy shortest path (FSP) and intuitionistic FSP algorithms.

Das and De [29] employed Bellman dynamic programming problem for solving FSP based on value and ambiguity of trapezoidal intuitionistic fuzzy numbers. De and Bhincher [30] have studied the FSP in a network under triangular fuzzy number (TFN) and trapezoidal fuzzy number (TpFN) using two approaches such as influential programming of Bellman and linear programming with multi-objective. Kumar et al. [31] proposed a model to find the SP of the network under intuitionistic trapezoidal fuzzy number based on interval value. Meenakshi and Kaliraja [32] formulated interval-valued FSPP for interval-valued type and developed a technique to solve SPP.

Elizabeth and Sujatha [33] solved FSPP using interval-valued fuzzy matrices. Based on traditional Dijkstra algorithm, Enayattabar et al. [34] solved SPP in the interval-valued pythagorean fuzzy setting. Dey et al. [35] formulated fuzzy shortest path problem with interval type 2 fuzzy numbers. But, if the indeterminate information has appeared, all these kinds of shortest path problems failed. For this reason, some new approaches have been developed using neutrosophic numbers. Then neutrosophic shortest path was first developed by Broumi et al. [36]. The authors in [36] constructed an extension of Dijkstra algorithm to solve neutrosophic SPP. Then they used the extended version to treat the NSPP where the edge weight is characterized by IVNNs [37].

Broumi et al. [38–40] first introduced a technique of finding SP under SV-trapezoidal and triangular fuzzy neutrosophic environment. In [41], the authors proposed another approach to solve SPP on a network using trapezoidal neutrosophic numbers. Broumi et al. [42] developed a new algorithm to solve SPP using bipolar neutrosophic setting. In another paper, Broumi et al. [43] discussed an algorithmic approach based on a score function defined in [44] for

Table 1 Authors' contributions towards neutrosophic shortest path problem

Author and references	Year	Contribution
Broumi et al. [36]	2016	Solved NSPP using Dijkstra algorithm
Broumi et al. [37]	2016	Solved NSPP for interval-based data using Dijkstra algorithm
Broumi et al. [38]	2016	Discovered the SP using SV-TpNNs
Broumi et al. [40]	2016	Worked out SPP using single-valued neutrosophic graphs
Broumi et al. [41]	2017	Solved SPP under neutrosophic setting as well as trapezoidal fuzzy
Broumi et al. [42]	2017	Solved SPP under bipolar neutrosophic environment.
Broumi et al. [43]	2017	Dealt SPP under interval-valued neutrosophic setting
Broumi et al. [44]	2018	Proposed maximizing deviation method with partial weight in a decision-making problem under the neutrosophic environment
This paper	–	Introduction of the neutrosophic version of a Bellman's algorithm

IVN interval-valued neutrosophic, *PA* proposed algorithm

solving NSPP on a network with IVNN as the edges. Liu and You proposed interval neutrosophic Muirhead mean operators and their applications in multiple-attribute group decision-making [45]. Thus, several papers are published in the field of neutrosophic sets [46–55]. Table 1 summarizes some contributions towards NSPP. Based on the idea of Bellman’s algorithm, SPP is solved for fuzzy network [29–32]. This algorithm is not applied yet on neutrosophic network. Therefore, there is a need to establish a neutrosophic version of Bellman’s algorithm for neutrosophic shortest path problems.

The main motivation of this study is to introduce an algorithmic approach for SPP in an uncertain environment which will be simple enough and effective in real-life problem. The main contributions of this paper are as follows.

- We concentrate on a NSP on a neutrosophic graph in which an IVNN, instead of a real number/fuzzy number, is assigned to each arc length.
- A modified Bellman’s algorithm is introduced to deal the shortest path problem in an uncertain environment.
- Based on the idea discussed in [15], we use an addition operation for adding the IVNNs corresponding to the edge weights present in the path. It is used to find the path length between source and destination nodes. We also use a ranking method to choose the shortest path associated with the lowest value of rank.

In this work, we are motivated to solve SPP by introducing a new version of BA where the edge weight is represented by IVNNs. The remaining part of the paper is presented as follows. The next section contains a few of the ideas and theories as overview of interval neutrosophic set followed by which the Bellman algorithm is discussed. In the subsequent section, an analytical illustration is presented, where our algorithm is applied. Then contingent study has been done with existing methods. Before the concluding section, advantages of the proposed algorithm are presented. Finally, conclusive observations are given.

Overview on interval-valued neutrosophic set

In this part, we recall few primary notions pertaining to NSs, SVNSs, IVNSs and some existing ranking functions for IVNNs which are the background of this study and will help us to further research.

Definition 1 [13] Let X be a set of elements and its universal elements denoted by x ; we define the neutrosophic set A (NS A) by $A = \{ \langle x: T_A(x), I_A(x), F_A(x) \rangle, x \in X \}$, where the functions $T, I, F: X \rightarrow]-0, 1^+[$ are called the truth,

indeterminate and false MS functions, respectively, and they satisfy the following condition:

$$-0 \leq T_A(x) + I_A(x) + F_A(x) \leq 3^+ \tag{1}$$

The values of the three MS functions are taken from $]^-0, 1^+[$. As we have difficulty of applying NSs to real-time issues, Wang et al. [14] put forward the approach of a SVNS, which is the simplification of a NS and can be applied to any real-world topic.

Definition 2 [14] \ddot{A} is the SVNS in X and is described by the set:

$$\ddot{A} = \{ \langle x : T_{\ddot{A}}(x), I_{\ddot{A}}(x), F_{\ddot{A}}(x) \rangle, x \in X \}, \tag{2}$$

where $T_{\ddot{A}}(x), I_{\ddot{A}}(x), F_{\ddot{A}}(x) \in [0, 1]$ satisfying the condition:

$$0 \leq T_{\ddot{A}}(x) + I_{\ddot{A}}(x) + F_{\ddot{A}}(x) \leq 3. \tag{3}$$

Definition 3 [15] An IVNS in X , which represented by:

$$\ddot{A} = \{ \langle x : \tilde{T}_{\ddot{A}}(x), \tilde{I}_{\ddot{A}}(x), \tilde{F}_{\ddot{A}}(x) \rangle, x \in X \}, \tag{4}$$

$$\ddot{A} = \{ \langle x : [T_{\ddot{A}}^L(x), T_{\ddot{A}}^U(x)], [I_{\ddot{A}}^L(x), I_{\ddot{A}}^U(x)], [F_{\ddot{A}}^L(x), F_{\ddot{A}}^U(x)] \rangle, x \in X \}, \tag{5}$$

where $[T_{\ddot{A}}^L(x), T_{\ddot{A}}^U(x)], [I_{\ddot{A}}^L(x), I_{\ddot{A}}^U(x)], [F_{\ddot{A}}^L(x), F_{\ddot{A}}^U(x)] \subseteq [0, 1]$ are the interval numbers satisfying the condition:

$$0 \leq \sup T_{\ddot{A}}(x) + \sup I_{\ddot{A}}(x) + \sup F_{\ddot{A}}(x) \leq 3. \tag{6}$$

Now we consider a few mathematical operations on interval-valued neutrosophic numbers (IVNNs)s.

Definition 4 [15] Let

$$\ddot{A} = \langle [T_a^L, T_a^U], [I_a^L, I_a^U], [F_a^L, F_a^U] \rangle \text{ and } \ddot{B} = \langle [T_b^L, T_b^U], [I_b^L, I_b^U], [F_b^L, F_b^U] \rangle,$$

be two IVNNs and $\eta > 0$.

Then

$$\ddot{A} \oplus \ddot{B} = \langle [T_a^L + T_b^L - T_a^L T_b^L, T_a^U + T_b^U - T_a^U T_b^U], [I_a^L I_b^L, I_a^U I_b^U], [F_a^L F_b^L, F_a^U F_b^U] \rangle, \tag{7}$$

$$\ddot{A} \otimes \ddot{B} = \langle [T_a^L T_b^L, T_a^U T_b^U], [I_a^L + I_b^L - I_a^L I_b^L, I_a^U + I_b^U - I_a^U I_b^U], [F_a^L + F_b^L - F_a^L F_b^L, F_a^U + F_b^U - F_a^U F_b^U] \rangle, \tag{8}$$

$$\eta \ddot{A} = \langle [1 - (1 - T_a^L)^\eta, 1 - (1 - T_a^U)^\eta], [(I_a^L)^\eta, (I_a^U)^\eta], [(F_a^L)^\eta, (F_a^U)^\eta] \rangle, \tag{9}$$

$$\ddot{A}^\eta = \langle [(T_a^L)^\eta, (T_a^U)^\eta], [1 - (1 - I_a^L)^\eta, 1 - (1 - I_a^U)^\eta], [1 - (1 - F_a^L)^\eta, 1 - (1 - F_a^U)^\eta] \rangle, \quad (10)$$

where $\eta > 0$.

Deneutrosophication formulas for interval-valued neutrosophic numbers

To compare two IVNNs \ddot{A}_1 and \ddot{A}_2 , a map from $[N(R)]$ to real line called score function has been used here. In the review of the literature, there are some formulas for deneutrosophication; in this paper, the following formulas have been focused [44, 45] and defined as follows:

$$S_{Ridvan}(\ddot{A}_1) = \left(\frac{1}{4}\right) \times [2 + T_x^L + T_x^U - 2I_x^L - 2I_x^U - F_x^L - F_x^U], \quad (11)$$

$$S_{Liu}(\ddot{A}_1) = \left[2 + \frac{T_x^L + T_x^U}{2} - \frac{I_x^L + I_x^U}{2} - \frac{F_x^L + F_x^U}{2} \right]. \quad (12)$$

Using score function (SF), the ranking technique is defined as below:

- (i) $\ddot{A}_1 < \ddot{A}_2$ if $SF(\ddot{A}_1) < SF(\ddot{A}_2)$.
- (ii) $\ddot{A}_1 > \ddot{A}_2$ if $SF(\ddot{A}_1) > SF(\ddot{A}_2)$.
- (iii) $\ddot{A}_1 = \ddot{A}_2$ if $SF(\ddot{A}_1) = SF(\ddot{A}_2)$.

Computation of the shortest path based on neutrosophic numbers

In this section, the new algorithmic approach to solve IVNSP is provided. It is pretended that there are n nodes with the source node (SN), node 1 and destination node (DN), node n . The neutrosophic length between nodes i and j is denoted by d_{ij} and the set of all nodes having a connection with the node i is denoted by $M_{N(i)}$.

Mathematical formulation of BELLMAN dynamic programming

Consider a directed connected graph $G = (V, E)$ from SN ‘1’ and the DN ‘ n ’ which is acyclic and they are organized by topological ordering ($E_{ij}; i < j$). Using the Bellman powerful programming system, the shortest path can be determined by forward pass computation method. The Bellman powerful programming system is defined as follows:

$$f(i) = \begin{cases} 0, & i = 1 \\ \min_{i < j} [f(i) + d_{ij}], & \text{otherwise} \end{cases}, \quad (13)$$

where d_{ij} is the weight the directed edge E_{ij} , $f(i)$ is the length of SP node i from the SN 1.

Neutrosophic Bellman–Ford algorithm:

Fig. 1 Interval-valued neutrosophic network

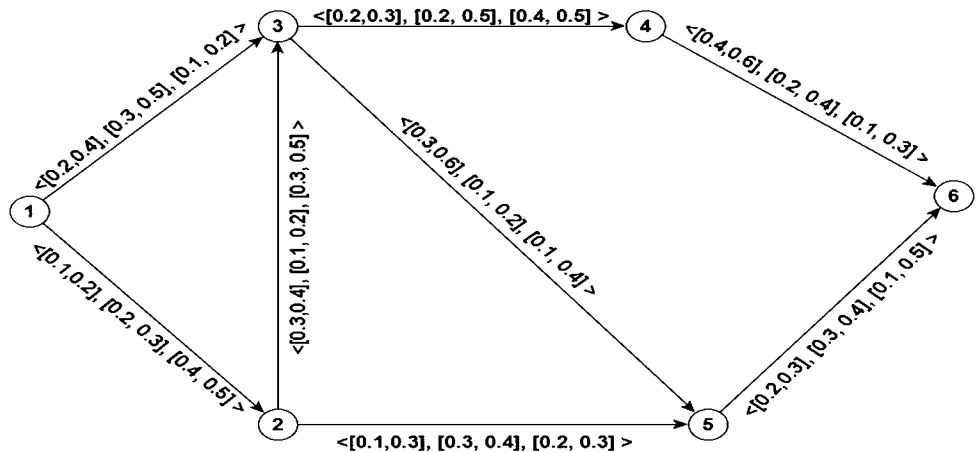

1. $nrank[s] \leftarrow 0$
2. $ndist[s] \leftarrow$ Emptyneutrosophic number.
3. Add s into Q
4. **For** every node i (excluding the s) in the neutrosophic graph G
5. $rank[i] \leftarrow \infty$
6. Add i into Q
7. **End For**
8. $u \leftarrow s$
9. **While**(Q is not empty)
10. eliminate the vertex u from Q
11. **For** each adjacent vertex v of vertex u
12. relaxed \leftarrow False
13. $temp_ndist[v] \leftarrow ndist[u] \oplus edge_weight(u,v)$ \oplus represents the addition of neutrosophic
14. $temp_nrank[v] \leftarrow rank_of_neutrosophic(temp_ndist[v])$
15. **If** $temp_nrank[v] < nrank[v]$ **then**
16. $ndist[v] \leftarrow temp_ndist[v]$
17. $nrank[v] \leftarrow temp_nrank[v]$
18. $prev[v] \leftarrow u$
19. **End If**
20. **End For**
21. **If** relaxed equals False **then**
22. exit the loop
23. **End If**
24. $u \leftarrow$ Node in Q with a minimum rank value
25. **End While**
26. **For** each arc (u,v) in neutrosophic graph G do
27. **If** $nrank[v] > rank_of_neutrosophic(ndist[u] \oplus edge_weight(u,v))$
28. return false
29. **End If**
30. **End For**
31. The neutrosophic number $ndist[u]$ is a neutrosophic number and it represents the SP from SN s and DN u .

In the posterior section, we present a simple illustration to show the brevity of our method.

Illustrative example

This part is based on a numerical problem adapted from [43] to show the potential application of the proposed algorithm.

Example 1 Consider an interval-valued neutrosophic network whose edge weights are represented by IVNNs with SN, node 1 and DN, node 6 (Fig. 1). Table 2 represents interval-valued neutrosophic distance.

Here we need to find the shortest distance from node 1 to node 6 (Table 3).

Using the proposed algorithm in previous section, the SP from SN and DN is calculated as follows:

Table 2 The details of edge information in terms of interval-valued neutrosophic numbers

Edges	IVN distance	Edges	IVN distance
1-2	([0.1, 0.2], [0.2, 0.3], [0.4, 0.5])	3-4	([0.2, 0.3], [0.2, 0.5], [0.4, 0.5])
1-3	([0.2, 0.4], [0.3, 0.5], [0.1, 0.2])	3-5	([0.3, 0.6], [0.1, 0.2], [0.1, 0.4])
2-3	([0.3, 0.4], [0.1, 0.2], [0.3, 0.5])	4-6	([0.4, 0.6], [0.2, 0.4], [0.1, 0.3])
2-5	([0.1, 0.3], [0.3, 0.4], [0.2, 0.3])	5-6	([0.2, 0.3], [0.3, 0.4], [0.1, 0.5])

Table 3 The details of de neutrosophication value of edge (i, j)

Edges	S_{Ridvan}	S_{Liu}
1-2	0.1	1.45
1-3	0.175	1.75
2-3	0.325	1.8
2-5	0.125	1.6
3-4	0.05	1.45
3-5	0.45	2.05
4-6	0.35	2
5-6	0.125	1.6

$$f(1) = 0,$$

$$f(2) = \min_{i < 2} \{f(i) + c_{i2}\} = c_{12}^* = 0, 1,$$

$$f(3) = \min_{i < 3} \{f(i) + c_{i3}\} = \min\{f(1) + c_{13}, f(2) + c_{23}\} \\ = \{0 + 0, 175, 0, 1 + 0, 235\} = \{0, 175, 0, 335\} = 0, 175,$$

$$f(4) = \min_{i < 4} \{f(i) + c_{i4}\} = \min\{f(3) + c_{34}\} \\ = \{0, 175 + 0, 05\} = 0, 225,$$

$$f(5) = \min_{i < 5} \{f(i) + c_{i5}\} = \min\{f(2) + c_{25}, f(3) + c_{35}\} \\ = \{0.1 + 0, 125, 0, 175 + 0, 455\} = \{0.225, 0, 625\} = 0.225,$$

$$f(6) = \min_{i < 6} \{f(i) + c_{i6}\} = \min\{f(4) + c_{46}, f(5) + c_{56}\} \\ = \{0.225 + 0, 35, 0, 225 + 0, 125\} = \{0.575, 0, 350\} = 0.350,$$

thus

$$f(6) = f(5) + c_{56} = f(2) + c_{25} + c_{56} \\ = f(1) + c_{12} + c_{25} + c_{56} = c_{12} + c_{25} + c_{56}.$$

Therefore, the path $P: 1 \rightarrow 2 \rightarrow 5 \rightarrow 6$ is recognized as the neutrosophic shortest path, and the crisp shortest path is 0.35.

Contingent study

In this section, the analysis of contingency for the proposed algorithm with existing approaches has been analyzed. A comparison of the results between the existing and new technique is shown in Table 4.

From the result, it is shown that the introduced algorithm contributes sequence of visited nodes which shown to be similar to neutrosophic shortest path presented in [43].

The neutrosophic shortest path (NSP) remains the same, namely $1 \rightarrow 2 \rightarrow 5 \rightarrow 6$, but the neutrosophic shortest path length (NSPL) differs, namely $([0.424, 0.608], [0.012, 0.06], [0.016, 0.125])$, respectively. From here we come to the conclusion that there exists no unique method for comparing neutrosophic numbers and different methods may satisfy different desirable criteria.

Advantages and limitations of the proposed algorithm

Advantages

By correlating our PA with Broumi et al. [43] to solve the same problem, we conclude that the proposed approach leads to the same path $1 \rightarrow 2 \rightarrow 5 \rightarrow 6$. The extended Bellman's algorithm operates on neutrosophic directed graphs with negative weight edges whereas the extended Dijkstra algorithm proposed in [37] cannot deal with. This approach can be easily extended and applied to other neutrosophic networks with the edge weight as

1. Single-value neutrosophic numbers.
2. Bipolar neutrosophic numbers.
3. Trapezoidal neutrosophic numbers.
4. Cubic neutrosophic numbers.
5. Interval bipolar neutrosophic numbers.
6. Triangular neutrosophic numbers and so on.

Limitations

1. Slow response will be observed when there is a change in the network as this change will spread node-by-node.
2. If node failure occurs then routing loops may exist.

Table 4 Comparison of the sequence of nodes using neutrosophic shortest path and our proposed algorithm

Possible path	Sequence of nodes	Crisp shortest path length
Neutrosophic shortest path with interval-valued neutrosophic numbers [43]	$1 \rightarrow 2 \rightarrow 5 \rightarrow 6$	$([0.35, 0.60], [0.01, 0.04], [0.008, 0.075])$
PA based on S_{Ridvan}	$1 \rightarrow 2 \rightarrow 5 \rightarrow 6$	0.35
PA based on S_{Liu}	$1 \rightarrow 2 \rightarrow 5 \rightarrow 6$	4.65

Conclusion

In this study, we describe the NSP, where edge weights are represented by IVNS. The advantage of using IVNSs in NSP is discussed in this paper. The classical Bellman's algorithm is modified by incorporating the uncertainty using IVNSs for NPP between source and destination nodes. We use a numerical example to illustrate the efficiency of our proposed algorithm. The main goal of this work is to describe an algorithm for NSP in the neutrosophic environment using IVNS as edge weight. The proposed algorithm is very effective for real-life problem. In this paper, we have used a simple numerical example to illustrate our proposed algorithm. Therefore, as future work, we need to consider a large-scale practical shortest path problem using our proposed algorithm and to compare our proposed algorithm with the existing algorithm in terms of strictness of optimality, efficiency, computational time, and other aspects.

References

- Zadeh LA (1965) Fuzzy sets. *Inf control* 8(3):338–353
- Atanassov KT (1986) Intuitionistic fuzzy sets. *Fuzzy Sets Syst* 20(1):87–96
- Yager RR (2017) Generalized orthopair fuzzy sets. *IEEE Trans Fuzzy Syst* 25(5):1222–1230
- Yager RR (2013) Pythagorean fuzzy subsets. In: *IFSA world congress and NAFIPS annual meeting (IFSA/NAFIPS)*. In: *IEEE international conference*, pp 57–61
- Cuong BC (2013) Picture fuzzy sets first results. part 1, Seminar neuro-fuzzy systems with applications, Preprint 03/2013, Institute of Mathematics, Hanoi, May 2013
- Ye J (2017) Hesitant interval neutrosophic linguistic set and its application in multiple attribute decision making. *Int J Mach Learn Cybern*. <https://doi.org/10.1007/s13042-017-0747-8>
- Broumi S, Deli I, Smarandache (2015) N-valued interval neutrosophic sets and their application in medical diagnosis. In: *Critical review*, vol 10, pp 45–69. Center for Mathematics of Uncertainty, Creighton University, Omaha
- Dutta P, Talukdar P (2018) A novel arithmetic technique for generalized interval-valued triangular intuitionistic fuzzy numbers and its application in decision making. *Open Cybern Syst* 12:72–120
- Dong JY, Wan SP (2015) Interval-valued trapezoidal intuitionistic fuzzy generalized aggregation operators and application to multi-attribute group decision making. *Cientia Iranica Trans E Ind Eng* 22:2702–2715
- Garg H (2016) A novel accuracy function under interval-valued Pythagorean fuzzy environment for solving multicriteria decision making problem. *J Intell Fuzzy Syst* 31(1):529–540
- Atanassov K, Gargov K (1989) Interval-valued intuitionistic fuzzy sets. *Fuzzy Sets Syst* 31:343–349
- Mendel JM, John R, Liu F (2006) Interval type-2 fuzzy logic systems made simple. *IEEE Trans Fuzzy Syst* 14(6):808–821
- Smarandache F (1998) *Neutrosophy. Neutrosophic probability, set, and logic*. ProQuest Information & Learning, Ann Arbor, p 105
- Wang H, Smarandache F, Zhang Y, Sunderraman R (2010) Single valued neutrosophic sets. *Multispace Multistruct* 4:410–413
- Wang H, Smarandache F, Sunderraman R, Zhang Y (2005) interval neutrosophic sets and logic: theory and applications in computing: theory and applications in computing. *Infinite Study, Hexis*, p 97
- Nancy Garg H (2016) An improved score function for ranking neutrosophic sets and its application to decision making process. *Int J Uncertain Quantif* 6(5):377–385
- Jun YB, Kim SJ, Smarandache F (2018) Interval neutrosophic sets with applications in BCK/BCI-Algebra. *Axioms* 7:1–23
- Sahin M, Ulucay V, Menekse M (2018) Some new operations of (α, β, γ) interval cut set of interval valued neutrosophic sets. *J Math Fundam Sci* 50(2):103–120
- Deli I, Yusuf S, Smarandache F, Ali M (2016) Interval valued bipolar neutrosophic sets and their application in pattern recognition. In: *IEEE world congress on computational intelligence*, pp 2460–2467
- Liu P, Shi L (2015) The generalized hybrid weighted average operator based on interval neutrosophic hesitant set and its application to multiple attribute decision making. *Neural Comput Appl* 26(2):457–471
- Liu PD, Shi LL (2015) The generalized hybrid weighted average operator based on interval neutrosophic hesitant set and its application to multiple attribute decision making. *Neural Comput Appl* 26:457–471
- Broumi S, Smarandache F (2014) Cosine similarity measure of interval valued neutrosophic sets. *Infinite Study*. <https://doi.org/10.5281/zenodo.30151>
- Broumi S, Smarandache F, Talea M, Bakali A (2016) Operations on interval valued neutrosophic graphs. In: Smarandache F, Pramanik S (eds) *New trends in neutrosophic theory and applications*, pp 231–254 (ISBN 978-1-59973-498-9)
- Peng X, Dai J (2017) Algorithms for interval neutrosophic multiple attribute decision-making based on MABAC, similarity measure, and EDAS. *Int J Uncertain Quantif* 7(5):395–421
- Bhattacharyya S, Roy BK, Majumdar P (2018) On distances and similarity measures between two interval neutrosophic sets. *J New Theory* 20:27–47
- Boltrurk E, Kahraman C (2018) A novel interval-valued neutrosophic AHP with cosine similarity measure. *Soft Comput*. <https://doi.org/10.1007/s00500-018-3140-y>
- Broumi S, Bakali A, Talea M, Smarandache F, Verma R (2017) Computing minimum spanning tree in interval valued bipolar neutrosophic environment. *Int J Model Optim* 7(5):300–304
- Broumi S, Bakali A, Talea M, Smarandache F, Son LH, Kishore K (2018) New matrix algorithm for minimum spanning tree with undirected interval valued neutrosophic graph. *Neutrosophic Oper Res* II:54–69
- Das D, De PK (2014) Shortest path problem under intuitionistic fuzzy setting. *Int J Comput Appl* 105(1):1–4
- De PK, Bhincher A (2011) Dynamic programming and multi objective linear programming approaches. *Appl Math Inf Sci* 5:253–263
- Kumar G, Bajaj RK, Gandotra N (2015) Algorithm for shortest path problem in a network with interval-valued intuitionistic trapezoidal fuzzy number. *Proc Comput Sci* 70:123–129
- Meenakshi AR, Kaliraja M (2012) Determination of the shortest path in interval valued fuzzy networks. *Int J Math Arch* 3(6):2377–2384

33. Elizabethand S, Sujatha L (2014) Fuzzy shortest path problem based on interval valued Fuzzy number matrices. *Int J Math Sci Eng Appl* 8(1):325–335
34. Enayattabar M, Ebrahimnejad A, Motameni H (2018) Dijkstra algorithm for shortest path problem under interval-valued Pythagorean fuzzy environment. *Complex Intell Syst.* <https://doi.org/10.1007/s40747-018-0083-y>
35. Dey A, Pal A, Pal T (2016) Interval type 2 fuzzy set in fuzzy shortest path problem. *Mathematics* 4:62. <https://doi.org/10.3390/mat>
36. Broumi S, Bakal A, Talea M, Smarandache F, Vladareanu L (2016) Applying Dijkstra algorithm for solving neutrosophic shortest path problem. In: *IEEE international conference on advanced mechatronic systems (ICAMechS)*, pp 412–416
37. Broumi S, Talea M, Bakali A, Smarandache F (2016) Application of Dijkstra algorithm for solving interval valued neutrosophic shortest path problem. In: *2016 IEEE symposium series on computational intelligence (SSCI)*, pp 1–6
38. Broumi S, Bakali A, Talea M, Smarandache F, Vladareanu L (2016) Computation of shortest path problem in a network with SV-trapezoidal neutrosophic numbers. In: *IEEE international conference on advanced mechatronic systems (ICAMechS)*, pp 417–422
39. Broumi S, Bakali A, Mohamed T, Smarandache F, Vladareanu L (2016) Shortest path problem under triangular fuzzy neutrosophic information. In: *10th international conference on software, knowledge, information management & applications (SKIMA)*, pp 169–174
40. Broumi S, Bakali A, Talea M, Smarandache F (2017) Shortest path problem on single valued neutrosophic graphs. In: *2017 international symposium on networks, computers and communications (ISNCC)*, pp 1–8
41. Broumi S, Bakali A, Talea M, Smarandache F (2017) Shortest path problem under trapezoidal neutrosophic information. In: *Computing conference 2017, 18–20 July 2017, London*, pp 142–148
42. Broumi S, Bakali A, Talea M, Smarandache F, Ali M (2017) Shortest path problem under bipolar neutrosophic setting. *Appl Mech Mater* 2017:859
43. Broumi S, Bakali A, Talea M, Smarandache F, Kishore KK, Sahin R (2018) Shortest path problem under interval valued neutrosophic setting. *J Fundam Appl Sci* 10(4S):168–174
44. Sahin R, Liu P (2015) Maximizing deviation method for neutrosophic multiple attribute decision making with incomplete weight information. *Neural Comput Appl* 27(7):2017–2029. <https://doi.org/10.1007/s00521-015-1995-8>
45. Liu P, You X (2017) Interval neutrosophic Muirhead mean operators and their applications in multiple-attribute group decision making. *Int J Uncertain Quantif* 7:303–334
46. Basset MA, Gunasekaran M, Mohamed M, Chilamkurti N (2019) A framework for risk assessment, management and evaluation: economic tool for quantifying risks in supply chain. *Future Gener Comput Syst* 90:489–502
47. Basset MA, Mohamed M, Sangaiyah AK, Jain V (2018) An integrated neutrosophic AHP and SWOT method for strategic planning methodology selection. *Benchmarking* 25(7):2546–2564
48. Basset MA, Mohamed M, Smarandache F (2018) A hybrid neutrosophic group ANP-TOPSIS framework for supplier selection problems. *Symmetry* 10(6):226
49. Basset MA, Mohamed M, Smarandache F (2018) An extension of neutrosophic AHP–SWOT analysis for strategic planning and decision-making. *Symmetry* 10(4):116
50. Basset MA, Mohamed M, Smarandache F, Chang V (2018) Neutrosophic association rule mining algorithm for big data analysis. *Symmetry* 10(4):106
51. Basset MA, Mohamed M, Chang V (2018) NMCDA: a framework for evaluating cloud computing services. *Future Gener Comput Syst* 86:12–29
52. Basset MA, Zhou Y, Mohamed M, Chang V (2018) A group decision making framework based on neutrosophic VIKOR approach for e-government website evaluation. *J Intell Fuzzy Syst* 34(6):4213–4224
53. Basset MA, Mohamed M, Zhou Y, Hezam I (2017) Multi-criteria group decision making based on neutrosophic analytic hierarchy process. *J Intell Fuzzy Syst* 33(6):4055–4066
54. Basset MA, Mohamed M (2018) The role of single valued neutrosophic sets and rough sets in smart city: imperfect and incomplete information systems. *Measurement* 124:47–55
55. Basset MA, Gunasekaram M, Gamal A, Smarandache F (2018) A hybrid approach of neutrosophic sets and DEMATEL method for developing supplier selection criteria. *Des Autom Embed Syst* 22(3):257–278
56. Dey A, Pal A (2019) Computing the shortest path with words. *Int J Adv Intell Paradigms* 12(3–4):355–369
57. Dey A, Pal A (2016) Prim's algorithm for solving minimum spanning tree problem. *Ann Fuzzy Math Inform* 12(3):419–430
58. Dey A, Broumi S, Son LH, Bakali A, Talea M, Smarandache F (2018) A new algorithm for finding minimum spanning trees with undirected neutrosophic graphs. *Granul Comput* 4(1):63–69
59. Broumi A, Dey A, Bakali A, Talea M, Smarandache F, Son LH, Koley D (2017) Uniform single valued neutrosophic graphs. *Neutrosophic Sets Syst* 17:42–49
60. Dey A, Pal A, Pal T (2016) Interval type 2 fuzzy set in fuzzy shortest path problem. *Mathematics* 4:62
61. Dey A, Pradhan R, Pal A, Pal T (2018) A genetic algorithm for solving fuzzy shortest path problems with interval type-2 fuzzy arc lengths. *Malays J Comput Sci* 31(4):1–20
62. Kumar R, Edaltpanah SA, Jha S, Broumi S, Dey A (2018) Neutrosophic shortest path problem. *Neutrosophic Sets Systems* 23:5–15

Generalization of Maximizing Deviation and TOPSIS Method for MADM in Simplified Neutrosophic Hesitant Fuzzy Environment

Muhammad Akram, Sumera Naz, Florentin Smarandache

Muhammad Akram, Sumera Naz, Florentin Smarandache (2019). Generalization of Maximizing Deviation and TOPSIS Method for MADM in Simplified Neutrosophic Hesitant Fuzzy Environment. *Symmetry* 11, 1058; DOI: 10.3390/sym1108105

Abstract: With the development of the social economy and enlarged volume of information, the application of multiple-attribute decision-making (MADM) has become increasingly complex, uncertain, and obscure. As a further generalization of hesitant fuzzy set (HFS), simplified neutrosophic hesitant fuzzy set (SNHFS) is an efficient tool to process the vague information and contains the ideas of a single-valued neutrosophic hesitant fuzzy set (SVNHFS) and an interval neutrosophic hesitant fuzzy set (INHFS). In this paper, we propose a decision-making approach based on the maximizing deviation method and TOPSIS (Technique for Order Preference by Similarity to Ideal Solution) to solve the MADM problems, in which the attribute weight information is incomplete, and the decision information is expressed in simplified neutrosophic hesitant fuzzy elements. Firstly, we inaugurate an optimization model on the basis of maximizing deviation method, which is useful to determine the attribute weights. Secondly, using the idea of the TOPSIS, we determine the relative closeness coefficient of each alternative and based on which we rank the considered alternatives to select the optimal one(s). Finally, we use a numerical example to show the detailed implementation procedure and effectiveness of our method in solving MADM problems under simplified neutrosophic hesitant fuzzy environment.

Keywords: simplified neutrosophic hesitant fuzzy set; multi-attribute decision-making; maximizing deviation; TOPSIS

1. Introduction

The concept of neutrosophy was originally introduced by Smarandache [1] from a philosophical viewpoint. Gradually, it has been discovered that without a specific description, it is not easy to apply neutrosophic sets in real applications because a truth-membership, an indeterminacy-membership, and a falsity-membership degree, in non-standard unit interval $]0^-, 1^+[$, are independently assigned to each element in the set. After analyzing this difficulty, Smarandache [2] and Wang [3] initiated the notion of a single-valued neutrosophic set (SVNS) and made the first ever neutrosophic publication. Ye [4] developed the concept of simplified neutrosophic set (SNS). SNS, a subclass of a neutrosophic set, contains the ideas of a SVNS and an interval neutrosophic set (INS), which are very useful in real science and engineering applications with incomplete, indeterminate, and inconsistent information existing commonly in real situations. Torra and Narukawa [5] put forward the concept of HFS as another extension of fuzzy set [6]. HFS is an effective tool to represent vague information in the process of MADM, as it permits the element membership degree to a set characterized by a few possible values in $[0, 1]$ and can be accurately described in terms of the judgment of the experts.

Ye [7] introduced SVNHFS as an extension of SVNS in the spirit of HFS and developed the single-valued neutrosophic hesitant fuzzy weighted averaging and weighted geometric operator. The SVNHFS represents some uncertain, incomplete, and inconsistent situations where each element has certain different values characterized by truth-membership hesitant, indeterminacy-membership hesitant, and falsity-membership hesitant function. For instance, when the opinion of three experts is required for a certain statement, they may state that the possibility that the statement is true is $\{0.3, 0.5, 0.8\}$, and the statement is false is $\{0.1, 0.4\}$, and the degree that they are not sure is $\{0.2, 0.7, 0.8\}$. For single-valued neutrosophic hesitant fuzzy notation, it can be expressed as $\{\{0.3, 0.5, 0.8\}, \{0.1, 0.4\}, \{0.2, 0.7, 0.8\}\}$. Liu and Luo [8] discussed the certainty function, score function, and accuracy function of SVNHFS and proposed the single-valued neutrosophic hesitant fuzzy ordered weighted averaging operator and hybrid weighted averaging operator. Sahin and Liu [9] proposed the correlation coefficient with single-valued neutrosophic hesitant fuzzy information and successfully applied it to decision-making problems. Li and Zhang [10] introduced Choquet aggregation operators with single-valued neutrosophic hesitant fuzzy information for MADM. Juan-Juan et al. [11] developed a decision-making technique using geometric weighted Choquet integral Heronian mean operator for SVNHFSs. Wang and Li [12] developed the generalized prioritized weighted average operator, the generalized prioritized weighted geometric operator with SVNHFS, and further developed an approach on the basis of the proposed operators to solve MADM problems. Recently, Akram et al. [13–16] and Naz et al. [17–19] put forward certain novel decision-making techniques in the frame work of extended fuzzy set theory. Furthermore, Liu and Shi [20] proposed the concept of INHFS by combining INS with HFS and developed the generalized weighted operator, generalized ordered weighted operator, and generalized hybrid weighted operator with the proposed interval neutrosophic hesitant fuzzy information. Ye [21] and Kakati et al. [22] proposed the correlation coefficients and Choquet integrals, respectively, with INHFS. Mahmood et al. [23] discussed the vector similarity measures with SNHFS. In practical terms, the SNHFS measures the truth-membership, the indeterminacy-membership and the falsity-membership degree by SVNHFSs and INHFSs. The classical sets, fuzzy sets, intuitionistic fuzzy sets, SVNSs, INSs, SNSs, and HFSs are the particular situations of SNHFSs. In modeling vague and uncertain information, SNHFS is more flexible and practice.

In the theory of decision analysis, MADM is one of the most important branches and several beneficial models and approaches have been developed related to decision analysis. However, due to limited time, lack of data or knowledge, and the limited expertise of the expert about the problem, MADM process under simplified neutrosophic hesitant fuzzy circumstances, encounters the situations where the information about attribute weights is completely unknown or incompletely known. The existing approaches are not suitable to handle these situations. Furthermore, among some useful MADM methodologies, the maximizing deviation method and the TOPSIS provide a ranking approach, which is measured by the farthest distance from the negative-ideal solution (NIS) and the shortest distance from the positive-ideal solution (PIS). For all these, in this paper, we propose an innovative approach of maximizing deviation and TOPSIS to objectively determine the attribute weights and rank the alternatives with completely unknown or partly known attribute weights. We propose the new distance measure and discuss the application of SNHFSs to MADM. In the framework of TOPSIS, we construct a novel generalized method under the simplified neutrosophic hesitant fuzzy environment. As compared to the existing work, the SNHFSs availablely depict more general decision-making situations.

The paper is structured as follows: Section 2 establishes a simplified neutrosophic hesitant fuzzy MADM based on maximizing deviations and TOPSIS. In Section 3, a numerical example is given to demonstrate the effectiveness of our model and method and finally we draw conclusions in Section 4.

SVNHFS as a more flexible general formal framework extends the concept of fuzzy set [6], intuitionistic fuzzy set [24], SVNS [3] and HFS [25]. Ye [7] proposed the following definition of SVNHFS.

Definition 1. [7] Let Z be a fixed set, a SVNHFS n on Z is defined as

$$n = \{ \langle z, t(z), i(z), f(z) \rangle | z \in Z \}$$

where $t(z), i(z), f(z)$ are the sets of a few values in $[0, 1]$, representing the possible truth-membership hesitant degree, indeterminacy-membership hesitant degree and falsity-membership hesitant degree of the element z to n , respectively; $t(z) = \{ \gamma_1, \gamma_2, \dots, \gamma_l \}$, $\gamma_1, \gamma_2, \dots, \gamma_l$ are the elements of $t(z)$; $i(z) = \{ \delta_1, \delta_2, \dots, \delta_p \}$, $\delta_1, \delta_2, \dots, \delta_p$ are the elements of $i(z)$; $f(z) = \{ \eta_1, \eta_2, \dots, \eta_q \}$, $\eta_1, \eta_2, \dots, \eta_q$ are the elements of $f(z)$, for every $z \in Z$; and l, p, q denote, respectively, the numbers of the hesitant fuzzy elements in t, i, f .

For simplicity, the expression $n(z) = \{ t(z), i(z), f(z) \}$ is called a single-valued neutrosophic hesitant fuzzy element (SVNHFE), which we represent by simplified symbol $n = \{ t, i, f \}$.

Definition 2. [7] Let n, n_1 and n_2 be three SVNHFEs. Then their operations are defined as follows:

1. $n_1 \oplus n_2 = \bigcup_{\gamma_1 \in t_1, \delta_1 \in i_1, \eta_1 \in f_1, \gamma_2 \in t_2, \delta_2 \in i_2, \eta_2 \in f_2} \{ \{ \gamma_1 + \gamma_2 - \gamma_1 \gamma_2 \}, \{ \delta_1 \delta_2 \}, \{ \eta_1 \eta_2 \} \}$;
2. $n_1 \otimes n_2 = \bigcup_{\gamma_1 \in t_1, \delta_1 \in i_1, \eta_1 \in f_1, \gamma_2 \in t_2, \delta_2 \in i_2, \eta_2 \in f_2} \{ \{ \gamma_1 \gamma_2 \}, \{ \delta_1 + \delta_2 - \delta_1 \delta_2 \}, \{ \eta_1 + \eta_2 - \eta_1 \eta_2 \} \}$;
3. $\zeta n = \bigcup_{\gamma \in t, \delta \in i, \eta \in f} \{ \{ 1 - (1 - \gamma)^\zeta \}, \{ \delta^\zeta \}, \{ \eta^\zeta \} \}$; $\zeta > 0$
4. $n^\zeta = \bigcup_{\gamma \in t, \delta \in i, \eta \in f} \{ \{ \gamma^\zeta \}, \{ 1 - (1 - \delta)^\zeta \}, \{ 1 - (1 - \eta)^\zeta \} \}$ $\zeta > 0$.

2. TOPSIS and Maximizing Deviation Method for Simplified Neutrosophic Hesitant Fuzzy Multi-Attribute Decision-Making

In this section, we propose the normalization technique and the distance measures of SNHFSs and based on this we develop further a new decision-making approach based on maximum deviation and TOPSIS under simplified neutrosophic hesitant fuzzy circumstances to explore the application of SNHFSs to MADM.

2.1. TOPSIS and Maximizing Deviation Method for Single-Valued Neutrosophic Hesitant Fuzzy Multi-Attribute Decision-Making

In this subsection, we only use SVNHFSs in SNHFSs and develop a new decision-making approach, by combining the idea of SVNHFSs with maximizing deviation, to solve a MADM problem in single-valued neutrosophic hesitant fuzzy environment.

2.1.1. Description of the MADM Problem

Consider a MADM problem containing a discrete set of m alternatives $\{ A_1, A_2, \dots, A_m \}$ and a set of all attributes $P = \{ P_1, P_2, \dots, P_n \}$. The evaluation information of the i th alternative with respect to the j th attribute is a SVNHFE $n_{ij} = \langle t_{ij}, i_{ij}, f_{ij} \rangle$, where t_{ij}, i_{ij} and f_{ij} indicate the preference degree, uncertain degree, and falsity degree, respectively, of the decision maker facing the i th alternative that satisfied the j th attribute. Then the single-valued neutrosophic hesitant fuzzy decision matrix (SVNHFD) \mathcal{N} , can be constructed as follows:

$$\mathcal{N} = \begin{bmatrix} n_{11} & n_{12} & \dots & n_{1n} \\ n_{21} & n_{22} & \dots & n_{2n} \\ \vdots & \vdots & \ddots & \vdots \\ n_{m1} & n_{m2} & \dots & n_{mn} \end{bmatrix}$$

Assume that each attribute has different importance, the weight vector of all attributes is defined as $w = (w_1, w_2, \dots, w_n)^t$, where $0 \leq w_j \leq 1$ and $\sum_{j=1}^n w_j = 1$ with w_j representing the importance degree

of the attribute P_j . Due to the complexity of the practical decision-making problems, the attribute weights information is frequently incomplete. For ease, let \mathfrak{S} be the set of the known information about attribute weights, which we can construct by the following forms, for $i \neq j$:

- (i) $w_i \geq w_j$ (weak ranking);
- (ii) $w_i - w_j \geq \alpha_i, \alpha_i > 0$ (strict ranking);
- (iii) $w_i - w_j \geq w_k - w_l, \text{ for } j \neq k \neq l$ (ranking of differences);
- (iv) $w_i \geq \alpha_i w_j, 0 \leq \alpha_i \leq 1$ (ranking with multiples);
- (v) $\alpha_i \leq w_i \leq \alpha_i + \xi_i, 0 \leq \alpha_i \leq \alpha_i + \xi_i \leq 1$ (interval form).

In the comparison of SVNHFES, the number of their corresponding element may be unequal. To handle this situation, we normalize the SVNHFES as follows:

Suppose that $n = \{t, i, f\}$ is a SVNHFE, then $\bar{\gamma} = \omega\gamma^+ + (1 - \omega)\gamma^-$, $\bar{\delta} = \omega\delta^+ + (1 - \omega)\delta^-$ and $\bar{\eta} = \omega\eta^+ + (1 - \omega)\eta^-$ are the added truth-membership, the indeterminacy-membership and the falsity-membership degree, respectively, where γ^- and γ^+ are the minimum and the maximum elements of t , respectively, δ^- and δ^+ are the minimum and the maximum elements of i , respectively, η^- and η^+ are the minimum and the maximum elements of f , respectively, and $\omega \in [0, 1]$ is a parameter assigned by the expert according to his risk preference.

For the normalization of SVNHFE, different values of ω produce different results for the added truth-membership, the indeterminacy-membership and the falsity-membership degree. Usually, there are three cases of the preference of the expert:

- If $\omega = 0$, the pessimist expert may add the minimum truth-membership degree γ^- , the minimum indeterminacy-membership degree δ^- and the minimum falsity-membership degree η^- .
- If $\omega = 0.5$, the neutral expert may add the truth-membership degree $\frac{\gamma^- + \gamma^+}{2}$, the indeterminacy-membership degree $\frac{\delta^- + \delta^+}{2}$ and the falsity-membership degree $\frac{\eta^- + \eta^+}{2}$.
- If $\omega = 1$, the optimistic expert may add the maximum truth-membership degree γ^+ , the maximum indeterminacy-membership degree δ^+ and the maximum falsity-membership degree η^+ .

For instance, if we have two SVNHFES $n_1 = \{t_1, i_1, f_1\} = \{\{0.3, 0.5\}, \{0.4, 0.6, 0.8\}, \{0.5, 0.7\}\}$, $n_2 = \{t_2, i_2, f_2\} = \{\{0.1, 0.4, 0.5\}, \{0.6, 0.7\}, \{0.2, 0.6, 0.9\}\}$. Here $\#t_1 = 2, \#i_1 = 3, \#f_1 = 2, \#t_2 = 3, \#i_2 = 2$ and $\#f_2 = 3$. Clearly, $\#t_1 \neq \#t_2, \#i_1 \neq \#i_2$, and $\#f_1 \neq \#f_2$. The truth-membership and the falsity-membership degree of n_1 , while the indeterminacy-membership degree of n_2 need to be pre-treated.

If $\omega = 0$, then we may add the minimum truth-membership degree or the indeterminacy-membership degree or the falsity-membership degree for the target object. For the SVNHFE n_1 , the truth-membership and falsity-membership degree of n_1 can be attained as $\{0.3, 0.3, 0.5\}$ and $\{0.5, 0.5, 0.7\}$, i.e., n_1 can be normalized as $n_1 = \{\{0.3, 0.3, 0.5\}, \{0.4, 0.6, 0.8\}, \{0.5, 0.5, 0.7\}\}$. For the SVNHFE n_2 , the indeterminacy-membership degree of n_2 can be obtained as $\{0.6, 0.6, 0.7\}$, i.e., n_2 is normalized as $n_2 = \{\{0.1, 0.4, 0.5\}, \{0.6, 0.6, 0.7\}, \{0.2, 0.6, 0.9\}\}$.

If $\omega = 0.5$, then we may add the average truth-membership degree or the indeterminacy-membership degree or the falsity-membership degree for the target object. For the SVNHFE n_1 , the truth-membership and falsity-membership degree of n_1 can be attained as $\{0.3, 0.4, 0.5\}$ and $\{0.5, 0.6, 0.7\}$, i.e., n_1 can be normalized as $n_1 = \{\{0.3, 0.4, 0.5\}, \{0.4, 0.6, 0.8\}, \{0.5, 0.6, 0.7\}\}$. For the SVNHFE n_2 , the indeterminacy-membership degree of n_2 can be obtained as $\{0.6, 0.65, 0.7\}$, i.e., n_2 is normalized as $n_2 = \{\{0.1, 0.4, 0.5\}, \{0.6, 0.65, 0.7\}, \{0.2, 0.6, 0.9\}\}$.

If $\omega = 1$, then we may add the maximum truth-membership degree or the indeterminacy-membership degree or the falsity-membership degree for the normalization. For the SVNHFE n_1 , the truth-membership and falsity-membership degree of n_1

can be attained as $\{0.3, 0.5, 0.5\}$ and $\{0.5, 0.7, 0.7\}$, i.e., n_1 is normalized as $n_1 = \{\{0.3, 0.5, 0.5\}, \{0.4, 0.6, 0.8\}, \{0.5, 0.7, 0.7\}\}$. For the SVNHFE n_2 , the indeterminacy-membership degree of n_2 can be attained as $\{0.6, 0.7, 0.7\}$, i.e., n_2 is normalized as $n_2 = \{\{0.1, 0.4, 0.5\}, \{0.6, 0.7, 0.7\}, \{0.2, 0.6, 0.9\}\}$.

The algorithm for the normalization of SVNHFES is given in Algorithm 1.

Algorithm 1 The algorithm for the normalization of SVNHFES.

INPUT: Two SVNHFES $n_1 = (t_1, i_1, f_1)$, $n_2 = (t_2, i_2, f_2)$ and the value of ω .

OUTPUT: The normalization of $n_1 = (t_1, i_1, f_1)$ and $n_2 = (t_2, i_2, f_2)$.

```

1: Count the number of elements of  $n_1$  and  $n_2$ , i.e.,  $\#t_1, \#i_1, \#f_1, \#t_2, \#i_2, \#f_2$ ;
2: Determine the minimum and the maximum of the elements of  $n_1$  and  $n_2$ ;
3:  $t = \arg \min_{i=1,2} \#t_i$ ,  $i = \arg \min_{i=1,2} \#i_i$ ,  $f = \arg \min_{i=1,2} \#f_i$ ;
4: if  $\#t_1 = \#t_2$  then break;
5: else if  $t = \#t_1$  then
6:    $n = \#t_2 - \#t_1$ ;
7:   Determine the value of  $\bar{\gamma}$  for  $t_1$ ;
8:   for  $i=1:1:n$  do
9:      $t_1 = t_1 \cup \bar{\gamma}$ ;
10:  end for
11: else
12:    $n = \#t_1 - \#t_2$ ;
13:   Determine the value of  $\bar{\gamma}$  for  $t_2$ ;
14:   for  $i=1:1:n$  do
15:      $t_2 = t_2 \cup \bar{\gamma}$ ;
16:   end for
17: end if
18: if  $\#i_1 = \#i_2$  then break;
19: else if  $i = \#i_1$  then
20:    $n = \#i_2 - \#i_1$ ;
21:   Determine the value of  $\bar{\delta}$  for  $i_1$ ;
22:   for  $i=1:1:n$  do
23:      $i_1 = i_1 \cup \bar{\delta}$ ;
24:   end for
25: else
26:    $n = \#i_1 - \#i_2$ ;
27:   Determine the value of  $\bar{\delta}$  for  $i_2$ ;
28:   for  $i=1:1:n$  do
29:      $i_2 = i_2 \cup \bar{\delta}$ ;
30:   end for
31: end if
32: if  $\#f_1 = \#f_2$  then break;
33: else if  $f = \#f_1$  then
34:    $n = \#f_2 - \#f_1$ ;
35:   Determine the value of  $\bar{\eta}$  for  $f_1$ ;
36:   for  $i=1:1:n$  do
37:      $f_1 = f_1 \cup \bar{\eta}$ ;
38:   end for
39: else
40:    $n = \#f_1 - \#f_2$ ;
41:   Determine the value of  $\bar{\eta}$  for  $f_2$ ;
42:   for  $i=1:1:n$  do
43:      $f_2 = f_2 \cup \bar{\eta}$ ;
44:   end for
45: end if

```

2.1.2. The Distance Measures for SVNHFSS

Definition 3. Let $n_1 = \{t_1, i_1, f_1\}$ and $n_2 = \{t_2, i_2, f_2\}$ be two normalized SVNHFES, then the single-valued neutrosophic hesitant fuzzy Hamming distance between n_1 and n_2 can be defined as follows:

$$d_1(n_1, n_2) = \frac{1}{3} \left(\frac{1}{\#t} \sum_{\zeta=1}^{\#t} |\gamma_1^{\sigma(\zeta)} - \gamma_2^{\sigma(\zeta)}| + \frac{1}{\#i} \sum_{\zeta=1}^{\#i} |\delta_1^{\sigma(\zeta)} - \delta_2^{\sigma(\zeta)}| + \frac{1}{\#f} \sum_{\zeta=1}^{\#f} |\eta_1^{\sigma(\zeta)} - \eta_2^{\sigma(\zeta)}| \right), \tag{1}$$

where $\#t = \#t_1 = \#t_2$, $\#i = \#i_1 = \#i_2$ and $\#f = \#f_1 = \#f_2$. $\gamma_i^{\sigma(\zeta)}$, $\delta_i^{\sigma(\zeta)}$ and $\eta_i^{\sigma(\zeta)}$ are the ζ th largest values in γ_i , δ_i and η_i , respectively ($i = 1, 2$).

In addition, the single-valued neutrosophic hesitant fuzzy Euclidean distance is defined as:

$$d_2(n_1, n_2) = \sqrt{\frac{1}{3} \left(\frac{1}{\#t} \sum_{\zeta=1}^{\#t} (\gamma_1^{\sigma(\zeta)} - \gamma_2^{\sigma(\zeta)})^2 + \frac{1}{\#i} \sum_{\zeta=1}^{\#i} (\delta_1^{\sigma(\zeta)} - \delta_2^{\sigma(\zeta)})^2 + \frac{1}{\#f} \sum_{\zeta=1}^{\#f} (\eta_1^{\sigma(\zeta)} - \eta_2^{\sigma(\zeta)})^2 \right)}. \tag{2}$$

By using the geometric distance model of [26], the above distances can be generalized as follows:

$$d(n_1, n_2) = \left(\frac{1}{3} \left(\frac{1}{\#t} \sum_{\zeta=1}^{\#t} |\gamma_1^{\sigma(\zeta)} - \gamma_2^{\sigma(\zeta)}|^\alpha + \frac{1}{\#i} \sum_{\zeta=1}^{\#i} |\delta_1^{\sigma(\zeta)} - \delta_2^{\sigma(\zeta)}|^\alpha + \frac{1}{\#f} \sum_{\zeta=1}^{\#f} |\eta_1^{\sigma(\zeta)} - \eta_2^{\sigma(\zeta)}|^\alpha \right) \right)^{\frac{1}{\alpha}}, \tag{3}$$

where α is constant and $\alpha > 0$. Based on the value of α , the relationship among $d(n_1, n_2)$, $d_1(n_1, n_2)$ and $d_2(n_1, n_2)$ can be deduced as:

- If $\alpha = 1$, then the distance $d(n_1, n_2) = d_1(n_1, n_2)$.
- If $\alpha = 2$, then the distance $d(n_1, n_2) = d_2(n_1, n_2)$.

Therefore, the distance $d(n_1, n_2)$ is a generalization of the single-valued neutrosophic hesitant fuzzy Hamming distance $d_1(n_1, n_2)$ and the single-valued neutrosophic hesitant fuzzy Euclidean distance $d_2(n_1, n_2)$.

Theorem 1. Let $n_1 = \{t_1, i_1, f_1\}$ and $n_2 = \{\{1\}, \{0\}, \{0\}\}$ be two SVNHFES, then the generalized distance $d(n_1, n'_2)$ can be calculated as:

$$d(n_1, n'_2) = \left(\frac{1}{3} \left(\frac{1}{\#t_1} \sum_{\gamma \in t_1} (1 - \gamma)^\alpha + \frac{1}{\#i_1} \sum_{\delta \in i_1} \delta^\alpha + \frac{1}{\#f_1} \sum_{\eta \in f_1} \eta^\alpha \right) \right)^{\frac{1}{\alpha}}$$

where n'_2 is the normalization outcome of n_2 by the comparison of n_1 and n_2 .

Proof. Using (3), the generalized distance $d(n_1, n'_2)$ can be calculated as:

$$\begin{aligned}
 d(n_1, n'_2) &= \left(\frac{1}{3} \left(\frac{1}{\#t} \sum_{\zeta=1}^{\#t} |\gamma_1^{\sigma(\zeta)} - \gamma_2^{\sigma(\zeta)}|^\alpha + \frac{1}{\#i} \sum_{\zeta=1}^{\#i} |\delta_1^{\sigma(\zeta)} - \delta_2^{\sigma(\zeta)}|^\alpha + \frac{1}{\#f} \sum_{\zeta=1}^{\#f} |\eta_1^{\sigma(\zeta)} - \eta_2^{\sigma(\zeta)}|^\alpha \right) \right)^{\frac{1}{\alpha}} \\
 &= \left(\frac{1}{3} \left(\frac{1}{\#t} \sum_{\zeta=1}^{\#t} |\gamma_1^{\sigma(\zeta)} - 1|^\alpha + \frac{1}{\#i} \sum_{\zeta=1}^{\#i} |\delta_1^{\sigma(\zeta)} - 0|^\alpha + \frac{1}{\#f} \sum_{\zeta=1}^{\#f} |\eta_1^{\sigma(\zeta)} - 0|^\alpha \right) \right)^{\frac{1}{\alpha}} \\
 &= \left(\frac{1}{3} \left(\frac{1}{\#t} \sum_{\zeta=1}^{\#t} (1 - \gamma_1^{\sigma(\zeta)})^\alpha + \frac{1}{\#i} \sum_{\zeta=1}^{\#i} (\delta_1^{\sigma(\zeta)})^\alpha + \frac{1}{\#f} \sum_{\zeta=1}^{\#f} (\eta_1^{\sigma(\zeta)})^\alpha \right) \right)^{\frac{1}{\alpha}} \\
 &= \left(\frac{1}{3} \left(\frac{1}{\#t_1} \sum_{\zeta=1}^{\#t_1} (1 - \gamma_1^{\sigma(\zeta)})^\alpha + \frac{1}{\#i_1} \sum_{\zeta=1}^{\#i_1} (\delta_1^{\sigma(\zeta)})^\alpha + \frac{1}{\#f_1} \sum_{\zeta=1}^{\#f_1} (\eta_1^{\sigma(\zeta)})^\alpha \right) \right)^{\frac{1}{\alpha}} \\
 &= \left(\frac{1}{3} \left(\frac{1}{\#t_1} \sum_{\gamma \in t_1} (1 - \gamma)^\alpha + \frac{1}{\#i_1} \sum_{\delta \in i_1} \delta^\alpha + \frac{1}{\#f_1} \sum_{\eta \in f_1} \eta^\alpha \right) \right)^{\frac{1}{\alpha}}.
 \end{aligned}$$

□

Theorem 2. Let $n_1 = \{t_1, i_1, f_1\}$ and $n_2 = \{\{0\}, \{1\}, \{1\}\}$ be two SVNHFES, then the generalized distance $d(n_1, n'_2)$ can be calculated as:

$$d(n_1, n'_2) = \left(\frac{1}{3} \left(\frac{1}{\#t_1} \sum_{\gamma \in t_1} \gamma^\alpha + \frac{1}{\#i_1} \sum_{\delta \in i_1} (1 - \delta)^\alpha + \frac{1}{\#f_1} \sum_{\eta \in f_1} (1 - \eta)^\alpha \right) \right)^{\frac{1}{\alpha}}.$$

where n'_2 is the normalization outcome of n_2 by the comparison of n_1 and n_2 .

Proof. Using (3), the generalized distance $d(n_1, n'_2)$ can be calculated as:

$$\begin{aligned}
 d(n_1, n'_2) &= \left(\frac{1}{3} \left(\frac{1}{\#t} \sum_{\zeta=1}^{\#t} |\gamma_1^{\sigma(\zeta)} - \gamma_2^{\sigma(\zeta)}|^\alpha + \frac{1}{\#i} \sum_{\zeta=1}^{\#i} |\delta_1^{\sigma(\zeta)} - \delta_2^{\sigma(\zeta)}|^\alpha + \frac{1}{\#f} \sum_{\zeta=1}^{\#f} |\eta_1^{\sigma(\zeta)} - \eta_2^{\sigma(\zeta)}|^\alpha \right) \right)^{\frac{1}{\alpha}} \\
 &= \left(\frac{1}{3} \left(\frac{1}{\#t} \sum_{\zeta=1}^{\#t} |\gamma_1^{\sigma(\zeta)} - 0|^\alpha + \frac{1}{\#i} \sum_{\zeta=1}^{\#i} |\delta_1^{\sigma(\zeta)} - 1|^\alpha + \frac{1}{\#f} \sum_{\zeta=1}^{\#f} |\eta_1^{\sigma(\zeta)} - 1|^\alpha \right) \right)^{\frac{1}{\alpha}} \\
 &= \left(\frac{1}{3} \left(\frac{1}{\#t} \sum_{\zeta=1}^{\#t} (\gamma_1^{\sigma(\zeta)})^\alpha + \frac{1}{\#i} \sum_{\zeta=1}^{\#i} (1 - \delta_1^{\sigma(\zeta)})^\alpha + \frac{1}{\#f} \sum_{\zeta=1}^{\#f} (1 - \eta_1^{\sigma(\zeta)})^\alpha \right) \right)^{\frac{1}{\alpha}} \\
 &= \left(\frac{1}{3} \left(\frac{1}{\#t_1} \sum_{\zeta=1}^{\#t_1} (\gamma_1^{\sigma(\zeta)})^\alpha + \frac{1}{\#i_1} \sum_{\zeta=1}^{\#i_1} (1 - \delta_1^{\sigma(\zeta)})^\alpha + \frac{1}{\#f_1} \sum_{\zeta=1}^{\#f_1} (1 - \eta_1^{\sigma(\zeta)})^\alpha \right) \right)^{\frac{1}{\alpha}} \\
 &= \left(\frac{1}{3} \left(\frac{1}{\#t_1} \sum_{\gamma \in t_1} \gamma^\alpha + \frac{1}{\#i_1} \sum_{\delta \in i_1} (1 - \delta)^\alpha + \frac{1}{\#f_1} \sum_{\eta \in f_1} (1 - \eta)^\alpha \right) \right)^{\frac{1}{\alpha}}.
 \end{aligned}$$

□

2.1.3. Computation of Optimal Weights Using Maximizing Deviation Method

Case I: Completely unknown attribute weight information

Construct an optimization model on the basis of the approach of maximizing deviation to determine the attributes optimal relative weights with SVNHFS. For the attribute $P_j \in Z$, the deviation of the alternative A_i to all the other alternatives can be represented as:

$$D_{ij}(w) = \sum_{k=1}^m d(n_{ij}, n_{kj})w_j, \quad i = 1, 2, \dots, m, \quad j = 1, 2, \dots, n$$

where $d(n_{ij}, n_{kj}) = \left(\frac{1}{3} \left(\frac{1}{\#\#t} \sum_{\varsigma=1}^{\#\#t} |\gamma_{ij}^{\sigma(\varsigma)} - \gamma_{kj}^{\sigma(\varsigma)}|^\alpha + \frac{1}{\#\#i} \sum_{\varsigma=1}^{\#\#i} |\delta_{ij}^{\sigma(\varsigma)} - \delta_{kj}^{\sigma(\varsigma)}|^\alpha + \frac{1}{\#\#f} \sum_{\varsigma=1}^{\#\#f} |\eta_{ij}^{\sigma(\varsigma)} - \eta_{kj}^{\sigma(\varsigma)}|^\alpha \right) \right)^{\frac{1}{\alpha}}$.

Let

$$D_j(w) = \sum_{i=1}^m D_{ij}(w) = \sum_{i=1}^m \sum_{k=1}^m w_j \left(\frac{1}{3} \left(\frac{1}{\#\#t} \sum_{\varsigma=1}^{\#\#t} |\gamma_{ij}^{\sigma(\varsigma)} - \gamma_{kj}^{\sigma(\varsigma)}|^\alpha + \frac{1}{\#\#i} \sum_{\varsigma=1}^{\#\#i} |\delta_{ij}^{\sigma(\varsigma)} - \delta_{kj}^{\sigma(\varsigma)}|^\alpha + \frac{1}{\#\#f} \sum_{\varsigma=1}^{\#\#f} |\eta_{ij}^{\sigma(\varsigma)} - \eta_{kj}^{\sigma(\varsigma)}|^\alpha \right) \right)^{\frac{1}{\alpha}},$$

$j = 1, 2, \dots, n$. Then $D_j(w)$ indicates the deviation value of all alternatives to other alternatives for the attribute $P_j \in Z$.

On the basis of the above analysis, to select the weight vector w which maximizes all deviation values for all the attributes, a non-linear programming model is constructed as follows:

$$(M-1) \begin{cases} \max D(w) = \sum_{j=1}^n \sum_{i=1}^m \sum_{k=1}^m w_j \left(\frac{1}{3} \left(\frac{1}{\#\#t} \sum_{\varsigma=1}^{\#\#t} |\gamma_{ij}^{\sigma(\varsigma)} - \gamma_{kj}^{\sigma(\varsigma)}|^\alpha + \frac{1}{\#\#i} \sum_{\varsigma=1}^{\#\#i} |\delta_{ij}^{\sigma(\varsigma)} - \delta_{kj}^{\sigma(\varsigma)}|^\alpha + \frac{1}{\#\#f} \sum_{\varsigma=1}^{\#\#f} |\eta_{ij}^{\sigma(\varsigma)} - \eta_{kj}^{\sigma(\varsigma)}|^\alpha \right) \right)^{\frac{1}{\alpha}} \\ \text{s.t. } w_j \geq 0, j = 1, 2, \dots, n, \quad \sum_{j=1}^n w_j^2 = 1 \end{cases}$$

To solve the above model, we construct the Lagrange function:

$$L(w, \xi) = \sum_{j=1}^n \sum_{i=1}^m \sum_{k=1}^m \left(\frac{1}{3} \left(\frac{1}{\#\#t} \sum_{\varsigma=1}^{\#\#t} |\gamma_{ij}^{\sigma(\varsigma)} - \gamma_{kj}^{\sigma(\varsigma)}|^\alpha + \frac{1}{\#\#i} \sum_{\varsigma=1}^{\#\#i} |\delta_{ij}^{\sigma(\varsigma)} - \delta_{kj}^{\sigma(\varsigma)}|^\alpha + \frac{1}{\#\#f} \sum_{\varsigma=1}^{\#\#f} |\eta_{ij}^{\sigma(\varsigma)} - \eta_{kj}^{\sigma(\varsigma)}|^\alpha \right) \right)^{\frac{1}{\alpha}} w_j + \frac{\xi}{2} \left(\sum_{j=1}^n w_j^2 - 1 \right)$$

where ξ is a real number, representing the Lagrange multiplier variable. Then we compute the partial derivatives of L and let:

$$\frac{\partial L}{\partial w_j} = \sum_{i=1}^m \sum_{k=1}^m \left(\frac{1}{3} \left(\frac{1}{\#\#t} \sum_{\varsigma=1}^{\#\#t} |\gamma_{ij}^{\sigma(\varsigma)} - \gamma_{kj}^{\sigma(\varsigma)}|^\alpha + \frac{1}{\#\#i} \sum_{\varsigma=1}^{\#\#i} |\delta_{ij}^{\sigma(\varsigma)} - \delta_{kj}^{\sigma(\varsigma)}|^\alpha + \frac{1}{\#\#f} \sum_{\varsigma=1}^{\#\#f} |\eta_{ij}^{\sigma(\varsigma)} - \eta_{kj}^{\sigma(\varsigma)}|^\alpha \right) \right)^{\frac{1}{\alpha}} + \xi w_j = 0$$

$$\frac{\partial L}{\partial \xi} = \frac{1}{2} \left(\sum_{j=1}^n w_j^2 - 1 \right) = 0$$

By solving above equations, an exact and simple formula for determining the attribute weights can be obtained as follows:

$$w_j^* = \frac{\sum_{i=1}^m \sum_{k=1}^m \left(\frac{1}{3} \left(\frac{1}{\#\#t} \sum_{\varsigma=1}^{\#\#t} |\gamma_{ij}^{\sigma(\varsigma)} - \gamma_{kj}^{\sigma(\varsigma)}|^\alpha + \frac{1}{\#\#i} \sum_{\varsigma=1}^{\#\#i} |\delta_{ij}^{\sigma(\varsigma)} - \delta_{kj}^{\sigma(\varsigma)}|^\alpha + \frac{1}{\#\#f} \sum_{\varsigma=1}^{\#\#f} |\eta_{ij}^{\sigma(\varsigma)} - \eta_{kj}^{\sigma(\varsigma)}|^\alpha \right) \right)^{\frac{1}{\alpha}}}{\sqrt{\sum_{j=1}^n \left[\sum_{i=1}^m \sum_{k=1}^m \left(\frac{1}{3} \left(\frac{1}{\#\#t} \sum_{\varsigma=1}^{\#\#t} |\gamma_{ij}^{\sigma(\varsigma)} - \gamma_{kj}^{\sigma(\varsigma)}|^\alpha + \frac{1}{\#\#i} \sum_{\varsigma=1}^{\#\#i} |\delta_{ij}^{\sigma(\varsigma)} - \delta_{kj}^{\sigma(\varsigma)}|^\alpha + \frac{1}{\#\#f} \sum_{\varsigma=1}^{\#\#f} |\eta_{ij}^{\sigma(\varsigma)} - \eta_{kj}^{\sigma(\varsigma)}|^\alpha \right) \right]^{\frac{1}{\alpha}}}}^2}$$

Because the weights of the attributes should satisfy the normalization condition, so we obtain the normalized attribute weights:

$$w_j = \frac{\sum_{i=1}^m \sum_{k=1}^m \left(\frac{1}{3} \left(\frac{1}{\#\mathfrak{t}} \sum_{\zeta=1}^{\#\mathfrak{t}} |\gamma_{ij}^{\sigma(\zeta)} - \gamma_{kj}^{\sigma(\zeta)}|^\alpha + \frac{1}{\#\mathfrak{i}} \sum_{\zeta=1}^{\#\mathfrak{i}} |\delta_{ij}^{\sigma(\zeta)} - \delta_{kj}^{\sigma(\zeta)}|^\alpha + \frac{1}{\#\mathfrak{f}} \sum_{\zeta=1}^{\#\mathfrak{f}} |\eta_{ij}^{\sigma(\zeta)} - \eta_{kj}^{\sigma(\zeta)}|^\alpha \right) \right)^{\frac{1}{\alpha}}}{\sum_{j=1}^n \sum_{i=1}^m \sum_{k=1}^m \left(\frac{1}{3} \left(\frac{1}{\#\mathfrak{t}} \sum_{\zeta=1}^{\#\mathfrak{t}} |\gamma_{ij}^{\sigma(\zeta)} - \gamma_{kj}^{\sigma(\zeta)}|^\alpha + \frac{1}{\#\mathfrak{i}} \sum_{\zeta=1}^{\#\mathfrak{i}} |\delta_{ij}^{\sigma(\zeta)} - \delta_{kj}^{\sigma(\zeta)}|^\alpha + \frac{1}{\#\mathfrak{f}} \sum_{\zeta=1}^{\#\mathfrak{f}} |\eta_{ij}^{\sigma(\zeta)} - \eta_{kj}^{\sigma(\zeta)}|^\alpha \right) \right)^{\frac{1}{\alpha}}} \quad (4)$$

Case II: Partly known attribute weight information

However, there are some situations that the information about the weight vector is partially known instead of completely known. For such situations, on the basis of the set of the known weight information, \mathfrak{S} , the constrained optimization model can be designed as:

$$(M-2) \begin{cases} \max D(w) = \sum_{j=1}^n \sum_{i=1}^m \sum_{k=1}^m w_j \left(\frac{1}{3} \left(\frac{1}{\#\mathfrak{t}} \sum_{\zeta=1}^{\#\mathfrak{t}} |\gamma_{ij}^{\sigma(\zeta)} - \gamma_{kj}^{\sigma(\zeta)}|^\alpha + \frac{1}{\#\mathfrak{i}} \sum_{\zeta=1}^{\#\mathfrak{i}} |\delta_{ij}^{\sigma(\zeta)} - \delta_{kj}^{\sigma(\zeta)}|^\alpha + \frac{1}{\#\mathfrak{f}} \sum_{\zeta=1}^{\#\mathfrak{f}} |\eta_{ij}^{\sigma(\zeta)} - \eta_{kj}^{\sigma(\zeta)}|^\alpha \right) \right)^{\frac{1}{\alpha}} \\ s.t. \ w \in \mathfrak{S}, \ w_j \geq 0, \ j = 1, 2, \dots, n, \ \sum_{j=1}^n w_j = 1 \end{cases}$$

where \mathfrak{S} is also a set of constraint conditions that the weight value w_j should satisfy according to the requirements in real situations. The model (M-2) is a linear programming model. By solving this model, we obtain the optimal solution $w = (w_1, w_2, \dots, w_n)^t$, which can be used as the attributes weight vector.

2.1.4. TOPSIS Method

Recently, several MADM techniques are established such as TOPSIS [27], TODIM [28], VIKOR [29], MULTIMOORA [30] and minimum deviation method [31]. TOPSIS method is attractive as limited subjective input is required from experts. It is quite well known that TOPSIS is a useful and easy approach helping an expert choose the optimal alternative according to both the minimal distance from the positive-ideal solution and the maximal distance from the negative-ideal solution. Therefore, after attaining the weight of attributes by using the maximizing deviation method, in this section, we develop a MADM approach based on TOPSIS model under single-valued neutrosophic hesitant fuzzy circumstances. The PIS A^+ , and the NIS A^- can be computed as:

$$A^+ = \{n_1^+, n_2^+, \dots, n_n^+\} \quad (5)$$

$$= \{ \{ \{1\}, \{0\}, \{0\} \}, \{ \{1\}, \{0\}, \{0\} \}, \dots, \{ \{1\}, \{0\}, \{0\} \} \}. \quad (6)$$

$$A^- = \{n_1^-, n_2^-, \dots, n_n^-\} \quad (7)$$

$$= \{ \{ \{0\}, \{1\}, \{1\} \}, \{ \{0\}, \{1\}, \{1\} \}, \dots, \{ \{0\}, \{1\}, \{1\} \} \}. \quad (8)$$

Based on Equation (3), Theorems 1 and 2, the separation measures d_i^+ and d_i^- of each alternative from the single-valued neutrosophic hesitant fuzzy PIS A^+ and the NIS A^- , respectively, are determined as:

$$d_i^+ = \sum_{j=1}^n d(n'_{ij}, n_j^+) w_j = \sum_{j=1}^n d(n'_{ij}, \{ \{1\}, \{0\}, \{0\} \}) w_j \quad (9)$$

$$= \sum_{j=1}^n w_j \left(\frac{1}{3} \left(\frac{1}{\#\mathfrak{t}'_{ij}} \sum_{\gamma \in \mathfrak{t}'_{ij}} (1 - \gamma)^\alpha + \frac{1}{\#\mathfrak{i}'_{ij}} \sum_{\delta \in \mathfrak{i}'_{ij}} \delta^\alpha + \frac{1}{\#\mathfrak{f}'_{ij}} \sum_{\eta \in \mathfrak{f}'_{ij}} \eta^\alpha \right) \right)^{\frac{1}{\alpha}}, \quad (10)$$

$$d_i^- = \sum_{j=1}^n d(n'_{ij}, n_j^-)w_j = \sum_{j=1}^n d(n'_{ij}, \{\{0\}, \{1\}, \{1\}\})w_j \tag{11}$$

$$= \sum_{j=1}^n w_j \left(\frac{1}{3} \left(\frac{1}{\#\iota'_{ij}} \sum_{\gamma \in \iota'_{ij}} \gamma^\alpha + \frac{1}{\#\delta'_{ij}} \sum_{\delta \in \delta'_{ij}} (1 - \delta)^\alpha + \frac{1}{\#\eta'_{ij}} \sum_{\eta \in \eta'_{ij}} (1 - \eta)^\alpha \right) \right)^{\frac{1}{\alpha}}, \tag{12}$$

where $i = 1, 2, \dots, m$.

The relative closeness coefficient of an alternative A_i with respect to the single-valued neutrosophic hesitant fuzzy PIS A^+ can be defined as follows:

$$RC(A_i) = \frac{d_i^-}{d_i^+ + d_i^-} \tag{13}$$

where $0 \leq RC(A_i) \leq 1, i = 1, 2, \dots, m$. The ranking orders of all alternatives can be determined according to the closeness coefficient $RC(A_i)$ and select the best one(s) from a set of appropriate alternatives.

The scheme of the proposed MADM technique is given in Figure 1. The detailed algorithm is constructed as follows:

- Step 1. Construct the decision matrix $\mathcal{N} = [n_{ij}]_{m \times n}$ for the MADM problem, where the entries $n_{ij} (i = 1, 2, \dots, m; j = 1, 2, \dots, n)$ are SVNHFES, given by the decision makers, for the alternative A_i according to the attribute P_j .
- Step 2. On the basis of Equation (4) determine the attribute weights $w = (w_1, w_2, \dots, w_m)^t$, if the attribute weights information is completely unknown, and turn to Step 4. Otherwise go to Step 3.
- Step 3. Use model (M-2) to determine the attribute weights $w = (w_1, w_2, \dots, w_m)^t$, if the information about the attribute weights is partially known.
- Step 4. Based on Equations (6) and (8), we determine the corresponding single-valued neutrosophic hesitant fuzzy PIS A^+ and the single-valued neutrosophic hesitant fuzzy NIS A^- , respectively.
- Step 5. Based on Equations (10) and (12), we compute the separation measures d_i^+ and d_i^- of each alternative A_i from the single-valued neutrosophic hesitant fuzzy PIS A^+ and the single-valued neutrosophic hesitant fuzzy NIS A^- , respectively.
- Step 6. Based on Equation (13), we determine the relative closeness coefficient $RC(A_i) (i = 1, 2, \dots, m)$ of each alternative A_i to the single-valued neutrosophic hesitant fuzzy PIS A^+ .
- Step 7. Rank the alternatives $A_i (i = 1, 2, \dots, m)$ based on the relative closeness coefficients $RC(A_i) (i = 1, 2, \dots, m)$ and select the optimal one(s).

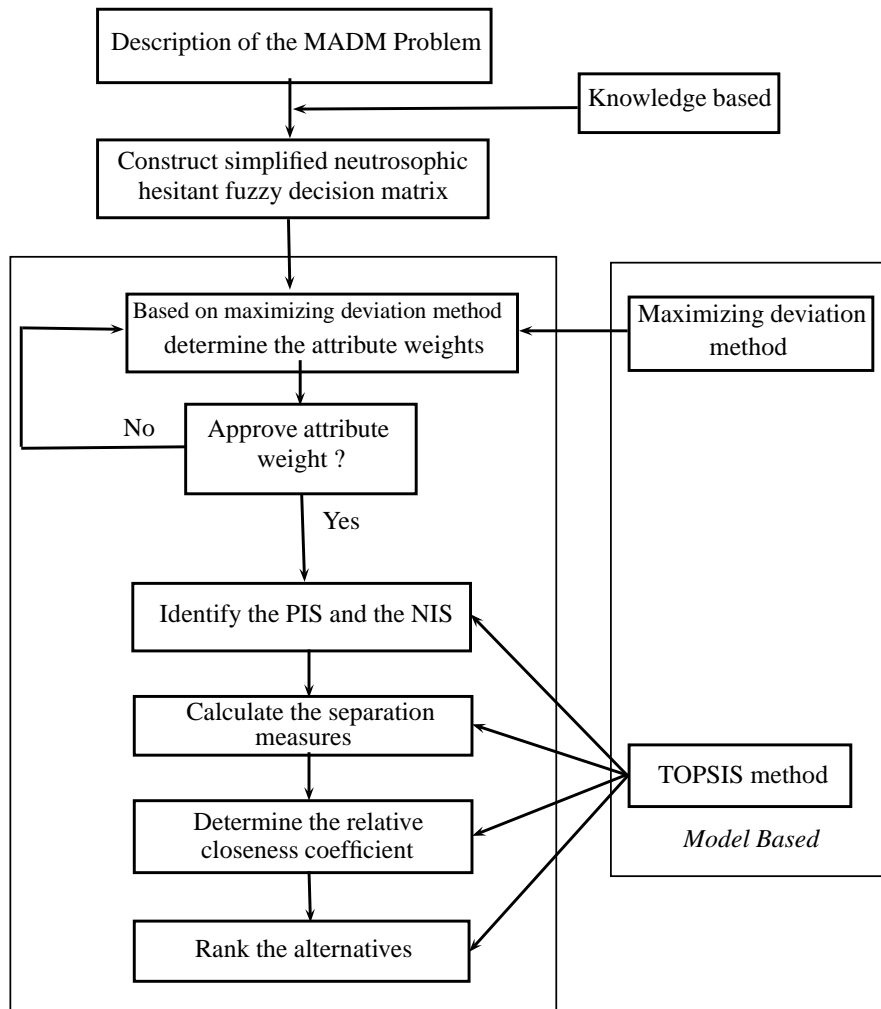

Figure 1. The scheme of the developed approach for MADM.
 Figure 1: The scheme of the developed approach for MADM.

2.2. TOPSIS and Maximizing Deviation Method for Interval Neutrosophic Hesitant Fuzzy Multi-Attribute Decision-Making

2.2 Maximizing deviation method for interval neutrosophic hesitant fuzzy multi-attribute decision making

In this subsection, we only use INHFSs in SNHFSs and put forward a novel decision-making approach, by combining the idea of INHFSs with maximizing deviation, to solve a MADM problem in interval neutrosophic hesitant fuzzy environment.

In this subsection, we only use INHFSs in SNHFSs and put forward a novel decision making approach, by combining the idea of INHFSs with maximizing deviation, to solve a MADM problem in interval neutrosophic hesitant fuzzy environment.

Definition 4 ([20]). Let Z be a fixed set, an INHFS \tilde{n} on Z is defined as:

Definition 2.2. [13] Let Z be a fixed set, an INHFS \tilde{n} on Z is defined as:

where $\tilde{t}(z), \tilde{i}(z), \tilde{f}(z)$ are sets of some interval-values in $[0, 1]$, indicating the possible truth-membership hesitant degree, indeterminacy-membership hesitant degree and falsity-membership hesitant degree of the element z to \tilde{n} , respectively; $\tilde{t}(z) = \{\tilde{\gamma}_1, \tilde{\gamma}_2, \dots, \tilde{\gamma}_l\}, \tilde{\gamma}_1, \tilde{\gamma}_2, \dots, \tilde{\gamma}_l$ are the elements of $\tilde{t}(z)$; $\tilde{i}(z) = \{\tilde{\delta}_1, \tilde{\delta}_2, \dots, \tilde{\delta}_p\}, \tilde{\delta}_1, \tilde{\delta}_2, \dots, \tilde{\delta}_p$ are the elements of $\tilde{i}(z)$; $\tilde{f}(z) = \{\tilde{\eta}_1, \tilde{\eta}_2, \dots, \tilde{\eta}_q\}, \tilde{\eta}_1, \tilde{\eta}_2, \dots, \tilde{\eta}_q$ are the elements of $\tilde{f}(z)$, for every $z \in Z$, and l, p, q denote, respectively, the numbers of the interval-valued hesitant fuzzy elements in $\tilde{t}, \tilde{i}, \tilde{f}$.

where $\tilde{t}(z), \tilde{i}(z), \tilde{f}(z)$ are sets of some interval-values in $[0, 1]$, indicating the possible truth-membership hesitant degree, indeterminacy-membership hesitant degree, and falsity-membership hesitant degree of the element z to \tilde{n} , respectively; $\tilde{t}(z) = \{\tilde{\gamma}_1, \tilde{\gamma}_2, \dots, \tilde{\gamma}_l\}, \tilde{\gamma}_1, \tilde{\gamma}_2, \dots, \tilde{\gamma}_l$ are the elements of $\tilde{t}(z)$; $\tilde{i}(z) = \{\tilde{\delta}_1, \tilde{\delta}_2, \dots, \tilde{\delta}_p\}, \tilde{\delta}_1, \tilde{\delta}_2, \dots, \tilde{\delta}_p$ are the elements of $\tilde{i}(z)$; $\tilde{f}(z) = \{\tilde{\eta}_1, \tilde{\eta}_2, \dots, \tilde{\eta}_q\}, \tilde{\eta}_1, \tilde{\eta}_2, \dots, \tilde{\eta}_q$ are the elements of $\tilde{f}(z)$, for every $z \in Z$, and l, p, q denote, respectively, the numbers of the interval-valued hesitant fuzzy elements in $\tilde{t}, \tilde{i}, \tilde{f}$.

For convenience, the expression $\tilde{n}(z) = \{\tilde{t}(z), \tilde{i}(z), \tilde{f}(z)\}$ is called an interval neutrosophic hesitant fuzzy element (INHFE), which we represent by simplified symbol $\tilde{n} = \{\tilde{t}, \tilde{i}, \tilde{f}\}$.

Similar to subsection 2.1, we consider a MADM problem, where $A = \{A_1, A_2, \dots, A_m\}$ is a discrete set of m alternatives and $P = \{P_1, P_2, \dots, P_n\}$ is a set of n attributes. The evaluation information of

Similar to Section 2.1, we consider a MADM problem, where $A = \{A_1, A_2, \dots, A_m\}$ is a discrete set of m alternatives and $P = \{P_1, P_2, \dots, P_n\}$ is a set of n attributes. The evaluation information of the i th alternative with respect to the j th attribute is an INHFE $\tilde{n}_{ij} = \langle \tilde{\tau}_{ij}, \tilde{\iota}_{ij}, \tilde{f}_{ij} \rangle$, where $\tilde{\tau}_{ij}$, $\tilde{\iota}_{ij}$ and \tilde{f}_{ij} indicate the interval-valued preference degree, interval-valued uncertain degree, and interval-valued falsity degree, respectively, of the expert facing the i th alternative that satisfied the j th attribute. Then the interval neutrosophic hesitant fuzzy decision matrix (INHFD) $\tilde{\mathcal{N}}$, can be constructed as follows:

$$\tilde{\mathcal{N}} = \begin{bmatrix} \tilde{n}_{11} & \tilde{n}_{12} & \dots & \tilde{n}_{1n} \\ \tilde{n}_{21} & \tilde{n}_{22} & \dots & \tilde{n}_{2n} \\ \vdots & \vdots & \ddots & \vdots \\ \tilde{n}_{m1} & \tilde{n}_{m2} & \dots & \tilde{n}_{mn} \end{bmatrix}$$

In the comparison of INHFEs, the number of their corresponding element may be unequal. To handle this situation, we normalize the INHFEs as follows:

Suppose that $\tilde{n} = \{\tilde{\tau}, \tilde{\iota}, \tilde{f}\}$ is an INHFE, then $\tilde{\gamma} = \omega\tilde{\gamma}^+ + (1 - \omega)\tilde{\gamma}^-$, $\tilde{\delta} = \omega\tilde{\delta}^+ + (1 - \omega)\tilde{\delta}^-$ and $\tilde{\eta} = \omega\tilde{\eta}^+ + (1 - \omega)\tilde{\eta}^-$ are the added truth-membership, the indeterminacy-membership and the falsity-membership degree, respectively, where $\tilde{\gamma}^-$, $\tilde{\gamma}^+$, $\tilde{\delta}^-$, $\tilde{\delta}^+$ and $\tilde{\eta}^-$, $\tilde{\eta}^+$ are the minimum and the maximum elements of $\tilde{\tau}$, $\tilde{\iota}$ and \tilde{f} , respectively, and $\omega \in [0, 1]$ is a parameter assigned by the expert according to his risk preference.

For the normalization of INHFE, different values of ω produce different results for the added truth-membership, the indeterminacy-membership and the falsity-membership degree. Usually, there are three cases of the preference of the expert:

- If $\omega = 0$, the pessimist expert may add the minimum truth-membership degree $\tilde{\gamma}^-$, the minimum indeterminacy-membership degree $\tilde{\delta}^-$ and the minimum falsity-membership degree $\tilde{\eta}^-$.
- If $\omega = 0.5$, the neutral expert may add the truth-membership degree $\frac{\tilde{\gamma}^- + \tilde{\gamma}^+}{2}$, the indeterminacy-membership degree $\frac{\tilde{\delta}^- + \tilde{\delta}^+}{2}$ and the falsity-membership degree $\frac{\tilde{\eta}^- + \tilde{\eta}^+}{2}$.
- If $\omega = 1$, the optimistic expert may add the maximum truth-membership degree $\tilde{\gamma}^+$, the maximum indeterminacy-membership degree $\tilde{\delta}^+$ and the maximum falsity-membership degree $\tilde{\eta}^+$.

The algorithm for the normalization of INHFEs is given in Algorithm 2.

Algorithm 2 The algorithm for the normalization of INHFES.

INPUT: Two INHFES $\tilde{n}_1 = (\tilde{t}_1, \tilde{i}_1, \tilde{f}_1)$ and $\tilde{n}_2 = (\tilde{t}_2, \tilde{i}_2, \tilde{f}_2)$ and the value of $\tilde{\omega}$.

OUTPUT: The normalization of $\tilde{n}_1 = (\tilde{t}_1, \tilde{i}_1, \tilde{f}_1)$ and $\tilde{n}_2 = (\tilde{t}_2, \tilde{i}_2, \tilde{f}_2)$.

```

1: Count the number of elements of  $\tilde{n}_1$  and  $\tilde{n}_2$ , i.e.,  $\#\tilde{t}_1, \#\tilde{i}_1, \#\tilde{f}_1, \#\tilde{t}_2, \#\tilde{i}_2, \#\tilde{f}_2$ ;
2: Determine the minimum and the maximum of the elements of  $\tilde{n}_1$  and  $\tilde{n}_2$ ;
3:  $\tilde{t} = \arg \min_{i=1,2} \#\tilde{t}_i, \tilde{i} = \arg \min_{i=1,2} \#\tilde{i}_i, \tilde{f} = \arg \min_{i=1,2} \#\tilde{f}_i$ 
4: if  $\#\tilde{t}_1 = \#\tilde{t}_2$  then break;
5: else if  $\tilde{t} = \#\tilde{t}_1$  then
6:    $n = \#\tilde{t}_2 - \#\tilde{t}_1$ ;
7:   Determine the value of  $\tilde{\gamma}$  for  $\tilde{t}_1$ ;
8:   for  $i=1:1:n$  do
9:      $\tilde{t}_1 = \tilde{t}_1 \cup \tilde{\gamma}$ ;
10:  end for
11: else
12:    $n = \#\tilde{t}_1 - \#\tilde{t}_2$ ;
13:   Determine the value of  $\tilde{\gamma}$  for  $\tilde{t}_2$ ;
14:   for  $i=1:1:n$  do
15:      $\tilde{t}_2 = \tilde{t}_2 \cup \tilde{\gamma}$ ;
16:   end for
17: end if
18: if  $\#\tilde{i}_1 = \#\tilde{i}_2$  then break;
19: else if  $\tilde{i} = \#\tilde{i}_1$  then
20:    $n = \#\tilde{i}_2 - \#\tilde{i}_1$ ;
21:   Determine the value of  $\tilde{\delta}$  for  $\tilde{i}_1$ ;
22:   for  $j=1:1:n$  do
23:      $\tilde{i}_1 = \tilde{i}_1 \cup \tilde{\delta}$ ;
24:   end for
25: else
26:    $n = \#\tilde{i}_1 - \#\tilde{i}_2$ ;
27:   Determine the value of  $\tilde{\delta}$  for  $\tilde{i}_2$ ;
28:   for  $j=1:1:n$  do
29:      $\tilde{i}_2 = \tilde{i}_2 \cup \tilde{\delta}$ ;
30:   end for
31: end if
32: if  $\#\tilde{f}_1 = \#\tilde{f}_2$  then break;
33: else if  $\tilde{f} = \#\tilde{f}_1$  then
34:    $n = \#\tilde{f}_2 - \#\tilde{f}_1$ ;
35:   Determine the value of  $\tilde{\eta}$  for  $\tilde{f}_1$ ;
36:   for  $i=1:1:n$  do
37:      $\tilde{f}_1 = \tilde{f}_1 \cup \tilde{\eta}$ ;
38:   end for
39: else
40:    $n = \#\tilde{f}_1 - \#\tilde{f}_2$ ;
41:   Determine the value of  $\tilde{\eta}$  for  $\tilde{f}_2$ ;
42:   for  $i=1:1:n$  do
43:      $\tilde{f}_2 = \tilde{f}_2 \cup \tilde{\eta}$ ;
44:   end for
45: end if

```

2.2.1. The Distance Measures for INHFSs

Definition 5. Let $\tilde{n}_1 = \{\tilde{t}_1, \tilde{i}_1, \tilde{f}_1\}$ and $\tilde{n}_2 = \{\tilde{t}_2, \tilde{i}_2, \tilde{f}_2\}$ be two normalized INHFES, then we define the interval neutrosophic hesitant fuzzy Hamming distance between \tilde{n}_1 and \tilde{n}_2 as follows:

$$\begin{aligned}
 \tilde{d}_1(\tilde{n}_1, \tilde{n}_2) = & \frac{1}{6} \left(\frac{1}{\#\tilde{t}} \sum_{\zeta=1}^{\#\tilde{t}} \left(\left| \tilde{\gamma}_1^{\sigma(\zeta)^L} - \tilde{\gamma}_2^{\sigma(\zeta)^L} \right| + \left| \tilde{\gamma}_1^{\sigma(\zeta)^U} - \tilde{\gamma}_2^{\sigma(\zeta)^U} \right| \right) + \frac{1}{\#\tilde{i}} \sum_{\zeta=1}^{\#\tilde{i}} \left(\left| \tilde{\delta}_1^{\sigma(\zeta)^L} - \tilde{\delta}_2^{\sigma(\zeta)^L} \right| \right. \right. \\
 & \left. \left. + \left| \tilde{\delta}_1^{\sigma(\zeta)^U} - \tilde{\delta}_2^{\sigma(\zeta)^U} \right| \right) + \frac{1}{\#\tilde{f}} \sum_{\zeta=1}^{\#\tilde{f}} \left(\left| \tilde{\eta}_1^{\sigma(\zeta)^L} - \tilde{\eta}_2^{\sigma(\zeta)^L} \right| + \left| \tilde{\eta}_1^{\sigma(\zeta)^U} - \tilde{\eta}_2^{\sigma(\zeta)^U} \right| \right) \right),
 \end{aligned}$$

where $\#\tilde{t} = \#\tilde{t}_1 = \#\tilde{t}_2$, $\#\tilde{f} = \#\tilde{f}_1 = \#\tilde{f}_2$ and $\#\tilde{f} = \#\tilde{f}_1 = \#\tilde{f}_2$. $\tilde{\gamma}_i^{\sigma(\zeta)}$, $\tilde{\delta}_i^{\sigma(\zeta)}$ and $\tilde{\eta}_i^{\sigma(\zeta)}$ are the ζ th largest values in $\tilde{\gamma}_i$, $\tilde{\delta}_i$ and $\tilde{\eta}_i$, respectively ($i = 1, 2$).

In addition, the interval neutrosophic hesitant fuzzy Euclidean distance is defined as:

$$\begin{aligned} \tilde{d}_2(\tilde{n}_1, \tilde{n}_2) &= \left(\frac{1}{6} \left(\frac{1}{\#\tilde{t}} \sum_{\zeta=1}^{\#\tilde{t}} \left((\tilde{\gamma}_1^{\sigma(\zeta)L} - \tilde{\gamma}_2^{\sigma(\zeta)L})^2 + (\tilde{\gamma}_1^{\sigma(\zeta)U} - \tilde{\gamma}_2^{\sigma(\zeta)U})^2 \right) + \frac{1}{\#\tilde{f}} \sum_{\zeta=1}^{\#\tilde{f}} \left((\tilde{\delta}_1^{\sigma(\zeta)L} - \tilde{\delta}_2^{\sigma(\zeta)L})^2 \right. \right. \right. \\ &\quad \left. \left. + (\tilde{\delta}_1^{\sigma(\zeta)U} - \tilde{\delta}_2^{\sigma(\zeta)U})^2 \right) + \frac{1}{\#\tilde{f}} \sum_{\zeta=1}^{\#\tilde{f}} \left((\tilde{\eta}_1^{\sigma(\zeta)L} - \tilde{\eta}_2^{\sigma(\zeta)L})^2 + (\tilde{\eta}_1^{\sigma(\zeta)U} - \tilde{\eta}_2^{\sigma(\zeta)U})^2 \right) \right) \right)^{\frac{1}{2}}. \end{aligned}$$

By using the geometric distance model of [26], the above distances can be generalized as follows:

$$\begin{aligned} \tilde{d}(\tilde{n}_1, \tilde{n}_2) &= \left(\frac{1}{6} \left(\frac{1}{\#\tilde{t}} \sum_{\zeta=1}^{\#\tilde{t}} \left((\tilde{\gamma}_1^{\sigma(\zeta)L} - \tilde{\gamma}_2^{\sigma(\zeta)L})^\alpha + (\tilde{\gamma}_1^{\sigma(\zeta)U} - \tilde{\gamma}_2^{\sigma(\zeta)U})^\alpha \right) + \frac{1}{\#\tilde{f}} \sum_{\zeta=1}^{\#\tilde{f}} \left((\tilde{\delta}_1^{\sigma(\zeta)L} - \tilde{\delta}_2^{\sigma(\zeta)L})^\alpha \right. \right. \right. \\ &\quad \left. \left. + (\tilde{\delta}_1^{\sigma(\zeta)U} - \tilde{\delta}_2^{\sigma(\zeta)U})^\alpha \right) + \frac{1}{\#\tilde{f}} \sum_{\zeta=1}^{\#\tilde{f}} \left((\tilde{\eta}_1^{\sigma(\zeta)L} - \tilde{\eta}_2^{\sigma(\zeta)L})^\alpha + (\tilde{\eta}_1^{\sigma(\zeta)U} - \tilde{\eta}_2^{\sigma(\zeta)U})^\alpha \right) \right) \right)^{\frac{1}{\alpha}}, \end{aligned}$$

where α is constant and $\alpha > 0$. Based on the value of α , the relationship among $\tilde{d}(\tilde{n}_1, \tilde{n}_2)$, $\tilde{d}_1(\tilde{n}_1, \tilde{n}_2)$ and $\tilde{d}_2(\tilde{n}_1, \tilde{n}_2)$ can be deduced as:

- If $\alpha = 1$, then the distance $\tilde{d}(\tilde{n}_1, \tilde{n}_2) = \tilde{d}_1(\tilde{n}_1, \tilde{n}_2)$.
- If $\alpha = 2$, then the distance $\tilde{d}(\tilde{n}_1, \tilde{n}_2) = \tilde{d}_2(\tilde{n}_1, \tilde{n}_2)$.

Therefore, the distance $\tilde{d}(\tilde{n}_1, \tilde{n}_2)$ is a generalization of the interval neutrosophic hesitant fuzzy Hamming distance $\tilde{d}_1(\tilde{n}_1, \tilde{n}_2)$ and the interval neutrosophic hesitant fuzzy Euclidean distance $\tilde{d}_2(\tilde{n}_1, \tilde{n}_2)$.

Theorem 3. Let $\tilde{n}_1 = \{\tilde{t}_1, \tilde{f}_1, \tilde{f}_1\}$ and $\tilde{n}_2 = \{\{[1, 1]\}, \{[0, 0]\}, \{[0, 0]\}\}$ be two INHFES, then the generalized distance $\tilde{d}(\tilde{n}_1, \tilde{n}'_2)$ can be calculated as:

$$\tilde{d}(\tilde{n}_1, \tilde{n}'_2) = \left(\frac{1}{6} \left(\frac{1}{\#\tilde{t}_1} \sum_{\tilde{\gamma} \in \tilde{t}_1} \left((1 - \tilde{\gamma}^L)^\alpha + (1 - \tilde{\gamma}^U)^\alpha \right) + \frac{1}{\#\tilde{f}_1} \sum_{\tilde{\delta} \in \tilde{f}_1} \left((\tilde{\delta}^L)^\alpha + (\tilde{\delta}^U)^\alpha \right) + \frac{1}{\#\tilde{f}_1} \sum_{\tilde{\eta} \in \tilde{f}_1} \left((\tilde{\eta}^L)^\alpha + (\tilde{\eta}^U)^\alpha \right) \right) \right)^{\frac{1}{\alpha}}.$$

where \tilde{n}'_2 is the normalization outcome of \tilde{n}_2 by the comparison of \tilde{n}_1 and \tilde{n}_2 .

Theorem 4. Let $\tilde{n}_1 = \{\tilde{t}_1, \tilde{f}_1, \tilde{f}_1\}$ and $\tilde{n}_2 = \{\{[0, 0]\}, \{[1, 1]\}, \{[1, 1]\}\}$ be two INHFES, then the generalized distance $\tilde{d}(\tilde{n}_1, \tilde{n}'_2)$ can be calculated as:

$$\tilde{d}(\tilde{n}_1, \tilde{n}'_2) = \left(\frac{1}{6} \left(\frac{1}{\#\tilde{t}_1} \sum_{\tilde{\gamma} \in \tilde{t}_1} \left((\tilde{\gamma}^L)^\alpha + (\tilde{\gamma}^U)^\alpha \right) + \frac{1}{\#\tilde{f}_1} \sum_{\tilde{\delta} \in \tilde{f}_1} \left((1 - \tilde{\delta}^L)^\alpha + (1 - \tilde{\delta}^U)^\alpha \right) + \frac{1}{\#\tilde{f}_1} \sum_{\tilde{\eta} \in \tilde{f}_1} \left((1 - \tilde{\eta}^L)^\alpha + (1 - \tilde{\eta}^U)^\alpha \right) \right) \right)^{\frac{1}{\alpha}}.$$

where \tilde{n}'_2 is the normalization outcome of \tilde{n}_2 by the comparison of \tilde{n}_1 and \tilde{n}_2 .

2.2.2. Computation of Optimal Weights Using Maximizing Deviation Method

Case I: Completely unknown information on attribute weights

Using the maximizing deviation method, we construct an optimization model to determine the attributes optimal relative weights in interval neutrosophic hesitant fuzzy setting. For the attribute $P_j \in Z$, the deviation of the alternative A_i to all the other alternatives can be represented as:

$$\tilde{D}_{ij}(w) = \sum_{k=1}^m \tilde{d}(\tilde{n}_{ij}, \tilde{n}_{kj})w_j, \quad i = 1, 2, \dots, m, \quad j = 1, 2, \dots, n$$

where

$$\begin{aligned} \tilde{d}(\tilde{n}_{ij}, \tilde{n}_{kj}) = & \left(\frac{1}{6} \left(\frac{1}{\#\tilde{t}} \sum_{\zeta=1}^{\#\tilde{t}} \left(\left| \tilde{\gamma}_{ij}^{\tilde{\sigma}(\zeta)L} - \tilde{\gamma}_{kj}^{\tilde{\sigma}(\zeta)L} \right|^\alpha + \left| \tilde{\gamma}_{ij}^{\tilde{\sigma}(\zeta)U} - \tilde{\gamma}_{kj}^{\tilde{\sigma}(\zeta)U} \right|^\alpha \right) + \frac{1}{\#\tilde{f}} \sum_{\zeta=1}^{\#\tilde{f}} \left(\left| \tilde{\delta}_{ij}^{\tilde{\sigma}(\zeta)L} - \tilde{\delta}_{kj}^{\tilde{\sigma}(\zeta)L} \right|^\alpha \right. \right. \\ & \left. \left. + \left| \tilde{\delta}_{ij}^{\tilde{\sigma}(\zeta)U} - \tilde{\delta}_{kj}^{\tilde{\sigma}(\zeta)U} \right|^\alpha \right) + \frac{1}{\#\tilde{f}} \sum_{\zeta=1}^{\#\tilde{f}} \left(\left| \tilde{\eta}_{ij}^{\tilde{\sigma}(\zeta)L} - \tilde{\eta}_{kj}^{\tilde{\sigma}(\zeta)L} \right|^\alpha + \left| \tilde{\eta}_{ij}^{\tilde{\sigma}(\zeta)U} - \tilde{\eta}_{kj}^{\tilde{\sigma}(\zeta)U} \right|^\alpha \right) \right) \right)^{\frac{1}{\alpha}}. \end{aligned}$$

Let

$$\begin{aligned} \tilde{D}_j(w) = \sum_{i=1}^m \tilde{D}_{ij}(w) = & \sum_{i=1}^m \sum_{k=1}^m w_j \left(\frac{1}{6} \left(\frac{1}{\#\tilde{t}} \sum_{\zeta=1}^{\#\tilde{t}} \left(\left| \tilde{\gamma}_{ij}^{\tilde{\sigma}(\zeta)L} - \tilde{\gamma}_{kj}^{\tilde{\sigma}(\zeta)L} \right|^\alpha + \left| \tilde{\gamma}_{ij}^{\tilde{\sigma}(\zeta)U} - \tilde{\gamma}_{kj}^{\tilde{\sigma}(\zeta)U} \right|^\alpha \right) + \frac{1}{\#\tilde{f}} \sum_{\zeta=1}^{\#\tilde{f}} \left(\left| \tilde{\delta}_{ij}^{\tilde{\sigma}(\zeta)L} - \tilde{\delta}_{kj}^{\tilde{\sigma}(\zeta)L} \right|^\alpha \right. \right. \\ & \left. \left. + \left| \tilde{\delta}_{ij}^{\tilde{\sigma}(\zeta)U} - \tilde{\delta}_{kj}^{\tilde{\sigma}(\zeta)U} \right|^\alpha \right) + \frac{1}{\#\tilde{f}} \sum_{\zeta=1}^{\#\tilde{f}} \left(\left| \tilde{\eta}_{ij}^{\tilde{\sigma}(\zeta)L} - \tilde{\eta}_{kj}^{\tilde{\sigma}(\zeta)L} \right|^\alpha + \left| \tilde{\eta}_{ij}^{\tilde{\sigma}(\zeta)U} - \tilde{\eta}_{kj}^{\tilde{\sigma}(\zeta)U} \right|^\alpha \right) \right) \right)^{\frac{1}{\alpha}}, \end{aligned}$$

$j = 1, 2, \dots, n$. Then $D_j(w)$ represents the deviation value of all alternatives to other alternatives for the attribute $P_j \in Z$.

On the basis of the analysis above, to select the weight vector w which maximizes all deviation values for all the attributes, a non-linear programming model is constructed as follows:

$$(M-3) \left\{ \begin{aligned} \max \tilde{D}(w) = & \sum_{j=1}^n \sum_{i=1}^m \sum_{k=1}^m w_j \left(\frac{1}{6} \left(\frac{1}{\#\tilde{t}} \sum_{\zeta=1}^{\#\tilde{t}} \left(\left| \tilde{\gamma}_{ij}^{\tilde{\sigma}(\zeta)L} - \tilde{\gamma}_{kj}^{\tilde{\sigma}(\zeta)L} \right|^\alpha + \left| \tilde{\gamma}_{ij}^{\tilde{\sigma}(\zeta)U} - \tilde{\gamma}_{kj}^{\tilde{\sigma}(\zeta)U} \right|^\alpha \right) + \frac{1}{\#\tilde{f}} \sum_{\zeta=1}^{\#\tilde{f}} \left(\left| \tilde{\delta}_{ij}^{\tilde{\sigma}(\zeta)L} - \tilde{\delta}_{kj}^{\tilde{\sigma}(\zeta)L} \right|^\alpha \right. \right. \\ & \left. \left. + \left| \tilde{\delta}_{ij}^{\tilde{\sigma}(\zeta)U} - \tilde{\delta}_{kj}^{\tilde{\sigma}(\zeta)U} \right|^\alpha \right) + \frac{1}{\#\tilde{f}} \sum_{\zeta=1}^{\#\tilde{f}} \left(\left| \tilde{\eta}_{ij}^{\tilde{\sigma}(\zeta)L} - \tilde{\eta}_{kj}^{\tilde{\sigma}(\zeta)L} \right|^\alpha + \left| \tilde{\eta}_{ij}^{\tilde{\sigma}(\zeta)U} - \tilde{\eta}_{kj}^{\tilde{\sigma}(\zeta)U} \right|^\alpha \right) \right) \right) \\ \text{s.t. } & w_j \geq 0, j = 1, 2, \dots, n, \sum_{j=1}^n w_j^2 = 1 \end{aligned} \right.$$

To solve the above model, we construct the Lagrange function:

$$\begin{aligned} L(w, \zeta) = & \sum_{j=1}^n \sum_{i=1}^m \sum_{k=1}^m \left(\frac{1}{6} \left(\frac{1}{\#\tilde{t}} \sum_{\zeta=1}^{\#\tilde{t}} \left(\left| \tilde{\gamma}_{ij}^{\tilde{\sigma}(\zeta)L} - \tilde{\gamma}_{kj}^{\tilde{\sigma}(\zeta)L} \right|^\alpha + \left| \tilde{\gamma}_{ij}^{\tilde{\sigma}(\zeta)U} - \tilde{\gamma}_{kj}^{\tilde{\sigma}(\zeta)U} \right|^\alpha \right) + \frac{1}{\#\tilde{f}} \sum_{\zeta=1}^{\#\tilde{f}} \left(\left| \tilde{\delta}_{ij}^{\tilde{\sigma}(\zeta)L} - \tilde{\delta}_{kj}^{\tilde{\sigma}(\zeta)L} \right|^\alpha \right. \right. \\ & \left. \left. + \left| \tilde{\delta}_{ij}^{\tilde{\sigma}(\zeta)U} - \tilde{\delta}_{kj}^{\tilde{\sigma}(\zeta)U} \right|^\alpha \right) + \frac{1}{\#\tilde{f}} \sum_{\zeta=1}^{\#\tilde{f}} \left(\left| \tilde{\eta}_{ij}^{\tilde{\sigma}(\zeta)L} - \tilde{\eta}_{kj}^{\tilde{\sigma}(\zeta)L} \right|^\alpha + \left| \tilde{\eta}_{ij}^{\tilde{\sigma}(\zeta)U} - \tilde{\eta}_{kj}^{\tilde{\sigma}(\zeta)U} \right|^\alpha \right) \right) \right)^{\frac{1}{\alpha}} w_j + \frac{\zeta}{2} \left(\sum_{j=1}^n w_j^2 - 1 \right) \end{aligned}$$

where ζ is a real number, representing the Lagrange multiplier variable. Then we compute the partial derivatives of L and let:

$$\begin{aligned} \frac{\partial L}{\partial w_j} = & \sum_{i=1}^m \sum_{k=1}^m \left(\frac{1}{6} \left(\frac{1}{\#\tilde{t}} \sum_{\zeta=1}^{\#\tilde{t}} \left(\left| \tilde{\gamma}_{ij}^{\tilde{\sigma}(\zeta)L} - \tilde{\gamma}_{kj}^{\tilde{\sigma}(\zeta)L} \right|^\alpha + \left| \tilde{\gamma}_{ij}^{\tilde{\sigma}(\zeta)U} - \tilde{\gamma}_{kj}^{\tilde{\sigma}(\zeta)U} \right|^\alpha \right) + \frac{1}{\#\tilde{f}} \sum_{\zeta=1}^{\#\tilde{f}} \left(\left| \tilde{\delta}_{ij}^{\tilde{\sigma}(\zeta)L} - \tilde{\delta}_{kj}^{\tilde{\sigma}(\zeta)L} \right|^\alpha \right. \right. \\ & \left. \left. + \left| \tilde{\delta}_{ij}^{\tilde{\sigma}(\zeta)U} - \tilde{\delta}_{kj}^{\tilde{\sigma}(\zeta)U} \right|^\alpha \right) + \frac{1}{\#\tilde{f}} \sum_{\zeta=1}^{\#\tilde{f}} \left(\left| \tilde{\eta}_{ij}^{\tilde{\sigma}(\zeta)L} - \tilde{\eta}_{kj}^{\tilde{\sigma}(\zeta)L} \right|^\alpha + \left| \tilde{\eta}_{ij}^{\tilde{\sigma}(\zeta)U} - \tilde{\eta}_{kj}^{\tilde{\sigma}(\zeta)U} \right|^\alpha \right) \right) \right)^{\frac{1}{\alpha}} + \zeta w_j = 0 \end{aligned}$$

$$\frac{\partial L}{\partial \zeta} = \frac{1}{2} \left(\sum_{j=1}^n w_j^2 - 1 \right) = 0$$

By solving the above equations, to determining the attribute weights, an exact and simple formula can be obtained as follows:

$$w_j^* = \frac{\sum_{i=1}^m \sum_{k=1}^m \left(\frac{1}{6} \left(\frac{1}{\#\tilde{i}} \sum_{\zeta=1}^{\#\tilde{i}} \left(|\tilde{\gamma}_{ij}^{\tilde{\sigma}(\zeta)L} - \tilde{\gamma}_{kj}^{\tilde{\sigma}(\zeta)L}|^\alpha + |\tilde{\gamma}_{ij}^{\tilde{\sigma}(\zeta)U} - \tilde{\gamma}_{kj}^{\tilde{\sigma}(\zeta)U}|^\alpha \right) + \frac{1}{\#\tilde{f}} \sum_{\zeta=1}^{\#\tilde{f}} \left(|\tilde{\delta}_{ij}^{\tilde{\sigma}(\zeta)L} - \tilde{\delta}_{kj}^{\tilde{\sigma}(\zeta)L}|^\alpha \right) \right) \right.}{\left. + |\tilde{\delta}_{ij}^{\tilde{\sigma}(\zeta)U} - \tilde{\delta}_{kj}^{\tilde{\sigma}(\zeta)U}|^\alpha \right) + \frac{1}{\#\tilde{f}} \sum_{\zeta=1}^{\#\tilde{f}} \left(|\tilde{\eta}_{ij}^{\tilde{\sigma}(\zeta)L} - \tilde{\eta}_{kj}^{\tilde{\sigma}(\zeta)L}|^\alpha + |\tilde{\eta}_{ij}^{\tilde{\sigma}(\zeta)U} - \tilde{\eta}_{kj}^{\tilde{\sigma}(\zeta)U}|^\alpha \right) \right)^{\frac{1}{\alpha}}}{\sqrt{\sum_{j=1}^n \left[\sum_{i=1}^m \sum_{k=1}^m \left(\frac{1}{6} \left(\frac{1}{\#\tilde{i}} \sum_{\zeta=1}^{\#\tilde{i}} \left(|\tilde{\gamma}_{ij}^{\tilde{\sigma}(\zeta)L} - \tilde{\gamma}_{kj}^{\tilde{\sigma}(\zeta)L}|^\alpha + |\tilde{\gamma}_{ij}^{\tilde{\sigma}(\zeta)U} - \tilde{\gamma}_{kj}^{\tilde{\sigma}(\zeta)U}|^\alpha \right) + \frac{1}{\#\tilde{f}} \sum_{\zeta=1}^{\#\tilde{f}} \left(|\tilde{\delta}_{ij}^{\tilde{\sigma}(\zeta)L} - \tilde{\delta}_{kj}^{\tilde{\sigma}(\zeta)L}|^\alpha \right) \right) \right. \right.} \right]^{\frac{1}{\alpha}}}$$

As the weights of the attributes should satisfy the normalization condition, so we obtain the normalized attribute weights:

$$w_j = \frac{\sum_{i=1}^m \sum_{k=1}^m \left(\frac{1}{6} \left(\frac{1}{\#\tilde{i}} \sum_{\zeta=1}^{\#\tilde{i}} \left(|\tilde{\gamma}_{ij}^{\tilde{\sigma}(\zeta)L} - \tilde{\gamma}_{kj}^{\tilde{\sigma}(\zeta)L}|^\alpha + |\tilde{\gamma}_{ij}^{\tilde{\sigma}(\zeta)U} - \tilde{\gamma}_{kj}^{\tilde{\sigma}(\zeta)U}|^\alpha \right) + \frac{1}{\#\tilde{f}} \sum_{\zeta=1}^{\#\tilde{f}} \left(|\tilde{\delta}_{ij}^{\tilde{\sigma}(\zeta)L} - \tilde{\delta}_{kj}^{\tilde{\sigma}(\zeta)L}|^\alpha \right) \right) \right.}{\left. + |\tilde{\delta}_{ij}^{\tilde{\sigma}(\zeta)U} - \tilde{\delta}_{kj}^{\tilde{\sigma}(\zeta)U}|^\alpha \right) + \frac{1}{\#\tilde{f}} \sum_{\zeta=1}^{\#\tilde{f}} \left(|\tilde{\eta}_{ij}^{\tilde{\sigma}(\zeta)L} - \tilde{\eta}_{kj}^{\tilde{\sigma}(\zeta)L}|^\alpha + |\tilde{\eta}_{ij}^{\tilde{\sigma}(\zeta)U} - \tilde{\eta}_{kj}^{\tilde{\sigma}(\zeta)U}|^\alpha \right) \right)^{\frac{1}{\alpha}}}{\sum_{j=1}^n \sum_{i=1}^m \sum_{k=1}^m \left(\frac{1}{6} \left(\frac{1}{\#\tilde{i}} \sum_{\zeta=1}^{\#\tilde{i}} \left(|\tilde{\gamma}_{ij}^{\tilde{\sigma}(\zeta)L} - \tilde{\gamma}_{kj}^{\tilde{\sigma}(\zeta)L}|^\alpha + |\tilde{\gamma}_{ij}^{\tilde{\sigma}(\zeta)U} - \tilde{\gamma}_{kj}^{\tilde{\sigma}(\zeta)U}|^\alpha \right) + \frac{1}{\#\tilde{f}} \sum_{\zeta=1}^{\#\tilde{f}} \left(|\tilde{\delta}_{ij}^{\tilde{\sigma}(\zeta)L} - \tilde{\delta}_{kj}^{\tilde{\sigma}(\zeta)L}|^\alpha \right) \right) \right.}{\left. + |\tilde{\delta}_{ij}^{\tilde{\sigma}(\zeta)U} - \tilde{\delta}_{kj}^{\tilde{\sigma}(\zeta)U}|^\alpha \right) + \frac{1}{\#\tilde{f}} \sum_{\zeta=1}^{\#\tilde{f}} \left(|\tilde{\eta}_{ij}^{\tilde{\sigma}(\zeta)L} - \tilde{\eta}_{kj}^{\tilde{\sigma}(\zeta)L}|^\alpha + |\tilde{\eta}_{ij}^{\tilde{\sigma}(\zeta)U} - \tilde{\eta}_{kj}^{\tilde{\sigma}(\zeta)U}|^\alpha \right) \right)^{\frac{1}{\alpha}}} \quad (14)$$

Case II: Partly known information on attribute weights

However, there are some situations that the information about the weight vector is partially known. For such situations, using the set of the known weight information, \mathfrak{S} , the constrained optimization model can be designed as:

$$(M-4) \left\{ \begin{array}{l} \max \tilde{D}(w) = \sum_{j=1}^n \sum_{i=1}^m \sum_{k=1}^m w_j \left(\frac{1}{6} \left(\frac{1}{\#\tilde{i}} \sum_{\zeta=1}^{\#\tilde{i}} \left(|\tilde{\gamma}_{ij}^{\tilde{\sigma}(\zeta)L} - \tilde{\gamma}_{kj}^{\tilde{\sigma}(\zeta)L}|^\alpha + |\tilde{\gamma}_{ij}^{\tilde{\sigma}(\zeta)U} - \tilde{\gamma}_{kj}^{\tilde{\sigma}(\zeta)U}|^\alpha \right) + \frac{1}{\#\tilde{f}} \sum_{\zeta=1}^{\#\tilde{f}} \left(|\tilde{\delta}_{ij}^{\tilde{\sigma}(\zeta)L} - \tilde{\delta}_{kj}^{\tilde{\sigma}(\zeta)L}|^\alpha \right) \right) \right. \\ \left. + |\tilde{\delta}_{ij}^{\tilde{\sigma}(\zeta)U} - \tilde{\delta}_{kj}^{\tilde{\sigma}(\zeta)U}|^\alpha \right) + \frac{1}{\#\tilde{f}} \sum_{\zeta=1}^{\#\tilde{f}} \left(|\tilde{\eta}_{ij}^{\tilde{\sigma}(\zeta)L} - \tilde{\eta}_{kj}^{\tilde{\sigma}(\zeta)L}|^\alpha + |\tilde{\eta}_{ij}^{\tilde{\sigma}(\zeta)U} - \tilde{\eta}_{kj}^{\tilde{\sigma}(\zeta)U}|^\alpha \right) \right)^{\frac{1}{\alpha}} \\ \text{s.t. } w \in \mathfrak{S}, w_j \geq 0, j = 1, 2, \dots, n, \sum_{j=1}^n w_j = 1 \end{array} \right.$$

where \mathfrak{S} is also a set of constraint conditions that the weight value w_j should satisfy according to the requirements in real situations. By solving the linear programming model (M-4), we obtain the optimal solution $w = (w_1, w_2, \dots, w_n)^t$, which can be used as the weight vector of attributes.

In interval neutrosophic hesitant fuzzy environment, the PIS \tilde{A}^+ , and the NIS \tilde{A}^- can be defined as follows:

$$\begin{aligned} \tilde{A}^+ &= \{\tilde{n}_1^+, \tilde{n}_2^+, \dots, \tilde{n}_n^+\} \\ &= \{ \{ \{ [1, 1] \}, \{ [0, 0] \}, \{ [0, 0] \} \}, \{ \{ [1, 1] \}, \{ [0, 0] \}, \{ [0, 0] \} \}, \dots, \{ \{ [1, 1] \}, \{ [0, 0] \}, \{ [0, 0] \} \} \}. \\ \tilde{A}^- &= \{\tilde{n}_1^-, \tilde{n}_2^-, \dots, \tilde{n}_n^-\} \\ &= \{ \{ \{ [0, 0] \}, \{ [1, 1] \}, \{ [1, 1] \} \}, \{ \{ [0, 0] \}, \{ [1, 1] \}, \{ [1, 1] \} \}, \dots, \{ \{ [0, 0] \}, \{ [1, 1] \}, \{ [1, 1] \} \} \}. \end{aligned}$$

On the basis of Equation (14), Theorems 3 and 4, the separation measures \tilde{d}_i^+ and \tilde{d}_i^- of each alternative from the interval neutrosophic hesitant fuzzy PIS \tilde{A}^+ and the interval neutrosophic hesitant fuzzy NIS \tilde{A}^- , respectively, are determined as:

$$\tilde{d}_i^+ = \sum_{j=1}^n \tilde{d}(\tilde{n}'_{ij}, \tilde{n}_j^+) w_j = \sum_{j=1}^n \tilde{d}(\tilde{n}'_{ij}, \{\{[1, 1]\}, \{[0, 0]\}, \{[0, 0]\}\}) w_j \tag{15}$$

$$= \sum_{j=1}^n w_j \left(\frac{1}{6} \left(\frac{1}{\#\tilde{\tau}'_{ij}} \sum_{\tilde{\gamma} \in \tilde{\tau}'_{ij}} ((1 - \tilde{\gamma}^L)^\alpha + (1 - \tilde{\gamma}^U)^\alpha) + \frac{1}{\#\tilde{\tau}'_{ij}} \sum_{\tilde{\delta} \in \tilde{\tau}'_{ij}} ((\tilde{\delta}^L)^\alpha + (\tilde{\delta}^U)^\alpha) + \frac{1}{\#\tilde{\tau}'_{ij}} \sum_{\tilde{\eta} \in \tilde{\tau}'_{ij}} ((\tilde{\eta}^L)^\alpha + (\tilde{\eta}^U)^\alpha) \right) \right)^{\frac{1}{\alpha}} \tag{16}$$

$$\tilde{d}_i^- = \sum_{j=1}^n \tilde{d}(\tilde{n}'_{ij}, \tilde{n}_j^-) w_j = \sum_{j=1}^n \tilde{d}(\tilde{n}'_{ij}, \{\{[0, 0]\}, \{[1, 1]\}, \{[1, 1]\}\}) w_j \tag{17}$$

$$= \sum_{j=1}^n w_j \left(\frac{1}{6} \left(\frac{1}{\#\tilde{\tau}'_{ij}} \sum_{\tilde{\gamma} \in \tilde{\tau}'_{ij}} ((\tilde{\gamma}^L)^\alpha + (\tilde{\gamma}^U)^\alpha) + \frac{1}{\#\tilde{\tau}'_{ij}} \sum_{\tilde{\delta} \in \tilde{\tau}'_{ij}} ((1 - \tilde{\delta}^L)^\alpha + (1 - \tilde{\delta}^U)^\alpha) + \frac{1}{\#\tilde{\tau}'_{ij}} \sum_{\tilde{\eta} \in \tilde{\tau}'_{ij}} ((1 - \tilde{\eta}^L)^\alpha + (1 - \tilde{\eta}^U)^\alpha) \right) \right)^{\frac{1}{\alpha}}, \tag{18}$$

where $i = 1, 2, \dots, m$. The relative closeness coefficient of an alternative \tilde{A}_i with respect to the PIS \tilde{A}^+ is defined as:

$$RC(\tilde{A}_i) = \frac{\tilde{d}_i^-}{\tilde{d}_i^+ + \tilde{d}_i^-} \tag{19}$$

where $0 \leq RC(\tilde{A}_i) \leq 1, i = 1, 2, \dots, m$. The ranking orders of all alternatives can be determined according to the closeness coefficient $CR(\tilde{A}_i)$ and select the optimal one(s) from a set of appropriate alternatives.

3. An Illustrative Example

To examine the validity and feasibility of developed decision-making approach in this section, we give a smartphone accessories supplier selection problem in realistic scenario as follows: In the smartphone fields, the Chinese market is the immense one in the world and the competition of smartphone field is so fierce that several companies could not avoid the destiny of bankrupt. In the Chinese market, a firm, who does not want to be defeated must choose the excellent accessories suppliers to fit its supply requirements and technology strategies. A new smartphone design firm called “Hua Xin” incorporated company, who wants to choose a few accessories suppliers for guaranteeing the productive throughput. For simplicity, we assume only one kind of accessory known as Central Processing Unit (CPU), which is used as an essential part in smartphones. The firm determines five CPU suppliers (alternatives) $A_i (i = 1, 2, \dots, 5)$ through the analysis of their planned level of effort and the market investigation. The evaluation criteria are (1) P_1 : cost; (2) P_2 : technical ability; (3) P_3 : product performance; (4) P_4 : service performance. Because the uncertainty of the information, the evaluation information given by the three experts is expressed as SVNHFES. The SVNHFDM is given in Table 1. The hierarchical structure of constructed decision-making problem is depicted in Figure 2.

Table 1. Single-valued neutrosophic hesitant fuzzy decision matrix.

	P_1	P_2
A_1	{{0.2},{0.3,0.5},{0.1,0.2,0.3}}	{{0.6,0.7},{0.1,0.3},{0.2,0.4}}
A_2	{{0.1},{0.3},{0.5,0.6}}	{{0.4},{0.3,0.5},{0.5,0.6}}
A_3	{{0.6,0.7},{0.2,0.3},{0.1,0.2}}	{{0.1,0.2},{0.3},{0.6,0.7}}
A_4	{{0.2,0.3},{0.1,0.2},{0.5,0.6}}	{{0.3,0.4},{0.2,0.3},{0.5,0.6,0.7}}
A_5	{{0.7},{0.4,0.5},{0.2,0.4,0.5}}	{{0.6},{0.1,0.7},{0.3,0.5}}
	P_3	P_4
A_1	{{0.2,0.3},{0.4},{0.7,0.8}}	{{0.4},{0.1,0.3},{0.5,0.7,0.9}}
A_2	{{0.1,0.3},{0.4},{0.5,0.6,0.8}}	{{0.6,0.8},{0.2},{0.3,0.5}}
A_3	{{0.2,0.3},{0.1,0.2},{0.6,0.7}}	{{0.2,0.3},{0.4},{0.2,0.5,0.6}}
A_4	{{0.2,0.4},{0.3},{0.1,0.2}}	{{0.6},{0.2},{0.3,0.5}}
A_5	{{0.3},{0.5},{0.1,0.4}}	{{0.5},{0.1,0.2},{0.3,0.4}}

Take $\varpi = 0.5, \alpha = 2$, and we normalize the SVNHFDM by using Algorithm 1. The normalized SVNHFDM is given in Table 2.

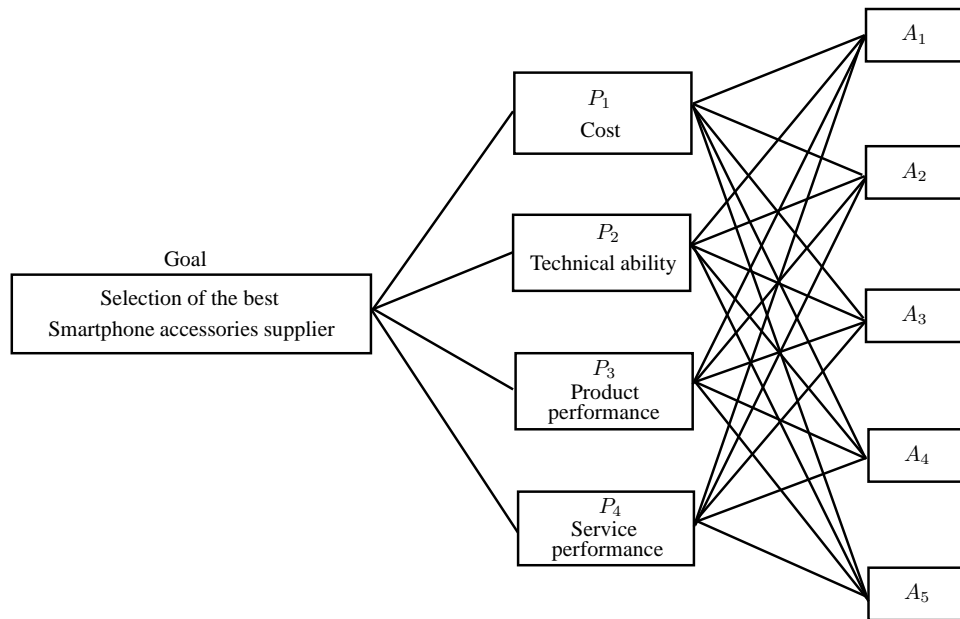

Figure 2: The smartphone accessories supplier selection hierarchical structure.
 Table 2: Normalized single-valued neutrosophic hesitant fuzzy decision matrix.

	P_1	P_2
A_1	$\{\{0.2,0.2\},\{0.3,0.5\},\{0.1,0.2,0.3\}\}$	$\{\{0.6,0.7\},\{0.1,0.3\},\{0.2,0.3,0.4\}\}$
A_2	$\{\{0.1\},\{0.2,0.3\},\{0.5,0.6,0.7\}\}$	$\{\{0.4,0.4\},\{0.3,0.5\},\{0.5,0.5,0.6\}\}$
A_3	$\{\{0.6,0.7\},\{0.2,0.3\},\{0.1,0.15,0.2\}\}$	$\{\{0.1,0.2\},\{0.3,0.3\},\{0.6,0.65,0.7\}\}$
A_4	$\{\{0.2,0.3\},\{0.1,0.2\},\{0.5,0.55,0.6\}\}$	$\{\{0.3,0.4\},\{0.2,0.3\},\{0.5,0.6,0.7\}\}$
A_5	$\{\{0.7,0.7\},\{0.4,0.5\},\{0.2,0.4,0.5\}\}$	$\{\{0.6,0.6\},\{0.1,0.7\},\{0.3,0.4,0.5\}\}$

Now to obtain the optimal accessory supplier, we use the developed method, which contains the following two cases:

Case 1: The information of the attribute weights is completely unknown, then the MADM approach related to accessory supplier selection includes the following steps:

Step 1: On the basis of Equation (4), we get the optimal weight vector:

A_1 $\{\{0.2,0.3\},\{0.4\},\{0.7,0.8\}\}$ $\{\{0.4\},\{0.1,0.3\},\{0.5,0.7,0.9\}\}$

A_2 $\{\{0.1,0.3\},\{0.4\},\{0.5,0.6,0.8\}\}$ $\{\{0.6,0.8\},\{0.2\},\{0.3,0.5\}\}$

A_3 $\{\{0.2,0.3\},\{0.1,0.2\},\{0.6,0.7\}\}$ $\{\{0.2,0.3\},\{0.4\},\{0.2,0.5,0.6\}\}$

A_4 $\{\{0.2,0.4\},\{0.3\},\{0.1,0.2\}\}$ $\{\{0.6\},\{0.2\},\{0.3,0.5\}\}$

A_5 $\{\{0.3\},\{0.5\},\{0.1,0.4\}\}$ $\{\{0.5\},\{0.1,0.2\},\{0.3,0.4\}\}$

Step 2: Based on the decision matrix of Table 2, we get the normalization of the reference points A^+ and A^- as follows:

Take $\varpi = 0.5, \alpha = 2$, and we normalize the SVNHFDM by utilizing Algorithm 1. The normalized SVNHFDM is given in Table 2.

$$\begin{aligned}
 A^- &= \{n_1^-, n_2^-, n_3^-, n_4^-\} \\
 &= \{\{0,0\}, \{1,1\}, \{1,1,1\}\}, \{\{0,0\}, \{1,1\}, \{1,1,1\}\}, \{\{0,0\}, \{1,1\}, \{1,1,1\}\}, \{\{0,0\}, \{1,1\}, \{1,1,1\}\}\}.
 \end{aligned}$$

Step 3: On the basis of Equations (10) and (12), we determine the geometric distances $d_i^+ = d(A_i, A^+)$ and $d_i^- = d(A_i, A^-)$ for the alternative $A_i (i = 1, 2, \dots, 5)$ as shown in Table 3.

Step 4: Use Equation (13) to determine the relative closeness of each alternative A_i with respect to the single-valued neutrosophic hesitant fuzzy PIS A^+ :

$$RC(A_1) = 0.5251, RC(A_2) = 0.4896, RC(A_3) = 0.5394, RC(A_4) = 0.5600, RC(A_5) = 0.5927.$$

Step 5: On the basis of the relative closeness coefficients $RC(A_i)$, rank the alternatives $A_i (i = 1, 2, \dots, 5)$: $A_5 \succ A_4 \succ A_3 \succ A_1 \succ A_2$. Thus, the optimal alternative (CPU supplier) is A_5 .

Table 3. The geometric distances for alternatives.

Geometric Distance	A_1	A_2	A_3	A_4	A_5
$d_i^+ = d(A_i, A^+)$	0.5142	0.5434	0.4974	0.4781	0.4279
$d_i^- = d(A_i, A^-)$	0.5685	0.5212	0.5824	0.6086	0.6226

Case 2: The information of the attribute weights is partly known, and the known weight information is as follows:

$$\mathfrak{S} = \{0.15 \leq w_1 \leq 0.2, 0.16 \leq w_2 \leq 0.18, 0.3 \leq w_3 \leq 0.35, 0.3 \leq w_4 \leq 0.45, \sum_{j=1}^4 w_j = 1\}$$

Step 1: Use the model (M-2) to establish the single-objective programming model as follows:

$$(M-2) \begin{cases} \max D(w) = 5.6368w_1 + 4.4554w_2 + 4.7465w_3 + 3.9864w_4 \\ \text{s.t. } w \in \mathfrak{S}, w_j \geq 0, j = 1, 2, 3, 4, \sum_{j=1}^4 w_j = 1 \end{cases}$$

By solving this model, we obtain the attributes weight vector:

$$w = (0.2000, 0.1600, 0.3400, 0.3000)^T$$

Step 2: According to the decision matrix of Table 2, the normalization of the reference points A^+ and A^- can be obtained as follows:

$$\begin{aligned}
 A^+ &= \{n_1^+, n_2^+, n_3^+, n_4^+\} \\
 &= \{\{1,1\}, \{0,0\}, \{0,0,0\}\}, \{\{1,1\}, \{0,0\}, \{0,0,0\}\}, \{\{1,1\}, \{0,0\}, \{0,0,0\}\}, \{\{1,1\}, \{0,0\}, \{0,0,0\}\}\},
 \end{aligned}$$

$$\begin{aligned}
 A^- &= \{n_1^-, n_2^-, n_3^-, n_4^-\} \\
 &= \{\{0,0\}, \{1,1\}, \{1,1,1\}\}, \{\{0,0\}, \{1,1\}, \{1,1,1\}\}, \{\{0,0\}, \{1,1\}, \{1,1,1\}\}, \{\{0,0\}, \{1,1\}, \{1,1,1\}\}\}.
 \end{aligned}$$

Step 3: Based on Equations (10) and (12), we determine the geometric distances $d(A_i, A^+)$ and $d(A_i, A^-)$ for the alternative $A_i (i = 1, 2, \dots, 5)$ as shown in Table 4.

Step 4: Use Equation (13) to determine the relative closeness of each alternative A_i with respect to the single-valued neutrosophic hesitant fuzzy PIS A^+ :

$$RC(A_1) = 0.4972, RC(A_2) = 0.5052, RC(A_3) = 0.5199, RC(A_4) = 0.5808, RC(A_5) = 0.5883.$$

Step 5: Based on the relative closeness coefficients $RC(A_i)$, rank the alternatives $A_i(i = 1, 2, \dots, 5)$: $A_5 \succ A_4 \succ A_3 \succ A_2 \succ A_1$. Thus, the optimal alternative (CPU supplier) is A_5 .

Taking $\omega = 0.5$, we normalize the single-valued neutrosophic hesitant fuzzy decision matrix and compute the closeness coefficient of the alternatives with the different values of α . The comparison results are given in Figure 3.

Table 4. The geometric distances for alternatives.

Geometric Distance	A_1	A_2	A_3	A_4	A_5
$d(A_i, A^+)$	0.5446	0.5244	0.5220	0.4534	0.4341
$d(A_i, A^-)$	0.5385	0.5355	0.5652	0.6281	0.6202

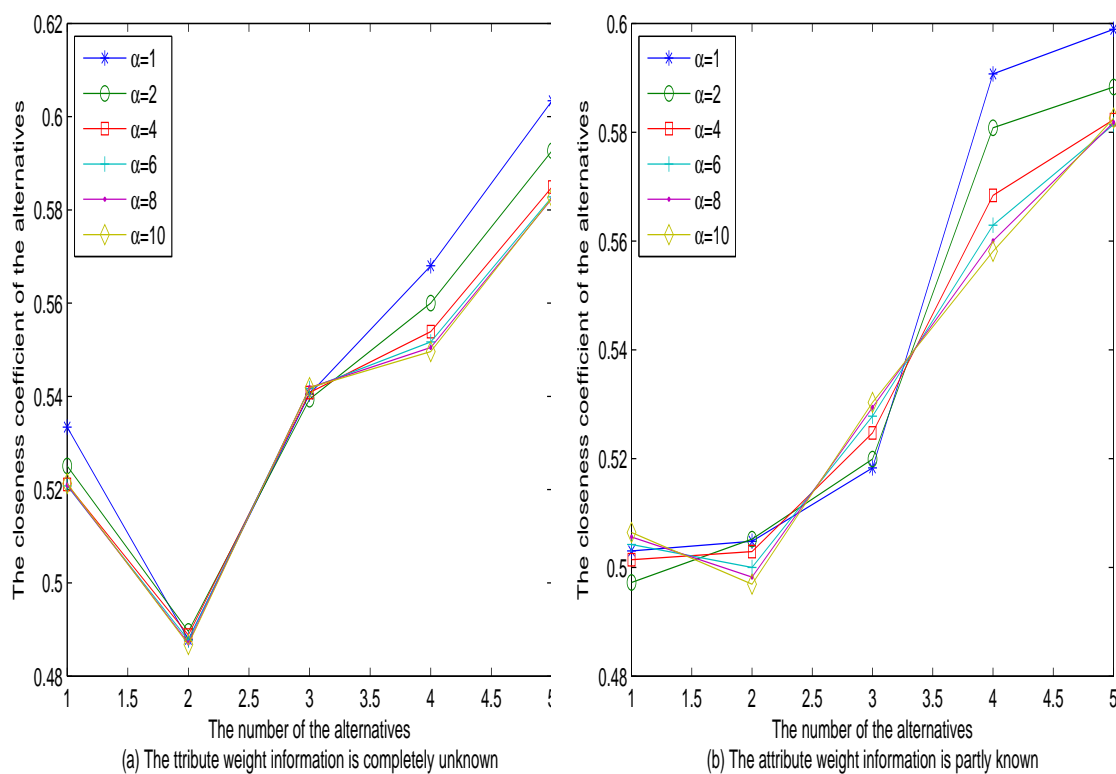

Figure 3. Comparison of the closeness coefficient of the alternative.

The analysis process under interval neutrosophic hesitant fuzzy circumstances:

In the above smartphone accessories supplier selection problem, if the information provided by the experts is indicated in INHFES, as in Table 5. Then, to choose the optimal CPU supplier, we proceed to use the developed approach.

Take $\omega = 0.5$, $\alpha = 2$, and we normalize the INHFDM by using Algorithm 2. The normalized INHFDM is given in Table 6.

Case 1: The information of the attribute weights is completely unknown, then the MADM method of accessory supplier selection consists of the following steps:

Step 1: On the basis of Equation (14), we get the optimal weight vector:

$$w = \{0.2963, 0.2562, 0.2388, 0.2087\}$$

Step 2: According to the decision matrix of Table 6, the normalization of the reference points \tilde{A}^+ and \tilde{A}^- can be obtained as follows:

$$\begin{aligned} \tilde{A}^+ &= \{\tilde{n}_1^+, \tilde{n}_2^+, \tilde{n}_3^+, \tilde{n}_4^+\} \\ &= \{\{\{[1, 1], [1, 1]\}, \{[0, 0], [0, 0]\}, \{[0, 0], [0, 0], [0, 0]\}\}, \{\{[1, 1], [1, 1]\}, \{[0, 0], [0, 0]\}, \{[0, 0], [0, 0], [0, 0]\}\}, \\ &\quad \{\{[1, 1], [1, 1]\}, \{[0, 0], [0, 0]\}, \{[0, 0], [0, 0], [0, 0]\}\}, \{\{[1, 1], [1, 1]\}, \{[0, 0], [0, 0]\}, \{[0, 0], [0, 0], [0, 0]\}\}, \\ \tilde{A}^- &= \{\tilde{n}_1^-, \tilde{n}_2^-, \tilde{n}_3^-, \tilde{n}_4^-\} \\ &= \{\{\{[0, 0], [0, 0]\}, \{[1, 1], [1, 1]\}, \{[1, 1], [1, 1], [1, 1]\}\}, \{\{[0, 0], [0, 0]\}, \{[1, 1], [1, 1]\}, \{[1, 1], [1, 1], [1, 1]\}\}, \\ &\quad \{\{[0, 0], [0, 0]\}, \{[1, 1], [1, 1]\}, \{[1, 1], [1, 1], [1, 1]\}\}, \{\{[0, 0], [0, 0]\}, \{[1, 1], [1, 1]\}, \{[1, 1], [1, 1], [1, 1]\}\}. \end{aligned}$$

Step 3: Based on Equations (15) and (17), we determine the geometric distances $\tilde{d}(A_i, A^-)$ and $\tilde{d}(A_i, A^+)$ for the alternative $A_i (i = 1, 2, \dots, 5)$ as shown in Table 7.

Step 4: Use Equation (19) to determine the relative closeness of each alternative \tilde{A}_i with respect to the interval neutrosophic hesitant fuzzy PIS \tilde{A}^+ :

$$RC(\tilde{A}_1) = 0.5169, RC(\tilde{A}_2) = 0.4592, RC(\tilde{A}_3) = 0.4969, RC(\tilde{A}_4) = 0.5368, RC(\tilde{A}_5) = 0.5643.$$

Step 5: Based on the relative closeness coefficients $RC(\tilde{A}_i)$, rank the alternatives $A_i (i = 1, 2, \dots, 5)$: $A_5 \succ A_4 \succ A_1 \succ A_3 \succ A_2$. Thus, the optimal alternative (CPU supplier) is A_5 .

Case 2: The information of the attribute weights is partly known, and the known weight information is given as follows:

$$\mathfrak{S} = \{0.15 \leq w_1 \leq 0.2, 0.16 \leq w_2 \leq 0.18, 0.3 \leq w_3 \leq 0.35, 0.3 \leq w_4 \leq 0.45, \sum_{j=1}^4 w_j = 1\}$$

Step 1: Use the model (M-4) to establish the single-objective programming model as follows: (M – 4)
$$\begin{cases} \max D(w) = 4.5556w_1 + 4.2000w_2 + 3.3222w_3 + 3.3111w_4 \\ s.t. w \in \mathfrak{S}, w_j \geq 0, j = 1, 2, 3, 4, \sum_{j=1}^4 w_j = 1 \end{cases}$$

By solving this model, we obtain the weight vector of attributes:

$$w = \{0.2000, 0.1800, 0.3200, 0.3000\}$$

Step 2: According to the decision matrix of Table 6, we can obtain the normalization of the reference points \tilde{A}^+ and \tilde{A}^- as follows:

$$\begin{aligned} \tilde{A}^+ &= \{\tilde{n}_1^+, \tilde{n}_2^+, \tilde{n}_3^+, \tilde{n}_4^+\} \\ &= \{\{\{[1, 1], [1, 1]\}, \{[0, 0], [0, 0]\}, \{[0, 0], [0, 0], [0, 0]\}\}, \{\{[1, 1], [1, 1]\}, \{[0, 0], [0, 0]\}, \{[0, 0], [0, 0], [0, 0]\}\}, \\ &\quad \{\{[1, 1], [1, 1]\}, \{[0, 0], [0, 0]\}, \{[0, 0], [0, 0], [0, 0]\}\}, \{\{[1, 1], [1, 1]\}, \{[0, 0], [0, 0]\}, \{[0, 0], [0, 0], [0, 0]\}\}, \\ \tilde{A}^- &= \{\tilde{n}_1^-, \tilde{n}_2^-, \tilde{n}_3^-, \tilde{n}_4^-\} \\ &= \{\{\{[0, 0], [0, 0]\}, \{[1, 1], [1, 1]\}, \{[1, 1], [1, 1], [1, 1]\}\}, \{\{[0, 0], [0, 0]\}, \{[1, 1], [1, 1]\}, \{[1, 1], [1, 1], [1, 1]\}\}, \\ &\quad \{\{[0, 0], [0, 0]\}, \{[1, 1], [1, 1]\}, \{[1, 1], [1, 1], [1, 1]\}\}, \{\{[0, 0], [0, 0]\}, \{[1, 1], [1, 1]\}, \{[1, 1], [1, 1], [1, 1]\}\}. \end{aligned}$$

Step 3: Use Equations (15) and (17) to determine the geometric distances $\tilde{d}(A_i, A^+)$ and $\tilde{d}(A_i, A^-)$ for the alternative $A_i (i = 1, 2, \dots, 5)$ as shown in Table 8.

Step 4: Use Equation (19) to determine the relative closeness of each alternative \tilde{A}_i with respect to the interval neutrosophic hesitant fuzzy PIS \tilde{A}^+ :

$$RC(\tilde{A}_1) = 0.4955, RC(\tilde{A}_2) = 0.4729, RC(\tilde{A}_3) = 0.4803, RC(\tilde{A}_4) = 0.5536, RC(\tilde{A}_5) = 0.5607.$$

Step 5: According to the relative closeness coefficients $RC(\tilde{A}_i)$, rank the alternatives $A_i (i = 1, 2, \dots, 5)$: $A_5 \succ A_4 \succ A_1 \succ A_3 \succ A_2$. Thus, the optimal alternative (CPU supplier) is A_5 .

Taking $\omega = 0.5$, we normalize the interval neutrosophic hesitant fuzzy decision matrix and compute the closeness coefficient of the alternatives with the different values of α . The comparison results are given in Figure 4

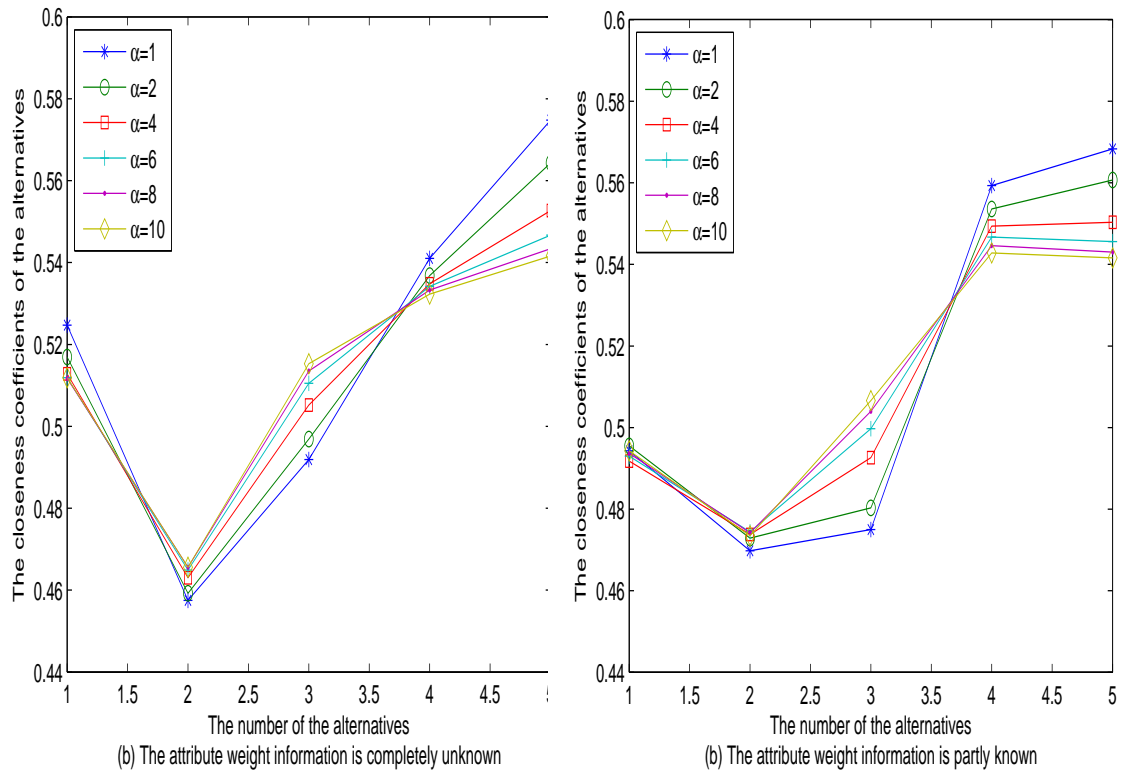

Figure 4. Comparison of the closeness coefficient of the alternative.

Table 5. Interval neutrosophic hesitant fuzzy decision matrix.

	P_1	P_2
A_1	{{[0.2,0.3],[0.3,0.4],[0.5,0.7]},{[0.1,0.3],[0.2,0.5],[0.3,0.6]}}	{{[0.6,0.8],[0.7,0.9]},{[0.1,0.2],[0.3,0.5]},{[0.2,0.3],[0.4,0.5]}}
A_2	{{[0.1,0.3],[0.3,0.5]},{[0.5,0.7],[0.6,0.8]}}	{{[0.4,0.6]},{[0.3,0.4],[0.5,0.6]},{[0.5,0.7],[0.6,0.8]}}
A_3	{{[0.6,0.7],[0.7,0.8]},{[0.2,0.4],[0.3,0.5]},{[0.1,0.3],[0.2,0.4]}}	{{[0.1,0.3],[0.2,0.4]},{[0.3,0.6]},{[0.6,0.8],[0.7,0.9]}}
A_4	{{[0.2,0.5],[0.3,0.4]},{[0.1,0.3],[0.2,0.3]},{[0.5,0.6],[0.6,0.7]}}	{{[0.3,0.5],[0.4,0.6]},{[0.2,0.3],[0.3,0.4]},{[0.5,0.7],[0.6,0.8],[0.7,0.9]}}
A_5	{{[0.7,0.8]},{[0.4,0.6],[0.5,0.7]},{[0.2,0.3],[0.4,0.6],[0.5,0.7]}}	{{[0.6,0.8]},{[0.1,0.3],[0.7,0.8]},{[0.3,0.4],[0.5,0.6]}}
	P_3	P_4
A_1	{{[0.2,0.4],[0.3,0.5]},{[0.4,0.5]},{[0.7,0.8],[0.8,0.9]}}	{{[0.4,0.6]},{[0.1,0.2],[0.3,0.4]},{[0.5,0.6],[0.7,0.8],[0.8,0.9]}}
A_2	{{[0.1,0.3],[0.3,0.5]},{[0.4,0.6]},{[0.5,0.6],[0.6,0.7],[0.8,0.9]}}	{{[0.6,0.7],[0.8,0.9]},{[0.2,0.5]},{[0.3,0.5],[0.5,0.7]}}
A_3	{{[0.2,0.3],[0.3,0.4]},{[0.1,0.3],[0.2,0.4]},{[0.6,0.8],[0.7,0.9]}}	{{[0.2,0.4],[0.3,0.5]},{[0.4,0.6]},{[0.2,0.3],[0.5,0.7],[0.6,0.8]}}
A_4	{{[0.2,0.3],[0.4,0.5]},{[0.3,0.6]},{[0.1,0.4],[0.2,0.5]}}	{{[0.6,0.8]},{[0.2,0.3]},{[0.3,0.4],[0.5,0.6]}}
A_5	{{[0.3,0.5]},{[0.5,0.6]},{[0.1,0.3],[0.4,0.5]}}	{{[0.5,0.7]},{[0.1,0.3],[0.2,0.5]},{[0.3,0.5],[0.4,0.8]}}

Table 6. Normalized interval neutrosophic hesitant fuzzy decision matrix.

	P_1	P_2
A_1	{{[0.2,0.3],[0.2,0.3]},{[0.3,0.4],[0.5,0.7]},{[0.1,0.3],[0.2,0.5],[0.3,0.6]}}	{{[0.6,0.8],[0.7,0.9]},{[0.1,0.2],[0.3,0.5]},{[0.2,0.3],[0.3,0.4],[0.4,0.5]}}
A_2	{{[0.1,0.3],[0.1,0.3]},{[0.3,0.5],[0.3,0.5]},{[0.5,0.7],[0.55,0.75],[0.6,0.8]}}	{{[0.4,0.6],[0.4,0.6]},{[0.3,0.4],[0.5,0.6]},{[0.5,0.7],[0.55,0.75],[0.6,0.8]}}
A_3	{{[0.6,0.7],[0.7,0.8]},{[0.2,0.4],[0.3,0.5]},{[0.1,0.3],[0.15,0.35],[0.2,0.4]}}	{{[0.1,0.3],[0.2,0.4]},{[0.3,0.6],[0.3,0.6]},{[0.6,0.8],[0.65,0.85],[0.7,0.9]}}
A_4	{{[0.2,0.5],[0.3,0.4]},{[0.1,0.3],[0.2,0.3]},{[0.5,0.6],[0.55,0.65],[0.6,0.7]}}	{{[0.3,0.5],[0.4,0.6]},{[0.2,0.3],[0.3,0.4]},{[0.5,0.7],[0.6,0.8],[0.7,0.9]}}
A_5	{{[0.7,0.8],[0.7,0.8]},{[0.4,0.6],[0.5,0.7]},{[0.2,0.3],[0.4,0.6],[0.5,0.7]}}	{{[0.6,0.8],[0.6,0.8]},{[0.1,0.3],[0.7,0.8]},{[0.3,0.4],[0.4,0.5],[0.5,0.6]}}
	P_3	P_4
A_1	{{[0.2,0.4],[0.3,0.5]},{[0.4,0.5],[0.4,0.5]},{[0.7,0.8],[0.75,0.85],[0.8,0.9]}}	{{[0.4,0.6],[0.4,0.6]},{[0.1,0.2],[0.3,0.4]},{[0.5,0.6],[0.7,0.8],[0.8,0.9]}}
A_2	{{[0.1,0.3],[0.3,0.5]},{[0.4,0.6],[0.4,0.6]},{[0.5,0.6],[0.6,0.7],[0.8,0.9]}}	{{[0.6,0.7],[0.8,0.9]},{[0.2,0.5],[0.2,0.5]},{[0.3,0.5],[0.4,0.6],[0.5,0.7]}}
A_3	{{[0.2,0.3],[0.3,0.4]},{[0.1,0.3],[0.2,0.4]},{[0.6,0.8],[0.65,0.85],[0.7,0.9]}}	{{[0.2,0.4],[0.3,0.5]},{[0.4,0.6],[0.4,0.6]},{[0.2,0.3],[0.5,0.7],[0.6,0.8]}}
A_4	{{[0.2,0.3],[0.4,0.5]},{[0.3,0.6],[0.3,0.6]},{[0.1,0.4],[0.15,0.45],[0.2,0.5]}}	{{[0.6,0.8],[0.6,0.8]},{[0.2,0.3],[0.2,0.3]},{[0.3,0.4],[0.4,0.5],[0.5,0.6]}}
A_5	{{[0.3,0.5],[0.3,0.5]},{[0.5,0.6],[0.5,0.6]},{[0.1,0.3],[0.25,0.4],[0.4,0.5]}}	{{[0.5,0.7],[0.5,0.7]},{[0.1,0.3],[0.2,0.5]},{[0.3,0.5],[0.35,0.65],[0.4,0.8]}}

Table 7. The geometric distances for alternatives.

Geometric Distance	A ₁	A ₂	A ₃	A ₄	A ₅
$\tilde{d}(A_i, A^+)$	0.5169	0.5711	0.5361	0.4952	0.4625
$\tilde{d}(A_i, A^-)$	0.5531	0.4849	0.5295	0.5740	0.5991

Table 8. The geometric distances for alternatives.

Geometric Distance	A ₁	A ₂	A ₃	A ₄	A ₅
$\tilde{d}(A_i, A^+)$	0.5406	0.5562	0.5569	0.4752	0.4653
$\tilde{d}(A_i, A^-)$	0.5310	0.4990	0.5147	0.5894	0.5938

3.1. Comparative Analysis

Zhao et al. [31] generalized the minimum deviation method to accommodate hesitant fuzzy values for solving the decision-making problems. We have used this approach on the above illustrative example and compared the decision results with proposed approach of this paper for SNHFSs. In the approach of Zhao et al., assume that the subjective preference values to all the alternatives $A_j(j = 1, 2, 3, 4, 5)$ assigned by the experts are: $s_1 = \{\{0.3, 0.4\}, \{0.2, 0.5\}, \{0.1, 0.3, 0.7\}\}$, $s_2 = \{\{0.2, 0.7\}, \{0.1, 0.9\}, \{0.3, 0.6\}\}$, $s_3 = \{\{0.8\}, \{0.5, 0.8\}, \{0.4, 0.7, 0.9\}\}$, $s_4 = \{\{0.1, 0.4\}, \{0.6\}, \{0.5, 0.7, 0.8\}\}$ and $s_5 = \{\{0.3\}, \{0.4, 0.6\}, \{0.2, 0.4\}\}$. Also $\tilde{s}_1 = \{\{[0.3, 0.5], [0.4, 0.6]\}, \{[0.2, 0.3], [0.5, 0.7]\}, \{[0.1, 0.2], [0.3, 0.4], [0.7, 0.9]\}\}$, $\tilde{s}_2 = \{\{[0.2, 0.3], [0.7, 0.9]\}, \{[0.1, 0.4], [0.7, 0.9]\}, \{[0.3, 0.4], [0.6, 0.8]\}\}$, $\tilde{s}_3 = \{\{[0.8, 0.9]\}, \{[0.5, 0.6], [0.8, 0.9]\}, \{[0.4, 0.6], [0.7, 0.9], [0.6, 0.7]\}\}$, $\tilde{s}_4 = \{\{[0.1, 0.4], [0.4, 0.5]\}, \{[0.6, 0.7]\}, \{[0.5, 0.7], [0.7, 0.8], [0.8, 0.9]\}\}$ and $\tilde{s}_5 = \{\{[0.3, 0.5]\}, \{[0.4, 0.5], [0.6, 0.8]\}, \{[0.2, 0.3], [0.4, 0.7]\}\}$.

The results corresponding to these approaches are summarized in Table 9.

Table 9. Comparative analysis.

Methods	Score of Alternatives					Ranking of Alternatives
Zhao et al. [31] for SVNHFS	0.4431	0.4025	0.4941	0.5073	0.5691	$A_5 \succ A_4 \succ A_3 \succ A_1 \succ A_2$
Our proposed method for SVNHFS	0.5251	0.4896	0.5394	0.5600	0.5927	$A_5 \succ A_4 \succ A_3 \succ A_1 \succ A_2$
Zhao et al. [31] for INHFS	0.4559	0.4206	0.4255	0.5334	0.5791	$A_5 \succ A_4 \succ A_1 \succ A_3 \succ A_2$
Our proposed method for INHFS	0.5169	0.4592	0.4969	0.5368	0.5643	$A_5 \succ A_4 \succ A_1 \succ A_3 \succ A_2$

From this comparative study, the results obtained by the approach [31] coincide with the proposed one which validates the proposed approach. The main reason is that in approach [31], the subjective preferences are taken into account to serve as decision information and will have a positive effect on the final decision results. Hence, the proposed approach can be suitably used to solve the MADM problems. The advantages of our proposed method are as follows: (1) The developed approach has good flexibility and extension. (2) The SNHFSs of developed approach availably depicts increasingly general decision-making situations. (3) With the aid of the maximizing deviation and TOPSIS, the developed approach uses the satisfaction level of the alternative to the ideal solutions to make the decision.

4. Conclusions

SNHFS is a suitable tool for dealing with the obscurity of an expert’s judgments over alternatives according to attributes. SNHFSs are useful for representing the hesitant assessments of the experts, and remains the edge of SNSs and HFSs, which accommodates an increasingly complex MADM situation. SNHFS (by combining SNS and HFS) as an extended format represents some general hesitant scenarios. In this paper, firstly we have developed the normalization method and the distance measures of SNHFSs and further, to obtain the attribute optimal relative weights, we have proposed a

decision-making approach called the maximizing deviation method with SNHFSs including SVNHFSs and INHFSs. Secondly, we have developed a new approach based on TOPSIS to solve MADM problems under SNHFS environment (SVNHFS and INHFS). Finally, we have illustrated the applicability and effectiveness of the developed method with a smartphone accessories supplier selection problem. In future work, we will extend the proposed approach of SNHFSs to other areas, such as pattern recognition, medical diagnosis, clustering analysis, and image processing.

References

1. Smarandache, F. *A Unifying Field in Logics. Neutrosophy: Neutrosophic Probability, Set and Logic*; American Research Press: Rehoboth, DE, USA, 1999.
2. Smarandache, F. *Neutrosophy. Neutrosophic Probability, Set, and Logic, ProQuest Information & Learning*; American Research Press: Ann Arbor, Michigan, USA, 1998; Volume 105, pp. 118–123.
3. Wang, H.; Smarandache, F.; Zhang, Y.Q.; Sunderraman, R. Single-valued neutrosophic sets. *Multispace Multistruct.* **2010**, *4*, 410–413.
4. Ye, J. A multi-criteria decision making method using aggregation operators for simplified neutrosophic sets. *J. Intell. Fuzzy Syst.* **2014**, *26*, 2459–2466.
5. Torra, V.; Narukawa, Y. On hesitant fuzzy sets and decision. In Proceedings of the 18th IEEE International Conference on Fuzzy Systems, Jeju Island, Korea, 20–24 August 2009; pp. 1378–1382.
6. Zadeh, L.A. Fuzzy sets. *Inf. Control* **1965**, *8*, 338–353.
7. Ye, J. Multiple-attribute decision making method under a single valued neutrosophic hesitant fuzzy environment. *J. Intell. Syst.* **2015**, *24*, 23–36.
8. Liu, C.F.; Luo, Y.S. New aggregation operators of single-valued neutrosophic hesitant fuzzy set and their application in multi-attribute decision making. *Pattern Anal. Appl.* **2019**, *22*, 417–427.
9. Sahin, R.; Liu, P. Correlation coefficient of single-valued neutrosophic hesitant fuzzy sets and its applications in decision making. *Neural Comput. Appl.* **2017**, *28*, 1387–1395.
10. Li, X.; Zhang, X. Single-valued neutrosophic hesitant fuzzy Choquet aggregation operators for multi-attribute decision making. *Symmetry* **2018**, *10*, 50.
11. Juan-juan, P.; Jian-qiang, W.; Jun-hua, H. Multi-criteria decision making approach based on single-valued neutrosophic hesitant fuzzy geometric weighted choquet integral heronian mean operator. *J. Intell. Fuzzy Syst.* **2018**, 1–14, doi:10.3233/JIFS-18249.
12. Wang, R.; Li, Y. Generalized single-valued neutrosophic hesitant fuzzy prioritized aggregation operators and their applications to multiple criteria decision making. *Information* **2018**, *9*, 10.
13. Akram, M.; Adeel, A.; Alcantud, J.C.R. Group decision making methods based on hesitant N -soft sets. *Expert Syst. Appl.* **2019**, *115*, 95–105.
14. Akram, M.; Adeel, A. TOPSIS approach for MAGDM based on interval-valued hesitant fuzzy N -soft environment. *Int. J. Fuzzy Syst.* **2019**, *21*, 993–1009.
15. Akram, M.; Adeel, A.; Alcantud, J.C.R. Hesitant Fuzzy N -Soft Sets: A New Model with Applications in Decision-Making. *J. Intell. Fuzzy Syst.* **2019**, doi:10.3233/JIFS-181972, 2019.
16. Akram, M.; Naz, S. A Novel Decision-Making Approach under Complex Pythagorean Fuzzy Environment. *Math. Comput. Appl.* **2019**, *24* 73, doi:10.3390/mca24030073.
17. Naz, S.; Ashraf, S.; Akram, M. A novel approach to decision making with Pythagorean fuzzy information. *Mathematics* **2018**, *6*, 95.
18. Naz, S.; Ashraf, S.; Karaaslan, F. Energy of a bipolar fuzzy graph and its application in decision making. *Italian J. Pure Appl. Math.* **2018**, *40*, 339–352.
19. Naz, S.; Akram, M. Novel decision making approach based on hesitant fuzzy sets and graph theory. *Comput. Appl. Math.* **2018**, doi:10.1007/s40314-019-0773-0.

20. Liu, P.; Shi, L. The generalized hybrid weighted average operator based on interval neutrosophic hesitant set and its application to multiple attribute decision making. *Neural Comput. Appl.* **2015**, *26*, 457–471.
21. Ye, J. Correlation coefficients of interval neutrosophic hesitant fuzzy sets and its application in a multiple attribute decision making method. *Informatica* **2016**, *27*, 179–202.
22. Kakati, P.; Borkotokey, S.; Mesiar, R.; Rahman, S. Interval neutrosophic hesitant fuzzy Choquet integral in multi-criteria decision making. *J. Intell. Fuzzy Syst.* **2018**, 1–19, doi:10.3233/JIFS-17166.
23. Mahmood, T.; Ye, J.; Khan, Q. Vector similarity measures for simplified neutrosophic hesitant fuzzy set and their applications. *J. Inequal. Spec. Funct.* **2016**, *7*, 176–194.
24. Atanassov, K.T. Intuitionistic fuzzy sets. *Fuzzy Sets Syst.* **1986**, *20*, 87–96.
25. Torra, V. Hesitant fuzzy sets. *Int. J. Intell. Syst.* **2010**, *25*, 529–539.
26. Xu, Z. Some similarity measures of intuitionistic fuzzy sets and their applications to multiple attribute decision making. *Fuzzy Optim. Decis. Mak.* **2007**, *6*, 109–121.
27. Xu, Z.; Zhang, X. Hesitant fuzzy multi-attribute decision making based on TOPSIS with incomplete weight information. *Knowl.-Based Syst.* **2013**, *52*, 53–64.
28. Wei, C.; Ren, Z.; Rodriguez, R.M. A hesitant fuzzy linguistic TODIM method based on a score function. *Int. J. Comput. Intell. Syst.* **2015**, *8*, 701–712.
29. Liao, H.; Xu, Z.; Zeng, X.J. Hesitant fuzzy linguistic VIKOR method and its application in qualitative multiple criteria decision making. *IEEE Trans. Fuzzy Syst.* **2015**, *23*, 1343–1355.
30. Gou, X.J.; Liao, H.C.; Xu, Z.S.; Herrera, F. Double hierarchy hesitant fuzzy linguistic term set and MULTIMOORA method: A case of study to evaluate the implementation status of haze controlling measures. *Inf. Fusion* **2017**, *38*, 22–34.
31. Zhao, H.; Xu, Z.; Wang, H.; Liu, S. Hesitant fuzzy multi-attribute decision making based on the minimum deviation method. *Soft Comput.* **2017**, *21*, 3439–3459.

Logarithmic Hybrid Aggregation Operators Based on Single Valued Neutrosophic Sets and Their Applications in Decision Support Systems

Shahzaib Ashraf, Saleem Abdullah, Florentin Smarandache, Noor ul Amin

Shahzaib Ashraf, Saleem Abdullah, Florentin Smarandache, Noor ul Amin (2019). Logarithmic Hybrid Aggregation Operators Based on Single Valued Neutrosophic Sets and Their Applications in Decision Support Systems. *Symmetry* 11, 364; DOI: 10.3390/sym11030364

Abstract: Recently, neutrosophic sets are found to be more general and useful to express incomplete, indeterminate and inconsistent information. The purpose of this paper is to introduce new aggregation operators based on logarithmic operations and to develop a multi-criteria decision-making approach to study the interaction between the input argument under the single valued neutrosophic (SVN) environment. The main advantage of the proposed operator is that it can deal with the situations of the positive interaction, negative interaction or non-interaction among the criteria, during decision-making process. In this paper, we also defined some logarithmic operational rules on SVN sets, then we propose the single valued neutrosophic hybrid aggregation operators as a tool for multi-criteria decision-making (MCDM) under the neutrosophic environment and discuss some properties. Finally, the detailed decision-making steps for the single valued neutrosophic MCDM problems were developed, and a practical case was given to check the created approach and to illustrate its validity and superiority. Besides this, a systematic comparison analysis with other existent methods is conducted to reveal the advantages of our proposed method. Results indicate that the proposed method is suitable and effective for decision process to evaluate their best alternative.

Keywords: single valued neutrosophic sets; logarithmic operational laws; logarithmic aggregation operators; MCGDM problems

1. Introduction

The information involves, in most of the real-life decision-making problems are often incomplete, indeterminate and inconsistent. Fuzzy set theory introduced by Zadeh [1] deals with imprecise, inconsistent information. Although fuzzy set information proved to be very handy but it cannot express the information about rejection. Atanassov [2] introduced the intuitionistic fuzzy set (IFS) to bring in non-membership. Non membership function represents degree of rejection. To incorporate indeterminate and inconsistent information, in addition to incomplete information, the concept of neutrosophic set (NS) proposed by Smarandache [3]. A NS generalizes the notion of the classic set, fuzzy set (FS) [1], IFS [2], paraconsistent set [4], dialetheist set, paradoxist set [4], and tautological set [4] to name a few. In NS, indeterminacy is quantified explicitly, and truth, indeterminacy, and falsity memberships are expressed independently. The NS generalizes different types of non-crisp sets but in real scientific and engineering applications the NS and the set-theoretic operators require to be specified. For a detailed study on NS we refer to [5–17].

Related Work

Most of the weighted aggregation operators consider situations in which criteria and preferences of experts are independent, which means that additivity is a main property of these operators. However, in real life decision-making problems, the criteria of the problems are often interdependent or interactive.

Most of the weighted average operators are based on the basic algebraic product and algebraic sum of single valued neutrosophic numbers (SVNNs) which are not the only operations available to model the intersection and union of SVNNs. The logarithmic algebraic product and sum are two good alternatives of algebraic operations which can be used the model intersection and union of SVNNs. Moreover, it is observed that in the literature there is little investigation on aggregation operators utilizing the logarithmic operations on SVNNs. For a detailed review on the applications of logarithmic operations, we refer to [10]. As already mentioned that the single valued neutrosophic set (SVNS) is an effective tool to describe the uncertain, incomplete and indeterminate information. The logarithmic single valued neutrosophic hybrid and logarithmic generalized single valued neutrosophic algebraic operators have the ability to express interactions among the criteria and it can replace the weighted average to aggregate dependent criteria for obtaining more accurate results. Motivated by these, we find it interesting to develop the logarithmic single valued neutrosophic hybrid aggregation operators for decision-making with neutrosophic information.

Also, we proposed the possibility of a degree-ranking technique for SVNNs from the probability point of view, since the ranking of SVNNs is very important for decision-making under the SVN environment. Furthermore, we proposed a multi-criteria decision-making model based on the logarithmic single valued neutrosophic hybrid weighted operators. For study the multi-criteria decision-making models, we refer [18–31].

The aim of writing this paper is to introduce a decision-making method for MCDM problems in which there exist interrelationships among the criteria. The contributions of this research are:

(1) A novel logarithmic operations for neutrosophic information is defined, which can overcome the weaknesses of algebraic operations and obtain the relationship between various SVNNs.

(2) Logarithmic operators for IFSs are extended to logarithmic single-valued neutrosophic hybrid operators and logarithmic generalized single-valued neutrosophic operators, namely, logarithmic single valued neutrosophic hybrid weighted averaging (L-SVNHWA), logarithmic single valued neutrosophic hybrid weighted geometric (L-SVNHWG), logarithmic generalized single-valued neutrosophic weighted averaging (L-GSVNWA) and logarithmic single-valued neutrosophic weighted geometric (L-GSVNWG) to SVNSs, which can overcome the algebraic operators drawbacks.

(3) A decision-making approach to handle the MCDM problems under the neutrosophic informations is introduced.

To attain our research goals which are stated above, the arrangement of the paper is offered as: Section 2 concentrates on basic definitions and operations of existing extensions of fuzzy set theories. In Section 3, some novel logarithmic operational laws of SVNSs are presented. Section 4 defines the logarithmic hybrid aggregation operators for SVNNs. In Section 5, an algorithm for handling the neutrosophic MCDM problem based on the developed logarithmic operators is presented. In Section 5.1, an application to verify the novel method is given and Section 5.2 presents the comparison study about algebraic and logarithmic aggregation operators. Section 6 consists of the conclusion of the study.

2. Preliminaries

This section includes the concepts and basic operations of existing extensions of fuzzy sets to make the study self contained.

Definition 1. [2] For a set \mathfrak{R} , by an intuitionistic fuzzy set in \mathfrak{R} , we have a structure

$$\zeta = \{ \langle P_\sigma(r), N_\sigma(r) \mid r \in \mathfrak{R} \rangle, \tag{1}$$

in which $P_\sigma : \mathfrak{R} \rightarrow \Theta$ and $N_\sigma : \mathfrak{R} \rightarrow \Theta$ indicate the membership and non-membership grades in \mathfrak{R} , $\Theta = [0, 1]$ be the unit interval. Also the following condition is satisfied by P_σ and N_σ , $0 \leq P_\sigma(r) + N_\sigma(r) \leq 1; \forall r \in \mathfrak{R}$. Then ζ is said to be intuitionistic fuzzy set in \mathfrak{R} .

Definition 2. [32] For a set \mathfrak{R} , by a neutrosophic set in \mathfrak{R} , we have a structure

$$\zeta = \{ \langle P_\sigma(r), I_\sigma(r), N_\sigma(r) \mid r \in \mathfrak{R} \rangle, \tag{2}$$

in which $P_\sigma : \mathfrak{R} \rightarrow \Theta$, $I_\sigma : \mathfrak{R} \rightarrow \Theta$ and $N_\sigma : \mathfrak{R} \rightarrow \Theta$ indicate the truth, indeterminacy and falsity memberships in \mathfrak{R} , $\Theta =]0^-, 1^+[$. Also the following condition is satisfied by P_σ , I_σ and N_σ , $0^- \leq P_\sigma(r) + I_\sigma(r) + N_\sigma(r) \leq 3^+; \forall r \in \mathfrak{R}$. Then, ζ is said to be neutrosophic set in \mathfrak{R} .

Definition 3. [33] For a set \mathfrak{R} , by a single valued neutrosophic set in \mathfrak{R} , we mean a structure

$$\zeta = \{ \langle P_\sigma(r), I_\sigma(r), N_\sigma(r) \mid r \in \mathfrak{R} \rangle, \tag{3}$$

in which $P_\sigma : \mathfrak{R} \rightarrow \Theta$, $I_\sigma : \mathfrak{R} \rightarrow \Theta$ and $N_\sigma : \mathfrak{R} \rightarrow \Theta$ indicate the truth, indeterminacy and falsity memberships in \mathfrak{R} , $\Theta = [0, 1]$. Also the following condition is satisfied by P_σ , I_σ and N_σ , $0 \leq P_\sigma(r) + I_\sigma(r) + N_\sigma(r) \leq 3; \forall r \in \mathfrak{R}$. Then, ζ is said to be a single valued neutrosophic set in \mathfrak{R} . We denote this triplet $\zeta = \langle P_\sigma(r), I_\sigma(r), N_\sigma(r) \rangle$, in whole study called SVN.

Ye [14], Wang et al. [33] and [34] proposed the basic operations of SVN, which are as follows:

Definition 4. [34] For any two SVN $\zeta_p = \langle P_{\zeta_p}(r), I_{\zeta_p}(r), N_{\zeta_p}(r) \rangle$ and $\zeta_q = \langle P_{\zeta_q}(r), I_{\zeta_q}(r), N_{\zeta_q}(r) \rangle$ in \mathfrak{R} . The union, intersection and compliment are proposed as:

- (1) $\zeta_p \subseteq \zeta_q$ iff $\forall r \in \mathfrak{R}, P_{\zeta_p}(r) \leq P_{\zeta_q}(r), I_{\zeta_p}(r) \geq I_{\zeta_q}(r)$ and $N_{\zeta_p}(r) \geq N_{\zeta_q}(r)$;
- (2) $\zeta_p = \zeta_q$ iff $\zeta_p \subseteq \zeta_q$ and $\zeta_q \subseteq \zeta_p$;
- (3) $\zeta_p \cup \zeta_q = \langle \max(P_{\zeta_p}, P_{\zeta_q}), \min(I_{\zeta_p}, I_{\zeta_q}), \min(N_{\zeta_p}, N_{\zeta_q}) \rangle$;
- (4) $\zeta_p \cap \zeta_q = \langle \min(P_{\zeta_p}, P_{\zeta_q}), \max(I_{\zeta_p}, I_{\zeta_q}), \max(N_{\zeta_p}, N_{\zeta_q}) \rangle$;
- (5) $\zeta_p^c = \langle N_{\zeta_p}, I_{\zeta_p}, P_{\zeta_p} \rangle$.

Definition 5. [13,15,33] For any two SVN $\zeta_p = \langle P_{\zeta_p}(r), I_{\zeta_p}(r), N_{\zeta_p}(r) \rangle$ and $\zeta_q = \langle P_{\zeta_q}(r), I_{\zeta_q}(r), N_{\zeta_q}(r) \rangle$ in \mathfrak{R} and $\beta \geq 0$. Then the operations of SVN are proposed as:

- (1) $\zeta_p \oplus \zeta_q = \{ P_{\zeta_p} + P_{\zeta_q} - P_{\zeta_p} \cdot P_{\zeta_q}, I_{\zeta_p} \cdot I_{\zeta_q}, N_{\zeta_p} \cdot N_{\zeta_q} \}$;
- (2) $\beta \cdot \zeta_p = \{ 1 - (1 - P_{\zeta_p})^\beta, (I_{\zeta_p})^\beta, (N_{\zeta_p})^\beta \}$;
- (3) $\zeta_p \otimes \zeta_q = \{ P_{\zeta_p} \cdot P_{\zeta_q}, I_{\zeta_p} + I_{\zeta_q} - I_{\zeta_p} \cdot I_{\zeta_q}, N_{\zeta_p} + N_{\zeta_q} - N_{\zeta_p} \cdot N_{\zeta_q} \}$;
- (4) $\zeta_p^\beta = \{ (P_{\zeta_p})^\beta, 1 - (1 - I_{\zeta_p})^\beta, 1 - (1 - N_{\zeta_p})^\beta \}$.
- (5) $\beta^{\zeta_p} = \begin{cases} (\beta^{1-P_{\zeta_p}}, 1 - \beta^{I_{\zeta_p}}, 1 - \beta^{N_{\zeta_p}}) & \text{if } \beta \in (0, 1) \\ \left(\left(\frac{1}{\beta}\right)^{1-P_{\zeta_p}}, 1 - \left(\frac{1}{\beta}\right)^{I_{\zeta_p}}, 1 - \left(\frac{1}{\beta}\right)^{N_{\zeta_p}} \right) & \text{if } \beta \geq 1 \end{cases}$

Definition 6. [33] For any three SVN $\zeta_p = \langle P_{\zeta_p}(r), I_{\zeta_p}(r), N_{\zeta_p}(r) \rangle$, $\zeta_q = \langle P_{\zeta_q}(r), I_{\zeta_q}(r), N_{\zeta_q}(r) \rangle$ and $\zeta_l = \langle P_{\zeta_l}(r), I_{\zeta_l}(r), N_{\zeta_l}(r) \rangle$ in \mathfrak{R} and $\beta_1, \beta_2 \geq 0$. Then, we have

- (1) $\zeta_p \oplus \zeta_q = \zeta_q \oplus \zeta_p$;
- (2) $\zeta_p \otimes \zeta_q = \zeta_q \otimes \zeta_p$;
- (3) $\beta_1(\zeta_p \oplus \zeta_q) = \beta_1\zeta_p \oplus \beta_1\zeta_q, \beta_1 > 0$;
- (4) $(\zeta_p \otimes \zeta_q)^{\beta_1} = \zeta_p^{\beta_1} \otimes \zeta_q^{\beta_1}, \beta_1 > 0$;
- (5) $\beta_1\zeta_p \oplus \beta_2\zeta_p = (\beta_1 + \beta_2)\zeta_p, \beta_1 > 0, \beta_2 > 0$;
- (6) $\zeta_p^{\beta_1} \otimes \zeta_p^{\beta_2} = \zeta_p^{\beta_1 + \beta_2}, \beta_1 > 0, \beta_2 > 0$;
- (7) $(\zeta_p \oplus \zeta_q) \oplus \zeta_l = \zeta_p \oplus (\zeta_q \oplus \zeta_l)$;
- (8) $(\zeta_p \otimes \zeta_q) \otimes \zeta_l = \zeta_p \otimes (\zeta_q \otimes \zeta_l)$.

Definition 7. [33] For any SVN $\zeta_p = \langle P_{\zeta_p}(r), I_{\zeta_p}(r), N_{\zeta_p}(r) \rangle$ in \mathfrak{R} . Then score and accuracy values are defined as:

- (1) $\tilde{S}(\zeta_p) = P_{\zeta_p} - I_{\zeta_p} - N_{\zeta_p}$
- (2) $\tilde{A}(\zeta_p) = P_{\zeta_p} + I_{\zeta_p} + N_{\zeta_p}$

The above definitions of score and accuracy functions suggest which SVN is greater than other SVNs. The comparison technique is defined in following definition.

Definition 8. [33] For any SVNs $\zeta_p = \langle P_{\zeta_p}(r), I_{\zeta_p}(r), N_{\zeta_p}(r) \rangle$ ($p = 1, 2$) in \mathfrak{R} .

Then comparison techniques are proposed as:

- (1) If $\tilde{S}(\zeta_1) < \tilde{S}(\zeta_2)$, then $\zeta_1 < \zeta_2$,
- (2) If $\tilde{S}(\zeta_1) > \tilde{S}(\zeta_2)$, then $\zeta_1 > \zeta_2$,
- (3) If $\tilde{S}(\zeta_1) = \tilde{S}(\zeta_2)$, and
 - (a) $\tilde{A}(\zeta_1) < \tilde{A}(\zeta_2)$, then $\zeta_1 < \zeta_2$,
 - (b) $\tilde{A}(\zeta_1) > \tilde{A}(\zeta_2)$, then $\zeta_1 > \zeta_2$,
 - (c) $\tilde{A}(\zeta_1) = \tilde{A}(\zeta_2)$, then $\zeta_1 \approx \zeta_2$.

Garg and Nancy [10] proposed some logarithmic-based aggregation operators, which are as follows:

Definition 9. [10] For any collection of SVNs $\zeta_p = \langle P_{\zeta_p}(r), I_{\zeta_p}(r), N_{\zeta_p}(r) \rangle$ ($p = 1, 2, \dots, n$) in \mathfrak{R} , with $0 < \sigma_p \leq \min \{P_{\zeta_p}, 1 - I_{\zeta_p}, 1 - N_{\zeta_p}\} < 1, \sigma \neq 1$. Then, the structure of logarithmic single valued neutrosophic weighted averaging (L-SVNWA) operator is defined as:

$$L - SVNWA (\zeta_1, \zeta_2, \dots, \zeta_n) = \left(\begin{array}{c} 1 - \prod_{p=1}^n (\log_{\sigma_p} P_{\zeta_p})^{\beta_p}, \\ \prod_{p=1}^n (\log_{\sigma_p} (1 - I_{\zeta_p}))^{\beta_p}, \\ \prod_{p=1}^n (\log_{\sigma_p} (1 - N_{\zeta_p}))^{\beta_p} \end{array} \right), \tag{4}$$

where β_p ($p = 1, 2, \dots, n$) are weight vectors with $\beta_p \geq 0$ and $\sum_{p=1}^n \beta_p = 1$.

Definition 10. [10] For any collection of SVNNS $\zeta_p = \langle P_{\zeta_p}(r), I_{\zeta_p}(r), N_{\zeta_p}(r) \rangle$ ($p = 1, 2, \dots, n$) in \mathfrak{R} , with $0 < \sigma_p \leq \min \{P_{\zeta_p}, 1 - I_{\zeta_p}, 1 - N_{\zeta_p}\} < 1, \sigma \neq 1$. Then, the structure of the logarithmic single-valued neutrosophic-ordered weighted averaging (L-SVNOWA) operator is defined as:

$$L - SVNOWA(\zeta_1, \zeta_2, \dots, \zeta_n) = \left(\begin{array}{c} 1 - \prod_{p=1}^n (\log_{\sigma_p} P_{\zeta_{\eta(p)}})^{\beta_p}, \\ \prod_{p=1}^n (\log_{\sigma_p} (1 - I_{\zeta_{\eta(p)}}))^{\beta_p}, \\ \prod_{p=1}^n (\log_{\sigma_p} (1 - N_{\zeta_{\eta(p)}}))^{\beta_p} \end{array} \right), \tag{5}$$

where β_p ($p = 1, 2, \dots, n$) are weighting vector with $\beta_p \geq 0, \sum_{p=1}^n \beta_p = 1$ and p th largest weighted value is $\zeta_{\eta(p)}$ consequently by total order $\zeta_{\eta(1)} \geq \zeta_{\eta(2)} \geq \dots \geq \zeta_{\eta(n)}$.

Definition 11. [10] For any collection of SVNNS $\zeta_p = \langle P_{\zeta_p}(r), I_{\zeta_p}(r), N_{\zeta_p}(r) \rangle$ ($p = 1, 2, \dots, n$) in \mathfrak{R} , with $0 < \sigma_p \leq \min \{P_{\zeta_p}, 1 - I_{\zeta_p}, 1 - N_{\zeta_p}\} < 1, \sigma \neq 1$. Then, the structure of logarithmic single-valued neutrosophic-weighted geometric (L-SVNWG) operator is defined as:

$$L - SVNWG(\zeta_1, \zeta_2, \dots, \zeta_n) = \left(\begin{array}{c} \prod_{p=1}^n (1 - \log_{\sigma_p} P_{\zeta_p})^{\beta_p}, \\ 1 - \prod_{p=1}^n (1 - \log_{\sigma_p} (1 - I_{\zeta_p}))^{\beta_p}, \\ 1 - \prod_{p=1}^n (1 - \log_{\sigma_p} (1 - N_{\zeta_p}))^{\beta_p} \end{array} \right), \tag{6}$$

where β_p ($p = 1, 2, \dots, n$) are weight vectors with $\beta_p \geq 0$ and $\sum_{p=1}^n \beta_p = 1$.

Definition 12. [10] For any collection of SVNNS $\zeta_p = \langle P_{\zeta_p}(r), I_{\zeta_p}(r), N_{\zeta_p}(r) \rangle$ ($p = 1, 2, \dots, n$) in \mathfrak{R} , with $0 < \sigma_p \leq \min \{P_{\zeta_p}, 1 - I_{\zeta_p}, 1 - N_{\zeta_p}\} < 1, \sigma \neq 1$. Then, the structure of logarithmic single valued neutrosophic ordered weighted geometric (L-SVNOWG) operator is defined as:

$$L - SVNOWG(\zeta_1, \zeta_2, \dots, \zeta_n) = \left(\begin{array}{c} \prod_{p=1}^n (1 - \log_{\sigma_p} P_{\zeta_{\eta(p)}})^{\beta_p}, \\ 1 - \prod_{p=1}^n (1 - \log_{\sigma_p} (1 - I_{\zeta_{\eta(p)}}))^{\beta_p}, \\ 1 - \prod_{p=1}^n (1 - \log_{\sigma_p} (1 - N_{\zeta_{\eta(p)}}))^{\beta_p} \end{array} \right), \tag{7}$$

where β_p ($p = 1, 2, \dots, n$) are weighting vector with $\beta_p \geq 0$ and $\sum_{p=1}^n \beta_p = 1$ and p th are the largest weighted value is $\zeta_{\eta(p)}$ consequently by total order $\zeta_{\eta(1)} \geq \zeta_{\eta(2)} \geq \dots \geq \zeta_{\eta(n)}$.

3. Logarithmic Operational Laws

Motivated by the well growing concept of SVNNSs, we introduce some novel logarithmic operational laws for single valued neutrosophic numbers. As in real number systems $\log_{\sigma} 0$ is meaningless and $\log_{\sigma} 1$ is not defined therefore, in our study we take non-empty SVNNSs and $\sigma \neq 1$, where σ is any real number.

Definition 13. For any SVNNS $\zeta_p = \langle P_{\zeta_p}(r), I_{\zeta_p}(r), N_{\zeta_p}(r) \rangle$ in \mathfrak{R} . The logarithmic SVNNS is defined as:

$$\log_{\sigma} \zeta_p = \left\{ \left\langle 1 - (\log_{\sigma} P_{\zeta_p}(r)), \log_{\sigma} (1 - I_{\zeta_p}(r)), \log_{\sigma} (1 - N_{\zeta_p}(r)) \right\rangle \mid r \in \mathfrak{R} \right\}, \tag{8}$$

in which $P_\sigma : \mathfrak{R} \rightarrow \Theta$, $I_\sigma : \mathfrak{R} \rightarrow \Theta$ and $N_\sigma : \mathfrak{R} \rightarrow \Theta$ are indicated the truth, indeterminacy and falsity memberships in \mathfrak{R} , $\Theta = [0, 1]$ be the unit interval. Also following condition is satisfied by P_σ , I_σ and N_σ , $0 \leq P_\sigma(r) + I_\sigma(r) + N_\sigma(r) \leq 3; \forall r \in \mathfrak{R}$. Therefore the truth membership grade is

$$1 - \left(\log_\sigma P_{\zeta_p}(r) \right) : \mathfrak{R} \rightarrow \Theta, \text{ such that } 0 \leq 1 - \left(\log_\sigma P_{\zeta_p}(r) \right) \leq 1, \text{ for all } r \in \mathfrak{R}$$

the indeterminacy membership is

$$\log_\sigma \left(1 - I_{\zeta_p}(r) \right) : \mathfrak{R} \rightarrow \Theta, \text{ such that } 0 \leq \log_\sigma \left(1 - I_{\zeta_p}(r) \right) \leq 1, \text{ for all } r \in \mathfrak{R}$$

and falsity membership is

$$\log_\sigma \left(1 - N_{\zeta_p}(r) \right) : \mathfrak{R} \rightarrow \Theta, \text{ such that } 0 \leq \log_\sigma \left(1 - N_{\zeta_p}(r) \right) \leq 1, \text{ for all } r \in \mathfrak{R}.$$

Therefore

$$\begin{aligned} \log_\sigma \zeta_p &= \left\{ \left\langle 1 - \left(\log_\sigma P_{\zeta_p}(r) \right), \log_\sigma \left(1 - I_{\zeta_p}(r) \right), \log_\sigma \left(1 - N_{\zeta_p}(r) \right) \right\rangle | r \in \mathfrak{R} \right\} \\ 0 &< \sigma \leq \min \left\{ P_{\zeta_p}, 1 - I_{\zeta_p}, 1 - N_{\zeta_p} \right\} \leq 1, \sigma \neq 1 \end{aligned}$$

is SVNS.

Definition 14. For any SVNN $\zeta_p = \langle P_{\zeta_p}(r), I_{\zeta_p}(r), N_{\zeta_p}(r) \rangle$ in \mathfrak{R} . If

$$\log_\sigma \zeta_p = \begin{cases} \left(\begin{array}{l} 1 - \left(\log_\sigma P_{\zeta_p}(r) \right), \\ \log_\sigma \left(1 - I_{\zeta_p}(r) \right), \\ \log_\sigma \left(1 - N_{\zeta_p}(r) \right) \end{array} \right) & 0 < \sigma \leq \min \left\{ P_{\zeta_p}, 1 - I_{\zeta_p}, 1 - N_{\zeta_p} \right\} < 1 \\ \left(\begin{array}{l} 1 - \left(\log_{\frac{1}{\sigma}} P_{\zeta_p}(r) \right), \\ \log_{\frac{1}{\sigma}} \left(1 - I_{\zeta_p}(r) \right), \\ \log_{\frac{1}{\sigma}} \left(1 - N_{\zeta_p}(r) \right) \end{array} \right) & 0 < \frac{1}{\sigma} \leq \min \left\{ P_{\zeta_p}, 1 - I_{\zeta_p}, 1 - N_{\zeta_p} \right\} < 1, \\ & \sigma \neq 1 \end{cases} \tag{9}$$

then the function $\log_\sigma \zeta_p$ is known to be a logarithmic operator for SVNS, and its value is said to be logarithmic SVNN (L-SVNN). Here, we take $\log_\sigma 0 = 0, \sigma > 0, \sigma \neq 1$.

Theorem 1. [10] For any SVNN $\zeta_p = \langle P_{\zeta_p}(r), I_{\zeta_p}(r), N_{\zeta_p}(r) \rangle$ in \mathfrak{R} , then $\log_\sigma \zeta_p$ is also be SVNN.

Now, we give some discussion on the basic properties of the L-SVNN.

Definition 15. For any two L-SVNNs $\log_\sigma \zeta_p = \left(\begin{array}{l} 1 - \left(\log_\sigma P_{\zeta_p}(r) \right), \\ \log_\sigma \left(1 - I_{\zeta_p}(r) \right), \\ \log_\sigma \left(1 - N_{\zeta_p}(r) \right) \end{array} \right)$ and $\log_\sigma \zeta_q =$

$\left(\begin{array}{l} 1 - \left(\log_\sigma P_{\zeta_q}(r) \right), \\ \log_\sigma \left(1 - I_{\zeta_q}(r) \right), \\ \log_\sigma \left(1 - N_{\zeta_q}(r) \right) \end{array} \right)$ in \mathfrak{R} and $\beta \geq 0$. Then the logarithmic operations of L-SVNNs are propose as

$$(1) \log_\sigma \zeta_p \oplus \log_\sigma \zeta_q = \left\{ \begin{array}{l} 1 - \left(\log_\sigma P_{\zeta_p}(r) \right) \cdot \left(\log_\sigma P_{\zeta_q}(r) \right), \\ \log_\sigma \left(1 - I_{\zeta_p}(r) \right) \cdot \log_\sigma \left(1 - I_{\zeta_q}(r) \right), \\ \log_\sigma \left(1 - N_{\zeta_p}(r) \right) \cdot \log_\sigma \left(1 - N_{\zeta_q}(r) \right) \end{array} \right\};$$

$$\begin{aligned}
 (2) \beta \cdot \log_{\sigma} \zeta_p &= \left\{ \begin{array}{l} 1 - (\log_{\sigma} P_{\zeta_p}(r))^{\beta}, \\ (\log_{\sigma} (1 - I_{\zeta_p}(r)))^{\beta}, \\ (\log_{\sigma} (1 - N_{\zeta_p}(r)))^{\beta} \end{array} \right\}; \\
 (3) \log_{\sigma} \zeta_p \otimes \log_{\sigma} \zeta_q &= \left\{ \begin{array}{l} 1 - (\log_{\sigma} P_{\zeta_p}(r)) \cdot 1 - (\log_{\sigma} P_{\zeta_q}(r)), \\ 1 - (1 - \log_{\sigma} (1 - I_{\zeta_p}(r))) \cdot (1 - \log_{\sigma} (1 - I_{\zeta_q}(r))), \\ 1 - (1 - \log_{\sigma} (1 - N_{\zeta_p}(r))) \cdot (1 - \log_{\sigma} (1 - N_{\zeta_q}(r))) \end{array} \right\}; \\
 (4) (\log_{\sigma} \zeta_p)^{\beta} &= \left\{ \begin{array}{l} (1 - (\log_{\sigma} P_{\zeta_p}(r))^{\beta}), \\ 1 - (1 - \log_{\sigma} (1 - I_{\zeta_p}(r)))^{\beta}, \\ 1 - (1 - \log_{\sigma} (1 - N_{\zeta_p}(r)))^{\beta} \end{array} \right\}.
 \end{aligned}$$

Theorem 2. [10] For any two L-SVNNs $\log_{\sigma} \zeta_p = \left(\begin{array}{l} 1 - (\log_{\sigma} P_{\zeta_p}(r)), \\ \log_{\sigma} (1 - I_{\zeta_p}(r)), \\ \log_{\sigma} (1 - N_{\zeta_p}(r)) \end{array} \right)$ ($p = 1, 2$) in \mathfrak{R} , with $0 <$

$\sigma \leq \min \{ P_{\zeta_p}, 1 - I_{\zeta_p}, 1 - N_{\zeta_p} \} < 1, \sigma \neq 1, \beta, \beta_1, \beta_2 > 0$ be any real numbers. Then

- (1) $\beta (\log_{\sigma} \zeta_1 \oplus \log_{\sigma} \zeta_2) = \beta \log_{\sigma} \zeta_1 \oplus \beta \log_{\sigma} \zeta_2;$
- (2) $(\log_{\sigma} \zeta_1 \otimes \log_{\sigma} \zeta_2)^{\beta} = (\log_{\sigma} \zeta_1)^{\beta} \otimes (\log_{\sigma} \zeta_2)^{\beta};$
- (3) $\beta_1 \log_{\sigma} \zeta_1 \oplus \beta_2 \log_{\sigma} \zeta_1 = (\beta_1 + \beta_2) \log_{\sigma} \zeta_1;$
- (4) $(\log_{\sigma} \zeta_1)^{\beta_1} \otimes (\log_{\sigma} \zeta_1)^{\beta_2} = (\log_{\sigma} \zeta_1)^{(\beta_1 + \beta_2)};$
- (5) $((\log_{\sigma} \zeta_1)^{\beta_1})^{\beta_2} = (\log_{\sigma} \zeta_1)^{\beta_1 \beta_2}.$

Comparison Technique for L-SVNNs

Definition 16. [10] For any L-SVNN $\log_{\sigma} \zeta_p = \left(\begin{array}{l} 1 - (\log_{\sigma} P_{\zeta_p}(r)), \\ \log_{\sigma} (1 - I_{\zeta_p}(r)), \\ \log_{\sigma} (1 - N_{\zeta_p}(r)) \end{array} \right)$ in \mathfrak{R} . Then score and accuracy

values are define as

- (1) $\tilde{S}(\log_{\sigma} \zeta_p) = 1 - (\log_{\sigma} P_{\zeta_p}(r)) - \log_{\sigma} (1 - I_{\zeta_p}(r)) - (\log_{\sigma} (1 - N_{\zeta_p}(r)))$
- (2) $\tilde{A}(\log_{\sigma} \zeta_p) = 1 - (\log_{\sigma} P_{\zeta_p}(r)) + \log_{\sigma} (1 - I_{\zeta_p}(r)) + (\log_{\sigma} (1 - N_{\zeta_p}(r)))$

The above defined score and accuracy values suggest which L-SVNN are greater than other L-SVNNs. The comparison technique is defined in the following definition.

Definition 17. For any L-SVNNs $\log_{\sigma} \zeta_p = \left(\begin{array}{l} 1 - (\log_{\sigma} P_{\zeta_p}(r)), \\ \log_{\sigma} (1 - I_{\zeta_p}(r)), \\ \log_{\sigma} (1 - N_{\zeta_p}(r)) \end{array} \right)$ ($p = 1, 2$) in \mathfrak{R} . Then, comparison

technique is proposed as:

- (1) If $\tilde{S}(\log_{\sigma} \zeta_1) < \tilde{S}(\log_{\sigma} \zeta_2)$ then $\log_{\sigma} \zeta_1 < \log_{\sigma} \zeta_2,$
- (2) If $\tilde{S}(\log_{\sigma} \zeta_1) > \tilde{S}(\log_{\sigma} \zeta_2)$ then $\log_{\sigma} \zeta_1 > \log_{\sigma} \zeta_2,$
- (3) If $\tilde{S}(\log_{\sigma} \zeta_1) = \tilde{S}(\log_{\sigma} \zeta_2)$ then
 - (a) $\tilde{A}(\log_{\sigma} \zeta_1) < \tilde{A}(\log_{\sigma} \zeta_2)$ then $\log_{\sigma} \zeta_1 < \log_{\sigma} \zeta_2,$
 - (b) $\tilde{A}(\log_{\sigma} \zeta_1) > \tilde{A}(\log_{\sigma} \zeta_2)$ then $\log_{\sigma} \zeta_1 > \log_{\sigma} \zeta_2,$
 - (c) $\tilde{A}(\log_{\sigma} \zeta_1) = \tilde{A}(\log_{\sigma} \zeta_2)$ then $\log_{\sigma} \zeta_1 \approx \log_{\sigma} \zeta_2.$

4. Logarithmic Aggregation Operators for L-SVNNs

Now, we propose novel logarithmic hybrid aggregation operators for L-SVNNs based on logarithmic operations laws as follows:

4.1. Logarithmic Hybrid Averaging Operator

Definition 18. For any collection of SVNNs $\zeta_p = \langle P_{\zeta_p}(r), I_{\zeta_p}(r), N_{\zeta_p}(r) \rangle$ ($p = 1, \dots, n$) in \mathfrak{R} , with $0 < \sigma_p \leq \min \{P_{\zeta_p}, 1 - I_{\zeta_p}, 1 - N_{\zeta_p}\} < 1, \sigma \neq 1$. The structure of logarithmic single valued neutrosophic hybrid weighted averaging (L-SVNHWA) operator is

$$L - SVNHWA (\zeta_1, \zeta_2, \dots, \zeta_n) = \sum_{p=1}^n \omega_p \log_{\sigma_p} \zeta_{\eta(p)}^* \tag{10}$$

where β_p ($p = 1, \dots, n$) is the weighting vector with $\beta_p \geq 0$ and $\sum_{p=1}^n \beta_p = 1$ and p th biggest weighted value is $\zeta_{\eta(p)}^*$ ($\zeta_{\eta(p)}^* = n\beta_p \zeta_{\eta(p)}, P \in N$) consequently by total order $\zeta_{\eta(1)}^* \geq \zeta_{\eta(2)}^* \geq \dots \geq \zeta_{\eta(n)}^*$. Also, the associated weights are $\omega = (\omega_1, \omega_2, \dots, \omega_n)$ with $\omega_p \geq 0, \sum_{p=1}^n \omega_p = 1$.

Theorem 3. For any collection of SVNNs $\zeta_p = \langle P_{\zeta_p}(r), I_{\zeta_p}(r), N_{\zeta_p}(r) \rangle$ ($p = 1, \dots, n$) in \mathfrak{R} , with $0 < \sigma_p \leq \min \{P_{\zeta_p}, 1 - I_{\zeta_p}, 1 - N_{\zeta_p}\} < 1, \sigma \neq 1$. Then by using logarithmic operations and Definition 18, L - SVNHWA is defined as

$$L - SVNHWA (\zeta_1, \zeta_2, \dots, \zeta_n) = \begin{cases} \left(\begin{array}{l} 1 - \prod_{p=1}^n \left(\log_{\sigma_p} P_{\zeta_{\eta(p)}^*} \right)^{\omega_p}, \\ \prod_{p=1}^n \left(\log_{\sigma_p} \left(1 - I_{\zeta_{\eta(p)}^*} \right) \right)^{\omega_p}, \\ \prod_{p=1}^n \left(\log_{\sigma_p} \left(1 - N_{\zeta_{\eta(p)}^*} \right) \right)^{\omega_p} \end{array} \right) & 0 < \sigma_p \leq \min \left\{ \begin{array}{l} P_{\zeta_p}, \\ 1 - I_{\zeta_p}, \\ 1 - N_{\zeta_p} \end{array} \right\} < 1 \\ \left(\begin{array}{l} 1 - \prod_{p=1}^n \left(\log_{\frac{1}{\sigma_p}} P_{\zeta_{\eta(p)}^*} \right)^{\omega_p}, \\ \prod_{p=1}^n \left(\log_{\frac{1}{\sigma_p}} \left(1 - I_{\zeta_{\eta(p)}^*} \right) \right)^{\omega_p}, \\ \prod_{p=1}^n \left(\log_{\frac{1}{\sigma_p}} \left(1 - N_{\zeta_{\eta(p)}^*} \right) \right)^{\omega_p} \end{array} \right) & 0 < \frac{1}{\sigma_p} \leq \min \left\{ \begin{array}{l} P_{\zeta_p}, \\ 1 - I_{\zeta_p}, \\ 1 - N_{\zeta_p} \end{array} \right\} < 1, \\ & \sigma \neq 1 \end{cases} \tag{11}$$

where β_p ($p = 1, \dots, n$) are weighting vector with $\beta_p \geq 0$ and $\sum_{p=1}^n \beta_p = 1$ and p th biggest weighted value is $\zeta_{\eta(p)}^*$ ($\zeta_{\eta(p)}^* = n\beta_p \zeta_{\eta(p)}, P \in N$) consequently by total order $\zeta_{\eta(1)}^* \geq \zeta_{\eta(2)}^* \geq \dots \geq \zeta_{\eta(n)}^*$. Also the associated weights are $\omega = (\omega_1, \omega_2, \dots, \omega_n)$ with $\omega_p \geq 0, \sum_{p=1}^n \omega_p = 1$.

Proof. Using mathematical induction to prove Equation (3), we proceed as:

(a) For $n = 2$, since

$$\omega_1 \log_{\sigma_1} \zeta_{\eta(1)}^* = \left(\begin{array}{l} 1 - \left(\log_{\sigma_1} P_{\zeta_{\eta(1)}^*} \right)^{\omega_1}, \\ \left(\log_{\sigma_1} \left(1 - I_{\zeta_{\eta(1)}^*} \right) \right)^{\omega_1}, \\ \left(\log_{\sigma_1} \left(1 - N_{\zeta_{\eta(1)}^*} \right) \right)^{\omega_1} \end{array} \right)$$

and

$$\omega_2 \log_{\sigma_2} \zeta_{\eta(2)}^* = \left(\begin{array}{c} 1 - \left(\log_{\sigma_2} P_{\zeta_{\eta(2)}}^* \right)^{\omega_2}, \\ \left(\log_{\sigma_2} \left(1 - I_{\zeta_{\eta(2)}}^* \right) \right)^{\omega_2}, \\ \left(\log_{\sigma_2} \left(1 - N_{\zeta_{\eta(2)}}^* \right) \right)^{\omega_2} \end{array} \right)$$

Then

$$\begin{aligned} L - SVNHWA (\zeta_1, \zeta_2) &= \omega_1 \log_{\sigma_1} \zeta_{\eta(1)}^* \oplus \omega_2 \log_{\sigma_2} \zeta_{\eta(2)}^* \\ &= \left(\begin{array}{c} 1 - \left(\log_{\sigma_1} P_{\zeta_{\eta(1)}}^* \right)^{\omega_1}, \\ \left(\log_{\sigma_1} \left(1 - I_{\zeta_{\eta(1)}}^* \right) \right)^{\omega_1}, \\ \left(\log_{\sigma_1} \left(1 - N_{\zeta_{\eta(1)}}^* \right) \right)^{\omega_1} \end{array} \right) \oplus \left(\begin{array}{c} 1 - \left(\log_{\sigma_2} P_{\zeta_{\eta(2)}}^* \right)^{\omega_2}, \\ \left(\log_{\sigma_2} \left(1 - I_{\zeta_{\eta(2)}}^* \right) \right)^{\omega_2}, \\ \left(\log_{\sigma_2} \left(1 - N_{\zeta_{\eta(2)}}^* \right) \right)^{\omega_2} \end{array} \right) \\ &= \left(\begin{array}{c} 1 - \left(\log_{\sigma_1} P_{\zeta_{\eta(1)}}^* \right)^{\omega_1} \cdot \left(\log_{\sigma_2} P_{\zeta_{\eta(2)}}^* \right)^{\omega_2}, \\ \left(\log_{\sigma_1} \left(1 - I_{\zeta_{\eta(1)}}^* \right) \right)^{\omega_1} \cdot \left(\log_{\sigma_2} \left(1 - I_{\zeta_{\eta(2)}}^* \right) \right)^{\omega_2}, \\ \left(\log_{\sigma_1} \left(1 - N_{\zeta_{\eta(1)}}^* \right) \right)^{\omega_1} \cdot \left(\log_{\sigma_2} \left(1 - N_{\zeta_{\eta(2)}}^* \right) \right)^{\omega_2} \end{array} \right) \\ &= \left(\begin{array}{c} 1 - \prod_{p=1}^2 \left(\log_{\sigma_p} P_{\zeta_{\eta(p)}}^* \right)^{\omega_p}, \\ \prod_{p=1}^2 \left(\log_{\sigma_p} \left(1 - I_{\zeta_{\eta(p)}}^* \right) \right)^{\omega_p}, \\ \prod_{p=1}^2 \left(\log_{\sigma_p} \left(1 - N_{\zeta_{\eta(p)}}^* \right) \right)^{\omega_p} \end{array} \right). \end{aligned}$$

(b) Now Equation (3) is true for $n = k$,

$$L - SVNHWA (\zeta_1, \zeta_2, \dots, \zeta_k) = \left(\begin{array}{c} 1 - \prod_{p=1}^k \left(\log_{\sigma_p} P_{\zeta_{\eta(p)}}^* \right)^{\omega_p}, \\ \prod_{p=1}^k \left(\log_{\sigma_p} \left(1 - I_{\zeta_{\eta(p)}}^* \right) \right)^{\omega_p}, \\ \prod_{p=1}^k \left(\log_{\sigma_p} \left(1 - N_{\zeta_{\eta(p)}}^* \right) \right)^{\omega_p} \end{array} \right).$$

(c) Now, we prove that Equation (3) for $n = k + 1$, that is

$$L - SVNHWA (\zeta_1, \zeta_2, \dots, \zeta_k) = \sum_{p=1}^k \omega_p \log_{\sigma_p} \zeta_{\eta(p)}^* + \omega_{k+1} \log_{\sigma_{k+1}} \zeta_{\eta(k+1)}^*$$

$$\begin{aligned}
 & L - SVNHWA (\zeta_1, \zeta_2, \dots, \zeta_k) \\
 &= \left(\begin{array}{l} 1 - \prod_{p=1}^k (\log_{\sigma_p} P_{\zeta_{\eta(p)}}^*)^{\omega_p}, \\ \prod_{p=1}^k (\log_{\sigma_p} (1 - I_{\zeta_{\eta(p)}}^*))^{\omega_p}, \\ \prod_{p=1}^k (\log_{\sigma_p} (1 - N_{\zeta_{\eta(p)}}^*))^{\omega_p} \end{array} \right) \oplus \left(\begin{array}{l} 1 - (\log_{\sigma_{k+1}} P_{\zeta_{\eta(k+1)}}^*)^{\omega_{k+1}}, \\ (\log_{\sigma_{k+1}} (1 - I_{\zeta_{\eta(k+1)}}^*))^{\omega_{k+1}}, \\ (\log_{\sigma_{k+1}} (1 - N_{\zeta_{\eta(k+1)}}^*))^{\omega_{k+1}} \end{array} \right) \\
 &= \left(\begin{array}{l} 1 - \prod_{p=1}^{k+1} (\log_{\sigma_p} P_{\zeta_{\eta(p)}}^*)^{\omega_p}, \\ \prod_{p=1}^{k+1} (\log_{\sigma_p} (1 - I_{\zeta_{\eta(p)}}^*))^{\omega_p}, \\ \prod_{p=1}^{k+1} (\log_{\sigma_p} (1 - N_{\zeta_{\eta(p)}}^*))^{\omega_p} \end{array} \right)
 \end{aligned}$$

Thus Equation (3) is true for $n = z + 1$. Hence its satisfies for whole n . Therefore

$$L - SVNHWA (\zeta_1, \zeta_2, \dots, \zeta_n) = \left(\begin{array}{l} 1 - \prod_{p=1}^n (\log_{\sigma_p} P_{\zeta_{\eta(p)}}^*)^{\omega_p}, \\ \prod_{p=1}^n (\log_{\sigma_p} (1 - I_{\zeta_{\eta(p)}}^*))^{\omega_p}, \\ \prod_{p=1}^n (\log_{\sigma_p} (1 - N_{\zeta_{\eta(p)}}^*))^{\omega_p} \end{array} \right).$$

In a similarly way, if $0 < \frac{1}{\sigma_p} \leq \min \{ P_{\zeta_p}, 1 - I_{\zeta_p}, 1 - N_{\zeta_p} \} < 1, \sigma \neq 1$, we can also obtain

$$L - SVNHWA (\zeta_1, \zeta_2, \dots, \zeta_n) = \left(\begin{array}{l} 1 - \prod_{p=1}^n (\log_{\frac{1}{\sigma_p}} P_{\zeta_{\eta(p)}}^*)^{\omega_p}, \\ \prod_{p=1}^n (\log_{\frac{1}{\sigma_p}} (1 - I_{\zeta_{\eta(p)}}^*))^{\omega_p}, \\ \prod_{p=1}^n (\log_{\frac{1}{\sigma_p}} (1 - N_{\zeta_{\eta(p)}}^*))^{\omega_p} \end{array} \right)$$

which completes the proof. \square

Remark 1. If $\sigma_1 = \sigma_2 = \sigma_3 = \dots = \sigma_n = \sigma$, that is $0 < \sigma \leq \min \{ P_{\zeta_p}, 1 - I_{\zeta_p}, 1 - N_{\zeta_p} \} < 1, \sigma \neq 1$, then $L - SVNHWA$ operator is reduced as follows

$$L - SVNHWA (\zeta_1, \zeta_2, \dots, \zeta_n) = \left(\begin{array}{l} 1 - \prod_{p=1}^n (\log_{\sigma} P_{\zeta_{\eta(p)}}^*)^{\omega_p}, \\ \prod_{p=1}^n (\log_{\sigma} (1 - I_{\zeta_{\eta(p)}}^*))^{\omega_p}, \\ \prod_{p=1}^n (\log_{\sigma} (1 - N_{\zeta_{\eta(p)}}^*))^{\omega_p} \end{array} \right). \tag{12}$$

Properties

$L - SVNHWA$ operator satisfies some properties are enlist below;

(1) Idempotency: For any collection of SVNNs $\zeta_p = \langle P_{\zeta_p}(r), I_{\zeta_p}(r), N_{\zeta_p}(r) \rangle (p = 1, \dots, n)$ in \mathfrak{R} . Then, if collection of SVNNs $\zeta_p = \langle P_{\zeta_p}(r), I_{\zeta_p}(r), N_{\zeta_p}(r) \rangle (p = 1, \dots, n)$ are identical, that is

$$L - SVNHWA (\zeta_1, \zeta_2, \dots, \zeta_n) = \zeta. \tag{13}$$

(2) Boundedness: for any collection of SVNNs $\zeta_p = \langle P_{\zeta_p}(r), I_{\zeta_p}(r), N_{\zeta_p}(r) \rangle$ ($p = 1, \dots, n$) in \mathfrak{R} . $\zeta_p^- = \langle \min_p P_{\zeta_p}^*, \max_p I_{\zeta_p}^*, \max_p N_{\zeta_p}^* \rangle$ and $\zeta_p^+ = \langle \max_p P_{\zeta_p}^*, \min_p I_{\zeta_p}^*, \min_p N_{\zeta_p}^* \rangle$ ($p = 1, \dots, n$) in \mathfrak{R} , therefore

$$\zeta_p^- \subseteq L - SVNHWA(\zeta_1, \zeta_2, \dots, \zeta_n) \subseteq \zeta_p^+. \tag{14}$$

(3) Monotonically: for any collection of SVNNs $\zeta_p = \langle P_{\zeta_p}(r), I_{\zeta_p}(r), N_{\zeta_p}(r) \rangle$ ($p = 1, \dots, n$) in \mathfrak{R} . If $\zeta_{\eta(p)} \subseteq \zeta_{\eta(p)}^*$ for ($p = 1, \dots, n$), then

$$L - SVNHWA(\zeta_1, \zeta_2, \dots, \zeta_n) \subseteq L - SVNHWA(\zeta_1^*, \zeta_2^*, \dots, \zeta_n^*). \tag{15}$$

4.2. Logarithmic Hybrid Geometric Operators

Definition 19. For any collection of SVNNs $\zeta_p = \langle P_{\zeta_p}(r), I_{\zeta_p}(r), N_{\zeta_p}(r) \rangle$ ($p = 1, \dots, n$) in \mathfrak{R} , with $0 < \sigma_p \leq \min \{P_{\zeta_p}, 1 - I_{\zeta_p}, 1 - N_{\zeta_p}\} < 1, \sigma \neq 1$. The structure of logarithmic single valued neutrosophic hybrid weighted geometric (L-SVNHWG) operator is

$$L - SVNHWG(\zeta_1, \zeta_2, \dots, \zeta_n) = \prod_{p=1}^n (\log_{\sigma_p} \zeta_{\eta(p)}^*)^{\omega_p} \tag{16}$$

where β_p ($p = 1, \dots, n$) are weight vectors with $\beta_p \geq 0$ and $\sum_{p=1}^n \beta_p = 1$ and p th biggest weighted value is $\zeta_{\eta(p)}^*$ ($\zeta_{\eta(p)}^* = (\zeta_{\eta(p)})^{n\beta_p}, P \in N$) consequently by total order $\zeta_{\eta(1)}^* \geq \zeta_{\eta(2)}^* \geq \dots \geq \zeta_{\eta(n)}^*$. Also associated weights are $\omega = (\omega_1, \omega_2, \dots, \omega_n)$ with $\omega_p \geq 0, \sum_{p=1}^n \omega_p = 1$.

Theorem 4. For any collection of SVNNs $\zeta_p = \langle P_{\zeta_p}(r), I_{\zeta_p}(r), N_{\zeta_p}(r) \rangle$ ($p = 1, \dots, n$) in \mathfrak{R} , with $0 < \sigma_p \leq \min \{P_{\zeta_p}, 1 - I_{\zeta_p}, 1 - N_{\zeta_p}\} < 1, \sigma \neq 1$. Then by using logarithmic operations and Definition 19, L-SVNHWG define as

$$L - SVNHWG(\zeta_1, \zeta_2, \dots, \zeta_n) = \left[\begin{array}{l} \left(\prod_{p=1}^n \left(1 - \log_{\sigma_p} P_{\zeta_{\eta(p)}^*} \right)^{\beta_p} \right. \\ \left. 1 - \prod_{p=1}^n \left(1 - \left(\log_{\sigma_p} \left(1 - I_{\zeta_{\eta(p)}^*} \right) \right) \right)^{\beta_p} \right. \\ \left. 1 - \prod_{p=1}^n \left(1 - \left(\log_{\sigma_p} \left(1 - N_{\zeta_{\eta(p)}^*} \right) \right) \right)^{\beta_p} \right)^{\omega_p} \\ \left(\prod_{p=1}^n \left(1 - \log_{\frac{1}{\sigma_p}} P_{\zeta_{\eta(p)}^*} \right)^{\beta_p} \right. \\ \left. 1 - \prod_{p=1}^n \left(1 - \left(\log_{\frac{1}{\sigma_p}} \left(1 - I_{\zeta_{\eta(p)}^*} \right) \right) \right)^{\beta_p} \right. \\ \left. 1 - \prod_{p=1}^n \left(1 - \left(\log_{\frac{1}{\sigma_p}} \left(1 - N_{\zeta_{\eta(p)}^*} \right) \right) \right)^{\beta_p} \right)^{\omega_p} \end{array} \right] \tag{17}$$

$$0 < \sigma_p \leq \min \left\{ \begin{array}{l} P_{\zeta_{\eta(p)}^*} \\ 1 - I_{\zeta_{\eta(p)}^*} \\ 1 - N_{\zeta_{\eta(p)}^*} \end{array} \right\} < 1$$

$$0 < \frac{1}{\sigma_p} \leq \min \left\{ \begin{array}{l} P_{\zeta_{\eta(p)}^*} \\ 1 - I_{\zeta_{\eta(p)}^*} \\ 1 - N_{\zeta_{\eta(p)}^*} \end{array} \right\} < 1, \sigma \neq 1$$

where β_p ($p = 1, \dots, n$) are weight vectors with $\beta_p \geq 0$ and $\sum_{p=1}^n \beta_p = 1$ and p th biggest weighted value is $\zeta_{\eta(p)}^*$ ($\zeta_{\eta(p)}^* = (\zeta_{\eta(p)})^{n\beta_p}, P \in N$) consequently by total order $\zeta_{\eta(1)}^* \geq \zeta_{\eta(2)}^* \geq \dots \geq \zeta_{\eta(n)}^*$. Also associated weights are $\omega = (\omega_1, \omega_2, \dots, \omega_n)$ with $\omega_p \geq 0, \sum_{p=1}^n \omega_p = 1$.

Proof. Using mathematical induction to prove Equation (4), we proceed as:

(a) For $n = 2$, since

$$(\log_{\sigma_1} \zeta_1^*)^{\omega_1} = \begin{pmatrix} (1 - \log_{\sigma_1} P_{\zeta_1}^*)^{\omega_1} \\ 1 - (1 - (\log_{\sigma_1} (1 - I_{\zeta_1}^*)))^{\omega_1} \\ 1 - (1 - (\log_{\sigma_1} (1 - N_{\zeta_1}^*)))^{\omega_1} \end{pmatrix}$$

and

$$(\log_{\sigma_2} \zeta_2^*)^{\omega_2} = \begin{pmatrix} (1 - \log_{\sigma_2} P_{\zeta_2}^*)^{\omega_2} \\ 1 - (1 - (\log_{\sigma_2} (1 - I_{\zeta_2}^*)))^{\omega_2} \\ 1 - (1 - (\log_{\sigma_2} (1 - N_{\zeta_2}^*)))^{\omega_2} \end{pmatrix}.$$

Then

$$\begin{aligned} L - SVNHWG(\zeta_1, \zeta_2) &= (\log_{\sigma_1} \zeta_1^*)^{\omega_1} \otimes (\log_{\sigma_2} \zeta_2^*)^{\omega_2} \\ &= \begin{pmatrix} (1 - \log_{\sigma_1} P_{\zeta_1}^*)^{\omega_1} \\ 1 - (1 - (\log_{\sigma_1} (1 - I_{\zeta_1}^*)))^{\omega_1} \\ 1 - (1 - (\log_{\sigma_1} (1 - N_{\zeta_1}^*)))^{\omega_1} \end{pmatrix} \otimes \begin{pmatrix} (1 - \log_{\sigma_2} P_{\zeta_2}^*)^{\omega_2} \\ 1 - (1 - (\log_{\sigma_2} (1 - I_{\zeta_2}^*)))^{\omega_2} \\ 1 - (1 - (\log_{\sigma_2} (1 - N_{\zeta_2}^*)))^{\omega_2} \end{pmatrix} \\ &= \left\{ \begin{array}{l} (1 - \log_{\sigma_1} P_{\zeta_1}^*)^{\omega_1} \cdot (1 - \log_{\sigma_2} P_{\zeta_2}^*)^{\omega_2} \\ 1 - (1 - (\log_{\sigma_1} (1 - I_{\zeta_1}^*)))^{\omega_1} \cdot (1 - (\log_{\sigma_2} (1 - I_{\zeta_2}^*)))^{\omega_2} \\ 1 - (1 - (\log_{\sigma_1} (1 - N_{\zeta_1}^*)))^{\omega_1} \cdot (1 - (\log_{\sigma_2} (1 - N_{\zeta_2}^*)))^{\omega_2} \end{array} \right\} \\ &= \begin{pmatrix} \prod_{p=1}^2 (1 - \log_{\sigma_p} P_{\zeta_p}^*)^{\omega_p} \\ 1 - \prod_{p=1}^2 (1 - (\log_{\sigma_p} (1 - I_{\zeta_p}^*)))^{\omega_p} \\ 1 - \prod_{p=1}^2 (1 - (\log_{\sigma_p} (1 - N_{\zeta_p}^*)))^{\omega_p} \end{pmatrix}. \end{aligned}$$

(b) Now Equation (4) is true for $n = k$,

$$L - SVNHWG(\zeta_1, \zeta_2, \dots, \zeta_k) = \begin{pmatrix} \prod_{p=1}^k (1 - \log_{\sigma_p} P_{\zeta_p}^*)^{\omega_p} \\ 1 - \prod_{p=1}^k (1 - (\log_{\sigma_p} (1 - I_{\zeta_p}^*)))^{\omega_p} \\ 1 - \prod_{p=1}^k (1 - (\log_{\sigma_p} (1 - N_{\zeta_p}^*)))^{\omega_p} \end{pmatrix},$$

(c) Now, we prove that Equation (4) for $n = k + 1$, that is

$$L - SVNHWG(\zeta_1, \zeta_2, \dots, \zeta_k, \zeta_{k+1}) = \prod_{p=1}^k (\log_{\sigma_p} \zeta_p)^{\omega_p} \otimes (\log_{\sigma_{k+1}} \zeta_{k+1})^{\omega_{k+1}}$$

$$\begin{aligned}
 &L - SVNHWG(\zeta_1, \zeta_2, \dots, \zeta_k, \zeta_{k+1}) \\
 &= \left(\begin{array}{c} \prod_{p=1}^k (1 - \log_{\sigma_p} P_{\zeta_p}^*)^{\omega_p} \\ 1 - \prod_{p=1}^k (1 - (\log_{\sigma_p} (1 - I_{\zeta_p}^*)))^{\omega_p} \\ 1 - \prod_{p=1}^k (1 - (\log_{\sigma_p} (1 - N_{\zeta_p}^*)))^{\omega_p} \end{array} \right) \otimes \left(\begin{array}{c} (1 - \log_{\sigma_p} P_{\zeta_{k+1}}^*)^{\omega_{k+1}} \\ 1 - (1 - (\log_{\sigma_p} (1 - I_{\zeta_{k+1}}^*)))^{\omega_{k+1}} \\ 1 - (1 - (\log_{\sigma_p} (1 - N_{\zeta_{k+1}}^*)))^{\omega_{k+1}} \end{array} \right) \\
 &= \left(\begin{array}{c} \prod_{p=1}^{k+1} (1 - \log_{\sigma_p} P_{\zeta_p}^*)^{\omega_p} \\ 1 - \prod_{p=1}^{k+1} (1 - (\log_{\sigma_p} (1 - I_{\zeta_p}^*)))^{\omega_p} \\ 1 - \prod_{p=1}^{k+1} (1 - (\log_{\sigma_p} (1 - N_{\zeta_p}^*)))^{\omega_p} \end{array} \right)
 \end{aligned}$$

Thus Equation (4) is true for $n = z + 1$. Hence it is satisfied for all n . Therefore

$$L - SVNHWG(\zeta_1, \zeta_2, \dots, \zeta_n) = \left(\begin{array}{c} \prod_{p=1}^n (1 - \log_{\sigma_p} P_{\zeta_p}^*)^{\omega_p} \\ 1 - \prod_{p=1}^n (1 - (\log_{\sigma_p} (1 - I_{\zeta_p}^*)))^{\omega_p} \\ 1 - \prod_{p=1}^n (1 - (\log_{\sigma_p} (1 - N_{\zeta_p}^*)))^{\omega_p} \end{array} \right).$$

In a similar way, if $0 < \frac{1}{\sigma_p} \leq \min \{P_{\zeta_p}, 1 - I_{\zeta_p}, 1 - N_{\zeta_p}\} < 1, \sigma \neq 1$, we can also obtain

$$L - SVNHWG(\zeta_1, \zeta_2, \dots, \zeta_n) = \left(\begin{array}{c} \prod_{p=1}^n (1 - \log_{\frac{1}{\sigma_p}} P_{\zeta_p}^*)^{\omega_p} \\ 1 - \prod_{p=1}^n (1 - (\log_{\frac{1}{\sigma_p}} (1 - I_{\zeta_p}^*)))^{\omega_p} \\ 1 - \prod_{p=1}^n (1 - (\log_{\frac{1}{\sigma_p}} (1 - N_{\zeta_p}^*)))^{\omega_p} \end{array} \right)$$

which completes the proof. \square

Remark 2. If $\sigma_1 = \sigma_2 = \sigma_3 = \dots = \sigma_n = \sigma$, that is $0 < \sigma \leq \min \{P_{\zeta_p}, 1 - I_{\zeta_p}, 1 - N_{\zeta_p}\} < 1, \sigma \neq 1$, then $L - SVNHWG$ operator reduced as follows

$$L - SVNHWG(\zeta_1, \zeta_2, \dots, \zeta_n) = \left(\begin{array}{c} \prod_{p=1}^n (1 - \log_{\sigma} P_{\zeta_p}^*)^{\omega_p} \\ 1 - \prod_{p=1}^n (1 - (\log_{\sigma} (1 - I_{\zeta_p}^*)))^{\omega_p} \\ 1 - \prod_{p=1}^n (1 - (\log_{\sigma} (1 - N_{\zeta_p}^*)))^{\omega_p} \end{array} \right). \tag{18}$$

Properties

$L - SVNHWG$ operator satisfies some properties are enlist below;

(1) Idempotency: for any collection of SVNNs $\zeta_p = \langle P_{\zeta_p}(r), I_{\zeta_p}(r), N_{\zeta_p}(r) \rangle (p = 1, \dots, n)$ in \mathfrak{R} .

Then, if collection of SVNNs $\zeta_p = \langle P_{\zeta_p}(r), I_{\zeta_p}(r), N_{\zeta_p}(r) \rangle (p = 1, \dots, n)$ are identical, that is

$$L - SVNHWG(\zeta_1, \zeta_2, \dots, \zeta_n) = \zeta. \tag{19}$$

(2) Boundedness: for any collection of SVNNS $\zeta_p = \langle P_{\zeta_p}(r), I_{\zeta_p}(r), N_{\zeta_p}(r) \rangle$ ($p = 1, \dots, n$) in \mathfrak{R} . $\zeta_p^- = \langle \min_p P_{\zeta_p}, \max_p I_{\zeta_p}, \max_p N_{\zeta_p} \rangle$ and $\zeta_p^+ = \langle \max_p P_{\zeta_p}, \min_p I_{\zeta_p}, \min_p N_{\zeta_p} \rangle$ ($p = 1, \dots, n$) in \mathfrak{R} , therefore

$$\zeta_p^- \subseteq L - SVNHWG(\zeta_1, \zeta_2, \dots, \zeta_n) \subseteq \zeta_p^+ \tag{20}$$

(3) Monotonically: for any collection of SVNNS $\zeta_p = \langle P_{\zeta_p}(r), I_{\zeta_p}(r), N_{\zeta_p}(r) \rangle$ ($p = 1, \dots, n$) in \mathfrak{R} . If $\zeta_p \subseteq \zeta_p^*$ for ($p = 1, \dots, n$), then

$$L - SVNHWG(\zeta_1, \zeta_2, \dots, \zeta_n) \subseteq L - SVNHWG(\zeta_1^*, \zeta_2^*, \dots, \zeta_n^*) \tag{21}$$

4.3. Generalized Logarithmic Averaging Operator

Definition 20. For any collection of SVNNS $\zeta_p = \langle P_{\zeta_p}(r), I_{\zeta_p}(r), N_{\zeta_p}(r) \rangle$ ($p = 1, \dots, n$) in \mathfrak{R} , with $0 < \sigma_p \leq \min \{P_{\zeta_p}, 1 - I_{\zeta_p}, 1 - N_{\zeta_p}\} < 1$, $\sigma \neq 1$. The structure of logarithmic generalized single-valued neutrosophic weighted averaging (L-GSVNWA) operator is

$$L - GSVNWA(\zeta_1, \zeta_2, \dots, \zeta_n) = \left(\sum_{p=1}^n \beta_p \log_{\sigma_p}(\zeta_p)^\gamma \right)^{\frac{1}{\gamma}} \tag{22}$$

where β_p ($p = 1, \dots, n$) are weighting vector with $\beta_p \geq 0$ and $\sum_{p=1}^n \beta_p = 1$.

Theorem 5. For any collection of SVNNS $\zeta_p = \langle P_{\zeta_p}(r), I_{\zeta_p}(r), N_{\zeta_p}(r) \rangle$ ($p = 1, \dots, n$) in \mathfrak{R} , with $0 < \sigma_p \leq \min \{P_{\zeta_p}, 1 - I_{\zeta_p}, 1 - N_{\zeta_p}\} < 1$, $\sigma \neq 1$, $\gamma \geq 1$. Then by using logarithmic operations and Definition 20, L - GSVNWA define as

$$L - GSVNWA(\zeta_1, \zeta_2, \dots, \zeta_n) \left\{ \begin{array}{l} \left(\begin{array}{l} \left(1 - \prod_{p=1}^n \left(1 - \left(1 - \left(\log_{\sigma_p} P_{\zeta_p} \right) \right)^\gamma \right)^{\beta_p} \right)^{\frac{1}{\gamma}} \\ 1 - \left[1 - \prod_{p=1}^n \left(1 - \left(1 - \log_{\sigma_p} \left(1 - I_{\zeta_p} \right) \right)^\gamma \right)^{\beta_p} \right]^{\frac{1}{\gamma}} \\ 1 - \left[1 - \prod_{p=1}^n \left(1 - \left(1 - \log_{\sigma_p} \left(1 - N_{\zeta_p} \right) \right)^\gamma \right)^{\beta_p} \right]^{\frac{1}{\gamma}} \end{array} \right) \\ \left(\begin{array}{l} \left(1 - \prod_{p=1}^n \left(1 - \left(1 - \left(\log_{\frac{1}{\sigma_p}} P_{\zeta_p} \right) \right)^\gamma \right)^{\beta_p} \right)^{\frac{1}{\gamma}} \\ 1 - \left[1 - \prod_{p=1}^n \left(1 - \left(1 - \log_{\frac{1}{\sigma_p}} \left(1 - I_{\zeta_p} \right) \right)^\gamma \right)^{\beta_p} \right]^{\frac{1}{\gamma}} \\ 1 - \left[1 - \prod_{p=1}^n \left(1 - \left(1 - \log_{\frac{1}{\sigma_p}} \left(1 - N_{\zeta_p} \right) \right)^\gamma \right)^{\beta_p} \right]^{\frac{1}{\gamma}} \end{array} \right) \end{array} \right. \tag{23}$$

where β_p ($p = 1, \dots, n$) are weighting vector with $\beta_p \geq 0$ and $\sum_{p=1}^n \beta_p = 1$.

Apparently, if we use $\gamma = 1$, then the L - GSVNWA operator is becomes into L - SVNWA operator.

Proof. Theorem 5 take the form by utilized the technique of mathematical induction and procedure is eliminate here. \square

Remark 3. If $\sigma_1 = \sigma_2 = \sigma_3 = \dots = \sigma_n = \sigma$, that is $0 < \sigma \leq \min \{P_{\zeta_p}, 1 - I_{\zeta_p}, 1 - N_{\zeta_p}\} < 1, \sigma \neq 1$, then $L - GSVNWA$ operator reduced as follows

$$L - GSVNWA (\zeta_1, \zeta_2, \dots, \zeta_n) = \left(\begin{array}{c} \left(1 - \prod_{p=1}^n \left(1 - \left(1 - (\log_{\sigma} P_{\zeta_p}) \right)^{\beta_p} \right)^{\frac{1}{\gamma}} , \\ 1 - \left[1 - \prod_{p=1}^n \left(1 - \left(1 - \log_{\sigma} (1 - I_{\zeta_p}) \right)^{\beta_p} \right)^{\frac{1}{\gamma}} \right] \\ 1 - \left[1 - \prod_{p=1}^n \left(1 - \left(1 - \log_{\sigma} (1 - N_{\zeta_p}) \right)^{\beta_p} \right)^{\frac{1}{\gamma}} \right] \end{array} \right). \quad (24)$$

Properties

$L - GSVNWA$ operator satisfies some properties are enlist below;

(1) Idempotency: For any collection of SVNNs $\zeta_p = \langle P_{\zeta_p}(r), I_{\zeta_p}(r), N_{\zeta_p}(r) \rangle$ ($p = 1, \dots, n$) in \mathfrak{R} . Then, if collection of SVNNs $\zeta_p = \langle P_{\zeta_p}(r), I_{\zeta_p}(r), N_{\zeta_p}(r) \rangle$ ($p = 1, \dots, n$) are identical, that is

$$L - GSVNWA (\zeta_1, \zeta_2, \dots, \zeta_n) = \zeta. \quad (25)$$

(2) Boundedness: for any collection of SVNNs $\zeta_p = \langle P_{\zeta_p}(r), I_{\zeta_p}(r), N_{\zeta_p}(r) \rangle$ ($p = 1, \dots, n$) in \mathfrak{R} . $\zeta_p^- = \langle \min_p P_{\zeta_p}, \max_p I_{\zeta_p}, \max_p N_{\zeta_p} \rangle$ and $\zeta_p^+ = \langle \max_p P_{\zeta_p}, \min_p I_{\zeta_p}, \min_p N_{\zeta_p} \rangle$ ($p = 1, \dots, n$) in \mathfrak{R} , therefore

$$\zeta_p^- \subseteq L - GSVNWA (\zeta_1, \zeta_2, \dots, \zeta_n) \subseteq \zeta_p^+. \quad (26)$$

(3) Monotonically: for any collection of SVNNs $\zeta_p = \langle P_{\zeta_p}(r), I_{\zeta_p}(r), N_{\zeta_p}(r) \rangle$ ($p = 1, \dots, n$) in \mathfrak{R} . If $\zeta_p \subseteq \zeta_p^*$ for ($p = 1, \dots, n$), then

$$L - GSVNWA (\zeta_1, \zeta_2, \dots, \zeta_n) \subseteq L - GSVNWA (\zeta_1^*, \zeta_2^*, \dots, \zeta_n^*). \quad (27)$$

4.4. Generalized Logarithmic Geometric Operator

Definition 21. For any collection of SVNNs $\zeta_p = \langle P_{\zeta_p}(r), I_{\zeta_p}(r), N_{\zeta_p}(r) \rangle$ ($p = 1, \dots, n$) in \mathfrak{R} , with $0 < \sigma_p \leq \min \{P_{\zeta_p}, 1 - I_{\zeta_p}, 1 - N_{\zeta_p}\} < 1, \sigma \neq 1$. The structure of logarithmic generalized single valued neutrosophic weighted geometric ($L - GSVNWG$) operator is

$$L - GSVNWG (\zeta_1, \zeta_2, \dots, \zeta_n) = \left(\sum_{p=1}^n \left(\log_{\sigma_p} (\zeta_p)^{\gamma} \right)^{\beta_p} \right)^{\frac{1}{\gamma}} \quad (28)$$

where β_p ($p = 1, \dots, n$) are weighting vector with $\beta_p \geq 0$ and $\sum_{p=1}^n \beta_p = 1$.

Theorem 6. For any collection of SVNNS $\zeta_p = \langle P_{\zeta_p}(r), I_{\zeta_p}(r), N_{\zeta_p}(r) \rangle$ ($p = 1, \dots, n$) in \mathfrak{R} , with $0 < \sigma_p \leq \min \{P_{\zeta_p}, 1 - I_{\zeta_p}, 1 - N_{\zeta_p}\} < 1, \sigma \neq 1, \gamma \geq 1$. Then by using logarithmic operations and definition (21), $L - GSVNNG$ define as

$$L - GSVNNG(\zeta_1, \zeta_2, \dots, \zeta_n) = \left(\begin{array}{l} \left(\begin{array}{l} 1 - \left[1 - \prod_{p=1}^n \left(1 - (\log_{\sigma_p} P_{\zeta_p})^\gamma \right)^{\beta_p} \right]^{\frac{1}{\gamma}}, \\ \left(1 - \prod_{p=1}^n \left(1 - (\log_{\sigma_p} (1 - I_{\zeta_p}))^\gamma \right)^{\beta_p} \right)^{\frac{1}{\gamma}} \\ \left(1 - \prod_{p=1}^n \left(1 - (\log_{\sigma_p} (1 - N_{\zeta_p}))^\gamma \right)^{\beta_p} \right)^{\frac{1}{\gamma}} \end{array} \right) \\ \left(\begin{array}{l} 1 - \left[1 - \prod_{p=1}^n \left(1 - (\log_{\frac{1}{\sigma_p}} P_{\zeta_p})^\gamma \right)^{\beta_p} \right]^{\frac{1}{\gamma}}, \\ \left(1 - \prod_{p=1}^n \left(1 - (\log_{\frac{1}{\sigma_p}} (1 - I_{\zeta_p}))^\gamma \right)^{\beta_p} \right)^{\frac{1}{\gamma}} \\ \left(1 - \prod_{p=1}^n \left(1 - (\log_{\frac{1}{\sigma_p}} (1 - N_{\zeta_p}))^\gamma \right)^{\beta_p} \right)^{\frac{1}{\gamma}} \end{array} \right) \end{array} \right) \quad \begin{array}{l} 0 < \sigma_p \leq \min \left\{ \begin{array}{l} P_{\zeta_p}, \\ 1 - I_{\zeta_p}, \\ 1 - N_{\zeta_p} \end{array} \right\} < 1 \\ \\ \\ 0 < \frac{1}{\sigma_p} \leq \min \left\{ \begin{array}{l} P_{\zeta_p}, \\ 1 - I_{\zeta_p}, \\ 1 - N_{\zeta_p} \end{array} \right\} < 1, \\ \sigma \neq 1 \end{array} \quad (29)$$

where β_p ($p = 1, \dots, n$) is the weighting vector with $\beta_p \geq 0$ and $\sum_{p=1}^n \beta_p = 1$.

Apparently, if we use $\gamma = 1$, then the $L - GSVNNG$ operator is becomes into $L - SVNNG$ operator.

Proof. Theorem 6 takes the form by utilizing the technique of mathematical induction and the procedure is eliminated here. \square

Remark 4. If $\sigma_1 = \sigma_2 = \sigma_3 = \dots = \sigma_n = \sigma$, that is $0 < \sigma \leq \min \{P_{\zeta_p}, 1 - I_{\zeta_p}, 1 - N_{\zeta_p}\} < 1, \sigma \neq 1$, then $L - GSVNNG$ operator reduced as follows

$$L - GSVNNG(\zeta_1, \zeta_2, \dots, \zeta_n) = \left(\begin{array}{l} 1 - \left[1 - \prod_{p=1}^n \left(1 - (\log_{\sigma} P_{\zeta_p})^\gamma \right)^{\beta_p} \right]^{\frac{1}{\gamma}}, \\ \left(1 - \prod_{p=1}^n \left(1 - (\log_{\sigma} (1 - I_{\zeta_p}))^\gamma \right)^{\beta_p} \right)^{\frac{1}{\gamma}} \\ \left(1 - \prod_{p=1}^n \left(1 - (\log_{\sigma} (1 - N_{\zeta_p}))^\gamma \right)^{\beta_p} \right)^{\frac{1}{\gamma}} \end{array} \right). \quad (30)$$

Properties

$L - GSVNNG$ operator satisfies some properties are enlist below;

(1) Idempotency: For any collection of SVNNS $\zeta_p = \langle P_{\zeta_p}(r), I_{\zeta_p}(r), N_{\zeta_p}(r) \rangle$ ($p = 1, \dots, n$) in \mathfrak{R} . Then, if collection of SVNNS $\zeta_p = \langle P_{\zeta_p}(r), I_{\zeta_p}(r), N_{\zeta_p}(r) \rangle$ ($p = 1, \dots, n$) are identical, that is

$$L - GSVNNG(\zeta_1, \zeta_2, \dots, \zeta_n) = \zeta. \quad (31)$$

(2) Boundedness: for any collection of SVNNS $\zeta_p = \langle P_{\zeta_p}(r), I_{\zeta_p}(r), N_{\zeta_p}(r) \rangle$ ($p = 1, \dots, n$) in \mathfrak{R} . $\zeta_p^- = \langle \min_p P_{\zeta_p}, \max_p I_{\zeta_p}, \max_p N_{\zeta_p} \rangle$ and $\zeta_p^+ = \langle \max_p P_{\zeta_p}, \min_p I_{\zeta_p}, \min_p N_{\zeta_p} \rangle$ ($p = 1, \dots, n$) in \mathfrak{R} , therefore

$$\zeta_p^- \subseteq L - GSVNWG(\zeta_1, \zeta_2, \dots, \zeta_n) \subseteq \zeta_p^+. \tag{32}$$

(3) Monotonically: for any collection of SVNNS $\zeta_p = \langle P_{\zeta_p}(r), I_{\zeta_p}(r), N_{\zeta_p}(r) \rangle$ ($p = 1, \dots, n$) in \mathfrak{R} . If $\zeta_p \subseteq \zeta_p^*$ for ($p = 1, \dots, n$), then

$$L - GSVNWG(\zeta_1, \zeta_2, \dots, \zeta_n) \subseteq L - GSVNWG(\zeta_1^*, \zeta_2^*, \dots, \zeta_n^*). \tag{33}$$

5. Proposed Technique for Solving Decision-Making Problems

This section includes the new approach to decision-making based on the single-valued neutrosophic sets, and we will propose a decision-making matrix as indicated below.

Let $H = (h_1, h_2, \dots, h_m)$ be a distinct collection of m probable alternatives and $Y = (y_1, y_2, \dots, y_n)$ be a finite collection of n criteria, where h_i indicate the i -th alternatives and y_j indicate the j -th criteria. Let $D = (d_1, d_2, \dots, d_t)$ be a finite set of t experts, where d_k indicate the k -th expert. The expert d_k supply her appraisal of an alternative h_i on an attribute y_j as a SVNNS ($i = 1, \dots, m; j = 1, \dots, n$). The expert's information is represented by the SVNS decision-making matrix $D^s = [E_{ip}^{(s)}]_{m \times n}$. Assume that β_p ($p = 1, \dots, m$) is the weight vector of the attribute y_j , where $0 \leq \beta_p \leq 1, \sum_{p=1}^n \beta_p = 1$ and $\psi = (\psi_1, \psi_2, \dots, \psi_m)$ be the weights of the decision makers d_k such that $\psi_k \leq 1, \sum_{k=1}^n \psi_k = 1$.

When we construct the SVNS decision-making matrices, $D^s = [E_{ip}^{(s)}]_{m \times n}$ for decision. Basically, criteria have two types, one is benefit criteria and other one is cost criteria. If the SVNS decision matrices have cost-type criteria metrics $D^s = [E_{ip}^s]_{m \times n}$ can be converted into the normalized SVNS decision matrices, $R^s = [r_{ip}^{(s)}]_{m \times n}$, where $r_{ip}^s = \begin{cases} E_{ip}^s, & \text{for benefit criteria } A_p \\ \bar{E}_{ip}^s, & \text{for cost criteria } A_p \end{cases} \quad j = 1, \dots, n$, and \bar{E}_{ip}^s is the complement of E_{ip}^s . The normalization is not required, if the criteria have the same type.

Step 1: In this step, we get the neutrosophic information, using the all proposed logarithmic aggregation operators to evolute the alternative preference values with associated weights, which are $\omega = (\omega_1, \omega_2, \dots, \omega_n)$ with $\omega_p \geq 0, \sum_{p=1}^n \omega_p = 1$.

Step 2: We find the score value $\tilde{S}(\log_{\sigma} \zeta_p)$ and the accuracy value $\tilde{A}(\log_{\sigma} \zeta_p)$ of the cumulative total preference value h_i ($i = 1, \dots, m$).

Step 3: By definition, we give ranking to the alternatives h_i ($i = 1, \dots, m$) and choose the best alternative which has the maximum score value.

5.1. Numerical Example

Assume that there is a committee which selects five applicable emerging technology enterprises H_g ($g = 1, \dots, 5$), which are given as follows.

- (1) Augmented reality (H_1),
- (2) Personalized medicine (H_2),
- (3) Artificial intelligence (H_3),
- (4) Gene drive (H_4) and
- (5) Quantum computing (H_5).

They assess the possible rising technology enterprises according to the five attributes, which are

- (1) Advancement (D_1),
- (2) Market risk (D_2),
- (3) Financial investments (D_3),

- (4) Progress of science and technology (D_4) and
- (5) Designs (D_5).

To avoid the conflict between them, the decision makers take the attribute weights as $\beta = (0.15, 0.28, 0.20, 0.22, 0.15)^T$. They construct the SVNS decision-making matrix given in Table 1.

Table 1. Emerging Technology Enterprises D^1 .

	D_1	D_2	D_3	D_4	D_5
H_1	(0.5, 0.3, 0.4)	(0.3, 0.2, 0.5)	(0.2, 0.2, 0.6)	(0.4, 0.2, 0.3)	(0.3, 0.3, 0.4)
H_2	(0.7, 0.1, 0.3)	(0.3, 0.2, 0.7)	(0.6, 0.3, 0.2)	(0.2, 0.4, 0.6)	(0.7, 0.1, 0.2)
H_3	(0.5, 0.3, 0.4)	(0.4, 0.2, 0.6)	(0.6, 0.1, 0.2)	(0.3, 0.1, 0.5)	(0.6, 0.4, 0.3)
H_4	(0.7, 0.3, 0.2)	(0.2, 0.2, 0.7)	(0.4, 0.5, 0.2)	(0.2, 0.2, 0.5)	(0.4, 0.5, 0.4)
H_5	(0.4, 0.1, 0.3)	(0.2, 0.1, 0.5)	(0.4, 0.1, 0.5)	(0.6, 0.3, 0.4)	(0.3, 0.2, 0.4)

Since D_1, D_3 are benefit-type criteria and D_2, D_4 is cost type criteria, the normalization is required for these decision matrices. Normalized decision matrices are shown in Table 2.

Table 2. Emerging Technology Enterprises R^1 .

	D_1	D_2	D_3	D_4	D_5
H_1	(0.5, 0.3, 0.4)	(0.5, 0.2, 0.3)	(0.2, 0.2, 0.6)	(0.3, 0.2, 0.4)	(0.3, 0.3, 0.4)
H_2	(0.7, 0.1, 0.3)	(0.7, 0.2, 0.3)	(0.6, 0.3, 0.2)	(0.6, 0.4, 0.2)	(0.7, 0.1, 0.2)
H_3	(0.5, 0.3, 0.4)	(0.6, 0.2, 0.4)	(0.6, 0.1, 0.2)	(0.5, 0.1, 0.3)	(0.6, 0.4, 0.3)
H_4	(0.7, 0.3, 0.2)	(0.7, 0.2, 0.2)	(0.4, 0.5, 0.2)	(0.5, 0.2, 0.2)	(0.4, 0.5, 0.4)
H_5	(0.4, 0.1, 0.3)	(0.5, 0.1, 0.2)	(0.4, 0.1, 0.5)	(0.4, 0.3, 0.6)	(0.3, 0.2, 0.4)

Step 1: Now, we apply all the proposed logarithmic aggregation operators to collective neutrosophic information as follows.

Case 1: Using logarithmic single-valued neutrosophic hybrid weighted averaging aggregation operator, we obtained the results shown in Table 3.

Table 3. Aggregated information using the logarithmic single valued neutrosophic hybrid weighted averaging (L-SVNHWA) operator for $\sigma = 0.3$.

H_1	(0.17624, 0.23432, 0.43885)
H_2	(0.66164, 0.16229, 0.21840)
H_3	(0.52788, 0.18347, 0.32224)
H_4	(0.49410, 0.30962, 0.20985)
H_5	(0.22496, 0.12393, 0.39318)

Case 2: Using Logarithmic single valued neutrosophic hybrid weighted geometric aggregation operator, we obtained the results shown in Table 4.

Table 4. Aggregated information using logarithmic single valued neutrosophic hybrid weighted geometric (L-SVNHWG) operator for $\sigma = 0.1$.

H_1	(0.52472, 0.12638, 0.24189)
H_2	(0.81968, 0.10633, 0.11764)
H_3	(0.74946, 0.11782, 0.17620)
H_4	(0.70685, 0.18942, 0.11685)
H_5	(0.58497, 0.07427, 0.23305)

Step 2: We find the score index $\tilde{S}(\log_{\sigma}\zeta_p)$ and the accuracy index $\tilde{A}(\log_{\sigma}\zeta_p)$ of the cumulative overall preference value h_i ($i = 1, 2, 3, 4, 5$).

Case 1: Using the score of aggregated information for L-SVNHWA operator, we obtained the results shown in Table 5.

Table 5. Score of aggregated information for L-SVNHWA operator.

$\tilde{S}(\log_{0.3}H_1)$	-1.14345	$\tilde{A}(\log_{0.3}H_1)$	0.25985
$\tilde{S}(\log_{0.3}H_2)$	0.30519	$\tilde{A}(\log_{0.3}H_2)$	1.0087
$\tilde{S}(\log_{0.3}H_3)$	-0.02207	$\tilde{A}(\log_{0.3}H_3)$	0.96078
$\tilde{S}(\log_{0.3}H_4)$	-0.08895	$\tilde{A}(\log_{0.3}H_4)$	0.91781
$\tilde{S}(\log_{0.3}H_5)$	-0.76389	$\tilde{A}(\log_{0.3}H_5)$	0.28571

Case 2: Score of Aggregated information for L-SVNHWA Operator, we obtained the results shown in Table 6.

Table 6. Score of aggregated information for L-SVNHWA operator.

$\tilde{S}(\log_{0.1}H_1)$	0.540979	$\tilde{A}(\log_{0.1}H_1)$	0.89888
$\tilde{S}(\log_{0.1}H_2)$	0.810463	$\tilde{A}(\log_{0.1}H_2)$	1.01683
$\tilde{S}(\log_{0.1}H_3)$	0.736126	$\tilde{A}(\log_{0.1}H_3)$	1.01338
$\tilde{S}(\log_{0.1}H_4)$	0.704159	$\tilde{A}(\log_{0.1}H_4)$	0.994506
$\tilde{S}(\log_{0.1}H_5)$	0.618387	$\tilde{A}(\log_{0.1}H_5)$	0.903179

Step 3: We find the best (suitable) alternative which has the maximum score value from the set of alternatives h_i ($i = 1, 2, 3, 4, 5$). Overall preference value and ranking of the alternatives are summarized in Table 7.

Table 7. Overall preference value and ranking of the alternatives.

	$\tilde{S}(H_1)$	$\tilde{S}(H_2)$	$\tilde{S}(H_3)$	$\tilde{S}(H_4)$	$\tilde{S}(H_5)$	Ranking
$L - SVNHWA$	-1.143	0.305	-0.022	-0.088	-0.763	$H_2 > H_3 > H_4 > H_5 > H_1$
$L - SVNHWG$	0.540	0.810	0.736	0.704	0.618	$H_2 > H_3 > H_4 > H_5 > H_1$

5.2. Comparison with Existing Methods

This section consists of the comparative analysis of several existing aggregation operators of neutrosophic information with the proposed logarithmic single valued hybrid weighted aggregation operators. Existing methods for aggregated neutrosophic information are shown in Table 8–11.

Table 8. Average aggregated SVN information.

	SVNWA [35]	SVNOWA [35]	NWA [14]
H_1	(0.3779, 0.2259, 0.4002)	(0.3820, 0.2449, 0.4071)	(0.3779, 0.2314, 0.4223)
H_2	(0.6615, 0.2052, 0.2381)	(0.6663, 0.1801, 0.2430)	(0.6615, 0.2426, 0.2446)
H_3	(0.5656, 0.1763, 0.3131)	(0.5597, 0.1838, 0.3122)	(0.5656, 0.2109, 0.3272)
H_4	(0.5722, 0.2929, 0.2219)	(0.5706, 0.3145, 0.2219)	(0.5722, 0.3348, 0.2338)
H_5	(0.4165, 0.1413, 0.3607)	(0.3960, 0.1373, 0.3696)	(0.4165, 0.1633, 0.4131)

Table 9. Average aggregated SVN information.

	SVNFWA [12]	SVNHWA [11] $\gamma = 2$
H_1	(0.3755, 0.2262, 0.4018)	(0.3725, 0.2264, 0.4033)
H_2	(0.6611, 0.2072, 0.2385)	(0.6608, 0.2086, 0.2388)
H_3	(0.5652, 0.1779, 0.3141)	(0.5648, 0.1790, 0.3149)
H_4	(0.5692, 0.2956, 0.2225)	(0.5663, 0.2978, 0.2230)
H_5	(0.4159, 0.1422, 0.3646)	(0.4151, 0.1427, 0.3680)

Table 10. Average aggregated SVN information.

	SVNHWA [11] $\gamma = 3$	L-SVNWA [10]
H_1	(0.3693, 0.2266, 0.4048)	(0.3130, 0.1753, 0.3544)
H_2	(0.6604, 0.2099, 0.2390)	(0.6486, 0.1989, 0.2313)
H_3	(0.5645, 0.1800, 0.3157)	(0.4989, 0.1733, 0.3321)
H_4	(0.5635, 0.3000, 0.2234)	(0.5585, 0.2736, 0.1942)
H_5	(0.4143, 0.1432, 0.3714)	(0.2849, 0.1249, 0.3758)

Table 11. Average aggregated SVN information.

	L-SVNOWA [10]
H_1	(0.3229, 0.1926, 0.3607)
H_2	(0.6549, 0.1719, 0.2368)
H_3	(0.4896, 0.1823, 0.3303)
H_4	(0.5561, 0.2975, 0.1942)
H_5	(0.2442, 0.1209, 0.3834)

Now, we analyze the ranking of the alternatives according to their aggregated information (in Table 12).

Table 12. Overall ranking of the alternatives.

Existing Operators	Ranking
NWA [14]	$H_2 > H_3 > H_4 > H_5 > H_1$
SVNWA [35]	$H_2 > H_3 > H_4 > H_5 > H_1$
SVNOWA [35]	$H_2 > H_3 > H_4 > H_5 > H_1$
SVNHWG [35]	$H_2 > H_3 > H_4 > H_5 > H_1$
SVNOWG [35]	$H_2 > H_3 > H_4 > H_5 > H_1$
SVNFWA [12]	$H_2 > H_3 > H_4 > H_5 > H_1$
SVNHWA [11] $\gamma = 2$	$H_2 > H_3 > H_4 > H_5 > H_1$
SVNHWA [11] $\gamma = 3$	$H_2 > H_3 > H_4 > H_5 > H_1$
NWG [14]	$H_2 > H_3 > H_4 > H_5 > H_1$
SVNFWG [12]	$H_2 > H_3 > H_4 > H_5 > H_1$
SVNHWG [11] $\gamma = 2$	$H_2 > H_3 > H_4 > H_5 > H_1$
SVNHWG [11] $\gamma = 3$	$H_2 > H_3 > H_4 > H_5 > H_1$
SNWEA [15]	$H_2 > H_3 > H_5 > H_4 > H_1$
L-SVNWA [10]	$H_2 > H_4 > H_3 > H_5 > H_1$
L-SVNOWA [10]	$H_2 > H_4 > H_3 > H_5 > H_1$
L-SVNHWG [10]	$H_2 > H_4 > H_3 > H_1 > H_5$
L-SVNOWG [10]	$H_2 > H_3 > H_4 > H_5 > H_1$
Proposed Operators	Ranking
L-SVNHWA	$H_2 > H_3 > H_4 > H_5 > H_1$
L-SVNHWG	$H_2 > H_3 > H_4 > H_5 > H_1$
L-GSVNWA	$H_2 > H_4 > H_3 > H_5 > H_1$
L-GSVNHWG	$H_2 > H_4 > H_3 > H_1 > H_5$

The best alternative was H_2 . The obtained results utilizing logarithmic single valued neutrosophic hybrid weighted operators and logarithmic generalized single valued neutrosophic weighted operators were same as results shows existing methods. Hence, this study proposed novel logarithmic aggregation operators to aggregate the neutrosophic information more effectively and efficiently. Utilizing the proposed logarithmic aggregation operators, we found the best alternative from a set of alternatives given by the decision maker. Hence the proposed MCDM technique based on logarithmic operators lets us find the best alternative as an applications in decision support systems.

6. Conclusions

In this work, an attempt has been made to present different kinds of logarithmic weighted averaging and geometric aggregation operators based on the single-valued neutrosophic set environment. Earlier, it has been observed that the various aggregation operators are defined under the SVNSS environment where the aggregation operators based on the algebraic or Einstein t-norm and t-conorm. In this paper, we proposed novel logarithmic hybrid aggregation operators and also logarithmic generalized averaging and geometric aggregation operators. Aggregation operators, namely L-SVNHWA, L-SVNHWG, L-GSVNWA and L-GSVNWA are developed under the SVNSS environment and we have studied their properties in detail. Further, depending on the standardization of the decision matrix and the proposed aggregation operators, a decision-making approach is presented to find the best alternative to the SVNSS environment. An illustrative example is taken for illustrating the developed approach, and their results are compared with some of the existing approaches of the SVNSS environment to show the validity of it. From the studies, we conclude that the proposed approach is more generic and suitable for solving the stated problem.

In the future, we shall link the proposed operators with some novel fuzzy sets, like as type 2 fuzzy sets, neutrosophic sets, and so on. Moreover, we may examine if our constructed approach can also be applied in different areas, such as personal evaluation, medical artificial intelligence, energy management and supplier selection evaluation.

References

1. Zadeh, L.A. Fuzzy sets. *Inf. Control* **1965**, *8*, 338–353. [[CrossRef](#)]
2. Atanassov, K.T. Intuitionistic fuzzy sets. *Fuzzy Sets Syst.* **1986**, *20*, 87–96. [[CrossRef](#)]
3. Smarandache, F. A unifying field in logics: Neutrosophic logic. *Am. Res. Press Rehoboth* **1999**, 1–141.
4. Soria Frisch, A.; Koppen, M.; Sy, T. Is she gonna like it? automated inspection system using fuzzy aggregation. In *Intelligent Systems for Information Processing*; Elsevier: Amsterdam, The Netherlands, 2003; pp. 465–476.
5. Broumi, S.; Bakal, A.; Talea, M.; Smarandache, F.; Vladareanu, L. Applying Dijkstra algorithm for solving neutrosophic shortest path problem. In *Proceedings of the 2016 International Conference on Advanced Mechatronic Systems (ICAMechS)*, Melbourne, VIC, Australia, 30 November–3 December 2016; IEEE: Piscataway, NJ, USA, 2016; pp. 412–416.
6. Broumi, S.; Bakal, A.; Talea, M.; Smarandache, F.; ALi, M. Shortest path problem under bipolar neutrosophic setting. *Appl. Mech. Mater.* **2017**, *859*, 59–66. [[CrossRef](#)]
7. Broumi, S.; Bakal, A.; Talea, M.; Smarandache, F.; Vladareanu, L. Computation of shortest path problem in a network with sv-trapezoidal neutrosophic numbers. In *Proceedings of the 2016 International Conference on Advanced Mechatronic Systems (ICAMechS)*, Melbourne, VIC, Australia, 30 November–3 December 2016; IEEE: Piscataway, NJ, USA, 2016; pp. 417–422.
8. Broumi, S.; Smarandache, F. Correlation coefficient of interval neutrosophic set. In *Applied Mechanics and Materials*; Trans Tech Publications: Zurich, Switzerland, 2013; Volume 436, pp. 511–517.
9. Broumi, S.; Talea, M.; Smarandache, F.; Bakali, A. Decision-making method based on the interval valued neutrosophic graph. In *Proceedings of the Future Technologies Conference (FTC)*, San Francisco, CA, USA, 6–7 December 2016; pp. 44–50.
10. Garg, H. New logarithmic operational laws and their applications to multiattribute decision making for single-valued neutrosophic numbers. *Cognit. Syst. Res.* **2018**, *52*, 931–946. [[CrossRef](#)]
11. Liu, P.; Chu, Y.; Li, Y.; Chen, Y. Some generalized neutrosophic number hamacher aggregation operators and their application to group decision making. *Int. J. Fuzzy Syst.* **2014**, *16*, 242–255.
12. Nancy, G.H.; Garg, H. Novel single-valued neutrosophic decision making operators under frank norm operations and its application. *Int. J. Uncertain. Quant.* **2016**, *6*, 361–375. [[CrossRef](#)]
13. Ye, J. Single valued neutrosophic cross-entropy for multicriteria decision making problems. *Appl. Math. Model.* **2014**, *38*, 1170–1175. [[CrossRef](#)]

14. Ye, J. Subtraction and division operations of simplified neutrosophic sets. *Information* **2017**, *8*, 51. [[CrossRef](#)]
15. Ye, J. Exponential operations and aggregation operators of interval neutrosophic sets and their decision making methods. *SpringerPlus* **2016**, *5*, 1488. [[CrossRef](#)] [[PubMed](#)]
16. Garg, H.; Nancy, G.H. Multi-Criteria Decision-Making Method Based on Prioritized Muirhead Mean Aggregation Operator under Neutrosophic Set Environment. *Symmetry* **2018**, *10*, 280. [[CrossRef](#)]
17. Khan, Q.; Hassan, N.; Mahmood, T. Neutrosophic Cubic Power Muirhead Mean Operators with Uncertain Data for Multi-Attribute Decision-Making. *Symmetry* **2018**, *10*, 444. [[CrossRef](#)]
18. Adlassnig, K.P. Fuzzy set theory in medical diagnosis. *IEEE Trans. Syst. Man Cybern.* **1986**, *16*, 260–265. [[CrossRef](#)]
19. Ashraf, S.; Mahmood, T.; Abdullah, S.; Khan, Q. Different Approaches to Multi-Criteria Group Decision Making Problems for Picture Fuzzy Environment. *Bull. Braz. Math. Soc. New Ser.* **2018**, 1–25. [[CrossRef](#)]
20. Ashraf, S.; Mehmood, T.; Abdullah, S.; Khan, Q. Picture Fuzzy Linguistic Sets and Their Applications for Multi-Attribute Group. *Nucleus* **2018**, *55*, 66–73.
21. Zeng, S.; Asharf, S.; Arif, M.; Abdullah, S. Application of Exponential Jensen Picture Fuzzy Divergence Measure in Multi-Criteria Group Decision Making. *Mathematics* **2019**, *7*, 191. [[CrossRef](#)]
22. Ashraf, S.; Abdullah, S. Spherical aggregation operators and their application in multi attribute group decision making. *Int. J. Intell. Syst.* **2019**, *34*, 493–523. [[CrossRef](#)]
23. Ashraf, S.; Abdullah, S.; Mahmood, T.; Ghani, F.; Mahmood, T. Spherical fuzzy sets and their applications in multi-attribute decision making problems. *J. Intell. Fuzzy Syst.* **2019**, 1–16. [[CrossRef](#)]
24. Wang, R.; Wang, J.; Gao, H.; Wei, G. Methods for MADM with Picture Fuzzy Muirhead Mean Operators and Their Application for Evaluating the Financial Investment Risk. *Symmetry* **2019**, *11*, 6. [[CrossRef](#)]
25. Xu, Z. Intuitionistic fuzzy aggregation operators. *IEEE Trans. Fuzzy Syst.* **2007**, *15*, 1179–1187.
26. Zhang, H.; Zhang, R.; Huang, H.; Wang, J. Some Picture Fuzzy Dombi Heronian Mean Operators with Their Application to Multi-Attribute Decision-Making. *Symmetry* **2018**, *10*, 593. [[CrossRef](#)]
27. Ashraf, S.; Abdullah, S.; Mahmood, T. GRA method based on spherical linguistic fuzzy Choquet integral environment and its application in multi attribute decision making problems. *Math. Sci.* **2018**, *12*, 263–275. [[CrossRef](#)]
28. Cuong, B.C. *Picture Fuzzy Sets—First Results. Part 1, Seminar Neuro-Fuzzy Systems with Applications*; Technical Report; Institute of Mathematics: Hanoi, Vietnam, 2013.
29. Deschrijver, G.; Cornelis, C.; Kerre, E.E. On the representation of intuitionistic fuzzy t-norms and t-conorms. *IEEE Trans. Fuzzy Syst.* **2004**, *12*, 45–61. [[CrossRef](#)]
30. Li, L.; Zhang, R.; Wang, J.; Shang, X.; Bai, K. A Novel Approach to Multi-Attribute Group Decision-Making with q-Rung Picture Linguistic Information. *Symmetry* **2018**, *10*, 172. [[CrossRef](#)]
31. Xu, Z.; Yager, R.R. Some geometric aggregation operators based on intuitionistic fuzzy sets. *Int. J. Gen. Syst.* **2006**, *35*, 417–433. [[CrossRef](#)]
32. Smarandache, F. *Neutrosophy. Neutrosophic Probability, Set, and Logic*; ProQuest Information & Learning: Ann Arbor, MI, USA, 1998.
33. Wang, H.; Smarandache, F.; Zhang, Y.Q.; Sunderraman, R. Single valued neutrosophic sets. *Multispace Multistruct.* **2010**, *4*, 410–413.
34. Zhang, X.; Bo, C.; Smarandache, F.; Dai, J. New inclusion relation of neutrosophic sets with applications and related lattice structure. *Int. J. Mach. Learn. Cybern.* **2018**, *9*, 1753–1763. [[CrossRef](#)]
35. Peng, J.J.; Wang, J.Q.; Wang, J.; Zhang, H.Y.; Chen, Z.H. Simplified neutrosophic sets and their applications in multi-criteria group decision-making problems. *Int. J. Syst. Sci.* **2016**, *47*, 2342–2358. [[CrossRef](#)]

Complex Neutrosophic Hypergraphs: New Social Network Models

Anam Luqman, Muhammad Akram, Florentin Smarandache

Anam Luqman, Muhammad Akram, Florentin Smarandache (2019). Complex Neutrosophic Hypergraphs: New Social Network Models. *Algorithms* 12, 234; DOI: 10.3390/a12110234

Abstract: A complex neutrosophic set is a useful model to handle indeterminate situations with a periodic nature. This is characterized by truth, indeterminacy, and falsity degrees which are the combination of real-valued amplitude terms and complex-valued phase terms. Hypergraphs are objects that enable us to dig out invisible connections between the underlying structures of complex systems such as those leading to sustainable development. In this paper, we apply the most fruitful concept of complex neutrosophic sets to theory of hypergraphs. We define complex neutrosophic hypergraphs and discuss their certain properties including lower truncation, upper truncation, and transition levels. Furthermore, we define T -related complex neutrosophic hypergraphs and properties of minimal transversals of complex neutrosophic hypergraphs. Finally, we represent the modeling of certain social networks with intersecting communities through the score functions and choice values of complex neutrosophic hypergraphs. We also give a brief comparison of our proposed model with other existing models.

Keywords: complex neutrosophic hypergraphs; T -related complex neutrosophic hypergraphs; algorithms; comparative analysis

1. Introduction

Fuzzy sets (FSs) were originally defined by Zadeh [1] as a novel approach to represent uncertainty arising in various fields that was questioned by many researchers at that time. A FS is characterized by a truth membership function μ which ranges over $[0, 1]$. To generalize the notion of FSs, intuitionistic fuzzy sets (IFSs) were proposed by Atanassov [2] because it is not always true that the falsity degree of an element in a FS is $1 - \mu(x)$ as there may be some hesitation part. Therefore, the truth (t) and falsity (f) membership functions are used independently to characterize an IFS such that the sum of truth and falsity degrees should not be greater than one. Fuzzy sets give the degree of membership of an element in a given set (the non-membership of degree equals one minus the degree of membership), while IFSs give both a degree of membership and a degree of non-membership, which are more-or-less independent from each other. Liu et al. [3] introduced different types of centroid transformations of IF values. Furthermore, Feng et al. [4] defined various new operations for generalized IF soft sets. As an extension of IFSs, Smarandache [5] introduced the concept of neutrosophy to study the nature, origin, and neutralities, and the neutrosophic set (NS). A NS is characterized by truth (t), indeterminacy (i), and falsity (f) membership functions. A NS is used as a powerful mathematical tool to deal the inconsistent data that exists in our daily life. For the practical use of NSs in science and engineering, Smarandache [5] and Wang et al. [6] introduced single-valued neutrosophic sets (SVNSs). A SVNS propose an additional choice to handle indeterminate information. Ye [7] proposed a decision-making method by using the weighted correlation coefficient or the weighted cosine similarity measure of SVNSs to rank the alternatives and proposed an illustrative example to demonstrate the application of

the proposed decision-making method. The same author defined SVN minimum spanning tree and its clustering method [8]. Ye [9] also proposed a multicriteria decision-making method using aggregation operators for simplified NSs.

The existing models such as FSs, IFs, SVNs cannot handle imprecise, inconsistent, and incomplete information of periodic nature. These theories are applicable to different areas of science, but there is one major deficiency in these sets, i.e., a lack of capability to model two-dimensional phenomena. To overcome this difficulty, the concept of complex fuzzy sets (CFSs) was introduced by Ramot et al. [10]. A CFS is characterized by a membership function $\mu(x)$ whose range is not limited to $[0, 1]$ but extends to the unit circle in the complex plane. Hence, $\mu(x)$ is a complex-valued function that assigns a grade of membership of the form $v(x)e^{i\alpha(x)}$, $i = \sqrt{-1}$ to any element x in the universe of discourse. Thus, the membership function $\mu(x)$ of CFS consists of two terms, i.e., amplitude term $v(x)$ which lies in the unit interval $[0, 1]$ and phase term (periodic term) $\alpha(x)$ which lies in the interval $[0, 2\pi]$. This phase term distinguishes a CFS model from all other models available in the literature. Opposing to a fuzzy characteristic function, the range of CFS's membership degrees is not restricted to $[0, 1]$, but extends to the complex plane with unit circle. Ramot et al. [11] discussed the union, intersection, and complement of CFSs with the help of illustrative examples. A systematic review of CFSs was proposed by Yazdanbakhsh and Dick [12]. To generalize the concept of CFSs, complex intuitionistic fuzzy sets (CIFs) were introduced by Alkouri and Salleh [13] by adding non-membership degree $\nu(x) = s(x)e^{i\beta(x)}$ to the CFSs subjected to the constraint $r + s \leq 1$. The CIFs are used to handle the information of uncertainty and periodicity simultaneously. The complex-valued truth and falsity membership degrees can be used to represent uncertainty in many physical quantities such as impedance in electrical engineering, wave function, and decision-making problems. The CFS has only one extra phase term, while CIF has two additional phase terms which are used in several concepts such as distance measure, projections, and cylindrical extensions. To handle imprecise information with a periodic nature, complex neutrosophic sets (CNSs) were proposed by Ali and Smarandache [14]. As we see that uncertainty, inconsistency, and falsity in data are periodic in nature, to handle these types of problems, the CNS plays an important role. A CNS is characterized by a complex-valued truth $t(x)$, complex-valued indeterminate $i(x)$, and complex-valued falsity $f(x)$ membership functions, whose range is extended from $[0, 1]$ to the unit disk in the complex plane. They proposed set theoretic operations such as complement, union, intersection, complex neutrosophic product, Cartesian product, distance measure, and δ -equalities of CNSs and presented an application of CNSs in signal processing.

The vagueness in the representation of various objects and the uncertain interactions between them originated the necessity of fuzzy graphs (FGs) that were first defined by Rosenfeld [15]. He studied several basic graph-theoretic concepts (e.g., bridges and trees), and established some of their properties. Some remarks on FGs were given by Bhattacharya [16] and he proved that results from (crisp) graph theory do not always hold for FGs. To handle the vague and uncertain relations with periodic nature, FGs were extended to complex fuzzy graphs (CFGs) by Thirunavukarasu et al. [17]. They studied the lower and upper bounds of energy of CFGs and illustrated these concepts through numeric examples. Since FGs and CFGs just provide the truth degrees and uncertainties occurring repeatedly, respectively, of pairwise relations. To consider the truth as well as falsity degrees between pairwise relationships simultaneously, intuitionistic fuzzy graphs (IFGs) were defined by Parvathi and Karunambigai [18]. To handle periodic nature of falsity degrees in IFGs, Yaqoob et al. [19] defined complex intuitionistic fuzzy graphs (CIFGs). They studied the homomorphisms of CIFGs and provided an application of CIFGs in cellular network provider companies for the testing of their proposed approach. To extend the concept of IFGs, Broumi et al. [20] defined single-valued neutrosophic graphs (SVNGs) and investigated some of their properties such as strong SVNGs, constant SVNGs, and complete SVNGs. Certain operations on SVNGs were studied by Akram and Shahzadi [21]. Single-valued neutrosophic planar graphs were defined by Akram [22]. Applications of neutrosophic soft graphs were studied by Akram and Shahzadi [23]. To generalize the concept of neutrosophic graphs and CIFGs, complex neutrosophic graphs (CNGs) were defined by Yaqoob and Akram [24]. They discussed some basic

operations on CNGs and described these operations with the help of concrete examples. They also presented energy of CNGs.

A hypergraph, as an extension of crisp graph, is considered to be the most developing and powerful tool to model different practical problems in various fields, including biological sciences, computer sciences, and social networks [25]. To deal uncertainty in crisp hypergraphs, fuzzy hypergraphs (FHGs), as an extension of FGs, were defined by Kaufmann [26]. Lee-Kwang and Lee [27] discussed the fuzzy partition using FHGs. A valuable contribution on FGs and FHGs has been proposed by Mordeson and Nair [28]. Fuzzy transversals of FHGs were studied by Goetschel et al. [29]. To discuss the falsity degrees of hypernetworks, intuitionistic fuzzy hypergraphs (IFHG) were defined by Parvathi et al. [30]. Akram and Dudek [31] proposed some applications of IFHG. A method for finding the shortest hyperpath in an IFHG (weighted) was proposed by Parvathi et al. [32]. They converted an IFN into intuitionistic fuzzy scores and find the IF shortest hyperpath in the network using the scores and accuracy values. Akram and Shahzadi [33] introduced SVN hypergraphs. Akram and Luqman [34] defined intuitionistic single-valued neutrosophic hypergraphs. The same authors [35] introduced bipolar neutrosophic hypergraphs and discussed the applications of these hypergraphs in marketing and biology. Transversals and minimal transversals of m -polar FHGs were studied by Akram and Sarwar [36]. For further studies on FHGs and related extensions, readers are referred to [37–40].

The motivation behind this research work is the existence of indeterminate information of periodic nature in hypernetwork models. A complex neutrosophic hypergraph model plays an important role in handling complicated behavior of indeterminacy and inconsistency with periodic nature. The proposed model generalizes the complex fuzzy model as well as complex intuitionistic fuzzy model. To prove the applicability of our proposed model, we consider two voting procedures. Suppose that 0.6 voters say “yes”, 0.2 say “no”, and 0.2 are “undecided” in the first voting procedure and 0.3 voters say “yes”, 0.3 say “no”, and 0.4 are “undecided” in the second voting procedure. We assume that these two procedures held at different days. It is clear that a CFS cannot handle this situation as it only depicts the truth membership 0.6 of voters but fails to represent the falsity and indeterminate degrees. Similarly, a CIFS represents the truth 0.6 and falsity 0.2 degrees of voters but it does not illustrate the 0.2 undecided voters. Now, if we set the amplitude terms as the membership degrees of first voting procedure and phase terms as the membership degrees of second voting procedure, then we can illustrate this information using a complex neutrosophic model as, $\{0.6e^{i(0.3)2\pi}, 0.2e^{i(0.3)2\pi}, 0.2e^{i(0.4)2\pi}\}$. The aim of the proposed work is to apply the most generalized concept of complex neutrosophic sets to hypergraphs to deal periodic nature of inconsistent information existing in hypernetworks. The proposed research generalizes the concepts of CNGs, CFHG, CIFHG, and overcomes the drawbacks occurring in previous research. The proposed model is more generalized framework as it does not only deal the reductant nature of imprecise information but also includes the benefits of hypergraphs. Thus, the main objective of this research work is to combine the fruitful effects of CNSs and hypergraph theory.

The contents of this paper are as follows: In Section 2, we define complex neutrosophic hypergraphs, level hypergraphs, lower truncation, upper truncation, and transition levels of these hypergraphs. In Section 3, we define T -related complex neutrosophic hypergraphs and discuss certain properties of minimal transversals of complex neutrosophic hypergraphs. We justify the proposed concepts through some concrete examples. Section 4 illustrates the modeling of some social networks with overlapping communities by means of complex neutrosophic hypergraphs. In Section 5, we present a brief comparison of our proposed model with other existing models. In Section 6, we discuss the results of our proposed research. Section 7 deals with conclusions and future directions.

2. Complex Neutrosophic Hypergraphs

Definition 1. [5] Let \mathcal{J} be a non-empty set. A neutrosophic set (NS) on \mathcal{J} is defined as,

$$N = \{(x, t_N(x), i_N(x), f_N(x)) | x \in \mathcal{J}\},$$

where $t_N, i_N, f_N : \mathcal{J} \rightarrow]0^-, 1^+[$ denote the truth, indeterminacy, and falsity degrees of N such that $0^- \leq t_N(x) + i_N(x) + f_N(x) \leq 3^+$.

Definition 2. [6] A single-valued neutrosophic set (SVNS) on \mathcal{J} is defined as,

$$S = \{(x, t_S(x), i_S(x), f_S(x)) | x \in \mathcal{J}\},$$

where $t_S, i_S, f_S : \mathcal{J} \rightarrow [0, 1]$ denote the truth, indeterminacy, and falsity degrees of S such that $0 \leq t_S(x) + i_S(x) + f_S(x) \leq 3$.

If \mathcal{J} is continues, then

$$S = \int_x \frac{(t_S(x), i_S(x), f_S(x))}{x}, \forall x \in \mathcal{J}.$$

If \mathcal{J} is discrete, then

$$S = \sum_x \frac{(t_S(x), i_S(x), f_S(x))}{x}, \forall x \in \mathcal{J}.$$

Definition 3. [13] A complex intuitionistic fuzzy set (CIFS) I on the universal set \mathcal{J} is defined as,

$$I = \{(u, t_I(u)e^{i\phi_I(u)}, f_I(u)e^{i\psi_I(u)}) | u \in \mathcal{J}\},$$

where $\iota = \sqrt{-1}$, $t_I(u), f_I(u) \in [0, 1]$ are known as amplitude terms, $\phi_I(u), \psi_I(u) \in [0, 2\pi]$ are called phase terms, and for every $u \in \mathcal{J}$, $0 \leq t_I(u) + f_I(u) \leq 1$.

Complex neutrosophic sets are defined using SVNSs.

Definition 4. [14] A complex neutrosophic set (CNS) \mathcal{N} on the universal set \mathcal{J} is defined as,

$$\mathcal{N} = \{(u, t_{\mathcal{N}}(u)e^{i\phi_{\mathcal{N}}(u)}, i_{\mathcal{N}}(u)e^{i\varphi_{\mathcal{N}}(u)}, f_{\mathcal{N}}(u)e^{i\psi_{\mathcal{N}}(u)}) | u \in \mathcal{J}\},$$

where $\iota = \sqrt{-1}$, $t_{\mathcal{N}}(u), i_{\mathcal{N}}(u), f_{\mathcal{N}}(u) \in [0, 1]$ are known as amplitude terms, $\phi_{\mathcal{N}}(u), \varphi_{\mathcal{N}}(u), \psi_{\mathcal{N}}(u) \in [0, 2\pi]$ are called phase terms, and for every $u \in \mathcal{J}$, $0 \leq t_{\mathcal{N}}(u) + i_{\mathcal{N}}(u) + f_{\mathcal{N}}(u) \leq 3$.

Definition 5. [24] A complex neutrosophic relation (CNR) is a CNS on $\mathcal{J} \times \mathcal{J}$ given as,

$$R = \{(rs, t_R(rs)e^{i\phi_R(rs)}, i_R(rs)e^{i\varphi_R(rs)}, f_R(rs)e^{i\psi_R(rs)}) | rs \in \mathcal{J} \times \mathcal{J}\},$$

where $\iota = \sqrt{-1}$, $t_R : \mathcal{J} \times \mathcal{J} \rightarrow [0, 1]$, $i_R : \mathcal{J} \times \mathcal{J} \rightarrow [0, 1]$, $f_R : \mathcal{J} \times \mathcal{J} \rightarrow [0, 1]$ characterize the truth, indeterminacy, and falsity degrees of R , and $\phi_R(rs), \varphi_R(rs), \psi_R(rs) \in [0, 2\pi]$ such that for all $rs \in \mathcal{J} \times \mathcal{J}$, $0 \leq t_R(rs) + i_R(rs) + f_R(rs) \leq 3$.

Definition 6. [24] A complex neutrosophic graph (CNG) on \mathcal{J} is an ordered pair $G = (A, B)$, where A is a CNS on \mathcal{J} and B is CNR on \mathcal{J} such that

$$\begin{aligned} t_B(ab) &\leq \min\{t_A(a), t_A(b)\}, \\ i_B(ab) &\leq \min\{i_A(a), i_A(b)\}, \\ f_B(ab) &\leq \max\{f_A(a), f_A(b)\}, \text{ (for amplitude terms)} \\ \phi_B(ab) &\leq \min\{\phi_A(a), \phi_A(b)\}, \\ \varphi_B(ab) &\leq \min\{\varphi_A(a), \varphi_A(b)\}, \\ \psi_B(ab) &\leq \max\{\psi_A(a), \psi_A(b)\}, \text{ (for phase terms)} \end{aligned}$$

$$0 \leq t_B(ab) + i_B(ab) + f_B(ab) \leq 3, \text{ for all } a, b \in \mathcal{J}.$$

Example 1. Consider a CNG $G = (A, B)$ on $\mathcal{J} = \{c_1, c_2, c_3\}$, where $A = \{(c_1, 0.7e^{i(0.9)\pi}, 0.6e^{i(0.8)\pi}, 0.9e^{i(0.7)\pi}), (c_2, 0.5e^{i(0.5)\pi}, 0.7e^{i(0.9)\pi}, 0.9e^{i(0.7)\pi}), (c_3, 0.8e^{i(0.8)\pi}, 0.6e^{i(0.9)\pi}, 0.5e^{i(0.7)\pi})\}$ and $B = \{(c_1c_2, 0.5e^{i(0.5)\pi}, 0.6e^{i(0.8)\pi}, 0.6e^{i(0.6)\pi}), (c_2c_3, 0.5e^{i(0.5)\pi}, 0.6e^{i(0.8)\pi}, 0.4e^{i(0.6)\pi}), (c_1c_3, 0.7e^{i(0.8)\pi}, 0.5e^{i(0.8)\pi}, 0.5e^{i(0.8)\pi}), 0.4e^{i(0.6)\pi})\}$ are CNS and CNR on \mathcal{J} , respectively. The corresponding graph is shown in Figure 1.

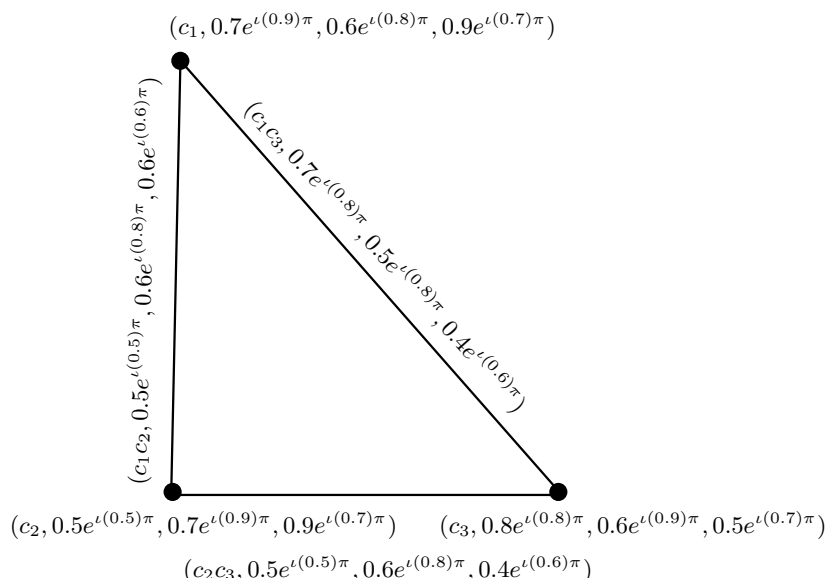

Figure 1. Complex neutrosophic graph.

Definition 7. [14] Let $N_1 = \{(u, t_{N_1}(u)e^{i\phi_{N_1}(u)}, i_{N_1}(u)e^{i\varphi_{N_1}(u)}, f_{N_1}(u)e^{i\psi_{N_1}(u)}) | u \in \mathcal{J}\}$ and $N_2 = \{(u, t_{N_2}(u)e^{i\phi_{N_2}(u)}, i_{N_2}(u)e^{i\varphi_{N_2}(u)}, f_{N_2}(u)e^{i\psi_{N_2}(u)}) | u \in \mathcal{J}\}$ be two CNSs in \mathcal{J} , then

- (i) $N_1 \subseteq N_2 \Leftrightarrow t_{N_1}(u) \leq t_{N_2}(u), i_{N_1}(u) \leq i_{N_2}(u), f_{N_1}(u) \geq f_{N_2}(u)$, and $\phi_{N_1}(u) \leq \phi_{N_2}(u), \varphi_{N_1}(u) \leq \varphi_{N_2}(u), \psi_{N_1}(u) \geq \psi_{N_2}(u)$ for amplitudes and phase terms, respectively, for all $u \in \mathcal{J}$.
- (ii) $N_1 = N_2 \Leftrightarrow t_{N_1}(u) = t_{N_2}(u), i_{N_1}(u) = i_{N_2}(u), f_{N_1}(u) = f_{N_2}(u)$, and $\phi_{N_1}(u) = \phi_{N_2}(u), \varphi_{N_1}(u) = \varphi_{N_2}(u), \psi_{N_1}(u) = \psi_{N_2}(u)$ for amplitudes and phase terms, respectively, for all $u \in \mathcal{J}$.
- (iii) $N_1 \cup N_2 = \{(u, \max\{t_{N_1}(u), t_{N_2}(u)\}e^{i\max\{\phi_{N_1}(u), \phi_{N_2}(u)\}}, \min\{i_{N_1}(u), i_{N_2}(u)\}e^{i\min\{\varphi_{N_1}(u), \varphi_{N_2}(u)\}}, \min\{f_{N_1}(u), f_{N_2}(u)\}e^{i\min\{\psi_{N_1}(u), \psi_{N_2}(u)\}}) | u \in N_1 \cup N_2\}$.
- (iv) $N_1 \cap N_2 = \{(u, \min\{t_{N_1}(u), t_{N_2}(u)\}e^{i\min\{\phi_{N_1}(u), \phi_{N_2}(u)\}}, \max\{i_{N_1}(u), i_{N_2}(u)\}e^{i\max\{\varphi_{N_1}(u), \varphi_{N_2}(u)\}}, \max\{f_{N_1}(u), f_{N_2}(u)\}e^{i\max\{\psi_{N_1}(u), \psi_{N_2}(u)\}}) | u \in N_1 \cap N_2\}$.

Definition 8. The support of a CNS $N = \{(u, t_N(u)e^{i\phi_N(u)}, i_N(u)e^{i\varphi_N(u)} f_N(u)e^{i\psi_N(u)}) | u \in \mathcal{J}\}$ is defined as

$$\text{supp}(N) = \{u | t_N(u) \neq 0, i_N(u) \neq 0, f_N(u) \neq 1, 0 < \phi_N(u), \varphi_N(u), \psi_N(u) < 2\pi\}.$$

The height of a CNS $N = \{(u, t_N(u)e^{i\phi_N(u)}, i_N(u)e^{i\varphi_N(u)} f_N(u)e^{i\psi_N(u)}) | u \in \mathcal{J}\}$ is defined as

$$h(N) = \left\{ \max_{u \in \mathcal{J}} t_N(u) e^{i \max_{u \in \mathcal{J}} \phi_N(u)}, \max_{u \in \mathcal{J}} i_N(u) e^{i \max_{u \in \mathcal{J}} \varphi_N(u)}, \min_{u \in \mathcal{J}} f_N(u) e^{i \min_{u \in \mathcal{J}} \psi_N(u)} \right\}.$$

Definition 9. A complex neutrosophic hypergraph (CNHG) on \mathcal{J} is defined as an ordered pair $\mathcal{H} = (\mathcal{N}, \lambda)$, where $\mathcal{N} = \{N_1, N_2, \dots, N_k\}$ is a finite family of CNSs on \mathcal{J} and λ is a CNR on CNSs N_j 's such that

(i)

$$\begin{aligned} t_\lambda(\{r_1, r_2, \dots, r_l\}) &\leq \min\{t_{N_j}(r_1), t_{N_j}(r_2), \dots, t_{N_j}(r_l)\}, \\ i_\lambda(\{r_1, r_2, \dots, r_l\}) &\leq \min\{i_{N_j}(r_1), i_{N_j}(r_2), \dots, i_{N_j}(r_l)\}, \\ f_\lambda(\{r_1, r_2, \dots, r_l\}) &\leq \max\{f_{N_j}(r_1), f_{N_j}(r_2), \dots, f_{N_j}(r_l)\}, \text{ (for amplitude terms)} \\ \phi_\lambda(\{r_1, r_2, \dots, r_l\}) &\leq \min\{\phi_{N_j}(r_1), \phi_{N_j}(r_2), \dots, \phi_{N_j}(r_l)\}, \\ \varphi_\lambda(\{r_1, r_2, \dots, r_l\}) &\leq \min\{\varphi_{N_j}(r_1), \varphi_{N_j}(r_2), \dots, \varphi_{N_j}(r_l)\}, \\ \psi_\lambda(\{r_1, r_2, \dots, r_l\}) &\leq \max\{\psi_{N_j}(r_1), \psi_{N_j}(r_2), \dots, \psi_{N_j}(r_l)\}, \text{ (for phase terms)} \end{aligned}$$

$$0 \leq t_\lambda + i_\lambda + f_\lambda \leq 3, \text{ for all } r_1, r_2, \dots, r_l \in \mathcal{J}.$$

(ii) $\bigcup_j \text{supp}(N_j) = \mathcal{J}$, for all $N_j \in \mathcal{N}$.

Please note that $E_k = \{r_1, r_2, \dots, r_l\}$ is the crisp hyperedge of $\mathcal{H} = (\mathcal{N}, \lambda)$.

Definition 10. Let $\mathcal{H} = (\mathcal{N}, \lambda)$ be a CNHG. The height of \mathcal{H} , denoted by $h(\mathcal{H})$, is defined as $h(\mathcal{H}) = (\max \lambda_l e^{i \max \phi}, \max \lambda_m e^{i \max \varphi}, \min \lambda_n e^{i \min \psi})$, where $\lambda_l = \max t_{\xi_j}(v_k)$, $\phi = \max \phi_{\xi_j}(v_k)$, $\lambda_m = \max i_{\xi_j}(v_k)$, $\varphi = \max \varphi_{\xi_j}(v_k)$, $\lambda_n = \min f_{\xi_j}(v_k)$, $\psi = \min \psi_{\xi_j}(v_k)$. Here, $t_{\xi_j}(v_k)$, $i_{\xi_j}(v_k)$, $f_{\xi_j}(v_k)$ denote the truth, indeterminacy, and falsity degrees of vertex v_k to hyperedge ξ_j , respectively.

Definition 11. Let $\mathcal{H} = (\mathcal{N}, \lambda)$ be a CNHG. Suppose that $\alpha, \beta, \gamma \in [0, 1]$ and $\Theta, \Phi, \Psi \in [0, 2\pi]$ such that $0 \leq \alpha + \beta + \gamma \leq 3$. The $(\alpha e^{i\Theta}, \beta e^{i\Phi}, \gamma e^{i\Psi})$ -level hypergraph of \mathcal{H} is defined as an ordered pair $\mathcal{H}^{(\alpha e^{i\Theta}, \beta e^{i\Phi}, \gamma e^{i\Psi})} = (\mathcal{N}^{(\alpha e^{i\Theta}, \beta e^{i\Phi}, \gamma e^{i\Psi})}, \lambda^{(\alpha e^{i\Theta}, \beta e^{i\Phi}, \gamma e^{i\Psi})})$, where

- (i) $\lambda^{(\alpha e^{i\Theta}, \beta e^{i\Phi}, \gamma e^{i\Psi})} = \{\lambda_j^{(\alpha e^{i\Theta}, \beta e^{i\Phi}, \gamma e^{i\Psi})} : \lambda_j \in \lambda\}$ and $\lambda_j^{(\alpha e^{i\Theta}, \beta e^{i\Phi}, \gamma e^{i\Psi})} = \{u \in \mathcal{J} : t_{\lambda_j}(u) \geq \alpha, \phi_{\lambda_j}(u) \geq \Theta, i_{\lambda_j}(u) \geq \beta, \varphi_{\lambda_j}(u) \geq \Phi, \text{ and } f_{\lambda_j}(u) \leq \gamma, \psi_{\lambda_j}(u) \leq \Psi\}$,
- (ii) $\mathcal{N}^{(\alpha e^{i\Theta}, \beta e^{i\Phi}, \gamma e^{i\Psi})} = \bigcup_{\lambda_j \in \lambda} \lambda_j^{(\alpha e^{i\Theta}, \beta e^{i\Phi}, \gamma e^{i\Psi})}$.

Please note that $(\alpha e^{i\Theta}, \beta e^{i\Phi}, \gamma e^{i\Psi})$ -level hypergraph of \mathcal{H} is a crisp hypergraph.

Definition 12. Let $\mathcal{H} = (\mathcal{N}, \lambda)$ be a CNHG and for $0 < \alpha \leq t(h(\mathcal{H}))$, $0 < \beta \leq i(h(\mathcal{H}))$, $\gamma \geq f(h(\mathcal{H})) > 0$, $0 < \Theta \leq \phi(h(\mathcal{H}))$, $0 < \Phi \leq \varphi(h(\mathcal{H}))$, and $\Psi \geq \psi(h(\mathcal{H})) > 0$, let $\mathcal{H}^{(\alpha e^{i\Theta}, \beta e^{i\Phi}, \gamma e^{i\Psi})} = (\mathcal{N}^{(\alpha e^{i\Theta}, \beta e^{i\Phi}, \gamma e^{i\Psi})}, \lambda^{(\alpha e^{i\Theta}, \beta e^{i\Phi}, \gamma e^{i\Psi})})$ be the level hypergraph of \mathcal{H} . The sequence of complex numbers $\{(\alpha_1 e^{i\Theta_1}, \beta_1 e^{i\Phi_1}, \gamma_1 e^{i\Psi_1}), (\alpha_2 e^{i\Theta_2}, \beta_2 e^{i\Phi_2}, \gamma_2 e^{i\Psi_2}), \dots, (\alpha_n e^{i\Theta_n}, \beta_n e^{i\Phi_n}, \gamma_n e^{i\Psi_n})\}$ such that $0 < \alpha_1 < \alpha_2 < \dots < \alpha_n = t(h(\mathcal{H}))$, $0 < \beta_1 < \beta_2 < \dots < \beta_n = i(h(\mathcal{H}))$, $\gamma_1 > \gamma_2 > \dots > \gamma_n = f(h(\mathcal{H})) > 0$, $0 < \Theta_1 < \Theta_2 < \dots < \Theta_n = \phi(h(\mathcal{H}))$, $0 < \Phi_1 < \Phi_2 < \dots < \Phi_n = \varphi(h(\mathcal{H}))$, and $\Psi_1 > \Psi_2 > \dots > \Psi_n = \psi(h(\mathcal{H})) > 0$ satisfying the conditions,

- (i) if $\alpha_{k+1} < \alpha' \leq \alpha_k$, $\beta_{k+1} < \beta' \leq \beta_k$, $\gamma_{k+1} > \gamma' \geq \gamma_k$, $\Theta_{k+1} < \phi \leq \Theta_k$, $\Phi_{k+1} < \varphi \leq \Phi_k$, $\Psi_{k+1} > \psi \geq \Psi_k$, then $\lambda^{(\alpha' e^{i\Theta}, \beta' e^{i\Phi}, \gamma' e^{i\Psi})} = \lambda^{(\alpha_k e^{i\Theta_k}, \beta_k e^{i\Phi_k}, \gamma_k e^{i\Psi_k})}$, and

(ii) $\lambda(\alpha_k e^{i\Theta_k}, \beta_k e^{i\Phi_k}, \gamma_k e^{i\Psi_k}) \subset \lambda(\alpha_{k+1} e^{i\Theta_{k+1}}, \beta_{k+1} e^{i\Phi_{k+1}}, \gamma_{k+1} e^{i\Psi_{k+1}})$,

is called the fundamental sequence of $\mathcal{H} = (\mathcal{N}, \lambda)$, denoted by $\mathcal{F}_s(\mathcal{H})$. The set of $(\alpha_j e^{i\Theta_j}, \beta_j e^{i\Phi_j}, \gamma_j e^{i\Psi_j})$ -level hypergraphs $\{\mathcal{H}^{(\alpha_1 e^{i\Theta_1}, \beta_1 e^{i\Phi_1}, \gamma_1 e^{i\Psi_1})}, \mathcal{H}^{(\alpha_2 e^{i\Theta_2}, \beta_2 e^{i\Phi_2}, \gamma_2 e^{i\Psi_2})}, \dots, \mathcal{H}^{(\alpha_n e^{i\Theta_n}, \beta_n e^{i\Phi_n}, \gamma_n e^{i\Psi_n})}\}$ is called the set of core hypergraphs or the core set of \mathcal{H} , denoted by $c(\mathcal{H})$.

Example 2. Consider a CNHG $\mathcal{H} = (\mathcal{N}, \lambda)$ on $\mathcal{J} = \{r_1, r_2, r_3, r_4, r_5, r_6\}$. The CNR λ is given as, $\lambda(\{r_1, r_2, r_3\}) = (0.6e^{i(0.6)2\pi}, 0.4e^{i(0.4)2\pi}, 0.3e^{i(0.3)2\pi})$, $\lambda(\{r_1, r_4\}) = (0.8e^{i(0.8)2\pi}, 0.5e^{i(0.5)2\pi}, 0.4e^{i(0.4)2\pi})$, $\lambda(\{r_3, r_4, r_5\}) = (0.3e^{i(0.3)2\pi}, 0.2e^{i(0.2)2\pi}, 0.1e^{i(0.1)2\pi})$, and $\lambda(\{r_1, r_5, r_6\}) = (0.3e^{i(0.3)2\pi}, 0.2e^{i(0.2)2\pi}, 0.1e^{i(0.1)2\pi})$. The corresponding CNHG is shown in Figure 2.

Let

$$\begin{aligned} (\alpha_1 e^{i\Theta_1}, \beta_1 e^{i\Phi_1}, \gamma_1 e^{i\Psi_1}) &= (0.9e^{i(0.9)2\pi}, 0.7e^{i(0.7)2\pi}, 0.6e^{i(0.6)2\pi}), \\ (\alpha_2 e^{i\Theta_2}, \beta_2 e^{i\Phi_2}, \gamma_2 e^{i\Psi_2}) &= (0.8e^{i(0.8)2\pi}, 0.5e^{i(0.5)2\pi}, 0.4e^{i(0.4)2\pi}), \\ (\alpha_3 e^{i\Theta_3}, \beta_3 e^{i\Phi_3}, \gamma_3 e^{i\Psi_3}) &= (0.6e^{i(0.6)2\pi}, 0.4e^{i(0.4)2\pi}, 0.3e^{i(0.3)2\pi}), \\ (\alpha_4 e^{i\Theta_4}, \beta_4 e^{i\Phi_4}, \gamma_4 e^{i\Psi_4}) &= (0.3e^{i(0.3)2\pi}, 0.2e^{i(0.2)2\pi}, 0.1e^{i(0.1)2\pi}). \end{aligned}$$

Please note that the sequence $\{(\alpha_1 e^{i\Theta_1}, \beta_1 e^{i\Phi_1}, \gamma_1 e^{i\Psi_1}), (\alpha_2 e^{i\Theta_2}, \beta_2 e^{i\Phi_2}, \gamma_2 e^{i\Psi_2}), (\alpha_3 e^{i\Theta_3}, \beta_3 e^{i\Phi_3}, \gamma_3 e^{i\Psi_3}), (\alpha_4 e^{i\Theta_4}, \beta_4 e^{i\Phi_4}, \gamma_4 e^{i\Psi_4})\}$ satisfies all the conditions of Definition 12. Thus, it is a fundamental sequence of \mathcal{H} . The corresponding $(\alpha_j e^{i\Theta_j}, \beta_j e^{i\Phi_j}, \gamma_j e^{i\Psi_j})$ -level hypergraphs are shown in Figures 3–5.

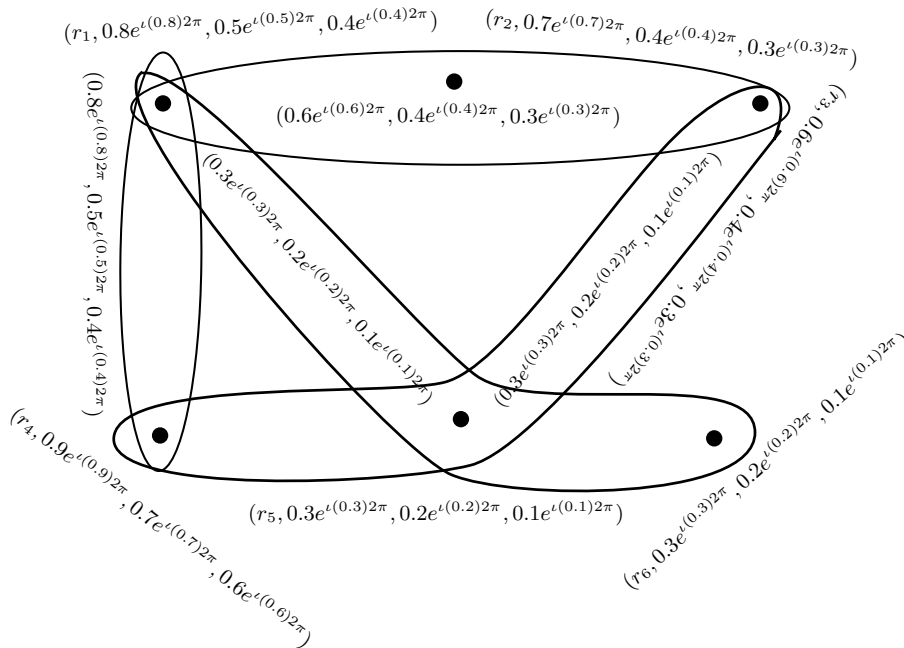

Figure 2. Complex neutrosophic hypergraph \mathcal{H} .

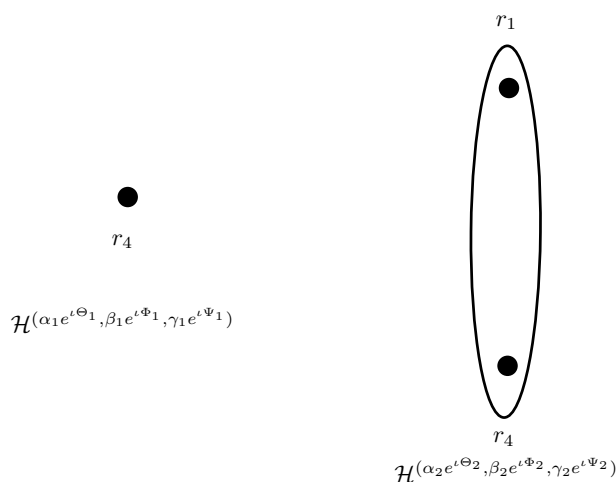

Figure 3. $\mathcal{H}(\alpha_1 e^{\Theta_1}, \beta_1 e^{\Phi_1}, \gamma_1 e^{\Psi_1})$, $\mathcal{H}(\alpha_2 e^{\Theta_2}, \beta_2 e^{\Phi_2}, \gamma_2 e^{\Psi_2})$ -level hypergraphs.

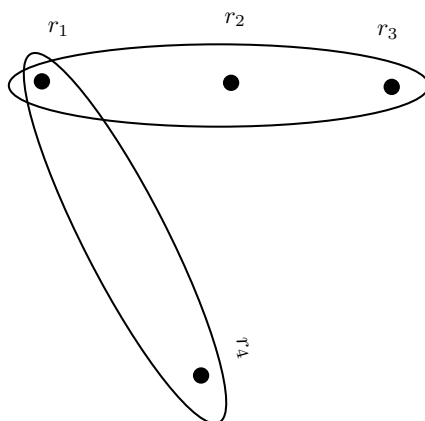

Figure 4. $\mathcal{H}(\alpha_3 e^{\Theta_3}, \beta_3 e^{\Phi_3}, \gamma_3 e^{\Psi_3})$ -level hypergraph.

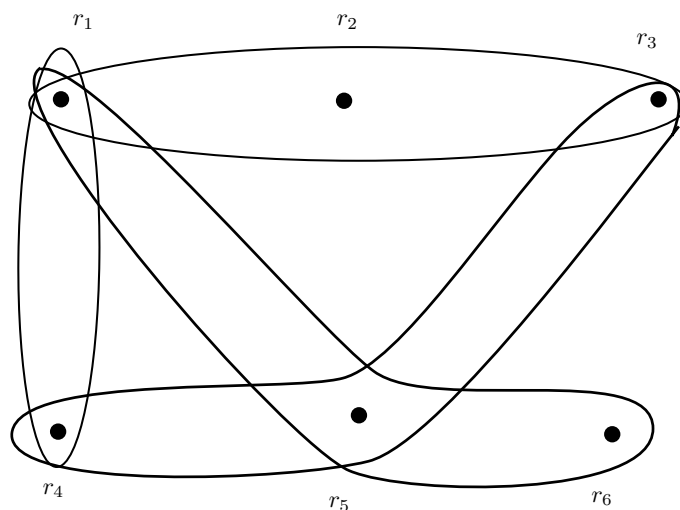

Figure 5. $\mathcal{H}(\alpha_4 e^{\Theta_4}, \beta_4 e^{\Phi_4}, \gamma_4 e^{\Psi_4})$ -level hypergraph.

Definition 13. A CNHG $\mathcal{H} = (\mathcal{N}, \lambda)$ is ordered if $c(\mathcal{H})$ is ordered, i.e., if $c(\mathcal{H}) = \{\mathcal{H}(\alpha_1 e^{\Theta_1}, \beta_1 e^{\Phi_1}, \gamma_1 e^{\Psi_1}), \mathcal{H}(\alpha_2 e^{\Theta_2}, \beta_2 e^{\Phi_2}, \gamma_2 e^{\Psi_2}), \dots, \mathcal{H}(\alpha_n e^{\Theta_n}, \beta_n e^{\Phi_n}, \gamma_n e^{\Psi_n})\}$, then $\{\mathcal{H}(\alpha_1 e^{\Theta_1}, \beta_1 e^{\Phi_1}, \gamma_1 e^{\Psi_1}) \subset \mathcal{H}(\alpha_2 e^{\Theta_2}, \beta_2 e^{\Phi_2}, \gamma_2 e^{\Psi_2}) \subset \dots \subset \mathcal{H}(\alpha_n e^{\Theta_n}, \beta_n e^{\Phi_n}, \gamma_n e^{\Psi_n})\}$.

A CNHG $\mathcal{H} = (\mathcal{N}, \lambda)$ is simply ordered if $c(\mathcal{H})$ is simply ordered, i.e., if $e \in E_{j+1} \setminus E_j$, then $e \notin \mathcal{J}_j$.

Example 3. Consider a CNHG $\mathcal{H} = (\mathcal{N}, \lambda)$ as shown in Figure 2. The set of core hypergraphs is given as,

$$c(\mathcal{H}) = \{\mathcal{H}^{(\alpha_1 e^{\Theta_1}, \beta_1 e^{\Phi_1}, \gamma_1 e^{\Psi_1})}, \mathcal{H}^{(\alpha_2 e^{\Theta_2}, \beta_2 e^{\Phi_2}, \gamma_2 e^{\Psi_2})}, \mathcal{H}^{(\alpha_3 e^{\Theta_3}, \beta_3 e^{\Phi_3}, \gamma_3 e^{\Psi_3})}, \mathcal{H}^{(\alpha_4 e^{\Theta_4}, \beta_4 e^{\Phi_4}, \gamma_4 e^{\Psi_4})}\},$$

where

$$\begin{aligned} \mathcal{H}^{(\alpha_1 e^{\Theta_1}, \beta_1 e^{\Phi_1}, \gamma_1 e^{\Psi_1})} &= (\mathcal{J}_1, E_1), \mathcal{J}_1 = \{r_4\}, E_1 = \{\}, \\ \mathcal{H}^{(\alpha_2 e^{\Theta_2}, \beta_2 e^{\Phi_2}, \gamma_2 e^{\Psi_2})} &= (\mathcal{J}_2, E_2), \mathcal{J}_2 = \{r_1, r_4\}, E_2 = \{\{r_1, r_4\}\}, \\ \mathcal{H}^{(\alpha_3 e^{\Theta_3}, \beta_3 e^{\Phi_3}, \gamma_3 e^{\Psi_3})} &= (\mathcal{J}_3, E_3), \mathcal{J}_3 = \{r_1, r_2, r_3, r_4\}, E_3 = \{\{r_1, r_4\}, \{r_1, r_2, r_3\}\}, \\ \mathcal{H}^{(\alpha_4 e^{\Theta_4}, \beta_4 e^{\Phi_4}, \gamma_4 e^{\Psi_4})} &= (\mathcal{J}_4, E_4), \mathcal{J}_4 = \{r_1, r_2, r_3, r_4, r_5, r_6\}, E_4 = \{\{r_1, r_4\}, \{r_1, r_2, r_3\}, \{r_1, r_5, r_6\}, \\ &\quad \{r_3, r_4, r_5\}\}. \end{aligned}$$

Please note that

$$\mathcal{H}^{(\alpha_1 e^{\Theta_1}, \beta_1 e^{\Phi_1}, \gamma_1 e^{\Psi_1})} \subseteq \mathcal{H}^{(\alpha_2 e^{\Theta_2}, \beta_2 e^{\Phi_2}, \gamma_2 e^{\Psi_2})} \subseteq \mathcal{H}^{(\alpha_3 e^{\Theta_3}, \beta_3 e^{\Phi_3}, \gamma_3 e^{\Psi_3})} \subseteq \mathcal{H}^{(\alpha_4 e^{\Theta_4}, \beta_4 e^{\Phi_4}, \gamma_4 e^{\Psi_4})}.$$

Hence, $\mathcal{H} = (\mathcal{N}, \lambda)$ is an ordered CNHG. Also, $\mathcal{H} = (\mathcal{N}, \lambda)$ is simply ordered.

Definition 14. A CNHG $\mathcal{H} = (\mathcal{N}, \lambda)$ with $\mathcal{F}_s(\mathcal{H}) = \{(\alpha_1 e^{\Theta_1}, \beta_1 e^{\Phi_1}, \gamma_1 e^{\Psi_1}), (\alpha_2 e^{\Theta_2}, \beta_2 e^{\Phi_2}, \gamma_2 e^{\Psi_2}), \dots, (\alpha_n e^{\Theta_n}, \beta_n e^{\Phi_n}, \gamma_n e^{\Psi_n})\}$ is called sectionally elementary if for every $\lambda_j \in \lambda$ and for $k \in \{1, 2, \dots, n\}$, $\lambda_j^{(\alpha e^{\Theta}, \beta e^{\Phi}, \gamma e^{\Psi})} = \lambda_j^{(\alpha_k e^{\Theta_k}, \beta_k e^{\Phi_k}, \gamma_k e^{\Psi_k})}$, for all $\alpha \in (\alpha_{k+1}, \alpha_k]$, $\beta \in (\beta_{k+1}, \beta_k]$, $\gamma \in (\gamma_{k+1}, \gamma_k]$, $\Theta \in (\Theta_{k+1}, \Theta_k]$, $\Phi \in (\Phi_{k+1}, \Phi_k]$, and $\Psi \in (\Psi_{k+1}, \Psi_k]$.

Definition 15. Let N be a CNS on \mathcal{J} . The lower truncation of N at level $(\alpha e^{\Theta}, \beta e^{\Phi}, \gamma e^{\Psi})$, $0 < \alpha, \beta, \gamma \leq 1$, $0 < \Theta, \Phi, \Psi \leq 2\pi$, is the CNSS $N_{[(\alpha e^{\Theta}, \beta e^{\Phi}, \gamma e^{\Psi})]}$ defined by,

$$\begin{aligned} t_{N_{[(\alpha e^{\Theta}, \beta e^{\Phi}, \gamma e^{\Psi})]}}(x) e^{i\phi_{N_{[(\alpha e^{\Theta}, \beta e^{\Phi}, \gamma e^{\Psi})]}}(x)} &= \begin{cases} t_N(x) e^{i\phi_N(x)}, & \text{if } x \in N^{(\alpha e^{\Theta}, \beta e^{\Phi}, \gamma e^{\Psi})}, \\ 0, & \text{otherwise.} \end{cases} \\ i_{N_{[(\alpha e^{\Theta}, \beta e^{\Phi}, \gamma e^{\Psi})]}}(x) e^{i\varphi_{N_{[(\alpha e^{\Theta}, \beta e^{\Phi}, \gamma e^{\Psi})]}}(x)} &= \begin{cases} i_N(x) e^{i\varphi_N(x)}, & \text{if } x \in N^{(\alpha e^{\Theta}, \beta e^{\Phi}, \gamma e^{\Psi})}, \\ 0, & \text{otherwise.} \end{cases} \\ f_{N_{[(\alpha e^{\Theta}, \beta e^{\Phi}, \gamma e^{\Psi})]}}(x) e^{i\psi_{N_{[(\alpha e^{\Theta}, \beta e^{\Phi}, \gamma e^{\Psi})]}}(x)} &= \begin{cases} f_N(x) e^{i\psi_N(x)}, & \text{if } x \in N^{(\alpha e^{\Theta}, \beta e^{\Phi}, \gamma e^{\Psi})}, \\ 0, & \text{otherwise.} \end{cases} \end{aligned}$$

Definition 16. Let N be a CNS on \mathcal{J} . The upper truncation of N at level $(\alpha e^{\Theta}, \beta e^{\Phi}, \gamma e^{\Psi})$, $0 < \alpha, \beta, \gamma \leq 1$, $0 < \Theta, \Phi, \Psi \leq 2\pi$, is the CNSS $N^{[(\alpha e^{\Theta}, \beta e^{\Phi}, \gamma e^{\Psi})]}$ defined by,

$$\begin{aligned} t_{N^{[(\alpha e^{\Theta}, \beta e^{\Phi}, \gamma e^{\Psi})]}}(x) e^{i\phi_{N^{[(\alpha e^{\Theta}, \beta e^{\Phi}, \gamma e^{\Psi})]}}(x)} &= \begin{cases} \alpha e^{\Theta}, & \text{if } x \in N^{(\alpha e^{\Theta}, \beta e^{\Phi}, \gamma e^{\Psi})}, \\ t_N(x) e^{i\phi_N(x)}, & \text{otherwise.} \end{cases} \\ i_{N^{[(\alpha e^{\Theta}, \beta e^{\Phi}, \gamma e^{\Psi})]}}(x) e^{i\varphi_{N^{[(\alpha e^{\Theta}, \beta e^{\Phi}, \gamma e^{\Psi})]}}(x)} &= \begin{cases} \beta e^{\Phi}, & \text{if } x \in N^{(\alpha e^{\Theta}, \beta e^{\Phi}, \gamma e^{\Psi})}, \\ i_N(x) e^{i\varphi_N(x)}, & \text{otherwise.} \end{cases} \\ f_{N^{[(\alpha e^{\Theta}, \beta e^{\Phi}, \gamma e^{\Psi})]}}(x) e^{i\psi_{N^{[(\alpha e^{\Theta}, \beta e^{\Phi}, \gamma e^{\Psi})]}}(x)} &= \begin{cases} \gamma e^{\Psi}, & \text{if } x \in N^{(\alpha e^{\Theta}, \beta e^{\Phi}, \gamma e^{\Psi})}, \\ f_N(x) e^{i\psi_N(x)}, & \text{otherwise.} \end{cases} \end{aligned}$$

Definition 17. Let $\mathcal{H} = (\mathcal{N}, \lambda)$ be a CNHG. The lower truncation $\mathcal{H}_{[(\alpha e^{t\Theta}, \beta e^{t\Phi}, \gamma e^{t\Psi})]}$ of \mathcal{H} at level $(\alpha e^{t\Theta}, \beta e^{t\Phi}, \gamma e^{t\Psi})$ is defined as, $\mathcal{H}_{[(\alpha e^{t\Theta}, \beta e^{t\Phi}, \gamma e^{t\Psi})]} = (\mathcal{N}_{[(\alpha e^{t\Theta}, \beta e^{t\Phi}, \gamma e^{t\Psi})]}, \lambda_{[(\alpha e^{t\Theta}, \beta e^{t\Phi}, \gamma e^{t\Psi})]})$, where $\mathcal{N}_{[(\alpha e^{t\Theta}, \beta e^{t\Phi}, \gamma e^{t\Psi})]} = \{N_{[(\alpha e^{t\Theta}, \beta e^{t\Phi}, \gamma e^{t\Psi})]} | N \in \mathcal{N}\}$.

The upper truncation $\mathcal{H}^{[(\alpha e^{t\Theta}, \beta e^{t\Phi}, \gamma e^{t\Psi})]}$ of \mathcal{H} at level $(\alpha e^{t\Theta}, \beta e^{t\Phi}, \gamma e^{t\Psi})$ is defined as, $\mathcal{H}^{[(\alpha e^{t\Theta}, \beta e^{t\Phi}, \gamma e^{t\Psi})]} = (\mathcal{N}^{[(\alpha e^{t\Theta}, \beta e^{t\Phi}, \gamma e^{t\Psi})]}, \lambda^{[(\alpha e^{t\Theta}, \beta e^{t\Phi}, \gamma e^{t\Psi})]})$, where $\mathcal{N}^{[(\alpha e^{t\Theta}, \beta e^{t\Phi}, \gamma e^{t\Psi})]} = \{N^{[(\alpha e^{t\Theta}, \beta e^{t\Phi}, \gamma e^{t\Psi})]} | N \in \mathcal{N}\}$.

Definition 18. Let N be a CNS on \mathcal{J} . Then, each $(\alpha e^{t\Theta}, \beta e^{t\Phi}, \gamma e^{t\Psi})$, such that $\alpha \in (0, t(h(N)))$, $\beta \in (0, i(h(N)))$, $\gamma \in (0, f(h(N)))$, $\Theta \in (0, \phi(h(N)))$, $\Phi \in (0, \varphi(h(N)))$, and $\Psi \in (0, \psi(h(N)))$, for which $N^{(\alpha e^{t\Theta}, \beta e^{t\Phi}, \gamma e^{t\Psi})} \subset N^{(\alpha e^{t\Theta}, \beta e^{t\Phi}, \gamma e^{t\Psi})}$, is called a transition level of N .

Example 4. Consider a CNHG $\mathcal{H} = (\mathcal{N}, \lambda)$ as shown in Figure 2. The $(0.6e^{t(0.6)2\pi}, 0.4e^{t(0.4)2\pi}, 0.3e^{t(0.3)2\pi})$ -level hypergraph of \mathcal{H} is shown in Figure 4. Then, the lower truncation $\mathcal{H}_{[(0.6e^{t(0.6)2\pi}, 0.4e^{t(0.4)2\pi}, 0.3e^{t(0.3)2\pi})]} = (\mathcal{N}_{[(0.6e^{t(0.6)2\pi}, 0.4e^{t(0.4)2\pi}, 0.3e^{t(0.3)2\pi})]}, \lambda_{[(0.6e^{t(0.6)2\pi}, 0.4e^{t(0.4)2\pi}, 0.3e^{t(0.3)2\pi})]})$ of \mathcal{H} is a CNHG on $\mathcal{J}_1 = \{r_1, r_2, r_3, r_4\}$ as given in Figure 6.

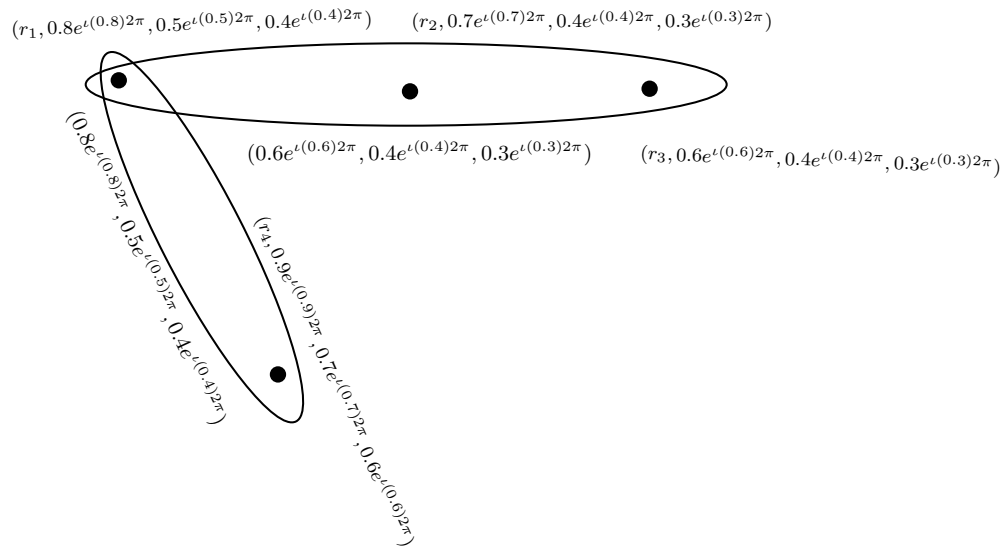

Figure 6. Lower truncation of \mathcal{H} .

Not that $\mathcal{J}_1 = \bigcup_{N \in \mathcal{N}} N_{[(0.6e^{t(0.6)2\pi}, 0.4e^{t(0.4)2\pi}, 0.3e^{t(0.3)2\pi})]}$. The upper truncation $\mathcal{H}^{[(0.6e^{t(0.6)2\pi}, 0.4e^{t(0.4)2\pi}, 0.3e^{t(0.3)2\pi})]} = (\mathcal{N}^{[(0.6e^{t(0.6)2\pi}, 0.4e^{t(0.4)2\pi}, 0.3e^{t(0.3)2\pi})]}, \lambda^{[(0.6e^{t(0.6)2\pi}, 0.4e^{t(0.4)2\pi}, 0.3e^{t(0.3)2\pi})]})$ of \mathcal{H} is a CNHG on $\mathcal{J} = \{r_1, r_2, r_3, r_4, r_5, r_6\}$ as given in Figure 7.

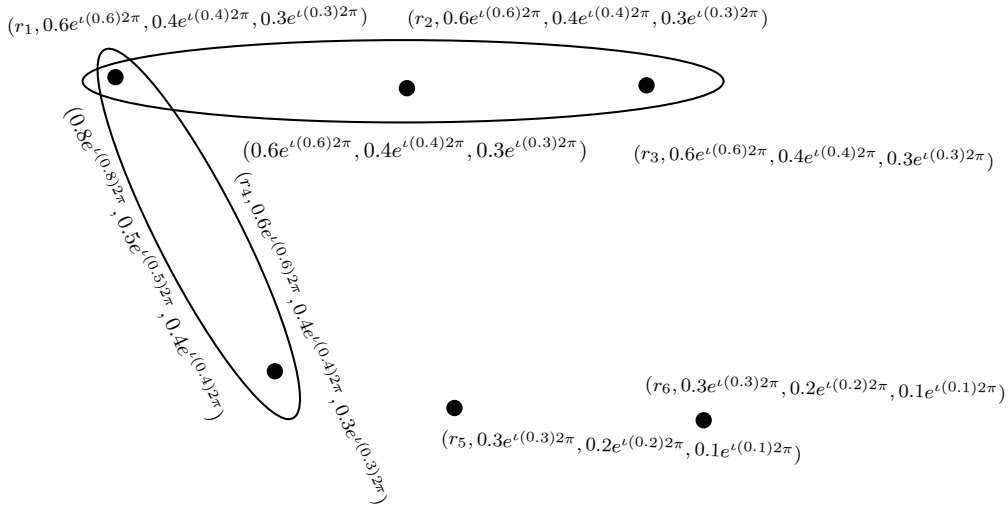

Figure 7. Upper truncation of \mathcal{H} .

Definition 19. Let $\mathcal{H} = (\mathcal{N}, \lambda)$ be a CNHG. A complex neutrosophic transversal (CNT) τ is a CNS of \mathcal{J} satisfying the condition $\xi^{h(\xi)} \cap \tau^{h(\xi)} \neq \emptyset$, for all $\xi \in \lambda$, where $h(\xi)$ is the height of ξ .

A minimal complex neutrosophic transversal τ_1 is the CNT of \mathcal{H} with the property that if $\tau \subset \tau_1$, then τ is not a CNT of \mathcal{H} .

Let us denote the family of minimal CNTs of \mathcal{H} by $T_r(\mathcal{H})$.

Definition 20. A CNT τ with the property that $\tau^{(\alpha e^{t\Theta}, \beta e^{t\Phi}, \gamma e^{t\Psi})} \in t_r(\mathcal{H}^{(\alpha e^{t\Theta}, \beta e^{t\Phi}, \gamma e^{t\Psi})})$, for all $\alpha, \beta, \gamma \in [0, 1]$, and $\Theta, \Phi, \Psi \in [0, 2\pi]$ is called the locally minimal CNT of \mathcal{H} . The collection of all locally minimal CNTs of \mathcal{H} is represented by $T_r^*(\mathcal{H})$.

Please note that $T_r^*(\mathcal{H}) \subseteq T_r(\mathcal{H})$, but the converse is not generally true.

Definition 21. Let N be a CNS on \mathcal{J} . Then, the basic sequence of N determined by N , denoted by $B_s(N)$, is defined as $\{(\alpha_1 e^{t\Theta_1}, \beta_1 e^{t\Phi_1}, \gamma_1 e^{t\Psi_1})^N, (\alpha_2 e^{t\Theta_2}, \beta_2 e^{t\Phi_2}, \gamma_2 e^{t\Psi_2})^N, \dots, (\alpha_n e^{t\Theta_n}, \beta_n e^{t\Phi_n}, \gamma_n e^{t\Psi_n})^N\}$, where

- (i) $\alpha_1 > \alpha_2 > \dots > \alpha_n, \beta_1 > \beta_2 > \dots > \beta_n, \gamma_1 < \gamma_2 < \dots < \gamma_n, \Theta_1 > \Theta_2 > \dots > \Theta_n, \Phi_1 > \Phi_2 > \dots > \Phi_n, \Psi_1 < \Psi_2 < \dots < \Psi_n$,
- (ii) $(\alpha_1 e^{t\Theta_1}, \beta_1 e^{t\Phi_1}, \gamma_1 e^{t\Psi_1}) = h(N)$,
- (iii) $\{(\alpha_2 e^{t\Theta_2}, \beta_2 e^{t\Phi_2}, \gamma_2 e^{t\Psi_2})^N, \dots, (\alpha_n e^{t\Theta_n}, \beta_n e^{t\Phi_n}, \gamma_n e^{t\Psi_n})^N\}$ are the transition levels of N .

Definition 22. Let $B_s(N) = \{(\alpha_1 e^{t\Theta_1}, \beta_1 e^{t\Phi_1}, \gamma_1 e^{t\Psi_1})^N, (\alpha_2 e^{t\Theta_2}, \beta_2 e^{t\Phi_2}, \gamma_2 e^{t\Psi_2})^N, \dots, (\alpha_n e^{t\Theta_n}, \beta_n e^{t\Phi_n}, \gamma_n e^{t\Psi_n})^N\}$ be the basic sequence of N . Then, the set of basic cuts $B_c(N)$ is defined as, $B_c(N) = \{N^{(\alpha e^{t\Theta}, \beta e^{t\Phi}, \gamma e^{t\Psi})} \mid (\alpha e^{t\Theta}, \beta e^{t\Phi}, \gamma e^{t\Psi}) \in B_s(N)\}$.

Lemma 1. Let $\mathcal{H} = (\mathcal{N}, \lambda)$ be a CNHG with $\mathcal{F}_s(\mathcal{H}) = \{(\alpha_1 e^{t\Theta_1}, \beta_1 e^{t\Phi_1}, \gamma_1 e^{t\Psi_1}), (\alpha_2 e^{t\Theta_2}, \beta_2 e^{t\Phi_2}, \gamma_2 e^{t\Psi_2}), \dots, (\alpha_n e^{t\Theta_n}, \beta_n e^{t\Phi_n}, \gamma_n e^{t\Psi_n})\}$. Then,

- (i) If $(\alpha e^{t\Theta}, \beta e^{t\Phi}, \gamma e^{t\Psi})$ is a transition level of $\tau \in T_r(\mathcal{H})$, then there exists an $\epsilon > 0$ such that for all $\alpha_1 \in (\alpha, \alpha + \epsilon], \beta_1 \in (\beta, \beta + \epsilon], \gamma_1 \in (\gamma, \gamma + \epsilon], \Theta_1 \in (\Theta, \Theta + \epsilon], \Phi_1 \in (\Phi, \Phi + \epsilon], \Psi_1 \in (\Psi, \Psi + \epsilon], \tau^{(\alpha_1 e^{t\Theta_1}, \beta_1 e^{t\Phi_1}, \gamma_1 e^{t\Psi_1})}$ is a minimal $\mathcal{H}^{(\alpha e^{t\Theta}, \beta e^{t\Phi}, \gamma e^{t\Psi})}$ transversal extension of $\tau^{(\alpha_1 e^{t\Theta_1}, \beta_1 e^{t\Phi_1}, \gamma_1 e^{t\Psi_1})}$, i.e., if $\tau^{(\alpha_1 e^{t\Theta_1}, \beta_1 e^{t\Phi_1}, \gamma_1 e^{t\Psi_1})} \subseteq C \subset \tau^{(\alpha e^{t\Theta}, \beta e^{t\Phi}, \gamma e^{t\Psi})}$, then C is not a transversal of $\mathcal{H}^{(\alpha e^{t\Theta}, \beta e^{t\Phi}, \gamma e^{t\Psi})}$.
- (ii) $T_r(\mathcal{H})$, i.e., the collection of minimal transversals of \mathcal{H} is sectionally elementary.
- (iii) $\mathcal{F}_s(T_r(\mathcal{H}))$ is properly contained in $\mathcal{F}_s(\mathcal{H})$.
- (iv) $\tau^{(\alpha e^{t\Theta}, \beta e^{t\Phi}, \gamma e^{t\Psi})} \in T_r(\mathcal{H}^{(\alpha e^{t\Theta}, \beta e^{t\Phi}, \gamma e^{t\Psi})})$, for all $\tau \in T_r(\mathcal{H})$ and for every $\alpha_2 < \alpha \leq \alpha_1, \beta_2 < \beta \leq \beta_1, \gamma_2 > \gamma \geq \gamma_1, \Theta_2 < \Theta \leq \Theta_1, \Phi_2 < \Phi \leq \Phi_1, \Psi_2 > \Psi \geq \Psi_1$.

Definition 23. Let $\mathcal{H} = (\mathcal{N}, \lambda)$ be a CNHG. The complex neutrosophic line graph of \mathcal{H} is defined as an ordered pair $l(\mathcal{H}) = (\mathcal{N}_l, \lambda_l)$, where $\mathcal{N}_l = \lambda$ and there exists an edge between two vertices in $l(\mathcal{H})$ if $|supp(\lambda_j) \cap supp(\lambda_k)| \geq 1$, for all $\lambda_j, \lambda_k \in \lambda$. The membership degrees of $l(\mathcal{H})$ are given as,

- (i) $\mathcal{N}_l(E_k) = \lambda(E_k)$,
- (ii) $\lambda_l(E_j E_k) = (\min\{t_\lambda(E_j), t_\lambda(E_k)\}e^{t \min\{\phi_\lambda(E_j), \phi_\lambda(E_k)\}}, \min\{i_\lambda(E_j), i_\lambda(E_k)\}e^{t \min\{\varphi_\lambda(E_j), \varphi_\lambda(E_k)\}}, \max\{f_\lambda(E_j), f_\lambda(E_k)\}e^{t \max\{\psi_\lambda(E_j), \psi_\lambda(E_k)\}})$.

3. T-Related Complex Neutrosophic Hypergraphs

Definition 24. A CNHG $\mathcal{H} = (\mathcal{N}, \lambda)$ is *N-tempered CNHG* of $H = (\mathcal{J}, E)$ if there exists $H = (\mathcal{J}, E)$, a crisp hypergraph, and a CNS N such that $\lambda = \{\delta_e | e \in E\}$, where

$$t_\delta(u)e^{t\phi_\delta(u)} = \begin{cases} \min\{t_N(x)e^{t \min\{\phi_N(x)\}} | x \in e\}, & \text{if } u \in e, \\ 0, & \text{otherwise.} \end{cases}$$

$$i_\delta(u)e^{t\varphi_\delta(u)} = \begin{cases} \min\{i_N(x)e^{t \min\{\varphi_N(x)\}} | x \in e\}, & \text{if } u \in e, \\ 0, & \text{otherwise.} \end{cases}$$

$$f_\delta(u)e^{t\psi_\delta(u)} = \begin{cases} \max\{f_N(x)e^{t \max\{\psi_N(x)\}} | x \in e\}, & \text{if } u \in e, \\ 0, & \text{otherwise} \end{cases}$$

An *N-tempered CNHG* $\mathcal{H} = (\mathcal{N}, \lambda)$ determined by H and CNS N is denoted by $N \otimes H$.

Definition 25. A pair (G, J) of crisp hypergraphs is *T-related* if whenever g is a minimal transversal of G , k is any transversal of J , and $g \subseteq k$, then there exists a minimal transversal t of J such that $g \subseteq t \subseteq k$.

Definition 26. Let $\mathcal{H} = (\mathcal{N}, \lambda)$ be a CNHG with $\mathcal{F}_s(\mathcal{H}) = \{(\alpha_1 e^{t\Theta_1}, \beta_1 e^{t\Phi_1}, \gamma_1 e^{t\Psi_1}), (\alpha_2 e^{t\Theta_2}, \beta_2 e^{t\Phi_2}, \gamma_2 e^{t\Psi_2}), \dots, (\alpha_n e^{t\Theta_n}, \beta_n e^{t\Phi_n}, \gamma_n e^{t\Psi_n})\}$. Then, \mathcal{H} is *T-related* if from the core set

$$c(\mathcal{H}) = \{\mathcal{H}^{(\alpha_1 e^{t\Theta_1}, \beta_1 e^{t\Phi_1}, \gamma_1 e^{t\Psi_1})}, \mathcal{H}^{(\alpha_2 e^{t\Theta_2}, \beta_2 e^{t\Phi_2}, \gamma_2 e^{t\Psi_2})}, \dots, \mathcal{H}^{(\alpha_n e^{t\Theta_n}, \beta_n e^{t\Phi_n}, \gamma_n e^{t\Psi_n})}\}$$

of \mathcal{H} , every successive ordered pair $(\mathcal{H}^{(\alpha_j e^{t\Theta_j}, \beta_j e^{t\Phi_j}, \gamma_j e^{t\Psi_j})}, \mathcal{H}^{(\alpha_{j-1} e^{t\Theta_{j-1}}, \beta_{j-1} e^{t\Phi_{j-1}}, \gamma_{j-1} e^{t\Psi_{j-1}})})$ is *T-related*.

If $\mathcal{F}_s(\mathcal{H})$ contains only one element, \mathcal{H} is considered to be trivially *T-related*.

Theorem 1. Let $\mathcal{H} = (\mathcal{N}, \lambda)$ be a *T-related CNHG*, then $T_r(\mathcal{H}) = T_r^*(\mathcal{H})$.

Proof. Let $\mathcal{H} = (\mathcal{N}, \lambda)$ be a *T-related CNHG* with $\mathcal{F}_s(\mathcal{H}) = \{(\alpha_1 e^{t\Theta_1}, \beta_1 e^{t\Phi_1}, \gamma_1 e^{t\Psi_1}), (\alpha_2 e^{t\Theta_2}, \beta_2 e^{t\Phi_2}, \gamma_2 e^{t\Psi_2}), \dots, (\alpha_n e^{t\Theta_n}, \beta_n e^{t\Phi_n}, \gamma_n e^{t\Psi_n})\}$. Then, there arises two cases:

Case (i) First we consider that $\mathcal{F}_s(\mathcal{H}) = \{(\alpha_1 e^{t\Theta_1}, \beta_1 e^{t\Phi_1}, \gamma_1 e^{t\Psi_1})\}$. Then, Lemma 1 implies that for each $\zeta \in T_r(\mathcal{H})$, $\zeta^{(\alpha e^{t\Theta}, \beta e^{t\Phi}, \gamma e^{t\Psi})} \in T_r(\mathcal{H}^{(\alpha e^{t\Theta}, \beta e^{t\Phi}, \gamma e^{t\Psi})})$, for all $0 < \alpha \leq t(h(\mathcal{H}))$, $0 < \beta \leq i(h(\mathcal{H}))$, $\gamma \geq f(h(\mathcal{H})) > 0$, $0 < \Theta \leq \phi(h(\mathcal{H}))$, $0 < \Phi \leq \varphi(h(\mathcal{H}))$, and $\Psi \geq \psi(h(\mathcal{H})) > 0$. Thus, $T_r(\mathcal{H}) = T_r^*(\mathcal{H})$.

Case (ii) We now suppose that $|\mathcal{F}_s(\mathcal{H})| \geq 2$. Since, $T_r^*(\mathcal{H}) \subseteq T_r(\mathcal{H})$, we just have to prove that $T_r(\mathcal{H}) \subseteq T_r^*(\mathcal{H})$. Let $\zeta \in T_r(\mathcal{H})$, and $\zeta^{(\alpha_1 e^{t\Theta_1}, \beta_1 e^{t\Phi_1}, \gamma_1 e^{t\Psi_1})} \subseteq \zeta^{(\alpha_2 e^{t\Theta_2}, \beta_2 e^{t\Phi_2}, \gamma_2 e^{t\Psi_2})}$. AS $\zeta^{(\alpha_1 e^{t\Theta_1}, \beta_1 e^{t\Phi_1}, \gamma_1 e^{t\Psi_1})} \in T_r(\mathcal{H}^{(\alpha_1 e^{t\Theta_1}, \beta_1 e^{t\Phi_1}, \gamma_1 e^{t\Psi_1})})$, $\zeta^{(\alpha_2 e^{t\Theta_2}, \beta_2 e^{t\Phi_2}, \gamma_2 e^{t\Psi_2})} \in T_r(\mathcal{H}^{(\alpha_2 e^{t\Theta_2}, \beta_2 e^{t\Phi_2}, \gamma_2 e^{t\Psi_2})})$, and the ordered pair $(\mathcal{H}^{(\alpha_2 e^{t\Theta_2}, \beta_2 e^{t\Phi_2}, \gamma_2 e^{t\Psi_2})}, \mathcal{H}^{(\alpha_1 e^{t\Theta_1}, \beta_1 e^{t\Phi_1}, \gamma_1 e^{t\Psi_1})})$ is *T-related*. If $\zeta^{(\alpha_2 e^{t\Theta_2}, \beta_2 e^{t\Phi_2}, \gamma_2 e^{t\Psi_2})} \notin T_r(\mathcal{H}^{(\alpha_2 e^{t\Theta_2}, \beta_2 e^{t\Phi_2}, \gamma_2 e^{t\Psi_2})})$, then there exists a minimal transversal τ of $\mathcal{H}^{(\alpha_2 e^{t\Theta_2}, \beta_2 e^{t\Phi_2}, \gamma_2 e^{t\Psi_2})}$ such that $\zeta^{(\alpha_1 e^{t\Theta_1}, \beta_1 e^{t\Phi_1}, \gamma_1 e^{t\Psi_1})} \subseteq \tau_2 \subseteq \zeta^{(\alpha_2 e^{t\Theta_2}, \beta_2 e^{t\Phi_2}, \gamma_2 e^{t\Psi_2})}$. Hence, we obtain a CNT δ of \mathcal{H} such that $\delta \subset \zeta$. Let $\zeta^{(\alpha_1 e^{t\Theta_1}, \beta_1 e^{t\Phi_1}, \gamma_1 e^{t\Psi_1})} = \tau_1$ and

$\delta = \zeta^{(\alpha_3 e^{i\Theta_3}, \beta_3 e^{i\Phi_3}, \gamma_3 e^{i\Psi_3})} \cup \rho_2 \cap \rho_1$, where ρ_k is an elementary CNS with support τ_k and height $(\alpha_k e^{i\Theta_k}, \beta_k e^{i\Phi_k}, \gamma_k e^{i\Psi_k})$, $k = 1, 2$. This contradiction shows that $\zeta^{(\alpha_2 e^{i\Theta_2}, \beta_2 e^{i\Phi_2}, \gamma_2 e^{i\Psi_2})} \in T_r(\mathcal{H}^{(\alpha_2 e^{i\Theta_2}, \beta_2 e^{i\Phi_2}, \gamma_2 e^{i\Psi_2})})$. Then, Lemma 1 implies that $\zeta^{(\alpha e^{i\Theta}, \beta e^{i\Phi}, \gamma e^{i\Psi})} \in T_r(\mathcal{H}^{(\alpha e^{i\Theta}, \beta e^{i\Phi}, \gamma e^{i\Psi})})$, for $\alpha \in (\alpha_3, \alpha_1]$, $\beta \in (\beta_3, \beta_1]$, $\gamma \in (\gamma_3, \gamma_1]$, $\Theta \in (\Theta_3, \Theta_1]$, $\Phi \in (\Phi_3, \Phi_1]$, $\Psi \in (\Psi_3, \Psi_1]$. Continuing the same recursive procedure, we show that $\zeta^{(\alpha e^{i\Theta}, \beta e^{i\Phi}, \gamma e^{i\Psi})} \in T_r(\mathcal{H}^{(\alpha e^{i\Theta}, \beta e^{i\Phi}, \gamma e^{i\Psi})})$, for each $\alpha \in (0, \alpha_1]$, $\beta \in (0, \beta_1]$, $\gamma \in (0, \gamma_1]$, $\Theta \in (0, \Theta_1]$, $\Phi \in (0, \Phi_1]$, $\Psi \in (0, \Psi_1]$.

□

Example 5. Let $\mathcal{H} = (\mathcal{N}, \lambda)$ be a CNHG represented by the incidence matrix as given in Table 1.

Please note that

$$\begin{aligned} \lambda^{(0.9e^{i(0.9)2\pi}, 0.9e^{i(0.9)2\pi}, 0.9e^{i(0.9)2\pi})} &= \{\{j_1, j_2\}, \{j_1, j_3\}, \{j_2, j_3\}\}, \\ \lambda^{(0.6e^{i(0.6)2\pi}, 0.6e^{i(0.6)2\pi}, 0.6e^{i(0.6)2\pi})} &= \{\{j_1, j_2, j_4\}, \{j_1, j_3, j_4\}, \{j_2, j_3, j_5\}\}, \\ \lambda^{(0.3e^{i(0.3)2\pi}, 0.3e^{i(0.3)2\pi}, 0.3e^{i(0.3)2\pi})} &= \{\{j_1, j_2, j_4, j_5\}, \{j_1, j_3, j_4, j_5\}, \{j_2, j_3, j_4, j_5\}\}. \end{aligned}$$

Clearly, $\mathcal{F}_s(\mathcal{H}) = \{(0.9e^{i(0.9)2\pi}, 0.9e^{i(0.9)2\pi}, 0.9e^{i(0.9)2\pi}), (0.6e^{i(0.6)2\pi}, 0.6e^{i(0.6)2\pi}, 0.6e^{i(0.6)2\pi}), (0.3e^{i(0.3)2\pi}, 0.3e^{i(0.3)2\pi}, 0.3e^{i(0.3)2\pi})\}$. Also, $T_r(\mathcal{H}) = \{\tau_1, \tau_2, \tau_3\} = T_r^*(\mathcal{H})$, where

$$\begin{aligned} \tau_1 &= \{(j_1, 0.9e^{i(0.9)2\pi}, 0.9e^{i(0.9)2\pi}, 0.9e^{i(0.9)2\pi}), (j_2, 0.9e^{i(0.9)2\pi}, 0.9e^{i(0.9)2\pi}, 0.9e^{i(0.9)2\pi})\}, \\ \tau_2 &= \{(j_1, 0.9e^{i(0.9)2\pi}, 0.9e^{i(0.9)2\pi}, 0.9e^{i(0.9)2\pi}), (j_3, 0.9e^{i(0.9)2\pi}, 0.9e^{i(0.9)2\pi}, 0.9e^{i(0.9)2\pi})\}, \\ \tau_3 &= \{(j_2, 0.9e^{i(0.9)2\pi}, 0.9e^{i(0.9)2\pi}, 0.9e^{i(0.9)2\pi}), (j_3, 0.9e^{i(0.9)2\pi}, 0.9e^{i(0.9)2\pi}, 0.9e^{i(0.9)2\pi})\}. \end{aligned}$$

Since, $\{j_4, j_5\} \in T_r(\mathcal{H}^{(0.6e^{i(0.6)2\pi}, 0.6e^{i(0.6)2\pi}, 0.6e^{i(0.6)2\pi})})$ and $\{j_4\} \in T_r(\mathcal{H}^{(0.3e^{i(0.3)2\pi}, 0.3e^{i(0.3)2\pi}, 0.3e^{i(0.3)2\pi})})$, i.e., no minimal transversal of $\mathcal{H}^{(0.3e^{i(0.3)2\pi}, 0.3e^{i(0.3)2\pi}, 0.3e^{i(0.3)2\pi})}$ contains $\{j_4, j_5\}$. Thus, $(\mathcal{H}^{(0.6e^{i(0.6)2\pi}, 0.6e^{i(0.6)2\pi}, 0.6e^{i(0.6)2\pi})}, \mathcal{H}^{(0.3e^{i(0.3)2\pi}, 0.3e^{i(0.3)2\pi}, 0.3e^{i(0.3)2\pi})})$ is not T -related, therefore \mathcal{H} is not T -related.

Table 1. Incidence matrix of CNHG $\mathcal{H} = (\mathcal{N}, \lambda)$.

I	λ_1	λ_2	λ_3
j_1	$(0.9e^{i(0.9)2\pi}, 0.9e^{i(0.9)2\pi}, 0.9e^{i(0.9)2\pi})$	$(0.9e^{i(0.9)2\pi}, 0.9e^{i(0.9)2\pi}, 0.9e^{i(0.9)2\pi})$	$(0, 0, 1)$
j_2	$(0.9e^{i(0.9)2\pi}, 0.9e^{i(0.9)2\pi}, 0.9e^{i(0.9)2\pi})$	$(0, 0, 1)$	$(0.9e^{i(0.9)2\pi}, 0.9e^{i(0.9)2\pi}, 0.9e^{i(0.9)2\pi})$
j_3	$(0, 0, 1)$	$(0.9e^{i(0.9)2\pi}, 0.9e^{i(0.9)2\pi}, 0.9e^{i(0.9)2\pi})$	$(0.9e^{i(0.9)2\pi}, 0.9e^{i(0.9)2\pi}, 0.9e^{i(0.9)2\pi})$
j_4	$(0.6e^{i(0.6)2\pi}, 0.6e^{i(0.6)2\pi}, 0.6e^{i(0.6)2\pi})$	$(0.6e^{i(0.6)2\pi}, 0.6e^{i(0.6)2\pi}, 0.6e^{i(0.6)2\pi})$	$(0.3e^{i(0.3)2\pi}, 0.3e^{i(0.3)2\pi}, 0.3e^{i(0.3)2\pi})$
j_5	$(0.3e^{i(0.3)2\pi}, 0.3e^{i(0.3)2\pi}, 0.3e^{i(0.3)2\pi})$	$(0.3e^{i(0.3)2\pi}, 0.3e^{i(0.3)2\pi}, 0.3e^{i(0.3)2\pi})$	$(0.6e^{i(0.6)2\pi}, 0.6e^{i(0.6)2\pi}, 0.6e^{i(0.6)2\pi})$

Theorem 2. Let $\mathcal{H} = (\mathcal{N}, \lambda)$ be an ordered CNHG, then $T_r(\mathcal{H}) = T_r^*(\mathcal{H}) \Leftrightarrow \mathcal{H}$ is T -related.

Proof. In view of Theorem 1, this is enough to prove that $T_r(\mathcal{H}) = T_r^*(\mathcal{H})$ implies \mathcal{H} is T -related. Suppose that $\mathcal{F}_s(\mathcal{H}) = \{(\alpha_1 e^{i\Theta_1}, \beta_1 e^{i\Phi_1}, \gamma_1 e^{i\Psi_1}), (\alpha_2 e^{i\Theta_2}, \beta_2 e^{i\Phi_2}, \gamma_2 e^{i\Psi_2}), \dots, (\alpha_n e^{i\Theta_n}, \beta_n e^{i\Phi_n}, \gamma_n e^{i\Psi_n})\}$ and \mathcal{H} is not T -related. Here, we obtain $\zeta \in T_r(\mathcal{H})$ such that $\zeta \notin T_r^*(\mathcal{H})$. Assume that the ordered pair $(\mathcal{H}^{(\alpha_j e^{i\Theta_j}, \beta_j e^{i\Phi_j}, \gamma_j e^{i\Psi_j})}, \mathcal{H}^{(\alpha_{j+1} e^{i\Theta_{j+1}}, \beta_{j+1} e^{i\Phi_{j+1}}, \gamma_{j+1} e^{i\Psi_{j+1}})})$ is not T -related and $c(\mathcal{H}) = \{\mathcal{H}^{(\alpha_1 e^{i\Theta_1}, \beta_1 e^{i\Phi_1}, \gamma_1 e^{i\Psi_1})}, \mathcal{H}^{(\alpha_2 e^{i\Theta_2}, \beta_2 e^{i\Phi_2}, \gamma_2 e^{i\Psi_2})}, \dots, \mathcal{H}^{(\alpha_n e^{i\Theta_n}, \beta_n e^{i\Phi_n}, \gamma_n e^{i\Psi_n})}\}$. Then, there exists a CNT τ_k such that $\tau_k \in T_r(\mathcal{H}^{(\alpha_k e^{i\Theta_k}, \beta_k e^{i\Phi_k}, \gamma_k e^{i\Psi_k})})$ and $\tau_k \subset \tau_{k+1}$, where

$$\tau_{k+1} \in T_r(\mathcal{H}^{(\alpha_{k+1} e^{i\Theta_{k+1}}, \beta_{k+1} e^{i\Phi_{k+1}}, \gamma_{k+1} e^{i\Psi_{k+1}})})$$

satisfying the condition that N is not a minimal transversal of $\mathcal{H}^{(\alpha_{k+1} e^{i\Theta_{k+1}}, \beta_{k+1} e^{i\Phi_{k+1}}, \gamma_{k+1} e^{i\Psi_{k+1}})}$, for every N , $\tau_k \subseteq N \subseteq \tau_{k+1}$. Since, $\mathcal{H} = (\mathcal{N}, \lambda)$ is an ordered CNHG, then $\mathcal{H}^{(\alpha_k e^{i\Theta_k}, \beta_k e^{i\Phi_k}, \gamma_k e^{i\Psi_k})} \subseteq \mathcal{H}^{(\alpha_{k+1} e^{i\Theta_{k+1}}, \beta_{k+1} e^{i\Phi_{k+1}}, \gamma_{k+1} e^{i\Psi_{k+1}})}$, therefore τ_k is not a transversal of $\mathcal{H}^{(\alpha_{k+1} e^{i\Theta_{k+1}}, \beta_{k+1} e^{i\Phi_{k+1}}, \gamma_{k+1} e^{i\Psi_{k+1}})}$,

for otherwise $\tau_k \in T_r(\mathcal{H}^{(\alpha_{k+1}e^{i\Theta_{k+1}}, \beta_{k+1}e^{i\Phi_{k+1}}, \gamma_{k+1}e^{i\Psi_{k+1}})})$, which is a contradiction to our assumption. Let δ be an arbitrary CNT of $\mathcal{H}^{(\alpha_{k+1}e^{i\Theta_{k+1}}, \beta_{k+1}e^{i\Phi_{k+1}}, \gamma_{k+1}e^{i\Psi_{k+1}})}$ such that $\tau_k \subseteq \delta \subseteq \tau_{k+1}$. Now, if $\tau_k \subseteq Q \subset \delta$, then Q is not a crisp transversal of $\mathcal{H}^{(\alpha_{k+1}e^{i\Theta_{k+1}}, \beta_{k+1}e^{i\Phi_{k+1}}, \gamma_{k+1}e^{i\Psi_{k+1}})}$. As we know that $\delta \notin T_r(\mathcal{H}^{(\alpha_{k+1}e^{i\Theta_{k+1}}, \beta_{k+1}e^{i\Phi_{k+1}}, \gamma_{k+1}e^{i\Psi_{k+1}})})$ and $\tau_k \subset \delta$. Thus, we can obtain a minimal CNT ξ of \mathcal{H} such that $\xi \notin T_r^*(\mathcal{H})$. First, we compute a minimal CNT ξ_1 of $\mathcal{H}^{(\alpha_k e^{i\Theta_k}, \beta_k e^{i\Phi_k}, \gamma_k e^{i\Psi_k})}$, where τ_k is the top level cut of ξ_1 at level $(\alpha_k e^{i\Theta_k}, \beta_k e^{i\Phi_k}, \gamma_k e^{i\Psi_k})$ and satisfies $\xi_1^{(\alpha_{k+1}e^{i\Theta_{k+1}}, \beta_{k+1}e^{i\Phi_{k+1}}, \gamma_{k+1}e^{i\Psi_{k+1}})} \subseteq \tau_{k+1}$. Then, Lemma 1 implies that the $(\alpha_{k+1}e^{i\Theta_{k+1}}, \beta_{k+1}e^{i\Phi_{k+1}}, \gamma_{k+1}e^{i\Psi_{k+1}})$ -cut, $\xi_1^{(\alpha_{k+1}e^{i\Theta_{k+1}}, \beta_{k+1}e^{i\Phi_{k+1}}, \gamma_{k+1}e^{i\Psi_{k+1}})}$ of ξ_1 should equal to some δ that satisfies $\tau_k \subseteq \delta \subseteq \tau_{k+1}$ and $\tau_k \subseteq Q \subset \delta$, then Q is not a crisp transversal of $\mathcal{H}^{(\alpha_{k+1}e^{i\Theta_{k+1}}, \beta_{k+1}e^{i\Phi_{k+1}}, \gamma_{k+1}e^{i\Psi_{k+1}})}$. Thus, we obtain $\xi_1 \in T_r(\mathcal{H}^{(\alpha_k e^{i\Theta_k}, \beta_k e^{i\Phi_k}, \gamma_k e^{i\Psi_k})}) \setminus T_r^*(\mathcal{H}^{(\alpha_k e^{i\Theta_k}, \beta_k e^{i\Phi_k}, \gamma_k e^{i\Psi_k})})$.

We now assume that $(\alpha_k e^{i\Theta_k}, \beta_k e^{i\Phi_k}, \gamma_k e^{i\Psi_k}) \subset (\alpha_1 e^{i\Theta_1}, \beta_1 e^{i\Phi_1}, \gamma_1 e^{i\Psi_1})$. Since, \mathcal{H} is ordered, then there exists an ordered sequence $t_k \supseteq t_{k-1} \supset \dots \supseteq t_1$ of crisp minimal transversals of $\mathcal{H}^{(\alpha_k e^{i\Theta_k}, \beta_k e^{i\Phi_k}, \gamma_k e^{i\Psi_k})}$, $\mathcal{H}^{(\alpha_{k-1} e^{i\Theta_{k-1}}, \beta_{k-1} e^{i\Phi_{k-1}}, \gamma_{k-1} e^{i\Psi_{k-1}})}$, \dots , $\mathcal{H}^{(\alpha_1 e^{i\Theta_1}, \beta_1 e^{i\Phi_1}, \gamma_1 e^{i\Psi_1})}$, respectively. Let ρ_l be an elementary CNSS with support t_l and height ζ_l . Then, $\zeta = \rho_1 \cup \dots \cup \rho_{l-1} \cup \delta$ such that $\zeta \in T_r(\mathcal{H})$ and $\zeta \notin T_r^*(\mathcal{H})$. \square

Corollary 1. Let $\mathcal{H} = (\mathcal{N}, \lambda)$ be an ordered CNHG with $\mathcal{F}_s(\mathcal{H}) = \{(\alpha_1 e^{i\Theta_1}, \beta_1 e^{i\Phi_1}, \gamma_1 e^{i\Psi_1}), (\alpha_2 e^{i\Theta_2}, \beta_2 e^{i\Phi_2}, \gamma_2 e^{i\Psi_2}), \dots, (\alpha_n e^{i\Theta_n}, \beta_n e^{i\Phi_n}, \gamma_n e^{i\Psi_n})\}$ and $c(\mathcal{H}) = \{\mathcal{H}^{(\alpha_1 e^{i\Theta_1}, \beta_1 e^{i\Phi_1}, \gamma_1 e^{i\Psi_1})}, \mathcal{H}^{(\alpha_2 e^{i\Theta_2}, \beta_2 e^{i\Phi_2}, \gamma_2 e^{i\Psi_2})}, \dots, \mathcal{H}^{(\alpha_n e^{i\Theta_n}, \beta_n e^{i\Phi_n}, \gamma_n e^{i\Psi_n})}\}$.

If an ordered pair $(\mathcal{H}^{(\alpha_j e^{i\Theta_j}, \beta_j e^{i\Phi_j}, \gamma_j e^{i\Psi_j})}, \mathcal{H}^{(\alpha_{j+1} e^{i\Theta_{j+1}}, \beta_{j+1} e^{i\Phi_{j+1}}, \gamma_{j+1} e^{i\Psi_{j+1}})})$ is not T-related, then

- (i) $(\alpha_{j+1} e^{i\Theta_{j+1}}, \beta_{j+1} e^{i\Phi_{j+1}}, \gamma_{j+1} e^{i\Psi_{j+1}}) \in \mathcal{F}_s(T_r(\mathcal{H}))$.
- (ii) $(\alpha_{j+1} e^{i\Theta_{j+1}}, \beta_{j+1} e^{i\Phi_{j+1}}, \gamma_{j+1} e^{i\Psi_{j+1}})$ is a transition level for $\zeta \in T_r(\mathcal{H}) \setminus T_r^*(\mathcal{H})$.

Example 6. Let $N = \{(u, t_N(u)e^{i\Phi_N(u)}, i_N(u)e^{i\Theta_N(u)}, f_N(u)e^{i\Psi_N(u)}) | u \in \mathcal{J}\}$ be a CNS on $\mathcal{J} = \{a_1, a_2, a_3, a_4, a_5, a_6, a_7\}$ such that $N(a_7) = (0.4e^{i(0.4)2\pi}, 0.4e^{i(0.4)2\pi}, 0.4e^{i(0.4)2\pi})$ and $N(a) = (0.9e^{i(0.9)2\pi}, 0.9e^{i(0.9)2\pi}, 0.9e^{i(0.9)2\pi})$, for all $a \in \mathcal{J} \setminus \{a_7\}$. Let $H = (\mathcal{J}, E)$ be a crisp hypergraph on \mathcal{J} , where $E_1 = \{a_1, a_2, a_4\}$, $E_2 = \{a_1, a_3, a_4\}$, $E_3 = \{a_4, a_5, a_6\}$, $E_4 = \{a_1, a_5\}$, and $E_5 = \{a_5, a_7\}$. Then, N -tempered CNHG $\mathcal{H} = (\mathcal{N}, \lambda)$ is given by the incidence matrix as shown in Table 2.

Here, $\mathbf{0} = (0, 0, 1)$, $\mathbf{0.9}e^{i(0.9)2\pi} = (0.9e^{i(0.9)2\pi}, 0.9e^{i(0.9)2\pi}, 0.9e^{i(0.9)2\pi})$, and $\mathbf{0.4}e^{i(0.4)2\pi} = (0.4e^{i(0.4)2\pi}, 0.4e^{i(0.4)2\pi}, 0.4e^{i(0.4)2\pi})$. Please note that $\mathcal{F}_s(\mathcal{H}) = \{(0.9e^{i(0.9)2\pi}, 0.9e^{i(0.9)2\pi}, 0.9e^{i(0.9)2\pi}), (0.4e^{i(0.4)2\pi}, 0.4e^{i(0.4)2\pi}, 0.4e^{i(0.4)2\pi})\}$ and $c(\mathcal{H}) = \{\mathcal{H}^{(0.9e^{i(0.9)2\pi}, 0.9e^{i(0.9)2\pi}, 0.9e^{i(0.9)2\pi})}, \mathcal{H}^{(0.4e^{i(0.4)2\pi}, 0.4e^{i(0.4)2\pi}, 0.4e^{i(0.4)2\pi})}\}$, where

$$\begin{aligned} \mathcal{H}^{(0.9e^{i(0.9)2\pi}, 0.9e^{i(0.9)2\pi}, 0.9e^{i(0.9)2\pi})} &= (\mathcal{I}_1, \mathcal{E}_1), \mathcal{I}_1 = \{a_1, a_2, a_3, a_4, a_5, a_6\}, \\ \mathcal{E}_1 &= \{\{a_1, a_2, a_4\}, \{a_1, a_3, a_4\}, \{a_4, a_5, a_6\}, \{a_1, a_5\}\}, \\ \mathcal{H}^{(0.4e^{i(0.4)2\pi}, 0.4e^{i(0.4)2\pi}, 0.4e^{i(0.4)2\pi})} &= (\mathcal{I}_2, \mathcal{E}_2), \mathcal{I}_2 = \{a_1, a_2, a_3, a_4, a_5, a_6, a_7\}, \\ \mathcal{E}_2 &= \{\{a_1, a_2, a_4\}, \{a_1, a_3, a_4\}, \{a_4, a_5, a_6\}, \{a_1, a_5\}\{a_5, a_7\}\}. \end{aligned}$$

Please note that

$$\{a_1, a_4\} \in T_r(\mathcal{H}^{(0.9e^{i(0.9)2\pi}, 0.9e^{i(0.9)2\pi}, 0.9e^{i(0.9)2\pi})}), \{a_1, a_4\} \notin T_r(\mathcal{H}^{(0.4e^{i(0.4)2\pi}, 0.4e^{i(0.4)2\pi}, 0.4e^{i(0.4)2\pi})}),$$

i.e., $\{a_1, a_4, a_5\}$ is a transversal of $\mathcal{H}^{(0.4e^{i(0.4)2\pi}, 0.4e^{i(0.4)2\pi}, 0.4e^{i(0.4)2\pi})}$ but not a minimal transversal. Therefore, the ordered pair $(\mathcal{H}^{(0.9e^{i(0.9)2\pi}, 0.9e^{i(0.9)2\pi}, 0.9e^{i(0.9)2\pi})}, \mathcal{H}^{(0.4e^{i(0.4)2\pi}, 0.4e^{i(0.4)2\pi}, 0.4e^{i(0.4)2\pi})})$ as well as \mathcal{H} is not T-related.

Table 2. Incidence matrix of N -tempered CNHG \mathcal{H} .

\mathcal{H}	λ_1	λ_2	λ_3	λ_4	λ_5
a_1	$0.9e^{t(0.9)2\pi}$	$0.9e^{t(0.9)2\pi}$	0	$0.9e^{t(0.9)2\pi}$	0
a_2	$0.9e^{t(0.9)2\pi}$	0	0	0	0
a_3	0	$0.9e^{t(0.9)2\pi}$	0	0	0
a_4	$0.9e^{t(0.9)2\pi}$	$0.9e^{t(0.9)2\pi}$	$0.9e^{t(0.9)2\pi}$	0	0
a_5	0	0	$0.9e^{t(0.9)2\pi}$	$0.9e^{t(0.9)2\pi}$	$0.4e^{t(0.4)2\pi}$
a_6	0	0	$0.9e^{t(0.9)2\pi}$	0	0
a_7	0	0	0	0	$0.4e^{t(0.4)2\pi}$

Remark 1.

- Example 6 shows that there exists some ordered CNHGs that are not T -related.
- Every simply ordered CNHG $\mathcal{H} = (\mathcal{N}, \lambda)$ satisfies $(T_r^*(\mathcal{H}))^{(\alpha e^{t\Theta}, \beta e^{t\Phi}, \gamma e^{t\Psi})} = T_r(\mathcal{H}^{(\alpha e^{t\Theta}, \beta e^{t\Phi}, \gamma e^{t\Psi})})$, for all $\alpha \in (0, t(h(\mathcal{H}))]$, $\beta \in (0, i(h(\mathcal{H}))]$, $\gamma \in (0, f(h(\mathcal{H}))]$, $\Theta \in (0, \phi(h(\mathcal{H}))]$, $\Phi \in (0, \varphi(h(\mathcal{H}))]$, $\Psi \in (0, \psi(h(\mathcal{H}))]$.

Lemma 2. Let $H = (\mathcal{J}, E)$ be a crisp hypergraph and j be an arbitrary vertex of H . Then $j \in \mathcal{E} \in T_r(H) \Leftrightarrow j \in E_k \in E$ such that for any hyperedge $E_l \neq E_k$ of H , $E_l \not\subseteq E_k$.

Proposition 1. Let $H_1 = (\mathcal{J}_1, E_1)$ be a crisp partial hypergraph of $H = (\mathcal{J}, E)$ that is obtained by removing those hyperedges of $H = (\mathcal{J}, E)$ that contain any other edges properly. Then,

- (i) $T_r(H_1) = T_r(H)$,
- (ii) $\cup T_r(H) = \mathcal{J}_1$.

Definition 27. Let $\mathcal{H} = (\mathcal{N}, \lambda)$ be a CNHG. The join of \mathcal{H} , denoted by $J(\mathcal{H})$, is defined as, $J(\mathcal{H}) = \bigcup_{\rho \in \lambda} \rho$, where λ is the CN hyperedge set of \mathcal{H} .

For every $\alpha \in (0, t(h(\mathcal{H}))]$, $\beta \in (0, i(h(\mathcal{H}))]$, $\gamma \in (0, f(h(\mathcal{H}))]$, $\Theta \in (0, \phi(h(\mathcal{H}))]$, $\Phi \in (0, \varphi(h(\mathcal{H}))]$, $\Psi \in (0, \psi(h(\mathcal{H}))]$, the $(\alpha e^{t\Theta}, \beta e^{t\Phi}, \gamma e^{t\Psi})$ -level cut of $J(\mathcal{H})$, i.e., $(J(\mathcal{H}))^{(\alpha e^{t\Theta}, \beta e^{t\Phi}, \gamma e^{t\Psi})}$ is the set of vertices of $(\alpha e^{t\Theta}, \beta e^{t\Phi}, \gamma e^{t\Psi})$ -level hypergraph of \mathcal{H} , i.e., $(J(\mathcal{H}))^{(\alpha e^{t\Theta}, \beta e^{t\Phi}, \gamma e^{t\Psi})} = \mathcal{J}(\mathcal{H}^{(\alpha e^{t\Theta}, \beta e^{t\Phi}, \gamma e^{t\Psi})})$.

Lemma 3. Let $\mathcal{H} = (\mathcal{N}, \lambda)$ be a CNHG and $\xi \in T_r(\mathcal{H})$. If $j \in \text{supp}(\xi)$, then there exists a CN hyperedge ρ of \mathcal{H} such that

- (i) $\rho(j) = h(\rho) = \xi(j) > 0$,
- (ii) $\xi^{h(\rho)} \cap \rho^{h(\rho)} = \{j\}$.

Proof. Let $j_0 \in \text{supp}(\xi)$ such that $\xi \in T_r(\mathcal{H})$ and $\xi(j_0) = (\alpha_0 e^{t\phi_0}, \beta_0 e^{t\varphi_0}, \gamma_0 e^{t\psi_0})$. Since every ξ_1 that is a transversal of \mathcal{H} contains a transversal ξ such that $\xi \subseteq j(\mathcal{H})$. This implies that $j_0 \in \mathcal{N}^{(\alpha_0 e^{t\phi_0}, \beta_0 e^{t\varphi_0}, \gamma_0 e^{t\psi_0})} = \mathcal{J}(\mathcal{H}^{(\alpha_0 e^{t\phi_0}, \beta_0 e^{t\varphi_0}, \gamma_0 e^{t\psi_0})})$. Therefore, there exists at least one hyperedge ρ of \mathcal{H} such that $\rho(j_0) \geq (\alpha_0 e^{t\phi_0}, \beta_0 e^{t\varphi_0}, \gamma_0 e^{t\psi_0})$. Let $\lambda = \{\lambda_1, \lambda_2, \dots, \lambda_m\}$ be the set of hyperedges of \mathcal{H} and $\rho(j_0) \geq (\alpha_0 e^{t\phi_0}, \beta_0 e^{t\varphi_0}, \gamma_0 e^{t\psi_0})$. We now prove that there exists at least one $\lambda_k \in \lambda$ such that $h(\lambda_j) = (\alpha_0 e^{t\phi_0}, \beta_0 e^{t\varphi_0}, \gamma_0 e^{t\psi_0})$. For otherwise, we have $h(\lambda_k) = (\alpha_k e^{t\phi_k}, \beta_k e^{t\varphi_k}, \gamma_k e^{t\psi_k}) \geq (\alpha_0 e^{t\phi_0}, \beta_0 e^{t\varphi_0}, \gamma_0 e^{t\psi_0})$, for all $\lambda_k \in \lambda$, $k = 1, 2, \dots, m$. This implies that for every $\lambda_k \in \lambda$, there exists an element $u_k \in \text{supp}(\xi)$ such that $u_k \in (\lambda_k)^{(\alpha_k e^{t\phi_k}, \beta_k e^{t\varphi_k}, \gamma_k e^{t\psi_k})} \cap \xi^{(\alpha_k e^{t\phi_k}, \beta_k e^{t\varphi_k}, \gamma_k e^{t\psi_k})}$, for $(\alpha_k e^{t\phi_k}, \beta_k e^{t\varphi_k}, \gamma_k e^{t\psi_k}) \geq (\alpha_0 e^{t\phi_0}, \beta_0 e^{t\varphi_0}, \gamma_0 e^{t\psi_0})$. Since, $\xi(j_0) = (\alpha_0 e^{t\phi_0}, \beta_0 e^{t\varphi_0}, \gamma_0 e^{t\psi_0})$, then $h(\lambda_k) = (\alpha_k e^{t\phi_k}, \beta_k e^{t\varphi_k}, \gamma_k e^{t\psi_k}) \geq (\alpha_0 e^{t\phi_0}, \beta_0 e^{t\varphi_0}, \gamma_0 e^{t\psi_0})$ and $u_k \in (\lambda_k)^{(\alpha_k e^{t\phi_k}, \beta_k e^{t\varphi_k}, \gamma_k e^{t\psi_k})} \cap \xi^{(\alpha_k e^{t\phi_k}, \beta_k e^{t\varphi_k}, \gamma_k e^{t\psi_k})}$ imply that $u_k \neq j_0$, $k = 1, 2, \dots, m$. If these hold, it could be shown that $\xi \notin T_r(\mathcal{H})$ by computing a CNT δ of \mathcal{H} that satisfies $\delta \subset \xi$. This argument follows from the fact that \mathcal{J} and λ are finite, there exist intervals $(\alpha_0 - \epsilon, \alpha_0]$, $(\beta_0 - \epsilon, \beta_0]$, $(\gamma_0 - \epsilon, \gamma_0]$, $(\phi_0 - 2\pi\epsilon, \phi_0]$, $(\varphi_0 - 2\pi\epsilon, \varphi_0]$, and $(\psi_0 - 2\pi\epsilon, \psi_0]$

such that $\mathcal{H}^{(\alpha e^{t\phi}, \beta e^{t\varphi}, \gamma e^{t\psi})} = \mathcal{H}^{(\alpha_0 e^{t\phi_0}, \beta_0 e^{t\varphi_0}, \gamma_0 e^{t\psi_0})}$ on $(\alpha_0 - \epsilon, \alpha_0], (\beta_0 - \epsilon, \beta_0], (\gamma_0 - \epsilon, \gamma_0], (\phi_0 - 2\pi\epsilon, \phi_0], (\varphi_0 - 2\pi\epsilon, \varphi_0],$ and $(\psi_0 - 2\pi\epsilon, \psi_0].$

Define $\delta(u)$ as,

$$t_\delta(u) = \begin{cases} t_\zeta(u), & \text{if } u \neq j_0, \\ \alpha_0 - \epsilon, & \text{if } u = j_0. \end{cases}, \quad i_\delta(u) = \begin{cases} i_\zeta(u), & \text{if } u \neq j_0, \\ \beta_0 - \epsilon, & \text{if } u = j_0. \end{cases}$$

$$f_\delta(u) = \begin{cases} f_\zeta(u), & \text{if } u \neq j_0, \\ \gamma_0 - \epsilon, & \text{if } u = j_0. \end{cases}, \quad \phi_\delta(u) = \begin{cases} \phi_\zeta(u), & \text{if } u \neq j_0, \\ \phi_0 - 2\pi\epsilon, & \text{if } u = j_0. \end{cases}$$

$$\varphi_\delta(u) = \begin{cases} \varphi_\zeta(u), & \text{if } u \neq j_0, \\ \varphi_0 - 2\pi\epsilon, & \text{if } u = j_0. \end{cases}, \quad \psi_\delta(u) = \begin{cases} \psi_\zeta(u), & \text{if } u \neq j_0, \\ \psi_0 - 2\pi\epsilon, & \text{if } u = j_0. \end{cases}$$

Clearly $\delta \subset \zeta$ and δ is a transversal of \mathcal{H} . Also, $\zeta^{(\alpha_0 e^{t\phi_0}, \beta_0 e^{t\varphi_0}, \gamma_0 e^{t\psi_0})} \setminus \{j_0\}$ contains $\{u_k | k = 1, 2, \dots, m\}$. Therefore, $\zeta^{(\alpha_0 e^{t\phi_0}, \beta_0 e^{t\varphi_0}, \gamma_0 e^{t\psi_0})} \setminus \{j_0\}$ is a transversal of $\mathcal{H}^{(\alpha_0 e^{t\phi_0}, \beta_0 e^{t\varphi_0}, \gamma_0 e^{t\psi_0})}$. The same argument holds for every $\mathcal{H}^{(\alpha e^{t\phi}, \beta e^{t\varphi}, \gamma e^{t\psi})}$, where $\alpha \in (\alpha_0 - \epsilon, \alpha_0], \beta \in (\beta_0 - \epsilon, \beta_0], \gamma \in (\gamma_0 - \epsilon, \gamma_0], \phi \in (\phi_0 - 2\pi\epsilon, \phi_0], \varphi \in (\varphi_0 - 2\pi\epsilon, \varphi_0], \psi \in (\psi_0 - 2\pi\epsilon, \psi_0]$. Since, $\delta^{(\alpha e^{t\phi}, \beta e^{t\varphi}, \gamma e^{t\psi})} = \zeta^{(\alpha e^{t\phi}, \beta e^{t\varphi}, \gamma e^{t\psi})}$, for all $\alpha \in (0, t(h(\mathcal{H})) \setminus (\alpha_0 - \epsilon, \alpha_0]), \beta \in (0, i(h(\mathcal{H})) \setminus (\beta_0 - \epsilon, \beta_0]), \gamma \in (0, f(h(\mathcal{H})) \setminus (\gamma_0 - \epsilon, \gamma_0]), \phi \in (0, \phi(h(\mathcal{H})) \setminus (\phi_0 - 2\pi\epsilon, \phi_0]), \varphi \in (0, \varphi(h(\mathcal{H})) \setminus (\varphi_0 - 2\pi\epsilon, \varphi_0]), \psi \in (0, \psi(h(\mathcal{H})) \setminus (\psi_0 - 2\pi\epsilon, \psi_0])$. This establishes the existence of $\rho \in \mathcal{H}$ for which $\rho(j_0) = h(\rho) = \zeta(j_0) > 0$.

We now suppose that every hyperedge from the set $\lambda = \{\lambda_1, \lambda_2, \dots, \lambda_m\}$ with height $\zeta(j_0)$ contain two or more than two elements of $\zeta^{(\alpha_0 e^{t\phi_0}, \beta_0 e^{t\varphi_0}, \gamma_0 e^{t\psi_0})} \setminus \{j_0\}$. BY repeating the above procedure, we can establish that $\zeta \notin T_r(\mathcal{H})$, which is a contradiction. \square

Example 7. Consider a CNHG $\mathcal{H} = (\mathcal{N}, \lambda)$ on $\mathcal{J} = \{u_1, u_2, u_3, u_4\}$ as represented by incidence matrix given in Table 3.

Here, $0.7e^{t(0.7)2\pi} = (0.7e^{t(0.7)2\pi}, 0.7e^{t(0.7)2\pi}, 0.7e^{t(0.7)2\pi})$, $0.9e^{t(0.9)2\pi} = (0.9e^{t(0.9)2\pi}, 0.9e^{t(0.9)2\pi}, 0.9e^{t(0.9)2\pi})$, $0.4e^{t(0.4)2\pi} = (0.4e^{t(0.4)2\pi}, 0.4e^{t(0.4)2\pi}, 0.4e^{t(0.4)2\pi})$. Then, we see that $\lambda_1, \lambda_3,$ and λ_5 have no transitions levels and $(0.4e^{t(0.4)2\pi}, 0.4e^{t(0.4)2\pi}, 0.4e^{t(0.4)2\pi})$ is the transition level of λ_2 and λ_4 . The basic sequences are given as,

$$B_s(\lambda_1) = \{(0.7e^{t(0.7)2\pi}, 0.7e^{t(0.7)2\pi}, 0.7e^{t(0.7)2\pi})\},$$

$$B_s(\lambda_2) = \{(0.9e^{t(0.9)2\pi}, 0.9e^{t(0.9)2\pi}, 0.9e^{t(0.9)2\pi}), (0.4e^{t(0.4)2\pi}, 0.4e^{t(0.4)2\pi}, 0.4e^{t(0.4)2\pi})\},$$

$$B_s(\lambda_3) = \{(0.9e^{t(0.9)2\pi}, 0.9e^{t(0.9)2\pi}, 0.9e^{t(0.9)2\pi})\},$$

$$B_s(\lambda_4) = \{(0.7e^{t(0.7)2\pi}, 0.7e^{t(0.7)2\pi}, 0.7e^{t(0.7)2\pi}), (0.4e^{t(0.4)2\pi}, 0.4e^{t(0.4)2\pi}, 0.4e^{t(0.4)2\pi})\},$$

$$B_s(\lambda_5) = \{(0.4e^{t(0.4)2\pi}, 0.4e^{t(0.4)2\pi}, 0.4e^{t(0.4)2\pi})\}.$$

Thus,

$$B_c(\lambda_1) = \{\lambda_1^{(0.7e^{t(0.7)2\pi}, 0.7e^{t(0.7)2\pi}, 0.7e^{t(0.7)2\pi})}\},$$

$$B_c(\lambda_2) = \{\lambda_2^{(0.9e^{t(0.9)2\pi}, 0.9e^{t(0.9)2\pi}, 0.9e^{t(0.9)2\pi})}, \lambda_2^{(0.4e^{t(0.4)2\pi}, 0.4e^{t(0.4)2\pi}, 0.4e^{t(0.4)2\pi})}\},$$

$$B_c(\lambda_3) = \{\lambda_3^{(0.9e^{t(0.9)2\pi}, 0.9e^{t(0.9)2\pi}, 0.9e^{t(0.9)2\pi})}\},$$

$$B_c(\lambda_4) = \{\lambda_4^{(0.7e^{t(0.7)2\pi}, 0.7e^{t(0.7)2\pi}, 0.7e^{t(0.7)2\pi})}, \lambda_4^{(0.4e^{t(0.4)2\pi}, 0.4e^{t(0.4)2\pi}, 0.4e^{t(0.4)2\pi})}\},$$

$$B_c(\lambda_5) = \{\lambda_5^{(0.4e^{t(0.4)2\pi}, 0.4e^{t(0.4)2\pi}, 0.4e^{t(0.4)2\pi})}\}.$$

Also, we have $\mathcal{F}_s(\mathcal{H}) = \{(0.9e^{i(0.9)2\pi}, 0.9e^{i(0.9)2\pi}, 0.9e^{i(0.9)2\pi}), (0.4e^{i(0.4)2\pi}, 0.4e^{i(0.4)2\pi}, 0.4e^{i(0.4)2\pi})\}$ and $c(\mathcal{H}) = \{\mathcal{H}^{(0.9e^{i(0.9)2\pi}, 0.9e^{i(0.9)2\pi}, 0.9e^{i(0.9)2\pi})}, \mathcal{H}^{(0.4e^{i(0.4)2\pi}, 0.4e^{i(0.4)2\pi}, 0.4e^{i(0.4)2\pi})}\}$, where

$$\begin{aligned} \lambda^{(0.9e^{i(0.9)2\pi}, 0.9e^{i(0.9)2\pi}, 0.9e^{i(0.9)2\pi})} &= \{\{u_1, u_2, u_3\}, \{u_1, u_2\}, \{u_2, u_3\}\}, \\ \lambda^{(0.4e^{i(0.4)2\pi}, 0.4e^{i(0.4)2\pi}, 0.4e^{i(0.4)2\pi})} &= \{\{u_1, u_2, u_3, u_4\}, \{u_1, u_2\}, \{u_1, u_2, u_4\}, \{u_2, u_3\}, \{u_2, u_3, u_4\}\}. \end{aligned}$$

We now determine $T_r(\mathcal{H})$ and $T_r^*(\mathcal{H})$. If $\tau \in T_r(\mathcal{H})$, then $\tau^{h(\lambda_1)} \cap \{u_1, u_2\} \neq \emptyset$, $\tau^{h(\lambda_2)} \cap \{u_1, u_2\} \neq \emptyset$, $\tau^{h(\lambda_3)} \cap \{u_2, u_3\} \neq \emptyset$, $\tau^{h(\lambda_4)} \cap \{u_2, u_3\} \neq \emptyset$, and $\tau^{h(\lambda_5)} \cap \{u_1, u_3, u_4\} \neq \emptyset$. Please note that $T_r(\mathcal{H}) = \{\tau_1, \tau_2, \tau_3, \tau_4\}$, where

$$\begin{aligned} \tau_1 &= \{(u_1, 0.9e^{i(0.9)2\pi}, 0.9e^{i(0.9)2\pi}, 0.9e^{i(0.9)2\pi}), (u_3, 0.9e^{i(0.9)2\pi}, 0.9e^{i(0.9)2\pi}, 0.9e^{i(0.9)2\pi})\}, \\ \tau_2 &= \{(u_2, 0.9e^{i(0.9)2\pi}, 0.9e^{i(0.9)2\pi}, 0.9e^{i(0.9)2\pi}), (u_3, 0.4e^{i(0.4)2\pi}, 0.4e^{i(0.4)2\pi}, 0.4e^{i(0.4)2\pi})\}, \\ \tau_3 &= \{(u_2, 0.9e^{i(0.9)2\pi}, 0.9e^{i(0.9)2\pi}, 0.9e^{i(0.9)2\pi}), (u_4, 0.4e^{i(0.4)2\pi}, 0.4e^{i(0.4)2\pi}, 0.4e^{i(0.4)2\pi})\}, \\ \tau_4 &= \{(u_2, 0.9e^{i(0.9)2\pi}, 0.9e^{i(0.9)2\pi}, 0.9e^{i(0.9)2\pi}), (u_1, 0.4e^{i(0.4)2\pi}, 0.4e^{i(0.4)2\pi}, 0.4e^{i(0.4)2\pi})\}. \end{aligned}$$

Now $T_r(\mathcal{H}^{(0.9e^{i(0.9)2\pi}, 0.9e^{i(0.9)2\pi}, 0.9e^{i(0.9)2\pi})}) = \{\{u_2\}, \{u_1, u_3\}\}$ and $T_r(\mathcal{H}^{(0.4e^{i(0.4)2\pi}, 0.4e^{i(0.4)2\pi}, 0.4e^{i(0.4)2\pi})}) = \{\{u_1, u_3\}, \{u_2, u_3\}, \{u_2, u_4\}, \{u_1, u_2\}, \{u_1, u_3, u_4\}\}$ and $\tau_k^{(\alpha e^{i\Theta}, \beta e^{i\Phi}, \gamma e^{i\Psi})} \in T_r(\mathcal{H}^{(\alpha e^{i\Theta}, \beta e^{i\Phi}, \gamma e^{i\Psi})})$, for all $\alpha \in (0, t(h(\mathcal{H}))]$, $\beta \in (0, i(h(\mathcal{H}))]$, $\gamma \in (0, f(h(\mathcal{H}))]$, $\Theta \in (0, \phi(h(\mathcal{H}))]$, $\Phi \in (0, \varphi(h(\mathcal{H}))]$, $\Psi \in (0, \psi(h(\mathcal{H}))]$. Hence, $T_r^*(\mathcal{H}) = \{\tau_1\}$.

We now illustrate Lemma 3 through the above example.

$$\begin{aligned} \lambda_2(u_1) &= h(\lambda_2) = \tau_1(u_1) = (0.9e^{i(0.9)2\pi}, 0.9e^{i(0.9)2\pi}, 0.9e^{i(0.9)2\pi}), \\ \lambda_3(u_3) &= h(\lambda_3) = \tau_1(u_3) = (0.9e^{i(0.9)2\pi}, 0.9e^{i(0.9)2\pi}, 0.9e^{i(0.9)2\pi}), \\ \lambda_2(u_2) &= h(\lambda_2) = \tau_2(u_2) = (0.9e^{i(0.9)2\pi}, 0.9e^{i(0.9)2\pi}, 0.9e^{i(0.9)2\pi}), \\ \lambda_5(u_3) &= h(\lambda_5) = \tau_2(u_3) = (0.4e^{i(0.4)2\pi}, 0.4e^{i(0.4)2\pi}, 0.4e^{i(0.4)2\pi}), \\ \lambda_3(u_2) &= h(\lambda_3) = \tau_3(u_2) = (0.9e^{i(0.9)2\pi}, 0.9e^{i(0.9)2\pi}, 0.9e^{i(0.9)2\pi}), \\ \lambda_5(u_4) &= h(\lambda_5) = \tau_3(u_4) = (0.4e^{i(0.4)2\pi}, 0.4e^{i(0.4)2\pi}, 0.4e^{i(0.4)2\pi}), \\ \lambda_5(u_1) &= h(\lambda_5) = \tau_4(u_2) = (0.4e^{i(0.4)2\pi}, 0.4e^{i(0.4)2\pi}, 0.4e^{i(0.4)2\pi}), \\ \lambda_3(u_2) &= h(\lambda_3) = \tau_4(u_2) = (0.9e^{i(0.9)2\pi}, 0.9e^{i(0.9)2\pi}, 0.9e^{i(0.9)2\pi}). \end{aligned}$$

Also note that

$$\begin{aligned} \tau_1^{(0.9e^{i(0.9)2\pi}, 0.9e^{i(0.9)2\pi}, 0.9e^{i(0.9)2\pi})} \cap \lambda_2^{(0.9e^{i(0.9)2\pi}, 0.9e^{i(0.9)2\pi}, 0.9e^{i(0.9)2\pi})} &= \{u_1\}, \\ \tau_1^{(0.9e^{i(0.9)2\pi}, 0.9e^{i(0.9)2\pi}, 0.9e^{i(0.9)2\pi})} \cap \lambda_3^{(0.9e^{i(0.9)2\pi}, 0.9e^{i(0.9)2\pi}, 0.9e^{i(0.9)2\pi})} &= \{u_3\}, \\ \tau_2^{(0.9e^{i(0.9)2\pi}, 0.9e^{i(0.9)2\pi}, 0.9e^{i(0.9)2\pi})} \cap \lambda_2^{(0.9e^{i(0.9)2\pi}, 0.9e^{i(0.9)2\pi}, 0.9e^{i(0.9)2\pi})} &= \{u_2\}, \\ \tau_2^{(0.4e^{i(0.4)2\pi}, 0.4e^{i(0.4)2\pi}, 0.4e^{i(0.4)2\pi})} \cap \lambda_5^{(0.4e^{i(0.4)2\pi}, 0.4e^{i(0.4)2\pi}, 0.4e^{i(0.4)2\pi})} &= \{u_3\}, \\ \tau_3^{(0.9e^{i(0.9)2\pi}, 0.9e^{i(0.9)2\pi}, 0.9e^{i(0.9)2\pi})} \cap \lambda_3^{(0.9e^{i(0.9)2\pi}, 0.9e^{i(0.9)2\pi}, 0.9e^{i(0.9)2\pi})} &= \{u_2\}, \\ \tau_3^{(0.4e^{i(0.4)2\pi}, 0.4e^{i(0.4)2\pi}, 0.4e^{i(0.4)2\pi})} \cap \lambda_5^{(0.4e^{i(0.4)2\pi}, 0.4e^{i(0.4)2\pi}, 0.4e^{i(0.4)2\pi})} &= \{u_4\}, \\ \tau_4^{(0.4e^{i(0.4)2\pi}, 0.4e^{i(0.4)2\pi}, 0.4e^{i(0.4)2\pi})} \cap \lambda_5^{(0.4e^{i(0.4)2\pi}, 0.4e^{i(0.4)2\pi}, 0.4e^{i(0.4)2\pi})} &= \{u_1\}, \\ \tau_4^{(0.9e^{i(0.9)2\pi}, 0.9e^{i(0.9)2\pi}, 0.9e^{i(0.9)2\pi})} \cap \lambda_3^{(0.9e^{i(0.9)2\pi}, 0.9e^{i(0.9)2\pi}, 0.9e^{i(0.9)2\pi})} &= \{u_2\}. \end{aligned}$$

Hence, $(T_r(\mathcal{H}))^{(0.9e^{i(0.9)2\pi}, 0.9e^{i(0.9)2\pi}, 0.9e^{i(0.9)2\pi})} = \{\tau_1^{(0.9e^{i(0.9)2\pi}, 0.9e^{i(0.9)2\pi}, 0.9e^{i(0.9)2\pi})}, \tau_2^{(0.9e^{i(0.9)2\pi}, 0.9e^{i(0.9)2\pi}, 0.9e^{i(0.9)2\pi})}, \tau_3^{(0.9e^{i(0.9)2\pi}, 0.9e^{i(0.9)2\pi}, 0.9e^{i(0.9)2\pi})}, \tau_4^{(0.9e^{i(0.9)2\pi}, 0.9e^{i(0.9)2\pi}, 0.9e^{i(0.9)2\pi})}\} = \{\{u_1, u_3\}, \{u_2\}, \{u_2\}, \{u_2\}\} = \{\{u_1, u_3\}, \{u_2\}\} = T_r(\mathcal{H}^{(0.9e^{i(0.9)2\pi}, 0.9e^{i(0.9)2\pi}, 0.9e^{i(0.9)2\pi})})$.

Table 3. Incidence matrix of \mathcal{H} .

$I_{\mathcal{H}}$	λ_1	λ_2	λ_3	λ_4	λ_5
u_1	$0.7e^{i(0.7)2\pi}$	$0.9e^{i(0.9)2\pi}$	$(0, 0, 1)$	$(0, 0, 1)$	$0.4e^{i(0.4)2\pi}$
u_2	$0.7e^{i(0.7)2\pi}$	$0.9e^{i(0.9)2\pi}$	$0.9e^{i(0.9)2\pi}$	$0.7e^{i(0.7)2\pi}$	$(0, 0, 1)$
u_3	$(0, 0, 1)$	$(0, 0, 1)$	$0.9e^{i(0.9)2\pi}$	$0.7e^{i(0.7)2\pi}$	$0.4e^{i(0.4)2\pi}$
u_4	$(0, 0, 1)$	$0.4e^{i(0.4)2\pi}$	$(0, 0, 1)$	$0.4e^{i(0.4)2\pi}$	$0.4e^{i(0.4)2\pi}$

Theorem 3. Let $\mathcal{H} = (\mathcal{N}, \lambda)$ be a CNHG and $j \in \mathcal{J}$. If $\xi \in T_r(\mathcal{H})$ with $j \in \text{supp}(\xi)$, then there exists an hyperedge $\rho \in \lambda$ such that

- (i) $\rho(j) = h(\rho)$,
- (ii) For $\lambda_1 \in \lambda$ such that $h(\lambda_1) \geq h(\rho)$, $\lambda_1^{h(\lambda_1)} \not\subseteq \rho^{h(\rho)}$,
- (iii) $\mathcal{E}_k \not\subseteq \rho^{h(\rho)}$, where \mathcal{E}_k is an arbitrary hyperedge of $\mathcal{H}^{h(\rho)}$,
- (iv) $\xi(j) = \rho(j)$.

Corollary 2. Let $\mathcal{H} = (\mathcal{N}, \lambda)$ be a CNHG. If $\lambda_1 \in \lambda$ satisfies $h(\lambda_1) \geq h(\rho)$, $\lambda_1^{h(\lambda_1)} \not\subseteq \rho^{h(\rho)}$, then $h(\lambda_1) \in \mathcal{F}_s(\mathcal{H})$.

4. Applications

In this section, we propose the modeling of overlapping communities that exist in different social networks through CNHGs. These communities intersect each other when one person belongs to multiple communities at the same time. The vertices of the CNHGs are used to represent different communities and the hyperlinks of individuals who participate in more than one community are illustrated using hyperedges of CNHGs. Here, we define a score function for ranking CNSs by considering the truth, indeterminacy, and falsity degrees.

Definition 28. Let $N = (te^{i\phi}, ie^{i\varphi}, fe^{i\psi})$ be a CNN, the score function S of N is defined as,

$$S(N) = \frac{1 + t - 2i - f}{2} + \frac{2\pi + \phi - 2\varphi - \psi}{4\pi},$$

where $S(N) \in [-2, 2]$.

4.1. Modeling of Intersecting Research Communities

Research scholars have different fields of interest and these multiple research interests make researchers parts of different research communities at the same time. For example, Mathematics, Physics, and Computer Science may be the fields of interest for one researcher at the same time. That is how overlapping communities occur in research fields. We use a CNHG to model intersecting communities that emerge in different research fields. The vertices of a CNHG represent the different research fields and these fields are connected through an hyperedge that represents a research scholar who works in the corresponding fields. The corresponding model of intersecting research communities is shown in Figure 8.

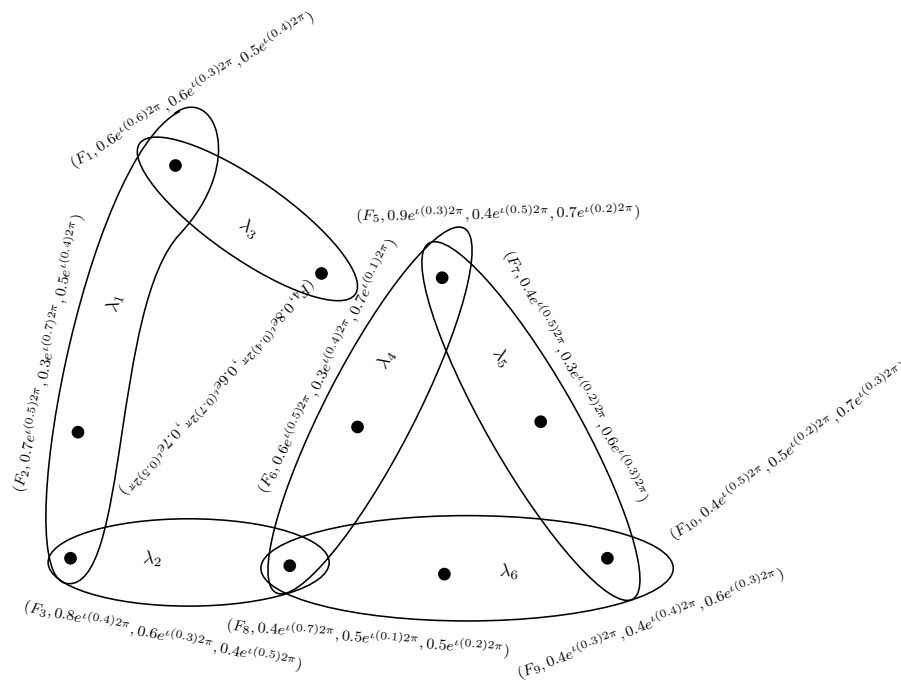

Figure 8. Intersecting research communities.

Here, the truth, indeterminacy, and falsity degrees of each vertex represent the accepted, submitted, and rejected articles of that community in a specific period of time that is represented by the phase terms. This inconsistent information with periodic nature is given in Table 4.

Table 4. Periodic behavior of research communities.

Research Fields	Accepted Articles	Submitted Articles	Rejected Articles
F_1	$0.6e^{i(0.6)2\pi}$	$0.6e^{i(0.3)2\pi}$	$0.5e^{i(0.4)2\pi}$
F_2	$0.7e^{i(0.5)2\pi}$	$0.3e^{i(0.7)2\pi}$	$0.5e^{i(0.4)2\pi}$
F_3	$0.8e^{i(0.4)2\pi}$	$0.6e^{i(0.3)2\pi}$	$0.4e^{i(0.5)2\pi}$
F_4	$0.8e^{i(0.4)2\pi}$	$0.6e^{i(0.7)2\pi}$	$0.7e^{i(0.5)2\pi}$
F_5	$0.9e^{i(0.3)2\pi}$	$0.4e^{i(0.5)2\pi}$	$0.7e^{i(0.2)2\pi}$
F_6	$0.6e^{i(0.5)2\pi}$	$0.3e^{i(0.4)2\pi}$	$0.7e^{i(0.1)2\pi}$
F_7	$0.4e^{i(0.5)2\pi}$	$0.3e^{i(0.2)2\pi}$	$0.6e^{i(0.3)2\pi}$
F_8	$0.4e^{i(0.7)2\pi}$	$0.5e^{i(0.1)2\pi}$	$0.5e^{i(0.2)2\pi}$
F_9	$0.4e^{i(0.3)2\pi}$	$0.4e^{i(0.4)2\pi}$	$0.6e^{i(0.3)2\pi}$
F_{10}	$0.4e^{i(0.5)2\pi}$	$0.5e^{i(0.2)2\pi}$	$0.7e^{i(0.3)2\pi}$

Please note that number of accepted, submitted, and rejected articles of community F_1 are 0.6, 0.6, and 0.5, and the corresponding behaviors repeat after $(0.6)2\pi$, $(0.3)2\pi$, and $(0.4)2\pi$ periods of time, respectively, and so on. The research scholar λ_1 belongs to communities F_1 , F_2 , and F_3 as he shares

these three fields of interest. Similarly, λ_2 belongs to F_3 and F_8 and the communities overlap with each other. The indeterminate information about a researcher is calculated using CNRs given as,

$$\begin{aligned} \lambda_1(\{F_1, F_2, F_3\}) &= (0.6e^{t(0.2)2\pi}, 0.3e^{t(0.3)2\pi}, 0.4e^{t(0.2)2\pi}), \\ \lambda_2(\{F_3, F_8\}) &= (0.4e^{t(0.3)2\pi}, 0.5e^{t(0.1)2\pi}, 0.4e^{t(0.2)2\pi}), \\ \lambda_3(\{F_1, F_4\}) &= (0.6e^{t(0.3)2\pi}, 0.4e^{t(0.2)2\pi}, 0.7e^{t(0.4)2\pi}), \\ \lambda_4(\{F_5, F_8, F_6\}) &= (0.4e^{t(0.3)2\pi}, 0.3e^{t(0.1)2\pi}, 0.7e^{t(0.2)2\pi}), \\ \lambda_5(\{F_5, F_7, F_{10}\}) &= (0.4e^{t(0.3)2\pi}, 0.3e^{t(0.2)2\pi}, 0.7e^{t(0.3)2\pi}), \\ \lambda_6(\{F_8, F_9, F_{10}\}) &= (0.4e^{t(0.3)2\pi}, 0.4e^{t(0.1)2\pi}, 0.7e^{t(0.3)2\pi}). \end{aligned}$$

It shows the researcher represented by λ_1 has 0.6 accepted, 0.3 submitted, and 0.4 rejected articles within some specific periods of time. The line graph of intersecting communities as given in Figure 8 is shown in Figure 9. Here, the nodes represent the individuals and the communities are described by the links of same color.

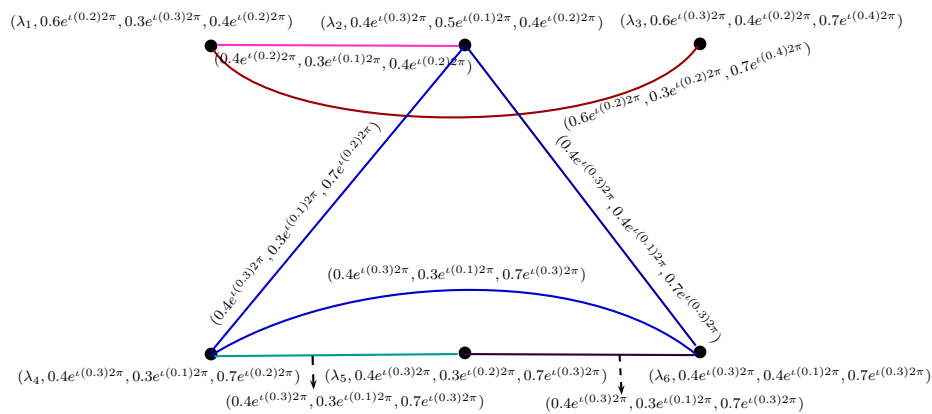

Figure 9. Line graph of intersecting research communities.

This line graph represents the relationships between researchers. The researchers that belong to the community F_3 are connected through pink edge, members of F_1 are linked by red edge, members of F_{10} are connected by purple links, cyan and blue edges are used to represent the relation between the members of F_5 and F_8 , respectively. The absence of $F_2, F_4, F_6, F_7,$ and F_9 in the above graph shows that these communities share no common researchers as their members. The membership degrees of each edge of this line graph represent the collective work of corresponding researchers. The score functions and choice values of a CNG are given as,

$$\begin{aligned} S_{jk} &= \frac{1}{2}[1 + t_{jk} - 2i_{jk} - f_{jk}] + \frac{1}{4\pi}[2\pi + \phi_{jk} - 2\varphi_{jk} - \psi_{jk}], \\ C_j &= \sum_k S_{jk} + \frac{1}{2}[1 + t_j - 2i_j - f_j] + \frac{1}{4\pi}[2\pi + \phi_j - 2\varphi_j - \psi_j], \end{aligned}$$

respectively. The score functions and choice values of researchers represented by the line graph given in Figure 9 are calculated in Table 5.

Table 5. Score and choice values of complex neutrosophic line graph.

S_{jk}	λ_1	λ_2	λ_3	λ_4	λ_5	λ_6	C_j
λ_1	0	0.600	0.350	0	0	0	0.450
λ_2	0.600	0	0	0.500	0	0.350	0.900
λ_3	0.350	0	0	0	0	0	-0.350
λ_4	0	0.500	0	0	0.450	0.450	0.900
λ_5	0	0	0	0.450	0	0.450	0.200
λ_6	0	0.350	0	0	0.450	0	-0.050

The choice values of Table 5 show that λ_2 and λ_4 are the most active and efficient participants of these research communities. Also, the score values show that λ_1 and λ_2 are the members with the strongest interactions between them and can share the most fruitful ideas relevant to their corresponding research fields being the participants of intersecting research communities. The procedure adopted in our application is described in Algorithm 1.

Algorithm 1: Selection of a systematic member from intersecting research communities

1. Input the set of vertices (research communities) F_1, F_2, \dots, F_j .
 2. Input the CNS N of vertices such that $N(F_k) = (t_k e^{i\phi_k}, i_k e^{i\phi_k}, f_k e^{i\psi_k}), 1 \leq k \leq j, 0 \leq t_k + i_k + f_k \leq 3$.
 3. Input the number of hyperedges (researchers) r of a CNHG $\mathcal{H} = (\mathcal{N}, \lambda)$.
 4. Input the membership degrees of the hyperedges E_1, E_2, \dots, E_r .
 5. Construct a complex neutrosophic line graph $l(\mathcal{H}) = (\mathcal{N}_l, \lambda_l)$ whose vertices are the r hyperedges E_1, E_2, \dots, E_n such that $\mathcal{N}_l(E_n) = \lambda(E_n)$.
 6. If $|supp(\lambda_j) \cap supp(\lambda_k)| \geq 1$, then draw an edge between E_j and E_k and $\lambda_l(E_j E_k) = (\min\{t_\lambda(E_j), t_\lambda(E_k)\} e^{i \min\{\phi_\lambda(E_j), \phi_\lambda(E_k)\}}, \min\{i_\lambda(E_j), i_\lambda(E_k)\} e^{i \min\{\phi_\lambda(E_j), \phi_\lambda(E_k)\}}, \max\{f_\lambda(E_j), f_\lambda(E_k)\} e^{i \max\{\psi_\lambda(E_j), \psi_\lambda(E_k)\}})$.
 7. Input the adjacency matrix $I = [(t_{mn}, i_{mn}, f_{mn})]_{r \times r}$ of vertices of complex neutrosophic line graph $l(\mathcal{H})$.
 8. **do** m from 1 $\rightarrow r$
 9. $C_m = 0$
 10. **do** n from 1 $\rightarrow r$
 11. $S_{mn} = \frac{1}{2}[1 + t_{mn} - 2i_{mn} - f_{mn}] + \frac{1}{4\pi}[2\pi + \phi_{mn} - 2\varphi_{mn} - \psi_{mn}]$
 12. $C_m = C_m + S_{mn}$
 13. **end do**
 14. $C_m = C_m + \frac{1}{2}[1 + t_m - 2i_m - f_m] + \frac{1}{4\pi}[2\pi + \phi_m - 2\varphi_m - \psi_m]$
 15. **end do**
 16. The vertex with highest choice value in $l(\mathcal{H})$ is the most effective researcher among all the participants.
-

4.2. Influence of Modern Teaching Strategies on Educational Institutes

Teaching strategies are defined as the methods, techniques, and procedures that an educational institute use to improve its performance. An educational institute can be judged according to its inputs and outputs that are highly affected through the teaching techniques adopted by that institute. Traditional teaching methods mainly depends on textbooks and emphasizes on basic skills while the modern techniques are based on technical approach and emphasizes on creative ideas. Thus, modern teaching is very important and most effective in this technological era. Presently, educational institutes are modified through modern teaching strategies to enhance their outputs and these modern techniques play a vital role for teachers to explain the concepts in more effective and radiant manner.

Here, we consider a CNHG model $\mathcal{H} = (\mathcal{N}, \lambda)$ to study the influence of modern teaching methods on a specific group of institutes in a time frame of 12 months. The vertices of a CNHG represent the different teaching strategies and these techniques are grouped through an hyperedge if they are applied in the same institute. Since more than one institute can adopt a same strategy so the intersecting communities occur in this case. Each strategy is different form the other in terms of its positive, neutral, and negative impacts on students. The truth, indeterminacy, and falsity degrees of each strategy represent the positive, neutral, and negative effects of the corresponding technique on some institute during the time period of 12 months. The indeterminate information about modern teaching strategies with periodic nature is given in Table 6.

Table 6. Impacts of modern teaching strategies.

Teaching Strategy	Positive Effects	Neutral Behavior	Negative Effects
Brain storming	$0.8e^{t(10/12)2\pi}$	$0.7e^{t(7/12)2\pi}$	$0.1e^{t(1/12)2\pi}$
Micro technique	$0.6e^{t(4/12)2\pi}$	$0.6e^{t(3/12)2\pi}$	$0.1e^{t(1/12)2\pi}$
Mind map	$0.6e^{t(6/12)2\pi}$	$0.3e^{t(5/12)2\pi}$	$0.7e^{t(7/12)2\pi}$
Cooperative learning	$0.8e^{t(10/12)2\pi}$	$0.7e^{t(7/12)2\pi}$	$0.1e^{t(1/12)2\pi}$
Dramatization	$0.5e^{t(3/12)2\pi}$	$0.3e^{t(3/12)2\pi}$	$0.2e^{t(2/12)2\pi}$
Educational software	$0.8e^{t(10/12)2\pi}$	$0.3e^{t(3/12)2\pi}$	$0.2e^{t(1/12)2\pi}$

Please note that the membership values $(0.8e^{t(10/12)2\pi}, 0.7e^{t(7/12)2\pi}, 0.1e^{t(1/12)2\pi})$ of brainstorming show that this teaching technique has positive influence with degree 0.8 and this effect spreads over ten months, the indeterminacy value represents the neutral effect or indeterminate behavior with degree 0.7 with time interval of seven months, and the falsity degree 0.1 illustrates some negative effects of this strategy that spreads over one month. Similarly, the effects of all other strategies can be seen form Table 6 along with their time periods. An hyperedge of a CNHG represent some institute in which the corresponding techniques are applied. The model of CNHG grouping these strategies is shown in Figure 10.

Here, each hyperedge represents an institute which groups the strategies adopted by that institute and the membership degrees of each hyperedge represent the combined effects of teaching strategies on corresponding institute. We now want to find a strategy or a collection of those techniques which are easy to apply, less in cost, and have higher positive effects on the performance of educational institutes. To find such methods, we calculate the minimal transversal of CNHG given in Figure 10 using Algorithm 2.

Algorithm 2: Find a minimal complex neutrosophic transversal

1. Input the CNSs $\lambda_1, \lambda_2, \dots, \lambda_r$ of hyperedges.
 2. Input the membership degrees of hyperedges.
 3. **do** j from $1 \rightarrow r$
 4. $S_j = \lambda_j^{h(\lambda_j)}$
 5. $S = S \cup S_j$
 6. **end do**
 7. Take τ as the CNSS with support S .
-

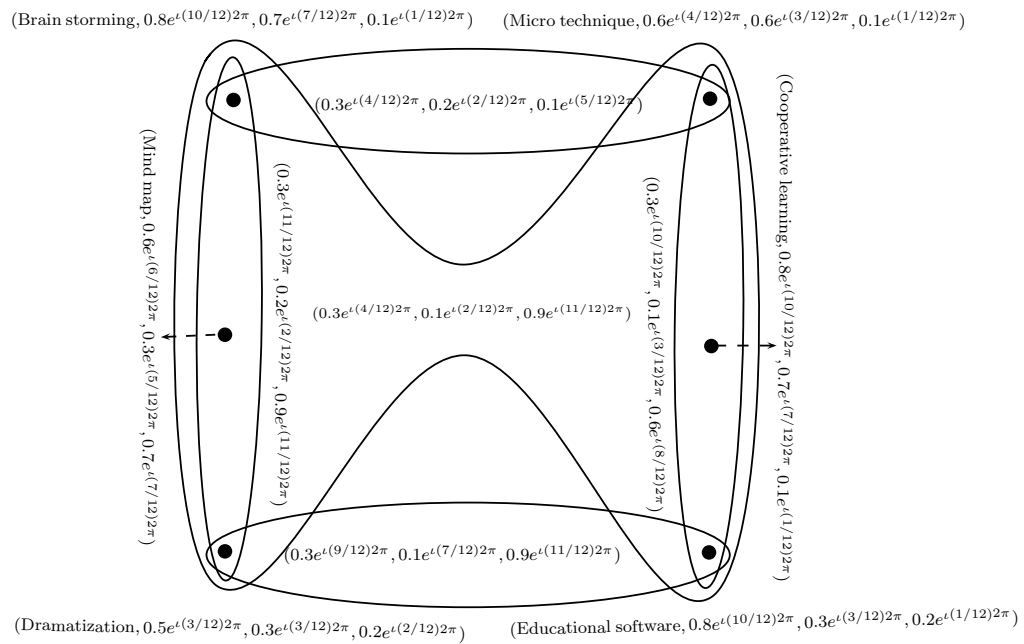

Figure 10. Complex neutrosophic hypergraph model of modern teaching strategies.

By following Algorithm 2, we construct a minimal CNT of $\mathcal{H} = (\mathcal{N}, \lambda)$.

We have five hyperedges E_1, E_2, E_3, E_4, E_5 of \mathcal{H} . The heights of all complex neutrosophic hyperedges are given as,

$$\begin{aligned}
 h(\lambda_1) &= (0.8e^{t(10/12)2\pi}, 0.7e^{t(7/12)2\pi}, 0.1e^{t(1/12)2\pi}), \lambda_1^{h(\lambda_1)} = \{\text{Brain storming}\}, \\
 h(\lambda_2) &= (0.7e^{t(10/12)2\pi}, 0.6e^{t(7/12)2\pi}, 0.1e^{t(1/12)2\pi}), \lambda_2^{h(\lambda_2)} = \{\text{Brain storming}\}, \\
 h(\lambda_3) &= (0.8e^{t(10/12)2\pi}, 0.3e^{t(3/12)2\pi}, 0.2e^{t(1/12)2\pi}), \lambda_3^{h(\lambda_3)} = \{\text{Educational software}\}, \\
 h(\lambda_4) &= (0.8e^{t(10/12)2\pi}, 0.7e^{t(7/12)2\pi}, 0.1e^{t(1/12)2\pi}), \lambda_4^{h(\lambda_4)} = \{\text{Cooperative learning}\}, \\
 h(\lambda_5) &= (0.8e^{t(10/12)2\pi}, 0.7e^{t(7/12)2\pi}, 0.1e^{t(1/12)2\pi}), \lambda_5^{h(\lambda_5)} = \{\text{Brainstorming, Cooperative learn.}\}.
 \end{aligned}$$

$$\begin{aligned}
 S &= \lambda_1^{h(\lambda_1)} \cup \lambda_2^{h(\lambda_2)} \cup \lambda_3^{h(\lambda_3)} \cup \lambda_4^{h(\lambda_4)} \cup \lambda_5^{h(\lambda_5)} \\
 &= \{\text{Brainstorming, Cooperative learning, Educational software}\}.
 \end{aligned}$$

The CNS with support S is given as,

$$\{ (\text{Brain storming}, 0.8e^{t(10/12)2\pi}, 0.7e^{t(7/12)2\pi}, 0.1e^{t(1/12)2\pi}), (\text{Cooperative learning}, 0.8e^{t(10/12)2\pi}, 0.7e^{t(7/12)2\pi}, 0.1e^{t(1/12)2\pi}), (\text{Educational software}, 0.8e^{t(10/12)2\pi}, 0.3e^{t(3/12)2\pi}, 0.2e^{t(1/12)2\pi}) \},$$

which is the minimal CNT of $\mathcal{H} = (\mathcal{N}, \lambda)$ and it shows that brainstorming, cooperative learning, and educational software are the most influential teaching strategies for the given period of time. Thus, for some certain period of time, an influential and effective collection of modern teaching techniques can be determined.

5. Comparative Analysis

A CNS is characterized by truth, indeterminacy, and falsity degrees which are the combination of real-valued amplitude terms and complex-valued phase terms. To prove the flexibility and generalization of our proposed model CNHGs, we propose the modeling of social networks through CNGs, CFHG, and CIFHG. Consider a part of the social network as described in Section 4.2. Here, we consider only three modern techniques that are brainstorming, cooperative learning, and educational software. A CFHG model of these techniques is given in Figure 11.

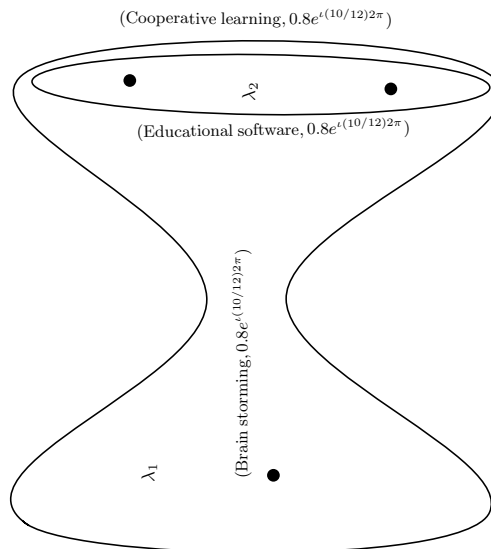

Figure 11. Complex fuzzy hypergraph model of teaching techniques.

Please note that a CFHG model of intersecting techniques just illustrates the positive effects of these methods during a specific time interval. We see that a CFHG model fails to describe the negative effects of teaching strategies. To describe the positive as well as negative effects of these strategies, we use a CIFHG model as shown in Figure 12.

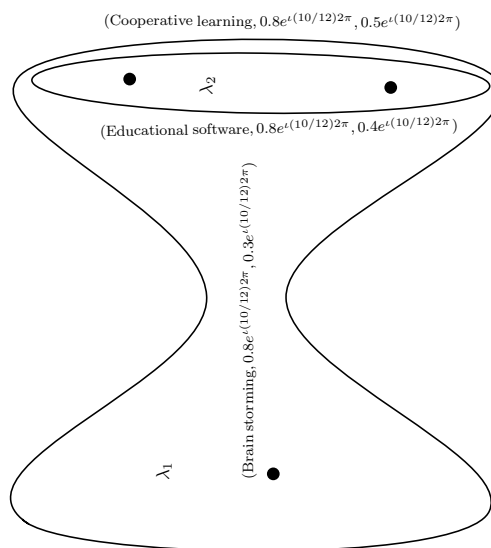

Figure 12. Complex intuitionistic fuzzy hypergraph model of teaching techniques.

This shows that a CIFHG model can well describe the positive and negative impacts of modern techniques on educational institutes but it cannot handle the situations when there is no effect during

some time interval or there is indeterminate behavior. To handle such type of situations, we use a complex neutrosophic model as shown in Figure 13.

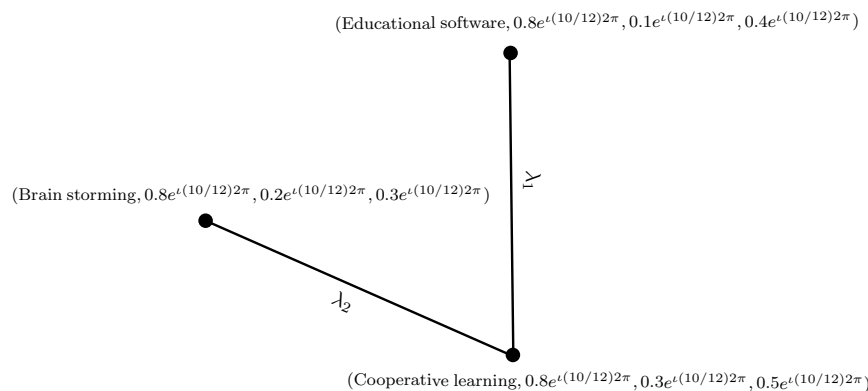

Figure 13. Complex neutrosophic graph model of modern techniques.

Please note that a CNG model describe the truth, indeterminacy, and falsity degrees of impacts of teaching methods for some specific interval of time and proves to be a more generalized model as compared to CF and CIF models. Figure 13 shows that λ_1 institute adopts the modern methods such as educational software and cooperative learning. Now, if an institute wants to use more than two strategies then this model fails to model the required situation. For example, λ_1 wants to adopt the all three modern teaching techniques. Then, we cannot model this social network using a simple graph. To handle such type of difficulties, i.e., for the modeling of indeterminate information with periodic nature existing in social hypernetworks, we have proposed CNHGs. The applicability and flexibility of our proposed model can be seen from Table 7.

Table 7. Comparative analysis.

Models	Edges	Hyperedge Containing Three Strategies	Positive Effect	Neutral Behavior	Negative Effect
CFHG model	λ_1	{Brain storming, Cooperative learning, Educational software}	$0.8e^{t(10/12)2\pi}$ $0.8e^{t(10/12)2\pi}$ $0.8e^{t(10/12)2\pi}$	- - -	- - -
CIFHG model	λ_1	{Brain storming, Cooperative learning, Educational software}	$0.8e^{t(10/12)2\pi}$ $0.8e^{t(10/12)2\pi}$ $0.8e^{t(10/12)2\pi}$	- - -	$0.3e^{t(10/12)2\pi}$ $0.5e^{t(10/12)2\pi}$ $0.4e^{t(10/12)2\pi}$
CNG model	Cannot combine more than two elements	- - -	$0.8e^{t(10/12)2\pi}$ $0.8e^{t(10/12)2\pi}$ $0.8e^{t(10/12)2\pi}$	$0.2e^{t(10/12)2\pi}$ $0.3e^{t(10/12)2\pi}$ $0.1e^{t(10/12)2\pi}$	$0.3e^{t(10/12)2\pi}$ $0.5e^{t(10/12)2\pi}$ $0.4e^{t(10/12)2\pi}$
CNHG model	λ_1	{Brain storming, Cooperative learning, Educational software}	$0.8e^{t(10/12)2\pi}$ $0.8e^{t(10/12)2\pi}$ $0.8e^{t(10/12)2\pi}$	$0.2e^{t(10/12)2\pi}$ $0.3e^{t(10/12)2\pi}$ $0.1e^{t(10/12)2\pi}$	$0.3e^{t(10/12)2\pi}$ $0.5e^{t(10/12)2\pi}$ $0.4e^{t(10/12)2\pi}$

6. Discussions

It can be seen clearly from Table 7 that all existing models, including CNGs, CFHGs, and CIFHGs lack some information to handle the periodic and indeterminate data in case of hypernetworks. Table 7 shows that a CFHG model can illustrate the combine effects of three different techniques through a hyperedge. The truth degrees $0.8e^{t(10/12)2\pi}$ of these techniques show that these methods provide very

good influence which spread over ten months but this model fails to describe the negative effects of some teaching technique happening periodically. A CIFHG model is then used to overcome such type of deficiencies. The falsity degree $0.4e^{i(10/12)2\pi}$ of “educational software” shows that this technique has some negative effects that spread over ten months. The failure of CIFHG model appears when neither positive nor negative effects or neutral effects of periodic nature are experienced because some information does not have only truth and falsity degrees but also some indeterminacy degrees which are independent of each other. For example, a 20° temperature in summer means a cool day and in winter means a warm day but neither cool nor warm day in spring. This phenomenon indicates that some real-life situations may have indeterminacy and periodicity along with uncertainty. To handle such type of phenomena, a CNS model is more flexible and applicable. As we have seen from Table 7 that a CNG illustrates the positive and negative as well as indeterminate effects of under consideration teaching strategies applied to different institutes. The membership degrees $(0.8e^{i(10/12)2\pi}, 0.2e^{i(10/12)2\pi}, 0.3e^{i(10/12)2\pi})$ show that some particular technique has 0.8 positive effects, 0.2 neutral effects, and 0.3 negative effects on some institute and all these effects spread over ten months. The main drawback of a CNG model is that a single edge can connect only two vertices, i.e., if we consider the teaching techniques as vertices and these vertices (techniques) are connected through an edge if they are adopted by a same institute. Then, a CNG model cannot illustrate the situation when more than two techniques are applied to a single institute. In modeling of such type of hypernetworks with indeterminacy of periodic nature, we propose a CNHG model. It can be seen clearly from Table 7 that our proposed model is more generalized framework as it does not only deal the reductant nature of imprecise information but also includes the benefits of hypergraphs. Hence, a CNHG model combines the fruitful effects of CNSs and hypergraph theory.

7. Conclusions and Future Directions

A CNS extends the concept of SVNS from real unit interval $[0, 1]$ to the complex plane and is used to represent two-dimensional imprecise and indeterminate information. A CNS plays a vital role in modeling the real-life applications where the truth, indeterminacy, and falsity degrees of given data are periodic in nature. Thus, a CNS is more effective and generalized framework to deal the periodic nature of indeterminacy where the CFS and CIFS fail. For example, a wave particle such as an electron can be in two different positions at the same time and the CFS is not able to deal with this phenomenon. A CIFS can only represent the information involving the information of the type: “yes” or “no” occurring periodically. These models fail to deal the information that is neither true nor false or true and false at the same time. A CNS model is more effectively used to deal such type of situations in our daily life. In this paper, we have defined CNHGs which generalize the concepts of CFHGs and CIFHGs. We have studied the level hypergraphs, lower truncation, upper truncation, and transition levels of CNHGs. Furthermore, we have defined T -related CNHGs and discussed their certain properties. We have illustrated the proposed ideas through some concrete examples. Moreover, we have presented the modeling of certain social networks with intersecting communities using CNHGs. We have determined a strong participant in overlapping research communities by defining the score and choice values of CNGs. We have also determined the collection of most influential teaching strategies using the minimal transversals of CNHGs. Finally, we have proved the novelty and applicability of this work by giving a brief comparison of our proposed model with other existing models. We have seen that the main drawback of CFHG models is that they cannot deal the falsity and indeterminate information existing in a periodic manner. Similarly, a CIFHG fails to handle the situations when the indeterminate and inconsistent information is happening repeatedly. The proposed analysis proved the dominance of CNHG model to all other existing models by comparing the applicability of CFHGs, CIFHGs, CNGs, and CNHGs using numeric examples as well as some theoretic results.

We aim to broaden our study to (1) Complex bipolar fuzzy hypergraphs, (2) Complex bipolar neutrosophic hypergraphs, (3) Complex fuzzy soft hypergraphs and (4) Complex Pythagorean fuzzy soft hypergraphs.

References

1. Zadeh, L.A. Fuzzy sets. *Inf. Control* **1965**, *8*, 338–353. [[CrossRef](#)]
2. Atanassov, K.T. Intuitionistic fuzzy sets. *Fuzzy sets. Syst.* **1986**, *20*, (1)87-96. (In Bulgarian) [[CrossRef](#)]
3. Liu, X.; Kim, H.; Feng, F.; Alcantud, J. Centroid transformations of intuitionistic fuzzy values based on aggregation operators. *Mathematics* **2018**, *6*, 215. [[CrossRef](#)]
4. Feng, F.; Fujita, H.; Ali, M.I.; Yager, R.R.; Liu, X. Another view on generalized intuitionistic fuzzy soft sets and related multiattribute decision making methods. *IEEE Trans. Fuzzy Syst.* **2018**, *27*, 474–488. [[CrossRef](#)]
5. Smarandache, F. *Neutrosophy Neutrosophic Probability; Set and Logic*; American Research Press: Rehoboth, DE, USA, 1998.
6. Wang, H.; Smarandache, F.; Zhang, Y.Q.; Sunderraman, R. Single valued neutrosophic sets. *Multispace Multistructure* **2010**, *4*, 410–413.
7. Ye, J. Multicriteria decision-making method using the correlation coefficient under singlevalued neutrosophic environment. *Int. J. General Syst.* **2013**, *42*, 386–394. [[CrossRef](#)]
8. Ye, J. Single-valued neutrosophic minimum spanning tree and its clustering method. *J. Intell. Syst.* **2014**, *23*, 311–324. [[CrossRef](#)]
9. Ye, J. A multicriteria decision-making method using aggregation operators for simplified neutrosophic sets. *J. Intell. Fuzzy Syst.* **2014**, *26*, 2459–2466.
10. Ramot, D.; Milo, R.; Friedman, M.; Kandel, A. Complex fuzzy sets. *IEEE Trans. Fuzzy Syst.* **2002**, *10*, 171–186. [[CrossRef](#)]
11. Ramot, D.; Friedman, M.; Langholz, G.; Kandel, A. Complex fuzzy logic. *IEEE Trans. Fuzzy Syst.* **2003**, *11*, 450–461. [[CrossRef](#)]
12. Yazdanbakhsh, O.; Dick, S. A systematic review of complex fuzzy sets and logic. *Fuzzy Sets. Syst.* **2018**, 338, 1–22. [[CrossRef](#)]
13. Alkouri, A.; Salleh, A. Complex intuitionistic fuzzy sets. *AIP Conf. Proc.* **2012**, *14*, 464–470.
14. Ali, M.; Smarandache, F. Complex neutrosophic set. *Neural Comput. Appl.* **2017**, *28*, 1817–1834. [[CrossRef](#)]
15. Rosenfeld, A. Fuzzy graphs. In *Fuzzy Sets and Their Applications*; Zadeh, L.A., Fu, K.S., Shimura, M., Eds.; Academic Press: New York, NY, USA, 1975; pp. 77–95.
16. Bhattacharya, P. Some remarks on fuzzy graphs. *Pattern Recognit. Lett.* **1987**, *6*, 297–302. [[CrossRef](#)]
17. Thirunavukarasu, P.; Suresh, R.; Viswanathan, K.K. Energy of a complex fuzzy graph. *Int. J. Math. Sci. Eng. Appl.* **2016**, *10*, 243–248.
18. Parvathi, R.; Karunambigai, M.G. Intuitionistic fuzzy graphs. In *Computational Intelligence, Theory and Applications*; Reusch, B., Ed.; Springer: Berlin/Heidelberg, Germany, 2006.
19. Yaqoob, N.; Gulistan, M.; Kadry, S.; Wahab, H. Complex intuitionistic fuzzy graphs with application in cellular network provider companies. *Mathematics* **2019**, *7*, 35. [[CrossRef](#)]
20. Broumi, S.; Talea, M.; Bakali, A.; Smarandache, F. Single valued neutrosophic graphs. *J. New Theory* **2016**, *10*, 86–101.
21. Akram, M.; Shahzadi, G. Operations on single-valued neutrosophic graphs. *J. Uncertain Syst.* **2017**, *11*, 176–196.
22. Akram, M. Single-valued neutrosophic planar graphs. *Int. J. Algebra Stat.* **2016**, *5*, 157–167. [[CrossRef](#)]
23. Akram, M.; Shahzadi, S. Neutrosophic soft graphs with application. *J. Intell. Fuzzy Syst.* **2017**, *32*, 841–858. [[CrossRef](#)]
24. Yaqoob, N.; Akram, M. Complex neutrosophic graphs. *Bull. Comput. Appl. Math.* **2018**, *6*, 85–109.
25. Berge, C. *Graphs and Hypergraphs*; North-Holland Publishing Company: Amsterdam, The Netherlands, 1973.
26. Kaufmann, A. *Introduction a la Thiorie des Sous-Ensemble Flous, 1*; Masson: Paris, France, 1977.
27. Lee-kwang, H.; Lee, K.-M. Fuzzy hypergraph and fuzzy partition. *IEEE Trans. Syst. Man Cybern.* **1995**, *25*, 196–201. [[CrossRef](#)]

28. Mordeson, J.N.; Nair, P.S. *Fuzzy Graphs and Fuzzy Hypergraphs*, 2nd ed.; Physica Verlag: Heidelberg, Germany, 1998.
29. Goetschel, R.H.; Craine, W.L.; Voxman, W. Fuzzy transversals of fuzzy hypergraphs. *Fuzzy Sets Syst.* **1996**, *84*, 235–254. [[CrossRef](#)]
30. Parvathi, R.; Thilagavathi, S.; Karunambigai, M.G. Intuitionistic fuzzy hypergraphs. *Cybern. Inf. Technol.* **2009**, *9*, 46–53.
31. Akram, M.; Dudek, W.A. Intuitionistic fuzzy hypergraphs with applications. *Inf. Sci.* **2013**, *218*, 182–193. [[CrossRef](#)]
32. Parvathi, R.; Akram, M.; Thilagavathi, S. Intuitionistic fuzzy shortest hyperpath in a network. *Inf. Process. Lett.* **2013**, *113*, 599–603.
33. Akram, M.; Shahzadi, S.; Saeid, A.B. Single-valued neutrosophic hypergraphs. *TWMS J. App. Eng. Math.* **2018**, *8*, 122–135. [[CrossRef](#)]
34. Akram, M.; Luqman, A. Intuitionistic single-valued neutrosophic hypergraphs. *Opsearch* **2017**, *54*, 799–815. [[CrossRef](#)]
35. Akram, M.; Luqman, A. Bipolar neutrosophic hypergraphs with applications. *J. Intell. Fuzzy Syst.* **2017**, *33*, 1699–1713. [[CrossRef](#)]
36. Akram, M.; Sarwar, M. Transversals of m -polar fuzzy hypergraphs with applications. *J. Intell. Fuzzy Syst.* **2017**, *33*, 351–364. [[CrossRef](#)]
37. Akram, M.; Luqman, A. Certain concepts of bipolar fuzzy directed hypergraphs. *Mathematics* **2017**, *5*, 17. [[CrossRef](#)]
38. Chen, S.M. Interval-valued fuzzy hypergraph and fuzzy partition. *IEEE Trans. Syst. Man Cybern.* **1997**, *27*, 725–733. [[CrossRef](#)] [[PubMed](#)]
39. Luqman, A.; Akram, M.; Koam, A.N. An m -polar fuzzy hypergraph model of granular computing. *Symmetry* **2019**, *11*, 483. [[CrossRef](#)]
40. Luqman, A.; Akram, M.; Koam, A.N. Granulation of hypernetwork models under the q -rung picture fuzzy environment. *Mathematics* **2019**, *7*, 496. [[CrossRef](#)]

Covering-Based Rough Fuzzy, Intuitionistic Fuzzy and Neutrosophic Nano Topology and Applications

Mohammed A. Al Shumrani, Selçuk Topal, Florentin Smarandache, Cenap Ozel

Mohammed A. Al Shumrani, Selçuk Topal, Florentin Smarandache, Cenap Ozel (2019). Covering-Based Rough Fuzzy, Intuitionistic Fuzzy and Neutrosophic Nano Topology and Applications. *IEEE Access* 7: 172839-172846, DOI: 10.1109/ACCESS.2019.2955923

ABSTRACT In recent years, “mathematical orientations on real-life problems”, which continue to increase, began to make a significant impact. Information systems for many decision-making problems consist of uncertain, incomplete, indeterminate and indiscernible structures and components. Classical set theory and interpretation methods fail to represent, express and solve the problems of these types or cause to make wrong decisions. For this reason, in this study, we provide definitions and methods to present information and problem representations in more detail and precision. This paper introduces three new topologies called covering-based rough fuzzy, covering-based rough intuitionistic fuzzy and covering-based rough neutrosophic nano topology. Some fundamental definitions such as open set, closed set, interior, closure and basis are given. Neutrosophic definitions and properties are mainly investigated. We give some real life applications of covering-based rough neutrosophic nano topology in the final part of the paper and an explanatory example of decision making application by defining core point.

INDEX TERMS Approximation space, core point, covering-based topology, fuzzy nano topology, fuzzy sets, intuitionistic nano topology, intuitionistic sets, neutrosophic nano topology, neutrosophic sets, rough decision making, location selection problem.

I. INTRODUCTION

The world of science has been working on and producing uncertain, incomplete, indeterminate, and indiscernible structures since crisp structures are understood to be unable to solve most real-life problems. In the last decade, uncertain representations, which have found enormous applications in engineering, medicine, computers, space research and even social sciences, make them feel that they will take more space in the future. In this sense, we would like to contribute to these recent developments with a study that includes both topology, generalized fuzzy and decision making. In this section, we will introduce the main uncertain information systems from the past to the present and explain why they need to work immediately after we talk about their applications.

Rough set theory is a way of representing and reasoning imprecision and uncertain information in data [1]. It deals with the approximation of sets constructed from descriptive data elements. This is helpful while aiming to explore decision rules, important features, and minimization of conditional attributes. While an information set represents the probabilistic uncertainty due to vagueness, rough set theory is widely used to represent imprecision due to incomplete knowledge.

Traditional rough approaches are based on equivalence relations, but this condition is not fulfilled in some cases. So, the approximations have been broadened to the similarity relation based rough sets [2], [3], the tolerance relation based rough sets [4], the dominance relation based rough sets [5], the arbitrary binary relation based rough sets [6], [7], [9]. An attractive and inherent research aim in rough set theory is to study rough set theory by means of topology. In fact,

Polkowski [10] made a sign that topological aspects of rough set theory were recognized early within the scope of topology of partitions. In 1988, Skowron [11] and Wiweger [12] discussed this issue separately for the traditional rough set theory. Topological spaces obtained by rough sets bottomed on information were systems putted up and characterized by Polkowski [13]. Kortelainen [14] paid regard to relationships among topological spaces, modified sets, and rough sets based on a pre-order. Skowron et al. [4], [15] generalized the classical approximation spaces to tolerance approximation spaces, and discussed the problems of attribute reduction in these spaces [16]. Lashin et al. [17] introduced the topology generated by a sub-base, and defined a topological rough membership function by the sub-base of the topology. In addition, connections between fuzzy rough set theory and fuzzy topology were also investigated [18]–[20]. General topology is accepted as an introduction to the understanding of topology, and the basis of general topology is the topological space, which is generally regarded as a representation of the universal space, and in particular the geometric shape in the concepts of mathematical analysis. The general topology has become the appropriate framework for each collection associated with relationships. Topology is also a strong mathematical instrument to examine into information systems, rough sets and so on [11], [17].

Recently, some of the works featured in the scope of this article and stand out are as follows. Zhan and his collaborations have studied on multi-criteria decision making problems of covering-based general multi-granulation intuitionistic fuzzy rough sets, covering based variable precision (I,T)-fuzzy rough sets, covering-based intuitionistic fuzzy rough sets, novel fuzzy rough set models [22]–[28]. Zhang, Yang and their collaborations have studied decision making problems of generalized interval neutrosophic rough sets, covering-based generalized IF rough sets, a hybrid model of single valued neutrosophic sets and rough sets, hesitant fuzzy linguistic rough set, and Merger and acquisition target selection based on interval neutrosophic multi-granulation rough sets [29]–[33].

This paper introduces some new topologies having properties of nano and covering. Furthermore, we give a decision making example of bus stations location on neutrosophic environment by using core points of the defined topologies.

Our main motivations in this study are that:

(i) We have shown that not only the classical approach spaces, but also the different mathematical structures of these spaces provide opportunities for decision-making.

(ii) The applications of approximation spaces and rough sets on decision making are generally interpreted in the field of medicine. In this work, we give an example of decision making on location selection. On the one hand, with the proposed new definitions, we presented wider versions of the approach space topologies and gave an example that can be applied to real life problems.

The proposed method has two important advantages.

(i) Firstly, since the method can be applied to neutrosophic data, more detailed evaluations can be made on the information.

(ii) Another important advantage is the complexity of the algorithm and the process step is not too much by disabling the process can only have ideas with the core point.

As the definitions in the paper are new, it is very difficult to compare with other publications and studies. In particular, the core definition in our study differs from the core definition in the classical sense for rough sets and approximation spaces. To compare the method with some existing methods, Lellis Thivagar and his collaborations [34]–[36], which provides intensive studies especially in the fields of Nano Topology and its applications, has given the definition of Nano topology within the framework of neutrosophy, but with this structure, they pointed out that one could find applications in areas such as Geographical Information Systems (GIS) field including remote sensing, object reconstruction from airborne laser scanner, real time tracking, routing applications and modeling cognitive agents [37]. They did not give a specific application example. Moreover, the definition of core used in many methods is different from the definition of core used in our study. On the other hand, while a decision-making process is generally in the form of algorithms consisting of five or six steps, our method can only make a definition with the core definition.

II. PRELIMINARIES

Fuzzy set notion was putted forward by Zadeh in 1965 [21]. Fuzzy sets and fuzzy logic have been performed in numerous real life applications to manage vagueness until today. On a universe K , a fuzzy set A defined, uses a value $\mu_A(u) \in [0, 1]$ to give the membership grade of A . Intuitionistic fuzzy set concept was introduced by Atanassov [38] in 1986. The concept is a generalization of fuzzy sets and provably equivalent to interval valued fuzzy sets. The concept takes both truth-membership $T_A(x)$ and falsity-membership $F_A(x)$, with $T_A(x), F_A(x) \in [0, 1]$ and $0 \leq T_A(x) + F_A(x) \leq 1$ into consideration. In [39], Smarandache introduced neutrosophy in 1995. Indeterminacy is quantified explicitly and truth-membership, indeterminacy membership and falsity-membership are independent in neutrosophic set. A neutrosophic set A defined on universe K . $x = x(T, I, F) \in A$ with T, I and F being the real standard or non-standard subsets of $]^{-0}, 1^{+}[$. T is the degree of truth-membership function in the set A , I is the indeterminacy-membership function in the set A and F is the falsity-membership function in the set A . In [1], Pawlak introduced the rough set theory in 1982. Rough set theory addresses vagueness and uncertainty in data analysis and information systems. It gives some ways to obtain the deciding factors from data.

Let K be a non-empty set and R be an equivalence relation on K , and (K, R) be an approximation space, and let $X \subseteq K$,

1) in A , the lower approximation of X is the set

$$\underline{X} = \{x \in K : [x]_R \subset X\}.$$

2) In A , the upper approximation of X is the set

$$\bar{X} = \{x \in K : [x]_R \wedge X \neq \phi\}.$$

3) In A , the boundary region of X is the set

$$BN(X) = \bar{X} - \underline{X}.$$

If (K, R) is an approximation space with $X, Y \subseteq K$, then

- 1) X and Y are roughly bottom-equal in A , written $(X \approx Y)$,
 $\iff \underline{X} = \underline{Y}$.
- 2) X and Y are roughly top-equal in A , written $(X \simeq Y)$,
 $\iff \bar{X} = \bar{Y}$.
- 3) X and Y are roughly equal in A , written $X \approx Y$, \iff
 $\underline{X} = \underline{Y}$ and $\bar{X} = \bar{Y}$.

\approx is an equivalence relation on the power set of K . The family of all equivalence classes of the rough relation \approx is denoted by

$$R_{\approx} = \{[X] : X \subseteq K\},$$

where $[X]$ is a rough set, its elements are subsets of K having the same lower approximation and the same upper approximation. For each rough set $X \subseteq K$, we write $X = (\underline{X}, \bar{X})$. Note that $\phi = (\underline{\phi}, \bar{\phi})$ and $K = (\underline{K}, \bar{K})$. So ϕ and K are rough sets. If $X, Y \in R_{\approx}$, then $Y \subseteq_{\approx} X \iff \underline{Y} \subseteq \underline{X}$ and $\bar{Y} \subseteq \bar{X}$, and Y will be called a rough subset of X . The family of all rough subsets of X in (K, R) is called rough power set of X .

If (K, R) is an approximation space and X, Y are rough subsets of K , then the rough union, rough intersection and rough complement are defined as follows:

- 1) $X \vee Y = (\underline{X} \vee \underline{Y}, \bar{X} \vee \bar{Y})$.
- 2) $X \wedge Y = (\underline{X} \wedge \underline{Y}, \bar{X} \wedge \bar{Y})$.
- 3) $X^c = (K \setminus \bar{X}, K \setminus \underline{X}) = K - X$.

In [40], Bryniarski defined the notion of covering-based rough sets, which is an extension of the classical Pawlak's rough set. If C is a family of non-empty subsets of a non-empty set K such that $\cup C = K$, then C is called a **covering** of K . Bryniarski defined the lower and upper approximations and the boundary region in a similar way as Pawlak.

By a covering approximation space (K, C) , we mean that K is a non-empty set and C is a covering of K satisfying the following approximation condition: $\forall A, B \subset C$ such that $A \subset B, \exists X \subset K$ with $A = \underline{X}, B = \bar{X}$. If $X \subset K$, then the ordered pair (\underline{X}, \bar{X}) is the covering-based rough set of X . The definition of the covering rough subsets in any covering approximation space (K, C) is similar to definition of rough subsets in any approximation space (K, R) , [41].

Definition 1 [41]: Let (K, C) be a covering approximation space and τ be a subfamily of the family of all covering rough subsets of $X = (\underline{X}, \bar{X}, BN(X))$ having the following properties:

- 1) $X, \emptyset \in \tau$.
- 2) Infinite union of the elements of τ is in τ .
- 3) Finite intersection of elements of τ is in τ .

Then τ is called a covering-based nano topology on X .

III. COVERING-BASED ROUGH FUZZY NANO TOPOLOGY

Definition 2 [21]: Let A be a non-empty set. A fuzzy set X is of the form $X = \{ \langle a : \mu_X(a) \rangle, a \in A \}$, where $0 \leq \mu_X(a) \leq 1$ is the degree of membership of each $a \in A$ to the set X .

Definition 3 [37]: Let R be an equivalence relation on a non-empty set X . Let F be a fuzzy set in X with the membership function μ_F . Then the fuzzy nano lower, fuzzy nano upper approximation of F and fuzzy nano boundary of F in the approximation (X, R) denoted by $\underline{\mathcal{F}}(F), \bar{\mathcal{F}}(F)$ and $B_{\mathcal{F}}(F)$ are respectively defined as follows:

- 1) $\underline{\mathcal{F}}(F) = \{ \langle x, \mu_{R(A)}(x) \rangle / y \in [x]_R, x \in X \}$
- 2) $\bar{\mathcal{F}}(F) = \{ \langle x, \mu_{\bar{R}(A)}(x) \rangle / y \in [x]_R, x \in X \}$
- 3) $B_{\mathcal{F}}(F) = \bar{\mathcal{F}}(F) - \underline{\mathcal{F}}(F)$

where $\mu_{R(A)}(x) = \wedge_{y \in [x]_R} \mu(y)$ and $\mu_{\bar{R}(A)}(x) = \vee_{y \in [x]_R} \mu(y)$.

Definition 4 [37]: Let R be an equivalence relation on a non-empty set X and F be a fuzzy set in X . Suppose that the collection $\tau_{\mathcal{F}}(F) = \{0_F, 1_F, \underline{\mathcal{F}}(F), \bar{\mathcal{F}}(F), B_{\mathcal{F}}(F)\}$ forms a topology. Then it is said to be a fuzzy nano topology. We call $(X, \tau_{\mathcal{F}}(F))$ the fuzzy nano topological space. The elements of $\tau_{\mathcal{F}}(F)$ are called fuzzy nano open sets.

Definition 5: Let (K, C) be a covering approximation space where K is a non-empty set and let X be a subset of K . Let A be a fuzzy set in K with the membership function μ_A . Then the covering-based rough fuzzy nano lower, covering-based rough fuzzy nano upper approximation of A and covering rough based fuzzy nano boundary of A in the approximation (K, C) denoted by $\underline{\mathcal{F}}_{C_X}(A), \bar{\mathcal{F}}_{C_X}(A)$ and $\mathcal{F}_{BN(X)}(A)$ are respectively defined as follows:

- 1) $\underline{\mathcal{F}}_{C_X}(A) = \{ \langle k, \mu_{C_{\underline{X}(A)}}(k) \rangle / y \in [k]_{C_{\underline{X}}}, k \in K \}$
- 2) $\bar{\mathcal{F}}_{C_X}(A) = \{ \langle k, \mu_{C_{\bar{X}(A)}}(k) \rangle / y \in [k]_{C_{\bar{X}}}, k \in K \}$
- 3) $\mathcal{F}_{BN(X)}(A) = \{ \langle k, \mu_{BN(X)(A)}(k) \rangle / y \in [k]_{BN(X)}, k \in K \}$

where $\mu_{C_{\underline{X}(A)}}(k) = \wedge_{y \in [k]_{C_{\underline{X}}}} \mu(y)$, $\mu_{C_{\bar{X}(A)}}(k) = \vee_{y \in [k]_{C_{\bar{X}}}} \mu(y)$ and $\mu_{BN(X)(A)}(k) = \vee_{y \in [k]_{BN(X)}} \mu(y)$. Addition to this, $C_{\underline{X}}$ is the lower approximation of X with respect to C , $C_{\bar{X}}$ is the upper approximation of X with respect to C and $C_{BN(X)} = C_{\bar{X}} \setminus C_{\underline{X}}$.

If $\tau_{\mathcal{F}}(C, X, A) = \{0_F, 1_F, \underline{\mathcal{F}}_{C_X}(A), \bar{\mathcal{F}}_{C_X}(A), \mathcal{F}_{BN(X)}(A)\}$ forms topology, $\tau_{\mathcal{F}}(C, X, A)$ is called **covering-based rough fuzzy nano topology**. The elements of $\tau_{\mathcal{F}}(C, X, A)$ are called covering-based rough fuzzy nano open sets.

Example 6: $\tau_{\mathcal{F}}(C, X, A)$ defines a topology for given a universe $K = \{P_1, P_2, P_3\}$, a covering set $C = \{\{P_1, P_2\}, \{P_2, P_3\}\}$, a subset $X = \{P_1, P_3\}$, and a fuzzy set $A = \{ \langle P_1, 0 \rangle, \langle P_2, 1 \rangle, \langle P_3, 0.3 \rangle \}$. Then,

$$C_{\underline{X}} = \emptyset$$

$$C_{\bar{X}} = \{\{P_1, P_2\}, \{P_2, P_3\}\}$$

$$C_{BN(X)} = \bar{\mathcal{F}}_{C_X}(A)$$

$$\underline{\mathcal{F}}_{C_X}(A) = \emptyset = 0_F,$$

$$\bar{\mathcal{F}}_{C_X}(A) = \{ \langle P_1, 1 \rangle, \langle P_2, 1 \rangle, \langle P_3, 1 \rangle \},$$

$$\mathcal{F}_{BN(X)}(A) = \bar{\mathcal{F}}_{C_X}(A)$$

Finally, $\tau_{\mathcal{F}}(C, X, A)$ defines a topology.

If $B = \{ \langle x, \mu_B(x) \rangle : x \in K \}$ is a fuzzy set, its complement is $B^c = \{ \langle x, 1 - \mu_B(x) \rangle : x \in K \}$. $[\tau_{\mathcal{F}}(C, X, A)]^c$ is a set containing B^c for every $B \in \tau_{\mathcal{F}}(C, X, A)$.

IV. COVERING-BASED ROUGH INTUITIONISTIC FUZZY TOPOLOGY

Definition 7 [38]: An intuitionistic set X in a non-empty set A is of the form $X = \{ \langle a : \mu_X(a), \nu_X(a) \rangle, a \in A \}$, where $\mu_X(a)$ and $\nu_X(a)$ represent the degree of membership function and the degree of non-membership respectively of each $a \in A$ to the set X and $0 \leq \mu_X(a) + \nu_X(a) \leq 1$ for all $a \in A$.

Definition 8 [37]: Let R be an equivalence relation on a non-empty set X . Let F be an intuitionistic set in X with the membership function μ_F and the non-membership function ν_F . The intuitionistic nano lower, intuitionistic nano upper approximation and intuitionistic nano boundary of F in the approximation (X, R) denoted by $\underline{I}(F)$, $\bar{I}(F)$ and $B_I(F)$, respectively, are defined as follows:

- 1) $\underline{I}(F) = \{ \langle x, \mu_{\underline{R}(A)}(x), \nu_{\underline{R}(A)}(x) \rangle / y \in [x]_R, x \in X \}$
- 2) $\bar{I}(F) = \{ \langle x, \mu_{\bar{R}(A)}(x), \nu_{\bar{R}(A)}(x) \rangle / y \in [x]_R, x \in X \}$
- 3) $B_I(F) = \bar{I}(F) - \underline{I}(F)$.

Definition 9: Let (K, C) be a covering approximation space in a non-empty set K . Assume that X is a subset of K . Let A be an intuitionistic fuzzy set in K with the membership function μ_A and the non-membership function ν . Then the covering based rough intuitionistic fuzzy nano lower, covering based rough intuitionistic fuzzy nano upper approximation of A and covering based rough intuitionistic fuzzy nano boundary of A in the approximation (K, C) denoted by $\underline{\mathcal{I}\mathcal{F}}_{C_X}(A)$, $\overline{\mathcal{I}\mathcal{F}}_{C_X}(A)$ and $\mathcal{I}\mathcal{F}_{BN(X)}(A)$, respectively, are defined as follows:

- 1) $\underline{\mathcal{I}\mathcal{F}}_{C_X}(A) = \{ \langle k, (\mu_{C_{\underline{X}}(A)}(k), \nu_{C_{\underline{X}}(A)}(k)) \rangle / y \in [k]_{C_{\underline{X}}}, k \in K \}$
- 2) $\overline{\mathcal{I}\mathcal{F}}_{C_X}(A) = \{ \langle k, (\mu_{C_{\bar{X}}(A)}(k), \nu_{C_{\bar{X}}(A)}(k)) \rangle / y \in [k]_{C_{\bar{X}}}, k \in K \}$
- 3) $\mathcal{I}\mathcal{F}_{BN(X)}(A) = \{ \langle k, (\mu_{BN(X)(A)}(k), \nu_{BN(X)(A)}(k)) \rangle / y \in [k]_{BN(X)}, k \in K \}$

where $\mu_{C_{\underline{X}}(A)}(k) = \bigwedge_{y \in [k]_{C_{\underline{X}}}} \mu_A(y)$, $\mu_{C_{\bar{X}}(A)}(k) = \bigvee_{y \in [k]_{C_{\bar{X}}}} \mu_A(y)$ and $\mu_{BN(X)(A)}(k) = \bigvee_{y \in [k]_{BN(X)}} \mu_A(y)$.
 $\nu_{C_{\underline{X}}(A)}(k) = \bigvee_{y \in [k]_{C_{\underline{X}}}} \nu_A(y)$, $\nu_{C_{\bar{X}}(A)}(k) = \bigwedge_{y \in [k]_{C_{\bar{X}}}} \nu_A(y)$ and $\nu_{BN(X)(A)}(k) = \bigwedge_{y \in [k]_{BN(X)}} \nu_A(y)$.

Addition to this, $C_{\underline{X}}$ is the lower approximation of X with respect to C , $C_{\bar{X}}$ is the upper approximation of X with respect to C and $C_{BN(X)} = C_{\bar{X}} \setminus C_{\underline{X}}$.

If $\tau_{\mathcal{I}\mathcal{F}}(C, X, A) = \{0_F, 1_F, \underline{\mathcal{I}\mathcal{F}}_{C_X}(A), \overline{\mathcal{I}\mathcal{F}}_{C_X}(A), \mathcal{I}\mathcal{F}_{BN(X)}(A)\}$ forms topology, $\tau_{\mathcal{I}\mathcal{F}}(C, X, A)$ is called **covering based rough intuitionistic fuzzy nano topology**. The elements of $\tau_{\mathcal{I}\mathcal{F}}(C, X, A)$ are called covering based rough intuitionistic fuzzy nano open sets.

V. COVERING BASED ROUGH NEUTROSOPHIC NANO TOPOLOGY

Definition 10 [43]: Let A be a non-empty set. A *neutrosophic set* N is defined as:

$$N = \{ \langle a, T(a), I(a), F(a) \rangle : a \in A \}$$

where $T_N : A \mapsto]0, 1^+[$ is a truth-membership function, $I_N : A \mapsto]0, 1^+[$ is an indeterminacy-membership function and $F_N : A \mapsto]0, 1^+[$ is a falsity-membership function.

Definition 11 [43]: Let A be a non-empty set. A *single valued neutrosophic set* N is defined as:

$$N = \{ \langle a, T(a), I(a), F(a) \rangle : a \in A \}$$

where $T_N : A \mapsto [0, 1]$, is a truth-membership function, $I_N : A \mapsto [0, 1]$ is an indeterminacy-membership function and $F_N : A \mapsto [0, 1]$ is a falsity-membership function with $0 \leq T_N(a) + I_N(a) + F_N(a) \leq 3$. We denote a single valued neutrosophic number by $x = (T, I, F)$.

Definition 12 [42]: Let X be a non-empty set. Let $A = \{ \langle x : T_A(x), I_A(x), F_A(x) \rangle, x \in X \}$ and $B = \{ \langle x : T_B(x), I_B(x), F_B(x) \rangle, x \in X \}$ be neutrosophic sets. Then the following statements hold:

- 1) $0_N = \{ \langle x, 0, 0, 1 \rangle : x \in X \}$ and $1_N = \{ \langle x, 1, 0, 0 \rangle : x \in X \}$.
- 2) $A \subseteq B$ iff $T_A(x) \leq T_B(x), I_A(x) \leq I_B(x), F_B(x) \leq F_A(x)$ for all $x \in X$.
- 3) $A = B$ iff $A \subseteq B$ and $B \subseteq A$.
- 4) $A^C = \{ \langle x, F_A(x), 1 - I_A(x), T_A(x) \rangle : x \in X \}$.
- 5) $A \cap B = \{ \langle x, T_A(x) \wedge T_B(x), I_A(x) \wedge I_B(x), F_A(x) \vee F_B(x) \rangle$ for all $x \in X \}$.
- 6) $A \cup B = \{ \langle x, T_A(x) \vee T_B(x), I_A(x) \vee I_B(x), F_A(x) \wedge F_B(x) \rangle$ for all $x \in X \}$.

Definition 13 [44]: Let R be an equivalence relation on a non-empty set X . Let A be a neutrosophic set in X such that μ_A is the membership function, ν_A is the indeterminacy function and ω_A is the non-membership function. Then in the approximation (X, R) , the lower and the upper approximations of A denoted by $\underline{N}(A)$ and $\bar{N}(A)$, respectively, are defined as follows:

$$\underline{N}(A) = \{ \langle x, \mu_{\underline{N}(A)}, \nu_{\underline{N}(A)}, \omega_{\underline{N}(A)} \rangle : y \in [x]_R, x \in X \}$$

$$\bar{N}(A) = \{ \langle x, \mu_{\bar{N}(A)}, \nu_{\bar{N}(A)}, \omega_{\bar{N}(A)} \rangle : y \in [x]_R, x \in X \}$$

$$\mu_{\underline{N}(A)}(x) = \bigwedge_{y \in [x]_R} \mu_A(y), \quad \nu_{\underline{N}(A)}(x) = \bigwedge_{y \in [x]_R} \nu_A(y),$$

$$\omega_{\underline{N}(A)}(x) = \bigvee_{y \in [x]_R} \omega_A(y)$$

and

$$\mu_{\bar{N}(A)}(x) = \bigvee_{y \in [x]_R} \mu_A(y), \quad \nu_{\bar{N}(A)}(x) = \bigvee_{y \in [x]_R} \mu_A(y),$$

$$\omega_{\bar{N}(A)}(x) = \bigwedge_{y \in [x]_R} \mu_A(y),$$

Thus, $0 \leq \mu_{\underline{N}(A)} + \nu_{\underline{N}(A)} + \omega_{\underline{N}(A)} \leq 3$ and $0 \leq \mu_{\bar{N}(A)} + \nu_{\bar{N}(A)} + \omega_{\bar{N}(A)} \leq 3$ where \bigvee means *max* operator and \bigwedge means *min* operator. $\mu_A(y)$, $\nu_A(y)$ and $\omega_A(y)$ are the membership, indeterminacy and non-membership of y with respect to A . It is fairly easy to show that $\bar{N}(A)$ and $\underline{N}(A)$ are two neutrosophic sets in X .

Definition 14 [37]: Let R be an equivalence relation on a non-empty set X . Let A be a neutrosophic set in X and if the collection $\tau_{N(A)} = \{0_N, 1_N, \bar{N}, \underline{N}\}$ forms a topology then it is said to be a rough neutrosophic topology. We call $(X, \tau_{N(A)})$ rough neutrosophic topological space. The elements of $(X, \tau_{N(A)})$ are called rough neutrosophic topological open sets.

Example 15: Let $X = \{P_1, P_2, P_3, P_4\}, X/R = \{\{P_1, P_2\}, \{P_3, P_4\}\}$, and

$$A = \{ \langle P_1, (0.8, 0.7, 0.4) \rangle, \langle P_2, (0.2, 0.3, 0.4) \rangle, \langle P_3, (0.1, 0.6, 0.2) \rangle, \langle P_4, (0, 0.4, 0.9) \rangle \}.$$

Then

$$\underline{N}(A) = \{ \langle P_1, (0.2, 0.3, 0.4) \rangle, \langle P_2, (0.2, 0.3, 0.4) \rangle, \langle P_3, (0, 0.4, 0.9) \rangle, \langle P_4, (0, 0.4, 0.9) \rangle \}$$

$$\bar{N}(A) = \{ \langle P_1, (0.8, 0.7, 0.4) \rangle, \langle P_2, (0.8, 0.7, 0.4) \rangle, \langle P_3, (0.1, 0.6, 0.2) \rangle, \langle P_4, (0.1, 0.6, 0.2) \rangle \}$$

$$\underline{N}(A) \cap \bar{N}(A) = \{ \langle P_1, (0.2, 0.3, 0.4) \rangle, \langle P_2, (0.2, 0.3, 0.6) \rangle, \langle P_3, (0, 0.4, 0.9) \rangle, \langle P_4, (0, 0.4, 0.9) \rangle \} = \underline{N}(A)$$

$$\underline{N}(A) \cup \bar{N}(A) = \{ \langle P_1, (0.8, 0.7, 0.4) \rangle, \langle P_2, (0.8, 0.7, 0.4) \rangle, \langle P_3, (0.1, 0.6, 0.2) \rangle, \langle P_4, (0.1, 0.6, 0.2) \rangle \} = \bar{N}(A)$$

$$0_N \cap \bar{N}(A) = 0_N, \quad 0_N \cap \underline{N}(A) = 0_N,$$

$$0_N \cup \bar{N}(A) = \bar{N}(A), \quad 0_N \cup \underline{N}(A) = \underline{N}(A)$$

$$1_N \cap \bar{N}(A) = \bar{N}(A), \quad 1_N \cap \underline{N}(A) = \underline{N}(A),$$

$$1_N \cup \bar{N}(A) = 1_N, \quad 1_N \cup \underline{N}(A) = 1_N$$

$$0_N \cap 1_N = 0_N, \quad 0_N \cup 1_N = 1_N$$

Therefore, $(X, \tau_{N(A)}) = \{0_N, 1_N, \bar{N}(A), \underline{N}(A)\}$ forms topology.

Definition 16: [44] Let R be an equivalence relation on a non-empty set X . Let A be a neutrosophic set in X such that μ_A is the membership function, ν_A is the indeterminacy function and ω_A is the non-membership function. Then in the approximation (X, R) , the lower, the upper and the boundary approximations of A denoted by $\underline{N}(A)$, $\bar{N}(A)$ and $BN(A)$, respectively, are defined as follows:

$$\underline{N}(A) = \{ \langle x, \mu_{\underline{N}(A)}, \nu_{\underline{N}(A)}, \omega_{\underline{N}(A)} \rangle : y \in [x]_R, x \in X \}$$

$$\bar{N}(A) = \{ \langle x, \mu_{\bar{N}(A)}, \nu_{\bar{N}(A)}, \omega_{\bar{N}(A)} \rangle : y \in [x]_R, x \in X \}$$

$$BN(A) = \bar{N}(A) - \underline{N}(A)$$

where;

$$\mu_{\underline{N}(A)}(x) = \bigwedge_{y \in [x]_R} \mu_A(y), \quad \nu_{\underline{N}(A)}(x) = \bigvee_{y \in [x]_R} \mu_A(y),$$

$$\omega_{\underline{N}(A)}(x) = \bigvee_{y \in [x]_R} \mu_A(y)$$

and

$$\mu_{\bar{N}(A)}(x) = \bigvee_{y \in [x]_R} \mu_A(y), \quad \nu_{\bar{N}(A)}(x) = \bigwedge_{y \in [x]_R} \mu_A(y),$$

$$\omega_{\bar{N}(A)}(x) = \bigwedge_{y \in [x]_R} \mu_A(y),$$

Thus, $0 \leq \mu_{\underline{N}(A)} + \nu_{\underline{N}(A)} + \omega_{\underline{N}(A)} \leq 3$ and $0 \leq \mu_{\bar{N}(A)} + \nu_{\bar{N}(A)} + \omega_{\bar{N}(A)} \leq 3$ where \bigvee means *max* operator and \bigwedge means *min* operator. $\mu_A(y)$, $\nu_A(y)$ and $\omega_A(y)$ are the membership, indeterminacy and non-membership of y with respect to A . It is not difficult to see that $\bar{N}(A)$, $\underline{N}(A)$ and $BN(A)$ are three neutrosophic sets in X .

Definition 17: Let K be a non-empty set, (K, C) be a covering approximation space and X be a subset of K . Let A be a neutrosophic set in K such that μ_A is the membership function, ν_A is the indeterminacy function and ω_A is the non-membership function. Then the covering based rough neutrosophic nano lower, covering based rough neutrosophic nano upper approximation of A and covering based rough neutrosophic nano boundary of A in the approximation (K, C) denoted by $\underline{\mathcal{N}}_{C_X}(A)$, $\bar{\mathcal{N}}_{C_X}(A)$ and $\mathcal{N}_{BN(X)}(A)$, respectively, are defined as follows:

$$\underline{\mathcal{N}}_{C_X}(A) = \{ \langle k, (\mu_{C_{\underline{X}(A)}}(k), \nu_{C_{\underline{X}(A)}}(k), \omega_{C_{\underline{X}(A)}}(k)) \rangle : y \in [k]_{C_X}, k \in K \}$$

$$\bar{\mathcal{N}}_{C_X}(A) = \{ \langle k, (\mu_{C_{\bar{X}(A)}}(k), \nu_{C_{\bar{X}(A)}}(k), \omega_{C_{\bar{X}(A)}}(k)) \rangle : y \in [k]_{C_{\bar{X}}}, k \in K \}$$

$$\mathcal{N}_{BN(X)}(A) = \{ \langle k, (\mu_{BN(X)(A)}(k), \nu_{BN(X)(A)}(k), \omega_{BN(X)(A)}(k)) \rangle : y \in [k]_{BN(X)}, k \in K \}$$

where

$$\mu_{C_{\underline{X}(A)}}(k) = \bigwedge_{y \in [k]_{C_{\underline{X}(A)}}} \mu(y), \quad \nu_{C_{\underline{X}(A)}}(k) = \bigwedge_{y \in [k]_{C_{\underline{X}(A)}}} \nu(y),$$

$$\omega_{C_{\underline{X}(A)}}(k) = \bigvee_{y \in [k]_{C_{\underline{X}(A)}}} \omega(y), \quad \mu_{C_{\bar{X}(A)}}(k) = \bigvee_{y \in [k]_{C_{\bar{X}(A)}}} \mu(y),$$

$$\nu_{C_{\bar{X}(A)}}(k) = \bigvee_{y \in [k]_{C_{\bar{X}(A)}}} \nu(y), \quad \omega_{C_{\bar{X}(A)}}(k) = \bigwedge_{y \in [k]_{C_{\bar{X}(A)}}} \omega(y),$$

$$\mu_{BN(X)(A)}(k) = \bigvee_{y \in [k]_{BN(X)}} \mu(y),$$

$$\nu_{BN(X)(A)}(k) = \bigvee_{y \in [k]_{BN(X)}} \nu(y),$$

and $\omega_{BN(X)(A)}(k) = \bigwedge_{y \in [k]_{BN(X)}} \omega(y)$. Addition to this, $C_{\underline{X}}$ is the lower approximation of X with respect to C , $C_{\bar{X}}$ is the upper approximation of X with respect to C and $C_{BN(X)} = C_{\bar{X}} \setminus C_{\underline{X}}$.

If $\tau_{\mathcal{N}}(C, X, A) = \{0_N, 1_N, \underline{\mathcal{N}}_{C_X}(A), \bar{\mathcal{N}}_{C_X}(A), \mathcal{N}_{BN(X)}(A)\}$ forms topology, $\tau_{\mathcal{N}}(C, X, A)$ is called **covering based rough neutrosophic nano topology**.

Example 18: $\tau_{\mathcal{N}}(C, X, A)$ defines a topology for a given universe $K = \{P_1, P_2, P_3\}$, a covering set $C = \{\{P_1, P_2\}, \{P_2, P_3\}\}$, a subset $X = \{P_1, P_3\}$, and a neutrosophic

set $A = \{ \langle P_1, (0, 0.2, 1) \rangle, \langle P_2, (1, 0, 0.6) \rangle, \langle P_3, (0.3, 0.4, 0.5) \rangle \}$. Then, $C_{\underline{X}} = \emptyset$, $C_{\overline{X}} = \{ \{P_1, P_2\}, \{P_2, P_3\} \}$, $C_{BN(X)} = C_{\overline{X}}$, $\mathcal{N}_{C_X}(A) = \emptyset = 0_N$, $\overline{\mathcal{N}}_{C_X}(A) = \{ \langle P_1, (1, 0.2, 0.6) \rangle, \langle P_2, (1, 0.2, 0.6) \rangle, \langle P_2, (1, 0.4, 0.6) \rangle, \langle P_3, (1, 0.4, 0.6) \rangle \}$, and $\mathcal{N}_{BN(X)}(A) = \overline{\mathcal{N}}_{C_X}(A)$.

Finally, it is not difficult to check that $\tau_{\mathcal{N}}(C, X, A)$ defines a topology. The complement of $\tau_{\mathcal{N}}(C, X, A)$ is $[\tau_{\mathcal{N}}(C, X, A)]^c = \{0_N, 1_N, \{ \langle P_1, (0.6, 0.8, 1) \rangle, \langle P_2, (0.6, 0.8, 1) \rangle, \langle P_2, (0.6, 0.6, 1) \rangle, \langle P_3, (0.6, 0.6, 1) \rangle \}$.

Definition 19: Let $\tau_{\mathcal{N}}(C, X, A)$ be covering based rough neutrosophic nano topology. The elements of $\tau_{\mathcal{N}}(C, X, A)$ are called covering based rough neutrosophic nano open sets.

Definition 20: Let $\tau_{\mathcal{N}}(C, X, A)$ be covering based rough neutrosophic topology. The elements of $[\tau_{\mathcal{N}}(C, X, A)]^c$ are called covering based rough neutrosophic nano closed sets.

Definition 21: If $\tau_{\mathcal{N}}(C, X, A)$ is a covering based rough neutrosophic nano topological space on an universe K and B be any neutrosophic subset of K . Then the covering based rough neutrosophic nano interior of B is defined as the union of all covering based rough neutrosophic nano open subsets of B and it is denoted by $\mathcal{N}_{int}(B)$. $\mathcal{N}_{int}(B)$ is the largest covering based rough neutrosophic nano open subset of B .

Example 22: Consider the covering based rough neutrosophic nano topology $\tau_{\mathcal{N}}(C, X, A)$ in Example 4.9. Let $B = \{ \langle P_2, (0.6, 0.8, 1) \rangle, \langle P_2, (0.6, 0.6, 1) \rangle, \langle P_3, (0.6, 0.6, 1) \rangle \}$. Then $\mathcal{N}_{int}(B) = \{ \langle P_1, (0.6, 0.8, 1) \rangle, \langle P_2, (0.6, 0.8, 1) \rangle, \langle P_2, (0.6, 0.6, 1) \rangle, \langle P_3, (0.6, 0.6, 1) \rangle \}$. If $B = \{ \langle P_2, (0.6, 0.8, 0) \rangle, \langle P_2, (0.3, 0.6, 1) \rangle, \langle P_3, (0.6, 0.5, 1) \rangle \}$, then $\mathcal{N}_{int}(B) = \emptyset$.

Definition 23: If $\tau_{\mathcal{N}}(C, X, A)$ is a covering based rough neutrosophic nano topological space on an universe K and B be any neutrosophic subset of K . The covering based rough neutrosophic nano closure of B is defined as the intersection of all covering based rough neutrosophic nano closed sets containing B and it is denoted by $\mathcal{N}_{cl}(B)$. $\mathcal{N}_{cl}(B)$ is the smallest covering based rough neutrosophic nano closed set containing B .

Definition 24: Let $\tau_{\mathcal{N}}(C, X, A)$ be a covering based rough neutrosophic nano topological space on an universe K and \mathcal{B} be a collection of subsets of $\tau_{\mathcal{N}}(C, X, A)$. If the collection of all unions members of \mathcal{B} is a covering based rough neutrosophic nano topological space on K , then it is called a base for $\tau_{\mathcal{N}}(C, X, A)$.

Definition 25: [45]: Let (K, C) be a covering based approximation space. For any $x \in K$, the neighbourhood of x is defined by $Neighbor(x) = \{M \in C \mid x \in M\}$.

By Definition 4.16, we give the following definition of the neighbourhood in our topology.

Definition 26: Let $\tau_{\mathcal{N}}(C, X, A)$ be a covering based rough neutrosophic nano topological space on a universe K , we define the neighbourhood of x as follows:

$$Neighbor(x) = \bigcap \{K \in \tau_{\mathcal{N}}(C, X, A) \mid x \in K\}.$$

Definition 27: Let $\tau_{\mathcal{N}}(C, X, A)$ be a covering based rough neutrosophic nano topological space on a universe K . If x is in each covering based rough neutrosophic nano set, then x is called a *core point*.

VI. APPLICATIONS

Thivagar and his associates showed that rough set, approximation space and especially nano topology has many real life applications in medical diagnosis, digital image segmentation, pattern recognition, nutrition modelling and recruitment process [34]–[36]. Generally, the symptoms of the patients or the opinions of the experts about certain attributes are evaluated on a table. In most of these studies, the core and the basis of the topologies of the approximation spaces formed by the lower and upper approximations, and boundaries are the determinants of the decision making with the data obtained from this table on a discourse. However, in some problems with more complex input and output, fuzzy, intuitionistic fuzzy or triple (neutrosophic) input or output are the features that are revealed. Especially in the field of pattern recognition, high-order spectra are used for the analysis and processing of triple inputs and outputs. When analysing these patterns, these triple inputs or outputs should be processed as data directly on their own property rather than being used as an attribute. In addition to pattern recognition, the use of higher order spectrum finds wide application in many areas such as diabetes diagnosis, heart rate, biomedical signals, radar HRRP target recognition [46]–[50]. More generally, *rough neutrosophic nano topology* can be used for analyzing and decision-making process on discourses with ternary data. Moreover, on the discourse of the data, *covering based rough neutrosophic nano topology* can be used to classify the discourse's parts in order to maintain the integrity of the discourse. When using *covering based rough neutrosophic nano topology*, the topology base will help to make a decision, just like other analyses via rough set and topology. Here, we give a simple application for a possible use of the topology.

Example 28: A city hall wants to make layout plan for bus stations with the intention of landscaping. Five bus stations that are indicated by $K = \{s_1, s_2, s_3, s_4, s_5\}$ are desired to be placed in the city. For some reasons, (information sharing, connection, distances to touristy areas, or convenience for fast transport of disabled individuals etc.) some buses moving between these stations are grouped to cover all stations of the city in terms of each station's situations. Let this covering set C be $\{\{s_1, s_2, s_3\}, \{s_2, s_4\}, \{s_3, s_5\}\}$. Moreover, they also offer a subset of non-surrendered options under certain options, and this subset is $X = \{s_2, s_3, s_5\}$. The city hall council presents an offer for the city hall's bus station placement and asks an expert A to prepare an evaluation report. The expert presents the report in the form of neutrosophic values because the expert evaluates many parameters. The report of the expert for the stations in accordance with the offer of the city hall is as follows: $A = \{ \langle s_1, (0.2, 0.6, 0.3) \rangle, \langle s_2, (0, 0.1, 0) \rangle, \langle s_3, (0, 0, 1) \rangle, \langle s_4, (1, 0, 0) \rangle, \langle s_5, (0, 0.2, 1) \rangle \}$.

As the first stage for checking whether the assessment of the expert is valid or not, we regard it as a *covering based rough neutrosophic nano topology* form in accordance with the offer and the report. If this structure forms the topology, we say that there is compatibility between the offer and the report. Now, let's examine it.

$$C_{\bar{X}} = \{\{s_2, s_4\}\{s_3, s_5\}, \{s_1, s_2, s_3\}\}$$

$$C_{\underline{X}} = \{\{s_3, s_5\}\}$$

$$C_{BN(X)} = \{\{s_1, s_2, s_3\}, \{s_2, s_4\}\}$$

$$\overline{\mathcal{N}}_{C_X}(A) = \{ \langle s_1, (0, 0, 1) \rangle, \langle s_2, (0, 0, 1) \rangle, \langle s_3, (0, 0, 1) \rangle, \langle s_4, (0, 0, 1) \rangle, \langle s_5, (0, 0, 1) \rangle \}$$

$$\underline{\mathcal{N}}_{C_X}(A) = \{ \langle s_3, (0, 0, 1) \rangle, \langle s_5, (0, 0, 1) \rangle \}$$

$$\overline{\mathcal{N}}_{BN(X)}(A) = \{ \langle s_1, (0, 0, 1) \rangle, \langle s_2, (0, 0, 1) \rangle, \langle s_3, (0, 0, 1) \rangle, \langle s_4, (0, 0, 1) \rangle \}$$

Then, it forms a *covering based rough neutrosophic nano topology*. On the other hand, there are two core points $\langle s_3, (0, 0, 1) \rangle$ and $\langle s_5, (0, 0, 1) \rangle$ in the topology. These points indicate that $\langle s_3, (0, 0, 1) \rangle$ and $\langle s_5, (0, 0, 1) \rangle$ definitely wrong decisions for the planned placement of s_3 and s_5 .

VII. CONCLUSION

Some new topologies and their definitions on covering property have been given in this paper. We gave new topology definitions that combine the sets such fuzzy, intuitionistic fuzzy, neutrosophic and rough with nano topology which are useful in many decision making problems. We showed that they are suitable to apply to many real life problems after the given definitions, and in the last part of the paper we gave the decision making application for a bus station placement problem. we hope that the work in this paper constitutes a new basis for new studies and applications.

In the future, we will define new points addition to core point definition and study decision making problems by using the points. Another future plan is to extend this study with interval valued and bipolar neutrosophic sets and their topologies and implement them on computer.

REFERENCES

- [1] Z. Pawlak, "Rough sets," *Int. J. Comput. Inf. Sci.*, vol. 11, no. 5, pp. 341–356, Oct. 1982.
- [2] E. A. Abo-Tabl, "Rough sets and topological spaces based on similarity," *Int. J. Mach. Learn. Cybern.*, vol. 4, pp. 451–458, Oct. 2013, doi: [10.1007/s13042-012-0107-7](https://doi.org/10.1007/s13042-012-0107-7).
- [3] R. Slowinski and D. Vanderpooten, "A generalized definition of rough approximations based on similarity," *IEEE Trans. Knowl. Data Eng.*, vol. 12, no. 2, pp. 331–336, Mar./Apr. 2000, doi: [10.1109/69.842271](https://doi.org/10.1109/69.842271).
- [4] A. Skowron and J. Stepaniuk, "Tolerance approximation spaces," *Fundam. Inform.*, vol. 27, nos. 2–3, pp. 245–253, 1996.
- [5] H.-P. Zhang, Y. Ouyang, and Z. Wang, "Note on 'Generalized rough sets based on reflexive and transitive relations,'" *Inf. Sci.*, vol. 179, pp. 471–473, Feb. 2009, doi: [10.1016/j.ins.2008.10.009](https://doi.org/10.1016/j.ins.2008.10.009).
- [6] G. Liu and W. Zhu, "The algebraic structures of generalized rough set theory," *Inf. Sci.*, vol. 178, pp. 4105–4113, Nov. 2008, doi: [10.1016/j.ins.2008.06.021](https://doi.org/10.1016/j.ins.2008.06.021).
- [7] Y. Y. Yao, "Relational interpretations of neighborhood operators and rough set approximation operators," *Inf. Sci.*, vol. 111, nos. 1–4, pp. 239–259, 1998, doi: [10.1016/S0020-0255\(98\)10006-3](https://doi.org/10.1016/S0020-0255(98)10006-3).
- [8] W. Zhu, "Relationship between generalized rough sets based on binary relation and covering," *Inf. Sci.*, vol. 179, pp. 210–225, Jan. 2009, doi: [10.1016/j.ins.2008.09.015](https://doi.org/10.1016/j.ins.2008.09.015).
- [9] G. L. Liu and Y. Sai, "A comparison of two types of rough sets induced by coverings," *Int. J. Approx. Reasoning*, vol. 50, pp. 521–528, Mar. 2009, doi: [10.1016/j.ijar.2008.11.001](https://doi.org/10.1016/j.ijar.2008.11.001).
- [10] L. Polkowski, *Rough Sets: Mathematical Foundations*. Berlin, Germany: Physica-Verlag, 2002, doi: [10.1007/978-3-7908-1776-8](https://doi.org/10.1007/978-3-7908-1776-8).
- [11] A. Skowron, "On topology in information system," in *Bulletin of Polish Academic Science and Mathematics*, vol. 36, 1988, pp. 477–480.
- [12] A. Wiweger, "On topological rough sets," in *Bulletin of Polish Academic Science and Mathematics*, vol. 37, 1988, pp. 51–62.
- [13] L. Polkowski, "On fractals defined in information systems via rough set theory," in *Proc. Bull. Int. Rough Set Soc. (RSTGC)*, vol. 5, 2001, pp. 163–166.
- [14] J. Kortelainen, "On relationship between modified sets, topological spaces and rough sets," *Fuzzy Sets Syst.*, vol. 61, pp. 91–95, Jan. 1994, doi: [10.1016/0165-0114\(94\)90288-7](https://doi.org/10.1016/0165-0114(94)90288-7).
- [15] A. Skowron, R. Świniarski, and P. Synak, "Approximation spaces and information granulation," in *Transactions on Rough Sets III (Lecture Notes in Computer Science)*, vol. 3400, 2005, pp. 175–189, doi: [10.1007/114278348](https://doi.org/10.1007/114278348).
- [16] J. Järvinen and J. Kortelainen, "A unifying study between modal-like operators, topologies and fuzzy sets," *Fuzzy Sets Syst.*, vol. 158, pp. 1217–1225, Jun. 2007, doi: [10.1016/j.fss.2007.01.011](https://doi.org/10.1016/j.fss.2007.01.011).
- [17] E. F. Lashin, A. M. Kozae, A. A. A. Khadra, and T. Medhat, "Rough set theory for topological spaces," *Int. J. Approx. Reasoning*, vol. 40, pp. 35–43, Jul. 2005, doi: [10.1016/j.ijar.2004.11.007](https://doi.org/10.1016/j.ijar.2004.11.007).
- [18] T.-J. Li, Y. Yeung, and W.-X. Zhang, "Generalized fuzzy rough approximation operators based on fuzzy coverings," *Int. J. Approx. Reasoning*, vol. 48, pp. 836–856, Aug. 2008, doi: [10.1016/j.ijar.2008.01.006](https://doi.org/10.1016/j.ijar.2008.01.006).
- [19] K. Qin and Z. Pei, "On the topological properties of fuzzy rough sets," *Fuzzy Sets Syst.*, vol. 151, pp. 601–613, May 2005, doi: [10.1016/j.fss.2004.08.017](https://doi.org/10.1016/j.fss.2004.08.017).
- [20] A. K. Srivastava and S. P. Tiwari, "On relationships among fuzzy approximation operators, fuzzy topology, and fuzzy automata," *Fuzzy Sets Syst.*, vol. 138, pp. 197–204, Aug. 2003, doi: [10.1016/S0165-0114\(02\)00442-6](https://doi.org/10.1016/S0165-0114(02)00442-6).
- [21] L. A. Zadeh, "Fuzzy sets," *Inf. Control*, vol. 8, no. 3, pp. 338–353, Jun. 1965.
- [22] H. Jiang, J. Zhan, and D. Chen, "Covering based variable precision (I, T)-fuzzy rough sets with applications to multi-attribute decision-making," *IEEE Trans. Fuzzy Syst.*, vol. 27, no. 8, pp. 1558–1572, Aug. 2019, doi: [10.1109/TFUZZ.2018.2883023](https://doi.org/10.1109/TFUZZ.2018.2883023).
- [23] K. Zhang, J. Zhan, and Y. Yao, "TOPSIS method based on a fuzzy covering approximation space: An application to biological nano-materials selection," *Inf. Sci.*, vol. 502, pp. 297–329, Oct. 2019, doi: [10.1016/j.ins.2019.06.043](https://doi.org/10.1016/j.ins.2019.06.043).
- [24] L. Zhang, J. Zhan, Z. Xu, and J. C. R. Alcántud, "Covering-based general multigranulation intuitionistic fuzzy rough sets and corresponding applications to multi-attribute group decision-making," *Inf. Sci.*, vol. 494, pp. 114–140, Aug. 2019.
- [25] K. Zhang, J. Zhan, and W.-Z. Wu, "Novel fuzzy rough set models and corresponding applications to multi-criteria decision-making," *Fuzzy Sets Syst.*, to be published, doi: [10.1016/j.fss.2019.06.019](https://doi.org/10.1016/j.fss.2019.06.019).
- [26] J. Zhan and W. Xu, "Two types of coverings based multigranulation rough fuzzy sets and applications to decision making," *Artif. Intell. Rev.*, to be published, doi: [10.1007/s10462-018-9649-8](https://doi.org/10.1007/s10462-018-9649-8).
- [27] J. Zhan and W. Xu, "Covering-based intuitionistic fuzzy rough sets and applications in multi-attribute decision-making," *Artif. Intell. Rev.*, to be published, doi: [10.1007/s10462-018-9674-7](https://doi.org/10.1007/s10462-018-9674-7).

- [28] J. Zhan, X. Zhang, and Y. Yao, "Covering based multigranulation fuzzy rough sets and corresponding applications," *Artif. Intell. Rev.*, to be published, doi: [10.1007/s10462-019-09690-y](https://doi.org/10.1007/s10462-019-09690-y).
- [29] H. L. Yang, Y. L. Bao, and Z. L. Guo, "Generalized interval neutrosophic rough sets and its application in multi-attribute decision making," in *Filomat*, vol. 3, 2018, pp. 11–33.
- [30] L. Zhang, J. Zhan, and Z. Xu, "Covering-based generalized IF rough sets with applications to multi-attribute decision-making," *Inf. Sci.*, vol. 478, pp. 275–302, Apr. 2019.
- [31] H.-L. Yang, C.-L. Zhang, Z. L. Guo, Y.-L. Liu, and X. Liao, "A hybrid model of single valued neutrosophic sets and rough sets: Single valued neutrosophic rough set model," *Soft Comput.*, vol. 21, no. 21, pp. 6253–6267, 2017.
- [32] C. Zhang, D. Li, and J. Liang, "Hesitant fuzzy linguistic rough set over two universes model and its applications," *Int. J. Mach. Learn. Cybern.*, vol. 9, no. 4, pp. 577–588, 2018.
- [33] C. Zhang, D. Li, A. Sangaiah, and S. Broumi, "Merger and acquisition target selection based on interval neutrosophic multigranulation rough sets over two universes," *Symmetry*, vol. 9, no. 7, p. 126, 2017.
- [34] M. L. Thivagar and C. Richard, "Nutrition modeling through nano topology," *Int. J. Eng. Res. Appl.*, vol. 4, no. 1, pp. 327–334, 2014.
- [35] M. L. Thivagar and V. S. Devi, "Computing technique for recruitment process via nano topology," *Sohag J. Math.*, vol. 3, no. 1, pp. 37–45, 2016.
- [36] M. L. Thivagar and S. P. R. Priyalatha, "Medical diagnosis in an indiscernibility matrix based on nano topology," *Cogent Math. Statist.*, vol. 4, no. 1, 2017, Art. no. 1330180.
- [37] M. L. Thivagar, S. Jafari, V. S. Devi, and V. Antonysamy, "A novel approach to nano topology via neutrosophic sets," in *Neutrosophic Sets and Systems*, vol. 20, 2018, pp. 86–94.
- [38] K. Atanassov, "Intuitionistic fuzzy sets," in *Fuzzy Sets and Systems*, vol. 20, 1986, pp. 87–96.
- [39] F. Smarandache, *Neutrosophy: Neutrosophic Probability, Set, and Logic: Analytic Synthesis & Synthetic Analysis*. Rehoboth, 1998, pp. 104–106.
- [40] E. Brynairski, "A calculus of rough sets of the first order, bull of the polish academy sciences," *Mathematics*, vol. 37, nos. 1–6, pp. 71–78, 1989.
- [41] N. Alharbi, H. Aydi, and C. Özel, "Rough spaces on covering based rough sets," *Eur. J. Pure Appl. Math.*, vol. 12, no. 2, pp. 533–543, 2019.
- [42] F. Smarandache, "Neutrosophic set—a generalization of the intuitionistic fuzzy set," *Int. J. Pure Appl. Math.*, vol. 24, no. 3, p. 287, 2005.
- [43] W. Haibin, F. Smarandache, Y. Zhang, R. Sunderraman, *Single Valued Neutrosophic Sets*. Infinite Study, 2010.
- [44] S. Broumi, F. Smarandache, and M. Dhar, "Rough neutrosophic sets," *Neutrosophic Sets Syst.*, vol. 3, pp. 60–65, May 2014, doi: [10.5281/zenodo.571606](https://doi.org/10.5281/zenodo.571606).
- [45] P. Zhu, "Covering rough sets based on neighborhoods: An approach without using neighborhoods," *Int. J. Approx. Reasoning*, vol. 52, no. 3, pp. 461–472, 2011.
- [46] V. Chandran, B. Carswell, B. Boashash, and S. Elgar, "Pattern recognition using invariants defined from higher order spectra: 2-D image inputs," *IEEE Trans. Image Process.*, vol. 6, no. 5, pp. 703–712, May 1997.
- [47] L. Du, H. Liu, and Z. Bao, and M. Xing, "Radar HRRP target recognition based on higher order spectra," *IEEE Trans. Signal Process.*, vol. 53, no. 7, pp. 2359–2368, Jul. 2005.
- [48] R. Acharya, C. K. Chua, E. Y. K. Ng, and W. Yu, and C. Chee, "Application of higher order spectra for the identification of diabetes retinopathy stages," *J. Med. Syst.*, vol. 32, no. 6, pp. 481–488, 2008.
- [49] K. C. Chua, V. Chandran, and U. R. Acharya, and C. M. Lim, "Application of higher order statistics/spectra in biomedical signals—A review," *Med. Eng. Phys.*, vol. 32, no. 7, pp. 679–689, 2010.
- [50] K. C. Chua, V. Chandran, U. R. Acharya, and C. M. Lim, "Cardiac state diagnosis using higher order spectra of heart rate variability," *J. Med. Eng. Technol.*, vol. 32, no. 2, pp. 145–155, 2008.

A Novel Neutrosophic Subsets Definition for Dermoscopic Image Segmentation

Amira S. Ashour, Chunlai Du, Yanhui Guo, Ahmed Refaat Hawas, Yuping Lai,
Florentin Smarandache

Amira S. Ashour, Chunlai Du, Yanhui Guo, Ahmed Refaat Hawas, Yuping Lai, Florentin Smarandache (2019). A Novel Neutrosophic Subsets Definition for Dermoscopic Image Segmentation. *IEEE Access* 7: 151047-151053, DOI: 10.1109/ACCESS.2019.2946762

ABSTRACT Dermoscopic images suffer from irregular and vague boundaries. New directions established the neutrosophic set (NS) approaches for clustering, and segmenting the dermoscopic images. In this work, an accurate segmentation process was developed by mapping initially the dermoscopic images to the NS domain. Thus, the neutrosophic image was defined by three subsets, namely True (T), Indeterminacy (I) and False (F). For accurate boundary detection and segmentation, different high pass (HP) filter types were used in the definition of I subset and low pass (LP) filter types in the definition of T . These filters form a new way to obtain an NS image for segmenting dermoscopy images. A comparative study was carried on the ISIC2016 skin lesion dermoscopic images dataset using different combinations of NS filter types and sizes. The results depicted the superiority of using an unsharp filter in implementing the I subset and an average filter for the T subset. 96% segmentation accuracy was reported using the proposed design compared to 92% accuracy using the default NS definition.

INDEX TERMS Neutrosophic set, dermoscopic images, unsharp filter, average filter, image segmentation.

This work was supported in part by the Natural Science Foundation of China under Grant 61702013, in part by the Joint of Beijing Natural Science Foundation and Education Commission under Grant KZ201810009011, and in part by the Science and Technology Innovation Project of North China University of Technology under Grant 19XN108.

I. INTRODUCTION

One of the most challenging tasks in healthcare is the accurate diagnosis due to the dependency on the physicians' experience along with the fuzziness in the medical images. For precise instinctive diagnosis, several medical image processing procedures, such as denoising, clustering, segmentation, and classification, have been presented based on fuzzy theory to infer the intrinsic vagueness, ambiguity, and uncertainty [1]–[3]. However, fuzzy-based approaches are sensitive to the artifacts and noise; thus, do not deliberate the pixels' spatial context [4]. To overcome this drawback, the neutrosophic concept which introduced by Smarandache as a generalization of the fuzzy set [5], [6], was applied. Generally, neutrosophic set (NS) generalizes the perception of the fuzzy-based approaches including the fuzzy set, and intuitionistic fuzzy set [7].

By integrating medical image analysis with the NS, several computer-aided diagnosis (CAD) systems have been developed in the clinical care. Accordingly, researchers developed different NS-based medical image segmentation methods for lesions and abnormalities detection in CAD systems [8]–[12]. Cheng and Guo [13] applied a thresholding based segmentation method after transforming the image in the NS domain. The three NS subsets, namely True (T), Indeterminacy (I), and False (F) were generated. Then, the entropy in NS was calculated to estimate the indetermination. In addition, to reduce the set's indetermination, an λ -mean operation was employed. Sert and Alkan [14] designed NS-based Chan–Vese segmentation approach for edge detection. Zhang *et al.* [15] applied the neutrosophy theory for image segmentation by mapping the image in the NS domain and employed a watershed approach to segment the image.

Furthermore, several studies were conducted on the clustering-based segmentation algorithm using NS. Shan *et al.* [16] proposed NS-based clustering procedure,

called neutrosophic L-means (NLM) for segmentation. In NS domain, Guo and Cheng [9] introduced fuzzy c-means clustering, where the entropy was used to calculate the indeterminacy of the image. An α -mean operator was proposed for diminishing the indeterminacy to guarantee homogenous image. Subsequently, the membership value in the fuzzy c-means clustering was updated in consistent with the indeterminacy value to obtain the segmented image. Moreover, Guo and Sengur [17] redefined a clustering convergence criterion by integrating NS with an improved fuzzy c-means (IFCM). Further, the same authors introduced the fuzzy c-means clustering with NS context [18]. This procedure was named neutrosophic c-means (NCM), where the clustering procedure was considered a constrained minimization problem of a pre-defined objective function. Another clustering-based segmentation, namely K-means was integrated with the NS by Mohan *et al.* [19], where a non-local neutrosophic wiener filter was designed to enhance the image quality. Recently, Ashour *et al.* [20] proposed a neutrosophic clustering with histogram estimation for dermoscopic image segmentation. Histogram-based cluster estimation was implemented firstly to determine the initial number of clusters in the image, and then the NCM algorithm was applied for segmentation.

In the previous NS-based studies, median filter and Sobel filter were used in the NS to implement the truth subset, and indeterminacy subset, respectively. For accurate boundary detection and segmentation, the present work designed a novel implementation of the T and I neutrosophic subsets to guarantee the superior segmentation performance for dermoscopic image. Subsequently, a comparative study was conducted on the size and type of the proposed NS filters that compute the T and I neutrosophic subsets in the NS. Different high-pass (HP) filters were employed to compute the I subset, namely Prewitt, Sobel, kernel, double kernel, and unsharp with different filter sizes. Moreover, different low-pass (LP) filters were tested to obtain the T subset, namely median, average, and order rank filters (minimum, maximum). The k-means clustering process was utilized for segmentation based on the values in T and I . The proposed new NS subsets were evaluated to segment the dermoscopic images' lesions in the International Skin Imaging Collaboration (ISIC) 2016 Challenge dataset [21].

The structure of the rest sections is as follows. Section II presents a new methodology for defining the neutrosophic subsets. Section III contains the detailed results, comparative studies and discussion. The conclusion of the present work is denoted in section IV.

II. METHODOLOGY

The dermoscopic images have inconsistent structures and suffer from asymmetrical and ambiguous boundaries along with the existence of artifacts, noise, hair and air bubbles. For precise analysis of skin lesions, several researchers transformed the dermoscopic images into the NS domain to solve the uncertainty and indeterminacy during the segmentation

process and to detect the boundaries of the lesion correctly [24], [25]. In this work, the k-means clustering is employed for segmenting the skin lesions' orbicular shape and groups the pixels of the image into different clusters. However, to increase the performance of the k-means, a new definition of the NS filters is introduced to guarantee the accurate boundary detection.

Usually, the HP filters are used for image enhancement, while the LP filters are used for smoothing and noise suppression. Accordingly, the traditional definitions of the NS subsets employed Sobel filter for computing the I subset, and a median filter for representing the T subset [10], [17]–[20]. Typically, the unsharp filter has better performance to enhance and sharpen the high frequency components in the images compared to other HP filters, such as Prewitt, Sobel, and kernel operators [22]. Moreover, the average (which is linear filter) filter has good performance and high speed compared to the median (which is a non-linear filter) in image processing and analysis [23]. Subsequently, in the present work, a new combination of the filters was proposed, where unsharp filter and average filter were used to define the I and T subsets, respectively. Likewise, the window size of each filter was determined along with a comparative study with other filter types. To evaluate the novel definition in the NS subsets for the segmentation process, the ISIC 2016 dataset was employed in this work.

A. NEUTROSOPHIC IMAGE

NS describes the indeterminacy and uncertainty in any environment. In the NS, three neutrosophic subsets, i.e. T , I , and F are defined for any event to represent the degrees of truth, indeterminacy, and falsity, respectively. These subsets are used to transform an image into the NS space creating a neutrosophic image, which is represented as $\langle T, I, F \rangle$.

Typically, the default NS was defined using Sobel filter and median filter. The proposed work designed a new NS definition on the dermoscopic images, where T represents the skin lesion region, while I represents the lesion boundary information, and F represents the background. Using the minimum and maximum intensities V_{\min} and V_{\max} , the T and F neutrosophic subsets are represented as follows [20], [25]:

$$T(l, m) = \frac{V(l, m) - V_{\min}}{V_{\min, \max}} \quad (1)$$

$$F(l, m) = 1 - T(l, m) \quad (2)$$

where for each pixel $V(l, m)$ in an image V , the three subsets are given by $\{T(l, m), I(l, m), F(l, m)\}$ in the neutrosophic image. Furthermore, using the local average intensity $\varepsilon(l, m)$, the I neutrosophic subset is given by:

$$I(l, m) = \frac{\varepsilon(l, m) - \varepsilon_{\min}}{\varepsilon_{\min, \max}} \quad (3)$$

where ε_{\min} and ε_{\max} are the minimum and maximum absolute difference values, respectively, of the local mean-value, and $\varepsilon_{\min, \max}$ represents the difference between them. A HP filter

$H(a, b)$ is applied to calculate the indeterminacy of the NS image.

In NS, the entropy specifies the pixels distribution in the neutrosophic image. The entropy of I is measured using the following expression:

$$Ent_I = - \sum_{i=\min\{I\}}^{\max\{I\}} pr_I(i) \ln(pr_I(i)) \quad (4)$$

where $pr_I(i)$ is probability of the pixel in the I subset. Consequently, the entropy of I is used to associate T and F with I .

B. PROPOSED NEUTROSOPHIC SET DEFINITION AND SEGMENTATION APPROACH

1) UNSHARP FILTER FOR I SUBSET DEFINITION

For precise mapping of the dermoscopic images into NS domain, it is indispensable to select the type and size of the HP filter for calculating the indeterminacy of the neutrosophic image. Unlike the Sobel filter which used in the previous studies of NS [20], [25], the unsharp filter is an accurate sharpening operator that augments the high-frequency components and boundary information [26]. Hence, in the proposed work, an unsharp operator $H_{Unsharp}$ is used to represent the $H(a, b)$ during the calculations of the I subset in equations 3 and 4. Furthermore, a comparative study using different HP filters is conducted to determine the best filter design for calculating the I subset.

By applying the unsharp filter on an image $O(x, y)$, the formed gradient image $P(x, y)$ is stated as:

$$P(x, y) = O(x, y) - O_{lowpass}(x, y) \quad (5)$$

where $O_{lowpass}(x, y)$ is the processed $O(x, y)$ image using the LP filter. For refining, the high frequency component is added back to the original image as follows:

$$O_{Unsharp}(x, y) = O(x, y) + c * P(x, y) \quad (6)$$

where c is a scaling constant. The unsharp filter $H_{Unsharp}$ with size 3×3 can be represented as:

-1/16	-2/16	-1/16
-2/16	12/16	-2/16
-1/16	-2/16	-1/16

In addition, the $H_{Unsharp}$ of size 5×5 is represented as:

-1/32	0	-2/32	0	-1/32
0	-1/32	-2/32	-1/32	0
-2/32	-2/32	24/32	-2/32	-2/32
0	-1/32	-2/32	-1/32	0
-1/32	0	-2/32	0	-1/32

Therefore, the I subset is defined for each pixel in the NS domain using the proposed $H_{Unsharp}$.

2) AVERAGE FILTER FOR T SUBSET DEFINITION

The subset I is used to find the pixels that will be considered while modifying the subset T in the next version NS finding. Typically, the average filter is a linear spatial filter which computes the pixels' average in the mask neighborhood.

This averaging process reduces the sharp transition in the image's intensities. Accordingly, the local mean $T(l, m)$ can be expressed using this average filter as follows:

$$T_{local_average}(l, m) = \frac{1}{s \times s} \sum_{a=m-s/2}^{m+s/2} \sum_{b=l-s/2}^{l+s/2} V(a, b) \quad (7)$$

where $V(a, b)$ is the local image that filtered by $H(a, b)$, and s is the filter size. In the α -mean operation, a LP (average filter) is employed to calculate the true subset of the neutrosophic image, and then T is modified according to the values of I . To use α -mean operation iteratively for updating T , the I is used to determine the pixels that will be taken α -mean operation. This α -mean operation used a threshold value α to identify the pixels for updating the used pixels' intensity in T as follows:

$$T_{updated}(l, m) = \begin{cases} T_{local_average}(l, m), & I(l, m) > \alpha \\ T(l, m), & I(l, m) \leq \alpha \end{cases} \quad (8)$$

Then, $T_{updated}(l, m)$ is used to produce the new updated NS image using the following formula:

$$V_{modified}(l, m) = V_{updated} \min_{\max} \quad (9)$$

Finally, the entropy of I is used as a terminating criterion of the iterative process using a threshold δ , which is given by:

$$\frac{Ent_I(i) - Ent_I(i+1)}{Ent_I(i)} < \delta \quad (10)$$

From the preceding methodology, the new definition of the NS subset is proposed. For the dermoscopic images segmentation, I subset used an unsharp (HP) filter for boundary detection of the skin lesion. Then, based on the α_{mean} , which are used in the updating of the final version of the T image in the NS. In the present work, for skin lesion segmentation, a dermoscopic image enhancement using hair removal was conducted. Then, the red channel of the RGB image, which contains all information about lesion, was transformed to the NS domain using the new NS definition. The generated components of the neutrosophic image are used to cluster the pixels of the dermoscopic images. A threshold value is used to update the T subset to obtain the modified version based on the computed I subset. Then, the k-means clustering process was applied for segmentation based on the values in T and I .

III. EXPERIMENTAL RESULTS AND DISCUSSION

In this section, different filters were used to implement I and T subsets to compare the proposed new NS filters with combinations of different filters for evaluating the performance of the proposed NS filters design (definition). Thus, for this comparative study, Prewitt, Sobel, kernel, double kernel and unsharp filters with different sizes were used in the design of the HP filters of the I subset. Additionally, another different LP filters' design for the T subset were used, namely median, average, and order filter (minimum, and maximum). Figure 1 illustrated the initial steps before using the NS filter on images.

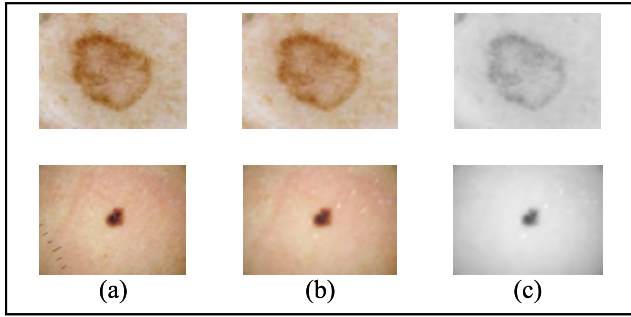

FIGURE 1. Initial pre-processing steps: (a) original images number ISIC_0000153 and ISIC_0011082 at the upper row and the lower row, respectively, (b) after hair removal filter, and (c) red channel of the filtered image.

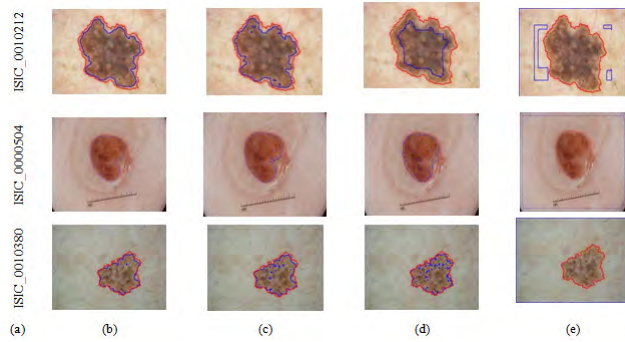

FIGURE 2. Comparative study of the different combinations for designing the NS filter for the images with numbers in (a), where (b) proposed unsharp of size 5×5 with average filter of size 3×3 , (c) kernel of 9×9 with median filter of 3×3 , (d) double kernel of 9×9 with maximum order filter of size 3×3 , and (e) unsharp of size 5×5 with minimum order filter of size 3×3 .

Different combinations of filters are used, and results are compared visually in Figure 2, which displayed the final segmented skin lesion images. These combinations are unsharp filter of size 5×5 with average filter of size 3×3 , kernel filter of 9×9 with median filter of 3×3 , double kernel filter of size 9×9 with maximum order filter of size 3×3 , and unsharp filter of size 5×5 with minimum order filter of size 3×3 .

Figure 2 established that the best combinations consist of using unsharp filter of size 5×5 with average filter of size 3×3 , or Laplacian kernel of 9×9 with median filter of 3×3 . However, using the unsharp of size 5×5 with average filter of size 3×3 provided more smooth borders compared to using the kernel of 9×9 with median filter of 3×3 . Accordingly, Figures 3 demonstrated a comparison between the unsharp of size 5×5 with average filter of size 3×3 combination, and the kernel of 9×9 with median filter of 3×3 combinations in terms of the NS steps for an example using the image ISIC_0000153, respectively.

To evaluate the performance of the new NS filters design, 90 dermoscopy images from the ISIC2016 skin lesion dermoscopy images were used. The segmentation performance was evaluated by measuring several metrics, including the Dice coefficient (Dice), JAC, accuracy, specificity,

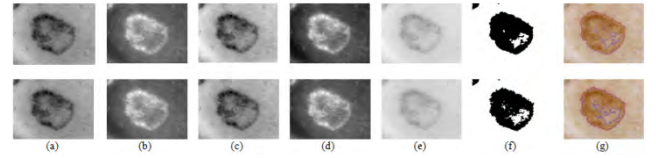

FIGURE 3. Comparative study in terms of the steps of the NS to obtain the segmented image using the proposed unsharp of size 5×5 with average filter of size 3×3 combination at the first row, and the Kernel of 9×9 with median filter of 3×3 at the second row of the figure for image number ISIC_0000153, where (a) initial T image, (b) initial F image, (c) last T version after the NS iterations, (d) Last F version after the last NS iterations, (e) final NS output, (f) k-means output, and (g) the final segmented image.

TABLE 1. Segmentation results comparison of different combinations.

NS filters combination	JAC	Dice	Sensitivity	Specificity	Accuracy
Double Kernel 9x9 with Maximum order filter 3x3	0.69	0.79	0.71	0.97	0.92
Unsharp 5x5 with Minimum order filter 3x3	0.70	0.79	0.82	0.87	0.87
Kernel 9x9 with Median 3x3	0.82	0.89	0.82	0.99	0.95
Unsharp 5x5 with Average 3x3 [Proposed]	0.83	0.91	0.83	0.99	0.96

and sensitivity [20]. The Dice measures the association between S_1 and S_2 is given by:

$$Dice = \frac{2|S_1 \cap S_2|}{|S_1| + |S_2|} \quad (11)$$

where \cup and \cap are the union and intersection operations, respectively. Additionally, the JAC for J_1 and J_2 is defined by:

$$JAC(J_1, J_2) = \frac{J_1 \cap J_2}{J_1 \cup J_2} \quad (12)$$

where J_1 and J_2 are the segmented and ground-truth images, respectively. The other metrics include accuracy which measures the ratio between the negative and positive results; specificity which measures how the segmentation method predicts the other regions in the image; and sensitivity which measures the detection capability of the segmentation method for detecting the lesion regions. Table 1 and Figure 4 reported the average evaluation metrics over the used dataset images using different combinations, where the ISIC2016 dataset includes different sizes of skin lesion dermoscopy images.

The results in Table 1 established the superiority of the used new NS filters definition even the used images have different images' sizes.

Table 1 and Figure 4 established the superiority of the proposed unsharp 5×5 with average 3×3 combination for the NS filter design compared to the other combinations in terms of the measured evaluation metrics. In addition, the computational time of the NS with the different combinations are reported in Figure 5.

However, the average computational time of the NS using the different combinations stated that the unsharp 5×5

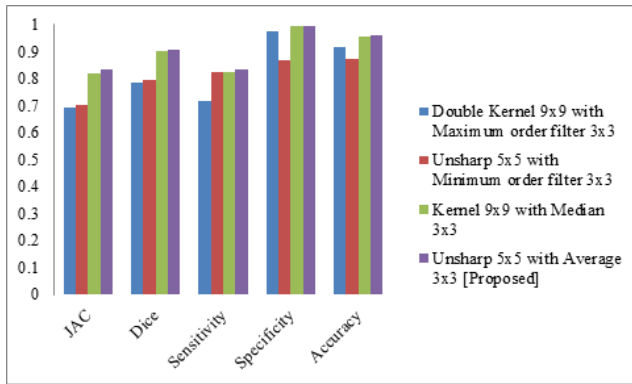

FIGURE 4. Comparison in terms of the average evaluation metrics over 90 images using different combinations followed by k-means.

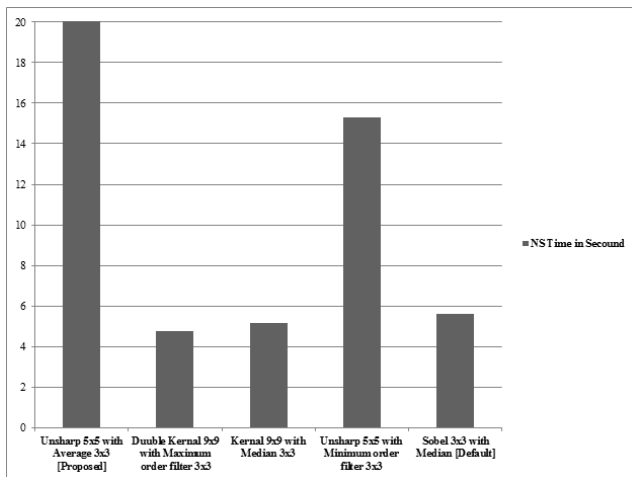

FIGURE 5. Comparison in terms of the average computational time in seconds over 90 images using different combinations followed by k-means and using in the traditional k-means and GC methods.

with average 3×3 took the maximum computational time of 22.07 seconds, while the kernel 9×9 with median 3×3 took less computational time of 5.17 seconds during the NS process. The double kernel 9×9 with maximum order filter 3×3 followed by k-means requires the least time during the NS process of 4.78 seconds in comparison to using the other NS combinations. Another comparison in terms of the different evaluation metrics using the traditional graph-cut, k-means and the NS default filters (Sobel 3×3 with median 3×3) followed by k-means in comparison with the proposed combinations of the NS filters followed by the k-means is described in Table 2.

Table 2 illustrated the superiority of the proposed NS definition for skin lesion segmentation. Accordingly, it is recommended in the future work to integrate the proposed NS definition with other segmentation methods. Moreover, the proposed definition can be tested with different medical images from different modalities, including microscopic images, ultrasound images, and magnetic resonance images to find the utmost appropriate NS definitions.

TABLE 2. Comparison between the traditional segmentation methods with the proposed NS filters in terms of the average evaluation metrics.

Segmentation method	JAC	Dice	Sensitivity	Specificity	Accuracy
Graph-cut (GC)	0.62	0.72	0.70	0.91	0.89
K-means	0.75	0.79	0.79	0.94	0.91
Default NS using Sobel 3×3 Median followed by K-means	0.79	0.80	0.79	0.95	0.92
Proposed NS using unsharp 5×5 with average 3×3 followed by K-means	0.83	0.91	0.83	0.99	0.96

IV. CONCLUSION

Edge detection and segmentation are significant steps for accurate recognition of skin lesion diseases in automated diagnostic systems. Due to the fuzziness, irregular shape, and intra-class inconsistency of the lesion boundaries, recently NS is employed efficiently in skin lesion segmentation. Since the NS depends mainly on its three subsets, namely T , I , and F , using different definitions of the NS filters have a great impact on the performance of the NS in image processing.

This work introduced new definitions of the NS subset and improved the overall performance of skin lesion segmentation in dermoscopic images. An experiment was taken on the proposed definition with different filters' combinations including the default filter of using Sobel with median filter. In addition, other combinations and segmentation methods, such as GC and k-means were examined. Furthermore, several evaluation metrics were measured on the images from the public ISIC2016 dataset.

The results established the superiority of the proposed combination using unsharp 5×5 with average 3×3 which achieved the best measured metric values of 96% accuracy, 99% specificity, and 83% sensitivity as well as 0.91 Dice and 0.83 JAC. However, the proposed design took the longest computational time of 22.07 seconds compared to the other combinations.

In future, a new dermoscopic image segmentation approach based on the proposed NS definition can be improved with other segmentation methods. Moreover, the same proposed segmentation algorithm can be used for segmenting in different medical applications including advanced diseases' images and identify the diseases as well as this new NS filters representation can be generalized with natural images dataset of different sizes.

REFERENCES

- [1] H. Bustince, E. Barrenechea, M. Pagola, J. Fernandez, Z. Xu, B. Bedregal, J. Montero, H. Hagra, F. Herrera, and B. B. De, "A historical account of types of fuzzy sets and their relationships," *IEEE Trans. Fuzzy Syst.*, vol. 24, no. 1, pp. 179–194, Feb. 2016.
- [2] H. Wang, Z. Xu, and W. Pedrycz, "An overview on the roles of fuzzy set techniques in big data processing: Trends, challenges and opportunities," *Knowl.-Based Syst.*, vol. 118, pp. 15–30, Feb. 2017.

- [3] M. A. Sodenkamp, M. Tavana, and D. Di Caprio, "An aggregation method for solving group multi-criteria decision-making problems with single-valued neutrosophic sets," *Appl. Soft Comput.*, vol. 71, pp. 715–727, Oct. 2018.
- [4] G. Liu, Y. Zhang, and A. Wang, "Incorporating adaptive local information into fuzzy clustering for image segmentation," *IEEE Trans. Image Process.*, vol. 24, no. 11, pp. 3990–4000, Nov. 2015.
- [5] F. Smarandache, *A Unifying Field in Logics: Neutrosophic Logic. Neutrosophy, Neutrosophic Set, Neutrosophic Probability*. Coimbatore, India: Infinite Study; 2005.
- [6] F. Smarandache, "Neutrosophic set—A generalization of the intuitionistic fuzzy set," *J. Defense Resour. Manage.*, vol. 1, no. 1, pp. 107–116, 2010.
- [7] S. Broumi and F. Smarandache, "Correlation coefficient of interval neutrosophic set," *Appl. Mech. Mater.*, vol. 436, pp. 511–517, Oct. 2013.
- [8] H. D. Cheng, Y. Guo, and Y. Zhang, "A novel image segmentation approach based on neutrosophic set and improved fuzzy C-means algorithm," *New Math. Natural Comput.*, vol. 7, no. 1, pp. 155–171, Mar. 2011.
- [9] Y. Guo and H. D. Cheng, "New neutrosophic approach to image segmentation," *Pattern Recognit.*, vol. 42, no. 5, pp. 587–595, May 2009.
- [10] Y. Guo, A. Şengür, and J. W. Tian, "A novel breast ultrasound image segmentation algorithm based on neutrosophic similarity score and level set," *Comput. Methods Programs Biomed.*, vol. 123, pp. 43–53, Jan. 2016.
- [11] H. D. Cheng, J. Shan, W. Ju, Y. Guo, and L. Zhang, "Automated breast cancer detection and classification using ultrasound images: A survey," *Pattern Recognit.*, vol. 43, no. 1, pp. 299–317, Jan. 2010.
- [12] M. Ali, L. H. Son, M. Khan, and N. T. Tung, "Segmentation of dental X-ray images in medical imaging using neutrosophic orthogonal matrices," *Expert Syst. Appl.*, vol. 91, pp. 434–441, Jan. 2018.
- [13] H. D. Cheng and Y. Guo, "A new neutrosophic approach to image thresholding," *New Math. Natural Comput.*, vol. 4, no. 3, pp. 291–308, Nov. 2008.
- [14] E. Sert and A. Alkan, "Image edge detection based on neutrosophic set approach combined with Chan-Vese algorithm," *Int. J. Pattern Recognit. Artif. Intell.*, vol. 33, no. 3, Mar. 2019, Art. no. 1954008.
- [15] M. Zhang, L. Zhang, and H. D. Cheng, "A neutrosophic approach to image segmentation based on watershed method," *Signal Process.*, vol. 90, no. 5, pp. 1510–1517, 2010.
- [16] J. Shan, H. D. Cheng, and Y. Wang, "A novel segmentation method for breast ultrasound images based on neutrosophic l-means clustering," *Med. Phys.*, vol. 39, no. 9, pp. 5669–5682, 2012.
- [17] Y. Guo and A. Sengur, "A novel color image segmentation approach based on neutrosophic set and modified fuzzy C-means," *Circuits, Syst., Signal Process.*, vol. 32, no. 4, pp. 1699–1723, Aug. 2013.
- [18] Y. Guo and A. Sengur, "NCM: Neutrosophic C-means clustering algorithm," *Pattern Recognit.*, vol. 48, no. 8, pp. 2710–2724, Aug. 2015.
- [19] J. Mohan, V. Krishnaveni, and Y. Huo, "Automated brain tumor segmentation on MR images based on neutrosophic set approach," in *Proc. 2nd Int. Conf. Electron. Commun. Syst. (ICECS)*, Feb. 2015, pp. 1078–1083.
- [20] A. S. Ashour, Y. Guo, E. Kucukkulahli, P. Erdogmus, and K. Polat, "A hybrid dermoscopy images segmentation approach based on neutrosophic clustering and histogram estimation," *Appl. Soft Comput.*, vol. 69, pp. 426–434, Aug. 2018.
- [21] *International Skin Imaging Collaboration*. Accessed: Aug. 14, 2019. [Online]. Available: <http://www.isdis.net/index.php/isc>
- [22] W. F. Schreiber, "Image processing for quality improvement," *Proc. IEEE*, vol. 66, no. 12, pp. 1640–1651, Dec. 1978.
- [23] A. Cichocki and S. I. Amari *Adaptive Blind Signal and Image Processing: Learning Algorithms and Applications*. Hoboken, NJ, USA: Wiley, 2002.
- [24] T. Matsumoto and A. Taguchi, "Removal of impulse noise from highly corrupted images by using noise position information and directional information of image," *Proc. SPIE*, vol. 4304, pp. 188–196, May 2001.
- [25] A. S. Ashour, A. R. Hawas, Y. Guo, and M. A. Wahba, "A novel optimized neutrosophic k-means using genetic algorithm for skin lesion detection in dermoscopy images," *Signal, Image Video Process.*, vol. 12, no. 7, pp. 1311–1318, Oct. 2018.
- [26] Y. Guo, A. Ashour, and F. Smarandache, "A novel skin lesion detection approach using neutrosophic clustering and adaptive region growing in dermoscopy images," *Symmetry*, vol. 10, no. 4, p. 119, Apr. 2018.
- [27] C. Solomon and T. Breckon, *Fundamentals of Digital Image Processing: A practical approach with examples in Matlab*. Hoboken, NJ, USA: Wiley, 2011.

Dynamic Interval Valued Neutrosophic Set: Modeling Decision Making in Dynamic Environments

Nguyen Tho Thong, Luu Quoc Dat, Le Hoang Son, Nguyen Dinh Hoa, Mumtaz Ali,
Florentin Smarandache

Nguyen Tho Thong, Luu Quoc Dat, Le Hoang Son, Nguyen Dinh Hoa, Mumtaz Ali, Florentin Smarandache (2019). Dynamic Interval Valued Neutrosophic Set: Modeling Decision Making in Dynamic Environments. *Computers in Industry* 108: 45-52; DOI: 10.1016/j.compind.2019.02.009

ABSTRACT

Dynamic decision problems constrained by time are of highly-interested in many aspects of real life. This paper proposes a new concept called the Dynamic Interval-valued Neutrosophic Set (DIVNS) for such the dynamic decision-making applications. Firstly, we define the definitions and mathematical operations, properties and correlations of DIVNSs. Next, we develop a new TOPSIS (Technique for Order of Preference by Similarity to Ideal Solution) method based on the proposed DIVNS theory. Finally, a practical application of the method for evaluating lecturers' performance at the University of Languages and International Studies, Vietnam National University, Hanoi (ULIS-VNU) is given to illustrate the efficiency of our approach.

Keywords:
Dynamic environment
Interval valued set
Neutrosophic set

1. Introduction

Neutrosophic set (NS) [45] is able to handle indeterminacy information [51,52,58]. NS and its extensions have become widely applied in almost areas, such as decision-making [1,12,20,21,33,34,41,42,49,58–62], clustering analysis [56,59], image processing [27,28], etc. However, in some complex problems in real-life, data may be collected from different time intervals or multi-periods, which raises the need for dynamic decision making for such the situations. The term 'dynamic' can be regarded in term of criteria such as (a) a series of decisions required to reach a goal; (b) path dependent decision; (c) the state of decision. This research considers the 'dynamic' decision problems which are constrained by time, as seen, for example, in emergency management and patient care. Specifically, when the economic situation of a certain company is investigated, the economic growth level of product series should be investigated by changes of the trend of profit of all products through the periods. Another example can be found in medical diagnosis where clinicians have to exam patients by different time intervals.

Recently, Yan et al. [53] developed a dynamic multiple attribute decision making method with grey number (considering both attribute value aggregation of all periods and their fluctuation among periods) to calculate degree of every alternative. This model was also used in [32] to manage linguistic bipolar scales using transformation between bipolar and unipolar linguistic terms. Ye [57] proposed a dynamic neutrosophic multiset. For decision assistance in dynamic environments, some algorithms that used TOPSIS under neutrosophic linguistic environments were presented in [2,10,11,22,23,25,26,33–37,40,55]. There have been also some works that applied the Interval-Valued Neutrosophic Set (IVNS) with the TOPSIS method for decision making [6,11,29,33,49,54,62]. Other relevant decision making methods can be retrieved in [3–5,7–9,13–19]. However, the existing researches did not consider different time intervals as the objective of this research aims. To the best of our knowledge, fluctuation of alternative's attribute values within periods on NSs has not been examined. In many practical cases, there is not enough available information to judge complicated situations, indeed it often given approximate ranges.

In this paper, we propose a new TOPSIS method based on a new extension of NS called the Dynamic Interval-valued Neutrosophic Set (DIVSN) for dynamic decision-making problems. The main contribution includes:

- (a) We define definitions and mathematical operations, properties and correlations of DIVNSs.

- (b) We develop a new TOPSIS method based on the proposed DIVNS theory.
- (c) A practical application of the method for evaluating lecturers' performance at the Vietnam National University, Hanoi (ULIS-VNU) is given to illustrate the efficiency of our approach.

Section 2 defines the new concept of Dynamic Interval-valued Neutrosophic Set (DIVNS). Section 3 presents the TOPSIS method for DIVNS. Section 4 illustrates the proposed method in a practical application. Finally, Section 5 summarizes the findings.

2. Dynamic interval-valued neutrosophic set

$$A = \left\{ \begin{array}{l} \langle x_1, ([0.1, 0.25], [0.15, 0.2], [0.3, 0.6]), ([0.45, 0.5], [0.1, 0.3], [0.2, 0.4]), ([0.6, 0.7], [0.52, 0.6], [0.7, 0.9]) \rangle, \\ \langle x_2, ([0.38, 0.4], [0.25, 0.4], [0.12, 0.3]), ([0.07, 0.1], [0.1, 0.2], [0.09, 0.1]), ([0.22, 0.3], [0.4, 0.5], [0.3, 0.43]) \rangle, \\ \langle x_3, ([0.7, 0.9], [0.33, 0.45], [0.59, 0.6]), ([0.2, 0.22], [0.5, 0.6], [0.2, 0.3]), ([0.8, 0.9], [0.3, 0.41], [0.3, 0.33]) \rangle \end{array} \right\}$$

2.1. Set definition

Definition 2.1. [45]: Let U be a universe of discourse. A neutrosophic set is:

$$A = \{ \langle x : T_A(x), I_A(x), F_A(x), x \in U \rangle \}$$

where $T_A(x), I_A(x), F_A(x) \in [0, 1]$ and $0 \leq \sup(T_A(x)) + \sup(I_A(x)) + \sup(F_A(x)) \leq 3$.

Definition 2.2. [45]: A neutrosophic number is defined as $N = a + bI$, where a and b are real numbers, and I is the indeterminacy.

Definition 2.3. [57]: A Dynamic Single-Valued Neutrosophic Set (DSVNS) is: $A = \{ \langle x \in U; x(T_x(t), I_x(t), F_x(t)) \rangle$ for all $x \in A$:

$$T_x, I_x, F_x : [0, \infty) \rightarrow [0, 1]$$

where T_x, I_x, F_x are continuous functions whose argument is time (t).

Based on the definition of DSVNS above, we formulate the new definition as below.

Definition 2.4. A Dynamic Interval-Valued Neutrosophic Set (DIVNS) is in the form below:

$$x \left(\left[T_x^L(t), T_x^U(t) \right], \left[I_x^L(t), I_x^U(t) \right], \left[F_x^L(t), F_x^U(t) \right] \right)$$

where $t \geq 0$,

$$T_x^L(t) < T_x^U(t), I_x^L(t) < I_x^U(t), F_x^L(t) < F_x^U(t)$$

And

$$\left[T_x^L(t), T_x^U(t) \right], \left[I_x^L(t), I_x^U(t) \right], \left[F_x^L(t), F_x^U(t) \right] \subseteq [0, 1]$$

In other words, a DIVNS is a neutrosophic set whose elements' neutrosophic components (membership, indeterminacy, non-membership) are all intervals changing with respect to time.

For a simplified notation, we denote:

$$T_x(t) = \left[T_x^L(t), T_x^U(t) \right], I_x(t) = \left[I_x^L(t), I_x^U(t) \right], F_x(t) = \left[F_x^L(t), F_x^U(t) \right]$$

where $T_x(t), I_x(t), F_x(t) : [0, \infty) \rightarrow P([0, 1])$ with $P([0, 1])$ been the power set of $[0, 1]$.

We can also use the notation $A(t)$ and $x(t)$, meaning that each element x in A depends on t . Or $T_x(t), I_x(t), F_x(t)$ are interval-valued functions (a particular case of neutrosophic function [1]).

The difference of the new definition against the existing one in [57]:

We have extended Ye's DSVNS [57] to DIVNS by considering a time sequence: $t = \{t_1, t_2, \dots, t_k\}$ then at each time $t_l, 1 \leq l \leq m$, the neutrosophic components of the generic element $x \in A$ change as follow:

$$x(\langle T_x(t_1), I_x(t_1), F_x(t_1) \rangle; \langle T_x(t_2), I_x(t_2), F_x(t_2) \rangle; \dots; \langle T_x(t_k), I_x(t_k), F_x(t_k) \rangle)$$

Example 2.1. A DIVNS in time sequence $t = \{t_1, t_2, t_3\}$ and a universal $NS = \{x_1, x_2, x_3\}$ is given:

2.2. Set theoretic operations of DIVNS

Let $A(t)$ and $B(t)$ be two DIVNSs included in U ;

$$A(t) = \left\{ \left\langle x(t), \left\langle T_x^A(t_l), I_x^A(t_l), F_x^A(t_l) \right\rangle \right\rangle, \forall t_l \in t, x \in U \right\}, B(t) = \left\{ \left\langle x(t), \left\langle T_x^B(t_l), I_x^B(t_l), F_x^B(t_l) \right\rangle \right\rangle, \forall t_l \in t, x \in U \right\}$$

Definition 2.5. : DIVNS Intersection

$$A(t) \cap B(t) = \left\{ \left\langle x(t), \left\langle T_x^A(t_l) \wedge T_x^B(t_l), I_x^A(t_l) \vee I_x^B(t_l), F_x^A(t_l) \vee F_x^B(t_l) \right\rangle \right\rangle, \forall t_l \in t, x \in U \right\}$$

Definition 2.6. DIVNS Union

$$A(t) \cup B(t) = \left\{ \left\langle x(t), \left\langle T_x^A(t_l) \vee T_x^B(t_l), I_x^A(t_l) \wedge I_x^B(t_l), F_x^A(t_l) \wedge F_x^B(t_l) \right\rangle \right\rangle, \forall t_l \in t, x \in U \right\}$$

Definition 2.7. DIVNS Complement

$$A(t)^C = \left\{ \left\langle x(t), \left\langle F_x^A(t_l), 1 - I_x^A(t_l), T_x^A(t_l) \right\rangle \right\rangle, \forall t_l \in t, x \in U \right\}$$

Definition 2.8. DIVNS inclusion

$$A(t) \subseteq B(t) \sim T_x^A(t_l) \leq T_x^B(t_l), I_x^A(t_l) \geq I_x^B(t_l) \text{ and } F_x^A(t_l) \geq F_x^B(t_l).$$

Definition 2.9. DIVNS Equality

$$A(t) = B(t) \Leftrightarrow A(t) \subseteq B(t) \text{ and } A(t) \supseteq B(t).$$

In the above DIVNS aggregation operators by “ \wedge ” we meant the “t-norm” and by “ \vee ”

the t-conorm from the single-valued fuzzy sets

2.3. Operations on DIVNS numbers

Let us consider two DIVNS numbers:

$$a(t) = \left\{ \left\langle T_x^A(t_1), I_x^A(t_1), F_x^A(t_1) \right\rangle, \dots, \left\langle T_x^A(t_k), I_x^A(t_k), F_x^A(t_k) \right\rangle \right\}$$

$$b(t) = \left\{ \left\langle T_x^B(t_1), I_x^B(t_1), F_x^B(t_1) \right\rangle, \dots, \left\langle T_x^B(t_k), I_x^B(t_k), F_x^B(t_k) \right\rangle \right\}.$$

Definition 2.14. Correlation coefficient of DIVNSs

Let

$$A(t) = \left\{ \left(x(t), \left\langle T^A(x, t_l), I^A(x, t_l), F^A(x, t_l) \right\rangle \right), \forall t_l \in t, x \in U \right\},$$

$$B(t) = \left\{ \left(x(t), \left\langle T^B(x, t_l), I^B(x, t_l), F^B(x, t_l) \right\rangle \right), \forall t_l \in t, x \in U \right\}$$

be two DIVNS in $t = \{t_1, t_2, \dots, t_k\}$ and $U = (x_1, x_2, \dots, x_n)$.
A correlation coefficient is:

$$\rho(A(t), B(t)) = \frac{1}{k} \sum_{l=1}^k \frac{\sum_{i=1}^n \left(\inf T^A(x_i, t_l) \times \inf T^B(x_i, t_l) + \sup T^A(x_i, t_l) \times \sup T^B(x_i, t_l) + \inf I^A(t_l) \times \inf I^B(x_i, t_l) + \sup I^A(x_i, t_l) \times \sup I^B(x_i, t_l) + \inf F^A(x_i, t_l) \times \inf F^B(x_i, t_l) + \sup F^A(x_i, t_l) \times \sup F^B(x_i, t_l) \right)}{\left(\sqrt{\sum_{i=1}^n \left[\left(\inf T^A(x_i, t_l) \right)^2 + \left(\sup T^A(x_i, t_l) \right)^2 + \left(\inf I^A(x_i, t_l) \right)^2 \right] + \left(\sup I^A(x_i, t_l) \right)^2 + \left(\inf F^A(x_i, t_l) \right)^2 + \left(\sup F^A(x_i, t_l) \right)^2} \right) \times \left(\sqrt{\sum_{i=1}^n \left[\left(\inf T^B(x_i, t_l) \right)^2 + \left(\sup T^B(x_i, t_l) \right)^2 + \left(\inf I^B(x_i, t_l) \right)^2 \right] + \left(\sup I^B(x_i, t_l) \right)^2 + \left(\inf F^B(x_i, t_l) \right)^2 + \left(\sup F^B(x_i, t_l) \right)^2} \right)} \quad (5)$$

Definition 2.10. Addition of DIVNS numbers

$$a(t) \oplus b(t) = \left\{ \left\langle \begin{matrix} T_x^A(t_1) + T_x^B(t_1) - T_x^A(t_1) \times T_x^B(t_1), \\ I_x^A(t_1) + I_x^B(t_1) - I_x^A(t_1) \times I_x^B(t_1), \\ F_x^A(t_1) + F_x^B(t_1) - F_x^A(t_1) \times F_x^B(t_1) \end{matrix} \right\rangle, \dots, \left\langle \begin{matrix} T_x^A(t_k) + T_x^B(t_k) - T_x^A(t_k) \times T_x^B(t_k), \\ I_x^A(t_k) + I_x^B(t_k) - I_x^A(t_k) \times I_x^B(t_k), \\ F_x^A(t_k) + F_x^B(t_k) - F_x^A(t_k) \times F_x^B(t_k) \end{matrix} \right\rangle \right\} \quad (1)$$

Definition 2.11. Multiplication of DIVNS numbers

$$a(t) \otimes b(t) = \left\{ \left\langle \begin{matrix} T_x^A(t_1) \times T_x^B(t_1), I_x^A(t_1) + I_x^B(t_1) - I_x^A(t_1) \times I_x^B(t_1), \\ F_x^A(t_1) + F_x^B(t_1) - F_x^A(t_1) \times F_x^B(t_1) \end{matrix} \right\rangle, \dots, \left\langle \begin{matrix} T_x^A(t_k) \times T_x^B(t_k), I_x^A(t_k) + I_x^B(t_k) - I_x^A(t_k) \times I_x^B(t_k), \\ F_x^A(t_k) + F_x^B(t_k) - F_x^A(t_k) \times F_x^B(t_k) \end{matrix} \right\rangle \right\} \quad (2)$$

Definition 2.12. Scalar Multiplication of DIVNS numbers

$$\alpha \times a(t) = \left\{ \left\langle 1 - \left(1 - T_x^A(t_1) \right)^\alpha, I_x^A(t_1)^\alpha, F_x^A(t_1)^\alpha \right\rangle, \dots, \left\langle 1 - \left(1 - T_x^A(t_k) \right)^\alpha, I_x^A(t_k)^\alpha, F_x^A(t_k)^\alpha \right\rangle \right\} \quad (3)$$

Definition 2.13. Power of the DIVNS numbers

$$a(t)^\alpha = \left\{ \left\langle T_x^A(t_1)^\alpha, 1 - \left(1 - I_x^A(t_1) \right)^\alpha, 1 - \left(1 - F_x^A(t_1) \right)^\alpha \right\rangle, \dots, \left\langle T_x^A(t_k)^\alpha, 1 - \left(1 - I_x^A(t_k) \right)^\alpha, 1 - \left(1 - F_x^A(t_k) \right)^\alpha \right\rangle \right\} \quad (4)$$

Theorem 2.1. The correlation coefficient between A and B satisfies:

- (Pr1) $0 \leq \rho(A(t), B(t)) \leq 1$;
- (Pr2) $\rho(A(t), B(t)) = 1$ if $A(t) = B(t)$;
- (Pr3) $\rho(A(t), B(t)) = \rho(B(t), A(t))$

Proof.

(Pr1) It is obvious that $\rho(A(t), B(t)) \geq 0$. From Cauchy-Schwarz inequality, we have

$$\sum_{i=1}^n \left(\inf T^A(x_i, t_l) \times \inf T^B(x_i, t_l) + \sup T^A(x_i, t_l) \times \sup T^B(x_i, t_l) + \inf I^A(t_l) \times \inf I^B(x_i, t_l) + \sup I^A(x_i, t_l) \times \sup I^B(x_i, t_l) + \inf F^A(x_i, t_l) \times \inf F^B(x_i, t_l) + \sup F^A(x_i, t_l) \times \sup F^B(x_i, t_l) \right) \leq \left(\sqrt{\sum_{i=1}^n \left[\left(\inf T^A(x_i, t_l) \right)^2 + \left(\sup T^A(x_i, t_l) \right)^2 + \left(\inf I^A(x_i, t_l) \right)^2 \right] + \left(\sup I^A(x_i, t_l) \right)^2 + \left(\inf F^A(x_i, t_l) \right)^2 + \left(\sup F^A(x_i, t_l) \right)^2} \right) \times \left(\sqrt{\sum_{i=1}^n \left[\left(\inf T^B(x_i, t_l) \right)^2 + \left(\sup T^B(x_i, t_l) \right)^2 + \left(\inf I^B(x_i, t_l) \right)^2 \right] + \left(\sup I^B(x_i, t_l) \right)^2 + \left(\inf F^B(x_i, t_l) \right)^2 + \left(\sup F^B(x_i, t_l) \right)^2} \right)$$

for each $l \in \{1, 2, \dots, k\}$. Thus, $0 \leq \rho(A(t), B(t)) \leq 1$.

(Pr2) $A(t) = B(t)$. $\forall l \in \{1, 2, \dots, k\}$. We have $\inf T^A(x_i, t_l) = \inf T^B(x_i, t_l)$; $\sup T^A(x_i, t_l) = \sup T^B(x_i, t_l)$; $\inf I^A(x_i, t_l) = \inf I^B(x_i, t_l)$; $\sup I^A(x_i, t_l) = \sup I^B(x_i, t_l)$; $\inf F^A(x_i, t_l) = \inf F^B(x_i, t_l)$; $\sup F^A(x_i, t_l) = \sup F^B(x_i, t_l)$; $\inf T^A(x_i, t_l) = \inf T^B(x_i, t_l) \Rightarrow \rho(A(t), B(t)) = 1$

(Pr3) It is easily observed.

Definition 2.15. Weighted Correlation Coefficient of DIVNSs

Different weights for $x_i(i = 1, \dots, n)$ and $t_l(l = 1, \dots, k)$ are integrated as follows.

$$\rho_w(A(t), B(t)) = \frac{1}{k} \sum_{l=1}^k \omega_l \times \frac{\sum_{i=1}^n w_i \times \left(\begin{aligned} &\inf T^A(x_i, t_l) \times \inf T^B(x_i, t_l) + \sup T^A(x_i, t_l) \times \sup T^B(x_i, t_l) \\ &+ \inf I^A(x_i, t_l) \times \inf I^B(x_i, t_l) + \sup I^A(x_i, t_l) \times \sup I^B(x_i, t_l) \\ &+ \inf F^A(x_i, t_l) \times \inf F^B(x_i, t_l) + \sup F^A(x_i, t_l) \times \sup F^B(x_i, t_l) \end{aligned} \right)}{\left(\sqrt{\sum_{i=1}^n w(x_i) \times \left(\begin{aligned} &(\inf T^A(x_i, t_l))^2 + (\sup T^A(x_i, t_l))^2 + (\inf I^A(x_i, t_l))^2 \\ &+ (\sup I^A(x_i, t_l))^2 + (\inf F^A(x_i, t_l))^2 + (\sup F^A(x_i, t_l))^2 \end{aligned} \right)} \right)} \right) \quad (6)$$

$$\times \left(\sqrt{\sum_{i=1}^n w(x_i) \times \left(\begin{aligned} &(\inf T^B(x_i, t_l))^2 + (\sup T^B(x_i, t_l))^2 + (\inf I^B(x_i, t_l))^2 \\ &+ (\sup I^B(x_i, t_l))^2 + (\inf F^B(x_i, t_l))^2 + (\sup F^B(x_i, t_l))^2 \end{aligned} \right)} \right)$$

where $w = (w_1, w_2, \dots, w_n)^T$ and $\omega = (\omega_1, \omega_2, \dots, \omega_m)^T$ are weighting vectors of $x_i (i = 1, \dots, n)$ and $t_l (l = 1, \dots, k)$ with $\sum_{i=1}^n w_i = 1$ and $\sum_{l=1}^k \omega_l = 1$.

When $w_i = 1/n; i = 1, \dots, n$ and $\omega_l = 1/k; l = 1, \dots, k$, Eq. (6) turns to (5).

The weighted correlation coefficient between A and B also satisfies the properties as in Theorem 2.1.

3. A topsis method for divns

Assume $A = \{A_1, A_2, \dots, A_n\}$ and $C = \{C_1, C_2, \dots, C_n\}$ and $D = \{D_1, D_2, \dots, D_h\}$ are sets of alternatives, attributes, and decision makers. For a decision maker $D_q; q = 1, \dots, h$, the evaluation characteristic of an alternatives $A_m; m = 1, \dots, v$, on an attribute $C_p; p = 1, \dots, n$, in time sequence $t = \{t_1, t_2, \dots, t_k\}$ is represented by the decision matrix $D^q(t) = (d_{mp}^q(t))_{v \times n}; l = 1, 2, \dots, k$. where

$$d_{mp}^q(t) = \langle x_{d_{mp}}^q(t), (T^q(d_{mp}, t), I^q(d_{mp}, t), F^q(d_{mp}, t)); t = \{t_1, t_2, \dots, t_k\} \rangle$$

$$\overline{T_{mp}(x)} = \left[\left(\sum_{q=1}^h T_{pmq}^L(x_{t_l}) \right) \frac{1}{h * k}, \left(\sum_{q=1}^h T_{pmq}^U(x_{t_l}) \right) \frac{1}{h * k} \right]$$

$$\overline{F_{mp}(x)} = \left[\left(\sum_{q=1}^h F_{pmq}^L(x_{t_l}) \right) \frac{1}{h * k}, \left(\sum_{q=1}^h F_{pmq}^U(x_{t_l}) \right) \frac{1}{h * k} \right]$$

3.2. Importance weight aggregation

Let $x_{pq}(t_l) = \{ [T_{pq}^L(x_{t_l}), T_{pq}^U(x_{t_l})], [I_{pq}^L(x_{t_l}), I_{pq}^U(x_{t_l})], [F_{pq}^L(x_{t_l}), F_{pq}^U(x_{t_l})] \}$ be weight of D_q to criterion C_p in time sequence t_l , where: $p = 1, \dots, n; q = 1, \dots, h; l = 1, \dots, k$. The average weight $\overline{w_p} = \{ [T_p^L(x), T_p^U(x)], [I_p^L(x), I_p^U(x)], [F_p^L(x), F_p^U(x)] \}$ can be evaluated as:

$$\overline{w_p} = \frac{1}{h * k} \otimes \left\langle \left\{ \left[T_{p1}^L(x_{t_1}), T_{p1}^U(x_{t_1}) \right], \left[I_{p1}^L(x_{t_1}), I_{p1}^U(x_{t_1}) \right], \left[F_{p1}^L(x_{t_1}), F_{p1}^U(x_{t_1}) \right] \right\} + \dots + \left\{ \left[T_{ph}^L(x_{t_h}), T_{ph}^U(x_{t_h}) \right], \left[I_{ph}^L(x_{t_h}), I_{ph}^U(x_{t_h}) \right], \left[F_{ph}^L(x_{t_h}), F_{ph}^U(x_{t_h}) \right] \right\} \right\rangle, \quad (8)$$

taken by DIVNSs evaluated by decision maker D_q .

3.1. Aggregate ratings

Let $x_{mpq}(t_l) = \{ [T_{mpq}^L(x_{t_l}), T_{mpq}^U(x_{t_l})], [I_{mpq}^L(x_{t_l}), I_{mpq}^U(x_{t_l})], [F_{mpq}^L(x_{t_l}), F_{mpq}^U(x_{t_l})] \}$ be the suitability rating of alternative A_m for criterion C_p by decision-maker D_q in time sequence t_l , where: $m = 1, \dots, v; p = 1, \dots, n; q = 1, \dots, h; l = 1, \dots, k$. The averaged suitability rating $\overline{x_{mp}} = \{ [T_{mp}^L(x), T_{mp}^U(x)], [I_{mp}^L(x), I_{mp}^U(x)], [F_{mp}^L(x), F_{mp}^U(x)] \}$ can be evaluated as:

$$\overline{x_{mp}} = \frac{1}{h * k} \otimes \left\langle \left\{ \left[T_{mpq}^L(x_{t_1}), T_{mpq}^U(x_{t_1}) \right], \left[I_{mpq}^L(x_{t_1}), I_{mpq}^U(x_{t_1}) \right], \left[F_{mpq}^L(x_{t_1}), F_{mpq}^U(x_{t_1}) \right] \right\} + \dots + \left\{ \left[T_{mpq}^L(x_{t_k}), T_{mpq}^U(x_{t_k}) \right], \left[I_{mpq}^L(x_{t_k}), I_{mpq}^U(x_{t_k}) \right], \left[F_{mpq}^L(x_{t_k}), F_{mpq}^U(x_{t_k}) \right] \right\} \right\rangle, \quad (7)$$

where,

$$\overline{T_{mp}(x)} = \left[\left\langle 1 - \left\{ 1 - \left(1 - \sum_{q=1}^h T_{pmq}^L(x_{t_l}) \right) \frac{1}{h} \right\} \frac{1}{k}, \left\langle 1 - \left\{ 1 - \left(1 - \sum_{q=1}^h T_{pmq}^U(x_{t_l}) \right) \frac{1}{h} \right\} \frac{1}{k} \right\rangle \right]$$

where,

$$\overline{T_p(x)} = \left[\left\langle 1 - \left\{ 1 - \left(1 - \sum_{q=1}^h T_{pq}^L(x_{t_i}) \right)^{\frac{1}{h}} \right\}^{\frac{1}{k}}, \left\langle 1 - \left\{ 1 - \left(1 - \sum_{q=1}^h T_{pq}^U(x_{t_i}) \right)^{\frac{1}{h}} \right\}^{\frac{1}{k}} \right\rangle \right]$$

$$\overline{I_p(x)} = \left[\left(\sum_{q=1}^h I_{pq}^L(x_{t_i}) \right)^{\frac{1}{h * k}}, \left(\sum_{q=1}^h I_{pq}^U(x_{t_i}) \right)^{\frac{1}{h * k}} \right]$$

$$\overline{F_p(x)} = \left[\left(\sum_{q=1}^h F_{pq}^L(x_{t_i}) \right)^{\frac{1}{h * k}}, \left(\sum_{q=1}^h F_{pq}^U(x_{t_i}) \right)^{\frac{1}{h * k}} \right]$$

3.3. Compute the average weighted ratings

Average weighted ratings of alternatives in t_i , are:

$$\overline{G}_m = \frac{1}{n} \sum_{p=1}^n \overline{x}_{mp} * \overline{w}_p; m = 1, \dots, v; p = 1, \dots, n; \tag{9}$$

3.4. Determination of A^+, A^-, d_i^+ and d_i^-

Interval neutrosophic positive and negative ideal solutions namely (PIS, A^+) and (NIS, A^-) are:

$$A^+ = \{x, ([1, 1], [0, 0], [0, 0])\} \tag{10}$$

$$A^- = \{x, ([0, 0], [1, 1], [1, 1])\} \tag{11}$$

The distances of each alternative $A_m, m = 1, \dots, t$ from A^+ and A^- in time sequence t_i , are calculated as:

$$\overline{d}_m^+ = \sqrt{(\overline{G}_m - A^+)^2} \tag{12}$$

$$\overline{d}_m^- = \sqrt{(\overline{G}_m - A^-)^2} \tag{13}$$

where \overline{d}_m^+ and \overline{d}_m^- represents the shortest and farthest distances of A_m .

3.4. Obtain best coefficient

The best coefficient in time sequence t_i , is shown below where high value indicates closer to interval neutrosophic PIS and farther from interval neutrosophic NIS:

$$\overline{CC}_m = \frac{\overline{d}_m^-}{\overline{d}_m^+ + \overline{d}_m^-} \tag{14}$$

4. Applications

This section applies the proposed method to evaluate lecturers' performance in the case study of ULIS-VNU having 11 Faculties, 11 Departments, 09 Functional departments, 05 Centers and 01 Foreign Language Specializing High School with over 700 lecturers and 8000 high school, undergraduate and graduate students. Assume that ULIS-VNU needs to evaluate the lecturers' performance. After preliminary screening, five lecturers, i.e. A_1, \dots, A_5 ,

and three decision makers, i.e. D_1, \dots, D_3 , are chosen. Ratings of five lecturers are done by criteria as total of publications (C_1), teaching student evaluations (C_2), personality characteristics (C_3), professional society (C_4), teaching experience (C_5), fluency of foreign language (C_6).

4.1. Aggregate ratings

Suitability ratings $S = \{Ve_Po, Po, Me, Go, Ve_Go\}$ in $t = \{t_1, t_2, t_3\}$ is,

Ve_Po = Very_Poor = ([0.1, 0.2], [0.6, 0.7], [0.7, 0.8]),

Po = Poor = ([0.2, 0.3], [0.5, 0.6], [0.6, 0.7]),

Me = Medium = ([0.3, 0.5], [0.4, 0.6], [0.4, 0.5]),

Go = Good = ([0.5, 0.6], [0.4, 0.5], [0.3, 0.4]),

Ve_Go = Very_Good = ([0.6, 0.7], [0.2, 0.3], [0.2, 0.3]),

Table 1 presents suitability ratings where the aggregated ratings of lecturers versus criteria are shown at the last column of Table 1.

4.2. Importance weight aggregation

The importance $V = \{U_IPA, O_IPA, IPA, V_IPA, A_IPA\}$ in $t = \{t_1, t_2, t_3\}$ is:

U_IPA = ([0.1, 0.2], [0.4, 0.5], [0.6, 0.7]) = Unimportant,

O_IPA = ([0.2, 0.4], [0.5, 0.6], [0.4, 0.5]) = Ordinary_Important,

IPA = ([0.4, 0.6], [0.4, 0.5], [0.3, 0.4]) = Important,

V_IPA = ([0.6, 0.8], [0.3, 0.4], [0.2, 0.3]) = Very_Important,

A_IPA = ([0.7, 0.9], [0.2, 0.3], [0.1, 0.2]) = Absolutely_Important (Tables 2-4),

4.3. Weighted ratings

A^+, A^-, d_i^+ and d_i^-

4.4. Determine the lecturer

Table 5 shows the ranking order is $A_2 \succ A_3 \succ A_4 \succ A_1 \succ A_5$. Thus, the best lecturer is A_2 .

5. Comparison

This section compares the proposed TOPSIS method for DIVSN with the similarity measures between INs proposed by Ye [62] to illustrate the advantages and applicability of the proposed method. Using Ye's [62] method and the data in Table 3, the score function, the accuracy function and the certainty function of the lecturers are shown in Table 6.

Table 1
Aggregated ratings.

Criteria	Lecturers	Decision makers									Aggregated ratings
		t_1			t_2			t_3			
		D_1	D_2	D_3	D_1	D_2	D_3	D_1	D_2	D_3	
C ₁	A ₁	Me	Go	Go	Go	Go	Go	Go	Ve_Go	Go	[(0.494, 0.603), [0.370, 0.5], [0.296, 0.4]]
	A ₂	Go	Go	Ve_Go	Ve_Go	Go	Ve_Go	Ve_Go	Go	Ve_Go	[(0.558, 0.659), [0.272, 0.4], [0.239, 0.3]]
	A ₃	Me	Go	Go	Go	Go	Go	Go	Go	Ve_Go	[(0.494, 0.603), [0.370, 0.5], [0.296, 0.4]]
	A ₄	Go	Me	Go	Go	Go	Go	Go	Go	Go	[(0.481, 0.590), [0.400, 0.5], [0.310, 0.4]]
	A ₅	Me	Go	Me	Go	Go	Me	Go	Go	Go	[(0.441, 0.569), [0.400, 0.5], [0.330, 0.4]]
C ₂	A ₁	Go	Go	Go	Ve_Go	Go	Go	Go	Go	Go	[(0.512, 0.613), [0.370, 0.5], [0.287, 0.4]]
	A ₂	Ve_Go	Go	Ve_Go	Me	Go	Go	Ve_Go	Go	Go	[(0.518, 0.627), [0.317, 0.4], [0.271, 0.4]]
	A ₃	Ve_Go	Go	Go	Go	Me	Go	Go	Me	Go	[(0.474, 0.593), [0.370, 0.5], [0.306, 0.4]]
	A ₄	Go	Go	Go	Go	Ve_Go	Go	Go	Go	Ve_Go	[(0.524, 0.625), [0.343, 0.4], [0.274, 0.4]]
	A ₅	Ve_Go	Go	Go	Go	Ve_Go	Go	Go	Go	Me	[(0.506, 0.615), [0.343, 0.5], [0.283, 0.4]]
C ₃	A ₁	Ve_Go	Ve_Go	Go	Go	Ve_Go	Go	Go	Me	Go	[(0.518, 0.627), [0.317, 0.4], [0.271, 0.4]]
	A ₂	Go	Ve_Go	Go	Ve_Go	Go	Ve_Go	Go	Go	Ve_Go	[(0.547, 0.648), [0.294, 0.4], [0.251, 0.4]]
	A ₃	Go	Ve_Go	Ve_Go	Go	Go	Go	Go	Ve_Go	Go	[(0.536, 0.637), [0.317, 0.4], [0.262, 0.4]]
	A ₄	Go	Go	Go	Ve_Go	Go	Go	Ve_Go	Go	Go	[(0.524, 0.625), [0.343, 0.4], [0.274, 0.4]]
	A ₅	Ve_Go	Go	Go	Go	Ve_Go	Go	Go	Go	Go	[(0.524, 0.625), [0.343, 0.4], [0.274, 0.4]]
C ₄	A ₁	Me	Go	Me	Go	Go	Me	Me	Go	Me	[(0.397, 0.547), [0.400, 0.6], [0.352, 0.5]]
	A ₂	Go	Me	Go	Go	Me	Go	Me	Go	Go	[(0.441, 0.569), [0.400, 0.5], [0.330, 0.4]]
	A ₃	Go	Go	Go	Go	Go	Me	Go	Go	Ve_Go	[(0.494, 0.603), [0.370, 0.5], [0.296, 0.4]]
	A ₄	Me	Po	Me	Go	Me	Me	Go	Go	Me	[(0.365, 0.518), [0.410, 0.6], [0.380, 0.5]]
	A ₅	Me	Me	Po	Me	Me	Me	Me	Go	Me	[(0.316, 0.494), [0.410, 0.6], [0.405, 0.5]]
C ₅	A ₁	Me	Go	Me	Me	Go	Go	Go	Me	Go	[(0.419, 0.558), [0.400, 0.5], [0.341, 0.4]]
	A ₂	Go	Ve_Go	Go	Ve_Go	Go	Go	Go	V_G	Go	[(0.536, 0.637), [0.317, 0.4], [0.262, 0.4]]
	A ₃	Go	Go	Me	Go	Go	Go	Go	Ve_Go	Go	[(0.494, 0.603), [0.370, 0.5], [0.296, 0.4]]
	A ₄	Ve_Go	Go	Go	Ve_Go	Go	Go	Ve_Go	Go	Go	[(0.536, 0.637), [0.317, 0.4], [0.262, 0.4]]
	A ₅	Go	Go	Go	Go	Go	Go	Go	Ve_Go	Go	[(0.512, 0.613), [0.370, 0.5], [0.287, 0.4]]
C ₆	A ₁	Ve_Go	Go	Go	Ve_Go	Go	Ve_Go	Ve_Go	Go	Ve_Go	[(0.558, 0.659), [0.272, 0.4], [0.239, 0.3]]
	A ₂	Go	Go	Go	Go	Ve_Go	Ge	Go	Go	Ve_Go	[(0.524, 0.625), [0.343, 0.4], [0.274, 0.4]]
	A ₃	Ve_Go	Go	Ve_Go	Ve_Go	Go	Ve_Go	Ve_Go	Go	Ve_Go	[(0.569, 0.670), [0.252, 0.4], [0.229, 0.3]]
	A ₄	Go	Ve_Go	Go	Go	Ve_Go	Go	Go	Go	Go	[(0.524, 0.625), [0.343, 0.4], [0.274, 0.4]]
	A ₅	Go	Go	Go	Ve_Go	Go	Go	Go	Ve_Go	Go	[(0.524, 0.625), [0.343, 0.4], [0.274, 0.4]]

Table 2
Aggregated weights.

Criteria	Decision-makers									Aggregated weights
	t_1			t_2			t_3			
	D_1	D_2	D_3	D_1	D_2	D_3	D_1	D_2	D_3	
C ₁	IPA	IPA	IPA	IPA	V_IPA	IPA	V_IPA	IPA	V_IPA	[(0.476, 0.683), [0.363, 0.5], [0.262, 0.4]]
C ₂	V_IPA	V_IPA	IPA	V_IPA	V_IPA	V_IPA	A_IPA	V_IPA	V_IPA	[(0.595, 0.800), [0.296, 0.4], [0.194, 0.3]]
C ₃	IPA	V_IPA	V_IPA	IPA	IPA	V_IPA	V_IPA	IPA	V_IPA	[(0.499, 0.706), [0.352, 0.5], [0.251, 0.4]]
C ₄	IPA	V_IPA	IPA	IPA	O_IPA	IPA	IPA	IPA	IPA	[(0.408, 0.613), [0.397, 0.5], [0.296, 0.4]]
C ₅	IPA	IPA	IPA	V_IPA	IPA	V_IPA	IPA	IPA	IPA	[(0.452, 0.657), [0.375, 0.5], [0.274, 0.4]]
C ₆	V_IPA	V_IPA	IPA	IPA	IPA	IPA	V_IPA	V_IPA	IPA	[(0.499, 0.706), [0.352, 0.5], [0.251, 0.4]]

Table 3
Weighted ratings.

Lecturers	Aggregated weights
A ₁	[(0.170, 0.397), [0.648, 0.8], [0.545, 0.6]]
A ₂	[(0.190, 0.436), [0.617, 0.7], [0.519, 0.6]]
A ₃	[(0.187, 0.419), [0.642, 0.8], [0.535, 0.6]]
A ₄	[(0.178, 0.400), [0.643, 0.8], [0.538, 0.6]]
A ₅	[(0.173, 0.395), [0.649, 0.8], [0.549, 0.6]]

Table 5
Closeness coefficient.

Lecturers	Closeness coefficient	Ranking
A ₁	0.339	4
A ₂	0.367	1
A ₃	0.351	2
A ₄	0.345	3
A ₅	0.338	5

Table 4
The distance of each lecturer from A⁺ and A⁻.

Lecturers	d^+	d^-
A ₁	0.346	0.675
A ₂	0.375	0.647
A ₃	0.359	0.662
A ₄	0.352	0.668
A ₅	0.345	0.676

Table 6
Modified score, accuracy and certainty function of each lecturer.

Lecturers	Score function	Accuracy function	Certainty function	Ranking
A ₁	0.332	-0.297	0.283	4
A ₂	0.361	-0.241	0.313	1
A ₃	0.345	-0.267	0.303	2
A ₄	0.339	-0.284	0.289	3
A ₅	0.331	-0.300	0.284	5

Table 6 shows that the ranking order of the five lecturers is $A_2 \succ A_3 \succ A_4 \succ A_1 \succ A_5$. Thus, the best lecturer is A_2 . The result is the same as that of the proposed method. This means that our method in the simplest form can procedure the results of the best method for this problem. Moreover, it is more generalized and flexible than the Ye's [62] method in dynamic environments.

6. Conclusion

This paper proposed a new concept of Dynamic Interval Valued Neutrosophic Set (DIVNS) where all the factors in DIVNSs such as truth, indeterminacy and falsity degrees are in different ranges of time. Mathematical operations associated with DIVNSs and correlation coefficients have also been defined. In addition, we have proposed a new TOPSIS method based on the DIVNSs and their application to evaluate lecturers' performance in the ULIS-VNU. This shows the feasibility and applications of Neutrosophic Theory in Industry.

In the future, we will use DIVNSs as well as the TOPSIS method to express dynamic information, and develop additional extension theories for DIVNSs such as operators, similarity measure. In addition, we extended this method to predictive problems such as in [24, 30, 31, 38, 39, 43, 44,46, 47, 48, 50, 63–92].

Acknowledgement

This research is funded by Vietnam National Foundation for Science and Technology Development (NAFOSTED) under grant number 502.01-2015.16.

References

- [1] M. Abdel-Basset, M. Gunasekaran, M. Mohamed, N. Chilamkurti, Three-way decisions based on neutrosophic sets and AHP-QFD framework for supplier selection problem, *Future Gener. Comput. Syst.* 89 (2018) 19–30.
- [2] M. Abdel-Basset, G. Manogaran, A. Gamal, F. Smarandache, A hybrid approach of neutrosophic sets and DEMATEL method for developing supplier selection criteria, *Des. Autom. Embed. Syst.* (2018) 1–22.
- [3] M. Abdel-Basset, M. Mohamed, A.N. Hussien, A.K. Sangaiah, A novel group decision-making model based on triangular neutrosophic numbers, *Soft Comput.* 22 (20) (2018) 6629–6643.
- [4] M. Abdel-Basset, M. Mohamed, F. Smarandache, An extension of neutrosophic AHP-SWOT analysis for strategic planning and decision-making, *Symmetry* 10 (4) (2018) 116.
- [5] M. Abdel-Basset, Y. Zhou, M. Mohamed, V. Chang, A group decision making framework based on neutrosophic VIKOR approach for e-government website evaluation, *J. Intell. Fuzzy Syst.* 34 (6) (2018) 4213–4224.
- [6] Z. Aiwu, D. Jianguo, G. Hongjun, Interval valued neutrosophic sets and multi-attribute decision-making based on generalized weighted aggregation operator, *J. Intell. Fuzzy Syst.* 29 (6) (2015) 2697–2706.
- [7] M. Ali, L.H. Son, I. Deli, N.D. Tien, Bipolar neutrosophic soft sets and applications in decision making, *J. Intell. Fuzzy Syst.* 33 (6) (2017) 4077–4087.
- [8] M. Ali, L.H. Son, N.D. Thanh, N. Van Minh, A neutrosophic recommender system for medical diagnosis based on algebraic neutrosophic measures, *Appl. Soft Comput.* 71 (2018) 1054–1071.
- [9] M.A. Basset, M. Mohamed, A.K. Sangaiah, V. Jain, An integrated neutrosophic AHP and SWOT method for strategic planning methodology selection, *Benchmarking Int. J.* 25 (7) (2018) 2546–2564.
- [10] P. Biswas, S. Pramanik, B.C. Giri, TOPSIS method for multi-attribute group decision-making under single-valued neutrosophic environment, *Neural Comput. Appl.* 27 (3) (2016) 727–737.
- [11] S. Broumi, J. Ye, F. Smarandache, An extended TOPSIS method for multiple attribute decision making based on interval neutrosophic uncertain linguistic variables, *Infinite Study* (2015).
- [12] S. Broumi, I. Deli, Correlation measure for neutrosophic refined sets and its application in medical diagnosis, *Palestine J. Math.* 5 (2015) 135–143.
- [13] S. Broumi, A. Dey, A. Bakali, M. Talea, F. Smarandache, L.H. Son, D. Koley, Uniform single valued neutrosophic graphs, *Neutrosophic Sets Syst.* 17 (2017) 42–49.
- [14] S. Broumi, L.H. Son, A. Bakali, M. Talea, F. Smarandache, G. Selvachandran, Computing operational matrices in neutrosophic environments: a matlab toolbox, *Neutrosophic Sets Syst.* 18 (2017).
- [15] S. Broumi, J. Ye, F. Smarandache, An Extended TOPSIS Method for Multiple Attribute Decision Making based on Interval Neutrosophic Uncertain Linguistic Variables, *Neutrosophic Sets Syst.* 8 (2015) 22–31.
- [16] O. Castillo, L. Amador-Angulo, J.R. Castro, M. Garcia-Valdez, A comparative study of type-1 fuzzy logic systems, interval type-2 fuzzy logic systems and generalized type-2 fuzzy logic systems in control problems, *Inf. Sci.* 354 (2016) 257–274.
- [17] O. Castillo, L. Cervantes, J. Soria, M. Sanchez, J.R. Castro, A generalized type-2 fuzzy granular approach with applications to aerospace, *Inf. Sci.* 354 (2016) 165–177.
- [18] O. Castillo, P. Melin, Intelligent systems with interval type-2 fuzzy logic, *Int. J. Innov. Comput. Inf. Control* 4 (4) (2008) 771–783.
- [19] L. Cervantes, O. Castillo, Type-2 fuzzy logic aggregation of multiple fuzzy controllers for airplane flight control, *Inf. Sci.* 324 (2015) 247–256.
- [20] P. Chi, P. Liu, An extended TOPSIS method for the multiple attribute decision making problems based on interval neutrosophic set, *Neutrosophic Sets Syst.* 1 (1) (2013) 63–70.
- [21] I. Deli, S. Broumi, F. Smarandache, On neutrosophic refined sets and their applications in medical diagnosis, *J. New Theory* 6 (2015) 88–98.
- [22] I. Deli, Y. Şubaş, A ranking method of single valued neutrosophic numbers and its applications to multi-attribute decision making problems, *Int. J. Mach. Learn. Cybern.* 8 (4) (2017) 1309–1322.
- [23] İ. Deli, Y. Şubaş, Bipolar neutrosophic refined sets and their applications in medical diagnosis, *Proceedings of the International Conference on Natural Science and Engineering (ICNASE'16)* (2016).
- [24] A. Dey, S. Broumi, L.H. Son, A. Bakali, M. Talea, F. Smarandache, A new algorithm for finding minimum spanning trees with undirected neutrosophic graphs, *Granul. Comput.* (2018) 1–7, doi:http://dx.doi.org/10.1007/s41066-018-0084-7.
- [25] W. Edwards, Dynamic decision theory and probabilistic information processings, *Hum. Factors* 4 (2) (1962) 59–74.
- [26] C. Fan, E. Fan, J. Ye, The cosine measure of single-valued neutrosophic multisets for multiple attribute decision-making, *Symmetry* 10 (5) (2018) 154.
- [27] Y. Guo, H.D. Cheng, New neutrosophic approach to image segmentation, *Pattern Recognit.* 42 (5) (2009) 587–595.
- [28] Y. Guo, A. Şengür, J. Ye, A novel image thresholding algorithm based on neutrosophic similarity score, *Measurement* 58 (2014) 175–186.
- [29] S.A.I. Hussain, S.P. Mondal, U.K. Mandal, VIKOR method for decision making problems in interval valued neutrosophic environment, *Fuzzy Multi-criteria Decision-Making Using Neutrosophic Sets*, Springer, Cham, 2019, pp. 587–602.
- [30] S. Jha, R. Kumar, L.H. Son, J.M. Chatterjee, M. Khari, N. Yadav, F. Smarandache, Neutrosophic soft set decision making for stock trending analysis, *Evol. Syst.* (2018) 1–7, doi:http://dx.doi.org/10.1007/s12530-018-9247-7.
- [31] M. Khan, L. Son, M. Ali, H. Chau, N. Na, F. Smarandache, Systematic review of decision making algorithms in extended neutrosophic sets, *Symmetry* 10 (8) (2018) 314.
- [32] H. Liu, L. Jiang, L. Martínez, A dynamic multi-criteria decision making model with bipolar linguistic term sets, *Expert Syst. Appl.* 95 (2018) 104–112.
- [33] P. Liu, G. Tang, Some power generalized aggregation operators based on the interval neutrosophic sets and their application to decision making, *J. Intell. Fuzzy Syst.* 30 (5) (2016) 2517–2528.
- [34] P. Liu, Y. Wang, Interval neutrosophic prioritized OWA operator and its application to multiple attribute decision making, *J. Syst. Sci. Complex.* 29 (3) (2016) 681–697.
- [35] S. Liu, T.A. Moughal, A novel method for dynamic multicriteria decision making with hybrid evaluation information, *J. Appl. Math.* (2014).
- [36] R. Lourenzutti, R.A. Krohling, A generalized TOPSIS method for group decision making with heterogeneous information in a dynamic environment, *Inf. Sci.* 330 (2016) 1–18.
- [37] R. Lourenzutti, R.A. Krohling, M.Z. Reformat, Choquet based TOPSIS and TODIM for dynamic and heterogeneous decision making with criteria interaction, *Inf. Sci.* 408 (2017) 41–69.
- [38] G.N. Nguyen, L.H. Son, A.S. Ashour, N. Dey, A survey of the state-of-the-arts on neutrosophic sets in biomedical diagnoses, *Int. J. Mach. Learn. Cybern.* (2018) 1–13, doi:http://dx.doi.org/10.1007/s13042-017-0691-7.
- [39] E. Ontiveros-Robles, P. Melin, O. Castillo, Comparative analysis of noise robustness of type 2 fuzzy logic controllers, *Kybernetika* 54 (1) (2018) 175–201.
- [40] J.J. Peng, J.Q. Wang, X.H. Wu, J. Wang, X.H. Chen, Multi-valued neutrosophic sets and power aggregation operators with their applications in multi-criteria group decision-making problems, *Int. J. Comput. Intell. Syst.* 8 (2) (2015) 345–363.
- [41] J.J. Peng, J.Q. Wang, J. Wang, H.Y. Zhang, X.H. Chen, Simplified neutrosophic sets and their applications in multi-criteria group decision-making problems, *Int. J. Syst. Sci.* 47 (10) (2016) 2342–2358.
- [42] R. Şahin, P. Liu, Possibility-induced simplified neutrosophic aggregation operators and their application to multi-criteria group decision-making, *J. Exp. Theor. Artif. Intell.* 29 (4) (2017) 769–785.
- [43] M.A. Sanchez, O. Castillo, J.R. Castro, Information granule formation via the concept of uncertainty-based information with Interval Type-2 Fuzzy sets representation and Takagi–Sugeno–Kang consequents optimized with Cuckoo search, *Appl. Soft Comput.* 27 (2015) 602–609.
- [44] M.A. Sanchez, O. Castillo, J.R. Castro, Generalized type-2 fuzzy systems for controlling a mobile robot and a performance comparison with interval type-2 and type-1 fuzzy systems, *Expert Syst. Appl.* 42 (14) (2015) 5904–5914.
- [45] F. Smarandache, *Neutrosophy. Neutrosophic Probability, Set, and Logic*, ProQuest Information & Learning, Ann Arbor, Michigan, USA, 1998, pp. 105.
- [46] N.D. Thanh, M. Ali, A novel clustering algorithm in a neutrosophic recommender system for medical diagnosis, *Cognit. Comput.* 9 (4) (2017) 526–544.

- [47] N.D. Thanh, L.H. Son, M. Ali, Neutrosophic recommender system for medical diagnosis based on algebraic similarity measure and clustering, 2017 IEEE International Conference on Fuzzy Systems (FUZZ-IEEE) (2017) 1–6.
- [48] N.X. Thao, B.C. Cuong, M. Ali, L.H. Lan, Fuzzy equivalence on standard and rough neutrosophic sets and applications to clustering analysis, *Information Systems Design and Intelligent Applications*, Springer, Singapore, 2018, pp. 834–842.
- [49] Z.P. Tian, H.Y. Zhang, J. Wang, J.Q. Wang, X.H. Chen, Multi-criteria decision-making method based on a cross-entropy with interval neutrosophic sets, *Int. J. Syst. Sci.* 47 (15) (2016) 3598–3608.
- [50] T.M. Tuan, P.M. Chuan, M. Ali, T.T. Ngan, M. Mittal, L.H. Son, Fuzzy and neutrosophic modeling for link prediction in social networks, *Evol. Syst.* (2018) 1–6, doi:http://dx.doi.org/10.1007/s12530-018-9251-y.
- [51] H. Wang, F. Smarandache, R. Sunderraman, Y.Q. Zhang, *Interval Neutrosophic Sets and Logic: Theory and Applications in Computing: Theory and Applications in Computing*, (2005), pp. 5.
- [52] H. Wang, F. Smarandache, Y.Q. Zhang, R. Sunderraman, *Single Valued Neutrosophic Sets. Multispace and Multistructure*, 4, Kalyan Mondal, and Surapati Pramanik, 2010, pp. 410–413.
- [53] S. Yan, S. Liu, J. Liu, L. Wu, Dynamic grey target decision making method with grey numbers based on existing state and future development trend of alternatives, *J. Intell. Fuzzy Syst.* 28 (5) (2015) 2159–2168.
- [54] W. Yang, Y. Pang, New multiple attribute decision making method based on DEMATEL and TOPSIS for multi-valued interval neutrosophic sets, *Symmetry* 10 (4) (2018) 115.
- [55] J. Ye, An extended TOPSIS method for multiple attribute group decision making based on single valued neutrosophic linguistic numbers, *J. Intell. Fuzzy Syst.* 28 (1) (2015) 247–255.
- [56] J. Ye, Clustering methods using distance-based similarity measures of single-valued neutrosophic sets, *J. Intell. Syst.* 23 (4) (2014) 379–389.
- [57] J. Ye, Correlation coefficient between dynamic single valued neutrosophic multisets and its multiple attribute decision-making method, *Information* 8 (2) (2017) 41.
- [58] J. Ye, Multicriteria decision-making method using the correlation coefficient under single-valued neutrosophic environment, *Int. J. Gen. Syst.* 42 (4) (2013) 386–394.
- [59] J. Ye, Single-valued neutrosophic minimum spanning tree and its clustering method, *J. Intell. Syst.* 23 (3) (2014) 311–324.
- [60] S. Ye, J. Fu, J. Ye, Medical diagnosis using distance-based similarity measures of single valued neutrosophic multisets, *Neutrosophic Sets Syst.* 7 (2015) 47–52.
- [61] J. Ye, Some aggregation operators of interval neutrosophic linguistic numbers for multiple attribute decision making, *J. Intell. Fuzzy Syst.* 27 (2014) 2231–2241, doi:http://dx.doi.org/10.3233/IFS-141187.
- [62] H. Zhang, J. Wang, X. Chen, An outranking approach for multi-criteria decision-making problems with interval-valued neutrosophic sets, *Neural Comput. Appl.* 27 (3) (2016) 615–627.
- [63] J. Hemanth, J. Anitha, A. Naaji, O. Geman, D. Popescu, L.H. Son, A modified deep convolutional neural network for abnormal brain image classification, *IEEE Access* 7 (1) (2018) 4275–4283.
- [64] L.H. Son, H. Fujita, Neural-fuzzy with representative sets for prediction of student performance, *Appl. Intell.* 49 (1) (2019) 172–187.
- [65] D.J. Hemanth, J. Anitha, L.H. Son, M. Mittal, Diabetic retinopathy diagnosis from retinal images using modified hopfield neural network, *J. Med. Syst.* 42 (12) (2018) 247.
- [66] D.J. Hemanth, J. Anitha, L.H. Son, Brain signal based human emotion analysis by circular back propagation and Deep Kohonen Neural Networks, *Comput. Electr. Eng.* 68 (2018) 170–180.
- [67] C.N. Giap, L.H. Son, F. Chiclana, Dynamic structural neural network, *J. Intell. Fuzzy Syst.* 34 (2018) 2479–2490.
- [68] S. Doss, A. Nayyar, G. Suseendran, S. Tanwar, A. Khanna, L.H. Son, P.H. Thong, APD-JFAD: accurate prevention and detection of jelly fish attack in MANET, *IEEE Access* 6 (2018) 56954–56965.
- [69] D.T. Hai, H. Son, L.T. Vinh, Novel fuzzy clustering scheme for 3D wireless sensor networks, *Appl. Soft Comput.* 54 (2017) 141–149.
- [70] R. Kapoor, R. Gupta, R. Kumar, L.H. Son, S. Jha, New scheme for underwater acoustically wireless transmission using direct sequence code division multiple access in MIMO systems, *Wirel. Netw.* (2019) 1–13, doi:http://dx.doi.org/10.1007/s11276-018-1750-z.
- [71] R. Kapoor, R. Gupta, L.H. Son, S. Jha, R. Kumar, Detection of power quality event using histogram of oriented gradients and support vector machine, *Measurement* 120 (2018) 52–75.
- [72] R. Kapoor, R. Gupta, L.H. Son, S. Jha, R. Kumar, Boosting performance of power quality event identification with KL Divergence measure and standard deviation, *Measurement* 126 (2018) 134–142.
- [73] H.V. Long, M. Ali, M. Khan, D.N. Tu, A novel approach for fuzzy clustering based on neutrosophic association matrix, *Comput. Ind. Eng.* (2019), doi:http://dx.doi.org/10.1016/j.cie.2018.11.007.
- [74] P.T.M. Phuong, P.H. Thong, L.H. Son, Theoretical analysis of picture fuzzy clustering: convergence and property, *J. Comput. Sci. Cybern.* 34 (1) (2018) 17–32.
- [75] Y.H. Robinson, E.G. Julie, K. Saravanan, R. Kumar, L.H. Son, FD-AOMDV: fault-tolerant disjoint ad-hoc on-demand multipath distance vector routing algorithm in mobile ad-hoc networks, *J. Ambient Intell. Humaniz. Comput.* (2019) 1–18, doi:http://dx.doi.org/10.1007/s12652-018-1126-3.
- [76] K. Saravanan, E. Anusuya, R. Kumar, L.H. Son, Real-time water quality monitoring using Internet of Things in SCADA, *Environ. Monit. Assess.* 190 (9) (2018) 556.
- [77] K. Saravanan, S. Aswini, R. Kumar, L.H. Son, How to prevent maritime border collision for fisheries?—A design of Real-Time Automatic Identification System, *Earth Sci. Inform.* (2019) 1–12, doi:http://dx.doi.org/10.1007/s12145-018-0371-5.
- [78] K. Singh, K. Singh, L.H. Son, A. Aziz, Congestion control in wireless sensor networks by hybrid multi-objective optimization algorithm, *Comput. Netw.* 138 (2018) 90–107.
- [79] N. Singh, L.H. Son, F. Chiclana, M. Jean-Pierre, A new fusion of salp swarm with sine cosine for optimization of non-linear functions, *Eng. Comput.* (2019), doi: http://dx.doi.org/10.1007/s00366-018-00696-8.
- [80] L.H. Son, A novel kernel fuzzy clustering algorithm for geo-demographic analysis, *Inf. Sci.—Inf. Comput. Sci. Intell. Syst. Appl.: Int. J.* 317 (C) (2015) 202–223.
- [81] L.H. Son, Generalized picture distance measure and applications to picture fuzzy clustering, *Appl. Soft Comput.* 46 (C) (2016) 284–295.
- [82] L.H. Son, P.V. Hai, A novel multiple fuzzy clustering method based on internal clustering validation measures with gradient descent, *Int. J. Fuzzy Syst.* 18 (5) (2016) 894–903.
- [83] L.H. Son, S. Jha, R. Kumar, J.M. Chatterjee, M. Khari, Collaborative handshaking approaches between internet of computing and internet of things towards a smart world: a review from 2009–2017, *Telecommun. Syst.* (2019) 1–18, doi: http://dx.doi.org/10.1007/s11235-018-0481-x.
- [84] L.H. Son, N.D. Tien, Tune up fuzzy C-means for big data: some novel hybrid clustering algorithms based on initial selection and incremental clustering, *Int. J. Fuzzy Syst.* 19 (5) (2017) 1585–1602.
- [85] L.H. Son, T.M. Tuan, A cooperative semi-supervised fuzzy clustering framework for dental X-ray image segmentation, *Expert Syst. Appl.* 46 (2016) 380–393.
- [86] L.H. Son, P.H. Thong, Some novel hybrid forecast methods based on picture fuzzy clustering for weather nowcasting from satellite image sequences, *Appl. Intell.* 46 (1) (2017) 1–15.
- [87] L.H. Son, T.M. Tuan, Dental segmentation from X-ray images using semi-supervised fuzzy clustering with spatial constraints, *Eng. Appl. Artif. Intell.* 59 (2017) 186–195.
- [88] N.T. Tam, D.T. Hai, L.H. Son, L.T. Vinh, Improving lifetime and network connections of 3D wireless sensor networks based on fuzzy clustering and particle swarm optimization, *Wirel. Netw.* 24 (5) (2018) 1477–1490.
- [89] P.H. Thong, L.H. Son, Picture fuzzy clustering: a new computational intelligence method, *Soft Comput.* 20 (9) (2016) 3549–3562.
- [90] P.H. Thong, L.H. Son, A novel automatic picture fuzzy clustering method based on particle swarm optimization and picture composite cardinality, *Knowl. Based Syst.* 109 (2016) 48–60.
- [91] P.H. Thong, L.H. Son, Picture fuzzy clustering for complex data, *Eng. Appl. Artif. Intell.* 56 (2016) 121–130.
- [92] T.M. Tuan, T.T. Ngan, L.H. Son, A novel semi-supervised fuzzy clustering method based on interactive fuzzy satisficing for dental X-ray image segmentation, *Appl. Intell.* 45 (2) (2016) 402–428.

How to Balance Intuitive and Analytical Functions of Brain: A Neutrosophic Way of Scientific Discovery Process

Victor Christianto, R. N. Boyd, Florentin Smarandache

Victor Christianto, R. N. Boyd, Florentin Smarandache (2019). How to Balance Intuitive and Analytical Functions of Brain: A Neutrosophic Way of Scientific Discovery Process. *EC Neurology* 11.7: 495-499

Introduction

Initially this article stems from our discussion on math and mysticism, inspired by an article by Ralph Abraham [1]. But it becomes a discussion on the role of intuition and inspiration in scientific discovery process.

Hopefully this article will help anyone who aspires to be good scientists or engineers.

Logic and experience

Logic and mystical experiences are exclusive domains that cross over into one another, on occasion, just as everything else does as participants in Experiences of the Wholeness, Harmony, Balance, Caring, and Oneness of the Alive Aware Intelligent Conscious Universe. All of this partly constitutes the *Mind of God*, which is vaster and more complex than most human beings are able to even vaguely comprehend.

For example, from the basis of Bhutatmas, the tiny Consciousness-experiencing creatures that have vast experiential memories, that Everything, all fields, all forces, all matter, all life, and the entire of the Infinite Cosmos, results from the activities and agglomerations of Bhutatmas, in an Infinite Universe constructed and operated by Intelligent Design.

According to the Vedic literature on this topic, Divinity resides in the Actually Infinitely Small, which is everywhere and nowhere, at the same time. Thus, it can and does act on everything that is and everything that happens. But Divinity has set things up so that Everything has Free Will and individual volition. A factor that has been left out of the Vedic literature on the topic of Bhutatmas, is that every Bhutatma is Unique, with a unique set of memories of experiences, regarding multiple Realities (not just this one). So, Uniqueness is an absolute in all the realms, and all the Realities.

Logic and Experience are mutually exclusive. If you are involved in logic, you are not able to have full and deep experiences of the senses and sensitivities, at the same time.

So, there is the Nature World operating in Divine Harmony, and the "people world", which made from analytical thought. Analytical thought separates the human being from being able to directly Experience the Cosmic Harmony, personally. However, Nature is constructed, and operates such that human beings can go beyond thought and into Direct Experience of the Cosmic Harmony and the Natural Harmony.

We hope that by now, the readers have arrived at some cognizant awareness of the differences between analytic thought and experiential thought; between the Nature and Divine Ways, and foolish people ways which are based in behavioral ignorance of the All and constrained by thought-originated pains and struggles, which result from the "ego", which is a product of analytical thought.

Direct experience, inner vision and experiencing God

More “right brain” activity, based on direct experiences, leads to direct experiences of the Divine. Your “inner vision” (the “mind’s eye”) can help readers in this, and in many other ways.

The inner vision is also the seat of many of the intuitive faculties, which are experientable facts, not imaginings. That means the information obtained by the intuitive faculty is verifiable and reproducibly observable.

In order to do that, the *Balanced Brain* is the most efficacious way to function, as well as the most efficient, and the most comfortable.

To obtain the Balanced Brain, the person usually needs to spend a great deal of their spare time being receptive, being the “receiver”, being accepting and exploring, and not using the analytical intellect, but instead, spending time in the Now and in the Senses and Sensitivities. This is best enjoyed in Natural settings.

For instance, one of us (RNB) spent one to three hours each day in the Forest in the Experiential State, exploring how Nature works, every day for 17 years. Somewhere in those years, he arrived into Transcendent States and Natural Awarenesses.

Not many people know what the Natural Man is like, because they’ve never experienced it. And they’ve never seen one. The Natural Man is removed from all varieties of intellectual indoctrinations and pain-producing ego-based behaviors.

Lao Tzu calls this condition “An uncarved section of wood”, partly because it is an arrival at the Original State. (How we were when we first came here, before all the indoctrinations and traumas started removing us from being who we were when we first came here).

In relation with discovery process, one of us (RNB) distinguishes discovery, soft vision from merging vision. Those three types of vision are based on Native American Spiritual Practice. For more explanation on these, see RNB’s article on penetrating insight [8].

The role of intuition and logic in scientific discovery process

Logical analysis is best used when following after an intuition or an “instinct”. An instinct is almost infallible. And once you have trained your mind to be attentive to their experience and sense, and they keep an open mind, then many ways of innovations will open their own ways to their mind.

All people got a lot of natural ability and learned skills, so it should be fairly easy for them to start tracking things down.

This is just the same thing, only better, because it’s about Discovering things and being Creative.

So, now we come to this conclusion: intuition leads to insights and this is actually the source of true discovery like Tesla etc. Logical analytic can pursue where the intuition leads them, but not the other way around.

In this train of thought, we can also learn from Neutrosophic Logic as discovered by one of us (FS), which emphasizes that there are middle ways, or dynamics of opposites and neutralities in everything we observe [9]. Similarly, in order to condense our discussion on the role of intuition and analysis in scientific discovery, let us emphasize that intuition and insight should come first then logical analysis can follow through to see what can be done with that intuition. We prefer to call it “*intuilytics*” process. That is: analytic work inspired by intuitions. Although, at first glance it looks difficult, it would be more smooth if we follow this path, not the other way around (intuition follows logical-analysis).

In the following section, we will discuss two examples of scientific discovery processes, which hopefully will emphasize our points as mentioned above.

Two examples of scientific discovery process

Learning from Henri Vidal

Let us discuss a novel concept in engineering, called: earth stabilization using Reinforced Earth. Sometimes, earth reinforcement is also called mechanically stabilized earth (MSE) [2].

Using straw, sticks, and branches to reinforce adobe bricks and mud dwellings has happened since the earliest part of human history, and around 1960s French engineer Sir Henri Vidal invented the modern form of MSE, he termed *Terre Armee* (reinforced earth). In his submission for his patents he covered every possible reinforcement and facing type. Reinforcing levees with branches has been done in China for at least a thousand years, and other reinforcements have been universally used to prevent soil erosion.

Modern use of soil reinforcing for retaining wall construction was pioneered by French architect and engineer Henri Vidal in the 1960s. The first MSE wall in the United States was built in 1971 on State Route 39 near Los Angeles. It is estimated that since 1997, approximately 23,000 MSE walls have been constructed in the world.

How the idea of Reinforced Earth came? It all began like a game, when Henri Vidal, a French highway engineer and architect, was trying to build a sandcastle on the beach. But the sand kept on falling off and this led to the idea of reinforcing the construction with pine needles. That is how the general principle of Reinforced Earth. From that experience, he went on and wrote his dissertation on *La Terre Armee* [3].

Here we see an example how a direct experience (playing with sand castles) gave an intuition which then leads to a scientific discovery.

Although usually, the materials used in reinforcing earth are metal, plastics or other man-made materials, we can use natural-made materials such as bamboo, which is commonly available in many villages in Asia or other tropical countries.

However, studies on bamboo-earth reinforcement is pretty scarce [4,5].

Learning from Monozukuri

Perhaps you've heard of the Japanese word monozukuri (sometimes written as 物作り, but most often written as ものづくり). Literally translated, it means to make (zukuri) things (mono). Yet, there is so much meaning lost in translation. A better translation would be "manufacturing; *craftsmanship*; or *making things by hand*". However, this translation also does not give justice to the weight and influence this idea has in Japan.

The word itself is quite old and considered to be an original Japanese (i.e., not Chinese or Western-origin) word. Historically, it was used in connection with an individual artisan and craftsman who took pride in his or her products.

You probably know of famous artists like Shakespeare, Michelangelo, Picasso, Kahlo, and many more. Now do you know a famous potter? No? How about a famous smith? A carpenter? How about a weaver? We'd surprised if you do. We didn't.

Japan also has its share of famous Japanese artists. Many of them are officially recognized as Living National Treasures (人間国宝 Ningen Kokuhō) of Japan. They include performing artists like musicians, dancers, and actors in traditional Japanese arts.

Yet another subtle way in which the Japanese express their value for work is in their greetings. At the end of the workday when the workers leave the factory, office, or general workplace, the custom greeting to the departing colleague is *gokurosama* (ご苦労さま), meaning thank you for your effort.

Yet, digging deeper into the Japanese character, this greeting implies more than just effort, directly connecting to hard and physical labor. The first kanji 苦 stands for pain, trouble, difficulty, hardship; and the second kanji 劳 stands for labor, toil, work, effort. Overall, this common message thanks the departing colleague for his hard and demanding physical work, even if the person is only an office worker. This is another example in how the value of physical work is deeply ingrained into the Japanese society.

A spin-off of monozukuri is *hitozukuri* (人作り, making people) for developing people. This includes the lifelong education, training, and coaching of people, not only in the classroom but especially at work.

At Nissan they are also *kotozukuri* (事作り, making stories) for “brand storytelling,” with the goal of entering into “*dialogue with the customer*.” However, this is little used outside of Nissan.

To summarize, the Monozukuri concept embraces more than the literal meaning. It offers the idea of possessing the “*spirit to produce excellent products and the ability to constantly improve a production system and process*”. The concept carries “overtones of excellence, skill, spirit, zest, and pride in the ability to make things good things very well. Monozukuri is not mindless repetition; it requires creative minds and is often related to craftsmanship which can be earned through lengthy apprenticeship practice rather than the structured course curricula taught at traditional schools.” In that sense, Monozukuri is an art rather than science [7].

Again, you see that deep in Japanese original work ethics they put high value on direct experience in work and arts, in other words “handcrafting” gets a special value in Japanese culture.

That partly explains why Japanese people often came out with new products which were simply designed to accommodate a special niche, such as Walkman by Sony, which was designed for people who like to enjoy music while walking or doing aerobic in the street without having to disturb other people nearby.

Once again, direct experience and hand working can lead to so many types of inventions and also in scientific discoveries.

Concluding Remarks

What we intend to show in this article is that the distinction between the logic and experience is something related to analytics function of the left brain and intuitive-wholeness function of the right brain. We suppose the healthy way is to optimise both function of left and right brain.

And similarly, in order to experience God, we shall feel Him intuitively not rationally.

So, now we come to this conclusion: intuition leads to insights and this is actually the source of true discovery like Tesla etc. Logical analysis can pursue where the intuition leads them, but not the other way around.

Using Neutrosophic Logic, we propose a new term for this process: *intuilytics*.

Bibliography

1. Ralph Abraham. "Math and mysticism" (2015).
2. Mechanically stabilized earth.
3. Umer Farooq. "Reinforced earth and Reinforced earth structures".
4. Alhaji Mohammed Mustapha. "Bamboo as Soil Reinforcement: A Laboratory Trial".
5. SAS Kulathilaka and UP Nawagamuwa. "A study of bamboo reinforced earth retaining structures" (2001).
6. Monozukuri introduction.
7. The Mindset of Monozukuri and creativity in a traditional art form applied in science and technology today.
8. Robert N Boyd. "Penetrating insight, soft vision, and merging vision".
9. Florentin Smarandache. "A unified field in logic. 6th edition". InfoLearnQuest (2007).

Linguistic Approaches to Interval Complex Neutrosophic Sets in Decision Making

Luu Quoc Dat, Nguyen Tho Thong, Le Hoang Son, Mumtaz Ali,
Florentin Smarandache, Mohamed Abdel-Basset, Hoang Viet Long

Luu Quoc Dat, Nguyen Tho Thong, Le Hoang Son, Mumtaz Ali, Florentin Smarandache, Mohamed Abdel-Basset, Hoang Viet Long (2019). Linguistic Approaches to Interval Complex Neutrosophic Sets in Decision Making. *IEEE Access* 7: 38902-38917; DOI: 10.1109/ACCESS.2019.2902841

ABSTRACT One of the most efficient tools for modeling uncertainty in decision-making problems is the neutrosophic set (NS) and its extensions, such as complex NS (CNS), interval NS (INS), and interval complex NS (ICNS). Linguistic variables have been long recognized as a useful tool in decision-making problems for solving the problem of crisp neutrosophic membership degree. In this paper, we aim to introduce new concepts: single-valued linguistic complex neutrosophic set (SVLCNS-2) and interval linguistic complex neutrosophic set (ILCNS-2) that are more applicable and adjustable to real-world implementation than those of their previous counterparts. Some set-theoretic operations and the operational rules of SVLCNS-2 and ILCNS-2 are designed. Then, gather classifications of the candidate versus criteria, gather the significance weights, gather the weighted rankings of candidates versus criteria and a score function to arrange the candidates are determined. New TOPSIS decision-making procedures in SVLCNS-2 and ICNS-2 are presented and applied to lecturer selection in the case study of the University of Economics and Business, Vietnam National University. The applications demonstrate the usefulness and efficiency of the proposal.

INDEX TERMS Lecturer selection, linguistic interval complex neutrosophic set, multi-criteria decision-making, neutrosophic set.

I. INTRODUCTION

One of the most efficient tools for demonstrating uncertainty and vagueness in decision making is the NS [1] which is the more generality of classical set, fuzzy set and intuitionistic fuzzy set (IFS) by adding three grades of truth, falsehood, and indeterminacy of a confirmed statement. It has been employed in various decision making processes such as in [2]–[8]. Yet, in order to adapt NS with more real complex cases, CNS and INS have been proposed accordingly. Wang *et al.* [9] suggested the notion of INS which is described by the degree of truth, falsehood and indeterminacy whose values and standards are intervals rather than real numbers. Ali and Smarandache [10] suggested the idiom CNS which

is an expansion form of complex fuzzy set and complex IFS to handle the unnecessary nature of ambiguity, incompleteness, indefiniteness and changeability in periodic data. These extensions have been applied to decision making problems successfully [7].

As an expansion to this trend, Ali *et al.* [11] have recently proposed the notion of ICNS by fusing CNS and INS in a homogeneous way. Therein, the authors defined some set notional procedures of ICNS such as intersection, union and complement, and afterwards the operational principles. A decision-making transaction in ICNS was presented and applied to green supplier selection [11]. It has been realized from this research that ICNS with suitable ranking methods generated from the score, accuracy and certainty functions can handle the real decision cases that have not been solved by the relevant works such as of Ye [12]. However, this

research remains a problem: It is not simple to discover a crisp neutrosophic membership degree (as in the Single-Valued Neutrosophic Set (SVN)). In many real applications, we have to deal with undecided and imprecise information in our everyday life that could be represented by linguistic variables instead of the crisp neutrosophic membership degree [13].

The idea of **linguistic variables** in decision making problems has been long recognized as a useful approach. Li, Zhang and Wang [13] advanced two multi-criteria decision-making (MCDM) techniques in which the interrelationships among individual data are considered under linguistic neutrosophic environments. Fang and Ye [14] gave the connotation of a linguistic neutrosophic number which is categorized independently by the truth, indeterminacy, and falsity linguistic variables for multiple attribute group decision-making. Interval neutrosophic linguistic numbers (INLNs) has also been defined by Ma, Wang, Wang & Wu [15] for an application of practical treatment selection using interval neutrosophic linguistic multi-criteria group decision-making. SVN linguistic trapezoid linguistic aggregation operators were developed for decision making problems [22]. Ye [24] studied some aggregation operators of INLNs for multiple attribute decision making (MADM). Some more literature can be seen in [4], [16]–[27].

TOPSIS is popular decision making technique for interval neutrosophic unclear semantic variables [23]. Poursmaeil *et al.* [35] utilized TOPSIS for defining the weights of decision makers with single valued neutrosophic information. Otay and Kahraman [36] employed interval neutrosophic TOPSIS method to evaluate Six Sigma projects, which aimed at providing almost defect-free products and/or services to customers. Pramanik *et al.* [37] planned TOPSIS method for MADM under neutrosophic cubic, which is the generalized form of cubic set and interval neutrosophic set. Liang, Zhao and Wu [38] designed a new term called linguistic neutrosophic numbers and integrated it into TOPSIS for investment and development of mineral resources. A multi-criteria group decision-making methodology incorporating power combination factors, TOPSIS-based QUALIFLEX and life cycle assessment technique was proposed in [21] to find the key to green product design selection using neutrosophic linguistic information. Altinirmak *et al.* [39] used single valued Neutrosophic Set based entropy to rank the banks for analyzing m-banking quality factors. Eraslan and Çağman [40] combined TOPSIS and Grey Relational Analysis under fuzzy soft sets for drug selection. It has been shown that TOPSIS is a well-known method for decision making under uncertain environments of neutrosophic and linguistic [2], [11], [18], [23], [33], [41], [42]. However, the current research on TOPSIS model do not mention the period of time when describing observation data in their model.

Meanwhile, many complex real-world problems about decision support system in which data contains some characters such as: uncertain, heterogeneous, inconsistent and have concerned with the period of time. To consider a financial corporation or company this chooses to set up novel software

to process and analyses company data. For this, the company goes into a huddle some experts who give the information concerning: various choices of software which data process and analysis in financial fields, corresponding software version and other information. Surveying and observing the software is done within a period of time. After that, the company desires to select the most favorable alternative of software with its newest version concurrently. Here, we need to pay attention two things (a) to choose the best candidate of software (b) its newest version. This cannot be simplified accurately using classical concept of Fuzzy Set or NS. So the preferable way to show all of the information in this problem is using the theory of Linguistic Variables and ICNS.

In this paper, we aim to introduce new concepts namely **Single-Valued Linguistic Interval Complex Neutrosophic Set (SVLCNS-2)** and **Interval Linguistic Interval Complex Neutrosophic Set (ILCNS-2)** that are more pliable and adjustable to real-world implementations than those of their previous counter parts motivated from the mentioned analysis. Specifically, we define the SVLCNS-2 and ILCNS-2. Next, we describe some set notional operations such as the intersection, union and complement. Moreover, we set the functioning basics of SVLCNS-2 and ILCNS-2. Then, we develop gather classifications of candidate versus criteria, gather the significance weights, gather the weighted classifications of candidates versus criteria and determine a score function to rank the candidates. Lastly, new TOPSIS decision making procedures in SVLCNS-2 and ICNS-2 are presented.

Personnel selection plays a crucial role in human resource administration since the inappropriate personnel might reason various problems affecting productivity, accuracy, pliability and goodness of the products adversely [28]. It is a complicated process in the meaning that several factors should be estimated concurrently in order to find the right people for the appropriate jobs [28]. Personnel selection is a decision making problem where quality of decision affects the success of a person in an organization [29]. In the context of university selection, the consideration for reasonable and realistic selection measures of adequate candidates and effective prediction of possible success at university, therefore, becomes more and more important [30]. It has been long recognized that measuring of intelligence is no longer enough as a medium for a person's skills and success estimation [31]. It is indeed adopted by various factors to judge the suitability and adaptability of a candidate in a university context. Hence, developing effective selection or decision making techniques is critical indeed [32].

The proposed TOPSIS methods are applied to lecturer selection in the case study of University of Economics and Business - Vietnam National University (UEB-VNU), which is one of the leading universities in Hanoi, Vietnam. A committee of four decision makers (DMs) and six selection criteria are presented in the application. The applications demonstrate the usefulness and efficiency of the proposal.

The rest of this paper is prepared as follows. The formulation of SVLCNS-2 and its operations are presented in

Sections 2 and 3 while ILCNS-2 and operations are given in Sections 4 and 5. The TOPSIS decision making procedures on SVLCNS-2 and ILCNS-2 are explained in Section 6. Lastly, an application of the procedures for lecturer selection on a real case study is illustrated in Section 7. Section 8 compares the suggested method with another decision making method. Conclusions and further studies allocate in Section 9.

II. SINGLE-VALUED LINGUISTIC COMPLEX NEUTROSOPHIC SET (SVLCNS-2)

Definition 1 (Type-1 Single VALUED Linguistic Complex Neutrosophic Set (SVLCNS-1)): Let \mathbb{I} be a universe of discourse and a complex neutrosophic set A included in \mathbb{I} . Let $\mathcal{S} = \{\mathcal{S}_1, \mathcal{S}_2, \dots, \mathcal{S}_n\}$, for $2 \leq n < \infty$, be a set of totally ordered labels (therefore the classical min/max operators work on S), with $\mathcal{S}_i < \mathcal{S}_j$ for $i < j$, where $i, j \in \{1, 2, 3, \dots, n\}$. Let $\bar{R} = \{[\mathcal{S}_i, \mathcal{S}_j], \mathcal{S}_i, \mathcal{S}_j \in \mathcal{S}, i < j\}$ be a set of label intervals. A **single-valued type-1 complex neutrosophic set (SVLCNS-1)** is a set $A \subset \mathbb{I}$ such that each element x in A has linguistic degree of complex truth membership $T_A(x) \in S \times S$, a linguistic degree of complex indeterminate membership $I_A(x) \in S \times S$, and a linguistic degree of complex falsity membership $F_A(x) \in S \times S$ and $s_{\theta(x)} \in S$. A SVLCNS set A can be written as,

$$A = \{ \langle x, [s_{\theta(x)}, (\mathbb{T}_A(x), \widehat{I}_A(x), \mathcal{F}_A(x))] \rangle \}$$

where

$$\left. \begin{aligned} \mathbb{T}_A(x) &= T_{1A}(x) \cdot e^{j \cdot T_{2A}(x)} \\ \widehat{I}_A(x) &= I_{1A}(x) \cdot e^{j \cdot I_{2A}(x)} \\ \mathcal{F}_A(x) &= F_{1A}(x) \cdot e^{j \cdot F_{2A}(x)} \end{aligned} \right\}$$

where $T_{1A}(x)$ is representing linguistic amplitude truth membership and $e^{j \cdot T_{2A}(x)}$ is denoting the linguistic phase truth membership function. Moreover, $I_{1A}(x)$ refers to linguistic amplitude indeterminate membership while $e^{j \cdot I_{2A}(x)}$ indicates linguistic phase indeterminate membership. Further, $F_{1A}(x)$ is called the linguistic amplitude falsity membership and $e^{j \cdot F_{2A}(x)}$ is said to be the linguistic phase falsehood membership function:

$$\begin{aligned} 3 * s_1 &\leq \min \{T_{1A}(x)\} + \min \{I_{1A}(x)\} + \min \{F_{1A}(x)\}, \\ \max \{T_{1A}(x)\} + \max \{I_{1A}(x)\} + \max \{F_{1A}(x)\} &\leq 3 * s_n, \\ 3 * s_1 &\leq \min \{T_{2A}(x)\} + \min \{I_{2A}(x)\} + \min \{F_{2A}(x)\}, \\ \max \{T_{2A}(x)\} + \max \{I_{2A}(x)\} + \max \{F_{2A}(x)\} &\leq 3 * s_n. \end{aligned}$$

Definition 2 (Type-2 Single Valued Linguistic Complex Neutrosophic Set (SVLCNS-2)): Let \mathbb{I} be a universe of discourse and a complex NS A included in \mathbb{I} . Let $\mathcal{S} = \{\mathcal{S}_1, \mathcal{S}_2, \dots, \mathcal{S}_n\}$, for $n \geq 2$, be a set of ordered labels with $s_i < s_j$ with $i, j \in \{1, 2, 3, \dots, n\}$. Let $R = \{[s_i, s_j], s_i, s_j \in S, i < j\}$ be a collection of label intervals. A single-valued type-2 linguistic complex neutrosophic set (SVLCNS-2) is a set $A \subset \mathbb{I}$ such that each element x in A has linguistic degree of complex truth membership $T_A(x) \in R$, a linguistic degree of complex indeterminate membership

$I_A(x) \in R$, and a linguistic degree of complex falsity membership $F_A(x) \in R$ and $\Theta_{\theta(x)} \in \mathcal{S}$. A SVLCNS set A can be written as,

$$A = \left\{ \left\langle x, \left[\Theta_{\theta(x)}, \left(\mathbb{T}_A(x), \widehat{I}_A(x), \mathcal{F}_A(x) \right) \right] \right\rangle \mid x \in \mathbb{I} \right\}$$

where

$$\left. \begin{aligned} \mathbb{T}_A(x) &= T_{1A}(x) \cdot e^{j \cdot T_{2A}(x)} \\ \widehat{I}_A(x) &= I_{1A}(x) \cdot e^{j \cdot I_{2A}(x)} \\ \mathcal{F}_A(x) &= F_{1A}(x) \cdot e^{j \cdot F_{2A}(x)} \end{aligned} \right\}$$

where $T_{1A}(x)$ represents the amplitude truth membership and $e^{j \cdot T_{2A}(x)}$ denotes the phase truth membership function. Moreover, $I_{1A}(x)$ refers to the amplitude indeterminate membership while $e^{j \cdot I_{2A}(x)}$ indicates the phase indeterminate membership function. Further, $F_{1A}(x)$ is called the amplitude falsity membership and $e^{j \cdot F_{2A}(x)}$ is said to be the phase falsehood membership function while $0 \leq \mathbb{T}_A(x), \widehat{I}_A(x), \mathcal{F}_A(x) \leq 3$.

Due to complexity of higher computation involved in SVLCNS-1, in this paper, we will use SVLCNS-2 for developing the TOPSIS method.

Definition 3: Let A and B be two SVLCNSs-2 over \mathbb{I} which are defined by $\langle \Theta_{\theta_A(x)}, (\mathbb{T}_A(x), \widehat{I}_A(x), \mathcal{F}_A(x)) \rangle$, and $\langle \Theta_{\theta_B(x)}, (\mathbb{T}_B(x), \widehat{I}_B(x), \mathcal{F}_B(x)) \rangle$, respectively. Their union signified as $A \cup B$ and is defined as:

$$\begin{aligned} \Theta_{\theta_{A \cup B}(x)} &= \Theta_{\theta_{1A \cup B}(x)}, \\ \mathbb{T}_{A \cup B}(x) &= T_{1A \cup B}(x) \cdot e^{j \cdot T_{2A \cup B}(x)}, \\ \widehat{I}_{A \cup B}(x) &= I_{1A \cup B}(x) \cdot e^{j \cdot I_{2A \cup B}(x)}, \\ \mathcal{F}_{A \cup B}(x) &= F_{1A \cup B}(x) \cdot e^{j \cdot F_{2A \cup B}(x)}, \end{aligned}$$

where

$$\begin{aligned} \Theta_{\theta_{1A \cup B}(x)} &= \vee (\Theta_{\theta_A(x)}, \Theta_{\theta_B(x)}), \\ \mathbb{T}_{1A \cup B}(x) &= \vee (\mathbb{T}_A(x), \mathbb{T}_B(x)), \\ \mathbb{T}_{2A \cup B}(x) &= \vee (\mathbb{T}_A(x), \mathbb{T}_B(x)), \\ \widehat{I}_{1A \cup B}(x) &= \wedge (\widehat{I}_A(x), \widehat{I}_B(x)), \\ \mathbb{T}_{2A \cup B}(x) &= \wedge (\inf \mathbb{T}_A(x), \inf \mathbb{T}_B(x)), \\ \mathcal{F}_{1A \cup B}(x) &= \wedge (\mathcal{F}_A(x), \mathcal{F}_B(x)), \\ \mathcal{F}_{2A \cup B}(x) &= \wedge (\mathcal{F}_A(x), \mathcal{F}_B(x)). \end{aligned}$$

for all $x \in X$. The symbols \vee, \wedge represents maximize and minimize operators.

Definition 4: Let A and B be two SVLCNSs-2 over \mathbb{I} which are defined by $\langle \Theta_{\theta_A(x)}, (\mathbb{T}_A(x), \widehat{I}_A(x), \mathcal{F}_A(x)) \rangle$, and $\langle \Theta_{\theta_B(x)}, (\mathbb{T}_B(x), \widehat{I}_B(x), \mathcal{F}_B(x)) \rangle$, respectively. Their **intersection** signified as $A \cap B$ and is defined as:

$$\Theta_{\theta_{A \cap B}(x)} = \Theta_{\theta_{1A \cap B}(x)},$$

$$\begin{aligned} \mathbb{F}_{\mathbb{A} \cap \mathbb{B}}(\mathbb{X}) &= \mathbb{F}_{1_{\mathbb{A} \cap \mathbb{B}}}(\mathbb{X}) \cdot e^{j.T_{2_{\mathbb{A} \cap \mathbb{B}}}(\mathbb{X})}, \\ \widehat{\mathbb{I}}_{\mathbb{A} \cap \mathbb{B}}(\mathbb{X}) &= \widehat{\mathbb{I}}_{1_{\mathbb{A} \cap \mathbb{B}}}(\mathbb{X}) \cdot e^{j.I_{2_{\mathbb{A} \cap \mathbb{B}}}(\mathbb{X})}, \\ \mathcal{F}_{\mathbb{A} \cap \mathbb{B}}(\mathbb{X}) &= \mathcal{F}_{1_{\mathbb{A} \cap \mathbb{B}}}(\mathbb{X}) \cdot e^{j.F_{2_{\mathbb{A} \cap \mathbb{B}}}(\mathbb{X})}, \end{aligned}$$

where

$$\begin{aligned} \Theta_{\theta_{1_{\mathbb{A} \cap \mathbb{B}}}(\mathbb{X})} &= \wedge \left(\Theta_{\theta_{\mathbb{A}}}(\mathbb{X}), \Theta_{\theta_{\mathbb{B}}}(\mathbb{X}) \right), \\ \mathbb{F}_{1_{\mathbb{A} \wedge \mathbb{B}}}(\mathbb{X}) &= \wedge \left(\mathbb{F}_{\mathbb{A}}(\mathbb{X}), \mathbb{F}_{\mathbb{B}}(\mathbb{X}) \right), \\ \mathbb{F}_{2_{\mathbb{A} \wedge \mathbb{B}}}(\mathbb{X}) &= \wedge \left(\mathbb{F}_{\mathbb{A}}(\mathbb{X}), \mathbb{F}_{\mathbb{B}}(\mathbb{X}) \right), \\ \widehat{\mathbb{I}}_{1_{\mathbb{A} \cap \mathbb{B}}}(\mathbb{X}) &= \vee \left(\widehat{\mathbb{I}}_{\mathbb{A}}(\mathbb{X}), \widehat{\mathbb{I}}_{\mathbb{B}}(\mathbb{X}) \right), \\ \mathbb{F}_{2_{\mathbb{A} \cup \mathbb{B}}}(\mathbb{X}) &= \vee \left(\inf \mathbb{F}_{\mathbb{A}}(\mathbb{X}), \inf \mathbb{F}_{\mathbb{B}}(\mathbb{X}) \right), \\ \mathcal{F}_{1_{\mathbb{A} \cap \mathbb{B}}}(\mathbb{X}) &= \vee \left(\mathcal{F}_{\mathbb{A}}(\mathbb{X}), \mathcal{F}_{\mathbb{B}}(\mathbb{X}) \right), \\ \mathcal{F}_{2_{\mathbb{A} \cap \mathbb{B}}}(\mathbb{X}) &= \vee \left(\mathcal{F}_{\mathbb{A}}(\mathbb{X}), \mathcal{F}_{\mathbb{B}}(\mathbb{X}) \right). \end{aligned}$$

for all $x \in X$. The symbols \vee, \wedge represents max and min operators.

Proposition 2: Let \mathbb{A} and \mathbb{B} be two SVLCNS-2 over \mathbb{I} . Then

- a) $\mathbb{A} \cup \mathbb{B} = \mathbb{B} \cup \mathbb{A}$,
- b) $\mathbb{A} \cap \mathbb{B} = \mathbb{B} \cap \mathbb{A}$,
- c) $\mathbb{A} \cup \mathbb{A} = \mathbb{A}$,
- d) $\mathbb{A} \cap \mathbb{A} = \mathbb{A}$,

Proof: Straightforward.

Proposition 6: Let A, B and C be three SVLCNS-2 over \mathbb{I} . Then

- a) $\mathbb{A} \cup (\mathbb{B} \cap \mathbb{C}) = (\mathbb{A} \cup \mathbb{B}) \cap \mathbb{C}$,
- b) $\mathbb{A} \cap (\mathbb{B} \cap \mathbb{C}) = \mathbb{A} \cap \mathbb{C}$,
- c) $\mathbb{A} \cup (\mathbb{B} \cap \mathbb{C}) = (\mathbb{A} \cup \mathbb{B}) \cap (\mathbb{A} \cup \mathbb{C})$
- d) $\mathbb{A} \cap (\mathbb{B} \cup \mathbb{C}) = (\mathbb{A} \cap \mathbb{B}) \cup (\mathbb{A} \cap \mathbb{C})$
- e) $\mathbb{A} \cup (\mathbb{B} \cap \mathbb{C}) = \mathbb{A}$,
- f) $\mathbb{A} \cup (\mathbb{A} \cap \mathbb{B}) = \mathbb{A}$.

Theorem 7: The SVLCNS-2 $\mathbb{A} \cup \mathbb{B}$ is the minimum set comprising together \mathbb{A} and \mathbb{B} .

Proof: Straightforward.

Theorem 8: The SVLCNS-2 $\mathbb{A} \cup \mathbb{B}$ is the leading one comprised in together \mathbb{A} and \mathbb{B} .

Proof: Straightforward.

Theorem 9: Let P be the power set of all SVLCNSs-2. Then (P, \cup, \cap) forms a distributive lattice.

Proof: Straightforward.

III. OPERATIONAL RULES OF SVLCNS-2

Let A and B be two SVLCNSs-2 over \mathbb{I} which are defined by $\langle \Theta_{\theta_{\mathbb{A}}}(\mathbb{X}), (\mathbb{F}_{\mathbb{A}}(\mathbb{X}), \widehat{\mathbb{I}}_{\mathbb{A}}(\mathbb{X}), \mathcal{F}_{\mathbb{A}}(\mathbb{X})) \rangle$, and $\langle \Theta_{\theta_{\mathbb{B}}}(\mathbb{X}), (\mathbb{F}_{\mathbb{B}}(\mathbb{X}), \widehat{\mathbb{I}}_{\mathbb{B}}(\mathbb{X}), \mathcal{F}_{\mathbb{B}}(\mathbb{X})) \rangle$, correspondingly. the operational rules of SVLCNS-2 are definite as:

- a) The **product** of \mathbb{A} and \mathbb{B} signified as

$\mathbb{A} \otimes \mathbb{B} = \langle \Theta_{\theta_{\mathbb{A} \otimes \mathbb{B}}}(\mathbb{X}), (\mathbb{F}_{\mathbb{A} \otimes \mathbb{B}}(\mathbb{X}), \widehat{\mathbb{I}}_{\mathbb{A} \otimes \mathbb{B}}(\mathbb{X}), \mathcal{F}_{\mathbb{A} \otimes \mathbb{B}}(\mathbb{X})) \rangle$, is defined as:

$$\begin{aligned} \Theta_{\theta_{\mathbb{A} \otimes \mathbb{B}}(x)} &= \Theta_{\theta_{\mathbb{A}}(x)} \cdot \Theta_{\theta_{\mathbb{B}}(x)}, \\ [\Theta_j, \Theta_k]^v &= [\Theta_j^v, \Theta_k^v], v > 0. \\ T_{\mathbb{A} \otimes \mathbb{B}}(x) &= (T_{1_{\mathbb{A}}}(x).T_{1_{\mathbb{B}}}(x)) \cdot e^{j(T_{2_{\mathbb{A}}}(x).T_{2_{\mathbb{B}}}(x))}, \end{aligned}$$

$$\begin{aligned} I_{\mathbb{A} \otimes \mathbb{B}}(\mathbb{X}) &= (I_{1_{\mathbb{A}}}(\mathbb{X}) + I_{1_{\mathbb{B}}}(\mathbb{X}) - I_{1_{\mathbb{A}}}(\mathbb{X}) I_{1_{\mathbb{B}}}(\mathbb{X})) \\ &\quad \cdot e^{j(I_{2_{\mathbb{A}}}(\mathbb{X}).I_{2_{\mathbb{B}}}(\mathbb{X}))}, \end{aligned}$$

$$\begin{aligned} F_{\mathbb{A} \otimes \mathbb{B}}(\mathbb{X}) &= (F_{1_{\mathbb{A}}}(\mathbb{X}) + F_{1_{\mathbb{B}}}(\mathbb{X}) - F_{1_{\mathbb{A}}}(\mathbb{X}) F_{1_{\mathbb{B}}}(\mathbb{X})) \\ &\quad \cdot e^{j(F_{2_{\mathbb{A}}}(\mathbb{X}).F_{2_{\mathbb{B}}}(\mathbb{X}))}, \end{aligned}$$

b) The **addition** of \mathbb{A} and \mathbb{B} indicated as $\mathbb{A} \oplus \mathbb{B} = \langle \Theta_{\theta_{\mathbb{A} \oplus \mathbb{B}}}(\mathbb{X}), (\mathbb{F}_{\mathbb{A} \oplus \mathbb{B}}(\mathbb{X}), \widehat{\mathbb{I}}_{\mathbb{A} \oplus \mathbb{B}}(\mathbb{X}), \mathcal{F}_{\mathbb{A} \oplus \mathbb{B}}(\mathbb{X})) \rangle$, is well-defined as:

$$\begin{aligned} \Theta_{\theta_{\mathbb{A} \oplus \mathbb{B}}(x)} &= \Theta_{\theta_{\mathbb{A}}(x)} + \Theta_{\theta_{\mathbb{B}}(x)}, \\ T_{\mathbb{A} \oplus \mathbb{B}}(x) &= ((T_{1_{\mathbb{A}}}(x) + T_{1_{\mathbb{B}}}(x)) - (T_{1_{\mathbb{A}}}(x).T_{1_{\mathbb{B}}}(x))) \\ &\quad \cdot e^{j(T_{2_{\mathbb{A}}}(x)+T_{2_{\mathbb{B}}}(x))}, \end{aligned}$$

$$\begin{aligned} I_{\mathbb{A} \oplus \mathbb{B}}(x) &= (I_{1_{\mathbb{A}}}(x).I_{1_{\mathbb{B}}}(x)) \cdot e^{j(I_{2_{\mathbb{A}}}(x)+I_{2_{\mathbb{B}}}(x))}, \\ F_{\mathbb{A} \oplus \mathbb{B}}(x) &= (F_{1_{\mathbb{A}}}(x).F_{1_{\mathbb{B}}}(x)) \cdot e^{j(F_{2_{\mathbb{A}}}(x)+F_{2_{\mathbb{B}}}(x))}. \end{aligned}$$

c) The **scalar multiplication** of A is a SVLCNS-2 denoted as $C = kA$ defined as:

$$\begin{aligned} k\Theta_{\theta_{\mathbb{A}}(x)} &= \Theta_{k\theta_{\mathbb{A}}(x)} \\ T_C(x) &= \left(1 - (1 - T_{1_{\mathbb{A}}}(x))^k \right) \cdot e^{j(T_{2_{\mathbb{A}}}(x))^k}, \\ I_C(x) &= \left((T_{1_{\mathbb{A}}}(x))^k \right) \cdot e^{j(I_{2_{\mathbb{A}}}(x))^k}, \\ F_C(x) &= \left((F_{1_{\mathbb{A}}}(x))^k \right) \cdot e^{j(F_{2_{\mathbb{A}}}(x))^k}. \end{aligned}$$

Proposition 10: Let A and B be two SVLCNSs-2 over \mathbb{I} which are defined by $\langle \Theta_{\theta_{\mathbb{A}}}(\mathbb{X}), (\mathbb{F}_{\mathbb{A}}(\mathbb{X}), \widehat{\mathbb{I}}_{\mathbb{A}}(\mathbb{X}), \mathcal{F}_{\mathbb{A}}(\mathbb{X})) \rangle$ and $\langle \Theta_{\theta_{\mathbb{B}}}(\mathbb{X}), (\mathbb{F}_{\mathbb{B}}(\mathbb{X}), \widehat{\mathbb{I}}_{\mathbb{B}}(\mathbb{X}), \mathcal{F}_{\mathbb{B}}(\mathbb{X})) \rangle$, respectively. Then

- a) $\mathbb{A} \otimes \mathbb{B} = \mathbb{B} \otimes \mathbb{A}$,
- b) $\mathbb{A} \oplus \mathbb{B} = \mathbb{B} \oplus \mathbb{A}$,
- c) $k(\mathbb{A} \otimes \mathbb{B}) = k(\mathbb{B} \otimes \mathbb{A})$,
- d) $(k_1 \otimes k_2)\mathbb{A} = k_1 \otimes k_2\mathbb{A}$.

IV. INTERVAL LINGUISTIC COMPLEX NEUTROSOPHIC SET (ILCNS-2)

Definition 11: Let \mathbb{I} be a universe of discourse and let $S = \{s_1, s_2, \dots, s_n\}$, for $\infty > n \geq 2$, be a collection of single value, linguistic markers, where $s_1 < s_2 < \dots < s_n$ and they are the qualitative values of a linguistic variable. The linguistic relation of order $s_i < s_j$, means that label s_i is less important than label s_j . An interval linguistic type-2 complex neutrosophic set (ILCNS-2) is a set $A \subset \mathbb{I}$ such that each element x in A has linguistic degree of complex interval-membership $T_A(x) \subseteq R \times R$, a linguistic degree of complex interval-indeterminate membership $I_A(x) \subseteq R \times R$, and a linguistic degree of complex interval-falsity membership $F_A(x) \subseteq R \times R$, $\Theta_{\theta(x)} \in S$. An ILCNS-2 set A can be written as,

$$A = \left\{ \left\langle x, \left[\Theta_{\theta(x)}, \left(\mathbb{F}_{\mathbb{A}}(x), \widehat{\mathbb{I}}_{\mathbb{A}}(x), \mathcal{F}_{\mathbb{A}}(x) \right) \right] \right\rangle \mid x \in \mathbb{I} \right\},$$

where

$$\left. \begin{aligned} T_A(x) &= [\inf T_{1_A}(x), \sup T_{1_A}(x)] \cdot e^{j[\inf T_{2_A}(x), \sup T_{2_A}(x)]} \\ I_A(x) &= [\inf I_{1_A}(x), \sup I_{1_A}(x)] \cdot e^{j[\inf I_{2_A}(x), \sup I_{2_A}(x)]} \\ F_A(x) &= [\inf F_{1_A}(x), \sup F_{1_A}(x)] \cdot e^{j[\inf F_{2_A}(x), \sup F_{2_A}(x)]} \end{aligned} \right\}$$

where $[\inf T_{1A}(x), \sup T_{1A}(x)]$ represents the interval amplitude truth membership and $e^{j[\inf T_{2A}(x), \sup T_{2A}(x)]}$ denotes the interval phase truth membership function. Moreover, $[\inf I_{1A}(x), \sup I_{1A}(x)]$ refers to the interval amplitude indeterminate membership while $e^{j[\inf I_{2A}(x), \sup I_{2A}(x)]}$ indicates the interval phase indeterminate membership function. Further, $[\inf F_{1A}(x), \sup F_{1A}(x)]$ is called the interval amplitude falsity membership and $e^{j[\inf F_{2A}(x), \sup F_{2A}(x)]}$ is said to be the interval phase falsehood membership function.

Definition 12: Let A and B be two ILCNSs-2 over Π which are defined by $\langle X, [\Theta_{\theta}(X)(\mathbb{F}_A(X), \widehat{I}_A(X), \mathcal{F}_A(X))] \rangle$, and $\langle X, [\Theta_{\theta}(X)(\mathbb{F}_B(X), \widehat{I}_B(X), \mathcal{F}_B(X))] \rangle$, respectively. Their union:

$$\begin{aligned} \mathbb{A} \cup \mathbb{B} &= \{ \langle X, [\Theta_{\theta}(\mathbb{A} \cup \mathbb{B})(X), (\mathbb{F}_{\mathbb{A} \cup \mathbb{B}}(X), \widehat{I}_{\mathbb{A} \cup \mathbb{B}}(X), \mathcal{F}_{\mathbb{A} \cup \mathbb{B}}(X))] \mid X \in \Pi \}, \\ &\text{is defined as:} \end{aligned}$$

$$\begin{aligned} \Theta_{\theta_{\mathbb{A} \cup \mathbb{B}}}(X) &= \Theta_{\theta_{1\mathbb{A} \cup \mathbb{B}}}(X), \\ \mathbb{F}_{\mathbb{A} \cup \mathbb{B}}(X) &= \left[\inf \mathbb{F}_{1\mathbb{A} \cup \mathbb{B}}(X), \sup \mathbb{F}_{1\mathbb{A} \cup \mathbb{B}}(X), \right. \\ &\quad \left. \cdot e^{j[\inf T_{2\mathbb{A} \cup \mathbb{B}}(X), \sup T_{2\mathbb{A} \cup \mathbb{B}}(X)]}, \right. \\ I_{\mathbb{A} \cup \mathbb{B}}(X) &= \left[\inf I_{1\mathbb{A} \cup \mathbb{B}}(X), \sup I_{1\mathbb{A} \cup \mathbb{B}}(X), \right. \\ &\quad \left. \cdot e^{j[\inf I_{2\mathbb{A} \cup \mathbb{B}}(X), \sup I_{2\mathbb{A} \cup \mathbb{B}}(X)]}, \right. \\ \mathcal{F}_{\mathbb{A} \cup \mathbb{B}}(X) &= \left[\inf \mathcal{F}_{1\mathbb{A} \cup \mathbb{B}}(X), \sup \mathcal{F}_{1\mathbb{A} \cup \mathbb{B}}(X), \right. \\ &\quad \left. \cdot e^{j[\inf F_{2\mathbb{A} \cup \mathbb{B}}(X), \sup F_{2\mathbb{A} \cup \mathbb{B}}(X)]}, \right. \end{aligned}$$

where

$$\begin{aligned} \Theta_{\theta_{1\mathbb{A} \cup \mathbb{B}}}(x) &= \vee (\theta_{\theta A(x)}, \theta_{\theta B(x)}), \\ \inf T_{1\mathbb{A} \cup \mathbb{B}}(x) &= \vee (\inf T_{1A}(x), \inf T_{1B}(x)), \\ \sup T_{1\mathbb{A} \cup \mathbb{B}}(x) &= \vee (\sup T_{1A}(x), \sup T_{1B}(x)), \\ \inf I_{1\mathbb{A} \cup \mathbb{B}}(x) &= \wedge (\inf I_{1A}(x), \inf I_{1B}(x)), \\ \sup I_{1\mathbb{A} \cup \mathbb{B}}(x) &= \wedge (\sup I_{1A}(x), \sup I_{1B}(x)), \\ \inf F_{1\mathbb{A} \cup \mathbb{B}}(x) &= \wedge (\inf F_{1A}(x), \inf F_{1B}(x)), \\ \sup F_{1\mathbb{A} \cup \mathbb{B}}(x) &= \wedge (\sup F_{1A}(x), \sup F_{1B}(x)), \end{aligned}$$

for all $x \in X$. The symbols \vee, \wedge represents max and min operators, respectively.

Definition 13: Let A and B be two ILCNSs-2 over Π which are defined by $\langle X, [\Theta_{\theta}(X)(\mathbb{F}_A(X), \widehat{I}_A(X), F_A(X))] \rangle$, and $\langle X, [\Theta_{\theta}(X)(\mathbb{F}_B(X), \widehat{I}_B(X), \mathcal{F}_B(X))] \rangle$, respectively. Their intersection denoted as, $\mathbb{A} \cap \mathbb{B} = \{ \langle X, [\Theta_{\theta}(\mathbb{A} \cap \mathbb{B})(X), (\mathbb{F}_{\mathbb{A} \cap \mathbb{B}}(X), \widehat{I}_{\mathbb{A} \cap \mathbb{B}}(X), \mathcal{F}_{\mathbb{A} \cap \mathbb{B}}(X))] \mid X \in \Pi \}$, is defined as:

$$\begin{aligned} \Theta_{\theta_{\mathbb{A} \cap \mathbb{B}}}(X) &= \Theta_{\theta_{1\mathbb{A} \cap \mathbb{B}}}(X) \\ \mathbb{F}_{\mathbb{A} \cap \mathbb{B}}(X) &= \left[\inf \mathbb{F}_{1\mathbb{A} \cap \mathbb{B}}(X), \sup \mathbb{F}_{1\mathbb{A} \cap \mathbb{B}}(X), \right. \\ &\quad \left. \cdot e^{j[\inf T_{2\mathbb{A} \cap \mathbb{B}}(X), \sup T_{2\mathbb{A} \cap \mathbb{B}}(X)]}, \right. \\ I_{\mathbb{A} \cap \mathbb{B}}(X) &= \left[\inf I_{1\mathbb{A} \cap \mathbb{B}}(X), \sup I_{1\mathbb{A} \cap \mathbb{B}}(X), \right. \end{aligned}$$

$$\begin{aligned} &\cdot e^{j[\inf I_{2\mathbb{A} \cap \mathbb{B}}(X), \sup I_{2\mathbb{A} \cap \mathbb{B}}(X)]}, \\ \mathcal{F}_{\mathbb{A} \cap \mathbb{B}}(X) &= \left[\inf \mathcal{F}_{1\mathbb{A} \cap \mathbb{B}}(X), \sup \mathcal{F}_{1\mathbb{A} \cap \mathbb{B}}(X), \right. \\ &\quad \left. \cdot e^{j[\inf F_{2\mathbb{A} \cap \mathbb{B}}(X), \sup F_{2\mathbb{A} \cap \mathbb{B}}(X)]}, \right. \end{aligned}$$

where

$$\begin{aligned} \Theta_{\theta_{1\mathbb{A} \cap \mathbb{B}}}(x) &= \wedge (\theta_{\theta A(x)}, \theta_{\theta B(x)}), \\ \inf T_{1\mathbb{A} \cap \mathbb{B}}(x) &= \wedge (\inf T_{1A}(x), \inf T_{1B}(x)), \\ \sup T_{1\mathbb{A} \cap \mathbb{B}}(x) &= \wedge (\sup T_{1A}(x), \sup T_{1B}(x)), \\ \inf I_{1\mathbb{A} \cap \mathbb{B}}(x) &= \vee (\inf I_{1A}(x), \inf I_{1B}(x)), \\ \sup I_{1\mathbb{A} \cap \mathbb{B}}(x) &= \vee (\sup I_{1A}(x), \sup I_{1B}(x)), \\ \inf F_{1\mathbb{A} \cap \mathbb{B}}(x) &= \vee (\inf F_{1A}(x), \inf F_{1B}(x)), \\ \sup F_{1\mathbb{A} \cap \mathbb{B}}(x) &= \vee (\sup F_{1A}(x), \sup F_{1B}(x)), \end{aligned}$$

for all $x \in X$. The symbols \vee, \wedge represents max and min operators, respectively.

Proposition 14: Let \mathbb{A} and \mathbb{B} be two ILCNS-2 over Π . Then

- a) $\mathbb{A} \cup \mathbb{B} = \mathbb{B} \cup \mathbb{A}$,
- b) $\mathbb{A} \cap \mathbb{B} = \mathbb{B} \cap \mathbb{A}$,
- c) $\mathbb{A} \cup \mathbb{A} = \mathbb{A}$,
- d) $\mathbb{A} \cap \mathbb{A} = \mathbb{A}$.

Proof: Straightforward.

Proposition 15: Let A, B and C be three ILCNS over Π .

Then

- a) $\mathbb{A} \cup (\mathbb{B} \cap \mathbb{C}) = (\mathbb{A} \cup \mathbb{B}) \cap \mathbb{C}$,
- b) $\mathbb{A} \cap (\mathbb{B} \cup \mathbb{C}) = (\mathbb{A} \cap \mathbb{B}) \cup \mathbb{C}$,
- c) $\mathbb{A} \cup (\mathbb{B} \cap \mathbb{C}) = (\mathbb{A} \cup \mathbb{B}) \cap (\mathbb{A} \cup \mathbb{C})$,
- d) $\mathbb{A} \cap (\mathbb{B} \cup \mathbb{C}) = (\mathbb{A} \cap \mathbb{B}) \cup (\mathbb{A} \cap \mathbb{C})$,
- e) $\mathbb{A} \cup (\mathbb{B} \cap \mathbb{C}) = \mathbb{A}$,
- f) $\mathbb{A} \cup (\mathbb{A} \cap \mathbb{B}) = \mathbb{A}$.

Proof: Straightforward.

Theorem 16: The ILCNS $\mathbb{A} \cup \mathbb{B}$ is the minimum set comprising together \mathbb{A} and \mathbb{B} .

Proof: Straightforward.

Theorem 17: The ILCNS $\mathbb{A} \cap \mathbb{B}$ is the leading one enclosed in \mathbb{A} and \mathbb{B} .

Proof: Straightforward.

Theorem 18: Let P be the power set of all ILCNSs. Then, (P, \cup, \cap) forms a distributive lattice.

Proof: Straightforward.

Definition 19: Let A and B be two ILCNSs over Π which are defined by Eq. (1, 2), as shown at the top of the next page.

The **Hamming and Euclidian distances** between two ILCNS A and B for **phase** terms are defined as follows by Eqs. (3, 4), as shown at the top of the next page

$$A = \langle x, [\Theta_{\theta A(x)}, ([T_A^L(x), T_A^U(x)], [I_A^L(x), I_A^U(x)], [F_A^L(x), F_A^U(x)])] \rangle$$

and

$$B = \langle x, [\Theta_{\theta B(x)}, ([T_B^L(x), T_B^U(x)], [I_B^L(x), I_B^U(x)], [F_B^L(x), F_B^U(x)])] \rangle,$$

respectively; where $[T_A^L(x), T_A^U(x)] = [t_A^L(x), t_A^U(x)] e^{j[\omega_A^L(x), \omega_A^U(x)]}$, $[I_A^L(x), I_A^U(x)] = [i_A^L(x), i_A^U(x)] e^{j[\psi_A^L(x), \psi_A^U(x)]}$,

$$d_H^a(A, B) = \frac{1}{6(n-1)} (|\theta_A \times t_A^L - \theta_B \times t_B^L| + |\theta_A \times t_A^R - \theta_B \times t_B^R| + |\theta_A \times i_A^L - \theta_B \times i_B^L| + |\theta_A \times i_A^R - \theta_B \times i_B^R| + |\theta_A \times f_A^L - \theta_B \times f_B^L| + |\theta_A \times f_A^R - \theta_B \times f_B^R|) \quad (1)$$

$$d_E^a(A, B) = \sqrt{\frac{1}{6(n-1)} ((\theta_A \times t_A^L - \theta_B \times t_B^L)^2 + (\theta_A \times t_A^R - \theta_B \times t_B^R)^2 + (\theta_A \times i_A^L - \theta_B \times i_B^L)^2 + (\theta_A \times i_A^R - \theta_B \times i_B^R)^2 + (\theta_A \times f_A^L - \theta_B \times f_B^L)^2 + (\theta_A \times f_A^R - \theta_B \times f_B^R)^2)} \quad (2)$$

$$d_H^p(A, B) = |\omega_A^L(x) - \omega_B^L(x)| + |\omega_A^R(x) - \omega_B^R(x)| + |\psi_A^L(x) - \psi_B^L(x)| + |\psi_A^R(x) - \psi_B^R(x)| + |\phi_A^L(x) - \phi_B^L(x)| + |\phi_A^R(x) - \phi_B^R(x)| \quad (3)$$

$$d_E^p(A, B) = \sqrt{(\omega_A^L(x) - \omega_B^L(x))^2 + (\omega_A^R(x) - \omega_B^R(x))^2 + (\psi_A^L(x) - \psi_B^L(x))^2 + (\psi_A^R(x) - \psi_B^R(x))^2 + (\phi_A^L(x) - \phi_B^L(x))^2 + (\phi_A^R(x) - \phi_B^R(x))^2} \quad (4)$$

$$[F_A^L(x), F_A^U(x)] = [f_A^L(x), f_A^U(x)] e^{j[\phi_A^L(x)\phi_A^U(x)]}, [T_B^L(x), T_B^U(x)] = [t_B^L(x), t_B^U(x)] e^{j[\omega_B^L(x)\omega_B^U(x)]}, [I_B^L(x), I_B^U(x)] = [i_B^L(x), i_B^U(x)] e^{j[\psi_B^L(x)\psi_B^U(x)]}, [F_A^L(x), F_A^U(x)] = [f_A^L(x), f_A^U(x)] e^{j[\phi_A^L(x)\phi_A^U(x)]}.$$

The Hamming and Euclidian distances between two ILCNS A and B for amplitude terms are well-defined as:

V. OPERATIONAL RULES OF ILCNS

Let A and B be two ILCNSs over \mathbb{I} which are illustrated by $\langle x, [\Theta_{\theta_A(x)}, (T_A(x), I_A(x), F_A(x))] \rangle$ and $\langle x, [\Theta_{\theta_B(x)}, (T_B(x), I_B(x), F_B(x))] \rangle$ respectively. Then, the operational rules of ILCNS-2 are illustrated as:

a) The product of A and B indicated as

$$A \otimes B = \langle x, [\Theta_{\theta_{A \otimes B}(x)}, (T_{A \otimes B}(x), I_{A \otimes B}(x), F_{A \otimes B}(x))] \rangle$$

is defined as:

$$\begin{aligned} \Theta_{\theta_{A \otimes B}(x)} &= \Theta_{\theta_A(x)} \cdot \Theta_{\theta_B(x)} \\ T_{A \otimes B}(x) &= (\inf T_{1A}(x) \cdot \inf T_{1B}(x)) \cdot e^{j(\inf T_{2A}(x) \cdot \inf T_{2B}(x))} \\ T_{A \oplus B}(x) &= (\sup T_{1A}(x) \cdot \sup T_{1B}(x)) \cdot e^{j(\sup T_{2A}(x) \cdot \sup T_{2B}(x))} \\ I_{A \otimes B}(x) &= (\inf I_{1A}(x) \cdot \inf I_{1B}(x)) \cdot e^{j(\inf I_{2A}(x) \cdot \inf I_{2B}(x))} \\ I_{A \oplus B}(x) &= (\sup I_{1A}(x) \cdot \sup I_{1B}(x)) \cdot e^{j(\sup I_{2A}(x) \cdot \sup I_{2B}(x))} \\ F_{A \otimes B}(x) &= (\inf F_{1A}(x) \cdot \inf F_{1B}(x)) \cdot e^{j(\inf F_{2A}(x) \cdot \inf F_{2B}(x))} \\ F_{A \oplus B}(x) &= (\sup F_{1A}(x) \cdot \sup F_{1B}(x)) \cdot e^{j(\sup F_{2A}(x) \cdot \sup F_{2B}(x))} \end{aligned}$$

b) The addition of A and B denoted as

$$A \oplus B = \langle x, [\Theta_{\theta_{A \oplus B}(x)}, (T_{A \oplus B}(x), I_{A \oplus B}(x), F_{A \oplus B}(x))] \rangle$$

is defined as:

$$\begin{aligned} \Theta_{\theta_{A \oplus B}(x)} &= \Theta_{\theta_A(x)} + \Theta_{\theta_B(x)}, \\ T_{A \oplus B}(x) &= \left(\begin{array}{l} (\inf T_{1A}(x) + \inf T_{1B}(x)) \\ - (\inf T_{1A}(x) \cdot \inf T_{1B}(x)) \end{array} \right) \cdot e^{j(\inf T_{2A}(x) + \inf T_{2B}(x))} \\ T_{A \otimes B}(x) &= \left(\begin{array}{l} (\sup T_{1A}(x) + \sup T_{1B}(x)) \\ - (\sup T_{1A}(x) \cdot \sup T_{1B}(x)) \end{array} \right) \cdot e^{j(\sup T_{2A}(x) + \sup T_{2B}(x))}, \end{aligned}$$

$$\begin{aligned} I_{A \oplus B}(x) &= (\inf I_{1A}(x) \cdot \inf I_{1B}(x)) \cdot e^{j(\inf I_{2A}(x) + \inf I_{2B}(x))}, \\ I_{A \otimes B}(x) &= (\sup I_{1A}(x) \cdot \sup I_{1B}(x)) \cdot e^{j(\sup I_{2A}(x) + \sup I_{2B}(x))}, \\ F_{A \oplus B}(x) &= (\inf F_{1A}(x) \cdot \inf F_{1B}(x)) \cdot e^{j(\inf F_{2A}(x) + \inf F_{2B}(x))}, \\ F_{A \otimes B}(x) &= (\sup F_{1A}(x) \cdot \sup F_{1B}(x)) \cdot e^{j(\sup F_{2A}(x) + \sup F_{2B}(x))}. \end{aligned}$$

c) The scalar multiplication of A is an ILCNS-2 denoted as $C = kA$ is defined as:

$$\begin{aligned} k \Theta_{\theta_A(x)} &= \Theta_{k\theta_A(x)}, \\ \inf T_C(x) &= \left(1 - (1 - \inf T_{1A}(x))^k \right) \cdot e^{jk \inf T_{2A}(x)}, \\ \sup T_C(x) &= \left(1 - (1 - \sup T_{1A}(x))^k \right) \cdot e^{jk \sup T_{2A}(x)}, \\ \inf I_C(x) &= \left(\inf T_{1A}(x) \right)^k \cdot e^{jk \inf T_{2A}(x)}, \\ \sup I_C(x) &= \left(\sup T_{1A}(x) \right)^k \cdot e^{jk \sup T_{2A}(x)}, \\ \inf F_C(x) &= \left(\inf F_{1A}(x) \right)^k \cdot e^{jk \inf F_{2A}(x)}, \\ \sup F_C(x) &= \left(\sup F_{1A}(x) \right)^k \cdot e^{jk \sup F_{2A}(x)}. \end{aligned}$$

Proposition 20: Let A and B be two SVLCNSs-2 over \mathbb{I} which are defined by $\langle \Theta_{\theta_A(x)}, (T_A(x), I_A(x), F_A(x)) \rangle$, and $\langle \Theta_{\theta_B(x)}, (T_B(x), I_B(x), F_B(x)) \rangle$ respectively. We have

- a) $A \otimes B = B \otimes A$,
- b) $A \oplus B = B \oplus A$,
- c) $k(A \otimes B) = k(B \otimes A), (k_1 \otimes k_2)A = k_1A \otimes k_2A$.

VI. A TOPSIS MODEL FOR SVLCNS-2 AND ILCNS-2

For simplicity, we only describe the model for ILCNS-2. The model for SVLCNS-2 can be deduced similarly. Let us suppose that a team of h DMs ($D_q, q = 1, \dots, h$) is accountable for assessing m alternatives ($A_m, m = 1, \dots, t$) under p selection criteria ($C_p, p = 1, \dots, n$), the stages of the proposed TOPSIS technique are as:

A. AGGREGATE RATINGS OF ALTERNATIVES VERSUS CRITERIA

Let

$$x_{mpq} = \left\langle x, \left\{ \Theta_{\theta_{mpq}(x)} \left(\begin{array}{l} [T_{mpq}^L(x), T_{mpq}^U(x)], \\ [I_{mpq}^L(x), I_{mpq}^U(x)], \\ [F_{mpq}^L(x), F_{mpq}^U(x)] \end{array} \right) \right\} \right\rangle \quad (5)$$

$$\begin{aligned}
 T_{mp}(x) &= \left[1 - \left(1 - \sum_{q=1}^h T_{pmq}^L(x) \right)^{\frac{1}{h}}, 1 - \left(1 - \sum_{q=1}^h T_{pmq}^R(x) \right)^{\frac{1}{h}} \right] e \left[j \left[\frac{1}{h} \sum_{q=1}^h w_{mq}^L(x), \frac{1}{h} \sum_{q=1}^h w_{mq}^U(x) \right] \right] \\
 I_{mp}(x) &= \left[\left(\sum_{q=1}^h I_{pmq}^L \right)^{\frac{1}{h}}, \left(\sum_{q=1}^h I_{pmq}^R \right)^{\frac{1}{h}} \right] e \left[j \left[\frac{1}{h} \sum_{q=1}^h \psi_{mq}^L(x), \frac{1}{h} \sum_{q=1}^h \psi_{mq}^U(x) \right] \right] \\
 F_{mp}(x) &= \left[\left(\sum_{q=1}^h F_{pmq}^L \right)^{\frac{1}{h}}, \left(\sum_{q=1}^h F_{pmq}^R \right)^{\frac{1}{h}} \right] e \left[j \left[\frac{1}{h} \sum_{q=1}^h \phi_{mq}^L(x), \frac{1}{h} \sum_{q=1}^h \phi_{mq}^U(x) \right] \right]
 \end{aligned}$$

be the suitability assessment allocated to alternative A_m by DM D_q for criterion C_p , where: $[T_{mpq}^L, T_{mpq}^U] = [t_{mpq}^L, t_{mpq}^U] \cdot e^{j[\omega_{mpq}^L(x), \omega_{mpq}^U(x)]}$, $[I_{mpq}^L, I_{mpq}^U] = [i_{mpq}^L, i_{mpq}^U] \cdot e^{j[\psi_{mpq}^L(x), \psi_{mpq}^U(x)]}$, $[F_{mpq}^L, F_{mpq}^U] = [f_{mpq}^L, f_{mpq}^U] \cdot e^{j[\phi_{mpq}^L(x), \phi_{mpq}^U(x)]}$, $m = 1, \dots, t; \mathfrak{P} = 1, \dots, \mathfrak{R} \mathfrak{Q} = 1, \dots, \mathfrak{H}$ Using the operational rules of the ILCNS, the averaged suitability rating $x_{mp} = \left\langle x, \left\{ \Theta_{\theta_{mp}}(x) \left(\begin{matrix} [T_{mp}^L(x), T_{mp}^U(x)], \\ [I_{mp}^L(x), I_{mp}^U(x)], \\ [F_{mp}^L(x), F_{mp}^U(x)] \end{matrix} \right) \right\} \right\rangle$ can be evaluated $T_{mp}(x), I_{mp}(x), F_{mp}(x)$, as shown at the top of the this page.

B. AGGREGATE THE IMPORTANCE WEIGHTS

Let

$$w_{pq} = \left\langle x, \left\{ \Theta_{\rho_{pq}}(x) \left(\begin{matrix} [T_{pq}^L(x), T_{pq}^U(x)], \\ [I_{pq}^L(x), I_{pq}^U(x)], \\ [F_{pq}^L(x), F_{pq}^U(x)] \end{matrix} \right) \right\} \right\rangle$$

be the weight allocated by DM D_q to criterion C_p , where $[T_{pq}^L, T_{pq}^U] = [t_{pq}^L, t_{pq}^U] \cdot e^{j[\omega_{pq}^L(x), \omega_{pq}^U(x)]}$, $[I_{pq}^L, I_{pq}^U] = [i_{pq}^L, i_{pq}^U] \cdot e^{j[\psi_{pq}^L(x), \psi_{pq}^U(x)]}$, $[F_{pq}^L, F_{pq}^U] = [f_{pq}^L, f_{pq}^U] \cdot e^{j[\phi_{pq}^L(x), \phi_{pq}^U(x)]}$, $F_{pq}^U = f_{pq}^U \cdot e^{j[\phi_{pq}^L(x), \phi_{pq}^U(x)]}$, $\mathfrak{P} = 1, \dots, \mathfrak{R} \mathfrak{Q} = 1, \dots, \mathfrak{H}$ Using the operational rules of the ILCNS, the average weight $w_p = \left\langle x, \left\{ \Theta_{\rho_p}(x) \left(\begin{matrix} [T_p^L(x), T_p^U(x)], \\ [I_p^L(x), I_p^U(x)], \\ [F_p^L(x), F_p^U(x)] \end{matrix} \right) \right\} \right\rangle$ can be evaluated as:

$$w_p = \left(\frac{1}{h} \right) \otimes (w_{p1} \oplus w_{p2} \oplus \dots \oplus w_{ph}), \tag{6}$$

where

$$\begin{aligned}
 T_p(x) &= \left[1 - \left(1 - \sum_{q=1}^h T_{pq}^L(x) \right)^{\frac{1}{h}}, 1 - \left(1 - \sum_{q=1}^h T_{pq}^R(x) \right)^{\frac{1}{h}} \right] e \left[j \left[\frac{1}{h} \sum_{q=1}^h w_q^L(x), \frac{1}{h} \sum_{q=1}^h w_q^U(x) \right] \right]
 \end{aligned}$$

$$\begin{aligned}
 I_p(x) &= \left[\left(\sum_{q=1}^h I_{pq}^L \right)^{\frac{1}{h}}, \left(\sum_{q=1}^h I_{pq}^R \right)^{\frac{1}{h}} \right] e \left[j \left[\frac{1}{h} \sum_{q=1}^h \psi_q^L(x), \frac{1}{h} \sum_{q=1}^h \psi_q^U(x) \right] \right] \\
 F_p(x) &= \left[\left(\sum_{q=1}^h F_{pq}^L \right)^{\frac{1}{h}}, \left(\sum_{q=1}^h F_{pq}^R \right)^{\frac{1}{h}} \right] e \left[j \left[\frac{1}{h} \sum_{q=1}^h \phi_q^L(x), \frac{1}{h} \sum_{q=1}^h \phi_q^U(x) \right] \right]
 \end{aligned}$$

C. AGGREGATE THE WEIGHTED RATINGS OF ALTERNATIVES VERSUS CRITERIA

The weighted ratings of alternatives can be advanced via the operations of ILCNS as follows:

$$G_m = \frac{1}{n} \sum_{p=1}^n x_{mp} * w_p, \quad m = 1, \dots, t; p = 1, \dots, n. \tag{7}$$

D. CALCULATION OF A^+, A^-, d_i^{p+} AND d_i^{p-}

The positive-ideal solution (FPIS, A^+) and fuzzy negative ideal solution (FNIS, A^-) are obtained as Eq. (8, 9), as shown at the top of the next page. The distances of each alternative $A_m, m = 1, \dots, t$ from A^+ and A^- for the amplitude terms and the phase terms are calculated as:

$$d_m^{a+} = \sqrt{(G_m^a - A^{a+})^2} \tag{10}$$

$$d_m^{a-} = \sqrt{(G_m^a - A^{a-})^2} \tag{11}$$

$$d_m^{p+} = \sqrt{(G_m^p - A^{p+})^2} \tag{12}$$

$$d_m^{p-} = \sqrt{(G_m^p - A^{p-})^2} \tag{13}$$

where d_m^{a+}, d_m^{p+} characterizes the shortest distances of candidate A_m , and d_m^{a-}, d_m^{p-} , characterizes the farthest distance of candidate A_m .

E. OBTAIN THE CLOSENESS COEFFICIENT

The closeness coefficients for the amplitude terms and the phase terms of every candidate, which are cleared to define

$$A^+ = \left\langle x, \left\{ \Theta_{\max(\theta_{mpq}, \rho_{pq})}(x) ([1, 1] e^{j \max([\omega_{mpq}^L(x), \omega_{pq}^L(x), \omega_{mpq}^U(x), \omega_{pq}^U(x)])}), [0, 0], [0, 0]} \right\} \right\rangle \quad (8)$$

$$A^- = \left\langle x, \left\{ \Theta_{\min(\theta_{mpq}, \rho_{pq})}(x) ([0, 0], [1, 1] e^{j \max([\psi_{mpq}^L(x), \psi_{pq}^L(x), \psi_{mpq}^U(x), \psi_{pq}^U(x)])}), [1, 1] e^{j \max([\phi_{mpq}^L(x), \phi_{pq}^L(x), \phi_{mpq}^U(x), \phi_{pq}^U(x)])}) \right\} \right\rangle \quad (9)$$

the classification order of all candidates, are calculated as:

$$CC_i^a = \frac{d_i^{a-}}{d_i^{a+} + d_i^{a-}} \quad (14)$$

$$CC_i^p = \frac{d_i^{p-}}{d_i^{p+} + d_i^{p-}} \quad (15)$$

A higher value of the closeness coefficient designates that an candidate is closer to PIS and farther from NIS concurrently. Let A_1 and A_2 be any two ILCNS-2. Then, the classification method can be cleared as follows:

If $CC_{A_1}^a > CC_{A_2}^a$ then $A_1 > A_2$

If $CC_{A_1}^a = CC_{A_2}^a$ and $CC_{A_1}^p > CC_{A_2}^p$ then $A_1 > A_2$

If $CC_{A_1}^a = CC_{A_2}^a$ and $CC_{A_1}^p = CC_{A_2}^p$ then $A_1 = A_2$.

VII. AN APPLICATION OF THE PROPOSED TOPSIS METHOD

This section applies the proposed TOPSIS method for lecturer selection in the case of University of Economics and Business - Vietnam National University (UEB-VNU), which is one of the leading universities in Hanoi, Vietnam. Assume that UEB-VNU need to choose an alternative for the teaching position. Data were gathered by conducting semi-structured discussions with UEB-VNU's Board of management, Office of Human resources and department head. A commission of four DMs, i.e. D_1, \dots, D_3 , and D_4 , were requested to distinctly proceed to their own evaluation for the significance weights of selection criteria and the ratings of four potential alternatives. Based on the discussion with the commission members, six selection criteria are considered including number of publications (C_1), quality of publications (C_2), personality factors (C_3), activity in professional society (C_4), classroom teaching experience (C_5), and fluency in a foreign language (C_6). The computational proceeding is concised as follows.

A. AGGREGATION OF THE RATINGS OF CANDIDATES VERSUS CRITERIA

Four DMs decide the suitability rankings of four potential alternatives versus the criteria using the ILCNS $\Theta = \{\Theta_1 = VP, \Theta_2 = P, \Theta_3 = M, \Theta_4 = G, \Theta_5 = VG\}$ where VP = Very Poor = $\langle (\Theta_1, ([0.1, 0.2]e^{j[0.5, 0.6]}, [0.6, 0.7]e^{j[0.4, 0.5]}, [0.6, 0.7]e^{j[0.3, 0.4]})) \rangle$, P = Poor = $\langle (\Theta_2, ([0.2, 0.3]e^{j[0.6, 0.7]}, [0.5, 0.6]e^{j[0.5, 0.6]}, [0.6, 0.7]e^{j[0.4, 0.5]})) \rangle$, M = Medium = $\langle (\Theta_3, ([0.3, 0.5]e^{j[0.7, 0.8]}, [0.4, 0.6]e^{j[0.6, 0.7]}, [0.4, 0.5]e^{j[0.5, 0.6]})) \rangle$, G = Good = $\langle (\Theta_4, ([0.5, 0.6]e^{j[0.8, 0.9]}, [0.4, 0.5]e^{j[0.7, 0.8]}, [0.3, 0.4]e^{j[0.6, 0.7]})) \rangle$, and VG = Very Good = $\langle (\Theta_5, ([0.6, 0.7]e^{j[0.9, 1.0]}, [0.2, 0.3]e^{j[0.8, 0.9]}, [0.2,$

$0.3]e^{j[0.7, 0.8]})) \rangle$, to evaluate the appropriateness of the candidates under six criteria.

Table 1 presents the suitability rankings of four alternatives (A_1, A_2, A_3, A_4) versus six criteria (C_1, \dots, C_6) from four DMs (D_1, D_2, D_3, D_4) using the ILCNS. Using Eq. (5), the aggregated ratings of the candidates versus the criteria from the DMs are shown at the last column of Table 1.

B. AGGREGATE THE IMPORTANCE WEIGHTS

After defining the lecturer assortment criteria, the commission members are asked to define the level of significance of every criterion using the ILCNS, $V = \{v_1 = UI, v_2 = OI, v_3 = I, v_4 = VI, v_5 = AI\}$, where UI = Unimportant = $\langle (v_1, ([0.1, 0.2]e^{j[0.4, 0.5]}, [0.4, 0.5]e^{j[0.3, 0.4]}, [0.6, 0.7]e^{j[0.2, 0.3]})) \rangle$, OI = Ordinary Important = $\langle (v_2, ([0.2, 0.4]e^{j[0.5, 0.6]}, [0.5, 0.6]e^{j[0.4, 0.5]}, [0.4, 0.5]e^{j[0.3, 0.4]})) \rangle$, I = Important = $\langle (v_3, ([0.4, 0.6]e^{j[0.6, 0.7]}, [0.4, 0.5]e^{j[0.5, 0.6]}, [0.3, 0.4]e^{j[0.4, 0.5]})) \rangle$, VI = Very Important = $\langle (v_4, ([0.6, 0.8]e^{j[0.7, 0.8]}, [0.3, 0.4]e^{j[0.6, 0.7]}, [0.2, 0.3]e^{j[0.5, 0.6]})) \rangle$, and AI = Absolutely Important = $\langle (v_5, ([0.7, 0.9]e^{j[0.8, 0.9]}, [0.2, 0.3]e^{j[0.7, 0.8]}, [0.1, 0.2]e^{j[0.6, 0.7]})) \rangle$.

Table 2 shows the significance weights of the six criteria from the four DMs. The gathered weights of criteria attained by Eq. (6) are displayed in the last column of Table 2.

C. AGGREGATE THE WEIGHTED RATINGS OF ALTERNATIVES VERSUS CRITERIA

Table 3 presents the weighted ratings of alternatives of each candidate using Eq. (7).

D. CALCULATION OF A^+, A^-, d_i^+ AND d_i^-

As presented in Table 4, the distance of each candidate from A^+ and A^- for the amplitude term and the phase term can be calculated using Eqs.(8-13).

E. OBTAIN THE CLOSENESS COEFFICIENT

The closeness coefficients of each alternative can be computed by Equations (14)-(15), as shown in Table 5. Therefore, the ranking order of the four candidate is $A_1 > A_4 > A_3 > A_2$. Consequently, the best candidate is A_1 .

The ILCNS is the generalization of ILNS and ICNS. Obviously, the extended decision making methods in [10], [12], [23], [25] are the special cases of the proposal in this paper.

F. SENSITIVITY ANALYSIS

A sensitivity analysis was performed to investigate the impact of criteria weights on the ranking of the candidates (lecturers). The detail of scenarios are shown in Table 6. The results show

TABLE 1. Aggregated ratings of lecturers versus the criteria.

Criteria	Candidates	Decision makers				Aggregated ratings
		D_1	D_2	D_3	D_4	
C_1	A_1	M	G	G	M	$\langle (\Theta_{3.5}, ([0.408, 0.553]e^{i[0.75,0.85]}, [0.4, 0.548]e^{i[0.65,0.75]}], [0.346, 0.447]e^{i[0.55,0.65]}) \rangle$
	A_2	G	G	VG	G	$\langle (\Theta_{4.25}, ([0.527, 0.628]e^{i[0.825,0.925]}, [0.336, 0.44]e^{i[0.725,0.825]}], [0.271, 0.372]e^{i[0.625,0.725]}) \rangle$
	A_3	M	G	G	G	$\langle (\Theta_{3.75}, ([0.456, 0.577]e^{i[0.775,0.875]}, [0.4, 0.523]e^{i[0.675,0.775]}], [0.322, 0.423]e^{i[0.575,0.675]}) \rangle$
	A_4	G	G	G	M	$\langle (\Theta_{3.75}, ([0.456, 0.577]e^{i[0.775,0.875]}, [0.4, 0.523]e^{i[0.675,0.775]}], [0.322, 0.423]e^{i[0.575,0.675]}) \rangle$
C_2	A_1	G	VG	G	G	$\langle (\Theta_{4.25}, ([0.527, 0.628]e^{i[0.825,0.925]}, [0.336, 0.44]e^{i[0.725,0.825]}], [0.271, 0.372]e^{i[0.625,0.725]}) \rangle$
	A_2	M	G	G	G	$\langle (\Theta_{3.75}, ([0.456, 0.577]e^{i[0.775,0.875]}, [0.4, 0.523]e^{i[0.675,0.775]}], [0.322, 0.423]e^{i[0.575,0.675]}) \rangle$
	A_3	VG	G	G	VG	$\langle (\Theta_{4.5}, ([0.553, 0.654]e^{i[0.85,0.95]}, [0.283, 0.387]e^{i[0.75,0.85]}], [0.245, 0.346]e^{i[0.65,0.75]}) \rangle$
	A_4	G	G	G	G	$\langle (\Theta_{4.0}, ([0.5, 0.6]e^{i[0.8,0.9]}, [0.4, 0.5]e^{i[0.7,0.8]}, [0.3, 0.4]e^{i[0.6,0.7]})) \rangle$
C_3	A_1	VG	VG	G	VG	$\langle (\Theta_{4.75}, ([0.577, 0.678]e^{i[0.875,0.975]}, [0.238, 0.341]e^{i[0.775,0.875]}], [0.221, 0.322]e^{i[0.675,0.775]}) \rangle$
	A_2	G	VG	G	G	$\langle (\Theta_{4.25}, ([0.527, 0.628]e^{i[0.825,0.925]}, [0.336, 0.44]e^{i[0.725,0.825]}], [0.271, 0.372]e^{i[0.625,0.725]}) \rangle$
	A_3	G	G	VG	G	$\langle (\Theta_{4.25}, ([0.527, 0.628]e^{i[0.825,0.925]}, [0.336, 0.44]e^{i[0.725,0.825]}], [0.271, 0.372]e^{i[0.625,0.725]}) \rangle$
	A_4	G	VG	G	VG	$\langle (\Theta_{4.5}, ([0.553, 0.654]e^{i[0.85,0.95]}, [0.283, 0.387]e^{i[0.75,0.85]}], [0.245, 0.346]e^{i[0.65,0.75]}) \rangle$
C_4	A_1	M	P	M	M	$\langle (\Theta_{1.75}, ([0.276, 0.456]e^{i[0.675,0.775]}, [0.423, 0.6]e^{i[0.575,0.675]}], [0.443, 0.544]e^{i[0.475,0.575]}) \rangle$
	A_2	M	G	G	G	$\langle (\Theta_{3.75}, ([0.456, 0.577]e^{i[0.775,0.875]}, [0.4, 0.523]e^{i[0.675,0.775]}], [0.322, 0.423]e^{i[0.575,0.675]}) \rangle$
	A_3	M	M	G	M	$\langle (\Theta_{2.25}, ([0.356, 0.527]e^{i[0.725,0.825]}, [0.4, 0.573]e^{i[0.625,0.725]}], [0.372, 0.473]e^{i[0.525,0.625]}) \rangle$
	A_4	G	G	M	G	$\langle (\Theta_{3.75}, ([0.456, 0.577]e^{i[0.775,0.875]}, [0.4, 0.523]e^{i[0.675,0.775]}], [0.322, 0.423]e^{i[0.575,0.675]}) \rangle$
C_5	A_1	G	M	G	G	$\langle (\Theta_{3.75}, ([0.456, 0.577]e^{i[0.775,0.875]}, [0.4, 0.523]e^{i[0.675,0.775]}], [0.322, 0.423]e^{i[0.575,0.675]}) \rangle$
	A_2	G	G	G	G	$\langle (\Theta_4, ([0.5, 0.6]e^{i[0.8,0.9]}, [0.4, 0.5]e^{i[0.7,0.8]}, [0.3, 0.4]e^{i[0.6,0.7]})) \rangle$
	A_3	G	G	M	G	$\langle (\Theta_{3.75}, ([0.456, 0.577]e^{i[0.775,0.875]}, [0.4, 0.523]e^{i[0.675,0.775]}], [0.322, 0.423]e^{i[0.575,0.675]}) \rangle$
	A_4	VG	G	G	VG	$\langle (\Theta_{4.5}, ([0.553, 0.654]e^{i[0.85,0.95]}, [0.283, 0.387]e^{i[0.75,0.85]}], [0.245, 0.346]e^{i[0.65,0.75]}) \rangle$
C_6	A_1	G	G	G	G	$\langle (\Theta_4, ([0.5, 0.6]e^{i[0.8,0.9]}, [0.4, 0.5]e^{i[0.7,0.8]}, [0.3, 0.4]e^{i[0.6,0.7]})) \rangle$
	A_2	G	G	G	M	$\langle (\Theta_{3.75}, ([0.456, 0.577]e^{i[0.775,0.875]}, [0.4, 0.523]e^{i[0.675,0.775]}], [0.322, 0.423]e^{i[0.575,0.675]}) \rangle$
	A_3	VG	G	VG	G	$\langle (\Theta_{4.5}, ([0.553, 0.654]e^{i[0.85,0.95]}, [0.283, 0.387]e^{i[0.75,0.85]}], [0.245, 0.346]e^{i[0.65,0.75]}) \rangle$
	A_4	G	VG	G	G	$\langle (\Theta_{4.25}, ([0.527, 0.628]e^{i[0.825,0.925]}, [0.336, 0.44]e^{i[0.725,0.825]}], [0.271, 0.372]e^{i[0.625,0.725]}) \rangle$

TABLE 2. The importance and aggregated weights of the criteria.

Criteria	DMs				Aggregated weights
	D_1	D_2	D_3	D_4	
\dot{C}_1	I	OI	I	I	$\langle (v_{2.75}, ([0.355, 0.557]e^{j[0.575, 0.675]}, [0.423, 0.523]e^{j[0.475, 0.575]}), [0.322, 0.423]e^{j[0.375, 0.475]}) \rangle$
\dot{C}_2	I	I	OI	OI	$\langle (v_{2.5}, ([0.307, 0.51]e^{j[0.55, 0.65]}, [0.447, 0.548]e^{j[0.45, 0.55]}), [0.346, 0.447]e^{j[0.35, 0.45]}) \rangle$
\dot{C}_3	I	I	I	VI	$\langle (v_{3.25}, ([0.458, 0.664]e^{j[0.625, 0.725]}, [0.372, 0.473]e^{j[0.525, 0.625]}), [0.271, 0.372]e^{j[0.425, 0.525]}) \rangle$
\dot{C}_4	AI	VI	AI	VI	$\langle (v_{4.5}, ([0.654, 0.859]e^{j[0.75, 0.85]}, [0.245, 0.346]e^{j[0.65, 0.75]}), [0.141, 0.245]e^{j[0.55, 0.65]}) \rangle$
\dot{C}_5	VI	VI	I	VI	$\langle (v_{3.75}, ([0.557, 0.762]e^{j[0.675, 0.775]}, [0.322, 0.423]e^{j[0.575, 0.675]}), [0.221, 0.322]e^{j[0.475, 0.575]}) \rangle$
\dot{C}_6	VI	I	VI	I	$\langle (v_{3.5}, ([0.51, 0.717]e^{j[0.65, 0.75]}, [0.346, 0.447]e^{j[0.55, 0.65]}), [0.245, 0.346]e^{j[0.45, 0.55]}) \rangle$

TABLE 3. Weighted assessments of each candidate.

Candidates	Aggregated weights
A_1	$\langle (\Theta_{v_{12.688}}, ([0.212, 0.372]e^{j[0.497, 0.634]}, [0.594, 0.682]e^{j[0.365, 0.484]}), [0.495, 0.57]e^{j[0.369, 0.433]}) \rangle$
A_2	$\langle (\Theta_{v_{13.313}}, ([0.232, 0.39]e^{j[0.507, 0.646]}, [0.602, 0.684]e^{j[0.374, 0.494]}), [0.48, 0.556]e^{j[0.379, 0.443]}) \rangle$
A_3	$\langle (\Theta_{v_{13.320}}, ([0.225, 0.385]e^{j[0.508, 0.646]}, [0.584, 0.671]e^{j[0.374, 0.494]}), [0.479, 0.554]e^{j[0.381, 0.444]}) \rangle$
A_4	$\langle (\Theta_{v_{13.927}}, ([0.243, 0.402]e^{j[0.518, 0.658]}, [0.58, 0.659]e^{j[0.383, 0.504]}), [0.466, 0.542]e^{j[0.391, 0.454]}) \rangle$

TABLE 4. The distance of every alternative from A^+ and A^- .

Candidates	Amplitude terms		Phase term	
	d^+	d^-	d^+	d^-
A_1	4.255	2.443	0.832	0.807
A_2	4.265	2.404	0.851	0.821
A_3	4.242	2.431	0.852	0.822
A_4	4.228	2.425	0.872	0.837

TABLE 5. Closeness coefficients of candidates.

Candidates	Closeness coefficient		Ranking
	Amplitude terms	Phase term	
A_1	0.3647	0.4923	1
A_2	0.3605	0.4911	4
A_3	0.3643	0.4910	3
A_4	0.3645	0.4899	2

that eight out of eleven scenarios, the candidate is ranked either as the first or the second candidate. This confirms domination of the candidate A_1 compared to other alternatives. Therefore, the candidate selection decision is relatively insensitive to criteria weights.

VIII. COMPARISON OF THE SUGGESTED METHOD WITH ANOTHER DECISION MAKING METHOD

This section compares the proposed TOPSIS decision making procedure in ICNS with a different MCDM methodology to

illustrate applicability and its advantages. We recall an example explored by Sahin and Yigider [33] in which a production industry wishes to choose and assess their suppliers. In this model, four DMs (D_1, \dots, D_4) have been selected to valuate five suppliers (S_1, \dots, S_5) with respect to five performance criteria including delivery (C_1), quality (C_2), flexibility (C_3), service (C_4) and price (C_5). The information of weights provided to the five criteria by the four DMs are offered in Table 7. The gathered weights of criteria gained by Eq. (4) are displayed in the last column of Table 7.

TABLE 6. Scenarios for sensitivity analysis.

Scenari os	Weights of criteria	Closeness coefficient (CC _i)								Ranking
		A ₁		A ₂		A ₃		A ₄		
		CC ₁ ^a	CC ₁ ^p	CC ₂ ^a	CC ₂ ^p	CC ₃ ^a	CC ₃ ^p	CC ₄ ^a	CC ₄ ^a	
1	w ₁ = w ₂ = w ₃ = w ₄ = w ₅ = w ₆ = UI	0,235	0,5088	0,220	0,508 0	0,222	0,5077	0,210	0,5069	A ₁ > A ₃ > A ₂ > A ₄
2	w ₁ = w ₂ = w ₃ = w ₄ = w ₅ = w ₆ = OI	0,276	0,4998	0,266	0,499 0	0,267	0,4986	0,259	0,4978	A ₁ > A ₃ > A ₂ > A ₄
3	w ₁ = w ₂ = w ₃ = w ₄ = w ₅ = w ₆ = I	0,3433	0,4936	0,337 5	0,492 8	0,340 6	0,4925	0,337 8	0,4917	A ₁ > A ₃ > A ₄ > A ₂
4	w ₁ = w ₂ = w ₃ = w ₄ = w ₅ = w ₆ = VI	0,4141	0,4892	0,412 3	0,488 4	0,417 6	0,4880	0,419 4	0,4873	A ₄ > A ₃ > A ₁ > A ₂
5	w ₁ = w ₂ = w ₃ = w ₄ = w ₅ = w ₆ = AI	0,4693	0,4859	0,469 6	0,485 1	0,476 9	0,4847	0,481 7	0,4840	A ₄ > A ₃ > A ₂ > A ₁
6	w ₁ = AI, w ₂ = w ₃ = w ₄ = w ₅ = w ₆ = UI	0,2715	0,5029	0,241 2	0,501 1	0,258 8	0,5016	0,254 0	0,5010	A ₁ > A ₃ > A ₄ > A ₂
7	w ₁ = w ₃ = w ₄ = w ₅ = UI w ₂ = AI,	0,2704	0,5017	0,276 5	0,501 9	0,261 4	0,5004	0,267 9	0,5006	A ₂ > A ₁ > A ₄ > A ₃
8	w ₁ = w ₂ = w ₄ = w ₅ = w ₆ = UI w ₃ = AI,	0,2836	0,5009	0,287 5	0,501 1	0,291 2	0,5008	0,281 7	0,4999	A ₃ > A ₂ > A ₁ > A ₄
9	w ₁ = w ₂ = w ₃ = w ₅ = w ₆ = UI w ₄ = AI,	0,2558	0,5043	0,212 7	0,501 9	0,233 1	0,5024	0,211 9	0,5010	A ₁ > A ₃ > A ₂ > A ₄
10	w ₁ = w ₂ = w ₃ = w ₄ = w ₆ = UI w ₅ = AI,	0,2719	0,5026	0,256 5	0,501 5	0,267 7	0,5016	0,245 2	0,4999	A ₁ > A ₃ > A ₂ > A ₄
11	w ₁ = w ₂ = w ₃ = w ₄ = w ₅ = UI w ₆ = AI,	0,2736	0,5021	0,274 0	0,501 9	0,257 2	0,5004	0,258 8	0,5002	A ₂ > A ₁ > A ₄ > A ₃

TABLE 7. The significance and aggregated weights of the criteria.

Criteria	DMs				Aggregated weights
	D ₁	D ₂	D ₃	D ₄	
C ₁	AI	AI	AI	VI	<(v _{4.75} , ([0.678, 0.881]e ^{i[0.775,0.875]} , [0.221, 0.322]e ^{i[0.675,0.775]}), [0.119, 0.221]e ^{i[0.575,0.675]})>
C ₂	VI	I	I	VI	<(v _{3.5} , ([0.51, 0.717]e ^{i[0.65,0.75]} , [0.346, 0.447]e ^{i[0.55,0.65]}), [0.245, 0.346]e ^{i[0.45,0.55]})>
C ₃	AI	AI	VI	AI	<(v _{4.75} , ([0.678, 0.881]e ^{i[0.775,0.875]} , [0.221, 0.322]e ^{i[0.675,0.775]}), [0.119, 0.221]e ^{i[0.575,0.675]})>
C ₄	VI	VI	I	OI	<(v _{3.25} , ([0.474, 0.687]e ^{i[0.625,0.725]} , [0.366, 0.468]e ^{i[0.525,0.625]}), [0.263, 0.366]e ^{i[0.425,0.525]})>
C ₅	I	I	AI	AI	<(v _{4.0} , ([0.576, 0.8]e ^{i[0.7,0.8]} , [0.283, 0.387]e ^{i[0.6,0.7]}), [0.173, 0.283]e ^{i[0.5,0.6]})>

The averaged ratings of suppliers versus the criteria are shown in Table 8.

Table 9 shows the last fuzzy valuation values of every supplier using Eq. (7).

The distance of each supplier from A⁺ and A⁻ for the amplitude term and the phase term can be calculated using Eqs. (8-13) as shown in Table 10.

The closeness coefficients of each supplier can be calculated by Eqs. (14-15), as shown in Table 11. Therefore, the ranking order of the five suppliers is A₅ > A₂ > A₃ > A₄ > A₁.

The result indicates that there is a slightly different among the rating order of suppliers using the suggested method and Sahin and Yigider [33]. This is due to the proposed technique

TABLE 8. Aggregated evaluations of suppliers versus the criteria.

Criteria	Suppliers	DMs				Aggregated ratings
		D_1	D_2	D_3	D_4	
C_1	A_1	G	M	G	G	$\langle (\Theta_{3.75}, ([0.456, 0.577]e^{i[0.775,0.875]}, [0.4, 0.523]e^{i[0.675,0.775]}, [0.322, 0.423]e^{i[0.575,0.675]})) \rangle$
	A_2	G	G	M	M	$\langle (\Theta_{3.5}, ([0.408, 0.553]e^{i[0.75,0.85]}, [0.4, 0.548]e^{i[0.65,0.75]}, [0.346, 0.447]e^{i[0.55,0.65]})) \rangle$
	A_3	P	G	M	P	$\langle (\Theta_{2.75}, ([0.312, 0.44]e^{i[0.675,0.775]}, [0.447, 0.573]e^{i[0.575,0.675]}, [0.456, 0.560]e^{i[0.475,0.575]})) \rangle$
	A_4	G	M	G	M	$\langle (\Theta_{3.5}, ([0.408, 0.553]e^{i[0.75,0.85]}, [0.4, 0.548]e^{i[0.65,0.75]}, [0.346, 0.447]e^{i[0.55,0.65]})) \rangle$
	A_5	M	G	G	G	$\langle (\Theta_{3.75}, ([0.456, 0.577]e^{i[0.775,0.875]}, [0.4, 0.523]e^{i[0.675,0.775]}, [0.322, 0.423]e^{i[0.575,0.675]})) \rangle$
C_2	A_1	G	G	M	G	$\langle (\Theta_{3.75}, ([0.456, 0.577]e^{i[0.775,0.875]}, [0.4, 0.523]e^{i[0.675,0.775]}, [0.322, 0.423]e^{i[0.575,0.675]})) \rangle$
	A_2	G	M	P	M	$\langle (\Theta_{3.0}, ([0.335, 0.486]e^{i[0.7,0.8]}, [0.423, 0.573]e^{i[0.6,0.7]}, [0.412, 0.514]e^{i[0.5,0.6]})) \rangle$
	A_3	P	G	G	G	$\langle (\Theta_{3.5}, ([0.438, 0.54]e^{i[0.75,0.85]}, [0.423, 0.523]e^{i[0.65,0.75]}, [0.357, 0.46]e^{i[0.55,0.65]})) \rangle$
	A_4	M	P	G	P	$\langle (\Theta_{2.75}, ([0.312, 0.44]e^{i[0.675,0.775]}, [0.447, 0.573]e^{i[0.575,0.675]}, [0.456, 0.560]e^{i[0.475,0.575]})) \rangle$
	A_5	G	G	M	G	$\langle (\Theta_{3.75}, ([0.456, 0.577]e^{i[0.775,0.875]}, [0.4, 0.523]e^{i[0.675,0.775]}, [0.322, 0.423]e^{i[0.575,0.675]})) \rangle$
C_3	A_1	M	M	P	P	$\langle (\Theta_{2.5}, ([0.252, 0.408]e^{i[0.65,0.75]}, [0.447, 0.6]e^{i[0.55,0.65]}, [0.49, 0.592]e^{i[0.45,0.55]})) \rangle$
	A_2	G	G	G	G	$\langle (\Theta_{4.0}, ([0.5, 0.6]e^{i[0.8,0.9]}, [0.4, 0.5]e^{i[0.7,0.8]}, [0.3, 0.4]e^{i[0.6,0.7]})) \rangle$
	A_3	P	G	M	M	$\langle (\Theta_{3.0}, ([0.335, 0.486]e^{i[0.7,0.8]}, [0.423, 0.573]e^{i[0.6,0.7]}, [0.412, 0.514]e^{i[0.5,0.6]})) \rangle$
	A_4	G	M	G	M	$\langle (\Theta_{3.5}, ([0.408, 0.553]e^{i[0.75,0.85]}, [0.4, 0.548]e^{i[0.65,0.75]}, [0.346, 0.447]e^{i[0.55,0.65]})) \rangle$
	A_5	M	G	G	G	$\langle (\Theta_{3.75}, ([0.456, 0.577]e^{i[0.775,0.875]}, [0.4, 0.523]e^{i[0.675,0.775]}, [0.322, 0.423]e^{i[0.575,0.675]})) \rangle$
C_4	A_1	G	P	M	P	$\langle (\Theta_{2.75}, ([0.312, 0.44]e^{i[0.675,0.775]}, [0.447, 0.573]e^{i[0.575,0.675]}, [0.456, 0.560]e^{i[0.475,0.575]})) \rangle$
	A_2	G	G	P	G	$\langle (\Theta_{3.5}, ([0.438, 0.54]e^{i[0.75,0.85]}, [0.423, 0.523]e^{i[0.65,0.75]}, [0.357, 0.46]e^{i[0.55,0.65]})) \rangle$
	A_3	M	M	M	M	$\langle (\Theta_{3.0}, ([0.3, 0.5]e^{i[0.7,0.8]}, [0.4, 0.6]e^{i[0.6,0.7]}, [0.4, 0.5]e^{i[0.5,0.6]})) \rangle$
	A_4	P	P	M	G	$\langle (\Theta_{2.75}, ([0.312, 0.44]e^{i[0.675,0.775]}, [0.447, 0.573]e^{i[0.575,0.675]}, [0.456, 0.560]e^{i[0.475,0.575]})) \rangle$
	A_5	M	G	G	G	$\langle (\Theta_{3.75}, ([0.456, 0.577]e^{i[0.775,0.875]}, [0.4, 0.523]e^{i[0.675,0.775]}, [0.322, 0.423]e^{i[0.575,0.675]})) \rangle$
C_5	A_1	P	M	G	P	$\langle (\Theta_{2.75}, ([0.312, 0.44]e^{i[0.675,0.775]}, [0.447, 0.573]e^{i[0.575,0.675]}, [0.456, 0.560]e^{i[0.475,0.575]})) \rangle$
	A_2	G	P	G	G	$\langle (\Theta_{3.5}, ([0.438, 0.54]e^{i[0.75,0.85]}, [0.423, 0.523]e^{i[0.65,0.75]}, [0.357, 0.46]e^{i[0.55,0.65]})) \rangle$
	A_3	G	G	P	M	$\langle (\Theta_{3.25}, ([0.388, 0.514]e^{i[0.725,0.825]}, [0.423, 0.548]e^{i[0.925,1.025]}, [0.383, 0.486]e^{i[0.775,0.875]})) \rangle$
	A_4	P	P	M	G	$\langle (\Theta_{2.75}, ([0.312, 0.44]e^{i[0.725,0.825]}, [0.447, 0.573]e^{i[0.625,0.725]}, [0.456, 0.560]e^{i[0.525,0.625]})) \rangle$
	A_5	G	G	G	G	$\langle (\Theta_{4.0}, ([0.5, 0.6]e^{i[0.8,0.9]}, [0.4, 0.5]e^{i[0.7,0.8]}, [0.3, 0.4]e^{i[0.6,0.7]})) \rangle$

TABLE 9. The last fuzzy valuation values of every supplier.

Suppliers	Aggregated weights
A_1	$\langle (\Theta_{12.263}, ([0.208, 0.388]e^{j[0.497,0.648]}, [0.594, 0.698]e^{j[0.366,0.497]}, [0.517, 0.601]e^{j[0.357,0.427]})) \rangle$
A_2	$\langle (\Theta_{14.625}, ([0.249, 0.435]e^{j[0.526,0.681]}, [0.583, 0.677]e^{j[0.391,0.526]}, [0.47, 0.554]e^{j[0.386,0.456]})) \rangle$
A_3	$\langle (\Theta_{12.225}, ([0.205, 0.390]e^{j[0.496,0.647]}, [0.592, 0.699]e^{j[0.365,0.496]}, [0.515, 0.598]e^{j[0.356,0.426]})) \rangle$
A_4	$\langle (\Theta_{12.338}, ([0.208, 0.392]e^{j[0.495,0.646]}, [0.592, 0.699]e^{j[0.365,0.495]}, [0.515, 0.599]e^{j[0.355,0.425]})) \rangle$
A_5	$\langle (\Theta_{15.2}, ([0.27, 0.461]e^{j[0.546,0.704]}, [0.574, 0.668]e^{j[0.408,0.546]}, [0.445, 0.527]e^{j[0.406,0.476]})) \rangle$

TABLE 10. The distance of each supplier from A^+ and A^- .

Suppliers	Amplitude terms		Phase term	
	d^+	d^-	d^+	d^-
A_1	4.528	2.303	0.834	0.822
A_2	4.487	2.300	0.888	0.862
A_3	4.522	2.317	0.833	0.821
A_4	4.523	2.309	0.832	0.820
A_5	4.470	2.355	0.925	0.891

TABLE 11. Closeness coefficients of suppliers.

Suppliers	Closeness coefficient		Rank
	Amplitude terms	Phase term	
A_1	0.33708	0.4964	5
A_2	0.33884	0.4925	2
A_3	0.33878	0.4964	3
A_4	0.33794	0.4964	4
A_5	0.34502	0.4906	1

applying the ILCNS, which is the generalization of ILNS, ICNS and INS.

IX. CONCLUSIONS

Linguistic based strategies are very useful tool in decision making problems for solving the problem of crisp values. In this paper, we proposed the Single-Valued Linguistic Interval Complex Neutrosophic Set (SVLCNS) and Interval Linguistic Interval Complex Neutrosophic Set (ILCNS) for decision making under uncertainty situations. Some basic set notional operations such as the intersection, union and complement as well as the functioning rules of SVLCNS and ILCNS were also defined of the proposed framework. Moreover, we also developed a new TOPSIS decision making method in SVLCNS and ICNS that was applied to lecturer selection problem for the case study of (UEB-VNU) with four DMs and six selection criteria. It has been explained throughout the elaborated computation in the application that the suggested decision making methods are efficient.

Further works of this research involve deriving variants of the TOPSIS methods in terms of multi-attribute decision making [11], [43]–[48]. Strategies for decision support in real-time and dynamic decision-making tasks are also our next target. In the follow up study, this work can be extended to the triangular and trapezoidal linguistic numbers of SVLCNS and ILCNS. Several types of similarity measures can be utilized to extend the proposed framework in the near future. The different types of correlation coefficients can also be studied in this regard. Linguistic complex interval neutrosophic prioritized aggregation operators can be designed for decision making issues based on the proposed work. Some other types of aggregation operators such as Hammy mean operators, weighted aggregation operators, arithmetic and harmonic aggregation operators, power aggregation operators etc. can be developed in the follow up works. Moreover, linguistic hesitant complex interval neutrosophic set can be another possible study in this regard. The proposed framework can be

embedded in soft set to develop linguistic complex interval neutrosophic set.

APPENDIX

This section reviews some basic notions and definitions of neutrosophic set, single-value neutrosophic set, interval-valued complex neutrosophic set and single-valued neutrosophic linguistic variable as follows [1], [9], [10], [13]:

Let U be a universe of discourse and a set $N \subset U$, such that

$$N = \{x(T_A(x), I_A(x), F_A(x)), x \in U\},$$

where $T_A(x), I_A(x), F_A(x) \subseteq [0, 1]$ are real subsets, for all $x \in U$, is called a neutrosophic set (NS)

If $T_A(x), I_A(x), F_A(x) \in [0, 1]$ are real (crisp) numbers, for all $x \in U$, then N is called a *single-valued neutrosophic set* (SVNS).

If $T_A(x), I_A(x), F_A(x) \subseteq [0, 1]$ are real intervals, for all $x \in U$, then N is called a *interval-valued neutrosophic set* (IVNS).

If $CN = \{x(T_{1A}(x)e^{j\theta} (jT_{2A}(x)), I_{1A}(x)e^{j\theta} (jI_{2A}(x)), F_{1A}(x)e^{j\theta} (jF_{2A}(x)), x \in U\}$, where $T_{1A}(x), T_{2A}(x), I_{1A}(x), I_{2A}(x), F_{1A}(x), F_{2A}(x) \subseteq [0, 1]$ are real subsets, for all $x \in U$, then CN is called a *complex neutrosophic set* (CNS).

If $T_{1A}(x), T_{2A}(x), I_{1A}(x), I_{2A}(x), F_{1A}(x), F_{2A}(x) \in [0, 1]$ are real (crisp) numbers, for all $x \in U$, then CN is called a *single-valued complex neutrosophic set* (SVCNS).

If $T_{1A}(x), T_{2A}(x), I_{1A}(x), I_{2A}(x), F_{1A}(x), F_{2A}(x) \subseteq [0, 1]$ are real intervals, for all $x \in U$, then CN is called a *interval-valued complex neutrosophic set* (IVCNS).

Let U be a universe of discourse and $S = \{s_1, s_2, \dots, s_n\}$ be a set of labels. A *single-valued linguistic variable* (L) with respect to the attribute A is defined as:

$$L: U \rightarrow S, L(x) = s_x \in \{s_1, s_2, \dots, s_n\}.$$

A *single-valued neutrosophic linguistic variable* (NL) with respect to the attribute A is defined as:

$$NL: U \rightarrow S^3, NL(x) = (t_x, i_x, f_x),$$

$$\text{where } t_x, i_x, f_x \in \{s_1, s_2, \dots, s_n\},$$

and t_x represents the positive degree of the element x with respect to the attribute A , i_x represents the indeterminate degree of the element x with respect to the attribute A , while f_x represents the false degree of the element x with respect to the attribute A .

REFERENCES

- [1] F. Smarandache, *Neutrosophy: Neutrosophic Probability, Set, and Logic: Analytic Synthesis & Synthetic Analysis*. 1998.
- [2] P. Biswas, S. Pramanik, and B. C. Giri, "TOPSIS method for multi-attribute group decision-making under single-valued neutrosophic environment," *Neural Comput. Appl.*, vol. 27, no. 3, pp. 727–737, 2016.
- [3] P. Liu, "The aggregation operators based on archimedean t-conorm and t-norm for single-valued neutrosophic numbers and their application to decision making," *Int. J. Fuzzy Syst.*, vol. 18, no. 5, pp. 849–863, 2016.
- [4] P. Liu and G. Tang, "Multi-criteria group decision-making based on interval neutrosophic uncertain linguistic variables and Choquet integral," *Cogn. Comput.*, vol. 8, no. 6, pp. 1036–1056, 2016.
- [5] P. Liu, L. Zhang, X. Liu, and P. Wang, "Multi-valued neutrosophic number Bonferroni mean operators with their applications in multiple attribute group decision making," *Int. J. Inf. Technol. Decis. Making*, vol. 15, no. 5, pp. 1181–1210, 2016.
- [6] Z.-P. Tian, H.-Y. Zhang, J. Wang, J.-Q. Wang, and X.-H. Chen, "Multi-criteria decision-making method based on a cross-entropy with interval neutrosophic sets," *Int. J. Syst. Sci.*, vol. 47, no. 15, pp. 3598–3608, 2016.
- [7] J. Ye, "Interval neutrosophic multiple attribute decision-making method with credibility information," *Int. J. Fuzzy Syst.*, vol. 18, no. 5, pp. 914–923, 2016.
- [8] M. Zhang, P. Liu, and L. Shi, "An extended multiple attribute group decision-making TODIM method based on the neutrosophic numbers," *J. Intell. Fuzzy Syst.*, vol. 30, no. 3, pp. 1773–1781, 2016.
- [9] H. Wang, F. Smarandache, Y.-Q. Zhang, and R. Sunderraman, *Interval Neutrosophic Sets and Logic: Theory and Applications in Computing*, vol. 5. Frontignan, France: Hexis, 2005, p. 97.
- [10] M. Ali and F. Smarandache, "Complex neutrosophic set," *Neural Comput. Appl.*, vol. 28, no. 7, pp. 1817–1834, 2017.
- [11] M. Ali, L. Q. Dat, L. H. Son, and F. Smarandache, "Interval complex neutrosophic set: Formulation and applications in decision-making," *Int. J. Fuzzy Syst.*, vol. 20, no. 3, pp. 986–999, 2018.
- [12] J. Ye, "Similarity measures between interval neutrosophic sets and their applications in multicriteria decision-making," *J. Intell. Fuzzy Syst.*, vol. 26, no. 1, pp. 165–172, 2014.
- [13] Y.-Y. Li, H. Zhang, and J.-Q. Wang, "Linguistic neutrosophic sets and their application in multicriteria decision-making problems," *Int. J. Uncertainty Quantification*, vol. 7, no. 2, pp. 135–154, 2017.
- [14] Z. Fang and J. Ye, "Multiple attribute group decision-making method based on linguistic neutrosophic numbers," *Symmetry*, vol. 9, no. 7, p. 111, 2017.
- [15] Y.-X. Ma, J.-Q. Wang, J. Wang, and X.-H. Wu, "An interval neutrosophic linguistic multi-criteria group decision-making method and its application in selecting medical treatment options," *Neural Comput. Appl.*, vol. 28, no. 9, pp. 2745–2765, 2017.
- [16] W. E. Yang, C. Q. Ma, and Z.-Q. Han, "Linguistic multi-criteria decision-making with representing semantics by programming," *Int. J. Syst. Sci.*, vol. 48, no. 2, pp. 225–235, 2017.
- [17] T.-Y. Chen, "IVIF-PROMETHEE outranking methods for multiple criteria decision analysis based on interval-valued intuitionistic fuzzy sets," *Fuzzy Optim. Decis. Making*, vol. 14, no. 2, pp. 173–198, 2015.
- [18] P. H. Phong and L. H. Son, "Linguistic vector similarity measures and applications to linguistic information classification," *Int. J. Intell. Syst.*, vol. 32, no. 1, pp. 67–81, 2017.
- [19] Y.-J. Liu and W.-G. Zhang, "Fuzzy portfolio selection model with real features and different decision behaviors," *Fuzzy Optim. Decis. Making*, vol. 17, no. 3, pp. 317–336, 2018.
- [20] Z.-P. Tian, J. Wang, H.-Y. Zhang, and J.-Q. Wang, "Multi-criteria decision-making based on generalized prioritized aggregation operators under simplified neutrosophic uncertain linguistic environment," *Int. J. Mach. Learn. Cybern.*, vol. 9, no. 3, pp. 523–539, 2018.
- [21] Z.-P. Tian, J. Wang, J.-Q. Wang, and H.-Y. Zhang, "Simplified neutrosophic linguistic multi-criteria group decision-making approach to green product development," *Group Decis. Negotiation*, vol. 26, no. 3, pp. 597–627, 2017.
- [22] S. Broumi and F. Smarandache, "Single valued neutrosophic trapezoid linguistic aggregation operators based multi-attribute decision making," *Bull. Pure Appl. Sci.-Math.*, vol. 33E, no. 2, pp. 135–155, 2014.
- [23] S. Broumi and J. F. Ye Smarandache, *An Extended TOPSIS Method for Multiple Attribute Decision Making Based on Interval Neutrosophic Uncertain Linguistic Variables*. 2015.
- [24] J. Ye, "Some aggregation operators of interval neutrosophic linguistic numbers for multiple attribute decision making," *J. Intell. Fuzzy Syst.*, vol. 27, no. 5, pp. 2231–2241, 2014.
- [25] J. Ye, "Multiple attribute group decision making based on interval neutrosophic uncertain linguistic variables," *Int. J. Mach. Learn. Cybern.*, vol. 8, no. 3, pp. 837–848, 2017.
- [26] Z.-P. Tian, J. Wang, J.-Q. Wang, and H.-Y. Zhang, "An improved MULTIMOORA approach for multi-criteria decision-making based on interdependent inputs of simplified neutrosophic linguistic information," *Neural Comput. Appl.*, vol. 28, no. 1, pp. 585–597, 2017.
- [27] P. P. Dey and S. B. C. Pramanik Giri, "An extended grey relational analysis based multiple attribute decision making in interval neutrosophic uncertain linguistic setting," *Neutrosophic Sets Systems*, vol. 11, pp. 21–30, Apr. 2016.

- [28] E. K. Zavadskas, Z. Turskis, T. Vilitienė, and N. Lepkova, "Integrated group fuzzy multi-criteria model: Case of facilities management strategy selection," *Expert Syst. Appl.*, vol. 82, pp. 317–331, Oct. 2017.
- [29] I. Hudson, L. Reinerman-Jones, and G. Teo, "A review of personnel selection approaches for the skill of decision making," in *Augmented Cognition. Enhancing Cognition and Behavior in Complex Human Environments* (Lecture Notes in Computer Science), vol. 10285, D. Schmorow and C. Fidopiastis, Eds. Cham, Switzerland: Springer, 2017.
- [30] M. J. Stadler, "Complex problem solving in University selection," Ph.D. dissertation, Fac. Lang. Literature, Humanities, Arts Educ., Univ. Luxembourg, Luxembourg, U.K., 2016.
- [31] M. A. Fuller and R. Delorey, "Making the choice: University and program selection factors for undergraduate management education in Maritime Canada," *Int. J. Manage. Educ.*, vol. 14, no. 2, pp. 176–186, 2016.
- [32] S.-P. Wan, F. Wang, G.-L. Xu, J.-Y. Dong, and J. Tang, "An intuitionistic fuzzy programming method for group decision making with interval-valued fuzzy preference relations," *Fuzzy Optim. Decis. Making*, vol. 16, no. 3, pp. 269–295, 2017.
- [33] R. Şahin and M. Yiğider. (2014). "A Multi-criteria neutrosophic group decision making method based TOPSIS for supplier selection." [Online]. Available: <https://arxiv.org/abs/1412.5077>
- [34] F. Smarandache. (2015). Symbolic Neutrosophic Theory. Europa Nova, Bruxelles. [Online]. Available: <https://arxiv.org/ftp/arxiv/papers/1512/1512.00047.pdf>
- [35] H. Poursmaeil, E. Shivanian, E. Khorram, and H. S. Fathabadi, "An extended method using TOPSIS and VIKOR for multiple attribute decision making with multiple decision makers and single valued neutrosophic numbers," *Adv. Appl. Statist.*, vol. 50, no. 4, pp. 261–292, 2017.
- [36] İ. Otay and C. Kahraman, "Six sigma project selection using interval neutrosophic TOPSIS," in *Advances in Fuzzy Logic and Technology*. Cham, Switzerland: Springer, 2017, pp. 83–93.
- [37] S. Pramanik, P. P. Dey, B. C. Giri, and F. Smarandache, "An extended TOPSIS for multi-attribute decision making problems with neutrosophic cubic information," *Neutrosophic Sets Syst.*, vol. 17, pp. 20–28, Oct. 2017.
- [38] W. Liang, G. Zhao, and H. Wu, "Evaluating investment risks of metallic mines using an extended TOPSIS method with linguistic neutrosophic numbers," *Symmetry*, vol. 9, no. 8, p. 149, 2017.
- [39] S. Altinirmak, B. Okoth, M. Ergun, and C. Karamasa, "Analyzing mobile banking quality factors under neutrosophic set perspective: A case study of TURKEY," *J. Econ. Finance Accounting*, vol. 4, no. 4, pp. 354–367, 2017.
- [40] S. Eraslan and N. Çağman, "A decision making method by combining TOPSIS and grey relation method under fuzzy soft sets," *Sigma J. Eng. Nat. Sci.*, vol. 8, no. 1, pp. 53–64, 2017.
- [41] P. Liu, Q. Khan, J. Ye, and T. Mahmood, "Group decision-making method under hesitant interval neutrosophic uncertain linguistic environment," *Int. J. Fuzzy Syst.*, vol. 20, no. 7, pp. 2337–2353, 2018. doi: [10.1007/s40815-017-0445-4](https://doi.org/10.1007/s40815-017-0445-4).
- [42] T. Rashid, S. Faizi, Z. Xu, and S. Zafar, "ELECTRE-based outranking method for multi-criteria decision making using hesitant intuitionistic fuzzy linguistic term sets," *Int. J. Fuzzy Syst.*, vol. 20, no. 1, pp. 78–92, 2018.
- [43] S. Jha *et al.*, "Neutrosophic soft set decision making for stock trending analysis," *Evolving Syst.*, to be published. doi: [10.1007/s12530-018-9247-7](https://doi.org/10.1007/s12530-018-9247-7).
- [44] N. T. Thong, L. Q. Dat, L. H. Son, N. D. Hoa, M. Ali, and F. Smarandache, "Dynamic interval valued neutrosophic set: Modeling decision making in dynamic environments," *Comput. Ind.*, vol. 108, pp. 45–52, Jun. 2019.
- [45] R. T. Ngan, L. H. Son, B. C. Cuong, and M. Ali, "H-max distance measure of intuitionistic fuzzy sets in decision making," *Appl. Soft Comput.*, vol. 69, pp. 393–425, Aug. 2018.
- [46] M. Khan, L. H. Son, M. Ali, H. T. M. Chau, N. T. N. Na, and F. Smarandache, "Systematic review of decision making algorithms in extended neutrosophic sets," *Symmetry*, vol. 10, no. 8, pp. 314–342, 2018.
- [47] M. Ali, L. H. Son, I. Deli, and N. D. Tien, "Bipolar neutrosophic soft sets and applications in decision making," *J. Intell. Fuzzy Syst.*, vol. 33, no. 6, pp. 4077–4087, 2017.
- [48] T. T. Ngan, T. M. Tuan, L. H. Son, N. H. Minh, and N. Dey, "Decision making based on fuzzy aggregation operators for medical diagnosis from dental X-ray images," *J. Med. Syst.*, vol. 40, no. 12, p. 280, 2016.

***m*-Polar Neutrosophic Topology with Applications to Multi-Criteria Decision-Making in Medical Diagnosis and Clustering Analysis**

Masooma Raza Hashmi, Muhammad Riaz, Florentin Smarandache

Masooma Raza Hashmi, Muhammad Riaz, Florentin Smarandache (2019). *m*-Polar Neutrosophic Topology with Applications to Multi-Criteria Decision-Making in Medical Diagnosis and Clustering Analysis. *International Journal of Fuzzy Systems* 22, 273-292; DOI: 10.1007/s40815-019-00763-2

Abstract In this paper, we first introduce novel concepts of *m*-polar neutrosophic set (MPNS) and topological structure on *m*-polar neutrosophic set by combining the *m*-polar fuzzy set (MPFS) and neutrosophic set. Then, we investigate several characterizations of *m*-polar neutrosophic set and establish its various operations with the help of examples. We propose score functions for the comparison of *m*-polar neutrosophic numbers (MPNNs). We establish *m*-polar neutrosophic topology and define interior, closure, exterior, and frontier for *m*-polar neutrosophic sets (MPNSs) with illustrative examples. We discuss some results with counter examples, which hold for classical set theory, but do not hold for *m*-polar neutrosophic set theory. We introduce a cosine similarity measure and a set theoretic similarity measure for *m*-polar neutrosophic sets (MPNSs). Furthermore, we present three algorithms for multi-criteria decision-making (MCDM) in medical diagnosis and clustering analysis under uncertainty by using *m*-polar neutrosophic sets (MPNSs) and *m*-polar neutrosophic topology. Lastly, we present advantages, validity, flexibility, and comparison of our proposed algorithms with the existing techniques.

Keywords *m*-Polar neutrosophic set · Score functions for MPNNs · *m*-Polar neutrosophic topological space · Similarity measures for MPNSs · Multi-criteria decision-making for medical diagnosis · Multi-criteria decision-making for clustering analysis

1 Introduction and Background

Multi-criteria decision-making (MCDM) is a process that explicitly evaluates best alternative(s) among the feasible options. In archaic times, decisions were framed without handling the uncertainties in the data, which may lead to inadequate results to the real-life operational situations. If we amass the data and deduce the result without handling hesitations, then given results will be ambivalent, indefinite, or equivocal. MCDM is an integral part in modern management, business, medical diagnosis, and many other real-world problems. Essentially, rational or sound decision is necessary for a decision-maker. Every decision-maker takes hundreds of decisions subconsciously or consciously making it as the central part of his execution. Medical diagnosis with MCDM provides solutions for the doctors to determine symptoms of disease and kind of illness. MCDM is used in solving problems that contain complex and multiple criteria. In MCDM, we have to identify the problem by determining the possible alternatives, evaluate each alternative based upon the criteria given by the decision-maker or group of decision-makers and lastly select the best alternative. MCDM problems under fuzzy environment were first introduced by Bellman and Zadeh in (1970) [4]. A number of useful mathematical tools such as fuzzy sets, *m*-polar fuzzy sets, neutrosophic sets, and soft sets have been developed to deal with uncertainties and ambiguities for multi-criteria decision-making problems.

Zadeh introduced fuzzy set [48] as a significant mathematical model to characterize and assembling of the objects whose boundary is ambiguous. A fuzzy set \mathfrak{F} in the reference set \mathcal{Q} is represented by a mapping $\sigma : \mathcal{Q} \rightarrow [0, 1]$. In real-life problems, we face various situations including uncertainties and ambiguities. For instance, if we speak about the “beautiful cities of a country” then the exact decision is ambiguous. Some cities are very beautiful, some of them are medium beautiful, and some are less beautiful. The criteria of being “beautiful” can be changed according to the decision-maker’s choice. In these situations, the classical set theory fails and we use fuzzy set theory to treat these type of hesitations in the decision-making problems. We use linguistic terms to relate a real-world situation to the fuzzy numeric value and accumulate the input in the form of fuzzy numbers or fuzzy sets.

After Zadeh, many extensions of fuzzy sets have been presented and investigated such as, intuitionistic fuzzy sets (IFSs) [3], single valued neutrosophic sets (SVNSs) [28–30, 35], picture fuzzy sets [8], bipolar fuzzy sets (BPFs) [50–52], m -polar fuzzy sets (MPFSs) [5], interval-valued fuzzy sets (IVFSs) [49], and Pythagorean fuzzy sets (PFSs) [42–44]. A neutrosophic set \mathfrak{N} is defined by $\mathfrak{N} = \{ \langle \zeta, \mathfrak{M}(\zeta), \mathfrak{S}(\zeta), \mathfrak{Y}(\zeta) \rangle, \zeta \in \mathcal{Q} \}$, where $\mathfrak{M}, \mathfrak{S}, \mathfrak{Y} : \mathcal{Q} \rightarrow]0, 1[$ and $-0 \leq \mathfrak{M}(\zeta) + \mathfrak{S}(\zeta) + \mathfrak{Y}(\zeta) \leq 3+$. The neutrosophic set yields the value from real standard or non-standard subsets of $]0, 1[$. It is difficult to utilize these values in daily life science and technology problems. Consequently, the neutrosophic set which takes the value from the subset of $[0, 1]$ is to be regarded here. An abstraction of bipolar fuzzy set was inaugurated by Chen [5] named as MPFS. An MPFS \mathfrak{C} in a non-empty universal set \mathcal{Q} is a function $\mathfrak{C} : \mathcal{Q} \rightarrow [0, 1]^m$, symbolized by $\mathfrak{C} = \{ \langle \zeta, P_i \circ \Lambda(\zeta) \rangle : \zeta \in \mathcal{Q}; i = 1, 2, 3, \dots, m \}$ where $P_i : [0, 1]^m \rightarrow [0, 1]$ is the i th projection mathematical function ($i \in m$). $\mathfrak{C}_\phi(\zeta) = (0, 0, \dots, 0)$ is the smallest value in $[0, 1]^m$, and $\mathfrak{C}_X(\zeta) = (1, 1, \dots, 1)$ is the greatest value in $[0, 1]^m$.

In the last few decades, many mathematicians worked on similarity measures, correlation coefficients, topological spaces, aggregation operators, and decision-making applications. These structures have different formulae according to the different sets and give better solutions to decision-making problems. It has numerous applications in the field of pattern recognition, medical diagnosis, artificial intelligence, social sciences, business, and multi-attribute decision-making problems.

Akram et al. [1] presented certain applications of m -polar fuzzy sets in the decision-making problems. Ali et al. [2] presented various properties of soft sets and rough sets with fuzzy soft sets. Garg [10] introduced new generalized Pythagorean fuzzy information aggregation using Einstein operations and established its application to

decision-making problems. Garg [11] introduced generalized intuitionistic fuzzy interactive geometric interaction operators using Einstein t-norm and t-conorm and their application to decision-making. Karaaslan [15] introduced neutrosophic soft sets with its applications in decision-making. Xu et al. [41] established clustering algorithm for intuitionistic fuzzy sets and presented its applications for clustering. Jose and Kuriaskose [14] investigated aggregation operators with the corresponding score function for MCDM in the context of IFNs. Mahmood et al. [19] established generalized aggregation operators for cubic hesitant fuzzy numbers (CHFNs) and use it into MCDM problems. In 1968, Chang [7] introduced fuzzy topology on fuzzy sets. After fuzzy topology, many researchers have been introduced topologies and their properties on different hybrid structures of fuzzy sets. Pao-Ming and Ying-Ming [20, 21] introduced the structure of neighborhood of fuzzy-point. They provided the concept of fuzzy quasi-coincident and Q-neighborhood. They also discussed important properties of fuzzy topological space by using fuzzy Q-neighborhood. Shabir and Naz [31] established soft topological spaces. Deli et al. [9] introduced bipolar neutrosophic sets and their application based on multi-criteria decision-making problems. Riaz and Hashmi [23–25] developed fixed point theorems of fuzzy neutrosophic soft (FNS) mapping with its decision-making. They established multi-attribute group decision-making (MAGDM) for agribusiness by using various cubic m -polar fuzzy averaging aggregation operators. They introduced a novel structure of linear Diophantine fuzzy set as a generalization of intuitionistic fuzzy set, Pythagorean fuzzy set, and q -rung orthopair fuzzy set with its applications in multi-attribute decision-making problems. Riaz et al. [26, 27] introduced N-soft topology and its applications to multi-criteria group decision-making (MCGDM). They established cubic bipolar fuzzy ordered weighted geometric aggregation operators and presented their applications by using internal and external bipolar fuzzy information.

Feng et al. [12, 13] introduced properties of soft sets combined with fuzzy soft sets and multi-attribute decision-making (MADM) models in the environment of generalized intuitionistic fuzzy soft sets and fuzzy soft sets. Liu et al. [16] established hesitant intuitionistic fuzzy linguistic operators and presented its MAGDM problems. Wei et al. [36] invented hesitant triangular fuzzy operators in MADM problems. Wei et al. [37, 38] worked on similarity measures on picture fuzzy sets and correlation coefficient to the interval-valued intuitionistic fuzzy sets with application in decision-making problems. Ye [45–47] introduced prioritized aggregation operators in the context of interval-valued hesitant fuzzy numbers (IVHFNs) and established it on MAGDM algorithms. He also established MCDM methods for interval neutrosophic sets and correlation coefficient

under single-value neutrosophic environment. He established cosine similarity measures for intuitionistic fuzzy sets with application in decision-making problems. Zhang et al. [53] introduced aggregation operators with MCDM by using interval-valued fuzzy neutrosophic sets (IVFNSs). An extended TOPSIS method for decision-making was developed by Chi and Lui [6] on IVFNSs. Zhao et al. [55] introduced generalized aggregation operators in the context of intuitionistic fuzzy sets. Zhang et al. [54] established various results on clustering approach to intuitionistic fuzzy sets. Peng et al. [22] introduced Pythagorean fuzzy information measures and established interesting results on Pythagorean fuzzy sets. They introduced clustering algorithm for Pythagorean fuzzy sets and presented numerous applications on Pythagorean fuzzy input data. Li and Cheng [17] established new similarity measures of IFSs and its applications to pattern recognition. Lin et al. [18] studied hesitant fuzzy linguistic information and presented its application to models of selecting an ERP system. Salton and McGill [32] introduced modern information retrieval. Singh [33] established correlation coefficients of picture fuzzy sets. Son [34] inaugurated a novel distributed picture fuzzy clustering method on picture fuzzy sets. Xu and Chen [39, 40] established correlation, distance, and similarity measures on intuitionistic fuzzy sets.

In this era, experts think that the universe is moving towards multi-polarity. Therefore, it comes as no surprise that multi-polarity in data and information plays a vital role in various fields of science and technology. In neurobiology, multi-polar neurons in brain gather a great deal of information from other neurons. In information technology, multi-polar technology can be exploited to operate large-scale systems. In some real-life situations, we have to deal with the dissatisfaction and indeterminacy grades for the alternatives of the reference set. For instance, in the operation of throwing up a ballot, there exist some people who vote in favor, some of them vote against, and some abstain. In the area of electrical engineering, we deal with the conductors and non-conductors, but there also exist some substances which are insulators. These types of situations can easily handled by using neutrosophic set theory. In some real-life applications, we have to deal with multi-polarity, truth values, indeterminacy, and falsity grades of alternatives. To deal with these type of hesitations and uncertainties, we establish the idea of m -polar neutrosophic set (MPNS).

The motivation and objectives of this extended and hybrid work are given step by step in the whole manuscript. We establish that other hybrid structures of fuzzy sets become special cases of MPNS under some suitable conditions. We discuss about the robustness, flexibility, simplicity, and superiority of our suggested model and algorithms. This model is most generalized form and use to collect data at a

large scale and applicable in medical, engineering, artificial intelligence, agriculture, and other daily life problems. In future, this work can be gone easily for other approaches and different types of hybrid structures.

The scheme of this manuscript is organized as follows. Section 2, implies a novel idea of m -polar neutrosophic set (MPNS). We establish some of its operations, score function, and improved score function. In Sect. 3, we use MPNS to establish m -polar neutrosophic topological space (MPNTS). We define various topological structures such as interior, closure, exterior, and frontier for MPNSs with the help of illustrations. We establish various results with their counter examples, which holds for classical set theory, but do not hold for m -polar neutrosophic set theory. We introduce cosine similarity measure and set theoretic similarity measure for MPNSs. In Sect. 4, we establish some methods for the solution of MCDM problems based on medical diagnosis and clustering analysis using MPNTS and MPNSs. We propose three algorithms with linguistic information based on m -polar neutrosophic data using MPNTS, similarity measures, and clustering analysis. It is interesting to note that first two algorithms for medical diagnosis yield the same result. Furthermore, we present advantages, simplicity, flexibility, and validity of the proposed algorithms. We give a brief discussion and comparative analysis of our proposed approach with some existing methodologies. In the end, the conclusion of this work is summarized in Sect. 5.

2 m -Polar Neutrosophic Set (MPNS)

Chen et al. [5] have proposed the concept of m -polar fuzzy set (MPFS) in 2014, which have the capability to deal with the data having vagueness and uncertainty under multi-criteria, multi-source, multi-sensor, and multi-polar information. Smarandache [30] extended the neutrosophic set, respectively, to neutrosophic overset (when some neutrosophic component is > 1), neutrosophic underset (when some neutrosophic component is < 0), and to neutrosophic offset (when some neutrosophic components are off the interval $[0, 1]$, i.e., some neutrosophic component > 1 and other neutrosophic component < 0). In 2016, Smarandache introduced the neutrosophic tripolar set and neutrosophic multi-polar set, also the neutrosophic tripolar graph and neutrosophic multi-polar graph [30].

The membership grades of m -polar fuzzy sets range over the interval $[0, 1]^m$, which represent m criteria of the object, but it cannot deal with the falsity and indeterminacy part of the object.

Neutrosophic set (NS) deals with truth, falsity, and indeterminacy for one criteria of the alternative, but cannot

deal with the multi-criteria, multi-source, multi-polar information fusion of the alternatives. To overcome this problem, we introduce a new model of m -polar neutrosophic set (MPNS) by combining the concepts of m -polar fuzzy set (MPFS) and neutrosophic set (NS). MPNS has the ability to deal with the m criteria and to deal with the truth, falsity, and indeterminacy grades for each alternative. In fact, m -polar neutrosophic set is an extension of bipolar neutrosophic set introduced by Deli et al. [9]. We establish various properties and operations on m -polar neutrosophic sets. We propose score functions for the comparison of m -polar neutrosophic numbers (MPNNs). In the whole manuscript, we use \mathcal{Q} as a fixed sample space and Δ as an indexing set. We use $\mathfrak{A}, \mathfrak{S}$ and \mathfrak{Y} as membership, indeterminacy, and non-membership grades, respectively.

Definition 2.1 An object $\mathcal{M}_{\mathfrak{R}}$ in the reference set \mathcal{Q} is called m -polar neutrosophic set (MPNS), if it can be expressed as

$$\mathcal{M}_{\mathfrak{R}} = \{(\zeta, \langle \mathfrak{A}_\alpha(\zeta), \mathfrak{S}_\alpha(\zeta), \mathfrak{Y}_\alpha(\zeta) \rangle) : \zeta \in \mathcal{Q}, \alpha = 1, 2, 3, \dots, m\}$$

where $\mathfrak{A}_\alpha, \mathfrak{S}_\alpha, \mathfrak{Y}_\alpha : \mathcal{Q} \rightarrow [0, 1]$ and $0 \leq \mathfrak{A}_\alpha(\zeta) + \mathfrak{S}_\alpha(\zeta) + \mathfrak{Y}_\alpha(\zeta) \leq 3; \alpha = 1, 2, 3, \dots, m$. This condition shows that all the three grades $\mathfrak{A}_\alpha, \mathfrak{S}_\alpha$ and $\mathfrak{Y}_\alpha; (\alpha = 1, 2, 3, \dots, m)$ are independent and represents the truth, indeterminacy, and falsity of the considered object or alternative for multiple criteria, respectively. Simply an m -polar neutrosophic number (MPNN) can be represented as $\mathfrak{T} = (\langle \mathfrak{A}_\alpha, \mathfrak{S}_\alpha, \mathfrak{Y}_\alpha \rangle)$, where $0 \leq \mathfrak{A}_\alpha + \mathfrak{S}_\alpha + \mathfrak{Y}_\alpha \leq 3; \alpha = 1, 2, 3, \dots, m$. In tabular form, the MPNS can be represented as Table 1.

Example 2.2 Let $\mathcal{Q} = \{\zeta_1, \zeta_2, \zeta_3\}$ be the collection of some well-known smart phones. Then 4-polar neutrosophic set in \mathcal{Q} can be written as

$$\begin{aligned} \mathcal{M}_{\mathfrak{R}} = \{ & (\zeta_1, \langle 0.512, 0.231, 0.321 \rangle, \langle 0.653, 0.223, 0.116 \rangle, \\ & \langle 0.875, 0.114, 0.243 \rangle, \langle 0.961, 0.115, 0.431 \rangle), \\ & (\zeta_2, \langle 0.657, 0.114, 0.226 \rangle, \langle 0.765, 0.224, 0.245 \rangle, \\ & \langle 0.875, 0.465, 0.213 \rangle, \langle 0.961, 0.141, 0.212 \rangle), \\ & (\zeta_3, \langle 0.876, 0.221, 0.321 \rangle, \langle 0.657, 0.115, 0.116 \rangle, \\ & \langle 0.987, 0.114, 0.322 \rangle, \langle 0.675, 0.221, 0.423 \rangle) \}. \end{aligned}$$

In this set, multi-polarity ($m = 1,2,3,4$) of each alternative ζ shows its characteristic or qualities according to the considered criteria such as

$$\begin{aligned} \alpha_1 &= \text{affordable}, \alpha_2 = \text{longlastingbattery}, \\ \alpha_3 &= \text{extrastorage}, \alpha_4 = \text{goodcameraquality}. \end{aligned}$$

For each ζ and each of its criteria, we have neutrosophic values to represent the truth, indeterminacy, and falsity of corresponding alternative according to the considered criteria under the influence of expert's opinion. In the set $\mathcal{M}_{\mathfrak{R}}$ for ζ_1 the first triplet $\langle 0.512, 0.231, 0.321 \rangle$ shows that the smart phone ζ_1 has 51.2% truth value, 23.1% indeterminacy, and 32.1% falsity value for the criteria "affordable." Similarly, we can see the values for all alternatives corresponding to the other criteria.

There is a relationship between MPNS and other hybrid structures of fuzzy set. This relationship can be elaborated in the given flow chart diagram of Fig. 1, where $\alpha = 1, 2, 3, \dots, m$.

Definition 2.3 An MPNS $\mathcal{M}_{\mathfrak{R}}$ is said to be an empty MPNS, if $\mathfrak{A}_\alpha(\zeta) = 0, \mathfrak{S}_\alpha(\zeta) = 1$ and $\mathfrak{Y}_\alpha(\zeta) = 1, \forall \alpha = 1, 2, 3, \dots, m$ and it can be written as

$${}^0\mathcal{M}_{\mathfrak{R}} = \{\zeta, (\langle 0, 1, 1 \rangle, \langle 0, 1, 1 \rangle, \dots, \langle 0, 1, 1 \rangle) : \zeta \in \mathcal{Q}\}$$

and for absolute MPNS we have $\mathfrak{A}_\alpha(\zeta) = 1, \mathfrak{S}_\alpha(\zeta) = 0$ and $\mathfrak{Y}_\alpha(\zeta) = 0, \forall \alpha = 1, 2, 3, \dots, m$ and it can be written as

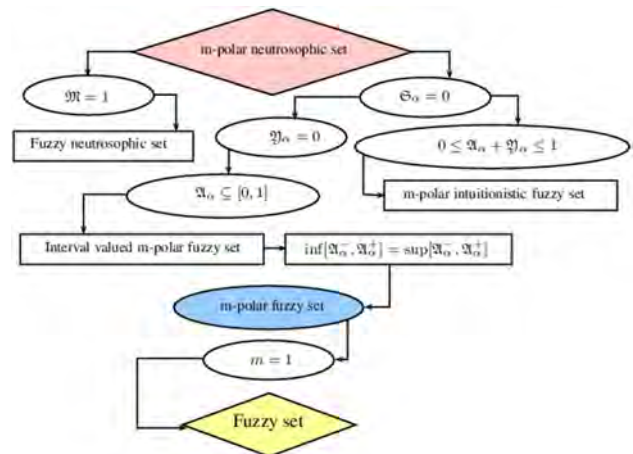

Fig. 1 Relationship between MPNS and other hybrid fuzzy sets

Table 1 Tabular representation of m -polar neutrosophic set

$\mathcal{M}_{\mathfrak{R}}$	MPNS
ζ_1	$(\langle \mathfrak{A}_1(\zeta_1), \mathfrak{S}_1(\zeta_1), \mathfrak{Y}_1(\zeta_1) \rangle, \langle \mathfrak{A}_2(\zeta_1), \mathfrak{S}_2(\zeta_1), \mathfrak{Y}_2(\zeta_1) \rangle, \dots, \langle \mathfrak{A}_m(\zeta_1), \mathfrak{S}_m(\zeta_1), \mathfrak{Y}_m(\zeta_1) \rangle)$
ζ_2	$(\langle \mathfrak{A}_1(\zeta_2), \mathfrak{S}_1(\zeta_2), \mathfrak{Y}_1(\zeta_2) \rangle, \langle \mathfrak{A}_2(\zeta_2), \mathfrak{S}_2(\zeta_2), \mathfrak{Y}_2(\zeta_2) \rangle, \dots, \langle \mathfrak{A}_m(\zeta_2), \mathfrak{S}_m(\zeta_2), \mathfrak{Y}_m(\zeta_2) \rangle)$
...
$\zeta_{\mathfrak{R}}$	$(\langle \mathfrak{A}_1(\zeta_{\mathfrak{R}}), \mathfrak{S}_1(\zeta_{\mathfrak{R}}), \mathfrak{Y}_1(\zeta_{\mathfrak{R}}) \rangle, \langle \mathfrak{A}_2(\zeta_{\mathfrak{R}}), \mathfrak{S}_2(\zeta_{\mathfrak{R}}), \mathfrak{Y}_2(\zeta_{\mathfrak{R}}) \rangle, \dots, \langle \mathfrak{A}_m(\zeta_{\mathfrak{R}}), \mathfrak{S}_m(\zeta_{\mathfrak{R}}), \mathfrak{Y}_m(\zeta_{\mathfrak{R}}) \rangle)$

$${}^1\mathcal{M}_{\mathfrak{N}} = \{\langle \varsigma, \langle (1, 0, 0), (1, 0, 0), \dots, (1, 0, 0) \rangle : \varsigma \in \mathcal{Q} \}$$

The assembling of all MPNSs in \mathcal{Q} is represented as $\text{mpn}(\mathcal{Q})$.

Now we define some operations for MPNSs.

Definition 2.4 Let $\mathcal{M}_{\mathfrak{N}_1}, \mathcal{M}_{\mathfrak{N}_\rho} \in \text{mpn}(\mathcal{Q})$, where

$$\begin{aligned} \mathcal{M}_{\mathfrak{N}_1} &= \{ \langle \varsigma, \langle \mathfrak{A}_\alpha(\varsigma), \mathfrak{C}_\alpha(\varsigma), \mathfrak{Y}_\alpha(\varsigma) \rangle : \varsigma \in \mathcal{Q}, \alpha = 1, 2, 3, \dots, m \} \\ \mathcal{M}_{\mathfrak{N}_\rho} &= \{ \langle \varsigma, \langle {}^\rho\mathfrak{A}_\alpha(\varsigma), {}^\rho\mathfrak{C}_\alpha(\varsigma), {}^\rho\mathfrak{Y}_\alpha(\varsigma) \rangle : \varsigma \in \mathcal{Q}, \alpha = 1, 2, 3, \dots, m \}, \rho \in \Delta \end{aligned}$$

then:

- (i) $\mathcal{M}_{\mathfrak{N}_1}^c = \{ \langle \varsigma, \langle \mathfrak{Y}_\alpha(\varsigma), 1 - \mathfrak{C}_\alpha(\varsigma), \mathfrak{A}_\alpha(\varsigma) \rangle : \varsigma \in \mathcal{Q}, \alpha = 1, 2, 3, \dots, m \}$
- (ii) $\mathcal{M}_{\mathfrak{N}_1} \oplus \mathcal{M}_{\mathfrak{N}_2} \Leftrightarrow \langle {}^1\mathfrak{A}_\alpha(\varsigma), {}^1\mathfrak{C}_\alpha(\varsigma), {}^1\mathfrak{Y}_\alpha(\varsigma) \rangle = \langle {}^2\mathfrak{A}_\alpha(\varsigma), {}^2\mathfrak{C}_\alpha(\varsigma), {}^2\mathfrak{Y}_\alpha(\varsigma) \rangle; \varsigma \in \mathcal{Q}, \alpha = 1, 2, 3, \dots, m$
- (iii) $\mathcal{M}_{\mathfrak{N}_1} \subseteq \mathcal{M}_{\mathfrak{N}_2} \Leftrightarrow {}^1\mathfrak{A}_\alpha(\varsigma) \leq {}^2\mathfrak{A}_\alpha(\varsigma), {}^1\mathfrak{C}_\alpha(\varsigma) \geq {}^2\mathfrak{C}_\alpha(\varsigma), {}^1\mathfrak{Y}_\alpha(\varsigma) \geq {}^2\mathfrak{Y}_\alpha(\varsigma); \varsigma \in \mathcal{Q}, \alpha = 1, 2, 3, \dots, m$
- (iv) $\bigcup_{\rho} \mathcal{M}_{\mathfrak{N}_\rho} = \{ \langle \varsigma, \langle \sup_{\rho} {}^\rho\mathfrak{A}_\alpha(\varsigma), \inf_{\rho} {}^\rho\mathfrak{C}_\alpha(\varsigma), \inf_{\rho} {}^\rho\mathfrak{Y}_\alpha(\varsigma) \rangle : \varsigma \in \mathcal{Q}, \rho \in \Delta, \alpha = 1, 2, 3, \dots, m \}$
- (v) $\bigcap_{\rho} \mathcal{M}_{\mathfrak{N}_\rho} = \{ \langle \varsigma, \langle \inf_{\rho} {}^\rho\mathfrak{A}_\alpha(\varsigma), \sup_{\rho} {}^\rho\mathfrak{C}_\alpha(\varsigma), \sup_{\rho} {}^\rho\mathfrak{Y}_\alpha(\varsigma) \rangle : \varsigma \in \mathcal{Q}, \rho \in \Delta, \alpha = 1, 2, 3, \dots, m \}$

Example 2.5 Consider two 4-polar neutrosophic sets $\mathcal{M}_{\mathfrak{N}_1}$ and $\mathcal{M}_{\mathfrak{N}_2}$ given in tabular form as Table 2.

Now we calculate complement, union, and intersection by using Definition 2.4 and results can be seen in tabular form as Table 3.

In order to deal with multi-criteria decision-making problems with m -polar neutrosophic numbers (MPNNs), we define some score functions for the ranking of MPNNs.

Definition 2.6 Let $\mathfrak{N} = \langle \langle \mathfrak{A}_\alpha, \mathfrak{C}_\alpha, \mathfrak{Y}_\alpha \rangle; \alpha = 1, 2, 3, \dots, m \rangle$ be an MPNN, then its score functions are given as:

$$\begin{aligned} \mathfrak{F}_1(\mathfrak{N}) &= \frac{1}{2m} \left(m + \sum_{\alpha=1}^m (\mathfrak{A}_\alpha - 2\mathfrak{C}_\alpha - \mathfrak{Y}_\alpha) \right); \mathfrak{F}_1(\mathfrak{N}) \in [0, 1] \\ \mathfrak{F}_2(\mathfrak{N}) &= \frac{1}{m} \sum_{\alpha=1}^m (\mathfrak{A}_\alpha - 2\mathfrak{C}_\alpha - \mathfrak{Y}_\alpha); \mathfrak{F}_2(\mathfrak{N}) \in [-1, 1] \end{aligned}$$

Table 2 4-polar neutrosophic sets $\mathcal{M}_{\mathfrak{N}_1}$ and $\mathcal{M}_{\mathfrak{N}_2}$

\mathcal{Q}	4PNSs
$\mathcal{M}_{\mathfrak{N}_1}$	$\langle (0.611, 0.111, 0.251), (0.821, 0.631, 0.111), (0.721, 0.381, 0.591), (0.211, 0.321, 0.411) \rangle$
$\mathcal{M}_{\mathfrak{N}_2}$	$\langle (0.321, 0.621, 0.511), (0.831, 0.111, 0.921), (0.521, 0.431, 0.391), (0.181, 0.931, 0.821) \rangle$

Table 3 Complement, union, and intersection of 4-polar neutrosophic sets

\mathcal{Q}	4PNSs
$\mathcal{M}_{\mathfrak{N}_1}^c$	$\langle (0.251, 0.889, 0.611), (0.111, 0.369, 0.821), (0.591, 0.619, 0.721), (0.411, 0.679, 0.211) \rangle$
$\mathcal{M}_{\mathfrak{N}_1} \cup \mathcal{M}_{\mathfrak{N}_2}$	$\langle (0.611, 0.111, 0.251), (0.831, 0.111, 0.111), (0.721, 0.381, 0.391), (0.211, 0.321, 0.411) \rangle$
$\mathcal{M}_{\mathfrak{N}_1} \cap \mathcal{M}_{\mathfrak{N}_2}$	$\langle (0.321, 0.621, 0.511), (0.821, 0.631, 0.921), (0.521, 0.431, 0.591), (0.181, 0.931, 0.821) \rangle$

In the case, when score value of two MPNNs is same, we define an improved score function for the ranking of MPNNs given as

$$\begin{aligned} \mathfrak{F}_3(\mathfrak{N}) &= \frac{1}{2m} \left(m + \sum_{\alpha=1}^m ((\mathfrak{A}_\alpha - 2\mathfrak{C}_\alpha - \mathfrak{Y}_\alpha)(2 - \mathfrak{A}_\alpha - \mathfrak{Y}_\alpha)) \right); \\ \mathfrak{F}_3(\mathfrak{N}) &\in [-1, 1]. \end{aligned}$$

In the case, when $\mathfrak{A}_\alpha + \mathfrak{Y}_\alpha = 1; \forall \alpha = 1, 2, \dots, m$, then $\mathfrak{F}_3(\mathfrak{N})$ reduces to $\mathfrak{F}_1(\mathfrak{N})$.

Definition 2.7 Let \mathfrak{N}_1 and \mathfrak{N}_2 be two MPNNs, then the following order relation between the score values of MPNNs hold:

- (a) If $\mathfrak{F}_1(\mathfrak{N}_1) > \mathfrak{F}_1(\mathfrak{N}_2)$ then $\mathfrak{N}_1 \succ \mathfrak{N}_2$.
- (b) If $\mathfrak{F}_1(\mathfrak{N}_1) = \mathfrak{F}_1(\mathfrak{N}_2)$ then
 - (1) If $\mathfrak{F}_2(\mathfrak{N}_1) > \mathfrak{F}_2(\mathfrak{N}_2)$ then $\mathfrak{N}_1 \succ \mathfrak{N}_2$.
 - (2) If $\mathfrak{F}_2(\mathfrak{N}_1) = \mathfrak{F}_2(\mathfrak{N}_2)$ then
 - (i) If $\mathfrak{F}_3(\mathfrak{N}_1) > \mathfrak{F}_3(\mathfrak{N}_2)$ then $\mathfrak{N}_1 \succ \mathfrak{N}_2$.
 - (ii) If $\mathfrak{F}_3(\mathfrak{N}_1) < \mathfrak{F}_3(\mathfrak{N}_2)$ then $\mathfrak{N}_1 \prec \mathfrak{N}_2$.
 - (iii) If $\mathfrak{F}_3(\mathfrak{N}_1) = \mathfrak{F}_3(\mathfrak{N}_2)$ then $\mathfrak{N}_1 \sim \mathfrak{N}_2$.

Example 2.8 Consider two 2-polar neutrosophic numbers \mathfrak{N}_1 and \mathfrak{N}_2 given in tabular form as Table 4.

Then by using Definition 2.6 $\mathfrak{F}_1(\mathfrak{N}_1) = \frac{1}{2(2)} [2 + 0.5 - 2(0.3) - 0.4 + 0.5 - 2(0.1) - 0.8] = 0.25$. Similarly, $\mathfrak{F}_1(\mathfrak{N}_2) = 0.25$. This shows that \mathfrak{F}_1 fails to give the ranking between both 2PNNs. Now we will use second score function \mathfrak{F}_2 . By using Definition 2.6, we obtain the score values $\mathfrak{F}_2(\mathfrak{N}_1) = -0.5 = \mathfrak{F}_2(\mathfrak{N}_2)$. This shows that \mathfrak{F}_2 also fails to evaluate the ranking. Now we will use improved score function for the ranking of 2PNNs. After calcula-

Table 4 2-polar neutrosophic numbers \mathfrak{N}_1 and \mathfrak{N}_2

\mathcal{Q}	2PNNs
\mathfrak{N}_1	$\langle (0.5, 0.3, 0.4), (0.5, 0.1, 0.8) \rangle$
\mathfrak{N}_2	$\langle (0.2, 0.3, 0.1), (0.2, 0.1, 0.5) \rangle$

tions, we get $\mathfrak{L}_3(\mathfrak{I}_1) = 0.275$ and $\mathfrak{L}_3(\mathfrak{I}_2) = 0.125$. Hence $\mathfrak{L}_3(\mathfrak{I}_1) \succ \mathfrak{L}_3(\mathfrak{I}_2)$, so $\mathfrak{I}_1 \succ \mathfrak{I}_2$.

Remark

- For null MPNN ${}^0\mathfrak{I}$ we have $\mathfrak{L}_3({}^0\mathfrak{I}) = -1$.
- For absolute MPNN ${}^1\mathfrak{I}$ we have $\mathfrak{L}_3({}^1\mathfrak{I}) = 1$.

Proposition 2.9 *Let $\mathcal{M}_{\mathfrak{R}} \in \text{mpn}(\mathcal{Q})$, and ${}^0\mathcal{M}_{\mathfrak{R}}$ and ${}^1\mathcal{M}_{\mathfrak{R}}$ be null and absolute MPNSs. Then the following axioms hold:*

- (i) $\mathcal{M}_{\mathfrak{R}} \subseteq \mathcal{M}_{\mathfrak{R}} \cup \mathcal{M}_{\mathfrak{R}}$,
- (ii) $\mathcal{M}_{\mathfrak{R}} \cap \mathcal{M}_{\mathfrak{R}} \subseteq \mathcal{M}_{\mathfrak{R}}$,
- (iii) $\mathcal{M}_{\mathfrak{R}} \cup {}^0\mathcal{M}_{\mathfrak{R}} = \mathcal{M}_{\mathfrak{R}}$,
- (iv) $\mathcal{M}_{\mathfrak{R}} \cap {}^0\mathcal{M}_{\mathfrak{R}} = {}^0\mathcal{M}_{\mathfrak{R}}$,
- (v) $\mathcal{M}_{\mathfrak{R}} \cup {}^1\mathcal{M}_{\mathfrak{R}} = {}^1\mathcal{M}_{\mathfrak{R}}$,
- (vi) $\mathcal{M}_{\mathfrak{R}} \cap {}^1\mathcal{M}_{\mathfrak{R}} = \mathcal{M}_{\mathfrak{R}}$

Proof The proof is obvious and can be proved by Definition 2.4. □

Proposition 2.10 *Let $\mathcal{M}_{\mathfrak{R}_1}, \mathcal{M}_{\mathfrak{R}_2}, \mathcal{M}_{\mathfrak{R}_3} \in \text{mpn}(\mathcal{Q})$, then the following results hold:*

- (i) $\mathcal{M}_{\mathfrak{R}_1} \cup \mathcal{M}_{\mathfrak{R}_2} = \mathcal{M}_{\mathfrak{R}_2} \cup \mathcal{M}_{\mathfrak{R}_1}$,
- (ii) $\mathcal{M}_{\mathfrak{R}_1} \cap \mathcal{M}_{\mathfrak{R}_2} = \mathcal{M}_{\mathfrak{R}_2} \cap \mathcal{M}_{\mathfrak{R}_1}$,
- (iii) $\mathcal{M}_{\mathfrak{R}_1} \cup (\mathcal{M}_{\mathfrak{R}_2} \cup \mathcal{M}_{\mathfrak{R}_3}) = (\mathcal{M}_{\mathfrak{R}_1} \cup \mathcal{M}_{\mathfrak{R}_2}) \cup \mathcal{M}_{\mathfrak{R}_3}$,
- (iv) $\mathcal{M}_{\mathfrak{R}_1} \cap (\mathcal{M}_{\mathfrak{R}_2} \cap \mathcal{M}_{\mathfrak{R}_3}) = (\mathcal{M}_{\mathfrak{R}_1} \cap \mathcal{M}_{\mathfrak{R}_2}) \cap \mathcal{M}_{\mathfrak{R}_3}$,
- (v) $(\mathcal{M}_{\mathfrak{R}_1} \cup \mathcal{M}_{\mathfrak{R}_2})^c = \mathcal{M}_{\mathfrak{R}_1}^c \cap \mathcal{M}_{\mathfrak{R}_2}^c$,
- (vi) $(\mathcal{M}_{\mathfrak{R}_1} \cap \mathcal{M}_{\mathfrak{R}_2})^c = \mathcal{M}_{\mathfrak{R}_1}^c \cup \mathcal{M}_{\mathfrak{R}_2}^c$

Proof The proof is obvious and can be proved by Definition 2.4. □

3 m-Polar Neutrosophic Topology

In this section, we introduce the m -polar neutrosophic topology on m -polar neutrosophic set and discuss interior, closure, exterior, and frontier of MPNSs with the help of illustrations. We introduce various results which hold for classical set theory, but do not hold for MPN data. We present a cosine similarity measure and set theoretic similarity measure to find the similarity between MPNSs.

3.1 m-Polar Neutrosophic Topological Space

In mathematics, topology is concerned with the alternatives of a geometric object that are kept under continuous deformations, such as stretching, twisting, crumpling, and

bending, but not tearing or gluing. “A topological space is a set endowed with a structure, called a topology, which allows defining continuous deformation of subspaces and more broadly, all kinds of continuity.” The concept of topology can be defined by using sets, continuous functions, manifolds, algebra, differentiable functions, differential geometry, etc. It has numerous applications in biology, medical diagnosis, physics, computer science, robotics, game theory, and fiber art.

The question arises here that why we use m -polar neutrosophic topological space? Crisp topological space cannot deal with the uncertainties and imprecision in the decision-making problems. To handle these ambiguities, Chang [7] introduced fuzzy topological spaces in 1968. After that, many mathematicians established topological spaces on other hybrid structures of fuzzy sets. Every topological space has its own boundaries, e.g., neutrosophic topological space cannot deal with the multiple criteria or multi-polarity of alternatives. m -polar topological space cannot deal with the indeterminacy part and dissatisfaction part of alternatives in decision-making problems. To remove these restrictions, we introduce m -polar neutrosophic topological space (MPNTS) by combining the m -polar fuzzy sets and neutrosophic sets. MPNTS handle these hesitations in the input data by treating with the multi-polarity, membership, non-membership, and indeterminacy grades for the decision-making problems. The motivation of our projected model is given step by step in the whole manuscript, especially in Sect. 4.

Definition 3.1 Let \mathcal{Q} be the non-empty reference set and $\text{mpn}(\mathcal{Q})$ be the collection of all MPNSs in \mathcal{Q} . Then the collection $\mathcal{T}_{\mathcal{M}_{\mathfrak{R}}}$ containing MPNSs is called m -polar neutrosophic topology (MPNT) if it satisfies the following properties:

- (i) ${}^0\mathcal{M}_{\mathfrak{R}}, {}^1\mathcal{M}_{\mathfrak{R}} \in \mathcal{T}_{\mathcal{M}_{\mathfrak{R}}}$.
- (ii) If $(\mathcal{M}_{\mathfrak{R}})_{\varphi} \in \mathcal{T}_{\mathcal{M}_{\mathfrak{R}}}, \forall \varphi \in \Delta$, then $\bigcup_{\varphi \in \Delta} (\mathcal{M}_{\mathfrak{R}})_{\varphi} \in \mathcal{T}_{\mathcal{M}_{\mathfrak{R}}}$.
- (iii) If $\mathcal{M}_{\mathfrak{R}_1}, \mathcal{M}_{\mathfrak{R}_2} \in \mathcal{T}_{\mathcal{M}_{\mathfrak{R}}}$, then $\mathcal{M}_{\mathfrak{R}_1} \cap \mathcal{M}_{\mathfrak{R}_2} \in \mathcal{T}_{\mathcal{M}_{\mathfrak{R}}}$.

Then the pair $(\mathcal{Q}, \mathcal{T}_{\mathcal{M}_{\mathfrak{R}}})$ is called MPNTS. The members of $\mathcal{T}_{\mathcal{M}_{\mathfrak{R}}}$ are called open MPNSs and their complements are called closed MPNSs.

Theorem 3.2 *Let $(\mathcal{Q}, \mathcal{T}_{\mathcal{M}_{\mathfrak{R}}})$ be an MPNTS. Then the following conditions are satisfied:*

- (i) ${}^0\mathcal{M}_{\mathfrak{R}}$ and ${}^1\mathcal{M}_{\mathfrak{R}}$ are open MPNSs.
- (ii) Union of any number of open MPNSs is open.

(iii) Intersection of finite number of closed MPNSs is closed.

Proof The proof is obvious. □

Example 3.3 Let $\mathcal{Q} = \{\zeta_1, \zeta_2, \zeta_3, \zeta_4\}$ be an assembling of books. Then $\text{mpn}(\mathcal{Q})$ be the collection of all MPNSs in \mathcal{Q} . We consider two 3-polar neutrosophic subsets of $\text{mpn}(\mathcal{Q})$ given as

$$\mathcal{M}_{\mathfrak{N}_1} = \left\{ (\zeta_1, \langle 0.871, 0.451, 0.412 \rangle, \langle 0.187, 0.213, 0.118 \rangle), (\zeta_2, \langle 0.547, 0.158, 0.413 \rangle, \langle 0.518, 0.152, 0.118 \rangle, \langle 0.618, 0.418, 0.321 \rangle), (\zeta_3, \langle 0.618, 0.341, 0.231 \rangle, \langle 0.815, 0.118, 0.527 \rangle, \langle 0.511, 0.431, 0.215 \rangle), (\zeta_4, \langle 0.518, 0.391, 0.812 \rangle, \langle 0.815, 0.321, 0.415 \rangle, \langle 0.911, 0.321, 0.512 \rangle) \right\}$$

$$\mathcal{M}_{\mathfrak{N}_2} = \left\{ (\zeta_1, \langle 0.611, 0.512, 0.611 \rangle, \langle 0.218, 0.531, 0.415 \rangle, \langle 0.035, 0.311, 0.211 \rangle), (\zeta_2, \langle 0.212, 0.218, 0.513 \rangle, \langle 0.435, 0.218, 0.315 \rangle, \langle 0.519, 0.511, 0.438 \rangle), (\zeta_3, \langle 0.418, 0.432, 0.321 \rangle, \langle 0.639, 0.218, 0.357 \rangle, \langle 0.211, 0.531, 0.316 \rangle), (\zeta_4, \langle 0.219, 0.491, 0.815 \rangle, \langle 0.716, 0.421, 0.518 \rangle, \langle 0.712, 0.421, 0.618 \rangle) \right\}$$

Then clearly the collection $\mathcal{T}_{\mathcal{M}_{\mathfrak{N}}} = \{ {}^0\mathcal{M}_{\mathfrak{N}}, {}^1\mathcal{M}_{\mathfrak{N}}, \mathcal{M}_{\mathfrak{N}_1}, \mathcal{M}_{\mathfrak{N}_2} \}$ is 3-polar neutrosophic topological space.

Definition 3.4 Let $(\mathcal{Q}, \mathcal{T}_{\mathcal{M}_{\mathfrak{N}}})$ and $(\mathcal{Q}, \mathcal{T}'_{\mathcal{M}_{\mathfrak{N}}})$ be two MPNTSs in \mathcal{Q} . Two MPNTSs are said to be comparable if $\mathcal{T}_{\mathcal{M}_{\mathfrak{N}}} \subseteq \mathcal{T}'_{\mathcal{M}_{\mathfrak{N}}}$ or $\mathcal{T}'_{\mathcal{M}_{\mathfrak{N}}} \subseteq \mathcal{T}_{\mathcal{M}_{\mathfrak{N}}}$.

If $\mathcal{T}_{\mathcal{M}_{\mathfrak{N}}} \subseteq \mathcal{T}'_{\mathcal{M}_{\mathfrak{N}}}$, then $\mathcal{T}_{\mathcal{M}_{\mathfrak{N}}}$ is courser or weaker than $\mathcal{T}'_{\mathcal{M}_{\mathfrak{N}}}$ and $\mathcal{T}'_{\mathcal{M}_{\mathfrak{N}}}$ is stronger and finer than $\mathcal{T}_{\mathcal{M}_{\mathfrak{N}}}$.

Theorem 3.5 Let $(\mathcal{Q}, \mathcal{T}_{\mathcal{M}_{\mathfrak{N}}})$ be an MPNTS. Then the following conditions are satisfied:

- (i) ${}^0\mathcal{M}_{\mathfrak{N}}$ and ${}^1\mathcal{M}_{\mathfrak{N}}$ are closed MPNSs.
- (ii) Intersection of any number of closed MPNSs is closed.
- (iii) Union of finite number of closed MPNSs is closed.

Proof

- (i) $({}^1\mathcal{M}_{\mathfrak{N}})^c = {}^0\mathcal{M}_{\mathfrak{N}}$ and $({}^0\mathcal{M}_{\mathfrak{N}})^c = {}^1\mathcal{M}_{\mathfrak{N}}$ are both open and closed MPNSs.

(ii) If $\{ \mathcal{M}_{\mathfrak{N}_\alpha} : \mathcal{M}_{\mathfrak{N}_\alpha}^c \in \mathcal{T}_{\mathcal{M}_{\mathfrak{N}}}, \alpha \in \Delta \}$ is an assembling of closed MPNSs then $(\bigcap_{\alpha \in \Delta} \mathcal{M}_{\mathfrak{N}_\alpha})^c = \bigcup_{\alpha \in \Delta} \mathcal{M}_{\mathfrak{N}_\alpha}^c$ is open.

This shows that $\bigcap_{\alpha \in \Delta} \mathcal{M}_{\mathfrak{N}_\alpha}$ is closed MPNS.

(iii) Since $\mathcal{M}_{\mathfrak{N}_\beta}$ is closed for $\beta = 1, 2, \dots, z$, then

$$(\bigcup_{\beta=1}^z \mathcal{M}_{\mathfrak{N}_\beta})^c = \bigcap_{\beta=1}^z \mathcal{M}_{\mathfrak{N}_\beta}^c$$

is open MPNS. Thus $\bigcup_{\beta=1}^z \mathcal{M}_{\mathfrak{N}_\beta}$ is closed MPNS. □

Definition 3.6 Let $(\mathcal{Q}, \mathcal{T}_{\mathcal{M}_{\mathfrak{N}}})$ be MPNTS and $\mathcal{M}_{\mathfrak{N}} \in \text{mpn}({}^1\mathcal{M}_{\mathfrak{N}})$, then interior of $\mathcal{M}_{\mathfrak{N}}$ is denoted as $\mathcal{M}_{\mathfrak{N}}^o$ and defined as the union of all open MPN subsets contained in $\mathcal{M}_{\mathfrak{N}}$. It is the greatest open MPNS contained in $\mathcal{M}_{\mathfrak{N}}$.

Example 3.7 We consider the 3-polar neutrosophic topological space constructed in Example 3.3 and let $\mathcal{M}_{\mathfrak{N}_3} \in \text{mpn}(\mathcal{Q})$ given as

$$\mathcal{M}_{\mathfrak{N}_3} = \{ (\zeta_1, \langle 0.713, 0.412, 0.311 \rangle, \langle 0.318, 0.418, 0.311 \rangle, \langle 0.451, 0.211, 0.218 \rangle), (\zeta_2, \langle 0.312, 0.117, 0.418 \rangle, \langle 0.513, 0.212, 0.218 \rangle, \langle 0.613, 0.411, 0.438 \rangle), (\zeta_3, \langle 0.518, 0.321, 0.311 \rangle, \langle 0.718, 0.118, 0.257 \rangle, \langle 0.317, 0.461, 0.217 \rangle), (\zeta_4, \langle 0.319, 0.219, 0.615 \rangle, \langle 0.719, 0.321, 0.418 \rangle, \langle 0.811, 0.321, 0.417 \rangle) \}$$

Then $\mathcal{M}_{\mathfrak{N}_3}^o = {}^o\mathcal{M}_{\mathfrak{N}_3} \cup \mathcal{M}_{\mathfrak{N}_2} = \mathcal{M}_{\mathfrak{N}_2}$ is open MPNS.

Theorem 3.8 Let $(\mathcal{Q}, \mathcal{T}_{\mathcal{M}_{\mathfrak{N}}})$ be MPNTS and $\mathcal{M}_{\mathfrak{N}} \in \text{mpn}(\mathcal{Q})$. Then $\mathcal{M}_{\mathfrak{N}}$ is open MPNS $\Leftrightarrow \mathcal{M}_{\mathfrak{N}}^o = \mathcal{M}_{\mathfrak{N}}$.

Proof If $\mathcal{M}_{\mathfrak{N}}$ is open MPNS then greatest open MPNS contained in $\mathcal{M}_{\mathfrak{N}}$ is itself $\mathcal{M}_{\mathfrak{N}}$. Thus $\mathcal{M}_{\mathfrak{N}}^o = \mathcal{M}_{\mathfrak{N}}$.

Conversely, if $\mathcal{M}_{\mathfrak{N}}^o = \mathcal{M}_{\mathfrak{N}}$ then $\mathcal{M}_{\mathfrak{N}}$ is open MPNS. This implies that $\mathcal{M}_{\mathfrak{N}}$ is open MPNS. □

Theorem 3.9 Let $(\mathcal{Q}, \mathcal{T}_{\mathcal{M}_{\mathfrak{N}}})$ be MPNTS and $\mathcal{M}_{\mathfrak{N}_1}, \mathcal{M}_{\mathfrak{N}_2} \in \text{mpn}({}^1\mathcal{M}_{\mathfrak{N}})$, then

- (i) $(\mathcal{M}_{\mathfrak{N}_1}^o)^o = \mathcal{M}_{\mathfrak{N}_1}^o$,
- (ii) $\mathcal{M}_{\mathfrak{N}_1} \subseteq \mathcal{M}_{\mathfrak{N}_2} \Rightarrow \mathcal{M}_{\mathfrak{N}_1}^o \subseteq \mathcal{M}_{\mathfrak{N}_2}^o$,
- (iii) $(\mathcal{M}_{\mathfrak{N}_1} \cap \mathcal{M}_{\mathfrak{N}_2})^o = \mathcal{M}_{\mathfrak{N}_1}^o \cap \mathcal{M}_{\mathfrak{N}_2}^o$,
- (iv) $(\mathcal{M}_{\mathfrak{N}_1} \cup \mathcal{M}_{\mathfrak{N}_2})^o \supseteq \mathcal{M}_{\mathfrak{N}_1}^o \cup \mathcal{M}_{\mathfrak{N}_2}^o$.

Proof The proof is obvious. □

Definition 3.10 Let $(\mathcal{Q}, \mathcal{T}_{\mathcal{M}_{\mathfrak{N}}})$ be MPNTS and $\mathcal{M}_{\mathfrak{N}} \in \text{mpn}(\mathcal{Q})$, then the closure of $\mathcal{M}_{\mathfrak{N}}$ is denoted by $\overline{\mathcal{M}_{\mathfrak{N}}}$ and defined by intersection of all closed-MPN supersets of $\mathcal{M}_{\mathfrak{N}}$. It is the smallest closed-MPN superset of $\mathcal{M}_{\mathfrak{N}}$.

Example 3.11 We consider the 3-polar neutrosophic topological space constructed in Example 3.3, then closed MPNSs are given as,

$$\begin{aligned} {}^o\mathcal{M}_{\mathfrak{N}}^c &= {}^1\mathcal{M}_{\mathfrak{N}}, {}^1\mathcal{M}_{\mathfrak{N}}^c = {}^o\mathcal{M}_{\mathfrak{N}}, \\ \mathcal{M}_{\mathfrak{N}_1}^c &= \{(\zeta_1, \langle 0.412, 0.549, 0.871 \rangle, \langle 0.321, 0.588, 0.317 \rangle, \\ &\quad \langle 0.118, 0.787, 0.187 \rangle), (\zeta_2, \langle 0.413, 0.842, 0.547 \rangle, \\ &\quad \langle 0.118, 0.848, 0.518 \rangle, \langle 0.321, 0.582, 0.618 \rangle), \\ &\quad (\zeta_3, \langle 0.231, 0.659, 0.618 \rangle, \langle 0.257, 0.882, 0.815 \rangle, \\ &\quad \langle 0.215, 0.569, 0.511 \rangle), (\zeta_4, \langle 0.812, 0.609, 0.518 \rangle, \\ &\quad \langle 0.415, 0.679, 0.815 \rangle, \langle 0.512, 0.679, 0.911 \rangle)\} \\ \mathcal{M}_{\mathfrak{N}_2}^c &= \{(\zeta_1, \langle 0.611, 0.488, 0.611 \rangle, \langle 0.415, 0.487, 0.218 \rangle, \\ &\quad \langle 0.211, 0.689, 0.035 \rangle), (\zeta_2, \langle 0.513, 0.782, 0.212 \rangle, \\ &\quad \langle 0.315, 0.782, 0.435 \rangle, \langle 0.438, 0.489, 0.519 \rangle), \\ &\quad (\zeta_3, \langle 0.321, 0.568, 0.418 \rangle, \langle 0.357, 0.782, 0.639 \rangle, \\ &\quad \langle 0.316, 0.469, 0.211 \rangle), (\zeta_4, \langle 0.815, 0.509, 0.219 \rangle, \\ &\quad \langle 0.518, 0.579, 0.716 \rangle, \langle 0.618, 0.579, 0.712 \rangle)\} \end{aligned}$$

Let $\mathcal{M}_{\mathfrak{N}_4} \in \text{mpn}({}^1\mathcal{M}_{\mathfrak{N}})$ given as

$$\begin{aligned} \mathcal{M}_{\mathfrak{N}_4} &= \{(\zeta_1, \langle 0.319, 0.615, 0.888 \rangle, \langle 0.217, 0.618, 0.411 \rangle, \\ &\quad \langle 0.115, 0.817, 0.345 \rangle), (\zeta_2, \langle 0.312, 0.888, 0.617 \rangle, \\ &\quad \langle 0.113, 0.878, 0.678 \rangle, \langle 0.231, 0.598, 0.765 \rangle), \\ &\quad (\zeta_3, \langle 0.112, 0.767, 0.887 \rangle, \langle 0.213, 0.889, 0.889 \rangle, \\ &\quad \langle 0.114, 0.667, 0.665 \rangle), (\zeta_4, \langle 0.319, 0.768, 0.615 \rangle, \\ &\quad \langle 0.321, 0.778, 0.898 \rangle, \langle 0.435, 0.767, 0.987 \rangle)\} \end{aligned}$$

Then $\overline{\mathcal{M}_{\mathfrak{N}_4}} = {}^1\mathcal{M}_{\mathfrak{N}} \cap \mathcal{M}_{\mathfrak{N}_1}^c \cap \mathcal{M}_{\mathfrak{N}_2}^c = \mathcal{M}_{\mathfrak{N}_1}^c$ is closed MPNS.

Theorem 3.12 Let $(\mathcal{Q}, \mathcal{T}_{\mathcal{M}_{\mathfrak{N}}})$ be MPNTS and $\mathcal{M}_{\mathfrak{N}} \in \text{mpn}(\mathcal{Q})$. $\mathcal{M}_{\mathfrak{N}}$ is closed MPNS $\Leftrightarrow \overline{\mathcal{M}_{\mathfrak{N}}} = \mathcal{M}_{\mathfrak{N}}$.

Proof The proof is obvious. □

Definition 3.13 Let $\mathcal{M}_{\mathfrak{N}}$ be an MPN-subset of $(\mathcal{Q}, \mathcal{T}_{\mathcal{M}_{\mathfrak{N}}})$, then its frontier or boundary is defined by $F_r(\mathcal{M}_{\mathfrak{N}}) = \overline{\mathcal{M}_{\mathfrak{N}}} \cap \overline{\mathcal{M}_{\mathfrak{N}}^c}$.

Definition 3.14 Let $\mathcal{M}_{\mathfrak{N}}$ be an MPN-subset of $(\mathcal{Q}, \mathcal{T}_{\mathcal{M}_{\mathfrak{N}}})$, then its exterior can be represented as $Ext(\mathcal{M}_{\mathfrak{N}})$ and defined as $Ext(\mathcal{M}_{\mathfrak{N}}) = \overline{(\mathcal{M}_{\mathfrak{N}})^c} = (\mathcal{M}_{\mathfrak{N}}^c)^o$.

Example 3.15 We consider the MPNTS constructed in Example 3.3 and consider the MPNSs $\mathcal{M}_{\mathfrak{N}_3}$ and $\mathcal{M}_{\mathfrak{N}_4}$

given in Examples 3.7 and 3.11. Then by using previous definitions we can write that

$$\begin{aligned} \mathcal{M}_{\mathfrak{N}_3}^o &= \mathcal{M}_{\mathfrak{N}_2}, \overline{\mathcal{M}_{\mathfrak{N}_3}} = {}^1\mathcal{M}_{\mathfrak{N}}, \\ F_r(\mathcal{M}_{\mathfrak{N}_3}) &= {}^1\mathcal{M}_{\mathfrak{N}}, Ext(\mathcal{M}_{\mathfrak{N}_3}) = {}^o\mathcal{M}_{\mathfrak{N}}, \\ \mathcal{M}_{\mathfrak{N}_4}^o &= {}^o\mathcal{M}_{\mathfrak{N}}, \overline{\mathcal{M}_{\mathfrak{N}_4}} = \mathcal{M}_{\mathfrak{N}_1}^c, \\ F_r(\mathcal{M}_{\mathfrak{N}_4}) &= \mathcal{M}_{\mathfrak{N}_1}^c, Ext(\mathcal{M}_{\mathfrak{N}_4}) = \mathcal{M}_{\mathfrak{N}_1}. \end{aligned}$$

Now, we present some results which do not hold in MPNTS but hold in crisp set theory due to the law of contradiction and law of excluded middle.

Remark

- (i) In MPNTS, the members of discrete topology are infinite due to the infinite subsets of an arbitrary MPNS.
- (ii) In MPNTS law of contradiction $\mathcal{M}_{\mathfrak{N}} \cap \mathcal{M}_{\mathfrak{N}}^c = {}^o\mathcal{M}_{\mathfrak{N}}$ and law of excluded middle $\mathcal{M}_{\mathfrak{N}} \cup \mathcal{M}_{\mathfrak{N}}^c = {}^1\mathcal{M}_{\mathfrak{N}}$ do not hold in general. In Example 3.15, we can observe that $\mathcal{M}_{\mathfrak{N}_3} \cap \mathcal{M}_{\mathfrak{N}_3}^c \neq {}^o\mathcal{M}_{\mathfrak{N}}$ and $\mathcal{M}_{\mathfrak{N}_3} \cup \mathcal{M}_{\mathfrak{N}_3}^c \neq {}^1\mathcal{M}_{\mathfrak{N}}$.
- (iii) In m -polar neutrosophic set theory, an assembling $\mathcal{T}_{\mathcal{M}_{\mathfrak{N}}} = \{{}^o\mathcal{M}_{\mathfrak{N}}, {}^1\mathcal{M}_{\mathfrak{N}}, \mathcal{M}_{\mathfrak{N}}, \mathcal{M}_{\mathfrak{N}}^c\}$ is not an MPNTS in general. But this result hold in classical set theory. This result can be easily seen by using Example 3.15.

Theorem 3.16 Let $\mathcal{M}_{\mathfrak{N}} \in \text{mpn}({}^1\mathcal{M}_{\mathfrak{N}})$, then

- (1) $(\mathcal{M}_{\mathfrak{N}}^o)^c = \overline{(\mathcal{M}_{\mathfrak{N}}^c)}$,
- (2) $\overline{(\mathcal{M}_{\mathfrak{N}})^c} = (\mathcal{M}_{\mathfrak{N}}^c)^o$,
- (3) $Ext(\mathcal{M}_{\mathfrak{N}}^c) = \mathcal{M}_{\mathfrak{N}}^o$,
- (4) $Ext(\mathcal{M}_{\mathfrak{N}}) = (\mathcal{M}_{\mathfrak{N}}^c)^o$,
- (5) $Ext(\mathcal{M}_{\mathfrak{N}}) \cup F_r(\mathcal{M}_{\mathfrak{N}}) \cup \mathcal{M}_{\mathfrak{N}}^o \neq {}^1\mathcal{M}_{\mathfrak{N}}$,
- (6) $F_r(\mathcal{M}_{\mathfrak{N}}) = F_r(\mathcal{M}_{\mathfrak{N}}^c)$,
- (7) $\mathcal{M}_{\mathfrak{N}}^o \cap F_r(\mathcal{M}_{\mathfrak{N}}) \neq {}^o\mathcal{M}_{\mathfrak{N}}$.

Proof

- (1) and (2): are obvious.
- (3) $Ext(\mathcal{M}_{\mathfrak{N}}^c) = \overline{(\mathcal{M}_{\mathfrak{N}}^c)^c} = \overline{\mathcal{M}_{\mathfrak{N}}}$
 $\Rightarrow Ext(\mathcal{M}_{\mathfrak{N}}^c) = [(\mathcal{M}_{\mathfrak{N}}^c)^c]^o$
 $\Rightarrow Ext(\mathcal{M}_{\mathfrak{N}}^c) = \mathcal{M}_{\mathfrak{N}}^o$.
- (4) $Ext(\mathcal{M}_{\mathfrak{N}}) = \overline{(\mathcal{M}_{\mathfrak{N}})^c}$
 $\Rightarrow Ext(\mathcal{M}_{\mathfrak{N}}) = (\mathcal{M}_{\mathfrak{N}}^c)^o$.
- (5) $Ext(\mathcal{M}_{\mathfrak{N}}) \cup F_r(\mathcal{M}_{\mathfrak{N}}) \cup \mathcal{M}_{\mathfrak{N}}^o \neq {}^1\mathcal{M}_{\mathfrak{N}}$. By Example 3.15, we can see that $\mathcal{M}_{\mathfrak{N}_3} \cup \mathcal{M}_{\mathfrak{N}_3}^o \cup {}^o\mathcal{M}_{\mathfrak{N}} \neq {}^1\mathcal{M}_{\mathfrak{N}}$.
- (6) $F_r(\mathcal{M}_{\mathfrak{N}}^c) = \overline{(\mathcal{M}_{\mathfrak{N}}^c)^c} \cap \overline{[(\mathcal{M}_{\mathfrak{N}}^c)^c]^c}$

$\Rightarrow F_r(\mathcal{M}_{\mathfrak{R}_1}^c) = \overline{(\mathcal{M}_{\mathfrak{R}_1}^c)} \cap \overline{(\mathcal{M}_{\mathfrak{R}_1})} = F_r(\mathcal{M}_{\mathfrak{R}_1})$.
 (7) $\mathcal{M}_{\mathfrak{R}_1}^o \cap F_r(\mathcal{M}_{\mathfrak{R}_1}) \neq {}^0\mathcal{M}_{\mathfrak{R}_1}$. Example 3.15 shows that $\mathcal{M}_{\mathfrak{R}_2} \cap {}^1\mathcal{M}_{\mathfrak{R}_1} \neq {}^0\mathcal{M}_{\mathfrak{R}_1}$.

□

3.2 Similarity Measures

In this part, we present two different formulae for similarity measures between MPNSs. This concept will help us in the forthcoming section of multi-criteria decision-making.

Definition 3.17 (Cosine similarity measure for MPNSs)

We define the cosine similarity measure for m -polar neutrosophic sets based on Bhattacharyas distance [32, 47]. Suppose that $\mathcal{M}_{\mathfrak{R}_1}, \mathcal{M}_{\mathfrak{R}_2} \in \text{mpn}(\mathcal{M}_{\mathfrak{R}})$, in $\mathcal{Q} = \{\zeta_1, \zeta_2, \dots, \zeta_l\}$. A cosine similarity measure between $\mathcal{M}_{\mathfrak{R}_1}$ and $\mathcal{M}_{\mathfrak{R}_2}$ is given as

$$\mathfrak{C}_{MPNS}^1(\mathcal{M}_{\mathfrak{R}_1}, \mathcal{M}_{\mathfrak{R}_2}) = \frac{\frac{1}{ml} \sum_{\eta=1}^l \sum_{z=1}^m \frac{{}^1\mathfrak{U}_z(\zeta_\eta)^2 \mathfrak{U}_z(\zeta_\eta) + {}^1\mathfrak{E}_z(\zeta_\eta)^2 \mathfrak{E}_z(\zeta_\eta) + {}^1\mathfrak{V}_z(\zeta_\eta)^2 \mathfrak{V}_z(\zeta_\eta)}{\sqrt{({}^1\mathfrak{U}_z(\zeta_\eta)^2 + {}^1\mathfrak{E}_z(\zeta_\eta)^2 + {}^1\mathfrak{V}_z(\zeta_\eta)^2) \sqrt{({}^2\mathfrak{U}_z(\zeta_\eta)^2 + {}^2\mathfrak{E}_z(\zeta_\eta)^2 + {}^2\mathfrak{V}_z(\zeta_\eta)^2)}}}{\sqrt{({}^1\mathfrak{U}_z(\zeta_\eta)^2 + {}^1\mathfrak{E}_z(\zeta_\eta)^2 + {}^1\mathfrak{V}_z(\zeta_\eta)^2) \sqrt{({}^2\mathfrak{U}_z(\zeta_\eta)^2 + {}^2\mathfrak{E}_z(\zeta_\eta)^2 + {}^2\mathfrak{V}_z(\zeta_\eta)^2}}}$$

\mathfrak{C}_{MPNS}^1 satisfies the following properties,

- (1) $0 \leq \mathfrak{C}_{MPNS}^1 \leq 1$,
- (2) $\mathfrak{C}_{MPNS}^1(\mathcal{M}_{\mathfrak{R}_1}, \mathcal{M}_{\mathfrak{R}_2}) = \mathfrak{C}_{MPNS}^1(\mathcal{M}_{\mathfrak{R}_2}, \mathcal{M}_{\mathfrak{R}_1})$,
- (3) $\mathfrak{C}_{MPNS}^1(\mathcal{M}_{\mathfrak{R}_1}, \mathcal{M}_{\mathfrak{R}_2}) = 1$ if $\mathcal{M}_{\mathfrak{R}_1} = \mathcal{M}_{\mathfrak{R}_2}$,
- (4) If $\mathcal{M}_{\mathfrak{R}_1} \subseteq \mathcal{M}_{\mathfrak{R}_2} \subseteq \mathcal{M}_{\mathfrak{R}_3}$ then $\mathfrak{C}_{MPNS}^1(\mathcal{M}_{\mathfrak{R}_1}, \mathcal{M}_{\mathfrak{R}_3}) \leq \mathfrak{C}_{MPNS}^1(\mathcal{M}_{\mathfrak{R}_1}, \mathcal{M}_{\mathfrak{R}_2})$ and $\mathfrak{C}_{MPNS}^1(\mathcal{M}_{\mathfrak{R}_1}, \mathcal{M}_{\mathfrak{R}_3}) \leq \mathfrak{C}_{MPNS}^1(\mathcal{M}_{\mathfrak{R}_2}, \mathcal{M}_{\mathfrak{R}_3})$. The proof of these properties can be easily done by using the above definition.

Definition 3.18 (Set theoretic similarity measure of MPNSs)

We define the set theoretic similarity measure for m -polar neutrosophic sets based on set theoretic viewpoint [40]. Suppose that $\mathcal{M}_{\mathfrak{R}_1}, \mathcal{M}_{\mathfrak{R}_2} \in \text{mpn}(\mathcal{M}_{\mathfrak{R}})$, in $\mathcal{Q} = \{\zeta_1, \zeta_2, \dots, \zeta_l\}$. A set theoretic similarity measure between $\mathcal{M}_{\mathfrak{R}_1}$ and $\mathcal{M}_{\mathfrak{R}_2}$ is given as

$$\mathfrak{C}_{MPNS}^2(\mathcal{M}_{\mathfrak{R}_1}, \mathcal{M}_{\mathfrak{R}_2}) = \frac{\frac{1}{ml} \sum_{\eta=1}^l \sum_{z=1}^m \frac{{}^1\mathfrak{U}_z(\zeta_\eta)^2 \mathfrak{U}_z(\zeta_\eta) + {}^1\mathfrak{E}_z(\zeta_\eta)^2 \mathfrak{E}_z(\zeta_\eta) + {}^1\mathfrak{V}_z(\zeta_\eta)^2 \mathfrak{V}_z(\zeta_\eta)}{\max\{({}^1\mathfrak{U}_z(\zeta_\eta)^2 + {}^1\mathfrak{E}_z(\zeta_\eta)^2 + {}^1\mathfrak{V}_z(\zeta_\eta)^2), ({}^2\mathfrak{U}_z(\zeta_\eta)^2 + {}^2\mathfrak{E}_z(\zeta_\eta)^2 + {}^2\mathfrak{V}_z(\zeta_\eta)^2)\}}}{\max\{({}^1\mathfrak{U}_z(\zeta_\eta)^2 + {}^1\mathfrak{E}_z(\zeta_\eta)^2 + {}^1\mathfrak{V}_z(\zeta_\eta)^2), ({}^2\mathfrak{U}_z(\zeta_\eta)^2 + {}^2\mathfrak{E}_z(\zeta_\eta)^2 + {}^2\mathfrak{V}_z(\zeta_\eta)^2)\}}$$

\mathfrak{C}_{MPNS}^2 satisfies the following properties,

- (1) $0 \leq \mathfrak{C}_{MPNS}^2 \leq 1$,
- (2) $\mathfrak{C}_{MPNS}^2(\mathcal{M}_{\mathfrak{R}_1}, \mathcal{M}_{\mathfrak{R}_2}) = \mathfrak{C}_{MPNS}^2(\mathcal{M}_{\mathfrak{R}_2}, \mathcal{M}_{\mathfrak{R}_1})$,
- (3) $\mathfrak{C}_{MPNS}^2(\mathcal{M}_{\mathfrak{R}_1}, \mathcal{M}_{\mathfrak{R}_2}) = 1$ if $\mathcal{M}_{\mathfrak{R}_1} = \mathcal{M}_{\mathfrak{R}_2}$,
- (4) If $\mathcal{M}_{\mathfrak{R}_1} \subseteq \mathcal{M}_{\mathfrak{R}_2} \subseteq \mathcal{M}_{\mathfrak{R}_3}$ then $\mathfrak{C}_{MPNS}^2(\mathcal{M}_{\mathfrak{R}_1}, \mathcal{M}_{\mathfrak{R}_3}) \leq \mathfrak{C}_{MPNS}^2(\mathcal{M}_{\mathfrak{R}_1}, \mathcal{M}_{\mathfrak{R}_2})$ and $\mathfrak{C}_{MPNS}^2(\mathcal{M}_{\mathfrak{R}_1}, \mathcal{M}_{\mathfrak{R}_3}) \leq \mathfrak{C}_{\mathfrak{R}_1 \mathfrak{R}_2 \mathfrak{R}_3 \mathfrak{E}}(\mathcal{M}_{\mathfrak{R}_1}, \mathcal{M}_{\mathfrak{R}_2})$. The proof of these properties can be easily done by using the above definition.

4 Multi-criteria Decision-Making Under m -Polar Neutrosophic Data

Multi-criteria decision-making (MCDM) is a process to find an optimal alternative that has the highest degree of satisfaction from a set of feasible alternatives characterized by multiple criteria, and these kinds of MCDM problems arise in many real-world situations. In this section, we discuss two applications of medical diagnosis and clustering analysis of students with the help of m -polar fuzzy neutrosophic data. We present three novel algorithms for multi-criteria decision-making (MCDM) with linguistic information based on the MPNTS and MPFNSs for medical diagnosis and clustering analysis.

In each algorithm, we use m -polar neutrosophic input data. Firstly, we collect input information for every algorithm in the form of linguistic variables and then convert them into m -polar neutrosophic numbers (MPNNs) by using fuzzy logics. When our data set is covered into proposed m -polar neutrosophic numeric values, then we apply each algorithm one by one. At last, we get better results for medical diagnosis and clustering analysis.

4.1 MCDM for Medical Diagnosis

In this part of our manuscript, we establish two different techniques based on MPNTS and on similarity measures to investigate the disease with m -polar neutrosophic information.

Proposed Technique of Algorithm 1

Algorithm 1 (Algorithm for m-polar neutrosophic topological space)

Input:

Step 1: Input the set \mathfrak{P} for a patient according to his doctor, corresponding to the "m" number of symptoms appearing to the patient. All the input data leads to those "p" diseases which will be possible outcome according to the appearing symptoms in the form of m-polar neutrosophic set.

Step 2: Input the sets $\mathfrak{S}_\xi; \xi = 1, 2, \dots, z$, for "p" diseases $\mathfrak{D}_\delta; \delta = 1, 2, \dots, p$, according to "z" number of experts, corresponding to the "m" number of symptoms in the form of m-polar neutrosophic sets (MPNSs).

Calculations:

Step 3: Construct m-polar neutrosophic topological space (MPNTS) $\mathcal{T}_{\mathcal{M}_{\mathfrak{M}}}$ using MPNSs $\mathfrak{S}_\xi; \xi = 1, 2, \dots, z$ given by "z" number of experts.

Step 4: Find interior \mathfrak{P}° of \mathfrak{P} by using Definition 3.6 under the constructed $\mathcal{T}_{\mathcal{M}_{\mathfrak{M}}}$. \mathfrak{P}° shows the actual condition of the patient according to the "z" number of experts and give better decision to diagnosis.

Step 5: Calculate scores of each disease corresponding to "m" number of symptoms by using Definition 2.6.

Output:

Step 6: We rank the alternative (disease) on the basis of score values according to the Definition 2.7.

Step 7: Alternative (disease) with the higher score has the maximum rank according to the given numerical example. This implies that patient is suffering from that disease.

In this algorithm, rating of each criteria according to the corresponding alternative is constructed by using *m*-polar neutrosophic information for MCDM and given in input matrix (can be taken in tabular form by using *m*-polar neutrosophic numbers) as

$$\mathfrak{P} = [\mathfrak{A}_{\eta\xi}^\alpha]_{r \times s} = [(\mathfrak{A}_{\eta\xi}^\alpha, \mathfrak{S}_{\eta\xi}^\alpha, \mathfrak{Y}_{\eta\xi}^\alpha)]_{r \times s}; \alpha = 1, 2, 3, \dots, m$$

$$\mathfrak{P} = [\mathfrak{A}_{\eta\xi}^\alpha]_{r \times s} = \begin{pmatrix} ((\mathfrak{A}_{11}^\alpha, \mathfrak{S}_{11}^\alpha, \mathfrak{Y}_{11}^\alpha)) & ((\mathfrak{A}_{12}^\alpha, \mathfrak{S}_{12}^\alpha, \mathfrak{Y}_{12}^\alpha)) & \dots & ((\mathfrak{A}_{1s}^\alpha, \mathfrak{S}_{1s}^\alpha, \mathfrak{Y}_{1s}^\alpha)) \\ ((\mathfrak{A}_{21}^\alpha, \mathfrak{S}_{21}^\alpha, \mathfrak{Y}_{21}^\alpha)) & ((\mathfrak{A}_{22}^\alpha, \mathfrak{S}_{22}^\alpha, \mathfrak{Y}_{22}^\alpha)) & \dots & ((\mathfrak{A}_{2s}^\alpha, \mathfrak{S}_{2s}^\alpha, \mathfrak{Y}_{2s}^\alpha)) \\ \vdots & \vdots & \ddots & \vdots \\ ((\mathfrak{A}_{r1}^\alpha, \mathfrak{S}_{r1}^\alpha, \mathfrak{Y}_{r1}^\alpha)) & ((\mathfrak{A}_{r2}^\alpha, \mathfrak{S}_{r2}^\alpha, \mathfrak{Y}_{r2}^\alpha)) & \dots & ((\mathfrak{A}_{rs}^\alpha, \mathfrak{S}_{rs}^\alpha, \mathfrak{Y}_{rs}^\alpha)) \end{pmatrix} \quad (1)$$

In matrix \mathfrak{P} , the entries $\mathfrak{A}_{\eta\xi}^\alpha$, $\mathfrak{S}_{\eta\xi}^\alpha$, and $\mathfrak{Y}_{\eta\xi}^\alpha$ represent truth, indeterminacy, and falsity membership grades for alternative \mathfrak{d}_η corresponding to the criteria \mathfrak{C}_ξ , where $\eta = 1, 2, 3, \dots, r; \xi = 1, 2, 3, \dots, s$. These grades satisfies the following properties under MPN environment.

- (1) $0 \leq \mathfrak{A}_{\eta\xi}^\alpha \leq 1; 0 \leq \mathfrak{S}_{\eta\xi}^\alpha \leq 1; 0 \leq \mathfrak{Y}_{\eta\xi}^\alpha \leq 1$.
- (2) $0 \leq \mathfrak{A}_{\eta\xi}^\alpha + \mathfrak{S}_{\eta\xi}^\alpha + \mathfrak{Y}_{\eta\xi}^\alpha \leq 3$, for $\eta = 1, 2, 3, \dots, r; \xi = 1, 2, 3, \dots, s; \alpha = 1, 2, 3, \dots, m$.

The rating of each criteria corresponding to the alternative for *m*-triplets is illustrated in this work. The input decision matrices $\mathfrak{A}_\xi; \xi = 1, 2, 3, \dots, z$ for *z* number of experts can be written by using *m*-polar neutrosophic data same as Equation 2. Then we construct an *m*-polar neutrosophic topological space $\mathcal{T}_{\mathcal{M}\mathcal{N}}$ by using experts data $\mathfrak{A}_\xi; \xi = 1, 2, 3, \dots, z$. Find interior \mathfrak{P}° of MPN-matrix \mathfrak{P} under the constructed $\mathcal{T}_{\mathcal{M}\mathfrak{M}}$. Then we calculate score

values of all the alternatives in \mathfrak{P}° . We rank these fuzzy values and choose alternative having maximum fuzzy value as an optimal decision. The step-wise description of this proposed technique is given as Algorithm 1.

4.1.1 Proposed Technique of Algorithm 2:

In this algorithm, rating of each criteria according to the corresponding alternative is constructed by using *m*-polar neutrosophic information for MCDM and given in input matrix (can be taken in tabular form by using *m*-polar neutrosophic numbers) as

$$\mathfrak{P} = [\mathfrak{A}_{\eta\xi}^\alpha]_{r \times s} = [(\mathfrak{A}_{\eta\xi}^\alpha, \mathfrak{S}_{\eta\xi}^\alpha, \mathfrak{Y}_{\eta\xi}^\alpha)]_{r \times s}; \alpha = 1, 2, 3, \dots, m$$

$$\mathfrak{P} = [\mathfrak{A}_{\eta\xi}^\alpha]_{r \times s} = \begin{pmatrix} ((\mathfrak{A}_{11}^\alpha, \mathfrak{S}_{11}^\alpha, \mathfrak{Y}_{11}^\alpha)) & ((\mathfrak{A}_{12}^\alpha, \mathfrak{S}_{12}^\alpha, \mathfrak{Y}_{12}^\alpha)) & \dots & ((\mathfrak{A}_{1s}^\alpha, \mathfrak{S}_{1s}^\alpha, \mathfrak{Y}_{1s}^\alpha)) \\ ((\mathfrak{A}_{21}^\alpha, \mathfrak{S}_{21}^\alpha, \mathfrak{Y}_{21}^\alpha)) & ((\mathfrak{A}_{22}^\alpha, \mathfrak{S}_{22}^\alpha, \mathfrak{Y}_{22}^\alpha)) & \dots & ((\mathfrak{A}_{2s}^\alpha, \mathfrak{S}_{2s}^\alpha, \mathfrak{Y}_{2s}^\alpha)) \\ \vdots & \vdots & \ddots & \vdots \\ ((\mathfrak{A}_{r1}^\alpha, \mathfrak{S}_{r1}^\alpha, \mathfrak{Y}_{r1}^\alpha)) & ((\mathfrak{A}_{r2}^\alpha, \mathfrak{S}_{r2}^\alpha, \mathfrak{Y}_{r2}^\alpha)) & \dots & ((\mathfrak{A}_{rs}^\alpha, \mathfrak{S}_{rs}^\alpha, \mathfrak{Y}_{rs}^\alpha)) \end{pmatrix} \quad (2)$$

In matrix \mathfrak{P} , the entries $\mathfrak{A}_{\eta\xi}^\alpha$, $\mathfrak{S}_{\eta\xi}^\alpha$, and $\mathfrak{Y}_{\eta\xi}^\alpha$ represents truth, indeterminacy, and falsity membership grades for alternative \mathfrak{d}_η corresponding to the criteria \mathfrak{C}_ξ , where $\eta = 1, 2, 3, \dots, r; \xi = 1, 2, 3, \dots, s$. These grades satisfies the following properties under MPN environment.

- (1) $0 \leq \mathfrak{A}_{\eta\xi}^\alpha \leq 1; 0 \leq \mathfrak{S}_{\eta\xi}^\alpha \leq 1; 0 \leq \mathfrak{Y}_{\eta\xi}^\alpha \leq 1$.
- (2) $0 \leq \mathfrak{A}_{\eta\xi}^\alpha + \mathfrak{S}_{\eta\xi}^\alpha + \mathfrak{Y}_{\eta\xi}^\alpha \leq 3$, for $\eta = 1, 2, 3, \dots, r; \xi = 1, 2, 3, \dots, s; \alpha = 1, 2, 3, \dots, m$.

The rating of each criteria corresponding to the alternative for m -triplets is illustrated in this work. The input decision matrices $\mathfrak{S}_\xi; \xi = 1, 2, 3, \dots, z$ for z number of experts can be written by using m -polar neutrosophic data same as Equation 2. We calculate cosine similarity measure and set theoretic similarity measure between $\mathfrak{S}_\xi; \xi = 1, 2, 3, \dots, z$ and \mathfrak{P} . We choose the m -polar neutrosophic sets from $\mathfrak{S}_\xi; \xi = 1, 2, 3, \dots, z$ having highest cosine similarity measure and highest set theoretic similarity measure. Then we calculate score values of all the alternatives in the selected sets from $\mathfrak{S}_\xi; \xi = 1, 2, 3, \dots, z$. We rank these fuzzy values and choose alternative having maximum fuzzy value as an optimal decision. The step-wise description of this proposed technique is given as Algorithm 2.

diseases and the set $\mathfrak{Z} = \{\mathcal{J}, \mathcal{J}, \mathcal{J}, \mathcal{J}\}$ of symptoms, where

- $\delta_1 =$ Tuberculosis, $\delta_2 =$ Hepatitis C, $\delta_3 =$ Typhoid fever,
- $\mathcal{J}_1 =$ Fever, $\mathcal{J}_2 =$ Poor immune system
- $\mathcal{J}_3 =$ Muscle and joint pain, fatigue,
- $\mathcal{J}_4 =$ Unintentional weight loss, loss of appetite

We input the data of patient according to his doctor in the form of 4-polar neutrosophic set for each disease corresponding to every symptom. In this data, the numeric values corresponding to each symptom show that how many chances he have to be suffered from the considered disease. In Table 5 for disease $\delta_1 =$ Tuberculosis, the first

Algorithm 2 (Algorithm for m -polar neutrosophic sets using similarity measures)

Input:

Step 1: Input the set \mathfrak{P} for a patient according to his doctor, corresponding to the "m" number of symptoms appearing to the patient. All the input data leads to those "p" diseases which will be possible outcome according to the appearing symptoms in the form of m -polar neutrosophic set.

Step 2: Input the sets $\mathfrak{S}_\xi; \xi = 1, 2, \dots, z$, for "p" diseases $\delta_\delta; \delta = 1, 2, \dots, p$, according to "z" number of experts, corresponding to the "m" number of symptoms in the form of m -polar neutrosophic sets (MPNSs).

Calculations:

Step 3: calculate cosine similarity measure using Definition 3.17 between $\mathfrak{S}_\xi; \xi = 1, 2, \dots, z$ and \mathfrak{P} .

Step 3': calculate set theoretic similarity measure using Definition 3.18 between $\mathfrak{S}_\xi; \xi = 1, 2, \dots, z$ and \mathfrak{P} .

Step 4: Choose the MPNS from $\mathfrak{S}_\xi; \xi = 1, 2, \dots, z$ having highest cosine similarity measure with \mathfrak{P} . That \mathfrak{S}_ξ gives the best decision for diagnosis of patient.

Step 4': Choose the MPNS from $\mathfrak{S}_\xi; \xi = 1, 2, \dots, z$ having highest set theoretic similarity measure with \mathfrak{P} . That \mathfrak{S}_ξ gives the best decision for diagnosis of patient.

Step 5: Calculate scores of each disease δ_δ of selected \mathfrak{S}_ξ after finding cosine and set theoretic similarity measures corresponding to "m" number of symptoms by using Definition 2.6. From this method we get two different results (rankings) according to two different similarity measures.

Output:

Step 6: We rank the alternative (disease) on the basis of score values according to the Definition 2.7.

Step 7: Alternative (disease) with the higher score has the maximum rank according to the given numerical example. This implies that patient is suffering from that disease.

The flow chart diagram of proposed algorithms can be seen in Fig. 2.

4.1.2 Numerical example

Suppose that a patient is facing some health issues and the symptoms are temperature, headache, fatigue, loss of appetite, stomach pain, inadequate immune system, muscle, and joint pain. According to the doctor's opinion, all these symptoms lead to the following diseases Tuberculosis, Hepatitis C, and Typhoid fever. Let us consider the set $\mathcal{Q} = \{\delta_1, \delta_2, \delta_3\}$ of the alternatives consisting of three

triplet $\langle 0.635, 0.115, 0.114 \rangle$ shows that according to his symptom " $\mathcal{J}_1 =$ fever" patient has 63,5% truth chances, 11.5% indeterminacy, and 11.4% falsity chances to have tuberculosis. Similarly, we can observe all values of patient according to his symptoms for all diseases.

We consider that we have "z=3" highly qualified experts, then according to these experts the data of each disease corresponding to each symptom is given in tabular form of 4-polar neutrosophic sets as Tables 6, 7, and 8. Each $\mathfrak{S}_\xi; \xi = 1, 2, 3$ representing the data of each disease corresponding to each symptom according to 3 experts. This means that for expert \mathfrak{S}_1 and disease $\delta_1 =$ tuberculosis

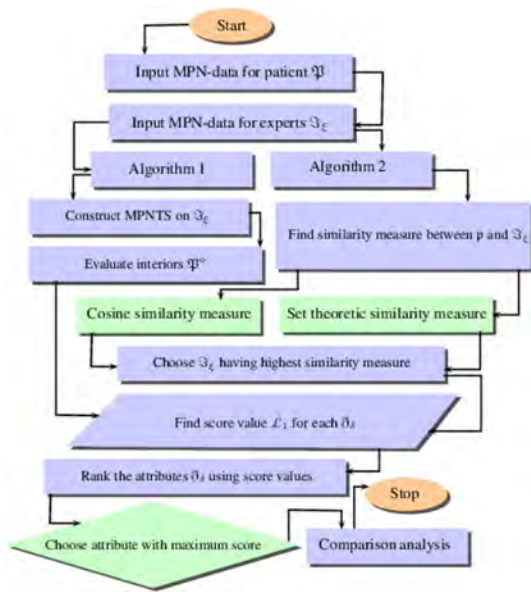

Fig. 2 Flowchart diagram of proposed algorithm 1 and algorithm 2

the first triplet $\langle 0.511, 0.311, 0.213 \rangle$ shows that according to symptom “ $\mathcal{J}_1 = \text{fever}$ ” there are 63,5% truth chances, 11.5% indeterminacy, and 11.4% falsity chances to have

Table 5 4-Polar neutrosophic data of patient \mathfrak{P}

\mathfrak{P}	4-polar neutrosophic sets
δ_1	$(\langle 0.635, 0.115, 0.114 \rangle, \langle 0.813, 0.239, 0.115 \rangle, \langle 0.513, 0.431, 0.513 \rangle \langle 0.911, 0.119, 0.238 \rangle)$
δ_2	$(\langle 0.739, 0.119, 0.115 \rangle, \langle 0.923, 0.111, 0.108 \rangle, \langle 0.889, 0.108, 0.117 \rangle, \langle 0.835, 0.113, 0.218 \rangle)$
δ_3	$(\langle 0.919, 0.113, 0.122 \rangle, \langle 0.818, 0.112, 0.211 \rangle, \langle 0.611, 0.513, 0.618 \rangle, \langle 0.713, 0.218, 0.319 \rangle)$

Table 6 4-polar neutrosophic data for expert \mathfrak{S}_1

\mathfrak{S}_1	4-polar neutrosophic sets
δ_1	$(\langle 0.511, 0.311, 0.213 \rangle, \langle 0.631, 0.431, 0.211 \rangle, \langle 0.328, 0.611, 0.782 \rangle \langle 0.713, 0.348, 0.411 \rangle)$
δ_2	$(\langle 0.638, 0.324, 0.237 \rangle, \langle 0.816, 0.118, 0.119 \rangle, \langle 0.717, 0.115, 0.218 \rangle, \langle 0.719, 0.222, 0.249 \rangle)$
δ_3	$(\langle 0.889, 0.212, 0.213 \rangle, \langle 0.699, 0.189, 0.232 \rangle, \langle 0.413, 0.718, 0.818 \rangle, \langle 0.518, 0.421, 0.518 \rangle)$

Table 7 4-polar neutrosophic data for expert \mathfrak{S}_2

\mathfrak{S}_2	4-polar neutrosophic sets
δ_1	$(\langle 0.611, 0.213, 0.118 \rangle, \langle 0.711, 0.321, 0.118 \rangle, \langle 0.412, 0.511, 0.611 \rangle \langle 0.813, 0.211, 0.341 \rangle)$
δ_2	$(\langle 0.718, 0.211, 0.117 \rangle, \langle 0.916, 0.113, 0.112 \rangle, \langle 0.817, 0.113, 0.211 \rangle, \langle 0.815, 0.211, 0.234 \rangle)$
δ_3	$(\langle 0.918, 0.116, 0.132 \rangle, \langle 0.713, 0.116, 0.213 \rangle, \langle 0.511, 0.611, 0.713 \rangle, \langle 0.613, 0.321, 0.416 \rangle)$

Table 8 4-polar neutrosophic data for expert \mathfrak{S}_3

\mathfrak{S}_3	4-polar neutrosophic sets
δ_1	$(\langle 0.711, 0.118, 0.108 \rangle, \langle 0.811, 0.213, 0.108 \rangle, \langle 0.512, 0.421, 0.521 \rangle \langle 0.815, 0.118, 0.213 \rangle)$
δ_2	$(\langle 0.723, 0.119, 0.111 \rangle, \langle 0.928, 0.112, 0.110 \rangle, \langle 0.888, 0.111, 0.119 \rangle, \langle 0.889, 0.181, 0.201 \rangle)$
δ_3	$(\langle 0.929, 0.115, 0.128 \rangle, \langle 0.813, 0.112, 0.211 \rangle, \langle 0.611, 0.511, 0.613 \rangle, \langle 0.718, 0.213, 0.325 \rangle)$

tuberculosis. On the same pattern, we can observe all values of diseases according to the corresponding symptoms for each expert.

4.1.3 Solution by using Algorithm 1

Now we construct 4-polar neutrosophic topological space $\mathcal{T}_{\mathcal{M}_{\mathfrak{N}}}$ on $\mathfrak{S}_\xi; \xi = 1, 2, 3$ given as $\mathcal{T}_{\mathcal{M}_{\mathfrak{N}}} = \{\mathfrak{S}_1, \mathfrak{S}_2, \mathfrak{S}_3, {}^0\mathcal{M}_{\mathfrak{N}}, {}^1\mathcal{M}_{\mathfrak{N}}\}$. We find the interior \mathfrak{P}^o of \mathfrak{P} by using Definition 3.6 under the 4PNTS $\mathcal{T}_{\mathcal{M}_{\mathfrak{N}}}$. Thus $\mathfrak{P}^o = {}^0\mathcal{M}_{\mathfrak{N}} \cup \mathfrak{S}_1 \cup \mathfrak{S}_2 = \mathfrak{S}_2$. Now we use Definition 2.6 on \mathfrak{S}_2 to find scores of all the diseases $\delta_\delta, \delta = 1, 2, 3$.

$$\begin{aligned} \mathfrak{L}_1(\mathfrak{S}_{2\delta_1}) &= \frac{1}{2 \times 4} (4 + (0.611 - 2(0.213) - 0.118) \\ &\quad + (0.711 - 2(0.321) - 0.118) \\ &\quad + (0.412 - 2(0.511) - 0.611) \\ &\quad + (0.813 - 2(0.211) - 0.341)) = 0.3558. \end{aligned}$$

Similarly, we can find $\mathfrak{L}_1(\mathfrak{S}_{2\delta_2}) = 0.662$ and $\mathfrak{L}_1(\mathfrak{S}_{2\delta_3}) = 0.3691$. By Definition 2.7 we can write that $\delta_2 \succ \delta_3 \succ \delta_1$. Hence, patient is suffering from Hepatitis C. Graphically results can be seen as Fig. 3.

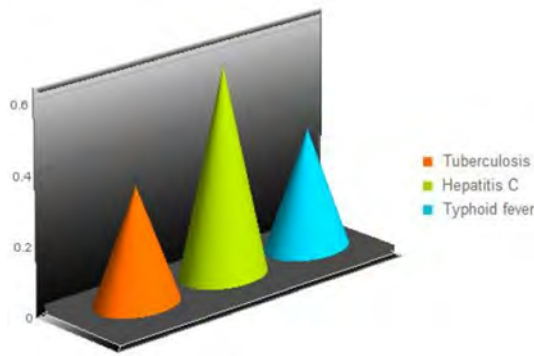

Fig. 3 Ranking of alternatives under MPNTS

4.1.4 Solution by using Algorithm 2

Now by using Tables 5, 6, 7, and 8, we find cosine similarity measures between $(\mathfrak{A}_1, \mathfrak{B})$, $(\mathfrak{A}_2, \mathfrak{B})$ and $(\mathfrak{A}_3, \mathfrak{B})$ by using Definition 3.17 given as

$$\mathfrak{C}_{MPNS}^1(\mathfrak{A}_2, \mathfrak{B}) = \frac{1}{3 \times 4} \left(\frac{(0.611)(0.635) + (0.213)(0.115) + (0.118)(0.114)}{\sqrt{(0.611)^2 + (0.213)^2 + (0.118)^2} \sqrt{(0.635)^2 + (0.115)^2 + (0.114)^2}} + \frac{(0.711)(0.813) + (0.321)(0.329) + (0.118)(0.115)}{\sqrt{(0.711)^2 + (0.321)^2 + (0.118)^2} \sqrt{(0.813)^2 + (0.329)^2 + (0.115)^2}} + \dots + \frac{(0.613)(0.713) + (0.321)(0.218) + (0.416)(0.319)}{\sqrt{(0.613)^2 + (0.321)^2 + (0.416)^2} \sqrt{(0.713)^2 + (0.218)^2 + (0.319)^2}} \right).$$

$\mathfrak{C}_{MPNS}^1(\mathfrak{A}_2, \mathfrak{B}) = \frac{11.89053}{12} = 0.990878$. Similarly, we can find similarity between other MPNSs given as $\mathfrak{C}_{MPNS}^1(\mathfrak{A}_1, \mathfrak{B}) = \frac{11.50807}{12} = 0.95900$, $\mathfrak{C}_{MPNS}^1(\mathfrak{A}_3, \mathfrak{B}) = \frac{11.996}{12} = 0.99966$. This shows that $\mathfrak{C}_{MPNS}^1(\mathfrak{A}_3, \mathfrak{B}) \succ \mathfrak{C}_{MPNS}^1(\mathfrak{A}_2, \mathfrak{B}) \succ \mathfrak{C}_{MPNS}^1(\mathfrak{A}_1, \mathfrak{B})$. From this ranking it is clear to see that opinion of expert \mathfrak{A}_3 is most related and similar to the condition of patient \mathfrak{B} . So, we select \mathfrak{A}_3 and calculate score values of all diseases $\delta_\delta; \delta = 1, 2, 3$ by using Definition 2.6. This implies that $\mathfrak{L}_1(\mathfrak{A}_3\delta_1) = 0.5198$, $\mathfrak{L}_1(\mathfrak{A}_3\delta_2) = 0.7301$, $\mathfrak{L}_1(\mathfrak{A}_3\delta_3) = 0.4977$. By Definition 2.7 we can write that $\delta_2 \succ \delta_1 \succ \delta_3$. Hence patient is suffering from Hepatitis C.

Now, we use set theoretic similarity measure \mathfrak{C}_{MPNS}^2 to find similarity between $(\mathfrak{A}_1, \mathfrak{B})$, $(\mathfrak{A}_2, \mathfrak{B})$ and $(\mathfrak{A}_3, \mathfrak{B})$ by using Definition 3.18 given as

$$\mathfrak{C}_{MPNS}^2(\mathfrak{A}_2, \mathfrak{B}) = \frac{1}{3 \times 4} \left(\frac{(0.611)(0.635) + (0.213)(0.115) + (0.118)(0.114)}{\max((0.611)^2 + (0.213)^2 + (0.118)^2, (0.635)^2 + (0.115)^2 + (0.114)^2)} + \frac{(0.711)(0.813) + (0.321)(0.329) + (0.118)(0.115)}{\max((0.711)^2 + (0.321)^2 + (0.118)^2, (0.813)^2 + (0.329)^2 + (0.115)^2)} + \dots + \frac{(0.613)(0.713) + (0.321)(0.218) + (0.416)(0.319)}{\max((0.613)^2 + (0.321)^2 + (0.416)^2, (0.713)^2 + (0.218)^2 + (0.319)^2)} \right).$$

$\mathfrak{C}_{MPNS}^2(\mathfrak{A}_2, \mathfrak{B}) = \frac{10.44972}{12} = 0.87081$. Similarly, we can find similarity between other MPNSs given as $\mathfrak{C}_{MPNS}^2(\mathfrak{A}_1, \mathfrak{B}) = \frac{10.51971}{12} = 0.87664$, $\mathfrak{C}_{MPNS}^2(\mathfrak{A}_3, \mathfrak{B}) = \frac{11.2283}{12} = 0.9355$. This shows that $\mathfrak{C}_{MPNS}^2(\mathfrak{A}_3, \mathfrak{B}) \succ \mathfrak{C}_{MPNS}^2(\mathfrak{A}_1, \mathfrak{B}) \succ \mathfrak{C}_{MPNS}^2(\mathfrak{A}_2, \mathfrak{B})$.

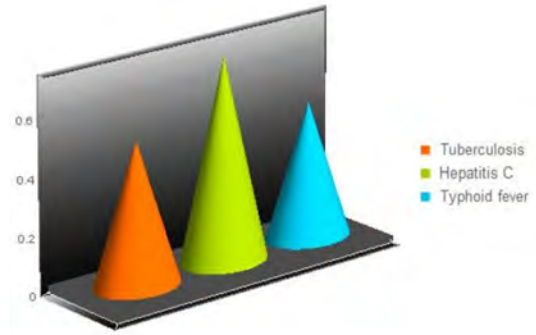

Fig. 4 Ranking of attributes under similarity measures

$(\mathfrak{A}_2, \mathfrak{B})$. From this ranking it is clear to see that opinion of expert \mathfrak{A}_3 is most related and similar to the condition of patient \mathfrak{B} . So, we select \mathfrak{A}_3 and calculate score values of all diseases $\delta_\delta; \delta = 1, 2, 3$ by using Definition 2.6. This implies that $\mathfrak{L}_1(\mathfrak{A}_3\delta_1) = 0.5198$, $\mathfrak{L}_1(\mathfrak{A}_3\delta_2) = 0.7301$, $\mathfrak{L}_1(\mathfrak{A}_3\delta_3) = 0.4977$. By Definition 2.7 we can write that $\delta_2 \succ \delta_1 \succ \delta_3$. Hence patient is suffering from Hepatitis C. Graphically results can be seen as Fig 4.

4.1.5 Discussion and Comparison Analysis:

In this section, we discuss advantages validity, simplicity, flexibility, and superiority of our proposed approach and algorithms. We also give a brief comparison analysis of proposed method with existing approaches.

Advantages of Proposed Approach

Now we discuss some advantages of the proposed techniques based on MPNSs.

(i) Validity of the Method

The suggested method is valid and suitable for all types of input data. we present two novel algorithms in this manuscript one for MPNTS and other for similarity measures. We introduced two similarity measures between MPNSs. It is interesting to note that both algorithms and both formulas of similarity gives the same result (see Table 9). In this work, both algorithms have their own importance and can be used according to the requirement of decision-maker. Both algorithms are valid and give best decision in multi-criteria decision-making (MCDM) problems.

(ii) Simplicity and Flexibility Dealing with Different Criteria

In MCDM problems, we experience different types of criteria and input data according to the given situations. The proposed algorithms are simple and easy to understand which can be applied easily on whatever type of alternatives and measures. Both algorithms are flexible and easily altered according to the different situations, inputs, and outputs. There is a slightly difference between the ranking of the proposed approaches because different formulae have

Table 9 Score values for optimal choice under both algorithms

Algorithm	Method	δ_1	δ_2	δ_3	Ranking of alternatives
Algorithm1	m -Polar neutrosophic topological space	0.3558	0.622	0.3691	$\delta_2 \succ \delta_3 \succ \delta_1$
Algorithm2	Cosine similarity on m -polar neutrosophic sets	0.5198	0.7301	0.4977	$\delta_2 \succ \delta_1 \succ \delta_3$
Algorithm2	Set theoretic similarity on m -polar neutrosophic sets	0.5198	0.7301	0.4977	$\delta_2 \succ \delta_1 \succ \delta_3$

Table 10 Comparison of proposed algorithms with some existing approaches

Methods	Similarity measures on sets	Ranking of alternatives
Wei [37]	Picture fuzzy set	$\delta_2 \succ \delta_1 \succ \delta_3$
Xu and Chen [39, 40]	Intuitionistic fuzzy set and correlation measures	$\delta_2 \succ \delta_1 \succ \delta_3$
Ye [45]	Correlation coefficient of neutrosophic set	$\delta_2 \succ \delta_1 \succ \delta_3$
Ye [47]	Intuitionistic fuzzy set	$\delta_2 \succ \delta_3 \succ \delta_1$
Li and Cheng [17]	Intuitionistic fuzzy set	$\delta_2 \succ \delta_3 \succ \delta_1$
Lin [18]	Hesitant fuzzy linguistic information	$\delta_2 \succ \delta_1 \succ \delta_3$
Wei [38]	Interval-valued intuitionistic fuzzy set	$\delta_2 \succ \delta_3 \succ \delta_1$
Proposed algorithm1	m -Polar neutrosophic topological space	$\delta_2 \succ \delta_3 \succ \delta_1$
Proposed algorithm2	Cosine similarity on m -polar neutrosophic sets	$\delta_2 \succ \delta_1 \succ \delta_3$
Proposed algorithm2	Set theoretic similarity on m -polar neutrosophic sets	$\delta_2 \succ \delta_1 \succ \delta_3$

different ordering strategies, so they can afford the slightly different effect according to their deliberations.

(iii) Superiority of Proposed Method

From all above discussion, we observe that our proposed models of m -polar neutrosophic set and m -polar neutrosophic topological space are superior to existing approaches including fuzzy neutrosophic sets, m -polar intuitionistic fuzzy sets, interval-valued m -polar fuzzy sets and m -polar fuzzy sets. Moreover, many hybrid structures of fuzzy sets become the special cases of m -polar neutrosophic set with the addition of some suitable conditions (see Fig. 1). So our proposed approach is valid, flexible, simple, and superior to other hybrid structures of fuzzy sets.

Comparison Analysis

(1) In our proposed method, we define m -polar neutrosophic topological space and two algorithms based on MPN input data. The impressive point of this model is that we can use it for mathematical modeling at a large scale or “ m ” numbers of criteria with its truth, falsity, and indeterminacy part. These m -degrees basically show the corresponding properties or any set criteria about the alternatives. As in giving numerical example, we use $m = 4$ to analyze the data for four symptoms appearing to the patient. The value of “ m ” can be taken as large as possible, which is not possible for other approaches. Moreover, many hybrid structures of fuzzy set become the special cases of m -polar neutrosophic set with the addition of some suitable conditions (see Fig. 1).

(2) Table 10 as given above listing the results of the comparison in the final ranking of top 3 alternatives (diseases). As it could be observed in the comparison Table 10, the best selection made by the proposed methods is comparable to already established methods which is expressive in itself and approves the reliability and validity of the proposed method. Now the question turns out that why we need to specify a novel algorithm based on this novel structure? There are many arguments which show that proposed operator is more suitable than other existing methods. As we know that intuitionistic fuzzy sets, picture fuzzy sets, fuzzy sets, hesitant fuzzy sets, neutrosophic sets, and other existing hybrid structures of fuzzy sets have some limitations and not able to present full information about the situation. But our proposed model of m -polar neutrosophic set is most suitable for MCDM methods and deals with multi-criteria having truth, indeterminacy, and falsity values. Due to the addition of neutrosophic nature in multi-polarity, these three grades go independent of each other and give a lot of information about the multiple criteria for the alternatives.

- (3) The similarity measures for other existing hybrid structures of fuzzy set become special cases of similarity measures of m -polar neutrosophic set. So, this model is more generalized and can easily deal with the problems involving intuitionistic, neutrosophy, hesitant, picture, and fuzziness of alternatives. The constructed topological space on MPNS becomes superior to existing topological spaces and easily deals with the problems in MCDM methods.

4.2 Clustering Analysis in Multi-criteria Decision-Making

We introduce a novel clustering algorithm under m -polar neutrosophic environment to solve multi-criteria decision-making problem. Before this, we revise some basic concepts.

Definition 4.1 [41] Let $\mathcal{M}_{\mathfrak{N}_\zeta}$ be “q” m -polar neutrosophic sets (MPNSs), then $\mathcal{G} = (g_{\beta\zeta})_{q \times q}$ is said to be similarity matrix, where $g_{\beta\zeta} = \mathfrak{C}(\mathcal{M}_{\mathfrak{N}_\beta}, \mathcal{M}_{\mathfrak{N}_\zeta})$ represents the similarity measure of MPNSs $\mathcal{M}_{\mathfrak{N}_\beta}$ and $\mathcal{M}_{\mathfrak{N}_\zeta}$ and satisfy the following:

- (1) $0 \leq g_{\beta\zeta} \leq 1; \beta, \zeta = 1, 2, 3, \dots, q,$
- (2) $g_{\beta\beta} = 1; \beta = 1, 2, 3, \dots, q,$
- (3) $g_{\beta\zeta} = g_{\zeta\beta}; \beta, \zeta = 1, 2, 3, \dots, q.$

Definition 4.2 [41] Let $\mathcal{G} = (g_{\beta\zeta})_{q \times q}$ be the similarity matrix. Then $\mathcal{G}^2 = \mathcal{G} \circ \mathcal{G} = (\overline{g_{\beta\zeta}})_{q \times q}$ is said to be a composition matrix of \mathcal{G} , where

$$\overline{g_{\beta\zeta}} = \max_{\delta} \{ \min \{ g_{\beta\delta}, g_{\delta\zeta} \} \}; \quad \beta, \zeta = 1, 2, 3, \dots, q$$

Theorem 4.3 [41] Let $\mathcal{G} = (g_{\beta\zeta})_{q \times q}$ be a similarity matrix, then after a finite compositions $(\mathcal{G} \rightarrow \mathcal{G}^2 \rightarrow \mathcal{G}^4 \rightarrow \dots \rightarrow \mathcal{G}^{2^\delta} \rightarrow \dots)$, \exists a positive integer δ such that $\mathcal{G}^{2^\delta} = \mathcal{G}^{2^{(\delta+1)}}$. \mathcal{G}^{2^δ} is an equivalence similarity matrix.

Definition 4.4 [41] Let $\mathcal{G} = (g_{\beta\zeta})_{q \times q}$ be an equivalence similarity matrix. Then $\mathcal{G}_\delta = (g_{\beta\zeta}^\delta)_{q \times q}$ is said to be δ -cutting matrix of \mathcal{G} , where

$$g_{\beta\zeta}^\delta = \begin{cases} 0 & \text{if } g_{\beta\zeta} < \delta \\ 1 & \text{if } g_{\beta\zeta} \geq \delta \end{cases}$$

$\beta, \zeta = 1, 2, 3, \dots, q$ and δ is confidence level with $\delta \in [0, 1]$.

Now, we use these basic ideas for the construction of a novel clustering algorithm based on MPNSs given as algorithm 3. In the constructed numerical example of clustering analysis, we discuss algorithm 3 with more detail and clarity.

Algorithm 3 (Algorithm for clustering analysis using m-polar neutrosophic sets)

Input:

Step 1: Let $\{\mathcal{M}_{\mathfrak{N}_1}, \mathcal{M}_{\mathfrak{N}_2}, \dots, \mathcal{M}_{\mathfrak{N}_q}\}$ be an assembling of MPNSs over \mathcal{Q} and $\{\eta_1, \eta_2, \dots, \eta_r\}$ be the collection of attributes. Input MPN-data in tabular form to see the relationship between sets and attributes.

Calculations:

Step 2: Construct similarity matrix $\mathcal{G} = (g_{\beta\zeta})_{q \times q}$, where $g_{\beta\zeta} = \mathfrak{C}(\mathcal{M}_{\mathfrak{N}_\beta}, \mathcal{M}_{\mathfrak{N}_\zeta})$ and can be calculated as

$$\mathfrak{C}(\mathcal{M}_{\mathfrak{N}_\beta}, \mathcal{M}_{\mathfrak{N}_\zeta}) = 1 - \frac{1}{3m} \sum_{\alpha=1}^m \sum_{t=1}^r \wp_t (|\beta^t \mathfrak{A}_\alpha - \zeta^t \mathfrak{A}_\alpha| + |\beta^t \mathfrak{S}_\alpha - \zeta^t \mathfrak{S}_\alpha| + |\beta^t \mathfrak{Y}_\alpha - \zeta^t \mathfrak{Y}_\alpha|).$$

Step 3: Find \mathcal{G}^2 and check whether the similarity matrix satisfy $\mathcal{G}^2 \subseteq \mathcal{G}$. If it does not hold, then find the equivalence similarity matrix \mathcal{G}^{2^δ} :

$$(\mathcal{G} \rightarrow \mathcal{G}^2 \rightarrow \mathcal{G}^4 \rightarrow \dots \rightarrow \mathcal{G}^{2^\delta} \rightarrow \dots) \quad \text{until, } \mathcal{G}^{2^\delta} = \mathcal{G}^{2^{(\delta+1)}}.$$

Step 4: Find confidence level δ and construct a δ -cutting matrix $\mathcal{G}_\delta = (g_{\beta\zeta}^\delta)_{q \times q}$ by using Definition 4.4.

Output:

Step 5: Classify the MPNSs by using the following argument:

If all the members of β th line (column) in \mathcal{G}_δ are same as the corresponding elements of ζ th line (column) in \mathcal{G} , then MPNSs $\mathcal{M}_{\mathfrak{N}_\beta}$ and $\mathcal{M}_{\mathfrak{N}_\zeta}$ are of the same type, otherwise not.

Table 11 Characteristics of decision variables

Decision variables	Characteristics for 2-polar neutrosophic soft set
Intellectually curious	$\langle \text{creative, originality} \rangle$
Obedient and punctual	$\langle \text{hard – working, honest} \rangle$
Experience	$\langle \text{high, mediumhigh} \rangle$

Table 12 Linguistic terms for rating criteria for weight vector

Linguistic terms (LTs)	Fuzzy numbers
Good/G	$0.60 \leq x \leq 1$
Medium good/MG	$0.20 \leq x < 0.60$
Medium/M	$0.10 \leq x < 0.20$
Medium bad/MB	$0.05 \leq x < 0.10$
Bad/B	$0 \leq x < 0.05$

4.2.1 Numerical Example

Suppose that $\mathcal{Q} = \{\mathcal{M}_{\eta_1}, \mathcal{M}_{\eta_2}, \mathcal{M}_{\eta_3}, \mathcal{M}_{\eta_4}, \mathcal{M}_{\eta_5}, \mathcal{M}_{\eta_6}, \mathcal{M}_{\eta_7}\}$ be the collection of seven students. They take an admission in a Science project learning academy for the preparation of a national competition on Science projects. Every student is evaluated on the basis of some important educational parameters, which are set according to the experts of that academy. To get fair assessment of these students, the evaluation committee establish the set of decision variables given as $\mathfrak{Z} = \{\eta_1, \eta_2, \eta_3\}$, where

$\eta_1 = \text{Intellectually curious}, \eta_2 = \text{Obedient and punctual},$
 $\eta_3 = \text{Experience}$

Experts need to categorize the students according to these parameters and create their clustering corresponding to

Table 13 2-Polar neutrosophic input table

Students	η_1	η_2	η_3
\mathcal{M}_{η_1}	$\langle (0.81, 0.21, 0.11), (0.89, 0.23, 0.38) \rangle$	$\langle (0.78, 0.32, 0.17), (0.83, 0.21, 0.11) \rangle$	$\langle (0.61, 0.42, 0.31), (0.71, 0.31, 0.41) \rangle$
\mathcal{M}_{η_2}	$\langle (0.73, 0.23, 0.18), (0.79, 0.21, 0.31) \rangle$	$\langle (0.79, 0.23, 0.14), (0.81, 0.31, 0.21) \rangle$	$\langle (0.83, 0.31, 0.18), (0.73, 0.41, 0.37) \rangle$
\mathcal{M}_{η_3}	$\langle (0.91, 0.11, 0.15), (0.86, 0.31, 0.24) \rangle$	$\langle (0.83, 0.21, 0.43), (0.89, 0.21, 0.41) \rangle$	$\langle (0.72, 0.43, 0.39), (0.69, 0.41, 0.43) \rangle$
\mathcal{M}_{η_4}	$\langle (0.74, 0.31, 0.44), (0.79, 0.37, 0.28) \rangle$	$\langle (0.79, 0.28, 0.32), (0.73, 0.41, 0.28) \rangle$	$\langle (0.81, 0.31, 0.21), (0.83, 0.19, 0.22) \rangle$
\mathcal{M}_{η_5}	$\langle (0.93, 0.11, 0.18), (0.91, 0.12, 0.15) \rangle$	$\langle (0.91, 0.21, 0.31), (0.89, 0.15, 0.19) \rangle$	$\langle (0.89, 0.21, 0.23), (0.87, 0.23, 0.24) \rangle$
\mathcal{M}_{η_6}	$\langle (0.78, 0.21, 0.37), (0.75, 0.21, 0.41) \rangle$	$\langle (0.82, 0.31, 0.34), (0.79, 0.25, 0.42) \rangle$	$\langle (0.88, 0.28, 0.23), (0.75, 0.21, 0.15) \rangle$
\mathcal{M}_{η_7}	$\langle (0.79, 0.28, 0.15), (0.83, 0.15, 0.19) \rangle$	$\langle (0.86, 0.23, 0.31), (0.87, 0.13, 0.31) \rangle$	$\langle (0.89, 0.31, 0.24), (0.79, 0.28, 0.24) \rangle$

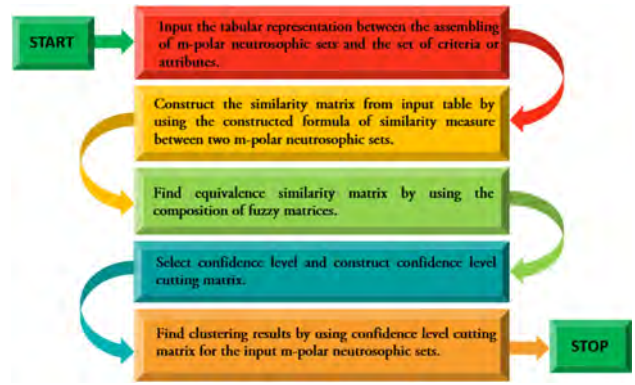

Fig. 5 Flow chart diagram of proposed algorithm 3 for clustering

different sections of that academy. We subdivide these parameters into further criteria given as

- “Intellectually curious” student may be creative and give his original ideas.
- “Obedient and punctual” may be hard-working and honest.
- “Experience” means that some students have high or medium high experience.

In tabular form, this information can be seen as Table 11.

Some linguistic terms are defined to convert verbal description of experts about \mathfrak{Z} into mathematical language given in Table 12.

Experts select the weight vector “ φ ” for the strength of established decision variables as $\varphi = (0.60, 0.25, 0.15)^T$. To clarify the differences of the opinion of experts and to cover the input data, we construct 2-polar neutrosophic sets given in Table 13. The flow chart diagram of proposed algorithm is given in Fig. 5.

Now, we calculate similarity measure \mathfrak{C} between elements of Table 13 and construct similarity matrix.

$$\mathcal{G} = \begin{pmatrix} 0.1000 & 0.9339 & 0.9100 & 0.8670 & 0.8863 & 0.9055 & 0.9092 \\ 0.9339 & 0.1000 & 0.8860 & 0.9130 & 0.8903 & 0.9207 & 0.9388 \\ 0.9100 & 0.8860 & 0.1000 & 0.8634 & 0.9145 & 0.8771 & 0.9100 \\ 0.8670 & 0.9130 & 0.8634 & 0.1000 & 0.8535 & 0.9204 & 0.8973 \\ 0.8863 & 0.8903 & 0.9145 & 0.8535 & 0.1000 & 0.8701 & 0.9354 \\ 0.9055 & 0.9207 & 0.8771 & 0.9204 & 0.8701 & 0.1000 & 0.9085 \\ 0.9092 & 0.9388 & 0.9100 & 0.8973 & 0.9354 & 0.9085 & 0.1000 \end{pmatrix}$$

$$\mathcal{G}^2 = \begin{pmatrix} 0.1000 & 0.9339 & 0.9100 & 0.9130 & 0.9100 & 0.9207 & 0.9339 \\ 0.9339 & 0.1000 & 0.9100 & 0.9204 & 0.9354 & 0.9207 & 0.9388 \\ 0.9100 & 0.9100 & 0.1000 & 0.8973 & 0.9145 & 0.9100 & 0.9145 \\ 0.9130 & 0.9204 & 0.8973 & 0.1000 & 0.8973 & 0.9204 & 0.9130 \\ 0.9100 & 0.9354 & 0.9145 & 0.8973 & 0.1000 & 0.9085 & 0.9354 \\ 0.9207 & 0.9207 & 0.9100 & 0.9204 & 0.9085 & 0.1000 & 0.9207 \\ 0.9339 & 0.9388 & 0.9145 & 0.9130 & 0.9354 & 0.9207 & 0.1000 \end{pmatrix}$$

As $\mathcal{G}^2 \notin \mathcal{G}$, so we move towards the further calculations.

$$\mathcal{G}^4 = \begin{pmatrix} 0.1000 & 0.9339 & 0.9145 & 0.9204 & 0.9339 & 0.9207 & 0.9339 \\ 0.9339 & 0.1000 & 0.9145 & 0.9204 & 0.9354 & 0.9207 & 0.9388 \\ 0.9145 & 0.9145 & 0.1000 & 0.9130 & 0.9145 & 0.9145 & 0.9145 \\ 0.9204 & 0.9204 & 0.9130 & 0.1000 & 0.9204 & 0.9204 & 0.9204 \\ 0.9339 & 0.9354 & 0.9145 & 0.9204 & 0.1000 & 0.9207 & 0.9354 \\ 0.9207 & 0.9207 & 0.9145 & 0.9204 & 0.9207 & 0.1000 & 0.9388 \\ 0.9339 & 0.9388 & 0.9145 & 0.9204 & 0.9354 & 0.9388 & 0.1000 \end{pmatrix}$$

$$\mathcal{G}^8 = \begin{pmatrix} 0.1000 & 0.9339 & 0.9145 & 0.9204 & 0.9339 & 0.9339 & 0.9339 \\ 0.9339 & 0.1000 & 0.9145 & 0.9204 & 0.9354 & 0.9339 & 0.9388 \\ 0.9145 & 0.9145 & 0.1000 & 0.9145 & 0.9145 & 0.9145 & 0.9145 \\ 0.9204 & 0.9204 & 0.9145 & 0.1000 & 0.9204 & 0.9204 & 0.9204 \\ 0.9339 & 0.9354 & 0.9145 & 0.9204 & 0.1000 & 0.9354 & 0.9354 \\ 0.9339 & 0.9339 & 0.9145 & 0.9204 & 0.9354 & 0.1000 & 0.9388 \\ 0.9339 & 0.9388 & 0.9145 & 0.9204 & 0.9354 & 0.9388 & 0.1000 \end{pmatrix}$$

$$\mathcal{G}^{16} = \begin{pmatrix} 0.1000 & 0.9339 & 0.9145 & 0.9204 & 0.9339 & 0.9339 & 0.9339 \\ 0.9339 & 0.1000 & 0.9145 & 0.9204 & 0.9354 & 0.9339 & 0.9388 \\ 0.9145 & 0.9145 & 0.1000 & 0.9145 & 0.9145 & 0.9145 & 0.9145 \\ 0.9204 & 0.9204 & 0.9145 & 0.1000 & 0.9204 & 0.9204 & 0.9204 \\ 0.9339 & 0.9354 & 0.9145 & 0.9204 & 0.1000 & 0.9354 & 0.9354 \\ 0.9339 & 0.9388 & 0.9145 & 0.9204 & 0.9354 & 0.1000 & 0.9388 \\ 0.9339 & 0.9388 & 0.9145 & 0.9204 & 0.9354 & 0.9388 & 0.1000 \end{pmatrix}$$

$$\mathcal{G}^{32} = \begin{pmatrix} 0.1000 & 0.9339 & 0.9145 & 0.9204 & 0.9339 & 0.9339 & 0.9339 \\ 0.9339 & 0.1000 & 0.9145 & 0.9204 & 0.9354 & 0.9339 & 0.9388 \\ 0.9145 & 0.9145 & 0.1000 & 0.9145 & 0.9145 & 0.9145 & 0.9145 \\ 0.9204 & 0.9204 & 0.9145 & 0.1000 & 0.9204 & 0.9204 & 0.9204 \\ 0.9339 & 0.9354 & 0.9145 & 0.9204 & 0.1000 & 0.9354 & 0.9354 \\ 0.9339 & 0.9388 & 0.9145 & 0.9204 & 0.9354 & 0.1000 & 0.9388 \\ 0.9339 & 0.9388 & 0.9145 & 0.9204 & 0.9354 & 0.9388 & 0.1000 \end{pmatrix}$$

It is clear that $\mathcal{G}^{32} = \mathcal{G}^{16} \circ \mathcal{G}^{16} = \mathcal{G}^{16}$ is an equivalence similarity matrix. Since the confidence level δ has a strong connection with the elements of the equivalence similarity matrix. For δ we construct δ -cutting matrix \mathcal{G}_δ . Different δ produces different \mathcal{G}_δ and different clustering for the universal set \mathcal{Q} . For different values of δ different clustering results are given in Table 14.

The clustering effect diagram for different δ -cutting of seven students can be seen in Fig. 6. This means that by utilizing this novel algorithm experts of academy can easily classify the students corresponding to different sections of the academy according to their ability. All the clustering depend upon the parameter δ , which is confidence level and selected according to the opinions and suggestions of experts.

4.2.2 Comparison

Now, we compare our proposed method with some existing approaches and we see that our proposed approach has the following advantages.

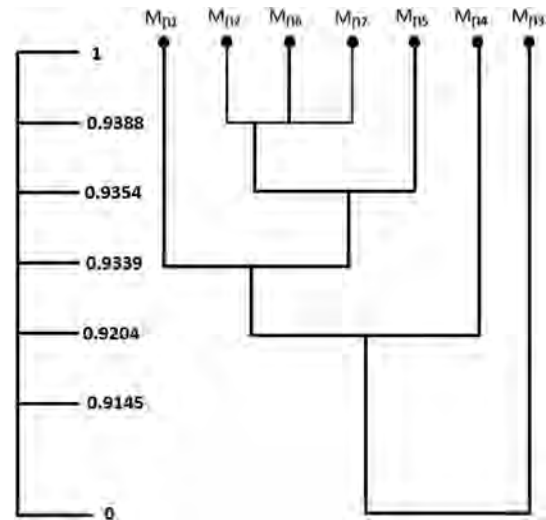

Fig. 6 The clustering effect diagram of seven students

Table 14 The clustering results of seven students

Confidence level δ	Clusters
$0.9388 < \delta \leq 1$	$\{\mathcal{M}_{g_1}\}, \{\mathcal{M}_{g_2}\}, \{\mathcal{M}_{g_3}\}, \{\mathcal{M}_{g_4}\}, \{\mathcal{M}_{g_5}\}, \{\mathcal{M}_{g_6}\}, \{\mathcal{M}_{g_7}\}$
$0.9354 < \delta \leq 0.9388$	$\{\mathcal{M}_{g_1}\}, \{\mathcal{M}_{g_2}, \mathcal{M}_{g_6}, \mathcal{M}_{g_7}\}, \{\mathcal{M}_{g_3}\}, \{\mathcal{M}_{g_4}\}, \{\mathcal{M}_{g_5}\}$
$0.9339 < \delta \leq 0.9354$	$\{\mathcal{M}_{g_1}\}, \{\mathcal{M}_{g_2}, \mathcal{M}_{g_5}, \mathcal{M}_{g_6}, \mathcal{M}_{g_7}\}, \{\mathcal{M}_{g_3}\}, \{\mathcal{M}_{g_4}\}$
$0.9204 < \delta \leq 0.9339$	$\{\mathcal{M}_{g_1}, \mathcal{M}_{g_2}, \mathcal{M}_{g_5}, \mathcal{M}_{g_6}, \mathcal{M}_{g_7}\}, \{\mathcal{M}_{g_3}\}, \{\mathcal{M}_{g_4}\}$
$0.9145 < \delta \leq 0.9204$	$\{\mathcal{M}_{g_1}, \mathcal{M}_{g_2}, \mathcal{M}_{g_4}, \mathcal{M}_{g_5}, \mathcal{M}_{g_6}, \mathcal{M}_{g_7}\}, \{\mathcal{M}_{g_3}\}$
$0 \leq \delta \leq 0.9145$	$\{\mathcal{M}_{g_1}, \mathcal{M}_{g_2}, \mathcal{M}_{g_3}, \mathcal{M}_{g_4}, \mathcal{M}_{g_5}, \mathcal{M}_{g_6}, \mathcal{M}_{g_7}\}$

Table 15 Comparison of proposed approach with the existing methodologies

Authors	Set	Truth grade	Indeterminacy grade	Falsity grade	Multi-polarity	Loss of information
Xu et al. [41]	IFS	✓	×	✓	×	×
Zhang et al. [54]	IFS	✓	×	✓	×	✓
Peng et al. [22]	PFS	✓	×	✓	×	×
Proposed approach	MPNS	✓	✓	✓	✓	×

- (1) By using the methods of Xu et al. [41] and Zhang et al. [54], we cannot handle the multi-polar input data and cannot deal with the indeterminacy part of the alternatives. They used intuitionistic fuzzy sets (IFSs) for the clustering of input data. In our proposed approach, we deal our clustering with the multiple data with the truth, indeterminacy, and falsity part of the alternatives. So, our method is more efficient and deal with numerous applications having multiple data.
- (2) Peng et al. [22] presented the clustering idea on Pythagorean fuzzy sets (PFSs). They increased the domain of Xu et al. [41] and Zhang et al. [54] approaches, but they cannot handle the multi-polar input data and cannot deal with the indeterminacy part of the alternatives. Our proposed method removes these restrictions and can easily handle multi-criteria decision-making problems.
- (3) According to Peng et al. [22] research idea, Zhang et al. [54] produced the loss of too much information in the data during the calculation by using intuitionistic fuzzy similarity degrees. This loss effects upon the final result of clustering. Our proposed approach does not lose any input data during the calculations and produces accurate and appropriate results. This comparison is given in tabular form in Table 15.

5 Conclusion

Decision analysis has been intensively examined by numerous scholars and researchers. The techniques developed for this task mainly depend on the type of decision problem under consideration. Most of its relating issues are associated with uncertain, imprecise and multi-polar information, which cannot be tackled properly through fuzzy set. To overcome this particular deficiency of fuzzy sets, Chen et al. [5] have proposed the concept of *m*-polar

fuzzy set (MPFS) in 2014, which has the capability to deal with the data having vagueness and uncertainty under multi-polar information. Neutrosophic set deals with the MCDM methods having truth, falsity, and indeterminacy grades for the corresponding alternatives. In this manuscript, we have established the idea of *m*-polar neutrosophic set (MPNS) by combining the two independent concepts of *m*-polar fuzzy set and neutrosophic set. We have established the notion of *m*-polar neutrosophic topology and defined interior, closure, exterior, and frontier in the context of MPNSs with the help of illustrations. We have presented cosine similarity measure and set theoretic similarity measure to find the similarity between MPNSs. Three novel algorithms for multi-criteria decision-making (MCDM) with linguistic information have been developed on the basis of MPNS, similarity measures, and clustering analysis. Furthermore, we have presented advantages, simplicity, flexibility, and validity of the proposed algorithms. We have discussed and compared our results with some existing methodologies.

References

1. Akram, M., Waseem, N., Liu, P.: Novel approach in decision making with *m*-polar fuzzy ELECTRE-I. Int J Fuzzy Syst (2019). <https://doi.org/10.1007/s40815-019-00608-y>
2. Ali, M.I.: A note on soft sets, rough soft sets and fuzzy soft sets. Appl Soft Comput **11**, 3329–3332 (2011)
3. Atanassov, K.T.: Intuitionistic fuzzy sets. Fuzzy Sets Syst **20**(1), 87–96 (1986)
4. Bellman, R.E., Zadeh, L.A.: Decision-making in a fuzzy environment. Manag Sci **4**(17), 141–164 (1970)
5. Chen, J., Li, S., Ma, S., Wang, X.: *m*-Polar fuzzy sets: an extension of bipolar fuzzy sets. Sci World J **2014**, 416530 (2014)
6. Chi, P.P., Lui, P.D.: An extended TOPSIS method for the multiple-attribute decision making problems based on interval neutrosophic set. Neutrosoph Sets Syst **1**, 63–70 (2013)
7. Chang, C.L.: Fuzzy topological spaces. J Math Anal Appl **24**, 182–190 (1968)
8. Coung, B.: Picture Fuzzy Sets-First Results, Part 1. Seminar “Neuro-Fuzzy Systems with Applications”, vol. 1, pp. 63–70. Institute of Mathematics, Hanoi (2013)
9. Deli, I., Ali, M., Smarandache, F.: Bipolar Neutrosophic Sets and Their Application Based on Multi- Criteria Decision Making Problems, Proceedings of the 2015 International Conference on Advanced Mechatronic Systems, Beijing, China, August, 22–24 (2015)

10. Garg, H.: A new generalized pythagorean fuzzy information aggregation using Einstein operations and its application to decision making. *Int J Intell Syst* **31**(9), 886–920 (2016)
11. Garg, H.: Generalized intuitionistic fuzzy interactive geometric interaction operators using Einstein t-norm and t-conorm and their application to decision-making. *J Comput Ind Eng* **101**, 53–69 (2016)
12. Feng, F., Jun, Y.B., Liu, X., Li, L.: An adjustable approach to fuzzy soft set based decision making. *J Comput Appl Math* **234**(1), 10–20 (2010)
13. Feng, F., Fujita, H., Ali, M.I., Yager, R.R., Liu, X.: Another view on generalized intuitionistic fuzzy soft sets and related multi-attribute decision making methods. *IEEE Trans Fuzzy Syst* **27**(3), 474–488 (2019)
14. Jose, S., Kuriaskose, S.: Aggregation operators, score function and accuracy function for multi criteria decision making in intuitionistic fuzzy context. *Notes Intuit Fuzzy Sets* **20**(1), 40–44 (2014)
15. Karaaslan, F.: Neutrosophic soft set with applications in decision making. *Int J Inf Sci Intell Syst* **4**(2), 1–20 (2015)
16. Liu, X., Ju, Y., Yang, S.: Hesitant intuitionistic fuzzy linguistic aggregation operators and their applications to multi attribute decision making. *J Intell Fuzzy Syst* **26**(3), 1187–1201 (2014)
17. Li, D.F., Cheng, C.: New similarity measures of intuitionistic fuzzy sets and applications to pattern recognition. *Patt Recogn Lett* **23**(1–3), 221–225 (2002)
18. Lin, R., Zhao, X.F., Wei, G.W.: Models of selecting an ERP system with hesitant fuzzy linguistic information. *J Intell Fuzzy Syst* **26**(5), 2155–2165 (2014)
19. Mahmood, T., Mehmood, F., Khan, Q.: Some generalized aggregation operators for cubic hesitant fuzzy sets and their application to multi criteria decision making. *Punjab Univ J Math* **49**(1), 31–49 (2017)
20. Pao-Ming, P., Ying-Ming, L.: Fuzzy topology. I. Neighborhood structure of a fuzzy point and Moore-Smith convergence. *J Math Anal Appl* **76**, 571–599 (1980)
21. Pao-Ming, P., Ying-Ming, L.: Fuzzy topology. II. Product and quotient spaces. *J Math Anal Appl* **77**, 20–37 (1980)
22. Peng, X., Yuan, H., Yang, Y.: Pythagorean fuzzy information measures and their applications. *Int J Intell Syst* **32**, 991–1029 (2017)
23. Riaz, M., Hashmi, M.R.: Linear diophantine fuzzy set and its applications towards multi-attribute decision-making problems. *J Intell Fuzzy Syst* **37**, 5417–5439 (2019). <https://doi.org/10.3233/JIFS-190550>
24. Riaz, M., Hashmi, M.R.: Fixed points of fuzzy neutrosophic soft mapping with decision-making. *Fixed Point Theor Appl* **7**, 1–10 (2018)
25. Riaz, M., Hashmi, M.R.: MAGDM for agribusiness in the environment of various cubic m -polar fuzzy averaging aggregation operators. *J Intell Fuzzy Syst* **37**, 3671–3691 (2019). <https://doi.org/10.3233/JIFS-182809>
26. Riaz, M., Çağman, N., Zareef, I., Aslam, M.: N-soft topology and its applications to multi-criteria group decision making. *J Intell Syst* **36**(6), 6521–6536 (2019). <https://doi.org/10.3233/JIFS-182919>
27. Riaz, M., Tehrim, S.T.: Cubic bipolar fuzzy ordered weighted geometric aggregation operators and their application using internal and external cubic bipolar fuzzy data. *Comput Appl Math* **38**(2), 1–25 (2019). <https://doi.org/10.1007/s40314-019-0843-3>
28. Smarandache, F.: *Neutrosophy Neutrosophic Probability, Set and Logic*. American Research Press, Rehoboth (1998)
29. Smarandache, F.: *A Unifying Field in Logics. Neutrosophic Logic. Neutrosophy, Neutrosophic Set, Neutrosophic Probability and Statistics*, 4th edn, pp. 1999–2000. American Research Press, New Mexic (2006)
30. Smarandache, F.: *Neutrosophic Overset, Neutrosophic Underset, and Neutrosophic Offset. Similarly for Neutrosophic Over-/Under-/Off-Logic, Probability, and Statistics*. Pons Editions, Bruxelles (2016)
31. Shabir, M., Naz, M.: On soft topological spaces. *Comput Math Appl* **61**, 1786–1799 (2011)
32. Salton, G., McGill, M.J.: *Introduction to modern information retrieval*. McGraw-Hill Book Company, New York (1983)
33. Singh, P.: Correlation coefficients of picture fuzzy sets. *J Intell Fuzzy Syst* **27**, 2857–2868 (2014)
34. Son, L.: DPFCM: a novel distributed picture fuzzy clustering method on picture fuzzy sets. *Exp Syst Appl* **2**, 51–66 (2015)
35. Wang, H., Smarandache, F., Zhang, Y.Q., Sunderraman, R.: Single valued neutrosophic sets. *Multispace Multistruct* **4**, 410–413 (2010)
36. Wei, G., Wang, H., Zhao, X., Lin, R.: Hesitant triangular fuzzy information aggregation in multiple attribute decision making. *J Intell Fuzzy Syst* **26**(3), 1201–1209 (2014)
37. Wei, G.W.: Some similarity measures for picture fuzzy sets and their applications. *Iran J Fuzzy Syst* **15**(1), 77–89 (2018)
38. Wei, G.W., Wang, H.J., Lin, R.: Applications of correlation coefficient to interval-valued intuitionistic fuzzy multiple attribute decision making with in-complete weight information. *Knowl Inf Syst* **26**(2), 337–349 (2011)
39. Xu, Z.S.: On correlation measures of intuitionistic fuzzy sets. *Lect Notes Comput Sci* **4224**, 16–24 (2006)
40. Xu, Z.S., Chen, J.: An overview on distance and similarity measures on intuitionistic fuzzy sets. *Int J Uncertain Fuzziness Knowl Based Syst* **16**(4), 529–555 (2008)
41. Xu, Z.S., Chen, J., Wu, J.J.: Clustering algorithm for intuitionistic fuzzy sets. *Inf Sci* **178**, 3775–3790 (2008)
42. Yager, R. R.: Pythagorean fuzzy subsets. In: *IFSA World Congress and NAFIPS Annual Meeting (IFSA/NAFIPS)*, 2013 Joint, Edmonton, Canada, IEEE, pp 57–61 (2013)
43. Yager, R.R., Abbasov, A.M.: Pythagorean membership grades, complex numbers, and decision-making. *Int J Intell Syst* **28**(5), 436–452 (2013)
44. Yager, R.R.: Pythagorean membership grades in multi-criteria decision making. *IEEE Trans Fuzzy Syst* **22**(4), 958–965 (2014)
45. Ye, J.: Multicriteria decision-making method using the correlation coefficient under single-value neutrosophic environment. *Int J Gen Syst* **42**, 386–394 (2013)
46. Ye, J.: A multicriteria decision-making method using aggregation operators for simplified neutrosophic sets. *J Intell Fuzzy Syst* **26**, 2459–2466 (2014)
47. Ye, J.: Cosine similarity measures for intuitionistic fuzzy sets and their applications. *Math Comput Model* **53**(1), 91–97 (2011)
48. Zadeh, L.A.: Fuzzy sets. *Inf Contr* **8**, 338–353 (1965)
49. Zadeh, L.A.: The concept of a linguistic variable and its application to approximate reasoning-I. *Inf Sci* **8**(3), 199249 (1975)
50. Zhang, W. R.: Bipolar fuzzy sets and relations. A computational framework for cognitive modeling and multiagent decision analysis. In: *Proceedings of IEEE conference fuzzy information processing society biannual conference*, pp 305–309 (1994)
51. Zhang, W.R.: NPN fuzzy sets and NPN qualitative algebra: a computational framework for bipolar cognitive modeling and multiagent decision analysis. *IEEE Trans Syst Man Cybernet Part B Cybern* **26**(4), 561–574 (1996)
52. Zhang, W.R.: Bipolar fuzzy sets. *Fuzzy Syst Proc IEEE World Congr Comput Intell WR* **1**, 835840 (1998)
53. Zhang, H.Y., Wang, J.Q., Chen, X.H.: Interval neutrosophic sets and their applications in multi-criteria decision-making problems. *Sci World J* **2014**, 1–15 (2014)
54. Zhang, H.M., Xu, Z.S., Chen, Q.: On clustering approach to intuitionistic fuzzy sets. *Contr Decis* **22**, 882–888 (2007)
55. Zhao, H., Xu, Z.S., Ni, M.F., Lui, S.S.: Generalized aggregation operators for intuitionistic fuzzy sets. *Int J Intell Syst* **25**, 1–30 (2010)

Neutrosophic Modal Logic

Florentin Smarandache

Florentin Smarandache (2019). Neutrosophic Modal Logic. *Broad Research in Artificial Intelligence and Neuroscience* 10(2): 26-36

Abstract

We introduce now for the first time the neutrosophic modal logic. The Neutrosophic Modal Logic includes the neutrosophic operators that express the modalities. It is an extension of neutrosophic predicate logic and of neutrosophic propositional logic.

1. Introduction

The paper extends the fuzzy modal logic (Girle, 2010; Hájek & Harmancová, 1993; & Liao & Pen Lin, 1992), fuzzy environment (Hur et. al., 2006) and neutrosophic sets, numbers and operators (Liu et. al., 2014; Liu & Shi, 2015; Liu & Tang, 2016; Liu & Wang, 2016; Liu & Li, 2017; Liu & Tang, 2016; Liu et. al., 2016; Liu, 2016), together with the last developments of the neutrosophic environment {including (t, i, f) -neutrosophic algeb-raic structures, neutrosophic triplet structures, and neutrosophic overset / underset / offset} (Smarandache, 2016a; Smarandache & Ali, 2016; Smarandache, 2016b) passing through the symbolic neutrosophic logic (Smarandache, 2015), ultimately to neutrosophic modal logic.

This paper also answers Riviaccio's question on neutrosophic modalities.

All definitions, sections, and notions in-troduced in this paper were never done before, neither in my previous work nor in other researchers'.

Therefore, we introduce now the Neutrosophic Modal Logic and the Refined Neutrosophic Modal Logic. Then we can extend them to Symbolic Neutrosophic Modal Logic and Refined Symbolic Neutrosophic Modal Logic, using labels instead of numerical values.

There is a large variety of neutrosophic modal logics, as actually happens in classical modal logic too. Similarly, the neutrosophic accessibility relation and possible neutrosophic worlds have many interpretations, depending on each par-ticular application. Several neutrosophic modal applications are also listed.

Due to numerous applications of neutrosophic modal logic (see the examples throughout the paper), the introduction of the neutrosophic modal logic was needed.

Neutrosophic Modal Logic is a logic where some neutrosophic modalities have been included.

Let \mathcal{P} be a neutrosophic proposition. We have the following types of *neutrosophic modalities*:

I. Neutrosophic Alethic Modalities (related to truth) has three neutros-ophic operators:

Neutrosophic Possibility: It is neutros-ophically possible that \mathcal{P} .

Neutrosophic Necessity: It is neutros-ophically necessary that \mathcal{P} .

Neutrosophic Impossibility: It is neutros-ophically impossible that \mathcal{P} .

II. Neutrosophic Temporal Modalities (related to time)

It was the neutrosophic case that \mathcal{P} .

It will neutrosophically be that \mathcal{P} .

And similarly:

It has always neutrosophically been that \mathcal{P} .

It will always neutrosophically be that \mathcal{P} .

III. Neutrosophic Epistemic Modalities (related to knowledge):

It is neutrosophically known that \mathcal{P} .

IV. Neutrosophic Doxastic Modalities (related to belief):

It is neutrosophically believed that \mathcal{P} .

V. Neutrosophic Deontic Modalities:

It is neutrosophically obligatory that \mathcal{P} .

It is neutrosophically permissible that \mathcal{P} .

2. Neutrosophic Alethic Modal Operators

The modalities used in classical (alethic) modal logic can be neutrosophicated by inserting the indeterminacy.

We insert the *degrees of possibility* and *degrees of necessity*, as refinement of classical modal operators.

2.1. Neutrosophic Possibility Operator

The classical Possibility Modal Operator $\langle\langle \Diamond P \rangle\rangle$ meaning $\langle\langle$ It is possible that $P \rangle\rangle$ is extended to *Neutrosophic Possibility Operator*: $\diamond_N \mathcal{P}$ meaning $\langle\langle$ It is (t, i, f) -possible that $\mathcal{P} \rangle\rangle$, using Neutrosophic Probability, where $\langle\langle$ (t, i, f)-possible $\rangle\rangle$ means t % possible (chance that \mathcal{P} occurs), i % indeterminate (indeterminate-chance that \mathcal{P} occurs), and f % impossible (chance that \mathcal{P} does not occur).

If $\mathcal{P}(t_p, i_p, f_p)$ is a neutrosophic proposition, with t_p, i_p, f_p subsets of $[0, 1]$, then the neutrosophic truth-value of the neutrosophic possibility operator is:

$$\diamond_N \mathcal{P} = (\sup(t_p), \inf(i_p), \inf(f_p)), \tag{1}$$

which means that if a proposition P is t_p true, i_p indeterminate, and f_p false, then the value of the neutrosophic possibility operator $\diamond_N \mathcal{P}$ is: $\sup(t_p)$ possibility, $\inf(i_p)$ indeterminate-possibility, and $\inf(f_p)$ impossibility.

For example.

Let $P = \langle\langle$ It will be snowing tomorrow $\rangle\rangle$.

According to the meteorological center, the neutrosophic truth-value of \mathcal{P} is:

$$\mathcal{P}([0.5, 0.6], (0.2, 0.4), \{0.3, 0.5\}),$$

i.e. $[0.5, 0.6]$ true, $(0.2, 0.4)$ indeterminate, and $\{0.3, 0.5\}$ false.

Then the neutrosophic possibility operator is:

$$\diamond_N \mathcal{P} = (\sup[0.5, 0.6], \inf(0.2, 0.4), \inf\{0.3, 0.5\}) = (0.6, 0.2, 0.3),$$

i.e. 0.6 possible, 0.2 indeterminate-possibility, and 0.3 impossible.

2.2. Neutrosophic Necessity Operator

The classical Necessity Modal Operator $\langle\langle \Box P \rangle\rangle$ meaning $\langle\langle$ It is necessary that $P \rangle\rangle$ is extended to *Neutrosophic Necessity Operator*: $\Box_N \mathcal{P}$ meaning $\langle\langle$ It is (t, i, f) -necessary that $\mathcal{P} \rangle\rangle$, using again the Neutrosophic Probability, where similarly $\langle\langle$ (t, i, f)-necessity $\rangle\rangle$ means t % necessary (surety that \mathcal{P} occurs), i % indeterminate (indeterminate-surety that \mathcal{P} occurs), and f % unnecessary (unsurely that \mathcal{P} occurs).

If $\mathcal{P}(t_p, i_p, f_p)$ is a neutrosophic proposition, with t_p, i_p, f_p subsets of $[0, 1]$, then the neutrosophic truth value of the neutrosophic necessity operator is:

$$\Box_N \mathcal{P} = (\inf(t_p), \sup(i_p), \sup(f_p)), \tag{2}$$

which means that if a proposition \mathcal{P} is t_p true, i_p indeterminate, and f_p false, then the value of the neutrosophic necessity operator $\Box_N \mathcal{P}$ is: $\inf(t_p)$ necessary, $\sup(i_p)$ indeterminate-necessity, and $\sup(f_p)$ unnecessary.

Taking the previous *example*:

$\mathcal{P} = \langle\langle$ It will be snowing tomorrow $\rangle\rangle$, with $\mathcal{P}([0.5, 0.6], (0.2, 0.4), \{0.3, 0.5\})$,

then the neutrosophic necessity operator is:

$\square_N \mathcal{P} = (\inf[0.5, 0.6], \sup(0.2, 0.4), \sup\{0.3, 0.5\}) = (0.5, 0.4, 0.5)$,
 i.e. 0.5 necessary, 0.4 indeterminate-necessity, and 0.5 unnecessary.

2.3. Other Possibility and Necessity Operators

The previously defined neutrosophic pos-sibility and respectively neutrosophic necessity operators, for $\mathcal{P}(t_p, i_p, f_p)$ a neutrosophic propos-ition, with t_p, i_p, f_p subset-valued included in $[0, 1]$,

$$\diamond_N \mathcal{P} = (\sup(t_p), \inf(i_p), \inf(f_p)),$$

$$\square_N \mathcal{P} = (\inf(t_p), \sup(i_p), \sup(f_p)),$$

work quite well for subset-valued (including interval-valued) neutrosophic components, but they fail for single-valued neutrosophic components because one gets $\diamond_N \mathcal{P} = \square_N \mathcal{P}$.

Depending on the applications, more possibility and necessity operators may be defined.

Their definitions may work, mostly based on *max / min / min* for possibility operator and *min / max / max* for necessity operator (when dealing with single-valued neutrosophic components in $[0, 1]$), or based on *sup / inf / inf* for possibility operator and *inf / sup / sup* for necessity operator (when dealing with interval-valued or more general with subset-valued of neutrosophic components included in $[0, 1]$):

For examples.

Let $\mathcal{P}(t_p, i_p, f_p)$ be a neutrosophic proposition, with t_p, i_p, f_p single-valued of $[0, 1]$, then the neutrosophic truth-value of the neutrosophic possibility operator is:

$$\diamond_N \mathcal{P} = (\max\{t_p, 1-f_p\}, \min\{i_p, 1-i_p\}, \min\{f_p, 1-t_p\})$$

or

$$\diamond_N \mathcal{P} = (\max\{t_p, 1-t_p\}, \min\{i_p, 1-i_p\}, \min\{f_p, 1-f_p\})$$

or

$$\diamond_N \mathcal{P} = (1-f_p, i_p, f_p)$$

{defined by Anas Al-Masarwah}.

Let $\mathcal{P}(t_p, i_p, f_p)$ be a neutrosophic proposition, with t_p, i_p, f_p single-valued of $[0, 1]$, then the neutrosophic truth-value of the neutrosophic necessity operator is:

$$\square_N \mathcal{P} = (\min\{t_p, 1-f_p\}, \max\{i_p, 1-i_p\}, \max\{f_p, 1-t_p\})$$

or

$$\square_N \mathcal{P} = (\min\{t_p, 1-t_p\}, \max\{i_p, 1-i_p\}, \max\{f_p, 1-f_p\})$$

or

$$\square_N \mathcal{P} = (t_p, i_p, 1-t_p)$$

{defined by Anas Al-Masarwah}.

The above six defined operators may be extended from single-valued numbers of $[0, 1]$ to interval and subsets of $[0, 1]$, by simply replacing the subtractions of numbers by subtractions of intervals or subsets, and “*min*” by “*inf*”, while “*max*” by “*sup*”.

3. Connection between Neutrosophic Possibility Operator and Neutrosophic Necessity Operator

In classical modal logic, a modal operator is equivalent to the negation of the other:

$$\diamond P \leftrightarrow \neg \square \neg P, \tag{3}$$

$$\square P \leftrightarrow \neg \diamond \neg P. \tag{4}$$

In neutrosophic logic one has a class of neutrosophic negation operators. The most used one is:

$$\overline{\neg}_N P(t, i, f) = \overline{P}(f, 1 - i, t), \tag{5}$$

where t, i, f are real subsets of the interval $[0, 1]$.

Let’s check what’s happening in the neutros-ophic modal logic, using the previous *example*. One had:

$$\begin{aligned} & \mathcal{P}([0.5, 0.6], (0.2, 0.4), \{0.3, 0.5\}), \\ & \text{then} \\ \neg_N \mathcal{P} &= \bar{\mathcal{P}}(\{0.3, 0.5\}, 1 - (0.2, 0.4), [0.5, 0.6]) = \\ \bar{\mathcal{P}}(\{0.3, 0.5\}, & 1 - (0.2, 0.4), [0.5, 0.6]) = \\ & \bar{\mathcal{P}}(\{0.3, 0.5\}, (0.6, 0.8), [0.5, 0.6]). \end{aligned}$$

Therefore, denoting by \leftrightarrow_N the neutrosophic equivalence, one has:

$$\begin{aligned} \neg \square \neg \mathcal{P}([0.5, 0.6], (0.2, 0.4), \{0.3, 0.5\}) & \leftrightarrow_N \\ \leftrightarrow_N & \text{It is not neutrosophically necessary that «It will not be snowing tomorrow»} \\ \leftrightarrow_N & \text{It is not neutrosophically necessary that } \bar{\mathcal{P}}(\{0.3, 0.5\}, (0.6, 0.8), [0.5, 0.6]) \\ \leftrightarrow_N & \text{It is neutrosophically possible that } \neg \bar{\mathcal{P}}(\{0.3, 0.5\}, (0.6, 0.8), [0.5, 0.6]) \\ \leftrightarrow_N & \text{It is neutrosophically possible that } \mathcal{P}([0.5, 0.6], 1 - (0.6, 0.8), \{0.3, 0.5\}) \\ \leftrightarrow_N & \text{It is neutrosophically possible that } \mathcal{P}([0.5, 0.6], (0.2, 0.4), \{0.3, 0.5\}) \\ \leftrightarrow_N \diamond & \mathcal{P}([0.5, 0.6], (0.2, 0.4), \{0.3, 0.5\}) = (0.6, 0.2, 0.3). \end{aligned}$$

Let's check the second neutrosophic equivalence.

$$\begin{aligned} \neg \diamond \neg \mathcal{P}([0.5, 0.6], (0.2, 0.4), \{0.3, 0.5\}) & \leftrightarrow_N \\ \leftrightarrow_N & \text{It is not neutrosophically possible that «It will not be snowing tomorrow»} \\ \leftrightarrow_N & \text{It is not neutrosophically possible that } \bar{\mathcal{P}}(\{0.3, 0.5\}, (0.6, 0.8), [0.5, 0.6]) \\ \leftrightarrow_N & \text{It is neutrosophically necessary that } \neg \bar{\mathcal{P}}(\{0.3, 0.5\}, (0.6, 0.8), [0.5, 0.6]) \\ \leftrightarrow_N & \text{It is neutrosophically necessary that } \mathcal{P}([0.5, 0.6], 1 - (0.6, 0.8), \{0.3, 0.5\}) \\ \leftrightarrow_N & \text{It is neutrosophically necessary that } \mathcal{P}([0.5, 0.6], (0.2, 0.4), \{0.3, 0.5\}) \\ \leftrightarrow_N \square & \mathcal{P}([0.5, 0.6], (0.2, 0.4), \{0.3, 0.5\}) = (0.6, 0.2, 0.3). \end{aligned}$$

4. Neutrosophic Modal Equivalences

Neutrosophic Modal Equivalences hold within a certain accuracy, depending on the definitions of neutrosophic possibility operator and neutros-ophic necessity operator, as well as on the definition of the neutrosophic negation – employed by the experts depending on each application. Under these conditions, one may have the following neutrosophic modal equivalences:

$$\diamond_N \mathcal{P}(t_p, i_p, f_p) \leftrightarrow \neg \square \neg \mathcal{P}(t_p, i_p, f_p) \tag{6}$$

$$\square_N \mathcal{P}(t_p, i_p, f_p) \leftrightarrow \neg \diamond \neg \mathcal{P}(t_p, i_p, f_p) \tag{7}$$

For example, other definitions for the *neutros-ophic modal operators* may be:

$$\diamond_N \mathcal{P}(t_p, i_p, f_p) = (\sup(t_p), \sup(i_p), \inf(f_p)), \tag{8}$$

or

$$\diamond_N \mathcal{P}(t_p, i_p, f_p) = (\sup(t_p), \frac{i_p}{2}, \inf(f_p)) \text{ etc.}, \tag{9}$$

while

$$\square_N \mathcal{P}(t_p, i_p, f_p) = (\inf(t_p), \inf(i_p), \sup(f_p)), \tag{10}$$

or

$$\Box_N \mathcal{P}(t_p, i_p, f_p) = (\inf(t_p), 2i_p \cap [0,1], \sup(f_p)) \quad (11)$$

etc.

5. Neutrosophic Truth Threshold

In neutrosophic logic, first we have to introduce a *neutrosophic truth threshold*, $TH = \langle T_{th}, I_{th}, F_{th} \rangle$, where T_{th}, I_{th}, F_{th} are subsets of $[0, 1]$. We use uppercase letters (T, I, F) in order to distinguish the neutrosophic components of the threshold from those of a proposition in general.

We can say that the proposition $\mathcal{P}(t_p, i_p, f_p)$ is *neutrosophically true* if:

$$\inf(t_p) \geq \inf(T_{th}) \text{ and } \sup(t_p) \geq \sup(T_{th}); \quad (12)$$

$$\inf(i_p) \leq \inf(I_{th}) \text{ and } \sup(i_p) \leq \sup(I_{th}); \quad (13)$$

$$\inf(f_p) \leq \inf(F_{th}) \text{ and } \sup(f_p) \leq \sup(F_{th}). \quad (14)$$

For the particular case when all T_{th}, I_{th}, F_{th} and t_p, i_p, f_p are single-valued numbers from the interval $[0, 1]$, then one has:

The proposition $\mathcal{P}(t_p, i_p, f_p)$ is *neutrosophically true* if:

$$t_p \geq T_{th};$$

$$i_p \leq I_{th};$$

$$f_p \leq F_{th}.$$

The neutrosophic truth threshold is established by experts in accordance to each application.

6. Neutrosophic Semantics

Neutrosophic Semantics of the *Neutrosophic Modal Logic* is formed by a *neutrosophic frame* G_N , which is a *non-empty neutrosophic set*, whose elements are called *possible neutrosophic worlds*, and a *neutrosophic binary relation* \mathcal{R}_N , called *neutrosophic accesibility relation*, between the possible neutrosophic worlds. By notation, one has:

$$\langle G_N, \mathcal{R}_N \rangle.$$

A neutrosophic world w'_N that is neutrosophically accessible from the neutrosophic world w_N is symbolized as:

$$w_N \mathcal{R}_N w'_N.$$

In a *neutrosophic model* each neutrosophic proposition \mathcal{P} has a *neutrosophic truth-value* $(t_{w_N}, i_{w_N}, f_{w_N})$ respectively to each *neutrosophic world* $w_N \in G_N$, where $t_{w_N}, i_{w_N}, f_{w_N}$ are subsets of $[0, 1]$.

A *neutrosophic actual world* can be similarly noted as in classical modal logic as $w_N *$.

Formalization

Let S_N be a set of neutrosophic propositional variables.

7. Neutrosophic Formulas

1. Every neutrosophic propositional variable $\mathcal{P} \in S_N$ is a neutrosophic formula.

2. If A, B are neutrosophic formulas, then $\neg_N A, A \overset{\wedge}{\underset{N}{\cap}} B, A \overset{\vee}{\underset{N}{\cup}} B, A \overset{\rightarrow}{\underset{N}{\Rightarrow}} B, A \overset{\leftrightarrow}{\underset{N}{\Leftrightarrow}} B$, and $\diamond_N A, \Box_N A$, are also neutrosophic formulas, where $\neg_N, \overset{\wedge}{\underset{N}{\cap}}, \overset{\vee}{\underset{N}{\cup}}, \overset{\rightarrow}{\underset{N}{\Rightarrow}}, \overset{\leftrightarrow}{\underset{N}{\Leftrightarrow}}$ and \diamond_N, \Box_N represent the neutrosophic negation, neutrosophic intersection, neutrosophic union, neutrosophic implication, neutrosophic equivalence, and neutrosophic possibility operator, neutrosophic necessity operator respectively.

8. Accesibility Relation in a Neutrosophic Theory

Let G_N be a set of neutrosophic worlds w_N such that each w_N characterizes the propositions (formulas) of a given neutrosophic theory τ .

We say that the neutrosophic world w'_N is accesible from the neutrosophic world w_N , and we write: $w_N \mathcal{R}_N w'_N$ or $\mathcal{R}_N(w_N, w'_N)$, if for any proposition (formula) $\mathcal{P} \in w_N$, meaning the neutrosophic truth-value of \mathcal{P} with respect to w_N is

$$\mathcal{P}(t_p^{w_N}, i_p^{w_N}, f_p^{w_N}),$$

one has the neutrosophic truth-value of \mathcal{P} with respect to w'_N

$$\mathcal{P}(t_p^{w'_N}, i_p^{w'_N}, f_p^{w'_N}),$$

where

$$\inf(t_p^{w'_N}) \geq \inf(t_p^{w_N}) \text{ and } \sup(t_p^{w'_N}) \geq \sup(t_p^{w_N}); \quad (15)$$

$$\inf(i_p^{w'_N}) \leq \inf(i_p^{w_N}) \text{ and } \sup(i_p^{w'_N}) \leq \sup(i_p^{w_N}); \quad (16)$$

$$\inf(f_p^{w'_N}) \leq \inf(f_p^{w_N}) \text{ and } \sup(f_p^{w'_N}) \leq \sup(f_p^{w_N}) \quad (17)$$

(in the general case when $t_p^{w_N}, i_p^{w_N}, f_p^{w_N}$ and $t_p^{w'_N}, i_p^{w'_N}, f_p^{w'_N}$ are subsets of the interval $[0, 1]$).

But in the instant of $t_p^{w_N}, i_p^{w_N}, f_p^{w_N}$ and $t_p^{w'_N}, i_p^{w'_N}, f_p^{w'_N}$ as single-values in $[0, 1]$, the above inequalities become:

$$t_p^{w'_N} \geq t_p^{w_N}, \quad (18)$$

$$i_p^{w'_N} \leq i_p^{w_N}, \quad (19)$$

$$f_p^{w'_N} \leq f_p^{w_N}. \quad (20)$$

9. Applications

If the neutrosophic theory τ is the Neutros-ophic Mereology, or Neutrosophic Gnosisology, or Neutrosophic Epistemology etc., the neutrosophic accesibility relation is defined as above.

9.1. Neutrosophic n-ary Accesibility Relation

We can also extend the classical *binary* accesibility relation \mathcal{R} to a *neutrosophic n-ary accesibility relation*

$$\mathcal{R}_N^{(n)}, \text{ for } n \text{ integer } \geq 2.$$

Instead of the classical $R(w, w')$, which means that the world w' is accesible from the world w , we generalize it to:

$$\mathcal{R}_N^{(n)}(w_{1N}, w_{2N}, \dots, w_{nN}; w'_N),$$

which means that the neutrosophic world w'_N is accesible from the neutrosophic worlds $w_{1N}, w_{2N}, \dots, w_{nN}$ all together.

9.2. Neutrosophic Kripke Frame

$k_N = \langle G_N, R_N \rangle$ is a neutrosophic Kripke frame, since:

i. G_N is an arbitrary non-empty neutrosophic set of *neutrosophic worlds*, or *neutrosophic states*, or *neutrosophic situations*.

ii. $R_N \subseteq G_N \times G_N$ is a *neutrosophic accesibility relation* of the neutrosophic Kripke frame. Actually, one has a degree of accesibility, degree of indeterminacy, and a degree of non-accesibility.

9.3. Neutrosophic (t, i, f)-Assignment

The Neutrosophic (t, i, f) -Assignment is a neutrosophic mapping

$$v_N: S_N \times G_N \rightarrow [0,1] \times [0,1] \times [0,1] \quad (21)$$

where, for any neutrosophic proposition $\mathcal{P} \in S_N$ and for any neutrosophic world w_N , one defines:

$$v_N(\mathcal{P}, w_N) = (t_p^{w_N}, i_p^{w_N}, f_p^{w_N}) \in [0,1] \times [0,1] \times [0,1] \quad (22)$$

which is the neutrosophical logical truth value of the neutrosophic proposition \mathcal{P} in the neutros-ophic world w_N .

9.4. Neutrosophic Deducibility

We say that the neutrosophic formula \mathcal{P} is neutrosophically deducible from the neutrosophic Kripke frame k_N , the neutrosophic (t, i, f) – assignment v_N , and the neutrosophic world w_N , and we write as:

$$k_N, v_N, w_N \vDash_N \mathcal{P}. \quad (23)$$

Let's make the notation:

$\alpha_N(\mathcal{P}; k_N, v_N, w_N)$

that denotes the neutrosophic logical value that the formula \mathcal{P} takes with respect to the neutrosophic Kripke frame k_N , the neutrosophic (t, i, f) -assignment v_N , and the neutrosophic world w_N .

We define α_N by neutrosophic induction:

1. $\alpha_N(\mathcal{P}; k_N, v_N, w_N) \stackrel{def}{=} v_N(\mathcal{P}, w_N)$ if $\mathcal{P} \in S_N$ and $w_N \in G_N$.
2. $\alpha_N(\neg_N \mathcal{P}; k_N, v_N, w_N) \stackrel{def}{=} \neg_N [\alpha_N(\mathcal{P}; k_N, v_N, w_N)]$.
3. $\alpha_N(\mathcal{P} \wedge_N Q; k_N, v_N, w_N) \stackrel{def}{=} [\alpha_N(\mathcal{P}; k_N, v_N, w_N)] \wedge_N [\alpha_N(Q; k_N, v_N, w_N)]$
4. $\alpha_N(\mathcal{P} \vee_N Q; k_N, v_N, w_N) \stackrel{def}{=} [\alpha_N(\mathcal{P}; k_N, v_N, w_N)] \vee_N [\alpha_N(Q; k_N, v_N, w_N)]$
5. $\alpha_N(\mathcal{P} \rightarrow_N Q; k_N, v_N, w_N) \stackrel{def}{=} [\alpha_N(\mathcal{P}; k_N, v_N, w_N)] \rightarrow_N [\alpha_N(Q; k_N, v_N, w_N)]$
6. $\alpha_N(\diamond_N \mathcal{P}; k_N, v_N, w_N) \stackrel{def}{=} \langle \sup, \inf, \inf \rangle \{ \alpha_N(\mathcal{P}; k_N, v_N, w'_N), w' \in G_N \text{ and } w_N R_N w'_N \}$.
7. $\alpha_N(\square_N \mathcal{P}; k_N, v_N, w_N) \stackrel{def}{=} \langle \inf, \sup, \sup \rangle \{ \alpha_N(\mathcal{P}; k_N, v_N, w'_N), w'_N \in G_N \text{ and } w_N R_N w'_N \}$.
8. $\vDash_N \mathcal{P}$ if and only if $w_N * \vDash \mathcal{P}$ (a formula \mathcal{P} is neutrosophically deducible if and only if \mathcal{P} is neutrosophically deducible in the actual neutrosophic world).

We should remark that α_N has a degree of truth (t_{α_N}), a degree of indeterminacy (i_{α_N}), and a degree of falsehood (f_{α_N}), which are in the general case subsets of the interval $[0, 1]$.

Applying $\langle \sup, \inf, \inf \rangle$ to α_N is equivalent to calculating:

$$\langle \sup(t_{\alpha_N}), \inf(i_{\alpha_N}), \inf(f_{\alpha_N}) \rangle,$$

and similarly

$$\langle \inf, \sup, \sup \rangle \alpha_N = \langle \inf(t_{\alpha_N}), \sup(i_{\alpha_N}), \sup(f_{\alpha_N}) \rangle.$$

10. Refined Neutrosophic Modal Single-Valued Logic

Using neutrosophic (t, i, f) - thresholds, we refine for the first time the neutrosophic modal logic as:

10.1. Refined Neutrosophic Possibility Operator

$\diamond_{N1} \mathcal{P}_{(t,i,f)} = \langle\langle$ It is very little possible (degree of possibility t_1) that $\mathcal{P}\rangle\rangle$, corresponding to the threshold (t_1, i_1, f_1) , i.e. $0 \leq t \leq t_1, i \geq i_1, f \geq f_1$, for t_1 a very little number in $[0, 1]$;

$\diamond_{N2} \mathcal{P}_{(t,i,f)} = \langle\langle$ It is little possible (degree of possibility t_2) that $\mathcal{P}\rangle\rangle$, corresponding to the threshold (t_2, i_2, f_2) , i.e. $t_1 < t \leq t_2, i \geq i_2 > i_1, f \geq f_2 > f_1$;

... ..

and so on;

$\diamond_{Nm} \mathcal{P}_{(t,i,f)} = \langle\langle$ It is possible (with a degree of possibility t_m) that $\mathcal{P}\rangle\rangle$, corresponding to the threshold (t_m, i_m, f_m) , i.e. $t_{m-1} < t \leq t_m, i \geq i_m > i_{m-1}, f \geq f_m > f_{m-1}$.

10.2. Refined Neutrosophic Necessity Operator

$\square_{N1} \mathcal{P}_{(t,i,f)} = \langle\langle$ It is a small necessity (degree of necessity t_{m+1}) that $\mathcal{P}\rangle\rangle$, i.e. $t_m < t \leq t_{m+1}, i \geq i_{m+1} \geq i_m, f \geq f_{m+1} > f_m$;

$\square_{N2} \mathcal{P}_{(t,i,f)} = \langle\langle$ It is a little bigger necessity (degree of necessity t_{m+2}) that $\mathcal{P}\rangle\rangle$, i.e. $t_{m+1} < t \leq t_{m+2}, i \geq i_{m+2} > i_{m+1}, f \geq f_{m+2} > f_{m+1}$;

... ..

and so on;

$\square_{Nk} \mathcal{P}_{(t,i,f)} = \langle\langle$ It is a very high necessity (degree of necessity t_{m+k}) that $\mathcal{P}\rangle\rangle$, i.e. $t_{m+k-1} < t \leq t_{m+k} = 1, i \geq i_{m+k} > i_{m+k-1}, f \geq f_{m+k} > f_{m+k-1}$.

11. Application of the Neutrosophic Threshold

We have introduced the term of (t, i, f) -physical law, meaning that a physical law has a degree of truth (t), a degree of indeterminacy (i), and a degree of falsehood (f). A physical law is 100% true, 0% indeterminate, and 0% false in perfect (ideal) conditions only, maybe in laboratory.

But our actual world (w_N^*) is not perfect and not steady, but continuously changing, varying, fluctuating.

For example, there are physicists that have proved a universal constant (c) is not quite universal (i.e. there are special conditions where it does not apply, or its value varies between $(c - \epsilon, c + \epsilon)$, for $\epsilon > 0$ that can be a tiny or even a bigger number).

Thus, we can say that a proposition \mathcal{P} is *neutrosophically nomological necessary*, if \mathcal{P} is neutrosophically true at all possible neutrosophic worlds that obey the (t, i, f) -physical laws of the actual neutrosophic world w_N^* .

In other words, at each possible neutrosophic world w_N , neutrosophically accessible from w_N^* , one has:

$$\mathcal{P}(t_p^{w_N}, i_p^{w_N}, f_p^{w_N}) \geq TH(T_{th}, I_{th}, F_{th}), \tag{24}$$

$$\text{i.e. } t_p^{w_N} \geq T_{th}, i_p^{w_N} \leq I_{th}, \text{ and } f_p^{w_N} \geq F_{th}. \tag{25}$$

12. Neutrosophic Mereology

Neutrosophic Mereology means the theory of the neutrosophic relations among the parts of a whole, and the neutrosophic relations between the parts and the whole.

A neutrosophic relation between two parts, and similarly a neutrosophic relation between a part and the whole, has a degree of connectivity (t), a degree of indeterminacy (i), and a degree of disconnectibility (f).

12.1. Neutrosophic Mereological Threshold

Neutrosophic Mereological Threshold is defined as:

$$TH_M = (\min(t_M), \max(i_M), \max(f_M)) \quad (26)$$

where t_M is the set of all degrees of connectivity between the parts, and between the parts and the whole;

i_M is the set of all degrees of indeterminacy between the parts, and between the parts and the whole;

f_M is the set of all degrees of disconnectibility between the parts, and between the parts and the whole.

We have considered all degrees as single-valued numbers.

13. Neutrosophic Gnosisology

Neutrosophic Gnosisology is the theory of (t, i, f) -knowledge, because in many cases we are not able to completely (100%) find whole knowledge, but only a part of it (t %), another part remaining unknown (f %), and a third part indeterminate (unclear, vague, contradictory) (i %), where t, i, f are subsets of the interval $[0, 1]$.

13.1. Neutrosophic Gnosisological Threshold

Neutrosophic Gnosisological Threshold is defined, similarly, as:

$$TH_G = (\min(t_G), \max(i_G), \max(f_G)) \quad (27)$$

where t_G is the set of all degrees of knowledge of all theories, ideas, propositions etc.,

i_G is the set of all degrees of indeterminate-knowledge of all theories, ideas, propositions etc.,

f_G is the set of all degrees of non-knowledge of all theories, ideas, propositions etc.

We have considered all degrees as single-valued numbers.

14. Neutrosophic Epistemology

And *Neutrosophic Epistemology*, as part of the Neutrosophic Gnosisology, is the theory of (t, i, f) -scientific knowledge. Science is infinite. We know only a small part of it (t %), another big part is yet to be discovered (f %), and a third part indeterminate (unclear, vague, contradictory) (i %). Of course, t, i, f are subsets of $[0, 1]$.

14.1. Neutrosophic Epistemological Threshold

Neutrosophic Epistemological Threshold is defined as:

$$TH_E = (\min(t_E), \max(i_E), \max(f_E)) \quad (28)$$

where t_E is the set of all degrees of scientific knowledge of all scientific theories, ideas, propositions etc.,

i_E is the set of all degrees of indeterminate scientific knowledge of all scientific theories, ideas, propositions etc.,

f_E is the set of all degrees of non-scientific knowledge of all scientific theories, ideas, propositions etc.

We have considered all degrees as single-valued numbers.

15. Conclusions

We have introduced for the first time the Neutrosophic Modal Logic and the Refined Neutrosophic Modal Logic.

Symbolic Neutrosophic Logic can be connected to the neutrosophic modal logic too, where instead of numbers we may use labels, or instead of quantitative neutrosophic logic we may have a quantitative neutrosophic logic. As an extension, we may introduce *Symbolic Neutrosophic Modal Logic* and *Refined Symbolic Neutrosophic Modal Logic*, where the symbolic neutrosophic modal operators (and the symbolic neutrosophic accessibility relation) have qualitative values (labels) instead on numerical values (subsets of the interval $[0, 1]$).

Applications of neutrosophic modal logic are to neutrosophic modal metaphysics. Similarly to classical modal logic, there is a plethora of neutrosophic modal logics. Neutrosophic modal logics is governed by a set of neutrosophic axioms and neutrosophic rules. The neutrosophic accessibility relation has various interpretations, depending on the applications. Similarly, the notion of possible neutrosophic worlds has many interpretations, as part of possible neutrosophic semantics.

References

- Girole, R. (2010). *Modal Logics and Philosophy*, 2nd ed., McGill-Queen's University Press.
- Hájek, P., & Harmanová, D. (1993). *A comparative fuzzy modal logic*, in *Fuzzy Logic in Artificial Intelligence*, Lecture Notes in AI 695: 27-34.
<http://meetings.aps.org/Meeting/GEC16/Session/HT6.111>
- Hur, K., Kang, H. W., & Lee, K. C. (2006). *Fuzzy equivalence relations and fuzzy partitions*, *Honam Math. J.* 28: 291-315.
- Liau, C. J., & Lin, B. I-Pen (1992). *Quantitative Modal Logic and Possibilistic Reasoning*, 10th European Conference on Artificial Intelligence, 43-47.
- Liu, P. (2016). *The aggregation operators based on Archimedean t-conorm and t-norm for the single valued neutrosophic numbers and their application to Decision Making*, *Int. J. Fuzzy Syst.*, 18(5): 849–863.
- Liu, P. D., & Li, H. G. (2017). *Multiple attribute decision making method based on some normal neutrosophic Bonferroni mean operators*, *Neural Computing and Applications*, 28(1), 179-194.
- Liu, P. D., & Shi, L. L. (2015). *The Generalized Hybrid Weighted Average Operator Based on Interval Neutrosophic Hesitant Set and Its Application to Multiple Attribute Decision Making*, *Neural Computing and Applications*, 26(2): 457-471.
- Liu, P. D., & Tang, G. L. (2016). *Some power generalized aggregation operators based on the interval neutrosophic numbers and their application to decision making*, *Journal of Intelligent & Fuzzy Systems* 30: 2517–2528.
- Liu, P. D., & Wang, Y. M. (2016). *Interval neutrosophic prioritized OWA operator and its application to multiple attribute decision making*, *Journal of Systems Science & Complexity*, 29(3): 681-697.
- Liu, P. D., Chu, Y. C., Li, Y. W., & Chen, Y.B. (2014). *Some generalized neutrosophic number Hamacher aggregation operators and their application to Group Decision Making*, *Int. J. Fuzzy Syst.*, 16(2): 242-255.
- Liu, P., & Tang, G. (2016). *Multi-criteria group decision-making based on interval neutrosophic uncertain linguistic variables and Choquet integral*, *Cognitive Computation*, 8(6), 1036-1056.
- Liu, P., Zhang, L., Liu, X., & Wang, P. (2016). *Multi-valued Neutrosophic Number Bonferroni mean Operators and Their Application in Multiple Attribute Group Decision Making*, *International Journal of Information Technology & Decision Making* 15(5), 1181–1210.
- Smarandache, F. (2015). *Symbolic Neutrosophic Theory*, EuropaNova, Brussels, 2015.

- Smarandache, F. (2016a). Neutrosophic Overset, Neutrosophic Underset, and Neutrosophic Offset. Pons Editions, Brussels, <https://arxiv.org/ftp/arxiv/papers/1607/1607.00234.pdf>
- Smarandache, F. (2016b). *Neutrosophic Overset, Neutrosophic Underset, and Neutrosophic Offset. Similarly for Neutrosophic Over-/Under-/Off- Logic, Probability, and Statistics*, 168 p., Pons Editions, Brussels.
- Smarandache, F. (2016, May 23-27). *(t, i, f)-Physical Laws and (t, i, f)-Physical Constants*, 47th Annual Meeting of the APS Division of Atomic, Molecular and Optical Physics, Providence, Rhode Island, Volume 61, Number 8, Monday-Friday.
- Smarandache, F., & Ali, M. (2016). Neutrosophic Triplet as extension of Matter Plasma, Unmatter Plasma, and Antimatter Plasma, 69th Annual Gaseous Electronics Conference, Bochum, Germany, Volume 61, Number 9, Monday-Friday, <https://arxiv.org/ftp/arxiv/papers/1512/1512.00047.pdf>.

Shortest Path Problem in Fuzzy, Intuitionistic Fuzzy and Neutrosophic Environment: An Overview

Said Broumi, Mohamed Talea, Assia Bakali, Florentin Smarandache,
Deivanayagampillai Nagarajan, Malayalan Lathamaheswari, Mani Parimala

Said Broumi, Mohamed Talea, Assia Bakali, Florentin Smarandache, Deivanayagampillai Nagarajan, Malayalan Lathamaheswari, Mani Parimala (2019). Shortest Path Problem in Fuzzy, Intuitionistic Fuzzy and Neutrosophic Environment: An Overview. *Complex & Intelligent Systems* 5: 371-378

Abstract

In the last decade, concealed by uncertain atmosphere, many algorithms have been studied deeply to workout the shortest path problem. In this paper, we compared the shortest path problem with various existing algorithms. Finally, we concluded the best algorithm for certain environment.

Keywords Fuzzy sets · Intuitionistic fuzzy sets · Vague sets · Neutrosophic sets · Shortest path problem

Introduction

SPP is a cardinal issue among familiar connective problems which occur in different areas of engineering and science, such as application in highway networks, portage and conquer in intelligence channels and problem of scheduling. The SPP focuses on recommending the path which has minimum length enclosed by two vertices. The length of the arc/edge produces the quantities of the real life, namely cost, time, etc. In the case of conventional method of measuring SP, the length of each bend is assumed as a crisp numbers. If there is uncertainty on the parameters in the network, then the length can be represented by fuzzy number.

In the current preceding, many of the SPPs with various types of input data have been examined in junction with

fuzzy, intuitionistic, vague, interval fuzzy, interval-valued intuitionistic fuzzy and neutrosophic sets [2, 3, 8, 9, 11, 13, 14, 17–20, 23, 30, 39, 46–52, 83–92]. Up until now plenty of new algorithms have been designed.

The paper is arranged as: section “**Preliminaries**” comprehends the primary definitions and overviewed SPP under different sets in sections, “**SPP in vague environment**”, “**SPP in fuzzy environment**”, “**SPP in intuitionistic fuzzy environment**” and “**SPP in neutrosophic environment**”, respectively. Lastly, conclusion has been presented for the objective of the paper.

Preliminaries

Here, we principally recollected some of the concepts connected to neutrosophic sets (NSs), single-valued neutrosophic sets (SVNSs) related to the present work. See especially [10, 12] for further details and background.

Definition 2.1. Let X be a nonempty set. A fuzzy set A drawn from X is defined as,

$$A = \{x, \mu_A(x) | x \in X\}, \tag{1}$$

where $\mu_A : X \rightarrow [0, 1]$, is called the membership function of A and defined over a universe of discourse X .

Definition 2.2. A type-2 fuzzy set, denoted by \bar{A} is characterized by a type-2 membership function $\mu_{\bar{A}}(x, u)$, where $x \in X, u \in J_x \subseteq [0, 1]$, i.e.,

$$\bar{A} = \{(x, u), \mu_{\bar{A}}(x, u) | x \in X, \forall u \in J_x \subseteq [0, 1]\}. \tag{2}$$

Definition 2.3. An interval-valued fuzzy set is a special case of type-2 fuzzy sets by representing the membership function $\mu_{\bar{A}} = [\underline{\mu}_{\bar{A}}, \overline{\mu}_{\bar{A}}]$, where $\underline{\mu}_{\bar{A}}$ is a lower membership function and $\overline{\mu}_{\bar{A}}$ is an upper membership function. The area between these lower and upper membership functions is called a footprint of uncertainty (FOU), which represents the level of uncertainty of the set.

Definition 2.4. Let X be a nonempty set. An intuitionistic fuzzy set (IFS) A in X is an object having the form

$$A = \{x, \mu_A(x), \nu_A(x) | x \in X\}, \tag{3}$$

where the functions $\mu_A(x), \nu_A(x) : X \rightarrow [0, 1]$ define the degree of membership and nonmembership, respectively, of the element $x \in X$ to A , for the entire element $x \in X$ $0 \leq \mu_A(x) + \nu_A(x) \leq 1$. Also, $\pi_A(x) = 1 - \mu_A(x) - \nu_A(x)$ is called the index of IFS, and is the degree of indeterminacy of $x \in X$ to the IFS A , which expresses the lack of knowledge of whether x belongs to IFS or not. Also $\pi_A(x) \in [0, 1]$, i.e., $\pi_A(x) : X \rightarrow [0, 1]$ and $0 \leq \pi_A(x) \leq 1, \forall x \in X$.

Definition 2.5. An interval-valued intuitionistic fuzzy set (IVIFS) A in X is defined as an object of the form

$$A = \{x, P_A(x), Q_A(x) | x \in X\}, \tag{4}$$

where the functions $P_A(x) : X \rightarrow [0, 1], Q_A(x) : X \rightarrow [0, 1]$ denote the degree of membership and non-membership of A , respectively. Also, $P_A(x) = [P_A^L(x), P_A^U(x)]$ and $Q_A(x) = [Q_A^L(x), Q_A^U(x)], 0 \leq P_A^U(x) + Q_A^U(x) \leq 1, \forall x \in X$

Definition 2.6. Let U be the universe, $U = \{x_1, x_2, \dots, x_n\}$, with a generic element of U denoted by $x_i, i = 1, 2, \dots, n$.

A vague set is defined as an object of the form $A = \{\langle x_i, T_A(x_i), F_A(x_i) \rangle | x_i \in X\}$ in U is characterized by a truth membership function T_A and a false membership function F_A , i.e., $T_A : U \rightarrow [0, 1], F_A : U \rightarrow [0, 1]$, where $T_A(x_i)$ is the lower bound on the grade of membership of x_i , $F_A(x_i)$ is the lower bound on the negation of x_i , derived from the evidence against x_i and $T_A(x_i) + F_A(x_i) \leq 1$. The grade of membership of x_i in the vague set A is bounded to the subinterval $[T_A(x_i), 1 - F_A(x_i)]$ of the interval $[0, 1]$. The vague value $[T_A(x_i), 1 - F_A(x_i)]$ indicates that the exact grade of membership $\mu_A(x_i)$ of x_i may be unknown. But it is bounded by $T_A(x_i) \leq \mu_A(x_i) \leq 1 - F_A(x_i)$.

Definition 2.7. An interval-valued vague set A over a universe of discourse X is defined as an object of the form $A = \{\langle x_i, [T_A^L, T_A^U], [F_A^L, F_A^U] \rangle | x_i \in X\}$, where $0 \leq T_A^L \leq T_A^U \leq 1$ and $0 \leq F_A^L \leq F_A^U \leq 1$. For each interval-valued vague set A , $\pi_A(x_i) = 1 - T_A^L(x_i) - F_A^L(x_i)$ and are called degree of hesitancy of x_i .

Definition 2.8 Consider the space X consists of universal elements characterized by x . The NS A is a phenomenon which has the structure $A = \{(T_A(x), I_A(x), F_A(x)) / x \in X\}$, where the three grades of memberships are from X to $]^{-}0, 1^{+}$ of the element $x \in X$ to the set A , with the criterion:

$$^{-}0 \leq T_A(x) + I_A(x) + F_A(x) \leq 3^{+}. \tag{5}$$

The functions, and are the truth, indeterminate and falsity grades which lie in real standard/non-standard subsets of $]^{-}0, 1^{+}$. Since there is a complication of applying NSs to realistic issues, Samarandache and Wang et al. [11, 12] proposed the notion of SVNS, which is a specimen of NS and it is useful for realistic applications of all the fields.

Definition 2.9. Let X be the space of objects which contains global elements. A SVNS is represented by degrees of membership grades mentioned in Definition 2.1. For all x in X , $T_A(x), I_A(x), F_A(x) \in [0, 1]$. A SVNS can be written as

$$A = \{x : T_A(x), I_A(x), F_A(x) > / x \in X\} \tag{6}$$

Definition 3. Let X be a space of objects with generic elements in X denoted by x . An interval-valued neutrosophic set (IVNS) A in X is characterized by truth membership function, $T_A(x)$, indeterminacy membership function $I_A(x)$ and falsity membership function $F_A(x)$. For each point x in X , $T_A(x), I_A(x), F_A(x) \in [0, 1]$, and an IVNS A is defined by

$$A = \{\langle [T_A^L(x), T_A^U(x)], [I_A^L(x), I_A^U(x)], [F_A^L(x), F_A^U(x)] \rangle | x \in X\}, \tag{7}$$

where $T_A(x) = [T_A^L(x), T_A^U(x)], I_A(x) = [I_A^L(x), I_A^U(x)]$ and $F_A(x) = [F_A^L(x), F_A^U(x)]$.

SPP in vague environment

A peculiar way for getting a shortest path (SP) of a given network was found by Dou et al. [26]. in 2008, where the sets are vague. Firstly, the authors recommended that the length of the SP was determined using vague sets from the source node (SN) to the destination node (DN) for conventional network with direction. Secondly, they calculated the degree of resemblance among the lengths of the vague paths under vague similarity measure. Finally, it was concluded that the path which has the greater degree of similarity is a SP. A novel algorithm was constructed to identify the SP in a directed graph (DG), where the distance between the arcs is considered as vague number in triangular measure rather than real number. In 2018, Rashmanlou et al. solved SPP using Euclidean distance for vague network [57].

SPP in fuzzy environment

This part describes about various methods to solve SPP using fuzzy arc length by many authors. SPP can be solved in an optimized way for a given network using fuzzy logic as the real-world problems are uncertain in nature. Dubois and Prade solved fuzzy SPP (FSPP) using Floyd's and Ford's algorithms firstly [5]. In the year 2000, Okada and Soper introduced an algorithm to solve FSPP in terms of multiple labeling procedure [32]. Klein [27] projected a vital programming fuzzy algorithm based on recursive concept. Lin [41] constructed a technique of fuzzy linear programming to find the fuzzy SP (FSPP) length of a network. Yao [42] contemplated two different FSPP such as SPP using triangular fuzzy numbers (TFNs) and SPP using level $(1-\beta, 1-\alpha)$ interval-valued fuzzy numbers (IVFNs).

In 2003, the same author solved FSSP using two different types of methods, namely TFNs and level $(1-\beta, 1-\alpha)$ interval-valued FNs (IVFNs). Nayeem and Pal introduced an algorithm to solve SPP using notoriety index, where the lengths of the arc were taken as interval numbers or TFNs [44]. In the year 2005, Chuang recommended a novel idea to identify FSP by finding the length of the FSP encompassed by all possible paths of a given network [38]. Kung et al. established new technique to handle FSPP by representing the arc length as TFN [40]. In 2009, Yadav and Biswas conferred a new method to solve SPP by considering the edge length as FN in a directed graph instead of real number. The authors constructed an algorithm to discover an optimal path by considering that both input and output are FNs [22]. Also in the same period, Lin solved SPP using interval-valued FNs and endorsed

distance method of defuzzification [62]. In 2010, Pandian and Rajendran introduced path classification algorithm to find the minimal path by considering crisp or uncertain weights (TFNs) from one node to another. In this method, indeterminate nodes in the minimum path can be found without going backward and this is the major advantage. This would be very helpful for the decision-makers to omit indeterminate nodes [28]. Seda presented all-pairs SPP by applying fuzzy ranking method [25]. In 2012, Meenakshi and Kaliraja determined SP for IVFN (Interval Valued Fuzzy Network) [61].

In 2013, Shukla projected Floyd's algorithm to solve SPP using a concept of fuzzy sets which is based on graded mean unification of FNs [21]. In 2014, Elizabeth and Sujatha introduced a novel approach to solve FSPP by finding minimum arithmetic mean among IVFN matrices [31]. The same authors Huyen et al. gave a direction on establishing a design for SPP with TFNs as the edge weights. In this work, mathematical concept of the algorithm is developed on Defined Strict Comparative Relation Function for the set of TFNs [56]. Nayeem proposed a novel expected value algorithm for the FSSP [60].

In 2015, Mukerje [34] explored the fuzzy approach programming to solve FSPP. Here, the authors converted a single-objective fuzzy linear programming (SOFLP) by considering TFNs and TpFNs as the edge weight into crisp multi-objective Linear Programming (CMOLP). Anusuya and Sathya proposed a design for SPP where the arc lengths are type-2 fuzzy numbers (T2FNs) from SN to DN in a network [54]. Also, the authors established an algorithm for SPP using type reduction on the edges using centroid and center of gravity of FS which gives the FSP where the arc lengths are represented by discrete T2FN [55]. Mahdavi et al. [16] applied dynamic programming method for finding the shortest chain in a fuzzy network. In [33] Okada solved FSPPs by incorporating interactivity among path. Deng et al. [53] established fuzzy Dijkstra algorithm for solving SPP under uncertain environment. Dey et al. have contributed the following ideas: solved FSPP using IT2FSs (interval type-2 fuzzy set) as the edge weights, they have altered conventional Dijkstra's design by including impreciseness using IT2FSs to solve SPP from SN to DN, afford a new way for SPP in imprecise setting using IT2FSs for the edge weights and examined the path algebra and its generalized algorithm for FSPP [6]. Meenakshi and Kaliraja described the SP for a network under the notion of interval valued fuzzy (IVF) where the SP in lower limit fuzzy networks coexists with the case for upper limit [7]. In 2016, Dey et al. introduced a model to solve FSPP for using Interval Type-2 Fuzzy (IT2F) [59]. In 2017, Biswas proposed IVFSP in a multi-graph [63]. In 2018, Eshaghnezhad et al. presented a first scientific paper for resolving of FSP by artificial network model which has the property of the global exponential stability [82].

SPP in intuitionistic fuzzy environment

In this part, various methods have been disclosed in literature to handle the SPP by taking intuitionistic fuzzy (IF) as the arc lengths by different authors.

In 2007, Karunambigai et al. refined an approach found on dynamic programming to solve SPP using intuitionistic fuzzy graphs (IFGs) [24]. In 2010, Gani also established a technique to identify intuitionistic fuzzy shortest path (IFSP) for a given network [3]. Mukherje pre-owned an interesting methodology to solve IFSP using the idea of Dijkstra’s algorithm and intuitionistic fuzzy hybrid Geometric (IFHG) operator [45]. Majudmder and Pal [30] solved SPP for intuitionistic fuzzy network. In 2013, Biswas modified an IF method for SPP in a realistic multi-graph [35]. Rangasamy et al. proposed score-based methodology to find the shortest hyper paths for a given network where hyper edges are characterized by IF weights without describing similarity measure and Euclidean distance [43]. Babacioru conferred an algorithm to find the minimum arc length of an IF hyper path using MAPLE [15]. In [29], Jayagowri and GeethaRamani solved SPP on a network with the use of Trapezoidal Intuitionistic Fuzzy Numbers (TpFNs). In 2014, Porchelvi and Sudha recommended a minimum path labeling algorithm to solve SPP using triangular IF number (TIFN) [36]. Also, they proposed a new and different methodology to solve SPP with TIFNs, where the authors found the minimal edge using IF distance by applying graded mean integration and examined SPP from a particular vertex to all other ones in a network [37]. In 2015, Kumar et al. suggested a design to identify the SP and shortest distance in an IVIF graph where the nodes are taken as crisp numbers and edge weights are assigned by IVITpFNs (Interval Valued Intuitionistic Trapezoidal Fuzzy Numbers) [1]. Kumar et al. proposed an algorithm for SPP using IVITpFN as the weights in a network [58].

SPP in neutrosophic environment

The authors modeled a design to find the ideal path where the inputs and outputs are neutrosophic numbers (NNs) [4]. In 2016, Broumi et al. solved SPP, by considering the edge weights as, SVTpNNs as the edge weights [68], Triangular fuzzy neutrosophic numbers (TFNNs) [69], bipolar neutrosophic set [70] and applied Dijkstra’s method to solve NSPP and IVNSPP [67, 72]. In 2017, Broumi et al. solved SPP using SVNGs [64], by adopting SVTNNs and SVTpNNs [65, 66]; found an optimal solution for the NSPP using trapezoidal data under neutrosophic

environment [68], by SVNN; solved the MST problem [73], by Trapezoidal fuzzy neutrosophic [74]; introduced a new notion of matrix design for MST in IVNG [79]; and introduced computational method to MST in IV bipolar neutrosophic setting [80]. Also in [75], Broumi et al. proposed another algorithm to solve MST problem on a network with the use of SVTpNNs. Broumi et al. [76] solved MST problem in a bipolar neutrosophic environment. Mullai et al. solved SPP by minimal spanning tree (MST) using BNS [77]. In 2018, Broumi et al. applied IVNNs and BNS SPP for a given network [70, 71]. Dey et al. proposed a novel design for MST for NGs which are undirected [78]. Jeyanthi and Radhika [81] solved NSPP using Floyd’s algorithm firstly. Basset et al. proposed a hybrid approach of neutrosophic sets and DEMATEL method for developing the criteria for supplier selection [83]. Basset et al. introduced a novel method, to solve the fully neutrosophic linear programming problems [84]. Basset et al. proposed three-way decisions based on neutrosophic sets and AHP-QFD framework for the problem supplier selection [85]. Basset et al. proposed a novel framework to evaluate cloud computing services [86]. Basset et al. introduced an extension of neutrosophic AHP-SWOT analysis for strategic planning and decision-making [87]. Basset et al. proposed an approach of hybrid neutrosophic multiple criteria group decision-making for project selection. [88]. Basset et al. proposed a framework for a group decision-making problem, based on neutrosophic VIKOR approach for e-government website evaluation [89]. Basset et al. proposed an economic tool for quantifying risks in supply chain as a framework for risk assessment, management and evaluation [90].

The following table confers four types of SPP containing FSPP, IFSP and neutrosophic SPP (NSPP) and for the case of interval numbers to all the types of parameters.

Short-est path problem on network with	Edges/ vertices	Indeterminacy	Ambiguity	Uncertainty
Crisp parameters	Crisp Number (CN)	Inadequate to handle	Inadequate to handle	Inadequate to handle
Crisp Interval Parameters	Crisp Interval Number (IN)	Inadequate to handle	Inadequate to handle	Inadequate to handle
Fuzzy parameters (FPs)	Fuzzy Number (FN)	Unable to deal	Unable to deal	Able to deal with uncertainty

Short-est path problem on network with	Edges/vertices	Indeterminacy	Ambiguity	Uncertainty
Interval FPs	Interval Fuzzy Number (IFN)	Unable to deal	Unable to deal	Able to deal with more uncertainty, as it has lower and upper membership values
Intuitionistic fuzzy parameters (IFPs)	Intuitionistic Fuzzy Number (IFN)	Inadequate to deal	Adequate to deal	Adequate to deal
Interval IFPs	Interval Intuitionistic Fuzzy Number (IFN)	Inadequate to deal	Adequate to deal clearly as it has lower and upper membership values	Adequate to deal more uncertainty as it has lower and upper membership functions
Neutrosophic parameters (NPs)	Neutrosophic Number (NN)	Able to handle	Able to handle	Able to handle
Interval NPs	Interval Neutrosophic Number (INN)	Able to handle more indeterminacy	Able to handle more ambiguity	Able to handle more uncertainty as it has lower and upper membership functions.

From the overhead table, it is seen that the available methods could not be employed to solve NSPP from SN to DN for a given network with IVNN as the edge weights.

But neutrosophic environment can be able to solve SPP effectively as it handles indeterminacy together with impreciseness and ambiguity to take the best decision in identifying the SP with the use of IVNN rather than single-valued NN. Effortlessly, the proposed algorithm can be adapted to any kind of NNs.

As the neutrosophic logic deals with indeterminacy with the collected/given information, the algorithms proposed to find SPP may be the best one than other algorithms under fuzzy and intuitionistic fuzzy environments.

Advantages and limitations of different types of sets

The below table expresses the capacity of various types of sets as an advantage and their incapability to handle some conditions or important situations towards to realistic problems.

Various types of sets	Advantages	Limitations
Crisp sets	Can accurately determine with no hesitation	Cannot describe the uncertain information
Fuzzy sets	Can describe the uncertain information	Cannot describe the uncertain information with non-membership degree
Interval valued fuzzy sets	Can be able to deal interval data instead of exact data	Cannot handle the uncertain information with non-membership degree
Intuitionistic fuzzy sets	Can describe the uncertain information with membership (MS) and non-membership (NMS) degrees simultaneously	Cannot describe the sum of MS and NMS degrees bigger than 1
Interval valued Intuitionistic fuzzy sets	Able to handle interval data	Cannot portray the addition of MS and NMS degrees bigger than 1
Vague sets	Can describe uncertain information with grades of MS and NMS at the same time.	Cannot describe the sum of MS and NMS degrees greater than 1.
Pythagorean fuzzy sets	It has full space to describe the sum of MS and NMS degrees greater than 1	Cannot describe the square sum of MS and NMS degrees greater than 1
Interval valued Pythagorean fuzzy sets	Capable of dealing interval data	Unable to define the square sum of MS and NMS degrees greater than 1
Neutrosophic Sets	Able to deal with indeterminacy of the data and the optimized solution can be obtained completely.	Unable to handle interval data
Interval valued Neutrosophic sets	Able to deal with indeterminacy of the interval data and the optimized solution can be obtained.	Unable to handle incomplete weight information

Conclusion

Crisp SPP (CSPP) can be adopted only if there exists certainty on the parameters of nodes and edges. If uncertainty exists in the arc, then the authors have been recommended to use FSPP. Later, FSPPs cannot be enforced for the certain message which is not endured and indecisive, and so the investigation invented the concept of IFSP. Further when the information about the path is indetermined, uncertain and unreliable, neutrosophic concept has been implemented and obtained the solution for neutrosophic shortest path problem in the literature. All the existing algorithms developed by the reserachers. The algorithms have been used for various real world problems but occasionally not suitable for persuade situations. Hence, the recognized algorithms in various sets such as vague set (VS), FS, IFS and NS are forced. In real world, the researcher who has clear knowledge about the data can accept and implement the algorithms for solving SPP. This paper will be very helpful to the new researchers to propose novel concepts to solve the shortest path problem. In the future, based on this present study, new algorithms and frameworks will be designed to find the shortest path for a given network under various types of sets environments.

References

1. Kumar A, Kaur M (2011) A new algorithm for solving shortest path problem on a network with imprecise edge weight. *Appl Appl Math* 6(2):602–619
2. Kumar A, Kaur M (2011) Solution of fuzzy maximal flow problems using fuzzy linear programming. *World Acad Sci Technol* 87:28–31
3. Gani AN (2010) On searching intuitionistic fuzzy shortest path in a network. *Appl Math Sci* 69(4):3447–3454
4. Thamaraiselvi A, Santhi R (2016) A new approach for optimization of real life transportation problems in neutrosophic environment. *Math Problems Eng*. <https://doi.org/10.1155/2016/5950747>
5. Dubois D, Prade H (1980) *Fuzzy sets and systems: theory and application*. Academic Press, New York
6. Dey A, Pal A, Pal T (2016) Interval type 2 fuzzy set in fuzzy shortest path problem. *Mathematics* 4(62):1–19
7. Meenakshi AR, Kaliraja M (2012) Determination of the shortest path in interval valued fuzzy networks. *Int J Math Arch* 3(6):2377–2384
8. Smarandache F (2015) Refined literal indeterminacy and the multiplication law of sub-indeterminacies. *Neutrosophic Sets Syst* 9:58–63
9. Smarandache F (2015) Types of Neutrosophic Graphs and neutrosophic Algebraic Structures together with their Applications in Technology, seminar. Universitatea Transilvania din Brasov, Facultatea de Design de Produsii Mediu, Brasov, Romania 06 June 2015
10. Smarandache F (2006) Neutrosophic set—a generalization of the intuitionistic fuzzy set, *Granular Computing*. IEEE Int Conf 2006:38–42
11. Smarandache F (2011) A geometric interpretation of the neutrosophic set—a generalization of the intuitionistic fuzzy set, *Granular Computing (GrC)*. IEEE Int Conf 2011:602–606
12. Wang H, Smarandache F, Zhang Y, Sunderraman R (2010) Single valued neutrosophic sets. *Multispace Multistruct* 4:410–413
13. Wang H, Smarandache F, Zhang YQ, Sunderraman R (2005) Interval neutrosophic sets and logic: theory and applications in computing. Hexis, Phoenix
14. Turksen I (1986) Interval valued fuzzy sets based on normal forms. *Fuzzy Sets Syst* 20:191–210
15. Barbacioru IC (2016) Using maple for determination minimum arc length of an intuitionistic fuzzy hyperpath. *Ann Constantin Brzncusi Univ Targu Jiu Eng Ser* 4:81–85
16. Mahdavi I, Nourifar R, Heidarzade A, Amiri NM (2009) A dynamic programming approach for finding shortest chains in a fuzzy network. *Appl Soft Comput* 9:503–511
17. Ye J (2014) Single-valued neutrosophic minimum spanning tree and its clustering method. *J Intell Syst* 23(3):311–324
18. Atanassov K (1986) Intuitionistic fuzzy sets. *Fuzzy Sets Syst* 20:87–96
19. Atanassov K (1999) *Intuitionistic fuzzy sets: theory and applications*. Physica, New York
20. Atanassov K, Gargov G (1989) Interval valued intuitionistic fuzzy sets. *Fuzzy Sets Syst* 31:343–349
21. Shukla KT (2013) Fuzzy Floyd's algorithm to find shortest route between nodes under uncertain environment. *Int J Math Comput Appl Res* 3(5):34–54
22. Yadav K, Biswas R (2009) On searching fuzzy shortest path in a network. *Int J Recent Trends Eng* 2(3):16–18
23. Zadeh L (1965) Fuzzy sets. *Inform Control* 8:338–353
24. Karunambigai MG, Rangasamy P, Atanassov K, Palaniappan N (2007) An intuitionistic fuzzy graph method for finding the shortest path in networks. *Adv Soft Comput* 42:3–10
25. Seda (2006), Fuzzy all-pair shortest path problem. In: *Proceedings of the computational intelligence, theory and applications international conference 9th fuzzy days in Dortmund*, September 18–20, Germany, pp 395–404
26. Dou Y, Guo H, Zho J (2008) On the shortest path to solve the problem base on vague sets. In: *Fifth international conference on fuzzy systems and knowledge discovery IEEE, 2008*, pp.85–89
27. Klein CM (1991) Fuzzy shortest paths. *Fuzzy Sets Syst* 39:27–41
28. Pandian P, Rajendran P (2010) A new algorithm for Minimum path in a network. *Appl Math Sci* 4(54):2697–2710
29. Jayagowri P, GeethaRamani G (2014) Using trapezoidal intuitionistic fuzzy number to find optimized path in a network. *Adv Fuzzy Syst*. <https://doi.org/10.1155/2014/183607>
30. Majumder S, Pal A (2013) Shortest path problem on intuitionistic fuzzy network. *Ann Pure Appl Math* 5(1):26–36
31. Elizabeth S, Sujatha L (2014) Fuzzy shortest path problem based on interval valued fuzzy numbers matrices. *IJMSEA* 8(1):325–335
32. Okada S, Soper T (2000) A shortest path problem on network with fuzzy arc length. *Fuzzy Sets Syst* 109:129–140

33. Okada S (2004) Fuzzy shortest path problems incorporating interactivity among path. *Fuzzy Sets Syst* 142:335–357
34. Mukherjee S (2015) Fuzzy programming technique for solving the shortest path problem on networks under triangular and trapezoidal fuzzy environment. *Int J Math Oper Res* 7:549–576
35. Biswas SS, Alam B, Doja MN (2013) Real time multigraph for communication network: an intuitionistic fuzzy mathematical Model. *J Comput Sci* 9(7):847–855
36. Porchelvi S, Sudha G (2014) A new approach for finding Minimum path in a network using triangular intuitionistic fuzzy number. *Int J Curr Res* 6(8):8103–8109
37. Porchelvi RS, Sudha G (2014) Modified Approach on shortest path in intuitionistic fuzzy environment. *Indian J Appl Res* 4(9):341–342
38. Chuang TN, Kung JY (2005) The fuzzy shortest path length and the corresponding shortest path in a network. *Comput Oper Res* 32:1409–1428
39. Chuang TN, Kung JY (2006) A new algorithm for the discrete shortest path problem in a network. *Appl Math Comput* 174:1660–1668
40. Kung JY, Hsiang TN, Lin CT (2006) Decision making on a network problem with fuzzy arc length, IMACS multicongress on computational engineering in System Application (CESA), October 4-6. Beijing, China
41. Lin K, Chen M (1994) The fuzzy shortest path problem and its most vital arcs. *Fuzzy Sets Syst* 58:343–353
42. Yao JS, Lin FT (2003) Fuzzy shortest path network problems with uncertain edge weights. *J Inf Sci Eng* 19:329–351
43. Rangasamy P, Akram M, Thilagavathi S (2013) Intuitionistic fuzzy shortest hyperpath in a network. *Inf Process Lett* 113:599–603
44. Nayeem SM, Pal M (2005) Shortest path problem on a network with imprecise edge weight. *Fuzzy Optim Decis Mak* 4:293–312
45. Mukherjee S (2012) Dijkstra's algorithm for solving the shortest path problem on networks under intuitionistic fuzzy environment. *J Math Model Algorithm* 11:345–359
46. Broumi S, Talea M, Bakali A, Smarandache F (2016) Single valued neutrosophic graphs. *J New Theory N* 10:86–101
47. Broumi S, Talea M, Bakali A, Smarandache F (2016) On bipolar single valued neutrosophic graphs. *J New Theory N* 11:84–102
48. Broumi S, Talea M, Bakali A, Smarandache F (2016) Interval valued neutrosophic graphs. In: *SISOM & ACOUSTICS 2016*, Bucharest 12–13 May, pp 79–91
49. Broumi S, Bakali A, Talea M, Smarandache F (2016) Isolated single valued neutrosophic graphs. *Neutrosophic Sets Syst* 11:74–78
50. Broumi S, Smarandache F, Talea M, Bakali A (2016) An introduction to bipolar single valued neutrosophic graph theory. *Appl Mech Mater* 841:184–191
51. Broumi S, Talea M, Smarandache F, Bakali A (2016) Single valued neutrosophic graphs: degree, order and size. In: *IEEE international conference on fuzzy systems (FUZZ)*, pp 2444–2451
52. Broumi S, Smarandache F (2014) New distance and similarity measures of interval neutrosophic sets. In: *Information fusion (FUSION), 2014 IEEE 17th international conference*, pp 1–7
53. Deng Y, Zhang Y, Mahadevan S (2012) Fuzzy Dijkstra algorithm for shortest path problem under uncertain environment. *Appl Soft Comput* 12:1231–1237
54. Anusuya V, Sathya R (2013) Type-2 fuzzy shortest path. *Int J Fuzzy Math Arch* 2:36–42
55. Anusuya V, Sathya R (2014) Type reduction on fuzzy shortest path problem. *IJMCAR* 4(6):53–60
56. Huyen VTT, Luan NT, Tuan LM (2014) Fuzzy shortest path algorithm based on comparative relation. *Int J Comput Sci Netw Security* 14(5):20–25
57. Rashmanlou O, Sahoo S, Borzoei RA, Pal M, Lakdashti A (2018) Computation of shortest path in a vague network by euclidean distance. *J Multi Valued Logic Soft Comput* 30:115–123
58. Kumar G, Balaji RK, Gandotra N (2015) Algorithm for shortest path problem in a network with interval-valued intuitionistic trapezoidal fuzzy number. *Proc Comput Sci* 70:123–129
59. Dey A, Pal A, Pal T (2016) Interval type-2 fuzzy set in fuzzy shortest path problem. *Math Project Fuzzy Shortest Path Problem* 4(62):1–19
60. Nayeem SKA (2014) A new expected value model for the FSSP. *Adv Intell Syst Comput* 236:209–215
61. Meenakshi AR, Kaliraja M (2012) Determination of shortest path in interval valued fuzzy networks. *Int J Math Arch* 3(6):2377–2384
62. Lin FT (2009) Shortest path problem based on interval-valued fuzzy numbers and signed distance defuzzification method. In: *2009 Fourth international conference on innovative computing, information and control*, pp 605–608
63. Biswas SS (2017) Interval valued fuzzy shortest path in a multigraph, oriental. *J Comput Sci Technol* 10(2):364–370
64. Broumi S, Bakali A, Talea M, Smarandache F (2017) Shortest path problem on single valued neutrosophic graphs. In: *2017 International symposium on networks, computers and communications*, pp 1–8
65. Broumi S, Bakali A, Talea M, Smarandache F, Vladareanu L (2016) Computation of shortest path problem in a network, with SV-trapezoidal neutrosophic numbers. In: *Proceedings of the 2016 international conference on advanced mechatronic systems*, Melbourne, Australia, pp 417–422
66. Broumi S, Bakali A, Talea M, Smarandache F (2017) Shortest path problem in a network with SV-triangular neutrosophic numbers. In: *2017 IEEE international conference on innovations in intelligent systems and applications*, Gdynia, Poland, 2017, pp 426–431
67. Broumi S, Bakali A, Talea M, Smarandache F (2016) Applying Dijkstra algorithm for solving neutrosophic shortest path problem. In: *Proceedings of the 2016, international conference on advanced mechatronics systems*, Melbourne, Australia, 2016, pp 412–416
68. Broumi S, Bakali A, Talea M, Smarandache F (2017) Shortest path problem under trapezoidal neutrosophic information. In: *Computing conference, 2017*, pp 142–148
69. Broumi S, Bakali A, Talea M, Smarandache F, Vladareanu L (2016) Shortest path problem under triangular fuzzy neutrosophic information. In: *10th International conference on software, knowledge, information management and applications*, pp 169–174
70. Broumi S, Bakali A, Talea M, Smarandache F, Ali M (2016) Shortest path problem under bipolar neutrosophic setting. *Appl Mech Mater* 859:59–66
71. Broumi S, Bakali A, Talea M, Smarandache F, Krishnan Kishore KP, Sahin R (2018) Shortest path problem under interval valued neutrosophic setting. *J Fundam Appl Sci* 10(4S):168–174
72. Broumi S, Talea M, Bakali A, Smarandache F (2016) Application of Dijkstra algorithm for solving interval valued neutrosophic shortest path problem. In: *IEEE symposium series on computational intelligence*, pp 1–6
73. Broumi S, Bakali A, Talea M, Smarandache F, Dey A, Son L (2018) Spanning tree problem with neutrosophic edge weights. *Proc Comput Sci* 127:190–199
74. Broumi S, Bakali A, Talea M, Smarandache F, Ulucay V (2017) Minimum spanning tree in trapezoidal fuzzy neutrosophic environment. In: *8th international conference on innovations in bio-inspired computing and applications*, pp 25–35

75. Broumi S, Talea M, Bakali A, Smarandache F, Patro SK (2019) Minimum spanning tree problem with single-valued trapezoidal neutrosophic numbers. *Adv Intell Syst Comput* 857:93–105
76. Broumi S, Talea M, Bakali M, Smarandache F, Ullah K (2018) Bipolar neutrosophic minimum spanning tree. *Smart Appl Data Anal Smart Cities* 2:201–206
77. Mullai M, Broumi S, Stephen A (2017) Shortest path problem by minimal spanning tree algorithm using bipolar neutrosophic numbers. *Int J Math Trends Technol* 46(2):80–87
78. Dey A, Broumi S, Son LH, Bakali A, Talea M, Smarandache F (2018) A new algorithm for finding minimum spanning trees with undirected neutrosophic graphs. *Granular Comput* 4(1):63–69
79. Broumi S, Bakali A, Talea M, Smarandache F, Kishore Kumar PK (2017) A new concept of matrix algorithm for MST in undirected interval valued neutrosophic graph. In: *Neutrosophic operational research, vol II*. Pons Publishing House, Brussels, Belgium
80. Broumi S, Bakali A, Talea M, Smarandache F, Verma R (2017) Computing minimum spanning tree in interval valued bipolar neutrosophic environment. *Int J Model Optim* 7(5):300–304
81. Jeyanthi V, Radhika VS (2018) Applying Floyd's algorithm for solving neutrosophic shortest path problems. *Int J Math Trends Technol* 61(1):58–63
82. Eshaghezhad M, Rahbarnia F, Effati S, Mansoori A (2018) An artificial neural network model to solve the fuzzy shortest path problem. *Neural Process Lett*. <https://doi.org/10.1007/s11063-018-9945-y>
83. Abdel-Basset M, Gunasekaran M, Mohamed M, Chilamkurti N (2019) A framework for risk assessment, management and evaluation: economic tool for quantifying risks in supply chain. *Future Gener Comput Syst* 90:489–502
84. Basset MA, Mohamed M, Sangaiah AK, Jain V (2018) An integrated neutrosophic AHP and SWOT method for strategic planning methodology selection. *Benchmarking Int J* 25(7):2546–2564
85. Abdel-Basset M, Mohamed M, Smarandache F (2018) A hybrid neutrosophic group ANP-TOPSIS framework for supplier selection problems. *Symmetry* 10(6):226
86. Abdel-Basset M, Mohamed M, Smarandache F (2018) An extension of neutrosophic AHP–SWOT analysis for strategic planning and decision-making. *Symmetry* 10(4):116
87. Abdel-Basset M, Mohamed M, Smarandache F, Chang V (2018) Neutrosophic association rule mining algorithm for big data analysis. *Symmetry* 10(4):106
88. Abdel-Basset M, Mohamed M, Chang V (2018) NMCDA: a framework for evaluating cloud computing services. *Future Gener Comput Syst* 86:12–29
89. Abdel-Basset M, Zhou Y, Mohamed M, Chang V (2018) A group decision making framework based on neutrosophic VIKOR approach for e-government website evaluation. *J Intell Fuzzy Syst* 34(6):4213–4224
90. Abdel-Basset M, Mohamed M, Zhou Y, Hezam I (2017) Multi-criteria group decision making based on neutrosophic analytic hierarchy process. *J Intell Fuzzy Syst* 33(6):4055–4066
91. Abdel-Basset M, Mohamed M (2018) The role of single valued neutrosophic sets and rough sets in smart city: imperfect and incomplete information systems. *Measurement* 124:47–55
92. Abdel-Basset M, Manogaran G, Gamal A, Smarandache F (2018) A hybrid approach of neutrosophic sets and DEMATEL method for developing supplier selection criteria. *Design Autom Embed Syst* 22(3):257–278

Interval Valued Neutrosophic Shortest Path Problem by A* Algorithm

S. Krishna Prabha, Said Broumi, Florentin Smarandache

S. Krishna Prabha, Said Broumi, Florentin Smarandache (2020). Interval Valued Neutrosophic Shortest Path Problem by A* Algorithm. *International Journal of Neutrosophic Science* 11(1): 53-61

Abstract

Many researchers have been proposing various algorithms to unravel different types of fuzzy shortest path problems. There are many algorithms like Dijkstra's, Bellman-Ford, Floyd-Warshall and Kruskal's etc are existing for solving the shortest path problems. In this work a shortest path problem with interval valued neutrosophic numbers is investigated using the proposed algorithm. A* algorithm is extensively applied in pathfinding and graph traversal. Unlike the other algorithms mentioned above, A* algorithm entails heuristic function to uncover the cost of path that traverses through the particular state. In the structured work A* algorithm is applied to unravel the length of the shortest path by utilizing ranking function from the source node to the destination node. A* algorithm is executed by applying best first search with the help of this search, it greedily decides which vertex to investigate subsequently. A* is equally complete and optimal if an acceptable heuristic is concerned. The arc lengths in interval valued neutrosophic numbers are defuzzified using the score function. A numerical example is used to illustrate the proposed approach.

Keywords: Heuristic function, Interval Valued Neutrosophic Graph, Score Function, Shortest Path Problem. Destination node, Source node.

1. Introduction

In order to overcome the real life situations which could not be handled in some conditions, Zadeh[1] introduced Fuzzy logic which was further developed by Zimmermann[2]. For handling uncertainty the interval valued neutrosophic set is used. The truth-membership, the indeterminacy-membership and the falsity-membership are characterized independently in interval valued neutrosophic set which are able to work with the information's which are conflicting, undetermined, and partial. The rational subdivision of studying the nature, origins, and scope of neutralities, in addition to interface with a variety of ideational spectra is phrased as neutrosophy. The extension of neutrosophic set to neutrosophic offset, underset, and overset was proposed by Smarandache[3]. Bipolar neutrosophic sets, simplified neutrosophic sets, interval valued neutrosophic sets, single valued neutrosophic sets etc are various extension of neutrosophic sets[4,5,6]. The single valued neutrosophic notion is helpful in a range of

fields, such as the decision making problem, medical diagnosis, etc. Various concepts in graph theory were introduced by combining single valued neutrosophic sets. The single valued neutrosophic graph is the simplification of fuzzy graphs and intuitionistic fuzzy graphs. An interval valued neutrosophic graph oversimplifies the notions of a fuzzy graph, an intuitionistic fuzzy graph, an interval valued fuzzy graph and a single valued neutrosophic graph. The most common topic in research is finding the shortest path of the graph by traversing the edges with different types of algorithms. By using the score function Broumi et. al. [7] proposed an algorithm to solve the neutrosophic shortest path problem where the network arc lengths are represented by interval valued neutrosophic numbers. Multiple labeling is applied for finding shortest path with intuitionistic fuzzy arc length by Jabarulla et.al[8]. Kumar and Kaur [9] provided the solution of fuzzy maximal flow problems using fuzzy linear programming. Garg et al. [10] have proposed the Hybrid model for medical diagnosis using Neutrosophic Cognitive Maps with Genetic Algorithms. An Algorithm for shortest path problem in a network with interval valued intuitionistic trapezoidal fuzzy number was presented by Kumar et al.[11]. Jayagowri et al. [12] used Trapezoidal Intuitionistic Fuzzy Number to Find Optimized Path in a Network. Broumi et al have dealt with various concepts of neutrosophic graphs like single valued neutrosophic graphs, on bipolar single valued neutrosophic graphs and interval valued neutrosophic graphs etc with different algorithms [13,14,15,16,17,18]. Various aspects of Neutrosophic Graphs were studied by Smarandache[19]. Pentagonal Neutrosophic Number and its Application in Networking Problem was proposed by Avishek Chakraborty [20]. Thamaraiselvi et al.[21] found a new approach for optimization of real life transportation problems in neutrosophic environment. Tuhin bera[22] gave an approach to solve the linear programming problem using single valued trapezoidal neutrosophic number. Sapan Kumar Das [23] have used neutrosophic numbers in integer programming. Edalatpanah [24] suggested a new technique to solve triangular neutrosophic linear programming . Majumdar et al.[25] has worked on shortest path problem on intuitionistic fuzzy network . Bhimraj basumatary[26] have unraveled the interval-valued triangular neutrosophic linear programming .There are many algorithms existing for solving the shortest path problems like Dijkstra’s, Bellman-Ford,Floyd-Warshall and kruskal’s etc for finding the optimal path . In this paper A * algorithm is applied for solving the interval valued neutrosophic shortest path problem.

A* algorithm is a best-first search algorithm that depends on an open list and a closed list to discover a path that is both optimal and complete towards the goal. A* search finds the shortest path through a search space to goal state using heuristic function. This technique finds minimal cost solutions and is directed to a goal state called A* search. This algorithm is complete if the branching factor is finite and every action has fixed cost. By defuzzifying the given interval valued neutrosophic cost by applying score function and by applying A* algorithm we find the optimal path.

This paper is organized as follows. In Section 2, the basic concepts about neutrosophic sets and interval valued neutrosophic graph is presented. In Section 3, A* algorithm is proposed to find the shortest path and distance in an interval valued neutrosophic graph. In Section 4 a numerical example is illustrated with the algorithm .Section 5 conclusion and proposals for future research is given.

2. Preliminaries[16]

Definition 2.1:

Let X be a space of points with generic elements in X denoted by x is the neutrosophic set A is an object having the form, $A = \{x : T_A(X), I_A(X), F_A(X)\}, x \in X$, where the functions $T, I, F : X \rightarrow]0, 1+[$ define respectively the truth-membership function, indeterminacy- membership function and falsity - membership function of the element $x \in X$ to the set A with the condition $0 \leq T_A(X) + I_A(X) + F_A(X) \leq 3^+$.The functions are real standard or non standard subsets of $]0, 1+[$.

Definition 2.2:

Let $R_N = \langle [R_T, R_I, R_M, R_E], [T_R, I_R, F_R] \rangle$ and $S_N = \langle [S_T, S_I, S_M, S_E], [T_S, I_S, F_S] \rangle$ be two trapezoidal neutrosophic numbers (TpNNs) and $\theta \geq 0$,then

$$R_N \oplus S_N = \langle [R_T + S_T, R_I + S_I, R_M + S_M, R_E + S_E] [T_R + T_S - T_R, T_S, I_R, I_S, F_R, F_S] \rangle$$

$$R_N \otimes S_N = \langle [R_T \cdot S_T, R_I \cdot S_I, R_M \cdot S_M, R_E \cdot S_E] [(T_R \cdot T_S, I_R + I_S - I_R \cdot I_S, F_R + F_S - F_R \cdot F_S)] \rangle$$

$$\theta R_N = \langle [\theta R_T, \theta R_I, \theta R_M, \theta R_E], (1 - (1 - T_R))^\theta, (I_R)^\theta, (F_R)^\theta \rangle$$

Definition 2.3:

Let X is a space of points (objects) with generic elements in X denoted by x. An interval valued neutrosophic set A (INS A) in X is shown by the truth- membership function $T_A(x)$, an indeterminacy-membership function $I_A(x)$, and a falsity-membership function $F_A(x)$. For each point x in X, there are $T_A(x) = [T_A^L, T_A^U] \subseteq [0, 1]$, $I_A(x) = [I_A^L, I_A^U] \subseteq [0, 1]$, $F_A(x) = [F_A^L, F_A^U] \subseteq [0, 1]$, and the sum $T_A(x)$, $I_A(x)$ and $F_A(x)$ satisfies the condition $0 \leq \sup T_A(x) + \sup I_A(x) + \sup F_A(x) \leq 3$, then an INS can be expressed as $A = \{ \langle x: T_A(x), I_A(x), F_A(x) \rangle, x \in X \}$

Definition 2.4:

$$\text{Let } \tilde{A}_1 = \langle [T_1^L, T_1^U], [I_1^L, I_1^U], [F_1^L, F_1^U] \rangle \text{ and } \tilde{A}_2 = \langle [T_2^L, T_2^U], [I_2^L, I_2^U], [F_2^L, F_2^U] \rangle$$

be two interval valued neutrosophic numbers and $l > 0$. Thus, the operational rules are defined as:

1. $\tilde{A}_1 \oplus \tilde{A}_2 = [T_1^L + T_2^L - T_1^L T_2^L, T_1^U + T_2^U - T_1^U T_2^U], [I_1^L I_2^L, I_1^U I_2^U], [F_1^L F_2^L, F_1^U F_2^U]$
2. $\tilde{A}_1 \otimes \tilde{A}_2 = [T_1^L T_2^L, T_1^U T_2^U], [I_1^L + I_2^L - I_1^L I_2^L, I_1^U + I_2^U - I_1^U I_2^U], [F_1^L + F_2^L - F_1^L F_2^L, F_1^U + F_2^U - F_1^U F_2^U]$
3. $\lambda \tilde{A} = \langle [1 - (1 - T_1^L)^\lambda, 1 - (1 - T_1^U)^\lambda], [(I_1^L)^\lambda, (I_1^U)^\lambda], [(F_1^L)^\lambda, (F_1^U)^\lambda] \rangle$
4. $\tilde{A}^\lambda = \langle [(T_1^L)^\lambda, (T_1^U)^\lambda], [1 - (1 - I_1^U)^\lambda, 1 - (1 - I_1^L)^\lambda], [1 - (1 - F_1^L)^\lambda, 1 - (1 - F_1^U)^\lambda] \rangle$, Where $\lambda > 0$

Definition 2.5: To compare between two IVNN, Ridvan [33] used a score function concept in 2014. The score function is used for comparing the IVNS grades. This function demonstrates that the greater the value, the greater the interval-valued neutrosophic sets, and through the use of this concept paths can be ranked.

Let $\tilde{A}_1 = (T_1, I_1, F_1)$ be an interval valued neutrosophic number, then, the score function $s(\tilde{A}_1)$ of an IVNN can be defined as follows:

$$S(\tilde{A}_1) = \left(\frac{1}{4}\right) \times [2 + T_1^L + T_1^U - 2I_1^L - 2I_1^U - F_1^L - F_1^U]$$

Comparison of interval valued neutrosophic numbers

Let $\tilde{A}_1 = (T_1, I_1, F_1)$ and $\tilde{A}_2 = (T_2, I_2, F_2)$ be two interval valued neutrosophic numbers then

- (i) $\tilde{A}_1 < \tilde{A}_2$ if $S(\tilde{A}_1) < S(\tilde{A}_2)$
- (ii) $\tilde{A}_1 > \tilde{A}_2$ if $S(\tilde{A}_1) > S(\tilde{A}_2)$
- (iii) $\tilde{A}_1 = \tilde{A}_2$ if $S(\tilde{A}_1) = S(\tilde{A}_2)$

3. Basic notations in A* search

f – f is the parameter of A* which is the sum of the other parameters G and H and is the least cost from one node to the next node. This parameter is responsible for helping us find the most optimal path from our source to destination. g – g is the cost of moving from one node to the other node. This parameter changes for every node as we move up to find the most optimal path.

h – h is the heuristic/estimated path between the current code to the destination node. This cost is not actual but is, in reality, a guess cost that we use to find which could be the most optimal path between our source and destination

3.1: Algorithm for A* Search

1. Locate the initial node on the list of ORIGIN.
2. If (ORIGIN is empty) or (ORIGIN = GOAL) terminate search.
3. Remove the first node from ORIGIN. Call this node as n.
4. If (n = GOAL) terminate search with success.
5. Else in case, if node a has successors, generate all of them. Find the fitness number of the successors by totaling the evaluation function value & the cost function value. Sort the list by fitness number.
6. Name the list as START.
7. Replace ORIGIN with START.

8. Go to step 2.

3.2: A* Pseudo Code

Let us have the following assumptions,

Let us denote the goal node as ng , node_current as nc , node_successor as nsc ,successor_current_cost as scc and source node is ns .

The nodes that have been evaluated by the heuristic function but not expanded into successors yet are collected in OPEN set.

The nodes that have been visited and expanded in CLOSE set.

1. Put ns in the OPEN list with $f(ns) = h(ns)$ (initialization)
2. While the OPEN list is not empty {
3. Take from the open list the node nc with the lowest
4. $f(nc) = g(nc) \oplus h(nc)$
5. if nc is ng we have found the solution; break
6. Generate each state nsc that come after nc
7. for each nsc of nc {
8. Set $scc = g(nc) \oplus w(nc, nsc)$
9. if ns is in the OPEN list {
10. if $g(ns) \leq scc$ then go to (line 20)
- 11.} else if nsc is in the CLOSED list {
12. if $g(nsc) \leq scc$ then go to (line 20)
13. Move nsc from the CLOSED list to the OPEN list
- 14.} else {
15. Add nsc to the OPEN list
16. Set $h(nsc)$ to be the heuristic distance to ng
- 17.}
18. Set $g(nsc) = scc$
19. Set the parent of nsc to nc
- 20.}
21. Add nc to the CLOSED list.
- 22.}
23. if($nc \neq ng$) exit with error (the OPEN list is empty)

4. Numerical Example

Consider the given interval valued neutrosophic shortest path problem with five edges with interval valued neutrosophic fuzzy weights as in Fig:1.

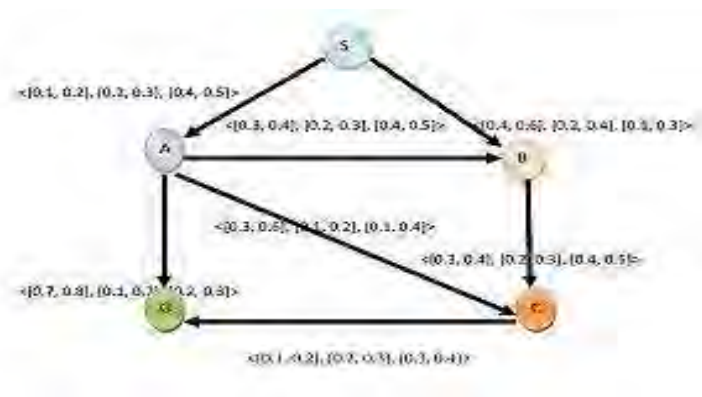

Fig.1.An interval valued neutrosophic shortest path problem

Let us take the interval valued neutrosophic fuzzy weight for the edge from S-A, by applying the score function formula we convert the interval valued neutrosophic fuzzy weights to crisp number,

$$\langle [0.1, 0.2], [0.2, 0.3], [0.4, 0.5] \rangle$$

$$\begin{aligned} S(A) &= \left(\frac{1}{4}\right) \times [2 + T_1^L + T_1^U - 2I_1^L - 2I_1^U - F_1^L - F_1^U] \\ &= \left(\frac{1}{4}\right) \times [2 + 0.1 + 0.2 - 2 \times 0.2 - 2 \times 0.3 - 0.4 - 0.5] \\ &= \left(\frac{1}{4}\right) \times [2.3 - 0.4 - 0.6 - 0.4 - 0.5] \\ &= \left(\frac{1}{4}\right) \times [0.4] = 0.1 \end{aligned}$$

Similarly by proceeding with the formula for score function, we can find the crisp values given in the table below.

Table:1. Interval valued Neutrosophic distance

Edges	Interval valued Neutrosophic distance	Crisp Values
S-A	$\langle [0.1, 0.2], [0.2, 0.3], [0.4, 0.5] \rangle$	0.1
S-B	$\langle [0.4, 0.6], [0.2, 0.4], [0.1, 0.3] \rangle$	0.35
A-B	$\langle [0.3, 0.4], [0.2, 0.3], [0.4, 0.5] \rangle$	0.2
B-C	$\langle [0.3, 0.4], [0.2, 0.3], [0.4, 0.5] \rangle$	0.2
A-C	$\langle [0.3, 0.6], [0.1, 0.2], [0.1, 0.4] \rangle$	0.45
A-G	$\langle [0.7, 0.8], [0.1, 0.2], [0.2, 0.3] \rangle$	0.6
C-G	$\langle [0.1, 0.2], [0.2, 0.3], [0.3, 0.4] \rangle$	0.15

After finding the crisp values and substituting in the corresponding paths we get,

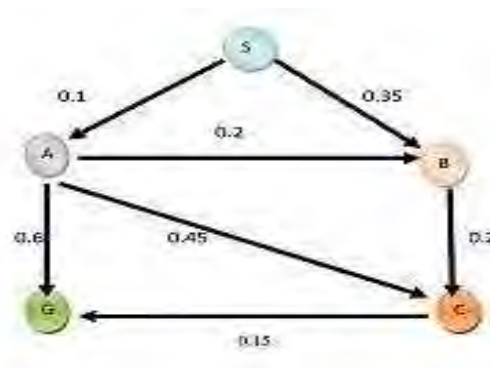

Fig.2. Crisp valued neutrosophic shortest path problem

Interval valued neutrosophic heuristic values to end nodes are given in the following table.2.

Table: 2. Heuristic values

Node	$h(n)$	Crisp $h(n)$
S	$\langle [0.9, 0.8], [0.1, 0.2], [0.2, 0.3] \rangle$	0.65
A	$\langle [0.7, 0.8], [0.1, 0.2], [0.2, 0.3] \rangle$	0.6
B	$\langle [0.3, 0.4], [0.2, 0.3], [0.4, 0.5] \rangle$	0.2
C	$\langle [0.1, 0.2], [0.2, 0.3], [0.4, 0.5] \rangle$	0.1
G	$\langle [0,0], [0,0], [1, 1] \rangle$	0

Let us start with the source node S

ITERATION: 0

$$S \rightarrow 0 \oplus 0.65 = 0.65$$

From the source node S the graph expands through two paths A and B.

ITERATION: 1

$$S \rightarrow A: f(A) = g(A) \oplus h(A) = 0.1 \oplus 0.6 = 0.7$$

$$S \rightarrow B: f(B) = g(B) \oplus h(B) = 0.35 \oplus 0.2 = 0.55(\text{MIN})$$

By comparing the above values the path $S \rightarrow B$ has minimum value, so we proceed to traverse from that path,

ITERATION: 2

$$S \rightarrow B \rightarrow C: f(C) = g(C) \oplus h(C) = (0.35 \oplus 0.2) \oplus 0.1 = 0.65$$

$$S \rightarrow A \rightarrow B: f(B) = g(B) \oplus h(B) = (0.1 \oplus 0.2) \oplus 0.2 = 0.5(\text{MIN})$$

$$S \rightarrow A \rightarrow C: f(C) = g(C) \oplus h(C) = (0.1 \oplus 0.45) \oplus 0.1 = 0.65$$

$$S \rightarrow A \rightarrow G: f(G) = g(G) \oplus h(G) = (0.1 \oplus 0.6) \oplus 0 = 0.7$$

By comparing the above values the path $S \rightarrow A \rightarrow B$ has minimum value, so we proceed to traverse from that path,

ITERATION: 3

$$S \rightarrow A \rightarrow B \rightarrow C: f(C) = g(C) \oplus h(C) = (0.1 \oplus 0.2 \oplus 0.2) \oplus 0.1 = 0.6(\text{MIN})$$

By comparing the paths $S \rightarrow A \rightarrow B \rightarrow C$ and $S \rightarrow B$ the path $S \rightarrow B$ is minimum.

So traverse from that path to reach the goal node.

ITERATION: 4

$$S \rightarrow B \rightarrow C \rightarrow G: f(G) = g(G) \oplus h(G) = (0.35 \oplus 0.2 \oplus 0.15) \oplus 0 = 0.7$$

By comparing the paths $S \rightarrow B \rightarrow C \rightarrow G$ and $S \rightarrow A \rightarrow B \rightarrow C$ the

path $S \rightarrow A \rightarrow B \rightarrow C$ is minimum.

So traverse from that path to reach the goal node.

ITERATION: 5

To reach the goal node we can traverse in the two paths,

$$S \rightarrow A \rightarrow B \rightarrow C \rightarrow G: f(G) = g(G) \oplus h(G) = (0.1 \oplus 0.2 \oplus 0.2 \oplus 0.15) \oplus 0 = 0.65(\text{MIN})$$

$$S \rightarrow A \rightarrow C \rightarrow G: f(G) = g(G) \oplus h(G) = (0.1 \oplus 0.45 \oplus 0.15) \oplus 0 = 0.7$$

By comparing the paths $S \rightarrow A \rightarrow B \rightarrow C \rightarrow G$ and $S \rightarrow A \rightarrow C \rightarrow G$ the path $S \rightarrow B \rightarrow C \rightarrow G$ is minimum

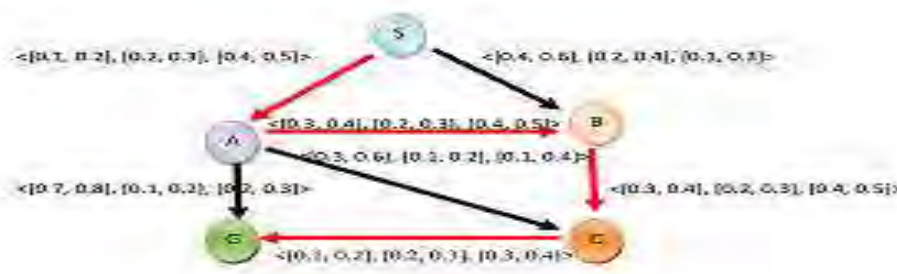

Fig.3. Shortest path from source node to goal node.

The shortest path is given by $S \rightarrow A \rightarrow B \rightarrow C \rightarrow G$.

5. Conclusion

A* algorithm is applied to solve the shortest path problem on a network with an interval valued neutrosophic arc lengths in this paper. A* algorithm is complete and optimal. A* algorithm is the best one from other techniques. It is used to solve very complex problems. A* algorithm is optimally efficient, i.e. there is no other optimal algorithm guaranteed to expand fewer nodes than A*. Heuristic values are considered in calculating the path by this method. Score function is used for defuzzification. The technique is enlightened by a numerical example with the help of theoretical information. The time complexity of A* depends on the heuristic. In the worst case of an unbounded search space, the number of nodes expanded is exponential in the depth of the solution (the shortest path) d : $O(b^d)$, where b is the branching factor. A* can also be adapted to a bidirectional search algorithm. Furthermore, the following algorithm of the interval neutrosophic shortest path problem can be extended into an interval valued bipolar neutrosophic environment.

References

1. L.Zadeh, "Fuzzy sets", Inform and Control, 8, 338-353, 1965.
2. H. J. Zimmermann, "Fuzzy set Theory - and Its Applications", Kluwer-Nijhoff Publishing, Boston-Dordrecht-Lancaster, 1985.
3. Florentin Smarandache, "Neutrosophic Overset, Neutrosophic Underset, and Neutrosophic Offset". Similarly for Neutrosophic Over-/Under-/Off- Logic, Probability, and Statistics, 168 p., Pons Editions, Bruxelles, Belgique.2016.
4. S.Broumi, A.Bakali, M.Talea, F.Smarandache, "On Bipolar Single Valued Neutrosophic Graphs", Journal of New Theory, N11, pp.84-102, 2016.
5. S.Broumi, A.Bakali, M.Talea, F.Smarandache, "Single Valued Neutrosophic Graphs", Journal of New Theory, N 10, pp. 86-101,2016.

6. S.Broumi, A. Bakali, M.Talea, F.Smarandache, “Single Valued Neutrosophic Graphs: Degree, Order and Size”, IEEE International Conference on Fuzzy Systems (FUZZ), pp.2444-2451,2016.
7. S.Broumi, A,Bakali, M.Talea, F.Smarandache , L.Vladareanu, “Computation of Shortest Path Problem in a Network with SV-Trapezoidal Neutrosophic Numbers”, Proceedings of the 2016 International Conference on Advanced Mechatronic Systems, Melbourne, Australia, pp.417-422,2016.
8. A.Ngoor and M.Jabarulla , “Multiple labeling Approach For Finding shortest Path with Intuitionistic Fuzzy Arc Length”, International Journal of Scientific and Engineering Research,V3,Issue 11,pp.102-106,2012.
9. A.Kumar and M.Kaur, “Solution of fuzzy maximal flow problems using fuzzy linear programming”,World Academy of Science and Technology.87,28-31,2011.
10. Gaurav, & Kumar, Megha & Bhutani, Kanika & Aggarwal, Swati, “Hybrid model for medical diagnosis using Neutrosophic Cognitive Maps with Genetic Algorithms”. 1-7. 10.1109/FUZZ-IEEE.2015.7338015,2015.
11. G.Kumar, R.K.Bajaj and N.Gandotra, “Algorithm for shortest path problem in a network with interval valued intuitionistic trapezoidal fuzzy number”, Procedia Computer Science, 70, pp.123-129, 2015.
12. P.Jayagowri and G.Geetha Ramani, “Using Trapezoidal Intuitionistic Fuzzy Number to Find Optimized Path in a Network”, Advances in Fuzzy Systems., Article ID 183607, 6 pages <http://dx.doi.org/10.1155/2014/183607>,2014.
13. S.Broumi, A,Bakali, M.Talea, F.Smarandache and L.Vladareanu, “Applying Dijkstra for Solving Neutrosophic Shortest Path Problem”, Proceedings of the 2016 International Conference on Advanced Mechatronic Systems, Melbourne, Australia, pp.412-416,2016.
14. S.Broumi, F.Smarandache, “New distance and similarity measures of interval neutrosophic sets, Information Fusion (FUSION)”, IEEE 17th International Conference, pp 1 –7,2014.
15. S.Broumi, M.Talea, A.Bakali, F.Smarandache, “An Introduction to Bipolar Single Valued Neutrosophic Graph Theory”. Applied Mechanics and Materials, vol.841, 184-191.2016.
16. S.Broumi, M.Talea, A.Bakali, F.Smarandache , K. P.Kishore,Şahin, “ Shortest Path Problem under Interval Valued Neutrosophic Setting”, International Journal of Advanced Trends in Computer Science and Engineering, volume 8,pg216-222,2019.
17. S.Broumi, A.Bakali, M.Talea, F.Smarandache, “Isolated Single Valued Neutrosophic Graphs”. Neutrosophic Sets and Systems, Vol. 11, pp.74-78, 2016.
18. S.Broumi, A.Bakali, M.Talea, F.Smarandache, “Interval Valued Neutrosophic Graphs”, Critical Review, XII, pp.5-33, 2016.
19. F.Smarandache,“Types of Neutrosophic Graphs and neutrosophic AlgebraicStructures together with their Applications in Technology”, seminar, Universitatea Transilvania din Brasov, Facultatea de Design de Produs si Mediu, Brasov, Romania .2015.
20. Avishek Chakraborty, “A New Score Function of Pentagonal Neutrosophic Number and its Application in Networking Problem”, International Journal of Neutrosophic Science, Volume 1, Issue 1, PP: 40-51, 2020.

21. R.Thamaraiselvi and R. Santhi, "A New Approach for Optimization of Real Life Transportation Problems in Neutrosophic Environment", *Mathematical Problems in Engineering*.Article ID 5950747,9<http://dx.doi.org/10.1155/2016/5950747>,2016.
22. Tuhin Bera, Nirmal Kumar Mahapatra, "An Approach to Solve the Linear Programming Problem Using Single Valued Trapezoidal Neutrosophic Number", *International Journal of Neutrosophic Science* ,Vol. 3, No. 2, PP. 54-66, 2020.
23. Sapan Kumar Das, S.A. Edalatpanah, " A new ranking function of triangular neutrosophic number and its application in integer programming", *International Journal of Neutrosophic Science*,Volume 4 , Issue 2, PP: 82-92 , 2020.
24. S.A.Edalatpanah, "A Direct Model for Triangular Neutrosophic Linear Programming", *International Journal of Neutrosophic Science* Volume 1 , Issue 1, PP: 19-28 , 2020.
25. S.Majumdar and A.Pal, "Shortest Path Problem on Intuitionistic Fuzzy Network", *Annals of Pure and Applied Mathematics*, Vol. 5, 1, 26-36, 2013.
26. Bhimraj Basumatary, Said Broumi, "Interval-Valued Triangular Neutrosophic Linear Programming Problem", *International Journal of Neutrosophic Science*, Volume 10, Issue 2, PP: 105-115, 2020.

Decision Making on Teachers' adaptation to Cybergogy in Saturated Interval-Valued Refined Neutrosophic overset /underset /offset Environment

Nivetha Martin, Priya R, Florentin Smarandache

Nivetha Martin, Priya R, Florentin Smarandache (2020). Decision Making on Teachers' adaptation to Cybergogy in Saturated Interval-Valued Refined Neutrosophic overset /underset /offset Environment. *International Journal of Neutrosophic Science* 12(2): 58-70; DOI: 10.5281/zenodo.4268284

Abstract

Neutrosophic overset, neutrosophic underset and neutrosophic offset introduced by Smarandache are the special kinds of neutrosophic sets with values beyond the range $[0,1]$ and these sets are pragmatic in nature as it represents the real life situations. This paper introduces the concept of saturated refined neutrosophic sets and extends the same to the special kinds of neutrosophic sets. The proposed concept is applied in decision making on Teacher's adaptation to cybergogy. The decision making environment is characterized by different types of teachers, online teaching skills and various training methods. Fuzzy relation is used to match the most suitable method to the different kinds of teachers with the intervention of saturated interval valued neutrosophic refined oversets, offsets and undersets. The results obtained by applying the notion of saturated refined sets using various distance measures represent the effect of training methods on teacher's adaptation to learner-centred teaching methods, which certainly give space to gain many insights on the relationship between quality of training and teacher's adaptation rate. The proposed concept has wide scope and few limitations.

Keywords: neutrosophic oversets, neutrosophic offsets, neutrosophic offsets, refined sets, saturated, interval-valued sets, cybergogy

1. Introduction

Decision making is an indispensable activity but the environment is highly characterized with uncertainty. The concept of fuzzy set introduced by Lofti.A.Zadeh [1] plays a vital role in tackling such uncertain and imprecise situations.

Fuzzy sets differ from crisp sets by membership functions and membership values. The elements of crisp sets contain binary membership values i.e either 1 or 0, it doesn't deal with intermediate values. Fuzzy sets overcome this short coming with the inclusion of intermediate values and extending the range of values from $\{0,1\}$ to $[0,1]$. Fuzzy sets are highly comprehensive and inclusive in nature. Fuzzy sets are extensively used to handle complex systems and control as these sets possess high rate of industrial applications. Fuzzy sets are extended to intuitionistic sets by Atanssov[2] with the introduction of non-membership function to membership function. The elements of intuitionistic sets possess both membership and non-membership values ranging from $[0,1]$. The hesitancy margin is calculated by subtracting the sum of membership and non-membership values from 1. In intuitionistic sets the hesitancy margin is dependent on membership and non-membership values. Intuitionistic sets and various forms of it are widely used in multiple attribute decision making. Khan et al [3] used Interval-valued Pythagorean fuzzy GRA method for multiple-attribute decision making with incomplete weight information. Zhuosheng Jia et al[4] used interval valued intuitionistic fuzzy sets in multiple attribute group decision making method TOPSIS. Intuitionistic sets are further extended to neutrosophic sets by Smarandache[5] and these sets have truth membership functions, indeterminacy functions and non-membership functions. The elements of neutrosophic sets are triplets with independent truth, indeterminacy and false membership values ranging from $[0,1]$. Neutrosophic sets are widely used in multiple attribute decision making. Abdel-Baset et al [6,7] developed multi criteria decision making method with neutrosophic representation in evaluating green supply chain management practices and in sustainable supplier selection. Hu et al [8] also contributed to neutrosophic decision making on the selection of doctors. Nada A. Nabeeh et al [9] proposed a hybrid approach of neutrosophic with MULTIMOORA in application of personnel selection. Ajay et al [10] developed the single -valued triangular neutrosophic approach of decision making on multi objectives based on ratio analysis. Sahidul Islam et al [11] formulated neutrosophic goal programming approach to a green supplier selection model with quantity discount. Mullai.M et al [12] used neutrosophic intelligent energy efficient routing for wireless ad-hoc network based on multi-criteria decision making. Abdel Nasser et al [13] proposed an integrated neutrosophic and TOPSIS for evaluating airline service quality. Neutrosophic hypersoft sets are also used in decision making. Muhammad Saqlain et al [14] presented the applications of neutrosophic hypersoft sets in TOPSIS using accuracy function. Surapati et al[15] developed Multi-level linear programming problem with neutrosophic numbers. Ajay et al [16,17] discussed decision making techniques based on bipolar neutrosophic sets, neutrosophic cubic fuzzy sets, Chakravarthy et al [18,19] expounded the implications of cylindrical and pentagonal neutrosophic numbers in networking and mobile communication respectively. Deli et al [20,21] proposed multi attribute decision making models based on weighted geometric operators and two centroid point for single valued triangular neutrosophic number. Neutrosophic graphs are also widely used in decision making. Juanjuan et al [22] developed a multi attribute decision making model using single valued neutrosophic graphs. Dragisa et al [23] proposed a novel approach of assessing the reliability of the data in decision making. Shahzaib et al [24] framed a decision making model to select agriculture land using neutrosophic information. Muhammad et al [25] developed auto car decision making model using Bipolar Neutrosophic Soft Sets. Philippe [26] has also discussed the neutrosophical representations in cognitive dimension. The neutrosophic sets are extensively applied in multi criteria decision making.

Smarandache [27] introduced neutrosophic oversets, offsets and undersets which are the special kinds of neutrosophic sets with values beyond $[0,1]$. Oversight is characterized with membership values greater than 1, underset is characterized with membership values less than 0 and the combination of both these sets is offset. Smarandache justified the practical implications of these special kinds of sets with real life illustrations. These kinds of neutrosophic sets highly influenced and motivated us to propose a fuzzy relational decision making model with saturated refined interval- valued neutrosophic oversets, undersets and offsets based on application of refined neutrosophic sets in medical diagnosis by Deli et al [28]. Smarandache conceptualized n-valued refined neutrosophic sets and these sets are used in decision making model of medical diagnosis. Broumi [29] extended the model of Deli et al by applying correlation measure. Various distance measures are used to make optimal decisions without changing the neutrosophic representations. In their model relation between symptoms and diseases was represented by neutrosophic sets; relation between patients and symptoms was represented by refined neutrosophic sets over certain interval period of time. In this decision making model the representation of the symptoms of the patients varies from time to time. But on

profound analysis, the effects of treatment on the status and the degree of symptoms lack representation. This deficit in the decision making model paved the way for developing a novel decision making model with new kind of representations. The same model is extended to fuzzy relation decision making model on teacher's adaptation to cybergogy in this research work. A relation between digital teaching skills and training methods is represented by neutrosophic sets and the relation between different kinds of teachers and the acquisition of digital skills after continuous stages of training is represented by refined neutrosophic oversets, undersets and offsets. Such kinds of representations are made to reflect the impact of training on skill acquisition rate by the teachers. The degree of digital skill acquisition by the teacher greatly depends on the personal interest, trainer's approach and training environment. The self-interest of the teachers may induce them to spend additional time other than the specified training time; also the disinterest of the teachers or dislike of trainer's approach may make them to refrain from the training and their participation rate is disturbed. At such circumstances refined neutrosophic oversets, underset and offset are used to represent such impacts. Also a new concept of saturated refined sets is introduced in this paper. The refined neutrosophic overset, underset and offset values remain to settle to a particular value over a consecutive period of time then it is called as saturated. The existences of situations where the degree of digital skill acquisition is confined and attained the maximum value and also there is no chance of further change over a period of training can be represented by saturated refined neutrosophic sets. The apt method of training to different kinds of teachers is determined by using hamming distance, normalized hamming distance, Euclidean distance and normalized Euclidean distance measures. The practical implications of neutrosophic overset, underset and offset are not explored to the best of the knowledge and so this research work will certainly fill the gap and it is intended to do so.

The paper is organized as follows: section 2 presents the basic definitions; section 3 describes about saturated refined neutrosophic sets; section 4 consists of the application of the proposed model; section 5 discusses the results and the last section concludes the work.

2. Preliminaries

Definition 2.1 [27]

Let X be an universe of discourse, A neutrosophic set A in X is expressed by $A = \{ \langle X; T_A(x), I_A(x), F_A(x) \rangle / x \in X \}$ and $T, I, F: X \rightarrow]0; 1+[$ where T, I, F are the degree of membership (True), the indeterminacy and degree of non-membership (False) respectively, and $0 \leq T_A(x) + I_A(x) + F_A(x) \leq 3$.

Definition 2.2 [27]

Let X be the universe of discourse with a generic element in X is denoted by x . An interval valued neutrosophic set (IVNS) A in X is defined by $A = \{ x, \langle [T_A^L(x), T_A^U(x)], [I_A^L(x), I_A^U(x)], [F_A^L(x), F_A^U(x)] \rangle; x \in X \}$

where T_A, I_A, F_A are the truth membership function, indeterminacy membership function, falsity membership function respectively. For each point x in X , We have $[T_A^L(x), T_A^U(x)], [I_A^L(x), I_A^U(x)], [F_A^L(x), F_A^U(x)] \subseteq [0, 1]$ with the condition $0 \leq T_A^U(x) + I_A^U(x) + F_A^U(x) \leq 3$.

Definition 2.3 [27]

Let U be a universe of discourse. A neutrosophic refined set (NRS) A on U can be defined as follows

$A = \{ \langle x, \langle T_A^1(x), T_A^2(x) \dots T_A^p(x) \rangle, \langle I_A^1(x), I_A^2(x) \dots I_A^p(x) \rangle, \langle F_A^1(x), F_A^2(x) \dots F_A^p(x) \rangle \rangle / x \in U \}$ and $0 \leq T_A^i(x) + I_A^i(x) + F_A^i(x) \leq 3, (i = 1, 2 \dots p)$ and $T_A^1(x) \leq T_A^2(x) \leq \dots \leq T_A^p(x)$ for any $x \in A, T_A^i(x), I_A^i(x), F_A^i(x), i = 1, 2 \dots p$ as the truth membership sequence, indeterminacy membership sequence and falsity membership sequence of the element x respectively.

Definition 2.4 [27]

Let U be the universe of discourse. A neutrosophic set A_1 in U which consist the membership function $T(x), I(x), F(x)$ that define true, Indeterminacy and falsity respectively, of a generic element $x \in U$,

$$T_A(x), I_A(x), F_A(x):U \rightarrow [0, \varphi] \text{ where } 0 < 1 < \varphi, \text{ and } \varphi \text{ is called over limit.}$$

A single valued neutrosophic over set A_1 is defined as

$A_1 = \{x, \langle T_A(x); I_A(x); F_A(x) \rangle \mid x \in U\}$ such that in the neutrosophic components contains there exist atleast one element in A_1 is >1 and no element is <0 .

Definition 2.5[27]

Let U be the universe of discourse. A neutrosophic set A_2 in U which consist the membership function $T(x), I(x), F(x)$ that define true, Indeterminacy and falsity respectively, of a generic element $x \in U$,

$$T_A(x), I_A(x), F_A(x):U \rightarrow [\psi, 1] \text{ where } \psi < 0 < 1, \text{ and } \psi \text{ is called under limit.}$$

A single valued neutrosophic underset A_2 is defined as

$$A_2 = \{x, \langle T_A(x); I_A(x); F_A(x) \rangle \mid x \in U\}$$

such that in the neutrosophic components contains there exist atleast one element in A_2 is <0 and no element is >1

Definition 2.6 [27]

Let U be the universe of discourse. A neutrosophic set A_3 in U which consist the membership function $T(x), I(x), F(x)$ that define true, Indeterminacy and falsity respectively, of a generic element $x \in U$,

$T_A(x), I_A(x), F_A(x):U \rightarrow [\psi, \varphi] \text{ where } \psi < 0 < 1 < \varphi, \text{ and } \psi \text{ is called under limit while } \varphi \text{ is called over limit, } T_A(x), I_A(x), F_A(x) \in [\psi, \varphi].$ The neutrosophic single-valued offset A_3 is defined by

$A_3 = \{x, \langle T_A(x); I_A(x); F_A(x) \rangle \mid x \in U\}$ such that in the neutrosophic components contains there is atleast one element is >1 and atleast another is <0 .

Definition 2.7 [27]

Let U be the universe of discourse. A neutrosophic set A_1 in U which consist the membership function $T(x), I(x), F(x)$ that define true, Indeterminacy and falsity respectively, of a generic element $x \in U$,

$$T_A(x), I_A(x), F_A(x):U \rightarrow P([0, \varphi]) \text{ where } 0 < 1 < \varphi, \text{ and } \varphi \text{ is called over limit,}$$

$T_A(x), I_A(x), F_A(x) \subseteq [0, \varphi], \text{ and } P([0, \varphi])$ is the set of all subsets of $[0, \varphi]$. An interval valued neutrosophic overset A_1 is defined as $A_1 = \{x, \langle T_A(x); I_A(x); F_A(x) \rangle \mid x \in U\}$ such that in the neutrosophic component contains there is atleast one is partially or totally above 1 and no element has partially or totally below 0.

Definition 2.8 [27]

Let U be the universe of discourse. A neutrosophic set A_2 in U which consist the membership function $T(x), I(x), F(x)$ that define true, Indeterminacy and falsity respectively, of a generic element $x \in U$,

$$T_A(x), I_A(x), F_A(x):U \rightarrow P([\psi, 1]) \text{ where } \psi < 0 < 1, \text{ and } \psi \text{ is called under limit.}$$

$T_A(x), I_A(x), F_A(x) \subseteq [\psi, 1]$, and $P([\psi, 1])$ is the set of all subsets of $[\psi, 1]$. An interval valued neutrosophic overset A_2 is defined as $A_2 = \{x, \langle T_A(x); I_A(x); F_A(x) \rangle \mid x \in U\}$ such that in the neutrosophic component contains there is at least one is partially or totally below 0 and no element has partially or totally above 1.

Definition 2.9 [27]

Let U be the universe of discourse. A neutrosophic set A_3 in U which consist the membership function $T(x), I(x), F(x)$ that define true, indeterminacy and falsity respectively, of a generic element $x \in U$,

$T_A(x), I_A(x), F_A(x) : U \rightarrow P[\psi, \varphi]$ where $\psi < 0 < 1 < \varphi$, and ψ is called under limit while φ is called over limit, $T_A(x), I_A(x), F_A(x) \subseteq P[\psi, \varphi]$ and $P[\psi, \varphi]$ is the set of all subsets of $[\psi, \varphi]$

An interval valued neutrosophic offset A_3 is defined as $A_3 = \{x, \langle T_A(x); I_A(x); F_A(x) \rangle \mid x \in U\}$ such that in the neutrosophic components contains atleast one is partially or totally above 1 and atleast another is partially or totally below 0.

Definition: 2.10 [17]

Let $A, B \in IVNRS(U)$. Then

1. Hamming distance between A and B is denoted as $d_H(A, B)$ and is defined by

$$d_H(A, B) = \frac{1}{6} \sum_{j=1}^P \sum_{i=1}^n |T_A^j(x_i) - T_B^j(x_i)| + |T_A^U(x_i) - T_B^U(x_i)| + |I_A^L(x_i) - I_B^L(x_i)| + |I_A^U(x_i) - I_B^U(x_i)| \\ + |F_A^L(x_i) - F_B^L(x_i)| + |F_A^U(x_i) - F_B^U(x_i)|$$

2. Normalized hamming distance between A and B is denoted as $d_{NH}(A, B)$ and is defined by

$$d_{NH}(A, B) = \frac{1}{6nP} \sum_{j=1}^P \sum_{i=1}^n |T_A^j(x_i) - T_B^j(x_i)| + |T_A^U(x_i) - T_B^U(x_i)| + |I_A^L(x_i) - I_B^L(x_i)| + |I_A^U(x_i) - I_B^U(x_i)| \\ + |F_A^L(x_i) - F_B^L(x_i)| + |F_A^U(x_i) - F_B^U(x_i)|$$

3. Euclidean distance between A and B is denoted as $d_E(A, B)$ and is defined by

$$d_E(A, B) = \frac{1}{6} \sum_{j=1}^P \sum_{i=1}^n \{|T_A^j(x_i) - T_B^j(x_i)|^2 + |T_A^U(x_i) - T_B^U(x_i)|^2 + |I_A^L(x_i) - I_B^L(x_i)|^2 + |I_A^U(x_i) - I_B^U(x_i)|^2 \\ + |F_A^L(x_i) - F_B^L(x_i)|^2 + |F_A^U(x_i) - F_B^U(x_i)|^2\}^{\frac{1}{2}}$$

4. Normalized Euclidean distance between A and B is denoted as $d_{NE}(A, B)$ and is defined $d_E(A, B) = \frac{1}{6nP} \sum_{j=1}^P \sum_{i=1}^n \{|T_A^j(x_i) - T_B^j(x_i)|^2 + |T_A^U(x_i) - T_B^U(x_i)|^2 + |I_A^L(x_i) - I_B^L(x_i)|^2 + |I_A^U(x_i) - I_B^U(x_i)|^2 + |F_A^L(x_i) - F_B^L(x_i)|^2 + |F_A^U(x_i) - F_B^U(x_i)|^2\}^{\frac{1}{2}}$

3. Saturated Refined Neutrosophic sets

Irfan Deli et al [28] presented the properties and various operations of neutrosophic refined sets. An element of neutrosophic refined set has a sequence of truth, indeterminacy and falsity membership values. In the model

proposed by Irfan Deli et al [28] the symptoms of the patients at three different intervals of time are presented as neutrosophic refined sets. But in reality if the patients are undergoing treatment and the symptoms are checked at different intervals of time, suppose if a patient gets cured and gets back to normal conditions, then the symptoms of the disease are nil and it takes same values if testing of symptoms takes place at consecutive period of time. At this junction the membership values gets saturated, and this instance is the origin of saturated refined neutrosophic sets.

Let U be a universe of discourse. A neutrosophic saturated refined set (NSRS) A on U can be defined as follows

$$A = \{ \langle x, (T_A^1(x), T_A^2(x) \dots, T_A^p(x), T_A^p(x)), (I_A^1(x), I_A^2(x) \dots, I_A^p(x), I_A^p(x)), (F_A^1(x), F_A^2(x) \dots, F_A^p(x), F_A^p(x)) \rangle \mid x \in U \text{ and } 0 \leq T_A^i(x) + I_A^i(x) + F_A^i(x) \leq 3, (i = 1, 2 \dots p) \text{ and } T_A^1(x) \leq T_A^2(x) \leq \dots \leq T_A^p(x) \text{ for any } x \in A, T_A^i(x), I_A^i(x), F_A^i(x), i = 1, 2 \dots p \text{ is the truth membership sequence, indeterminacy membership sequence and falsity membership sequence of the element } x \text{ respectively.} \}$$

Let U be a universe of discourse. An interval – valued saturated refined neutrosophic set A on U can be defined as follows

$$A = \{ \langle x, ([T_A^{L1}(x), T_A^{U1}(x)], [T_A^{L2}(x), T_A^{U2}(x)], \dots, [T_A^{Lp}(x), T_A^{Up}(x)]), ([I_A^{L1}(x), I_A^{U1}(x)], [I_A^{L2}(x), I_A^{U2}(x)], \dots, [I_A^{Lp}(x), I_A^{Up}(x)]), ([F_A^{L1}(x), F_A^{U1}(x)], [F_A^{L2}(x), F_A^{U2}(x)], \dots, [F_A^{Lp}(x), F_A^{Up}(x)]) \rangle \mid x \in U \text{ and } 0 \leq T_A^i(x) + I_A^i(x) + F_A^i(x) \leq 3, (i = 1, 2 \dots p) \text{ and } T_A^1(x) \leq T_A^2(x) \leq \dots \leq T_A^p(x) \text{ for any } x \in A, T_A^i(x), I_A^i(x), F_A^i(x), i = 1, 2 \dots p \text{ is the truth membership sequence, indeterminacy membership sequence and falsity membership sequence of the element } x \text{ respectively.} \}$$

Remark:

1. If any of the membership values is saturated it is partial in nature and it is also a saturated refined set.
2. The saturated refined neutrosophic sets can be extended to overset, underset and offset.
3. The interval – valued refined neutrosophic sets are also extended to saturated interval- valued refined neutrosophic sets and the saturated values varies from interval sets to single valued sets over a period of time.
4. Application of the proposed decision making model

A decision making model together with fuzzy relational matrix and saturated refined neutrosophic overset, underset and offset is validated with the following illustration.

Decision Making Environment

Presently COVID – 19 has brought a paradigm shift in teaching and learning process, the teaching fraternity is expected to possess digital teaching skills to face the post quarantine period. The developing nations have begun to encourage online educational system with the motive of unlocking learning during lock down. In this juncture the teachers are categorized based on their attributes and exposed to different kinds of training method to foster the acquisition of digital skills. The ultimate aim of this decision making model is to determine the suitable training method to the different kinds of teachers. This training programme is conducted to train the teachers to acquire online teaching skills. The expected outcome is enhancement of teacher’s online teaching skills. The effectiveness of the programme is evaluated based on certain attributes and these attributes duly play crucial role in the enhancement of teacher’s online teaching skills.

The attributes are

- A1 Trainer’s efficiency- Refers to mastery
- A2 Teacher’s interest
- A3 Teacher’s duration of participation – present throughout the sessions
- A4 Teacher’s grasping ability – how quick they understand
- A5 Trainer’s Approach – Refers to inter personal relationship/ social skills

The teachers are made to undergo four phases of training namely I, II, III, IV and they are grouped into four categories and their characteristic features are presented in Table 4.1

Table 4.1 Types of Teachers & Attributes

Types of Teachers	Chara cteri zation
T1	Encouraging,Motivating,Systematic,Holistic
T2	Optimistic,creative,interactive,Facilitative
T3	Pragmatic,realistic,joyful,flexible
T4	Weak commitment, Projective,Low professional ,Resistant to change

The training to teachers are given using the following modes such as Self- paced learning, Blended learning, Adaptive learning, Virtual classes. The digital skills that are focussed in this training programme are Online skills, Digital literacy skills, Administrative skills of Learning Management System (LMS), Technology skills, Organization skills. The relation between digital skills and training methods are presented in Table 4.2

Table 4.2 Relation between skills and methods

	Blended Mode	Self- paced Mode	Adaptive Mode	Virtual Mode
Online Skills	([.45,.6],[0.2,.3],[0.39,.46])	([0.66,.8],[0.43,.57],[0.2,.38])	([0.63,.75],[0.49,.7],[0.3,.4])	([0.43,.58],[0.33,.5],[0.61,.68])
Digital literacy Skills	([0.5,.61],[0.1,.39],[.35,0.48])	([0.43,.6],[0.15,.25],[0.38,.5])	([0.13,.31],[0.5,.71],[0.44,.47])	([0.3,.39],[0.1,.43],[0.51,.62])
Administrative skills of LMS	([0.5,.65],[0.21,.45],[0.36,.57])	([0.45,.68],[0.2,.37],[0.64,.71])	([0.46,.62],[0.2,.39],[0.24,.29])	([0.65,.78],[0.32,.39],[0.53,.62])
Technology Skills	([0.4,.63],[0.1,.25],[.69,.71])	([0.44,.5],[0.61,.69],[0.25,.45])	([0.27,.3],[0.53,.6],[0.39,.48])	(0.51,.59],[0.35,.4],[0.23,.33])
Organization skills	([0.45,.5],[0.61,.69],[0.15,.2])	([0.3,.65],[0.42,.52],[0.18,.28])	([0.33,.45],[0.45,.5],[0.25,.3])	([0.4,.53],[0.2,.35],[0.13,.25])

The degree of acquisition rate of digital teaching skills is presented as saturated refined interval-valued neutrosophic overset, underset and offset in Table 4.3.

Table 4.3 Relation between Teachers and Skill acquisition

	Online Skills	Digital literacy Skills	Administrative skills of LMS	Technology Skills	Organization skills
T1	([0.7,0.8],[0.3,0.4],[0.5,0.7])	([0.6,0.7],[0.2,0.3],[0.5,0.6])	([0.5,0.6],[0.2,0.3],[0.1,0.3])	([0.3,0.4],[0.7,0.8],[0.4,0.6])	([0.4,0.5],[0.2,0.3],[0.03,0.05])
	([0.75,0.85],[0.41,0.5],[0.45,0.6])	([0.65,0.75],[0.28,0.35],[0.43,0.48])	([0.55,0.67],[0.31,0.43],[0.1,0.28])	([0.37,0.45],[0.81,0.93],[0.52,0.58])	([0.46,0.57],[0.26,0.35],[0.01,0.03])
	([0.79,0.95],[0.45,0.58],[0.4])	([0.78,0.88],[0.36,0.4],[0.31])	(0.61,[0.33,0.44],[0.1,0.15])	([0.39,0.48],1.3,[0.53,0.56])	(0.52,[0.28,0.37],[0.01,0.02])
		([0.89,1.1],[0.37,0.41],[0.31])	(0.61,[0.35,0.44],[0.1,0.12])	([0.43,0.52],1.3,[0.54,0.55])	

	[[0.9,1.2],[0.48,0.59],0.4)				[[0.52,[0.31,0.38],[-0.01,0.01]]
T2	[[0.6,0.7],[0.3,0.4],[0.7,0.8]) [[0.75,0.83],[0.33,0.46],[0.71,0.75]) [[0.83,0.95],[0.4,0.48],0.68) [[0.96,1.3],[0.44,0.54],0.68)	[[0.5,0.6],[0.6,0.7],[0.1,0.2]) [[0.56,0.61],[0.68,0.73],[0.1,0.15]) [[0.59,[0.71,0.75],[0.1,0.12]) [[0.59,[0.72,0.77],[0.1,0.11])	[[0.4,0.5],[0.8,0.9],[0.3,0.4]) [[0.47,0.58],[0.88,0.97],[0.3,0.35]) [[0.55,0.63],1.13,[0.3,0.34]) [[0.55,0.78],1.13,[0.3,0.31])	[[0.7,0.8],[0.3,0.4],[0.2,0.3]) [[0.75,0.83],[0.35,0.43],[0.1,0.2]) [[0.86,0.95],0.39,[0.05,0.1) [[0.96,1.1],0.39,[-0.01,0.04])	[[0.3,0.4],[0.7,0.8],[0.5,0.6]) [[0.36,0.46],[0.79,0.89],[0.5,0.55]) [[0.37,0.53],[0.89,0.99],0.52) [[0.45,0.56],[0.95,1.1],0.52)
T3	[[0.8,0.9],[0.2,0.3],[0.4,0.5]) [[0.86,0.98],[0.3,0.41],[0.4,0.45]) (1.1,[0.38,0.49],[0.35,0.4) (1.1,[0.42,0.51],[0.35,0.38))	[[0.4,0.5],[0.8,0.9],[0.5,0.6]) [[0.47,0.57],[0.83,0.93],[0.45,0.57]) [[0.55,0.61],1.2,[0.45,0.51]) [[0.55,0.62],1.2,[0.45,0.49])	[[0.3,0.4],[0.2,0.3],[0.1,0.2]) [[0.38,0.47],[0.26,0.37],[0.1,0.15]) (0.45,[0.28,0.39],[0.1,0.12]) (0.45,[0.28,0.42],[-0.1,0.1])	[[0.5,0.6],[0.7,0.8],[0.3,0.4]) [[0.57,0.68],[0.85,0.91],[0.2,0.3]) (0.63,[0.91,0.99],[0.2,0.25]) (0.63,[0.98,1.2],[0.21,0.23])	[[0.3,0.4],[0.4,0.5],[0.2,0.3]) [[0.35,0.46],[0.47,0.57],[0.1,0.2]) (0.43,0.52,[0.1,0.15]) (0.43,0.52,[-0.1,0.12])
T4	[[0.3,0.4],[0.5,0.6],[0.2,0.3]) [[0.41,0.49],[0.6,0.67],[0.1,0.2]) [[0.45,0.53],0.61,[0.1,0.15]) [[0.45,0.55],0.61,	[[0.5,0.6],[0.8,0.9],[0.6,0.7]) [[0.52,0.61],[0.88,0.98],[0.5,0.6]) [[0.63,0.64],1.3,[0.5,0.55])	[[0.7,0.8],[0.5,0.6],[0.36,0.57]) [[0.8,0.91],[0.55,0.65],[0.36,0.55]) [[0.88,0.99],0.61,[0.2,0.25])	[[0.2,0.3],[0.1,0.27], [0.1,0.2]) [[0.4,0.63],[0.1,0.25],[0.1,0.13]) [[0.46,0.63],0.26,[0.05,0.1])	[[0.3,0.4],[0.8,0.9],[0.5,0.6]) [[0.45,0.53],[0.88,0.91],[0.45,0.5]) (0.45,[0.98,1.1],0.41)

	$[-0.1,0.11]$	$([0.65,0.71],1.3,[0.48,0.52])$	$([0.98,1.1],0.61,[0.2,0.23])$	$([0.47,0.63],0.26,[-0.05,0.05])$	$(0.45,[0.99,1.2],0.41)$
--	---------------	---------------------------------	--------------------------------	-----------------------------------	--------------------------

The normalized Hamming distance is used to determine the most suitable training method to teachers and the values are presented in Table 4.4.

Table 4.4 Normalized Hamming Distance between Teachers and Methods

	Blended Mode	Self-paced Mode	Adaptive Mode	Virtual Mode
T1	0.214	0.183	0.194	0.217
T2	0.286	0.299	0.28	0.279
T3	0.245	0.199	0.185	0.246
T4	0.254	0.286	0.26	0.27

The results obtained by Hamming distance, Euclidean and Normalized Euclidean distance methods are presented in Table 4.5, 4.6 and 4.7 respectively

Table 4.5 Hamming Distance between Teachers and Methods

	Blended Mode	Self-paced Mode	Adaptive Mode	Virtual Mode
T1	0.858	0.73	0.774	0.866
T2	1.142	1.174	1.122	1.117
T3	0.999	0.798	0.741	0.986
T4	1.014	1.143	1.037	1.076

Table 4.6 Euclidean Distance between Teachers and Methods

	Blended Mode	Self-paced Mode	Adaptive Mode	Virtual Mode
T1	0.115	0.095	0.096	0.12
T2	0.129	0.13	0.128	0.127
T3	0.131	0.112	0.0876	0.124

T4	0.129	0.132	0.131	0.133
----	-------	-------	-------	-------

Table 4.7 Normalized Euclidean Distance between Teachers and Methods

	Blended Mode	Self-paced Mode	Adaptive Mode	Virtual Mode
T1	0.0289	0.0239	0.024	0.0274
T2	0.0321	0.0325	0.0323	0.0317
T3	0.0328	0.028	0.0219	0.031
T4	0.0277	0.033	0.0324	0.0332

Discussion

Table 4.4,4.5,4.6 &4.7 clearly presents the most suitable training method to various kinds of teachers. The lowest distance gives the apt method. Self- paced mode is suitable to type I teachers; Virtual mode to type II teachers; Adaptive mode to type III teachers and blended mode to type IV teachers. This optimal relation between teachers and methods are highly pragmatic as it has incorporated the influence of external and internal factors of the training programme. The various methods of distance measures are used to determine the feasible method of teaching and on comparative analysis, the results obtained by using the different methods, are same. The proposed decision making model with saturated refined neutrosophic sets of different kinds can be extended further with other representations of neutrosophic sets, also other kinds of distance measures can be applied to find the optimal method of teaching. This model also has certain limitations as neutrosophic oversets, undersets and offsets of representations are used only specifically and these special kinds of representations cannot be applied at all circumstances. This decision -making model caters to particular needs.

Conclusion

In this research work the concept of saturated refined neutrosophic sets, interval –valued saturated refined neutrosophic sets and its extension to neutrosophic overset, underset and offset are proposed. A decision making model with fuzzy relational matrix and saturated refined neutrosophic overset, underset and offset is proposed in this paper. The model is validated with a real life application. This research work will certainly enlighten the researchers to explore in deep about the concepts of neutrosophic overset, underset and offset. The profound extension of these concepts will disclose new portals of neutrosophic research.

References

[1] Zadeh,L.A., “ Fuzzy sets”, Information and Control, vol. 8, pp. 338–353, 1965.
 [2] Atanassov,K.T., “Intuitionistic fuzzy sets”, Fuzzy sets system, vol. 20, pp.87-96,1983.

- [3] Khan .,Saleem Abdullah., “ Interval-valued Pythagorean fuzzy GRA method for multiple-attribute decision making with incomplete weight information”, *International journal of Intelligent systems*,Vol.33, pp .1689-1716, 2018.
- [4] Zhuosheng Jia,Yingjun Zhang., “Interval valued Intuitionistic fuzzy multiple attribute group decision making with uncertain weights”, *Mathematical Problems in Engineering*, Special Issue, pp 1-9,2019.
- [5] Smarandache,F., “Neutrosophic set, a generalization of the Intuitionistic Fuzzy Sets”, *International Journal of Pure and Applied Mathematics*, vol 24, pp.287-297, 2005.
- [6] Abdel-Baset, M., Chang, V., & Gamal, A., “Evaluation of the green supply chain management practices: A novel neutrosophic approach” *Computers in Industry*, vol.108, pp. 210-220, 2019.
- [7] Abdel-Baset, M., Chang, V., Gamal, A., &Smarandache, F., “An integrated neutrosophic ANP and VIKOR method for achieving sustainable supplier selection: A case study in importing field”, *Computers in Industry*, vol.106, pp.94-110,2019.
- [8] Hu.J,Pan.L, and Chen.X, “An interval neutrosophic projection-based VIKOR method for selecting doctors”. *Cognitive Computation*, vol.9, pp.801-816,2017.
- [9] Nada A., Nabeeh, Ahmed Abdel-Monem and Ahmed Abdelmouty., “A Hybrid Approach of Neutrosophic with MULTIMOORA in Application of Personnel Selection”, *Neutrosophic Sets and Systems*, vol. 30, pp. 1-21,2019.
- [10] Ajay, D., Aldring, J., Abirami, S., and Martina, D. J. S., “A SVTrN-number approach of multi-objective optimisation on the basis of simple ratio analysis based on MCDM method”, *International Journal of Neutrosophic Science*, vol .5, pp.16-28, 2020
- [11] Sahidul Islam and Sayan Chandra Deb., “Neutrosophic Goal Programming Approach to A Green Supplier Selection Model with Quantity Discount”, *Neutrosophic Sets and Systems*, vol. 30, pp. 98-112 ,2019.
- [12] Mullai,M., Broumi, S., Surya,R., and Madhan Kumar,G., “ Neutrosophic Intelligent Energy Efficient Routing for Wireless ad-hoc Network Based on Multi-criteria Decision Making”, *Neutrosophic Sets and Systems*, vol. 30,pp. 113-121,2019.
- [13] Abdel Nasser H, Zaied., Abdullallah Gamal, Mahmoud Ismail., “An Integrated Neutrosophic and TOPSIS for Evaluating Airline Service Quality”, *Neutrosophic Sets and Systems*, vol. 29, pp. 30-39, 2019.

- [14] Muhammad Saqlain, Muhammad Saeed, Muhammad Rayees Ahmad, Smarandache, F., “Generalization of TOPSIS for Neutrosophic Hypersoft set using Accuracy Function and its Application”, *Neutrosophic Sets and Systems*, vol. 27, pp. 131-137, 2019.
- [15] Surapati Pramanik, Partha Pratim Dey., “Multi-level linear programming problem with neutrosophic numbers: A goal programming strategy”, *Neutrosophic Sets and Systems*, vol. 29, pp. 242-254, 2019.
- [16] Ajay, D., & Aldring, J., “A Decision Making Technique Based on Similarity Measure and Entropy of Bipolar Neutrosophic Sets”. *The International journal of analytical and experimental modal analysis*, vol. 1, pp.520-529, 2019.
- [17] Ajay, D., Broumi, S., & Aldring, J., “An MCDM Method under Neutrosophic Cubic Fuzzy Sets with Geometric Bonferroni Mean Operator”, *Neutrosophic Sets and Systems*, vol-32, pp.187, 2020.
- [18] Chakraborty A, Mondal, Alam, Mahata, “Cylindrical Neutrosophic Single-Valued Number and its Application in Networking problem, Multi Criterion Decision Making Problem and Graph Theory”, 2020 CAAI Transactions on Intelligence Technology; DOI: 10.1049/trit.2019.0083.
- [19] Chakraborty.A, Banik.B, Mondal and Alam, “Arithmetic and Geometric Operators of Pentagonal Neutrosophic Number and its Application in Mobile Communication Based MCGDM Problem”, Vol 32, 2020. DOI: 10.5281/zenodo.3723145.
- [20] Deli, I., & Şubaş, Y., “Some weighted geometric operators with SVTrN-numbers and their application to multi-criteria decision making problems” *Journal of Intelligent & Fuzzy Systems*, vol.32, pp.291-301, 2017.
- [21] Deli, I., & ozturk, E. K., “Two Centroid Point for SVTN-Numbers and SVTrN-Numbers: SVN-MADM Method”, In *Neutrosophic Graph Theory and Algorithms*, pp. 279-307, pp.279-307, 2020.
- [22] Juanjuan ding, Wenhui Bai, Chao Zhang., “A New Multi-Attribute Decision Making Method with single-valued Neutrosophic Graphs”, *International journal of neutrosophic science*, vol.11, pp.76-86, 2020.
- [23] Dragisa stanujkic, Darjan Karabasevic, Florentin Smarandache, Gabrijela Popovic., “A novel Approach for assessing the Reliability of Data Contained in a single valued

- Neutrosophic number and its application in multiple criteria decision making”, International journal of neutrosophic science, vol.11, pp.22-29, 2020.
- [24] Shahzaib Ashraf, Saleem Abdullah., “Decision Support Modeling for agriculture land selection based on sine trigonometric single valued neutrosophic information”, International journal of Neutrosophic Science, vol.9, pp.60-73, 2020.
- [25] Muhammad Naveed Jafar , Mushal Zia , Ayisha Saeed , Maryam Yaqoob , samreen habib, “Aggregation Operators of Bipolar Neutrosophic Soft Sets and It’s Applications In Auto Car Selection”, International journal of Neutrosophic Science, vol-9, pp.37-46, 2020.
- [26] Philippe Schweizer, “Thinking on Thinking: The Elementary forms of Mental Life Neutrosophical representation as enabling cognitive heuristics”, International Journal of Neutrosophic Science, vol 2 , pp.63-71,2020.
- [27] Florentin Smarandache , “Operators on single valued neutrosophic oversets, neutrosophic undersets and neutrosophic off sets”, Journal of Mathematics and Informatics, vol-5, pp.63-67, 2016.
- [28] Irfan Deli., Said Broumi., Florentin Smarandache , “ On neutrosophic refined sets and their applications in medical diagnosis”, Journal of New Theory,vol. 6, pp.88-98, 2015.
- [29] Said Broumi and Irfan Deli., “Correlation measure for neutrosophic refined sets and its application in medical diagnosis”, Palestine Journal of Mathematics, vol 5, pp.135-143, 2016.

A Novel Dynamic Multi-Criteria Decision-Making Method Based on Generalized Dynamic Interval-Valued Neutrosophic Set

Nguyen Tho Thong, Florentin Smarandache, Nguyen Dinh Hoa, Le Hoang Son,
Luong Thi Hong Lan, Cu Nguyen Giap, Dao The Son, Hoang Viet Long

Nguyen Tho Thong, Florentin Smarandache, Nguyen Dinh Hoa, Le Hoang Son, Luong Thi Hong Lan, Cu Nguyen Giap, Dao The Son, Hoang Viet Long (2020). A Novel Dynamic Multi-Criteria Decision-Making Method Based on Generalized Dynamic Interval-Valued Neutrosophic Set. *Symmetry*, 12, 618; DOI: 10.3390/sym12040618

Abstract: Dynamic multi-criteria decision-making (DMCDM) models have many meaningful applications in real life in which solving indeterminacy of information in DMCDMs strengthens the potential application of DMCDM. This study introduces an extension of dynamic interval-valued neutrosophic sets namely generalized dynamic interval-valued neutrosophic sets. Based on this extension, we develop some operators and a TOPSIS method to deal with the change of both criteria, alternatives, and decision-makers by time. In addition, this study also applies the proposal model to a real application that facilitates ranking students according to attitude-skill-knowledge evaluation model. This application not only illustrates the correctness of the proposed model but also introduces its high potential appliance in the education domain.

Keywords: generalized dynamic interval-valued neutrosophic set; hesitant fuzzy set; dynamic neutrosophic environment; dynamic TOPSIS method; neutrosophic data analytics

1. Introduction

Multi-criteria decision-making (MCDM) in real world is often dynamic [1]. In the dynamic MCDM (DMCDM) model, neither alternatives nor criteria are constant throughout the whole problem and do not change over time. Besides, the DMCDM model has to cope with both dynamic and indeterminate problems of data. For example, when ranking tertiary students during learning time in a university by the set of criteria based on attitudes-skills-knowledge model (ASK), the criteria, students and lecturers are changing during semesters. The lecturers' evaluations using scores, or other ordered scales, are also

subject to indeterminacy because of lecturers’ personal experiences and biases. Therefore, a ranking model that can handle these issues is necessary.

In [2], Smarandache introduced neutrosophic set including truth-membership, an indeterminacy-membership and a falsity-membership to well treat the problem of information indeterminacy. Since then, variant forms of MCDM and DMCDM models have been proposed as in [3–15]. In order to consider the time dimension, Wang [16] proposed the interval neutrosophic set and its mathematical operators. Ye [9] proposed MCDM in interval-valued neutrosophic set. Dynamic MCDM for dynamic interval-valued neutrosophic set (DIVNS) was proposed in [14]. The authors have developed mathematical operators for TOPSIS method in DIVNSs.

In some cases, criteria, alternatives and decision-makers are changing by time. This fact requires a new method for DMCDM using TOPSIS method in the interval-valued neutrosophic set [17] with diversion of history data. The TOPSIS method for DIVNS in [14] did not solve the problem with the changing criteria, alternatives, and decision-makers. Liu et al. [13] combined the theory of both interval-valued neutrosophic set and hesitant fuzzy set to solve the MCDM problem. However, this study did not use TOPSIS method, and it did not consider the change of criteria also. In order to take the history data into account, Je [10] proposed two hesitant interval neutrosophic linguistic weighted operators to ranking alternatives in dynamic environment. In short, the DMCDM model in DIVNS based on TOPSIS method has not been addressed before.

The purpose of this paper is to deal with the change of criteria, alternatives, and decision-makers during time. We define generalized dynamic interval-valued neutrosophic set (GDIVNS) and some operators. Based on mathematical operators in GDIVNS (distance and weighted aggregation operators), a framework of dynamic TOPSIS is introduced. The proposed method is applied for ranking students of Thuongmai University, Vietnam on attributes of ASK model. ASK model is applicable for evaluation of tertiary students’ performance, and it gives more information that support employers besides a set of university exit benchmark. It also facilitates students to make proper self-adjustments and help them pursue appropriate professional orientation for their future career [18–21]. This application proves the suitability of the proposed model for real ranking problems.

This paper is structured as follows: The Section 1 is an introduction, and the Section 2 provides the brief preliminaries for DMCDM model in both legacy environment and interval-valued neutrosophic set. The Section 3 presents the definition of GDIVNS and some mathematical operators on this set. The Section 4 introduces the framework of dynamic TOPSIS method in GDIVNSs environment. The Section 5 presents the application of dynamic TOPSIS method in the problem of ranking students based on attributes of ASK model. The Section 6 compares the result of proposed model with previous TOPSIS model in DIVNS. The last section mentions the brief summary of this study and intended future works.

2. Preliminary

2.1. Multi-Criteria Decision-Making Model Based on History

A dynamic multi-criteria decision-making model introduced by Campanella and Ribeiro [1] is a DMCDM in which all alternatives and criteria are subject to change. The model gives decisions at all periods or just at the last one. The final rating of alternatives is calculated as:

$$E_t(a) = \begin{cases} R_t(a), & a \in A_t \setminus H_{t-1}^A \\ D_E(E_{t-1}(a), R_t(a)), & a \in A_t \cap H_{t-1}^A \\ E_{t-1}(a), & a \in H_{t-1}^A \setminus A_t \end{cases} \quad (1)$$

where A_t is a set of alternatives at period t , H_{t-1}^A is a historical set of alternatives at period $t - 1$ ($H_0^A = \emptyset$), $R_t(a)$ is rating of alternative a at period t , and D_E is an aggregation operator.

2.2. Dynamic Interval-Valued Neutrosophic Set and Hesitant Fuzzy Set

Thong et al. [14] introduced the concept of dynamic interval-valued neutrosophic set (DIVNS).

Definition 1. [14] Let U be a universe of discourse, and A be a dynamic interval-valued neutrosophic Set (DIVNS) expressed by,

$$A = \left\{ x, \left\langle \left[T_x^L(\tau), T_x^U(\tau) \right], \left[I_x^L(\tau), I_x^U(\tau) \right], \left[F_x^L(\tau), F_x^U(\tau) \right] \right\rangle \mid x \in U \right\} \quad (2)$$

where T_x, I_x, F_x are the truth-membership, indeterminacy-membership, falsity-membership respectively, $\tau = \{\tau_1, \tau_2, \dots, \tau_k\}$ is set of time sequence and

$$\left[T_x^L(\tau), T_x^U(\tau) \right] \subseteq [0, 1]; \left[I_x^L(\tau), I_x^U(\tau) \right] \subseteq [0, 1]; \left[F_x^L(\tau), F_x^U(\tau) \right] \subseteq [0, 1]$$

Example 1. A DIVNS in time sequence $\tau = \{\tau_1, \tau_2\}$ and universal $U = \{x_1, x_2, x_3\}$ is:

$$A = \left\{ \begin{array}{l} x_1, \langle ([0.5, 0.6], [0.1, 0.3], [0.2, 0.4]), ([0.4, 0.55], [0.25, 0.3], [0.3, 0.42]) \rangle \\ x_2, \langle ([0.7, 0.81], [0.1, 0.2], [0.1, 0.2]), ([0.72, 0.8], [0.11, 0.25], [0.2, 0.4]) \rangle \\ x_3, \langle ([0.3, 0.5], [0.4, 0.5], [0.6, 0.7]), ([0.4, 0.5], [0.5, 0.6], [0.66, 0.73]) \rangle \end{array} \right\}$$

Hesitant fuzzy set (HFS) first introduced by Torra and Narukawa [19] and Torra [20] is defined as follows.

Definition 2. [20] A hesitant fuzzy set E on U is defined by the function $h_E(x)$. When $h_E(x)$ is applied to U , it returns a finite subset of $[0, 1]$, which can be represented as

$$E = \{ \langle x, h_E(x) \rangle \mid x \in U \} \quad (3)$$

where $h_E(x)$ is a set of some values in $[0, 1]$.

Example 2. Let $X = \{x_1, x_2, x_3\}$ be the discourse set, and $h_E(x_1) = \{0.1, 0.2\}$, $h_E(x_2) = \{0.3\}$ and $h_E(x_3) = \{0.2, 0.3, 0.5\}$. Then, E can be considered as a HFS:

$$E = \{ \langle x_1, \{0.1, 0.2\} \rangle, \langle x_2, \{0.3\} \rangle, \langle x_3, \{0.2, 0.3, 0.5\} \rangle \}$$

3. Generalized Dynamic Interval-Valued Neutrosophic Set

Extending DIVNS by the concept of HFS is considered how to express the criteria, alternatives, and DMs that are changing during time criteria, alternatives and decision-makers are changing by time.

In this section, we propose the concepts of generalized dynamic interval-valued neutrosophic set (GDIVNS) and generalized dynamic interval-valued neutrosophic element (GDIVNE) including fundamental elements, operational laws as well as the score functions. Then, GDIVNS's theory is applied for the decision-making model in Section 4.

Definition 3. Let U be a universe of discourse. A generalized dynamic interval-valued neutrosophic set (GDIVNS) in U can be expressed as,

$$\tilde{E} = \left\{ \langle x, \tilde{h}_{\tilde{E}}(x(t_r)) \rangle \mid x \in U; \forall t_r \in t; \right\} \quad (4)$$

where $\tilde{h}_{\tilde{E}}(x(t_r))$ is expressed for importing HFS into DIVNS. $\tilde{h}_{\tilde{E}}(x(t_r))$ is a set of DIVNSs at period t_r and $t = \{t_1, t_2, t_3, \dots, t_s\}$, which denotes the possible DIVNSs of the element $x \in X$ to the set \tilde{E} , $\tilde{h}_{\tilde{E}}(x(t_r))$ can be represented by a generalized dynamic interval-valued neutrosophic element (GDIVNE). When $s = 1$ and

$|\widetilde{h}_{\widetilde{E}}(x(t_r))| = 1$, GDIVNS simplifies to DIVNS [14]. For convenience, we denote $\widetilde{h} = \widetilde{h}_{\widetilde{E}}(x(t)) = \{\gamma | \gamma \in \widetilde{h}\}$, where

$$\gamma = \left(\left[T^L(x(\tau)), T^U(x(\tau)) \right], \left[I^L(x(\tau)), I^U(x(\tau)) \right], \left[F^L(x(\tau)), F^U(x(\tau)) \right] \right)$$

is a dynamic interval-valued neutrosophic number.

Example 3. Let $t = \{t_1, t_2\}$; $\tau = \{\tau_1, \tau_2\}$ and an universal $X = \{x_1, x_2, x_3\}$. A GDIVNS in X is given as:

$$\widetilde{E} = \left\{ \left\langle x_1, \left\{ \langle ([0.2, 0.33], [0.4, 0.5], [0.6, 0.7]), ([0.24, 0.39], [0.38, 0.47], [0.56, 0.7]) \rangle, \right\} \right\rangle, \left\langle x_2, \left\{ \langle ([0.29, 0.37], [0.3, 0.5], [0.4, 0.58]), ([0.4, 0.5], [0.2, 0.3], [0.35, 0.42]) \rangle, \right\} \right\rangle, \left\langle x_3, \left\{ \langle ([0.8, 0.9], [0.1, 0.2], [0.1, 0.2]), ([0.72, 0.8], [0.11, 0.25], [0.23, 0.45]) \rangle, \right\} \right\rangle \right\}$$

$$\left\{ \left\langle x_2, \left\{ \langle ([0.4, 0.6], [0.2, 0.4], [0.3, 0.4]), ([0.41, 0.5], [0.26, 0.39], [0.2, 0.3]) \rangle, \right\} \right\rangle, \left\langle x_3, \left\{ \langle ([0.6, 0.7], [0.2, 0.3], [0.4, 0.5]), ([0.52, 0.66], [0.34, 0.4], [0.6, 0.77]) \rangle, \right\} \right\rangle \right\}$$

$$\left\{ \left\langle x_3, \left\{ \langle ([0.54, 0.62], [0.15, 0.3], [0.2, 0.4]), ([0.4, 0.5], [0.25, 0.32], [0.39, 0.43]) \rangle, \right\} \right\rangle \right\}$$

Definition 4. Let $\widetilde{h}, \widetilde{h}_1$ and \widetilde{h}_2 be three GDIVNEs. When $\lambda > 0$, the operations of GDIVNEs are defined as follows:

(i) Addition

$$\widetilde{h}_1 \oplus \widetilde{h}_2 = \cup_{\forall \gamma_1 \in \widetilde{h}_1; \forall \gamma_2 \in \widetilde{h}_2} \{\gamma_1 \oplus \gamma_2\}$$

$$= \left\{ \left\langle \left[T_{\gamma_1}^L(x(\tau)) + T_{\gamma_2}^L(x(\tau)) - T_{\gamma_1}^L(x(\tau)) \times T_{\gamma_2}^L(x(\tau)), T_{\gamma_1}^U(x(\tau)) + T_{\gamma_2}^U(x(\tau)) - T_{\gamma_1}^U(x(\tau)) \times T_{\gamma_2}^U(x(\tau)) \right], \right\rangle \right\}$$

$$\left\{ \left\langle \left[I_{\gamma_1}^L(x(\tau)) \times I_{\gamma_2}^L(x(\tau)), I_{\gamma_1}^U(x(\tau)) \times I_{\gamma_2}^U(x(\tau)) \right], \left[F_{\gamma_1}^L(x(\tau)) \times F_{\gamma_2}^L(x(\tau)), F_{\gamma_1}^U(x(\tau)) \times F_{\gamma_2}^U(x(\tau)) \right] \right\rangle \right\}$$

(ii) Multiplication

$$\widetilde{h}_1 \otimes \widetilde{h}_2 = \cup_{\forall \gamma_1 \in \widetilde{h}_1; \forall \gamma_2 \in \widetilde{h}_2} \{\gamma_1 \otimes \gamma_2\}$$

$$= \left\{ \left\langle \left[T_{\gamma_1}^L(x(\tau)) \times T_{\gamma_2}^L(x(\tau)), T_{\gamma_1}^U(x(\tau)) \times T_{\gamma_2}^U(x(\tau)) \right], \right\rangle \right\}$$

$$\left\{ \left\langle \left[I_{\gamma_1}^L(x(\tau)) + I_{\gamma_2}^L(x(\tau)) - I_{\gamma_1}^L(x(\tau)) \times I_{\gamma_2}^L(x(\tau)), I_{\gamma_1}^U(x(\tau)) + I_{\gamma_2}^U(x(\tau)) - I_{\gamma_1}^U(x(\tau)) \times I_{\gamma_2}^U(x(\tau)) \right], \right\rangle \right\}$$

$$\left\{ \left\langle \left[F_{\gamma_1}^L(x(\tau)) + F_{\gamma_2}^L(x(\tau)) - F_{\gamma_1}^L(x(\tau)) \times F_{\gamma_2}^L(x(\tau)), F_{\gamma_1}^U(x(\tau)) + F_{\gamma_2}^U(x(\tau)) - F_{\gamma_1}^U(x(\tau)) \times F_{\gamma_2}^U(x(\tau)) \right] \right\rangle \right\}$$

(iii) Scalar Multiplication

$$\lambda \widetilde{h} = \cup_{\forall \gamma \in \widetilde{h}} \{\lambda \gamma\}$$

$$= \cup_{\forall \gamma \in \widetilde{h}} \left\{ \left\langle \left[1 - (1 - T^L(x(\tau)))^\lambda, 1 - (1 - T^U(x(\tau)))^\lambda \right], \right\rangle \right\}$$

$$\left\{ \left\langle \left[(I^L(x(\tau)))^\lambda, (I^U(x(\tau)))^\lambda \right], \left[(F^L(x(\tau)))^\lambda, (F^U(x(\tau)))^\lambda \right] \right\rangle \right\}$$

(iv) Power

$$\widetilde{h}^\lambda = \cup_{\forall \gamma \in \widetilde{h}} \{\gamma^\lambda\}$$

$$= \cup_{\forall \gamma \in \widetilde{h}} \left\{ \left\langle \left[(T^L(x(\tau)))^\lambda, (T^U(x(\tau)))^\lambda \right], \left[1 - (1 - I^L(x(\tau)))^\lambda, 1 - (1 - I^U(x(\tau)))^\lambda \right], \right\rangle \right\}$$

$$\left\{ \left\langle \left[1 - (1 - F^L(x(\tau)))^\lambda, 1 - (1 - F^U(x(\tau)))^\lambda \right] \right\rangle \right\}$$

Definition 5. Let \widetilde{h} be a GDIVNE. Then, the score functions of the GDIVNE \widetilde{h} are defined by,

$$s(\widetilde{h}) = \frac{1}{\#\widetilde{h}} \times \frac{1}{k} \sum_{\forall \gamma \in \widetilde{h}} \sum_{l=1}^k \left(\left(\frac{T^L(\tau_l) + T^U(\tau_l)}{2} + \left(1 - \frac{I^L(\tau_l) + I^U(\tau_l)}{2} \right) + \left(1 - \frac{F^L(\tau_l) + F^U(\tau_l)}{2} \right) \right) / 3 \right) \quad (5)$$

where $\tau = \{\tau_1, \tau_2, \dots, \tau_k\}$, and $\#\tilde{h}$ is number of elements in \tilde{h} . Obviously, $S(\tilde{h}) \in [0, 1]$. If $S(\tilde{h}_1) \geq S(\tilde{h}_2)$, then $\tilde{h}_1 \geq \tilde{h}_2$.

Example 4. Let three GDIVNEs:

$$\begin{aligned} \tilde{h}_1 &= \{ \langle ([1, 1], [0, 0], [0, 0]), ([1, 1], [0, 0], [0, 0]) \rangle, \langle ([1, 1], [0, 0], [0, 0]), ([1, 1], [0, 0], [0, 0]) \rangle \} \\ \tilde{h}_2 &= \{ \langle ([0, 0], [1, 1], [0, 0]), ([0, 0], [1, 1], [0, 0]) \rangle, \langle ([0, 0], [1, 1], [0, 0]), ([0, 0], [1, 1], [0, 0]) \rangle \} \\ \tilde{h}_3 &= \{ \langle ([0, 0], [1, 1], [1, 1]), ([0, 0], [1, 1], [1, 1]) \rangle, \langle ([0, 0], [1, 1], [1, 1]), ([0, 0], [1, 1], [1, 1]) \rangle \} \end{aligned}$$

According to Equation (5), we have $S(\tilde{h}_1) = 1$; $S(\tilde{h}_2) = \frac{1}{3}$; $S(\tilde{h}_3) = 0$. Thus, $\tilde{h}_1 > \tilde{h}_2 > \tilde{h}_3$.

Definition 6. Let $\tilde{h}_j (j = 1, 2, \dots, n)$ be a collection of GDIVNEs. Generalized dynamic interval-valued neutrosophic weighted average (GDIVNWA) operator is defined as

$$\begin{aligned} GDIVNWA(\tilde{h}_1, \tilde{h}_2, \dots, \tilde{h}_n) &= \sum_{j=1}^n w_j \tilde{h}_j \\ &= \bigcup_{\gamma_1 \in \tilde{h}_1, \gamma_2 \in \tilde{h}_2, \dots, \gamma_n \in \tilde{h}_n} \left\{ \left(\left[1 - \prod_{j=1}^n (1 - T_{\gamma_j}^L(\tau))^{w_j}, 1 - \prod_{j=1}^n (1 - T_{\gamma_j}^U(\tau))^{w_j} \right], \right. \right. \\ &\quad \left. \left. \left[\prod_{j=1}^n (I_{\gamma_j}^L(\tau))^{w_j}, \prod_{j=1}^n (I_{\gamma_j}^U(\tau))^{w_j} \right], \left[\prod_{j=1}^n (F_{\gamma_j}^L(\tau))^{w_j}, \prod_{j=1}^n (F_{\gamma_j}^U(\tau))^{w_j} \right] \right) \right\} \end{aligned} \tag{6}$$

Theorem 1. Let $\tilde{h}_j (j = 1, 2, \dots, n)$ be the collection of GDIVNEs. The result aggregated from GDIVNWA operator is still a GDIVNE.

Proof. The Equation (6) is proved by mathematical inductive reasoning method. \square

When $n = 1$, Equation (6) holds because it simplifies to the trivial outcome, which is obviously GDIVNE as,

$$GDIVNWA(\tilde{h}_1) = \left(\left[1 - (1 - T_{\gamma_1}^L(\tau))^{w_1}, 1 - (1 - T_{\gamma_1}^U(\tau))^{w_1} \right], \left[(I_{\gamma_1}^L(\tau))^{w_1}, (I_{\gamma_1}^U(\tau))^{w_1} \right], \left[(F_{\gamma_1}^L(\tau))^{w_1}, (F_{\gamma_1}^U(\tau))^{w_1} \right] \right) \tag{7}$$

Let us assume that (6) is true for $n = z$,

$$\sum_{j=1}^z w_j \tilde{h}_j = \bigcup_{\gamma_1 \in \tilde{h}_1, \gamma_2 \in \tilde{h}_2, \dots, \gamma_z \in \tilde{h}_z} \left\{ \left(\left[1 - \prod_{j=1}^z (1 - T_{\gamma_j}^L(\tau))^{w_j}, 1 - \prod_{j=1}^z (1 - T_{\gamma_j}^U(\tau))^{w_j} \right], \right. \right. \\ \left. \left. \left[\prod_{j=1}^z (I_{\gamma_j}^L(\tau))^{w_j}, \prod_{j=1}^z (I_{\gamma_j}^U(\tau))^{w_j} \right], \left[\prod_{j=1}^z (F_{\gamma_j}^L(\tau))^{w_j}, \prod_{j=1}^z (F_{\gamma_j}^U(\tau))^{w_j} \right] \right) \right\} \tag{8}$$

When $n = z + 1$

$$\begin{aligned}
 \sum_{j=1}^{z+1} w_j \tilde{h}_j &= \sum_{j=1}^z w_j \tilde{h}_j \oplus w_{z+1} \tilde{h}_{z+1} \\
 &= \bigcup_{\gamma_1 \in \tilde{h}_1, \gamma_2 \in \tilde{h}_2, \dots, \gamma_z \in \tilde{h}_z} \left\{ \left[\begin{aligned} & \left[1 - \prod_{j=1}^z (1 - T_{\gamma_j}^L(\tau))^{w_j}, 1 - \prod_{j=1}^z (1 - T_{\gamma_j}^U(\tau))^{w_j} \right], \\ & \left[\prod_{j=1}^z (I_{\gamma_j}^L(\tau))^{w_j}, \prod_{j=1}^z (I_{\gamma_j}^U(\tau))^{w_j} \right], \left[\prod_{j=1}^z (F_{\gamma_j}^L(\tau))^{w_j}, \prod_{j=1}^z (F_{\gamma_j}^U(\tau))^{w_j} \right] \end{aligned} \right\} \\
 &\oplus \left(\left[\begin{aligned} & \left[1 - (1 - T_{\gamma_{z+1}}^L(\tau))^{w_{z+1}}, 1 - (1 - T_{\gamma_{z+1}}^U(\tau))^{w_{z+1}} \right], \\ & \left[(I_{\gamma_{z+1}}^L(\tau))^{w_{z+1}}, (I_{\gamma_{z+1}}^U(\tau))^{w_{z+1}} \right], \left[(F_{\gamma_{z+1}}^L(\tau))^{w_{z+1}}, (F_{\gamma_{z+1}}^U(\tau))^{w_{z+1}} \right] \end{aligned} \right) \right. \\
 &= \bigcup_{\gamma_1 \in \tilde{h}_1, \gamma_2 \in \tilde{h}_2, \dots, \gamma_{z+1} \in \tilde{h}_{z+1}} \left\{ \left[\begin{aligned} & \left[1 - \prod_{j=1}^{z+1} (1 - T_{\gamma_j}^L(\tau))^{w_j}, 1 - \prod_{j=1}^{z+1} (1 - T_{\gamma_j}^U(\tau))^{w_j} \right], \\ & \left[\prod_{j=1}^{z+1} (I_{\gamma_j}^L(\tau))^{w_j}, \prod_{j=1}^{z+1} (I_{\gamma_j}^U(\tau))^{w_j} \right], \left[\prod_{j=1}^{z+1} (F_{\gamma_j}^L(\tau))^{w_j}, \prod_{j=1}^{z+1} (F_{\gamma_j}^U(\tau))^{w_j} \right] \end{aligned} \right\} \quad (9)
 \end{aligned}$$

It follows that if (6) holds for $n = z$, then it holds for $n = z + 1$. Because it is also true for $n = 1$, according to the method of mathematical inductive reasoning, Equation (6) holds for natural numbers N and Theorem 1 is proven.

Definition 7. Let $\tilde{h}_j (j = 1, 2, \dots, n)$ be a collection of GDIVNEs. Generalized dynamic interval-valued neutrosophic weighted geometric (GDIVNWG) operator is defined as

$$\begin{aligned}
 GDIVNWG(\tilde{h}_1, \tilde{h}_2, \dots, \tilde{h}_n) &= \prod_{j=1}^n \tilde{h}_j^{w_j} \\
 &= \bigcup_{\gamma_1 \in \tilde{h}_1, \gamma_2 \in \tilde{h}_2, \dots, \gamma_n \in \tilde{h}_n} \left\{ \left[\begin{aligned} & \left[\prod_{j=1}^n (T_{\gamma_j}^L(\tau))^{w_j}, \prod_{j=1}^n (T_{\gamma_j}^U(\tau))^{w_j} \right], \left[1 - \prod_{j=1}^n (1 - I_{\gamma_j}^L(\tau))^{w_j}, 1 - \prod_{j=1}^n (1 - I_{\gamma_j}^U(\tau))^{w_j} \right], \\ & \left[1 - \prod_{j=1}^n (1 - F_{\gamma_j}^L(\tau))^{w_j}, 1 - \prod_{j=1}^n (1 - F_{\gamma_j}^U(\tau))^{w_j} \right] \end{aligned} \right\} \quad (10)
 \end{aligned}$$

Theorem 2. Let $\tilde{h}_j (j = 1, 2, \dots, n)$ be the collection of GDIVNEs. The result aggregated from GDIVNWG operator is still a GDIVNE.

Proof. The Equation (10) is proved by mathematical inductive reasoning method. \square

When $n = 1$, Equation (10) is true because it simplifies to the trivial outcome, which is obviously GDIVNE,

$$GDIVNWG(\tilde{h}_1) = \left(\left[\begin{aligned} & \left[(T_{\gamma_1}^L(\tau))^{w_1}, (T_{\gamma_1}^U(\tau))^{w_1} \right], \left[1 - (1 - I_{\gamma_1}^L(\tau))^{w_1}, 1 - (1 - I_{\gamma_1}^U(\tau))^{w_1} \right], \\ & \left[1 - (1 - F_{\gamma_1}^L(\tau))^{w_1}, 1 - (1 - F_{\gamma_1}^U(\tau))^{w_1} \right] \end{aligned} \right] \right) \quad (11)$$

Let us assume that (10) is true for $n = z$.

$$\prod_{j=1}^z \tilde{h}_j^{w_j} = \bigcup_{\gamma_1 \in \tilde{h}_1, \gamma_2 \in \tilde{h}_2, \dots, \gamma_z \in \tilde{h}_z} \left\{ \left[\begin{aligned} & \left[\prod_{j=1}^z (T_{\gamma_j}^L(\tau))^{w_j}, \prod_{j=1}^z (T_{\gamma_j}^U(\tau))^{w_j} \right], \left[1 - \prod_{j=1}^z (1 - I_{\gamma_j}^L(\tau))^{w_j}, 1 - \prod_{j=1}^z (1 - I_{\gamma_j}^U(\tau))^{w_j} \right], \\ & \left[1 - \prod_{j=1}^z (1 - F_{\gamma_j}^L(\tau))^{w_j}, 1 - \prod_{j=1}^z (1 - F_{\gamma_j}^U(\tau))^{w_j} \right] \end{aligned} \right\} \quad (12)$$

When $n = z + 1$

$$\begin{aligned}
 \prod_{j=1}^{z+1} \tilde{h}_j^{w_j} &= \prod_{j=1}^z \tilde{h}_j^{w_j} \otimes \tilde{h}_{z+1}^{w_{z+1}} \\
 &= \bigcup_{\gamma_1 \in \tilde{h}_1, \gamma_2 \in \tilde{h}_2, \dots, \gamma_z \in \tilde{h}_z} \left\{ \left(\left[\prod_{j=1}^k (T_{\gamma_j}^L(\tau))^{w_j}, \prod_{j=1}^k (T_{\gamma_j}^U(\tau))^{w_j} \right], \left[1 - \prod_{j=1}^k (1 - I_{\gamma_j}^L(\tau))^{w_j}, 1 - \prod_{j=1}^k (1 - I_{\gamma_j}^U(\tau))^{w_j} \right] \right) \right. \\
 &\quad \left. \otimes \left(\left[(T_{\gamma_{z+1}}^L(\tau))^{w_{z+1}}, (T_{\gamma_{z+1}}^U(\tau))^{w_{z+1}} \right], \left[1 - (1 - I_{\gamma_{z+1}}^L(\tau))^{w_{z+1}}, 1 - (1 - I_{\gamma_{z+1}}^U(\tau))^{w_{z+1}} \right] \right) \right. \\
 &= \bigcup_{\gamma_1 \in \tilde{h}_1, \gamma_2 \in \tilde{h}_2, \dots, \gamma_{z+1} \in \tilde{h}_{z+1}} \left\{ \left(\left[\prod_{j=1}^{z+1} (T_{\gamma_j}^L(\tau))^{w_j}, \prod_{j=1}^{z+1} (T_{\gamma_j}^U(\tau))^{w_j} \right], \left[1 - \prod_{j=1}^{z+1} (1 - I_{\gamma_j}^L(\tau))^{w_j}, 1 - \prod_{j=1}^{z+1} (1 - I_{\gamma_j}^U(\tau))^{w_j} \right] \right) \right. \\
 &\quad \left. \left(\left[1 - \prod_{j=1}^{z+1} (1 - F_{\gamma_j}^L(\tau))^{w_j}, 1 - \prod_{j=1}^{z+1} (1 - F_{\gamma_j}^U(\tau))^{w_j} \right] \right) \right\} \tag{13}
 \end{aligned}$$

It follows that if (10) holds for $n = z$, then it holds for $n = z + 1$. Because it is also true for $n = 1$, according to the method of mathematical inductive reasoning, Equation (10) holds for all natural numbers N and Theorem 2 is proven.

Herein, we define the generalized dynamic interval-valued neutrosophic hybrid weighted averaging (GDIVNHWA) operator to combine the effects of attribute weight vector and the positional weight vector, which are mentioned in Definitions 6 and 7.

Definition 8. Let $\lambda > 0$ and $\tilde{h}_j (j = 1, 2, \dots, n)$ be a collection of GDIVNEs. Generalized dynamic interval-valued neutrosophic hybrid weighted averaging (GDIVNHWA) operator is defined as,

$$\begin{aligned}
 \text{DIVHNWG}(\tilde{h}_1, \tilde{h}_2, \dots, \tilde{h}_n) &= \left(\sum_{j=1}^n w_j \tilde{h}_j^\lambda \right)^{\frac{1}{\lambda}} \\
 &= \bigcup_{\gamma_1 \in \tilde{h}_1, \gamma_2 \in \tilde{h}_2, \dots, \gamma_n \in \tilde{h}_n} \left\{ \left(\left[\left(1 - \prod_{j=1}^n (1 - (T_{\gamma_j}^L(\tau))^\lambda)^{w_j} \right)^{\frac{1}{\lambda}}, \left(1 - \prod_{j=1}^n (1 - (T_{\gamma_j}^U(\tau))^\lambda)^{w_j} \right)^{\frac{1}{\lambda}} \right], \right. \\
 &\quad \left. \left[1 - \left(1 - \prod_{j=1}^n (1 - (1 - I_{\gamma_j}^L(\tau))^\lambda)^{w_j} \right)^{\frac{1}{\lambda}}, 1 - \left(1 - \prod_{j=1}^n (1 - (1 - I_{\gamma_j}^U(\tau))^\lambda)^{w_j} \right)^{\frac{1}{\lambda}} \right] \right) \right. \\
 &\quad \left. \left(\left[1 - \left(1 - \prod_{j=1}^n (1 - (1 - F_{\gamma_j}^L(\tau))^\lambda)^{w_j} \right)^{\frac{1}{\lambda}}, 1 - \left(1 - \prod_{j=1}^n (1 - (1 - F_{\gamma_j}^U(\tau))^\lambda)^{w_j} \right)^{\frac{1}{\lambda}} \right] \right) \right\} \tag{14}
 \end{aligned}$$

Theorem 3. Let $\tilde{h}_j (j = 1, 2, \dots, n)$ be the collection of GDIVNEs. The result aggregated from GDIVNHWA operator is still a GDIVNE.

Proof. The Equation (14) can be proved by mathematical inductive reasoning method. \square

We first prove that (15) is a collection of GDIVNEs,

$$\sum_{j=1}^n w_j \tilde{h}_j^\lambda = \bigcup_{\gamma_1 \in \tilde{h}_1, \gamma_2 \in \tilde{h}_2, \dots, \gamma_n \in \tilde{h}_n} \left\{ \left(\left[1 - \prod_{j=1}^n (1 - (T_{\gamma_j}^L(\tau))^\lambda)^{w_j}, 1 - \prod_{j=1}^n (1 - (T_{\gamma_j}^U(\tau))^\lambda)^{w_j} \right], \right. \right. \tag{15}$$

When $n = 1$, Equation (15) is true because it simplifies to the trivial outcome, which is obviously GDIVNE,

$$w_1 \tilde{h}_1^\lambda = \left(\begin{array}{l} \left[1 - \left(1 - (T_{\gamma_1}^L(\tau))^\lambda \right)^{w_1}, 1 - \left(1 - (T_{\gamma_1}^U(\tau))^\lambda \right)^{w_1} \right], \\ \left[1 - \left(1 - (1 - I_{\gamma_1}^L(\tau))^\lambda \right)^{w_1}, 1 - \left(1 - (1 - I_{\gamma_1}^U(\tau))^\lambda \right)^{w_1} \right], \\ \left[1 - \left(1 - (1 - F_{\gamma_1}^L(\tau))^\lambda \right)^{w_1}, 1 - \left(1 - (1 - F_{\gamma_1}^U(\tau))^\lambda \right)^{w_1} \right] \end{array} \right) \quad (16)$$

Let us assume that (15) is true for $n = z$,

$$\sum_{j=1}^z w_j \tilde{h}_j^\lambda = \bigcup_{\gamma_1 \in \tilde{h}_1, \gamma_2 \in \tilde{h}_2, \dots, \gamma_z \in \tilde{h}_z} \left\{ \left(\begin{array}{l} \left[1 - \prod_{j=1}^z \left(1 - (T_{\gamma_j}^L(\tau))^\lambda \right)^{w_j}, 1 - \prod_{j=1}^z \left(1 - (T_{\gamma_j}^U(\tau))^\lambda \right)^{w_j} \right], \\ \left[1 - \prod_{j=1}^z \left(1 - (1 - I_{\gamma_j}^L(\tau))^\lambda \right)^{w_j}, 1 - \prod_{j=1}^z \left(1 - (1 - I_{\gamma_j}^U(\tau))^\lambda \right)^{w_j} \right], \\ \left[1 - \prod_{j=1}^z \left(1 - (1 - F_{\gamma_j}^L(\tau))^\lambda \right)^{w_j}, 1 - \prod_{j=1}^z \left(1 - (1 - F_{\gamma_j}^U(\tau))^\lambda \right)^{w_j} \right] \end{array} \right\} \quad (17)$$

When $n = z + 1$,

$$\begin{aligned} \sum_{j=1}^{z+1} w_j \tilde{h}_j^\lambda &= \sum_{j=1}^z w_j \tilde{h}_j^\lambda \oplus w_{z+1} \tilde{h}_{z+1}^\lambda \\ &= \bigcup_{\gamma_1 \in \tilde{h}_1, \gamma_2 \in \tilde{h}_2, \dots, \gamma_z \in \tilde{h}_z} \left\{ \left(\begin{array}{l} \left[1 - \prod_{j=1}^z \left(1 - (T_{\gamma_j}^L(\tau))^\lambda \right)^{w_j}, 1 - \prod_{j=1}^z \left(1 - (T_{\gamma_j}^U(\tau))^\lambda \right)^{w_j} \right], \\ \left[1 - \prod_{j=1}^z \left(1 - (1 - I_{\gamma_j}^L(\tau))^\lambda \right)^{w_j}, 1 - \prod_{j=1}^z \left(1 - (1 - I_{\gamma_j}^U(\tau))^\lambda \right)^{w_j} \right], \\ \left[1 - \prod_{j=1}^z \left(1 - (1 - F_{\gamma_j}^L(\tau))^\lambda \right)^{w_j}, 1 - \prod_{j=1}^z \left(1 - (1 - F_{\gamma_j}^U(\tau))^\lambda \right)^{w_j} \right] \end{array} \right\} \\ &\oplus \left\{ \left(\begin{array}{l} \left[1 - \left(1 - (T_{\gamma_{z+1}}^L(\tau))^\lambda \right)^{w_{z+1}}, 1 - \left(1 - (T_{\gamma_{z+1}}^U(\tau))^\lambda \right)^{w_{z+1}} \right], \\ \left[1 - \left(1 - (1 - I_{\gamma_{z+1}}^L(\tau))^\lambda \right)^{w_{z+1}}, 1 - \left(1 - (1 - I_{\gamma_{z+1}}^U(\tau))^\lambda \right)^{w_{z+1}} \right], \\ \left[1 - \left(1 - (1 - F_{\gamma_{z+1}}^L(\tau))^\lambda \right)^{w_{z+1}}, 1 - \left(1 - (1 - F_{\gamma_{z+1}}^U(\tau))^\lambda \right)^{w_{z+1}} \right] \end{array} \right\} \quad (18) \\ &= \bigcup_{\gamma_1 \in \tilde{h}_1, \gamma_2 \in \tilde{h}_2, \dots, \gamma_{k+1} \in \tilde{h}_{k+1}} \left\{ \left(\begin{array}{l} \left[1 - \prod_{j=1}^{k+1} \left(1 - (T_{\gamma_j}^L(\tau))^\lambda \right)^{w_j}, 1 - \prod_{j=1}^{k+1} \left(1 - (T_{\gamma_j}^U(\tau))^\lambda \right)^{w_j} \right], \\ \left[1 - \prod_{j=1}^{k+1} \left(1 - (1 - I_{\gamma_j}^L(\tau))^\lambda \right)^{w_j}, 1 - \prod_{j=1}^{k+1} \left(1 - (1 - I_{\gamma_j}^U(\tau))^\lambda \right)^{w_j} \right], \\ \left[1 - \prod_{j=1}^{k+1} \left(1 - (1 - F_{\gamma_j}^L(\tau))^\lambda \right)^{w_j}, 1 - \prod_{j=1}^{k+1} \left(1 - (1 - F_{\gamma_j}^U(\tau))^\lambda \right)^{w_j} \right] \end{array} \right\} \end{aligned}$$

It follows that if (15) holds for $n = z$, then it holds for $n = z + 1$. Because it is also true for $n = 1$, according to the method of mathematical inductive reasoning, Equation (15) holds for natural numbers N . According to Equation (15) and Definition 4, we have,

$$\begin{aligned}
 \text{DIVHNWG}(\tilde{h}_1, \tilde{h}_2, \dots, \tilde{h}_n) &= \left(\sum_{j=1}^n w_j \tilde{h}_j^\lambda \right)^{\frac{1}{\lambda}} \\
 &= \bigcup_{\gamma_1 \in \tilde{h}_1, \gamma_2 \in \tilde{h}_2, \dots, \gamma_n \in \tilde{h}_n} \left\{ \left[\left[\left(1 - \prod_{j=1}^n \left(1 - (T_{\gamma_j}^L(\tau))^\lambda \right)^{w_j} \right)^{\frac{1}{\lambda}}, \left(1 - \prod_{j=1}^n \left(1 - (T_{\gamma_j}^U(\tau))^\lambda \right)^{w_j} \right)^{\frac{1}{\lambda}} \right], \right. \right. \\
 &\quad \left. \left[1 - \left(1 - \prod_{j=1}^n \left(1 - (1 - I_{\gamma_j}^L(\tau))^\lambda \right)^{w_j} \right)^{\frac{1}{\lambda}}, 1 - \left(1 - \prod_{j=1}^n \left(1 - (1 - I_{\gamma_j}^U(\tau))^\lambda \right)^{w_j} \right)^{\frac{1}{\lambda}} \right], \right. \\
 &\quad \left. \left[1 - \left(1 - \prod_{j=1}^n \left(1 - (1 - F_{\gamma_j}^L(\tau))^\lambda \right)^{w_j} \right)^{\frac{1}{\lambda}}, 1 - \left(1 - \prod_{j=1}^n \left(1 - (1 - F_{\gamma_j}^U(\tau))^\lambda \right)^{w_j} \right)^{\frac{1}{\lambda}} \right] \right\}
 \end{aligned}$$

Thus, Theorem 3 is proven.

4. Dynamic TOPSIS Method

Based on the theory of GDVINS, the dynamic decision-making model is proposed to deal with the change of criteria, alternatives, and decision-makers during time.

For each period $t = \{t_1, t_2, \dots, t_s\}$, assume $\tilde{A}(t_r) = \{A_1, A_2, \dots, A_{v_r}\}$ and $\tilde{C}(t_r) = \{C_1, C_2, \dots, C_{n_r}\}$ and $\tilde{D}(t_r) = \{D_1, D_2, \dots, D_{h_r}\}$ being the sets of alternatives, criteria, and decision-makers at period r^{th} , $r = \{1, 2, \dots, s\}$. For a decision-maker $D_q; q = 1, \dots, h_r$, the evaluation of an alternative $A_m; m = 1, \dots, v_r$, on a criteria $C_p; p = 1, \dots, n_r$, in time sequence $\tau = \{\tau_1, \tau_2, \dots, \tau_{k_r}\}$ is represented by the Neutrosophic decision matrix $\mathfrak{X}^q(t_r) = (\xi_{mp}^q(\tau))_{v_r \times n_r}; l = 1, 2, \dots, k_r$. where

$$\xi_{mp}^q(\tau) = \left\langle x_{d_{mp}}^q(\tau), (T^q(d_{mp}, \tau), I^q(d_{mp}, \tau), F^q(d_{mp}, \tau)) \right\rangle;$$

taken by GDIVNSs evaluated by decision maker D_q .

Step 1. Calculate aggregate ratings at period r^{th} .

Let $x_{mpq}(\tau_l) = \left\{ [T_{mpq}^L(x_{\tau_l}), T_{mpq}^U(x_{\tau_l})], [I_{mpq}^L(x_{\tau_l}), I_{mpq}^U(x_{\tau_l})], [F_{mpq}^L(x_{\tau_l}), F_{mpq}^U(x_{\tau_l})] \right\}$ be the appropriateness rating of alternative A_m for criterion C_p by decision-maker D_q in time sequence τ_l , where: $m = 1, \dots, v_r; p = 1, \dots, n_r; q = 1, \dots, h_r; l = 1, \dots, k_r$. The averaged appropriateness rating $\bar{x}_{mp} = \left\{ \left[\overline{T_{mp}^L(x)}, \overline{T_{mp}^U(x)} \right], \left[\overline{I_{mp}^L(x)}, \overline{I_{mp}^U(x)} \right], \left[\overline{F_{mp}^L(x)}, \overline{F_{mp}^U(x)} \right] \right\}$ can be evaluated as:

$$\begin{aligned}
 \bar{x}_{mp} &= \frac{1}{h_r \times k_r} \times \left\langle \left[1 - \left\{ 1 - \left(1 - \sum_{q=1}^{h_r} T_{pmq}^L(x_{\tau_l}) \right)^{\frac{1}{h_r}} \right\}^{\frac{1}{k_r}}, 1 - \left\{ 1 - \left(1 - \sum_{q=1}^{h_r} T_{pmq}^U(x_{\tau_l}) \right)^{\frac{1}{h_r}} \right\}^{\frac{1}{k_r}} \right], \right. \\
 &\quad \left. \left[\left(\sum_{q=1}^h I_{pmq}^L(x_{\tau_l}) \right)^{\frac{1}{h_r \times k_r}}, \left(\sum_{q=1}^h I_{pmq}^U(x_{\tau_l}) \right)^{\frac{1}{h_r \times k_r}} \right], \right. \\
 &\quad \left. \left[\left(\sum_{q=1}^h F_{pmq}^L(x_{\tau_l}) \right)^{\frac{1}{h_r \times k_r}}, \left(\sum_{q=1}^h F_{pmq}^U(x_{\tau_l}) \right)^{\frac{1}{h_r \times k_r}} \right] \right\} \quad (19)
 \end{aligned}$$

Step 2. Calculate importance weight aggregation at period r^{th} .

Let $y_{pq}(\tau_l) = \left\{ [T_{pq}^L(y_{\tau_l}), T_{pq}^U(y_{\tau_l})], [I_{pq}^L(y_{\tau_l}), I_{pq}^U(y_{\tau_l})], [F_{pq}^L(y_{\tau_l}), F_{pq}^U(y_{\tau_l})] \right\}$ be the weight of D_q to criterion C_p in time sequence τ_l , where: $p = 1, \dots, n_r; q = 1, \dots, h_r; l = 1, \dots, k$. The average weight $\bar{w}_p = \left\{ \left[\overline{T_p^L(y)}, \overline{T_p^U(y)} \right], \left[\overline{I_p^L(y)}, \overline{I_p^U(y)} \right], \left[\overline{F_p^L(y)}, \overline{F_p^U(y)} \right] \right\}$ can be evaluated as:

$$\bar{w}_p = \frac{1}{h_r \times k_r} \times \left\langle \left[\begin{array}{l} 1 - \left\{ 1 - \left(1 - \sum_{q=1}^{h_r} T_{pq}^L(y_{\tau_l}) \right)^{\frac{1}{h_r}} \right\}^{\frac{1}{k_r}}, 1 - \left\{ 1 - \left(1 - \sum_{q=1}^h T_{pq}^U(y_{\tau_l}) \right)^{\frac{1}{h_r}} \right\}^{\frac{1}{k_r}} \right], \right. \\ \left. \left[\left(\sum_{q=1}^{h_r} I_{pq}^L(y_{\tau_l}) \right)^{\frac{1}{h_r \times k_r}}, \left(\sum_{q=1}^{h_r} I_{pq}^U(y_{\tau_l}) \right)^{\frac{1}{h_r \times k_r}} \right], \right. \\ \left. \left[\left(\sum_{q=1}^{h_r} F_{pq}^L(y_{\tau_l}) \right)^{\frac{1}{h_r \times k_r}}, \left(\sum_{q=1}^{h_r} F_{pq}^U(y_{\tau_l}) \right)^{\frac{1}{h_r \times k_r}} \right] \right\}, \quad (20)$$

Step 3. Evaluation for aggregate ratings of alternatives with history data.

Using Equation (21), evaluate aggregate ratings and importance weight aggregation.

$$\begin{aligned} \tilde{A}(t_r^*) &= \{A_1, A_2, \dots, A_{v_r}\} \cup \tilde{A}(t_{r-1}) \\ \bar{x}_{mp}^* &= \begin{cases} \bar{x}_{mp}^r & \text{if } \left(\begin{array}{l} A_m \in \tilde{A}(t_r) \setminus \tilde{A}(t_{r-1}) \& C_p \in \tilde{C}(t_r) \setminus \tilde{C}(t_{r-1}) \\ \text{or } A_m \in \tilde{A}(t_{r-1}) \setminus \tilde{A}(t_r) \& C_p \in \tilde{C}(t_r) \setminus \tilde{C}(t_{r-1}) \\ \text{or } A_m \in \tilde{A}(t_r) \setminus \tilde{A}(t_{r-1}) \& C_p \in \tilde{C}(t_{r-1}) \setminus \tilde{C}(t_r) \end{array} \right) \\ \bar{x}_{mp}^r \oplus \bar{x}_{mp}^{r-1} & \text{if } A_m \in \tilde{A}(t_r) \cap \tilde{A}(t_{r-1}) \& C_p \in \tilde{C}(t_r) \cap \tilde{C}(t_{r-1}) \\ \bar{x}_{mp}^{r-1} & \text{if } A_m \in \tilde{A}(t_{r-1}) \setminus \tilde{A}(t_r) \& C_p \in \tilde{C}(t_{r-1}) \setminus \tilde{C}(t_r) \end{cases} \end{aligned} \quad (21)$$

Step 4. Evaluation for importance weight aggregation of criteria with history data.

Using Equation (22), evaluate aggregate ratings and importance weight aggregation.

$$\begin{aligned} \tilde{C}(t_r^*) &= \{C_1, C_2, \dots, C_{n_r}\} \cup \tilde{C}(t_{r-1}) \\ \bar{w}_p^* &= \begin{cases} \bar{w}_p^r & \text{if } C_p \in \tilde{C}(t_r) \setminus \tilde{C}(t_{r-1}) \\ \bar{w}_p^r \oplus \bar{w}_p^{r-1} & \text{if } C_p \in \tilde{C}(t_r) \cap \tilde{C}(t_{r-1}) \\ \bar{w}_p^{r-1} & \text{if } C_p \in \tilde{C}(t_{r-1}) \setminus \tilde{C}(t_r) \end{cases} \end{aligned} \quad (22)$$

Step 5. Calculate the average weighted ratings at period r^{th} .

The average weighted ratings of alternatives at period t_r , can be calculated by:

$$\Theta_m = \frac{1}{n_r^*} \sum_{p=1}^{n_r^*} \bar{x}_{mp}^* * \bar{w}_p^*; m = 1, \dots, v_r^*; p = 1, \dots, n_r^*; \quad (23)$$

Step 6. Determination of A_r^+ , A_r^- and d_r^+ , d_r^- at period r^{th} .

Interval-valued neutrosophic positive ideal solution (PIS, A_r^+) and interval-valued neutrosophic negative ideal solution (NIS, A_r^-) are:

$$A_r^+ = \{x, \{([1, 1], [0, 0], [0, 0])_1, ([1, 1], [0, 0], [0, 0])_2, \dots, ([1, 1], [0, 0], [0, 0])_{n_r^*}\}\} \quad (24)$$

$$A_r^- = \{x, \{([0, 0], [1, 1], [1, 1])_1, ([0, 0], [1, 1], [1, 1])_2, \dots, ([0, 0], [1, 1], [1, 1])_{n_r^*}\}\} \quad (25)$$

The distances of each alternative $A_m, m = 1, 2, \dots, n^*$ from A_r^+ and A_r^- at period t_r , are calculated as:

$$d_m^+ = \sqrt{(\Theta_m - A_r^+)^2} \quad (26)$$

$$d_m^- = \sqrt{(\Theta_m - A_r^-)^2} \tag{27}$$

where d_m^+ and d_m^- respectively represent the shortest and farthest distances of A_m .

Step 7. Determination the closeness coefficient.

The closeness coefficient at period t_r , is calculated in Equation (28), where an alternative that is close to interval-valued neutrosophic PIS and far from interval-valued neutrosophic NIS, has high value:

$$BC_m = \frac{d_m^-}{d_m^+ + d_m^-} \tag{28}$$

Step 8. Rank the alternatives.

The alternatives are ranked by their closeness coefficient values. See Figure 1 for illustration.

Symmetry 2020, 12, x FOR PEER REVIEW

12 of 23

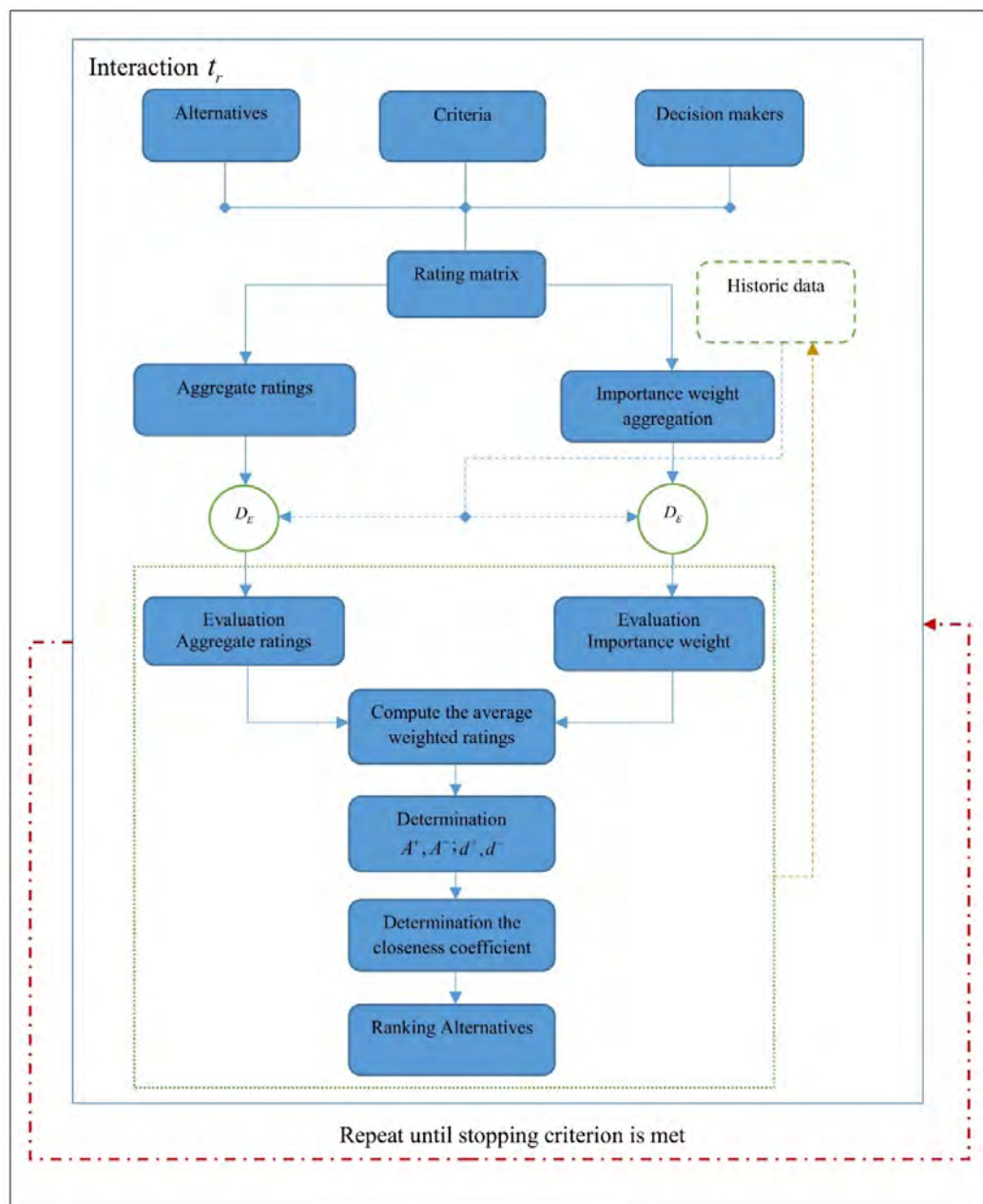

Figure 1. Dynamic TOPSIS method.

5. Applications

5.1. ASK Model for Ranking Students

Human resources recruitment plays a pivotal role in any enterprise as it exerts tremendous impact on its sustainable development. Thus, the selection of competent and job-relevant staff will lay the solid foundation for the successful performance of an enterprise. Notably, every year most of the businesses invest a large sum of money for job vacancy advertisements (on newspapers, websites, and in job fairs) and recruitment activities including application screening and interview. However, to recruit new graduated student the organizations are likely to encounter high potential risks as there are definitely inevitable employee turnovers or the selected candidates fall short of employers' expectation [22]. Mis-assessment of candidate's competence might be rooted from assessors' criteria and model for new graduated student evaluation.

The above problems underline the need for making the right assessment of potential employees. Currently, ASK model (attitude, skill and knowledge) has been widely used by many organizations because of its comprehensive assessment. This model was initially proposed by Bloom [11] with three factors including knowledge which is acquired through education, comprehension, analysis, and application skills which are the ability to process the knowledge to perform activities or tasks, and attitude which is concerned with feeling, emotions, or motivation toward employment. These elements are given divergent weights in the assessment model according to positions and requirements of the job. ASK is applicable to evaluate tertiary students' performance to give more information that support employers besides a set of university exit benchmark. It also facilitates students to make proper self-adjustments and pursue appropriate professional orientation for their future career [23,24]. Ranking students based on attributes of ASK model requires a dynamic multi-criteria decision-making model that is able to combine the estimations of different lecturers in different periods. The proposed DTOPSIS completely fit to this complex task, and the application model is depicted bellow.

5.2. Application Model

As mentioned above, the proposed method is applied to rank students of Thuongmai University, Hanoi, Vietnam. In this research, the datasets were surveyed through three consecutive semesters under three criteria (attitudes-skills-knowledge). Each student will be surveyed at the beginning of semester and by the end of semester. With the model assessing student competence, it will be conducted over semesters and over school years. This is the way of setting the time period in the decision-making model of this research.

Figure 2 shows the ASK model for ranking students where three lectures i.e., D_1, D_2, D_3 are chosen. According to the language labels shown in Tables 1 and 2, rating of five students and criteria' weights are done by the lectures based on fourteenth criteria in three groups: attitude, skill, and knowledge. The attitude group includes five criteria [25], the skill group includes six criteria [26], and the knowledge group includes three criteria [23].

The criteria used for ranking Thuongmai university's students contain 14 criteria divided into three groups (attitudes-skills-knowledge) in the ASK model. In the early stage of each semester, the knowledge criteria will not cause many impacts on student competency assessment so that we only pay attention to 11 criteria in the two remaining groups: attitudes and skills. In the following semesters, the knowledge criterion shall be supplemented that why all 14 criteria in three group shall be conducted.

(1) Period t_1 (the first semester): the decision-maker t_1 provides assessments of three students A_1, A_2, A_3 according to 11 criteria in two groups: attitude, skill. Tables 3 and 4 show the steps of the model at time t_1 and Table 5 shows the ranking order as $A_1 > A_2 > A_3$. Thus, the best student is A_1 .

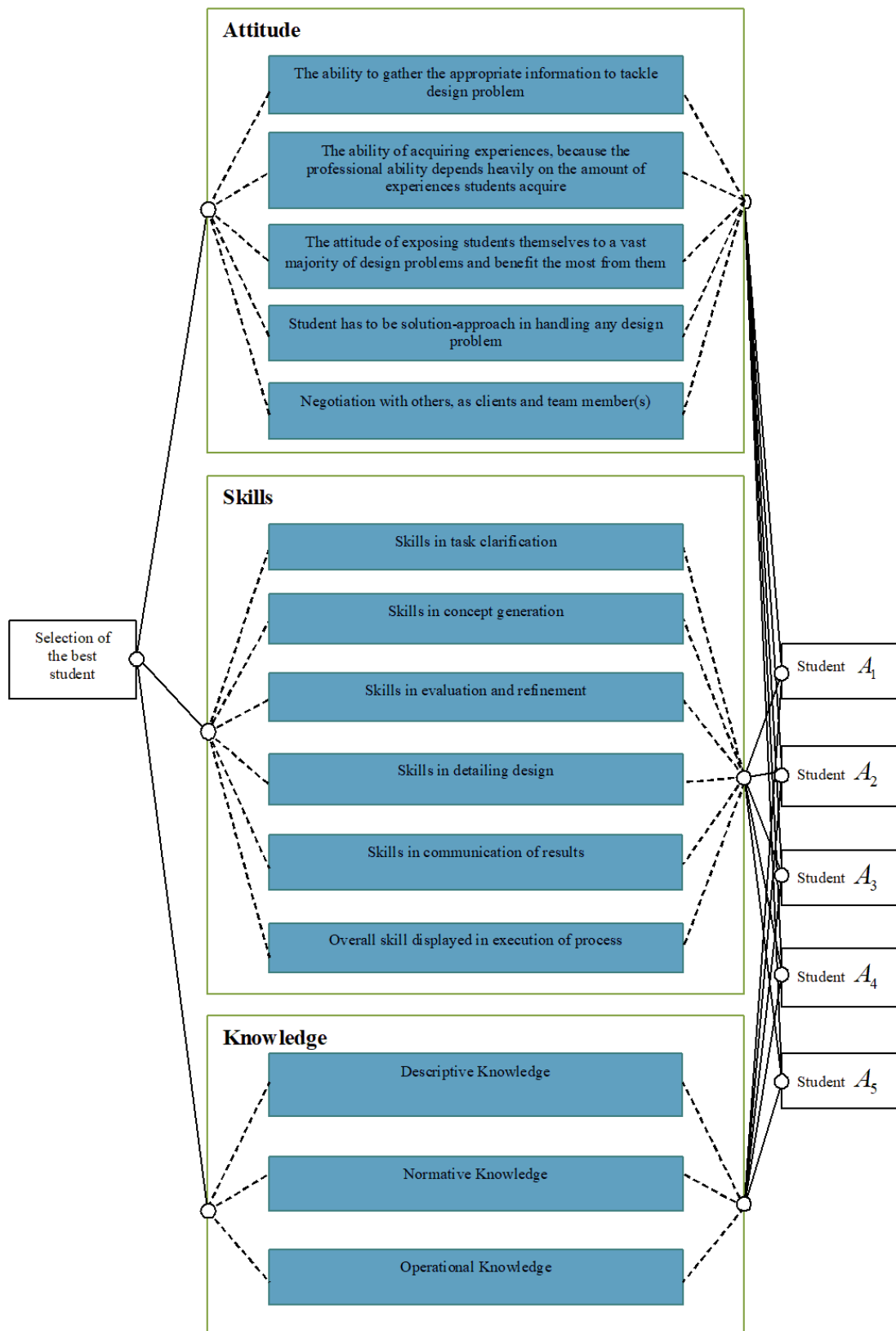

Figure 2. Attitudes-skills-knowledge (ASK) model for recruitment of ternary students.

Table 1. Appropriateness ratings.

Language Labels	Values
Very Poor	([0.1, 0.26], [0.4, 0.5], [0.63, 0.76])
Poor	([0.26, 0.38], [0.47, 0.6], [0.51, 0.6])
Medium	([0.38, 0.5], [0.4, 0.61], [0.44, 0.55])
Good	([0.5, 0.65], [0.36, 0.5], [0.31, 0.48])
Very Good	([0.65, 0.8], [0.1, 0.2], [0.12, 0.2])

Table 2. The importance of criteria.

Language Labels	Values
Unimportant	([0.1, 0.19], [0.32, 0.47], [0.64, 0.8])
Slightly Important	([0.2, 0.38], [0.46, 0.62], [0.36, 0.55])
Important	([0.45, 0.63], [0.41, 0.53], [0.2, 0.42])
Very Important	([0.66, 0.8], [0.3, 0.39], [0.22, 0.32])
Absolutely Important	([0.8, 0.94], [0.18, 0.29], [0.1, 0.2])

Table 3. Aggregated ratings at period t_1 .

Criteria	Students		
	A_1	A_2	A_3
C_1	([0.463, 0.606], [0.018, 0.054], [0.014, 0.044])	([0.38, 0.5], [0.022, 0.082], [0.029, 0.059])	([0.43, 0.577], [0.021, 0.053], [0.017, 0.048])
C_2	([0.488, 0.632], [0.005, 0.025], [0.008, 0.021])	([0.419, 0.578], [0.011, 0.037], [0.011, 0.026])	([0.419, 0.578], [0.011, 0.037], [0.011, 0.026])
C_3	([0.463, 0.606], [0.018, 0.054], [0.014, 0.044])	([0.463, 0.606], [0.018, 0.054], [0.014, 0.044])	([0.423, 0.556], [0.02, 0.066], [0.02, 0.051])
C_4	([0.423, 0.556], [0.02, 0.066], [0.02, 0.051])	([0.463, 0.606], [0.018, 0.054], [0.014, 0.044])	([0.388, 0.523], [0.023, 0.065], [0.024, 0.056])
C_5	([0.523, 0.673], [0.005, 0.021], [0.005, 0.018])	([0.423, 0.556], [0.02, 0.066], [0.02, 0.051])	([0.43, 0.577], [0.021, 0.053], [0.017, 0.048])
C_6	([0.43, 0.577], [0.021, 0.053], [0.017, 0.048])	([0.38, 0.5], [0.022, 0.082], [0.029, 0.059])	([0.342, 0.463], [0.026, 0.081], [0.034, 0.065])
C_7	([0.38, 0.5], [0.022, 0.082], [0.029, 0.059])	([0.388, 0.523], [0.023, 0.065], [0.024, 0.056])	([0.342, 0.463], [0.026, 0.081], [0.034, 0.065])
C_8	([0.26, 0.38], [0.036, 0.078], [0.046, 0.078])	([0.38, 0.5], [0.022, 0.082], [0.029, 0.059])	([0.38, 0.5], [0.022, 0.082], [0.029, 0.059])
C_9	([0.463, 0.606], [0.018, 0.054], [0.014, 0.044])	([0.523, 0.673], [0.005, 0.021], [0.005, 0.018])	([0.463, 0.606], [0.018, 0.054], [0.014, 0.044])
C_{10}	([0.5, 0.65], [0.016, 0.044], [0.01, 0.038])	([0.38, 0.5], [0.022, 0.082], [0.029, 0.059])	([0.43, 0.577], [0.021, 0.053], [0.017, 0.048])
C_{11}	([0.463, 0.606], [0.018, 0.054], [0.014, 0.044])	([0.302, 0.423], [0.03, 0.079], [0.04, 0.071])	([0.38, 0.5], [0.022, 0.082], [0.029, 0.059])

Table 4. Aggregated weights at period t_1 .

Criteria	Importance Aggregated Weights
C_1	([0.963, 0.996], [0.022, 0.06], [0.004, 0.027])
C_2	([0.908, 0.968], [0.041, 0.094], [0.017, 0.056])
C_3	([0.758, 0.89], [0.077, 0.174], [0.014, 0.097])
C_4	([0.648, 0.816], [0.087, 0.204], [0.026, 0.127])
C_5	([0.604, 0.794], [0.06, 0.154], [0.046, 0.185])
C_6	([0.963, 0.992], [0.022, 0.06], [0.004, 0.027])
C_7	([0.834, 0.925], [0.069, 0.149], [0.008, 0.074])
C_8	([0.758, 0.89], [0.077, 0.174], [0.014, 0.097])
C_9	([0.758, 0.89], [0.077, 0.174], [0.014, 0.097])
C_{10}	([0.936, 0.975], [0.037, 0.081], [0.01, 0.043])
C_{11}	([0.897, 0.959], [0.05, 0.11], [0.009, 0.056])

Table 5. Weighted ratings at period t_1 .

Students	Weighted Ratings
A_1	([0.368, 0.409], [0.069, 0.168], [0.03, 0.114])
A_2	([0.34, 0.382], [0.071, 0.181], [0.035, 0.12])
A_3	([0.338, 0.377], [0.072, 0.178], [0.035, 0.121])

(2) Period t_2 (the second semester): At this stage, a new student A_4 is added with new criteria in knowledge group. The steps are shown in Tables 6–12. Finally, the ranking is obtained: $A_1 > A_2 > A_3 > A_4$. Thus, the best student is A_1 .

Table 6. The distance of each student from $A_{t_1}^+$ and $A_{t_1}^-$ at period t_1 .

Students	$d_{t_1}^+$	$d_{t_1}^-$
A_1	0.364193	0.773329
A_2	0.380989	0.763987
A_3	0.382736	0.763579

Table 7. Closeness coefficient at period t_1 .

Students	Closeness Coefficients	Ranking Order
A_1	0.679837	1
A_2	0.667251	2
A_3	0.666116	3

Table 8. Aggregated ratings at period t_2 .

Criteria	Students			
	A_1	A_2	A_3	A_4
C_1	([0.699, 0.83], [0.001, 0.005], [0, 0.002])	([0.566, 0.75], [0.001, 0.009], [0.001, 0.003])	([0.637, 0.759], [0.001, 0.007], [0.001, 0.003])	([0.5, 0.6], [0.022, 0.046], [0.009, 0.022])
C_2	([0.707, 0.852], [0.001, 0.007], [0, 0.002])	([0.686, 0.834], [0.001, 0.008], [0, 0.003])	([0.72, 0.862], [0.001, 0.006], [0, 0.002])	([0.498, 0.6], [0.023, 0.049], [0.009, 0.023])
C_3	([0.709, 0.848], [0.003, 0.016], [0, 0.005])	([0.643, 0.783], [0.003, 0.018], [0, 0.006])	([0.603, 0.767], [0.003, 0.019], [0.001, 0.006])	([0.56, 0.669], [0.008, 0.029], [0.004, 0.016])
C_4	([0.598, 0.766], [0.004, 0.022], [0.001, 0.007])	([0.639, 0.782], [0.004, 0.021], [0.001, 0.007])	([0.634, 0.793], [0.004, 0.02], [0.001, 0.008])	([0.506, 0.643], [0.009, 0.034], [0.006, 0.021])
C_5	([0.721, 0.866], [0.002, 0.012], [0.001, 0.015])	([0.651, 0.823], [0.002, 0.013], [0.002, 0.016])	([0.616, 0.765], [0.002, 0.014], [0.002, 0.017])	([0.461, 0.604], [0.013, 0.042], [0.009, 0.035])
C_6	([0.685, 0.81], [0.001, 0.005], [0, 0.002])	([0.623, 0.803], [0.001, 0.007], [0, 0.002])	([0.546, 0.72], [0.001, 0.009], [0.001, 0.004])	([0.3, 0.5], [0.022, 0.08], [0.022, 0.044])
C_7	([0.62, 0.802], [0.002, 0.013], [0, 0.004])	([0.618, 0.769], [0.002, 0.013], [0.001, 0.005])	([0.543, 0.72], [0.002, 0.015], [0.001, 0.006])	([0.438, 0.569], [0.024, 0.061], [0.012, 0.03])
C_8	([0.491, 0.648], [0.005, 0.025], [0.002, 0.013])	([0.686, 0.862], [0.004, 0.02], [0, 0.006])	([0.499, 0.709], [0.005, 0.025], [0.001, 0.009])	([0.43, 0.567], [0.026, 0.071], [0.012, 0.033])
C_9	([0.702, 0.847], [0.004, 0.021], [0, 0.007])	([0.761, 0.891], [0.004, 0.019], [0, 0.006])	([0.682, 0.828], [0.004, 0.022], [0, 0.007])	([0.488, 0.598], [0.026, 0.062], [0.009, 0.027])
C_{10}	([0.687, 0.8], [0.002, 0.01], [0, 0.003])	([0.663, 0.836], [0.001, 0.008], [0, 0.003])	([0.718, 0.842], [0.001, 0.008], [0, 0.003])	([0.534, 0.636], [0.012, 0.032], [0.006, 0.018])
C_{11}	([0.608, 0.751], [0.001, 0.009], [0.001, 0.003])	([0.557, 0.722], [0.001, 0.01], [0.001, 0.006])	([0.565, 0.75], [0.001, 0.011], [0.001, 0.004])	([0.499, 0.6], [0.023, 0.048], [0.009, 0.023])
C_{12}	([0.36, 0.533], [0.043, 0.12], [0.021, 0.06])	([0.4, 0.516], [0.049, 0.11], [0.023, 0.065])	([0.463, 0.606], [0.033, 0.089], [0.012, 0.047])	([0.258, 0.439], [0.049, 0.133], [0.037, 0.087])
C_{13}	([0.229, 0.373], [0.05, 0.119], [0.055, 0.108])	([0.229, 0.373], [0.05, 0.119], [0.055, 0.108])	([0.43, 0.568], [0.038, 0.095], [0.017, 0.047])	([0.43, 0.568], [0.038, 0.095], [0.017, 0.047])
C_{14}	([0.284, 0.408], [0.083, 0.167], [0.046, 0.123])	([0.284, 0.408], [0.083, 0.167], [0.046, 0.123])	([0.269, 0.486], [0.071, 0.179], [0.03, 0.098])	([0.431, 0.592], [0.061, 0.137], [0.017, 0.076])

Table 9. Aggregated weights at period t_2 .

Criteria	Importance Aggregated Weights
C_1	([0.999, 1], [0, 0.003], [0, 0.001])
C_2	([0.997, 1], [0.001, 0.006], [0, 0.002])
C_3	([0.985, 0.998], [0.003, 0.014], [0, 0.004])
C_4	([0.978, 0.997], [0.003, 0.016], [0, 0.005])
C_5	([0.959, 0.993], [0.002, 0.011], [0.001, 0.015])
C_6	([0.999, 1], [0, 0.003], [0, 0.001])
C_7	([0.993, 0.999], [0.002, 0.009], [0, 0.002])
C_8	([0.975, 0.997], [0.004, 0.019], [0, 0.005])
C_9	([0.975, 0.997], [0.004, 0.019], [0, 0.005])
C_{10}	([0.996, 1], [0.001, 0.006], [0, 0.002])
C_{11}	([0.998, 1], [0.001, 0.005], [0, 0.001])
C_{12}	([0.963, 0.996], [0.022, 0.06], [0.004, 0.027])
C_{13}	([0.977, 0.998], [0.016, 0.044], [0.005, 0.02])
C_{14}	([0.897, 0.973], [0.05, 0.11], [0.009, 0.056])

Table 10. Weighted ratings at period t_2 .

Students	Weighted Ratings
A_1	([0.605, 0.76], [0.004, 0.02], [0.001, 0.009])
A_2	([0.594, 0.761], [0.004, 0.02], [0.001, 0.009])
A_3	([0.581, 0.744], [0.004, 0.021], [0.001, 0.009])
A_4	([0.458, 0.588], [0.022, 0.058], [0.011, 0.031])

Table 11. The distance of each student from $A_{t_2}^+$ and $A_{t_2}^-$ at period t_2 .

Students	$d_{t_2}^+$	$d_{t_2}^-$
A_1	0.188874	0.901553
A_2	0.192392	0.900405
A_3	0.200641	0.896588
A_4	0.279475	0.848118

Table 12. Closeness coefficient at period t_2 .

Students	Closeness Coefficients	Ranking Order
A_1	0.826789	1
A_2	0.823945	2
A_3	0.817138	3
A_4	0.752149	4

(3) Period t_3 (the third semester): At this stage, a new student A_5 is considered and an existing student A_2 is discarded. The criteria remain the same as in the previous period t_2 . Tables 13–17 show the steps of this stage. Finally, the ranking is obtained: $A_5 > A_4 > A_2 > A_1 > A_3$. Thus, the best student is A_5 .

5.3. Comparison with the Related Methods

The proposed dynamic TOPSIS method has superior features compared to the method in [14]. In Table 18, the ranking order of five students in three periods are presented. We can observe that at period t_1 , the results of the both methods are the same i.e., $A_1 > A_2 > A_3$.

Table 13. Aggregated ratings at period t_3 .

Criteria	Students				
	A_1	A_2	A_3	A_4	A_5
C_1	([0.794, 0.9], [0, 0], [0, 0])	([0.51, 0.75], [0, 0.006], [0, 0.002])	([0.764, 0.893], [0, 0], [0, 0])	([0.711, 0.822], [0, 0.003], [0, 0.001])	([0.441, 0.569], [0.022, 0.053], [0.012, 0.027])
C_2	([0.871, 0.951], [0, 0], [0, 0])	([0.675, 0.818], [0, 0.002], [0, 0.001])	([0.881, 0.96], [0, 0], [0, 0])	([0.788, 0.891], [0, 0.001], [0, 0])	([0.441, 0.569], [0.022, 0.053], [0.012, 0.027])
C_3	([0.829, 0.918], [0, 0.001], [0, 0])	([0.608, 0.785], [0.001, 0.005], [0, 0.001])	([0.728, 0.884], [0, 0.001], [0, 0])	([0.817, 0.91], [0, 0.001], [0, 0])	([0.569, 0.67], [0.005, 0.016], [0.004, 0.012])
C_4	([0.711, 0.875], [0, 0.001], [0, 0])	([0.608, 0.785], [0.001, 0.005], [0, 0.001])	([0.816, 0.922], [0, 0.001], [0, 0])	([0.663, 0.795], [0, 0.002], [0, 0.001])	([0.569, 0.67], [0.005, 0.016], [0.004, 0.012])
C_5	([0.81, 0.912], [0, 0.001], [0, 0.001])	([0.635, 0.804], [0, 0.003], [0, 0.001])	([0.777, 0.889], [0, 0.001], [0, 0.001])	([0.751, 0.872], [0, 0.001], [0, 0.001])	([0.48, 0.608], [0.011, 0.032], [0.008, 0.021])
C_6	([0.832, 0.923], [0, 0], [0, 0])	([0.608, 0.785], [0, 0.004], [0, 0.001])	([0.744, 0.902], [0, 0], [0, 0])	([0.482, 0.69], [0.001, 0.006], [0.001, 0.003])	([0.536, 0.637], [0.011, 0.026], [0.006, 0.016])
C_7	([0.689, 0.86], [0, 0.001], [0, 0])	([0.591, 0.759], [0.001, 0.004], [0, 0.002])	([0.682, 0.86], [0, 0.001], [0, 0])	([0.586, 0.733], [0.001, 0.004], [0.001, 0.002])	([0.441, 0.569], [0.022, 0.053], [0.012, 0.027])
C_8	([0.751, 0.898], [0, 0.001], [0, 0])	([0.662, 0.822], [0, 0.003], [0, 0.001])	([0.732, 0.89], [0, 0.001], [0, 0])	([0.699, 0.83], [0, 0.004], [0, 0.001])	([0.268, 0.441], [0.027, 0.079], [0.033, 0.062])
C_9	([0.874, 0.95], [0, 0.002], [0, 0])	([0.749, 0.861], [0, 0.002], [0, 0.001])	([0.889, 0.963], [0, 0.002], [0, 0])	([0.743, 0.853], [0, 0.003], [0, 0.001])	([0.418, 0.578], [0.011, 0.039], [0.011, 0.026])
C_{10}	([0.757, 0.891], [0, 0], [0, 0])	([0.636, 0.804], [0, 0.003], [0, 0.001])	([0.837, 0.926], [0, 0], [0, 0])	([0.712, 0.818], [0, 0.002], [0, 0.001])	([0.5, 0.6], [0.022, 0.044], [0.009, 0.022])
C_{11}	([0.753, 0.88], [0, 0], [0, 0])	([0.521, 0.71], [0.001, 0.005], [0.001, 0.003])	([0.696, 0.875], [0, 0.001], [0, 0])	([0.651, 0.769], [0.001, 0.004], [0, 0.002])	([0.569, 0.67], [0.005, 0.015], [0.004, 0.012])
C_{12}	([0.753, 0.884], [0.001, 0.007], [0, 0.002])	([0.53, 0.662], [0.002, 0.011], [0.001, 0.007])	([0.778, 0.903], [0.001, 0.007], [0, 0.002])	([0.544, 0.72], [0.002, 0.013], [0.001, 0.005])	([0.534, 0.636], [0.012, 0.032], [0.006, 0.018])
C_{13}	([0.677, 0.845], [0, 0.002], [0, 0.001])	([0.338, 0.521], [0.001, 0.006], [0.003, 0.009])	([0.759, 0.881], [0, 0.002], [0, 0])	([0.699, 0.83], [0.001, 0.004], [0, 0.001])	([0.374, 0.536], [0.022, 0.065], [0.016, 0.035])
C_{14}	([0.688, 0.837], [0.001, 0.005], [0, 0.001])	([0.407, 0.555], [0.002, 0.008], [0.002, 0.008])	([0.777, 0.916], [0.001, 0.005], [0, 0.001])	([0.699, 0.826], [0.001, 0.007], [0, 0.002])	([0.44, 0.569], [0.023, 0.057], [0.012, 0.029])

Table 14. Aggregated weights at period t_3 .

Criteria	Importance Aggregated Weights
C_1	([0.99999, 1], [0, 0.00009], [0, 0.00001])
C_2	([0.99995, 1], [0.00001, 0.00019], [0, 0.00002])
C_3	([0.99964, 1], [0.00005, 0.00062], [0, 0.00009])
C_4	([0.99912, 0.99998], [0.00009, 0.00097], [0, 0.00018])
C_5	([0.99776, 0.99995], [0.00004, 0.00077], [0.00001, 0.00053])
C_6	([0.99999, 1], [0, 0.00006], [0, 0])
C_7	([0.99985, 1], [0.00003, 0.00039], [0, 0.00005])
C_8	([0.99907, 0.99999], [0.00009, 0.00114], [0, 0.00015])
C_9	([0.99842, 0.99996], [0.00014, 0.00154], [0, 0.00024])
C_{10}	([0.99991, 1], [0.00002, 0.00029], [0, 0.00004])
C_{11}	([0.99997, 1], [0.00001, 0.00016], [0, 0.00001])
C_{12}	([0.99615, 0.99988], [0.00112, 0.00657], [0.00004, 0.00152])
C_{13}	([0.99969, 1], [0.00016, 0.00145], [0.00001, 0.00026])
C_{14}	([0.99762, 0.99993], [0.00082, 0.00483], [0.00004, 0.00116])

Table 15. Weighted ratings at period t_3 .

Students	Weighted Ratings
A_1	([0.78, 0.901], [0, 0.001], [0, 0])
A_2	([0.589, 0.759], [0.001, 0.004], [0, 0.002])
A_3	([0.785, 0.91], [0, 0.001], [0, 0])
A_4	([0.693, 0.822], [0, 0.003], [0, 0.001])
A_5	([0.476, 0.599], [0.014, 0.037], [0.009, 0.022])

Table 16. The distance of each student from $A_{t_3}^+$ and $A_{t_3}^-$ at period t_3 .

Students	$d_{t_3}^+$	$d_{t_3}^-$
A_1	0.37844	0.776416
A_2	0.352522	0.752181
A_3	0.381797	0.777005
A_4	0.358066	0.764391
A_5	0.325366	0.738391

Table 17. Closeness coefficient at period t_3 .

Students	Closeness Coefficients	Ranking Order
A_1	0.672305	4
A_2	0.680890	3
A_3	0.670525	5
A_4	0.680998	2
A_5	0.694135	1

Table 18. The dynamic rankings obtained at periods.

Time Period	The Method in [14]	The Proposed Method
t_1	$A_1 > A_2 > A_3$	$A_1 > A_2 > A_3$
t_2	$A_4 > A_2 > A_3 > A_1$	$A_1 > A_2 > A_3 > A_4$
t_3	$A_5 > A_3 > A_4 > A_1$	$A_5 > A_4 > A_2 > A_1 > A_3$

At period t_2 , the method in [14] and the proposed method show difference in ranking order of A_1 and A_4 . In this period, $A_2 > A_3$ according to both methods, and the method in [14] ranks A_4 at the top, meanwhile, A_1 is ranked at the top by the proposed method. The reason is that A_4 is evaluated at the first time and it has not appeared while A_1 has historical data, particularly A_1 were ranked at the top in the previous period. In this circumstance, the proposed model better utilizes the effect of historical data on the alternatives A_1 and A_4 . The result of the dynamic TOPSIS model is time-dependent and combines the effect of current and historical data.

At period t_3 , the result shows difference in the number of ranked alternatives and in their preferential order. In this period, the alternative A_2 is not evaluated by decision-makers and it has only historical data. The method in [14] could not process alternative A_2 , meanwhile the proposed model could. Moreover, the alternative A_5 is highly ranked by both methods. However, there is a change in the relative order of A_3 and A_4 . The method in [14] ranks $A_3 > A_4$, but the proposed method ranks $A_4 > A_3$.

The comparison between the methods again illustrates the effect of historical data over the output of the proposed decision-making model. If an alternative is considered and it has good evaluation in the previous periods, this alternative will have high potential to reach high order. From that point of view, the proposed model presents good compliance with the perceived dynamic rules. It illustrates the advantage and applicability of the model.

6. Conclusions

The proposed dynamic TOPSIS (DTOPSIS) model in dynamic interval-valued neutrosophic sets presents its advantages to cope with dynamic and indeterminate information in decision-making model. DTOPSIS model handles historical data including the change of criteria, alternatives, and decision-makers during periods. The concepts of generalized dynamic interval-valued neutrosophic set, GDIVNS, and their mathematical operators on GDIVNSs have been proposed. Distance and weighted aggregation operators are used to construct a framework of DTOPSIS in DIVNS environment. The proposed DTOPSIS fulfills the requirement of an issue that is evaluates tertiary

students' performance based on the attributes of ASK model. Data of Thuongmai University students were used to illustrate the proper of DTOPSIS model which opened the potential application in larger scale also. For the future works, we will extend generalized dynamic interval-valued neutrosophic sets for some other real-world applications [27–35]. Furthermore, we hope to apply GDIVNS for dealing with the unlimited time problems in decision-making model in dynamic neutrosophic environment based on the idea in [36,37].

Funding: This research is funded by the Ministry of Education and Training and Thuongmai University under grant number B2019-TMA-02.

References

1. Campanella, G.; Ribeiro, R.A. A framework for dynamic multiple-criteria decision making. *Decis. Support Syst.* **2011**, *52*, 52–60. [[CrossRef](#)]
2. Smarandache, F. *Neutrosophy: Neutrosophic Probability, Set, and Logic: Analytic Synthesis & Synthetic Analysis*; American Research Press: Santa Fe, NM, USA, 1998.
3. Abdel-Basset, M.; Manogaran, G.; Gamal, A.; Smarandache, F. A hybrid approach of neutrosophic sets and DEMATEL method for developing supplier selection criteria. *Des. Autom. Embed. Syst.* **2018**, *22*, 257–278. [[CrossRef](#)]
4. Deli, I.; Broumi, S.; Smarandache, F. On neutrosophic refined sets and their applications in medical diagnosis. *J. New Theory* **2015**, *6*, 88–98.
5. Peng, J.-J.; Wang, J.-Q.; Wang, J.; Zhang, H.-Y.; Chen, X.-H. Simplified neutrosophic sets and their applications in multi-criteria group decision-making problems. *Int. J. Syst. Sci.* **2015**, *47*, 1–17. [[CrossRef](#)]
6. Şahin, R.; Liu, P. Possibility-induced simplified neutrosophic aggregation operators and their application to multi-criteria group decision-making. *J. Exp. Theor. Artif. Intell.* **2016**, *29*, 1–17. [[CrossRef](#)]
7. Ye, J. Multicriteria decision-making method using the correlation coefficient under single-valued neutrosophic environment. *Int. J. Gen. Syst.* **2013**, *42*, 386–394. [[CrossRef](#)]
8. Ye, J. Single-Valued Neutrosophic Minimum Spanning Tree and Its Clustering Method. *J. Intell. Syst.* **2014**, *23*, 311–324. [[CrossRef](#)]
9. Ye, J. Similarity measures between interval neutrosophic sets and their applications in multicriteria decision-making. *J. Intell. Fuzzy Syst.* **2014**, *26*, 165–172. [[CrossRef](#)]
10. Ye, J. Hesitant interval neutrosophic linguistic set and its application in multiple attribute decision making. *Int. J. Mach. Learn. Cybern.* **2017**, *10*, 667–678. [[CrossRef](#)]
11. Bloom, B.S.; Davis, A.; Hess, R.O.B.E.R.T. *Com-Pensatory Education for Cultural Depri-Vation*; Holt, Rinehart, & Winston: New York, NY, USA, 1965.
12. Huang, Y.-H.; Wei, G.; Wei, C. VIKOR Method for Interval Neutrosophic Multiple Attribute Group Decision-Making. *Information* **2017**, *8*, 144. [[CrossRef](#)]
13. Liu, P.; Shi, L. The generalized hybrid weighted average operator based on interval neutrosophic hesitant set and its application to multiple attribute decision making. *Neural Comput. Appl.* **2014**, *26*, 457–471. [[CrossRef](#)]
14. Thong, N.T.; Dat, L.Q.; Son, L.H.; Hoa, N.D.; Ali, M.; Smarandache, F. Dynamic interval valued neutrosophic set: Modeling decision making in dynamic environments. *Comput. Ind.* **2019**, *108*, 45–52. [[CrossRef](#)]
15. Wang, L.; Zhang, H.-Y.; Wang, J.-Q. Frank Choquet Bonferroni Mean Operators of Bipolar Neutrosophic Sets and Their Application to Multi-criteria Decision-Making Problems. *Int. J. Fuzzy Syst.* **2017**, *20*, 13–28. [[CrossRef](#)]

16. Wang, H.; Smarandache, F.; Sunderraman, R.; Zhang, Y.Q. *Interval Neutrosophic Sets and Logic: Theory and Applications in Computing: Theory and Applications in Computing*; Infinite Study; Hexis: Phoenix, AZ, USA, 2005; Volume 5.
17. Lupiáñez, F.G. Interval neutrosophic sets and topology. *Kybernetes* **2009**, *38*, 621–624. [[CrossRef](#)]
18. Bera, T.; Mahapatra, N.K. Distance Measure Based MADM Strategy with Interval Trapezoidal Neutrosophic Numbers. *Neutrosophic Sets Syst.* **2018**, *20*, 7.
19. Torra, V.; Narukawa, Y. On hesitant fuzzy sets and decision. In Proceedings of the 2009 IEEE International Conference on Fuzzy Systems, Jeju Island, Korea, 20–24 August 2009; Institute of Electrical and Electronics Engineers (IEEE); pp. 1378–1382.
20. Torra, V. Hesitant fuzzy sets. *Int. J. Intell. Syst.* **2010**, *25*, 529–539. [[CrossRef](#)]
21. Rubb, S. Overeducation, undereducation and asymmetric information in occupational mobility. *Appl. Econ.* **2013**, *45*, 741–751. [[CrossRef](#)]
22. Bakarman, A.A. Attitude, Skill, and Knowledge: (ASK) a New Model for Design Education. In Proceedings of the Canadian Engineering Education Association (CEEA), Queen's University Library, Kingston, ON, Canada, 6–8 June 2011.
23. Bell, R. Unpacking the link between entrepreneurialism and employability. *Educ. Train.* **2016**, *58*, 2–17. [[CrossRef](#)]
24. Cross, N. Expertise in design: An overview. *Des. Stud.* **2004**, *25*, 427–441. [[CrossRef](#)]
25. Lewis, W.; Bonollo, E. An analysis of professional skills in design: Implications for education and research. *Des. Stud.* **2002**, *23*, 385–406. [[CrossRef](#)]
26. Son, N.T.K.; Dong, N.P.; Long, H.V.; Son, L.H.; Khastan, A. Linear quadratic regulator problem governed by granular neutrosophic fractional differential equations. *ISA Trans.* **2020**, *97*, 296–316. [[CrossRef](#)] [[PubMed](#)]
27. Thong, N.T.; Giap, C.N.; Tuan, T.M.; Chuan, P.M.; Hoang, P.M. Modeling multi-criteria decision-making in dynamic neutrosophic environments bases on Choquet integral. *J. Comput. Sci. Cybern.* **2020**, *36*, 33–47. [[CrossRef](#)]
28. Son, N.T.K.; Dong, N.P.; Son, L.H.; Long, H.V. Towards granular calculus of single-valued neutrosophic functions under granular computing. *Multimedia Tools Appl.* **2019**, *78*, 1–37. [[CrossRef](#)]
29. Son, N.T.K.; Dong, N.P.; Son, L.H.; Abdel-Basset, M.; Manogaran, G.; Long, H.V. On the Stabilizability for a Class of Linear Time-Invariant Systems under Uncertainty. *Circuits, Syst. Signal Process.* **2019**, *39*, 919–960. [[CrossRef](#)]
30. Long, H.V.; Ali, M.; Son, L.H.; Khan, M.; Tu, D.N. A novel approach for fuzzy clustering based on neutrosophic association matrix. *Comput. Ind. Eng.* **2019**, *127*, 687–697. [[CrossRef](#)]
31. Jha, S.; Kumar, R.; Son, L.H.; Chatterjee, J.M.; Khari, M.; Yadav, N.; Smarandache, F. Neutrosophic soft set decision making for stock trending analysis. *Evol. Syst.* **2018**, *10*, 621–627. [[CrossRef](#)]
32. Ngan, R.T.; Son, L.H.; Cuong, B.C.; Ali, M. H-max distance measure of intuitionistic fuzzy sets in decision making. *Appl. Soft Comput.* **2018**, *69*, 393–425. [[CrossRef](#)]
33. Ali, M.; Dat, L.Q.; Son, L.H.; Smarandache, F. Interval Complex Neutrosophic Set: Formulation and Applications in Decision-Making. *Int. J. Fuzzy Syst.* **2017**, *20*, 986–999. [[CrossRef](#)]
34. Nguyen, G.N.; Son, L.H.; Ashour, A.S.; Dey, N. A survey of the state-of-the-arts on neutrosophic sets in biomedical diagnoses. *Int. J. Mach. Learn. Cybern.* **2017**, *10*, 1–13. [[CrossRef](#)]
35. Thong, N.T.; Lan, L.T.H.; Chou, S.-Y.; Son, L.H.; Dong, D.D.; Ngan, T.T. An Extended TOPSIS Method with Unknown Weight Information in Dynamic Neutrosophic Environment. *Mathematics* **2020**, *8*, 401. [[CrossRef](#)]
36. Ali, M.; Son, L.H.; Deli, I.; Tien, N.D. Bipolar neutrosophic soft sets and applications in decision making. *J. Intell. Fuzzy Syst.* **2017**, *33*, 4077–4087. [[CrossRef](#)]
37. Alcantud, J.C.R.; Torrecillas, M.M. Intertemporal Choice of Fuzzy Soft Sets. *Symmetry* **2018**, *10*, 371. [[CrossRef](#)]

Triangular Single Valued Neutrosophic Data Envelopment Analysis: Application to Hospital Performance Measurement

Wei Yang, Lulu Cai, Seyed Ahmad Edalatpanah, Florentin Smarandache

Wei Yang, Lulu Cai, Seyed Ahmad Edalatpanah, Florentin Smarandache (2020). Triangular Single Valued Neutrosophic Data Envelopment Analysis: Application to Hospital Performance Measurement. *Symmetry* 12, 588; DOI: 10.3390/sym12040588

Abstract: The foremost broadly utilized strategy for the valuation of the overall performance of a set of identical decision-making units (DMUs) that use analogous sources to yield related outputs is data envelopment analysis (DEA). However, the witnessed values of the symmetry or asymmetry of different types of information in real-world applications are sometimes inaccurate, ambiguous, inadequate, and inconsistent, so overlooking these conditions may lead to erroneous decision-making. Neutrosophic set theory can handle these occasions of data and makes an imitation of the decision-making procedure with the aid of thinking about all perspectives of the decision. In this paper, we introduce a model of DEA in the context of neutrosophic sets and sketch an innovative process to solve it. Furthermore, we deal with the problem of healthcare system evaluation with inconsistent, indeterminate, and incomplete information using the new model. The triangular single-valued neutrosophic numbers are also employed to deal with the mentioned data, and the proposed method is utilized in the assessment of 13 hospitals of Tehran University of Medical Sciences of Iran. The results exhibit the usefulness of the suggested approach and point out that the model has practical outcomes for decision-makers.

Keywords: single-valued neutrosophic set; triangular neutrosophic number; data envelopment analysis; healthcare systems; performance evaluation

1. Introduction

As a strong analytical tool for benchmarking and efficiency evaluation, DEA (data envelopment analysis) is a technique for evaluating the relation efficiency of decision-making units (DMUs), developed initially by Charens et al. [1] on a printed paper named the Charnes, Cooper, and Rhodes (CCR) model. They extended the nonparametric method introduced by Farrell [2] to gauge DMUs with multiple inputs and outputs. The Banker, Charnes, and Cooper (BCC) model is an extension of the previous model under the assumption of variable returns-to-scale (VRS) [3]. With this technique, managers can obtain the relative efficiency of a set of DMUs. In time, many theoretical and empirical studies have applied DEA to several fields of science and engineering, such as healthcare, agriculture, banking supply chains, and financial services, among others. For more details, the reader is referred to the studies of [4–14].

Conventional DEA models require crisp information that may not be permanently accessible in real-world applications. Nevertheless, in numerous cases, data are unstable, uncertain, and complicated; therefore, they cannot be accurately measured. Zadeh [15] first proposed the theory of fuzzy sets (FSs)

against certain logic. After this work, many researchers studied this topic; details of some approaches can be observed in [16–20]. Several researchers also proposed some models of DEA under a fuzzy environment [21–25].

However, Zadeh's fuzzy sets consider only the membership function and cannot deal with other parameters of vagueness. To overcome this lack of information, Atanassov [26] introduced an extension of FSs called intuitionistic fuzzy sets (IFSs). There are also several models of DEA with intuitionistic fuzzy data: see [27–30].

Although the theory of IFSs can handle incomplete information for various real-world issues, it cannot address all types of uncertainty such as inconsistent and indeterminate evidence. Therefore, Smarandache [31,32] established the neutrosophic set (NS) as a robust overall framework that generalizes classical and all kinds of fuzzy sets (FSs and IFSs).

NSs can accommodate indeterminate, ambiguous, and conflicting information where the indeterminacy is clearly quantified, and define three kinds of membership function independently.

In the past years, some versions of NSs such as interval neutrosophic sets [33,34], bipolar neutrosophic sets [35,36], single-valued neutrosophic sets [37–39], and neutrosophic linguistic sets [40] have been presented. In addition, in the field of neutrosophic sets, logic, measure, probability, statistics, pre-calculus and calculus, and their applications in multiple areas have been extended: see [41–44].

In real circumstances, some data in DEA may be uncertain, indeterminate, and inconsistent, and considering truth, falsity, and indeterminacy membership functions for each input/output of DMUs in the neutrosophic sets help decision-makers to obtain a better interpretation of information. In addition, by using the NS in DEA, analysts can better set their acceptance, indeterminacy, and rejection degrees regarding each datum. Moreover, with NSs, we can obtain a better depiction of reality through seeing all features of the decision-making procedure. Therefore, the NS can embrace imprecise, vague, incomplete, and inconsistent evidence powerfully and efficiently. Although there are several approaches to solve various problems under neutrosophic environments, there are not many studies that have dealt with DEA under NSs.

The utilization of neutrosophic logic in DEA can be traced to Edalatpanah [45]. Kahraman et al. [46] proposed a hybrid algorithm based on a neutrosophic analytic hierarchy process (AHP) and DEA for bringing a solution to the efficiency of private universities. Edalatpanah and Smarandache [47], based on some operators and natural logarithms, proposed an input-oriented DEA model with simplified neutrosophic numbers. Abdelfattah [48], by converting a neutrosophic DEA into an interval DEA, developed a new DEA model under neutrosophic numbers. Although these approaches are interesting, some restrictions exist. One of them is that these methods have high running times, mainly when we have many inputs and outputs. Furthermore, the main flaw of [48] is the existence of several production frontiers in the steps of efficiency measure, and this leads to the lack of comparability between efficiencies.

Therefore, in this paper, we design an innovative simple model of DEA in which all inputs and outputs are triangular single-valued neutrosophic numbers (TSVNNs), and establish a new efficient strategy to solve it. Furthermore, we use the suggested technique for the performance assessment of 13 hospitals of Tehran University of Medical Sciences (TUMS) of Iran.

The paper unfolds as follows: some basic knowledge, concepts, and arithmetic operations on NSs and TSVNNs are discussed in Section 2. In Section 3, some concepts of DEA and the CCR model are reviewed. In Section 4, we establish the mentioned model of DEA under the neutrosophic environment and propose a method to solve it. In Section 5, the suggested model is utilized for a case study of TUMS. Lastly, conclusions and future directions are presented in Section 6.

2. Preliminaries

In this section, we discuss some basic definitions related to neutrosophic sets and single-valued neutrosophic numbers, respectively.

Smarandache put forward an indeterminacy degree of membership as an independent component in his papers [31,32], and since the principle of excluded middle cannot be applied to new logic, he combines non-standard analysis with three-valued logic, set theory, probability theory, and philosophy. As a result, neutrosophic means “neutral thinking knowledge.” Given this meaning and the use of the term neutral, along with the components of truth (membership) and falsity (non-membership), its distinction is marked by fuzzy sets and intuitionistic fuzzy sets. Here, it is appropriate to give a brief explanation of the non-standard analysis.

In the early 1960s, Robinson developed non-standard analysis as a form of analysis and a branch of logic in which infinitesimals are precisely defined [49]. Formally, x is called an infinitesimal number if and only if for any non-null positive integer n we have $|x| \leq \frac{1}{n}$. Let $\varepsilon > 0$ be an infinitesimal number; then, the extended real number set is an extension of the set of real numbers that contains the classes of infinite numbers and the infinitesimal numbers. If we consider non-standard finite numbers $1^+ = 1 + \varepsilon$ and $-0 = 0 - \varepsilon$, where 0 and 1 are the standard parts and ε is the non-standard part, then $]^{-0}, 1^+[$ is a non-standard unit interval. It is clear that $0, 1$, as well as the non-standard infinitesimal numbers that are less than zero and infinitesimal numbers that are more than one belong to this non-standard unit interval. Now, let us define a neutrosophic set:

Definition 1 ([31,32,41]) (neutrosophic set). *A neutrosophic set in universal U is defined by three membership functions for the truth, indeterminacy, and falsity of x in the real non-standard $]^{-0}, 1^+[$, where the summation of them belongs to $[0, 3]$.*

Definition 2 ([34]). *If the three membership functions of a NS are singleton in the real standard $[0, 1]$, then a single-valued neutrosophic set (SVNS) ψ is denoted by:*

$$\psi = \{(x, \tau_\psi(x), \iota_\psi(x), \nu_\psi(x)) \mid x \in U\},$$

which satisfies the following condition:

$$0 \leq \tau_\psi(x) + \iota_\psi(x) + \nu_\psi(x) \leq 3.$$

Definition 3 ([38]). *A TSVNN $A^N = \langle (a^l, a^m, a^u), (b^l, b^m, b^u), (c^l, c^m, c^u) \rangle$ is a particular single-valued neutrosophic number (SVNN) whose $\tau_{A^N}(x)$, $\iota_{A^N}(x)$, and $\nu_{A^N}(x)$ are presented as follows:*

$$\tau_{A^N}(x) = \begin{cases} \frac{(x-a^l)}{(a^m-a^l)} & a^l \leq x < a^m, \\ 1 & x = a^m, \\ \frac{(a^u-x)}{(a^u-a^m)} & a^m < x \leq a^u, \\ 0 & \text{otherwise.} \end{cases},$$

$$\iota_{A^N}(x) = \begin{cases} \frac{(b^m-x)}{(b^m-b^l)} & b^l \leq x < b^m, \\ 0 & x = b^m, \\ \frac{(x-b^m)}{(b^u-b^m)} & b^m < x \leq b^u, \\ 1 & \text{otherwise.} \end{cases},$$

$$\nu_{A^N}(x) = \begin{cases} \frac{(c^m-x)}{(c^m-c^l)} & c^l \leq x < c^m, \\ 0 & c = c^m, \\ \frac{(x-c^m)}{(c^u-c^m)} & c^m < x \leq c^u, \\ 1 & \text{otherwise.} \end{cases},$$

Definition 4 ([38]). Let $A^{\mathfrak{N}} = \langle (a^l, a^m, a^u), (b^l, b^m, b^u), (c^l, c^m, c^u) \rangle$ and $B^{\mathfrak{N}} = \langle (d^l, d^m, d^u), (e^l, e^m, e^u), (f^l, f^m, f^u) \rangle$ be two TSVNNs, where their elements are in $[L_1, U_1]$. Then, Equations (1) to (3) are true:

$$(i) A^{\mathfrak{N}} \oplus B^{\mathfrak{N}} = \langle (\min(a^l + d^l, U_1), \min(a^m + d^m, U_1), \min(a^u + d^u, U_1); \min(b^l + e^l, U_1), \min(b^m + e^m, U_1), \min(b^u + e^u, U_1); \min(c^l + f^l, U_1), \min(c^m + f^m, U_1), \min(c^u + f^u, U_1)) \rangle, \tag{1}$$

$$(ii) -A^{\mathfrak{N}} = \langle (-a^u, -a^m, -a^l), (-b^u, -b^m, -b^l), (-c^u, -c^m, -c^l) \rangle, \tag{2}$$

$$(iii) \lambda A^{\mathfrak{N}} = \langle (\lambda a^l, \lambda a^m, \lambda a^u), (\lambda b^l, \lambda b^m, \lambda b^u), (\lambda c^l, \lambda c^m, \lambda c^u) \rangle, \quad \lambda > 0. \tag{3}$$

Definition 5 ([38]). Consider $A^{\mathfrak{N}} = \langle (a^l, a^m, a^u), (b^l, b^m, b^u), (c^l, c^m, c^u) \rangle$ as a TSVNN. Then, the ranking function of $A^{\mathfrak{N}}$ can be defined with Equation (4):

$$\xi(A^{\mathfrak{N}}) = \frac{(a^l + b^l + c^l) + 2(a^m + b^m + c^m) + (a^u + b^u + c^u)}{12} \tag{4}$$

Definition 6 ([20]). Suppose $P^{\mathfrak{N}}$ and $Q^{\mathfrak{N}}$ are two TSVNNs, then:

- (i) $P^{\mathfrak{N}} \leq Q^{\mathfrak{N}}$ if and only if $\xi(P^{\mathfrak{N}}) \leq \xi(Q^{\mathfrak{N}})$,
- (ii) $P^{\mathfrak{N}} < Q^{\mathfrak{N}}$ if and only if $\xi(P^{\mathfrak{N}}) < \xi(Q^{\mathfrak{N}})$.

3. Data Envelopment Analysis

Let a set of n DMUs, with each DMU $_j$ ($j = 1, 2, \dots, n$) using m inputs p_{ij} ($i = 1, 2, \dots, m$) produce s outputs q_{rj} ($r = 1, 2, \dots, s$). If DMU $_0$ is under consideration, then the *input-oriented CCR multiplier* model for the relative efficiency is computed on the basis of Equation (5) [1]:

$$\theta_0^* = \max \frac{\sum_{r=1}^s v_r q_{r0}}{\sum_{i=1}^m u_i p_{i0}} \tag{5}$$

s.t:

$$\frac{\sum_{r=1}^s v_r q_{rj}}{\sum_{i=1}^m u_i p_{ij}} \leq 1, \quad j = 1, 2, \dots, n$$

$$v_r, u_i \geq 0 \quad r = 1, \dots, s, i = 1, \dots, m.$$

where v_r and u_i are the related weights. The above nonlinear programming may be converted as Equation (6) to simplify the computation:

$$\theta_0^* = \max \sum_{r=1}^s v_r q_{r0} \tag{6}$$

s.t:

$$\sum_{i=1}^m u_i p_{i0} = 1$$

$$\sum_{r=1}^s v_r q_{rj} - \sum_{i=1}^m u_i p_{ij} \leq 0, \quad j = 1, 2, \dots, n$$

$$v_r, u_i \geq 0 \quad r = 1, \dots, s, i = 1, \dots, m.$$

The DMU $_0$ is efficient if $\theta_0^* = 1$; otherwise, it is inefficient.

4. Neutrosophic Data Envelopment Analysis

Like every other model, DEA has been the subject of evolution. One of the critical improvements in this field is related to circumstances where the information of DMUs is characterized and measured beneath conditions of uncertainty and indeterminacy. Indeed, one of the traditional DEA models' assumptions is their crispness of inputs and outputs.

However, it seems questionable to assume the data and observations are crisp in situations where uncertainty and indeterminacy are inevitable features of a real environment. In addition, most management decisions are not made based on known calculations, and there is a lot of uncertainty, indeterminacy, and ambiguity in decision-making problems. The DEA under a neutrosophic environment is more advantageous than a crisp DEA because a decision-maker, in the preparation of the problem, is not obliged to make a subtle formulation. Furthermore, because of a lack of comprehensive knowledge and evidence, precise mathematics are not sufficient to model a complex system. Therefore, the approach based on neutrosophic logic seems fit for such problems [31,32]. In this section, we establish DEA under a neutrosophic environment.

Consider the input and output for the j th DMU as follows:

$$\begin{aligned} \ddot{p}_{ij} &= \left\langle \begin{matrix} a_i & b_i & c_i \\ p_{ij} & \bar{p}_{ij} & \check{p}_{ij} \end{matrix} \right\rangle = \left\langle \begin{matrix} [a_1 & a_2 & a_3] & [b_1 & b_2 & b_3] & [c_1 & c_2 & c_3] \\ [p_{ij} & \bar{p}_{ij} & \check{p}_{ij}] & [p_{ij} & \bar{p}_{ij} & \check{p}_{ij}] & [p_{ij} & \bar{p}_{ij} & \check{p}_{ij}] \end{matrix} \right\rangle, \\ \ddot{q}_{rj} &= \left\langle \begin{matrix} a_i & b_i & c_i \\ q_{rj} & \bar{q}_{rj} & \check{q}_{rj} \end{matrix} \right\rangle = \left\langle \begin{matrix} [a_1 & a_2 & a_3] & [b_1 & b_2 & b_3] & [c_1 & c_2 & c_3] \\ [q_{rj} & \bar{q}_{rj} & \check{q}_{rj}] & [q_{rj} & \bar{q}_{rj} & \check{q}_{rj}] & [q_{rj} & \bar{q}_{rj} & \check{q}_{rj}] \end{matrix} \right\rangle, \end{aligned}$$

which are TSVNNs. Then, the triangular single-valued neutrosophic CCR model called TSVNN-CCR is defined as follows:

$$\theta_o^{**} = \max \sum_{r=1}^s v_r \ddot{q}_{ro} \tag{7}$$

s.t:

$$\begin{aligned} \sum_{i=1}^m u_i \ddot{p}_{io} &= 1 \\ \sum_{r=1}^s v_r \ddot{q}_{rj} - \sum_{i=1}^m u_i \ddot{p}_{ij} &\leq 0, \quad j = 1, 2, \dots, n \\ v_r, u_i &\geq 0 \quad r = 1, \dots, s, i = 1, \dots, m. \end{aligned}$$

Next, to solve Model (7), we propose the following algorithm:

Algorithm 1. The solution of TSVNN-CCR Model

Step 1. Construct the problem based on Model (8).

Step 2. Using Definition 3 (ii, iii), transform the TSVNN-CCR model of Step 1 into Model (8):

$$\theta_0^* = \max \sum_{r=1}^s \left([v_r q_{r0}, v_r q_{r0}, v_r q_{r0}], [v_r q_{r0}, v_r q_{r0}, v_r q_{r0}], [v_r q_{r0}, v_r q_{r0}, v_r q_{r0}] \right) \quad (8)$$

s.t:

$$\begin{aligned} & \sum_{i=1}^m \left([u_i p_{i0}, u_i p_{i0}, u_i p_{i0}], [u_i p_{i0}, u_i p_{i0}, u_i p_{i0}], [u_i p_{i0}, u_i p_{i0}, u_i p_{i0}] \right) = 1 \\ & \sum_{r=1}^s \left([v_r q_{rj}, v_r q_{rj}, v_r q_{rj}], [v_r q_{rj}, v_r q_{rj}, v_r q_{rj}], [v_r q_{rj}, v_r q_{rj}, v_r q_{rj}] \right) \oplus \\ & \sum_{i=1}^m \left([-u_i p_{ij}, -u_i p_{ij}, -u_i p_{ij}], [-u_i p_{ij}, -u_i p_{ij}, -u_i p_{ij}], [-u_i p_{ij}, -u_i p_{ij}, -u_i p_{ij}] \right) \leq 0, \\ & v_r, u_i \geq 0 \quad r = 1, \dots, s, i = 1, \dots, m. \end{aligned}$$

Step 3. Transform Model (8) into the following model:

$$\theta_0^* = \max \left(\left(\sum_{r=1}^s v_r q_{r0}, \sum_{r=1}^s v_r q_{r0}, \sum_{r=1}^s v_r q_{r0} \right), \left(\sum_{r=1}^s v_r q_{r0}, \sum_{r=1}^s v_r q_{r0}, \sum_{r=1}^s v_r q_{r0} \right), \left(\sum_{r=1}^s v_r q_{r0}, \sum_{r=1}^s v_r q_{r0}, \sum_{r=1}^s v_r q_{r0} \right) \right) \quad (9)$$

s.t:

$$\begin{aligned} & \left(\left(\sum_{i=1}^m u_i p_{i0}, \sum_{i=1}^m u_i p_{i0}, \sum_{i=1}^m u_i p_{i0} \right), \left(\sum_{i=1}^m u_i p_{i0}, \sum_{i=1}^m u_i p_{i0}, \sum_{i=1}^m u_i p_{i0} \right), \left(\sum_{i=1}^m u_i p_{i0}, \sum_{i=1}^m u_i p_{i0}, \sum_{i=1}^m u_i p_{i0} \right) \right) = 1 \\ & \left(\left(\sum_{r=1}^s v_r q_{rj} \oplus \sum_{i=1}^m -u_i p_{ij}, \sum_{r=1}^s v_r q_{rj} \oplus \sum_{i=1}^m -u_i p_{ij}, \sum_{r=1}^s v_r q_{rj} \oplus \sum_{i=1}^m -u_i p_{ij} \right), \right. \\ & \left. \left(\sum_{r=1}^s v_r q_{rj} \oplus \sum_{i=1}^m -u_i p_{ij}, \sum_{r=1}^s v_r q_{rj} \oplus \sum_{i=1}^m -u_i p_{ij}, \sum_{r=1}^s v_r q_{rj} \oplus \sum_{i=1}^m -u_i p_{ij} \right), \right. \\ & \left. \left(\sum_{r=1}^s v_r q_{rj} \oplus \sum_{i=1}^m -u_i p_{ij}, \sum_{r=1}^s v_r q_{rj} \oplus \sum_{i=1}^m -u_i p_{ij}, \sum_{r=1}^s v_r q_{rj} \oplus \sum_{i=1}^m -u_i p_{ij} \right) \right) \leq 0, \\ & v_r, u_i \geq 0 \quad r = 1, \dots, s, i = 1, \dots, m. \end{aligned}$$

Step 4. Based on Definitions 4–5, convert TSVNN-CCR Model (9) into crisp Model (10):

$$\theta_0^* \approx \xi(\theta_0^*) = \quad (10)$$

$$\max \sum_{r=1}^s \xi \left(\left([v_r q_{r0}, v_r q_{r0}, v_r q_{r0}], [v_r q_{r0}, v_r q_{r0}, v_r q_{r0}], [v_r q_{r0}, v_r q_{r0}, v_r q_{r0}] \right) \right)$$

s.t:

$$\begin{aligned} & \sum_{i=1}^m \xi \left(\left([u_i p_{i0}, u_i p_{i0}, u_i p_{i0}], [u_i p_{i0}, u_i p_{i0}, u_i p_{i0}], [u_i p_{i0}, u_i p_{i0}, u_i p_{i0}] \right) \right) = 1 \\ & \sum_{r=1}^s \xi \left(\left([v_r q_{rj}, v_r q_{rj}, v_r q_{rj}], [v_r q_{rj}, v_r q_{rj}, v_r q_{rj}], [v_r q_{rj}, v_r q_{rj}, v_r q_{rj}] \right) \right) \oplus \\ & \sum_{i=1}^m \xi \left(\left([-u_i p_{ij}, -u_i p_{ij}, -u_i p_{ij}], [-u_i p_{ij}, -u_i p_{ij}, -u_i p_{ij}], [-u_i p_{ij}, -u_i p_{ij}, -u_i p_{ij}] \right) \right) \leq 0, \\ & v_r, u_i \geq 0 \quad r = 1, \dots, s, i = 1, \dots, m. \end{aligned}$$

Step 5. Run Model (10) and get the optimal efficiency of each DMU.

5. Numerical Experiment

In this section, a case study of a DEA problem under a neutrosophic environment is used to reveal the validity and usefulness of the proposed model.

Case Study: The Efficiency of the Hospitals of TUMS

Performance assessments in healthcare frameworks are a noteworthy worry of policymakers so that reforms to improve performance in the health sector are on the policy agenda of numerous national governments and worldwide agencies. In the related literature, various methods such as least squares and simple ratio analysis have been applied to assess the performance of healthcare systems (see for instance: [50–52]). Nonetheless, due to the applicability of DEA in the solution of problems with multiple inputs and outputs, it is most commonly used in healthcare systems [53]. The utilizations of DEA in the healthcare sector can be found in several works of literature, including for crisp data [54–56], fuzzy data [57,58], and intuitionistic fuzzy data [59]. To the best of our knowledge, none of these current works assessed the efficiency of healthcare organizations with neutrosophic sets. Therefore, to assess the efficiency of the mentioned systems under a neutrosophic environment, we used the proposed model to evaluate 13 hospitals of TUMS. It is worth emphasizing that due to privacy policies, the names of these hospitals are not shared. Furthermore, for the selection of the most suitable and acceptable items of the healthcare system, which are commonly used for measuring efficiency

in the literature, we considered two inputs, namely the number of doctors and number of beds, and three outputs, namely the total yearly days of hospitalization of all patients, number of outpatient department visits, and overall patient satisfaction.

For each hospital, we gathered the related data from the medical records unit of the hospitals, Center of Statistics of the University of Medical Sciences, the reliable library, online resources, and the judgments of some experts. After collecting data, we found that the information was sometimes inconsistent, indeterminate, and incomplete. The investigation revealed that several reforms by the mentioned hospitals and other issues have led to considerable uncertainty and indeterminacy about the data. As a result, we identified them as triangular single-valued neutrosophic numbers (TSVNNs). For example, for “Patient Satisfaction,” we collected data in terms of “satisfaction,” “dissatisfaction,” and “abstention,” and for each term, the related data was expressed by a triangular fuzzy number. In addition, each triangular fuzzy number was constructed based on min, average, and max. All data were expressed by using TSVNNs, and can be found in Tables 1 and 2.

Table 1. Input information of the nominee hospitals.

DMU	Inputs 1	Inputs 2
	Number of Doctors	Number of Beds
1	$\langle [404, 540, 674], [350, 440, 560], [420, 645, 700] \rangle$	$\langle [520, 530, 535], [520, 525, 530], [532, 534, 540] \rangle$
2	$\langle [119, 136, 182], [122, 125, 137], [125, 178, 200] \rangle$	$\langle [177, 180, 188], [173, 175, 179], [185, 189, 195] \rangle$
3	$\langle [139, 145, 158], [139, 140, 147], [146, 155, 167] \rangle$	$\langle [208, 214, 218], [195, 209, 215], [210, 217, 230] \rangle$
4	$\langle [86, 93, 151], [83, 85, 87], [89, 138, 160] \rangle$	$\langle [114, 116, 118], [114, 115, 117], [116, 118, 125] \rangle$
5	$\langle [84, 93, 143], [84, 89, 120], [90, 140, 155] \rangle$	$\langle [110, 117, 121], [105, 112, 120], [113, 119, 128] \rangle$
6	$\langle [101, 113, 170], [110, 112, 115], [112, 120, 177] \rangle$	$\langle [101, 107, 111], [95, 100, 104], [108, 112, 115] \rangle$
7	$\langle [561, 694, 864], [510, 640, 750], [582, 857, 930] \rangle$	$\langle [492, 495, 508], [492, 494, 500], [493, 506, 520] \rangle$
8	$\langle [123, 179, 199], [122, 125, 130], [195, 200, 205] \rangle$	$\langle [66, 68, 73], [63, 67, 69], [68, 70, 78] \rangle$
9	$\langle [101, 153, 155], [140, 145, 150], [145, 149, 167] \rangle$	$\langle [192, 195, 198], [185, 193, 197], [194, 196, 205] \rangle$
10	$\langle [147, 164, 170], [147, 160, 167], [165, 169, 180] \rangle$	$\langle [333, 340, 357], [335, 338, 350], [338, 347, 364] \rangle$
11	$\langle [130, 158, 192], [110, 144, 173], [146, 177, 205] \rangle$	$\langle [96, 100, 114], [97, 99, 103], [99, 110, 129] \rangle$
12	$\langle [128, 137, 187], [128, 133, 164], [134, 184, 199] \rangle$	$\langle [213, 220, 224], [208, 215, 223], [216, 222, 231] \rangle$
13	$\langle [151, 160, 210], [151, 156, 187], [157, 207, 222] \rangle$	$\langle [320, 327, 331], [315, 322, 330], [323, 329, 338] \rangle$

Next, we used Algorithm 1 to solve the performance valuation problem. For example, Algorithm 1 for DMU₁ can be used as follows:

First, we construct a DEA model with the mentioned TSVNNs:

$$\begin{aligned} \max \tilde{\theta}_1 \approx & \langle [121.13, 139.24, 140.04], [138.64, 139.14, 139.81], [139.14, 140.02, 141.17] \rangle v_1 \oplus \\ & \langle [38, 41, 45], [38, 40, 43], [41, 44, 49] \rangle v_2 \oplus \\ & \langle [104.23, 114.04, 278.51], [102.37, 109.15, 235.72], [104.81, 275.25, 279.88] \rangle v_3 \end{aligned}$$

s.t:

$$\begin{aligned} & \langle [404, 540, 674], [350, 440, 560], [420, 645, 700] \rangle u_1 \\ & \oplus \langle [520, 530, 535], [520, 525, 530], [532, 534, 540] \rangle u_2 = 1, \\ & (\langle [121.13, 139.24, 140.04], [138.64, 139.14, 139.81], [139.14, 140.02, 141.17] \rangle v_1 \oplus \langle [38, 41, 45], [38, 40, 43], \\ & [41, 44, 49] \rangle v_2 \oplus \langle [104.23, 114.04, 278.51], [102.37, 109.15, 235.72], [104.81, 275.25, 279.88] \rangle v_3) - \\ & (\langle [404, 540, 674], [350, 440, 560], [420, 645, 700] \rangle u_1 \oplus \langle [520, 530, 535], [520, 525, 530], [532, 534, 540] \rangle u_2) \leq 0, \\ & (\langle [31.54, 34.93, 38.89], [31.54, 34.15, 38.27], [34.86, 38.15, 39.83] \rangle v_1 \oplus \langle [40, 44, 47], [35, 52, 45], \\ & [41, 46, 50] \rangle v_2 \oplus \langle [34.54, 36.98, 54.82], [36.45, 36.80, 41.57], [47.61, 54.25, 55.35] \rangle v_3) - \\ & (\langle [109, 126, 172], [112, 115, 127], [115, 168, 190] \rangle u_1 \oplus \langle [177, 180, 188], [173, 175, 179], [185, 189, 195] \rangle u_2) \leq 0, \end{aligned}$$

$$\begin{aligned}
 & (\langle [81.62, 82.07, 85.51], [81.41, 81.94, 83.35], [81.78, 85.49, 88.16] \rangle v_1 \oplus \langle [18, 20, 29], [19, 21, 23], \\
 & [28, 30, 35] \rangle v_2 \oplus \langle [157.75, 177.57, 264.52], [157.75, 176.68, 250.75], [180.29, 263.98, 272.16] \rangle v_3) - \\
 & (\langle [139, 145, 158], [139, 140, 147], [146, 155, 167] \rangle u_1 \oplus \langle [208, 214, 218], [195, 209, 215], [210, 217, 230] \rangle u_2) \leq 0, \\
 & (\langle [19.54, 20.41, 20.59], [20.15, 20.25, 20.32], [20.54, 20.58, 20.70] \rangle v_1 \oplus \langle [18, 21, 25], [15, 19, 23], \\
 & [20, 24, 30] \rangle v_2 \oplus \langle [32.89, 35.56, 87.74], [35.25, 35.50, 35.61], [87.50, 87.94, 88.30] \rangle v_3) - \\
 & (\langle [86, 93, 151], [83, 85, 87], [89, 138, 160] \rangle u_1 \oplus \langle [114, 116, 118], [114, 115, 117], [116, 118, 125] \rangle u_2) \leq 0, \\
 & (\langle [23.89, 24.60, 26.09], [23.56, 23.60, 23.68], [25.97, 26.35, 26.72] \rangle v_1 \oplus \langle [30, 36, 41], [34, 35, 37], \\
 & [35, 40, 57] \rangle v_2 \oplus \langle [63.23, 69.58, 120.73], [63, 65.17, 94.93], [64.47, 118.75, 124.75] \rangle v_3) - \\
 & (\langle [84, 93, 143], [84, 89, 120], [90, 140, 155] \rangle u_1 \oplus \langle [110, 117, 121], [105, 112, 120], [113, 119, 128] \rangle u_2) \leq 0, \\
 & (\langle [21.33, 21.49, 23.31], [20.94, 24.25, 22.68], [21.38, 23.14, 23.94] \rangle v_1 \oplus \langle [50, 55, 60], [50, 53, 57], \\
 & [56, 59, 70] \rangle v_2 \oplus \langle [72.84, 82.84, 94.18], [82.15, 82.68, 84.89], [85.75, 93.50, 97.18] \rangle v_3) - \\
 & (\langle [101, 113, 170], [110, 112, 115], [112, 120, 177] \rangle u_1 \oplus \langle [101, 107, 111], [95, 100, 104], [108, 112, 115] \rangle u_2) \leq 0, \\
 & (\langle [145.77, 148.28, 169.01], [145.77, 147.16, 168.31], [150.69, 168.95, 175.18] \rangle v_1 \oplus \langle [40, 44, 46], [42, 43, 45], \\
 & [43, 44, 55] \rangle v_2 \oplus \langle [147.59, 150.37, 227.12], [147.30, 147.45, 148.25], [218.24, 224.61, 229.63] \rangle v_3) - \\
 & (\langle [561, 694, 864], [510, 640, 750], [582, 857, 930] \rangle u_1 \oplus \langle [492, 495, 508], [492, 494, 500], [493, 506, 520] \rangle u_2) \leq 0, \\
 & (\langle [11.56, 11.74, 12.96], [11.42, 11.61, 11.98], [11.58, 12.64, 13.16] \rangle v_1 \oplus \langle [60, 75, 80], [55, 60, 62], \\
 & [78, 83, 85] \rangle v_2 \oplus \langle [189.37, 202.08, 284.99], [189.37, 200.52, 281.63], [270.16, 284.55, 289.12] \rangle v_3) - \\
 & (\langle [123, 179, 199], [122, 125, 130], [195, 200, 205] \rangle u_1 \oplus \langle [66, 68, 73], [63, 67, 69], [68, 70, 78] \rangle u_2) \leq 0, \\
 & (\langle [57.55, 62.67, 63.03], [62.15, 62.50, 62.93], [62.50, 62.97, 63.61] \rangle v_1 \oplus \langle [32, 35, 38], [32, 33, 35], \\
 & [34, 36, 45] \rangle v_2 \oplus \langle [14.63, 14.85, 29.40], [14.70, 14.75, 15.25], [24.75, 28.36, 32.64] \rangle v_3) - \\
 & (\langle [101, 153, 155], [140, 145, 150], [145, 149, 167] \rangle u_1 \oplus \langle [192, 195, 198], [185, 193, 197], [194, 196, 205] \rangle u_2) \leq 0, \\
 & (\langle [73.21, 76.03, 81.90], [75.76, 76.05, 76.25], [81.67, 82.27, 82.64] \rangle v_1 \oplus \langle [22, 25, 40], [20, 24, 27], \\
 & [23, 25, 29] \rangle v_2 \oplus \langle [96.77, 97.27, 110.39], [96.77, 96.89, 105.14], [99.76, 108.62, 115.27] \rangle v_3) - \\
 & (\langle [147, 164, 170], [147, 160, 167], [165, 169, 180] \rangle u_1 \oplus \langle [333, 340, 357], [335, 338, 350], [338, 347, 364] \rangle u_2) \leq 0, \\
 & (\langle [22.90, 27.71, 35.56], [22.90, 26.45, 31.28], [27.92, 34.62, 39.41] \rangle v_1 \oplus \langle [20, 23, 26], [21, 22, 24], \\
 & [22, 25, 30] \rangle v_2 \oplus \langle [171.53, 182.46, 384.99], [171.12, 178.65, 210.34], [175.59, 270.65, 400.12] \rangle v_3) - \\
 & (\langle [130, 158, 192], [110, 144, 173], [146, 177, 205] \rangle u_1 \oplus \langle [96, 100, 114], [97, 99, 103], [99, 110, 129] \rangle u_2) \leq 0, \\
 & (\langle [58.41, 59.12, 60.61], [58.08, 58.12, 58.20], [60.49, 60.87, 61.24] \rangle v_1 \oplus \langle [25, 31, 37], [29, 30, 32], \\
 & [30, 35, 52] \rangle v_2 \oplus \langle [59.87, 66.22, 117.37], [59.64, 61.81, 91.57], [61.11, 115.39, 121.39] \rangle v_3) - \\
 & (\langle [128, 137, 187], [128, 133, 164], [134, 184, 199] \rangle u_1 \oplus \langle [213, 220, 224], [208, 215, 223], [216, 222, 231] \rangle u_2) \leq 0, \\
 & (\langle [66.97, 67.68, 69.17], [66.64, 66.68, 66.76], [69.05, 69.43, 69.80] \rangle v_1 \oplus \langle [20, 27, 31], [23, 26, 28], \\
 & [24, 30, 46] \rangle v_2 \oplus \langle [96.97, 103.32, 154.47], [96.74, 98.91, 128.67], [98.21, 152.49, 158.50] \rangle v_3) - \\
 & (\langle [151, 160, 210], [151, 156, 187], [157, 207, 222] \rangle u_1 \oplus \langle [320, 327, 331], [315, 322, 330], [323, 329, 338] \rangle u_2) \leq 0,
 \end{aligned}$$

$$v_r, u_i \geq 0, r = 1, 2, 3, i = 1, 2.$$

Table 2. Output information of the nominee hospitals.

DMU	Outputs 1 Days of Hospitalization (in Thousands)	Outputs 2 Patient Satisfaction (%)	Outputs 3 Number of Outpatients (in Thousands)
1	$\langle [121.13, 139.24, 140.04], [138.64, 139.14, 139.81], [139.14, 140.02, 141.17] \rangle$	$\langle [38, 41, 45], [38, 40, 43], [41, 44, 49] \rangle$	$\langle [104.23, 114.04, 278.51], [102.37, 109.15, 235.72], [104.81, 275.25, 279.88] \rangle$
2	$\langle [31.54, 34.93, 38.89], [31.54, 34.15, 38.27], [34.86, 38.15, 39.83] \rangle$	$\langle [40, 44, 47], [35, 42, 45], [41, 46, 50] \rangle$	$\langle [34.54, 36.98, 54.82], [36.45, 36.80, 41.57], [47.61, 54.25, 55.35] \rangle$
3	$\langle [81.62, 82.07, 85.51], [81.41, 81.94, 83.35], [81.78, 85.49, 88.16] \rangle$	$\langle [18, 20, 29], [19, 21, 23], [28, 30, 35] \rangle$	$\langle [157.75, 177.57, 264.52], [157.75, 176.68, 250.75], [180.29, 263.98, 272.16] \rangle$
4	$\langle [19.54, 20.41, 20.59], [20.15, 20.25, 20.32], [20.54, 20.58, 20.70] \rangle$	$\langle [18, 21, 25], [15, 19, 23], [20, 24, 30] \rangle$	$\langle [32.89, 35.56, 87.74], [35.25, 35.50, 35.61], [87.50, 87.94, 88.30] \rangle$
5	$\langle [23.89, 24.60, 26.09], [23.56, 23.60, 23.68], [25.97, 26.35, 26.72] \rangle$	$\langle [30, 36, 41], [34, 35, 37], [35, 40, 57] \rangle$	$\langle [63.23, 69.58, 120.73], [63, 65.17, 94.93], [64.47, 118.75, 124.75] \rangle$
6	$\langle [21.33, 21.49, 23.31], [20.94, 24.25, 22.68], [21.38, 23.14, 23.94] \rangle$	$\langle [50, 55, 60], [50, 53, 57], [56, 59, 70] \rangle$	$\langle [72.84, 82.84, 94.18], [82.15, 82.68, 84.89], [85.75, 93.50, 97.18] \rangle$
7	$\langle [145.77, 148.28, 169.01], [145.77, 147.16, 168.31], [150.69, 168.95, 175.18] \rangle$	$\langle [40, 44, 46], [42, 43, 45], [43, 44, 55] \rangle$	$\langle [147.59, 150.37, 227.12], [147.30, 147.45, 148.25], [218.24, 224.61, 229.63] \rangle$
8	$\langle [11.56, 11.74, 12.96], [11.42, 11.61, 11.98], [11.58, 12.64, 13.16] \rangle$	$\langle [60, 75, 80], [55, 60, 62], [78, 83, 85] \rangle$	$\langle [189.37, 202.08, 284.99], [189.37, 200.52, 281.63], [270.16, 284.55, 289.12] \rangle$
9	$\langle [57.55, 62.67, 63.03], [62.15, 62.50, 62.93], [62.50, 62.97, 63.61] \rangle$	$\langle [32, 35, 38], [32, 33, 35], [34, 36, 45] \rangle$	$\langle [14.63, 14.85, 29.40], [14.70, 14.75, 15.25], [24.75, 28.36, 32.64] \rangle$
10	$\langle [73.21, 76.03, 81.90], [75.76, 76.05, 76.25], [81.67, 82.27, 82.64] \rangle$	$\langle [22, 25, 40], [20, 24, 27], [23, 25, 29] \rangle$	$\langle [96.77, 97.27, 110.39], [96.77, 96.89, 105.14], [99.76, 108.62, 115.27] \rangle$
11	$\langle [22.90, 27.71, 35.56], [22.90, 26.45, 31.28], [27.92, 34.62, 39.41] \rangle$	$\langle [20, 23, 26], [21, 22, 24], [22, 25, 30] \rangle$	$\langle [171.53, 182.46, 384.99], [171.12, 178.65, 210.34], [175.59, 270.65, 400.12] \rangle$
12	$\langle [58.41, 59.12, 60.61], [58.08, 58.12, 58.20], [60.49, 60.87, 61.24] \rangle$	$\langle [25, 31, 37], [29, 30, 32], [30, 35, 52] \rangle$	$\langle [59.87, 66.22, 117.37], [59.64, 61.81, 91.57], [61.11, 115.39, 121.39] \rangle$
13	$\langle [66.97, 67.68, 69.17], [66.64, 66.68, 66.76], [69.05, 69.43, 69.80] \rangle$	$\langle [20, 27, 31], [23, 26, 28], [24, 30, 46] \rangle$	$\langle [96.97, 103.32, 154.47], [96.74, 98.91, 128.67], [98.21, 152.49, 158.50] \rangle$

Finally, based on Definition 4, we convert the above model to the following model:

$$\max \tilde{\theta}_1 \approx 138.0608v_1 + 42v_2 + 175.2v_3$$

s.t:

$$\begin{aligned}
 &529.8333u_1 + 529.5833u_2 = 1, \\
 &138.0608v_1 + 42v_2 + 175.2v_3 - 529.8333u_1 - 529.5833u_2 \leq 0, \\
 &35.7792v_1 + 43.5v_2 + 43.8667v_3 - 146.9167u_1 - 182.0833u_2 \leq 0, \\
 &83.4025v_1 + 24.5v_2 + 209.9733v_3 - 148u_1 - 213u_2 \leq 0, \\
 &20.36v_1 + 21.5833v_2 + 57.1075v_3 - 104.3333u_1 - 116.8333u_2 \leq 0, \\
 &24.9175v_1 + 38v_2 + 86.5092v_3 - 110u_1 - 116.0833u_2 \leq 0, \\
 &22.6117v_1 + 56.4167v_2 + 86.2525v_3 - 122.9167u_1 - 106u_2 \leq 0, \\
 &156.9592v_1 + 44.4167v_2 + 180.2492v_3 - 714.9167u_1 - 499.5833u_2 \leq 0, \\
 &12.0533v_1 + 71.3333v_2 + 239.9117v_3 - 165.1667u_1 - 68.9167u_2 \leq 0, \\
 &62.3375v_1 + 35.3333v_2 + 20.6075v_3 - 146u_1 - 194.9167u_2 \leq 0, \\
 &78.3442v_1 + 25.75v_2 + 102.4717v_3 - 163.5u_1 - 343.9167u_2 \leq 0, \\
 &29.7942v_1 + 23.5833v_2 + 231.4342v_3 - 159.5u_1 - 104.6667u_2 \leq 0, \\
 &59.4375v_1 + 33.0833v_2 + 83.1492v_3 - 154u_1 - 219.0833u_2 \leq 0, \\
 &67.9975v_1 + 28.1667v_2 + 120.25v_3 - 177u_1 - 326.0833u_2 \leq 0, \\
 &v_r, u_i \geq 0, r = 1, 2, 3, i = 1, 2.
 \end{aligned}$$

After computations with Lingo, we obtained $\theta_1^* = 0.6673$ for DMU_1 . Similarly, for the other DMUs, we reported the results in Table 3. From these results, we can see that DMUs 3, 6, 8, and 11 are efficient and others are inefficient.

Table 3. The efficiencies of the decision-making units (DMUs) by the triangular single-valued neutrosophic number-Charnes, Cooper, and Rhodes (TSVNN-CCR) model.

DMUs	EFFICIENCY	Ranking
1	0.6673	9
2	0.8057	6
3	1.00	1
4	0.5950	10
5	0.8754	4
6	1.00	1
7	0.7024	7
8	1.00	1
9	0.9116	2
10	0.8751	3
11	1.00	1
12	0.8536	5
13	0.7587	8

To authenticate the suggested efficiencies, these efficiencies were compared with the efficiencies obtained by the crisp CCR (Model (6)), and are given in Figure 1. In this figure, the efficiencies of DMUs are found to be smaller for TSVNN-CCR compared to crisp CCR.

It is interesting that DMU 12 is efficient in crisp DEA, but it is inefficient with an efficiency score of 0.8536 using TSVNN-CCR. Therefore, TSVNN-CCR is more realistic than crisp CCR. In addition, crisp CCR and TSVNN-CCR may give the same efficiencies for certain data. However, the crisp CCR model does not deal with the uncertain, indeterminate, and incongruous information. Therefore, TSVNN-CCR is more realistic than crisp CCR.

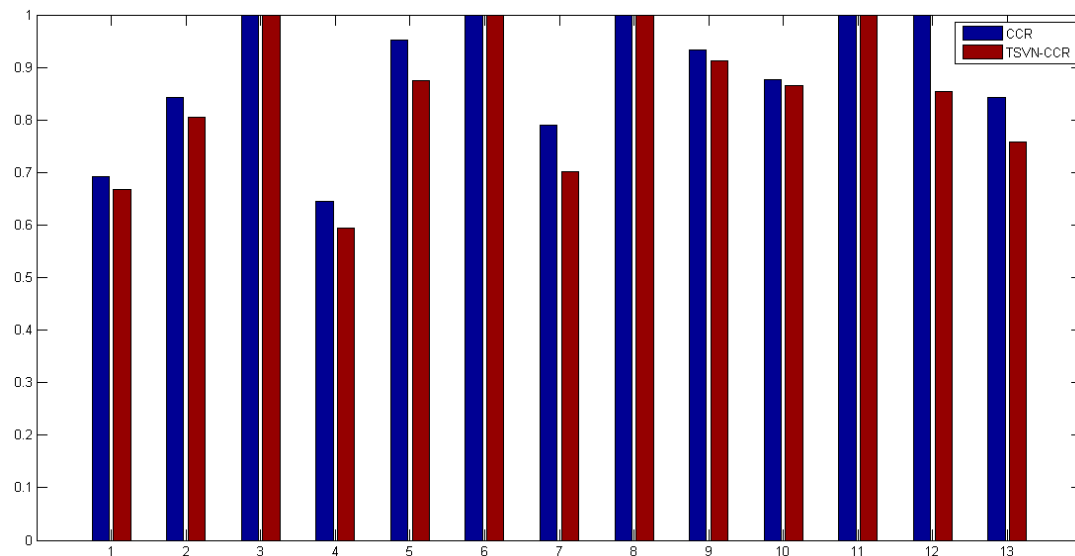

Figure 1. Comparison of suggested and crisp models.

6. Conclusions and Future Work

In this paper, a new approach for data envelopment analysis was proposed in that indeterminacy, uncertainty, vagueness, inconsistent, and incompleteness of data were shown by neutrosophic sets. Furthermore, the sorting of DMUs in DEA has been presented, and using a de-neutrosophication technique, a ranking order has been extracted. The efficiency scores of the proposed model have a similar meaning and interpretation with the conventional CCR model. Finally, the application of the proposed model was examined in a real-world case study of 13 hospitals of TUMS. The new model is appropriate in situations where some inputs or outputs do not have an exact quantitative value, and the proposed approach has produced promising results from computing efficiency and performance aspects.

The proposed study had some barriers: first, the indeterminacy, uncertainty, and ambiguity in the present report was limited to triangular single-valued neutrosophic numbers, but the other forms of NSs such as bipolar NSs and interval-valued neutrosophic numbers can also be used to indicate variables characterizing the neutrosophic core in global problems. Second, the presented model was investigated under a constant returns-to-scale (CRS), but the suggested method can also be extended under a VRS assumption, so we plan to extend this model to the VRS. Moreover, although the arithmetic operations, model, and results presented here demonstrate the effectiveness of our methodology, it could also be considered in other types of DEA models such as network DEA and its applications to banks, supplier selection, tax offices, police stations, schools, and universities. While developing data envelopment analysis, models based on bipolar and interval-valued neutrosophic data is another area for further studies. As for future research, we intend to study these problems.

Abbreviations: List of Acronyms

DEA	Data Envelopment Analysis
DMU	Decision-Making Units
CCR model	Charnes, Cooper, Rhodes model
BCC model	Banker, Charnes, Cooper model
CRS	Constant Returns-to-Scale
VRS	Variable Returns-to-Scale
AHP	Analytic Hierarchy Process
TUMS	Tehran University of Medical Sciences
FS	Fuzzy Set
IFS	Intuitionistic Fuzzy Set
NS	Neutrosophic Set
SVNS	Single-Valued Neutrosophic Set
TSVNN	Triangular Single-Valued Neutrosophic number

References

1. Charnes, A.; Cooper, W.W.; Rhodes, E. Measuring the efficiency of decision making units. *Eur. J. Oper. Res.* **1978**, *2*, 429–444. [[CrossRef](#)]
2. Farrell, M.J. The measurement of productive efficiency. *J. R. Stat. Soc.* **1957**, *120*, 253–290. [[CrossRef](#)]
3. Banker, R.D.; Charnes, A.; Cooper, W.W. Some models for estimating technical and scale inefficiencies in data envelopment analysis. *Manag. Sci.* **1984**, *30*, 1078–1092. [[CrossRef](#)]
4. Sahoo, B.K.; Tone, K. Decomposing capacity utilization in data envelopment analysis: An application to banks in India. *Eur. J. Oper. Res.* **2009**, *195*, 575–594. [[CrossRef](#)]
5. Lee, Y.J.; Joo, S.J.; Park, H.G. An application of data envelopment analysis for Korean banks with negative data. *Benchmarking Int. J.* **2017**, *24*, 1052–1067. [[CrossRef](#)]
6. Jiang, H.; He, Y. Applying Data Envelopment Analysis in Measuring the Efficiency of Chinese Listed Banks in the Context of Macroprudential Framework. *Mathematics* **2018**, *6*, 184. [[CrossRef](#)]
7. Karasakal, E.; Aker, P. A multicriteria sorting approach based on data envelopment analysis for R&D project selection problem. *Omega* **2017**, *73*, 79–92.
8. Lacko, R.; Hajduová, Z.; Gábor, V. Data Envelopment Analysis of Selected Specialized Health Centres and Possibilities of its Application in the Terms of Slovak Republic Health Care System. *J. Health Manag.* **2017**, *19*, 144–158. [[CrossRef](#)]
9. Ertay, T.; Ruan, D.; Tuzkaya, U.R. Integrating data envelopment analysis and analytic hierarchy for the facility layout design in manufacturing systems. *Inf. Sci.* **2006**, *176*, 237–262. [[CrossRef](#)]
10. Düzakın, E.; Düzakın, H. Measuring the performance of manufacturing firms with super slacks based model of data envelopment analysis: An application of 500 major industrial enterprises in Turkey. *Eur. J. Oper. Res.* **2007**, *182*, 1412–1432. [[CrossRef](#)]
11. Jahanshahloo, G.R.; Lotfi, F.H.; Valami, H.B. Malmquist productivity index with interval and fuzzy data, an application of Data envelopment analysis. *Int. Math. Forum* **2006**, *1*, 1607–1623. [[CrossRef](#)]
12. Shafiee, M.; Lotfi, F.H.; Saleh, H. Supply chain performance evaluation with data envelopment analysis and balanced scorecard approach. *Appl. Math. Model.* **2014**, *38*, 5092–5112. [[CrossRef](#)]
13. Soheilrad, S.; Govindan, K.; Mardani, A.; Zavadskas, E.K.; Nilashi, M.; Zakuan, N. Application of data envelopment analysis models in supply chain management: A systematic review and meta-analysis. *Ann. Oper. Res.* **2018**, *271*, 915–969. [[CrossRef](#)]
14. Krmac, E.; Djordjević, B. A New DEA Model for Evaluation of Supply Chains: A Case of Selection and Evaluation of Environmental Efficiency of Suppliers. *Symmetry* **2019**, *11*, 565. [[CrossRef](#)]
15. Zadeh, L.A. Fuzzy sets. *Inf. Control* **1965**, *8*, 338–353. [[CrossRef](#)]
16. Hsu, T.; Tsai, Y.; Wu, H. The preference analysis for tourist choice of destination: A case study of Taiwan. *Tour. Manag.* **2009**, *30*, 288–297. [[CrossRef](#)]
17. Finol, J.; Guo, Y.K.; Jing, X.D. A rule based fuzzy model for the prediction of petrophysical rock parameters. *J. Pet. Sci. Eng.* **2001**, *29*, 97–113. [[CrossRef](#)]

18. Najafi, H.S.; Edalatpanah, S.A. An improved model for iterative algorithms in fuzzy linear systems. *Comput. Math. Modeling* **2013**, *24*, 443–451. [[CrossRef](#)]
19. Hosseinzadeh, A.; Edalatpanah, S.A. A new approach for solving fully fuzzy linear programming by using the lexicography method. *Adv. Fuzzy Syst.* **2016**. [[CrossRef](#)]
20. Das, S.K.; Edalatpanah, S.A.; Mandal, T. A proposed model for solving fuzzy linear fractional programming problem: Numerical Point of View. *J. Comput. Sci.* **2018**, *25*, 367–375. [[CrossRef](#)]
21. Hatami-Marbini, A.; Emrouznejad, A.; Tavana, M. A taxonomy and review of the fuzzy data envelopment analysis literature: Two decades in the making. *Eur. J. Oper. Res.* **2011**, *214*, 457–472. [[CrossRef](#)]
22. Emrouznejad, A.; Tavana, M.; Hatami-Marbini, A. The state of the art in fuzzy data envelopment analysis. In *Performance Measurement with Fuzzy Data Envelopment Analysis*; Springer: Berlin/Heidelberg, Germany, 2014; pp. 1–45.
23. Emrouznejad, A.; Yang, G.L. A survey and analysis of the first 40 years of scholarly literature in DEA: 1978–2016. *Socio-Econ. Plan. Sci.* **2018**, *61*, 4–8. [[CrossRef](#)]
24. Yen, B.T.; Chiou, Y.C. Dynamic fuzzy data envelopment analysis models: Case of bus transport performance assessment. *RAIRO-Oper. Res.* **2019**, *53*, 991–1005. [[CrossRef](#)]
25. Lotfi, F.H.; Ebrahimnejad, A.; Vaez-Ghasemi, M.; Moghaddas, Z. *Data Envelopment Analysis with R*; Springer: Cham, Switzerland, 2020.
26. Atanassov, K.T. Intuitionistic fuzzy sets. *Fuzzy Sets Syst.* **1986**, *20*, 87–96. [[CrossRef](#)]
27. Rouyendegh, B.D. The DEA and intuitionistic fuzzy TOPSIS approach to departments' performances: A pilot study. *J. Appl. Math.* **2011**, 1–16. [[CrossRef](#)]
28. Puri, J.; Yadav, S.P. Intuitionistic fuzzy data envelopment analysis: An application to the banking sector in India. *Expert Syst. Appl.* **2015**, *42*, 4982–4998. [[CrossRef](#)]
29. Edalatpanah, S.A. A data envelopment analysis model with triangular intuitionistic fuzzy numbers. *Int. J. Data Envel. Anal.* **2019**, *7*, 47–58.
30. Arya, A.; Yadav, S.P. Development of intuitionistic fuzzy data envelopment analysis models and intuitionistic fuzzy input–output targets. *Soft Comput.* **2019**, *23*, 8975–8993. [[CrossRef](#)]
31. Smarandache, F. *A Unifying Field in Logics. Neutrosophy: Neutrosophic Probability, Set and Logic*; American Research Press: Rehoboth, MA, USA, 1999.
32. Smarandache, F. A unifying field in logics: Neutrosophic logic. In *Neutrosophy, Neutrosophic Set, Neutrosophic Probability and Statistics*, 3rd ed.; American Research Press: Rehoboth, MA, USA, 2003.
33. Broumi, S.; Smarandache, F. Correlation coefficient of interval neutrosophic set. *Appl. Mech. Mater.* **2013**, *436*, 511–517. [[CrossRef](#)]
34. Ye, J. Similarity measures between interval neutrosophic sets and their applications in multicriteria decision-making. *J. Intell. Fuzzy Syst.* **2014**, *26*, 165–172. [[CrossRef](#)]
35. Broumi, S.; Smarandache, F.; Talea, M.; Bakali, A. An introduction to bipolar single valued neutrosophic graph theory. *Appl. Mech. Mater.* **2016**, *841*, 184–191. [[CrossRef](#)]
36. Wang, L.; Zhang, H.Y.; Wang, J.Q. Frank Choquet Bonferroni mean operators of bipolar neutrosophic sets and their application to multi-criteria decision-making problems. *Int. J. Fuzzy Syst.* **2018**, *20*, 13–28. [[CrossRef](#)]
37. Ye, J. Multicriteria decision-making method using the correlation coefficient under single-valued neutrosophic environment. *Int. J. Gen. Syst.* **2013**, *42*, 386–394. [[CrossRef](#)]
38. Chakraborty, A.; Mondal, S.P.; Ahmadian, A.; Senu, N.; Alam, S.; Salahshour, S. Different Forms of Triangular Neutrosophic Numbers, De-Neutrosophication Techniques, and their Applications. *Symmetry* **2018**, *10*, 327. [[CrossRef](#)]
39. Garg, H. New Logarithmic operational laws and their applications to multiattribute decision making for single-valued neutrosophic numbers. *Cogn. Syst. Res.* **2018**, *52*, 931–946. [[CrossRef](#)]
40. Garg, H. Linguistic single-valued neutrosophic prioritized aggregation operators and their applications to multiple-attribute group decision-making. *J. Ambient Intell. Hum. Comput.* **2018**, *9*, 1975–1997. [[CrossRef](#)]
41. Smarandache, F. *About Nonstandard Neutrosophic Logic: Answers to Imamura's "Note on the Definition of Neutrosophic Logic"*; Infinite Study: Coimbatore, India, 2019.
42. Garg, H. Algorithms for possibility linguistic single-valued neutrosophic decision-making based on COPRAS and aggregation operators with new information measures. *Measurement* **2019**, *138*, 278–290. [[CrossRef](#)]
43. Kumar, R.; Edalatpanah, S.A.; Jha, S.; Broumi, S.; Dey, A. Neutrosophic shortest path problem. *Neutrosophic Sets Syst.* **2018**, *23*, 5–15.

44. Edalatpanah, S.A. Nonlinear approach for neutrosophic linear programming. *J. Appl. Res. Ind. Eng.* **2019**, *6*, 367–373.
45. Edalatpanah, S.A. Neutrosophic perspective on DEA. *J. Appl. Res. Ind. Eng.* **2018**, *5*, 339–345.
46. Kahraman, C.; Otay, I.; Öztaysi, B.; Onar, S.C. An Integrated AHP & DEA Methodology with Neutrosophic Sets. In *Fuzzy Multi-Criteria Decision-Making Using Neutrosophic Sets*; Springer: Cham, Switzerland, 2019; pp. 623–645.
47. Edalatpanah, S.A.; Smarandache, F. Data Envelopment Analysis for Simplified Neutrosophic Sets. *Neutrosophic Sets Syst.* **2019**, *29*, 215–226.
48. Abdelfattah, W. Data envelopment analysis with neutrosophic inputs and outputs. *Expert Syst.* **2019**, *36*, e12453. [[CrossRef](#)]
49. Robinson, A. *Non-Standard Analysis*; Princeton University Press: Princeton, NJ, USA, 2016.
50. Aristovnik, A. Measuring relative efficiency in health and education sector: The case of East European countries. *Actual Probl. Econ.* **2012**, *136*, 305–314.
51. Barros, C.P.; de Menezes, A.G.; Vieira, J.C. Measurement of hospital efficiency, using a latent class stochastic frontier model. *Appl. Econ.* **2013**, *45*, 47–54. [[CrossRef](#)]
52. Colombi, R.; Martini, G.; Vittadini, G. Determinants of transient and persistent hospital efficiency: The case of Italy. *Health Econ.* **2017**, *26*, 5–22. [[CrossRef](#)] [[PubMed](#)]
53. Bryce, C.L.; Engberg, J.B.; Wholey, D.R. Comparing the agreement among alternative models in evaluating HMO efficiency. *Health Serv. Res.* **2000**, *35*, 509. [[PubMed](#)]
54. Kalhor, R.; Amini, S.; Sokhanvar, M.; Lotfi, F.; Sharifi, M.; Kakemam, E. Factors affecting the technical efficiency of general hospitals in Iran: Data envelopment analysis. *J. Egypt. Public Health Assoc.* **2016**, *91*, 20–25. [[CrossRef](#)]
55. Chen, H.; Liu, J.; Li, Y.; Chiu, Y.-H.; Lin, T.Y. A Two-stage Dynamic Undesirable Data Envelopment Analysis Model Focused on Media Reports and the Impact on Energy and Health Efficiency. *Int. J. Environ. Res. Public Health* **2019**, *16*, 1535. [[CrossRef](#)]
56. Kohl, S.; Schoenfelder, J.; Fügener, A.; Brunner, J.O. The use of Data Envelopment Analysis (DEA) in healthcare with a focus on hospitals. *Health Care Manag. Sci.* **2019**, *22*, 245–286. [[CrossRef](#)]
57. Ji, A.B.; Qiao, Y.; Liu, C. Fuzzy DEA-based classifier and its applications in healthcare management. *Health Care Manag. Sci.* **2019**, *22*, 560–568. [[CrossRef](#)]
58. Dotoli, M.; Epicoco, N.; Falagario, M.; Sciancalepore, F. A cross-efficiency fuzzy data envelopment analysis technique for performance evaluation of decision making units under uncertainty. *Comput. Ind. Eng.* **2015**, *79*, 103–114. [[CrossRef](#)]
59. Otay, İ.; Öztaysi, B.; Onar, S.C.; Kahraman, C. Multi-expert performance evaluation of healthcare institutions using an integrated intuitionistic fuzzy AHP&DEA methodology. *Knowl. Based Syst.* **2017**, *133*, 90–106.

Study of Imaginative Play in Children Using Single-Valued Refined Neutrosophic Sets

Vasanth W. B., Ilanthenral Kandasamy, Florentin Smarandache, Vinayak Devvrat, Shivam Ghildiyal

Vasanth W. B., Ilanthenral Kandasamy, Florentin Smarandache, Vinayak Devvrat, Shivam Ghildiyal (2020). Study of Imaginative Play in Children Using Single-Valued Refined Neutrosophic Sets. *Symmetry* 12, 402; DOI: 10.3390/sym12030402

Abstract: This paper introduces Single Valued Refined Neutrosophic Set (SVRNS) which is a generalized version of the neutrosophic set. It consists of six membership functions based on imaginary and indeterminate aspect and hence, is more sensitive to real-world problems. Membership functions defined as complex (imaginary), a falsity tending towards complex and truth tending towards complex are used to handle the imaginary concept in addition to existing memberships in the Single Valued Neutrosophic Set (SVNS). Several properties of this set were also discussed. The study of imaginative pretend play of children in the age group from 1 to 10 years was taken for analysis using SVRNS, since it is a field which has an ample number of imaginary aspects involved. SVRNS will be more apt in representing these data when compared to other neutrosophic sets. Machine learning algorithms such as K-means, parallel axes coordinate, etc., were applied and visualized for a real-world application concerned with child psychology. The proposed algorithms help in analysing the mental abilities of a child on the basis of imaginative play. These algorithms aid in establishing a correlation between several determinants of imaginative play and a child's mental abilities, and thus help in drawing logical conclusions based on it. A brief comparison of the several algorithms used is also provided.

Keywords: neutrosophic sets; Single Valued Refined Neutrosophic Set; applications of Neutrosophic sets; k-means algorithm; clustering algorithms

1. Introduction

Neutrosophy is an emerging branch in modern mathematics. It is based on philosophy and was introduced by Smarandache and deals with the concept of indeterminacy [1]. Neutrosophic logic is a generalization of fuzzy logic proposed by Zadeh [2]. A proposition in Neutrosophic logic is either true (T), false (F) or indeterminate (I). This inclusion of indeterminacy makes the neutrosophic logic capable of analyzing uncertainty in datasets. Hence, it can be used to logically represent the uncertain and often inconsistent information in the real world problems. Single Valued Neutrosophic Sets (SVNS) [3] are an instance of a neutrosophic set which can be used in real scientific and engineering applications such as Decision-making problems [4–11], Image Processing [12–14], Social Network Analysis [15], Social problems [16,17] and psychology [18]. The distance and similarity measures have found practical applications in the fields of psychology for comparing different behavioural and cognitive patterns.

Imaginative or pretend play is one of the fascinating topics in child psychology. It begins around the age of 1 year or so. It is at its most prominent during the preschool years when children begin to interact with other children of their own age and begin to access more toys. It is crucial in child development as it helps in the development of language (sometimes the child language which cannot

be deciphered by everyone) and also helps nurture the imagination of tiny-tots. However, the factors determining the level of imaginative play in children are varied and complicated and a study of them would help one to assess their mental development. It is here that fuzzy neutrosophic logic comes into play. In this paper, we propose a new notion of Single Valued Refined Neutrosophic Sets (SVRNS) which is a model structured on indeterminate and imaginary notions, coupled with machine learning techniques such as heat maps, clustering, parallel axes coordinate, etc., to study the factors that determine and influence imaginative play in children and how it differs in children with different abilities and skills.

Every child is born different. The personality and behaviour of children is an interplay of several different factors. Psychology is a complicated and varied science and open to subjective interpretations. The study of child psychology in an objective manner can help one uncover several aspects of child behaviour and also result in early detection of certain mental disorders. One of the key motivations of this research is to uncover the factors that determine the mental abilities of a child and the extent of their imagination which helps in predicting their academic and overall performance in later stages. Machine Learning is slowly but steadily becoming one of the hot topics of computer science. Amalgamation of machine learning algorithms and psychology on the basis of complex and neutrosophic logic is certainly exciting and will help to cover new bounds.

This study primarily focuses on the analysis of imaginative play in children on the basis of neutrosophic logic and draws conclusions on the same with the help of clustering algorithms. The approach is initialized by generating a finite number of complex and neutrosophic sets determined by several cognitive, psychological and biological factors that affect imaginative play in the mentioned age group. The primary advantage here is the ability of such sets to deal with the uncertainty, imagination and indeterminacy present in the study of pretend play in children in the age group from 1 to 10 years. With the help of this study, we aim to distinguish the contribution of several factors of imaginative play in children and conclude from the study whether the child has any mental disorders or not and about the general cognitive skills coupled with imagination. This model will also help in identifying factors which may contribute to potential psychological disorders in young children at an early stage and predict the academic performance of the child.

In this research, a new complex fuzzy neutrosophic set is defined which will be used as a model to study the imaginary and indeterminate behaviour in young children in the age group from 1 to 10 years by giving them suitable stimuli for imaginary play. The data were collected from different sources with the help of a questionnaire, observations, recorded sessions and interviews, and after transforming the data into the proposed new neutrosophic logic, they were fitted into the newly constructed model and conclusions were drawn from them using a child psychologist as an expert. This model attempts to discover the extent to which several factors contribute to imaginative play in children of the specified age group and to detect possibilities of mental disorders such as autism and hyperactivity in young children on the basis of the trained model.

The paper is organized into seven major sections which are further divided into a few subsections. Section one is introductory in nature. A detailed analysis of the works related to neutrosophy and its applications to a few relevant fields are presented in section two. It also provides the gaps that have been identified in those works. Section 3 introduces Single Valued Refined Neutrosophic Sets (SVRNS) along with their properties, such as distance measures and related algorithms. It also introduces and discusses several machine learning techniques used for assessment. The description of the dataset used for the application of algorithms such as K-means clustering, heat maps, parallel axes coordinate is given in section four. It also includes the approach involved in processing the data obtained appropriately into SVRNSs. Section 5 provides an illustrative example of the methods described in the preceding section. Section 6 details the results obtained from the application of the discussed algorithms and their respective visualizations. Section 7 discusses the conclusions based on our study and its future scope.

2. Related Works

Fink [19] explored the role of imaginative play in the attainment of conservation and perspectivism with the help of a training study paradigm. Kindergarten children were assigned to certain conditions such as free play in the presence of an experimenter and a control group. The method of their data collection was observation. The results indicate that imaginative play can result in new cognitive structures. The relationship between different types of play experiences and the construction of certain physical or social concepts were also discussed, along with educational implications.

Udwin [20] studied a group of children who had been removed from harmful family backgrounds and placed in institutional care. These children were exposed to imaginative play training sessions. These subjects showed an increase in imaginative behaviour. Age, non-verbal intelligence and fantasy predisposition were determinants of the subjects' response to the training programme, with younger, high-fantasy and high-IQ children being most susceptible to the influence of the training exercises.

Huston-Stein [21] attempted to establish a relationship between social structure and child psychology by employing methods of direct observations of field experiments. The behaviour was then categorised on the basis of a set of defined behavioural categories and evaluated on the basis of suitable metrics. The results focus on establishing correlations between these behavioural categories and classroom structure and draw conclusions on how such social structures impact imaginative play.

Bodrova [22] related another important parameter, namely academic performance, to imaginative play. They have established imaginative play as a necessary prerequisite and one of the major sources of child development. They deduced how imaginative play scenarios require a certain knowledge of environmental setting and how it affects the academic excellence of a child.

Seja [23] explored another important factor in child psychology—emotions. They attempted to determine how imaginative play helps to understand the emotional integration of children. The source of data collected in this study is elementary school children who were tested on verbal intelligence and by standard psychological tests. Conclusions were drawn on the basis of an extensive statistical analysis which also attempted to investigate gender differences.

Neutrosophy has given importance to the imprecision and complexity of data. This is an important reason behind using neutrosophic logic in real life applications. Dhingra et al. [24] attempted to classify a given leaf as diseased or healthy based on the membership functions of the neutrosophic sets. Image segmentation into true, false and indeterminate regions after preprocessing was used to extract features and several classifiers were used to arrive at a classification. A comparative analysis of these classifiers was also provided.

Several researchers [25–30] dealt with algebraic structures of neutrosophic duplets, which are a special case of neutrality. Single Valued Neutrosophic Sets (SVNS), which is particular cases of triplet following the fuzzy neutrosophic membership concepts in their mathematical properties and operations are dealt by Haibin [31].

Haibin [31] gave the notion of Single Valued Neutrosophic Sets (SVNS) along with their mathematical properties and set operations. Properties such as inclusion, complement and union were defined on SVNS. They also gave examples of how such sets can be used in practical engineering applications. SVNS has found a major application in medical diagnosis. Shehzadi [32] presented the use of Hamming distance and similarity measures of given SVNSs to diagnose a patient as having Diabetes, Dengue or Tuberculosis. The three membership functions (truth, falsity and indeterminacy) were assigned suitable values and distance and similarity measures were applied on them. These measures were then used to provide a medical diagnosis. Smarandache and Ali [33] provided the notion of complex neutrosophic sets (CNS). Membership values given to them were of the form $a+bi$. Several properties of these sets were defined. These sets find applications in electrical engineering and decision-making fields. Neutrosophic Refined Sets were defined in [34].

A more refined and precise view of indeterminacy is provided by Kandasamy [35]. The indeterminacy membership function was further categorized as indeterminacy tending towards truth and indeterminacy tending towards false. Hence, resulting in Double-Valued Neutrosophic

Set (DVNS). Their properties, such as complement, union and equality were also discussed and distance measures were also defined on them. On the basis of these properties, minimum spanning trees and clustering algorithms were described [36]. Dice measures on DVNS were proposed in [37]. The importance given to the indeterminacy of incomplete and imprecise data, as often found in the real world, is a major advantage of the DVNS and hence, is more apt for several engineering and medical applications.

The model of Triple Refined Indeterminate Neutrosophic Set (TRINS) was also introduced by Kandasamy and Smarandache [38]. It categorizes indeterminacy membership function as leaning towards truth and leaning towards false in addition to the traditional three membership functions of neutrosophic sets. After defining the several properties and distance measures, the TRINS was used for personality classification. The personality classification using TRINS has been found to be more accurate and realistic as compared to SVNS and DVNS. Indeterminate Likert scaling using five point scale was introduced in [39] and a sentiment analysis using Neutrosophic refined sets was conducted in [40,41].

To date, the study of imaginative play in children has not been analysed using neutrosophy coupled with an imaginary concept; thus, to cover this unexplored area, the new notion of Single Valued Refined Neutrosophic Sets (SVRNS) that represent imaginary and indeterminate memberships individually were defined. A study of imaginative play in children using Neutrosophic Cognitive Maps (NCM) model was carried out in [42].

3. Single Valued Refined Neutrosophic Set (SVRNS) and Its Properties

This section presents the definition of Single Valued Refined Neutrosophic Set (SVRNS). These sets are based on the essential concepts of real, complex and neutrosophic values which takes membership from the fuzzy interval $[0,1]$. In a way this can be realized as a mixture of refined neutrosophic sets coupled with real membership values for imaginary aspect. However SVRNS are different from traditional neutrosophic sets. The neutrosophic logic is powerful and can model concepts of arbitrary complexity covering incomplete and imprecise data. Children's behaviour is one such complicated and the imprecise branch that can be modelled as objectively as possible by coupling imaginary or complex nature of data with its indeterminacy.

The concept of SVRNS are defined, developed and described in the following.

3.1. Single Valued Refined Neutrosophic Set (SVRNS)

Definition 1. Let X be a space of points (objects), with a generic element in X denoted by x . A neutrosophic set A in X is characterised by a truth membership function $T_A(x)$, a true tending towards complex membership function $TC_A(x)$, a complex membership function $C_A(x)$, a false tending towards complex membership function $FC_A(x)$, an indeterminacy membership function $I_A(x)$, and a falsity membership function $F_A(x)$. For each point x in X , there are $T_A(x), TC_A(x), C_A(x), FC_A(x), I_A(x), F_A(x) \in [0, 1]$ and $0 \leq T_A(x) + TC_A(x) + C_A(x) + FC_A(x) + I_A(x) + F_A(x) \leq 6$. Therefore, a Single Valued Refined Neutrosophic Set (SVRNS) A can be represented by

$$A = \{ \langle T_A(x), TC_A(x), C_A(x), FC_A(x), I_A(x), F_A(x) \rangle | x \in X \}.$$

3.2. Distance Measures of SVRNS

The distance measures of SVRNSs are defined in this section and the related algorithm for determining the distance is given.

Definition 2. Consider two SVRNSs A and B in a universe of discourse, $X = x_1, x_2, \dots, x_n$, which are denoted by

$$A = \{ \langle T_A(x_i), TC_A(x_i), C_A(x_i), FC_A(x_i), I_A(x_i), F_A(x_i) \rangle | x_i \in X \},$$

and

$$B = \{ \langle T_B(x_i), TC_B(x_i), C_B(x_i), FC_B(x_i), I_B(x_i), F_B(x_i)) \mid x_i \in X \},$$

where $T_A(x_i), TC_A(x_i), C_A(x_i), FC_A(x_i), I_A(x_i), F_A(x_i), T_B(x_i), TC_B(x_i), C_B(x_i), FC_B(x_i), I_B(x_i), F_B(x_i) \in [0, 1]$ for every $x_i \in X$. Let $w_i (i = 1, 2, \dots, n)$ be the weight of an element $x_i (i = 1, 2, \dots, n)$, with $w_i \geq 0 (i = 1, 2, \dots, n)$ and $\sum_{i=1}^n w_i = 1$. Then, the generalised SVRNS weighted distance is defined as follows:

$$d_\lambda(A, B) = \left\{ \frac{1}{6} \sum_{i=1}^n w_i [|T_A(x_i) - T_B(x_i)|^\lambda + |TC_A(x_i) - TC_B(x_i)|^\lambda + |C_A(x_i) - C_B(x_i)|^\lambda + |FC_A(x_i) - FC_B(x_i)|^\lambda + |I_A(x_i) - I_B(x_i)|^\lambda + |F_A(x_i) - F_B(x_i)|^\lambda] \right\}^{\frac{1}{\lambda}}$$

where $\lambda > 0$.

The above equation reduces to the SVRNS weighted Hamming distance and the SVRNS weighted Euclidean distance, when $\lambda = 1, 2$, respectively. The SVRNS weighted Hamming distance is given as

$$d_\lambda(A, B) = \left\{ \frac{1}{6} \sum_{i=1}^n w_i [|T_A(x_i) - T_B(x_i)| + |TC_A(x_i) - TC_B(x_i)| + |C_A(x_i) - C_B(x_i)| + |FC_A(x_i) - FC_B(x_i)| + |I_A(x_i) - I_B(x_i)| + |F_A(x_i) - F_B(x_i)|] \right\}$$

where $\lambda = 1$.

The SVRNS weighted Euclidean distance is given as

$$d_\lambda(A, B) = \left\{ \frac{1}{6} \sum_{i=1}^n w_i [|T_A(x_i) - T_B(x_i)|^2 + |TC_A(x_i) - TC_B(x_i)|^2 + |C_A(x_i) - C_B(x_i)|^2 + |FC_A(x_i) - FC_B(x_i)|^2 + |I_A(x_i) - I_B(x_i)|^2 + |F_A(x_i) - F_B(x_i)|^2] \right\}^{\frac{1}{2}}$$

where $\lambda = 2$.

The algorithm to obtain the generalized SVRNS weighted distance $d_\lambda(A, B)$ between two SVRNS A and B is given in Algorithm 1.

Algorithm 1: Generalized SVRNS weighted distance $d_\lambda(A, B)$

Input: $X = x_1, x_2, \dots, x_n$, SVRNS A, B where

$$A = \{ \langle T_A(x_i), TC_A(x_i), C_A(x_i), FC_A(x_i), I_A(x_i), F_A(x_i)) \mid x_i \in X \},$$

$$B = \{ \langle T_B(x_i), TC_B(x_i), C_B(x_i), FC_B(x_i), I_B(x_i), F_B(x_i)) \mid x_i \in X \}, w_i (i = 1, 2, \dots, n)$$

Output: $d_\lambda(A, B)$

begin

$$d_\lambda \leftarrow 0$$

for $i = 1$ to n **do**

$$d_\lambda \leftarrow d_\lambda + \sum_{i=1}^n w_i [|T_A(x_i) - T_B(x_i)|^\lambda + |TC_A(x_i) - TC_B(x_i)|^\lambda + |C_A(x_i) - C_B(x_i)|^\lambda + |FC_A(x_i) - FC_B(x_i)|^\lambda + |I_A(x_i) - I_B(x_i)|^\lambda + |F_A(x_i) - F_B(x_i)|^\lambda]$$

end

$$d_\lambda \leftarrow d_\lambda / 6$$

$$d_\lambda \leftarrow d_\lambda^{\left(\frac{1}{\lambda}\right)}$$

end

The related flowchart is given in Figure 1.

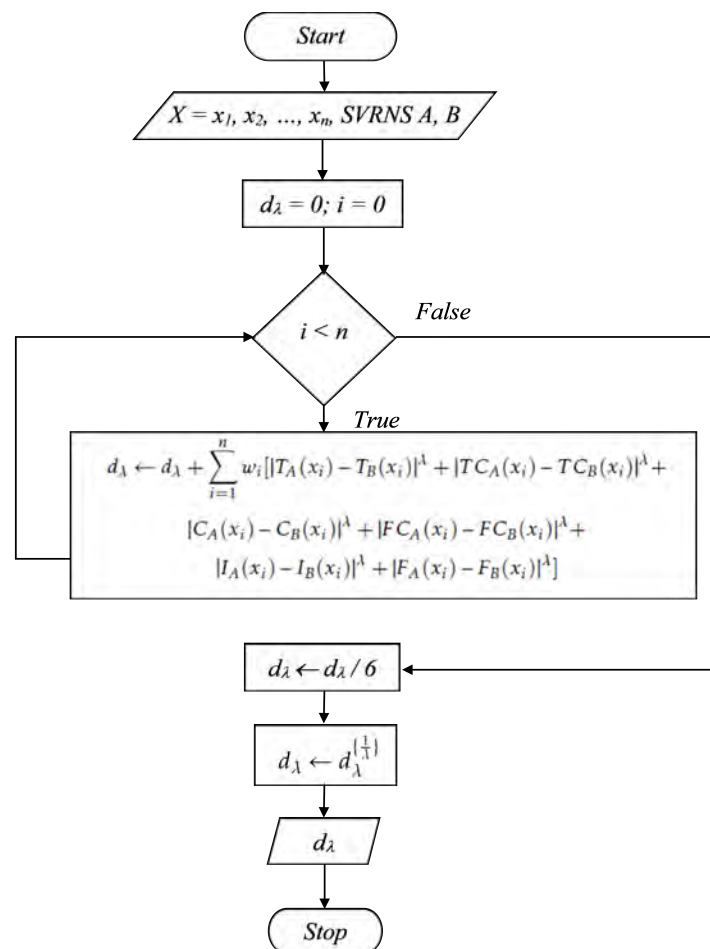

Figure 1. Flow Chart for Generalized SVRNS weighted distance $d_{(\lambda)}$.

The generalised SVRNS weighted distance $d_{\lambda}(A, B)$ for $\lambda > 0$ satisfies the following properties:

1. $d_{\lambda}(A, B) \geq 0$
2. $d_{\lambda}(A, B) = 0$ if and only if $A = B$
3. $d_{\lambda}(A, B) = d_{\lambda}(B, A)$
4. If $A \subseteq B \subseteq C$, C is a SVRNS in X , then $d_{\lambda}(A, C) \geq d_{\lambda}(A, B)$ and $d_{\lambda}(A, C) \geq d_{\lambda}(B, C)$

3.3. K-Means Algorithm

The K-means algorithm for SVRNS is given in Algorithm 2.

Algorithm 2: K-means algorithm for clustering SVRNS values

Input: A_1, A_2, \dots, A_n SVRNS, K —Number of Clusters

Output: K Clusters

begin

Step 1: Choose K different SVRNS A_j as the initial centroids, denoted as $\alpha_j, j = 1, \dots, K$

Step 2: Initialize $\beta_j \leftarrow 0, j = 1, \dots, K$; // $\mathbf{0}$ is a vector with all 0 's

Step 3: Initialize $n_j \leftarrow 0, j = 1, \dots, K$; // n_j is the number of points in cluster j

Step 4: Creation of Clusters **repeat**

for $i = 1$ to n **do**

$$j \leftarrow \underset{j \in \{1, \dots, K\}}{\operatorname{argmin}} d_\lambda(A_i, \alpha_j)$$

// From Algorithm 1

assign A_i to cluster j

$$\beta_j \leftarrow \beta_j + a$$

$$n_j \leftarrow n_j + 1$$

end

$$\alpha_j \leftarrow \frac{\beta_j}{n_j}, j = 1, \dots, K$$

until Clusters do not change

end

The related flowchart is given in Figure 2.

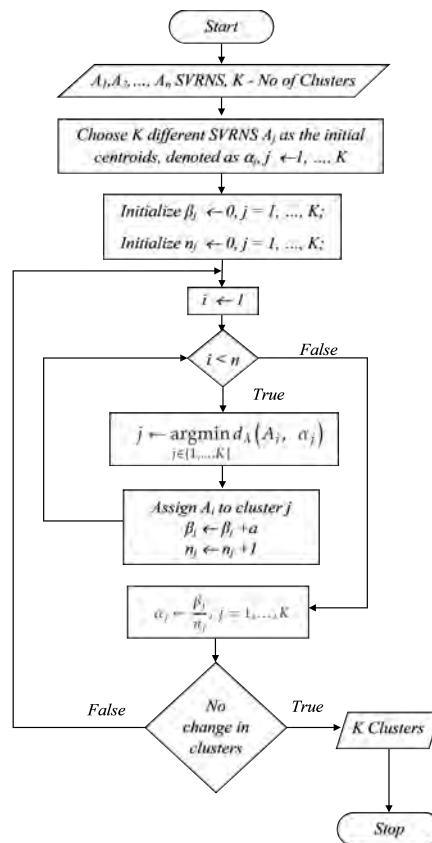

Figure 2. Flow Chart for k means clustering of SVRNS values.

We used the following machine learning techniques in this paper after obtaining and processing the data.

3.4. Other Machine Learning Techniques

The Elbow method is a technique used to find the value of appropriate value of K (Number of clusters) in K-means clustering. It makes the cluster analysis design consistent. A heat map is a data visualization technique used to show correlation between two attributes in the form of a matrix where each value is represented as colours. The Principal Component Analysis (PCA) makes use of orthogonal transformation to convert a set of observations of variables which might be possibly correlated, into a set of values of linearly uncorrelated variables called principal components. It is a widely used statistical technique. Parallel coordinates (also known as Parallel Axes Chart (PAC)) are highly used for the visualization of multi-dimensional geometry and analysis of multivariate data. Easy visualization of multiple dimensions is an innate feature of PAC plot, making it simple to analyse attributes which are associated with other attributes in a similar manner.

4. Dataset Description

Imaginative play is defined as “a form of symbolic play where children use objects, actions or ideas to represent other objects, actions, or ideas using their imaginations to assign roles to inanimate objects or people”. During the early stage, “toddlers begin to develop their imaginations, with sticks becoming boats and brooms becoming horses. Their play is mostly solitary, assigning roles to inanimate objects like their dolls and teddy bears”. It has proven to be highly beneficial as it results in early use of language and proper use of tenses and adjectives. It gives the children a sense of freedom and allows them to be creative in their own space. It helps children make sense of the physical world and also their inner selves. It can develop with the help of the most basic tools such as a toy mobile or a cardboard tube.

The data regarding imaginative play in children were collected from the local school and an orphanage in Vellore, India.

A child psychologist was present throughout the sessions, analyzed and suggested the various parameters and recorded the observations about each session. The session at each of these places began with the expert talking to the child about general things and everyday life as an ice-breaker exercise. This included talking about his/her favourite subjects, parents and treating him/her with biscuits or chocolates. The surroundings were made as comfortable as possible. The child was then asked to conduct an imaginary phone call in whichever way he/she liked. The imaginary conversation was then recorded as video on a phone. The expert made observations that were recorded on paper in a running hand description. This signified the end of the session.

Overall, 10 such sessions were conducted at the school and 2 were conducted at the orphanage. The children belonged to the age group of 6 to 8 years. Additionally, in order to make the dataset diverse as suggested by the expert, 7 videos were taken from the internet in which children conducted imaginary conversations over the phone. The running hand description thus collected was used by this expert to assign values to the six membership functions based on which the SVRNS is constructed.

Table 1 provides the parameters which have been used to study imaginative play along with their description. The parameters 1 to 11 are available in [19] and the other 4 parameters from 12 to 15 are introduced by us.

Table 1. Parameter Description.

S.No	Parameter Name	Description
1	Imaginative Theme (IT)	The theme of the imaginative play is assumed by the child and can be based on a real or imaginative situation and/or setting.
2	Physical Movements (PM)	The movements a child may make while s/he conducts the imaginative play are also an important determinant of the child's cognitive patterns. They are the ways in which the child uses his/her body during the play.
3	Gestures (G)	They are the ways in which the child moves a part of the body in order to express an idea or some meaning. They are the non-verbal means of communication using hands, head, etc.
4	Facial Expressions (FE)	The movement of facial muscles for non-verbal communication and also convey the emotions experienced by the child.
5	Nature and Length of Social Interaction (NoI/LoI)	The time duration during which the child engages in the imaginative play activity can determine the extent of his/her imagination. The nature of any form of interaction which may take place during the imaginative play be day-to-day, meaningful in some way, etc. and even the combination of the two.
6	Play Materials Used (PMU)	They are the objects provided to the child to conduct an imaginative play activity. The play material used here was a play mobile phone to conduct an imaginary talk.
7	Way Play Materials were Used (WPMwu)	The child's approach to using the play material provided can give an insight into his/her imaginative capabilities.
8	Verbalisation (V)	It is the way in which the child is expressing his/her feelings or emotions during the imaginative play activity.
9	Tone of Voice (ToI)	It is an important aspect that child's mood and state of mind as in if the child is happy, sad or nervous. For example, a high pitched voice may indicate happiness or excitement.
10	Role Identification (RI)	It is the role a child assumes during the imaginative play and the role s/he assigns to other people.
11	Engagement Level (EL)	It is the extent to which the child involves in the activity of imaginative play.
12	Eye Reaction (ER)	It refers to the movement of the eyes during the imaginative play activity. It can give insight into the child's emotions during the play.
13	Cognitive Response (CR)	It is the mental process by which the child forms association between things.
14	Grammar and Linguistics (GaL)	It refers to the ability of a child to make grammatically correct sentences with proper sentence structure and syntax.
15	Coherence (C)	Whether the child is making sense of the talks, i.e., if the sentences formed are related to one another is called coherence.

Method of Evaluation

The running hand description of the above-mentioned parameters was transformed into a complex fuzzy neutrosophic sets by the expert/child psychologist, for applying machine learning algorithms discussed in the earlier section. The methods of evaluation for each parameter as suggested by the expert are discussed below.

1. *Imaginative Theme*: An imaginative theme that is based on the real situation will result in the increase in the truth membership function and otherwise if the theme is entirely imaginative. However, since there is always a degree of complex and indeterminacy in this parameter, the complex and indeterminate membership functions was also assigned certain values from [0,1].
2. *Physical Movements*: If physical movements are made, the value of truth membership function will increase else the falsity membership function will increase. Complex and indeterminacy values from [0,1] shall be assigned values if movements are difficult to interpret properly or happened to be imaginary.
3. *Gestures*: Similar to physical movements, any gestures made in accordance with the imaginative activity will result in an increase in the truth membership value and in falsity value otherwise. Any indeterminate or complex feature will result in values being assigned to indeterminate and complex respectively from [0,1].
4. *Facial Expressions*: Any facial expressions made in accordance with the imaginative activity conducted will lead to an increase in the truth membership and in falsity membership function otherwise. Complex and indeterminacy membership functions shall be assigned values if facial expressions are difficult to interpret properly.

5. *Nature and Length of Social Interaction:* Any interaction that is made in accordance with the play activity will result in an increase in truth membership functions and in falsity membership functions otherwise. Indeterminate and complex membership functions shall be assigned values if the interactions are difficult to interpret properly.
6. *Play Materials Used:* These are nouns and need not be translated to SVRNS.
7. *Way Play Materials were Used:* Any usage of play materials in a realistic manner will lead to an increase in the truth membership and in falsity membership function otherwise. Complex and indeterminacy membership functions shall be assigned values if usage is difficult to interpret properly.
8. *Verbalisation:* Any verbalisation that is made in accordance with the play activity will result in an increase in truth membership functions and in falsity membership functions otherwise. Complex and indeterminacy membership functions shall be assigned values if the verbalization is difficult to interpret properly.
9. *Tone of Voice:* If the tone of voice is in accordance with the situation of play activity and high, it will result in an increase in truth membership functions and in falsity membership functions otherwise. Complex and indeterminacy membership functions shall be assigned values if the interactions are difficult to interpret properly.
10. *Role Identification:* Any role identification that is realistic will lead to an increase in the truth membership and in falsity membership function otherwise. Complex and indeterminacy membership functions shall be assigned values if role identification is difficult to interpret properly.
11. *Engagement Level:* If the engagement level is high but the theme and role identification are realistic, truth membership function value increases. If the engagement level is high but the theme and role identification are imaginative, falsity membership function value increases. Other combinations of engagement level, theme and role identification will result in assigning values to the other membership functions.
12. *Eye Reaction:* Any eye reaction that is made in accordance with the play activity will result in an increase in truth membership functions and in falsity membership functions otherwise. Complex and indeterminacy membership functions shall be assigned values if the eye reaction is difficult to interpret properly.
13. *Cognitive Response:* Any cognitive response that is made in accordance with the play activity will result in an increase in truth membership functions and in falsity membership functions otherwise. Complex and indeterminacy membership functions shall be assigned values if the cognitive is difficult to interpret properly.
14. *Grammar and Linguistics:* If the grammar, sentence structure and syntax are correct, the value of truth membership function will increase. Any error in grammar, syntax or sentence structure will lead to an increase in the value of falsity membership function. If, however, the linguistics are difficult to comprehend, indeterminate and complex membership functions' value will increase.
15. *Coherence:* If the sentences made are related to one another, the value of truth membership function will increase. Any incoherence, i.e., making sentences are not related to one another will lead to an increase in the value of falsity membership function. If, however, the coherence of sentences is difficult to comprehend, indeterminate and complex membership functions' value will increase.

5. Illustrative Example

This section provides an example on processing of the data obtained as a running hand description. On the basis of this description, the expert estimated and evaluated the child. The following example is based on a video of 3-year-old child and the following observations given by the expert are made in form of running hand descriptions of the 15 parameters given in Table 2.

Table 2. Parameter Description for Example.

S.No	Parameter Name	Description
1	Imaginative Theme	The child talks to Mickey Mouse over the phone. The child attempts to discuss something she describes “gross”.
2	Physical Movements	The child does not use a lot of her body during the conversation.
3	Gestures	The child does not use any significant gestures during the conversation.
4	Facial Expressions	The child is cheerful, serious and astonished when she initiates the conversation, asks something to the receiver and when comes to know about something “gross” respectively.
5	Nature and Length of Social Interaction	The child engages in the conversation for about a minute. The interaction is mostly day-to-day and the child is rather expressive of her emotions.
6	Play Materials Used	The child uses a toy mobile to conduct an imaginative conversation between herself and Mickey Mouse.
7	Way Play Materials were Used	The child uses the mobile in a very realistic way.
8	Verbalisation	The child makes sound and noises in accordance with the mood of the conversation.
9	Tone of Voice	The tone of the child’s voice is high-pitched. She is very expressive.
10	Role Identification	The child does not assume any role other than herself. However, she does imagine herself to be a friend of Mickey Mouse.
11	Engagement Level	The child’s engagement level is high and she is attentive throughout the play activity.
12	Eye Reaction	The child’s eyes widen and narrow during different points of the play activity.
13	Cognitive Response	The cognitive response is direct, quick and coherent.
14	Grammar and Linguistics	The child makes grammatically correct sentences except she does skip supportive verbs like “will”.
15	Coherence	The sentences made are coherent and in sync with the imaginative conversation.

Table 2 depicts a running hand description of the discussed parameters. These parameters are then assigned real values by the expert. These values are discussed in Table 3.

Table 3. SVRNS for Example.

S.No	Parameter	Description	SVRNS
1	IT	Entirely imaginative theme though the conversation was realistic	$\langle 0.75, 0, 0, 0, 0.25, 0 \rangle$
2	PM	Not a lot	$\langle 0, 0, 0, 0, 0.25, 0.75 \rangle$
3	G	Not a lot	$\langle 0, 0, 0, 0, 0.25, 0.75 \rangle$
4	FE	Cheerful, confident, serious	$\langle 0, 0.75, 0.25, 0, 0, 0 \rangle$
5	NoI/LoI	1 minute; day-to-day, verbal	$\langle 0.5, 0.25, 0.25, 0, 0, 0 \rangle$
6	PMU	Mobile	NA
7	WPMwu	Realistic	$\langle 0.75, 0, 0, 0, 0.25 \rangle$
8	V	In accordance with imaginative play	$\langle 0.5, 0.25, 0.25, 0, 0, 0 \rangle$
9	ToI	In accordance with imaginative play; high pitched	$\langle 0.5, 0.25, 0.25, 0, 0, 0 \rangle$
10	RI	Self	$\langle 0.5, 0, 0.25, 0, 0.25, 0 \rangle$
11	EL	High	$\langle 0.5, 0.25, 0.25, 0, 0, 0 \rangle$
12	ER	Widening, narrowing; In accordance with imaginative play	$\langle 0, 0, 0.5, 0, 0.5, 0 \rangle$
13	CR	Direct; In accordance with imaginative play	$\langle 0.75, 0, 0, 0, 0.25, 0 \rangle$
14	GaL	Partially correct; In accordance with imaginative play	$\langle 0.75, 0, 0.25, 0, 0, 0 \rangle$
15	C	In accordance with imaginative play	$\langle 0.75, 0, 0, 0.25, 0, 0 \rangle$

Likewise the SVRNS tuples for the other data sets was done with the help of the expert. Then these SVRNS sets are used for analysis using machine learning algorithms.

6. Results and Discussions

Several libraries such as pandas, numpy, matplotlib, sklearn, seaborn and pylab associated with Python were used for data visualization. Programming was carried out using python for the visualization of the previous discussed algorithms, based on the result of elbow curve, K-means clustering was done. Logical conclusions have been drawn from these visualizations and the role several determinants play in determining the imaginative capabilities of the child has also been highlighted.

Heat map, which strongly demonstrates the factors of correlation and associativity, has a colour scale in which lighter shades signify positive correlation and darker shades signify a negative correlation. Correlation between any two parameters signifies their associated relation. Positive correlation happens when an increase in one attribute shows an increase in another attribute as well. Negative correlation happens when an increase in one attribute shows a decrease in another attribute. The heat map, which strongly demonstrates the factors of correlation and associativity, has a colour scale in which lighter shades signify positive correlation and darker shades signify a negative correlation. For example, in Figure 3, which is a heat map for feature T, Grammar and Coherence show extremely positive correlation whereas Eye Reaction and Role Identification show a negative correlation.

The results from the Figure 3 shows the heatmap for feature T (Truth membership).

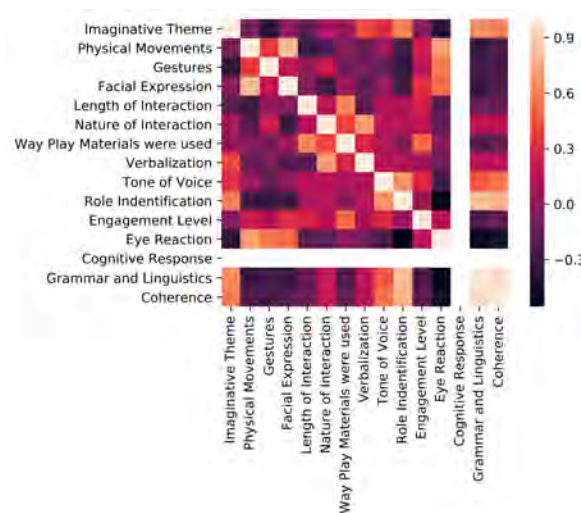

Figure 3. Heat map for feature T.

An elbow curve was plotted to determine the optimal number of clusters for K-means and PCA K-means clustering. Figure 4 shows our elbow curve for feature T where we can see that the sharp bend comes at $k = 4$, thus, 4 clusters are optimal.

In Figure 5, while testing K-means on feature T for the parameters 'Facial Expression' on the y-axis against 'Imaginative Theme' on the x-axis, it was found that higher concentration of points lies near $x = 0.5$ and $y = 0.2$.

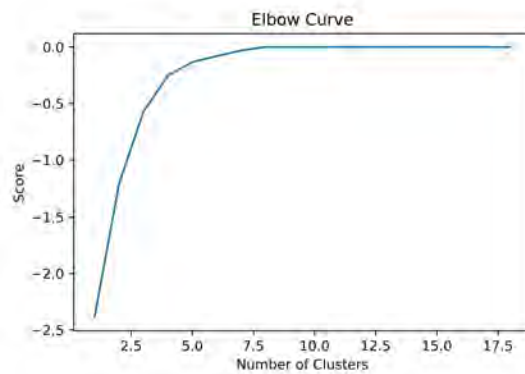

Figure 4. Elbow curve for feature T.

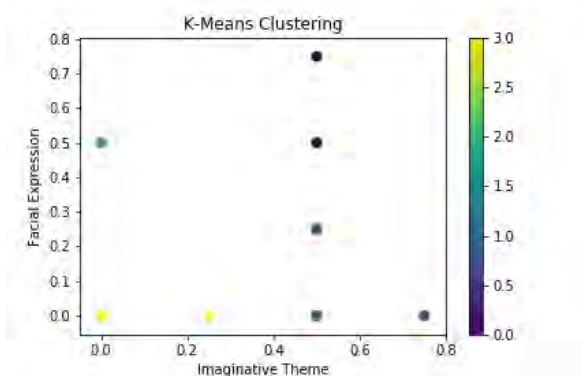

Figure 5. K-means for feature T.

Then, the data was resolved along its principal components, thus giving a new spatial arrangement of the feature, which was then clustered again using K-Means. Figure 6 shows the output for PCA K-Means Clustering for T. A significant deviation of the spatial arrangement of data points is seen in the figure. Now, the higher concentration of points shift to $x = 0.2, y = 0.08$. 'Tone of Voice' and 'Engagement Level' are similarly associated with 'Role Identification' as the co-ordinate axis is symmetrical about it, as shown in Figure 7.

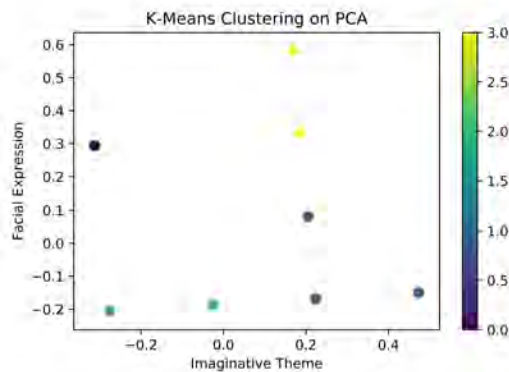

Figure 6. PCA K-means for feature T.

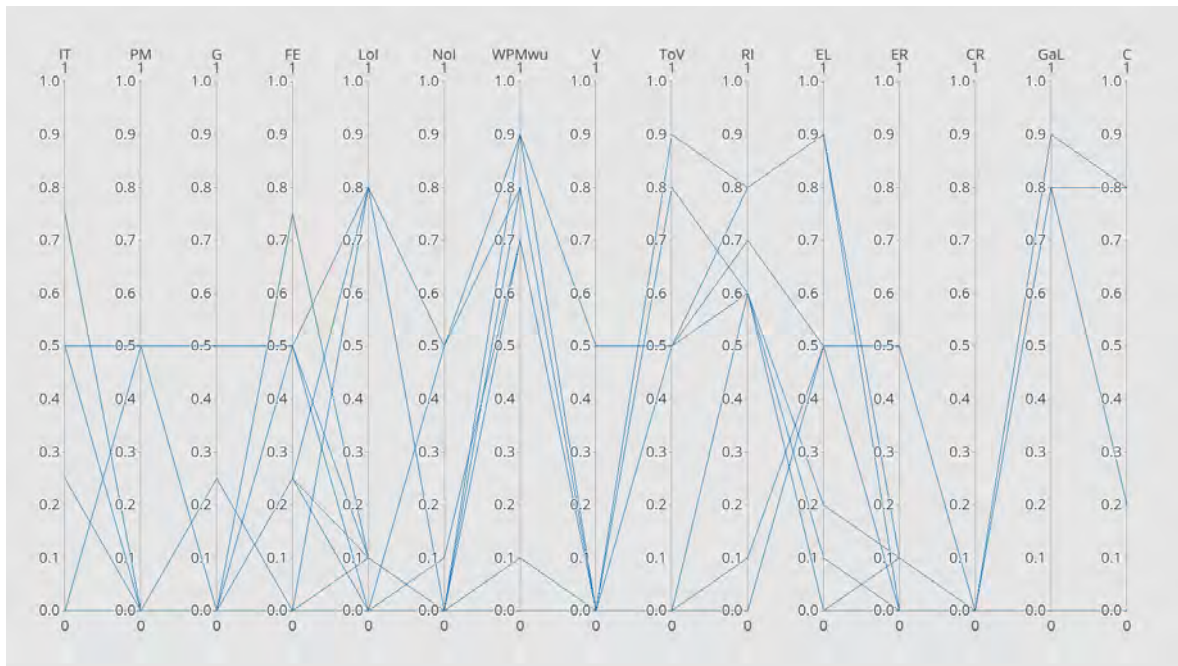

Figure 7. PAC for feature T.

The comparative analysis in Table 4 focuses on five common factors between the four algorithms. The correlation between any two parameters signifies their associated relation. A positive correlation happens when an increase in one attribute shows an increase in another attribute as well. A negative correlation happens when an increase in one attribute shows a decrease in another attribute. The heat map, which strongly demonstrates the factors of correlation and associativity, has a colour scale in which lighter shades signify positive correlation and darker shades signify a negative correlation. For example, in Figure 3, which is a heat map for feature T, Grammar and Coherence show extremely positive correlation whereas Eye Reaction and Role Identification show a negative correlation. The visibility of data points is best observed in the PAC graph while the least was observed in the Heat Map, which focused more on their associativity. Associativity, the reverse of this happened in PAC Graphs and Heat Maps where associativity in the former decreased due to conflict of interest in the arrangement of axes. The dynamicity of PAC, unlike for all other graphs, is the highest because the axes can be rearranged to see which arrangement gives us the best results. However, in K-Means, PCA K-Means and Heat map, the axes are static and rearranging them does not show any significant change. Scalability is a measure of how many data points can be represented in the same graph without the loss of visibility. This was found to be strongest in K-Means and PCA K-means as each point could be seen uniquely on a 2D Cartesian space.

Table 4. Comparative Analysis.

Factors	Heat Map	K-Means	PCA K-Means	PAC Graph
Correlation	Strong	Weak	Weak	Weak
Visibility	Weak	Medium	Medium	Strong
Associativity	Strong	Strong	Strong	Medium
Dynamicity	Medium	Strong	Strong	Very Strong
Scalability	Medium	Strong	Strong	Medium

7. Conclusions and Future Work

The authors have defined the new concept of Single Valued Refined Neutrosophic Sets (SVRNS) which is a generalized version of neutrosophic sets which functions using six memberships values. Furthermore, these SVRNS make use of imaginary values for the memberships. This newly defined

concept of SVRNS was used to study the imaginative play in children. The model proposed also consists of distance measures such as Hamming distance and Euclidean distance for two given SVRNSs.

On the basis of expert opinion, the data was successfully transformed into SVRNS. These sets were helpful in drawing clusters, heat maps, parallel axes coordinate and so on. The pictorial representation of the results of these algorithms has helped to gain useful insight into the data collected. We were able to objectively interpret, for instance, the role of factors such as grammar in imaginative play in children.

On the basis of the data collected and processed to form SVRNSs, we will be able to successfully develop an artificial neural network (ANN), decision trees and other supervised learning algorithms in this domain for future research and they will be useful for drawing insights into the role of these parameters by varying the values of the parameters. Other quality measures such as p-value, confusion matrix and accuracy can also be drawn from it. Since the data under consideration were small, we were not able to construct ANN.

For future work, we will study the mentally retarded children in this age group and perform a comparative analysis with the normal children in this age group.

The model will help us in identifying children with autism and attention deficit hyperactivity disorder (ADHD) and other psychological disorders. The detection of such disorders if any at an early stage with the help of our model will help parents and doctors to use the necessary measures to treat and control them quickly.

The model can be further used for other psychological studies like for modeling destructive behaviours of alcoholics and bulimic children and/or adults.

With this given dataset, cross culture validation was not done. For future research, we shall consider the study of cross culture among children and try to generate a variation from cross culture and its effect or influence on the cognitive and language abilities of children.

Abbreviations

The following abbreviations are used in this manuscript:

SVNS	Single Valued Neutrosophic Sets
SVRNS	Single Valued Refined Neutrosophic Sets
CNS	Complex Neutrosophic Sets
DVNS	Double Valued Neutrosophic Sets
TRINS	Triple Refined Indeterminate Neutrosophic Sets
NCM	Neutrosophic Cognitive Maps
PCA	Principal Component Analysis
PAC	Parallel Axes Chart
ANN	Artificial Neural Networks
ADHD	Attention deficit hyperactivity disorder

References

1. Smarandache, F. *A Unifying Field in Logics: Neutrosophic Logic. Neutrosophy, Neutrosophic Set, Probability, and Statistics*; American Research Press: Rehoboth, DE, USA, 2000.
2. Zadeh, L.A. Fuzzy sets. *Inf. Control.* **1965**, *8*, 338–353. [[CrossRef](#)]
3. Wang, H.; Smarandache, F.; Zhang, Y.; Sunderraman, R. *Single Valued Neutrosophic Sets*; Infinite Study: Phoenix, AZ, USA, 2010; p. 10.

4. Liu, P.; Wang, Y. Multiple attribute decision-making method based on single-valued neutrosophic normalized weighted Bonferroni mean. *Neural Comput. Appl.* **2014**, *25*, 2001–2010. [[CrossRef](#)]
5. Liu, P.; Shi, L. The generalized hybrid weighted average operator based on interval neutrosophic hesitant set and its application to multiple attribute decision making. *Neural Comput. Appl.* **2015**, *26*, 457–471. [[CrossRef](#)]
6. Liu, P.; Teng, F. Multiple attribute group decision making methods based on some normal neutrosophic number Heronian Mean operators. *J. Intell. Fuzzy Syst.* **2017**, *32*, 2375–2391. [[CrossRef](#)]
7. Liu, P.; Li, H. Multiple attribute decision-making method based on some normal neutrosophic Bonferroni mean operators. *Neural Comput. Appl.* **2017**, *28*, 179–194. [[CrossRef](#)]
8. Ye, J. Multicriteria decision-making method using the correlation coefficient under single-valued neutrosophic environment. *Int. J. Gen. Syst.* **2013**, *42*, 386–394. [[CrossRef](#)]
9. Ye, J. A multicriteria decision-making method using aggregation operators for simplified neutrosophic sets. *J. Intell. Fuzzy Syst.* **2014**, *26*, 2459–2466. [[CrossRef](#)]
10. Ye, J. Single valued neutrosophic cross-entropy for multicriteria decision making problems. *Appl. Math. Model.* **2014**, *38*, 1170–1175. [[CrossRef](#)]
11. Ye, J. Similarity measures between interval neutrosophic sets and their applications in multicriteria decision-making. *J. Intell. Fuzzy Syst.* **2014**, *26*, 165–172. [[CrossRef](#)]
12. Cheng, H.D.; Guo, Y. A new neutrosophic approach to image thresholding. *New Math. Nat. Comput.* **2008**, *4*, 291–308. [[CrossRef](#)]
13. Sengur, A.; Guo, Y. Color texture image segmentation based on neutrosophic set and wavelet transformation. *Comput. Vis. Image Underst.* **2011**, *115*, 1134–1144. [[CrossRef](#)]
14. Zhang, M.; Zhang, L.; Cheng, H. A neutrosophic approach to image segmentation based on watershed method. *Signal Process.* **2010**, *90*, 1510–1517. [[CrossRef](#)]
15. Salama, A.; Haitham, A.; Manie, A.; Lotfy, M. Utilizing Neutrosophic Set in Social Network Analysis e-Learning Systems. *Int. J. Inf. Sci. Intell. Syst.* **2014**, *3*, 61–72.
16. Vasantha, W.; Smarandache, F. *Fuzzy Cognitive Maps and Neutrosophic Cognitive Maps*; Infinite Study: Phoenix, AZ, USA, 2003
17. Vasantha, W.; Smarandache, F. *Analysis of Social Aspects of Migrant Labourers Living With HIV/AIDS Using Fuzzy Theory and Neutrosophic Cognitive Maps: With Special Reference to Rural Tamil Nadu in India*; Infinite Study: Phoenix, AZ, USA, 2004.
18. Smarandache, F. Neutropsyche personality. In *A Mathematical Approach to Psychology*; Pons: Brussels, Belgium, 2018
19. Fink, R.S. Role of imaginative play in cognitive development. *Psychol. Rep.* **1976**, *39*, 895–906. [[CrossRef](#)]
20. Udwin, O. Imaginative play training as an intervention method with institutionalised preschool children. *Br. J. Educ. Psychol.* **1983**, *53*, 32–39. [[CrossRef](#)]
21. Huston-Stein, A.; Friedrich-Cofer, L.; Susman, E.J. The relation of classroom structure to social behavior, imaginative play, and self-regulation of economically disadvantaged children. *Child Dev.* **1977**, *48*, 908–916. [[CrossRef](#)]
22. Bodrova, E. Make-believe play versus academic skills: A Vygotskian approach to today's dilemma of early childhood education. *Eur. Early Child. Educ. Res. J.* **2008**, *16*, 357–369. [[CrossRef](#)]
23. Seja, A.L.; Russ, S.W. Children's fantasy play and emotional understanding. *J. Clin. Child Psychol.* **1999**, *28*, 269–277. [[CrossRef](#)]
24. Dhingra, G.; Kumar, V.; Joshi, H.D. A novel computer vision based neutrosophic approach for leaf disease identification and classification. *Measurement* **2019**, *135*, 782–794. [[CrossRef](#)]
25. Vasantha, W.B.; Kandasamy, I.; Smarandache, F. Neutrosophic Duplets of $Z_{pn, \times}$ and $Z_{pq, \times}$ and Their Properties. *Symmetry* **2018**, *10*, 345. [[CrossRef](#)]
26. Vasantha, W.; Kandasamy, I.; Smarandache, F. Algebraic Structure of Neutrosophic Duplets in Neutrosophic Rings. *Neutrosophic Sets Syst.* **2018**, *23*, 85–95.
27. Vasantha, W.B.; Kandasamy, I.; Smarandache, F. A Classical Group of Neutrosophic Triplet Groups Using $Z_{2p, \times}$. *Symmetry* **2018**, *10*, 194. [[CrossRef](#)]
28. Kandasamy W.B.; Kandasamy, I.; Smarandache, F. Semi-Idempotents in Neutrosophic Rings. *Mathematics* **2019**, *7*, 507. [[CrossRef](#)]
29. Kandasamy, W.B.; Kandasamy, I.; Smarandache, F. Neutrosophic Triplets in Neutrosophic Rings. *Mathematics* **2019**, *7*, 563. [[CrossRef](#)]

30. Kandasamy, W.V.; Kandasamy, I.; Smarandache, F. Neutrosophic Quadruple Vector Spaces and Their Properties. *Mathematics* **2019**, *7*, 758.
31. Haibin, W.; Smarandache, F.; Zhang, Y.; Sunderraman, R. *Single Valued Neutrosophic Sets*; Infinite Study: Tamil Nadu, India, 2010; Volume 1, pp. 10–14.
32. Shahzadi, G.; Akram, M.; Saeid, A.B. An application of single-valued neutrosophic sets in medical diagnosis. *Neutrosophic Sets Syst.* **2018**, *18*, 80–88.
33. Ali, M.; Smarandache, F. Complex neutrosophic set. *Neural Comput. Appl.* **2017**, *28*, 1817–1834. [[CrossRef](#)]
34. Smarandache, F. n-Valued Refined Neutrosophic Logic and Its Applications to Physics. *Prog. Phys.* **2013**, *4*, 143–146.
35. Kandasamy, I. Double-valued neutrosophic sets, their minimum spanning trees, and clustering algorithm. *J. Intell. Syst.* **2018**, *27*, 163–182. [[CrossRef](#)]
36. Kandasamy, I.; Smarandache, F. Multicriteria Decision Making Using Double Refined Indeterminacy Neutrosophic Cross Entropy and Indeterminacy Based Cross Entropy. *Appl. Mech. Mater.* **2016**, *859*, 129–143. [[CrossRef](#)]
37. Khan, Q.; Liu, P.; Mahmood, T. Some Generalized Dice Measures for Double-Valued Neutrosophic Sets and Their Applications. *Mathematics* **2018**, *6*, 121. [[CrossRef](#)]
38. Kandasamy, I.; Smarandache, F. Triple Refined Indeterminate Neutrosophic Sets for Personality Classification. In Proceedings of the 2016 IEEE Symposium Series on Computational Intelligence (SSCI), Athens, Greece, 6–9 December 2016; IEEE: Piscataway, NJ, USA, 2016; pp. 1–8. [[CrossRef](#)]
39. Kandasamy, I.; Vasantha, W.B.; Obbineni, J.; Smarandache, F. Indeterminate Likert Scaling. *Soft Comput.* **2019**, 1–10. [[CrossRef](#)]
40. Kandasamy, I.; Vasantha, W.; Mathur, N.; Bisht, M.; Smarandache, F. Chapter 6 Sentiment analysis of the MeToo movement using neutrosophy: Application of single-valued neutrosophic sets. In *Optimization Theory Based on Neutrosophic and Plithogenic Sets*; Elsevier: Amsterdam, The Netherlands, 2020. [[CrossRef](#)]
41. Kandasamy, I.; Vasantha, W.; Obbineni, J.M.; Smarandache, F. Sentiment analysis of tweets using refined neutrosophic sets. *Comput. Ind.* **2020**, *115*, 103180. [[CrossRef](#)]
42. Kandasamy W.B., V.; Kandasamy, I.; Smarandache, F.; Devvrat, V.; Ghildiyal, S. Study of Imaginative Play in Children using Neutrosophic Cognitive Maps Model. *Neutrosophic Sets Syst.* **2019**, *30*, 241–252.

Derivable Single Valued Neutrosophic Graphs Based on KM-Fuzzy Metric

Mohammad Hamidi, Florentin Smarandache

Mohammad Hamidi, Florentin Smarandache (2020). Derivable Single Valued Neutrosophic Graphs Based on KM-Fuzzy Metric. *IEEE Access* 8: 131076-131087, DOI: 10.1109/ACCESS.2020.3006164

ABSTRACT In this paper we consider the concept of *KM*-fuzzy metric spaces and we introduce a novel concept of *KM*-single valued neutrosophic metric graphs based on *KM*-fuzzy metric spaces. Then we investigate the finite *KM*-fuzzy metric spaces with respect to *KM*-fuzzy metrics and we construct the *KM*-fuzzy metric spaces on any given non-empty sets. We try to extend the concept of *KM*-fuzzy metric spaces to a larger class of *KM*-fuzzy metric spaces such as union and product of *KM*-fuzzy metric spaces and in this regard we investigate the class of products of *KM*-single valued neutrosophic metric graphs. In the final, we define some operations such as tensor product, Cartesian product, semi-strong product, strong product, union, semi-ring sum, suspension, and complement of *KM*-single valued neutrosophic metric graphs.

INDEX TERMS (Derivable) *KM*-single valued neutrosophic metric graph, *KM*-fuzzy metric space, triangular-norm (conorm).

I. INTRODUCTION

Classical theory is a pure concept and without quality or criteria, so it is not attractive to use in our world, that's why we use the neutrosophic sets theory as one of a generalizations of set theory in order to deal with uncertainties, which is a key action in the contemporary world introduced by Smarandache for the first time in 1998 [22] and in 2005 [23]. This concept is a new mathematical tool for handling problems involving imprecise, indeterminacy, and inconsistent data. This theory describes an important role in modeling and controlling unsure hypersystems in nature, society and industry. In addition, fuzzy topological spaces as a generalization of topological spaces, have a fundamental role in construction of fuzzy metric spaces as an extension of the concept of metric spaces. The theory of fuzzy metric spaces works on finding the distance between two points as non-negative fuzzy numbers, which have various applications. The structure of fuzzy metric spaces is equipped with mathematical tools such as triangular norms and fuzzy subsets depending on time parameter and on other variables. This theory has been proposed by different researchers with different definitions from several points of views ([3]–[5], [12]), and that this study was applied to the notion of *KM*-fuzzy metric space introduced in 1975 [4] by Kramosil

and Michalek. Fuzzy graphs, introduced by Rosenfeld, are finding an increasing number of applications in modelling real time systems where the level of information inherent in the system varies with respect to different levels of precision. Fuzzy models are becoming useful because of their aim in reducing the difference between the traditional numerical models used in engineering and sciences [19]. The generalization of the concept of a fuzzy graph is noticed by some researchers on more subjects, such as fuzzy graph based on t-norm, intuitionistic fuzzy threshold graphs, m-polar fuzzy graphs and single-valued neutrosophic graphs. Mordeson *et al.* [17] generalized the definition of a fuzzy graph by replacing minimum in the basic definitions with an arbitrary t-norm. They developed a measure on the susceptibility of trafficking in persons for networks by using a t-norm other than minimum [17]. Recently, F. Smarandache, introduced a new concept as a generalization of hypergraphs to n-SuperHypergraph, Plithogenic n-SuperHypergraph {with super-vertices (that are groups of vertices) and hyper-edges {defined on power-set of power-set...} that is the most general form of graph as today}, and n-ary HyperAlgebra, n-ary NeutroHyperAlgebra, n-ary AntiHyperAlgebra respectively, which have several properties and are connected with the real world [24]. Further materials regarding graphs, single-valued neutrosophic metric graphs, hypergraphs, intuitionistic fuzzy set, n-SuperHypergraph and Plithogenic n-SuperHypergraph, and NeutroAlgebras {Smarandache generalized the classical

algebraic structures to neutro algebraic structures (or Neutro Algebras) [whose operations and axioms are partially true, partially indeterminate, and partially false] as extensions of PartialAlgebra, and to AntiAlgebraic structures (or Anti Algebras) [whose operations and axioms are totally false], and in general, he extended any classical structure, in no matter what field of knowledge, to a Neutro structure and an Anti structure}. All these are available in the literature too [2], [7]–[10], [13], [18], [20], [21], [25]–[29].

Regarding these points, we introduce the concept of KM-single valued neutrosophic metric graphs based on the concept of KM-fuzzy metrics. One of the main motivations of KM-single valued neutrosophic metric graphs is obtained from the fuzzy graphs and so we want to use this concept to model many decision making problems in uncertain environment. We need to construct the KM-single valued neutrosophic metric graphs based on finite or infinite sets, so we develop the concept of KM-fuzzy metric on any nonempty set and prove that for every given set with respect to the concept of C-graphable sets one can construct a KM-metric space. It is a natural generalization of the fuzzy graphs to the single-valued neutrosophic metric graphs, so it shows our main motivation for introducing the notion of the KM-single valued neutrosophic metric graphs. This notion is based on one of the fundamental concepts of fuzzy mathematics, which includes tools such as t-norms, t-conorms, and fuzzy subsets. We apply the notation of KM-fuzzy metric spaces to generate the finite KM-single valued neutrosophic metric graphs. We have extended some production operations on the KM-fuzzy metric spaces to the KM-single valued neutrosophic metric graphs.

II. PRELIMINARIES

In this section, we recall some definitions and results, which we use in what follows.

Definition 1 ([11], [14]): Let $G_1 = (V_1, E_1)$, $G_2 = (V_2, E_2)$ be simple graphs, $(x_1, x_2), (y_1, y_2) \in V_1 \times V_2$, where $V_1 \times V_2$ is the vertex set of the following graphs:

(i) categorical(tensor, direct, cardinal, Kronecker) product graph $G_1 \times G_2$:

$$E(G_1 \times G_2) = \{(x_1, x_2)(y_1, y_2) \mid x_1y_1 \in E_1 \text{ and } x_2y_2 \in E_2\};$$

(ii) Cartesian product graph $G_1 \otimes G_2$:

$$E(G_1 \otimes G_2) = \{(x_1, x_2)(y_1, y_2) \mid (x_1 = y_1 \text{ and } x_2y_2 \in E_2) \text{ or } (x_1y_1 \in E_1 \text{ and } x_2 = y_2)\};$$

(iii) semi-strong product graph $G_1 \cdot G_2$:

$$E(G_1 \cdot G_2) = \{(x_1, x_2)(y_1, y_2) \mid (x_1 = y_1 \text{ and } x_2y_2 \in E_2) \text{ or } (x_1y_1 \in E_1 \text{ and } x_2y_2 \in E_2)\};$$

(iv) strong product (symmetric composition) graph $G_1 \odot G_2$:

$$E(G_1 \odot G_2) = E(G_1 \otimes G_2) \cup E(G_1 \times G_2);$$

(v) lexicographic product (composition)graph $G_1 \circ G_2$:

$$E(G_1 \circ G_2) = \{(x_1, x_2)(y_1, y_2) \mid (x_1y_1 \in E_1) \text{ or } (x_1 = y_1 \text{ and } x_2y_2 \in E_2)\};$$

(vi) union graph $G_1 \cup G_2$:

$$V(G_1 \cup G_2) = V(G_1) \cup V(G_2); \text{ and } E(G_1 \cup G_2) = E(G_1) \cup E(G_2);$$

(vii) join product graph $G_1 + G_2$:

$$E(G_1 + G_2) = E(G_1) \cup E(G_2) \cup E', \text{ where } E' \text{ is the set of all line joining } V_1 \text{ with } V_2.$$

Definition 2 [16]: A fuzzy graph $G = (V, \sigma, \mu)$ is an algebraic structure of non-empty set V together with a pair of functions $\sigma : V \rightarrow [0, 1]$ and $\mu : V \times V \rightarrow [0, 1]$ such that for all $x, y \in V$, $\mu(x, y) \leq \sigma(x) \wedge \sigma(y)$. It is called σ as fuzzy vertex set and μ as fuzzy edge set of G .

Definition 3 [1]: A single valued neutrosophic graph (SVN-G) is defined to be a form $G = (V, E, A, B)$ where

- (i) $V = \{v_1, v_2, \dots, v_n\}$, $T_A, I_A, F_A : V \rightarrow [0, 1]$ denote the degree of membership, degree of indeterminacy and non-membership of the element $v_i \in V$; respectively, and for every $1 \leq i \leq n$, we have $0 \leq T_A(v_i) + I_A(v_i) + F_A(v_i) \leq 3$.
- (ii) $E \subseteq V \times V$, $T_B, I_B, F_B : E \rightarrow [0, 1]$ are called degree of truth-membership, indeterminacy-membership and falsity-membership of the edge $(v_i, v_j) \in E$ respectively, such that for any $1 \leq i, j \leq n$, we have $T_B(v_i, v_j) \leq \min\{T_A(v_i), T_A(v_j)\}$, $I_B(v_i, v_j) \geq \max\{I_A(v_i), I_A(v_j)\}$, $F_B(v_i, v_j) \geq \max\{F_A(v_i), F_A(v_j)\}$ and $0 \leq T_B(v_i, v_j) + I_B(v_i, v_j) + F_B(v_i, v_j) \leq 3$. Also A is called the single valued neutrosophic vertex set of V and B is called the single valued neutrosophic edge set of E .

Definition 4 [15]: A triplet (X, ρ, T) is called a KM-fuzzy metric space, if X is an arbitrary non-empty set, T is a left-continuous t-norm and $\rho : X^2 \times \mathbb{R}^{\geq 0} \rightarrow [0, 1]$ is a fuzzy set, such that for each $x, y, z, \in X$ and $t, s \geq 0$, we have:

- (i) $\rho(x, y, 0) = 0$,
- (ii) $\rho(x, x, t) = 1$ for all $t > 0$,
- (iii) $\rho(x, y, t) = \rho(y, x, t)$ (commutative property),
- (iv) $T(\rho(x, y, t), \rho(y, z, s)) \leq \rho(x, z, t + s)$ (triangular inequality),
- (vi) $\rho(x, y, -) : \mathbb{R}^{\geq 0} \rightarrow [0, 1]$ is a left-continuous map,
- (vii) $\lim_{t \rightarrow \infty} \rho((x, y, t)) = 1$,
- (viii) $\rho(x, y, t) = 1, \forall t > 0$ implies that $x = y$.

If (X, ρ, T) satisfies in conditions (i)–(viii), then it is called KM-fuzzy pseudo metric space and ρ is called a KM-fuzzy pseudo metric. a fuzzy version of the triangular inequality. The value $\rho(x, y, t)$ is considered as the degree of nearness from

Theorem 1 [15]: Let (X, ρ, T) be a KM-fuzzy metric space. Then $\rho(x, y, -) : \mathbb{R}^{\geq 0} \rightarrow [0, 1]$ is a non-decreasing map.

Proof 1: See [15].

III. FINITE KM-FUZZY METRIC SPACE

In this section, we apply the concept of KM-fuzzy metric spaces and construct a new class of KM-fuzzy metric spaces under operation product and union of KM-fuzzy metric spaces. In addition, for any given non-empty set we construct

KM-fuzzy metric space with respect to α -discrete metric, where $\alpha \in \mathbb{R}^+$. From now on, for all $x, y \in [0, 1]$ we consider $T_{min}(x, y) = \min\{x, y\}$, $T_{pr}(x, y) = xy$, $T_{lu}(x, y) = \max(0, x + y - 1)$, $T_{do}(x, y) = \frac{xy}{x + y - xy}$ and $\mathcal{C}_T = \{T : [0, 1] \times [0, 1] \rightarrow [0, 1] \mid T \text{ is a left-continuous t-norm}\}$.

Theorem 2: If (X, ρ, T_{min}) is a *KM*-fuzzy metric space and $T \in \mathcal{C}_T$. Then (X, ρ, T) is a *KM*-fuzzy metric space.

Proof 2: Let $x, y, z \in X, r, s \in \mathbb{R}^{\geq 0}$ and $T \in \mathcal{C}_T$. Since for all $x, y \in [0, 1]$, $T(x, y) \leq T_{min}(x, y)$, we get that $T(\rho(x, y, t), \rho(y, z, s)) \leq T_{min}(\rho(x, y, t), \rho(y, z, s)) \leq \rho(x, z, t + s)$. Hence (X, ρ, T) is a *KM*-fuzzy metric space.

Let X be an arbitrary set and $\alpha \in \mathbb{R}^+$. For all $x, y \in X$, define $d_\alpha : X \times X \rightarrow \mathbb{R}$ by $d_\alpha(x, y) = 0$, where $x = y$ and $d_\alpha(x, y) = \alpha$, where $x \neq y$ as an α -discrete metric. So we have the following theorem.

Theorem 3: Let X be an arbitrary set and $|X| \geq 2$. Then there exists a fuzzy set $\rho : X^2 \times \mathbb{R}^{\geq 0} \rightarrow [0, 1]$, such that (X, ρ, T_{min}) is a *KM*-fuzzy metric space.

Proof 3: Let $|X| \geq 2$ and $\alpha \in \mathbb{R}^+$ be a fixed element. Clearly (X, d_α) is a metric space, now for all $x, y \in X, 0 \neq m, s, t \in \mathbb{R}^{\geq 0}$, define $\rho : X^2 \times \mathbb{R}^{\geq 0} \rightarrow [0, 1]$ by $\rho(x, y, 0) = 0$ and $\rho(x, y, t > 0) = \frac{\varphi(t)}{\varphi(t) + md_\alpha(x, y)}$, where $\varphi : \mathbb{R}^{\geq 0} \rightarrow \mathbb{R}^{\geq 0}$ is an increasing continuous function and for all $x, y \in X$, we have $\varphi(t) + md_\alpha(x, y) \neq 0$ and $\varphi(t) \rightarrow 0$, whence $t \rightarrow 0$. Now, we show that (X, ρ, T_{min}) is a *KM*-fuzzy metric space. We prove only the triangular inequality and for all $x, y, z \in X$, consider the five cases $x = y = z, x = y \neq z, x = z \neq y, x \neq y = z$ and $x \neq y \neq z$. In all cases for $0 \in \{t, s\}$ is clear, now for $0 \notin \{t, s\}$ we investigate it. For $x = y \neq z$, since $\varphi(t + s) \geq \varphi(s)$, we have $\varphi(t + s)(\varphi(s) + m\alpha) - \varphi(s)(\varphi(t + s) + m\alpha) \geq 0$ and so $\frac{\varphi(s) + m\alpha}{\varphi(t + s) + m\alpha} \leq \frac{\varphi(s)}{\varphi(t + s)}$. If $x \neq y \neq z$, then $d_\alpha(x, y) = d_\alpha(z, y) = d_\alpha(x, z) = \alpha$. Since φ is an increasing map, we get that $m\alpha\varphi(t) \leq m\alpha\varphi(t + s)$ and it implies that $\varphi(t)(\varphi(t + s) + m\alpha) \leq \varphi(t + s)(\varphi(t) + m\alpha)$ and so $\frac{\varphi(t)}{\varphi(t + s) + m\alpha} \leq \frac{\varphi(t + s)}{\varphi(t) + m\alpha}$, which means that $\rho(x, y, t) \leq \rho(x, z, t + s)$. By a similar way, $\rho(z, y, s) \leq \rho(x, z, t + s)$ and so $T_{min}(\rho(x, y, t), \rho(z, y, s)) \leq \rho(x, z, t + s)$.

The other cases, are proved in a similar way and so (X, ρ, T_{min}) is a *KM*-fuzzy metric space.

Corollary 1: Let X be an arbitrary set and $|X| \geq 2$. Then there exists a fuzzy set $\rho : X^2 \times \mathbb{R}^{\geq 0} \rightarrow [0, 1]$, such that for all $T \in \mathcal{C}_T$, (X, ρ, T) is a *KM*-fuzzy metric space.

A. FINITE KM-FUZZY METRIC SPACE BASED ON METRIC

In this subsection, we apply the concept of finite metric for constructing of *KM*-fuzzy metric space on any given non-empty set.

Definition 5: Let X be a finite set. We say that X is a C-graphable set, if $G = (X, E)$ is a connected graph, where $E \subseteq X \times X$ and $G = (X, E)$ is called an X -derived graph. Let \mathcal{G}_X be the set of all connected graphs which are constructed on X as the set of vertices, so we have the following results.

Let $G = (X, E)$ be a connected graph. For all $x, y \in X$, define $d^g(x, y) = \min\{|P_{x,y}| \text{ where } P_{x,y} \text{ is a path between } x, y\}$. Obviously, d^g is a metric on X .

Theorem 4: Let X be a finite set and $|X| \geq 2$. Then there exists a non-discrete metric d on X such that (X, d) is a metric space.

Proof 4: Let $|X| \geq 2$. Clearly, X is a C-graphable set and so there exists a graph $G = (X, E) \in \mathcal{G}_X$. For all $x, y \in X$, define $d(x, y) = d^g(x, y)$. Clearly (X, d^g) is a metric space.

Corollary 2: Let $n \in \mathbb{N}, X$ be a set and $|X| = n$.

- (i) If $G = (X, E) \cong K_n$ is the complete graph, then for metric spaces (X, d^g) and (X, d_1) , we have $d^g = d_1$.
- (ii) If $G = (X, E) \cong C_n$ is the cycle graph, then for metric spaces (X, d^g) and (X, d_1) , we have $d_1 \leq d^g \leq d_{\lfloor \frac{n}{2} \rfloor}$.

Theorem 5: Let X be a non-empty set. Then there exists a fuzzy subset $\rho : X^2 \times \mathbb{R}^{\geq 0} \rightarrow [0, 1]$, such that (X, ρ, T_{pr}) is a *KM*-fuzzy metric space.

Proof 5: Let $|X| \geq 2$. Then clearly, X is a C-graphable set and by Theorem 4, (X, d^g) is a metric space. For all $x, y \in X$ and for all $0 \neq m, t \in \mathbb{R}^{\geq 0}$, define $\rho(x, y, 0) = 0$ and $\rho(x, y, t > 0) = \frac{\varphi(t)}{\varphi(t) + md^g(x, y)}$, where $\varphi : \mathbb{R}^{\geq 0} \rightarrow \mathbb{R}^{\geq 0}$ is an increasing continuous function, $\varphi(t) + md^g(x, y) \neq 0$ and $\varphi(t) \rightarrow 0$, whence $t \rightarrow 0$. Now, we show that (X, ρ, T_{pr}) is a *KM*-fuzzy metric space and in this regard, only prove triangular inequality property. Let $x, y, z \in X$. For $0 \in \{t, s\}$ is clear, now for $0 \notin \{t, s\}$ we investigate it. Since for all $s, t, m \in \mathbb{R}^+$,

$$\begin{aligned} & \varphi(t + s)\varphi(s)md^g(x, y) + \varphi(t + s)\varphi(t)md^g(y, z) \\ & \geq \varphi(t)\varphi(s)md^g(x, y) + \varphi(s)\varphi(t)md^g(y, z) \\ & \geq \varphi(s)\varphi(t)md^g(x, z), m^2d^g(y, z)d^g(y, z)\varphi(t + s) > 0, \end{aligned}$$

we get that $T_{pr}\left(\frac{\varphi(t)}{\varphi(t) + md^g(x, y)}, \frac{\varphi(s)}{\varphi(s) + md^g(y, z)}\right) \leq \frac{\varphi(t + s)}{\varphi(t + s) + md^g(x, z)}$.

It follows that $T_{pr}(\rho(x, y, t), \rho(y, z, s)) \leq \rho(x, z, t + s)$ and so (X, ρ, T_{pr}) is a *KM*-fuzzy metric space.

Corollary 3: Let X be a non-empty set. Then there exists a fuzzy subset $\rho : X^2 \times \mathbb{R}^{\geq 0} \rightarrow [0, 1]$, such that for all left-continuous t-norm $T \leq T_{pr}$, (X, ρ, T) is a *KM*-fuzzy metric space.

B. OPERATIONS ON KM-FUZZY METRIC SPACES

In this subsection, we extend *KM*-fuzzy metric spaces to union and product of *KM*-fuzzy metric spaces. Let (X_1, ρ_1, T) and (X_2, ρ_2, T) be *KM*-fuzzy metric spaces, $(x_1, y_1), (x_2, y_2) \in X_1 \times X_2$ and $t \in \mathbb{R}^{\geq 0}$. For an arbitrary $T \in \mathcal{C}_T$, define $T(\rho) : (X_1 \times X_2)^2 \times \mathbb{R}^{\geq 0} \rightarrow [0, 1]$ by $T(\rho)((x_1, y_1), (x_2, y_2), t) = T(\rho_1(x_1, x_2, t), \rho_2(y_1, y_2, t))$. So we have the following theorem.

Theorem 6: Let (X_1, ρ_1, T) and (X_2, ρ_2, T) be *KM*-fuzzy metric spaces. Then $(X_1 \times X_2, T_{min}(\rho), T)$ is a *KM*-fuzzy metric space.

Proof 6: Let $(x_1, y_1), (x_2, y_2), (x_3, y_3) \in X_1 \times X_2$ and $t, s \in \mathbb{R}^{\geq 0}$.

(i) Since for all $x_1, x_2 \in X_1, y_1, y_2 \in X_2, \rho_1(x_1, x_2, 0) = 0$ and $\rho_2(y_1, y_2, 0) = 0$, have $T_{min}(\rho)((x_1, y_1), (x_2, y_2), 0) = 0$.

(ii) $T_{min}(\rho)((x_1, y_1), (x_2, y_2), t) = 1$ if and only if $T_{min}(\rho_1(x_1, x_2, t), \rho_2(y_1, y_2, t)) = 1$ if and only if $\rho_1(x_1, x_2, t) = \rho_2(y_1, y_2, t) = 1$ if and only if $(x_1, y_1) = (x_2, y_2)$.

(iii) It is clear that $T_{min}(\rho)$ is a commutative map.

(iv)

$$\begin{aligned} & T(T_{min}(\rho)((x_1, y_1), (x_2, y_2), t), T_{min}(\rho)((x_2, y_2), (x_3, y_3), s)) \\ &= T(T_{min}(\rho_1(x_1, x_2, t), \rho_2(y_1, y_2, t)), \\ & \quad T_{min}(\rho_1(x_2, x_3, s), \rho_2(y_2, y_3, s))) \leq T_{min}(T(\rho_1(x_1, \\ & \quad x_2, t), \rho_1(x_2, x_3, s)), T(\rho_2(y_1, y_2, t), \rho_2(y_2, y_3, s))) \\ & \leq T_{min}(\rho_1(x_1, x_3, t+s), \rho_2(y_1, y_3, t+s)) \\ &= T_{min}(\rho)((x_1, y_1), (x_3, y_3), t+s). \end{aligned}$$

(v) Since ρ_1, ρ_2 are left-continuous maps, we get that ρ is a left-continuous map.

(vi) Clearly $\lim_{t \rightarrow \infty} T_{min}(\rho_1(x_1, x_2, t), \rho_2(y_1, y_2, t)) = T_{min}(\lim_{t \rightarrow \infty} \rho_1(x_1, x_2, t), \lim_{t \rightarrow \infty} \rho_2(y_1, y_2, t)) = T_{min}(1, 1) = 1$. Thus $(X_1 \times X_2, T_{min}(\rho), T)$ is a *KM*-fuzzy metric space.

is easy to check that (X_1, ρ_1, T_{lu}) and (X_2, ρ_2, T_{lu}) are *KM*-fuzzy metric spaces and by Theorem 6, $(X_1 \times X_2, T_{min}(\rho), T_{lu})$ is a *KM*-fuzzy metric space.

where $\rho_1(x, y, t) = \frac{\min(x, y) + t}{\max(x, y) + t}$ and $\rho_2(x, y, t) = \frac{\min(x, y)}{\max(x, y)}$. Applying Theorem 6, $(\mathbb{R}^{\geq 0} \times \mathbb{N}, \rho, T_{pr})$ is a *KM*-fuzzy metric space, where $\rho((x_1, y_1), (x_2, y_2), t) = \min\{\frac{\min(x_1, x_2) + t}{\max(x_1, x_2) + t}, \frac{\min(y_1, y_2)}{\max(y_1, y_2)}\}$.

Let $X_1 \cap X_2 = \emptyset$, (X_1, ρ_1, T) and (X_2, ρ_2, T) be *KM*-fuzzy metric spaces, $x, y \in X_1 \cup X_2$ and $t \in \mathbb{R}^{\geq 0}$. Consider $\epsilon(x, y, t) = \bigwedge_{x, u \in X_1, y, v \in X_2} (\rho_1(x, u, t) \wedge \rho_2(y, v, t))$, define $\rho_1 \cup \rho_2 : (X_1 \cup X_2)^2 \times \mathbb{R}^{\geq 0} \rightarrow [0, 1]$ by

$$(\rho_1 \cup \rho_2)(x, y, t) = \begin{cases} \rho_1(x, y, t) & \text{if } x, y \in X_1, \\ \rho_2(x, y, t) & \text{if } x, y \in X_2, \\ \epsilon(x, y, t) & \text{if } x \in X_1, y \in X_2, . \end{cases}$$

So we have the following theorem.

Theorem 7: Let (X_1, ρ_1, T) and (X_2, ρ_2, T) be *KM*-fuzzy metric spaces. Then $(X_1 \cup X_2, \rho_1 \cup \rho_2, T)$ is a *KM*-fuzzy metric space, where $X_1 \cap X_2 = \emptyset$.

Proof 7: Let $x, y, z \in X_1 \cup X_2$ and $t, s \in \mathbb{R}^{\geq 0}$. We only prove the triangular inequality property and other cases are immediate. Let $x, y \in X_1$ (for $x, y \in X_2$, one can prove in a similar way), then $T((\rho_1 \cup \rho_2)(x, y, t), (\rho_1 \cup \rho_2)(y, z, s)) = T(\rho_1(x, y, t), \rho_1(y, z, s))$. If $z \in X_1$, then $T((\rho_1 \cup \rho_2)(x, y, t), (\rho_1 \cup \rho_2)(y, z, s)) = T(\rho_1(x, y, t), \rho_1(y, z, s)) \leq \rho_1(x, z, t+s) = (\rho_1 \cup \rho_2)(x, z, t+s)$. If $z \in X_2$, then $T((\rho_1 \cup \rho_2)(x, y, t), (\rho_1 \cup \rho_2)(y, z, s)) = T(\rho_1(x, y, t), \epsilon) \leq \epsilon = (\rho_1 \cup \rho_2)(x, z, t+s)$. Let $x \in X_1, y \in X_2$.

Then $T((\rho_1 \cup \rho_2)(x, y, t), (\rho_1 \cup \rho_2)(y, z, s)) = T(\epsilon, (\rho_1 \cup \rho_2)(y, z, s))$. If $z \in X_2$, since $x \in X_1$ and $y \in X_2$, we get that $(\rho_1 \cup \rho_2)(x, z, t+s) = \epsilon$ and so $T(\epsilon, (\rho_1 \cup \rho_2)(y, z, s)) = T(\epsilon, \rho_2(y, z, s)) \leq \epsilon = (\rho_1 \cup \rho_2)(x, z, t+s)$. If $z \in X_1$, since $x \in X_1$ and $y \in X_2$, we get that $(\rho_1 \cup \rho_2)(x, z, t+s) \neq \epsilon$ and so $T(\epsilon, (\rho_1 \cup \rho_2)(y, z, s)) = T(\epsilon, \epsilon) \leq \epsilon \leq \rho_1(x, z, t+s) = (\rho_1 \cup \rho_2)(x, z, t+s)$. It follows that $(X_1 \cup X_2, \rho_1 \cup \rho_2, T)$ is a *KM*-fuzzy metric space.

IV. KM-SINGLE VALUED NEUTROSOPHIC METRIC GRAPH

In this section, we introduce a novel concept as *KM*-single valued neutrosophic metric graphs and analyse some their properties.

Definition 6: Let (V, ρ, T) be a fuzzy metric space and $G^* = (V, E)$ be a simple graph. Then $G = (X = (T_V, I_V, F_V), Y = (T_E, I_E, F_E), \rho, T, S)$ is called a *KM*-single valued neutrosophic metric graph (a strong *KM*-single valued neutrosophic metric graph) on G^* , if there exists some time $t \in \mathbb{R}^{\geq 0}$ (for $t = 0$, we call starting time) such that for all $xy \in E$, we have

- (i) the functions $T_V : V \rightarrow [0, 1], I_V : V \rightarrow [0, 1]$ and $F_V : V \rightarrow [0, 1]$ represent the degree of truth-membership, indeterminacy-membership and falsity-membership of the element $x \in V$, respectively. There is no restriction on the sum of $T_V(x), I_V(x)$ and $F_V(x)$, therefore $0 \leq T_V(x) + I_V(x) + F_V(x) \leq 3$ for all $x \in V$.
- (ii) the functions $T_E : E \subseteq V \times V \rightarrow [0, 1], I_E : E \subseteq V \times V \rightarrow [0, 1]$ and $F_E : E \subseteq V \times V \rightarrow [0, 1]$ are defined by $T(T_E(xy), T(T_V(x), T_V(y))) \leq \rho(x, y, t)$ ($T(T_E(xy), T(T_V(x), T_V(y))) = \rho(x, y, t)$), $S(I_E(xy), S(I_V(x), I_V(y))) \geq \rho(x, y, t)$ ($S(I_E(xy), S(I_V(x), I_V(y))) = \rho(x, y, t)$) and $S(F_E(xy), S(F_V(x), F_V(y))) \geq \rho(x, y, t)$ ($S(F_E(xy), S(F_V(x), F_V(y))) = \rho(x, y, t)$), where S is a triangular conorm as a dual of triangular norm T , via a negation η .

We call X as a *KM*-single valued neutrosophic metric vertex set of G and Y is *KM*-single valued neutrosophic edge set of G .

In definition of *KM*-single valued neutrosophic metric graph, if $t \rightarrow \infty$, then for all $x, y \in V$, $\rho(x, y, t) \rightarrow 1$ and so it follows that $F_E(xy) = S(F_V(x), F_V(y)) = I_E(xy) = S(I_V(x), I_V(y)) = \rho(x, y, t)$ and $T_E(xy), T(T_V(x), T_V(y))$ can be any given fuzzy values. The concept of *KM*-single valued neutrosophic metric graph is a generalization of *KM*-fuzzy metric graph, where is introduced by M. Hamidi et.al [6].

Theorem 8: Let (V, ρ, T) be a fuzzy metric space and $G = (X, Y, \rho, T, S)$ be a *KM*-single valued neutrosophic metric graph on $G^* = (V, E)$. Then for starting time:

- (i) for all $xy \in E$, $T_E(xy) = 0$ or $T_V(x) = 0$ or $T_V(y) = 0$.
- (ii) $|Range(I_E)| = |Range(I_V)| = |Range(F_E)| = |Range(F_V)| = |[0, 1]|$.

Proof 8: (i) Let $xy \in E$. Since $G = (X, Y, \rho, T, S)$ is a *KM*-single valued neutrosophic metric graph $G^* = (V, E)$,

we get that $T(T_E(xy), T(T_V(x), T_V(y))) \leq \rho(x, y, 0)$. Hence $T(T_E(xy), T(T_V(x), T_V(y))) = 0$ and so $T_E(xy) = 0$ or $T_V(x) = 0$ or $T_V(y) = 0$.

(ii) It is immediate by Definition.

Example 1: Let $V = \{1, 2, 3, 4\}$ and $x, y \in X$. Consider a fuzzy subset $\rho(x, y, 0) = 0$ and $\rho(x, y, t > 0) = \frac{\min\{x, y\} + t}{\max\{x, y\} + t}$. We take the negation $\eta(m) = 1 - m$ ($m \in [0, 1]$) and obtain a KM-single valued neutrosophic metric graph $G = (V, (X = (T_V, I_V, F_V), Y = (T_E, I_E, F_E), \rho, T_{min}, S_{max}))$ on the cycle graph C_4 for $t = 1$, in Figure 1.

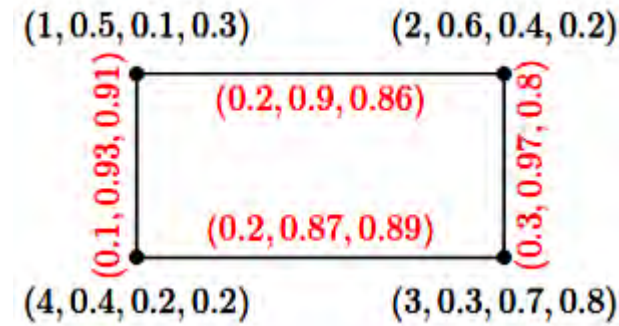

FIGURE 1. KM-single valued neutrosophic metric graph $G = (X, Y, \rho, T_{min}, S_{max})$.

Let (V, ρ, T) be a fuzzy metric space and $G = (X, Y, \rho, T, S)$ be a KM-single valued neutrosophic metric graph on $G^* = (V, E)$ and $\alpha, \beta, \gamma \in [0, 1]$. Define $T_V^\alpha = \{x \in V \mid T_V(x) \geq \alpha\}$, $I_V^\beta = \{x \in V \mid I_V(x) \leq \beta\}$, $F_V^\gamma = \{x \in V \mid F_V(x) \leq \gamma\}$, $T_E^\alpha = \{xy \in E \mid T_E(xy) \geq \alpha\}$, $I_E^\beta = \{xy \in E \mid I_E(xy) \leq \beta\}$, $F_E^\gamma = \{xy \in E \mid F_E(xy) \leq \gamma\}$, $X^{(\alpha, \beta, \gamma)} = \{x \in V \mid T_V(x) \geq \alpha, I_V(x) \leq \beta, F_V(x) \leq \gamma\}$ and $Y^{(\alpha, \beta, \gamma)} = \{xy \in E \mid T_E(xy) \geq \alpha, I_E(xy) \leq \beta, F_E(xy) \leq \gamma\}$.

Theorem 9: Let (V, ρ, T) be a fuzzy metric space and $G = (X, Y, \rho, T, S)$ be a KM-single valued neutrosophic metric graph on $G^* = (V, E)$ and $\alpha, \beta, \gamma \in [0, 1]$. Then $X^{(\alpha, \beta, \gamma)} = T_V^\alpha \cap I_V^\beta \cap F_V^\gamma$ and $Y^{(\alpha, \beta, \gamma)} = T_E^\alpha \cap I_E^\beta \cap F_E^\gamma$.

Proof 9: Let $x \in X^{(\alpha, \beta, \gamma)}$. Then $T_V(x) \geq \alpha, I_V(x) \leq \beta$ and $F_V(x) \leq \gamma$ implies that $x \in T_V^\alpha \cap I_V^\beta \cap F_V^\gamma$ and conversely. In similar a way, one can see that $Y^{(\alpha, \beta, \gamma)} = T_E^\alpha \cap I_E^\beta \cap F_E^\gamma$.

Let $G = (X, Y, \rho, T, S)$ be a KM-single valued neutrosophic metric graph on $G^* = (V, E)$. Consider $\alpha_{min} = \bigwedge_{xy \in E} T(T_E(xy), T(T_V(x), T_V(y)))$, $\beta_{max} = \bigvee_{xy \in E} S(I_E(xy), S(I_V(x), I_V(y)))$, $\gamma_{max} = \bigvee_{xy \in E} S(F_E(xy), S(F_V(x), F_V(y)))$. Thus we have the following theorem.

Theorem 10: Let (V, ρ, T) be a fuzzy metric space and $G = (X, Y, \rho, T, S)$ be a KM-single valued neutrosophic metric graph on $G^* = (V, E)$. Then For any $\alpha \leq \alpha_{min}, \beta \geq \beta_{max}, \gamma \geq \gamma_{max}$, $G^{(\alpha, \beta, \gamma)} = (X^{(\alpha, \beta, \gamma)}, Y^{(\alpha, \beta, \gamma)})$ is a subgraph of $G^* = (X, Y)$. parameters of \mathbb{R}^+ .

Proof 10: Let $xy \in E$. Since $T(T_E(xy), T(T_V(x), T_V(y))) \leq T_{min}(T_E(xy), T(T_V(x), T_V(y)))$, we get that $T_E(xy) \geq \alpha_{min} \geq \alpha$. So for any $\alpha \leq \alpha_{min}$, $T_E^\alpha \subseteq E$. Also since $S(I_E(xy), S(I_V(x), I_V(y))) \geq S_{max}(I_E(xy), S(I_V(x), I_V(y)))$, we get that $I_E(xy) \leq \beta_{max} \leq \beta$. So for any $\beta \geq \beta_{max}$, $I_E^\beta \subseteq E$. In a similar way, can see that $F_E^\beta \subseteq E$. Using Theorem 9, $Y^{(\alpha, \beta, \gamma)} \subseteq E$ and so $G^{(\alpha, \beta, \gamma)} = (X^{(\alpha, \beta, \gamma)}, Y^{(\alpha, \beta, \gamma)})$ is a subgraph of $G^* = (X, Y)$.

Theorem 11: Let (V, ρ, T) be a KM-fuzzy metric space and $G^* = (V, E)$ be a simple graph.

- (i) If $T_E \leq \rho, I_E \geq \rho$ and $F_E \geq \rho$ then $G = (X, Y, \rho, T)$ is a KM-single valued neutrosophic metric graph on G^* .
- (ii) If $G = (X, Y, \rho, T_{min}, S_{max})$ is a KM-single valued neutrosophic metric graph on G^* and $T_E > \rho, I_E < \rho$ and $F_E < \rho$, then $G = (X, Y)$ is not a single valued neutrosophic graph on G^* .
- (iii) If $G = (X, Y, \rho, T_{min}, S_{max})$ is a strong KM-single valued neutrosophic metric graph on G^* , then $G = (X, Y)$ is a KM-single valued neutrosophic graph on G^* if and only if $\rho(x, y, t) \geq T_E(xy), \rho(x, y, t) \leq I_E(xy)$ and $\rho(x, y, t) \leq F_E(xy)$.

Proof 11: Let $x, y \in V$. Then for some $t \in \mathbb{R}^{\geq 0}$:

(i) Since $T(T_E(xy), T(T_V(x), T_V(y))) \leq T_E(xy)$, $S(I_E(xy), S(I_V(x), I_V(y))) \geq I_E(xy)$ and $S(F_E(xy), S(F_V(x), F_V(y))) \geq F_E(xy)$ then $T_E \leq \rho, I_E \geq \rho$ and $F_E \geq \rho$ imply that $T(T_E(xy), T(T_V(x), T_V(y))) \leq \rho(x, y, t)$, $S(I_E(xy), S(I_V(x), I_V(y))) \geq \rho(x, y, t)$ and $S(F_E(xy), S(F_V(x), F_V(y))) \geq \rho(x, y, t)$. So $G = (X, Y, \rho, T)$ is a KM-single valued neutrosophic graph metric graph on G^* .

(ii) Let $G = (X, Y)$ be a single valued neutrosophic graph on G^* . For all $xy \in E$, since $G = (X, Y, \rho, T_{min}, S_{max})$ is a KM-single valued neutrosophic metric graph on G^* , using $T_E(xy) \leq T_{min}(T_V(x), T_V(y)), I_E(xy) \geq S_{max}(I_V(x), I_V(y))$ and $F_E(xy) \geq S_{max}(F_V(x), F_V(y))$, we get that $T_E(xy) = T_{min}(T_E(xy), T_{min}(T_V(x), T_V(y))) \leq \rho(x, y, t)$, $I_E(xy) = S_{max}(I_E(xy), S_{max}(I_V(x), I_V(y))) \geq \rho(x, y, t)$ and $F_E(xy) = S_{max}(F_E(xy), S_{max}(F_V(x), F_V(y))) \geq \rho(x, y, t)$ which it is a contradiction.

(iii) $G = (X, Y)$ is a single valued neutrosophic graph on G^* if and only if for all $xy \in E$, $T_E(xy) \leq T_{min}(T_V(x), T_V(y)), I_E(xy) \geq S_{max}(I_V(x), I_V(y))$ and $F_E(xy) \geq S_{max}(F_V(x), F_V(y))$. Then $G = (X, Y)$ is a KM-single valued neutrosophic graph on G^* if and only if $T_{min}(T_E(xy)(xy), T_{min}(T_V(x), T_V(y))) = T_E(xy)$, $S_{max}(I_E(xy)(xy), S_{max}(I_V(x), I_V(y))) = I_E(xy)$ and $S_{max}(F_E(xy)(xy), S_{max}(F_V(x), F_V(y))) = F_E(xy)$ if and only if $\rho(x, y, t) \geq T_E(xy), \rho(x, y, t) \leq I_E(xy)$ and $\rho(x, y, t) \leq F_E(xy)$.

Corollary 4: Let $G = (X, Y, \rho, T, S)$ be a KM-fuzzy metric connected graph on $G^* = (V, E)$. Then for starting time $G = (X, Y)$ is not a single valued neutrosophic graph on G^* .

Theorem 12: Let (V, ρ, T) be a KM-fuzzy metric space, $G^* = (V, E)$ be a simple graph and $xy \in E$. Then for $T_V, I_V, F_V : V \rightarrow [0, 1]$ and $T_E, I_E, F_E : E \rightarrow [0, 1]$,

- (i) If $T_V(x) + T_V(y) \leq 1$, $I_V(x) + I_V(y) = 1$ and $F_V(x) + F_V(y) = 1$ then $G = (X, Y, \rho, T_{lu}, S_{lu})$ is a KM -single valued neutrosophic metric graph on G^* .
- (ii) If $T_E(xy) + 1 \leq T_V(xy) + T_V(x) + T_V(y) \leq 2$, $I_V(x) + I_V(y) = F_V(x) + F_V(y) = 1$, then $G = (X, Y, \rho, T_{lu}, S_{lu})$ is a KM -single valued neutrosophic metric graph on G^* .

Proof 12: Let $x, y \in V$. Then for some $t \in \mathbb{R}^{\geq 0}$:

(i) We have

$$\begin{aligned} T_{lu}(T_E(xy), T_{lu}(T_V(x), T_V(y))) \\ = \max(0, T_E(xy) + T_{lu}(T_V(x), T_V(y)) - 1) \\ = \max(0, T_E(xy) + \max(0, T_V(x) + T_V(y) - 1) - 1). \end{aligned}$$

If $T_V(x) + T_V(y) \leq 1$, then $T_{lu}(T_E(xy), T_{lu}(T_V(x), T_V(y))) = \max(0, T_E(xy) - 1) = 0$, since for all $x, y \in V$ we have $T_E(xy) \leq 1$. It concludes that for any time $t \in \mathbb{R}^{\geq 0}$ get that $T_{lu}(T_E(xy), T_{lu}(T_V(x), T_V(y))) \leq \rho(x, y, t)$. In addition, $I_V(x) + I_V(y) = 1$, implies that

$$\begin{aligned} S_{lu}(I_E(xy), S_{lu}(I_V(x), I_V(y))) \\ = \min(1, I_E(xy) + S_{lu}(I_V(x), I_V(y))) \\ = \min(1, I_E(xy) + \min(1, I_V(x) + I_V(y))) \\ = \min(1, I_E(xy) + 1) = 1 \geq \rho(x, y, t). \end{aligned}$$

In a similar way, one can prove that $S_{lu}(F_E(xy), S_{lu}(F_V(x), F_V(y))) \geq \rho(x, y, t)$ and so $G = (X, Y, \rho, T_{lu}, S_{lu})$ is a KM -single valued neutrosophic metric graph on G^* .

(ii) Because $T_E(xy) + 1 \leq T_E(xy) + T_V(x) + T_V(y) \leq 2$, we get that $T_V(x) + T_V(y) \geq 1$ and by item (i), have $T_{lu}(T_E(xy), T_{lu}(T_V(x), T_V(y))) = T_{lu}(0, T_E(xy) + T_V(x) + T_V(y) - 2) = 0$. Moreover, $I_V(x) + I_V(y) = F_V(x) + F_V(y) = 1$, implies that

$$\begin{aligned} S_{lu}(F_E(xy), S_{lu}(F_V(x), F_V(y))) \\ = \min(1, F_E(xy) + S_{lu}(F_V(x), F_V(y))) \\ = \min(1, F_E(xy) + \min(1, F_V(x) + F_V(y))) \\ = \min(1, F_E(xy) + 1) = 1 \geq \rho(x, y, t). \end{aligned}$$

KM -fuzzy metric graph on G^* . It follows that $G = (X, Y, \rho, T_{lu}, S_{lu})$ is a KM -single valued neutrosophic metric graph on G^* .

A. OPERATIONS ON KM -FUZZY METRIC GRAPHS

In this section, for any given two KM -single valued neutrosophic metric graphs, define some product operations and show that the product of KM -single valued neutrosophic metric graphs is a KM -fuzzy metric graph. From now on, we consider $G_1 = (X_1 = (T_V^{(1)}, I_V^{(1)}, F_V^{(1)}), Y_1 = (T_E^{(1)}, I_E^{(1)}, F_E^{(1)}), \rho_1, T, S)$, $G_2 = (X_2 = (T_V^{(2)}, I_V^{(2)}, F_V^{(2)}), Y_2 = (T_E^{(2)}, I_E^{(2)}, F_E^{(2)}), \rho_2, T, S)$ as KM -single valued neutrosophic metric graphs on simple graphs $G_1^* = (V_1, E_1)$ and $G_2^* = (V_2, E_2)$, respectively.

Definition 7: Let G_1, G_2 be KM -single valued neutrosophic metric graphs on simple graphs G_1^* and G_2^* , respectively. Define the categorical product (tensor product) of

fuzzy subsets $X_1 \times X_2 = (T_V^{(1)} \times T_V^{(2)}, I_V^{(1)} \times I_V^{(2)}, F_V^{(1)} \times F_V^{(2)})$, $Y_1 \times Y_2 = (T_E^{(1)} \times T_E^{(2)}, I_E^{(1)} \times I_E^{(2)}, F_E^{(1)} \times F_E^{(2)})$, where $T_V^{(1)} \times T_V^{(2)}, I_V^{(1)} \times I_V^{(2)}, F_V^{(1)} \times F_V^{(2)} : V(G_1^* \times G_2^*) \rightarrow [0, 1]$ by

$$\begin{aligned} (T_V^{(1)} \times T_V^{(2)})(x_1, x_2) &= T_{\min}(T_V^{(1)}(x_1), T_V^{(2)}(x_2)), \\ (I_V^{(1)} \times I_V^{(2)})(x_1, x_2) &= S_{\max}(I_V^{(1)}(x_1), I_V^{(2)}(x_2)), \\ (F_V^{(1)} \times F_V^{(2)})(x_1, x_2) &= S_{\max}(F_V^{(1)}(x_1), F_V^{(2)}(x_2)), \end{aligned}$$

and $T_E^{(1)} \times T_E^{(2)}, I_E^{(1)} \times I_E^{(2)}, F_E^{(1)} \times F_E^{(2)} : E(G_1^* \times G_2^*) \rightarrow [0, 1]$ by

$$\begin{aligned} (T_E^{(1)} \times T_E^{(2)})(x_1, x_2)(y_1, y_2) &= T_{\min}(T_E^{(1)}(x_1y_1), \\ &T_E^{(2)}(x_2y_2)), (I_E^{(1)} \times I_E^{(2)})(x_1, x_2)(y_1, y_2) = S_{\max} \\ &(I_E^{(1)}(x_1y_1), I_E^{(2)}(x_2y_2)), (F_E^{(1)} \times F_E^{(2)})(x_1, x_2)(y_1, y_2) \\ &= S_{\max}(F_E^{(1)}(x_1y_1), F_E^{(2)}(x_2y_2)). \end{aligned}$$

Theorem 13: Let G_1 and G_2 be KM -single valued neutrosophic metric graphs on simple graphs G_1^* and G_2^* , respectively. Then $G_1 \times G_2 = (X_1 \times X_2, Y_1 \times Y_2, T_{\min}(\rho), T, S)$ is a KM -single valued neutrosophic metric graph on $G_1^* \times G_2^*$.

Proof 13: Firstly, by Theorem 6, $(V_1 \times V_2, T_{\min}(\rho), T)$ is a KM -fuzzy metric space. Let $(x_1, x_2)(y_1, y_2) \in E(G_1^* \times G_2^*)$. Since G_1 is a KM -single valued neutrosophic metric graph on G_1^* and G_2 is a KM -single valued neutrosophic metric graph on G_2^* , for some $t_1, t_2 \in \mathbb{R}^{\geq 0}$, we get that

$$\begin{aligned} T((T_E^{(1)} \times T_E^{(2)})(x_1, x_2)(y_1, y_2)), T((T_V^{(1)} \times T_V^{(2)})(x_1, x_2), (T_V^{(1)} \times T_V^{(2)})(y_1, y_2)) &= T(T_{\min}(T_E^{(1)}(x_1y_1), \\ &T_E^{(2)}(x_2y_2)), T((T_{\min}(T_V^{(1)}(x_1), T_V^{(1)}(x_2)), (T_{\min} \\ &(T_V^{(1)}(y_1), T_V^{(2)}(y_2)))) \leq T(T_E^{(1)}(x_1y_1), T(T_V^{(1)}(x_1), \\ &T_V^{(1)}(y_1))) \leq \rho_1(x_1, y_1, t_1) \text{ and} \\ T((T_E^{(1)} \times T_E^{(2)})(x_1, x_2)(y_1, y_2)), T((T_V^{(1)} \times T_V^{(2)})(x_1, x_2), (T_V^{(1)} \times T_V^{(2)})(y_1, y_2)) &= T(T_{\min}(T_E^{(1)}(x_1y_1), \\ &T_E^{(2)}(x_2y_2)), T((T_{\min}(T_V^{(1)}(x_1), T_V^{(2)}(x_2)), (T_{\min}(T_V^{(1)} \\ &(y_1), T_V^{(2)}(y_2)))) \leq T(T_E^{(2)}(x_2y_2), T(T_V^{(2)}(x_2), \\ &T_V^{(2)}(y_2))) \leq \rho_2(x_2, y_2, t_2). \end{aligned}$$

Consider $t = \max\{t_1, t_2\}$, so by Theorem 1, we obtain

$$\begin{aligned} T((T_E^{(1)} \times T_E^{(2)})(x_1, x_2)(y_1, y_2)), \\ T((T_V^{(1)} \times T_V^{(2)})(x_1, x_2), (T_V^{(1)} \times T_V^{(2)})(y_1, y_2)) \\ \leq T_{\min}(\rho_1(x_1, y_1, t_1), \rho_2(x_2, y_2, t_2)) \\ \leq T_{\min}(\rho)(x_1, x_2, (y_1, y_2), t). \end{aligned}$$

In addition,

$$\begin{aligned} S((I_E^{(1)} \times I_E^{(2)})(x_1, x_2)(y_1, y_2)), \\ S((I_V^{(1)} \times I_V^{(2)})(x_1, x_2), (I_V^{(1)} \times I_V^{(2)})(y_1, y_2)) \\ = S(S_{\max}(I_E^{(1)}(x_1y_1), I_E^{(2)}(x_2y_2)), S((S_{\max}(I_V^{(1)}(x_1), \\ I_V^{(1)}(x_2)), (S_{\max}(I_V^{(1)}(y_1), I_V^{(2)}(y_2)))) \\ \geq S(I_E^{(1)}(x_1y_1), S(I_V^{(1)}(x_1), I_V^{(1)}(y_1))) \geq \rho_1(x_1, y_1, t_1) \end{aligned}$$

$$\begin{aligned} &\text{and } S((I_E^{(1)} \times I_E^{(2)})(x_1, x_2)(y_1, y_2)), S((I_V^{(1)} \times I_V^{(2)})(x_1, x_2), (I_V^{(1)} \times I_V^{(2)})(y_1, y_2)) = S(S_{\max}(I_E^{(1)}(x_1 y_1), \\ &I_E^{(2)}(x_2 y_2)), S((S_{\max}(I_V^{(1)}(x_1), I_V^{(2)}(x_2)), (S_{\max}(I_V^{(1)}(y_1), I_V^{(2)}(y_2)))) \geq S(I_E^{(2)}(x_2 y_2), S(I_V^{(2)}(x_2), I_V^{(2)}(y_2))) \\ &\geq \rho_2(x_2, y_2, t_2). \end{aligned}$$

Consider $t = \min\{t_1, t_2\}$, so by Theorem 1, we obtain

$$\begin{aligned} &S((I_E^{(1)} \times I_E^{(2)})(x_1, x_2)(y_1, y_2)), \\ &S((I_V^{(1)} \times I_V^{(2)})(x_1, x_2), (I_V^{(1)} \times I_V^{(2)})(y_1, y_2)) \\ &\geq S_{\max}(\rho_1(x_1, y_1, t_1), \rho_2(x_2, y_2, t_2)) \geq S_{\max}(\rho)(x_1, x_2), (y_1, y_2), t). \end{aligned}$$

In a similar way, can see that $S((F_E^{(1)} \times F_E^{(2)})(x_1, x_2)(y_1, y_2)), S((F_V^{(1)} \times F_V^{(2)})(x_1, x_2), (F_V^{(1)} \times F_V^{(2)})(y_1, y_2)) \geq S_{\max}(\rho)(x_1, x_2), (y_1, y_2), t)$. Thus $G_1 \times G_2 = (X_1 \times X_2, Y_1 \times Y_2, T_{\min}(\rho), T, S)$ is a *KM*-single valued neutrosophic metric graph on $G_1^* \times G_2^*$.

Definition 8: Let G_1, G_2 be *KM*-single valued neutrosophic metric graphs on simple graphs G_1^* and G_2^* , respectively. Define the Cartesian product (or product) fuzzy subsets $X_1 \otimes X_2 = (T_V^{(1)} \otimes T_V^{(2)}, I_V^{(1)} \otimes I_V^{(2)}, F_V^{(1)} \otimes F_V^{(2)})$, $Y_1 \otimes Y_2 = (T_E^{(1)} \otimes T_E^{(2)}, I_E^{(1)} \otimes I_E^{(2)}, F_E^{(1)} \otimes F_E^{(2)})$, where $T_V^{(1)} \otimes T_V^{(2)}, I_V^{(1)} \otimes I_V^{(2)}, F_V^{(1)} \otimes F_V^{(2)} : V(G_1^* \times G_2^*) \rightarrow [0, 1]$ by $(T_V^{(1)} \otimes T_V^{(2)})(x_1, x_2) = T_{\min}(T_V^{(1)}(x_1), T_V^{(2)}(x_2))$, $(I_V^{(1)} \otimes I_V^{(2)})(x_1, x_2) = S_{\max}(I_V^{(1)}(x_1), I_V^{(2)}(x_2))$, $(F_V^{(1)} \otimes F_V^{(2)})(x_1, x_2) = S_{\max}(F_V^{(1)}(x_1), F_V^{(2)}(x_2))$, and $T_E^{(1)} \otimes T_E^{(2)}, I_E^{(1)} \otimes I_E^{(2)}, F_E^{(1)} \otimes F_E^{(2)} : E(G_1^* \times G_2^*) \rightarrow [0, 1]$ by $(T_E^{(1)} \otimes T_E^{(2)})(x, y) = T_{\min}(T_E^{(1)}(x), T_E^{(2)}(y))$, $(I_E^{(1)} \otimes I_E^{(2)})(x, y) = S_{\max}(I_E^{(1)}(x), I_E^{(2)}(y))$, $(F_E^{(1)} \otimes F_E^{(2)})(x, y) = S_{\max}(F_E^{(1)}(x), F_E^{(2)}(y))$.

Example 2: Consider the *KM*-fuzzy metric spaces $(V_1 = \{1, 2\}, \rho_1, T_{\min})$, $(V_2 = \{3, 4, 5\}, \rho_2, T_{\min})$, where $\rho_1(1, 1, t > 0) = 1, \rho_1(2, 2, t > 0) = 1, \rho_1(1, 2, t > 0) = \frac{1+t}{2+t}, \rho_1(x, y, 0) = 0, x, y \in V_1$ and for all $x, y \in \{3, 4, 5\}$,

$$\rho_2(x, y, t) = \begin{cases} \frac{\min\{x, y\} + t}{\max\{x, y\} + t} & \text{if } t > 0 \\ 0 & \text{if } t = 0 \end{cases}$$

. We take the negation $\eta(m) = 1 - m (m \in [0, 1])$ and obtain the *KM*-single valued neutrosophic metric graphs $G_1 = (V_1, (X = (T_V, I_V, F_V), Y = (T_E, I_E, F_E), \rho_1, T_{\min}, S_{\max}))$ in unit time $t_1 = 1$ and $G_2 = (V_2, (X = (T_V, I_V, F_V), Y = (T_E, I_E, F_E), \rho_2, T_{\min}, S_{\max}))$ in unit time $t_2 = 1$ on G_1^* and G_2^* in Figure 2, where $A = (0.6, 0.4, 0.2), B = (0.5, 0.1, 0.3), C = (0.3, 0.5, 0.7), D = (0.5, 0.6, 0.2), E = (0.1, 0.2, 0.5), AB = (0.5, 0.97, 0.95), CE = (0.1, 0.96, 0.91), ED = (0.5, 0.98, 0.99)$ and $DC = (0.3, 0.93, 0.96)$. Now, we obtain the *KM*-fuzzy metric graph $G_1 \times G_2$ in

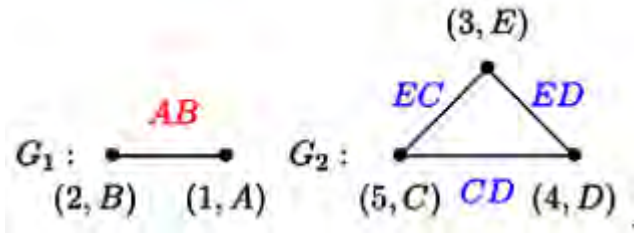

FIGURE 2. *KM*-single valued neutrosophic metric graphs G_1 and G_2 for $t = 1$.

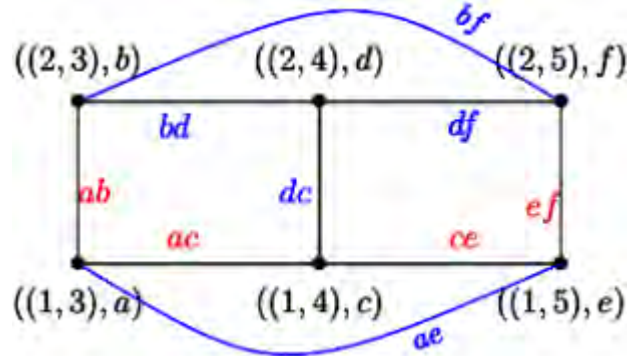

FIGURE 3. *KM*-single valued neutrosophic metric graph $G_1 \otimes G_2$ for $t = 1$.

Figure 3, where $a = (0.1, 0.4, 0.5), b = (0.1, 0.4, 0.5), c = (0.5, 0.6, 0.2), d = (0.5, 0.6, 0.3), e = (0.3, 0.5, 0.7), f = (0.3, 0.5, 0.7), ab = (0.1, 0.97, 0.95), dc = (0.5, 0.97, 0.95), ef = (0.3, 0.97, 0.95), bd = (0.5, 0.98, 0.99), df = (0.3, 0.93, 0.96), ac = (0.5, 0.98, 0.99), ce = (0.3, 0.93, 0.96), bf = (0.1, 0.96, 0.961)$ and $ae = (0.1, 0.96, 0.91)$.

Theorem 14: Let G_1 and G_2 be *KM*-single valued neutrosophic metric graphs on simple graphs G_1^* and G_2^* , respectively.

- (i) If $(G_1^* \otimes G_2^*, T(\rho), T)$ is a *KM*-fuzzy metric space, then $T(\rho) = \rho_1$ or $T(\rho) = \rho_2$, where $T \in \mathcal{C}_T$.
- (ii) $G_1 \otimes G_2 = (X_1 \otimes X_2, Y_1 \otimes Y_2, T_{\min}(\rho), T, S)$ is a *KM*-single valued neutrosophic metric graph on $G_1^* \otimes G_2^*$.

Proof 14: (i) Let $(x_1, x_2), (y_1, y_2) \in E(G_1^* \otimes G_2^*)$. Then $x_1 = y_1$ and $x_2 y_2 \in E(G_2^*)$ or $x_2 = y_2$ and $x_1 y_1 \in E(G_1^*)$. If $x_1 = y_1$ and $x_2 y_2 \in E(G_2^*)$, then $T(\rho)((x_1, x_2), (x_1, y_2), t) = T(\rho_1(x_1, x_1, t), \rho_2(x_2, y_2, t)) = T(1, \rho_2(x_2, y_2, t)) = \rho_2(x_2, y_2, t)$. If $x_2 = y_2$ and $x_1 y_1 \in E(G_1^*)$, then $T(\rho)((x_1, x_2), (y_1, x_2), t) = T(\rho_1(x_1, y_1, t), \rho_2(x_2, x_2, t)) = T(\rho_1(x_1, y_1, t), 1) = \rho_1(x_1, y_1, t)$.

(ii) Firstly, by Theorem 6, $(V_1 \times V_2, T_{\min}(\rho), T)$ is a *KM*-fuzzy metric space. Let $(x_1, x_2), (y_1, y_2) \in E(G_1^* \otimes G_2^*)$. Since G_1 is a *KM*-single valued neutrosophic metric graph on G_1^* and G_2 is a *KM*-single valued neutrosophic metric graph on G_2^* , for some $t_1, t_2 \in \mathbb{R}^{\geq 0}$, give $t = \max\{t_1, t_2\}$, so by item (i) and Theorem 1, we get that

$$T((T_E^{(1)} \otimes T_E^{(2)})(x, x_2)(x, y_2)), T((T_V^{(1)} \otimes T_V^{(2)})(x, x_2), (T_V^{(1)} \otimes T_V^{(2)})(x, y_2))$$

$$\begin{aligned}
 &= T(T_{\min}(T_V^{(1)}(x), T_E^{(2)}(x_2y_2)), T(T_{\min}(T_V^{(1)}(x), T_V^{(2)}(x_2)), T_{\min}(T_V^{(1)}(x), T_V^{(2)}(y_2))) \\
 &\leq T(T_E^{(2)}(x_2y_2), T(T_V^{(2)}(x), T_V^{(2)}(y_2))) \leq \rho_2(x_2, y_2, t_2) \\
 &\leq T_{\min}(\rho)((x, x_2)(x, y_2), t) \text{ and} \\
 &\quad T((T_E^{(1)} \otimes T_E^{(2)})((x_1, y)(y_1, y)), T((T_V^{(1)} \otimes T_V^{(2)})(x_1, y), (T_V^{(1)} \otimes T_V^{(2)})(y_1, y))) \\
 &= T(T_{\min}(T_V^{(2)}(y), T_E^{(1)}(x_1y_1)), T(T_{\min}(T_V^{(1)}(x_1), T_V^{(2)}(y)), T_{\min}(T_V^{(1)}(y_1), T_V^{(2)}(y)))) \\
 &\leq T(T_E^{(1)}(x_1y_1), T(T_V^{(1)}(x_1), T_V^{(1)}(y_1))) \leq \rho_1(x_1, y_1, t_1) \\
 &\leq T_{\min}(\rho)((x_1, y)(y_1, y), t)
 \end{aligned}$$

Now, give $t = \min\{t_1, t_2\}$, so by item (i) and Theorem 1, we get that

$$\begin{aligned}
 &S((I_E^{(1)} \otimes I_E^{(2)})((x, x_2)(x, y_2)), S((I_V^{(1)} \otimes I_V^{(2)})(x, x_2), (I_V^{(1)} \otimes I_V^{(2)})(x, y_2)) \\
 &= S(S_{\max}(I_V^{(1)}(x), I_E^{(2)}(x_2y_2)), S(S_{\max}(I_V^{(1)}(x), I_V^{(2)}(x_2)), S_{\max}(I_V^{(1)}(x), I_V^{(2)}(y_2)))) \\
 &\geq S(I_E^{(2)}(x_2y_2), S(I_V^{(2)}(x), I_V^{(2)}(y_2))) \geq \rho_2(x_2, y_2, t_2) \\
 &\geq S_{\max}(\rho)((x, x_2)(x, y_2), t) \text{ and } S((I_E^{(1)} \otimes I_E^{(2)})((x_1, y)(y_1, y)), S((T_V^{(1)} \otimes I_V^{(2)})(x_1, y), (T_V^{(1)} \otimes I_V^{(2)})(y_1, y))) \\
 &= S(S_{\max}(I_V^{(2)}(y), I_E^{(1)}(x_1y_1)), T(S_{\max}(I_V^{(1)}(x_1), I_V^{(2)}(y)), S_{\max}(I_V^{(1)}(y_1), I_V^{(2)}(y)))) \\
 &\geq S(I_E^{(1)}(x_1y_1), S(I_V^{(1)}(x_1), I_V^{(1)}(y_1))) \geq \rho_1(x_1, y_1, t_1) \\
 &\geq S_{\max}(\rho)((x_1, y)(y_1, y), t).
 \end{aligned}$$

In a similar way, can see that $S((F_E^{(1)} \otimes F_E^{(2)})((x_1, x_2)(y_1, y_2)), S((F_V^{(1)} \otimes F_V^{(2)})(x_1, x_2), (F_V^{(1)} \otimes F_V^{(2)})(y_1, y_2))) \geq S_{\max}(\rho)((x_1, x_2), (y_1, y_2), t)$. Thus $G_1 \otimes G_2 = (X_1 \otimes X_2, Y_1 \otimes Y_2, T_{\min}(\rho), T, S)$ is a KM -single valued neutrosophic metric graph on $G_1^* \otimes G_2^*$.

Definition 9: Let G_1, G_2 be KM -single valued neutrosophic metric graphs on simple graphs G_1^* and G_2^* , respectively.

Define the semi-strong product of fuzzy subsets $X_1 \cdot X_2 = (T_V^{(1)} \cdot T_V^{(2)}, I_V^{(1)} \cdot I_V^{(2)}, F_V^{(1)} \cdot F_V^{(2)})$, $Y_1 \cdot Y_2 = (T_E^{(1)} \cdot T_E^{(2)}, I_E^{(1)} \cdot I_E^{(2)}, F_E^{(1)} \cdot F_E^{(2)})$, where $T_V^{(1)} \cdot T_V^{(2)}, I_V^{(1)} \cdot I_V^{(2)}, F_V^{(1)} \cdot F_V^{(2)} : V(G_1^* \times G_2^*) \rightarrow [0, 1]$ by $(T_V^{(1)} \cdot T_V^{(2)})(x_1, x_2) = T_{\min}(T_V^{(1)}(x_1), T_V^{(2)}(x_2))$, $(I_V^{(1)} \cdot I_V^{(2)})(x_1, x_2) = S_{\max}(I_V^{(1)}(x_1), I_V^{(2)}(x_2))$, $(F_V^{(1)} \cdot F_V^{(2)})(x_1, x_2) = S_{\max}(F_V^{(1)}(x_1), F_V^{(2)}(x_2))$, and $T_E^{(1)} \cdot T_E^{(2)}, I_E^{(1)} \cdot I_E^{(2)}, F_E^{(1)} \cdot F_E^{(2)} : E(G_1^* \times G_2^*) \rightarrow [0, 1]$ by $(T_E^{(1)} \cdot T_E^{(2)})((x, x_2)(x, y_2)) = T_{\min}(T_E^{(1)}(x_1y_1), T_E^{(2)}(x_2y_2))$, $(T_E^{(1)} \cdot T_E^{(2)})((x_1, x_2)(y_1, y_2)) = T_{\min}(T_E^{(1)}(x_1y_1), T_E^{(2)}(x_2y_2))$, $(I_E^{(1)} \cdot I_E^{(2)})((x, x_2)(x, y_2)) = S_{\max}(I_E^{(1)}(x_1y_1), I_E^{(2)}(x_2y_2))$, $(I_E^{(1)} \cdot I_E^{(2)})(x_1, x_2)(y_1, y_2) = S_{\max}(I_E^{(1)}(x_1y_1), I_E^{(2)}(x_2y_2))$, $(F_E^{(1)} \cdot F_E^{(2)})((x, x_2)(x, y_2)) = S_{\max}(F_E^{(1)}(x_1y_1), F_E^{(2)}(x_2y_2))$, $(F_E^{(1)} \cdot F_E^{(2)})((x_1, x_2)(y_1, y_2)) = S_{\max}(F_E^{(1)}(x_1y_1), F_E^{(2)}(x_2y_2))$.

Example 3: Consider the KM -single valued neutrosophic metric graphs G_1 and G_2 in Example 2. So we obtain the KM -fuzzy metric graph $G_1 \cdot G_2$ in Figure 4, where $a = (0.1, 0.4, 0.5)$, $b = (0.1, 0.4, 0.5)$, $c = (0.5, 0.6, 0.2)$, $d = (0.5, 0.6, 0.3)$, $e = (0.3, 0.5, 0.7)$, $f = (0.3, 0.5, 0.7)$, $be = (0.1, 0.97, 0.95)$, $bc = (0.5, 0.98, 0.99)$, $af = (0.1, 0.97, 0.95)$, $bd = (0.5, 0.98, 0.99)$, $df = (0.3, 0.93, 0.96)$, $ac = (0.5, 0.98, 0.99)$, $ce = (0.3, 0.93, 0.96)$, $bf = (0.1, 0.96, 0.961)$, $cf = (0.3, 0.97, 0.96)$, $de = (0.3, 0.97, 0.96)$, $ad = (0.5, 0.98, 0.99)$ and $ae = (0.1, 0.96, 0.91)$.

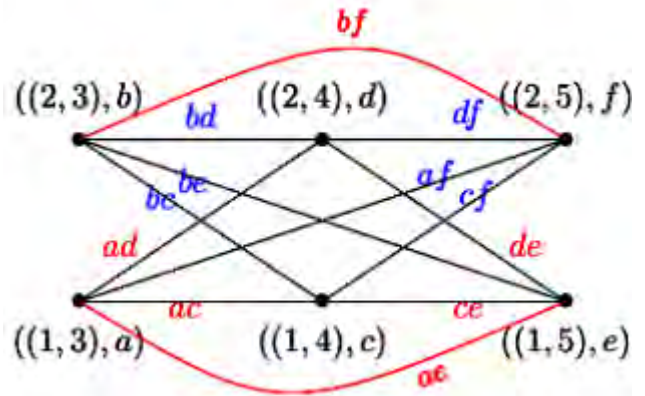

FIGURE 4. KM -single valued neutrosophic metric graph $G_1 \cdot G_2$ for $t = 1$.

Theorem 15: Let G_1 and G_2 be KM -single valued neutrosophic metric graphs on simple graphs G_1^* and G_2^* , respectively. Then $G_1 \cdot G_2 = (X_1 \cdot X_2, Y_1 \cdot Y_2, T_{\min}(\rho), T, S)$ is a KM -single valued neutrosophic metric graph on $G_1^* \cdot G_2^*$.

Proof 15: It is similar to Theorems 13 and 14.

Definition 10: Let G_1, G_2 be KM -single valued neutrosophic metric graphs on simple graphs G_1^* and G_2^* , respectively. Define the strong product of fuzzy subsets $X_1 \odot X_2 = (T_V^{(1)} \odot T_V^{(2)}, I_V^{(1)} \odot I_V^{(2)}, F_V^{(1)} \odot F_V^{(2)})$, $Y_1 \odot Y_2 = (T_E^{(1)} \odot T_E^{(2)}, I_E^{(1)} \odot I_E^{(2)}, F_E^{(1)} \odot F_E^{(2)})$, where $T_V^{(1)} \odot T_V^{(2)}, I_V^{(1)} \odot I_V^{(2)}, F_V^{(1)} \odot F_V^{(2)} : V(G_1^* \times G_2^*) \rightarrow [0, 1]$ by $(T_V^{(1)} \odot T_V^{(2)})(x_1, x_2) = T_{\min}(T_V^{(1)}(x_1), T_V^{(2)}(x_2))$, $(I_V^{(1)} \odot I_V^{(2)})(x_1, x_2) = S_{\max}(I_V^{(1)}(x_1), I_V^{(2)}(x_2))$, $(F_V^{(1)} \odot F_V^{(2)})(x_1, x_2) = S_{\max}(F_V^{(1)}(x_1), F_V^{(2)}(x_2))$, and $T_E^{(1)} \odot T_E^{(2)}, I_E^{(1)} \odot I_E^{(2)}, F_E^{(1)} \odot F_E^{(2)} : E(G_1^* \times G_2^*) \rightarrow [0, 1]$ by $(T_E^{(1)} \odot T_E^{(2)})(x, x_2)(x, y_2) = T_{\min}(T_E^{(1)}(x_1y_1), T_E^{(2)}(x_2y_2))$, $(T_E^{(1)} \odot T_E^{(2)})(x_1, y_1)(x_2, y_2) = T_{\min}(T_E^{(1)}(x_1y_1), T_E^{(2)}(x_2y_2))$, $(I_E^{(1)} \odot I_E^{(2)})(x, x_2)(x, y_2) = S_{\max}(I_E^{(1)}(x_1y_1), I_E^{(2)}(x_2y_2))$, $(I_E^{(1)} \odot I_E^{(2)})(x_1, y_1)(x_2, y_2) = S_{\max}(I_E^{(1)}(x_1y_1), I_E^{(2)}(x_2y_2))$, $(F_E^{(1)} \odot F_E^{(2)})(x, x_2)(x, y_2) = S_{\max}(F_E^{(1)}(x_1y_1), F_E^{(2)}(x_2y_2))$, $(F_E^{(1)} \odot F_E^{(2)})(x_1, y_1)(x_2, y_2) = S_{\max}(F_E^{(1)}(x_1y_1), F_E^{(2)}(x_2y_2))$.

Example 4: Consider the KM -fuzzy metric spaces $(V_1 = \{1, 2\}, \rho_1, T_{\min})$, $(V_2 = \{3, 4, 5\}, \rho_2, T_{\min})$, where for all

$x, y \in \{1, 2\}, \rho_1(x, y, 0) = 0, \rho_1(x, y, t > 0) = \frac{\min\{x, y\} + t}{\max\{x, y\} + t}$ and for all $x, y \in \{3, 4, 5\},$

$$\rho_2(x, y, 0) = 0, \rho_2(x, y, t > 0) = \begin{cases} 1 & \text{if } x = y \\ \frac{5+t}{10+t} & \text{if } x \neq y. \end{cases}$$

We take the negation $\eta(m) = 1 - m(m \in [0, 1])$ and obtain the *KM*-single valued neutrosophic metric graphs $G_1 = (V_1, (X = (T_V, I_V, F_V), Y = (T_E, I_E, F_E), \rho_1, T_{min}, S_{max}))$ in unit time $t_1 = 2$ and $G_2 = (V_2, (X = (T_V, I_V, F_V), Y = (T_E, I_E, F_E), \rho_2, T_{min}, S_{max}))$ in unit time $t_2 = 1$ on G_1^* and G_2^* in Figure 5, where $A = (0.1, 0.5, 0.4), B = (0.2, 0.3, 0.3), C = (0.3, 0.4, 0.5), D = (0.4, 0.6, 0.5), E = (0.5, 0.2, 0.1), AB = (0.5, 0.97, 0.95), DE = (0.5, 0.98, 0.99)$ and $DC = (0.3, 0.93, 0.96)$. Now, we obtain the

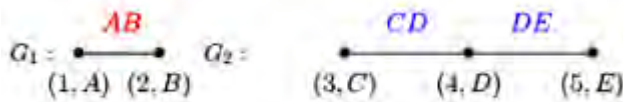

FIGURE 5. *KM*-single valued neutrosophic metric graphs G_1, G_2 for $t_1 = 2, t_2 = 1$.

KM-single valued neutrosophic metric graph $G_1 \odot G_2$ in Figure 6, where $a = (0.1, 0.5, 0.5), b = (0.1, 0.6, 0.5), c = (0.1, 0.5, 0.4), d = (0.2, 0.4, 0.5), e = (0.2, 0.6, 0.5), f = (0.2, 0.3, 0.3), ab = (0.1, 0.93, 0.96), bc = (0.1, 0.98, 0.99), de = (0.2, 0.93, 0.96), ef = (0.2, 0.98, 0.99), ad = (0.3, 0.97, 0.95), be = (0.4, 0.97, 0.95), cf = (0.5, 0.97, 0.95), ae = (0.3, 0.97, 0.96), bf = (0.5, 0.98, 0.99), bd = (0.3, 0.97, 0.96), ce = (0.5, 0.98, 0.99)$.

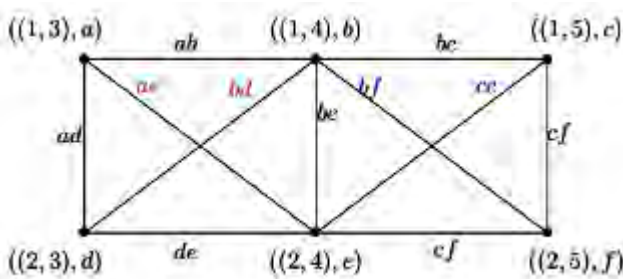

FIGURE 6. *KM*-single valued neutrosophic $G_1 \odot G_2$ for $t = 2$.

Theorem 16: Let G_1 and G_2 be *KM*-single valued neutrosophic metric graphs on simple graphs G_1^* and G_2^* , respectively. Then $G_1 \odot G_2 = (X_1 \odot X_2, Y_1 \odot Y_2, T_{min}(\rho), T, S)$ is a *KM*-single valued neutrosophic metric graph on $G_1^* \odot G_2^*$.

Proof 16: It is similar to Theorems 13 and 14.

Definition 11: Let G_1, G_2 be *KM*-single valued neutrosophic metric graphs on simple graphs G_1^* and G_2^* , respectively. Define the union of fuzzy subsets $X_1 \cup X_2 = (T_V^{(1)} \cup T_V^{(2)}, I_V^{(1)} \cup I_V^{(2)}, F_V^{(1)} \cup F_V^{(2)}), Y_1 \cup Y_2 = (T_E^{(1)} \cup T_E^{(2)},$

$I_E^{(1)} \cup I_E^{(2)}, F_E^{(1)} \cup F_E^{(2)})$, where $T_V^{(1)} \cup T_V^{(2)}, I_V^{(1)} \cup I_V^{(2)}, F_V^{(1)} \cup F_V^{(2)} : (V_1 \cup V_2) \rightarrow [0, 1]$ by

$$(T_V^{(1)} \cup T_V^{(2)})(x_1, x_2) = \begin{cases} T_V^{(1)}(x) & \text{if } x \in V_1 \setminus V_2 \\ T_V^{(2)}(x) & \text{if } x \in V_2 \setminus V_1 \\ T_{min}(T_V^{(1)}(x), T_V^{(2)}(x)) & \text{if } x \in V_2 \cap V_1, \end{cases}$$

$$(I_V^{(1)} \cup I_V^{(2)})(x_1, x_2) = \begin{cases} I_V^{(1)}(x) & \text{if } x \in V_1 \setminus V_2 \\ I_V^{(2)}(x) & \text{if } x \in V_2 \setminus V_1 \\ S_{max}(I_V^{(1)}(x), I_V^{(2)}(x)) & \text{if } x \in V_2 \cap V_1, \end{cases}$$

$$(F_V^{(1)} \cup F_V^{(2)})(x_1, x_2) = \begin{cases} F_V^{(1)}(x) & \text{if } x \in V_1 \setminus V_2 \\ F_V^{(2)}(x) & \text{if } x \in V_2 \setminus V_1 \\ S_{max}(F_V^{(1)}(x), F_V^{(2)}(x)) & \text{if } x \in V_2 \cap V_1 \end{cases}$$

and $T_E^{(1)} \cup T_E^{(2)}, I_E^{(1)} \cup I_E^{(2)}, F_E^{(1)} \cup F_E^{(2)} : (E_1 \cup E_2) \rightarrow [0, 1]$, by

$$(T_E^{(1)} \cup T_E^{(2)})(xy) = \begin{cases} T_E^{(1)}(xy) & \text{if } xy \in E_1 \setminus E_2 \\ T_E^{(2)}(xy) & \text{if } xy \in E_2 \setminus E_1 \\ T_{min}(T_E^{(1)}(xy), T_E^{(2)}(xy)) & \text{if } xy \in E_2 \cap E_1, \end{cases}$$

$$(I_E^{(1)} \cup I_E^{(2)})(xy) = \begin{cases} I_E^{(1)}(xy) & \text{if } xy \in E_1 \setminus E_2 \\ I_E^{(2)}(xy) & \text{if } xy \in E_2 \setminus E_1 \\ S_{max}(I_E^{(1)}(xy), I_E^{(2)}(xy)) & \text{if } xy \in E_2 \cap E_1, \end{cases}$$

$$(F_E^{(1)} \cup F_E^{(2)})(xy) = \begin{cases} F_E^{(1)}(xy) & \text{if } xy \in E_1 \setminus E_2 \\ F_E^{(2)}(xy) & \text{if } xy \in E_2 \setminus E_1 \\ S_{max}(F_E^{(1)}(xy), F_E^{(2)}(xy)) & \text{if } xy \in E_2 \cap E_1. \end{cases}$$

Example 5: Consider the *KM*-single valued neutrosophic metric graphs G_1 and G_2 in Example 4. It is easy to see that *KM*-single valued neutrosophic metric graph $G_1 \cup G_2$ with $t = 2$ in Figure 4.

Theorem 17: Let $G_1 = (X_1, Y_1, \rho_1, T, S), G_2 = (X_2, Y_2, \rho_2, T, S)$ be *KM*-single valued neutrosophic metric graphs on simple graphs $G_1^* = (V_1, E_1)$ and $G_2^* = (V_2, E_2)$, respectively. If $G_1^* = (V_1, E_1)$ and $G_2^* = (V_2, E_2)$ are two simple graphs, where $V_1 \cap V_2 = \emptyset$, then $G_1 \cup G_2 = (X_1 \cup X_2, Y_1 \cup Y_2, \rho_1 \cup \rho_2, T, S)$ is a *KM*-single valued neutrosophic metric graph on $G_1^* \cup G_2^*$.

Proof 17: Firstly, by Theorem 7, $(V_1 \cup V_2, T_{min}(\rho), T)$ is a *KM*-fuzzy metric space. Let $xy \in E(G_1^* \cup G_2^*)$. Since $G_1^* = (V_1, E_1)$ and $G_2^* = (V_2, E_2)$ are two simple graphs, $xy \in E_1 \setminus E_2$ implies that $(x, y \in V_1 \setminus V_2)$ and $xy \in E_2 \setminus E_1$ implies that $(x, y \in V_2 \setminus V_1)$. Since G_1 is a *KM*-single valued neutrosophic metric graph on G_1^* and G_2 is a *KM*-single valued neutrosophic metric graph on G_2^* , for some $t_1, t_2 \in \mathbb{R}^{\geq 0}$,

take $t = \max\{t_1, t_2\}$ so by Theorems 1 and 7, if $xy \in E_1 \setminus E_2$, we have

$$\begin{aligned} T((T_E^{(1)} \cup T_E^{(2)})(xy), T((T_V^{(1)} \cup T_V^{(2)})(x), (T_V^{(1)} \cup T_V^{(2)})(y))) \\ = T(T_V^{(1)}(xy), T(T_V^{(1)}(x), T_V^{(1)}(y))) \\ \leq \rho_1(x, y, t) \leq (\rho_1 \cup \rho_2)(x, y, t). \end{aligned}$$

In a similar way, if $xy \in E_2 \setminus E_1$, one can see that $T_{min}((T_E^{(1)} \cup T_E^{(2)})(xy), T_{min}((T_V^{(1)} \cup T_V^{(2)})(x), (T_V^{(1)} \cup T_V^{(2)})(y))) \leq \rho_2(x, y, t) = (\rho_1 \cup \rho_2)(x, y, t)$. Other cases is similar to.

Now consider $t = \min\{t_1, t_2\}$ so by Theorems 1 and 7, if $xy \in E_1 \setminus E_2$, we have

$$\begin{aligned} S((I_E^{(1)} \cup I_E^{(2)})(xy), S((I_V^{(1)} \cup I_V^{(2)})(x), (I_V^{(1)} \cup I_V^{(2)})(y))) \\ = S(I_V^{(1)}(xy), T(I_V^{(1)}(x), I_V^{(1)}(y))) \\ \geq \rho_1(x, y, t) \geq (\rho_1 \cup \rho_2)(x, y, t). \end{aligned}$$

In a similar way, if $xy \in E_2 \setminus E_1$, one can see that $S((I_E^{(1)} \cup I_E^{(2)})(xy), S((I_V^{(1)} \cup I_V^{(2)})(x), (I_V^{(1)} \cup I_V^{(2)})(y))) \geq \rho_2(x, y, t) = (\rho_1 \cup \rho_2)(x, y, t)$. Other cases is similar to and in a similar way, we can prove that $S((F_E^{(1)} \cup F_E^{(2)})(xy), S((F_V^{(1)} \cup F_V^{(2)})(x), (F_V^{(1)} \cup F_V^{(2)})(y))) \geq (\rho_1 \cup \rho_2)(x, y, t)$. Thus $G_1 \cup G_2 = (X_1 \cup X_2, Y_1 \cup Y_2, \rho_1 \cup \rho_2, T, S)$ is a *KM*-single valued neutrosophic metric graph on $G_1^* \cup G_2^*$.

Definition 12: Let G_1, G_2 be *KM*-single valued neutrosophic metric graphs on simple graphs G_1^* and G_2^* , respectively. Define the semi-ring sum of fuzzy subsets $X_1 \otimes X_2 = (T_V^{(1)} \otimes T_V^{(2)}, I_V^{(1)} + I_V^{(2)}, F_V^{(1)} \otimes F_V^{(2)})$, $Y_1 \otimes Y_2 = (T_E^{(1)} \otimes T_E^{(2)}, I_E^{(1)} + I_E^{(2)}, F_E^{(1)} + F_E^{(2)})$, where $T_V^{(1)} \otimes T_V^{(2)}, I_V^{(1)} \otimes I_V^{(2)}, F_V^{(1)} \otimes F_V^{(2)} : (V_1 \otimes V_2) \rightarrow [0, 1]$ by $(T_V^{(1)} \otimes T_V^{(2)})(x_1, x_2) = (T_V^{(1)} \cup T_V^{(2)})(x_1, x_2)$, $(I_V^{(1)} \otimes I_V^{(2)})(x_1, x_2) = (I_V^{(1)} \cup I_V^{(2)})(x_1, x_2)$, $(F_V^{(1)} \otimes F_V^{(2)})(x_1, x_2) = (F_V^{(1)} \cup F_V^{(2)})(x_1, x_2)$ and $T_E^{(1)} \otimes T_E^{(2)}, I_E^{(1)} \otimes I_E^{(2)}, F_E^{(1)} \otimes F_E^{(2)} : (E_1 \otimes E_2) \rightarrow [0, 1]$, by

$$\begin{aligned} (T_E^{(1)} \otimes T_E^{(2)})(xy) &= \begin{cases} T_E^{(1)}(xy) & \text{if } xy \in E_1 \setminus E_2 \\ T_E^{(2)}(xy) & \text{if } xy \in E_2 \setminus E_1 \\ 0 & \text{if } xy \in E_2 \cap E_1, \end{cases} \\ (I_E^{(1)} \otimes I_E^{(2)})(xy) &= \begin{cases} I_E^{(1)}(xy) & \text{if } xy \in E_1 \setminus E_2 \\ I_E^{(2)}(xy) & \text{if } xy \in E_2 \setminus E_1 \\ 1 & \text{if } xy \in E_2 \cap E_1, \end{cases} \\ (F_E^{(1)} \otimes F_E^{(2)})(xy) &= \begin{cases} F_E^{(1)}(xy) & \text{if } xy \in E_1 \setminus E_2 \\ F_E^{(2)}(xy) & \text{if } xy \in E_2 \setminus E_1 \\ 1 & \text{if } xy \in E_2 \cap E_1. \end{cases} \end{aligned}$$

Theorem 18: Let G_1 and G_2 be *KM*-single valued neutrosophic metric graphs on simple graphs G_1^* and G_2^* , respectively. If G_1^* and G_2^* are two simple graphs, where $V_1 \cap V_2 = \emptyset$, then $G_1 \otimes G_2 = (X_1 \otimes X_2, Y_1 \otimes Y_2, \rho_1 \cup \rho_2, T, S)$ is a *KM*-single valued neutrosophic metric graph on $G_1^* \cup G_2^*$.

Proof 18: It is similar to Theorem 17.

Definition 13: Let G_1, G_2 be *KM*-single valued neutrosophic metric graphs on simple graphs G_1^* and G_2^* , respectively. Define the join(or suspension) of fuzzy subsets

$X_1 + X_2 = (T_V^{(1)} + T_V^{(2)}, I_V^{(1)} + I_V^{(2)}, F_V^{(1)} + F_V^{(2)})$, $Y_1 + Y_2 = (T_E^{(1)} + T_E^{(2)}, I_E^{(1)} + I_E^{(2)}, F_E^{(1)} + F_E^{(2)})$, where $T_V^{(1)} + T_V^{(2)}, I_V^{(1)} + I_V^{(2)}, F_V^{(1)} + F_V^{(2)} : (V_1 \otimes V_2) \rightarrow [0, 1]$ by $(T_V^{(1)} + T_V^{(2)})(x_1, x_2) = (T_V^{(1)} \cup T_V^{(2)})(x_1, x_2)$, $(I_V^{(1)} + I_V^{(2)})(x_1, x_2) = (I_V^{(1)} \cup I_V^{(2)})(x_1, x_2)$, $(F_V^{(1)} + F_V^{(2)})(x_1, x_2) = (F_V^{(1)} \cup F_V^{(2)})(x_1, x_2)$ and $T_E^{(1)} + T_E^{(2)}, I_E^{(1)} + I_E^{(2)}, F_E^{(1)} + F_E^{(2)} : (E_1 \otimes E_2) \rightarrow [0, 1]$, by

$$\begin{aligned} (T_E^{(1)} + T_E^{(2)})(xy) &= \begin{cases} T_E^{(1)}(xy) \cup T_E^{(2)}(xy) & \text{if } xy \in E_1 \cup E_2 \\ (\rho_1 \cup \rho_2)(x, y, t) & \text{if } xy \in E'(x \in V_1, y \in V_2), \end{cases} \\ (I_E^{(1)} + I_E^{(2)})(xy) &= \begin{cases} I_E^{(1)}(xy) \cup I_E^{(2)}(xy) & \text{if } xy \in E_1 \cup E_2 \\ (\rho_1 \cup \rho_2)(x, y, t) & \text{if } xy \in E'(x \in V_1, y \in V_2), \end{cases} \\ (F_E^{(1)} + F_E^{(2)})(xy) &= \begin{cases} F_E^{(1)}(xy) \cup F_E^{(2)}(xy) & \text{if } xy \in E_1 \cup E_2 \\ (\rho_1 \cup \rho_2)(x, y, t) & \text{if } xy \in E'(x \in V_1, y \in V_2), \end{cases} \end{aligned}$$

where E' is the set of all edges joining the vertices of V_1 and V_2 and $t \in R^{\geq 0}$.

Theorem 19: Let G_1 and G_2 be *KM*-single valued neutrosophic metric graphs on simple graphs G_1^* and G_2^* , respectively. If G_1^* and G_2^* are two simple graphs, where $V_1 \cap V_2 = \emptyset$, then $G_1 + G_2 = (X_1 + X_2, Y_1 + Y_2, \rho_1 \cup \rho_2, T, S)$ is a *KM*-single valued neutrosophic metric graph on $G_1^* + G_2^*$.

Proof 19: Let $xy \in E(G_1^* + G_2^*)$. Then $xy \in E_1 \setminus E_2, xy \in E_2 \setminus E_1$ or $xy \in E'$. We only consider $xy \in E'$ and other cases are similar to Theorem 17. Since $xy \in E'$, we get that $(x \in V_1 \setminus V_2, y \in V_2 \setminus V_1)$ or $(y \in V_1 \setminus V_2, x \in V_2 \setminus V_1)$. If $x \in V_1 \setminus V_2, y \in V_2 \setminus V_1$ ($y \in V_1 \setminus V_2, x \in V_2 \setminus V_1$ is proved in a similar way), for some $t_1, t_2 \in \mathbb{R}^{\geq 0}$, take $t = \max\{t_1, t_2\}$ so by Theorem 1, we have $T((T_E^{(1)} + T_E^{(2)})(xy), T((T_V^{(1)} + T_V^{(2)})(x), (T_V^{(1)} + T_V^{(2)})(y))) \leq T((\rho_1 \cup \rho_2)(x, y, t), T(T_V^{(1)}(x), T_V^{(1)}(y))) \leq (\rho_1 \cup \rho_2)(x, y, t)$. Now, consider $t = \min\{t_1, t_2\}$ so by Theorem 1, we have $S((I_E^{(1)} + I_E^{(2)})(xy), S((I_V^{(1)} + I_V^{(2)})(x), (I_V^{(1)} + I_V^{(2)})(y))) \geq S((\rho_1 \cup \rho_2)(x, y, t), S(I_V^{(1)}(x), I_V^{(1)}(y))) \geq (\rho_1 \cup \rho_2)(x, y, t)$ and $S((F_E^{(1)} + F_E^{(2)})(xy), S((F_V^{(1)} + F_V^{(2)})(x), (F_V^{(1)} + F_V^{(2)})(y))) \geq S((\rho_1 \cup \rho_2)(x, y, t), S(F_V^{(1)}(x), F_V^{(1)}(y))) \geq (\rho_1 \cup \rho_2)(x, y, t)$. It follows that $G_1 + G_2 = (X_1 + X_2, Y_1 + Y_2, \rho_1 \cup \rho_2, T, S)$ is a *KM*-single valued neutrosophic metric graph on $G_1^* + G_2^*$.

Definition 14: Let (V, ρ, T) be a *KM*-single valued neutrosophic metric space and $G^* = (V, E)$ be a simple graph. If $G = (X, Y, \rho, T, S)$ is a *KM*-fuzzy metric graph on G^* , then define the complement of fuzzy subsets $\bar{X} = (\bar{T}_V, \bar{I}_V, \bar{F}_V)$, $\bar{Y} = (\bar{T}_E, \bar{I}_E, \bar{F}_E)$, where $\bar{T}_V, \bar{I}_V, \bar{F}_V : V \rightarrow [0, 1]$ and $\bar{T}_E, \bar{I}_E, \bar{F}_E : E \rightarrow [0, 1]$ by $\bar{T}_V(x) = T_V(x), \bar{I}_V(x) = I_V(x), \bar{F}_V(x) = F_V(x)$ and $\bar{T}_E(xy) = \rho(x, y, t) - T(T_E(xy), T(T_V(x), T_V(y)))$, $\bar{I}_E(xy) = S(I_E(xy), S(I_V(x), I_V(y)))$, $\bar{F}_E(xy) = S(F_E(xy), S(F_V(x), F_V(y)))$, where $x, y \in V$. We will denote the complement of a *KM*-single valued neutrosophic metric graph $G = (X, Y, \rho, T, S)$, by $\bar{G} = (\bar{X}, \bar{Y}, \rho, T, S)$.

Theorem 20: Let (V, ρ, T) be a KM -fuzzy metric space and $G^* = (V, E)$ be a simple graph. If $G = (X, Y, \rho, T, S)$ is a KM -single valued neutrosophic metric graph on G^* , then $\bar{G} = (\bar{X}, \bar{Y}, \rho, T, S)$ is a KM -single valued neutrosophic metric graph.

Proof 20: Let $x, y \in V$. Since G is a KM -single valued neutrosophic metric graph on G^* , for some $t \in \mathbb{R}^{\geq 0}$,

$$\begin{aligned} & T(\bar{T}_E(xy), T(\bar{T}_V(x), \bar{T}_V(y))) \\ &= T(\rho(x, y, t) - T(T_E(xy), T(T_V(x), T_V(y))), T(T_V(x), T_V(y))) \\ &\leq \rho(x, y, t) - T(T_E(xy), T(T_V(x), T_V(y))) \\ &\leq \rho(x, y, t). \end{aligned}$$

In addition,

$$\begin{aligned} & S(\bar{I}_E(xy), S(\bar{I}_V(x), \bar{I}_V(y))) \\ &= S(S(I_E(xy), S(I_V(x), I_V(y))), S(I_V(x), I_V(y))) \\ &\geq S(I_E(xy), S(I_V(x), I_V(y))) \geq \rho(x, y, t). \end{aligned}$$

In a similar way, it is easy to see that $S(\bar{F}_E(xy), S(\bar{F}_V(x), \bar{F}_V(y))) \geq \rho(x, y, t)$. It follows that $\bar{G} = (\bar{X}, \bar{Y}, \rho, T, S)$ is a KM -single valued neutrosophic metric graph.

Example 6: Consider the KM -single valued neutrosophic-metric graph G in Example 1. So obtain a KM -single valued neutrosophic metric graph \bar{G} on the cycle graph C_4 for $t = 1$, in Figure 7.



FIGURE 7. KM -single valued neutrosophic metric graph \bar{G} .

V. CONCLUSION

The current paper has introduced a novel concept fuzzy algebra as KM -single valued neutrosophic metric graph and a new generalization of graphs based on KM -fuzzy metric spaces. This work extended and obtained some properties in KM -fuzzy metric spaces. Also it showed that every non empty set converted to a KM -fuzzy metric space, the product and union of KM -fuzzy metric spaces is a KM -fuzzy metric space, the extended KM -fuzzy metric spaces are constructed using the some algebraic operations on KM -fuzzy metric spaces, the concept of complement of KM -single valued neutrosophic metric graph is defined and investigated some its properties. We hope that these results are helpful for further studies in theory of graphs. In our future studies, we hope to obtain more results regarding intuitionistic metric graphs, neutrosophic metric graphs, KM -single valued neutrosophic metric hypergraphs, bipolar KM -single valued neutrosophic metric graphs, automorphism KM -single valued neutrosophic metric graphs and their applications.

REFERENCES

- [1] S. Broumi, M. Talea, A. Bakkali, and F. Smarandache, "Single valued neutrosophic graphs," *J. New Theory*, vol. 10, pp. 86–101, Feb. 2016.
- [2] A. Dey, R. Pradhan, A. Pal, and T. Pal, "A genetic algorithm for solving fuzzy shortest path problems with interval type-2 fuzzy arc lengths," *Malaysian J. Comput. Sci.*, vol. 31, no. 4, pp. 255–270, Oct. 2018.
- [3] M. A. Erceg, "Metric spaces in fuzzy set theory," *J. Math. Anal. Appl.*, vol. 69, no. 1, pp. 205–230, 1979.
- [4] M. Grabiec, "Fixed points in fuzzy metric spaces," *Fuzzy Sets Syst.*, vol. 27, no. 3, pp. 385–389, Sep. 1988.
- [5] A. George and P. Veeramani, "On some results in fuzzy metric spaces," *Fuzzy Sets Syst.*, vol. 64, no. 3, pp. 395–399, Jun. 1994.
- [6] M. Hamidi, S. Jahanpanah, and A. Radfar, "Extended graphs based on KM-fuzzy metric spaces," *Iranian J. Fuzzy Syst.*, vol. 17, no. 5, pp. 81–95, 2020.
- [7] M. Hamidi and A. Borumand Saeid, "Creating and computing graphs from hypergraphs," *Kragujevac J. Math.*, vol. 43, no. 1, pp. 139–164, 2019.
- [8] M. Hamidi and F. Smarandache, "Single-valued neutrosophic directed (hyper)graphs and applications in networks," *J. Intell. Fuzzy Syst.*, vol. 37, no. 2, pp. 2869–2885, Sep. 2019.
- [9] M. Hamidi and A. Borumand Saeid, "Achievable single-valued neutrosophic graphs in wireless sensor networks," *New Math. Natural Comput.*, vol. 14, no. 2, pp. 157–185, Jul. 2018.
- [10] M. Hamidi and B. Saeid, "On derivable trees," *Trans. Combinatorics*, vol. 8, no. 2, pp. 21–43, 2019.
- [11] F. Harary, *Graph Theory*. Reading, MA, USA: Addison-Wesley, 1969.
- [12] K. Kramosil and J. Michálek, "Fuzzy metrics and statistical metric spaces," *Kybernetika*, vol. 11, no. 5, pp. 336–344, 1975.
- [13] S. Kalathian, S. Ramalingam, N. Srinivasan, S. Raman, and S. Broumi, "Embedding of fuzzy graphs on topological surfaces," *Neural Comput. Appl.*, vol. 32, no. 9, pp. 5059–5069, May 2020.
- [14] L. Mancinska and D. E. Roberson, "Quantum homomorphisms," *J. Combinat. Theory, Ser. B*, vol. 118, pp. 228–267, May 2016.
- [15] I. Mardones-Pérez and M. A. de Prada Vicente, "Fuzzy pseudometric spaces vs fuzzifying structures," *Fuzzy Sets Syst.*, vol. 267, pp. 117–132, May 2015.
- [16] S. Mathew and J. N. Mordeson, "Connectivity concepts in fuzzy incidence graphs," *Inf. Sci.*, vols. 382–383, pp. 326–333, Mar. 2017.
- [17] J. N. Mordeson and S. Mathew, "T-norm fuzzy graphs," *New Math. Natural Comput.*, vol. 14, no. 1, pp. 129–143, Mar. 2018.
- [18] M. Mullai and S. Broumi, "Dominating energy in neutrosophic graphs," *Int. J. Neutrosophic Sci.*, vol. 5, no. 1, pp. 38–58, 2020.
- [19] A. Rosenfeld, "Fuzzy graphs," in *Fuzzy Sets and Their Applications to Cognitive and Decision Processes*, L. A. Zadeh, K. S. Fu, K. Tanaka, and M. Shimura, Eds. New York, NY, USA: Academic, 1975, pp. 77–95.
- [20] S. Rana, M. Saeed, M. Qayyum, and F. Smarandache, "Plithogenic subjective hyper-super-soft matrices with new definitions & local, global, universal subjective ranking model," *Int. J. Neutrosophic Sci.*, vol. 6, no. 2, pp. 56–79, 2020.
- [21] P. K. Singh, "Plithogenic set for multi-variable data analysis," *Int. J. Neutrosophic Sci.*, vol. 1, no. 2, pp. 81–89, 2020.
- [22] F. Smarandache, *Neutrosophy. Neutrosophic Probability, Set, and Logic*. Ann Arbor, MI, USA: ProQuest Information & Learning, 1998, p. 105.
- [23] F. Smarandache, "Neutrosophic set, a generalization of the intuitionistic fuzzy set," *Int. J. Pure Appl. Math.*, vol. 24, no. 3, pp. 287–297, 2005.
- [24] F. Smarandache, "Extension of HyperGraph to n-SuperHyperGraph and to plithogenic n-SuperHyperGraph, and extension of HyperAlgebra to n-ary (classical-/neutro-/anti-)HyperAlgebra," *Neutrosophic Sets Syst.*, vol. 33, no. 18, pp. 290–296, 2020.
- [25] F. Smarandache, "Neutro algebra is a generalization of partial algebra," *Int. J. Neutrosophic Sci.*, vol. 2, no. 1, pp. 8–17, 2020.
- [26] F. Smarandache, *Set is a Generalization of Intuitionistic Fuzzy Set, Inconsistent Intuitionistic Fuzzy Set (Picture Fuzzy Set, Ternary Fuzzy Set), Pythagorean Fuzzy Set (Atanassov's Intuitionistic Fuzzy Set of second type), q-Rung Orthopair Fuzzy Set, Spherical Fuzzy Set, and n-HyperSpherical Fuzzy Set, while Neutrosophication is a Generalization of Regret Theory, Grey System Theory, and Three-Ways Decision (Revisited)*. New York, NY, USA: Cornell Univ., 2019.
- [27] F. Smarandache, "n-SuperHyperGraph and Plithogenic n-SuperHyperGraph," in *Nidus Idearum*, vol. 7, 2nd ed. Brussels, Belgium: Pons asbl, 2019, pp. 107–113.
- [28] F. Smarandache, *The Neutrosophic Triplet (n-Ary HyperAlgebra, n-Ary NeutroHyperAlgebra, n-Ary AntiHyperAlgebra)*, in *Nidus Idearum*, vol. 7, 2nd ed. Brussels, Belgium: Pons asbl, 2019, 104–106.
- [29] F. Smarandache and N. Martin, "Plithogenic n-super hypergraph in novel multi-attribute decision making," *Int. J. Neutrosophic Sci.*, vol. 7, no. 1, pp. 8–30, 2020.
- [30] C. Virgil Negoita, "Fuzzy sets," *Fuzzy Sets Syst.*, vol. 133, no. 2, p. 275, Jan. 2003.

Solution of an EPQ Model for Imperfect Production Process under Game and Neutrosophic Fuzzy Approach

Sujit Kumar De, Prasun Kumar Nayak, Anup Khan, Kousik Bhattacharya,
Florentin Smarandache

Sujit Kumar De, Prasun Kumar Nayak, Anup Khan, Kousik Bhattacharya, Florentin Smarandache (2020). Solution of an EPQ Model for Imperfect Production Process under Game and Neutrosophic Fuzzy Approach. *Applied Soft Computing Journal* 93, 106397; DOI: 10.1016/j.asoc.2020.106397

A B S T R A C T

This article deals with an Economic Production Quantity (EPQ) deteriorating inventory model for non-random uncertain environment. It includes rework process, screening of imperfect items and partial backlogging. The items are partially serviceable, because at the time of production some items are found to be defective which cannot be recoverable or serviceable. At first, we develop a cost minimization problem under several assumptions related to imperfect items and rework process under certain linear constraints. We solve the crisp model (primal nonlinear problem) first, and then we convert this model into equivalent game problem taking the help of the theories related to strong and weak duality theorem. However, this game problem consists of the Lagrangian function that correspond a nonlinear objective function subject to some linear constraints. The main objective of the study is to develop a solution procedure of the problem associated to an imperfect process where all unit cost components might increase or decrease neutrosophically. Thus, according to the experiences gained by the decision maker (DM) we fuzzify all cost components as sub-neutrosophic offset. To defuzzify the model we have utilized the sine cuts of neutrosophic fuzzy numbers followed by a solution procedure developed in solving the matrix game exclusively. To validate the model, a numerical example is studied then we have compared the optimal results among the original problem, the equivalent game problem and the game problem under neutrosophic environment explicitly. Our findings reveal that under negative α -cuts the value of the objective function assumes lower and higher values. Finally, sensitivity analysis, graphical illustrations, conclusions and scope of future works have been discussed.

Keywords:
EPQ model
Imperfect items
Rework
Deterioration
Backlogging
Game theory
Neutrosophic offset
Sine-cut
Optimization

1. Introduction

In real world scenario, the defectiveness and deterioration of the items are the major concern of any kind of production process which is unavoidable. Some of these items are basically reworkable and the rests are disposed of. For this reason, a situation may come when backlogging of items are partially applied to the production plant for customers' satisfaction. Traditionally, researchers were involved to optimize the items of good quality order quantity, optimum cycle time, optimum screening time, optimum rework time, optimum inventory run time to control imperfect production process. In the literature numerous research articles are available along these directions. Wee et al.

[1] developed optimal inventory model for items with imperfect quality and shortage backordering. Cardenas-Barron [2] studied economic production quantity with rework process at a single-stage manufacturing system with planned backorders. Tai [3] developed economic production quantity models for deteriorating/imperfect products and service with rework. Hsu and Hsu [4] developed two backorder EPQ models with imperfect production processes, inspection errors and sales returns. Ruidas et al. [5,6,7] studied on production inventory model for imperfect production system with rework of regular production, shortages and sales return via particle swarm optimization. A single-stage manufacturing system with rework and backorder options was also studied by Kang et al. [8] and Sanjai and Periyasamy [9]. Li et al. [10] developed an EPQ model for deteriorating reworkable items. A manufacturing model of imperfect reworkable items and random breakdown under abort/resume policy has been studied by Chiu et al. [11,12]. Kuzyutin et al. [13] implemented a cooperative multistage multicriteria game problem and its solution procedure. Recently, the production system having synchronous and

asynchronous flexible rework rates was analysed by Muhammad Al-Salamah [14]. The concept of advertisement cost dependent demand was introduced by Khara et al. [15] and it has been solved by utilizing branch and bound technique which is another kind of extension in imperfect production process.

However, to capture the non-random uncertainty of the real-world phenomenon Zadeh [16] invented the concept of 'Fuzzy sets'. After that several research articles have been developed by the numerous eminent researchers by implementing fuzzy sets in various decision-making problems. Researchers like De [17] studied an economic order quantity (EOQ) model with natural idle time and wrongly measured demand rate using intuitionistic fuzzy set. De and Sana [18,19] discussed backlogging model under fuzzy environment considering promotional effort and selling price sensitive demand. The application of dense fuzzy set into a pollution sensitive production model was developed by Karmakar et al. [20]. The application of embedded fuzzy logic controller for positive and negative pressure control in pneumatic soft robots was wisely introduced by Oguntosin et al. [21]. In addition, De [22] introduced first time the concept of fuzzy lock sets which is solely based on learning experiences and studied a new defuzzification method after extending the triangular dense fuzzy lock sets into $m \times n$ lock fuzzy matrices. Karmakar et al. [23] applied the fuzzy lock set and its corresponding defuzzification method to analyse a pollution sensitive remanufacturing model with waste items. De and Mahata [24] implemented cloudy fuzzy set and new defuzzification approach in developing EOQ model for imperfect-quality items with allowable proportionate discounts.

Moreover, the concept of game theory was introduced by Karlin [25] through various mathematical methods. Preda [26] extensively analysed convex optimization with nested maxima and consider corresponding matrix game problem. In 1994, he applied matrix game theory in nonlinear programming problem also. Some notable research articles over game theory incorporating linear programming problem under fuzzy environment may be discussed over here. Researchers like Chinchuluun et al. [27] applied game theory in supply chain management problem. Nayak and Pal [28] discussed bi-matrix games with intuitionistic fuzzy goals. Seikh et al. [29] studied matrix games with intuitionistic fuzzy pay-offs. Wu [30] and Metzger and Rieger [31] extensively analysed interval valued dominance cores and non-cooperative games with prospect theory players and dominated strategies respectively.

The concept of neutrosophic fuzzy set is coined by Smarandache [32] in his new book Neutrosophy which is the new branch of Philosophy. In 2005, he also able to discovered that the neutrosophic set is nothing but a generalization of intuitionistic fuzzy set. On the basis of the fundamental concept on neutrosophic set De and Beg [33,34] analysed new defuzzification procedure for triangular dense fuzzy sets and triangular dense fuzzy neutrosophic sets. Through its long journey, the neutrosophic set itself has been classified into several sub neutrosophic sets in various truth values generated from the basic philosophy of science. Smarandache [35] invented neutrosophic overset, neutrosophic underset, and neutrosophic offset to characterize the special class of decision making in different production sectors based on behavioural science and ability to each individual associated in a particular production process. The subject neutrosophic set has also been extended to neutrosophic vague sets with the help of Hashim et al. [36] recently.

From the above study, it is seen that not a single article has been developed yet which includes neutrosophic fuzzy set through solving game theory in imperfect and reworkable production inventory system in which the positive and negative membership degree of neutrosophic fuzzy numbers acts simultaneously for describing the learning experiences of the DM.

Therefore, in this study we develop a cost minimization problem of an imperfect production process through the extension of Tai [3]'s model by incorporating all cost components as neutrosophic fuzzy set and we solve the problem utilizing fuzzy game theory in which the concept of lock fuzzy set and a solution algorithm have been employed. We organize the article as follows: Section 1 includes a brief literature review highlighting major research works, Section 2 discusses preliminaries of some basic definitions and theorems which have been used in developing the proposed model, Section 3 includes notations and assumptions of the model, Section 4 defines the formulation of EPQ model followed by four subsections; Section 4.1 gives model formulation over game theory, 4.2 gives solution procedure of the game problem, 4.3 gives neutrosophic fuzzy model and 4.4 gives methodology to solve the neutrosophic model. Section 5 includes numerical illustrations, Section 6 includes sensitivity analysis, Section 7 expresses graphical illustrations and finally Section 8 gives the conclusion.

Indeed, we include a chronological literature review on some major articles for imperfect production process with game theory, crisp and fuzzy environment are included in Table 1 to show the novelty of this article also.

2. Preliminaries

2.1. Single valued Neutrosophic Offset (Smarandache [35])

Definition 1. Let U be a universe of discourse and the neutrosophic set $A \subset U$. Let $T(x), I(x), F(x)$ be the functions that describe the degrees of membership, indeterminate-membership and non-membership respectively, of a generic element $x \in U$, with respect to the set $A: T(x), I(x), F(x): U \rightarrow [\Psi, \Omega]$ where $\Psi < 0 < 1 < \Omega$, and Ψ is called underlimit, while Ω is called overlimit, $T(x), I(x), F(x) \in [\Psi, \Omega]$.

A Single-Valued Neutrosophic Offset A is defined as: $A = \{ \langle x, \langle T(x), I(x), F(x) \rangle \rangle, x \in U \}$, such that there exist some elements in A that have at least one neutrosophic component that is > 1 , and at least another neutrosophic component that is < 0 .

2.2. Fuzzy subset of sub-neutrosophic offset

Definition 2. In Neutrosophic set theory the component triplets $\langle T(x), I(x), F(x) \rangle$ has specific meaning in any kind of decision theory. Now if we wish to draw the subsets of subneutrosophic sets that correspond any one of these components taking one or more at a time then it is called Subsets of Sub-Neutrosophic set. If these subsets satisfy the properties of Neutrosophic offset then we call such subsets as Sub-Neutrosophic offset.

In fuzzy set theory, the membership function and its corresponding α -cuts are always belonging to $[0, 1]$. But to get a fuzzy sub-Neutrosophic offset we may consider the membership value of the fuzzy set which belongs to $[-1, 1]$. To do this we may take the help of sine-cut of fuzzy membership which itself lies within $[-1, 1]$.

Definition 3. Let $\tilde{A} = \langle x, \mu(x) \rangle$ is a fuzzy sub-Neutrosophic offset defined in the universal set $x \in X \subseteq \mathbb{R}$ then the sine-cuts of $\mu(x)$ is obtained from $\mu(x) \geq \sin(\alpha p)$, ($p > 0$ is the shape parameter of control parameter of the decision maker). In other words, $\alpha \leq \frac{1}{p} \sin^{-1} [\mu(x)] \in [-1, 1]$

Definition 4. Let $\tilde{B} = \langle \langle x, T_B(x), I_B(x), F_B(x) \rangle : x \in X \subseteq \mathbb{R} \rangle$ be a Neutrosophic set where $T_B(x), I_B(x)$ and $F_B(x)$ refer the true membership function, Indeterminacy membership and falsity membership function respectively. Then the sine-cuts of the corresponding membership functions are given by $T_B(x) \geq \sin(\alpha p)$,

Table 1
Literature review on recent major imperfect production process.

Authors	Model	Assumption	Demand	Cost component	Fuzzy/Crisp	Solution procedure
Chiu et al. [11]	EPQ	Rework, random breakdown (Poisson)	Constant	Finite	Crisp	Cost minimization, Convex optimization
Chan and Prakash [37]	EPQ	Reliability, maintenance policy, capital cost	Linguistic fuzzy	Linguistic fuzzy	Triangular Fuzzy Number, Trapezoidal Fuzzy Number	Profit maximization, MCDM, Proximity ratio
Manna et al. [38]	Three-layer supply chain	Two storage facility, Rework, Transportation	Stock dependent fuzzy rough	Nonrandom uncertain	Fuzzy rough set	Profit maximization, Convex optimization
Li et al. [10]	EPQ	Deterioration, system rework, backlog, maintenance, no lost sale	Constant	Finite	Crisp	Cost minimization, Convex optimization
Jauhari et al. [39]	EPQ	Inspection error (Type I, II), warranty, transportation, partial backorder, vender-buyer	Fuzzy stochastic demand	Finite	Fuzzy	Cost minimization, Convex optimization
Khanna et al. [40]	EPQ	Inspection error (Type I, II), sales return, rework, random imperfect item	Constant	Finite	Crisp	Profit maximization, Convex optimization
Nobil et al. [41]	EPQ	Rework (delayed & immediate), Without shortage, Inspection	Constant	Finite	Crisp	Cost minimization, Convex optimization
Taleizadeh et al. [42]	EPQ	Two warranty policy, returns, shortages, maximum budget	Random (Normal distribution)	Random	Crisp	Cost minimization, Metaheuristic, Non-Dominated Sorting Genetic Algorithm
Tayyab et al. [43]	EPQ	Rework, Inspection, n- stage production system	Triangular fuzzy demand	Finite	Fuzzy	Cost minimization, Centre of Gravity, Convex optimization
Kuzyutin et al. [13]	EPQ	Backorder, rework, inspection, Multi criteria multi stage game	Constant	Finite	Crisp	Profit maximization, Unique Pareto Efficient solution
Khedlekar and Tiwari [44]	EPQ	Discount rate, random imperfect quality item, customers' impatient function, partial backorder	Demand is a function of selling price and discount rate	Finite	Crisp	Profit maximization, Convex optimization
This Paper	EPQ	Rework, inspection, learning experience, deterioration, partial backorder	Constant	Neutrosophic fuzzy, lock fuzzy	Neutrosophic fuzzy, lock fuzzy	Primal-dual problem, Lagrangian, Matrix game, Algorithm

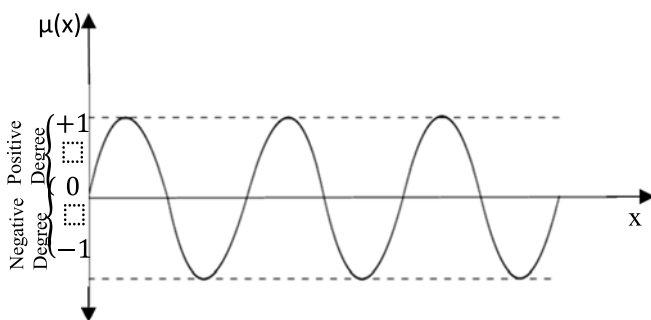

Fig. 1. Neutrosophic fuzzy membership function with sine-cuts.

$I_B(x) \geq \sin(\beta q)$ and $F_B(x) \geq \sin(\gamma r)$ where $\alpha \in [-1, 1]$, $\beta \in [-1, 1]$ and $\gamma \in [-1, 1]$, $p, q, r > 0$ such that $-3 \leq \alpha + \beta + \gamma \leq +3 \Rightarrow -3 \leq \frac{1}{p} \sin^{-1} T_B(x) + \frac{1}{q} \sin^{-1} I_B(x) + \frac{1}{r} \sin^{-1} F_B(x) \leq +3$. The following diagram shows Fig. 1 the basic nature of sine-cut (degree of subset of sub-neutrosophic offset).

2.3. Concept of game theory

The subject of game theory is strongly associated with two or more than competitors (players) who are competing to gain more profit in one side and to achieve minimum loss from another side. In the literature, several definitions have been found but we put two formal definitions stated below which have been used to develop our proposed model.

Definition 5. A game is described by a set of players and their possibilities to play the game according to some rules, that is, their set of strategies. It is situational (time dependent) where the result for a particular player does not depend only on his own decisions, but also on the behaviour of the other players.

Definition 6. A game G consists of a set of players (leaders/agents) $M = \{1, 2, \dots, m\}$, an action set denoted by Ω_i (also referred to as a set of strategies S_i) available for each player i and an individual payoff (utility) U_i or cost function F_i for each player $i \in M$. Here, each player individually takes an optimal action which optimizes its own objective function and each

player's success in making decisions depends on the decisions of the others. We define a non-co-operative game G as an object specified by (M, S, Ω, F) , where $S = S_1 \times S_2 \times \dots \times S_m$ is known as the strategy space, $\Omega = \Omega_1 \times \Omega_2 \times \dots \times \Omega_m$ is the action space, and $F: \Omega \rightarrow \mathbb{R}^m$, defined as $F(u) = [F_1(u), F_2(u), \dots, F_m(u)]^T$, $u \in \Omega$ is the vector of objective functions associated to each of the m players, or agents participating in the game. In some cases, a graph notation might be more appropriate than the set M notation. Conventionally F represents a vector of cost functions to be minimized by the agents.

2.4. Mixed Strategy Game with Linear Constraints (Preda [45])

Let us consider the linearly constrained non-linear programming problem (P) together with its Mond-Weir dual problem (D) , as follows:

$$\begin{aligned} (P) & \begin{cases} \min f(x) \\ \text{subject to: } A(x) \geq b, x \geq 0; \end{cases} \\ (D) & \begin{cases} \max g(x, u) = f(x) - u^T(Ax - b) \\ \text{subject to: } \nabla f(x) - A^T u \geq 0 \\ x^T [\nabla f(x) - A^T u] \leq 0, u \geq 0, \end{cases} \end{aligned} \quad (1)$$

where $x \in \mathbb{R}^n$, $b \in \mathbb{R}^m$, $u \in \mathbb{R}^m$, $A = (a_{ij})$ is an $m \times n$ real matrix, the symbol T denotes the transpose, $f: \mathbb{R}^n \rightarrow \mathbb{R}$ is differentiable and $\nabla f(x)$ denotes the gradient (column) vector of f at x .

Now we consider the matrix game associated with the following $(n + 1) \times (m + 1)$ matrix $M_1(x)$ (depending on x), given by

$$M_1(x) = \begin{pmatrix} A^T & \nabla f(x) \\ -b^T & x^T \nabla f(x) \end{pmatrix} \quad (2)$$

Theorem 1. Let $P^0 = \begin{pmatrix} x^0 \\ z_1^0 \end{pmatrix}$, $Q^0 = \begin{pmatrix} u^0 \\ z_2^0 \end{pmatrix}$, $\bar{x} = x^0/z_1^0$, $\bar{u} = u^0/z_2^0$, with $z_1^0, z_2^0 > 0$. Let (P^0, Q^0) solve the matrix game $M_1(\bar{x})$ and $P^{0T}M_1(\bar{x})Q^0 = 0$. Then \bar{x} and (\bar{x}, \bar{u}) are feasible solution to (P) and (D) respectively with $f(\bar{x}) = g(\bar{x}, \bar{u})$. In addition, if there exists weak duality between (P) and (D) then \bar{x} and (\bar{x}, \bar{u}) are optimal to respective problems.

Proof. We know that if the value of the game (in random extension) is zero then (P^0, Q^0) is the equilibrium point of the given problem. Then we write: $M_1(\bar{x})Q^0 \leq 0$ and $M_1(\bar{x})^T P^0 \geq 0$; which gives

$$\begin{cases} A^T u^0 - z_1^0 \nabla f(\bar{x}) \leq 0 \\ -b^T u^0 + z_1^0 \bar{x}^T \nabla f(\bar{x}) \leq 0 \\ Ax^0 \geq z_2^0 b \\ -x^{0T} \nabla f(\bar{x}) + z_2^0 \bar{x}^T \nabla f(\bar{x}) \geq 0 \end{cases} \quad (3)$$

But we are given $x^0 \geq 0$, $u^0 \geq 0$, $z_1^0 > 0$, $z_2^0 > 0$ and therefore from above we get

$$\begin{cases} A^T \bar{u} - \nabla f(\bar{x}) \leq 0 \\ -b^T \bar{u} + \bar{x}^T \nabla f(\bar{x}) \leq 0 \\ A\bar{x} \geq b \\ -\bar{x}^T \nabla f(\bar{x}) + \bar{x}^T \nabla f(\bar{x}) \geq 0 \end{cases} \quad (4)$$

The above relations reduce to $\bar{x}^T \nabla f(\bar{x}) \leq b^T \bar{u} \leq \bar{x}^T A^T \bar{u} \leq \bar{x}^T \nabla f(\bar{x})$

$$\Rightarrow b^T \bar{u} = \bar{x}^T A^T \bar{u} = \bar{x}^T \nabla f(\bar{x}) \quad (5)$$

Now, $g(\bar{x}, \bar{u}) = f(\bar{x}) - \bar{u}^T(A\bar{x} - b) = f(\bar{x})$. Thus using (3)–(5) we have: $\bar{x}^T [\nabla f(\bar{x}) - A^T \bar{u}] = 0$. Hence \bar{x} , (\bar{x}, \bar{u}) are feasible solution for (P) and (D) respectively. When a weak duality exists between (P) and (D) then \bar{x} is optimal for (P) and (\bar{x}, \bar{u}) is optimal for (D) .

Theorem 2. Let \bar{x} and (\bar{x}, \bar{u}) be the feasible solutions to (P) and (D) respectively, such that $\bar{u}^T(A\bar{x} - b) = 0$. We define $z_1^0 = 1/(1 + \sum_{i=1}^n \bar{x}_i)$, $z_2^0 = 1/(1 + \sum_{j=1}^m \bar{u}_j)$, $P^0 = \begin{pmatrix} \bar{x}z_1^0 \\ z_1^0 \end{pmatrix}$ and $Q^0 = \begin{pmatrix} \bar{u}z_2^0 \\ z_2^0 \end{pmatrix}$. Then (P^0, Q^0) solves the matrix game $M_1(\bar{x})$ and the value of this game is zero.

Proof. Taking the equilibrium point (P^0, Q^0) over matrix game $M_1(\bar{x})$ we have

$$\begin{aligned} P^{0T}M_1(\bar{x})Q^0 &= (z_1^0 \bar{x}^T A^T - z_1^0 b^T, -z_1^0 \bar{x}^T \nabla f(\bar{x}) + z_1^0 \bar{x}^T \nabla f(\bar{x})) \begin{pmatrix} \bar{u}z_2^0 \\ z_2^0 \end{pmatrix} \\ &= z_1^0 z_2^0 [\bar{x}^T A^T \bar{u} - b^T \bar{u} - \bar{x}^T \nabla f(\bar{x}) + \bar{x}^T \nabla f(\bar{x})] \\ &= z_1^0 z_2^0 \bar{u}^T(A\bar{x} - b) = 0. \end{aligned}$$

Since, \bar{x} and (\bar{x}, \bar{u}) are feasible solutions to (P) and (D) respectively, and $\bar{u}^T(A\bar{x} - b) = 0$, we obtain

$$\bar{x}^T A^T \bar{u} = \bar{x}^T \nabla f(\bar{x}) = b^T \bar{u} \quad (6)$$

Now utilizing weak duality theorem and the condition (6) we have

$$M_1(\bar{x})Q^0 = z_2^0 \begin{pmatrix} A^T \bar{u} - \nabla f(\bar{x}) \\ -b^T \bar{u} + \bar{x}^T \nabla f(\bar{x}) \end{pmatrix} \leq 0 \text{ and } P^{0T}M_1(\bar{x}) = z_1^0 (\bar{x}^T A^T - b, -\bar{x}^T \nabla f(\bar{x}) + \bar{x}^T \nabla f(\bar{x})) \geq 0.$$

Thus (P^0, Q^0) solves the matrix game $M_1(\bar{x})$ and the value of the game is zero.

3. Assumption and notations

The following notations and assumptions are used to develop the model.

Notations

- p Production rate per unit time
- p_r Rate of rework process per unit time
- α' Percentage of good quality items produced
- α_r Percentage of imperfect quality items recovered
- λ Demand rate per unit time
- θ Percentage of customers who accept backlogging
- β Percentage of items deteriorated per unit time
- γ Percentage of deteriorated items screened out from the inventory
- I_b Unfilled order backlogged
- I_s Inventory level of serviceable items
- I_m Maximum inventory level of serviceable items
- I_c Maximum inventory level of imperfect quality items
- K Setup cost per cycle (\$)
- C Deterioration cost per unit time per unit item (\$)
- C_d Penalty cost of selling deteriorated items to customers per unit item (\$)
- C_p Cost of unrecoverable perfect quality items per unit time (\$)
- C_s Shortage cost per unit item per unit time (\$)
- C_u Unsatisfied demands penalty cost per unit time (\$)
- h_s Holding cost of serviceable items per unit item per unit time (\$)
- h_r Holding cost of imperfect quality items per unit item per unit time (\$)
- T_1 Recover time of backlogged items (year)
- T_2 Screening of serviceable item (year)
- T_3 Duration of recovering serviceable items (year)
- T_4 Normal inventory time after the production stops (year)
- T_5 Duration of backlogging time (year)
- T Inventory cycle time (year)

Assumption

- i. The imperfect production system involves single period and single item.
- ii. Rework is processed instantly and all defective items are recovered to good quality items.
- iii. Only good and serviceable items are deteriorating with constant rate θ .
- iv. Shortages are partially backlogged and the rests are treated as unsatisfied demand.
- v. Backlogged demands are meet up at the beginning of each cycle.
- vi. Deteriorated items and unrecoverable imperfect quality items are disposed of.
- vii. For fuzzy model, all cost parameters are assumed to be neutrosophic fuzzy number.

4. Formulation of EPQ model

We consider the above assumptions and notations for developing an imperfect production process studied by Tai [3], the schematic diagram of the production flow in given in Fig. 2 and subsequently the average inventory cost function of the proposed model is discussed as follows

$$TC = [\text{Holding cost for (serviceable items + imperfect items)} + \text{Deterioration cost} + \text{Shortage cost} + \text{Penalty cost} + \text{Unsatisfied cost} + \text{Unrecoverable cost} + \text{Setup cost}] / \text{Total cycle time}$$

$$TC = \frac{1}{T} [\eta_1 T_4^2 + \eta_2 T_3^2 + K + \eta_3 T_2^2 + 2\eta_3 T_2 T_3 + \eta_4 T_3^2 + \eta_5 T_4^2 + \eta_6 T_3 + \eta_7 (T - T_2 - T_3 - T_4)^2 + \eta_8 (T - T_2 - T_3 - T_4)]$$

where

$$\begin{cases} \eta_1 = \frac{\lambda\theta[\gamma C + (1-\gamma)C_d]}{2}, & \eta_2 = \frac{h_r[p_r^2 + (1-\alpha')p_r]}{2(1-\alpha')p}, & \eta_3 = \frac{h_s(\alpha'p-\lambda)}{2} \\ \eta_4 = \frac{h_s(\alpha_r p_r - \lambda)}{2}, & \eta_5 = \frac{h_s \lambda}{2}, & \eta_6 = C_p(1 - \alpha_r)p_r \\ \eta_7 = \frac{C_s \beta \lambda (\alpha' p - \lambda)}{2(\alpha' p - \beta' \lambda)}, & \eta_8 = \frac{C_{ii} \beta' \lambda (\alpha' p - \lambda)}{2(\alpha' p - \beta' \lambda)} \end{cases} \quad (7)$$

Therefore, our given problem can be developed as follows:

$$\begin{cases} \min TC(T, T_4) = f(T, T_4) \\ = \psi_1 T - \psi_2 T_4 + \psi_3 \frac{T_4^2}{T} - \psi_5 \frac{T_4}{T} + \frac{K}{T} + \psi_4 \\ \text{Subject to, } \begin{bmatrix} a_{11} & -a_{12} \\ -a_{21} & a_{22} \end{bmatrix} \begin{bmatrix} T \\ T_4 \end{bmatrix} = \begin{bmatrix} T_1 \\ T_2 \end{bmatrix} \\ q = (a_{11} - a_{21})pT - (a_{12} - a_{22})pT_4 \end{cases} \quad (8)$$

where

$$\begin{cases} \psi_1 = \eta_2 a_{31}^2 + \eta_3 a_{21}^2 - 2\eta_3 a_{21} a_{31} + \eta_4 a_{31}^2 + \eta_7 (1 + a_{21} - a_{31})^2 \\ \psi_2 = -2(\eta_2 a_{31} a_{32} + \eta_3 a_{21} a_{22} + \eta_3 a_{21} a_{32} + \eta_3 a_{22} a_{31} + \eta_4 a_{31} a_{32} - \eta_7 (1 + a_{21} - a_{31})(1 + a_{22} + a_{32})) \\ \psi_3 = \eta_1 + \eta_2 a_{32}^2 + \eta_3 a_{22}^2 + 2\eta_3 a_{22} a_{32} + \eta_4 a_{32}^2 + \eta_5 + \eta_7 (1 + a_{22} + a_{32})^2 \\ \psi_4 = \eta_6 a_{31} + \eta_8 (1 + a_{21} - a_{31}) \\ \psi_5 = -\eta_6 a_{32} + \eta_8 (1 + a_{22} + a_{32}) \end{cases} \quad (9)$$

and the other relations are given below:

$$\begin{cases} T_3 = a_{31}T_4 + a_{32}T \\ T_5 = \frac{(\alpha'p-\lambda)}{\beta\lambda}T_1 \\ \omega = \beta\lambda + \frac{(\alpha'p-\beta'\lambda)p_r}{(1-\alpha')p} \\ \begin{bmatrix} a_{11} & -a_{12} \\ -a_{21} & a_{22} \\ a_{31} & a_{32} \end{bmatrix} = \begin{bmatrix} \frac{\beta\lambda(1-a_{21}-a_{31})}{(\alpha'p-\beta'\lambda)} & \frac{-\beta\lambda(1+a_{22}+a_{32})}{(\alpha'p-\beta'\lambda)} \\ -\frac{\beta\lambda-a_{31}\omega}{(\alpha'p-\lambda)} & \frac{a_{32}\omega+\beta\lambda}{(\alpha'p-\lambda)} \\ \frac{\beta\lambda}{\omega+\alpha_r p_r-\lambda} & \frac{\beta'\lambda}{\omega+\alpha_r p_r-\lambda} \end{bmatrix} \end{cases} \quad (10)$$

4.1. Formulation of EPQ model under game theory

Let us consider the objective function, to be minimized as

$$f(T, T_4) = \psi_1 T - \psi_2 T_4 + \psi_3 \frac{T_4^2}{T} - \psi_5 \frac{T_4}{T} + \frac{K}{T} + \psi_4$$

Subject to the constraint $\begin{bmatrix} a_{11} & -a_{12} \\ -a_{21} & a_{22} \end{bmatrix} \begin{bmatrix} T \\ T_4 \end{bmatrix} = \begin{bmatrix} T_1 \\ T_2 \end{bmatrix}$

Rewriting the fundamental decision variables (T, T_4) in terms of (x, y) and replacing the coefficient matrix by A , the decision variable by X and the requirement time vector by B ; then the given problem reduces to

$$\begin{cases} \min f(x, y) = \psi_1 x - \psi_2 y + \psi_3 \frac{y^2}{x} - \psi_5 \frac{y}{x} + \frac{K}{x} + \psi_4 \\ \text{Subject to, } AX = B \end{cases} \quad (11)$$

where

$$A = \begin{bmatrix} a_{11} & -a_{12} \\ -a_{21} & a_{22} \end{bmatrix}, X = \begin{bmatrix} x \\ y \end{bmatrix} \text{ and } B = \begin{bmatrix} T_1 \\ T_2 \end{bmatrix} \quad (12)$$

Utilizing the Section 2.4 the equivalent game problem can be defined as follows

$$(P) \begin{cases} \min f(X) \\ \text{subject to: } AX \geq B, X \geq 0 \end{cases} \quad (13)$$

$$(D) \begin{cases} \max g(X, U) = f(X) - U^T(AX - B) \\ \text{subject to: } \nabla f(X) - A^T U \geq 0 \\ X^T [\nabla f(X) - A^T U] \leq 0, U \geq 0 \end{cases} \quad (14)$$

where $X, B, U \in \mathbb{R}^2, A = (a_{ij})_{2 \times 2}$ real matrix, U denotes the Lagrangian multiplier vector defined by $U = [\zeta_1, \zeta_2]^T$, the symbol T denotes the usual transpose operator.

4.2. Solution procedure of the game problem

To solve (13) and (14) we shall proceed as follows:

Step 1: Take the gradient vector of f at X , defined by $\nabla f =$

$$\begin{bmatrix} \psi_1 - \psi_3 \frac{y^2}{x^2} + \psi_5 \frac{y}{x^2} - \frac{K}{x^2} \\ -\psi_2 + 2\psi_3 \frac{y}{x} - \frac{\psi_5}{x} \end{bmatrix}$$

Step 2: Construct the matrix game utilizing the relations (11)-(12) as

$$M(X) = \begin{bmatrix} a_{11} & -a_{21} & \psi_1 - \psi_3 \frac{y^2}{x^2} + \psi_5 \frac{y}{x^2} - \frac{K}{x^2} \\ -a_{12} & a_{22} & -\psi_2 + 2\psi_3 \frac{y}{x} - \frac{\psi_5}{x} \\ -T_1 & -T_2 & \psi_1 x - \psi_2 y + \psi_3 \frac{y^2}{x} - \frac{K}{x} \end{bmatrix}$$

Step 3 Let (P^*, Q^*) solve the matrix game $M(\bar{X})$, such that $P^{*T} M(\bar{X}) Q^* = 0$ then calculate \bar{X} and (\bar{X}, \bar{U}) such that they are the feasible solutions of (P) and (D) respectively with $f(\bar{X}) = g(\bar{X}, \bar{U})$ where $P^* = (x^*, z_1^*)^T = (x^*, y^*, z_1^*)^T, Q^* = (u^*, z_2^*)^T = (\zeta_1^*, \zeta_2^*, z_2^*)^T, \bar{X} = \left(\frac{x^*}{z_1^*}, \frac{y^*}{z_1^*}\right)^T$ and $\bar{U} = \left(\frac{\zeta_1^*}{z_2^*}, \frac{\zeta_2^*}{z_2^*}\right)^T$. Utilizing the

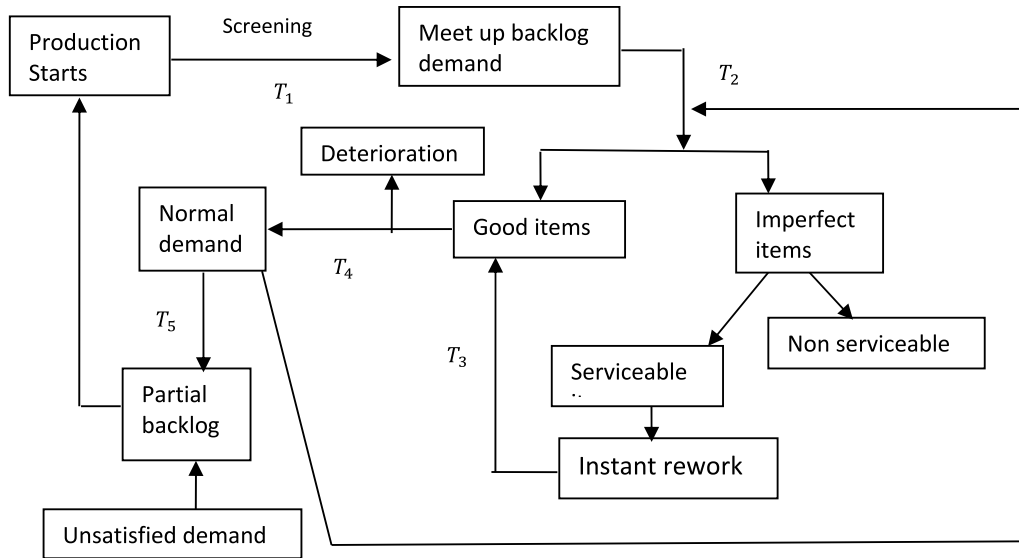

Fig. 2. Imperfect production flow over time.

condition $P^{*T}M(\bar{X})Q^* = 0$ the nonlinear functional satisfies the equation

$$\zeta_1 \{a_{11}x + a_{12}y - z_1 (a_{11}x - a_{12}y)\} + \zeta_2 \{a_{21}x + a_{22}y - z_1 (-a_{21}x + a_{22}y)\} + 2z_2 \left\{ \psi_1x - \psi_2y + \psi_3 \frac{y^2}{x} - \frac{Kz_1^2}{x} \right\} = 0$$

Step 4: Find X^* and $f(X^*)$ satisfying the matrix inequality $M(\bar{X})Q^* \leq 0$ that is

$$\begin{bmatrix} a_{11}\zeta_1 - a_{21}\zeta_2 + \psi_1z_2 - \psi_3 \frac{y^2z_2}{x^2} + \psi_5 \frac{yz_1z_2}{x^2} - \frac{Kz_1^2z_2}{x} \\ -a_{12}\zeta_1 + a_{22}\zeta_2 - \psi_2z_2 + 2\psi_3 \frac{yz_2}{x} - \psi_5 \frac{z_1z_2}{x} \\ -a_{11}\zeta_1x + a_{12}\zeta_1y + a_{21}\zeta_2x - a_{22}\zeta_2y \\ + \psi_1 \frac{xz_2}{z_1} - \psi_2 \frac{yz_2}{z_1} + \psi_3 \frac{y^2z_2}{xz_1} - \frac{Kz_1^2z_2}{x} \end{bmatrix} \leq 0$$

and $M(\bar{X})^T P^* \geq 0$ that is $\begin{bmatrix} a_{11}x - a_{12}y - z_1a_{11}x + z_1a_{12}y \\ -a_{21}x + a_{22}y + z_1a_{21}x - z_1a_{22}y \\ 2\psi_1x - 2\psi_2y + 2\psi_3 \frac{y^2}{x} - \frac{Kz_1^2}{x} \end{bmatrix} \geq 0.$

4.3. Formulation of fuzzy neutrosophic EPQ model

Let all the cost components associated with the imperfect production process behave as fuzzy sub-Neutrosophic offset by means of interval valued lock fuzzy number. The basic characteristic of the lock fuzzy number is, it refers the special class of α -cuts namely sine-cuts as developed in Section 2.2. If κ be the learning parameter over the cycle time T , then we may assume the degree of learning achieved by $\alpha = \sin(\kappa T)$. Let the fuzzy intervals are of the form $[x_{i1}, x_{i1} + \delta_i]$ if $\delta_i > 0$ and it is $[x_{i1} + \delta_i, x_{i1}]$ if $\delta_i < 0$ for $i = 0, 1, 2, \dots$, with interval length (tolerance parameter) δ_i . Now we may define the membership function of the cost parameter given in (15)

$$\mu_{\tilde{x}_i}(x) = \begin{cases} 1 & \text{for } x \leq x_0 \\ \frac{x-x_{i1}}{\delta_i} & \text{for } x_{i1} \leq x \leq x_{i1} + \delta_i \\ 0 & \text{for } x \geq x_{i1} + \delta_i \end{cases} \quad (15)$$

along with its graphical representation shown in Fig. 3.

Let the cost components may vary according to the learning experiences (gain or loss) designed by the decision maker. Thus,

we may assign the cost vector as fuzzy sub-Neutrosophic offset and the given problem can be stated as

$$\left\{ \begin{array}{l} \min \tilde{f}(T, T_4) \doteq \tilde{\psi}_1 T - \tilde{\psi}_2 T_4 + \tilde{\psi}_3 \frac{T_4^2}{T} - \tilde{\psi}_5 \frac{T_4}{T} + \frac{K}{T} + \tilde{\psi}_4 \\ \text{subject to: } \begin{bmatrix} a_{11} & -a_{12} \\ -a_{21} & a_{22} \end{bmatrix} \begin{bmatrix} T \\ T_4 \end{bmatrix} = \begin{bmatrix} T_1 \\ T_2 \end{bmatrix} \\ q = (a_{11} - a_{21})pT - (a_{12} - a_{22})pT_4 \end{array} \right. \quad (16)$$

where

$$\left\{ \begin{array}{l} \tilde{\psi}_1 \doteq \tilde{\eta}_2 a_{31}^2 + \tilde{\eta}_3 a_{21}^2 - 2\tilde{\eta}_3 a_{21} a_{31} + \tilde{\eta}_4 a_{31}^2 + \tilde{\eta}_7 (1 + a_{21} - a_{31})^2 \\ \tilde{\psi}_2 \doteq -2(\tilde{\eta}_2 a_{31} a_{32} + \tilde{\eta}_3 a_{21} a_{22} + \tilde{\eta}_3 a_{21} a_{32} + \tilde{\eta}_3 a_{22} a_{31} \\ + \tilde{\eta}_4 a_{31} a_{32} - \tilde{\eta}_7 (1 + a_{21} - a_{31})(1 + a_{22} + a_{32})) \\ \tilde{\psi}_3 \doteq \tilde{\eta}_1 + \tilde{\eta}_2 a_{32}^2 + \tilde{\eta}_3 a_{22}^2 + 2\tilde{\eta}_3 a_{22} a_{32} + \tilde{\eta}_4 a_{32}^2 \\ + \tilde{\eta}_5 + \tilde{\eta}_7 (1 + a_{22} + a_{32})^2 \\ \tilde{\psi}_4 \doteq \tilde{\eta}_6 a_{31} + \tilde{\eta}_8 (1 + a_{21} - a_{31}) \\ \tilde{\psi}_5 \doteq -\tilde{\eta}_6 a_{32} + \tilde{\eta}_8 (1 + a_{22} + a_{32}) \\ \tilde{\eta}_1 \doteq \frac{\lambda\theta [\gamma\tilde{c} + (1-\gamma)\tilde{c}_d]}{2}, \quad \tilde{\eta}_2 \doteq \frac{\tilde{h}_r [p_r^2 + (1-\alpha')p_r]}{2(1-\alpha')p}, \quad \tilde{\eta}_3 \doteq \frac{\tilde{h}_s(\alpha'p-\lambda)}{2} \\ \tilde{\eta}_4 \doteq \frac{\tilde{h}_s(\alpha_r p_r - \lambda)}{2}, \quad \tilde{\eta}_5 \doteq \frac{\tilde{h}_s \lambda}{2}, \quad \tilde{\eta}_6 \doteq \tilde{C}_p(1 - \alpha_r)p_r \\ \tilde{\eta}_7 \doteq \frac{\tilde{C}_s \beta \lambda (\alpha'p - \lambda)}{2(\alpha'p - \beta'\lambda)}, \quad \tilde{\eta}_8 \doteq \frac{\tilde{C}_u \beta' \lambda (\alpha'p - \lambda)}{2(\alpha'p - \beta'\lambda)} \end{array} \right. \quad (17)$$

4.4. Methodology to solve the neutrosophic fuzzy problem

To defuzzify the proposed neutrosophic fuzzy problem we shall use sine-cut approach as stated in Section 2.2. Now taking the sine-cut of the objective function (16), the equivalent deterministic problem of fuzzy neutrosophic model can be written as

$$\left\{ \begin{array}{l} \min(-\alpha) \\ \alpha = \sin(\kappa T) \\ \text{Subject to } f_\alpha(T, T_4, \kappa) \geq \psi_{1\alpha} T - \psi_{2\alpha} T_4 \\ + \psi_{3\alpha} \frac{T_4^2}{T} - \psi_{5\alpha} \frac{T_4}{T} + \frac{K}{T} + \psi_{4\alpha} \end{array} \right. \quad (18)$$

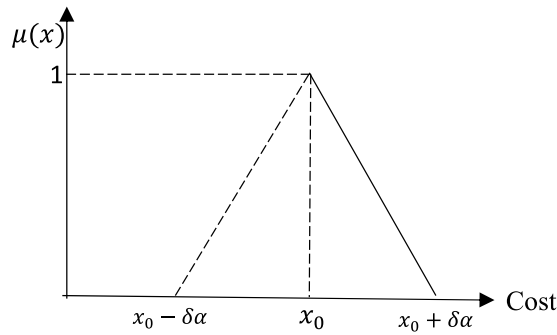

Fig. 3. Nature of membership value of the cost vector.

where

$$\left. \begin{aligned}
 \psi_{1\alpha} &= \eta_{2\alpha} a_{31}^2 + \eta_{3\alpha} a_{21}^2 - 2\eta_{3\alpha} a_{21} a_{31} + \eta_{4\alpha} a_{31}^2 \\
 &\quad + \eta_{7\alpha} (1 + a_{21} - a_{31})^2 \\
 \psi_{2\alpha} &= -2(\eta_{2\alpha} a_{31} a_{32} + \eta_{3\alpha} a_{21} a_{22} + \eta_{3\alpha} a_{21} a_{32} + \eta_{3\alpha} a_{22} a_{31} \\
 &\quad + \eta_{4\alpha} a_{31} a_{32} - \eta_{7\alpha} (1 + a_{21} - a_{31})(1 + a_{22} + a_{32})) \\
 \psi_{3\alpha} &= \eta_{1\alpha} + \eta_{2\alpha} a_{32}^2 + \eta_{3\alpha} a_{22}^2 + 2\eta_{3\alpha} a_{22} a_{32} + \eta_{4\alpha} a_{32}^2 \\
 &\quad + \eta_{5\alpha} + \eta_{7\alpha} (1 + a_{22} + a_{32})^2 \\
 \psi_{4\alpha} &= \eta_{6\alpha} a_{31} + \eta_{8\alpha} (1 + a_{21} - a_{31}) \\
 \psi_{5\alpha} &= -\eta_{6\alpha} a_{32} + \eta_{8\alpha} (1 + a_{22} + a_{32}) \\
 \eta_{1\alpha} &= \frac{\lambda\theta[\gamma C_\alpha + (1-\gamma)C_{d\alpha}]}{2}, \quad \eta_{2\alpha} = \frac{h_{r\alpha}[p_r^2 + (1-\alpha')p_r]}{2(1-\alpha')p}, \\
 \eta_{3\alpha} &= \frac{h_{s\alpha}(\alpha'p-\lambda)}{2} \\
 \eta_{4\alpha} &= \frac{h_{s\alpha}(\alpha_r p_r - \lambda)}{2}, \quad \eta_{5\alpha} = \frac{h_{s\alpha}\lambda}{2}, \quad \eta_{6\alpha} = C_{p\alpha}(1-\alpha_r)p_r \\
 \eta_{7\alpha} &= \frac{C_{s\alpha}\beta\lambda(\alpha'p-\lambda)}{2(\alpha'p-\beta'\lambda)}, \quad \eta_{8\alpha} = \frac{C_{u\alpha}\beta'\lambda(\alpha'p-\lambda)}{2(\alpha'p-\beta'\lambda)} \\
 C_\alpha &= C_0 + \delta_1 \sin(\kappa T), \quad C_{d\alpha} = C_{d0} + \delta_2 \sin(\kappa T), \\
 h_{r\alpha} &= h_{r0} + \delta_3 \sin(\kappa T) \\
 h_{s\alpha} &= h_{s0} + \delta_4 \sin(\kappa T), \quad C_{p\alpha} = C_{p0} + \delta_5 \sin(\kappa T), \\
 C_{s\alpha} &= C_{s0} + \delta_6 \sin(\kappa T) \\
 C_{u\alpha} &= C_{u0} + \delta_7 \sin(\kappa T), \quad K_\alpha = K_0 + \delta_8 \sin(\kappa T)
 \end{aligned} \right\} \tag{19}$$

where $\delta_i (i = 1, 2, \dots, 8)$ represents tolerance level of the cost components of the cost vector $\{C, C_d, h_r, h_s, C_p, C_s, C_u, K\}$ and the elements with 0 suffix indicates their initial values and taking the constraints used in Eqs. (10) and (16).

Now we may construct a schematic diagram of the solution procedure (shown in Fig. 4) and compute the numerical results using the solution algorithm developed in Section 4.2.

5. Numerical illustration

For numerical computation, we assume the imperfect production system parameter values $p = 6000, p_r = 4000, \lambda = 1000, \alpha' = 0.9, \alpha_r = 0.7, \gamma = 0.6, \theta = 0.1, \beta = 0.6$ and the costs parameter values $C = \$0.4, C_d = \$100, C_p = \$30, C_s = \$20, C_u = \$6, h_s = \$2.5, h_r = \$1.5$ and $K = \$300$. For Neutrosophic Game Model we also use the neutrosophic learning

parameter $\kappa = 3.5$ and obtain the result which is shown in Table 2.

Table 2 reveals the optimum cost of the proposed imperfect rework model under various approaches like crisp, game and neutrosophic fuzzy respectively. For the crisp model the average inventory cost is \$2505.73 with respect to the cycle time 0.41 year and the order quantity is 314.213 units. Here also we see the backlog recovery time requires 0.01 year while the inventory exhaust time reaches to 0.27 year approximately. The game model gives the average inventory cost value to \$2506.41 which is \$0.68 more ($\sim +0.03\%$) with respect to the crisp value. But with the application of learning theory the neutrosophic model giving the cost value \$2438.25 (which is 2.7% less) with respect to the learning parameter $\kappa = 3.5$ with α cut value -0.946 over the cycle time 1.252 years where the inventory run time getting maximum at 0.72 year.

6. Sensitivity analysis

Table 3 shows the optimum solution of the proposed neutrosophic game model while the changes of the learning parameter κ on and from -20% to $+20\%$ are performed. At 5% reduction of κ , the average inventory cost gets negligible change. But at -15% and $+10\%$ changes the inventory cost becomes slightly change by $+8\%$ and -8% respectively. For the change of -10% , $+5\%$ and $+20\%$ the objective function gets more than double values ($> 100\%$) with respect to crisp solution. The other cases correspond moderately sensitive. Throughout the whole study it is also observe that the cycle time gets the range $[0.32, 4]$ years with respect to the order quantity range $[308, 4231]$ units. The optimum backlogging recovery time (T_1^*) gets a range $[0.005, 0.166]$ year, the screening time (T_2^*) has the bound $[0.046, 0.539]$ year, the rework time (T_3^*) gets the range $[0.008, 0.107]$ year, normal inventory run time (T_4^*) after production stops gets the range $[0.217, 2.565]$ year and finally the inventory backlogging time duration (T_5^*) assumes the range $[0.041, 1.273]$ year exclusively.

7. Graphical illustration

Fig. 5 shows the comparative study of the total average inventory cost under different methodologies.

It is clear that the cost value of the problem under neutrosophic fuzzy environment assumes minimum with respect to other two cases namely crisp and game problem. The crisp model as well as game model assume values of the objective function more than \$2500 while the neutrosophic fuzzy model assumes value nearly \$2440 which is approximately reduced by -2.7% with respect to the other models.

Fig. 6 indicates the variation and deviation of several time (10^{-2}) components of the model under crisp, game and neutrosophic fuzzy environment. The times of recovery of backlogging items (T_1) due to crisp and game model is very much closer to that of the neutrosophic fuzzy model. If we consider the screening completion time (T_2), the backlogging duration time (T_5) and the normal inventory run time (T_4) then we see that their deviation of the values obtained from neutrosophic fuzzy game problem with respect to the other two models keep an ascending order. However, it is also be noted that the rework time (T_3) for serviceable items gets almost same values for all the cases (models). Although the total cycle time is very much larger (the time gap approximately 10.15 months) to the neutrosophic fuzzy model with respect to the other models. Finally the time bounds for each task completion has the ranges $T_1[0, 10], T_2[5, 15], T_3[0, 5], T_4[25, 72], T_5[5, 35]$ and $T[40, 125]$ respectively.

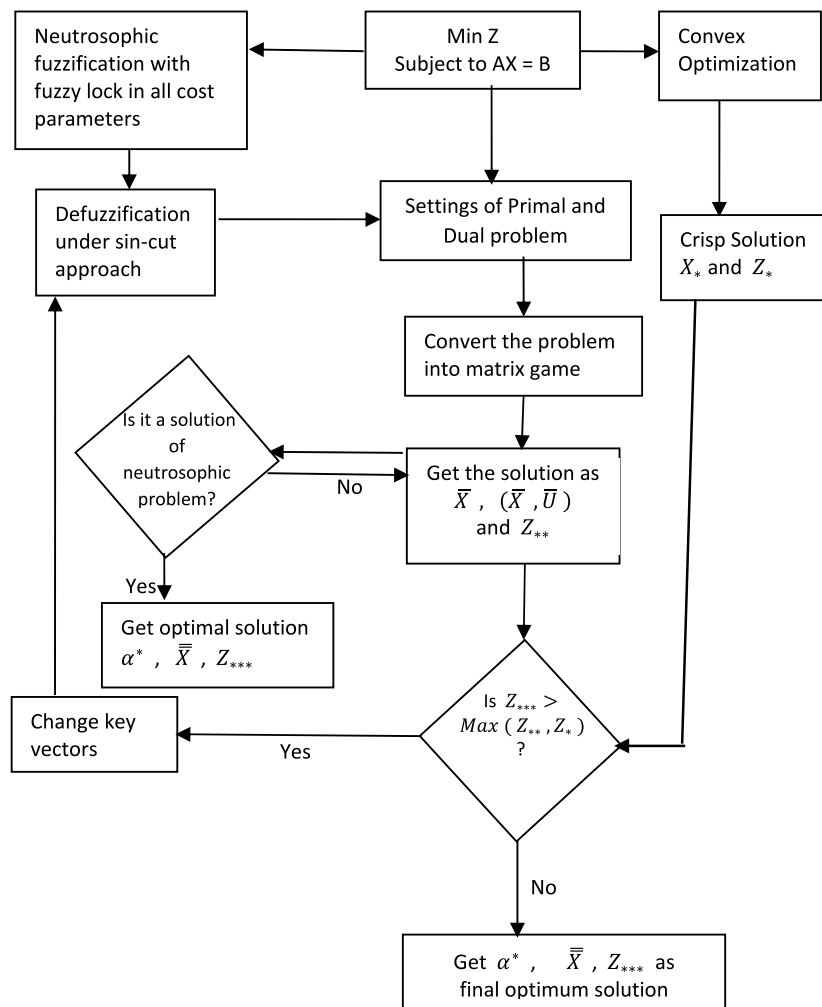

Fig. 4. Schematic overview of solution procedure.

Table 2
Optimal solutions of various models.

Model	T_1^*	T_2^*	T_3^*	T_4^*	T_5^*	T^*	Q^*	α^*	f^*	R_E
Crisp Model	0.0097	0.0576	0.0101	0.2695	0.0708	0.4177	314.213	...	2505.73	...
Game Model	0.0089	0.0572	0.0100	0.2698	0.0705	0.4171	396.811	...	2506.41	+0.03%
Neutrosophic Model	0.0404	0.1512	0.0290	0.7177	0.3115	1.2519	1149.801	-0.946	2438.25	-2.69%

Note: $R_E = \frac{f^* - f_c}{f_c} \times 100\%$ is the relative percentage error where f_c indicates the crisp value.

Table 3
Optimal solution for the change of the learning parameter κ from -20% to +20%.

Change in κ	T_1^*	T_2^*	T_3^*	T_4^*	T_5^*	T^*	Q^*	α^*	TC^*	% change
-20%	0.005	0.046	0.008	0.217	0.041	0.318	307.999	+0.777	3274.39	30.64
-15%	0.048	0.175	0.034	0.829	0.368	1.456	1334.48	-0.928	2699.67	7.71
-10%	0.12	0.398	0.079	1.892	0.922	3.417	3108.216	-0.973	5093.22	103.21
-5%	0.043	0.158	0.03	0.751	0.329	1.313	1205.176	-0.941	2515.66	0.37
+5%	0.166	0.539	0.107	2.565	1.273	4.658	4231.108	-0.987	6641.26	164.97
+10%	0.037	0.139	0.027	0.66	0.282	1.146	1053.521	-0.955	2306.06	-7.99
+15%	0.035	0.134	0.026	0.634	0.269	1.099	1011.398	-0.959	2249.33	-10.26
+20%	0.145	0.473	0.094	2.25	1.11	4.077	3705.614	-0.988	5902.41	135.49

Fig. 7 expresses the trend studies of the required task completion time duration over the % changes of learning parameter κ . The backlog recovery time (T_1) and rework time (T_3) keep almost same value for any kind of changes of the learning parameter (κ) within $\pm 20\%$. The rework time (T_3) and the backlog generation time (T_5) have remarkable gap and they have the

bounds within $130(10^{-2})$ years throughout. The other time parameters like inventory exhaust time (T_4) and total cycle time (T) are easily separable and interpretable within the real time zone $[20, 460](10^{-2})$ years. Moreover, it is observed that if we wish to change the learning parameter (κ) at -20%, -5%, +10% and +15% then we see that the time curves get 'V' shape for all the task completion independently. But if we wish to change the learning

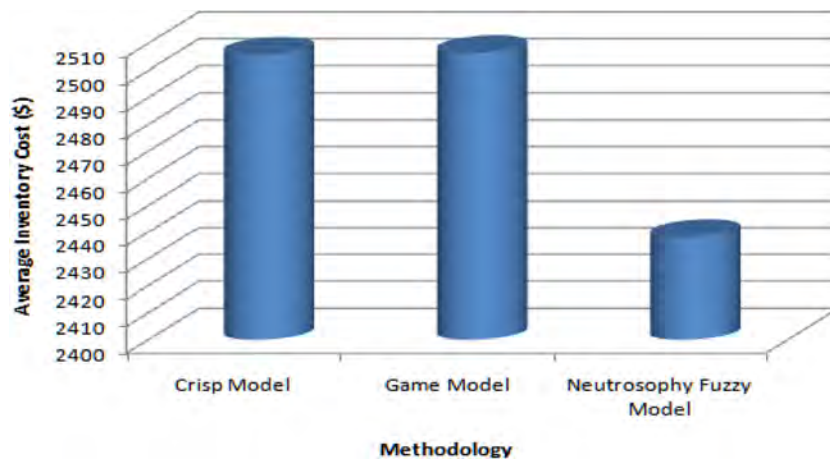

Fig. 5. Inventory cost under several approaches.

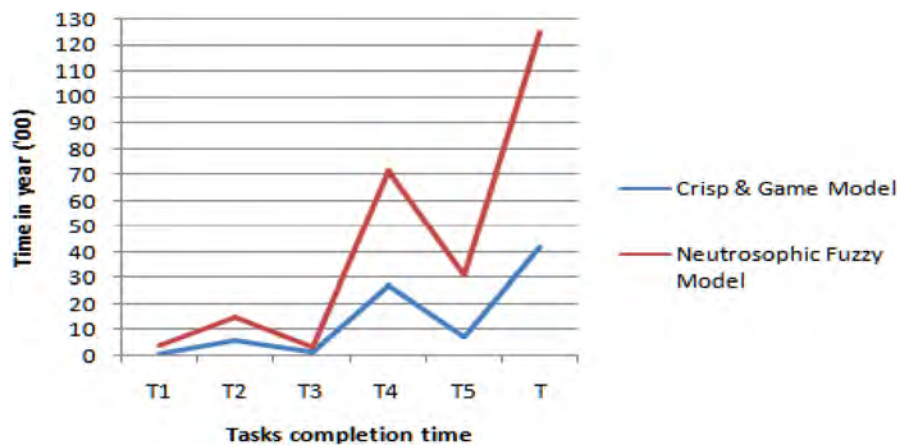

Fig. 6. Task completion time in year under several approaches.

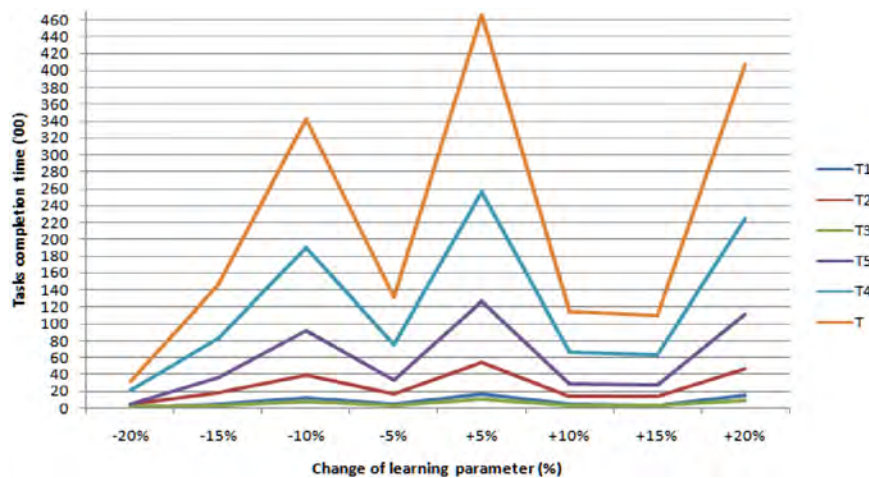

Fig. 7. Tasks completion time under variation of learning parameter (κ)

parameter (κ) at -10% , $+5\%$ and $+20\%$ then the task completion time curves get ‘^’ shape independently. Whenever the learning parameter changes from -20% to -15% then the curves generates family of non-intersecting straight lines with different slopes. In addition, when the learning parameter changes from $+10\%$ to $+15\%$ then the curves becomes almost horizontal non intersecting straight lines having significant distances.

Fig. 8 shows the variation of total average inventory cost with the variation of cycle time. It is observed that the average inventory cost is minimum if it assumes value between $[1.099, 1.456]$ years. Beyond this the total average inventory cost increases. The inventory cost has a paradigm shift up to $\$6641$ approximately within the cycle time range $[1.456, 4.7]$ years alone. Having ‘S’ shaped cycle time curve, the tail of ‘S’ indicates the average cost of the inventory $\$3274$ with cycle time 0.318 year that appears

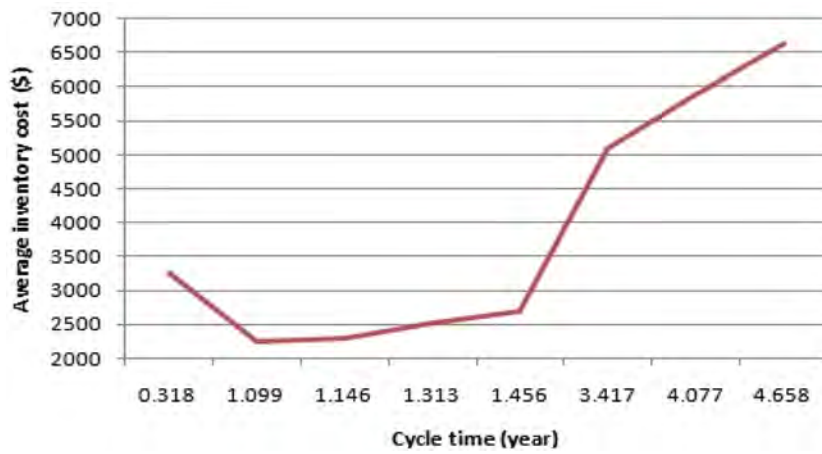

Fig. 8. Variation of average inventory cost with variation of cycle time.

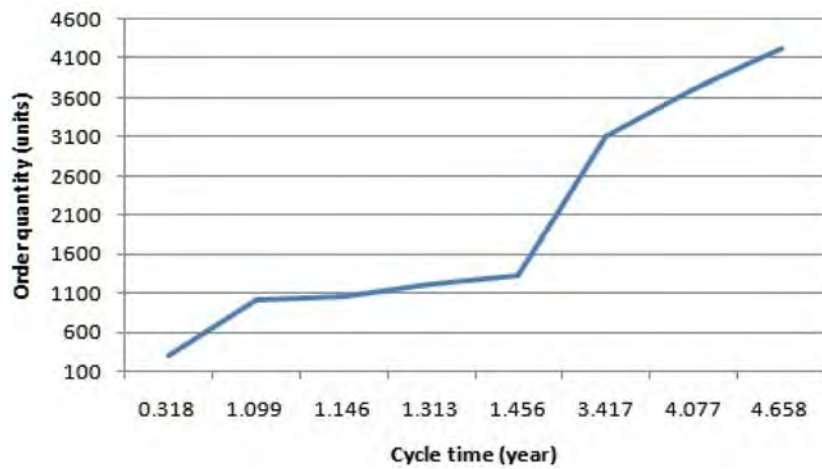

Fig. 9. Variation of order quantity with variation of cycle time.

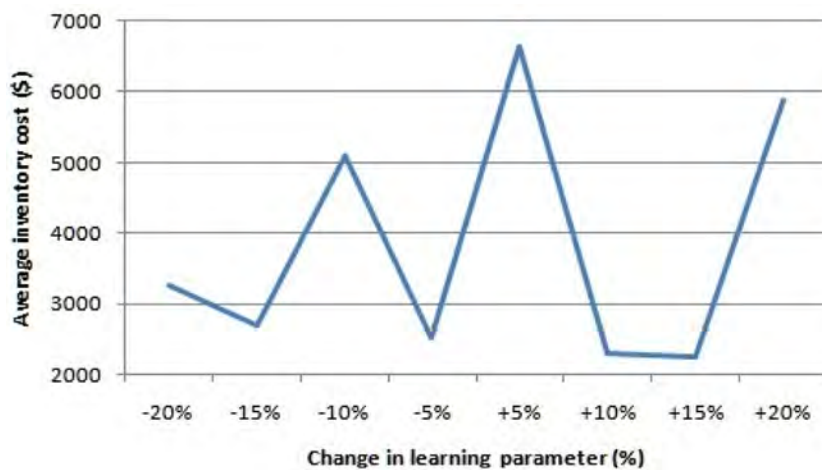

Fig. 10. Variation of average inventory cost with respect to learning parameter k .

due to positive α cut ($\alpha = +0.777$) for the neutrosophic fuzzy model.

Fig. 9 shows the variation of order quantity with respect to the variation of cycle time. As the cycle time increases the order quantity is also increases. A sudden jump of order quantity has

been viewed at the cycle time duration [1.5, 3.417] years approximately. The curve looks like a continuous monotonic increasing function.

Fig. 10 indicates the variation of average inventory cost with a zigzag path like (saw tooth) over the percentage change of the key vector of the fuzzy lock κ (learning parameter). The average inventory cost assume increasing value for the change

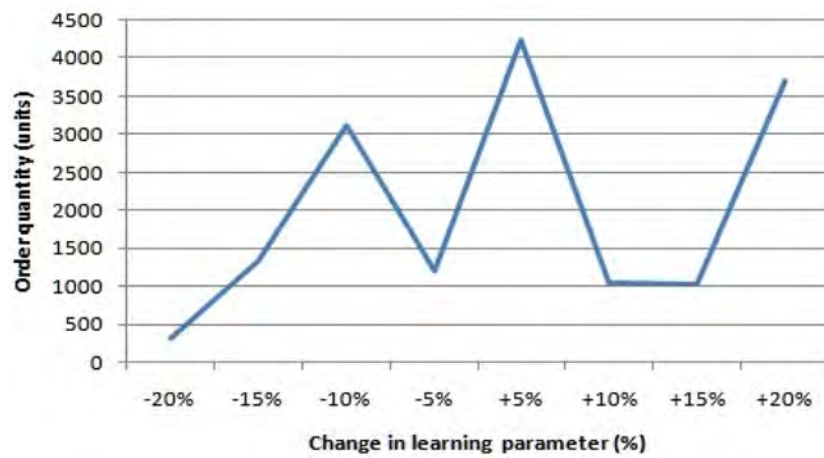

Fig. 11. Variation of order quantity with respect to the learning parameter κ .

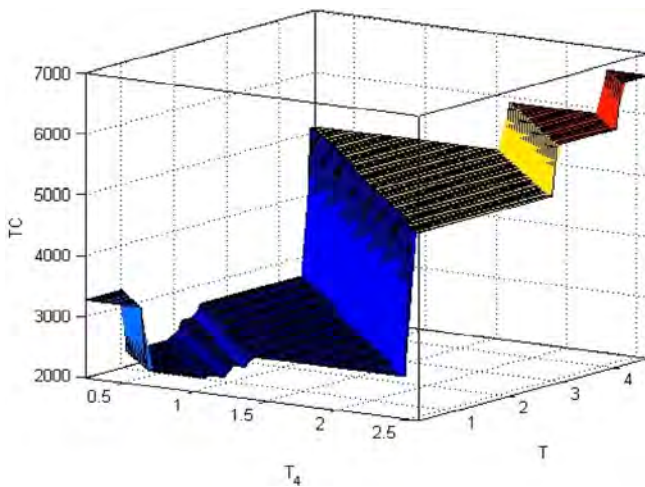

Fig. 12. Variation of average inventory cost with variation of T_4 and T .

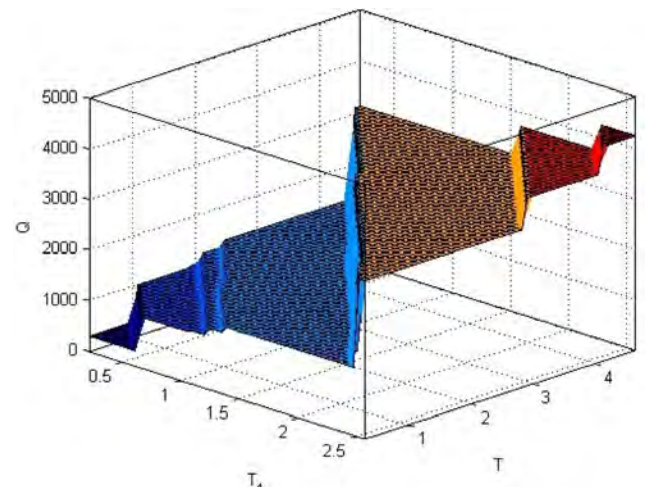

Fig. 13. Variation of order quantity with variation of T_4 and T .

of the lock parameter within the change zone $[-15\%, -10\%]$, $[-5\%, +5\%]$, $[+15\%, +20\%]$ and it is decreasing for the change interval $[-20\%, -15\%]$, $[-10\%, -5\%]$, $[+5\%, +15\%]$ exclusively. Throughout the whole figure the average inventory cost gets a bound $[\$2100, 6600]$ approximately which is the maximum range of the objective function of neutrosophic fuzzy model.

Fig. 11 indicates the variation of order quantity with respect to the % change of learning parameter κ . The order quantity has modal(maximum) values at the changes of the learning parameter κ at -10% , 5% and 20% respectively. Also, at the changes in -20% , -5% , 10% and 15% the values of the order quantity get minimum keeping the values within 1205 units. However, the highest peak of the order quantity curve arises at 4231 units whenever the learning parameter κ increases to $+5\%$.

Fig. 12 reveals the variation of total average inventory cost with respect to inventory exhaust time and cycle time simultaneously. As cycle time increase, cost value increases with step size. On the other hand, the cost value decreases with the decrease of inventory exhaust time within time limit (0.5 ~ 2.5) years but if inventory exhaust time assumes value within 0.5 years the inventory cost refers little more value.

Fig. 13 expresses the variation of order quantity with respect to the variation of inventory exhaust time and variation of cycle time simultaneously. As cycle time increases, order quantity is also increasing with step size. On the other hand, the order

quantity decreases with the increase of inventory exhaust time within time limit (0.5 ~ 2.5) years but if the inventory exhaust time assumes value within 0.5 years the order quantity refers lesser value. The order quantity reaches its maximum value (4231 units) at the cycle time duration 4.7 years approximately.

Fig. 14 expresses the nature of average inventory cost curve under different negative α cuts. We see that at $\alpha = -0.959$ the cost curve reaches minimum point. As α increases the curve slowly goes up following almost a straight line, but the curve gets a sudden jump in the left side of minimum point, reaching a highest peak at $\alpha = -0.987$ and then began to fall down whenever the values of α goes towards -1 . Moreover, the curve also indicates the range of average inventory cost assumes values $[\$ 2249, 6641]$ whenever we are experiencing with negative α cuts throughout.

8. Conclusion

In this study, we have developed an imperfect and reworkable deteriorating production inventory model under fuzzy sub-neutrosophic offset environment. Here, the decision maker has several options to change the real-time managerial strategies so as to reduce (control) several cost components associated with the production inventory problem. Simultaneously, the DM might be able to control the several time parameters as (s)he wishes.

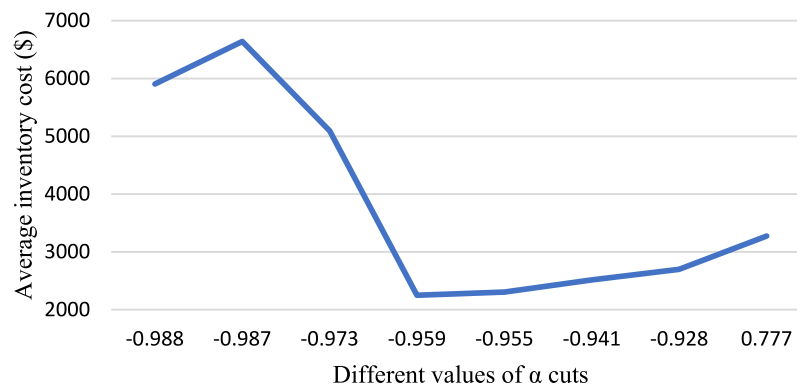

Fig. 14. Variation of inventory cost with the change of α cuts.

The basic merit of this article by using neutrosophic off set is that the DM might be able to get enough time at each and every stages of imperfect production process namely the time duration of backlogs meet up, the screening time, the rework time, the normal inventory exhaust time and the partial backorder time by utilizing lower minimum average inventory cost with respect to other approaches. However, for defuzzification we have utilized α -cuts by means of sine-cuts of neutrosophic fuzzy parameters (several cost components) and then employed game theoretic approach for its solution to primal–dual problem. Our findings reveal that decision making under neutrosophic fuzzy environment is much economical, comfortable and easily applicable even for less qualified decision maker in any kind of management system.

References

- [1] H.M. Wee, J. Yu, M.C. Chen, Optimal inventory model for items with imperfect quality and shortage backordering, *Omega* 35 (1) (2007) 7–11.
- [2] L.E. Cardenas-Barron, Economic production quantity with rework process at a single-stage manufacturing system with planned backorders, *Comput. Ind. Eng.* 57 (3) (2009) 1105–1113.
- [3] A.H. Tai, Economic production quantity models for deteriorating/imperfect products and service with rework, *Comput. Ind. Eng.* 66 (4) (2013) 879–888.
- [4] J.-T. Hsu, L.-F. Hsu, Two epq models with imperfect production processes, inspection errors, planned backorders, and sales returns, *Comput. Ind. Eng.* 64 (1) (2013) 389–402.
- [5] S. Ruidas, M. Seikh, P. Nayak, M. Pal, An interval valued EPQ model in imperfect production system with rework of regular production, shortages and sales return via particle swarm optimization, *Int. J. Pure Appl. Math* 113 (6) (2017) 375–384.
- [6] S. Ruidas, M. Rahaman Seikh, P.K. Nayak, M. Pal, Interval valued eoq model with two types of defective items, *J. Stat. Manag. Syst.* 21 (6) (2018) 1059–1082.
- [7] S. Ruidas, M.R. Seikh, P.K. Nayak, An epq model with stock and selling price dependent demand and variable production rate in interval environment, *Int. J. Syst. Assur. Eng. Manag.* (2019) 1–15.
- [8] C.W. Kang, M. Ullah, M. Sarkar, M. Omair, B. Sarkar, A single-stage manufacturing model with imperfect items, inspections, rework and planned backorders, *Mathematics* (2019) <http://dx.doi.org/10.3390/math7050446>.
- [9] M. Sanjai, S. Periyasamy, An inventory model for imperfect production system with rework and shortages, *Int. J. Oper. Res.* (2019) <http://dx.doi.org/10.1504/IJOR.2019.10017908>.
- [10] N. Li, F.T.S. Chan, S.H. Chung, A.H. Tai, An EPQ model for deteriorating production system and items with rework, *Math. Probl. Eng.* (2015) <http://dx.doi.org/10.1155/2015/957970>.
- [11] Y.S.P. Chiu, C.Y. Tseng, W.C. Liu, C.K. Ting, Economic manufacturing quantity model with imperfect rework and random breakdown under abort/resume policy, *J. Eng. Manuf.* (2008) <http://dx.doi.org/10.1243/09544054JEM1197>.
- [12] S.W. Chiu, C.T. Tseng, M.F. Wu, P.C. Sung, Multi-item EPQ model with scrap, rework and multi-delivery using common cycle policy, *J. Appl. Res. Technol* 12 (2014) 615–622.
- [13] D. Kuzyutin, N. Smirnova, E. Gromova, Long-term implementation of the cooperative solution in a multistage multicriteria game, *Oper. Res. Perspect.* (2019) <http://dx.doi.org/10.1016/j.orp.2019.100107>.
- [14] M. Muhammad Al-Salamah, Economic production quantity in an imperfect manufacturing process with synchronous and asynchronous flexible rework rates, *Oper. Res. Perspect.* (2019) <http://dx.doi.org/10.1016/j.orp.2019.100103>.
- [15] B. Khara, J.K. Dey, S.K. Mondal, An integrated imperfect production system with advertisement dependent demand using branch and bound technique, *Flex. Serv. Manuf. J.* (2020) <http://dx.doi.org/10.1007/s10696-020-09377-5>.
- [16] L.A. Zadeh, Fuzzy sets, *Inf. Control* 8 (3) (1965) 338–353.
- [17] S.K. De, EOQ model with natural idle time and wrongly measured demand rate, *Int. J. Inventory Control Manag.* 3 (1–2) (2013) 329–354.
- [18] S.K. De, S.S. Sana, Fuzzy order quantity inventory model with fuzzy shortage quantity and fuzzy promotional index, *Econ. Model.* 31 (2013) 351–358.
- [19] S.K. De, S.S. Sana, An alternative fuzzy EOQ model with backlogging for selling price and promotional effort sensitive demand, *Int. J. Appl. Comput. Math.* 1 (1) (2015) 69–86.
- [20] S. Karmakar, S.K. De, A. Goswami, A pollution sensitive dense fuzzy economic production quantity model with cycle time dependent production rate, *J. Clean. Prod.* 154 (2017) 139–150.
- [21] V. Oguntosin, S.J. Nasuto, Y. Hayashi, Embedded fuzzy logic controller for positive and negative pressure control in pneumatic soft robots, in: 2017 UKSim-AMSS 19th International Conference on Computer Modelling & Simulation (UKSim), IEEE, 2017, pp. 63–68.
- [22] S.K. De, Triangular dense fuzzy lock sets, *Soft Comput.* 22 (7243) (2017).
- [23] S. Karmakar, S.K. De, A. Goswami, A pollution sensitive remanufacturing model with waste items: Triangular dense fuzzy lock set approach, *J. Cleaner Prod.* 187 (2018) 789–803.
- [24] S.K. De, G.C. Mahata, A cloudy fuzzy economic order quantity model for imperfect-quality items with allowable proportionate discounts, *J. Ind. Eng. Int.* (2019) 1–13.
- [25] S. Karlin, Mathematical methods and theory in game, in: *Programming and Economics*, 1959.
- [26] V. Preda, Convex optimization with nested maxima and matrix game equivalence, *Ann. Buchar. Univ.* 3 (1989) 57–60.
- [27] A. Chinchuluun, A. Karakitsion, A. Mavrommati, Game theory models and their applications in inventory management and supply chain, *Game Theory Models Inventory* (2008) 833–865.
- [28] P.K. Nayak, M. Pal, Bi-matrix games with intuitionistic fuzzy goals, *Iran. J. Fuzzy Syst.* 7 (1) (2010) 65–79.

- [29] M.R. Seikh, P.K. Nayak, M. Pal, Matrix games with intuitionistic fuzzy pay-offs, *J. Inform. Optim. Sci.* 36 (1–2) (2015) 159–181.
- [30] H.-C. Wu, Interval valued cores and interval valued dominance cores of cooperative games endowed with interval valued pay offs, *Mathematics* 6 (11) (2018) 255–270.
- [31] L.P. Metzger, M.O. Rieger, Non-cooperative games with prospect theory players and dominated strategies, *Games Econ. Behav.* 115 (2019) 396–409.
- [32] F. Smarandache, Neutrosophy, a new branch of philosophy, *Infinite Study* (2002).
- [33] S.K. De, I. Beg, Triangular dense fuzzy sets and new defuzzification methods, *J. Intel. Fuzzy Syst.* 31 (1) (2016) 469–477.
- [34] S.K. De, I. Beg, Triangular dense fuzzy neutrosophic sets, *Neutrosophic Sets Syst.* 13 (2016) 24–37.
- [35] F. Smarandache, Neutrosophic overset, neutrosophic underset, and neutrosophic offset, 2017, florentin smarandache similarly for neutrosophic over-/under-/off-logic, probability, and statistics. 17.
- [36] H. Hashim, L. Abdullah, A. Al-Quran, Interval neutrosophic vague sets, *Neutrosophic Sets Syst.* (2019) 66.
- [37] F.T.S. Chan, A. Prakash, Maintenance policy selection in manufacturing firms using the fuzzy MCDM approach, *Int. J. Prod. Res.* 50 (23) (2012) 7044–7056.
- [38] A.K. Manna, J.K. Dey, S.K. Mondal, Three-layer supply chain in an imperfect production inventory model with two storage facilities under fuzzy rough environment, *J. Uncertain. Anal. Appl.* 2 (17) (2014).
- [39] W.A. Jauhari, S. Mayangsari, N.A. Kurdhi, K.Y. Wong, A fuzzy periodic review integrated inventory model involving stochastic demand, imperfect production process and inspection errors, in: *Cogent Engineering*, 2017, <http://dx.doi.org/10.1080/23311916.2017.1308653>.
- [40] A. Khanna, A. Kishore, C.K. Jaggi, Inventory modelling for imperfect production process with inspection errors, sales return and imperfect rework process, *Int. J. Math. Eng. Manag. Sci.* 2 (4) (2017) 242–258.
- [41] A.H. Nabil, E. Nabil, B.R. Sarker, Optimal decision making for a single-stage manufacturing system with rework options, *Int. J. Syst. Sci. Oper. Logist.* (2018) <http://dx.doi.org/10.1080/23302674.2018.1514087>.
- [42] A.A. Taleizadeh, P. Pourreza, I. Moon, Hybrid for an imperfect production system considering product quality and returns under two warranty policies, *Appl. Soft Comput. J.* (2018) <http://dx.doi.org/10.1016/j.asoc.2018.11.013>.
- [43] M. Tayyab, B. Sarkar, B.N. Yahya, Imperfect multi-stage lean manufacturing system with rework under fuzzy demand, *Mathematics* (2019) <http://dx.doi.org/10.3390/math7010013>.
- [44] U.K. Khedlekar, R.K. Tiwari, Decision makings in discount pricing policy for imperfect production system, *Yugosl. J. Oper. Res.* 29 (2) (2019) 273–293.
- [45] V. Preda, On nonlinear programming and matrix game equivalence, *ANZIAM J.* 35 (4) (1994) 429–438.

Certain Properties of Single-Valued Neutrosophic Graph with Application in Food and Agriculture Organization

Shouzhen Zeng, Muhammad Shoaib, Shahbaz Ali, Florentin Smarandache, Hossein Rashmanlou

Shouzhen Zeng, Muhammad Shoaib, Shahbaz Ali, Florentin Smarandache, Hossein Rashmanlou (2021). Certain Properties of Single-Valued Neutrosophic Graph with Application in Food and Agriculture Organization. *International Journal of Computational Intelligence Systems* 14(1): 1516–1540; DOI: 10.2991/ijcis.d.210413.001

ABSTRACT

Fuzzy graph models are present everywhere from natural to artificial structures, embodying the dynamic processes in physical, biological, and social systems. As real-life problems are often uncertain on account of inconsistent and indeterminate information, it seems very demanding for an expert to model those problems using a fuzzy graph. To deal with the uncertainty associated with the inconsistent and indeterminate information of any real-world problems, a neutrosophic graph can be applied, where fuzzy graphs may not bear any fruitful results. The past definitions limitations in fuzzy graphs have directed us to present new definitions in single-valued neutrosophic graph (SVNG). A SVNG has several applications in the fields of physics, bio and connectivity of socialism. It has been an advantageous scope in the recent times for providing such information which is incomplete or uncertain accounting in real problems that gives the direction to describe the relationship between nodes. Operations are conveniently used in many combinatorial applications. In various situations, they present a suitable construction means; therefore, the current study, seeks to present and explore the key features of new operations, including: rejection, maximal product, symmetric difference, and residue product of SVNG. We have discuss the concept of maximal product on two strong-(SVNGS) and maximal product of connected-SVNG with examples. This research article presents the notions of degree of a vertex and total degree of a vertex in SVNG. Moreover, this study summarizes the specific conditions needed for obtaining vertices degrees in SVNG under the operations of maximal product, symmetric difference, residue product, and rejection. In addition, an application was illustrated in the food and agriculture organization with an algorithm to emphasize the contributions of this research article in practical applications.

Keywords Single-valued neutrosophic graph maximal product
rejection
symmetric difference
residue product

1. INTRODUCTION

Graph theory is an exceptionally advantageous device in tackling combinatorial issues in different regions including calculation, variable-based math, number hypothesis, geography, and social frameworks. A graph is chiefly a model of relations, and it is applied to speak to the genuine issues including connections between objects. The vertices and edges of the graph are utilized to connote the articles and the relations between objects, individually. In numerous improvement issues, the current data is vague or loose for different reasons, for example, the loss of data, the absence of proof, flawed measurable information, and inadequate data. By and large, the vulnerability, in actuality, issues may show up in the data that characterizes the issue. Fuzzy chart models are important numerical apparatuses for treating the combinatorial issues of different areas

enveloping exploration, streamlining, variable-based math, figuring, ecological science, and geography. Fuzzy graphical models are observably more helpful than graphical models due to the common presence of unclearness and equivocalness. Initially, fuzzy set hypothesis is needed to manage numerous perplexing issues including inadequate data. Zadeh [32], firstly exemplified the idea of the set known as the fuzzy set. He described the fuzzy set characterized by true membership function value ranging from closed interval $[0, 1]$. Fuzzy set theory serves as a very powerful mathematical tool for solving approximate reasoning related problems. These notions effectively illustrate complex phenomena, which are not precisely described by classical mathematics.

The fuzzy graphs idea and concept are discussed by Smarandache and Rosenfeld [27]. The fuzzy graphs application has been extended in few years and it has a scope from 19th century [4,5,10,11,15,16]. It is not necessarily true membership degree of 1, also, the

nonmembership degree and indeterminacy occur. Nonmembership degree is presented by Atanassove [3] in an intuitionistic fuzzy set. Shao *et al.* [31] labeled new concepts of bondage number in intuitionistic fuzzy graph. Rashmanlou *et al.* [20–26] introduced new concepts in bipolar fuzzy graph and interval-valued fuzzy graphs. Krishna *et al.* [13,14] analyzed the concept of vague set and vague graph. Devi *et al.* [8] investigated new ways in intuitionistic fuzzy labeling graph. Pythagorean fuzzy set also known as IF-set of type-2 [1] is the extension of intuitionistic fuzzy set (IF-set). Parvathi and Karunambigai [19] studied about Intuitionistic fuzzy graphs. After while, Smarandache [31] included the indeterminacy concept in a neutrosophic set. Neutrosophy is the kind of philosophy which analyzes the nature and scope of neutralities. Neutrosophic set is the speculation of fuzzy set and furthermore neutrosophic rationale is the expansion of fuzzy rationale. Smarandache gives the possibility of a neutrosophic set due to introducing the vulnerability in the issues of different fields like clinical science and financial aspects and so forth. He portrayed significant classifications [29] of neutrosophic diagrams from which two classifications are relied upon the strict indeterminacy and other two classes depended [7] on its (t, i, f) parts. Malik and Hassan [12] presented the classification of bipolar single-valued neutrosophic graph (SVNG) classification. Later Malik and Naz *et al.* [17] described new operations on SVNG. Naz *et al.* [17] discussed operations on single-valued neutrosophic graphs with application. Malik *et al.* [18] also investigated some properties of bipolar SVNG. Product operations have applications in different branches, such as coding theory, network designs, chemical graph theory, and others. Many scholars discussed product operations on various generalized FGs. Mordeson and Peng [16] defined some of these product operations on FGs and some new fuzzy models are discussed in [33–38].

In this research, some new properties, including maximal product, symmetric difference, residue product, and rejection of SVNG are presented. Also, the examples of these operations are discussed. We found the degree and the total degree of SVNG. Finally, an application was illustrated in the food and agriculture organization with an algorithm to highlight the contributions of this research article in practical applications.

2. PRELIMINARIES

In this section, the key preliminary notions and definitions that are used in this current research study will be introduced.

Definition 1. [9] A graph $G = (V, E)$ is an ordered pair of set of vertices and set of edges.

Definition 2. [30] Suppose that X is a space of points with generic element in X denoted by x . Then, the neutrosophic set M (NS-M) is defined as $M = \langle x : T_M(x), I_M(x), F_M(x) \rangle, x \in X$ which obey $0 \leq \{T_M(x) + I_M(x) + F_M(x)\} \leq 3$. $T_M : V \rightarrow [0, 1]$, $I_M : V \rightarrow [0, 1]$, and $F_M : V \rightarrow [0, 1]$ represents the degree of true membership function, degree of indeterminacy membership function, and degree of false membership function of the element $x \in X$, respectively.

Definition 3. [27] A SVNG $G = (M, N)$ with underlying set of V is defined to be a pair of $G = (V, E)$ which is defined as (i) $T_M : V \rightarrow [0, 1]$, $F_M : V \rightarrow [0, 1]$ and $I_M : V \rightarrow [0, 1]$ represents the degree of true membership function, degree of false membership function,

and degree of indeterminacy membership function of the element $m \in V$, respectively, where $0 \leq T_M(m) + I_M(m) + F_M(m) \leq 3, \forall m \in V$.

(ii) The function $T_N : E \rightarrow [0, 1]$, $I_N : E \rightarrow [0, 1]$ and $F_N : E \rightarrow [0, 1]$ are defined by

$$\begin{aligned} T_N(mn) &\leq \min \{T_M(m), T_M(n)\} \\ I_N(mn) &\geq \max \{I_M(m), I_M(n)\} \\ F_N(mn) &\geq \max \{F_M(m), F_M(n)\}. \end{aligned}$$

It is free of any restriction so $0 \leq T_N(mn) + I_N(mn) + F_N(mn) \leq 3$.

Example 1. Consider the Figure 1 such that $V = \{a, b, c\}$, $E = \{ab, bc, ca\}$, $M = \langle \left(\frac{a}{0.3}, \frac{b}{0.2}, \frac{c}{0.4}\right), \left(\frac{a}{0.6}, \frac{b}{0.4}, \frac{c}{0.5}\right), \left(\frac{a}{0.2}, \frac{b}{0.2}, \frac{c}{0.1}\right) \rangle$, and $N = \langle \left(\frac{ab}{0.1}, \frac{bc}{0.1}, \frac{ac}{0.2}\right), \left(\frac{ab}{0.7}, \frac{bc}{0.6}, \frac{ac}{0.8}\right), \left(\frac{ab}{0.3}, \frac{bc}{0.2}, \frac{ac}{0.3}\right) \rangle$.

By routine computations, it is easy to show that G is a SVNG.

Definition 4. A SVNG G is said to be strong if $T_N(mn) = \min(T_M(m), T_M(n))$, $I_N(mn) = \max(I_M(m), I_M(n))$ and $F_N(mn) = \max(F_M(m), F_M(n))$, for all mn in V .

Definition 5. A SVNG G is said to be complete if $T_N(mn) = \min(T_M(m), T_M(n))$, $I_N(mn) = \max(I_M(m), I_M(n))$ and $F_N(mn) = \max(F_M(m), F_M(n))$, for all m, n in E .

Definition 6. A SVNG G is said to be connected if $T_N^\infty(m_i m_j) > 0$, $I_N^\infty(m_i m_j) < 1$, $F_N^\infty(m_i m_j) < 1$, for all $m_i, m_j \in V$. Also, we have

$$T_N^\infty(mn) = \sup \{T_N(mn_1) \wedge T_N(n_1 n_2) \wedge T_N(n_2 n_3) \wedge \dots \wedge T_N(n_{k-1} n) \mid m, n_1, n_2, \dots, n_{k-1}, n \in V\},$$

$$I_N^\infty(mn) = \inf \{I_N(mn_1) \vee I_N(n_1 n_2) \vee I_N(n_2 n_3) \vee \dots \vee I_N(n_{k-1} n) \mid m, n_1, n_2, \dots, n_{k-1}, n \in V\}.$$

and

$$F_N^\infty(mn) = \inf \{F_N(mn_1) \vee F_N(n_1 n_2) \vee F_N(n_2 n_3) \vee \dots \vee F_N(n_{k-1} n) \mid m, n_1, n_2, \dots, n_{k-1}, n \in V\}.$$

3. OPERATIONS ON SVNGs

In this section, we define four new kinds of operations on (SVNGs) including maximal product, residue product, rejection, and symmetric difference. We show that maximal product, residue product, and rejection of two (SVNGs) are a SVNG.

Definition 7. The maximal product $G_1 * G_2 = (M_1 * M_2, N_1 * N_2)$ of two (SVNGs) $G_1 = (M_1, N_1)$ and $G_2 = (M_2, N_2)$ is defined as

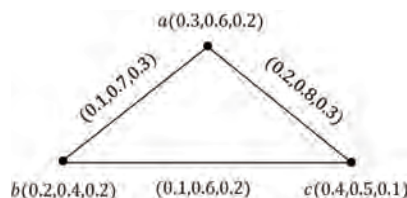

Figure 1 | SVNG(G).

- (i) $(T_{M_1} * T_{M_2})((m_1, m_2)) = \max \{T_{M_1}(m_1), T_{M_2}(m_2)\}$
 $(I_{M_1} * I_{M_2})((m_1, m_2)) = \min \{I_{M_1}(m_1), I_{M_2}(m_2)\}$
 $(F_{M_1} * F_{M_2})((m_1, m_2)) = \min \{F_{M_1}(m_1), F_{M_2}(m_2)\}$
 $\forall (m_1, m_2) \in (V_1 \times V_2),$
- (ii) $(T_{M_1} * T_{M_2})((m, m_2)(m, n_2)) = \max \{T_{M_1}(m), T_{N_2}(m_2 n_2)\}$
 $(I_{M_1} * I_{M_2})((m, m_2)(m, n_2)) = \min \{I_{M_1}(m), I_{N_2}(m_2 n_2)\}$
 $(F_{M_1} * F_{M_2})((m, m_2)(m, n_2)) = \min \{F_{M_1}(m), F_{N_2}(m_2 n_2)\}$
 $\forall m \in V_1 \text{ and } m_2 n_2 \in E_2.$
- (iii) $(T_{M_1} * T_{M_2})((m_1, z)(n_1, z)) = \max \{T_{N_1}(m_1 n_1), T_{M_2}(z)\}$
 $(I_{M_1} * I_{M_2})((m_1, z)(n_1, z)) = \min \{I_{N_1}(m_1 n_1), I_{M_2}(z)\}$
 $(F_{M_1} * F_{M_2})((m_1, z)(n_1, z)) = \min \{F_{N_1}(m_1 n_1), F_{M_2}(z)\}$
 $\forall z \in V_2 \text{ and } m_1 n_1 \in E_1.$

Example 2. Consider two (SVNGs) $G_1 = (M_1, N_1)$ and $G_2 = (M_2, N_2)$, as shown in Figures 2 and 3. Their maximal product $G_1 * G_2$ is shown in Figure 4.

For vertex (e, a) , we find membership value, indeterminacy and nonmembership value as follows:

$$(T_{M_1} * T_{M_2})((e, a)) = \max \{T_{M_1}(e), T_{M_2}(a)\} = \max \{0.3, 0.1\} = 0.3,$$

$$(I_{M_1} * I_{M_2})((e, a)) = \min \{I_{M_1}(e), I_{M_2}(a)\} = \min \{0.4, 0.3\} = 0.3,$$

$$(F_{M_1} * F_{M_2})((e, a)) = \min \{F_{M_1}(e), F_{M_2}(a)\} = \min \{0.5, 0.4\} = 0.4,$$

for $e \in V_1$ and $a \in V_2$. For edge $(e, a)(e, b)$, we find membership value, indeterminacy, and nonmembership value.

$$(T_{M_1} * T_{M_2})((e, a)(e, b)) = \max \{T_{M_1}(e), T_{N_2}(ab)\} = \max \{0.3, 0.1\} = 0.3,$$

$$(I_{M_1} * I_{M_2})((e, a)(e, b)) = \min \{I_{M_1}(e), I_{N_2}(ab)\} = \min \{0.4, 0.4\} = 0.4,$$

$$(F_{M_1} * F_{M_2})((e, a)(e, b)) = \min \{F_{M_1}(e), F_{N_2}(ab)\} = \min \{0.5, 0.4\} = 0.4,$$

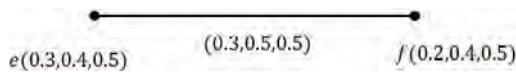

Figure 2 | G_1 .

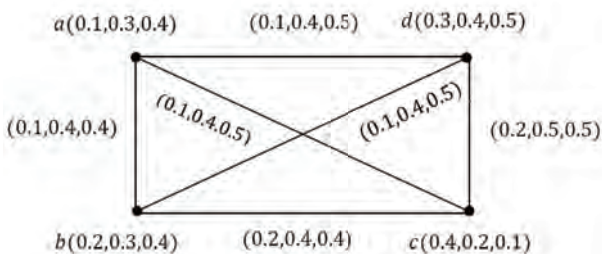

Figure 3 | G_2 .

for $e \in V_1$ and $ab \in E_2$. Now, for edge $(e, a)(f, a)$ we have:

$$(T_{M_1} * T_{M_2})((e, a)(f, a)) = \max \{T_{N_1}(ef), T_{M_2}(a)\} = \max \{0.3, 0.1\} = 0.3,$$

$$(I_{M_1} * I_{M_2})((e, a)(f, a)) = \min \{I_{N_1}(ef), I_{M_2}(a)\} = \min \{0.5, 0.3\} = 0.3,$$

$$(F_{M_1} * F_{M_2})((e, a)(f, a)) = \min \{F_{N_1}(ef), F_{M_2}(a)\} = \min \{0.5, 0.4\} = 0.4,$$

for $a \in V_2$ and $ef \in E_1$.

Similarly, we can find membership, indeterminacy, and nonmembership value for all remaining vertices and edges.

Proposition 1. The maximal product of two (SVNGs) G_1 and G_2 , is a SVNG.

Proof. Let $G_1 = (M_1, N_1)$ and $G_2 = (M_2, N_2)$ be two (SVNGs) on crisp graphs $G_1 = (V_1, E_1)$ and $G_2 = (V_2, E_2)$, respectively and $((m_1, m_2)(n_1, n_2)) \in E_1 \times E$. Then, by Definition 7, we have two cases:

- (i) If $m_1 = n_1 = m$

$$(T_{N_1} * T_{N_2})((m, m_2)(m, n_2)) = \max \{T_{M_1}(m), T_{N_2}(m_2 n_2)\} \leq \max \{T_{M_1}(m), \min \{T_{M_2}(m_2), T_{M_2}(n_2)\}\} = \min \{\max \{T_{M_1}(m), T_{M_2}(m_2)\}, \max \{T_{M_1}(m), T_{M_2}(n_2)\}\} = \min \{(T_{M_1} * T_{M_2})(m, m_2), (T_{M_1} * T_{M_2})(m, n_2)\},$$

$$(I_{N_1} * I_{N_2})((m, m_2)(m, n_2)) = \min \{I_{M_1}(m), I_{N_2}(m_2 n_2)\} \geq \min \{I_{M_1}(m), \max \{I_{M_2}(m_2), I_{M_2}(n_2)\}\} = \max \{\min \{I_{M_1}(m), I_{M_2}(m_2)\}, \min \{I_{M_1}(m), I_{M_2}(n_2)\}\} = \max \{(I_{M_1} * I_{M_2})(m, m_2), (I_{M_1} * I_{M_2})(m, n_2)\},$$

$$(F_{N_1} * F_{N_2})((m, m_2)(m, n_2)) = \min \{F_{M_1}(m), F_{N_2}(m_2 n_2)\} \geq \min \{F_{M_1}(m), \max \{F_{M_2}(m_2), F_{M_2}(n_2)\}\} = \max \{\min \{F_{M_1}(m), F_{M_2}(m_2)\}, \min \{F_{M_1}(m), F_{M_2}(n_2)\}\} = \max \{(F_{M_1} * F_{M_2})(m, m_2), (F_{M_1} * F_{M_2})(m, n_2)\}.$$

- (ii) If $m_2 = n_2 = z$

$$(T_{N_1} * T_{N_2})((m_1, z)(n_1, z)) = \max \{T_{N_1}(m_1 n_1), T_{M_2}(z)\} \leq \max \{\min \{T_{N_1}(m_1 n_1), T_{M_2}(z)\}\} = \min \{\max \{T_{N_1}(m_1), T_{M_2}(z)\}, \max \{T_{M_1}(n_1), T_{M_2}(z)\}\} = \min \{(T_{M_1} * T_{M_2})(m_1, z), (T_{M_1} * T_{M_2})(n_1, z)\},$$

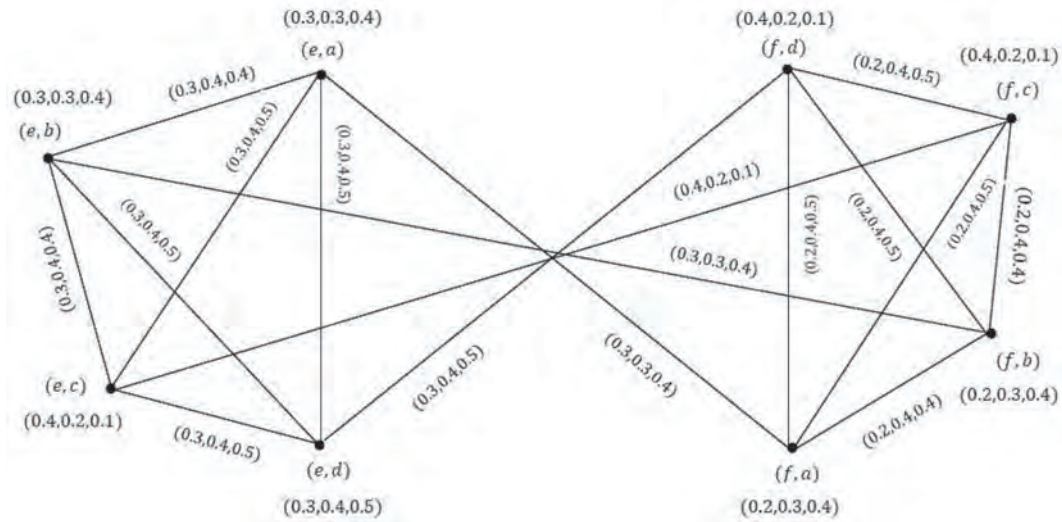

Figure 4 | $G_1 * G_2$.

$$\begin{aligned}
 & (I_{N_1} * I_{N_2}) ((m_1, z) (n_1, z)) \\
 &= \min \{ I_{N_1} (m_1 n_1), I_{M_2} (z) \} \\
 &\geq \min \{ \max \{ I_{N_1} (m_1 n_1), I_{M_2} (z) \} \\
 &= \max \{ \min \{ \{ I_{M_1} (m_1), I_{M_2} (z) \}, \\
 &\quad \min \{ \{ I_{M_1} (n_1), I_{M_2} (z) \} \} \\
 &= \max \{ (I_{M_1} * I_{M_2}) (m_1, z), (I_{M_1} * I_{M_2}) (n_1, z) \},
 \end{aligned}$$

$$\begin{aligned}
 & (I_{N_1} * I_{N_2}) ((m, m_2) (m, n_2)) \\
 &= \min \{ I_{M_1} (m), I_{N_2} (m_2 n_2) \} \\
 &= \min \{ I_{M_1} (m), \max \{ I_{M_2} (m_2), I_{M_2} (n_2) \} \} \\
 &= \max \{ \min \{ \{ I_{M_1} (m), I_{M_2} (m_2) \}, \\
 &\quad \min \{ \{ I_{M_1} (m), I_{M_2} (n_2) \} \} \\
 &= \max \{ (I_{M_1} * I_{M_2}) (m, m_2), (I_{M_1} * I_{M_2}) (m, n_2) \},
 \end{aligned}$$

$$\begin{aligned}
 & (F_{N_1} * F_{N_2}) ((m_1, z) (n_1, z)) \\
 &= \min \{ F_{N_1} (m_1 n_1), F_{M_2} (z) \} \\
 &\geq \min \{ \max \{ F_{N_1} (m_1 n_1), F_{M_2} (z) \} \\
 &= \max \{ \min \{ \{ F_{M_1} (m_1), F_{M_2} (z) \}, \\
 &\quad \min \{ \{ F_{M_1} (n_1), F_{M_2} (z) \} \} \\
 &= \max \{ (F_{M_1} * F_{M_2}) (m_1, z), (F_{M_1} * F_{M_2}) (n_1, z) \}.
 \end{aligned}$$

$$\begin{aligned}
 & (F_{N_1} * F_{N_2}) ((m, m_2) (m, n_2)) \\
 &= \min \{ F_{M_1} (m), F_{N_2} (m_2 n_2) \} \\
 &= \min \{ F_{M_1} (m), \max \{ F_{M_2} (m_2), F_{M_2} (n_2) \} \} \\
 &= \max \{ \min \{ \{ F_{M_1} (m), F_{M_2} (m_2) \}, \min \{ \{ F_{M_1} (m), F_{M_2} (n_2) \} \} \} \\
 &= \max \{ (F_{M_1} * F_{M_2}) (m, m_2), (F_{M_1} * F_{M_2}) (m, n_2) \}.
 \end{aligned}$$

(ii) If $m_2 = n_2 = z$

$$\begin{aligned}
 & (T_{N_1} * T_{N_2}) ((m_1, z) (n_1, z)) \\
 &= \max \{ T_{N_1} (m_1 n_1), T_{M_2} (z) \} \\
 &= \max \{ \min \{ T_{N_1} (m_1 n_1), T_{M_2} (z) \} \\
 &= \min \{ \max \{ \{ T_{N_1} (m_1), T_{M_2} (z) \}, \\
 &\quad \max \{ \{ T_{M_1} (n_1), T_{M_2} (z) \} \} \\
 &= \min \{ (T_{M_1} * T_{M_2}) (m_1, z), (T_{M_1} * T_{M_2}) (n_1, z) \},
 \end{aligned}$$

Therefore, $G_1 * G_2$ is a SVNG. \square

Theorem 2. The maximal product of two strong-(SVNGS) G_1 and G_2 , is a strong-SVNG.

Proof. Let $G_1 = (M_1, N_1)$ and $G_2 = (M_2, N_2)$ be two strong-(SVNGS) on crisp graphs $G_1 = (V_1, E_1)$ and $G_2 = (V_2, E_2)$, respectively and $((m_1, m_2)(n_1, n_2)) \in E_1 \times E_2$. Then by Proposition 1, $G_1 * G_2$ is a SVNG. Now we have two cases:

(i) If $m_1 = n_1 = m$

$$\begin{aligned}
 & (T_{N_1} * T_{N_2}) ((m, m_2) (m, n_2)) \\
 &= \max \{ T_{M_1} (m), T_{N_2} (m_2 n_2) \} \\
 &= \max \{ T_{M_1} (m), \min \{ T_{M_2} (m_2), T_{M_2} (n_2) \} \} \\
 &= \min \{ \max \{ \{ T_{M_1} (m), T_{M_2} (m_2) \} \\
 &\quad \max \{ \{ T_{M_1} (m), T_{M_2} (n_2) \} \} \\
 &= \min \{ (T_{M_1} * T_{M_2}) (m, m_2), (T_{M_1} * T_{M_2}) (m, n_2) \},
 \end{aligned}$$

$$\begin{aligned}
 & (I_{N_1} * I_{N_2}) ((m_1, z) (n_1, z)) \\
 &= \min \{ I_{N_1} (m_1 n_1), I_{M_2} (z) \} \\
 &= \min \{ \max \{ I_{N_1} (m_1 n_1), I_{M_2} (z) \} \\
 &= \max \{ \min \{ \{ I_{M_1} (m_1), I_{M_2} (z) \}, \\
 &\quad \min \{ \{ I_{M_1} (n_1), I_{M_2} (z) \} \} \\
 &= \max \{ (I_{M_1} * I_{M_2}) (m_1, z), (I_{M_1} * I_{M_2}) (n_1, z) \},
 \end{aligned}$$

$$\begin{aligned}
 & (F_{N_1} * F_{N_2})((m_1, z)(n_1, z)) \\
 &= \min \{F_{N_1}(m_1 n_1), F_{M_2}(z)\} \\
 &= \min \{ \max \{F_{N_1}(m_1 n_1), F_{M_2}(z)\} \\
 &= \max \{ \min \{ \{F_{M_1}(m_1), F_{M_2}(z)\}, \\
 &\quad \min \{ \{F_{M_1}(n_1), F_{M_2}(z)\} \} \\
 &= \max \{ (F_{M_1} * F_{M_2})(m_1, z), (F_{M_1} * F_{M_2})(n_1, z) \}.
 \end{aligned}$$

Therefore, $G_1 * G_2$ is a strong-SVNG. □

Example 3. Consider the strong-(SVNGS) G_1 and G_2 as in Figure 5. It is easy to see that $G_1 * G_2$ is a strong-SVNG, too.

Remark 1. If the maximal product of two (SVNGs) $G_1 = (M_1, N_1)$ and $G_2 = (M_2, N_2)$ is strong, then $G_1 = (M_1, N_1)$ and $G_2 = (M_2, N_2)$ need not to be strong, in general.

Example 4. Consider the (SVNGs) G_1 and G_2 as in Figures 6 and 7. We can see that the maximal product of two (SVNGs) G_1 and G_2 , that is $G_1 * G_2$ in Figure 8.

Then G_1 and $G_1 * G_2$ are strong-(SVNGS), but G_2 is not strong. Since $T_{N_2}(m_2, n_2) = 0.1$, but

$\min\{T_{M_2}(m_2), T_{M_2}(n_2) = \min\{0.2, 0.2\} = 0.2$. Hence, $T_{N_2}(m_2, n_2) \neq \min\{T_{M_2}(m_2), T_{M_2}(n_2)$.

Theorem 3. The maximal product of two connected-(SVNGs) is a connected-SVNG.

Proof. Let $G_1 = (M_1, N_1)$ and $G_2 = (M_2, N_2)$ be two connected-(SVNGs) on crisp graphs $G_1 = (V_1, E_1)$ and $G_2 = (V_2, E_2)$, respectively, where $V_1 = \{m_1, m_2, \dots, m_k\}$ and $V_2 = \{n_1, n_2, \dots, n_s\}$. Then $T_{N_1}^\infty(m_i, m_j) > 0$, for all $m_i, m_j \in V_1$ and $T_{N_2}^\infty(n_i, n_j) > 0$, for all $n_i, n_j \in V_2$ (or $I_{N_1}^\infty(m_i, m_j) < 1$, for all $m_i, m_j \in V_1$ and $I_{N_2}^\infty(n_i, n_j) < 1$, for all $n_i, n_j \in V_2$ (or $F_{N_1}^\infty(m_i, m_j) < 1$, for all $m_i, m_j \in V_1$ and $F_{N_2}^\infty(n_i, n_j) < 1$, for all $n_i, n_j \in V_2$). The maximal product of $G_1 = (M_1, N_1)$ and $G_2 = (M_2, N_2)$ can be taken as $G = (M, N)$. Now, consider the 'k' subgraphs of G with the vertex set $\{(m_i, n_1), (m_i, n_2), \dots, (m_i, n_s)\}$, for $i = 1, 2, \dots, k$. Each of these subgraphs of G is connected, since the m_i 's are the same and since G_2 is connected, each n_i is adjacent to at least one of the vertices in V_2 . Also, since G_1 is connected, each x_i is adjacent to at least one of the vertices in V_1 .

Hence, there exists at least one edge between any pair of the above "k" subgraphs. Thus we have $T_N^\infty((m_i, n_j)(m_m, n_n)) > 0$ or $I_N^\infty((m_i, n_j)(m_m, n_n)) < 1$ (or $F_N^\infty((m_i, n_j)(m_m, n_n)) < 1$) for all $((m_i, n_j)(m_m, n_n)) \in E$. Hence, G is a connected-SVNG. □

Remark 2. The maximal product of two complete-(SVNGs) is not a complete-SVNG, in general. Because we do not include the case $(m_1, m_2) \in E_1$ and $(n_1, n_2) \in E_2$ in the definition of the maximal product of two (SVNGs).

Remark 3. The maximal product of two complete-(SVNGS) is a strong-SVNG.

Example 5. Consider the complete-(SVNGs) G_1 and G_2 as in Figure 5. A simple calculation concludes that $G_1 * G_2$ is a strong-SVNG.

Definition 8. Let $G_1 = (M_1, N_1)$ and $G_2 = (M_2, N_2)$ be two (SVNGs). $\forall (m_1, m_2) \in V_1 \times V_2$:

$$\begin{aligned}
 (d_T)_{G_1 * G_2}(m_1, m_2) &= \\
 & \sum_{(m_1, m_2)(n_1, n_2) \in E_1 \times E_2} (T_{N_1} * T_{N_2})((m_1, m_2)(n_1, n_2)) = \\
 & \sum_{m_1=n_1, m_2=n_2 \in E_2} \max \{T_{M_1}(m_1), T_{N_2}(m_2, n_2)\} + \\
 & \sum_{m_1, n_1 \in E_1, m_2=n_2} \max \{T_{N_1}(m_1, n_1), T_{M_2}(m_2)\},
 \end{aligned}$$

$$\begin{aligned}
 (d_I)_{G_1 * G_2}(m_1, m_2) &= \\
 & \sum_{(m_1, m_2)(n_1, n_2) \in E_1 \times E_2} (I_{N_1} * I_{N_2})((m_1, m_2)(n_1, n_2)) = \\
 & \sum_{m_1=n_1, m_2=n_2 \in E_2} \min \{I_{M_1}(m_1), I_{N_2}(m_2, n_2)\} + \\
 & \sum_{m_1, n_1 \in E_1, m_2=n_2} \min \{I_{N_1}(m_1, n_1), I_{M_2}(m_2)\},
 \end{aligned}$$

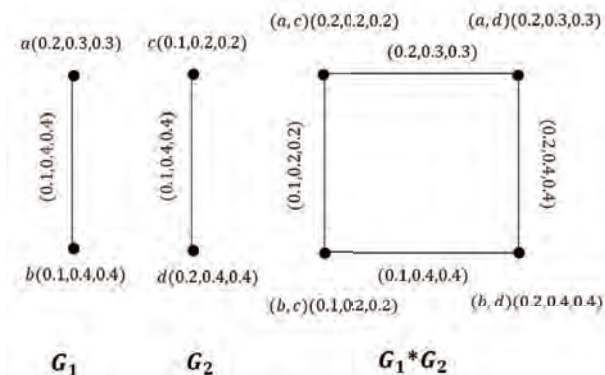

Figure 5 | Single-valued neutrosophic graphs.

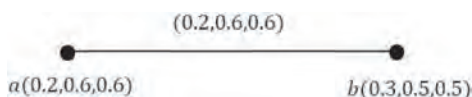

Figure 6 | G_1 .

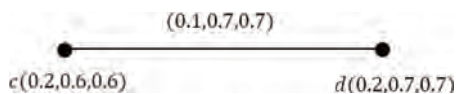

Figure 7 | G_2 .

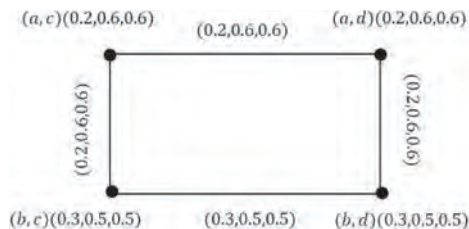

Figure 8 | $G_1 * G_2$.

$$\begin{aligned}
 (d_F)_{G_1 * G_2} (m_1, m_2) &= \\
 &\sum_{(m_1, m_2)(n_1, n_2) \in E_1 \times E_2} (F_{N_1} * F_{N_2}) ((m_1, m_2) (n_1, n_2)) = \\
 &\sum_{m_1=n_1, m_2 n_2 \in E_2} \min \{F_{M_1} (m_1), F_{N_2} (m_2 n_2)\} + \\
 &\sum_{m_1 n_1 \in E_1, m_2=n_2} \min \{F_{N_1} (m_1 n_1), F_{M_2} (m_2)\}.
 \end{aligned}$$

$$\begin{aligned}
 (d_F)_{G_1 * G_2} (m_1, m_2) &= \\
 &\sum_{(m_1, m_2)(n_1, n_2) \in E_1 \times E_2} (F_{N_1} * F_{N_2}) ((m_1, m_2) (n_1, n_2)) \\
 &= \sum_{m_1=n_1, m_2 n_2 \in E_2} \min \{F_{M_1} (m_1), F_{N_2} (m_2 n_2)\} \\
 &\quad + \sum_{m_1 n_1 \in E_1, m_2=n_2} \min \{F_{N_1} (m_1 n_1), F_{M_2} (m_2)\} \\
 &= \sum_{m_2 n_2 \in E_2, m_1=n_1} F_{N_2} (m_2 n_2) + \sum_{m_1 n_1 \in E_1, m_2=n_2} F_{N_1} (m_1 n_1) \\
 &= (d)_{G_2} (m_2) F_{M_1} (m_1) + (d)_{G_1} (m_1) F_{M_2} (m_2).
 \end{aligned}$$

Theorem 4. Let $G_1 = (M_1, N_1)$ and $G_2 = (M_2, N_2)$ are two (SVNGs). If $T_{M_1} \geq T_{N_2}, I_{M_1} \leq I_{N_2}, F_{M_1} \leq F_{N_2}$ and $T_{M_2} \geq T_{N_1}, I_{M_2} \leq I_{N_1}, F_{M_2} \leq F_{N_1}$ then for every $(m_1, m_2) \in V_1 \times V_2$ we have:

Example 6. Consider the (SVNGs) G_1, G_2 , and $G_1 * G_2$ as in Figure 9. Since $T_{M_1} \geq T_{N_2}, I_{M_1} \leq I_{N_2}, F_{M_1} \leq F_{N_2}, T_{M_2} \geq T_{N_1}, I_{M_2} \leq I_{N_1}$ and $F_{M_2} \leq F_{N_1}$ by Theorem 4, we have

$$\begin{aligned}
 (d_T)_{G_1 * G_2} (m_1, m_2) &= (d)_{G_2} (m_2) T_{M_1} (m_1) \\
 &\quad + (d)_{G_1} (m_1) T_{M_2} (m_2), \\
 (d_I)_{G_1 * G_2} (m_1, m_2) &= (d)_{G_2} (m_2) I_{M_1} (m_1) \\
 &\quad + (d)_{G_1} (m_1) I_{M_2} (m_2), \\
 (d_F)_{G_1 * G_2} (m_1, m_2) &= (d)_{G_2} (m_2) F_{M_1} (m_1) \\
 &\quad + (d)_{G_1} (m_1) F_{M_2} (m_2).
 \end{aligned}$$

$$\begin{aligned}
 (d_T)_{G_1 * G_2} (a, c) &= (d)_{G_2} (c) T_{M_1} (a) + (d)_{G_1} (a) T_{M_2} (c) \\
 &= 1 \cdot (0.3) + 1 \cdot (0.2) = 0.5, \\
 (d_I)_{G_1 * G_2} (a, c) &= (d)_{G_2} (c) I_{M_1} (a) + (d)_{G_1} (a) I_{M_2} (c) \\
 &= 1 \cdot (0.4) + 1 \cdot (0.3) = 0.7, \\
 (d_F)_{G_1 * G_2} (a, c) &= (d)_{G_2} (c) F_{M_1} (a) + (d)_{G_1} (a) F_{M_2} (c) \\
 &= 1 \cdot (0.4) + 1 \cdot (0.3) = 0.7.
 \end{aligned}$$

Proof.

$$\begin{aligned}
 (d_T)_{G_1 * G_2} (m_1, m_2) &= \\
 &\sum_{(m_1, m_2)(n_1, n_2) \in E_1 \times E_2} (T_{N_1} * T_{N_2}) ((m_1, m_2) (n_1, n_2)) \\
 &= \sum_{m_1=n_1, m_2 n_2 \in E_2} \max \{T_{M_1} (m_1), T_{N_2} (m_2 n_2)\} \\
 &\quad + \sum_{m_1 n_1 \in E_1, m_2=n_2} \max \{T_{N_1} (m_1 n_1), T_{M_2} (m_2)\} \\
 &= \sum_{m_2 n_2 \in E_2, m_1=n_1} T_{N_2} (m_2 n_2) + \sum_{m_1 n_1 \in E_1, m_2=n_2} T_{N_1} (m_1 n_1) \\
 &= (d)_{G_2} (m_2) T_{M_1} (m_1) + (d)_{G_1} (m_1) T_{M_2} (m_2),
 \end{aligned}$$

$$\begin{aligned}
 (d_T)_{G_1 * G_2} (a, d) &= (d)_{G_2} (d) T_{M_1} (a) + (d)_{G_1} (a) T_{M_2} (d) \\
 &= 1 \cdot (0.3) + 1 \cdot (0.3) = 0.6, \\
 (d_I)_{G_1 * G_2} (a, d) &= (d)_{G_2} (d) I_{M_1} (a) + (d)_{G_1} (a) I_{M_2} (d) \\
 &= 1 \cdot (0.4) + 1 \cdot (0.4) = 0.8, \\
 (d_F)_{G_1 * G_2} (a, d) &= (d)_{G_2} (d) F_{M_1} (a) + (d)_{G_1} (a) F_{M_2} (d) \\
 &= 1 \cdot (0.4) + 1 \cdot (0.4) = 0.8.
 \end{aligned}$$

$$\begin{aligned}
 (d_I)_{G_1 * G_2} (m_1, m_2) &= \\
 &\sum_{(m_1, m_2)(n_1, n_2) \in E_1 \times E_2} (I_{N_1} * I_{N_2}) ((m_1, m_2) (n_1, n_2)) \\
 &= \sum_{m_1=n_1, m_2 n_2 \in E_2} \min \{I_{M_1} (m_1), I_{N_2} (m_2 n_2)\} \\
 &\quad + \sum_{m_1 n_1 \in E_1, m_2=n_2} \min \{I_{N_1} (m_1 n_1), I_{M_2} (m_2)\} \\
 &= \sum_{m_2 n_2 \in E_2, m_1=n_1} I_{N_2} (m_2 n_2) + \sum_{m_1 n_1 \in E_1, m_2=n_2} I_{N_1} (m_1 n_1) \\
 &= (d)_{G_2} (m_2) I_{M_1} (m_1) + (d)_{G_1} (m_1) I_{M_2} (m_2),
 \end{aligned}$$

$$\begin{aligned}
 (d_T)_{G_1 * G_2} (b, c) &= (d)_{G_2} (c) T_{M_1} (b) + (d)_{G_1} (b) T_{M_2} (c) \\
 &= 1 \cdot (0.2) + 1 \cdot (0.2) = 0.4, \\
 (d_I)_{G_1 * G_2} (b, c) &= (d)_{G_2} (c) I_{M_1} (b) + (d)_{G_1} (b) I_{M_2} (c) \\
 &= 1 \cdot (0.3) + 1 \cdot (0.3) = 0.6, \\
 (d_F)_{G_1 * G_2} (b, c) &= (d)_{G_2} (c) F_{M_1} (b) + (d)_{G_1} (b) F_{M_2} (c) \\
 &= 1 \cdot (0.3) + 1 \cdot (0.3) = 0.6.
 \end{aligned}$$

$$\begin{aligned}
 (d_T)_{G_1 * G_2} (b, d) &= (d)_{G_2} (d) T_{M_1} (b) + (d)_{G_1} (b) T_{M_2} (d) \\
 &= 1 \cdot (0.2) + 1 \cdot (0.3) = 0.5, \\
 (d_I)_{G_1 * G_2} (b, d) &= (d)_{G_2} (d) I_{M_1} (b) + (d)_{G_1} (b) I_{M_2} (d) \\
 &= 1 \cdot (0.3) + 1 \cdot (0.4) = 0.7, \\
 (d_F)_{G_1 * G_2} (b, d) &= (d)_{G_2} (d) F_{M_1} (b) + (d)_{G_1} (b) F_{M_2} (d) \\
 &= 1 \cdot (0.3) + 1 \cdot (0.4) = 0.7.
 \end{aligned}$$

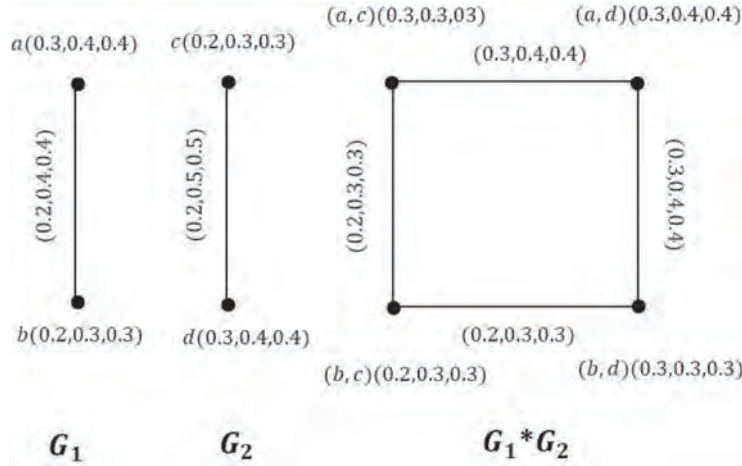

Figure 9 | Single-valued neutrosophic graphs.

By direct calculations:

$$\begin{aligned}
 (d_T)_{G_1 * G_2}(a, c) &= 0.3 + 0.2 = 0.5, \\
 (d_I)_{G_1 * G_2}(a, c) &= 0.4 + 0.3 = 0.7, \\
 (d_F)_{G_1 * G_2}(a, c) &= 0.4 + 0.3 = 0.7, \\
 (d_T)_{G_1 * G_2}(a, d) &= 0.3 + 0.3 = 0.6, \\
 (d_I)_{G_1 * G_2}(a, d) &= 0.4 + 0.4 = 0.8, \\
 (d_F)_{G_1 * G_2}(a, d) &= 0.4 + 0.4 = 0.8, \\
 (d_T)_{G_1 * G_2}(b, c) &= 0.2 + 0.2 = 0.4, \\
 (d_I)_{G_1 * G_2}(b, c) &= 0.3 + 0.3 = 0.6, \\
 (d_F)_{G_1 * G_2}(b, c) &= 0.3 + 0.3 = 0.6, \\
 (d_T)_{G_1 * G_2}(b, d) &= 0.3 + 0.2 = 0.5, \\
 (d_I)_{G_1 * G_2}(b, d) &= 0.3 + 0.4 = 0.7, \\
 (d_F)_{G_1 * G_2}(b, d) &= 0.3 + 0.4 = 0.7.
 \end{aligned}$$

It is clear from the above calculations that the degrees of vertices calculated by using the formula of the above theorem and by directed method are the same.

Definition 9. Let $G_1 = (M_1, N_1)$ and $G_2 = (M_2, N_2)$ be two (SVNGs). For any vertex $(m_1, m_2) \in V_1 \times V_2$ we have

$$\begin{aligned}
 (td_T)_{G_1 * G_2}(m_1, m_2) &= \\
 &\sum_{(m_1, m_2)(n_1, n_2) \in E_1 \times E_2} (T_{N_1} * T_{N_2})((m_1, m_2)(n_1, n_2)) \\
 &+ (T_{M_1} * T_{M_2}(m_1, m_2)) \\
 &= \sum_{m_1=n_1, m_2=n_2 \in E_2} \max\{T_{M_1}(m_1), T_{N_2}(m_2, n_2)\} \\
 &+ \sum_{m_1, n_1 \in E_1, m_2=n_2} \max\{T_{N_1}(m_1, n_1), T_{M_2}(m_2)\} \\
 &+ \max\{T_{M_1}(m_1), T_{M_2}(m_2)\},
 \end{aligned}$$

$$\begin{aligned}
 (td_I)_{G_1 * G_2}(m_1, m_2) &= \\
 &\sum_{(m_1, m_2)(n_1, n_2) \in E_1 \times E_2} (I_{N_1} * I_{N_2})((m_1, m_2)(n_1, n_2)) + \\
 &(I_{M_1} * I_{M_2}(m_1, m_2)) \\
 &= \sum_{m_1=n_1, m_2=n_2 \in E_2} \min\{I_{M_1}(m_1), I_{N_2}(m_2, n_2)\} \\
 &+ \sum_{m_1, n_1 \in E_1, m_2=n_2} \min\{I_{N_1}(m_1, n_1), I_{M_2}(m_2)\} \\
 &+ \min\{I_{M_1}(m_1), I_{M_2}(m_2)\},
 \end{aligned}$$

$$\begin{aligned}
 (td_F)_{G_1 * G_2}(m_1, m_2) &= \\
 &\sum_{(m_1, m_2)(n_1, n_2) \in E_1 \times E_2} (F_{N_1} * F_{N_2})((m_1, m_2)(n_1, n_2)) + \\
 &(F_{M_1} * F_{M_2}(m_1, m_2)) \\
 &= \sum_{m_1=n_1, m_2=n_2 \in E_2} \min\{F_{M_1}(m_1), F_{N_2}(m_2, n_2)\} \\
 &+ \sum_{m_1, n_1 \in E_1, m_2=n_2} \min\{F_{N_1}(m_1, n_1), F_{M_2}(m_2)\} \\
 &+ \min\{F_{M_1}(m_1), F_{M_2}(m_2)\}.
 \end{aligned}$$

Theorem 5. Let $G_1 = (M_1, N_1)$ and $G_2 = (M_2, N_2)$ be two (SVNGs). If $T_{M_1} \geq T_{N_2}, I_{M_1} \leq I_{N_2}, F_{M_1} \leq F_{N_2}$ and $T_{M_2} \geq T_{N_1}, I_{M_2} \leq I_{N_1}, F_{M_2} \leq F_{N_1}$, then for every $(m_1, m_2) \in V_1 \times V_2$ we have

$$\begin{aligned}
 (td_T)_{G_1 * G_2}(m_1, m_2) &= (d_{G_2}(m_2) T_{M_1}(m_1) + (d_{G_1}(m_1) T_{M_2}(m_2) \\
 &+ \max\{T_{M_1}(m_1), T_{M_2}(m_2)\}), \\
 (td_I)_{G_1 * G_2}(m_1, m_2) &= (d_{G_2}(m_2) I_{M_1}(m_1) + (d_{G_1}(m_1) I_{M_2}(m_2) \\
 &+ \min\{I_{M_1}(m_1), I_{M_2}(m_2)\}), \\
 (td_F)_{G_1 * G_2}(m_1, m_2) &= (d_{G_2}(m_2) F_{M_1}(m_1) + (d_{G_1}(m_1) F_{M_2}(m_2) \\
 &+ \min\{F_{M_1}(m_1), F_{M_2}(m_2)\}).
 \end{aligned}$$

Proof.

$$\begin{aligned}
 (td_T)_{G_1 * G_2}(m_1, m_2) &= \\
 &\sum_{(m_1, m_2)(n_1, n_2) \in E_1 \times E_2} (T_{N_1} * T_{N_2})((m_1, m_2)(n_1, n_2)) + \\
 &(T_{M_1} * T_{M_2})(m_1, m_2) \\
 &= \sum_{m_1=n_1, m_2, n_2 \in E_2} \max\{T_{M_1}(m_1), T_{N_2}(m_2, n_2)\} \\
 &\quad + \sum_{m_1, n_1 \in E_1, m_2=n_2} \max\{T_{N_1}(m_1, n_1), T_{M_2}(m_2)\} \\
 &+ \max\{T_{M_1}(m_1), T_{M_2}(m_2)\} \\
 &= \sum_{m_2, n_2 \in E_2, m_1=n_1} T_{N_2}(m_2, n_2) + \sum_{m_1, n_1 \in E_1, m_2=n_2} T_{N_1}(m_1, n_1) \\
 &+ \max\{T_{M_1}(m_1), T_{M_2}(m_2)\} \\
 &= (d_{G_2}(m_2) T_{M_1}(m_1) + (d_{G_1}(m_1) T_{M_2}(m_2) + \\
 &\max\{T_{M_1}(m_1), T_{M_2}(m_2)\}.
 \end{aligned}$$

$$\begin{aligned}
 (td_I)_{G_1 * G_2}(m_1, m_2) &= \\
 &\sum_{(m_1, m_2)(n_1, n_2) \in E_1 \times E_2} (I_{N_1} * I_{N_2})((m_1, m_2)(n_1, n_2)) + \\
 &(I_{M_1} * I_{M_2})(m_1, m_2) \\
 &= \sum_{m_1=n_1, m_2, n_2 \in E_2} \min\{I_{M_1}(m_1), I_{N_2}(m_2, n_2)\} \\
 &\quad + \sum_{m_1, n_1 \in E_1, m_2=n_2} \min\{I_{N_1}(m_1, n_1), I_{M_2}(m_2)\} \\
 &+ \min\{I_{M_1}(m_1), I_{M_2}(m_2)\} \\
 &= \sum_{m_2, n_2 \in E_2, m_1=n_1} I_{N_2}(m_2, n_2) + \sum_{m_1, n_1 \in E_1, m_2=n_2} I_{N_1}(m_1, n_1) \\
 &+ \min\{I_{M_1}(m_1), I_{M_2}(m_2)\} \\
 &= (d_{G_2}(m_2) I_{M_1}(m_1) + (d_{G_1}(m_1) I_{M_2}(m_2) \\
 &+ \min\{I_{M_1}(m_1), I_{M_2}(m_2)\}.
 \end{aligned}$$

$$\begin{aligned}
 (td_F)_{G_1 * G_2}(m_1, m_2) &= \\
 &\sum_{(m_1, m_2)(n_1, n_2) \in E_1 \times E_2} (F_{N_1} * F_{N_2})((m_1, m_2)(n_1, n_2)) + \\
 &(F_{M_1} * F_{M_2})(m_1, m_2) \\
 &= \sum_{m_1=n_1, m_2, n_2 \in E_2} \min\{F_{M_1}(m_1), F_{N_2}(m_2, n_2)\} \\
 &\quad + \sum_{m_1, n_1 \in E_1, m_2=n_2} \min\{F_{N_1}(m_1, n_1), F_{M_2}(m_2)\} \\
 &+ \min\{F_{M_1}(m_1), F_{M_2}(m_2)\} \\
 &= \sum_{m_2, n_2 \in E_2, m_1=n_1} F_{N_2}(m_2, n_2) + \sum_{m_1, n_1 \in E_1, m_2=n_2} F_{N_1}(m_1, n_1) \\
 &+ \min\{F_{M_1}(m_1), F_{M_2}(m_2)\} \\
 &= (d_{G_2}(m_2) F_{M_1}(m_1) + (d_{G_1}(m_1) F_{M_2}(m_2) \\
 &+ \min\{F_{M_1}(m_1), F_{M_2}(m_2)\}.
 \end{aligned}$$

Example 7. Consider the (SVNGs) G_1 , G_1 , and $G_1 * G_2$ as in Figures 2–4. We find the total degree of vertices in maximal product. Hence, we choose vertex (e, a) .

$$\begin{aligned}
 (td_T)_{G_1 * G_2}(e, a) &= (d_{G_2}(e) T_{M_1}(a) + (d_{G_1}(a) T_{M_2}(e) \\
 &\quad + \max\{T_{M_1}(e), T_{M_2}(a)\} \\
 &= 1(0.1) + 3(0.3) + \max\{0.1, 0.3\} \\
 &= 0.1 + 0.9 + 0.3 = 1.3 \\
 (td_I)_{G_1 * G_2}(e, a) &= (d_{G_2}(e) I_{M_1}(a) + (d_{G_1}(a) I_{M_2}(e) \\
 &\quad + \min\{I_{M_1}(e), I_{M_2}(a)\} \\
 &= 1(0.3) + 3(0.4) + \min\{0.3, 0.4\} \\
 &= 0.3 + 1.2 + 0.3 = 1.8 \\
 (td_F)_{G_1 * G_2}(e, a) &= (d_{G_2}(e) F_{M_1}(a) + (d_{G_1}(a) F_{M_2}(e) \\
 &\quad + \min\{F_{M_1}(e), F_{M_2}(a)\} \\
 &= 1(0.4) + 3(0.5) + \min\{0.4, 0.5\} \\
 &= 0.4 + 1.5 + 0.4 = 2.3.
 \end{aligned}$$

In the same way we can find the total degree for all remaining vertices.

Definition 10. The rejection $G_1 | G_2 = (M_1 | M_2, N_1 | N_2)$ of two (SVNGs) $G_1 = (M_1, N_1)$ and $G_2 = (M_2, N_2)$ is defined as

- (i) $(T_{M_1} | T_{M_2})((m_1, m_2)) = \min\{T_{M_1}(m_1), T_{M_2}(m_2)\}$
 $(I_{M_1} | I_{M_2})((m_1, m_2)) = \max\{I_{M_1}(m_1), I_{M_2}(m_2)\}$
 $(F_{M_1} | F_{M_2})((m_1, m_2)) = \max\{F_{M_1}(m_1), F_{M_2}(m_2)\}$
 $\forall (m_1, m_2) \in (V_1 \times V_2),$
- (ii) $(T_{N_1} | T_{N_2})((m, m_2)(m, n_2)) = \min\{T_{M_1}(m), \forall m \in T_{M_2}(m_2), T_{M_2}(n_2)\}$
 $(I_{N_1} | I_{N_2})((m, m_2)(m, n_2)) = \max\{I_{M_1}(m), I_{M_2}(m_2), I_{M_2}(n_2)\}$
 $(F_{N_1} | F_{N_2})((m, m_2)(m, n_2)) = \max\{F_{M_1}(m), \{F_{M_2}(m_2), F_{M_2}(n_2)\}$
 $V_2 \text{ and } m_2, n_2 \notin E_2,$
- (iii) $(T_{N_1} | T_{N_2})((m, m_2)(m, n_2)) = \min\{T_{M_1}(m), \forall z \in T_{M_2}(m_2), T_{M_2}(n_2)\}$
 $(I_{N_1} | I_{N_2})((m, m_2)(m, n_2)) = \max\{I_{M_1}(m), I_{M_2}(m_2), I_{M_2}(n_2)\}$
 $(F_{N_1} | F_{N_2})((m, m_2)(m, n_2)) = \max\{F_{M_1}(m), F_{M_2}(m_2), F_{M_2}(n_2)\}$
 $V_2 \text{ and } m_1, n_1 \notin E_1,$

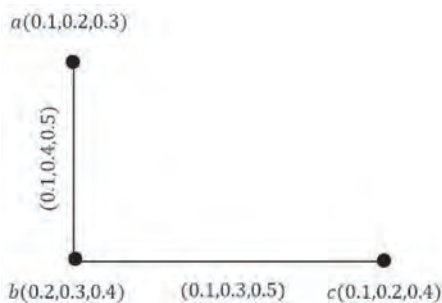

Figure 10 | G_1 .

Proposition 6. The rejection of two (SVNGs) G_1 and G_2 , is a SVNG.

Proof. Let $G_1 = (M_1, N_1)$ and $G_2 = (M_2, N_2)$ be two (SVNGs) on crisp graphs $G_1 = (V_1, E_1)$ and $G_2 = (V_2, E_2)$, respectively and $(m_1, m_2)(n_1, n_2) \in E_1 \times E_2$. Then by Definition 10, we have

$$\begin{aligned} (I_{N_1} | I_{N_2}) ((m_1, m_2) (n_1, n_2)) &= \\ &= \max \{ I_{M_1} (m_1), I_{M_1} (n_1), I_{M_2} (m_2), I_{M_2} (n_2) \} \\ &= \max \{ \max \{ I_{M_1} (m_1), I_{M_2} (m_2) \}, \\ &\quad \max \{ I_{M_1} (n_1), I_{M_2} (n_2) \} \} \\ &= \max \{ (I_{M_1} | I_{M_2}) (m_1, m_2), (I_{M_1} | I_{M_2}) (n_1, n_2) \}, \end{aligned}$$

$$\begin{aligned} \text{(iv)} \quad (T_{N_1} | T_{N_2}) ((m_1, m_2) (n_1, n_2)) &= \min \{ T_{M_1} (m_1), T_{M_1} (n_1), \\ &\quad T_{M_2} (m_2), T_{M_2} (n_2) \} \\ (I_{N_1} | I_{N_2}) ((m_1, m_2) (n_1, n_2)) &= \max \{ I_{M_1} (m_1), I_{M_1} (n_1), \\ &\quad I_{M_2} (m_2), I_{M_2} (n_2) \} \\ (F_{N_1} | F_{N_2}) ((m_1, m_2) (n_1, n_2)) &= \max \{ F_{M_1} (m_1), F_{M_1} (n_1), \\ &\quad F_{M_2} (m_2), F_{M_2} (n_2) \} \\ \forall m_1 n_1 \notin E_1 \text{ and } m_2 n_2 \notin E_2. \end{aligned}$$

Example 8. Consider the (SVNGs) G_1 and G_2 as in Figures 10 and 11. We can see that the rejection of two (SVNGs) G_1 and G_2 , that is $G_1|G_2$ in Figure 12.

For vertex (e, a) , we find true membership value, indeterminacy, and false membership value as follows:

$$\begin{aligned} (T_{M_1} | T_{M_2}) ((e, a)) &= \min \{ T_{M_1} (e), T_{M_2} (a) \} \\ &= \min \{ 0.3, 0.1 \} = 0.1, \\ (I_{M_1} | I_{M_2}) ((e, a)) &= \max \{ I_{M_1} (e), I_{M_2} (a) \} \\ &= \max \{ 0.2, 0.2 \} = 0.2, \\ (F_{M_1} | F_{M_2}) ((e, a)) &= \max \{ F_{M_1} (e), F_{M_2} (a) \} \\ &= \max \{ 0.4, 0.3 \} = 0.4, \end{aligned}$$

for $a \in V_1$ and $e \in V_2$. For edge $(e, c)(e, a)$, we calculate true membership value, indeterminacy, and false membership value, also.

$$\begin{aligned} (T_{N_1} | T_{N_2}) ((e, c)(e, a)) &= \min \{ T_{M_1} (e), T_{M_2} (c), T_{M_2} (a) \} \\ &= \min \{ 0.3, 0.1, 0.1 \} = 0.1, \\ (I_{N_1} | I_{N_2}) ((e, c)(e, a)) &= \max \{ I_{M_1} (e), I_{M_2} (c), I_{M_2} (a) \} \\ &= \max \{ 0.2, 0.2, 0.2 \} = 0.2, \\ (F_{N_1} | F_{N_2}) ((e, c)(e, a)) &= \max \{ F_{M_1} (e), F_{M_2} (c), F_{M_2} (a) \} \\ &= \max \{ 0.4, 0.4, 0.3 \} = 0.4, \end{aligned}$$

for $e \in V_2$ and $ac \notin E_1$.

Similarly, we can find both membership and non-membership value for all remaining vertices and edges.

$$\begin{aligned} (F_{N_1} | F_{N_2}) ((m_1, m_2) (n_1, n_2)) &= \\ &= \max \{ F_{M_1} (m_1), F_{M_1} (n_1), F_{M_2} (m_2), F_{M_2} (n_2) \} \\ &= \max \{ \max \{ F_{M_1} (m_1), F_{M_2} (m_2) \}, \\ &\quad \max \{ F_{M_1} (n_1), F_{M_2} (n_2) \} \} \\ &= \max \{ (F_{M_1} | F_{M_2}) (m_1, m_2), (F_{M_1} | F_{M_2}) (n_1, n_2) \}. \end{aligned}$$

(i) If $m_1 = n_1, m_2 n_2 \notin E_2$

$$\begin{aligned} (T_{N_1} | T_{N_2}) ((m_1, m_2) (n_1, n_2)) &= \\ &= \min \{ T_{M_1} (m_1), T_{M_2} (m_2), T_{M_2} (n_2) \} \\ &= \min \{ \min \{ T_{M_1} (m_1), T_{M_2} (m_2) \}, \\ &\quad \min \{ T_{M_1} (n_1), T_{M_2} (n_2) \} \} \\ &= \min \{ (T_{M_1} | T_{M_2}) (m_1, m_2), (T_{M_1} | T_{M_2}) (n_1, n_2) \}, \end{aligned}$$

$$\begin{aligned} (I_{N_1} | I_{N_2}) ((m_1, m_2) (n_1, n_2)) &= \\ &= \max \{ I_{M_1} (m_1), I_{M_2} (m_2), I_{M_2} (n_2) \} \\ &= \max \{ \max \{ I_{M_1} (m_1), I_{M_2} (m_2) \}, \end{aligned}$$

$$\begin{aligned} &\quad \max \{ I_{M_1} (n_1), I_{M_2} (n_2) \} \} \\ &= \max \{ (I_{M_1} | I_{M_2}) (m_1, m_2), (I_{M_1} | I_{M_2}) (n_1, n_2) \}, \end{aligned}$$

$$\begin{aligned} (F_{N_1} | F_{N_2}) ((m_1, m_2) (n_1, n_2)) &= \\ &= \max \{ F_{M_1} (m_1), F_{M_2} (m_2), F_{M_2} (n_2) \} \\ &= \max \{ \max \{ F_{M_1} (m_1), F_{M_2} (m_2) \}, \\ &\quad \max \{ F_{M_1} (n_1), F_{M_2} (n_2) \} \} \\ &= \max \{ (F_{M_1} | F_{M_2}) (m_1, m_2), (F_{M_1} | F_{M_2}) (n_1, n_2) \}. \end{aligned}$$

(ii) If $m_2 = n_2, m_1 n_1 \notin E_1$

$$\begin{aligned} (T_{N_1} | T_{N_2}) ((m_1, m_2) (n_1, n_2)) &= \\ &= \min \{ T_{M_1} (m_1), T_{M_1} (n_1), T_{M_2} (m_2) \} \\ &= \min \{ \min \{ T_{M_1} (m_1), T_{M_2} (m_2) \}, \\ &\quad \min \{ T_{M_1} (n_1), T_{M_2} (n_2) \} \} \\ &= \min \{ (T_{M_1} | T_{M_2}) (m_1, m_2), (T_{M_1} | T_{M_2}) (n_1, n_2) \}, \end{aligned}$$

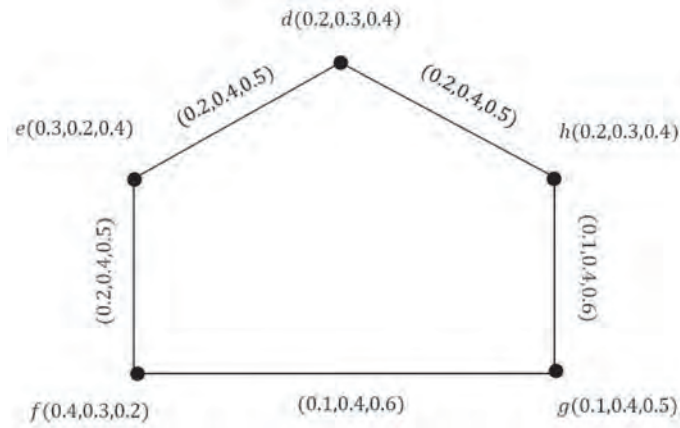

Figure 11 | G_2 .

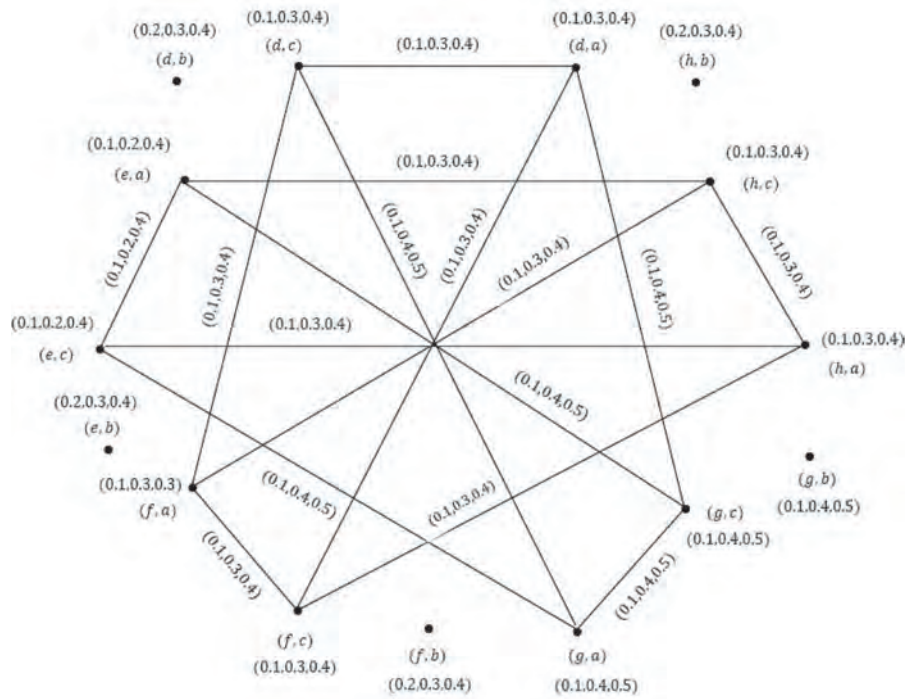

Figure 12 | $G_1|G_2$.

$$\begin{aligned}
 & (I_{N_1} | I_{N_2}) ((m_1, m_2) (n_1, n_2)) \\
 &= \max \{I_{M_1}(m_1), I_{M_1}(n_1), I_{M_2}(m_2)\} \\
 &= \max \{\max\{I_{M_1}(m_1), I_{M_2}(m_2)\} \\
 &\quad \max \{I_{M_1}(n_1), I_{M_2}(n_2)\}\} \\
 &= \max \{(I_{M_1} | I_{M_2})(m_1, m_2), (I_{M_1} | I_{M_2})(n_1, n_2)\}
 \end{aligned}$$

$$\begin{aligned}
 & (F_{N_1} | F_{N_2}) ((m_1, m_2) (n_1, n_2)) \\
 &= \min \{F_{M_1}(m_1), F_{M_1}(n_1), F_{M_2}(m_2)\} \\
 &= \min \{\min\{F_{M_1}(m_1), F_{M_2}(m_2)\}, \\
 &\quad \min \{F_{M_1}(n_1), F_{M_2}(n_2)\}\} \\
 &= \min \{(F_{M_1} | F_{M_2})(m_1, m_2), (F_{M_1} | F_{M_2})(n_1, n_2)\},
 \end{aligned}$$

(iii) If $m_1n_1 \notin E_1$ and $m_2n_2 \notin E_2$

$$\begin{aligned} & (T_{N_1} | T_{N_2}) ((m_1, m_2) (n_1, n_2)) \\ &= \min \{ T_{M_1} (m_1), T_{M_1} (n_1), T_{M_2} (m_2), T_{M_2} (n_2) \} \\ &= \min \{ \min \{ T_{M_1} (m_1), T_{M_2} (m_2) \}, \\ &\quad \min \{ T_{M_1} (n_1), T_{M_2} (n_2) \} \} \\ &= \min \{ (T_{M_1} | T_{M_2}) (m_1, m_2), (T_{M_1} | T_{M_2}) (n_1, n_2) \}, \end{aligned}$$

$$\begin{aligned} & (I_{N_1} | I_{N_2}) ((m_1, m_2) (n_1, n_2)) = \\ &\quad \max \{ I_{M_1} (m_1), I_{M_1} (n_1), I_{M_2} (m_2), I_{M_2} (n_2) \} \\ &= \max \{ \max \{ I_{M_1} (m_1), I_{M_2} (m_2) \}, \\ &\quad \max \{ I_{M_1} (n_1), I_{M_2} (n_2) \} \} \\ &= \max \{ (I_{M_1} | I_{M_2}) (m_1, m_2), (I_{M_1} | I_{M_2}) (n_1, n_2) \}, \end{aligned}$$

$$\begin{aligned} & (F_{N_1} | F_{N_2}) ((m_1, m_2) (n_1, n_2)) = \\ &\quad \max \{ F_{M_1} (m_1), F_{M_1} (n_1), F_{M_2} (m_2), F_{M_2} (n_2) \} \\ &= \max \{ \max \{ F_{M_1} (m_1), F_{M_2} (m_2) \}, \\ &\quad \max \{ F_{M_1} (n_1), F_{M_2} (n_2) \} \} \\ &= \max \{ (F_{M_1} | F_{M_2}) (m_1, m_2), (F_{M_1} | F_{M_2}) (n_1, n_2) \}, \end{aligned}$$

Therefore, $G_1|G_2 = (M_1|M_2, N_1|N_2)$ is a SVNG. \square

Remark 4. The rejection of two complete (SVNGs) $G_1 = (M_1, N_1)$ and $G_2 = (M_2, N_2)$ is a complete-SVNG.

Definition 11. Let $G_1 = (M_1, N_1)$ and $G_2 = (M_2, N_2)$ be two (SVNGs). For any vertex $(m_1, m_2) \in V_1 \times V_2$ we have

$$\begin{aligned} & (d_T)_{G_1|G_2} (m_1, m_2) = \\ & \sum_{(m_1, m_2)(n_1, n_2) \in E_1 \times E_2} (T_{N_1} | T_{N_2}) ((m_1, m_2) (n_1, n_2)) \\ &= \sum_{m_1=n_1, m_2, n_2 \notin E_2} \min \{ T_{M_1} (m_1), T_{M_2} (m_2) |, T_{M_2} (n_2) \} \\ &\quad + \sum_{m_2=n_2, m_1, n_1 \notin E_1} \min \{ T_{M_1} (m_1), T_{M_1} (n_1), T_{M_2} (m_2) \} \\ &\quad + \sum_{m_1, n_1 \notin E_1 \text{ and } m_2, n_2 \notin E_2} \min \{ T_{M_1} (m_1), T_{M_1} (n_1), \\ &\quad T_{M_2} (m_2), T_{M_2} (n_2) \}, \end{aligned}$$

$$\begin{aligned} & (d_I)_{G_1|G_2} (m_1, m_2) = \\ & \sum_{(m_1, m_2)(n_1, n_2) \in E_1 \times E_2} (I_{N_1} | I_{N_2}) ((m_1, m_2) (n_1, n_2)) \\ &= \sum_{m_1=n_1, m_2, n_2 \notin E_2} \max \{ I_{M_1} (m_1), I_{M_2} (m_2), I_{M_2} (n_2) \} \\ &\quad + \sum_{m_2=n_2, m_1, n_1 \notin E_1} \max \{ I_{M_1} (m_1), I_{M_1} (n_1), I_{M_2} (m_2) \} \\ &\quad + \sum_{m_1, n_1 \notin E_1 \text{ and } m_2, n_2 \notin E_2} \max \{ I_{M_1} (m_1), I_{M_1} (n_1), \\ &\quad I_{M_2} (m_2), I_{M_2} (n_2) \}, \end{aligned}$$

$$\begin{aligned} & (d_F)_{G_1|G_2} (m_1, m_2) = \\ & \sum_{(m_1, m_2)(n_1, n_2) \in E_1 \times E_2} (F_{N_1} | F_{N_2}) ((m_1, m_2) (n_1, n_2)) \\ &= \sum_{m_1=n_1, m_2, n_2 \notin E_2} \max \{ F_{M_1} (m_1), F_{M_2} (m_2), F_{M_2} (n_2) \} \\ &\quad + \sum_{m_2=n_2, m_1, n_1 \notin E_1} \max \{ F_{M_1} (m_1), F_{M_1} (n_1), F_{M_2} (m_2) \} \\ &\quad + \sum_{m_1, n_1 \notin E_1 \text{ and } m_2, n_2 \notin E_2} \max \{ F_{M_1} (m_1), F_{M_1} (n_1), \\ &\quad F_{M_2} (m_2), F_{M_2} (n_2) \}. \end{aligned}$$

Definition 12. Let $G_1 = (M_1, N_1)$ and $G_2 = (M_2, Y_2)$ be two (SVNGs). $\forall (m_1, m_2) \in V_1 \times V_2$

$$\begin{aligned} & (td_T)_{G_1|G_2} (m_1, m_2) = \\ & \sum_{(m_1, m_2)(n_1, n_2) \in E_1 \times E_2} (T_{N_1} | T_{N_2}) ((m_1, m_2) (n_1, n_2)) + \\ & (T_{M_1} | T_{M_2}) (m_1, m_2) \\ &= \sum_{m_1=n_1, m_2, n_2 \notin E_2} \min \{ T_{M_1} (m_1), T_{M_2} (m_2), T_{M_2} (n_2) \} \\ &\quad + \sum_{m_2=n_2, m_1, n_1 \notin E_1} \min \{ T_{M_1} (m_1), T_{M_1} (n_1), T_{M_2} (m_2) \} \\ &\quad + \sum_{m_1, n_1 \in E_1 \text{ and } m_2, n_2 \in E_2} \min \{ T_{M_1} (m_1), T_{M_1} (n_1), \\ &\quad T_{M_2} (m_2), T_{M_2} (n_2) \}, \end{aligned}$$

$$\begin{aligned} & (td_I)_{G_1|G_2} (m_1, m_2) = \\ & \sum_{(m_1, m_2)(n_1, n_2) \in E_1 \times E_2} (I_{N_1} | I_{N_2}) ((m_1, m_2) (n_1, n_2)) + \\ & (I_{M_1} | I_{M_2}) (m_1, m_2) \\ &= \sum_{m_1=n_1, m_2, n_2 \notin E_2} \max \{ I_{M_1} (m_1), I_{M_2} (m_2), I_{M_2} (n_2) \} \\ &\quad + \sum_{m_2=n_2, m_1, n_1 \notin E_1} \max \{ I_{M_1} (m_1), I_{M_1} (n_1), I_{M_2} (m_2) \} \\ &\quad + \sum_{m_1, n_1 \notin E_1 \text{ and } m_2, n_2 \notin E_2} \max \{ I_{M_1} (m_1), I_{M_1} (n_1), \\ &\quad I_{M_2} (m_2), I_{M_2} (n_2) \}, \end{aligned}$$

$$\begin{aligned} & (td_F)_{G_1|G_2} (m_1, m_2) = \\ & \sum_{(m_1, m_2)(n_1, n_2) \in E_1 \times E_2} (F_{N_1} | F_{N_2}) ((m_1, m_2) (n_1, n_2)) + \\ & (F_{M_1} | F_{M_2}) (m_1, m_2) \\ &= \sum_{m_1=n_1, m_2, n_2 \notin E_2} \max \{ F_{M_1} (m_1), F_{M_2} (m_2), F_{M_2} (n_2) \} \\ &\quad + \sum_{m_2=n_2, m_1, n_1 \notin E_1} \max \{ F_{M_1} (m_1), F_{M_1} (n_1), F_{M_2} (m_2) \} \end{aligned}$$

$$+ \sum_{\substack{m_1, n_1 \notin E_1 \text{ and } m_2, n_2 \notin E_2 \\ F_{M_2}(m_2), F_{M_2}(n_2)}} \max \{F_{M_1}(m_1), F_{M_1}(n_1), F_{M_2}(m_2), F_{M_2}(n_2)\}.$$

Example 9. In this example we find the degree and the total degree of vertex (d, a) in Example 8.

$$\begin{aligned} (d_T)_{G_1|G_2}(d, a) &= \min \{T_{M_2}(d), T_{M_1}(a), T_{M_1}(c)\} + \\ &\min \{T_{M_2}(d), T_{M_1}(a), T_{M_2}(f), T_{M_1}(c)\} \\ &+ \min \{T_{M_2}(d), T_{M_1}(a), T_{M_2}(g), T_{M_1}(c)\} \\ &= \min \{0.2, 0.1, 0.1\} + \min \{0.2, 0.1, 0.4, 0.1\} + \\ &\min \{0.2, 0.1, 0.1, 0.1\} = 0.1 + 0.1 + 0.1 = 0.3, \end{aligned}$$

$$\begin{aligned} (d_I)_{G_1|G_2}(d, a) &= \max \{I_{M_2}(d), I_{M_1}(a), I_{M_1}(c) + \\ &\max \{I_{M_2}(d), I_{M_1}(a), I_{M_2}(f), I_{M_1}(c)\} \\ &+ \max \{I_{M_2}(d), I_{M_1}(a), I_{M_2}(g), I_{M_1}(c)\} \\ &= \max \{0.3, 0.2, 0.3\} + \max \{0.3, 0.2, 0.3, 0.2\} + \\ &\max \{0.3, 0.2, 0.4, 0.2\} = 0.3 + 0.3 + 0.4 = 1.0, \end{aligned}$$

$$\begin{aligned} (d_F)_{G_1|G_2}(d, a) &= \max \{F_{M_2}(d), F_{M_1}(a), F_{M_1}(c)\} + \\ &\max \{F_{M_2}(d), F_{M_1}(a), F_{M_2}(f), F_{M_1}(c)\} \\ &+ \max \{F_{M_2}(d), F_{M_1}(a), F_{M_2}(g), F_{M_1}(c)\} \\ &= \max \{0.4, 0.3, 0.4\} + \max \{0.4, 0.3, 0.2, 0.4\} + \\ &\max \{0.4, 0.3, 0.5, 0.4\} = 0.4 + 0.4 + 0.5 = 1.3. \end{aligned}$$

Hence, $d_{G_1|G_2}(a, c) = (0.3, 1.0, 1.3)$.

In addition, by definition of total vertex degree in rejection,

$$\begin{aligned} (td_T)_{G_1|G_2}(d, a) &= \min \{T_{M_2}(d), T_{M_1}(a), T_{M_1}(c)\} + \\ &\min \{T_{M_2}(d), T_{M_1}(a), T_{M_2}(f), T_{M_1}(c)\} \\ &+ \min \{T_{M_2}(d), T_{M_1}(a), T_{M_2}(g), T_{M_1}(c)\} + \\ &\min \{T_{M_2}(d), T_{M_1}(a) \\ &= \min \{0.2, 0.1, 0.1\} + \min \{0.2, 0.1, 0.4, 0.1\} + \\ &\min \{0.2, 0.1, 0.1, 0.1\} + \\ &\min \{0.2, 0.1\} = 0.1 + 0.1 + 0.1 + 0.1 = 0.4, \end{aligned}$$

$$\begin{aligned} (td_I)_{G_1|G_2}(d, a) &= \max \{I_{M_2}(d), I_{M_1}(a), I_{M_1}(c)\} + \\ &\max \{I_{M_2}(d), I_{M_1}(a), I_{M_2}(f), I_{M_1}(c)\} \\ &+ \max \{I_{M_2}(d), I_{M_1}(a), I_{M_2}(g), I_{M_1}(c)\} + \\ &\max \{I_{M_2}(d), I_{M_1}(a)\} \\ &= \max \{0.3, 0.2, 0.3\} + \max \{0.3, 0.2, 0.3, 0.3\} + \\ &\max \{0.3, 0.2, 0.4, 0.3\} + \max \{0.3, 0.2\} \\ &= 0.3 + 0.3 + 0.4 + 0.3 = 1.3, \end{aligned}$$

$$\begin{aligned} (td_F)_{G_1|G_2}(d, a) &= \max \{F_{M_2}(d), F_{M_1}(a), F_{M_1}(c)\} + \\ &\max \{F_{M_2}(d), F_{M_1}(a), F_{M_2}(f), F_{M_1}(c)\} \\ &+ \max \{F_{M_2}(d), F_{M_1}(a), F_{M_2}(g), F_{M_1}(c)\} + \\ &\max \{F_{M_2}(d), F_{M_1}(a)\} \\ &= \max \{0.4, 0.3, 0.4\} + \max \{0.4, 0.3, 0.2, 0.4\} + \\ &\max \{0.4, 0.3, 0.5, 0.4\} + \max \{0.4, 0.3\} \\ &= 0.4 + 0.4 + 0.5 + 0.4 = 1.7. \end{aligned}$$

So, $td_{G_1|G_2}(a, c) = (0.4, 1.3, 1.7)$.

Similarly, we can find the degree and the total degree of all vertices in $G_1|G_2$.

Definition 13. The symmetric difference $G_1 \oplus G_2 = (M_1 \oplus M_2, N_1 \oplus N_2)$ of two (SVNGs) $G_1 = (M_1, N_1)$ and $G_2 = (M_2, N_2)$ is defined as

- (i) $(T_{M_1} \oplus T_{M_2})((m_1, m_2)) = \min \{T_{M_1}(m_1), T_{M_2}(m_2)\}$
 $(I_{M_1} \oplus I_{M_2})((m_1, m_2)) = \max \{I_{M_1}(m_1), I_{M_2}(m_2)\}$
 $(F_{M_1} \oplus F_{M_2})((m_1, m_2)) = \max \{F_{M_1}(m_1), F_{M_2}(m_2)\}$
 $\forall (m_1, m_2) \in (V_1 \times V_2)$
- (ii) $(T_{N_1} \oplus T_{N_2})((m, m_2)(m, n_2)) = \min \{T_{M_1}(m), T_{N_2}(m_2 n_2)\}$
 $(I_{N_1} \oplus I_{N_2})((m, m_2)(m, n_2)) = \max \{I_{M_1}(m), I_{N_2}(m_2 n_2)\}$
 $(F_{N_1} \oplus F_{N_2})((m, m_2)(m, n_2)) = \max \{F_{M_1}(m), F_{N_2}(m_2 n_2)\}$
 $\forall m \in V_1 \text{ and } m_2 n_2 \in E_2$
- (iii) $(T_{N_1} \oplus T_{N_2})((m_1, z)(n_1, z)) = \min \{T_{N_1}(m_1 n_1), T_{M_2}(z)\}$
 $(I_{N_1} \oplus I_{N_2})((m_1, z)(n_1, z)) = \max \{I_{N_1}(m_1 n_1), I_{M_2}(z)\}$
 $(F_{N_1} \oplus F_{N_2})((m_1, z)(n_1, z)) = \max \{F_{N_1}(m_1 n_1), F_{M_2}(z)\}$
 $\forall z \in V_2 \text{ and } m_1 n_1 \in E_1$
- (iv) $(T_{N_1} \oplus T_{N_2})((m_1, m_2)(n_1, n_2)) = \min \{T_{M_1}(m_1), T_{M_1}(n_1), T_{N_2}(m_2 n_2)\}$ for all $m_1 n_1 \notin E_1$ and $m_2 n_2 \in E_2$
or
 $= \min \{T_{M_2}(m_2), T_{M_2}(n_2), T_{N_1}(m_1 n_1)\}$
for all $m_1 n_1 \in E_1$ and $m_2 n_2 \notin E_2$,
 $(I_{N_1} \oplus I_{N_2})((m_1, m_2)(n_1, n_2)) = \max \{I_{M_1}(m_1), I_{M_1}(n_1), I_{N_2}(m_2 n_2)\}$ for all $m_1 n_1 \notin E_1$ and $m_2 n_2 \in E_2$
or
 $= \max \{I_{M_2}(m_2), I_{M_2}(n_2), I_{N_1}(m_1 n_1)\}$

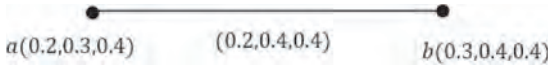

Figure 13 | G_1 .

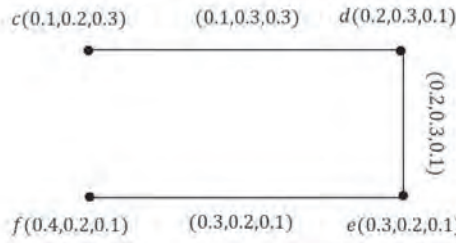

Figure 14 | G_2 .

for all $m_1 n_1 \in E_1$ and $m_2 n_2 \notin E_2$,

$$(F_{N_1} \oplus F_{N_2})((m_1, m_2)(n_1, n_2)) = \max \{F_{M_1}(m_1), F_{M_1}(n_1), F_{N_2}(m_2 n_2)\}$$

or

$$= \max \{F_{M_2}(m_2), F_{M_2}(n_2), F_{N_2}(m_1 n_1)\}$$

for all $m_1 n_1 \in E_1$ and $m_2 n_2 \notin E_2$.

Example 10. Consider the (SVNGs) G_1 and G_2 as in Figures 13 and 14. We can see the symmetric difference of two (SVNGs) G_1 and G_2 , that is $G_1 \oplus G_2$ in Figure 15.

For vertex (a, f) , we find the true membership value, indeterminacy, and the false membership value as follows:

$$\begin{aligned} (T_{M_1} \oplus T_{M_2})((a, f)) &= \min \{T_{M_1}(a), T_{M_2}(f)\} \\ &= \min \{0.2, 0.4\} = 0.2, \\ (I_{M_1} \oplus I_{M_2})((a, f)) &= \max \{I_{M_1}(a), I_{M_2}(f)\} \\ &= \max \{0.3, 0.2\} = 0.3, \\ (F_{M_1} \oplus F_{M_2})((a, f)) &= \max \{F_{M_1}(a), F_{M_2}(f)\} \\ &= \max \{0.4, 0.1\} = 0.4, \end{aligned}$$

for $a \in V_1$ and $f \in V_2$.

For edge $(a, d)(a, e)$, we calculate the true membership value, indeterminacy, and the false membership value.

$$\begin{aligned} (T_{N_1} \oplus T_{N_2})((a, d)(a, e)) &= \min \{T_{M_1}(a), T_{N_2}(de)\} \\ &= \min \{0.2, 0.2\} = 0.2, \\ (I_{N_1} \oplus I_{N_2})((a, d)(a, e)) &= \max \{I_{M_1}(a), I_{N_2}(de)\} \\ &= \max \{0.3, 0.3\} = 0.3, \\ (F_{N_1} \oplus F_{N_2})((a, d)(a, e)) &= \max \{F_{M_1}(a), F_{N_2}(de)\} \\ &= \max \{0.4, 0.1\} = 0.4. \end{aligned}$$

for $a \in V_1$ and $de \in E_2$.

Now, for edge $(a, d)(b, d)$ we have

$$\begin{aligned} (T_{N_1} \oplus T_{N_2})((a, d)(b, d)) &= \min \{T_{N_1}(ab), T_{M_2}(d)\} \\ &= \min \{0.2, 0.2\} = 0.2, \\ (I_{N_1} \oplus I_{N_2})((a, d)(b, d)) &= \max \{I_{N_1}(ab), I_{M_2}(d)\} \\ &= \max \{0.4, 0.3\} = 0.4, \\ (F_{N_1} \oplus F_{N_2})((a, d)(b, d)) &= \max \{F_{N_1}(ab), F_{M_2}(d)\} \\ &= \max \{0.4, 0.1\} = 0.4, \end{aligned}$$

for $ab \in E_1$ and $d \in V_2$.

Finally, for edge $(a, c)(b, f)$ we can find the true membership value, indeterminacy, and the false membership value as follows:

$$\begin{aligned} (T_{N_1} \oplus T_{N_2})((a, c)(b, f)) &= \min \{T_{M_2}(c), T_{M_2}(f), \\ &T_{N_1}(ab)\} = \min \{0.1, 0.4, 0.2\} = 0.1, \\ (I_{N_1} \oplus I_{N_2})((a, c)(b, f)) &= \max \{I_{M_2}(c), F_{M_2}(f), \\ &I_{N_1}(ab)\} = \max \{0.2, 0.2, 0.4\} = 0.4, \\ (F_{N_1} \oplus F_{N_2})((a, c)(b, f)) &= \max \{F_{M_2}(c), F_{M_2}(f), \\ &\{F_{N_1}(ab)\}\} = \max \{0.3, 0.4, 0.4\} = 0.4, \end{aligned}$$

for $ab \in E_1$ and $cf \notin E_2$. In the same way, we can find the true membership value, indeterminacy, and the false membership value for all remaining vertices and edges.

Proposition 7. The symmetric difference of two (SVNGs) G_1 and G_2 , is a SVNG.

Proof. Let $G_1 = (M_1, N_1)$ and $G_2 = (M_2, N_2)$ be two (SVNGs) on crisp graphs $G_1 = (V_1, E_1)$ and $G_2 = (V_2, E_2)$, respectively and $((m_1, m_2)(n_1, n_2)) \in E_1 \times E_2$. Then by Definition 3.21 we have

(i) If $m_1 = n_1 = m$

$$\begin{aligned} (T_{N_1} \oplus T_{N_2})((m, m_2)(m, n_2)) &= \min \{T_{M_1}(m), T_{N_2}(m_2 n_2)\} \\ &\leq \min \{T_{M_1}(m), \min \{T_{M_2}(m_2), T_{M_2}(n_2)\}\} \\ &= \min \{\min \{T_{M_1}(m), T_{M_2}(m_2)\}, \min \{T_{M_1}(m), T_{M_2}(n_2)\}\} \\ &= \min \{(T_{M_1} \oplus T_{M_2})(m, m_2), (T_{M_1} \oplus T_{M_2})(m, n_2)\}, \\ (I_{N_1} \oplus I_{N_2})((m, m_2)(m, n_2)) &= \max \{I_{M_1}(m), I_{N_2}(m_2 n_2)\} \\ &\geq \max \{I_{M_1}(m), \max \{I_{M_2}(m_2), I_{M_2}(n_2)\}\} \\ &= \max \{\max \{I_{M_1}(m), I_{M_2}(m_2)\}, \max \{I_{M_1}(m), I_{M_2}(n_2)\}\} \\ &= \max \{(I_{M_1} \oplus I_{M_2})(m, m_2), (I_{M_1} \oplus I_{M_2})(m, n_2)\}, \end{aligned}$$

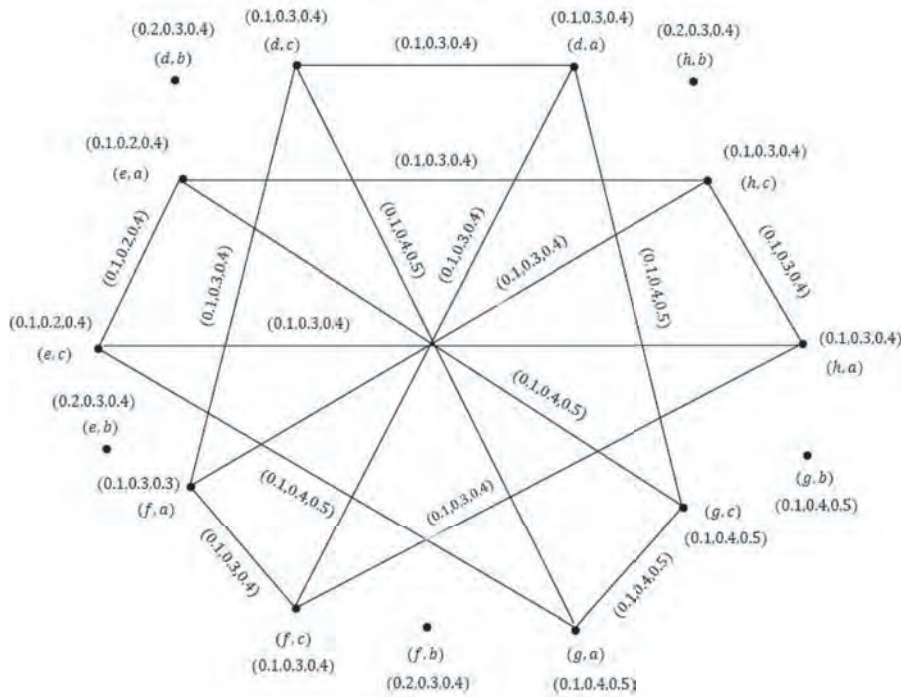

Figure 15 | $G_1 \oplus G_2$.

$$\begin{aligned}
 & (F_{N_1} \oplus F_{N_2}) ((m, m_2) (m, n_2)) \\
 &= \max \{F_{M_1}(m), F_{N_2}(m_2 n_2)\} \\
 &\geq \max \{F_{M_1}(m), \max \{F_{M_2}(m_2), F_{M_2}(n_2)\}\} \\
 &= \max \{\max \{F_{M_1}(m), F_{M_2}(m_2)\}, \max \{F_{M_1}(m), F_{M_2}(n_2)\}\} \\
 &= \max \{(F_{M_1} \oplus F_{M_2})(m, m_2), (F_{M_1} \oplus F_{M_2})(m, n_2)\}.
 \end{aligned}$$

(ii) If $m_2 = n_2 = z$

$$\begin{aligned}
 & (T_{N_1} \oplus T_{N_2}) ((m_1, z) (n_1, z)) \\
 &= \min \{T_{N_1}(m_1 n_1), T_{M_2}(z)\} \\
 &\leq \min \{\min \{T_{N_1}(m_1 n_1), T_{M_2}(z)\}\} \\
 &= \min \{\min \{T_{M_1}(m_1), T_{M_2}(z)\}, \min \{T_{M_1}(n_1), T_{M_2}(z)\}\} \\
 &= \min \{(T_{M_1} \oplus T_{M_2})(m_1, z), (T_{M_1} \oplus T_{M_2})(n_1, z)\},
 \end{aligned}$$

$$\begin{aligned}
 & (I_{N_1} \oplus I_{N_2}) ((m_1, z) (n_1, z)) \\
 &= \max \{I_{N_1}(m_1 n_1), I_{M_2}(z)\} \\
 &\geq \max \{\max \{I_{N_1}(m_1 n_1), I_{M_2}(z)\}\} \\
 &= \max \{\max \{I_{M_1}(m_1), I_{M_2}(z)\}, \max \{I_{M_1}(n_1), I_{M_2}(z)\}\} \\
 &= \max \{(I_{M_1} \oplus I_{M_2})(m_1, z), (I_{M_1} \oplus I_{M_2})(n_1, z)\},
 \end{aligned}$$

$$\begin{aligned}
 & (F_{N_1} \oplus F_{N_2}) ((m_1, z) (n_1, z)) \\
 &= \max \{F_{N_1}(m_1 n_1), F_{M_2}(z)\} \\
 &\geq \max \{\max \{F_{N_1}(m_1 n_1), T_{M_2}(z)\}\} \\
 &= \max \{\max \{F_{M_1}(m_1), F_{M_2}(z)\}, \max \{F_{M_1}(n_1), F_{M_2}(z)\}\} \\
 &= \max \{(F_{M_1} \oplus F_{M_2})(m_1, z), (F_{M_1} \oplus F_{M_2})(n_1, z)\}.
 \end{aligned}$$

(iii) If $m_1 n_1 \in E_1$ and $m_2 n_2 \notin E_2$

$$\begin{aligned}
 & (T_{N_1} \oplus T_{N_2}) ((m_1, m_2) (n_1, n_2)) \\
 &= \min \{T_{M_1}(m_1), T_{M_1}(n_1), T_{N_2}(m_2 n_2)\} \\
 &\leq \min \{T_{M_1}(m_1), T_{M_1}(n_1), \min \{T_{M_2}(m_2), T_{M_2}(n_2)\}\} \\
 &= \min \{\min \{T_{M_1}(m_1), T_{M_2}(m_2)\}, \min \{T_{M_1}(n_1), T_{M_2}(n_2)\}\} \\
 &= \min \{(T_{M_1} \oplus T_{M_2})(m_1, m_2), (T_{M_1} \oplus T_{M_2})(n_1, n_2)\},
 \end{aligned}$$

$$\begin{aligned}
 & (I_{N_1} \oplus I_{N_2}) ((m_1, m_2) (n_1, n_2)) \\
 &= \max \{I_{M_1}(m_1), I_{M_1}(n_1), I_{N_2}(m_2 n_2)\} \\
 &\geq \max \{I_{M_1}(m_1), I_{M_1}(n_1), \max \{I_{M_2}(m_2), I_{M_2}(n_2)\}\} \\
 &= \max \{\max \{I_{M_1}(m_1), I_{M_2}(m_2)\}, \max \{I_{M_1}(n_1), I_{M_2}(n_2)\}\} \\
 &= \max \{(I_{M_1} \oplus I_{M_2})(m_1, m_2), (I_{M_1} \oplus I_{M_2})(n_1, n_2)\},
 \end{aligned}$$

$$\begin{aligned}
 & (F_{N_1} \oplus F_{N_2}) ((m_1, m_2) (n_1, n_2)) \\
 &= \max \{F_{M_1}(m_1), F_{M_1}(n_1), F_{N_2}(m_2 n_2)\} \\
 &\geq \max \{F_{M_1}(m_1), F_{M_1}(n_1), \max \{F_{M_2}(m_2), F_{M_2}(n_2)\}\} \\
 &= \max \{\max \{F_{M_1}(m_1), F_{M_2}(m_2)\}, \max \{F_{M_1}(n_1), F_{M_2}(n_2)\}\} \\
 &= \max \{(F_{M_1} \oplus F_{M_2})(m_1, m_2), (F_{M_1} \oplus F_{M_2})(n_1, n_2)\}.
 \end{aligned}$$

(iv) If $m_1 n_1 \in E_1$ and $m_2 n_2 \notin E_2$

$$\begin{aligned}
 & (T_{N_1} \oplus T_{N_2}) ((m_1, m_2) (n_1, n_2)) \\
 &= \min \{T_{M_2}(m_2), T_{M_2}(n_2), T_{N_1}(m_1 n_1)\} \\
 &\leq \min \{T_{M_2}(m_2), T_{M_2}(n_2), \min \{T_{M_1}(m_1), T_{M_1}(n_1)\}\} \\
 &= \min \{\min \{T_{M_1}(m_1), T_{M_2}(m_2)\}, \min \{T_{M_1}(n_1), T_{M_2}(n_2)\}\} \\
 &= \min \{(T_{M_1} \oplus T_{M_2})(m_1, m_2), (T_{M_1} \oplus T_{M_2})(n_1, n_2)\},
 \end{aligned}$$

$$\begin{aligned} & (I_{N_1} \oplus I_{N_2}) ((m_1, m_2) (n_1, n_2)) \\ &= \max \{I_{M_2} (m_2), I_{M_2} (n_2), I_{N_1} (m_1 n_1)\} \\ &\geq \max \{I_{M_2} (m_2), I_{M_2} (n_2), \max \{I_{M_1} (m_1) I_{M_1} (n_1)\}\} \\ &= \max \{ \max \{I_{M_2} (m_2), I_{M_1} (m_1)\}, \\ &\quad \max \{I_{M_2} (m_2), I_{M_1} (n_1)\} \} \\ &= \max \{ (I_{M_1} \oplus I_{M_2}) (m_1, m_2), (I_{M_1} \oplus I_{M_2}) (n_1, n_2) \}, \end{aligned}$$

$$\begin{aligned} & (F_{N_1} \oplus F_{N_2}) ((m_1, m_2) (n_1, n_2)) \\ &= \max \{F_{M_2} (m_2), F_{M_2} (n_2), F_{N_1} (m_1 n_1)\} \\ &\geq \max \{F_{M_2} (m_2), F_{M_2} (n_2), \max \{F_{M_1} (m_1) F_{M_1} (n_1)\}\} \\ &= \max \{ \max \{F_{M_2} (m_2), F_{M_1} (m_1)\}, \\ &\quad \max \{F_{M_2} (m_2), F_{M_1} (n_1)\} \} \\ &= \max \{ (F_{M_1} \oplus F_{M_2}) (m_1, m_2), (F_{M_1} \oplus F_{M_2}) (n_1, n_2) \}. \end{aligned}$$

Hence, $G_1 \oplus G_2$ is a SVNG. \square

Remark 5. The symmetric difference of two connected-(SVNGs) $G_1 = (M_1, N_1)$ and $G_2 = (M_2, N_2)$ is connected. Because we include the case $(m_1, m_2) \in E_1$ and $(n_1, n_2) \in E_2$ in the definition of the symmetric difference of two (SVNGs).

Definition 14. Let $G_1 = (M_1, N_1)$ and $G_2 = (M_2, N_2)$ be two (SVNGs). For any vertex $(m_1, m_2) \in V_1 \times V_2$ we have

$$\begin{aligned} (d_T)_{G_1 \oplus G_2} (m_1, m_2) &= \\ & \sum_{(m_1, m_2)(n_1, n_2) \in E_1 \times E_2} (T_{N_1} \oplus T_{N_2}) ((m_1, m_2) (n_1, n_2)) \\ &= \sum_{m_1=n_1, m_2, n_2 \in E_2} \min \{T_{M_1} (m_1), T_{N_2} (m_2 n_2)\} \\ &+ \sum_{m_1 n_1 \in E_1, m_2=n_2} \min \{T_{N_1} (m_1 n_1), T_{M_2} (m_2)\} \\ &+ \sum_{m_1 n_1 \notin E_1 \text{ and } m_2, n_2 \in E_2} \min \{T_{M_1} (m_1), T_{M_1} (n_1), T_{N_2} (m_2 n_2)\} \\ &+ \sum_{m_1 n_1 \notin E_1 \text{ and } m_2, n_2 \in E_2} \min \{T_{N_1} (m_1 n_1), T_{M_1} (m_2), T_{M_2} (n_2)\}, \end{aligned}$$

$$\begin{aligned} (d_I)_{G_1 \oplus G_2} (m_1, m_2) &= \\ & \sum_{(m_1, m_2)(n_1, n_2) \in E_1 \times E_2} (I_{N_1} \oplus I_{N_2}) ((m_1, m_2) (n_1, n_2)) \\ &= \sum_{m_1=n_1, m_2, n_2 \in E_2} \min \{I_{M_1} (m_1), I_{N_2} (m_2 n_2)\} \\ &+ \sum_{m_1 n_1 \in E_1, m_2=n_2} \min \{I_{N_1} (m_1 n_1), I_{M_2} (m_2)\} \\ &+ \sum_{m_1 n_1 \notin E_1 \text{ and } m_2, n_2 \in E_2} \min \{I_{M_1} (m_1), I_{M_1} (n_1), I_{N_2} (m_2 n_2)\} \\ &+ \sum_{m_1 n_1 \in E_1 \text{ and } m_2, n_2 \notin E_2} \min \{I_{N_1} (m_1 n_1), I_{M_1} (m_2), I_{M_2} (n_2)\}, \end{aligned}$$

$$\begin{aligned} (d_F)_{G_1 \oplus G_2} (m_1, m_2) &= \\ & \sum_{(m_1, m_2)(n_1, n_2) \in E_1 \times E_2} (F_{N_1} \oplus F_{N_2}) ((m_1, m_2) (n_1, n_2)) \\ &= \sum_{m_1=n_1, m_2, n_2 \in E_2} \max \{F_{M_1} (m_1), F_{N_2} (m_2 n_2)\} \\ &\quad + \sum_{m_1 n_1 \in E_1, m_2=n_2} \max \{F_{N_1} (m_1 n_1), F_{M_2} (m_2)\} \\ &+ \sum_{m_1 n_1 \notin E_1 \text{ and } m_2, n_2 \in E_2} \max \{F_{M_1} (m_1), F_{M_1} (n_1), F_{N_2} (m_2 n_2)\} \\ &+ \sum_{m_1 n_1 \in E_1 \text{ and } m_2, n_2 \notin E_2} \max \{F_{N_1} (m_1 n_1), F_{M_2} (m_2), F_{M_2} (n_2)\}. \end{aligned}$$

Theorem 8. Let $G_1 = (M_1, N_1)$ and $G_2 = (M_2, Y_2)$ be two (SVNGs). If $T_{M_1} \geq T_{N_2}, I_{M_1} \leq I_{N_2}, F_{M_1} \leq F_{N_2}$ and $T_{M_2} \geq T_{N_1}, I_{M_2} \leq I_{N_1}, F_{M_2} \leq F_{N_1}$, then for every $(m_1, m_2) \in V_1 \times V_2$ we have

$$(d)_{G_1 \oplus G_2} (m_1, m_2) = q(d)_{G_1} (m_1) + s(d)_{G_2} (m_2) \text{ where } s = |V_1| - (d)_{G_1} (m_1) \text{ and } q = |V_2| - (d)_{G_2} (m_2).$$

Proof.

$$\begin{aligned} (d_T)_{G_1 \oplus G_2} (m_1, m_2) &= \\ & \sum_{(m_1, m_2)(n_1, n_2) \in E_1 \times E_2} (T_{N_1} \oplus T_{N_2}) ((m_1, m_2) (n_1, n_2)) \\ &= \sum_{m_1=n_1, m_2, n_2 \in E_2} \min \{T_{M_1} (m_1), T_{N_2} (m_2 n_2)\} \\ &\quad + \sum_{m_1 n_1 \in E_1, m_2=n_2} \min \{T_{N_1} (m_1 n_1), T_{M_2} (m_2)\} \\ &\quad + \sum_{m_1 n_1 \notin E_1 \text{ and } m_2, n_2 \in E_2} \min \{T_{M_1} (m_1), T_{M_1} (n_1), T_{N_2} (m_2 n_2)\} \\ &\quad + \sum_{m_1 n_1 \in E_1 \text{ and } m_2, n_2 \notin E_2} \min \{T_{N_1} (m_1 n_1), T_{M_2} (m_2), T_{M_2} (n_2)\} \\ &= \sum_{m_2, n_2 \in E_2} T_{N_2} (m_2 n_2) + \sum_{m_1 n_1 \in E_1} T_{N_1} (m_1 n_1) \\ &\quad + \sum_{m_1 n_1 \notin E_1 \text{ and } m_2, n_2 \in E_2} T_{N_2} (m_2 n_2) \} + \\ &\quad \sum_{m_1 n_1 \in E_1 \text{ and } m_2, n_2 \notin E_2} T_{N_1} (m_1 n_1) \\ &= q (d_T)_{G_1} (m_1) + s (d_T)_{G_2} (m_2), \end{aligned}$$

$$\begin{aligned} (d_I)_{G_1 \oplus G_2} (m_1, m_2) &= \\ & \sum_{(m_1, m_2)(n_1, n_2) \in E_1 \times E_2} (I_{N_1} \oplus I_{N_2}) ((m_1, m_2) (n_1, n_2)) \\ &= \sum_{m_1=n_1, m_2, n_2 \in E_2} \max \{I_{M_1} (m_1), I_{N_2} (m_2 n_2)\} \\ &\quad + \sum_{m_1 n_1 \in E_1, m_2=n_2} \max \{I_{N_1} (m_1 n_1), I_{M_2} (m_2)\} \\ &\quad + \sum_{m_1 n_1 \notin E_1 \text{ and } m_2, n_2 \in E_2} \max \{I_{M_1} (m_1), I_{M_1} (n_1), I_{N_2} (m_2 n_2)\} \\ &\quad + \sum_{m_1 n_1 \in E_1 \text{ and } m_2, n_2 \notin E_2} \max \{I_{N_1} (m_1 n_1), I_{M_2} (m_2), I_{M_2} (n_2)\} \\ &= \sum_{m_2, n_2 \in E_2} I_{N_2} (m_2 n_2) + \sum_{m_1 n_1 \in E_1} I_{N_1} (m_1 n_1) \\ &\quad + \sum_{m_1 n_1 \notin E_1 \text{ and } m_2, n_2 \in E_2} I_{N_2} (m_2 n_2) + \\ &\quad \sum_{m_1 n_1 \in E_1 \text{ and } m_2, n_2 \notin E_2} I_{N_1} (m_1 n_1) \\ &= q (d_I)_{G_1} (m_1) + s (d_I)_{G_2} (m_2), \end{aligned}$$

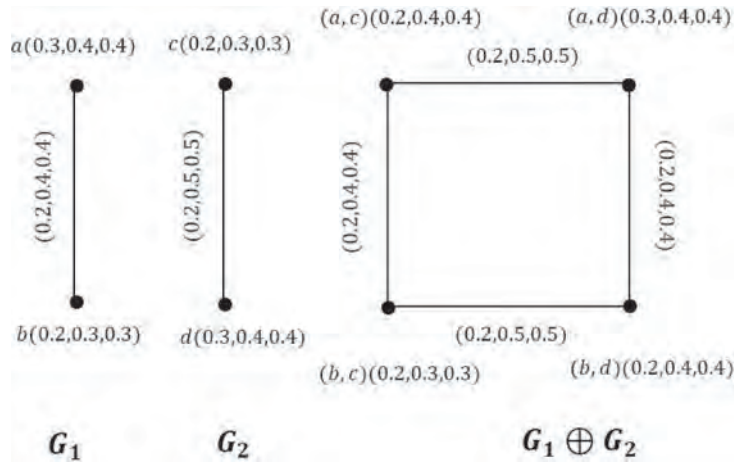

Figure 16 | Symmetric difference.

$$\begin{aligned}
 & (d_F)_{G_1 \oplus G_2}(m_1, m_2) \\
 &= \sum_{(m_1, m_2)(n_1, n_2) \in E_1 \times E_2} (F_{N_1} \oplus F_{N_2})((m_1, m_2)(n_1, n_2)) \\
 &= \sum_{m_1=n_1, m_2=n_2 \in E_2} \max\{F_{M_1}(m_1), F_{N_2}(m_2n_2)\} \\
 &+ \sum_{m_1n_1 \in E_1, m_2=n_2} \max\{F_{N_1}(m_1n_1), F_{M_2}(m_2)\} \\
 &+ \sum_{m_1n_1 \notin E_1 \text{ and } m_2n_2 \in E_2} \max\{F_{M_1}(m_1), F_{M_1}(n_1), F_{N_2}(m_2n_2)\} \\
 &+ \sum_{m_1n_1 \in E_1 \text{ and } m_2n_2 \notin E_2} \max\{F_{N_1}(m_1n_1), F_{M_2}(m_2), F_{M_2}(n_2)\} \\
 &= \sum_{m_2n_2 \in E_2} F_{N_2}(m_2n_2) + \sum_{m_1n_1 \in E_1} F_{N_1}(m_1n_1) \\
 &+ \sum_{m_1n_1 \notin E_1 \text{ and } m_2n_2 \in E_2} F_{N_2}(m_2n_2) \\
 &+ \sum_{m_1n_1 \in E_1 \text{ and } m_2n_2 \notin E_2} F_{N_1}(m_1n_1) \\
 &= q(d_F)_{G_1}(m_1) + s(d_F)_{G_2}(m_2).
 \end{aligned}$$

We conclude that $(d)_{G_1 \oplus G_2}(m_1, m_2) = q(d)_{G_1}(m_1) + s(d)_{G_2}(m_2)$ where $s = |V_1| - (d)_{G_1}(m_1)$ and $q = |V_2| - (d)_{G_2}(m_2)$. \square

Example 11. In Figure 16, $T_{M_1} \geq T_{N_2}, F_{M_1} \leq F_{N_2}, T_{M_2} \geq T_{N_1}$, and $F_{M_2} \leq F_{N_1}$. So, the total degree of vertex in symmetric difference is calculated by using the following formula:

$$\begin{aligned}
 & (d_T)_{G_1 \oplus G_2}(m_1, m_2) = q(d_T)_{G_1}(m_1) + s(d_T)_{G_2}(m_2), \\
 & (d_I)_{G_1 \oplus G_2}(m_1, m_2) = q(d_I)_{G_1}(m_1) + s(d_I)_{G_2}(m_2), \\
 & (d_F)_{G_1 \oplus G_2}(m_1, m_2) = q(d_F)_{G_1}(m_1) + s(d_F)_{G_2}(m_2).
 \end{aligned}$$

$$\begin{aligned}
 & (d_T)_{G_1 \oplus G_2}(a, c) = 1 \cdot (0.2) + 1 \cdot (0.1) = 0.3, \\
 & (d_I)_{G_1 \oplus G_2}(a, c) = 1 \cdot (0.4) + 1 \cdot (0.3) = 0.7, \\
 & (d_F)_{G_1 \oplus G_2}(a, c) = 1 \cdot (0.4) + 1 \cdot (0.3) = 0.7, \\
 & (d_T)_{G_1 \oplus G_2}(a, d) = 1 \cdot (0.2) + 1 \cdot (0.1 + 0.2) = 0.5, \\
 & (d_I)_{G_1 \oplus G_2}(a, d) = 1 \cdot (0.4) + 1 \cdot (0.3 + 0.3) = 1.0, \\
 & (d_F)_{G_1 \oplus G_2}(a, d) = 1 \cdot (0.4) + 1 \cdot (0.3 + 0.1) = 0.8.
 \end{aligned}$$

Hence, $(d)_{G_1 \oplus G_2}(a, c) = (0.3, 0.7, 0.7)$ and $(d)_{G_1 \oplus G_2}(a, d) = (0.5, 1.0, 0.8)$. In the same way, we can show that $(d)_{G_1 \oplus G_2}(b, c) = (d)_{G_1 \oplus G_2}(b, d) = (0.4, 0.9, 0.9)$. By direct calculations:

$$\begin{aligned}
 & (d_T)_{G_1 \oplus G_2}(a, c) = 0.3, \\
 & (d_I)_{G_1 \oplus G_2}(a, c) = 0.7, \\
 & (d_F)_{G_1 \oplus G_2}(a, c) = 0.7, \\
 & (d_T)_{G_1 \oplus G_2}(a, d) = 0.5, \\
 & (d_I)_{G_1 \oplus G_2}(a, d) = 1.0, \\
 & (d_F)_{G_1 \oplus G_2}(a, d) = 0.8, \\
 & (d_T)_{G_1 \oplus G_2}(b, c) = 0.3, \\
 & (d_I)_{G_1 \oplus G_2}(b, c) = 0.7, \\
 & (d_F)_{G_1 \oplus G_2}(b, c) = 0.7, \\
 & (d_T)_{G_1 \oplus G_2}(b, d) = 0.5, \\
 & (d_I)_{G_1 \oplus G_2}(b, d) = 1.0, \\
 & (d_F)_{G_1 \oplus G_2}(b, d) = 0.8.
 \end{aligned}$$

It is obvious from the above calculations that the degrees of vertices calculated by using the formula of the above theorem and by direct method are the same.

Definition 15. Let $\mathbf{G}_1 = (M_1, N_1)$ and $\mathbf{G}_2 = (M_2, N_2)$ be two (SVNGs). For any vertex $(m_1, m_2) \in V_1 \times V_2$ we have

$$\begin{aligned} & (td_T)_{\mathbf{G}_1 \oplus \mathbf{G}_2}(m_1, m_2) \\ &= \sum_{(m_1, m_2)(n_1, n_2) \in E_1 \times E_2} (T_{N_1} \oplus T_{N_2})((m_1, m_2)(n_1, n_2)) + \\ & (T_{M_1} \oplus T_{M_2})(m_1, m_2) \\ &= \sum_{m_1=n_1, m_2, n_2 \in E_2} \min \{T_{M_1}(m_1), T_{N_2}(m_2, n_2)\} \\ & + \sum_{m_1, n_1 \in E_1, m_2=n_2} \min \{T_{N_1}(m_1, n_1), T_{M_2}(m_2)\} \\ & + \sum_{m_1, n_1 \notin E_1 \text{ and } m_2, n_2 \in E_2} \min \{T_{M_1}(m_1), T_{M_1}(n_1), T_{N_2}(m_2, n_2)\} \\ & + \sum_{m_1, n_1 \in E_1 \text{ and } m_2, n_2 \notin E_2} \min \{T_{N_1}(m_1, n_1), T_{M_2}(m_2), T_{M_2}(n_2)\} \\ & + \min \{T_{M_1}(m_1), T_{M_2}(m_2)\}, \end{aligned}$$

$$\begin{aligned} & (td_I)_{\mathbf{G}_1 \oplus \mathbf{G}_2}(m_1, m_2) \\ &= \sum_{(m_1, m_2)(n_1, n_2) \in E_1 \times E_2} (I_{N_1} \oplus I_{N_2})((m_1, m_2)(n_1, n_2)) + \\ & (I_{M_1} \oplus I_{M_2})(m_1, m_2) \\ &= \sum_{m_1=n_1, m_2, n_2 \in E_2} \max \{I_{M_1}(m_1), I_{N_2}(m_2, n_2)\} \\ & + \sum_{m_1, n_1 \in E_1, m_2=n_2} \max \{I_{N_1}(m_1, n_1), I_{M_2}(m_2)\} \\ & + \sum_{m_1, n_1 \notin E_1 \text{ and } m_2, n_2 \in E_2} \max \{I_{M_1}(m_1), I_{M_1}(n_1), I_{N_2}(m_2, n_2)\} \\ & + \sum_{m_1, n_1 \in E_1 \text{ and } m_2, n_2 \notin E_2} \max \{I_{N_1}(m_1, n_1), I_{M_2}(m_2), I_{M_2}(n_2)\} \\ & + \max \{I_{M_1}(m_1), I_{M_2}(m_2)\}, \end{aligned}$$

$$\begin{aligned} & (td_F)_{\mathbf{G}_1 \oplus \mathbf{G}_2}(m_1, m_2) \\ &= \sum_{(m_1, m_2)(n_1, n_2) \in E_1 \times E_2} (F_{N_1} \oplus F_{N_2})((m_1, m_2)(n_1, n_2)) + \\ & (F_{M_1} \oplus F_{M_2})(m_1, m_2) \\ &= \sum_{m_1=n_1, m_2, n_2 \in E_2} \max \{F_{M_1}(m_1), F_{N_2}(m_2, n_2)\} \\ & + \sum_{m_1, n_1 \in E_1, m_2=n_2} \max \{F_{N_1}(m_1, n_1), F_{M_2}(m_2)\} \\ & + \sum_{m_1, n_1 \notin E_1 \text{ and } m_2, n_2 \in E_2} \max \{F_{M_1}(m_1), F_{M_1}(n_1), F_{N_2}(m_2, n_2)\} \\ & + \sum_{m_1, n_1 \in E_1 \text{ and } m_2, n_2 \notin E_2} \max \{F_{N_1}(m_1, n_1), F_{M_2}(m_2), F_{M_2}(n_2)\} \\ & + \max \{F_{M_1}(m_1), F_{M_2}(m_2)\}. \end{aligned}$$

Theorem 9. Let $\mathbf{G}_1 = (M_1, N_1)$ and $\mathbf{G}_2 = (M_2, Y_2)$ be two (SVNGs).

(i) If $T_{M_1} \geq T_{N_2}$ and $T_{M_2} \geq T_{N_1}$, then $\forall (m_1, m_2) \in V_1 \times V_2$:

$$(td_T)_{\mathbf{G}_1 \oplus \mathbf{G}_2}(m_1, m_2) = q(td_T)_{\mathbf{G}_1}(m_1) + s(td_T)_{\mathbf{G}_2}(m_2) - (q-1)T_{\mathbf{G}_1}(m_1) - \max \{T_{\mathbf{G}_1}(m_1), T_{\mathbf{G}_1}(m_1)\}.$$

(ii) If $I_{M_1} \leq I_{N_2}$ and $I_{M_2} \leq I_{N_1}$, then $\forall (m_1, m_2) \in V_1 \times V_2$:

$$(td_I)_{\mathbf{G}_1 \oplus \mathbf{G}_2}(m_1, m_2) = q(td_I)_{\mathbf{G}_1}(m_1) + s(td_I)_{\mathbf{G}_2}(m_2) - (q-1)I_{\mathbf{G}_1}(m_1) - \min \{I_{\mathbf{G}_1}(m_1), I_{\mathbf{G}_1}(m_1)\}.$$

(iii) If $F_{M_1} \leq F_{N_2}$ and $F_{M_2} \geq F_{N_1}$, then $\forall (m_1, m_2) \in V_1 \times V_2$:

$$(td_F)_{\mathbf{G}_1 \oplus \mathbf{G}_2}(m_1, m_2) = q(td_F)_{\mathbf{G}_1}(m_1) + s(td_F)_{\mathbf{G}_2}(m_2) - (q-1)F_{\mathbf{G}_1}(m_1) - \min \{F_{\mathbf{G}_1}(m_1), F_{\mathbf{G}_1}(m_1)\}.$$

$\forall (m_1, m_2) \in V_1 \times V_2, s = |V_1| - (d)_{\mathbf{G}_1}(m_1)$ and $q = |V_2| - (d)_{\mathbf{G}_2}(m_2)$.

Proof. $\forall (m_1, m_2) \in V_1 \times V_2$ we have

$$\begin{aligned} & (td_T)_{\mathbf{G}_1 \oplus \mathbf{G}_2}(m_1, m_2) \\ &= \sum_{(m_1, m_2)(n_1, n_2) \in E_1 \times E_2} (T_{N_1} \oplus T_{N_2})((m_1, m_2)(n_1, n_2)) + \\ & (T_{M_1} \oplus T_{M_2})(m_1, m_2) \\ &= \sum_{m_1=n_1, m_2, n_2 \in E_2} \min \{T_{M_1}(m_1), T_{N_2}(m_2, n_2)\} \\ & + \sum_{m_1, n_1 \in E_1, m_2=n_2} \min \{T_{N_1}(m_1, n_1), T_{M_2}(m_2)\} \\ & + \sum_{m_1, n_1 \notin E_1 \text{ and } m_2, n_2 \in E_2} \min \{T_{M_1}(m_1), T_{M_1}(n_1), T_{N_2}(m_2, n_2)\} \\ & + \sum_{m_1, n_1 \in E_1 \text{ and } m_2, n_2 \notin E_2} \min \{T_{N_1}(m_1, n_1), T_{M_2}(m_2), T_{M_2}(n_2)\} \\ & + \max \{T_{M_1}(m_1), T_{M_2}(m_2)\} \\ &= \sum_{m_2, n_2 \in E_2} T_{N_2}(m_2, n_2) + \sum_{m_1, n_1 \in E_1} T_{N_1}(m_1, n_1) \\ & + \sum_{m_1, n_1 \in E_1 \text{ and } m_2, n_2 \notin E_2} T_{N_2}(m_2, n_2) \} + \\ & \sum_{m_1, n_1 \in E_1 \text{ and } m_2, n_2 \notin E_2} T_{N_1}(m_1, n_1) + \max \{T_{M_1}(m_1), T_{M_2}(m_2)\} \\ &= \sum_{m_2, n_2 \in E_2} T_{N_2}(m_2, n_2) + \sum_{m_1, n_1 \in E_1} T_{N_1}(m_1, n_1) + \\ & \sum_{m_1, n_1 \notin E_1 \text{ and } m_2, n_2 \in E_2} T_{N_2}(m_2, n_2) \} \\ & \sum_{m_1, n_1 \in E_1 \text{ and } m_2, n_2 \notin E_2} T_{N_1}(m_1, n_1) + T_{M_1}(m_1) + T_{M_2}(m_2) - \\ & \max \{T_{M_1}(m_1), T_{M_2}(m_2)\} \\ &= q(td_T)_{\mathbf{G}_1}(m_1) + s(td_T)_{\mathbf{G}_2}(m_2) \\ & - (q-1)T_{\mathbf{G}_1}(m_1) - \max \{T_{\mathbf{G}_1}(m_1), T_{\mathbf{G}_1}(m_1)\}, \end{aligned}$$

$$\begin{aligned}
 & (td_I)_{G_1 \oplus G_2}(m_1, m_2) \\
 &= \sum_{(m_1, m_2)(n_1, n_2) \in E_1 \times E_2} (I_{N_1} \oplus I_{N_2})((m_1, m_2)(n_1, n_2)) \\
 & \quad + (I_{M_1} \oplus I_{M_2})(m_1, m_2) \\
 &= \sum_{m_1=n_1, m_2=n_2 \in E_2} \max \{I_{M_1}(m_1), I_{N_2}(m_2 n_2)\} \\
 & \quad + \sum_{m_1 n_1 \in E_1, m_2=n_2} \max \{I_{N_1}(m_1 n_1), I_{M_2}(m_2)\} \\
 & \quad + \sum_{m_1 n_1 \notin E_1 \text{ and } m_2 n_2 \in E_2} \max \{I_{M_1}(m_1), I_{M_1}(n_1), I_{N_2}(m_2 n_2)\} \\
 & \quad + \sum_{m_1 n_1 \in E_1 \text{ and } m_2 n_2 \notin E_2} \max \{I_{N_1}(m_1 n_1), I_{M_2}(m_2), I_{M_2}(n_2)\} \\
 & \quad + \min \{I_{M_1}(m_1), I_{M_2}(m_2)\} \\
 &= \sum_{m_2 n_2 \in E_2} I_{N_2}(m_2 n_2) + \sum_{m_1 n_1 \in E_1} I_{N_1}(m_1 n_1) \\
 & \quad + \sum_{m_1 n_1 \notin E_1 \text{ and } m_2 n_2 \in E_2} I_{N_2}(m_2 n_2) + \\
 & \quad \sum_{m_1 n_1 \in E_1 \text{ and } m_2 n_2 \notin E_2} I_{N_1}(m_1 n_1) + \min \{I_{M_1}(m_1), I_{M_2}(m_2)\} \\
 &= \sum_{m_2 n_2 \in E_2} I_{N_2}(m_2 n_2) + \sum_{m_1 n_1 \in E_1} I_{N_1}(m_1 n_1)
 \end{aligned}$$

$$\begin{aligned}
 & + \sum_{m_1 n_1 \notin E_1 \text{ and } m_2 n_2 \in E_2} I_{N_2}(m_2 n_2) \\
 & \quad + \sum_{m_1 n_1 \in E_1 \text{ and } m_2 n_2 \notin E_2} I_{N_1}(m_1 n_1) + I_{M_1}(m_1) + I_{M_2}(m_2) \\
 & \quad - \min \{I_{M_1}(m_1), I_{M_2}(m_2)\} \\
 &= q(td_I)_{G_1}(m_1) + s(td_I)_{G_2}(m_2) \\
 & \quad - (q-1)I_{G_1}(m_1) - \min \{I_{G_1}(m_1), I_{G_1}(m_1)\},
 \end{aligned}$$

$$\begin{aligned}
 & (td_F)_{G_1 \oplus G_2}(m_1, m_2) \\
 &= \sum_{(m_1, m_2)(n_1, n_2) \in E_1 \times E_2} (F_{N_1} \oplus F_{N_2})((m_1, m_2)(n_1, n_2)) \\
 & \quad + (F_{M_1} \oplus F_{M_2})(m_1, m_2) \\
 &= \sum_{m_1=n_1, m_2=n_2 \in E_2} \max \{F_{M_1}(m_1), F_{N_2}(m_2 n_2)\} \\
 & \quad + \sum_{m_1 n_1 \in E_1, m_2=n_2} \max \{F_{N_1}(m_1 n_1), F_{M_2}(m_2)\} \\
 & \quad + \sum_{m_1 n_1 \notin E_1 \text{ and } m_2 n_2 \in E_2} \max \{F_{M_1}(m_1), F_{M_1}(n_1), F_{N_2}(m_2 n_2)\} \\
 & \quad + \sum_{m_1 n_1 \in E_1 \text{ and } m_2 n_2 \notin E_2} \max \{F_{N_1}(m_1 n_1), F_{M_2}(m_2), F_{M_2}(n_2)\} \\
 & \quad + \min \{F_{M_1}(m_1), F_{M_2}(m_2)\} \\
 &= \sum_{m_2 n_2 \in E_2} F_{N_2}(m_2 n_2) + \sum_{m_1 n_1 \in E_1} F_{N_1}(m_1 n_1) \\
 & \quad + \sum_{m_1 n_1 \notin E_1 \text{ and } m_2 n_2 \in E_2} F_{N_2}(m_2 n_2) \\
 & \quad + \sum_{m_1 n_1 \in E_1 \text{ and } m_2 n_2 \notin E_2} F_{N_1}(m_1 n_1) + \min \{F_{M_1}(m_1), F_{M_2}(m_2)\} \\
 &= \sum_{m_2 n_2 \in E_2} F_{N_2}(m_2 n_2) + \sum_{m_1 n_1 \in E_1} F_{N_1}(m_1 n_1) \\
 & \quad + \sum_{m_1 n_1 \notin E_1 \text{ and } m_2 n_2 \in E_2} F_{N_2}(m_2 n_2) \\
 & \quad + \sum_{m_1 n_1 \in E_1 \text{ and } m_2 n_2 \notin E_2} F_{N_1}(m_1 n_1) + \{F_{M_1}(m_1) + F_{M_2}(m_2) \\
 & \quad - \min \{F_{M_1}(m_1), F_{M_2}(m_2)\}
 \end{aligned}$$

$$\begin{aligned}
 &= q(td_F)_{G_1}(m_1) + s(td_F)_{G_2}(m_2) \\
 & \quad - (q-1)F_{G_1}(m_1) - \min \{F_{G_1}(m_1), F_{G_1}(m_1)\},
 \end{aligned}$$

where $s = |V_1| - (d)_{G_1}(m_1)$ and $q = |V_2| - (d)_{G_2}(m_2)$. \square

Example 12. In this example, we calculate the total degree of vertices in Example 10.

$$(d_T)_{G_1 \oplus G_2}(a, e) = q(d_T)_{G_1}(a) + s(d_T)_{G_2}(e),$$

where $s = |V_1| - (d)_{G_1}(a)$ and $q = |V_2| - (d)_{G_2}(e)$.

$$s = |V_1| - (d)_{G_1}(a) = 2 - 1 = 1.$$

Similarly,

$$q = |V_2| - (d)_{G_2}(e) = 4 - 2 = 2.$$

$$\begin{aligned}
 & (td_T)_{G_1 \oplus G_2}(a, e) = q(td_T)_{G_1}(a) + s(td_T)_{G_2}(e) \\
 & \quad - (s-1)T_{G_2}(e) - (q-1)T_{G_1}(a) - \max \{T_{G_1}(a), T_{G_2}(e)\} \\
 &= 2(0.2 + 0.2) + 1(0.3 + 0.3 + 0.2) \\
 & \quad - (1-1)(0.3) - (2-1)(0.2) - \max \{0.2, 0.3\} \\
 &= 2(0.4) + 0.8 - 0.2 - 0.3 = 1.1, \\
 & (td_I)_{G_1 \oplus G_2}(a, e) = q(td_I)_{G_1}(a) + s(td_I)_{G_2}(e) \\
 & \quad - (s-1)I_{G_2}(e) - (q-1)I_{G_1}(a) - \min \{I_{G_1}(a), I_{G_2}(e)\} \\
 &= 2(0.3 + 0.4) + 1(0.2 + 0.2 + 0.3) \\
 & \quad - (1-1)(0.2) - (2-1)(0.3) - \min \{0.3, 0.2\} \\
 &= 2(0.7) + 0.7 - 0.3 - 0.2 = 1.6,
 \end{aligned}$$

$$\begin{aligned}
 & (td_F)_{G_1 \oplus G_2}(a, e) = q(td_F)_{G_1}(a) + s(td_F)_{G_2}(e) \\
 & \quad - (s-1)F_{G_2}(e) - (q-1)F_{G_1}(a) - \min \{F_{G_1}(a), F_{G_2}(e)\} \\
 &= 2(0.4 + 0.4) + 1(0.1 + 0.1 + 0.1) \\
 & \quad - (1-1)(0.1) - (2-1)(0.4) - \min \{0.4, 0.1\} \\
 &= 2(0.8) + 0.3 - 0.4 - 0.1 = 0.6,
 \end{aligned}$$

and

$$(td)_{G_1 \oplus G_2}(a, e) = (1.1, 1.6, 0.6).$$

It is clear from the above calculations that total degrees of vertices calculated by using the formula of the above theorem and by direct method are same.

Definition 16. The residue product $G_1 \bullet G_2 = (M_1 \bullet M_2, N_1 \bullet N_2)$ of two (SVNGs) $G_1 = (M_1, N_1)$ and $G_2 = (M_2, N_2)$ is defined as

$$\begin{aligned}
 \text{(i)} \quad & (T_{M_1} \bullet T_{M_2})((m_1, m_2)) = \max \{T_{M_1}(m_1), T_{M_2}(m_2)\} \\
 & (I_{M_1} \bullet I_{M_2})((m_1, m_2)) = \min \{I_{M_1}(m_1), I_{M_2}(m_2)\} \\
 & (F_{M_1} \bullet F_{M_2})((m_1, m_2)) = \min \{F_{M_1}(m_1), F_{M_2}(m_2)\}
 \end{aligned}$$

$$\forall (m_1, m_2) \in (V_1 \times V_2),$$

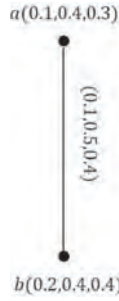

Figure 17 | G_1 .

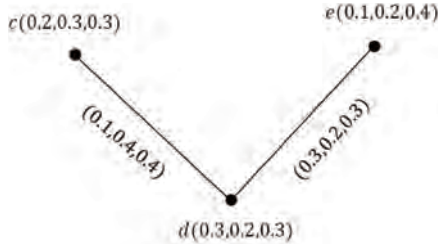

Figure 18 | G_2 .

Proposition 10. The residue product of two (SVNGs) G_1 and G_2 , is a SVNG.

Proof. Let $G_1 = (M_1, N_1)$ and $G_2 = (M_2, N_2)$ be two (SVNGs) on crisp graphs $G_1 = (V_1, E_1)$ and $G_2 = (V_2, E_2)$, respectively and $((m_1, m_2)(n_1, n_2)) \in E_1 \times E_2$. If $m_1 n_1 \in E_1$ and $m_2 \neq n_2$ then we have

$$\begin{aligned} (T_{N_1} \cdot T_{N_2})((m_1, m_2)(n_1, n_2)) &= T_{N_1}(m_1 n_1) \\ &\leq \min\{T_{M_1}(m_1), T_{M_1}(n_1)\} \\ &\leq \max\{\min\{T_{M_1}(m_1), T_{M_1}(n_1)\}, \\ &\quad \min\{T_{M_2}(m_2), T_{M_2}(n_2)\}\} \\ &= \min\{\max\{T_{M_1}(m_1), T_{M_1}(n_1)\}, \\ &\quad \max\{T_{M_2}(m_2), T_{M_2}(n_2)\}\} \\ &= \min\{(T_{M_1} \cdot T_{M_2})(m_1, m_2), (T_{M_1} \cdot T_{M_2})(n_1, n_2)\}, \end{aligned}$$

$$\begin{aligned} (I_{N_1} \cdot I_{N_2})((m_1, m_2)(n_1, n_2)) &= I_{N_1}(m_1 n_1) \\ &\geq \max\{I_{M_1}(m_1), I_{M_1}(n_1)\} \\ &\geq \min\{\max\{I_{M_1}(m_1), I_{M_1}(n_1)\}, \\ &\quad \max\{I_{M_2}(m_2), I_{M_2}(n_2)\}\} \\ &= \max\{\min\{I_{M_1}(m_1), I_{M_1}(n_1)\}, \\ &\quad \min\{I_{M_2}(m_2), I_{M_2}(n_2)\}\} \\ &= \max\{(I_{M_1} \cdot I_{M_2})(m_1, m_2), (I_{M_1} \cdot I_{M_2})(n_1, n_2)\}, \end{aligned}$$

$$\begin{aligned} (F_{N_1} \cdot F_{N_2})((m_1, m_2)(n_1, n_2)) &= F_{N_1}(m_1 n_1) \\ &\geq \max\{F_{M_1}(m_1), F_{M_1}(n_1)\} \\ &\geq \min\{\max\{F_{M_1}(m_1), F_{M_1}(n_1)\}, \\ &\quad \max\{F_{M_2}(m_2), F_{M_2}(n_2)\}\} \end{aligned}$$

$$\begin{aligned} &= \max\{\min\{F_{M_1}(m_1), F_{M_1}(n_1)\}, \\ &\quad \min\{F_{M_2}(m_2), F_{M_2}(n_2)\}\} \\ &= \max\{(F_{M_1} \cdot F_{M_2})(m_1, m_2), (F_{M_1} \cdot F_{M_2})(n_1, n_2)\}. \end{aligned}$$

Definition 17. Let $G_1 = (M_1, N_1)$ and $G_2 = (M_2, N_2)$ be two (SVNGs). For any vertex $(m_1, m_2) \in V_1 \times V_2$ we have

$$\begin{aligned} (d_T)_{G_1 \cdot G_2}(m_1, m_2) &= \\ &\sum_{(m_1, m_2)(n_1, n_2) \in E_1 \times E_2} (T_{N_1} \cdot T_{N_2})((m_1, m_2)(n_1, n_2)) \\ &= \sum_{m_1 n_1 \in E_1, m_2 \neq n_2} T_{N_1}(m_1 n_1) \\ &= (d_T)_{G_1}(m_1), \end{aligned}$$

$$\begin{aligned} (d_I)_{G_1 \cdot G_2}(m_1, m_2) &= \\ &\sum_{(m_1, m_2)(n_1, n_2) \in E_1 \times E_2} (I_{N_1} \cdot I_{N_2})((m_1, m_2)(n_1, n_2)) \\ &= \sum_{m_1 n_1 \in E_1, m_2 \neq n_2} I_{N_1}(m_1 n_1) \\ &= (d_I)_{G_1}(m_1), \end{aligned}$$

$$\begin{aligned} \text{(ii)} \quad (T_{N_1} \cdot T_{N_2})((m_1, m_2)(n_1, n_2)) &= T_{N_1}(m_1 n_1) \\ (I_{N_1} \cdot I_{N_2})((m_1, m_2)(n_1, n_2)) &= I_{N_1}(m_1 n_1) \\ (F_{N_1} \cdot F_{N_2})((m_1, m_2)(n_1, n_2)) &= F_{N_1}(m_1 n_1) \end{aligned}$$

$$\forall m_1 n_1 \in E_1, m_2 \neq n_2.$$

Example 13. Consider the (SVNGs) G_1 and G_2 as in Figures 17 and 18. We can see the residue product of two (SVNGs) G_1 and G_2 , that is $G_1 \cdot G_2$ in Figure 19.

For vertex (b, e) , we find the true membership value, indeterminacy, and the false membership value as follows:

$$\begin{aligned} (T_{M_1} \cdot T_{M_2})((b, e)) &= \max\{T_{M_1}(b), T_{M_2}(e)\} \\ &= \max\{0.2, 0.1\} = 0.2, \end{aligned}$$

$$\begin{aligned} (I_{M_1} \cdot I_{M_2})((b, e)) &= \min\{I_{M_1}(b), I_{M_2}(e)\} \\ &= \min\{0.4, 0.2\} = 0.2, \end{aligned}$$

$$\begin{aligned} (F_{M_1} \cdot F_{M_2})((b, e)) &= \min\{F_{M_1}(b), F_{M_2}(e)\} \\ &= \min\{0.4, 0.4\} = 0.4, \end{aligned}$$

for $b \in V_1$ and $e \in V_2$.

For edge $(a, c)(b, d)$, we calculate the true membership value, indeterminacy, and the false membership value as follows:

$$(T_{N_1} \cdot T_{N_2})((a, c)(b, d)) = T_{N_1}(ab) = 0.1,$$

$$(I_{N_1} \cdot I_{N_2})((a, c)(b, d)) = F_{N_1}(ab) = 0.5,$$

$$(F_{N_1} \cdot F_{N_2})((a, c)(b, d)) = F_{N_1}(ab) = 0.4,$$

for $ab \in E_1$ and $c \neq d$.

Similarly, we can find the true membership value, indeterminacy, and the false membership value for all remaining vertices and edges.

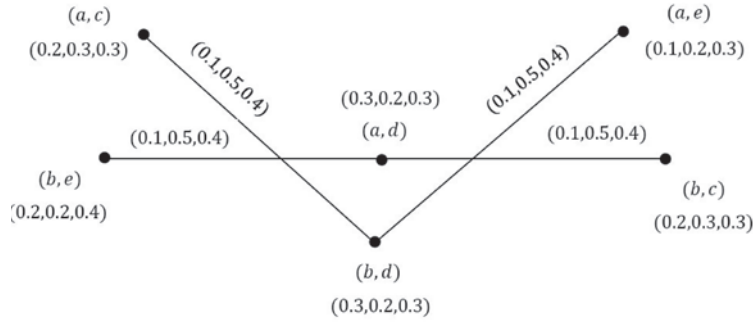

Figure 19 | $G_1 \oplus G_2$.

$$\begin{aligned}
 (d_F)_{G_1 \bullet G_2}(m_1, m_2) &= \sum_{(m_1, m_2)(n_1, n_2) \in E_1 \times E_2} (F_{N_1} \bullet F_{N_2})((m_1, m_2)(n_1, n_2)) \\
 &= \sum_{\substack{m_1 n_1 \in E_1, m_2 \neq n_2}} F_{N_1}(m_1 n_1) \\
 &= (d_F)_{G_1}(m_1).
 \end{aligned}$$

$$\begin{aligned}
 (td_F)_{G_1 \bullet G_2}(m_1, m_2) &= \sum_{(m_1, m_2)(n_1, n_2) \in E_1 \times E_2} (F_{N_1} \bullet F_{N_2})((m_1, m_2)(n_1, n_2)) \\
 &\quad + (F_{M_1} \bullet F_{M_2})(m_1, m_2) \\
 &= \sum_{m_1 n_1 \in E_1, m_2 \neq n_2} F_{N_1}(m_1 n_1) + \max\{F_{M_1}(m_1), F_{M_2}(m_2)\} \\
 &= \sum_{m_1 n_1 \in E_1, m_2 \neq n_2} F_{N_1}(m_1 n_1) + F_{M_1}(m_1) + F_{M_2}(m_2) \\
 &\quad - \min\{F_{M_1}(m_1), F_{M_2}(m_2)\} \\
 &= (td_F)_{G_1}(m_1) + F_{M_2}(m_2) - \min\{F_{M_1}(m_1), F_{M_2}(m_2)\}.
 \end{aligned}$$

Definition 18. Let $G_1 = (M_1, N_1)$ and $G_2 = (M_2, N_2)$ be two (SVNGs). For any vertex $(m_1, m_2) \in V_1 \times V_2$ we have

$$\begin{aligned}
 (td_T)_{G_1 \bullet G_2}(m_1, m_2) &= \sum_{(m_1, m_2)(n_1, n_2) \in E_1 \times E_2} (T_{N_1} \bullet T_{N_2})((m_1, m_2)(n_1, n_2)) \\
 &\quad + (T_{M_1} \bullet T_{M_2})(m_1, m_2) \\
 &= \sum_{m_1 n_1 \in E_1, m_2 \neq n_2} T_{N_1}(m_1 n_1) + \min\{T_{M_1}(m_1), T_{M_2}(m_2)\} \\
 &= \sum_{m_1 n_1 \in E_1, m_2 \neq n_2} T_{N_1}(m_1 n_1) + T_{M_1}(m_1) + T_{M_2}(m_2) \\
 &\quad - \max\{T_{M_1}(m_1), T_{M_2}(m_2)\} \\
 &= (td_T)_{G_1}(m_1) + T_{M_2}(m_2) - \max\{T_{M_1}(m_1), T_{M_2}(m_2)\},
 \end{aligned}$$

Example 14. In this example we find the degree and the total degree of vertex (b, e) in Example 13.

$$\begin{aligned}
 (d_T)_{G_1 \bullet G_2}(b, e) &= (d_T)_{G_1}(b) = 0.1, \\
 (d_I)_{G_1 \bullet G_2}(b, e) &= (d_I)_{G_1}(b) = 0.5, \\
 (d_F)_{G_1 \bullet G_2}(b, e) &= (d_F)_{G_1}(b) = 0.4.
 \end{aligned}$$

Therefore,

$$(d)_{G_1 \bullet G_2}(b, e) = (0, 1, 0, 5, 0, 7, 4).$$

Also, total degree of vertex (a, e) is given by

$$\begin{aligned}
 (td_I)_{G_1 \bullet G_2}(m_1, m_2) &= \sum_{(m_1, m_2)(n_1, n_2) \in E_1 \times E_2} (I_{N_1} \bullet I_{N_2})((m_1, m_2)(n_1, n_2)) \\
 &\quad + (I_{M_1} \bullet I_{M_2})(m_1, m_2) \\
 &= \sum_{m_1 n_1 \in E_1, m_2 \neq n_2} I_{N_1}(m_1 n_1) + \max\{I_{M_1}(m_1), I_{M_2}(m_2)\} \\
 &= \sum_{m_1 n_1 \in E_1, m_2 \neq n_2} I_{N_1}(m_1 n_1) + I_{M_1}(m_1) + I_{M_2}(m_2) \\
 &\quad - \min\{I_{M_1}(m_1), I_{M_2}(m_2)\} \\
 &= (td_I)_{G_1}(m_1) + I_{M_2}(m_2) - \min\{I_{M_1}(m_1), I_{M_2}(m_2)\},
 \end{aligned}$$

$$\begin{aligned}
 (td_T)_{G_1 \bullet G_2}(a, e) &= (td_T)_{G_1}(a) + T_{M_2}(e) - \max\{T_{M_1}(a), T_{M_2}(e)\} \\
 &= (0.2 + 0.1) + 0.1 - \max(0.2, 0.1) = 0.2,
 \end{aligned}$$

$$\begin{aligned}
 (td_I)_{G_1 \bullet G_2}(a, e) &= (td_I)_{G_1}(a) + I_{M_2}(e) - \min\{I_{M_1}(a), I_{M_2}(e)\} \\
 &= (0.4 + 0.5) + 0.2 - \min(0.4, 0.2) = 0.9,
 \end{aligned}$$

$$\begin{aligned}
 (td_F)_{G_1 \bullet G_2}(a, e) &= (td_F)_{G_1}(a) + F_{M_2}(e) - \min\{F_{M_1}(a), F_{M_2}(e)\} \\
 &= (0.4 + 0.4) + 0.4 - \min(0.4, 0.4) = 0.8.
 \end{aligned}$$

Table 1 | SVNPR of the exporter from Pakistan.

R_1	b_1	b_2	b_3	b_4	b_5
b_1	<0.5, 0.5, 0.5>	<0.2, 0.8, 0.1>	<0.1, 0.6, 0.2>	<0.2, 0.3, 0.6>	<0.1, 0.2, 0.4>
b_2	<0.1, 0.2, 0.2>	<0.5, 0.5, 0.5>	<0.2, 0.4, 0.7>	<0.1, 0.4, 0.2>	<0.9, 0.3, 0.4>
b_3	<0.1, 0.4, 0.2>	<0.7, 0.6, 0.2>	<0.5, 0.5, 0.5>	<0.6, 0.3, 0.2>	<0.4, 0.2, 0.6>
b_4	<0.6, 0.7, 0.1>	<0.2, 0.6, 0.1>	<0.2, 0.7, 0.6>	<0.5; 0.5; 0.5>	<0.3; 0.2; 0.7>
b_5	<0.4, 0.8, 0.1>	<0.4, 0.7, 0.9>	<0.6, 0.8, 0.4>	<0.7, 0.8, 0.3>	<0.5; 0.5; 0.5>

Table 2 | SVNPR of the exporter from India.

R_2	b_1	b_2	b_3	b_4	b_5
b_1	<0.5, 0.5, 0.5>	<0.4, 0.6, 0.3>	<0.9, 0.4, 0.3>	<0.2, 0.1, 0.6>	<0.8, 0.3, 0.4>
b_2	<0.3, 0.4, 0.4>	<0.5, 0.5, 0.5>	<0.4, 0.8, 0.2>	<0.2, 0.1, 0.8>	<0.6, 0.3, 0.4>
b_3	<0.3, 0.6, 0.9>	<0., 20.2, 0.4>	<0.5, 0.5, 0.5>	<0.4, 0.2, 0.6>	<0.3, 0.2, 0.7>
b_4	<0.6, 0.9, 0.2>	<0.8, 0.9, 0.2>	<0.6, 0.8, 0.4>	<0.5, 0.5, 0.5>	<0.2, 0.1, 0.6>
b_5	<0.4, 0.7, 0.8>	<0.4, 0.7, 0.6>	<0.7, 0.8, 0.3>	<0.6, 0.9, 0.2>	<0.5, 0.5, 0.5>

Table 3 | SVNPR of the exporter from America.

R_3	b_1	b_2	b_3	b_4	b_5
b_1	<0.5, 0.5, 0.5>	<0.6, 0.4, 0.3>	<0.5, 0.3, 0.2>	<0.4, 0.3, 0.9>	<0.2, 0.1, 0.6>
b_2	<0.3, 0.6, 0.6>	<0.5, 0.5, 0.5>	<0.4, 0.3, 0.2>	<0.5, 0.1, 0.6>	<0.2, 0.3, 0.1>
b_3	<0.2, 0.7, 0.5>	<0.2, 0.7, 0.4>	<0.5, 0.5, 0.5>	<0.4, 0.3, 0.9>	<0.2, 0.6, 0.1>
b_4	<0.9, 0.7, 0.4>	<0.6, 0.9, 0.5>	<0.9, 0.7, 0.4>	<0.5, 0.5, 0.5>	<0.4, 0.3, 0.6>
b_5	<0.6, 0.9, 0.2>	<0.1, 0.7, 0.2>	<0.1, 0.4, 0.2>	<0.6, 0.7, 0.4>	<0.5, 0.5, 0.5>

Table 4 | Collective SVNPR of all above individuals SVNPRs.

R	b_1	b_2	b_3	b_4	b_5
b_1	<0.500, 0.5000, 0.5000>	<0.4231, 0.5769, 0.2080>	<0.6443, 0.4160, 0.2289>	<0.2732, 0.2080, 0.6868>	<0.4759, 0.1817, 0.4579>
b_2	<0.2388, 0.3634, 0.3634>	<0.5000, 0.5000, 0.5000>	<0.3396, 0.4579, 0.3037>	<0.2886, 0.1587, 0.4579>	<0.6825, 0.3000, 0.2520>
b_3	<0.2042, 0.5518, 0.4481>	<0.4231, 0.4380, 0.3175>	<0.5000, 0.5000, 0.5000>	<0.4759, 0.2621, 0.4762>	<0.3048, 0.2885, 0.3476>
b_4	<0.7480, 0.7612, 0.2000>	<0.6000, 0.7862, 0.2154>	<0.6825, 0.7319, 0.4579>	<0.5000, 0.5000, 0.5000>	<0.3048, 0.1817, 0.6316>
b_5	<0.4759, 0.7958, 0.2520>	<0.3132, 0.7000, 0.4762>	<0.5238, 0.6350, 0.2885>	<0.6366, 0.7958, 0.2885>	<0.5000, 0.5000, 0.5000>

Hence,

$$(td)_{G_1 \bullet G_2}(a, e) = (0.2, 0.9, 0.8).$$

Similarly, the degree and the total degree of all vertices can be defined in $G_1 \bullet G_2$.

4. APPLICATION OF SVNG IN GROUP DECISION-MAKING

Definition 19. Let [2] $Q = \{q_1, q_2, \dots, q_n\}$ be the set on which single-valued neutrosophic preference relation (SVNPR) is defined. It can be denoted by a matrix of $R = (m_{st})_{n \times n}$ where $m_{st} = \langle q_s, q_t, T(q_s, q_t), I(q_s, q_t), F(q_s, q_t) \rangle$ for all s and t varies from 1 to n .

4.1. Food and Agriculture Organization of United Nation Select a Most Suitable Company

FAO is attempting to help in the disposal of yearning, food instability, and creation strength the executives. Objectives can be

accomplished when this association chooses the most reasonable organization for formers and works together with it which can assist Former with developing more food, offer types of assistance, and suitable item. There are five organizations of Syngenta b_1 , Bayer's b_2 , Investment organization Institute (ICI) b_3 , Agria Corporation Company (ACC) b_4 , and Fazal Mahmood Company (FMC) b_5 . Three exporters from various nations are welcome to partake in the choice examination. One exporter is from Pakistan, the second is from India, and the third is from America. These exporters use SVNPRs $R_i = (q_{xy}^{(i)})_{5 \times 5}$ SVNDGs D_i comparing to SVNPRs $R_i (i = 1, 2, 3)$ are given in Table 1-3.

By using the aggregation operator to find all SVNPRs $R_i = (q_{xy}^i)_{5 \times 5}$, where $i=1,2,3$ into total SVNPR $R = (q_{st})_{5 \times 5}$ which is shown in Table 4. For SVNPR, we use operator SVNWA

$$[6]. \text{SVNWA} \left(q_{st}^{(1)}, q_{st}^{(2)}, \dots, q_{st}^{(k)} \right) = \left\langle 1 - \prod_{i=1}^k \left(1 - T_{st}^{(i)} \right)^{\frac{1}{k}}, \prod_{i=1}^k \left(I_{st}^{(i)} \right)^{\frac{1}{k}}, \prod_{i=1}^k \left(F_{st}^{(i)} \right)^{\frac{1}{k}} \right\rangle.$$

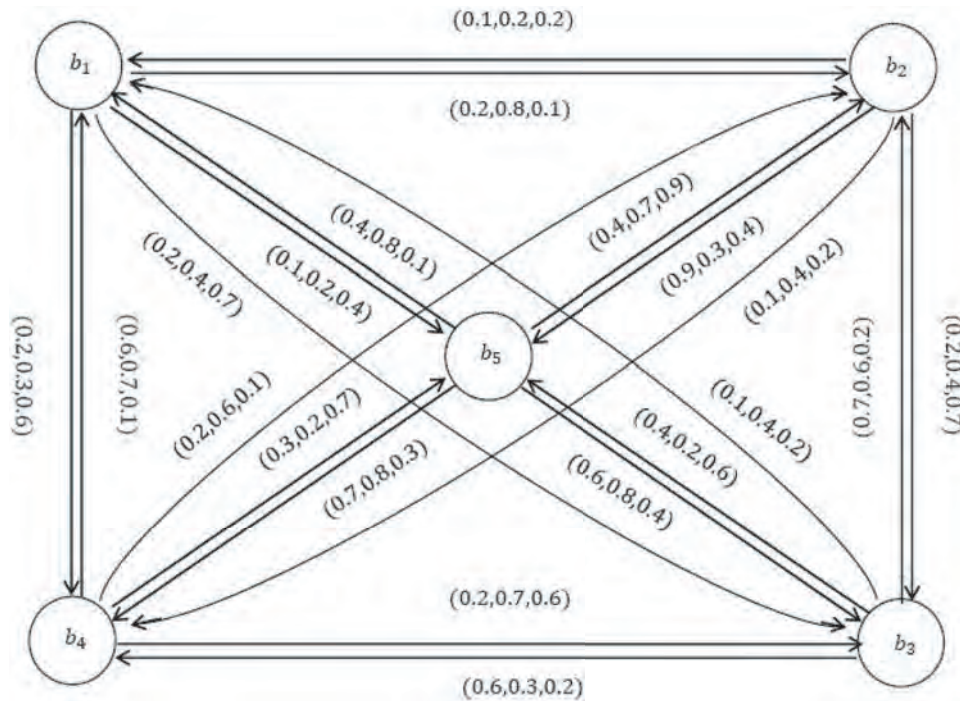

Figure 20 | Single-valued neutrosophic digraph D_1 .

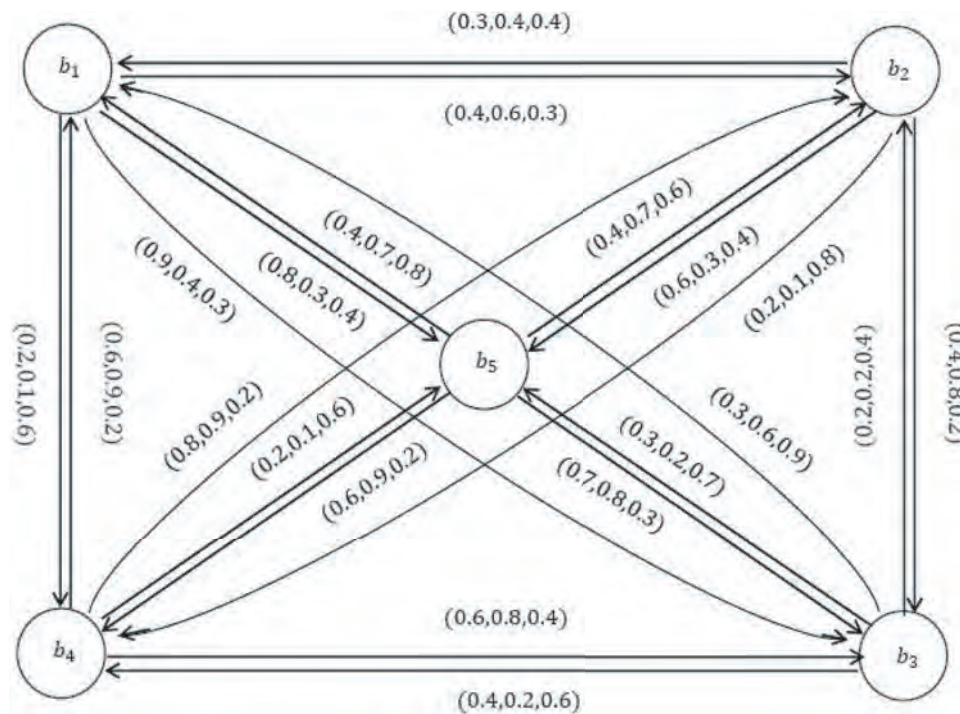

Figure 21 | Single-valued neutrosophic digraph D_2 .

Data is converted in digraphs which shown in Figures 20–22. We can draw directed network corresponding to a collective SVNPR above, which is already shown in Figure 23. Under some conditions, $T_{xy} > 0.5$, where x and y ranges from 1 to 5. Likewise, we have a partial diagram of all fused SVNPR which shown in Figure 24.

We will find out the degrees which are denoted by $out - dout - d(b_x)$ with $x = 1,2,3,4,5$ of the whole criteria in a partial directed network as follows:

$$out - d(b_1) = (0.0000, 0.0000, 0.0000)$$

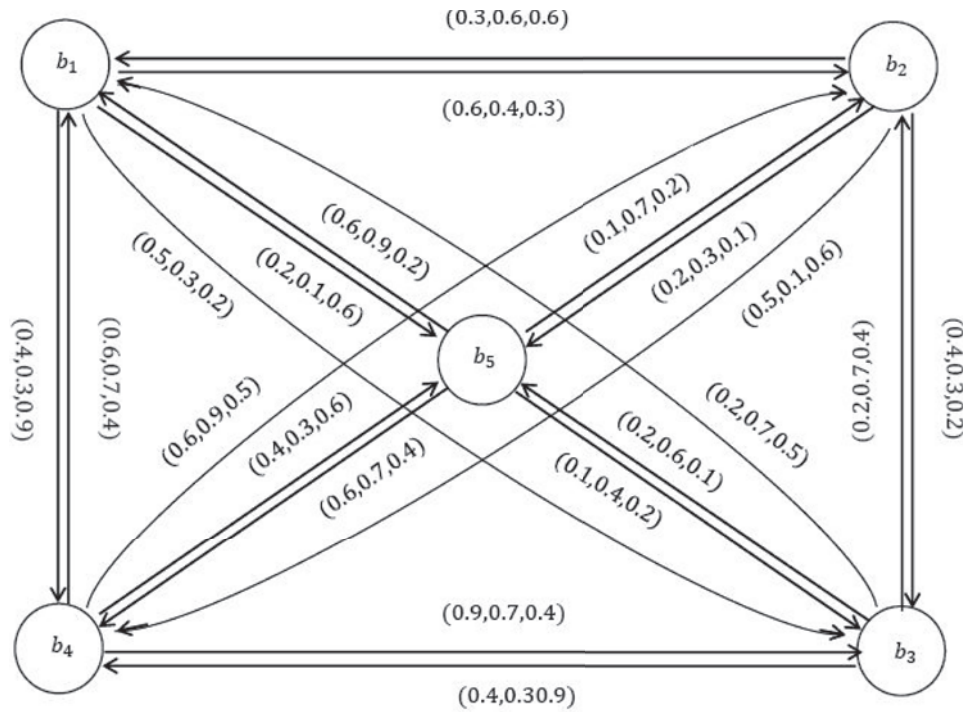

Figure 22 | Single-valued neutrosophic digraph D_3

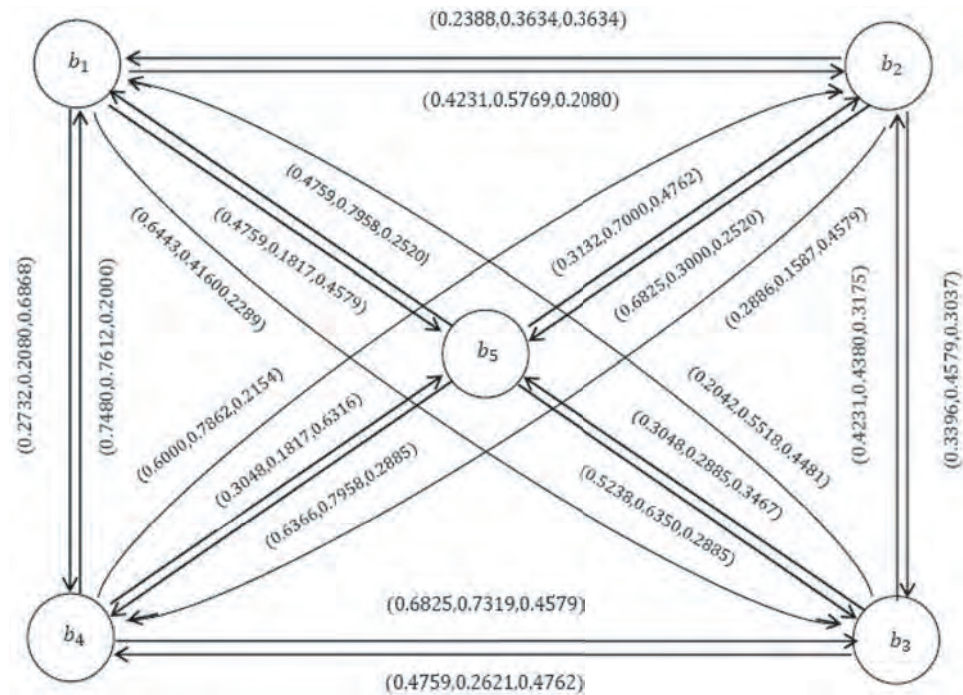

Figure 23 | Directed network of all fused SVNPR.

$out - d(b_2) = (0.6825, 0.3000, 0.2520)$

$out - d(b_3) = (0.0000, 0.0000, 0.0000)$

$out - d(b_4) = (2.0305, 2.2793, 0.6733)$

$out - d(b_5) = (1.1604, 1.4308, 0.5770)$ according to the membership degree rule of $out - d(b_x)$, $x = 1, 2, 3, 4, 5$, a ranking factors which is given below is obtained

$b_4 > b_5 > b_2 > b_1 \sim b_3$. So the ranking of b_5 is higher and serves as the best choice ACC b_4 . To discuss the application, we give an algorithm as follows:

5. CONCLUSION

The adaptability and equivalence of neutrosophic models are higher than fluffy models and intuitionistic fluffy models. A SVNG is

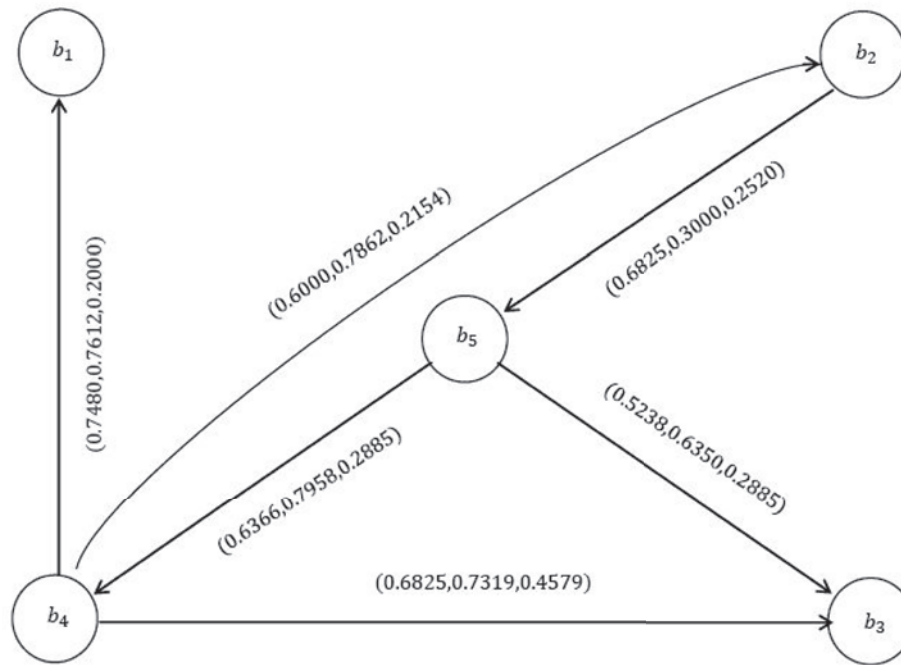

Figure 24 | Partial directed network of all fused SVNPR.

broadly utilized in clinical sciences, financial matters, and logical designing. At the point when filtering happens in a genuine issue then the SVNPG has a fundamental part to investigate the vulnerability since chart and the fluffy diagram don't think about the vulnerability among the relationship of the articles. We have examined the new properties on a SVNPG known as the buildup item, maximal item, symmetric distinction, and dismissal of a chart. We likewise examined the thought with guides to discover the degree and absolute level of vertices of some specific charts. A few hypotheses of these diagrams were recently settled by utilizing the idea of degree and complete level of a vertex of a chart. Additionally, the hypotheses which were identified with these properties were demonstrated. Additionally, the fascinating and helpful use of a SVNPG was examined which was a choice of reasonable organization by FAO. At last, a calculation which is the strategy of our application was introduced. Next, our motivation in future work is to introduce this idea on (1) complex bipolar-SVNPG, (2) complex bipolar fuzzy graph, and (3) complex interval-valued fuzzy graph with their connected applications.

ACKNOWLEDGMENTS

This work is supported by the Social Sciences Planning Projects of Zhejiang (21QNYC11ZD).

REFERENCES

- [1] M. Akram, A. Habib, F. Ilyas, J.M. Dar, Specific types of Pythagorean fuzzy graphs and application to decision-making. *Math. Comput. Appl.* (2018).
- [2] M. Akram, S. Naz, F. Smarandache, Certain notions of energy in single-valued neutrosophic graphs, *Axioms*. 7 (2018), 50.
- [3] K.T. Atanassov, Intuitionistic fuzzy sets, *Fuzzy Sets Syst.* 20 (1986), 87–96.
- [4] P. Bhattacharya, Some remarks on fuzzy graphs, *Pattern Recognit. Lett.*, 6 (1987), 297–302.
- [5] K.R. Bhutani, On automorphisms of fuzzy graphs, *Pattern Recognit. Lett.* 9 (1989), 159–162.
- [6] P. Biswas, S. Pramanik, B.C. Giri, TOPSIS method for multi-attribute group decision-making under single-valued neutrosophic environment, *Neutral Comput. Appl.* 27 (2016), 727–737.
- [7] A.V. Devadoss, A. Rajkumar, N.J.P. Parveena, A study on miracles through holy bible using Neutro-sophic Cognitive Maps (NCMS), *Int. J. Comput. Appl.* 69 (2013), 22–27.
- [8] A. Devi, K.A. Bibi, H. Rashmanlou, New concepts in intuitionistic fuzzy labeling graphs, *Int. J. Adv. Intell. Paradig.* (in press).
- [9] R. Diestel, *Graph Theory*, third ed., Springer-Verlag, New York, NY, USA, 2005,
- [10] A.N. Gani, S.R. Latha, On irregular fuzzy graphs, *Appl. Math. Sci.* 6 (2012), 517–523.
- [11] A.N. Gani, A.B. Ahamed, Order and size in fuzzy graphs, *Bull. Pure Appl. Sci.* 22 (2003), 145–148.
- [12] A. Hassan, M.A. Malik, The classes of bipolar single-valued neutrosophic graphs, *TWMS J. Appl. Eng. Math.* (2016).
- [13] K.K. Krishna, H. Rashmanlou, S. Firouzian, M. Noori, Some applications Of vague sets, *Int. J. Adv. Intell. Paradig.* (in press).

- [14] K.K. Krishna, S. Lavanya, H. Rashmanlou, A.A. Talebi, New concepts of product vague graphs with applications, *Int. J. Adv. Intell. Paradig.* (in press).
- [15] S. Mathew, M.S. Sunitha, *Fuzzy Graphs, Basic Concepts and Applications*, Lap Lambert Academic Publishing, Saarbrücken, Germany. 2012.
- [16] J.N. Mordeson, C.S. Peng, Operations on fuzzy graphs, *Inform. Sci.* 79 (1994), 159–170.
- [17] S. Naz, H. Rashmanlou, M.A. Malik, Operations on single-valued neutrosophic graphs with application, *J. Intell. Fuzzy Syst.* 32 (2017), 2137–2151.
- [18] M.A. Malik, H. Rashmanlou, M. Shoaib, R.A. Borzooei, M. Taheri, B. Said, A study on bipolar single-valued neutrosophic graphs with application, *Neutrosophic Sets Syst.* 32 (2020), 221–268.
- [19] R. Parvathi, M.G. Karunambigai, Intuitionistic fuzzy graphs, in *Computational Intelligence, International Conference in Germany, Germany. 2020*, pp. 18–20.
- [20] H. Rashmanlou, M. Pal, Some properties of highly irregular interval-valued fuzzy graphs, *World Appl. Sci. J.* 27 (2013), 1756–1773.
- [21] H. Rashmanlou, M. Pal, Balanced interval-valued fuzzy graph, *J. Phys. Sci.* 17 (2013), 43–57.
- [22] H. Rashmanlou, M. Pal, Antipodal interval-valued fuzzy graphs, *Int. J. Appl. Fuzzy Sets Artif. Intell.* 3 (2013), 107–130.
- [23] H. Rashmanlou, Y.B. Jun, Complete interval-valued fuzzy graphs, *Ann. Fuzzy Math. Inform.* 6 (2013), 677–687.
- [24] H. Rashmanlou, S. Samanta, M. Pal, R.A. Borzooei, Bipolar fuzzy graphs with categorical properties, *Int. J. Comput. Intell. Syst.* 8 (2015), 808–818.
- [25] H. Rashmanlou, S. Samanta, M. Pal, R.A. Borzooei, A study on bipolar fuzzy graphs, *J. Intell. Fuzzy Syst.* 28 (2015), 571–580.
- [26] H. Rashmanlou, S. Samanta, M. Pal, R.A. Borzooei, Product of bipolar fuzzy graphs and their degree, *Int. J. Gen. Syst.* 45 (2016), 1–14.
- [27] F. Smarandache, A. Rosenfeld, Fuzzy graphs, in: L.A. Zadeh, K.S. Fu, M. Shimura (Eds.), *Fuzzy Sets and their Application*, Academic Press, New York, NY, USA, 1975, pp. 77–95.
- [28] F. Smarandache, Neutrosophic set-a generalization of intuitionistic fuzzy sets, *Int. J. Pure Appl. Math.* 24 (2015), 287–297.
- [29] F. Smarandache, Refined literal indeterminacy and the multiplication law of sub indeterminacy, *Neutrosophic Set Syst.* 9 (2015), 58–63.
- [30] F. Smarandache, A generalization of the intuitionistic fuzzy set, A geometric interpretation of the neutrosophic set, in *2011 IEEE International Conference Granular Computing (GrC)*, Kaohsiung, Taiwan, 2011, pp. 602–606.
- [31] S. Shao, S. Kosari, H. Rashmanlou, M. Shoaib, New concepts in intuitionistic fuzzy graph with application in water supplier systems, *Mathematics.* 8 (2020), 1241.
- [32] L.A. Zadeh, *Fuzzy sets*, *Inf. Control.* 8 (1965), 338–353.
- [33] J.F. Wang, S.Z. Zeng, C.H. Zhang, Single-valued neutrosophic linguistic logarithmic weighted distance measures and their application to supplier selection of fresh aquatic products, *Mathematics.* 8 (2020), 439.
- [34] S.Z. Zeng, Y.J. Hu, T. Balezentis, D. Streimikiene, A multi-criteria sustainable supplier selection framework based on neutrosophic fuzzy data and entropy weighting, *Sustain. Dev.* 28 (2020), 1431–1440.
- [35] Z.M. Mu, S.Z. Zeng, P.Y. Wang, Novel approach to multi-attribute group decision-making based on interval-valued Pythagorean fuzzy power Maclaurin symmetric mean operator, *Comput. Ind. Eng.* 155 (2021), 107049.
- [36] M. Gulfam, M.M. Khalid, F. Smarandache, A. Shah-baz, New Dombi aggregation operators on bipolar neutrosophic set with application in multi-attribute decision-making problems, *J. Intell. Fuzzy Syst.* 40 (2021), 5043–5060.
- [37] S. Zeng, M. Shoaib, S. Ali, Q. Abbas, M.S. Nadeem, Complex vague graphs and their application in decision-making problems, *IEEE Access.* 8 (2020), 174094–174104.
- [38] M.K. Mahmood, S. Zeng, M. Gulfam, S. Ali, Y. Jin, Bipolar neutrosophic dombi aggregation operators with application in multi-attribute decision making problems, *IEEE Access.* 8 (2020), 156600–156614.

Complex Neutrosophic Soft Matrices Framework: An Application in Signal Processing

Madad Khan, Saima Anis, Kainat Bibi, Sohail Iqbal, Florentin Smarandache

Madad Khan, Saima Anis, Kainat Bibi, Sohail Iqbal, Florentin Smarandache (2021). Complex Neutrosophic Soft Matrices Framework: An Application in Signal Processing. *Journal of Mathematics* 8887824, 10; DOI: 10.1155/2021/8887824

Abstract

In this paper, we introduce the concept of complex neutrosophic soft matrices. We define some basic operations including complement, union, and intersection on these matrices. We extend the concept of complex neutrosophic soft sets to complex neutrosophic soft matrices and prove related properties. Moreover, we develop an algorithm using complex neutrosophic soft matrices and apply it in signal processing.

Acknowledgments

This work was financially supported by the Higher Education Commission of Pakistan (Grant No. 7750/Federal/NRPU/R&D/HEC/2017).

1. Introduction

The models of real-life problems in almost every field of science like mathematics, physics, operations research, medical sciences, engineering, computer science, artificial intelligence, and management sciences are mostly full of complexities. Many theories have been developed to overcome these uncertainties; one among those theories is fuzzy set theory. Zadeh was the first who gave the concept of a fuzzy set in 1965 [1]. Fuzzy sets are the generalizations or extensions of crisp sets.

In order to add the concept of nonmembership term to the definition of fuzzy set, the concept of an intuitionistic fuzzy set was introduced by Atanassov in 1986 [2], where he added the concept of nonmembership term to the definition of fuzzy set. The intuitionistic fuzzy set is characterized by a membership function μ and a nonmembership function ν with ranges $[0, 1]$. The intuitionistic fuzzy set is the generalization of a fuzzy set. An intuitionistic fuzzy set can be applied in several fields including modeling, medical diagnosis, and decision-making. [3] Molodtsov introduced the concept of a soft set in 1999 and developed the fundamental results related to this theory. Basic operations including complement, union, and intersection are also defined on this set. Molodtsov used soft sets for applications in games,

probability, and operational theories [3–6]. In 2018, Smarandache generalized the soft set to the hypersoft set by transforming the classical uniargument function F into a multiargument function [7]. Maji et al. [8] introduced the concept of fuzzy soft sets by combining soft sets and fuzzy sets and applied them in decision-making problems [9]. In [10], Cagman and Enginolu used soft matrix theory for applications in decision-making problems.

The concept of neutrosophy was introduced by Smarandache [11] in 1998. A neutrosophic set is characterized by a truth membership function T , an indeterminacy function I , and a falsity membership function F . A neutrosophic set is a mathematical framework which generalizes the concept of a classical set, fuzzy set, intuitionistic fuzzy set, and interval valued fuzzy set [12]. In [13], Nabeeh introduced a method that can promote a personal selection process by integrating the neutrosophic analytical hierarchy process to show the proper solution among distinct options with order preference technique similar to an ideal solution (TOPSIS). In [14], Baset introduced a concept of a neutrosophy technique called type 2 neutrosophic numbers. By combining type 2 neutrosophic numbers and TOPSIS, they suggested a novel method T2NN-TOPSIS which has a lot of applications in group decision-making. They worked on a multicriteria group decision-making technique of the analytical network

process method and Visekriterijumska Optmzacija I Kompromisno Resenje method under neutrosophic environment that deals high-order imprecision and incomplete information [15].

The largest number set is a complex set which is introduced by Gauss in 1795 and is the extension of a real number set. According to same fashion, a complex fuzzy set is extension to a fuzzy set as here the range set is extended from interval $[0, 1]$ to a closed disc of radius one in complex plane. The degree of membership a complex fuzzy set is not restricted to a value in $[0, 1]$; it is extended to a complex value lies in a disc of radius one in the complex plane.

Complex fuzzy sets are not simply a linear extension of conventional fuzzy sets; complex fuzzy sets allow a natural extension of fuzzy set theory to problems that are either very difficult or impossible to address with one-dimensional grades of membership. It is an obvious fact that uncertainty, indeterminacy, inconsistency, and incompleteness in data are periodic in nature. In order to address this difficulty, in 2002, Daniel Ramot was the first who gave the concept of a complex fuzzy set. The concept of a complex neutrosophic set was introduced in [16].

The complex fuzzy set C is described as membership function, with range in closed unit disc in the complex plane. The complex-valued membership function $\phi_s(x)$ is defined as $\phi_s(x) = t_s(x)e^{i\eta_s(x)}$ that assigns a complex value of membership to any x in U (universal set) such that $t_s(x)$ and $\eta_s(x)$ both are real-valued with $t_s(x)$ is fuzzy set and $i = \sqrt{-1}$, where $t_s(x)$ is called amplitude term and $\eta_s(x)$ is called phase term.

Physically the complex fuzzy set is used for representing the complex fuzzy solar activity (solar maximum and solar minimum) through the measurement of sunspot number and is also used in signal processing. The complex neutrosophic set is the generalization of a complex fuzzy set and a neutrosophic set. The complex neutrosophic set is characterized by complex-valued truth membership function, complex-valued indeterminate function, and complex-valued falsehood function. In short, a complex neutrosophic set is more generalized because it is not only the generalization of all the current frameworks but also describes the information in a complete and comprehensive way.

A fuzzy set with its generalizations, like intuitionistic fuzzy sets, interval valued fuzzy sets, and cubic sets, represents uncertainties in models of the one-dimensional phenomenon while a complex fuzzy set is the only generalization of a fuzzy set which deals with the models of real-life problems with the two-dimensional and periodic phenomenon. A complex fuzzy set is more applicable because of its nature and can be used more widely in all branches of sciences. Since it is similar to that of a Fourier transform, more explicitly it is a particular sort of Fourier transform with the only restriction on the range which is a complex unit disc. A Fourier transform is used in signals and systems; that is, a Fourier transform is the mathematical tool for representing both continuous and discrete signals. Taking advantage of a complex fuzzy set, being a specific form of Fourier transform, it can be used to represent signals in a particular region of consideration. A neutrosophic set is

the generalization of a fuzzy set which deals with the problems containing uncertainties of truthfulness, falsehood, and neutrality. The complex neutrosophic set has three major parts, that is, truth, intermediate, and falsehood membership functions. The truth membership function is totally the same as that of a complex fuzzy set while intermediate and falsehood membership functions are the new additions to it. Thus, a complex neutrosophic set can be applied more widely compared with other fuzzy sets.

In the vast area of science and technology, matrices play an important role. Classical matrix theory cannot solve all models of the daily life problems. In order to overcome these difficulties, Yang and Ji in [17] initiated a matrix representation of a fuzzy soft set and successfully applied the proposed notion of a fuzzy soft matrix in certain decision-making problems.

This work is basically the extension of the work of Ramot et al. [18], Alkouri and Saleh [19], Cai [20, 21], and Zhang et al. [22] to neutrosophic sets. Here, in this paper, we extend the concept by defining the complex neutrosophic fuzzy soft set and then the complex neutrosophic fuzzy soft matrix (CNFSM). Further, we discuss some basic operations on CNFSM and finally we develop an algorithm using these matrices and apply it in signal processing.

Soft matrices are widely used in signals and systems, decision-making problems, and medical diagnosis. This article has two aims. In the first part, we present theoretical foundations of the complex neutrosophic fuzzy soft matrices. These theoretical foundations provide basic notions and operations on complex neutrosophic soft matrices such as complex neutrosophic fuzzy soft zero matrix, complex neutrosophic fuzzy soft universal matrix, complex neutrosophic fuzzy soft submatrices, union of complex neutrosophic fuzzy soft matrices, intersection of complex neutrosophic fuzzy soft matrices, and complement of complex neutrosophic fuzzy soft matrices. Then, we introduce some fundamental results and discuss main strategies for applications of this concept in signals and systems, as well as a coherent discussion of the theory of complex neutrosophic fuzzy soft matrices. The aim of these new concepts is to provide a modern method with mathematical procedure to identify a reference signal out of large number of signals received by a digital receiver. The complex neutrosophic fuzzy soft matrix is the generalization of the fuzzy soft matrix, complex fuzzy soft matrix, and Pythagorean fuzzy soft matrix. The degree of membership function, nonmembership function, and phase terms are all applied to each entry of the matrix which give more fruitful results for a better choice in signals and systems along with other fields such as decision-making problems, medical diagnosis, and pattern recognition. These applied contexts provide solid evidence of the wide applications of the complex neutrosophic fuzzy soft matrices approach to signals and systems and decision-making problems.

2. Preliminaries

Here, we begin with a numerical example of a complex neutrosophic set which is already defined above.

Example 1. Let $X = \{x_1, x_2, x_3\}$ be a universe of discourse. Then, the complex neutrosophic set S in X is given as

$$S = \frac{(0.6e^{j0.3}, e^{j\pi/2}, 0.3e^{j0.6})}{x_1} + \frac{(0.4e^{j0}, 0.9e^{j\pi/4}, 0.4e^{j\pi/4})}{x_2} + \frac{(0.5e^{j2\pi/3}, 0.2e^{j0.2}, 0.7e^{j\pi/3})}{x_3}. \quad (1)$$

Definition 1 (fuzzy set (FS) [1]). Fuzzy set is defined by an arbitrary mapping from a nonempty set X to the unit interval $[0, 1]$, i.e., $f: X \rightarrow [0, 1]$. The set of all fuzzy subsets of X is denoted by $F(X)$, i.e., $F(X) = \{f: f \text{ is a function from } X \text{ into } [0, 1]\}$.

Soft set theory is a generalization of fuzzy set theory, which was proposed by Molodtsov in 1999.

Definition 2 (soft set (SS) [3]). Let U be the universal set, E be the set of parameters, and $A \subseteq E$ and $P(U)$ be the power set of U , then a soft set F_A is defined by a mapping.

$$f_A: E \rightarrow P(U) \text{ such that } f_A(x) = \phi \text{ if } x \notin A.$$

In other words, we can say that soft set F_A over U is the parameterized family of subsets of U , that is, $F_A = \{(x, f_A(x)): x \in E, f_A(x) \in P(U)\}$.

Definition 3 (fuzzy soft set (FSS) [8]). Let U be the universe of discourse, E be the set of parameters, and $A \subseteq E$, then a fuzzy soft set G_A is defined by a mapping: $g_A: E \rightarrow P'(U)$ where $P'(U)$ is the collection of all fuzzy subsets of U , such that $g_A(x) = \phi$ if $x \notin A$.

In other words, we can say that fuzzy soft set G_A over U is the parameterized family of fuzzy subsets of U , that is, $G_A = \{(x, g_A(x)): x \in E, g_A(x) \in P'(U)\}$.

Definition 4 (intuitionistic fuzzy set (IFS) [2]). An intuitionistic fuzzy set I on a nonempty set U (universal set) is defined by the set of triplets given by

$$I = \{(x, \mu_I(x), \gamma_I(x)): x \in U\}. \quad (2)$$

Here, $\mu_I(x)$ and $\gamma_I(x)$ both are functions from U to $[0, 1]$ as $\mu_I(x): U \rightarrow [0, 1]$ and $\gamma_I(x): U \rightarrow [0, 1]$. Here, $\mu_I(x)$ represents the degree of membership and $\gamma_I(x)$ represents the degree of nonmembership of each element $x \in U$ to the set I , respectively, also $0 \leq \mu_I(x) + \gamma_I(x) \leq 2$, for all $x \in U$.

Definition 5 (complex fuzzy set (CFS) [18]). The complex fuzzy set S on universe of discourse X is described as complex-valued membership function $\mu_S(x)$ that assigns value of membership of the form $r_s(x)e^{jw_s(x)}$ to any element $x \in X$, where $j = \sqrt{-1}$, $\mu_S(x)$ involves two real-valued $r_s(x)$ and $w_s(x)$, with $r_s(x) \in [0, 1]$.

Mathematically, $S = \{(x, \mu_s(x)): x \in X\}$.

Definition 6 (complex intuitionistic fuzzy set (CIFS) [19]). The complex intuitionistic fuzzy set CI on a nonempty set U (universal set) is defined by the set of triplets given by $CI = \{(x, \mu_{CI}(x), \gamma_{CI}(x)): x \in U\}$. Here, $\mu_{CI}(x) = r_{CI}(x)e^{jw_{CI}(x)}$ and $\gamma_{CI}(x) = l_{CI}(x)e^{jm_{CI}(x)}$ both are functions from U to closed unit disc in the complex plane and also $\mu_{CI}(x)$ represents the degree of membership and $\gamma_{CI}(x)$ represents the degree of nonmembership of each element $x \in U$ to the set CI , respectively, and also $0 \leq r_{CI}(x) + l_{CI}(x) \leq 2$, for all $x \in U$.

Definition 7 (complex neutrosophic fuzzy set (CNFS) [16]). The complex neutrosophic fuzzy set N on a nonempty set U (universal set) is defined by the set as $N = \{(x, T_N(x), I_N(x), F_N(x)): x \in U\}$. Here, $T_N(x) = r_N(x)e^{jw_N(x)}$, $I_N(x) = l_N(x)e^{jm_N(x)}$, and $F_N(x) = p_N(x)e^{jq_N(x)}$ are the complex-valued functions from U to the closed unit disc in the complex plane where $T_N(x)$ describes complex-valued truth membership function, $I_N(x)$ describes complex-valued indeterminate membership function, and $F_N(x)$ describes complex-valued falsehood membership function of each element $x \in U$ to the set N , respectively, and also $0 \leq r_N(x) + l_N(x) + p_N(x) \leq 3$, for all $x \in U$.

3. Complex Neutrosophic Fuzzy Soft Matrix Theory

In this section, we introduced a new concept of complex neutrosophic fuzzy soft matrices. We defined the operations of union, intersection, compliment, and submatrices. We defined zero and universal matrices. Moreover, we proved some related results.

Definition 8 (complex neutrosophic fuzzy soft matrix (CNFSM)). Consider a universal set $U = \{u_1, u_2, u_3, \dots, u_m\}$ and set of parameters $E = \{e_1, e_2, e_3, \dots, e_n\}$ such that $A \subseteq E$ and (c_A, A) be a complex neutrosophic fuzzy soft set over (U, E) . Then, the CNFSS (c_A, A) in matrix form is represented by $A_{m \times n} = [a_{ij}]_{m \times n}$ or $A = [a_{ij}]$ where $i = 1, 2, 3, \dots, m$ and $j = 1, 2, 3, \dots, n$.

$$\text{Here, } a_{ij} = \begin{cases} |\mu_j(u_i)| = (|\mu_j^T(u_i)|, |\mu_j^I(u_i)|, |\mu_j^F(u_i)|), & \text{if } e_j \in A, \\ (0, 0, 0) & \text{if } e_j \notin A. \end{cases} \quad (3)$$

Now, $(\mu_j^T(u_i), \mu_j^I(u_i), \mu_j^F(u_i))$ represents degrees of membership of truth, intermediate, and falsehood on u_i . Throughout this paper, we will use the abbreviation $CNFSM_{m \times n}$ for complex neutrosophic fuzzy soft matrix over U . Following is the example of a complex neutrosophic fuzzy soft matrix.

Example 2. Let $U = \{u_1, u_2, u_3\}$ be a universal set representing the three firms, $E = \{e_1 \text{ (costly)}, e_2 \text{ (beautiful)}, e_3 \text{ (luxurious)}\}$ be the parameters set, and $A = \{e_1, e_2\} \subseteq E$. Then, CNFSS (c_A, A) over the universal set U is given by

$$\begin{aligned} (c_A, A) &= \{c_A(e_1) = \{(u_1, (|0.3e^{j\pi}|, |0.6e^{j\pi/2}|, |e^{j\pi}|)), (u_2, (|0.7e^{j\pi/4}|, |0.8e^{j\pi/4}|, |0.5e^{j\pi/2}|)), (u_3, (|0.9e^{j\pi}|, |0.1e^{j\pi/6}|, |0.2e^{j\pi/2}|)), c_A(e_2) \\ &= \{(u_1, (|0.1e^{j\pi/3}|, |0.2e^{j\pi/6}|, |0.1e^{j\pi}|)), (u_2, (|0.3e^{j\pi/2}|, |0.9e^{j\pi/2}|, |0.9e^{j\pi/4}|)), (u_3, (|0.5e^{j\pi/3}|, |0.5e^{j\pi}|, |0.6e^{j\pi/3}|))\}. \end{aligned} \tag{4}$$

Here,

$$\begin{aligned} 0.3e^{j\pi} &= 0.3(\cos \pi + j \sin \pi) = 0.3(-1 + 0) = -0.3 \\ |0.3e^{j\pi}| &= |-0.3| = 0.3 \quad 0.6 \\ 0.6e^{j\pi/2} &= 0.6\left(\cos\left(\frac{\pi}{2}\right) + j \sin\left(\frac{\pi}{2}\right)\right) = 0.6(0 + j) = 0.6j \\ |0.6e^{j\pi/2}| &= |0.6j| = \sqrt{0.36} = 0.6 \\ e^{j\pi} &= \cos \pi + j \sin \pi = -1 + 0 = -1 \\ |e^{j\pi}| &= |-1| = 1, 0.7e^{j\pi/4} = 0.7\left(\cos\left(\frac{\pi}{4}\right) + j \sin\left(\frac{\pi}{4}\right)\right) = 0.7\left(\frac{1}{\sqrt{2}} + j \frac{1}{\sqrt{2}}\right) \\ &= 0.7(0.707 + j0.707) = 0.494 + j0.494 \\ |0.7e^{j\pi/4}| &= |0.494 + j0.494| = \sqrt{0.244 + 0.244} = 0.69, \\ 0.8e^{j\pi/4} &= 0.8\left(\cos\left(\frac{\pi}{4}\right) + j \sin\left(\frac{\pi}{4}\right)\right) = 0.8\left(\frac{1}{\sqrt{2}} + j \frac{1}{\sqrt{2}}\right) \\ &= 0.8(0.707 + j0.707) = 0.5656 + j0.5656, \\ |0.8e^{j\pi/4}| &= |0.5656 + j0.5656| = \sqrt{0.319 + 0.319} = 0.7905 \\ 0.5e^{j\pi/2} &= 0.5\left(\cos\left(\frac{\pi}{2}\right) + j \sin\left(\frac{\pi}{2}\right)\right) = 0.5j \\ |0.5e^{j\pi/2}| &= |0.5j| = \sqrt{0.25} = 0.5, \\ 0.9e^{j\pi} &= 0.9(\cos \pi + j \sin \pi) = 0.9(-1) = -0.9 \\ |0.9e^{j\pi}| &= |-0.9| = 0.9 \\ 0.1e^{j\pi/6} &= 0.1\left(\cos\left(\frac{\pi}{6}\right) + j \sin\left(\frac{\pi}{6}\right)\right) = 0.1(0.866 + j0.5) = 0.0866 + j0.05 \\ |0.1e^{j\pi/6}| &= |0.0866 + j0.05| = \sqrt{0.0074 + 0.0025} = 0.099, \end{aligned}$$

$$\begin{aligned}
 0.2e^{j\pi/2} &= 0.2\left(\cos\left(\frac{\pi}{2}\right) + j \sin\left(\frac{\pi}{2}\right)\right) = 0.2(0 + j) = 0.2j \\
 |0.2e^{j\pi/2}| &= |0.2j| = \sqrt{0.04} = 0.2, \\
 0.1e^{j\pi/3} &= 0.1\left(\cos\left(\frac{\pi}{3}\right) + j \sin\left(\frac{\pi}{3}\right)\right) = 0.1(0.5 + j0.866) = 0.05 + j0.0866 \\
 |0.1e^{j\pi/3}| &= |0.05 + j0.0866| = \sqrt{0.0025 + 0.0074} = 0.0902e^{j\pi/6} \\
 &= 0.2\left(\cos\left(\frac{\pi}{6}\right) + j \sin\left(\frac{\pi}{6}\right)\right) = 0.2(0.866 + j0.5) = 0.1732 + j0.1 \\
 |0.2e^{j\pi/6}| &= |0.1732 + j0.1| = \sqrt{0.029 + 0.01} = 0.19, \\
 0.1e^{j\pi} &= 0.1(\cos \pi + j \sin \pi) = 0.1(-1 + 0) = -0.1 \\
 |0.1e^{j\pi}| &= |-0.1| = 0.1, \\
 0.3e^{j\pi/2} &= 0.3\left(\cos\left(\frac{\pi}{2}\right) + j \sin\left(\frac{\pi}{2}\right)\right) = 0.3j \\
 |0.3e^{j\pi/2}| &= |0.3j| = \sqrt{0.09} = 0.3 \\
 0.9e^{j\pi/2} &= 0.9\left(\cos \pi/2 + j \sin\left(\frac{\pi}{2}\right)\right) = 0.9j \tag{5} \\
 |0.9e^{j\pi/2}| &= |0.9j| = \sqrt{0.81} = 0.9, \\
 0.9e^{j\pi/4} &= 0.9\left(\cos\left(\frac{\pi}{4}\right) + j \sin\left(\frac{\pi}{4}\right)\right) = 0.9\left(\frac{1}{\sqrt{2}} + j\frac{1}{\sqrt{2}}\right) \\
 &= 0.9(0.707 + j0.707) = 0.636 + j0.636 \\
 |0.9e^{j\pi/4}| &= |0.636 + j0.636| = \sqrt{0.404 + 0.404} = 0.898, \\
 0.5e^{j\pi/3} &= 0.5\left(\cos\left(\frac{\pi}{3}\right) + j \sin\left(\frac{\pi}{3}\right)\right) = 0.5(0.5 + j0.866) = 0.25 + j0.433 \\
 |0.5e^{j\pi/3}| &= |0.25 + j0.433| = \sqrt{0.0625 + 0.187} = 0.499 \\
 0.5e^{j\pi} &= 0.5(\cos \pi + j \sin \pi) = 0.5(-1) = -0.5 \\
 |0.5e^{j\pi}| &= |-0.5| = 0.5, \\
 0.6e^{j\pi/3} &= 0.6\left(\cos\left(\frac{\pi}{3}\right) + j \sin\left(\frac{\pi}{3}\right)\right) = 0.6(0.5 + j0.866) = 0.3 + j0.519 \\
 |0.6e^{j\pi/3}| &= |0.3 + j0.519| = \sqrt{0.09 + 0.269} = 0.599.
 \end{aligned}$$

Now, the abovementioned CNFSS (c_A, A) in matrix form is given by

$$A = \begin{bmatrix} (0.3, 0.6, 1) & (0.09, 0.19, 0.1) & (0, 0, 0) \\ (0.69, 0.79, 0.5) & (0.3, 0.9, 0.898) & (0, 0, 0) \\ (0.9, 0.099, 0.2) & (0.499, 0.5, 0.599) & (0, 0, 0) \end{bmatrix}. \tag{6}$$

Example 3

$$[0] = \begin{bmatrix} (0, 0, 0) & (0, 0, 0) & (0, 0, 0) \\ (0, 0, 0) & (0, 0, 0) & (0, 0, 0) \\ (0, 0, 0) & (0, 0, 0) & (0, 0, 0) \end{bmatrix}. \tag{7}$$

Definition 9 (complex neutrosophic fuzzy soft zero matrix). Let $[a_{ij}] \in CNFSM_{m \times n}$, then $[a_{ij}]$ is called complex neutrosophic fuzzy soft zero matrix if $(a_{ij}, r_{ij}, l_{ij}) = (0, 0, 0)$, for all i and j , and is denoted by $[0]$.

Definition 10 (complex neutrosophic fuzzy soft universal matrix). Let $[a_{ij}] \in CNFSM_{m \times n}$, then $[a_{ij}]$ is called complex neutrosophic fuzzy soft universal matrix if $(a_{ij}, r_{ij}, l_{ij}) = (1, 1, 1)$, for all i and j , and is represented by $[1]$.

$$[1] = \begin{bmatrix} (1, 1, 1) & (1, 1, 1) & (1, 1, 1) \\ (1, 1, 1) & (1, 1, 1) & (1, 1, 1) \\ (1, 1, 1) & (1, 1, 1) & (1, 1, 1) \end{bmatrix}. \quad (8)$$

Definition 11 (complex neutrosophic fuzzy soft submatrices). Let $A_{m \times n}$ and $B_{m \times n}$ be two CNFSMs, then

- (i) $A_{m \times n}$ is a CNFS submatrix of $B_{m \times n}$ and is denoted by $A_{m \times n} \sqsubseteq B_{m \times n}$ if $a_{ij} = (a_{ij}, a'_{ij}, a''_{ij}) \leq b_{ij} = (b_{ij}, b'_{ij}, b''_{ij})$, that is, $(a_{ij} \leq b_{ij}, a''_{ij} \leq b'_{ij}, a'_{ij} \leq b''_{ij})$, for all $a_{ij} \in A_{m \times n}, b_{ij} \in B_{m \times n}$
- (ii) $A_{m \times n}$ is a proper CNFS submatrix of $B_{m \times n}$ and is denoted by $A_{m \times n} \sqsubset B_{m \times n}$ if $a_{ij} = (a_{ij}, a'_{ij}, a''_{ij}) < b_{ij} = (b_{ij}, b'_{ij}, b''_{ij})$, that is, $(a_{ij} < b_{ij}, a'_{ij} < b'_{ij}, a''_{ij} < b''_{ij})$, for all $a_{ij} \in A_{m \times n}, b_{ij} \in B_{m \times n}$ and for at least one entry $a_{ij} < b_{ij}$, that is, $(a_{ij} < b_{ij}, a'_{ij} < b'_{ij}, a''_{ij} < b''_{ij})$
- (iii) Two CNFSMs $A_{m \times n}$ and $B_{m \times n}$ are equal and are denoted by $A_{m \times n} = B_{m \times n}$ if $a_{ij} = (a_{ij}, a'_{ij}, a''_{ij}) = b_{ij} = (b_{ij}, b'_{ij}, b''_{ij})$, that is, $(a_{ij} = b_{ij}, a'_{ij} = b'_{ij}, a''_{ij} = b''_{ij})$, for all $a_{ij} \in A_{m \times n}, b_{ij} \in B_{m \times n}$

Example 4. Let

$$A_{2 \times 2} = \begin{bmatrix} (0.2, 0.4, 0.1) & (0.1, 0.5, 0.2) \\ (0.3, 0.7, 0.3) & (0.5, 0.4, 0.4) \end{bmatrix}, \quad (9)$$

$$B_{2 \times 2} = \begin{bmatrix} (0.2, 0.4, 0.1) & (0.3, 0.7, 0.9) \\ (0.3, 0.7, 0.3) & (0.7, 0.5, 0.7) \end{bmatrix}.$$

So, we can write that $A_{2 \times 2} \sqsubset B_{2 \times 2}$. Moreover, $A \sqsubset B$.

Definition 12. (union/intersection and compliment of complex neutrosophic fuzzy soft matrices).

Let $A_{m \times n}$ and $B_{m \times n}$ be two CNFSM, then the CNFSM $C_{m \times n}$ is called

- (i) Union of $A_{m \times n}$ and $B_{m \times n}$ and is denoted by $A_{m \times n} \sqcup B_{m \times n}$ if $C_{m \times n} = \max\{A_{m \times n}, B_{m \times n}\}$, for all i and j , that is, $c_{ij} = (\max(a_{ij}, b_{ij}), \min(a'_{ij}, b'_{ij}), \min(a''_{ij}, b''_{ij}))$ where $c_{ij} = (c_{ij}, c'_{ij}, c''_{ij})$
- (ii) Intersection of $A_{m \times n}$ and $B_{m \times n}$ is denoted by $A_{m \times n} \sqcap B_{m \times n}$ if $C_{m \times n} = \min\{A_{m \times n}, B_{m \times n}\}$, for all i and j , that is, $c_{ij} = (\min(a_{ij}, b_{ij}), \max(a'_{ij}, b'_{ij}), \max(a''_{ij}, b''_{ij}))$, where $c_{ij} = (c_{ij}, c'_{ij}, c''_{ij})$
- (iii) Complement of $A_{m \times n}$ is denoted by $A'_{m \times n}$ if $C_{m \times n} = 1 - A_{m \times n}$, for all i and j , that is, $c_{ij} = (1 - a_{ij}, 1 - a'_{ij}, 1 - a''_{ij})$, where $c_{ij} = (c_{ij}, c'_{ij}, c''_{ij})$

Example 5. Assume that

$$A_{2 \times 2} = \begin{bmatrix} (0.3, 0.6, 1) & (0.65, 0, 0.6) \\ (0.3, 0.9, 0) & (0.8, 0.7, 0.9) \end{bmatrix},$$

$$B_{2 \times 2} = \begin{bmatrix} (0.49, 0.5, 0.4) & (0.2, 0, 0.3) \\ (0.1, 0.9, 0.3) & (0, 0, 0) \end{bmatrix},$$

then,

$$A_{2 \times 2} \sqcup B_{2 \times 2} = \begin{bmatrix} (0.49, 0.5, 0.4) & (0.65, 0, 0.3) \\ (0.3, 0.9, 0) & (0.8, 0, 0) \end{bmatrix}, \quad (10)$$

$$A_{2 \times 2} \sqcap B_{2 \times 2} = \begin{bmatrix} (0.3, 0.6, 1) & (0.2, 0, 0.6) \\ (0.1, 0.9, 0.3) & (0, 0.7, 0.9) \end{bmatrix},$$

$$A'_{2 \times 2} = \begin{bmatrix} (0.7, 0.4, 0) & (0.35, 1, 0.4) \\ (0.7, 0.1, 1) & (0.2, 0.3, 0.1) \end{bmatrix}.$$

Proposition 1. Let $A_{m \times n}$ be a CNFSM, then

- (i) $((A_{m \times n})')' = A_{m \times n}$,
- (ii) $[0]' = [1]$.

Proof. It follows from definition. □

Proposition 2. Let $A_{m \times n}, B_{m \times n}$, and $C_{m \times n}$ be three CNFSMs, then

- (i) $A_{m \times n} = B_{m \times n}$ and $B_{m \times n} = C_{m \times n} \implies A_{m \times n} = C_{m \times n}$
- (ii) $A_{m \times n} \sqsubseteq B_{m \times n}$ and $B_{m \times n} \sqsubseteq A_{m \times n} \implies A_{m \times n} = B_{m \times n}$.

Proof. It follows from definition. □

Proposition 3. Let $A_{m \times n}$ and $B_{m \times n}$ be two CNFSMs, then

$$A_{m \times n} \sqsubseteq B_{m \times n} \text{ and } B_{m \times n} \sqsubseteq C_{m \times n} \implies A_{m \times n} \sqsubseteq C_{m \times n}. \quad (13)$$

Proof. It follows from definition. □

Proposition 4. Let $A_{m \times n}$ and $B_{m \times n}$ be two CNFSMs, then

- (i) $A_{m \times n} \sqcup B_{m \times n} = B_{m \times n} \sqcup A_{m \times n}$,
- (ii) $A_{m \times n} \sqcap B_{m \times n} = B_{m \times n} \sqcap A_{m \times n}$,
- (iii) $(A_{m \times n} \sqcup B_{m \times n}) \sqcup C_{m \times n} = A_{m \times n} \sqcup (B_{m \times n} \sqcup C_{m \times n})$,
- (iv) $(A_{m \times n} \sqcap B_{m \times n}) \sqcap C_{m \times n} = A_{m \times n} \sqcap (B_{m \times n} \sqcap C_{m \times n})$,
- (v) $A_{m \times n} \sqcup (B_{m \times n} \sqcap C_{m \times n}) = (A_{m \times n} \sqcup B_{m \times n}) \sqcap (A_{m \times n} \sqcup C_{m \times n})$,
- (vi) $A \sqcap (B_{m \times n} \sqcup C_{m \times n}) = (A_{m \times n} \sqcap B_{m \times n}) \sqcup (A_{m \times n} \sqcap C_{m \times n})$.

(14)

Proof

$$\begin{aligned}
 \text{(i)} \quad & A_{m \times n} \sqcup B_{m \times n} = \max(A_{m \times n}, B_{m \times n}) \\
 & = \max(B_{m \times n}, A_{m \times n}) \\
 & = B_{m \times n} \sqcup A_{m \times n}, \\
 \text{(ii)} \quad & A_{m \times n} \sqcap B_{m \times n} = \min(A_{m \times n}, B_{m \times n}) \\
 & = \min(B_{m \times n}, A_{m \times n}) \\
 & = B_{m \times n} \sqcap A_{m \times n}, \\
 \text{(iii)} \quad & (A_{m \times n} \sqcup B_{m \times n}) \sqcup C_{m \times n} = \max((A_{m \times n} \sqcup B_{m \times n}), C_{m \times n}) \\
 & = \max(\max(A_{m \times n}, B_{m \times n}), C_{m \times n}) \\
 & = \max(A_{m \times n}, \max(B_{m \times n}, C_{m \times n})) \\
 & = \max(A_{m \times n}, (B_{m \times n} \sqcup C_{m \times n})) \\
 & = A_{m \times n} \sqcup (B_{m \times n} \sqcup C_{m \times n}), \\
 \text{(iv)} \quad & (A_{m \times n} \sqcap B_{m \times n}) \sqcap C_{m \times n} = \min((A_{m \times n} \sqcap B_{m \times n}), C_{m \times n}) \\
 & = \min(\min(A_{m \times n}, B_{m \times n}), C_{m \times n}) \\
 & = \min(A_{m \times n}, \min(B_{m \times n}, C_{m \times n})) \\
 & = \min(A_{m \times n}, (B_{m \times n} \sqcap C_{m \times n})) \\
 & = A_{m \times n} \sqcap (B_{m \times n} \sqcap C_{m \times n}), \\
 \text{(v)} \quad & A_{m \times n} \sqcup (B_{m \times n} \sqcap C_{m \times n}) = \max(A_{m \times n}, (B_{m \times n} \sqcap C_{m \times n})) \\
 & = \max(A_{m \times n}, \min(B_{m \times n}, C_{m \times n})) \\
 & = \min(\max(A_{m \times n}, B_{m \times n}), \max(A_{m \times n}, C_{m \times n})) \\
 & = \min((A_{m \times n} \sqcup B_{m \times n}), (A_{m \times n} \sqcup C_{m \times n})) \\
 & = (A_{m \times n} \sqcup B_{m \times n}) \sqcap (A_{m \times n} \sqcup C_{m \times n}), \\
 \text{(vi)} \quad & A_{m \times n} \sqcap (B_{m \times n} \sqcup C_{m \times n}) = \min(A_{m \times n}, (B_{m \times n} \sqcup C_{m \times n})) \\
 & = \min(A_{m \times n}, \max(B_{m \times n}, C_{m \times n})) \\
 & = \max(\min(A_{m \times n}, B_{m \times n}), \min(A_{m \times n}, C_{m \times n})) \\
 & = \max((A_{m \times n} \sqcap B_{m \times n}), (A_{m \times n} \sqcap C_{m \times n})) \\
 & = (A_{m \times n} \sqcap B_{m \times n}) \sqcup (A_{m \times n} \sqcap C_{m \times n}).
 \end{aligned}$$

(15)

□

Proposition 5. *Let $A_{m \times n}$ and $B_{m \times n}$ be two CNFSMs, then the De-Morgan laws are valid:*

$$\begin{aligned}
 \text{(i)} \quad & (A_{m \times n} \sqcup B_{m \times n})' = (A_{m \times n})' \sqcap (B_{m \times n})' \\
 \text{(ii)} \quad & (A_{m \times n} \sqcap B_{m \times n})' = (A_{m \times n})' \sqcup (B_{m \times n})'.
 \end{aligned}$$

(16)

Proof.

$$\begin{aligned}
 \text{(i)} \quad & (A_{m \times n} \sqcup B_{m \times n})' = [\max(A_{m \times n}, B_{m \times n})]' \\
 & = [1 - \max(A_{m \times n}, B_{m \times n})] \\
 & = [\min(1 - A_{m \times n}, 1 - B_{m \times n})] \\
 & = [A_{m \times n}]' \sqcap [B_{m \times n}]', \\
 & (A_{m \times n} \sqcap B_{m \times n})' = [\min(A_{m \times n}, B_{m \times n})]' \\
 & = [1 - \min(A_{m \times n}, B_{m \times n})] \\
 & = [\max(1 - A_{m \times n}, 1 - B_{m \times n})] \\
 & = [A_{m \times n}]' \sqcup [B_{m \times n}]'.
 \end{aligned}$$

(17)

□

4. Complex Neutrosophic Fuzzy Soft Decision-Making Method

Now, we are going to discuss real-life applications of newly defined CNFSM_{m×n}. We will show how our theoretical concepts and results can be applied to the real-life phenomenon. Specifically, we will show that CNFSM_{m×n} explains how to get a better and clear signal for identification with a given reference signal. Before moving towards the algorithm, we will define the fuzzy soft (FS) max-min decision-making method (FSMmDM) by using FS max-min decision function and also define here the optimum FS on universal set U .

Definition 13 (fuzzy soft (FS) max-min decision-making function [10]). Let $[c_{ip}] \in SM_{m \times n^2}$, $I_k = \{p: \text{there exists } c_{ip} \neq 0, (k-1)n < p \leq kn\}$, for all $k \in I = \{1, 2, 3, \dots, n\}$. Then, soft max-min decision function, denoted Mm , is defined as follows:

$$Mm: SM_{m \times n^2} \longrightarrow SMm_{m \times 1}, \quad Mm[c_{ip}] = [\max_{k \in I} \{t_k\}], \tag{18}$$

where

$$t_k = \begin{cases} \min_{p \in I_k} \{c_{ip}\}, & \text{if } I_k \neq \{\}, \\ 0, & \text{if } I_k = \{\}. \end{cases} \tag{19}$$

The one column soft matrix $Mm[c_{ip}]$ is called max-min soft decision-making matrix.

Definition 14 (see [10]). Let $U = \{u_1, u_2, \dots, u_m\}$ be a universal set and $Mm[c_{ip}] = [d_{i1}]$. Then, a subset of U can be obtained by using $[d_{i1}]$ as in the following way $\text{opt}_{[d_{i1}]}(U) = \{u_i: u_i \in U, d_{i1} = 1\}$, which is called an optimum set on U .

4.1. Decision-Making Algorithm

step 1. Suppose that M different signals $S_1(t')$, $S_2(t')$, \dots , $S_M(t')$ are detected and sampled by a receiver and let $U = \{S_1(t'), S_2(t'), \dots, S_M(t')\}$. Each of these signals is sampled N times. Let $S_m(r')$ denote the r' th sample ($1 \leq r' \leq N$) of the m th signal ($1 \leq m \leq M$). Now, we know that each signal has its Fourier transform. So, each received signal can be expressed as summation of its Fourier components as

$$S_m(r') = \left(\frac{1}{N}\right) \sum_{n=1}^N C_{m,n} e^{i2\pi(n-1)(r'-1)/N}, \text{ then} \tag{20}$$

$$|S_m(r')| = \left(\frac{1}{N}\right) \sum_{n=1}^N |C_{m,n}| \cdot |e^{i2\pi(n-1)(r'-1)/N}|,$$

where $C_{m,n}$ ($1 \leq n \leq N$) represents complex Fourier coefficients of S_m . The above expression can also be rewritten as follows:

$|S_m(r')| = (1/N) \sum_{n=1}^N |B_{m,n}| \cdot |e^{i(2\pi(n-1)(r'-1)+N\beta_{m,n})/N}|$,
 where $C_{m,n} = B_{m,n}e^{i\beta_{m,n}}$, with $B_{m,n}, \beta_{m,n}$ real-valued and $B_{m,n} \geq 0$, for all n , where $1 \leq n \leq N$.

step 2. The above given signals are expressed as in matrix form as $A = [S_m(r')]_{N \times M}$, that is, express N samples of each signal (total M signals) in columns:

$$A = \begin{bmatrix} (S_1^T(1), S_1^I(1), S_1^F(1)) & (S_2^T(1), S_2^I(1), S_2^F(1)) & \dots & (S_M^T(1), S_M^I(1), S_M^F(1)) \\ (S_1^T(2), S_1^I(2), S_1^F(2)) & (S_2^T(2), S_2^I(2), S_2^F(2)) & \dots & (S_M^T(2), S_M^I(2), S_M^F(2)) \\ \vdots & \vdots & \dots & \vdots \\ (S_1^T(N), S_1^I(N), S_1^F(N)) & (S_2^T(N), S_2^I(N), S_2^F(N)) & \dots & (S_M^T(N), S_M^I(N), S_M^F(N)) \end{bmatrix}. \quad (21)$$

step 3. Similarly, we will construct another matrix by the signals $S_m^*(r)$.

$$B = \begin{bmatrix} (S_1^{*T}(1), S_1^{*I}(1), S_1^{*F}(1)) & (S_2^{*T}(1), S_2^{*I}(1), S_2^{*F}(1)) & \dots & (S_M^{*T}(1), S_M^{*I}(1), S_M^{*F}(1)) \\ (S_1^{*T}(2), S_1^{*I}(2), S_1^{*F}(2)) & (S_2^{*T}(2), S_2^{*I}(2), S_2^{*F}(2)) & \dots & (S_M^{*T}(2), S_M^{*I}(2), S_M^{*F}(2)) \\ \vdots & \vdots & \dots & \vdots \\ (S_1^{*T}(N), S_1^{*I}(N), S_1^{*F}(N)) & (S_2^{*T}(N), S_2^{*I}(N), S_2^{*F}(N)) & \dots & (S_M^{*T}(N), S_M^{*I}(N), S_M^{*F}(N)) \end{bmatrix}. \quad (22)$$

step 4. Multiply matrices A and B using usual multiplication of matrices. In this multiplication, the truth value of the entry of the first matrix will be multiplied by the truth value of the entry of the second matrix. The intermediate and false values of the entries are multiplied similarly.

step 5. The complex neutrosophic fuzzy soft max-min decision-making matrix (CNFSMmDM) is found by taking minimum of truth, intermediate memberships, and maximum of falsehood membership values of each column, and we will get a column matrix $[d_{i1}]$, where $1 \leq i \leq M$.

step 6. An optimum set $\text{opt}_{Mm[AB]}(U)$ on U is found, that is,

$$\left\{ \left(\max\{|S_j^T(i)|, \max\{|S_j^I(u_i)|\}, \min\{|S_j^F(u_i)|\} \right), \text{ for } 1 \leq j \leq M \text{ and } 1 \leq i \leq N \right\}. \quad (23)$$

5. Applications

Step 1. Assume that u_1, u_2 , and u_3 be any three signals received by a digital receiver from any source. Each signal is a triplet of numbers. The first number of triplet represents the truth value, second represents the intermediate value, and the third represents the false value corresponding to each signal. Now, each of these signals is sampled three times. Let R be the given known reference signal. Each signal is compared with the reference signal in order to get the high degree of resemblance with the reference signal R . Now, we obtain the matrix A by setting the signals along column and their three times sampling along row. Similarly, we will obtain the matrix B .

step 2. Matrices A and B are given by

$$A = \begin{bmatrix} (0.7, 0.4, 0.5) & (0.6, 0.7, 1) & (0.8, 1, 0.7) \\ (0.8, 0.5, 0.3) & (0.2, 0, 0.9) & (0.5, 0.8, 0.4) \\ (0.4, 0, 0.8) & (0.8, 0.4, 0.6) & (0, 0.3, 0.9) \end{bmatrix}. \quad (24)$$

step 3

$$B = \begin{bmatrix} (0.4, 0.4, 0) & (0.6, 0.7, 0.4) & (0.1, 0.3, 0) \\ (0.3, 0.7, 0.7) & (0.4, 0.9, 0.4) & (0.1, 0.6, 0.4) \\ (0.2, 0.4, 0.5) & (0.4, 0.5, 0.3) & (0.8, 0.5, 0.8) \end{bmatrix}. \quad (25)$$

step 4. Now, we will calculate the product of above defined matrices by usual multiplication of matrices. In this multiplication, the truth value of the entry of the first matrix will be multiplied by the truth value of the entry of the second matrix. Similarly, the intermediate and false values of the entries are multiplied.

$$AB = \begin{bmatrix} (0.62, 0.69, 0.42) & (0.98, 0.96, 0.45) & (0.77, 0.59, 0.6) \\ (0.48, 0.52, 0.83) & (0.76, 0.75, 0.6) & (0.5, 0.55, 0.68) \\ (0.4, 0.4, 0.87) & (0.56, 0.51, 0.83) & (0.12, 0.39, 0.96) \end{bmatrix}. \quad (26)$$

step 5. We calculate $\text{CNFSMmDM}[AB] = [d_{i1}]$, for all $i = 1, 2, 3$, where d_{i1} is defined as $d_{i1} = \min\{t_{k1}\} = \min\{t_{11}, t_{21}, t_{31}\}$ for all $k = 1, 2, 3$.

$$\begin{aligned}
d_{11} &= \min\{t_{k1}\} = \min\{t_{11}, t_{21}, t_{31}\} \\
&= \min\{(0.62, 0.69, 0.42), (0.48, 0.52, 0.83), (0.4, 0.4, 0.87)\} = (0.4, 0.4, 0.42), \\
d_{21} &= \min\{t_{k2}\} = \min\{t_{12}, t_{22}, t_{32}\} \\
&= \min\{(0.98, 0.96, 0.45), (0.76, 0.75, 0.6), (0.56, 0.51, 0.83)\} = (0.56, 0.51, 0.45), \\
d_{31} &= \min\{t_{k3}\} = \min\{t_{13}, t_{23}, t_{33}\} \\
&= \min\{(0.77, 0.59, 0.6), (0.5, 0.55, 0.68), (0.12, 0.39, 0.96)\} = (0.12, 0.39, 0.6).
\end{aligned} \tag{27}$$

We obtain CNFSMmDM as follows:

$$\text{CNFSMmDM}[AB] = [d_{i1}] = \begin{bmatrix} (0.4, 0.4, 0.42) \\ (0.56, 0.51, 0.45) \\ (0.12, 0.39, 0.6) \end{bmatrix}. \tag{28}$$

Step 6. Finally, we find out an optimum set on U as follows: $\text{opt}_{Mm[AB]}(U) = u_2$. So, the signal which is identified as a reference signal is the signal u_2 .

6. Conclusion

This paper consists of CNFSM and different types of complex neutrosophic soft matrices with examples. We introduced some new operations on complex neutrosophic fuzzy soft matrices and explore related properties. Further, we constructed a complex neutrosophic soft decision-making algorithm with the help of these matrices and used it in signal processing. We hope that our finding will help in enhancing the study on complex neutrosophic soft theory and will open a new direction for applications especially in decision sciences. In future, we will define some new operations on complex neutrosophic fuzzy soft sets and will introduce some new algorithms for signals and other related decision-making in social sciences. Specifically, we will use complex fuzzy sets and complex neutrosophic fuzzy sets in signal processing for modeling of continuous signals.

References

- [1] L. A. Zadeh, "Fuzzy sets," *Information and Control*, vol. 8, no. 3, pp. 338–353, 1965.
- [2] K. T. Atanassov, "Intuitionistic fuzzy sets," *Fuzzy Sets and Systems*, vol. 20, no. 1, pp. 87–96, 1986.
- [3] D. Molodtsov, "Soft set theory-first results," *Computers & Mathematics with Applications*, vol. 37, no. 4-5, pp. 19–31, 1999.
- [4] D. A. Molodtsov, "The description of a dependence with the help of soft sets," *Journal of Computer and Systems Sciences International*, vol. 40, no. 6, pp. 977–984, 2001.
- [5] D. A. Molodtsov, *The Theory of Soft Sets*, URSS Publishers, Moscow, Russia, in Russian, 2004.
- [6] D. A. Molodtsov, V. Yu. Leonov, and D. V. Kovkov, "Soft sets technique and its application," *Nechetkie Sistemy i Myagkie Vychisleniya*, vol. 1, no. 1, pp. 8–39, 2006.
- [7] F. Smarandache, "Extension of soft set to hypersoft set, and then to plithogenic hypersoft set," *Neutrosophic Sets and Systems*, vol. 22, pp. 168–170, 2018.
- [8] P. K. Maji, R. Biswas, and A. R. Roy, "Fuzzy soft sets," *Journal of Fuzzy Mathematics*, vol. 9, no. 3, pp. 589–602, 2001.
- [9] P. K. Maji, A. R. Biswas, and A. R. Roy, "An application of soft sets in a decision making problem," *Computers & Mathematics with Applications*, vol. 44, no. 8-9, pp. 1077–1083, 2002.
- [10] N. Cagman and S. Enginolu, "Soft matrix theory and its decision making," *Computers and Mathematics with Applications*, vol. 59, pp. 3308–3314, 2010.
- [11] F. Smarandache, *A Unifying Field in Logics Neutrosophy: Neutrosophic Probability, Set and Logic*, American Research Press, Rehoboth, DE, USA, 1999.
- [12] F. Smarandache, *Plithogeny, Plithogenic Set, Logic, Probability, and Statistics*, Pons Publishing House, Brussels, Belgium, 2017.
- [13] N. A. Nabeeh, F. Smarandache, M. Abdel-Basset, H. A. El-Ghareeb, and A. Aboelfetouh, "An integrated neutrosophic-TOPSIS approach and its application to personnel selection: a new trend in brain processing and analysis," *IEEE Access*, vol. 7, pp. 29734–29744, 2019.
- [14] M. Abdel-Basset, M. Saleh, A. Gamal, and F. Smarandache, "An approach of TOPSIS technique for developing supplier selection with group decision making under type-2 neutrosophic number," *Applied Soft Computing*, vol. 77, pp. 438–452, 2019.
- [15] M. Abdel-Baset, V. Chang, A. Gamal, and F. Smarandache, "An integrated neutrosophic ANP and VIKOR method for achieving sustainable supplier selection: a case study in importing field," *Computers in Industry*, vol. 106, pp. 94–110, 2019.
- [16] M. Ali and F. Smarandache, "Complex neutrosophic set," *Neural Computing & Applications*, vol. 28, no. 7, pp. 1817–1834, 2016.
- [17] Y. Yang and C. Ji, "Fuzzy soft matrices and their applications," *Artificial Intelligence and Computational Intelligence*, vol. 7002, pp. 618–627, 2011.
- [18] D. Ramot, R. Milo, M. Friedman, and A. Kandel, "Complex fuzzy sets," *IEEE Transactions on Fuzzy Systems*, vol. 10, no. 2, pp. 171–186, 2002.
- [19] A. Alkouri and A. Salleh, "Complex intuitionistic fuzzy sets," in *Proceedings of the International Conference on Fundamental and Applied Sciences, AIP Conference Proceedings*, vol. 1482, pp. 464–470, Kuala Lumpur, Malaysia, June 2012.
- [20] K.-Y. Cai, " δ -Equalities of fuzzy sets," *Fuzzy Sets and Systems*, vol. 76, no. 1, pp. 97–112, 1995.
- [21] Y. K. Cai, "Robustness of fuzzy reasoning and δ -equalities of fuzzy sets," *IEEE Transactions on Fuzzy Systems*, vol. 9, no. 5, pp. 738–750, 2001.
- [22] G. Zhang, K.-Y. Cai, J. Lu, and J. Lu, "Operation properties and δ -equalities of complex fuzzy sets," *International Journal of Approximate Reasoning*, vol. 50, no. 8, pp. 1227–1249, 2009.

A Single-Valued Neutrosophic Extension of the EDAS Method

Dragiša Stanujkić, Darjan Karabašević, Gabrijela Popović, Dragan Pamučar,
Željko Stević, Edmundas Kazimieras Zavadskas, Florentin Smarandache

Dragiša Stanujkić, Darjan Karabašević, Gabrijela Popović, Dragan Pamučar, Željko Stević, Edmundas Kazimieras Zavadskas, Florentin Smarandache (2021). A Single-Valued Neutrosophic Extension of the EDAS Method. *Axioms* 10, 245. DOI: 10.3390/axioms10040245

Abstract: This manuscript aims to propose a new extension of the EDAS method, adapted for usage with single-valued neutrosophic numbers. By using single-valued neutrosophic numbers, the EDAS method can be more efficient for solving complex problems whose solution requires assessment and prediction, because truth- and falsity-membership functions can be used for expressing the level of satisfaction and dissatisfaction about an attitude. In addition, the indeterminacy-membership function can be used to point out the reliability of the information given with truth- and falsity-membership functions. Thus, the proposed extension of the EDAS method allows the use of a smaller number of complex evaluation criteria. The suitability and applicability of the proposed approach are presented through three illustrative examples.

Keywords: neutrosophic set; single-valued neutrosophic set; EDAS; MCDM

1. Introduction

Multicriteria decision making facilitates the evaluation of alternatives based on a set of criteria. So far, this technique has been used to solve a number of problems in various fields [1–6].

Notable advancement in solving complex decision-making problems has been made after Bellman and Zadeh [7] introduced fuzzy multiple-criteria decision making, based on fuzzy set theory [8].

In fuzzy set theory, belonging to a set is shown using the membership function $\mu(x) \in [0, 1]$. Nonetheless, in some cases, it is not easy to determine the membership to the set using a single crisp number, particularly when solving complex decision-making problems. Therefore, Atanassov [9] extended fuzzy set theory by introducing nonmembership to a set $\nu(x) \in [0, 1]$. In Atanassov's theory, intuitionistic sets' indeterminacy is, by default, $1 - \mu(x) - \nu(x)$.

Smarandache [10,11] further extended fuzzy sets by proposing a neutrosophic set. The neutrosophic set includes three independent membership functions, named the truth-membership $T_A(x)$, the falsity-membership $F_A(x)$ and the indeterminacy-membership $I_A(x)$ functions. Smarandache [11] and Wang et al. [12] further proposed a single-valued neutrosophic set, by modifying the conditions $T_A(x)$, $I_A(x)$ and $F_A(x) \in [0, 1]$ and $0 \leq T_A(x) + I_A(x) + F_A(x) \leq 3$, which are more suitable for solving scientific and engineering problems [13].

When solving some kinds of decision-making problems, such as problems related to estimates and predictions, it is not easy to express the ratings of alternatives using crisp values, especially in cases when ratings are collected through surveys. The use of fuzzy sets, intuitionistic fuzzy sets, as well as neutrosophic fuzzy sets can significantly simplify the solving of such types of complex decision-making problems. However, the use of fuzzy sets and intuitionistic fuzzy sets has certain limitations related to the neutrosophic set theory. By using three mutually independent membership functions applied in neutrosophic set theory, the respondent involved in surveys has the possibility of easily expressing their views and preferences. The researchers recognized the potential of the neutrosophic set and involved it in the multiple-criteria decision-making process [14,15].

The Evaluation Based on Distance from Average Solution (EDAS) method was introduced by Keshavarz Ghorabae et al. [16]. Until now, this method has been applied to solve various problems in different areas, such as: ABC inventory classification [16], facility location selection [17], supplier selection [18–20], third-party logistics provider selection [21], prioritization of sustainable development goals [22], autonomous vehicles selection [23], evaluation of e-learning materials [24], renewable energy adoption [25], safety risk assessment [26], industrial robot selection [27], and so forth.

Several extensions are also proposed for the EDAS method, such as: a fuzzy EDAS [19], an interval type-2 fuzzy extension of the EDAS method [18], a rough EDAS [20], Grey EDAS [28], intuitionistic fuzzy EDAS [29], interval-valued fuzzy EDAS [30], an extension of EDAS method in Minkowski space [23], an extension of the EDAS method under q-rung orthopair fuzzy environment [31], an extension of the EDAS method based on interval-valued complex fuzzy soft weighted arithmetic averaging (IV-CFSWAA) operator and the interval-valued complex fuzzy soft weighted geometric averaging (IV-CFSWGA) operator with interval-valued complex fuzzy soft information [32], and an extension of the EDAS equipped with trapezoidal bipolar fuzzy information [33].

Additionally, part of the EDAS extensions is based on neutrosophic environments, such as refined single-valued neutrosophic EDAS [34], trapezoidal neutrosophic EDAS [35], single-valued complex neutrosophic EDAS [36], single-valued triangular neutrosophic EDAS [37], neutrosophic EDAS [38], an extension of the EDAS method based on multi-valued neutrosophic sets [39], a linguistic neutrosophic EDAS [40], the EDAS method under 2-tuple linguistic neutrosophic environment [41], interval-valued neutrosophic EDAS [22,42], interval neutrosophic [43].

In order to enable the usage of the EDAS method for solving complex decision-making problems, a novel extension that enables usage of single-valued neutrosophic numbers is proposed in this article. Therefore, the rest of this paper is organized as follows: In Section 2, some basic definitions related to the single-valued neutrosophic set are given. In Section 3, the computational procedure of the ordinary EDAS method is presented, whereas in Section 3.1, the single-valued neutrosophic extension of the EDAS method is proposed. In Section 4, three illustrative examples are considered with the aim of explaining in detail the proposed methodology. The conclusions are presented in the final section.

2. Preliminaries

Definition 1. Let X be the universe of discourse, with a generic element in X denoted by x . A Neutrosophic Set (NS) A in X is an object having the following form [11]:

$$A = \{x < T_A(x), I_A(x), F_A(x) >: x \in X\}, \quad (1)$$

where: $T_A(x)$, $I_A(x)$, and $F_A(x)$ are the truth-membership function, the indeterminacy-membership function and the falsity-membership function, respectively, $T_A(x), I_A(x), F_A(x) : X \rightarrow]^{-0}, 1^+[$, $^{-0} \leq T_A(x) + I_A(x) + F_A(x) \leq 3^+$, and $]^{-0}, 1^+[$ denotes bounds of NS.

Definition 2. Let X be a space of points, with a generic element in X denoted by x . A Single-Valued Neutrosophic Set (SVNS) A over X is as follows [12]:

$$A = \{x < T_A(x), I_A(x), F_A(x) > | x \in X\}, \tag{2}$$

where: $T_A(x)$, $I_A(x)$ and $F_A(x)$ are the truth-membership function, the indeterminacy-membership function and the falsity-membership function, respectively, $T_A(x), I_A(x), F_A(x) : X \rightarrow [0, 1]$ and $0 \leq T_A(x) + I_A(x) + F_A(x) \leq 3$.

Definition 3. A Single-Valued Neutrosophic Number $a = \langle t_a, i_a, f_a \rangle$ is a special case of an SVNS on the set of real numbers \mathfrak{R} , where $t_a, i_a, f_a \in [0, 1]$ and $0 \leq t_a + i_a + f_a \leq 3$ [12].

Definition 4. Let $x_1 = \langle t_1, i_1, f_1 \rangle$ and $x_2 = \langle t_2, i_2, f_2 \rangle$ be two SVNNs and $\lambda > 0$. The basic operations over two SVNNs are as follows:

$$x_1 + x_2 = \langle t_1 + t_2 - t_1 t_2, i_1 i_2, f_1 f_2 \rangle, \tag{3}$$

$$x_1 \cdot x_2 = \langle t_1 t_2, i_1 + i_2 - i_1 i_2, f_1 + f_2 - f_1 f_2 \rangle. \tag{4}$$

$$\lambda x_1 = \langle 1 - (1 - t_1)^\lambda, i_1^\lambda, f_1^\lambda \rangle. \tag{5}$$

$$x_1^\lambda = \langle t_1^\lambda, i_1^\lambda, 1 - (1 - f_1)^\lambda \rangle. \tag{6}$$

Definition 5. Let $x = \langle t_i, i_i, f_i \rangle$ be an SVNN. The score function s_x of x is as follows [44]:

$$s_i = (1 + t_i - 2i_i - f_i) / 2, \tag{7}$$

where $s_i \in [-1, 1]$.

Definition 6. Let $a_j = \langle t_j, i_j, f_j \rangle (j = 1, \dots, n)$ be a collection of SVNSs and $W = (w_1, w_2, \dots, w_n)^T$ be an associated weighting vector. The Single-Valued Neutrosophic Weighted Average (SVNWA) operator of a_j is as follows [40]:

$$SVNWA(a_1, a_2, \dots, a_n) = \sum_{j=1}^n w_j a_j = \left(1 - \prod_{j=1}^n (1 - t_j)^{w_j}, \prod_{j=1}^n (i_j)^{w_j}, \prod_{j=1}^n (f_j)^{w_j} \right), \tag{8}$$

where: w_j is the element j of the weighting vector, $w_j \in [0, 1]$ and $\sum_{j=1}^n w_j = 1$.

Definition 7. Let $x = \langle t_i, i_i, f_i \rangle$ be an SVNN. The reliability r_i of x is as follows [45]:

$$r_i = \begin{cases} \frac{|t_i - f_i|}{t_i + i_i + f_i} & t_i + i_i + f_i \neq 0 \\ 0 & t_i + i_i + f_i = 0 \end{cases}. \tag{9}$$

Definition 8. Let D be a decision matrix, dimension $m \times n$, whose elements are SVNNs. The overall reliability of the information contained in the decision matrix is as follows:

$$r_d = \frac{\sum_{j=1}^n r_{ij}}{\sum_{i=1}^m \sum_{j=1}^n r_{ij}}. \tag{10}$$

3. The EDAS Method

The procedure of solving a decision-making problem with m alternatives and n criteria using the EDAS method can be presented using the following steps:

Step 1. Determine the average solution according to all criteria, as follows:

$$x_j^* = (x_1, x_2, \dots, x_n), \tag{11}$$

with:

$$x_j^* = \frac{\sum_{i=1}^m x_{ij}}{m}. \tag{12}$$

where: x_{ij} denotes the rating of the alternative i in relation to the criterion j .

Step 2. Calculate the positive distance from average (PDA) d_{ij}^+ and the negative distance from average (NDA) d_{ij}^- , as follows:

$$d_{ij}^+ = \begin{cases} \frac{\max(0, (x_{ij} - x_j^*))}{x_j^*}; & j \in \Omega_{\max} \\ \frac{\max(0, (x_j^* - x_{ij}))}{x_j^*}; & j \in \Omega_{\min} \end{cases}, \tag{13}$$

$$d_{ij}^- = \begin{cases} \frac{\max(0, (x_j^* - x_{ij}))}{x_j^*}; & j \in \Omega_{\max} \\ \frac{\max(0, (x_{ij} - x_j^*))}{x_j^*}; & j \in \Omega_{\min} \end{cases}, \tag{14}$$

where: Ω_{\max} and Ω_{\min} denote the set of the beneficial criteria and the nonbeneficial criteria, respectively.

Step 3. Determine the weighted sum of PDA, Q_i^+ , and the weighted sum of NDS, Q_i^- , for all alternatives, as follows:

$$Q_i^+ = \sum_{j=1}^n w_j d_{ij}^+, \tag{15}$$

$$Q_i^- = \sum_{j=1}^n w_j d_{ij}^-, \tag{16}$$

where w_j denotes the weight of the criterion j .

Step 4. Normalize the values of the weighted sum of the PDA and NDA, respectively, for all alternatives, as follows:

$$S_i^+ = \frac{Q_i^+}{\max_k Q_k^+}, \tag{17}$$

$$S_i^- = 1 - \frac{Q_i^-}{\max_k Q_k^-}, \tag{18}$$

where: S_i^+ and S_i^- denote the normalized weighted sum of the PDA and the NDA, respectively.

Step 5. Calculate the appraisal score S_i for all alternatives, as follows:

$$S_i = \frac{1}{2}(S_i^+ + S_i^-). \tag{19}$$

Step 6. Rank the alternatives according to the decreasing values of appraisal score. The alternative with the highest S_i is the best choice among the candidate alternatives.

3.1. The Extension of the EDAS Method Adopted for the Use of Single-Valued Neutrosophic Numbers in a Group Environment

Let us suppose a decision-making problem that include m alternatives, n criteria and k decision makers, where ratings are given using SVNNS. Then, the computational procedure of the proposed extension of the EDAS method can be expressed concisely through the following steps:

Step 1. Construct the single-valued neutrosophic decision-making matrix for each decision maker, as follows:

$$\tilde{X}^k = \begin{bmatrix} \langle t_{11}^k, i_{11}^k, f_{11}^k \rangle & \langle t_{12}^k, i_{12}^k, f_{12}^k \rangle & \cdots & \langle t_{1n}^k, i_{1n}^k, f_{1n}^k \rangle \\ \langle t_{21}^k, i_{21}^k, f_{21}^k \rangle & \langle t_{22}^k, i_{22}^k, f_{22}^k \rangle & \cdots & \langle t_{2n}^k, i_{2n}^k, f_{2n}^k \rangle \\ \vdots & \vdots & \vdots & \vdots \\ \langle t_{m1}^k, i_{m1}^k, f_{m1}^k \rangle & \langle t_{m2}^k, i_{m2}^k, f_{m2}^k \rangle & \cdots & \langle t_{mn}^k, i_{mn}^k, f_{mn}^k \rangle \end{bmatrix} \quad (20)$$

whose elements $\tilde{x}_{ij} = \langle t_{ij}^k, i_{ij}^k, f_{ij}^k \rangle$ are SVNNS.

Step2. Construct the single-valued neutrosophic decision making using Equation (8):

$$\tilde{X} = \begin{bmatrix} \langle t_{11}, i_{11}, f_{11} \rangle & \langle t_{12}, i_{12}, f_{12} \rangle & \cdots & \langle t_{1n}, i_{1n}, f_{1n} \rangle \\ \langle t_{21}, i_{21}, f_{21} \rangle & \langle t_{22}, i_{22}, f_{22} \rangle & \cdots & \langle t_{2n}, i_{2n}, f_{2n} \rangle \\ \vdots & \vdots & \vdots & \vdots \\ \langle t_{m1}, i_{m1}, f_{m1} \rangle & \langle t_{m2}, i_{m2}, f_{m2} \rangle & \cdots & \langle t_{mn}, i_{mn}, f_{mn} \rangle \end{bmatrix} \quad (21)$$

Step 3. Determine the single-valued average solution (SVAS) \tilde{x}_j^* according to all criteria, as follows:

$$\tilde{x}_j^* = (\langle t_1^*, i_1^*, f_1^* \rangle, \langle t_2^*, i_2^*, f_2^* \rangle, \dots, \langle t_n^*, i_n^*, f_n^* \rangle), \quad (22)$$

where:

$$t_j^* = \frac{\sum_{l=1}^m t_{lj}}{m} \quad (23)$$

$$i_j^* = \frac{\sum_{l=1}^m i_{lj}}{m}, \text{ and} \quad (24)$$

$$f_j^* = \frac{\sum_{l=1}^m f_{lj}}{m} \quad (25)$$

Step 4. Calculate a single-valued neutrosophic PDA (SVNPPDA), $\tilde{d}_{ij}^+ = \langle t_{ij}^+, i_{ij}^+, f_{ij}^+ \rangle$, and a single-valued neutrosophic NDA (SVNNDA), $\tilde{d}_{ij}^- = \langle t_{ij}^-, i_{ij}^-, f_{ij}^- \rangle$, as follows:

$$\tilde{d}_{ij}^+ = \langle t_{ij}^+, i_{ij}^+, f_{ij}^+ \rangle = \begin{cases} \left\langle \frac{\max(0, (t_{ij} - t_j^*))}{x_j^*}, \frac{\max(0, (i_{ij} - i_j^*))}{x_j^*}, \frac{\max(0, (f_{ij} - f_j^*))}{x_j^*} \right\rangle & j \in \Omega_{\max} \\ \left\langle \frac{\max(0, (t_j^* - t_{ij}))}{x_j^*}, \frac{\max(0, (i_j^* - i_{ij}))}{x_j^*}, \frac{\max(0, (f_j^* - f_{ij}))}{x_j^*} \right\rangle & j \in \Omega_{\min} \end{cases} \quad (26)$$

$$\tilde{d}_{ij}^- = \langle t_{ij}^-, i_{ij}^-, f_{ij}^- \rangle = \begin{cases} \left\langle \frac{\max(0, (t_j^* - t_{ij}))}{x_j^*}, \frac{\max(0, (i_j^* - i_{ij}))}{x_j^*}, \frac{\max(0, (f_j^* - f_{ij}))}{x_j^*} \right\rangle & j \in \Omega_{\max} \\ \left\langle \frac{\max(0, (t_{ij} - t_j^*))}{x_j^*}, \frac{\max(0, (i_{ij} - i_j^*))}{x_j^*}, \frac{\max(0, (f_{ij} - f_j^*))}{x_j^*} \right\rangle & j \in \Omega_{\min} \end{cases} \quad (27)$$

where:

$$x_j^* = \max\left(\frac{\sum_{i=1}^m t_{ij}}{m}, \frac{\sum_{i=1}^m i_{ij}}{m}, \frac{\sum_{i=1}^m f_{ij}}{m}\right) \quad (28)$$

For a decision-making problem that includes only beneficial criteria, the SVNPPDA and SVNNDA can be determined as follows:

$$\tilde{d}_{ij}^+ = \langle t_{ij}^+, i_{ij}^+, f_{ij}^+ \rangle = \left\langle \frac{\max(0, (t_{ij} - t_j^*))}{x_j^*}, \frac{\max(0, (i_{ij} - i_j^*))}{x_j^*}, \frac{\max(0, (f_{ij} - f_j^*))}{x_j^*} \right\rangle \quad (29)$$

$$\tilde{d}_{ij}^- = \langle t_{ij}^-, i_{ij}^-, f_{ij}^- \rangle = \left\langle \frac{\max(0, (t_j^* - t_{ij}))}{x_j^*}, \frac{\max(0, (i_j^* - i_{ij}))}{x_j^*}, \frac{\max(0, (f_j^* - f_{ij}))}{x_j^*} \right\rangle \quad (30)$$

Step 5. Determine the weighted sum of the SVNPDAs, $\tilde{Q}_i^+ = \langle t_i^+, i_i^+, f_i^+ \rangle$, and the weighted sum of the SVNNDAs, $\tilde{Q}_i^- = \langle t_i^-, i_i^-, f_i^- \rangle$, for all alternatives. Based on Equations (5) and (8) the weighted sum of the SVNPDAs, \tilde{Q}_i^+ , and the weighted sum of the SVNNDAs, \tilde{Q}_i^- , can be calculated as follows:

$$\tilde{Q}_i^+ = \sum_{j=1}^n w_j \tilde{d}_{ij}^+ = \left\langle 1 - \prod_{j=1}^n (1 - t_{ij}^+)^{w_j}, \prod_{j=1}^n (i_{ij}^+)^{w_j}, \prod_{j=1}^n (f_{ij}^+)^{w_j} \right\rangle, \tag{31}$$

$$\tilde{Q}_i^- = \sum_{j=1}^n w_j \tilde{d}_{ij}^- = \left\langle 1 - \prod_{j=1}^n (1 - t_{ij}^-)^{w_j}, \prod_{j=1}^n (i_{ij}^-)^{w_j}, \prod_{j=1}^n (f_{ij}^-)^{w_j} \right\rangle. \tag{32}$$

Step 6. In order to normalize the values of the weighted sum of the single-valued neutrosophic PDA and the weighted sum of the single-valued neutrosophic NDA, these values should be transformed into crisp values. This transformation can be performed using the score function or similar approaches. After that, the following three steps remain the same as in the ordinary EDAS method.

Step 7. Normalize the values of the weighted sum of the SVNPDAs and the single-valued neutrosophic SVNNDAs for all alternatives, as follows:

$$S_i^+ = \frac{Q_i^+}{\max_k Q_k^+}, \tag{33}$$

$$S_i^- = 1 - \frac{Q_i^-}{\max_k Q_k^-}. \tag{34}$$

Step 8. Calculate the appraisal score S_i for all alternatives, as follows:

$$S_i = \frac{1}{2}(S_i^+ + S_i^-). \tag{35}$$

Step 9. Rank the alternatives according to the decreasing values of the appraisal score. The alternative with the highest S_i is the best choice among the candidate alternatives.

4. A Numerical Illustrations

In this section, three numerical illustrations are presented in order to indicate the applicability of the proposed approach. The first numerical illustration shows in detail the procedure for applying the neutrosophic extension of the EDAS method. The second numerical illustration shows the application of the proposed extension in the case of solving MCDM problems that contain nonbeneficial criteria, while the third numerical illustration shows the application of the proposed approach in combination with the reliability of the information contained in SVNNS.

4.1. The First Numerical Illustration

In this numerical illustration, an example adopted from Biswas et al. [46] is used to demonstrate the proposed approach in detail. Suppose that a team of three IT specialists was formed to select the best tablet from four initially preselected tablets for university students. The purpose of these tablets is to make university e-learning platforms easier to use.

The preselected tablets are evaluated based on the following criteria: Features— C_1 , Hardware— C_2 , Display— C_3 , Communication— C_4 , Affordable Price— C_5 , and Customer care— C_6 . The ratings obtained from three IT specialists are shown in Tables 1–3.

Table 1. The ratings of three tablets obtained from the first of three IT specialist.

	C ₁	C ₂	C ₃	C ₄	C ₅	C ₆
A ₁	<1.0, 0.0, 0.0>	<1.0, 0.2, 0.0>	<1.0, 0.0, 0.0>	<0.7, 0.3, 0.0>	<0.8, 0.2, 0.2>	<0.9, 0.1, 0.1>
A ₂	<1.0, 0.0, 0.0>	<0.9, 0.0, 0.0>	<1.0, 0.0, 0.0>	<0.7, 0.0, 0.2>	<1.0, 0.0, 0.0>	<0.7, 0.0, 0.0>
A ₃	<0.9, 0.0, 0.0>	<0.9, 0.0, 0.0>	<0.7, 0.2, 0.3>	<0.5, 0.0, 0.0>	<0.9, 0.0, 0.0>	<0.7, 2.0, 2.0>
A ₄	<0.7, 0.0, 0.3>	<0.7, 0.3, 0.3>	<0.6, 0.4, 0.2>	<0.4, 0.0, 0.0>	<0.9, 0.0, 0.0>	<0.5, 0.0, 0.2>

Table 2. The ratings of three tablets obtained from the second of three IT specialist.

	C ₁	C ₂	C ₃	C ₄	C ₅	C ₆
A ₁	<0.8, 0.2, 0.2>	<1.0, 0.0, 0.1>	<0.7, 0.3, 0.2>	<0.7, 0.3, 0.2>	<1.0, 0.0, 0.0>	<0.8, 0.1, 0.1>
A ₂	<1.0, 0.0, 0.0>	<1.0, 0.0, 0.0>	<1.0, 0.0, 0.2>	<0.6, 0.0, 0.2>	<1.0, 0.0, 0.0>	<1.0, 0.1, 0.1>
A ₃	<0.7, 0.3, 0.2>	<0.9, 0.0, 0.0>	<0.7, 0.2, 0.3>	<0.5, 0.0, 0.0>	<0.9, 0.0, 0.0>	<0.7, 0.2, 0.2>
A ₄	<0.7, 0.0, 0.3>	<0.7, 0.3, 0.3>	<0.6, 0.4, 0.2>	<0.4, 0.0, 0.0>	<0.9, 0.0, 0.0>	<0.5, 0.1, 0.2>

Table 3. The ratings of three tablets obtained from the third of three IT specialist.

	C ₁	C ₂	C ₃	C ₄	C ₅	C ₆
A ₁	<0.9, 1.0, 1.0>	<0.9, 0.0, 0.2>	<1.0, 0.0, 1.0>	<0.7, 0.3, 0.2>	<1.0, 0.0, 0.0>	<0.9, 0.0, 0.1>
A ₂	<1.0, 0.0, 0.0>	<1.0, 0.0, 0.0>	<0.9, 0.2, 0.1>	<0.6, 0.0, 0.2>	<1.0, 0.0, 0.0>	<1.0, 0.1, 0.1>
A ₃	<0.6, 0.3, 0.2>	<0.9, 0.0, 0.0>	<0.5, 0.2, 0.2>	<0.5, 0.3, 0.2>	<0.9, 0.2, 0.4>	<0.7, 0.0, 0.0>
A ₄	<0.6, 0.0, 0.3>	<0.5, 0.3, 0.4>	<0.4, 0.4, 0.2>	<0.4, 0.0, 0.0>	<0.9, 0.2, 0.3>	<0.7, 0.0, 0.2>

After that, a group evaluation matrix, shown in Table 4, is calculated using Equation (8) and $w_k = (0.33, 0.33, 0.33)$, where w_k denotes the importance of k -th IT specialist.

Table 4. The group evaluation matrix.

	C ₁	C ₂	C ₃	C ₄	C ₅	C ₆
A ₁	<1.0, 0.0, 0.0>	<1.0, 0.0, 0.0>	<1.0, 0.0, 0.0>	<0.7, 0.3, 0.0>	<1.0, 0.0, 0.0>	<0.9, 0.0, 0.1>
A ₂	<1.0, 0.0, 0.0>	<1.0, 0.0, 0.0>	<1.0, 0.0, 0.0>	<0.6, 0.0, 0.2>	<1.0, 0.0, 0.0>	<1.0, 0.0, 0.0>
A ₃	<0.8, 0.0, 0.0>	<0.9, 0.0, 0.0>	<0.6, 0.2, 0.3>	<0.5, 0.0, 0.0>	<0.9, 0.0, 0.0>	<0.7, 0.0, 0.0>
A ₄	<0.7, 0.0, 0.3>	<0.6, 0.3, 0.3>	<0.5, 0.4, 0.2>	<0.4, 0.0, 0.0>	<0.9, 0.0, 0.0>	<0.6, 0.0, 0.2>

The SVNPDAs and the SVNPDA, shown in Tables 5 and 6, are calculated using Equations (29) and (30).

Table 5. The SVNPDAs.

	C ₁	C ₂	C ₃	C ₄	C ₅	C ₆
A ₁	<0.2, 0.0, 0.0>	<0.1, 0.0, 0.0>	<0.3, 0.0, 0.0>	<0.3, 0.4, 0.0>	<0.1, 0.0, 0.0>	<0.1, 0.0, 0.0>
A ₂	<0.2, 0.0, 0.0>	<0.1, 0.0, 0.0>	<0.3, 0.0, 0.0>	<0.1, 0.0, 0.3>	<0.1, 0.0, 0.0>	<0.3, 0.0, 0.0>
A ₃	<0.0, 0.0, 0.0>	<0.0, 0.0, 0.0>	<0.0, 0.1, 0.2>	<0.0, 0.0, 0.0>	<0.0, 0.0, 0.0>	<0.0, 0.0, 0.0>
A ₄	<0.0, 0.0, 0.2>	<0.0, 0.3, 0.3>	<0.0, 0.3, 0.1>	<0.0, 0.0, 0.0>	<0.0, 0.0, 0.0>	<0.0, 0.0, 0.1>

Table 6. The SVNNDA.

	C ₁	C ₂	C ₃	C ₄	C ₅	C ₆
A ₁	<0.0, 0.0, 0.1>	<0.0, 0.1, 0.1>	<0.0, 0.2, 0.1>	<0.0, 0.0, 0.1>	<0.0, 0.0, 0.0>	<0.0, 0.0, 0.0>
A ₂	<0.0, 0.0, 0.1>	<0.0, 0.1, 0.1>	<0.0, 0.2, 0.2>	<0.0, 0.1, 0.0>	<0.0, 0.0, 0.0>	<0.0, 0.0, 0.1>
A ₃	<0.1, 0.0, 0.1>	<0.0, 0.1, 0.1>	<0.2, 0.0, 0.0>	<0.1, 0.1, 0.1>	<0.1, 0.0, 0.0>	<0.1, 0.0, 0.1>
A ₄	<0.2, 0.0, 0.0>	<0.3, 0.0, 0.0>	<0.3, 0.0, 0.0>	<0.3, 0.1, 0.1>	<0.1, 0.0, 0.0>	<0.3, 0.0, 0.0>

The weighted sum of SVNPDAs and the weighted sum of SVNNDA, shown in Table 7, are calculated using Equations (31) and (32), as well as weighting vector $w_j = (0.19, 0.19, 0.18, 0.16, 0.14, 0.13)$. Before calculating the normalized weighted sums of the SVNPDAs and SVNNDA, using Equations (33) and (34), as well as appraisal score, using Equation (35), the values of the weighted sum of SVNPDAs and SVNNDA are transformed into crisp values using Equation (7).

Table 7. Computational details and ranking order of considered tablets.

	\tilde{Q}_i^+		\tilde{Q}_i^-		S_i^+	S_i^-	S_i	Rank
	SVNN	Score	SVNN	Score				
A_1	<0.168, 0.000, 0.000>	0.58	<0.000, 0.000, 0.000>	0.50	1.00	0.20	0.597	2
A_2	<0.170, 0.000, 0.000>	0.59	<0.000, 0.027, 0.000>	0.47	1.00	0.24	0.620	1
A_3	<0.003, 0.000, 0.000>	0.50	<0.096, 0.000, 0.000>	0.55	0.86	0.12	0.488	3
A_4	<0.000, 0.000, 0.000>	0.50	<0.245, 0.000, 0.000>	0.62	0.85	0.00	0.427	4

The ranking order of considered alternatives is also shown in Table 7. As it can be seen from Table 7, the most appropriate alternative is the alternative denoted as A_2 .

4.2. The Second Numerical Illustration

The second numerical illustration shows the application of the NS extension of the EDAS method in the case of solving MCDM problems that include nonbeneficial criteria.

An example taken from Stanujkic et al. [47] was used for this illustration. In the given example, the evaluation of three comminution circuit designs (CCDs) was performed based on five criteria: Grinding efficiency— C_1 , Economic efficiency— C_2 , Technological reliability— C_3 , Capital investment costs— C_4 , and Environmental impact— C_5 . The group decision-making matrix, as well as the types of criteria, are shown in Table 8.

Table 8. Group decision-making matrix.

	C_1	C_2	C_3	C_4	C_5
Optimization	Max	Max	Max	Min	Min
A_1	<0.9, 0.1, 0.2>	<0.7, 0.2, 0.3>	<0.9, 0.1, 0.2>	<0.9, 0.1, 0.2>	<0.9, 0.1, 0.2>
A_2	<0.8, 0.1, 0.3>	<0.8, 0.1, 0.3>	<0.8, 0.1, 0.3>	<0.9, 0.1, 0.2>	<0.8, 0.1, 0.3>
A_3	<1.0, 0.1, 0.3>	<0.9, 0.1, 0.2>	<0.9, 0.1, 0.2>	<0.7, 0.2, 0.5>	<0.7, 0.2, 0.3>

Values of the SVNPDAs and SVNNPDAs, calculated using Equations (26) and (27), are shown in Tables 9 and 10.

Table 9. The SVNPDAs.

	C_1	C_2	C_3	C_4	C_5
A_1	<0.2, 0.0, 0.0>	<0.1, 0.0, 0.0>	<0.3, 0.0, 0.0>	<0.3, 0.4, 0.0>	<0.1, 0.0, 0.0>
A_2	<0.2, 0.0, 0.0>	<0.1, 0.0, 0.0>	<0.3, 0.0, 0.0>	<0.1, 0.0, 0.3>	<0.1, 0.0, 0.0>
A_3	<0.0, 0.0, 0.2>	<0.0, 0.3, 0.3>	<0.0, 0.3, 0.1>	<0.0, 0.0, 0.0>	<0.0, 0.0, 0.0>

Table 10. The SVNNPDAs.

	C_1	C_2	C_3	C_4	C_5
A_1	<0.0, 0.0, 0.1>	<0.0, 0.1, 0.1>	<0.0, 0.2, 0.1>	<0.0, 0.0, 0.1>	<0.0, 0.0, 0.0>
A_2	<0.0, 0.0, 0.1>	<0.0, 0.1, 0.1>	<0.0, 0.2, 0.2>	<0.0, 0.1, 0.0>	<0.0, 0.0, 0.0>
A_3	<0.2, 0.0, 0.0>	<0.3, 0.0, 0.0>	<0.3, 0.0, 0.0>	<0.3, 0.1, 0.1>	<0.1, 0.0, 0.0>

The weighted sum of SVNPDAs and the weighted sum of SVNNPDAs are shown in Table 11. The calculation was performed using the following weighting vector $w_j = (0.24, 0.17, 0.24, 0.21, 0.14)$. The remaining part of the calculation procedure, carried out using formulas Equations (33)–(35) is also summarized in Table 11.

Table 11. Computational details and ranking order of considered GCDs.

	\tilde{Q}_i^+		\tilde{Q}_i^-		S_i^+	S_i^-	S_i	Rank
	SVNN	Score	SVNN	Score				
A_1	<0.009, 0.000, 0.000>	0.50	<0.057, 0.000, 0.000>	0.53	0.910	0.005	0.458	2
A_2	<0.000, 0.000, 0.000>	0.50	<0.063, 0.000, 0.000>	0.53	0.902	0.000	0.451	3
A_3	<0.109, 0.000, 0.000>	0.55	<0.000, 0.000, 0.000>	0.50	1.000	0.059	0.530	1

As can be seen from Table 11, by applying the proposed extension of the EDAS method, the following ranking order of alternatives is obtained $A_3 > A_1 > A_2$, i.e., the alternative A_3 is selected as the most appropriate.

A similar order of alternatives was obtained in Stanujkic et al. [45] using the Neutrosophic extension of the MULTIMOORA method, where the following order of alternatives was achieved $A_3 > A_2 > A_1$.

4.3. The Third Numerical Illustration

The third numerical illustration shows the use of a newly proposed approach with an approach that allows for determining the reliability of data contained in SVNNs, proposed by Stanujkic et al. [43]. Using this approach, inconsistently completed questionnaires can be identified and, if necessary, eliminated from further evaluation of alternatives.

In order to demonstrate this approach, an example was taken from Stanujkic et al. [48]. In this example, the websites of five wineries were evaluated based on the following five criteria: Content— C_1 , Structure and Navigation— C_2 , Visual Design— C_3 , Interactivity— C_4 , and Functionality— C_5 .

The ratings obtained from the three respondents are also shown in Tables 12–14.

Table 12. The ratings obtained from the first of three respondents.

	C_1	C_2	C_3	C_4	C_5
A_1	<1.0, 0.0, 0.0>	<1.0, 0.2, 0.0>	<1.0, 0.0, 0.0>	<0.7, 0.3, 0.0>	<0.8, 0.2, 0.2>
A_2	<1.0, 0.0, 0.0>	<1.0, 0.0, 0.0>	<1.0, 0.0, 0.0>	<0.6, 0.0, 0.2>	<1.0, 0.0, 0.0>
A_3	<0.9, 0.0, 0.0>	<0.9, 0.0, 0.0>	<0.7, 0.2, 0.3>	<0.5, 0.0, 0.0>	<0.9, 0.0, 0.0>
A_4	<0.7, 0.0, 0.3>	<0.7, 0.3, 0.3>	<0.6, 0.4, 0.2>	<0.4, 0.0, 0.0>	<0.9, 0.0, 0.0>
A_5	<1.0, 0.0, 0.0>	<1.0, 0.0, 0.0>	<1.0, 0.0, 0.0>	<0.7, 0.0, 0.2>	<1.0, 0.0, 0.0>

Table 13. The ratings obtained from the second of three respondents.

	C_1	C_2	C_3	C_4	C_5
A_1	<0.8, 0.2, 0.2>	<1.0, 0.0, 0.0>	<0.7, 0.3, 0.1>	<0.7, 0.3, 0.2>	<1.0, 0.0, 0.0>
A_2	<1.0, 0.0, 0.0>	<1.0, 0.0, 0.0>	<1.0, 0.0, 0.0>	<0.6, 0.0, 0.2>	<1.0, 0.0, 0.0>
A_3	<0.7, 0.3, 0.2>	<0.9, 0.0, 0.0>	<0.7, 0.2, 0.3>	<0.5, 0.0, 0.0>	<0.9, 0.0, 0.0>
A_4	<0.7, 0.0, 0.3>	<0.7, 0.3, 0.3>	<0.6, 0.4, 0.2>	<0.4, 0.0, 0.0>	<0.9, 0.0, 0.0>
A_5	<1.0, 0.0, 0.0>	<1.0, 0.0, 0.0>	<1.0, 0.0, 0.0>	<0.7, 0.0, 0.2>	<1.0, 0.0, 0.0>

Table 14. The ratings obtained from the third of three respondents.

	C_1	C_2	C_3	C_4	C_5
A_1	<0.9, 1.0, 1.0>	<0.9, 0.0, 0.2>	<1.0, 0.0, 1.0>	<0.7, 0.3, 0.2>	<1.0, 0.0, 0.0>
A_2	<1.0, 0.0, 0.0>	<1.0, 0.0, 0.0>	<1.0, 0.0, 0.0>	<0.6, 0.0, 0.2>	<1.0, 0.0, 0.0>
A_3	<0.6, 0.3, 0.2>	<0.9, 0.0, 0.0>	<0.5, 0.2, 0.3>	<0.5, 0.3, 0.3>	<0.9, 0.3, 0.4>
A_4	<0.6, 0.0, 0.3>	<0.5, 0.3, 0.4>	<0.4, 0.4, 0.2>	<0.4, 0.0, 0.0>	<0.9, 0.3, 0.3>
A_5	<1.0, 0.0, 0.0>	<1.0, 0.0, 0.0>	<1.0, 0.0, 0.0>	<0.7, 0.0, 0.2>	<1.0, 0.0, 0.0>

The reliability of the collected information calculated using Equations (9) and (10) are shown in Tables 15–17. In this case, the lowest value of overall reliability of information was 0.61 which is why all collected questionnaires were used to evaluate alternatives.

Table 15. The reliability of information obtained from the first of three respondents.

	C_1	C_2	C_3	C_4	C_5	<i>Reliability</i>
A_1	1.00	0.83	1.00	0.70	0.50	0.81
A_2	1.00	1.00	1.00	0.50	1.00	0.90
A_3	1.00	1.00	0.33	1.00	1.00	0.87
A_4	0.40	0.31	0.33	1.00	1.00	0.61
A_5	1.00	1.00	1.00	0.56	1.00	0.91
Overall reliability						0.82

Table 16. The reliability of information obtained from the second of three respondents.

	C_1	C_2	C_3	C_4	C_5	<i>Reliability</i>
A_1	0.50	1.00	0.55	0.42	1.00	0.69
A_2	1.00	1.00	1.00	0.50	1.00	0.90
A_3	0.42	1.00	0.33	1.00	1.00	0.75
A_4	0.40	0.31	0.33	1.00	1.00	0.61
A_5	1.00	1.00	1.00	0.56	1.00	0.91
Overall reliability						0.77

Table 17. The reliability of information obtained from the third of three respondents.

	C_1	C_2	C_3	C_4	C_5	<i>Reliability</i>
A_1	0.03	0.64	0.00	0.42	1.00	0.42
A_2	1.00	1.00	1.00	0.50	1.00	0.90
A_3	0.36	1.00	0.20	0.18	0.31	0.41
A_4	0.33	0.08	0.20	1.00	0.40	0.40
A_5	1.00	1.00	1.00	0.56	1.00	0.91
Overall reliability						0.61

The group decision-making matrix formed on the basis of the ratings from Tables 12–14 is shown in Table 18, while the calculation details are summarized in Table 19, using the following weight vector $w_j = (0.22, 0.20, 0.25, 0.18, 0.16)$.

Table 18. The group decision-making matrix.

	C_1	C_2	C_3	C_4	C_5
A_1	<1.0, 0.0, 0.0>	<1.0, 0.0, 0.0>	<1.0, 0.0, 0.0>	<0.7, 0.3, 0.0>	<1.0, 0.0, 0.0>
A_2	<1.0, 0.0, 0.0>	<1.0, 0.0, 0.0>	<1.0, 0.0, 0.0>	<0.6, 0.0, 0.2>	<1.0, 0.0, 0.0>
A_3	<0.8, 0.0, 0.0>	<0.9, 0.0, 0.0>	<0.6, 0.2, 0.3>	<0.5, 0.0, 0.0>	<0.9, 0.0, 0.0>
A_4	<0.7, 0.0, 0.3>	<0.6, 0.3, 0.3>	<0.5, 0.4, 0.2>	<0.4, 0.0, 0.0>	<0.9, 0.0, 0.0>
A_5	<1.0, 0.0, 0.0>	<1.0, 0.0, 0.0>	<1.0, 0.0, 0.0>	<0.7, 0.0, 0.2>	<1.0, 0.0, 0.0>

Table 19. Computational details and ranking order of considered websites.

	\tilde{Q}_i^+		\tilde{Q}_i^-		S_i^+	S_i^-	S_i	Rank
	SVNN	Score	SVNN	Score				
A_1	<0.141, 0.000, 0.000>	0.57	<0.000, 0.000, 0.000>	0.50	1.00	0.21	0.61	3
A_2	<0.110, 0.000, 0.000>	0.56	<0.000, 0.006, 0.000>	0.47	0.97	0.26	0.62	2
A_3	<0.000, 0.000, 0.000>	0.50	<0.125, 0.000, 0.000>	0.56	0.88	0.11	0.49	4
A_4	<0.000, 0.000, 0.000>	0.50	<0.269, 0.000, 0.000>	0.63	0.88	0.00	0.44	5
A_5	<0.141, 0.000, 0.000>	0.57	<0.000, 0.006, 0.000>	0.47	1.00	0.26	0.63	1

From Table 15 it can be seen that the following order of ranking of alternatives was achieved $A_5 > A_2 > A_1 > A_3 > A_4$, which is similar to the order of alternatives $A_5 = A_2 > A_1 > A_3 > A_4$ given in Stanujkic et al. [48].

5. Conclusions

A novel extension of the EDAS method based on the use of single-valued neutrosophic numbers is proposed in this article. Single-valued neutrosophic numbers enable simultaneous use of truth- and falsity-membership functions, and thus enable expressing the level of satisfaction and the level of dissatisfaction about an attitude. At the same time, using the indeterminacy-membership function, decision makers can express their confidence about already-given satisfaction and dissatisfaction levels.

The evaluation process using the ordinary EDAS method can be considered as simple and easy to understand. Therefore, the primary objective of the development of this extension was the formation of an easy-to-use and easily understandable extension of the EDAS method. By integrating the benefits that can be obtained by using single-valued neutrosophic numbers and simple-to-use and understandable computational procedures of the EDAS method, the proposed extension can be successfully used for solving complex decision-making problems, while the evaluation procedure remains easily understood for decision makers who are not familiar with neutrosophy and multiple-criteria decision making.

Finally, the usability and efficiency of the proposed extension is demonstrated on an example of tablet evaluation.

Acknowledgments: The research presented in this article was done with the financial support of the Ministry of Education, Science and Technological Development of the Republic of Serbia, within the funding of the scientific research work at the University of Belgrade, Technical Faculty in Bor, according to the contract with registration number 451-03-9/2021-14/200131.

References

1. Karamaşa, Ç.; Demir, E.; Memiş, S.; Korucuk, S. Weighing the factors affecting logistics outsourcing. *Decis. Mak. Appl. Manag. Eng.* **2021**, *4*, 19–33. [[CrossRef](#)]
2. Valipour, A.; Sarvari, H.; Tamošaitiene, J. Risk Assessment in PPP Projects by Applying Different MCDM Methods and Comparative Results Analysis. *Adm. Sci.* **2018**, *8*, 80. [[CrossRef](#)]
3. Ferreira, F.A.; Ilander, G.O.P.-B.; Ferreira, J. MCDM/A in practice: Methodological developments and real-world applications. *Manag. Decis.* **2019**, *57*, 295–299. [[CrossRef](#)]
4. Chen, Y.-C.; Lien, H.-P.; Tzeng, G.-H. Measures and evaluation for environment watershed plans using a novel hybrid MCDM model. *Expert Syst. Appl.* **2010**, *37*, 926–938. [[CrossRef](#)]
5. Bakır, M.; Atalık, Ö. Application of fuzzy AHP and fuzzy MARCOS approach for the evaluation of e-service quality in the airline industry. *Decis. Mak. Appl. Manag. Eng.* **2021**, *4*, 127–152. [[CrossRef](#)]
6. Cakar, T.; Çavuş, B. Supplier selection process in dairy industry using fuzzy TOPSIS method. *Oper. Res. Eng. Sci. Theory Appl.* **2021**, *4*, 82–98. [[CrossRef](#)]
7. Bellman, R.E.; Zadeh, L.A. Decision-Making in a Fuzzy Environment. *Manag. Sci.* **1970**, *17*, B141. [[CrossRef](#)]
8. Zadeh, L. Fuzzy sets. *Inf. Control.* **1965**, *8*, 338–353. [[CrossRef](#)]
9. Atanassov, K.T. Intuitionistic fuzzy sets. *Fuzzy Set. Syst.* **1986**, *20*, 87–96. [[CrossRef](#)]
10. Smarandache, F. *Neutrosophy Probability Set and Logic*; American Research Press: Rehoboth, NM, USA, 1998.
11. Smarandache, F. *A Unifying Field in Logics. Neutrosophy: Neutrosophic Probability, Set and Logic*; American Research Press: Rehoboth, NM, USA, 1999.
12. Wang, H.; Smarandache, F.; Zhang, Y.; Sunderraman, R. Single valued neutrosophic sets. *Rev. Air Force Acad.* **2010**, *1*, 10–14.
13. Li, Y.; Liu, P.; Chen, Y. Some Single Valued Neutrosophic Number Heronian Mean Operators and Their Application in Multiple Attribute Group Decision Making. *Informatica* **2016**, *27*, 85–110. [[CrossRef](#)]
14. Zavadskas, E.K.; Bausys, R.; Lescauskiene, I.; Omran, J. M-generalised q-neutrosophic MULTIMOORA for Decision Making. *Stud. Inform. Control.* **2020**, *29*, 389–398. [[CrossRef](#)]
15. Zavadskas, E.K.; Bausys, R.; Lescauskiene, I.; Usovaitė, A. MULTIMOORA under Interval-Valued Neutrosophic Sets as the Basis for the Quantitative Heuristic Evaluation Methodology HEBIN. *Mathematics* **2021**, *9*, 66. [[CrossRef](#)]

16. Ghorabae, M.K.; Zavadskas, E.K.; Olfat, L.; Turskis, Z. Multi-Criteria Inventory Classification Using a New Method of Evaluation Based on Distance from Average Solution (EDAS). *Informatica* **2015**, *26*, 435–451. [[CrossRef](#)]
17. Keshavarz Ghorabae, M.; Zavadskas, E.K.; Amiri, M.; Antucheviciene, J. Evaluation by an area-based method of ranking interval type-2 fuzzy sets (EAMRIT-2F) for multi-criteria group decision-making. *Trans. Bus. Econ.* **2016**, *15*, 76–95.
18. Ghorabae, M.K.; Amiri, M.; Zavadskas, E.K.; Turskis, Z.; Antucheviciene, J. A new multi-criteria model based on interval type-2 fuzzy sets and EDAS method for supplier evaluation and order allocation with environmental considerations. *Comput. Ind. Eng.* **2017**, *112*, 156–174. [[CrossRef](#)]
19. Ghorabae, M.K.; Zavadskas, E.K.; Amiri, M.; Turskis, Z. Extended EDAS Method for Fuzzy Multi-criteria Decision-making: An Application to Supplier Selection. *Int. J. Comput. Commun. Control.* **2016**, *11*, 358–371. [[CrossRef](#)]
20. Stević, Ž.; Pamučar, D.; Vasiljević, M.; Stojić, G.; Korica, S. Novel Integrated Multi-Criteria Model for Supplier Selection: Case Study Construction Company. *Symmetry* **2017**, *9*, 279. [[CrossRef](#)]
21. Ecer, F. Third-party logistics (3PLs) provider selection via Fuzzy AHP and EDAS integrated model. *Technol. Econ. Dev. Econ.* **2018**, *24*, 615–634. [[CrossRef](#)]
22. Karaşan, A.; Kahraman, C. A novel interval-valued neutrosophic EDAS method: Prioritization of the United Nations national sustainable development goals. *Soft Comput.* **2018**, *22*, 4891–4906. [[CrossRef](#)]
23. Zavadskas, E.K.; Stević, Ž.; Turskis, Z.; Tomašević, M. A Novel Extended EDAS in Minkowski Space (EDAS-M) Method for Evaluating Autonomous Vehicles. *Stud. Inform. Control.* **2019**, *28*, 255–264. [[CrossRef](#)]
24. Jauković-Jocić, K.; Karabašević, D.; Popović, G. An approach for e-learning courses evaluation based on the EDAS method. *Ekonomika* **2020**, *66*, 47–59. [[CrossRef](#)]
25. Asante, D.; He, Z.; Adjei, N.O.; Asante, B. Exploring the barriers to renewable energy adoption utilising MULTIMOORA-EDAS method. *Energy Policy* **2020**, *142*, 111479. [[CrossRef](#)]
26. Hou, W.-H.; Wang, X.-K.; Zhang, H.-Y.; Wang, J.-Q.; Li, L. Safety risk assessment of metro construction under epistemic uncertainty: An integrated framework using credal networks and the EDAS method. *Appl. Soft Comput.* **2021**, *108*, 107436. [[CrossRef](#)]
27. Rashid, T.; Ali, A.; Chu, Y.-M. Hybrid BW-EDAS MCDM methodology for optimal industrial robot selection. *PLoS ONE* **2021**, *16*, e0246738. [[CrossRef](#)]
28. Stanujkic, D.; Zavadskas, E.K.; Ghorabae, M.K.; Turskis, Z. An Extension of the EDAS Method Based on the Use of Interval Grey Numbers. *Stud. Inform. Control.* **2017**, *26*, 5–12. [[CrossRef](#)]
29. Kahraman, C.; Keshavarz-Ghorabae, M.; Zavadskas, E.K.; Onar, S.C.; Yazdani, M.; Oztaysi, B. Intuitionistic fuzzy EDAS method: An application to solid waste disposal site selection. *J. Environ. Eng. Landsc. Manag.* **2017**, *25*, 1–12. [[CrossRef](#)]
30. Peng, X.; Dai, J.; Yuan, H. Interval-valued Fuzzy Soft Decision Making Methods Based on MABAC, Similarity Measure and EDAS. *Fundam. Informaticae* **2017**, *152*, 373–396. [[CrossRef](#)]
31. Li, Z.; Wei, G.; Wang, R.; Wu, J.; Wei, C.; Wei, Y. EDAS method for multiple attribute group decision making under q-rung orthopair fuzzy environment. *Technol. Econ. Dev. Econ.* **2020**, *26*, 86–102. [[CrossRef](#)]
32. Fan, J.-P.; Cheng, R.; Wu, M.-Q. Extended EDAS Methods for Multi-Criteria Group Decision-Making Based on IV-CFSWAA and IV-CFSWGA Operators with Interval-Valued Complex Fuzzy Soft Information. *IEEE Access* **2019**, *7*, 105546–105561. [[CrossRef](#)]
33. Özçelik, G.; Nalkiran, M. An Extension of EDAS Method Equipped with Trapezoidal Bipolar Fuzzy Information: An Application from Healthcare System. *Int. J. Fuzzy Syst.* **2021**. [[CrossRef](#)]
34. Tan, R.-P.; Zhang, W.-D. Decision-making method based on new entropy and refined single-valued neutrosophic sets and its application in typhoon disaster assessment. *Appl. Intell.* **2021**, *51*, 283–307. [[CrossRef](#)]
35. Abdel-Basset, M.; Gamal, A.; Chakraborty, R.K.; Ryan, M. Development of a hybrid multi-criteria decision-making approach for sustainability evaluation of bioenergy production technologies: A case study. *J. Clean. Prod.* **2021**, *290*, 125805. [[CrossRef](#)]
36. Xu, D.; Cui, X.; Xian, H. An Extended EDAS Method with a Single-Valued Complex Neutrosophic Set and Its Application in Green Supplier Selection. *Mathematics* **2020**, *8*, 282. [[CrossRef](#)]
37. Fan, J.; Jia, X.; Wu, M. A new multi-criteria group decision model based on Single-valued triangular Neutrosophic sets and EDAS method. *J. Intell. Fuzzy Syst.* **2020**, *38*, 2089–2102. [[CrossRef](#)]
38. Supçiller, A.A.; Toprak, F. Selection of wind turbines with multi-criteria decision making techniques involving neutrosophic numbers: A case from Turkey. *Energy* **2020**, *207*, 118237. [[CrossRef](#)]
39. Han, L.; Wei, C. An Extended EDAS Method for Multicriteria Decision-Making Based on Multivalued Neutrosophic Sets. *Complexity* **2020**, *2020*, 1–9. [[CrossRef](#)]
40. Li, Y.-Y.; Wang, J.-Q.; Wang, T.-L. A Linguistic Neutrosophic Multi-criteria Group Decision-Making Approach with EDAS Method. *Arab. J. Sci. Eng.* **2019**, *44*, 2737–2749. [[CrossRef](#)]
41. Wang, P.; Wang, J.; Wei, G. EDAS method for multiple criteria group decision making under 2-tuple linguistic neutrosophic environment. *J. Intell. Fuzzy Syst.* **2019**, *37*, 1597–1608. [[CrossRef](#)]
42. Karaşan, A.; Kahraman, C. Interval-Valued Neutrosophic Extension of EDAS Method. In *Advances in Fuzzy Logic and Technology*; Springer: Cham, Switzerland, 2017; pp. 343–357.
43. Peng, X.; Dai, J. Algorithms for interval neutrosophic multiple attribute decision-making based on MABAC, similarity measure, and EDAS. *Int. J. Uncertain. Quantif.* **2017**, *7*, 395–421. [[CrossRef](#)]

44. Sahin, R. Multi-criteria neutrosophic decision making method based on score and accuracy functions under neutrosophic environment. *arXiv* **2014**, arXiv:1412.5202.
45. Stanujkic, D.; Karabasevic, D.; Smarandache, F.; Popovic, G. A novel approach for assessing the reliability of data contained in a single valued neutrosophic number and its application in multiple criteria decision making. *Int. J. Neutrosophic. Sci.* **2020**, *11*, 22. [[CrossRef](#)]
46. Biswas, P.; Pramanik, S.; Giri, B.C. TOPSIS method for multi-attribute group decision-making under single-valued neutrosophic environment. *Neural Comput. Appl.* **2016**, *27*, 727–737. [[CrossRef](#)]
47. Stanujkic, D.; Zavadskas, E.K.; Smarandache, F.; Brauers, W.K.; Karabasevic, D. A neutrosophic extension of the MULTI-MOORA method. *Informatica* **2017**, *28*, 181–192. [[CrossRef](#)]
48. Stanujkic, D.; Smarandache, F.; Zavadskas, E.K.; Karabasevic, D. An Approach to Measuring the Website Quality Based on Neutrosophic Sets. In *New Trends in Neutrosophic Theory and Applications*; EU: Brussels, Belgium, 2018; Volume II, pp. 40–50.

Exploring the Historical Debates on Irrational Numbers Using Neutrosophic Logic as a Balance between Intuition and Rational

Victor Christianto, Florentin Smarandache

Victor Christianto, Florentin Smarandache (2021). Exploring the Historical Debates on Irrational Numbers Using Neutrosophic Logic as a Balance between Intuition and Rational. *EC Neurology* 13.6: 28-36

Abstract

A short book by Dennis P. Allen, Jr, a senior mathematician, inspires this article, and henceforth it is dedicated to him. A good movie about S. Ramanujan, *The Man who knew Infinity*, also triggers this work. As a note, this is not a conventional math paper. Instead, its purpose is to dig deeper into how a mathematician or a scientist should deal with intuition and balance it with a logical thinking process. Literature exploration on important inventions in mathematics becomes the method of this study combined with analysis of Iain McGilchrist's theory and Wittgenstein's Philosophy of Language added with the Cognitive Language Theory. The findings show the absolutistic view of rationality or rational number will not suffice to give a holistic insight into reality. Such finding serves as a reminder concerning whom should be the Master and who should be the emissary in the path toward knowledge. Based on Neutrosophic Logic, the "intuilytics" which combines both parts of brain hemispheres might become the best contribute a holistic approach, something that hints that further exploration on the capacity of human brain or the essence of human beings is needed..

Keywords: *Irrational Numbers; Intuition; Mathematics; Right-Left Brain; Logico Philosophico; Cognitive Linguistics Analysis; Neutrosophic Logic; Philosophical-Theological View of Human Beings, Intuilytic*

Introduction

In the writing of Krishnaswami Alladi, he commented movie *The Man who knew Infinity*, which depicts a story on how Ramanujan, a great mathematician from India met with another great mathematician in Cambridge, Prof G. Hardy¹. The movie is more than just an exciting introduction to Ramanujan's remarkable invention of partition theorem, and also the number 1729 (discovery inspired by a taxi-cab number in London). It sharpens the contrasts between two significant figures in mathematics at their time. First is G. Hardy, who used a rigorous math-proving method, while the second, Ramanujan was intuitive in his approach.

While one can believe how things should work based on discovering new science and mathematics ideas from G. Hardy's famous book: *A Mathematician's Apology*, a more recent book by a psychiatrist Iain McGilchrist yields something fresh that might significantly shed light more holistically.

¹Krishnaswami Alladi, review of the movie on the mathematical genius ramanujan (unknown date).

Hardy's account on Hippasus story

A book was written by mathematician Dennis Allen, Jr, as a memoir of his long career in various diverse areas in science serves as this article point of departure [1]. Allen opens Chapter One of his book by quoting Thomas Phipp, Jr.'s remark on G. Hardy's book *A Mathematician's Apology*: "People like G.H. Hardy ('A Mathematician's Apology, Cambridge, 1969), who forms the chief role models for modern pure mathematicians, have charted just this regrettable course - with a cost to mathematics that can never be reckoned. Hardy incidentally uses the word 'significance' where I use 'fruitfulness'. His 'mathematician's apology' consists of dividing mathematics into two disjoint halves, one 'trivial' or 'useful' that he consigns to perdition, the other 'real', useless, and ...on both aesthetic and moral grounds. Writing in 1940, he says that 'No one has yet discovered any warlike purpose to be served by the theory of numbers or relativity', and by such reasoning placessubjects on the moral plane of the angels along with all 'real' mathematicians".

With those statements, such as the usefulness and real, beauty mathematics which serve for nothing, the 26-dimensional bosonic superstring theories or something to serve people in doing better to improve their life apparently, it is not just a problem of fancy mathematics is at stake. Those judgmental statements need deeper analysis as it brings forward absolute rationalism.

Succinctly, this article posits the following questions: which is real mathematics? Is it "something with all glory and fanciness," or those which is "closer to realism?" If one call "realism" helpful in doing mathematics, does it mean that intuition in developing new ideas can play roles in the equations? Then, the main question is whether logical processes are the only method that humans should rely on or another possibility co-exists. Those questions could be related to the exploration of the essence of human beings and their capacity in perceiving reality. The hypothesis of this article is that the absolutistic logical or rational approach is insufficient to depict reality as it needs an intuitive approach to yield a holistic result together. The hypothesis roots in view concerning the essence of human beings with the complex features in their brain capacities.

The method of this explorative study is literature exploration. Thus it belongs to a qualitative methodology. This short article's foci are as follows: first of all, the discussion will be on the classic story of Hippasus' invention: irrational numbers versus the famous Pythagoreans' approach. Then, the exploration of McGilchrist's concept of the Right and left brain will follow [3,14]. The last is the analysis on Logico Philosophico of Wittgenstein and Lakoff's Cognitive Linguistic Theory to shed light on the issues.

Literature analysis

What happened between hippasus and pythagoreans rationalism

In discussing G. Hardy's discovery of irrational numbers, Allen continues: "Further, Hardy's philosophy as set forth in his above mentioned book is fanciful in other ways too, as for example in his (with Wright) "An Introduction to the Theory of Numbers" (fourth edition) on page 39, he ascribes the proof that the square root of two is irrational-this being the first irrational number to be discovered - to Pythagoras".

Peter Gainsford also wrote: "There is a widespread notion that the discovery of irrational numbers was a thing of horror to the ancient Greeks, especially for the school of Pythagoras. Pythagoras is best known today for a famous theorem about right-angled triangles, but in antiquity, his significant contribution lies in the fact that he was a semi-legendary guru who founded a philosophical-religious sect in southern Italy. No writings by Pythagoras himself survive (and it is unlikely he ever wrote any). The records about the sect sound bizarre at times such as the Pythagoreans conveyed their teachings only in a cave or they had weirdly specific beliefs about reincarnation, and they venerated unexpected plants like fava beans and mallow. The vast majority of this information is reported very late and is almost certainly false; the bits that are true (whichever ones they are) are difficult to understand out of context".

Gainsford went on with a quote from Kleine's book, discussing Hippasus: "In 1972, the mathematician Morris Kline wrote in his book *Mathematical Thought from Ancient to Modern times* (vol. 1, p. 32): Numbers to the Pythagoreans meant whole numbers only....Actual fractions... were employed in commerce, but such commercial uses of arithmetic were outside the pale of Greek mathematics proper. Hence, the Pythagoreans were startled and disturbed by the discovery that some ratios -- for example, the ratio of the hypotenuse of an

isosceles right triangle to an arm or the ratio of a diagonal to a side of a square -- cannot be expressed by whole numbers....The discovery of incommensurable ratios is attributed to Hippasus of Metapontum (5th cent. B.C.). The Pythagoreans were supposed to have thrown Hippasus overboard for having produced an element in the universe which denied the Pythagorean doctrine that all phenomena in the universe can be reduced to whole numbers or their ratios".

In short, this bitter denial of irrational numbers for centuries can be attributed to a conviction or belief that all things should be rational, something that may be called Pythagoreanistic rationalism. Only in the last centuries that Georg Cantor and others investigated irrational numbers.

Weierstrass discussed the real numbers' completeness publicly in the lectures he gave at Berlin University in 1865. Weierstrass's construction of irrational numbers used infinite sets of positive rationals with bounded partial sums. In 1872, Kossak publicized this construction. Later, Pincherle in 1883 and Biermann in 1997 further expounded it. Weierstrass insisted on the foundational importance of the property that an infinite bounded set has a cluster point. Further, he added that a continuous function on a closed interval was bounded and attained its bounds. This statement is his invention.

The students of Weierstrass, notably H. A. Schwarz, who was a student in Berlin 1859-1861, and G. Cantor, a student in Berlin 1863-1866, recognized the importance of Weierstrass's ideas and sought to present a more accessible construction of irrational numbers. In 1872, both Cantor and Heine (to whom Schwarz had been and whom Cantor was, an assistant at Halle) published constructions of irrational numbers as rational Cauchy sequences.

Referring back to the question posited earlier in this article whether similar debate concerning intuition and logical processes in these modern days continue, regretfully, the answer is affirmative. The underlying reason behind such continuous debate brings this study to the concept of McGilchrist that might shed light on it.

Contribution of Iain McGilchrist's concept

After discussing the historical origin of the irrational number, the contribution of Iain McGilchrist needs attention. As a psychiatrist, his arguments on the Left and Right (divided) brain function mean that the left hemisphere, which usually processes in detailed manner any problem (logically), should not predominate the right brain, capturing holistic and spiritual process. McGilchrist might echo the words of Blaise Pascal, a great mathematician from 16th century: "The heart has its Logic, which reason cannot understand".

In that sense, the left brain function should and could not rule over the right brain. In other words, for example, in the spirituality, especially in worshipping God, the emissary who is the logical process should not predominate the human's heart as its Master. It should be the other way around.

This problem of choosing between Logic or going beyond Logic or rationality to go beyond rational thinking (intuition) can be traced back even to the classical history of mathematics. As discussed in the preceding section, Pythagoreans overly worshiped rationality and Logic in mathematics up to the point they could not absorb the shock when one of their disciples found an irrational number. The shock caused Pythagoreans to let the disciple get drowned in the sea. In short, the Pythagoreans cannot fathom the contribution of the human brain's right-sphere in pursuing truth.

Similarly, in history, people cannot easily accept several mathematics inventions, such as transcendental numbers, complex numbers, transfinite set, Cantor sets, or non-Diophantine arithmetics.

Philosophy of language and cognitive linguistic theory

In 1918, the Austrian philosopher Ludwig Wittgenstein wrote the *Tractatus Logico Philosophicus*. Its content identified the relationship between language and reality, even to formulate the boundaries of science. This work emerged because he was concerned about seeing the many languages of philosophy and science collide and confuse people.

In this first work, Wittgenstein makes seven propositions. One of which is: A proposition is a picture of reality: for if I understand a proposition, I know the situation that it represents. And I understand the proposition without having had its sense explained to me. A proposition shows its sense. A proposition shows how things stand if it is true. And says that they do so stand².

Thus, Wittgenstein stressed that the world is not an accumulation of things but facts. To clarify his proposition, he described the differences between fact, forms, and substance³. Further, deviating from Immanuel Kant, for Wittgenstein, the substance only exists in the space of the world. The world consists of interrelated facts. Thus, humans make an effort to map or depict it. Language, whether it is oral, mathematical, artistic, or other kinds of symbols, are a human's effort to make such maps or pictures, but it needs roles as it only serves as a projection of reality or the world⁴.

Wittgenstein also emphasizes that reality is complicated and ever-changing. Therefore, the effort to depict or map it needs more than the rational approach as human logic can be paradoxical⁵. Thus, mathematical language or symbol only serves essentially as symbols that interact and needs structure.

In the second phase of his thought, Wittgenstein realized that all language as the projection of reality exists in societal contexts. In his second work, *Philosophical Investigation*, he formulated a Language Game Theory. His work is often multi-interpretable. His concept is pervasive and all inclusive.

Some analysts view that Wittgenstein stayed away from any epistemological, metaphysical or theological discourse while other state that he included those dimensions in his writings implicitly, especially the essence of human beings which philosophically or theologically is loaded with the ability to create language⁶. Thus, he included theology which he coins as the grammar of God. Nevertheless, Wittgenstein often signified that he opened a room of intuition or irrationality in the process of language creation. It is the capacity of human beings rooted in their existence. The name Language Game indicates that there are rational rules in the game and intuitive ways and spontaneity. Later, in 1970, a further and applicable concept emerges with the philosophy of language from Wittgenstein as backbone.

The spread of the Cognitive Linguistics theory shows dynamic energy that contributes to various frameworks for studying a natural language. This theory explores the meaning side of language. Thus, linguistic form and later symbols in their various forms become the focus to delve as the expressions of meaning⁷. According to the framework, meaning is not something that exists in isolation, but it connects and integrates with the full spectrum of human experience-something that Wittgenstein has stated before.

The basic concepts of Cognitive Linguistics encompass conceptual metaphor, image schemas, mental spaces, construction grammar, prototypicality and radial sets. The founding fathers of this theory are George Lakoff and Mark Johnson⁸. Basically, the theory states that there are the concrete domain of a language and an abstract concept that the concrete domain signifies. Whatever aspects one purposely emphasizes or downplays in the concrete form indicate the abstract concepts. Thus, if one states that reality is like a dance, the dance as a concrete experience that most people know means there are aspects of movement, beauty, and artistic sense in that concrete domain. Dance as such will indicate that life also has movement, beauty, and artistic dimension. Therefore, mathematical language and logic is insufficient to describe the complexities and dynamic of the abstract concepts.

²Vsevolod Ladov, "Wittgenstein's Tractatus Logico-Philosophicus and a Hierarchical Approach to Solving Logical Paradoxes," *Filosofija, Sociologija* 30, no. 1 (2019): 4.021-4022, doi:10.6001/fil-soc.v30i1.3914.

³DAVID MILLER, "The Uniqueness of Atomic Facts in Wittgenstein's Tractatus," *Theoria* 43, no. 3 (1977): 174-85, doi:10.1111/j.1755-2567.1977.tb00786.x.

⁴Antonio Manuel Liz Gutiérrez, "ZALABARDO, José Luis (2015): Representation and Reality in Wittgenstein's Tractatus. Oxford: Oxford University Press," *Daímon*, no. 75 (2018), doi:10.6018/daimon/346951.

⁵Ladov, "Wittgenstein's Tractatus Logico-Philosophicus and a Hierarchical Approach to Solving Logical Paradoxes".

⁶Tim Labron, *Wittgenstein and Theology*, Continuum, 2009 <https://ndpr.nd.edu/reviews/wittgenstein-and-theology/>

⁷Dirk Geeraerts, *Cognitive Linguistics: Basic Readings*, Cognitive Linguistics: Basic Readings, 2008.

⁸G. Lakoff and M. Johnson, "Conceptual Metaphor in Everyday Language," in *Shaping Entrepreneurship Research* (Eds, Saras D. Sarasvathy, Nicholas Dew, Sankaran Venkatarama) (Abingdon on the Thames: Routledge, 2020), 475-504, doi:10.4324/9781315161921-21.

The role of neutrosophic logic

Any effort to depict or map life or reality as an abstract substance needs to use real life or concrete experience to arrive at such an understanding. To choose the concrete experience and to connect it with the abstract domain, one needs intuition.

As this work emphasizes [8]: “More “right brain” activity, based on direct experiences, leads to direct experiences of the Divine. Your “inner vision” (the “mind’s eye”) can help readers in this, and in many other ways. The inner vision is also the seat of many of the intuitive faculties, which are experiential facts, not imaginings. That means the information obtained by the intuitive faculty is verifiable and reproducibly observable.

In order to do that, the Balanced Brain is the most efficacious way to function, as well as the most efficient, and the most comfortable.

To obtain the Balanced Brain, the person usually needs to spend a great deal of their spare time being receptive, being the “receiver”, being accepting and exploring, and not using the analytical intellect, but instead, spending time in the Now and in the Senses and Sensitivities. This is best enjoyed in Natural settings”.

Therefore, to reply to the question concerning how we can rectify the problem of overemphasizing rationality in mathematics and beyond, McGilchrist’s concept and Conceptual Linguistics theory can shed light. From Neutrosophic Logic viewpoint, this article recommends that a combination of both the intuitive aspect of the right hemisphere and the analytical or logical thinking processes of the human’s left brain will be more adequate in creating a holistic approach. The article proposes a term: intuilytics to capture the essence of the Balanced Brain [8].

With regards to scientific discovery processes, the proposed scheme as outlined above hint toward a slightly different approach compared to Popperian method or Kuhnian concept of paradigm change. See figure 1 below.

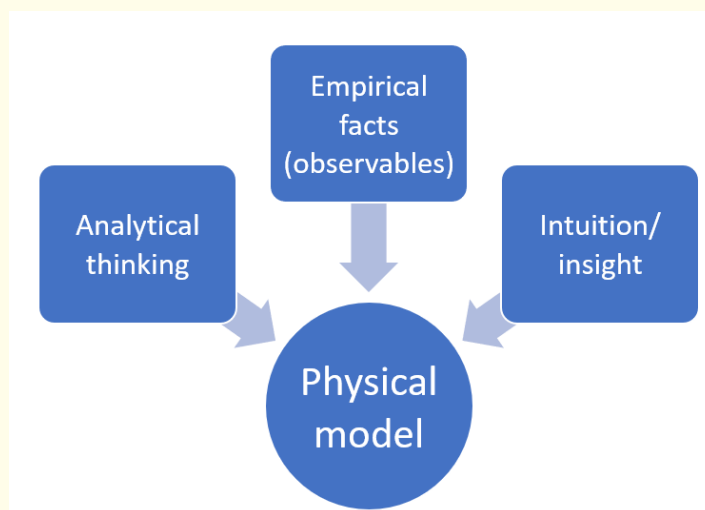

Figure 1: The role of intuition, analytical thinking, and empirical facts.

In other words, McGilchrist’s theme: the Master (right brain) governs the direction, and then the logical process keeps on finding the detailed answer or path indeed sheds light to the problem that this article struggles with.

Discussion: A few implications for definition of reality and consciousness

The aforementioned explanations concern how balanced brain functions are required for a realistic mathematics and sciences (may be called “evidence-based mathematics”).

Then, what is reality in this context? Yes, it seems that this is a simple question, but a complex topic to discuss. For some philosophers, there are real objects out there, but for others there are only perceived senses. Berkeley put it to the extreme that objective reality per se does not exist, everything can exist because of the mind which perceive it. This conviction has been put into succinct fiction story for instance by J.L. Borges, in his story: *Tlon, Uqbar, Orbis Tertius*⁹.

From Neutrosophic Logic perspective, whenever there are two opposite stances, then one can consider a middle ground or it can be called “dynamics of neutralities”. In the same way, between A= “everything are real objects” and B= “everything is perception,” we can find a middle ground, i.e. reality can be viewed as perceived objects, i.e. something which does exist independent of the observer, yet it must be perceived through human senses. In this way, this article rejects Mermin’s interpretation of quantum mechanics that “the moon is not there if nobody sees it”.

Such a discussion on the meaning of reality seems to be put aside into obscurity by recent trend in neuroscience. For instance it is known: “Modern neuroscience research generally shies away from such discussions, concentrating on what are called the neuronal correlates of consciousness, and actually their minimal number. All available evidence implicates neocortical tissue in generating feelings. On the other hand, brain activity originates in a broad set of cortical regions (parietal, occipital and temporal regions), the so-called posterior “hot zone””.

First of all, sensory perception needs consciousness, therefore, a rather pragmatic definition of what constitutes consciousness is needed. For instance: “The origin and nature of these experiences, sometimes referred to as qualia, have been a mystery from the earliest days of antiquity right up to the present. Many modern analytic philosophers of mind, most prominently perhaps Daniel Dennett of Tufts University, find the existence of consciousness such an intolerable affront to what they believe should be a meaningless universe of matter and the void that they declare it to be an illusion. That is, they either deny that qualia exist or argue that they can never be meaningfully studied by science”¹⁰.

Apart from such a qualia debate, a more “clinical” approach based on experiments has been presented as follows: “It has been speculated that frontal cortex and the extrastriate play a significant role in the expression of conscious awareness. The significance is not only because higher cognitive processing requires effective communication between frontal cortex and the posterior cortical areas that store domain specific information, but also because awareness requires construction of a multilevel symbolic interpretation of the information”¹¹.

Others argue that most aspects of self-awareness happens in cerebral cortex, although in some cases that may be not true: “Numerous neuroimaging studies have suggested that thinking about ourselves, recognizing images of ourselves, and reflecting on our thoughts and feelings-that is, different forms of self-awareness-all involve the cerebral cortex, the outermost, intricately wrinkled part of the brain. The fact that humans have a particularly large and wrinkly cerebral cortex relative to body size supposedly explains why we seem to be more self-aware than most other animals. But new evidence is casting doubt on this idea”¹².

⁹Jorge Luis Borges. *Tlon, Uqbar, Orbis Tertius*. Url: https://www.tlonprojects.org/content/6-about/_tuot-jorgeluisborges.pdf.

¹⁰Christof Koch, What is consciousness. *Nature*, May 2018. url: <https://www.nature.com/articles/d41586-018-05097-x>

¹¹R.D. Badgaiyan. Conscious Awareness and Brain processing. *Elements (Que)*. 2005; 3(3): 8–12. url: <https://www.ncbi.nlm.nih.gov/pmc/articles/PMC3007594/>

¹²Ferris Jabr. Self-awareness with simple brain. *Scientific American*. Url: <https://www.scientificamerican.com/article/self-awareness-with-a-simple-brain/>

However, Ortinski and Meador argue of neuronal mechanism behind self-awareness¹³. Other emphasizes the role of thalamus in human consciousness¹⁴.

Last but not least, scientists from Max Planck Institute seem to figure out the seat of consciousness: "Scientists from the Max Planck Institute in Tübingen measured the activity of neurons in the brains of macaques while the animals observed images on a screen. The results show that neurons in one part of the frontal lobe of the cerebral cortex are active when the monkeys are aware of what they have seen. Therefore, this region of the brain appears to play a role in deciding which impressions reach our consciousness. Thus the content of consciousness is based in two different brain regions. The decision as to which sensory impressions will reach our consciousness is not made by a single region. Instead, neurons from different regions must cooperate for this purpose. With the help of the tests on the monkeys, it is possible to establish how consciousness arises. This knowledge could benefit people with impaired consciousness in the future"¹⁵.

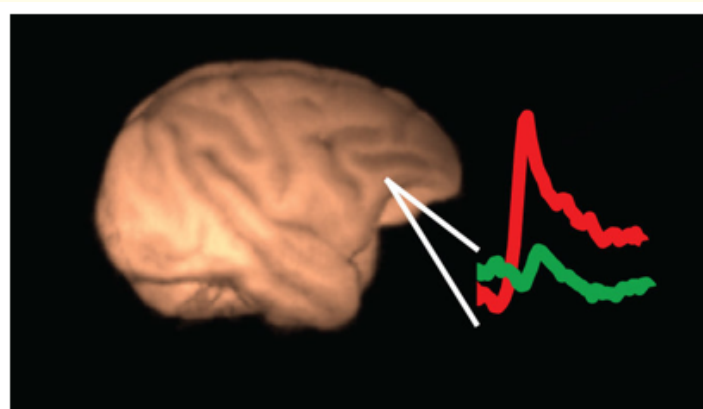

Figure 2: Neurons in the lateral prefrontal cortex represent the content of consciousness. The red trace depicts neural activity (source: MPI for Biological Cybernetics)*.

Concluding Remarks

Returning to the "Man Who Knew Infinity" movie, the lesson learned is as follow: Ramanujan led the discovery of the partition theorem, then he tried to find the proof with his logical processes. The four analyses yield a result that the rational number, symbol, or approach is insufficient by itself. Human beings need a space for intuition (something parallel to irrational numbers in the frame of Pythagorean's rationality doctrine) to pursue reality or truth without underestimating rational language contribution in mathematics or other domain of sciences. In the essence of human being lies richness and complexities that language and logics by itself cannot describe, especially by merely using rational number, symbol, or approach.

¹³P. Ortinski & K.J. Meador. Neuronal mechanism behind self-awareness. Neurological Review, 2004. url: <https://jamanetwork.com/journals/jamaneurology/fullarticle/786070>

¹⁴https://www.college-de-france.fr/media/en-stanislas-dehaene/UPL753837796513926252_Ward_4.pdf

¹⁵Original publication: Theofanis I. Panagiotaropoulos, Gustavo Deco, Vishal Kapoor & Nikos K. Logothetis Visual Consciousness in the Lateral Prefrontal Cortex, Neuron, Volume 74, Issue 5, 924-935, June 7th, 2012, 10.1016/j.neuron.2012.04.013

*Source: <https://www.mpg.de/8425992/seat-of-consciousness>; see also : https://www.mpg.de/5839948/conscious_perception

Therefore, to rectify the overemphasizing rationality in mathematics and beyond, four concepts in agreement propose a significant contribution. The McGilchrist's concept, Wittgenstein's view and the Conceptual Linguistics theory with the Neutrosophic approach recommend that a combination of both the intuitive aspect of the right hemisphere and the analytic or logical thinking processes of the left brain to create a holistic approach. The term can be: intuilytics. In other words, the Master (right brain) governs the direction, and then the logical process keeps on finding the detailed answer or paths.

Those theories implicitly signify the need of further journey to explore the essence of human beings with their brain capacities in dealing with reality that they perceive as mathematicians, philosophers, and theologians have been studying continuously.

Acknowledgements

This article was partly inspired in particular by a short book by Dennis P. Allen, Jr, a senior mathematician, and henceforth it is dedicated to him, and partly a continuation of our previous article in this journal [8]. These authors also wish to extend sincere gratitude to Robert Neil Boyd, PhD, who always emphasizes the role of intuition and direct experience in understanding Nature. Special thanks go to Prof. Iwan Pranoto, a senior mathematics professor, to discuss G. Hardy's book. Special thanks also go to an anonymous reviewer for suggesting improvement.

Bibliography

1. Dennis P Allen Jr. "The reality-oriented mathematician: A memoir". (A short book) - Available at ResearchGate (2019).
2. Robert Kanigel. "The Man Who Knew Infinity". Charles Scribners (1991).
3. Iain Mc Gilchrist. "The Master and his emissary: The divided brain and the making of the Western World". Yale University Press (2009).
4. Mario Beauregard and Denyse O'Leary. "The spiritual brain". Jakarta: Penerbit Obor (2009).
5. R Burn. "The irrational Numbers in English Language Textbooks, 1890-1915: Constructions and Postulates for the Completeness of the Real Numbers". *Historia Mathematica* 19 (1992): 158-176.
6. Ivan Niven. "Irrational Numbers". The Mathematical Association of America (1956).
7. Julian Havil. "The Irrationals". Princeton: Princeton University Press (2012).
8. V Christianto., *et al.* "How to balance the intuitive and analytical function of the human brain". *EC Neurology* 11.7 (2019): 495-499.
9. Geeraerts Dirk. "Cognitive Linguistics: Basic Readings" (2008).
10. Ladov Vsevolod. "Wittgenstein's Tractatus Logico-Philosophicus and a Hierarchica] Approach to Solving Logical Paradoxes". *Filosofija Sociologija* 30.1 (2019).
11. Lakoff G and M Johnson. "Conceptual Metaphor in Everyday Language". In *Shaping Entrepreneurship Research* (Eds, Saras D. Sarasvathy, Nicholas Dew, Sankaran Venkatarama), (2020): 475-404.
12. Liz Gutiérrez Antonio Manuel. "ZALABARDO, José Luis (2015): Representation and Reality in Wittgenstein's Tractatus. Oxford: Oxford University Press". *Daímon* 75 (2018).
13. Miller David. "The Uniqueness of Atomic Facts in Wittgenstein's Tractatus". *Theoria* 43.3 (1977): 174-185.
14. Iain Mc Gilchrist. *The Divided Brain and the Search for Meaning*. New Haven: Yale University Press (2011).

Neutro-Intelligent Set is a particular case of the Refined Neutrosophic Set

Florentin Smarandache, Said Broumi

Florentin Smarandache, Said Broumi (2021). Neutro-Intelligent Set is a particular case of the Refined Neutrosophic Set. *Journal of Neutrosophic and Fuzzy Systems* 1(1): 34-36; DOI: 10.54216/JNFS.010103

Abstract

In this short note we show that the newly introduced concept of Neutro-Intelligent Set (NIS) deserves attention in its applications to the human brain activity, and that NIS is a particular case of the Refined Neutrosophic Set.

Keywords: Neutrosophic Logic, Physical Neutrosophy, gravitation, physics constants

1. Introduction

In order to simplify the notations, we use Latin descriptive letters, instead of Greek letters, to denote by T the truth (or membership), by I the indeterminacy, and by F the falsehood (or nonmembership).

2. Definition of Neutrosophic Set

Let U be a universe of discourse, and A be a non-empty neutrosophic subset of U, defined as follows:

$A = \{x, \langle T_A(x), I_A(x), F_A(x) \rangle, x \in U\}$, where for all $x \in U$ one has

$$T_A(x), I_A(x), F_A(x) \in [0, 1], 0 \leq T_A(x) + I_A(x) + F_A(x) \leq 3.$$

3. Definition of the Neutral Degree of the Neutrosophic Set

Sunny Raza Qureshi [1] has introduced the Neutral Degree (N_A) of the Neutrosophic Set, defined as follows:

$$N_A : U \rightarrow [0, 1], N_A(x) = 1 - \frac{T_A(x) + I_A(x) + F_A(x)}{3}, x \in U.$$

4. Definition of the Neutro-Intelligent Set

It was a nice idea to extend the neutrosophic set from 3 to 4 components, where for all $x \in U$, the original components $T_A(x)$, $I_A(x)$, $F_A(x)$ remain totally independent from each other, while the fourth component

$N_A(x)$ is totally dependent of the first three components.

Then Sunny Raza Qureshi [1] introduced the Neutro-Intelligent Set (NIS) by adding the neutral Degree to each element, defined as follows:

Let U be a universe of discourse, and A_{NIS} be a non-empty subset of U , defined as follows:

$$A_{NIS} = \{x, \langle T_A(x), I_A(x), N_A(x), F_A(x) \rangle, x \in U\}, \text{ where for all } x \in U$$

$$T_A(x), I_A(x), N_A(x), F_A(x) \in [0, 1], 0 \leq T_A(x) + I_A(x) + F_A(x) \leq 3,$$

$$N_A(x) = 1 - \frac{T_A(x) + I_A(x) + F_A(x)}{3}.$$

5. Example of Neutro-Intelligent Set

$A_{RNS} = \{a_1(0.4, 0.2, 0.7, 0.3), a_2(0.7, 0.2, 0.6, 0.3)\}$, because:

$$T_1 = 0.4, I_1 = 0.2, F_1 = 0.3, \text{ whence the neutral } N_1 = 1 - \frac{T_1 + I_1 + F_1}{3} = 1 - \frac{0.4 + 0.2 + 0.3}{3} = 0.7.$$

$$T_2 = 0.7, I_2 = 0.2, F_2 = 0.3, \text{ whence the neutral } N_2 = 1 - \frac{T_2 + I_2 + F_2}{3} = 1 - \frac{0.7 + 0.2 + 0.3}{3} = 0.6.$$

6. Definition of the Refined Neutrosophic Set

In 2013 the neutrosophic theories were extended to the *refined [n-valued] neutrosophic set, refined neutrosophic logic, and refined neutrosophic probability respectively* [2], i.e. the truth value T was refined/split into types of sub-truths such as T_1, T_2, \dots, T_p , similarly indeterminacy I was refined/split into types of sub-indeterminacies I_1, I_2, \dots, I_r , and the falsehood F was refined/split into sub-falsehood F_1, F_2, \dots, F_s .

Let U be a universe of discourse, and A_{RNS} be a non-empty subset of U , then the Refined Neutrosophic Set is defined as follows:

$$A_{RNS} = \{x, \langle T_{1A}(x), T_{2A}(x), \dots, T_{pA}(x); I_{1A}(x), I_{2A}(x), \dots, I_{rA}(x); F_{1A}(x), F_{2A}(x), \dots, F_{sA}(x) \rangle, x \in U\},$$

where p, r, s are positive integers, and at least one of them is ≥ 2 ,

also for all $x \in U$,

$$T_{1A}(x), T_{2A}(x), \dots, T_{pA}(x); I_{1A}(x), I_{2A}(x), \dots, I_{rA}(x); F_{1A}(x), F_{2A}(x), \dots, F_{sA}(x) \in [0, 1].$$

If one takes the particular case: $p = 1, r = 2, s = 1$, one gets T, I_1, I_2, F , with $I_1 =$ indeterminacy and $I_2 =$ neutrality, one gets the Neutro-Intelligent Set (NIS). The original part of the NIS is that I_2 (neutrality) is taken as dependent from T, I , and F .

7. Applications

The author [1] has introduced a neutrosophic model of the human brain, the Multi-Phase/State Neutrosophic Set and aggregated it to its Neutro-Intelligent Set forming a Final Phase Neutrosophic Set, to analyze the human mind uncertainty, especially the sentimental and emotional activities.

References

- [1] Sunny Raza Qureshi, New Dimensions in MCDM with Multi Phase Hyper Neutrosophic Sets, Master of Science In Mathematics, Supervisor Dr. Madiha Qayyum Senior Scientific Officer (OG-II), COMSATS University Islamabad, Lahore Campus, Pakistan, Spring 2021.
- [2] Florentin Smarandache, n-Valued Refined Neutrosophic Logic and Its Applications in Physics, Progress in Physics, 143-146, Vol. 4, 2013;
<https://arxiv.org/ftp/arxiv/papers/1407/1407.1041.pdf>
<http://fs.unm.edu/n-ValuedNeutrosophicLogic-PiP.pdf>

On N_m - α -Open Sets in Neutrosophic Minimal Structure Spaces

S. Ganesan, C. Alexander, Florentin Smarandache

S. Ganesan, C. Alexander, F. Smarandache (2021). On N_m - α -Open Sets in Neutrosophic Minimal Structure Spaces. *Journal of Mathematics and Computational Intelligence* 1(1): 23–32

Abstract. In this paper, we introduced the notions of N_m - α -open sets, α -interior and α -closure operators in neutrosophic minimal structures. We investigate some basic properties of such notions. Also we introduced the notion of N_m - α -continuous maps and study characterizations of N_m - α -continuous maps by using the α -interior and α -closure operators. We introduced the classes of N_m lc-set, N_m α lc-sets and study some of its basic properties. Finally, we introduced and studied N_m lc-continuous, N_m α lc-continuous map, N_m lc-irresolute map and N_m α lc-irresolute map and investigate some properties of such concepts.

Keywords: Neutrosophic minimal structure spaces, N_m - α -closed, N_m - α -open, N_m lc-set, N_m - α -lc-set and N_m - α -continuous.

1. INTRODUCTION

L. A. Zadeh's [12] Fuzzy set laid the foundation of many theories such as intuitionistic fuzzy set and neutrosophic set, rough sets etc. Later, researchers developed K. T. Atanassov's [4] intuitionistic fuzzy set theory in many fields such as differential equations, topology, computer science and so on. F. Smarandache [10, 11] found that some objects have indeterminacy or neutral other than membership and non-membership. So he coined the notion of neutrosophy. The theories of neutrosophic set have achieved greater success in various areas such as medical diagnosis, database, topology, image processing and decision making problem. While the neutrosophic set is a powerful tool to deal with indeterminate and inconsistent data, the theory of rough set is a powerful mathematical tool to deal with incompleteness. Neutrosophic sets and rough sets are two different topics, none conflicts the other. Valeiru Popa and Noiri [8] introduced the notion of minimal structure which is a generalization of a topology on a given nonempty set. And they introduced the notion of \mathcal{M} -continuous functions as functions defined between minimal structures. M. Karthika et al [7] introduced and studied neutrosophic minimal structure spaces. S. Ganesan [6] introduced and studied N_m -semi open sets. The main objective of this study is to introduce a new hybrid intelligent structure called N_m - α -open sets in neutrosophic minimal structure spaces. The significance of introducing hybrid structures is that the computational techniques, based on any one of these structures alone, will not always yield the best results but a fusion of two or more of them can often give better results. The rest of this paper is organized as follows. Some preliminary concepts required in our work are briefly recalled in section 2. In section 3, the concepts of N_m - α -open, N_m - α -closure, N_m - α -interior, N_m - α -continuous is investigated.

2. PRELIMINARIES

Definition 2.1. [8] A subfamily m_x of the power set $\wp(X)$ of a nonempty set X is called a minimal structure (briefly, m -structure) on X if \emptyset in m_x and $X \in m_x$. By (X, m_x) , we denote a nonempty set X with a minimal structure m_x on X and call it an m -space. Each member of m_x is said to be m_x -open (or briefly, m -open) and the complement of an m_x -open set is said to be m_x -closed (or briefly, m -closed).

Definition 2.2. [10, 11] A neutrosophic set (in short ns) K on a set $X \neq \emptyset$ is defined by $K = \{ \prec a, P_K(a), Q_K(a), R_K(a) \succ : a \in X \}$ where $P_K : X \rightarrow [0,1]$, $Q_K : X \rightarrow [0,1]$ and $R_K : X \rightarrow [0,1]$ denotes the membership of an object, indeterminacy and non-membership of an object, for each $a \in X$ to K , respectively and $0 \leq P_K(a) + Q_K(a) + R_K(a) \leq 3$ for each $a \in X$.

Definition 2.3. [9] Let $K = \{ \prec a, P_K(a), Q_K(a), R_K(a) \succ : a \in X \}$ be a ns. We must introduce the ns 0_\sim and 1_\sim in X as follows:

0_\sim may be defined as:

- (1) $0_\sim = \{ \prec x, 0, 0, 1 \succ : x \in X \}$
- (2) $0_\sim = \{ \prec x, 0, 1, 1 \succ : x \in X \}$
- (3) $0_\sim = \{ \prec x, 0, 1, 0 \succ : x \in X \}$
- (4) $0_\sim = \{ \prec x, 0, 0, 0 \succ : x \in X \}$

1_\sim may be defined as:

- (1) $1_\sim = \{ \prec x, 1, 0, 0 \succ : x \in X \}$
- (2) $1_\sim = \{ \prec x, 1, 0, 1 \succ : x \in X \}$
- (3) $1_\sim = \{ \prec x, 1, 1, 0 \succ : x \in X \}$
- (4) $1_\sim = \{ \prec x, 1, 1, 1 \succ : x \in X \}$

Proposition 2.4. [9] For any ns S , then the following conditions are holds:

- (1) $0_\sim \leq S, 0_\sim \leq 0_\sim$.
- (2) $S \leq 1_\sim, 1_\sim \leq 1_\sim$.

Definition 2.5. [9] Let $K = \{ \prec a, P_K(a), Q_K(a), R_K(a) \succ : a \in X \}$ be a ns.

- (1) A ns K is an empty set i.e., $K = 0_\sim$ if 0 is membership of an object and 0 is an indeterminacy and 1 is an non-membership of an object respectively. i.e., $0_\sim = \{x, (0, 0, 1) : x \in X\}$
- (2) A ns K is a universal set i.e., $K = 1_\sim$ if 1 is membership of an object and 1 is an indeterminacy and 0 is an non-membership of an object respectively. $1_\sim = \{x, (1, 1, 0) : x \in X\}$
- (3) $K_1 \cup K_2 = \{a, \max \{P_{K_1}(a), P_{K_2}(a)\}, \max \{Q_{K_1}(a), Q_{K_2}(a)\}, \min \{R_{K_1}(a), R_{K_2}(a)\} : a \in X\}$
- (4) $K_1 \cap K_2 = \{a, \min \{P_{K_1}(a), P_{K_2}(a)\}, \min \{Q_{K_1}(a), Q_{K_2}(a)\}, \max \{R_{K_1}(a), R_{K_2}(a)\} : a \in X\}$
- (5) $K^c = \{ \prec a, R_K(a), 1 - Q_K(a), P_K(a) \succ : a \in X \}$

Definition 2.6. [9] A neutrosophic topology (nt) in Salama's sense on a nonempty set X is a family τ of ns in X satisfying three axioms:

- (1) Empty set (0_\sim) and universal set (1_\sim) are members of τ .
- (2) $K_1 \cap K_2 \in \tau$ where $K_1, K_2 \in \tau$.
- (3) $\cup K_\delta \in \tau$ for every $\{K_\delta : \delta \in \Delta\} \leq \tau$.

Each ns in nt are called neutrosophic open sets. Its complements are called neutrosophic closed sets.

Definition 2.7. [7] Let the neutrosophic minimal structure space over a universal set X be denoted by N_m . N_m is said to be neutrosophic minimal structure space (in short, nms) over X if it satisfying following the axiom: $0_{\sim}, 1_{\sim} \in N_m$. A family of neutrosophic minimal structure space is denoted by (X, N_{mX}) .

Note that neutrosophic empty set and neutrosophic universal set can form a topology and it is known as neutrosophic minimal structure space.

Each ns in nms is neutrosophic minimal open set. The complement of neutrosophic minimal open set is neutrosophic minimal closed set.

Remark 2.8. [7] Each ns in nms is neutrosophic minimal open set.

The complement of neutrosophic minimal open set is neutrosophic minimal closed set.

Definition 2.9. [7] A is N_m -closed if and only if $N_m cl(A) = A$. Similarly, A is a N_m -open if and only if $N_m int(A) = A$.

Definition 2.10. [7] Let N_m be any nms and A be any neutrosophic set. Then

- (1) Every $A \in N_m$ is open and its complement is closed.
- (2) N_m -closure of $A = \min \{F : F \text{ is a neutrosophic minimal closed set and } F \geq A\}$ and it is denoted by $N_m cl(A)$.
- (3) N_m -interior of $A = \max \{F : F \text{ is a neutrosophic minimal open set and } F \leq A\}$ and it is denoted by $N_m int(A)$.

In general $N_m int(A)$ is subset of A and A is a subset of $N_m cl(A)$.

Proposition 2.11. [7] Let R and S are any ns of nms N_m over X . Then

- (1) $N_m^c = \{0, 1, R_i^c\}$ where R_i^c is a complement of ns R_i .
- (2) $X - N_m int(S) = N_m cl(X - S)$.
- (3) $X - N_m cl(S) = N_m int(X - S)$.
- (4) $N_m cl(R^c) = (N_m cl(R))^c = N_m int(R)$.
- (5) N_m closure of an empty set is an empty set and N_m closure of a universal set is a universal set. Similarly, N_m interior of an empty set and universal set respectively an empty and a universal set.
- (6) If S is a subset of R then $N_m cl(S) \leq N_m cl(R)$ and $N_m int(S) \leq N_m int(R)$.
- (7) $N_m cl(N_m cl(R)) = N_m cl(R)$ and $N_m int(N_m int(R)) = N_m int(R)$.
- (8) $N_m cl(R \vee S) = N_m cl(R) \vee N_m cl(S)$.
- (9) $N_m cl(R \wedge S) = N_m cl(R) \wedge N_m cl(S)$.

Definition 2.12. [7] Let (X, N_{mX}) be nms.

- (1) Arbitrary union of neutrosophic minimal open sets in (X, N_{mX}) is neutrosophic minimal open. (Union Property).
- (2) Finite intersection of neutrosophic minimal open sets in (X, N_{mX}) is neutrosophic minimal open. (intersection Property).

Definition 2.13. [7] A map $f : (X, N_{mX}) \rightarrow (Y, N_{mY})$ is called neutrosophic minimal continuous map if and only if $f^{-1}(V) \in N_{mX}$ whenever $V \in N_{mY}$.

Definition 2.14. [6] Let (X, N_{mX}) be a nms and $A \leq X$. A subset A of X is called an N_m -semi-open set if $A \leq N_m cl(N_m int(A))$. The complement of an N_m -semi open set is called an N_m -semi-closed set.

3. N_m - α -OPEN SETS

Definition 3.1. Let (X, N_{mX}) be a nms and $A \leq X$. A subset A of X is called an N_m - α -open set if $A \leq N_m int(N_m cl(N_m int(A)))$. The complement of an N_m - α -open set is called an N_m - α -closed set.

Remark 3.2. Let (X, \mathcal{T}) be a nt and $A \leq X$. A is called an $\mathcal{N}\alpha$ -open set [3] if $A \leq \mathcal{N}int(\mathcal{N}cl(\mathcal{N}int(A)))$. If the nms N_{mX} is a topology, clearly an N_m - α -open set is $\mathcal{N}\alpha$ -open.

Example 3.3. Let $X = \{a, b\}$ with $\mathcal{T} = \{0_\sim, A, B, C, D, 1_\sim\}$ and $\mathcal{T}^c = \{1_\sim, F, G, H, I, 0_\sim\}$ where $A = \prec (0.5, 0.4, 0.5), (0.5, 0.6, 0.5) \succ$; $B = \prec (0.5, 0.6, 0.5), (0.5, 0.6, 0.6) \succ$; $C = \prec (0.6, 0.6, 0.5), (0.4, 0.4, 0.5) \succ$; $D = \prec (0.5, 0.5, 0.5), (0.5, 0.5, 0.5) \succ$. $F = \prec (0.5, 0.6, 0.5), (0.5, 0.4, 0.5) \succ$; $G = \prec (0.5, 0.4, 0.5), (0.6, 0.4, 0.6) \succ$; $H = \prec (0.5, 0.4, 0.6), (0.5, 0.6, 0.4) \succ$; $I = \prec (0.5, 0.5, 0.5), (0.5, 0.5, 0.5) \succ$. Now we define the neutrosophic set as follows: $V = \prec (0.5, 0.5, 0.5), (0.5, 0.5, 0.5) \succ$. Let $X = \{a, b\}$ with $N_m = \{0_\sim, E, 1_\sim\}$ and $N_m^c = \{1_\sim, J, 0_\sim\}$ where $E = \prec (0.4, 0.3, 0.6), (0.5, 0.4, 0.8) \succ$; $J = \prec (0.6, 0.7, 0.4), (0.8, 0.6, 0.5) \succ$. We know that $0_\sim = \{\prec x, 0, 0, 1 \succ : x \in X\}$, $1_\sim = \{\prec x, 1, 1, 0 \succ : x \in X\}$ and $0_\sim^c = \{\prec x, 1, 1, 0 \succ : x \in X\}$, $1_\sim^c = \{\prec x, 0, 0, 1 \succ : x \in X\}$. Here, $\mathcal{N}int(V) = D$, $\mathcal{N}cl(\mathcal{N}int(V)) = \mathcal{N}cl(D) = I$, $\mathcal{N}int(\mathcal{N}cl(\mathcal{N}int(V))) = \mathcal{N}int(I) = D$. Therefore, V is a $\mathcal{N}\alpha$ -open but it is not N_m - α -open.

From Definition of 3.1, obviously the following statement are obtained.

Lemma 3.4. Let (X, N_{mX}) be a nms. Then

- (1) Every N_m -open set is N_m - α -open.
- (2) A is an N_m - α -open set if and only if $A \leq N_m int(N_m cl(N_m int(A)))$.
- (3) Every N_m -closed set is N_m - α -closed.
- (4) A is an N_m - α -closed set if and only if $N_m cl(N_m int(N_m cl(A))) \leq A$.

Theorem 3.5. Let (X, N_{mX}) be a nms. Any union of N_m - α -open sets is N_m - α -open.

Proof. Let A_δ be an N_m - α -open set for $\delta \in \Delta$. From Definition 3.1 and Proposition 2.11(6), it follows $A_\delta \leq N_m int(N_m cl(N_m int(A_\delta))) \leq N_m int(N_m cl(N_m int(\bigcup A_\delta)))$. This implies $\bigcup A_\delta \leq N_m int(N_m cl(N_m int(\bigcup A_\delta)))$. Hence $\bigcup A_\delta$ is an N_m - α -open set. \square

Remark 3.6. Let (X, N_{mX}) be a nms. The intersection of any two N_m - α -open sets may not be N_m - α -open set as shown in the next example.

Example 3.7. Let $X = \{a, b\}$ with $N_m = \{0_\sim, P, Q, R, S, 1_\sim\}$ and $N_m^c = \{1_\sim, I, J, K, L, 0_\sim\}$ where $P = \prec (0.4, 0.6, 0.5), (0.7, 0.3, 0.5) \succ$; $Q = \prec (0.3, 0.6, 0.8), (0.6, 0.3, 0.5) \succ$; $R = \prec (0.3, 0.7, 0.8), (0.6, 0.5, 0.2) \succ$; $S = \prec (0.4, 0.7, 0.5), (0.6, 0.4, 0.2) \succ$; $I = \prec (0.5, 0.4, 0.4), (0.5, 0.7, 0.7) \succ$; $J = \prec (0.8, 0.4, 0.3), (0.5, 0.7, 0.6) \succ$; $K = \prec (0.8, 0.3, 0.3), (0.2, 0.5, 0.6) \succ$; $L = \prec (0.5, 0.3, 0.4), (0.2, 0.6, 0.6) \succ$. Now we define the two N_m - α -open sets as follows : $D = \prec (0.5, 0.7, 0.5), (0.9, 0.4, 0.5) \succ$; $E = \prec (0.9, 0.8, 0.3), (0.6, 0.4, 0.1) \succ$. Here

$N_m \text{int}(D) = P, N_m \text{cl}(N_m \text{int}(D)) = N_m \text{cl}(P) = 0_{\sim}^c, N_m \text{int}(N_m \text{cl}(N_m \text{int}(D))) = N_m \text{int}(0_{\sim}^c) = 1_{\sim}, N_m \text{int}(E) = S, N_m \text{cl}(N_m \text{int}(E)) = N_m \text{cl}(S) = 0_{\sim}^c, N_m \text{int}(N_m \text{cl}(N_m \text{int}(E))) = N_m \text{int}(0_{\sim}^c) = 1_{\sim}$. But $D \wedge E = \prec (0.5, 0.7, 0.5), (0.6, 0.4, 0.5) \succ$ is not a N_m - α -open set in X .

Proposition 3.8. *Let $(X, N_m X)$ be a nms. Every N_m - α -open set is N_m -semi-open set.*

Proof. The proof is straightforward from the definitions. □

Example 3.9. *Let $X = \{a, b\}$ with $N_m = \{0_{\sim}, A, 1_{\sim}\}$ and $N_m^c = \{1_{\sim}, B, 0_{\sim}\}$ where $A = \prec (0.4, 0.3, 0.7), (0.5, 0.4, 0.9) \succ$; $B = \prec (0.7, 0.7, 0.4), (0.9, 0.6, 0.5) \succ$. Now we define the neutrosophic set as follows: $C = \prec (0.5, 0.4, 0.6), (0.5, 0.5, 0.4) \succ$. Here, $N_m \text{int}(C) = A, N_m \text{cl}(N_m \text{int}(C)) = N_m \text{cl}(A) = B, N_m \text{int}(N_m \text{cl}(N_m \text{int}(C))) = N_m \text{int}(B) = A$. Therefore, C is a N_m -semi-open but it is not N_m - α -open.*

Definition 3.10. *Let $(X, N_m X)$ be a nms. For a subset A of X , the N_m - α -closure of A and the N_m - α -interior of A , denoted by N_m - $\alpha \text{cl}(A)$ and N_m - $\alpha \text{int}(A)$, respectively, are defined as the following:*

- (1) N_m - α -closure of $A = \min \{F : F \text{ is } N_m$ - α -closed set and $F \geq A\}$ and it is denoted by N_m - $\alpha \text{cl}(A)$.
- (2) N_m - α -interior of $A = \max \{G : G \text{ is } N_m$ - α -open set and $G \leq A\}$ and it is denoted by N_m - $\alpha \text{int}(A)$.

Theorem 3.11. *Let $(X, N_m X)$ be a nms and $A \leq X$. Then*

- (1) N_m - $\alpha \text{int}(A) \leq A$.
- (2) If $A \leq B$, then N_m - $\alpha \text{int}(A) \leq N_m$ - $\alpha \text{int}(B)$.
- (3) A is N_m - α -open if and only if N_m - $\alpha \text{int}(A) = A$.
- (4) N_m - $\alpha \text{int}(N_m$ - $\alpha \text{int}(A)) = N_m$ - $\alpha \text{int}(A)$.
- (5) N_m - $\alpha \text{cl}(X - A) = X - N_m$ - $\alpha \text{int}(A)$ and N_m - $\alpha \text{int}(X - A) = X - N_m$ - $\alpha \text{cl}(A)$.

Proof. (1), (2) Obvious.

(3) It follows from Theorem 3.5.

(4) It follows from (3).

(5) For $A \leq X, X - N_m$ - $\alpha \text{int}(A) = X - \max \{U : U \leq A, U \text{ is } N_m$ - α -open\} = $\min \{X - U : U \leq A, U \text{ is } N_m$ - α -open\} = $\min \{X - U : X - A \leq X - U, U \text{ is } N_m$ - α -open\} = N_m - $\alpha \text{cl}(X - A)$. Similarly, we have N_m - $\alpha \text{int}(X - A) = X - N_m$ - $\alpha \text{cl}(A)$. □

Theorem 3.12. *Let $(X, N_m X)$ be a nms and $A \leq X$. Then*

- (1) $A \leq N_m$ - $\alpha \text{cl}(A)$.
- (2) If $A \leq B$, then N_m - $\alpha \text{cl}(A) \leq N_m$ - $\alpha \text{cl}(B)$.
- (3) F is N_m - α -closed if and only if N_m - $\alpha \text{cl}(F) = F$.
- (4) N_m - $\alpha \text{cl}(N_m$ - $\alpha \text{cl}(A)) = N_m$ - $\alpha \text{cl}(A)$.

Proof. It is similar to the proof of Theorem 3.11. □

Theorem 3.13. *Let $(X, N_m X)$ be a nms and $A \leq X$. Then*

- (1) $x \in N_m$ - $\alpha \text{cl}(A)$ if and only if $A \cap V \neq \emptyset$ for every N_m - α -open set V containing x .
- (2) $x \in N_m$ - $\alpha \text{int}(A)$ if and only if there exists an N_m - α -open set U such that $U \leq A$.

Proof. (1) Suppose there is an N_m - α -open set V containing x such that $A \cap V = \emptyset$. Then $X - V$ is an N_m - α -closed set such that $A \leq X - V$, $x \notin X - V$. This implies $x \notin N_m\text{-}\alpha\text{cl}(A)$.

The reverse relation is obvious.

(2) Obvious. □

Lemma 3.14. *Let (X, N_{mX}) be a nms and $A \leq X$. Then*

- (1) $N_m\text{cl}(N_m\text{int}(N_m\text{cl}(A))) \leq N_m\text{cl}(N_m\text{int}(N_m\text{cl}(N_m\text{-}\alpha\text{cl}(A)))) \leq N_m\text{-}\alpha\text{cl}(A)$.
- (2) $N_m\text{-}\alpha\text{int}(A) \leq N_m\text{int}(N_m\text{cl}(N_m\text{int}(N_m\text{-}\alpha\text{int}(A)))) \leq N_m\text{int}(N_m\text{cl}(N_m\text{int}(A)))$.

Proof. (1) For $A \leq X$, by Theorem 3.12, $N_m\text{-}\alpha\text{cl}(A)$ is an N_m - α -closed set. Hence from Lemma 3.4, we have $N_m\text{cl}(N_m\text{int}(N_m\text{cl}(A))) \leq N_m\text{cl}(N_m\text{int}(N_m\text{cl}(N_m\text{-}\alpha\text{cl}(A)))) \leq N_m\text{-}\alpha\text{cl}(A)$.

(2) It is similar to the proof of (1). □

Definition 3.15. *A map $f : (X, N_{mX}) \rightarrow (Y, N_{mY})$ is called N_m - α -continuous map if and only if $f^{-1}(V) \in N_m$ - α -open whenever $V \in N_{mY}$.*

Theorem 3.16. *Every neutrosophic minimal continuous is N_m - α -continuous but the conversely.*

Proof. The proof follows from Lemma 3.4 (1). □

Theorem 3.17. *Let $f : X \rightarrow Y$ be a map on two nms (X, N_{mX}) and (Y, N_{mY}) . Then the following statements are equivalent:*

- (1) f is N_m - α -continuous.
- (2) $f^{-1}(V)$ is an N_m - α -open set for each N_m -open set V in Y .
- (3) $f^{-1}(B)$ is an N_m - α -closed set for each N_m -closed set B in Y .
- (4) $f(N_m\text{-}\alpha\text{cl}(A)) \leq N_m\text{cl}(f(A))$ for $A \leq X$.
- (5) $N_m\text{-}\alpha\text{cl}(f^{-1}(B)) \leq f^{-1}(N_m\text{cl}(B))$ for $B \leq Y$.
- (6) $f^{-1}(N_m\text{int}(B)) \leq N_m\text{-}\alpha\text{int}(f^{-1}(B))$ for $B \leq Y$.

Proof. (1) \Rightarrow (2) Let V be an N_m -open set in Y and $x \in f^{-1}(V)$. By hypothesis, there exists an N_m - α -open set U_x containing x such that $f(U_x) \leq V$. This implies $x \in U_x \leq f^{-1}(V)$ for all $x \in f^{-1}(V)$. Hence by Theorem 3.5, $f^{-1}(V)$ is N_m - α -open.

(2) \Rightarrow (3) Obvious.

(3) \Rightarrow (4) For $A \leq X$, $f^{-1}(N_m\text{cl}(f(A))) = f^{-1}(\min \{F \leq Y : f(A) \leq F \text{ and } F \text{ is } N_m\text{-closed}\}) = \min \{f^{-1}(F) \leq X : A \leq f^{-1}(F) \text{ and } F \text{ is } N_m\text{-}\alpha\text{-closed}\} \geq \min \{K \leq X : A \leq K \text{ and } K \text{ is } N_m\text{-}\alpha\text{-closed}\} = N_m\text{-}\alpha\text{cl}(A)$. Hence $f(N_m\text{-}\alpha\text{cl}(A)) \leq N_m\text{cl}(f(A))$.

(4) \Rightarrow (5) For $A \leq X$, from (4), it follows $f(N_m\text{-}\alpha\text{cl}(f^{-1}(A))) \leq N_m\text{cl}(f(f^{-1}(A))) \leq N_m\text{cl}(A)$. Hence we get (5).

(5) \Rightarrow (6) For $B \leq Y$, from $N_m\text{int}(B) = Y - N_m\text{cl}(Y - B)$ and (5), it follows: $f^{-1}(N_m\text{int}(B)) = f^{-1}(Y - N_m\text{cl}(Y - B)) = X - f^{-1}(N_m\text{cl}(Y - B)) \leq X - N_m\text{-}\alpha\text{cl}(f^{-1}(Y - B)) = N_m\text{-}\alpha\text{int}(f^{-1}(B))$. Hence (6) is obtained.

(6) \Rightarrow (1) Let $x \in X$ and V an N_m -open set containing $f(x)$. Then from (6) and Proposition 2.11, it follows $x \in f^{-1}(V) = f^{-1}(N_m\text{int}(V)) \leq N_m\text{-}\alpha\text{int}(f^{-1}(V))$. So from Theorem 3.13, we can say that there exists an N_m - α -open set U containing x such that $x \in U \leq f^{-1}(V)$. Hence f is N_m - α -continuous. □

Theorem 3.18. *Let $f : X \rightarrow Y$ be a map on two nms (X, N_{mX}) and (Y, N_{mY}) . Then the following statements are equivalent:*

- (1) f is N_m - α -continuous.

- (2) $f^{-1}(V) \leq N_m \text{int}(N_m \text{cl}(N_m \text{int}(f^{-1}(V))))$ for each N_m -open set V in Y .
- (3) $N_m \text{cl}(N_m \text{int}(N_m \text{cl}(f^{-1}(F)))) \leq f^{-1}(F)$ for each N_m -closed set F in Y .
- (4) $f(N_m \text{cl}(N_m \text{int}(N_m \text{cl}(A)))) \leq N_m \text{cl}(f(A))$ for $A \leq X$.
- (5) $N_m \text{cl}(N_m \text{int}(N_m \text{cl}(f^{-1}(B)))) \leq f^{-1}(N_m \text{cl}(B))$ for $B \leq Y$.
- (6) $f^{-1}(N_m \text{int}(B)) \leq N_m \text{int}(N_m \text{cl}(N_m \text{int}(f^{-1}(B))))$ for $B \leq Y$.

Proof. (1) \Leftrightarrow (2) It follows from Theorem 3.17 and Definition of N_m - α -open sets.

(1) \Leftrightarrow (3) It follows from Theorem 3.17 and Lemma 3.4.

(3) \Rightarrow (4) Let $A \leq X$. Then from Theorem 3.17(4) and Lemma 3.14, it follows $N_m \text{cl}(N_m \text{int}(N_m \text{cl}(A))) \leq N_m\text{-}\alpha \text{Cl}(A) \leq f^{-1}(N_m \text{cl}(f(A)))$. Hence $f(N_m \text{cl}(N_m \text{int}(N_m \text{cl}(A)))) \leq N_m \text{cl}(f(A))$.

(4) \Rightarrow (5) Obvious.

(5) \Rightarrow (6) From (5) and Proposition 2.11, it follows: $f^{-1}(N_m \text{int}(B)) = f^{-1}(Y - N_m \text{cl}(Y - B)) = X - f^{-1}(N_m \text{cl}(Y - B)) \leq X - N_m \text{cl}(N_m \text{int}(N_m \text{cl}(f^{-1}(Y - B)))) = N_m \text{int}(N_m \text{cl}(N_m \text{int}(f^{-1}(B))))$. Hence, (6) is obtained.

(6) \Rightarrow (1) Let V be an N_m -open set in Y . Then by (6) and Proposition 2.11, we have $f^{-1}(V) = f^{-1}(N_m \text{int}(V)) \leq N_m \text{int}(N_m \text{cl}(N_m \text{int}(f^{-1}(V))))$. This implies $f^{-1}(V)$ is an N_m - α -open set. Hence by (2), f is N_m - α -continuous. \square

Definition 3.19. A subset A of an nms (X, N_{mX}) is called an N_m -locally closed (briefly, $N_m \text{lc}$) sets if $A = S \wedge G$, where S is N_m -open and N is N_m -closed (X, N_{mX}) . The class of all N_m -locally closed sets in a nms (X, N_{mX}) is denoted by $N_m \text{LC}(X)$.

Definition 3.20. A subset A of an nms (X, N_{mX}) is called an N_m - α -locally closed (briefly, $N_m \alpha \text{lc}$) sets if $A = S \wedge G$, where S is N_m - α -open and N is N_m - α -closed (X, N_{mX}) . The class of all N_m - α -locally closed sets in a nms (X, N_{mX}) is denoted by $N_m \alpha \text{LC}(X)$.

Proposition 3.21. Every N_m -closed (resp. N_m -open) set is $N_m \text{lc}$ -set but not conversely.

Proof. It follows from Definition 3.19. \square

Example 3.22. Let $X = \{a\}$ with $N_m = \{0_{\sim}, A, 1_{\sim}\}$ and $N_m^c = \{1_{\sim}, G, 0_{\sim}^c\}$ where $A = \prec (0.5, 0.6, 0.9) \succ$; $G = \prec (0.9, 0.4, 0.5) \succ$. Then the collection of $N_m \text{lc}$ -sets are $0_{\sim} \wedge 1_{\sim}^c = \prec (0, 0, 1) \succ$; $0_{\sim} \wedge G = \prec (0, 0, 1) \succ$; $0_{\sim} \wedge 0_{\sim}^c = \prec (0, 0, 1) \succ$; $A \wedge 1_{\sim}^c = \prec (0, 0, 1) \succ$; $A \wedge G = \prec (0.5, 0.4, 0.9) \succ$; $A \wedge 0_{\sim}^c = \prec (0.5, 0.6, 0.9) \succ$; $1_{\sim} \wedge 1_{\sim}^c = \prec (0, 0, 1) \succ$; $1_{\sim} \wedge G = \prec (0.9, 0.4, 0.5) \succ$; $1_{\sim} \wedge 0_{\sim}^c = \prec (1, 1, 0) \succ$. Here, G is $N_m \text{lc}$ -set but it is not N_m -open and A is $N_m \text{lc}$ -set but it is not N_m -closed.

Proposition 3.23. Every N_m - α -closed (resp. N_m - α -open) set is $N_m \alpha \text{lc}$ -set but not conversely.

Proof. It follows from Definition 3.20. \square

Example 3.24. Let X and N_m as in the Example 3.7. Then N_m - α -closed set are $D^c = \prec (0.5, 0.3, 0.5), (0.5, 0.6, 0.9) \succ$; $E^c = \prec (0.3, 0.2, 0.9), (0.1, 0.6, 0.6) \succ$. Here, D^c is $N_m \alpha \text{lc}$ -set but it is not N_m - α -open and D is $N_m \alpha \text{lc}$ -set but it is not N_m - α -closed.

Proposition 3.25. Every $N_m \text{lc}$ -set is $N_m \alpha \text{lc}$ -set but not conversely.

Proof. It follows from Proposition 3.4(1), (3). \square

Definition 3.26. A map $f : (X, N_mX) \rightarrow (Y, N_mY)$ is said to be N_m -locally closed-continuous (briefly, N_mLC -continuous) if $f^{-1}(V)$ is N_mLC -set in (X, N_mX) for every N_m -open set V of (Y, N_mY) .

Definition 3.27. A map $f : (X, N_mX) \rightarrow (Y, N_mY)$ is said to be N_m - α -locally closed-continuous (briefly, $N_m\alpha LC$ -continuous) if $f^{-1}(V)$ is $N_m\alpha LC$ -set in (X, N_mX) for every N_m -open set V of (Y, N_mY) .

Theorem 3.28. Let $f : (X, N_mX) \rightarrow (Y, N_mY)$ be a map. Then

- (1) If f is N_m -continuous, then it is N_mLC -continuous.
- (2) If f is N_m -continuous, then it is $N_m\alpha LC$ -continuous.
- (3) If f is N_mLC -continuous, then it is $N_m\alpha LC$ -continuous.

Proof. (1) It is an immediate consequence of Proposition 3.21.

(2) It is an immediate consequence of Proposition 3.21 and 3.25.

(3) It is an immediate consequence of Proposition 3.25. □

Definition 3.29. A map $f : (X, N_mX) \rightarrow (Y, N_mY)$ is said to be N_mLC -irresolute (resp. $N_m\alpha LC$ -irresolute) if $f^{-1}(V)$ is N_mLC -set (resp. $N_m\alpha LC$ -set) in (X, N_mX) for every N_mLC -set (resp. $N_m\alpha LC$ -set) V of (Y, N_mY) .

Theorem 3.30. Let $f : (X, N_mX) \rightarrow (Y, N_mY)$ be a map. The

- (1) If f is N_mLC -irresolute then it is N_mLC -continuous.
- (2) If f is $N_m\alpha LC$ -irresolute then it is $N_m\alpha LC$ -continuous.

Proof. (1) Let $f : (X, N_mX) \rightarrow (Y, N_mY)$ be a N_mLC -irresolute map. Let V be a N_m -open set of (Y, N_mY) . Since every N_m -open set is N_mlc -set [by the Proposition 3.21], V is N_mLC -set of (Y, N_mY) . Since f is N_mLC -irresolute, then $f^{-1}(V)$ is a N_mLC -set of (X, N_mX) . Therefore f is N_mLC -continuous.

(2) Let $f : (X, N_mX) \rightarrow (Y, N_mY)$ be a $N_m\alpha LC$ -irresolute map. Let V be a N_m -open set of (Y, N_mY) . Since every N_m -open set is N_mlc -set and every N_mlc -set is $N_m\alpha lc$ -set [by the Proposition 3.21 and Proposition 3.25], V is $N_m\alpha LC$ -set of (Y, N_mY) . Since f is $N_m\alpha LC$ -irresolute, then $f^{-1}(V)$ is a $N_m\alpha LC$ -set of (X, N_mX) . Therefore f is $N_m\alpha LC$ -continuous. □

Theorem 3.31. Let $f : (X, N_mX) \rightarrow (Y, N_mY)$ and $g : (Y, N_mY) \rightarrow (Z, N_mZ)$ be any two maps. Then

- (1) $g \circ f$ is N_mLC -continuous if g is N_m -continuous and f is N_mLC -continuous.
- (2) $g \circ f$ is N_mLC -irresolute if both f and g are N_mLC -irresolute.
- (3) $g \circ f$ is N_mLC -continuous if g is N_mLC -continuous and f is N_mLC -irresolute.

Proof. (1) Since g is a N_m -continuous from $(Y, N_mY) \rightarrow (Z, N_mZ)$, for any N_m -open set z as a subset of Z , we get $g^{-1}(z) = G$ is a N_m -open set in (Y, N_mY) . As f is a N_mLC -continuous map. We get $(g \circ f)^{-1}(z) = f^{-1}(g^{-1}(z)) = f^{-1}(G) = S$ and S is a N_mLC -set in (X, N_mX) , since every N_m -open set is N_mlc -set [by the Proposition 3.21]. Hence $(g \circ f)$ is a N_mLC -continuous map.

(2) Consider two N_mLC -irresolute maps, $f : (X, N_mX) \rightarrow (Y, N_mY)$ and $g : (Y, N_mY) \rightarrow (Z, N_mZ)$ is a N_mLC -irresolute maps. As g is consider to be a N_mLC -irresolute map, by Definition 3.29, for every N_mlc -set $z \leq (Z, N_mZ)$, $g^{-1}(z) = G$ is a N_mlc -set in (Y, N_mY) . Again since f is N_mLC -irresolute, $(g \circ f)^{-1}(z) = f^{-1}(g^{-1}(z)) = f^{-1}(G) = S$ and S is a N_mlc -set in (X, N_mX) .

Hence $(g \circ f)$ is a N_mLC -irresolute map.

(3) Let g be a N_mLC -continuous map from $(Y, N_mY) \rightarrow (Z, N_mZ)$ and z subset of Z be a N_m -open set. Therefore $g^{-1}(z) = G$ is a N_mlc -set in (Y, N_mY) , since every N_m -open set is N_mlc -set [by the Proposition 3.21]. Also since f is N_mLC -irresolute, we get $(g \circ f)^{-1}(z) = f^{-1}(g^{-1}(z)) = f^{-1}(G) = S$ and S is a N_mlc -set in (X, N_mX) . Hence $(g \circ f)$ is a N_mLC -continuous map. \square

Theorem 3.32. *Let $f : (X, N_mX) \rightarrow (Y, N_mY)$ and $g : (Y, N_mY) \rightarrow (Z, N_mZ)$ be any two maps. Then*

- (1) $g \circ f$ is $N_m\alpha LC$ -continuous if g is N_m -continuous and f is $N_m\alpha LC$ -continuous.
- (2) $g \circ f$ is $N_m\alpha LC$ -irresolute if both f and g are $N_m\alpha LC$ -irresolute.
- (3) $g \circ f$ is $N_m\alpha LC$ -continuous if g is $N_m\alpha LC$ -continuous and f is $N_m\alpha LC$ -irresolute.

Proof. (1) Since g is a N_m -continuous from $(Y, N_mY) \rightarrow (Z, N_mZ)$, for any N_m -open set z as a subset of Z , we get $g^{-1}(z) = G$ is a N_m -open set in (Y, N_mY) . As f is a $N_m\alpha LC$ -continuous map. We get $(g \circ f)^{-1}(z) = f^{-1}(g^{-1}(z)) = f^{-1}(G) = S$ and S is a $N_m\alpha LC$ -set in (X, N_mX) , since every N_m -open set is N_mlc -set and every N_mlc -set is $N_m\alpha LC$ -set [by the Propositions 3.21 and 3.25]. Hence $(g \circ f)$ is a $N_m\alpha LC$ -continuous map.

(2) Consider two $N_m\alpha LC$ -irresolute maps, $f : (X, N_mX) \rightarrow (Y, N_mY)$ and $g : (Y, N_mY) \rightarrow (Z, N_mZ)$ is a $N_m\alpha LC$ -irresolute maps. As g is consider to be a $N_m\alpha LC$ -irresolute map, by Definition 3.29, for every $N_m\alpha LC$ -set $z \leq (Z, N_mZ)$, $g^{-1}(z) = G$ is a $N_m\alpha LC$ -set in (Y, N_mY) . Again since f is $N_m\alpha LC$ -irresolute, $(g \circ f)^{-1}(z) = f^{-1}(g^{-1}(z)) = f^{-1}(G) = S$ and S is a $N_m\alpha LC$ -set in (X, N_mX) . Hence $(g \circ f)$ is a $N_m\alpha LC$ -irresolute map.

(3) Let g be a $N_m\alpha LC$ -continuous map from $(Y, N_mY) \rightarrow (Z, N_mZ)$ and z subset of Z be a N_m -open set. Therefore $g^{-1}(z) = G$ is a $N_m\alpha LC$ -set in (Y, N_mY) , since every N_m -open set is N_mlc -set and every N_mlc -set is $N_m\alpha LC$ -set [by the Propositions 3.21 and 3.25]. Also since f is $N_m\alpha LC$ -irresolute, we get $(g \circ f)^{-1}(z) = f^{-1}(g^{-1}(z)) = f^{-1}(G) = S$ and S is a $N_m\alpha LC$ -set in (X, N_mX) . Hence $(g \circ f)$ is a $N_m\alpha LC$ -continuous map. \square

4. CONCLUSION

Neutrosophic set is a general formal framework, which generalizes the concept of classic set, fuzzy set, interval valued fuzzy set, intuitionistic fuzzy set, and interval intuitionistic fuzzy set. Since the world is full of indeterminacy, the neutrosophic minimal structure spaces found its place into contemporary research world. Hence $N_m\alpha$ -open can also be extended to a neutrosophic spatial region. The results of this study may be help in many researches.

REFERENCES

- [1] Abdel-Basset, M., Gamal, A., Son, L. H., Smarandache, F., A bipolar neutrosophic multi criteria decision Making frame work for professional selection, Appl. Sci.(2020), 10, 1202.
- [2] Abdel-Basset, M., Mohamed, R., Zaided, A. E. N. H., Gamal, A., Smarandache, F., Solving the supply chain problem using the best-worst method based on a novel plithogenic model, In Optimization Theory Based on Neutrosophic and Plithogenic Sets,(2020), (pp. 1-19). Academic Press.
- [3] Arokiarani, I., Dhavaseelan, R., Jafari, S., Parimalal, M., On some new notions and functions in neutrosophic topological spaces, Neutrosophic Sets and Systems, (2017), 16, 16-19.
- [4] Atanassov, K.T., Intuitionistic fuzzy sets. Fuzzy sets and systems, (1986), 20, 87-96.
- [5] Ganesan, S., Smarandache, F., Some new classes of neutrosophic minimal open sets, Asia Mathematika, 5(1), (2021), 103-112. doi.org/10.5281/zenodo.4724804

- [6] Ganesan, S., On N_m -semi open sets in neutrosophic minimal structure spaces (communicated).
- [7] Karthika1, M., Parimala1, M., Smarandache, F., An introduction to neutrosophic minimal structure spaces, *Neutrosophic Sets and Systems*, (2020), 36, 378-388.
- [8] Popa, V., Noiri, T., On M-continuous functions, *Anal. Univ. Dunarea de Jos Galati. Ser. Mat. Fiz. Mec. Teor. Fasc, II*, (2000), 18(23), 31-41.
- [9] Salama, A. A., Alblowi, S. A., Neutrosophic Set and Neutrosophic Topological Spaces. *IOSR J. Math*, (2012), 3, 31-35.
- [10] Smarandache, F., Neutrosophy and Neutrosophic Logic. First International Conference on Neutrosophy, Neutrosophic Logic Set, Probability and Statistics, University of New Mexico, Gallup, NM, USA, (2002).
- [11] Smarandache, F., A Unifying Field in Logics: Neutrosophic Logic. Neutrosophy, Neutrosophic Set, Neutrosophic Probability, American Research Press: Rehoboth, NM, USA, (1999).
- [12] Zadeh, L. A., Fuzzy Sets, *Information and Control*, (1965), 18, 338-353.

Ranking of Single-Valued Neutrosophic Numbers Through the Index of Optimism and Its Reasonable Properties

Rituparna Chutia, Florentin Smarandache

Rituparna Chutia, Florentin Smarandache (2021). Ranking of Single-Valued Neutrosophic Numbers Through the Index of Optimism and Its Reasonable Properties. *Artificial Intelligence Review* 2, 30; DOI: 10.1007/s10462-021-09981-3

Abstract

In this paper an innovative method of ranking neutrosophic number based on the notions of value and ambiguity of a single-valued neutrosophic number is being developed. The method is based on the convex combination of value and ambiguity of truth-membership function with the sum of values and ambiguities of indeterminacy-membership and falsity-membership functions. This convex combination is also termed as an index of optimism. The index of optimism, $\lambda = 1$, is termed as optimistic decision-maker as it considers the value and the ambiguity of the truth-membership function, ignoring the contributions from indeterminacy-membership and falsity-membership functions. Similarly, the index of optimism, $\lambda = 0$, is termed as pessimistic decision-maker as it considers the values and the ambiguities of the indeterminacy-membership and falsity-membership functions, ignoring the contribution from truth-membership function. Further, the index of optimism, $\lambda = 0.5$, is termed as moderate decision-maker as it considers the values and the ambiguities of all the membership functions. The approach is a novel as it completely oath to follow the reasonable properties of a ranking method. It is worth to mention that the current approach consistently ranks the single-valued neutrosophic numbers as well as their corresponding images.

Keywords Neutrosophic number · Ranking · Value · Ambiguity · Index of optimism

1 Introduction

Uncertainty due to vagueness is generally handled by the branch of mathematics called fuzzy set theory developed by Zadeh (1965). In such mathematics, the parameters involved are linguistic variables which in turn can be expressed as fuzzy numbers. There are various generalizations of fuzzy numbers, one such generalization is intuitionistic fuzzy number (IFN) developed by Atanassov (1989, 1999, 2000) and octahedron sets developed by Lee et al. (2020). The generalization of fuzzy number to IFN adds more information to the latter as it incorporates non-membership or incomplete information in a fuzzy number.

Another such generalization of fuzzy numbers, in fact IFNs are neutrosophic numbers, which incorporates indeterminacy-membership apart from the truth-membership and the falsity-membership functions. This generalization was initiated by Smarandache (1998, 1999, 2006). This generalization has added various development in diverse filed, namely, graph theory (Karaaslan and Davvaz 2018) and structure theory (Edalatpanah 2020a), linear equations (Edalatpanah 2020b), etc. This generalization has been used in various fields of decision-making, namely, Ulucay et al. (2018), Karaaslan (2018a), Giri et al. (2018), Deli (2018), etc. Apart from these, various studies are performed by Karaaslan and Hunu (2020), Karaaslan and Hayat (2018), Jana et al. (2020) and Karaaslan (2018b) in multi-criteria group decision making problems. Also, data envelopment analysis under neutrosophic environment are discussed by Yang et al. (2020), Edalatpanah (2020), Edalatpanah and Smarandache (2019) and Mao et al. (2020). Neutrosophic linear programming problems are also being discussed by Edalatpanah (2020). One of the tools in the decision-making process is ranking or ordering of neutrosophic numbers. Single-valued neutrosophic number (SVNN) is a particular type of neutrosophic number developed by Wang et al. (2010). In this work, an attempt to develop a robust method of ranking SVNNs will be made.

A very few works are available in ranking of SVNNs so far. An outranking approach was developed by Peng et al. (2014) and applied in multi-criteria decision-making problems. A outranking approach for multi-criteria decision making problems with neutrosophic multi-sets was discussed by Ulucay et al. (2019). Ranking of neutrosophic sets based on score function was developed by Nancy and Garg (2016). The notions of the values and the ambiguities of truth-membership, indeterminacy-membership and falsity-membership functions was developed for ranking SVNNs by Deli and Subas (2017). The ranking done on by Deli and Subas (2017) is based on the values; and if the values are equal then the ordering is done by ambiguities, that is, if the \tilde{a} and \tilde{b} are SVNNs and ambiguity of \tilde{a} is numerical greater than \tilde{b} , then \tilde{a} is ranked to be bigger than \tilde{b} . This ordering is completely irrational, because the SVNN with more ambiguity should be ranked smaller. Aal et al. (2018) concept of ranking SVNNs is similar to that of Deli and Subas (2017), hence their method retains the same drawback as that of Deli and Subas (2017). Evidently, Biswas et al. (2016) rectified the drawbacks of Deli and Subas (2017) and Aal et al. (2018), however in some situations their method fails to rank consistently the corresponding images of the SVNNs. Further, none of the existing method investigated the rationality validation of the methods developed. Intuitively, the existing methods of ranking SVNNs lacks rationality validation. As such these methods are not rich enough to be applied in the decision-making problems. Further, it has been observed that the ranking of SVNNs is in a very premature stage. Motivated by the chronology of the ranking method of SVNNs, it is being observed that a robust method of ranking SVNNs is unavailable. Hence, it is essential to develop a robust and logical methodology of ranking SVNNs for an appropriate decision-making process. In this work, such an attempt will be made to develop a rational and consistent method of ranking SVNNs. It was seen that the existing methods never investigated the ordering of the images of SVNNs. Hence, one objective is to see the consistency in ranking SVNNs with their corresponding images. Further, another objective is to check the robustness of the method by proving the reasonable properties of Wang and Kerre (2001a, 2001b).

The next section discusses various definitions and notations of SVNNs, which will be utilized in discussing the method and its properties. In Sect. 3, the definitions and notions of value and ambiguity of a SVNN are being discussed; and also the proposed method along with its properties are being discussed. In Sect. 4, the method is demonstrated through some numerical examples and compared with some existing methods. Finally, in Sect. 5 conclusions are made and the main features are highlighted.

2 Preliminaries

In this section, a few definitions and notations are being discussed. This discussion will further help in the discussion of the proposed method.

Definition 2.1 A SVN $\tilde{a} = \langle \mu_{\tilde{a}}, \rho_{\tilde{a}}, \nu_{\tilde{a}} \rangle$ in the set of real numbers \mathbb{R} with truth-membership function $\mu_{\tilde{a}}$, indeterminacy-membership function $\rho_{\tilde{a}}$ and falsity-membership function $\nu_{\tilde{a}}$ is defined as

$$\mu_{\tilde{a}}(x) = \begin{cases} f_{\tilde{a}}(x), & \text{if } a_1 \leq x \leq x_{0,1} \\ 1, & \text{if } x_{0,1} \leq x \leq y_{0,1} \\ g_{\tilde{a}}(x), & \text{if } y_{0,1} \leq x \leq b_1 \\ 0, & \text{otherwise,} \end{cases} \quad (1)$$

$$\rho_{\tilde{a}}(x) = \begin{cases} l_{\tilde{a}}(x), & \text{if } a_2 \leq x \leq x_{0,2} \\ 0, & \text{if } x_{0,2} \leq x \leq y_{0,2} \\ m_{\tilde{a}}(x), & \text{if } y_{0,2} \leq x \leq b_2 \\ 1, & \text{otherwise,} \end{cases} \quad (2)$$

and

$$\nu_{\tilde{a}}(x) = \begin{cases} h_{\tilde{a}}(x), & \text{if } a_3 \leq x \leq x_{0,3} \\ 0, & \text{if } x_{0,3} \leq x \leq y_{0,3} \\ k_{\tilde{a}}(x), & \text{if } y_{0,3} \leq x \leq b_3 \\ 1, & \text{otherwise,} \end{cases} \quad (3)$$

respectively, where $0 \leq \mu_{\tilde{a}}(x) + \rho_{\tilde{a}}(x) + \nu_{\tilde{a}}(x) \leq 3$ and $a_i, x_{0,i}, y_{0,i}, b_i \in \mathbb{R}$ such that $a_i \leq x_{0,i} \leq y_{0,i} \leq b_i, i = 1, 2, 3$, and the functions $f_{\tilde{a}}, g_{\tilde{a}}, l_{\tilde{a}}, m_{\tilde{a}}, h_{\tilde{a}}, k_{\tilde{a}} : \mathbb{R} \rightarrow [0, 1]$ are legs of truth-membership function $\mu_{\tilde{a}}$, indeterminacy-membership function $\rho_{\tilde{a}}$ and falsity-membership function $\nu_{\tilde{a}}$. The functions $f_{\tilde{a}}, l_{\tilde{a}}$ and $k_{\tilde{a}}$ are non-decreasing continuous functions and the functions $h_{\tilde{a}}, m_{\tilde{a}}$ and $g_{\tilde{a}}$ are non-increasing continuous functions. Hence, the SVN can also be denoted by $\tilde{a} = \langle (a_1, x_{0,1}, y_{0,1}, b_1), (a_2, x_{0,2}, y_{0,2}, b_2), (a_3, x_{0,3}, y_{0,3}, b_3) \rangle$.

Definition 2.2 Let $\tilde{a} = \langle (a_1, x_{0,1}, y_{0,1}, b_1), (a_2, x_{0,2}, y_{0,2}, b_2), (a_3, x_{0,3}, y_{0,3}, b_3) \rangle$ be a trapezoidal SVN where the real numbers are such that $a_i \leq x_{0,i} \leq y_{0,i} \leq b_i, i = 1, 2, 3$. Then truth-membership function, indeterminacy-membership function and falsity-membership function are defined as

$$\mu_{\tilde{a}}(x) = \begin{cases} \frac{x-a_1}{x_{0,1}-a_1}, & \text{if } a_1 \leq x \leq x_{0,1} \\ 1, & \text{if } x_{0,1} \leq x \leq y_{0,1} \\ \frac{b_1-x}{b_1-y_{0,1}}, & \text{if } y_{0,1} \leq x \leq b_1 \\ 0, & \text{otherwise,} \end{cases} \quad (4)$$

$$\rho_{\tilde{a}}(x) = \begin{cases} \frac{x-x_{0,2}}{a_2-x_{0,2}}, & \text{if } a_2 \leq x \leq x_{0,2} \\ 0, & \text{if } x_{0,2} \leq x \leq y_{0,2} \\ \frac{x-y_{0,2}}{b_2-y_{0,2}}, & \text{if } y_{0,2} \leq x \leq b_2 \\ 1, & \text{otherwise,} \end{cases} \quad (5)$$

and

$$v_{\tilde{a}}(x) = \begin{cases} \frac{x-x_{0,3}}{a_3-x_{0,3}}, & \text{if } a_3 \leq x \leq x_{0,3} \\ 0, & \text{if } x_{0,3} \leq x \leq y_{0,3} \\ \frac{x-y_{0,3}}{b_3-y_{0,3}}, & \text{if } y_{0,3} \leq x \leq b_3 \\ 1, & \text{otherwise,} \end{cases} \quad (6)$$

respectively, where $0 \leq \mu_{\tilde{a}}(x) + \rho_{\tilde{a}}(x) + v_{\tilde{a}}(x) \leq 3$.

As like IFN, the cut sets of SVNN can also be defined for truth-membership, indeterminacy-membership and falsity-membership functions. These definitions are being thoroughly discussed by Deli and Subas (2017). These definitions are being adopted in this study.

A $\langle \alpha, \gamma, \beta \rangle$ -cut set, of a SVNN \tilde{a} , is a crisp subset of \mathbb{R} , which is defined as

$$\tilde{a}_{\langle \alpha, \gamma, \beta \rangle} = \{x | \mu_{\tilde{a}}(x) \geq \alpha, \rho_{\tilde{a}}(x) \leq \gamma, v_{\tilde{a}}(x) \leq \beta\}$$

where $0 \leq \alpha + \gamma + \beta \leq 3$, $\mu_{\tilde{a}}$, $\rho_{\tilde{a}}$ and $v_{\tilde{a}}$ are truth-membership, indeterminacy-membership and falsity-membership functions of \tilde{a} respectively.

A α -cut set is a crisp subset of \mathbb{R} , which is defined as $\tilde{a}_{\alpha} = \{x | \mu_{\tilde{a}}(x) \geq \alpha\}$ where $0 \leq \alpha \leq 1$. Further, \tilde{a}_{α} represents a closed interval, denoted by $\tilde{a}_{\alpha} = [L_{\alpha}^{\mu}(\alpha), R_{\alpha}^{\mu}(\alpha)]$. Now, for the truth-membership function defined in Eq. 4, the α -cut set is defined as

$$\tilde{a}_{\alpha} = [L_{\alpha}^{\mu}(\alpha), R_{\alpha}^{\mu}(\alpha)] = [a_1 + \alpha(x_{0,1} - a_1), b_1 - \alpha(b_1 - y_{0,1})]. \quad (7)$$

A γ -cut set is also a crisp subset of \mathbb{R} , which is defined as $\tilde{a}_{\gamma} = \{x | \rho_{\tilde{a}}(x) \leq \gamma\}$, where $0 \leq \gamma \leq 1$. Further, \tilde{a}_{γ} represents a closed interval, denoted by $\tilde{a}_{\gamma} = [L_{\alpha}^{\rho}(\gamma), R_{\alpha}^{\rho}(\gamma)]$. Also, for the falsity-membership function defined in Eq. 5, the γ -cut set is defined as

$$\tilde{a}_{\gamma} = [L_{\alpha}^{\rho}(\gamma), R_{\alpha}^{\rho}(\gamma)] = [x_{0,2} + \beta(a_2 - x_{0,2}), y_{0,2} + \beta(b_2 - y_{0,2})]. \quad (8)$$

A β -cut set is again a crisp subset of \mathbb{R} , which is defined as $\tilde{a}_{\beta} = \{x | v_{\tilde{a}}(x) \leq \beta\}$, where $0 \leq \beta \leq 1$. Further, \tilde{a}_{β} represents a closed interval, denoted by $\tilde{a}_{\beta} = [L_{\alpha}^v(\beta), R_{\alpha}^v(\beta)]$. Also, for the falsity-membership function defined in Eq. 6, the β -cut set is defined as

$$\tilde{a}_{\beta} = [L_{\alpha}^v(\beta), R_{\alpha}^v(\beta)] = [x_{0,3} + \beta(a_3 - x_{0,3}), y_{0,3} + \beta(b_3 - y_{0,3})]. \quad (9)$$

Another notion that are necessary for the discussion is the notions of the support of a SVNN. As a SVNN requires three types of functions to represent it. Hence, for each of these functions, the support can be defined. The supports of truth-membership, indeterminacy-membership and falsity-membership functions are denoted and defined as $\text{supp}(\mu_{\tilde{a}}) = \{x | \mu_{\tilde{a}}(x) > 0\}$, $\text{supp}(\rho_{\tilde{a}}) = \{x | \rho_{\tilde{a}}(x) < 1\}$ and $\text{supp}(v_{\tilde{a}}) = \{x | v_{\tilde{a}}(x) < 1\}$ respectively. Further, the following notations will be used in the further discussion, that is,

$$L_{\tilde{a}}^{\mu}(0) = \inf \text{supp}(\mu_{\tilde{a}}), R_{\tilde{a}}^{\mu}(0) = \sup \text{supp}(\mu_{\tilde{a}}), \quad L_{\tilde{a}}^{\rho}(1) = \inf \text{supp}(\rho_{\tilde{a}}), R_{\tilde{a}}^{\rho}(1) = \sup \text{supp}(\rho_{\tilde{a}}),$$

$$L_{\tilde{a}}^{\nu}(1) = \inf \text{supp}(\nu_{\tilde{a}}) \text{ and } R_{\tilde{a}}^{\nu}(1) = \sup \text{supp}(\nu_{\tilde{a}}).$$

Let $\tilde{a} = \langle \mu_{\tilde{a}}, \rho_{\tilde{a}}, \nu_{\tilde{a}} \rangle$ be a SVN, then the image of \tilde{a} is given by $-\tilde{a} = \langle \mu_{-\tilde{a}}, \rho_{-\tilde{a}}, \nu_{-\tilde{a}} \rangle$. Thus, if $\tilde{a}_{\alpha} = [L_{\tilde{a}}^{\mu}(\alpha), R_{\tilde{a}}^{\mu}(\alpha)]$, $\tilde{a}_{\gamma} = [L_{\tilde{a}}^{\rho}(\gamma), R_{\tilde{a}}^{\rho}(\gamma)]$ and $\tilde{a}_{\beta} = [L_{\tilde{a}}^{\nu}(\beta), R_{\tilde{a}}^{\nu}(\beta)]$ be the cut sets of \tilde{a} , then the cut set of $-\tilde{a}$ are $-\tilde{a}_{\alpha} = [-R_{\tilde{a}}^{\mu}(\alpha), -L_{\tilde{a}}^{\mu}(\alpha)]$, $-\tilde{a}_{\gamma} = [-R_{\tilde{a}}^{\rho}(\gamma), -L_{\tilde{a}}^{\rho}(\gamma)]$ and $-\tilde{a}_{\beta} = [-R_{\tilde{a}}^{\nu}(\beta), -L_{\tilde{a}}^{\nu}(\beta)]$. A SVN \tilde{a} is symmetric about y-axis, if $-L_{\tilde{a}}^{\mu}(\alpha) = R_{\tilde{a}}^{\mu}(\alpha)$, $-L_{\tilde{a}}^{\rho}(\gamma) = R_{\tilde{a}}^{\rho}(\gamma)$ and $-L_{\tilde{a}}^{\nu}(\beta) = R_{\tilde{a}}^{\nu}(\beta)$.

2.1 Arithmetic of SVN

The arithmetic operations of IFNs was extensively studied by Chakraborty et al. (2015) using different methodology, namely, (α, β) -cut method, vertex method and extension principle method. As SVN is an extension of IFN, these methodology of arithmetic of IFNs can be extended to arithmetic of SVN. The arithmetic of SVN are also discussed by Biswas et al. (2016) and Deli and Subas (2017) using the (α, γ, β) -cut sets method. In this study, the arithmetic of SVN by the (α, γ, β) -cut sets method is adopted. Let $\tilde{a} = \langle (a_1, x_{0,1}, y_{0,1}, b_1), (a_2, x_{0,2}, y_{0,2}, b_2), (a_3, x_{0,3}, y_{0,3}, b_3) \rangle$ and $\tilde{b} = \langle (p_1, m_{0,1}, n_{0,1}, q_1), (p_2, m_{0,2}, n_{0,2}, q_2), (p_3, m_{0,3}, n_{0,3}, q_3) \rangle$ be two SVN. Let the α -cut, γ -cut and β -cut sets of truth-membership, indeterminacy-membership and falsity-membership functions of \tilde{a} and \tilde{b} be $\tilde{a}_{\alpha} = [L_{\tilde{a}}^{\mu}(\alpha), R_{\tilde{a}}^{\mu}(\alpha)]$, $\tilde{a}_{\gamma} = [L_{\tilde{a}}^{\rho}(\gamma), R_{\tilde{a}}^{\rho}(\gamma)]$ and $\tilde{a}_{\beta} = [L_{\tilde{a}}^{\nu}(\beta), R_{\tilde{a}}^{\nu}(\beta)]$, and $\tilde{b}_{\alpha} = [L_{\tilde{b}}^{\mu}(\alpha), R_{\tilde{b}}^{\mu}(\alpha)]$, $\tilde{b}_{\gamma} = [L_{\tilde{b}}^{\rho}(\gamma), R_{\tilde{b}}^{\rho}(\gamma)]$ and $\tilde{b}_{\beta} = [L_{\tilde{b}}^{\nu}(\beta), R_{\tilde{b}}^{\nu}(\beta)]$ respectively. Then the arithmetic operations addition, subtraction and scalar multiplication are defined as

$$[\tilde{a} + \tilde{b}]_{\alpha}$$

$$= [L_{\tilde{a}}^{\mu}(\alpha) + L_{\tilde{b}}^{\mu}(\alpha), R_{\tilde{a}}^{\mu}(\alpha) + R_{\tilde{b}}^{\mu}(\alpha)], [\tilde{a} + \tilde{b}]_{\gamma} = [L_{\tilde{a}}^{\rho}(\gamma) + L_{\tilde{b}}^{\rho}(\gamma), R_{\tilde{a}}^{\rho}(\gamma) + R_{\tilde{b}}^{\rho}(\gamma)],$$

$$[\tilde{a} + \tilde{b}]_{\beta} = [L_{\tilde{a}}^{\nu}(\beta) + L_{\tilde{b}}^{\nu}(\beta), R_{\tilde{a}}^{\nu}(\beta) + R_{\tilde{b}}^{\nu}(\beta)];$$

$$[\tilde{a} - \tilde{b}]_{\alpha}$$

$$= [L_{\tilde{a}}^{\mu}(\alpha) - R_{\tilde{b}}^{\mu}(\alpha), R_{\tilde{a}}^{\mu}(\alpha) - L_{\tilde{b}}^{\mu}(\alpha)], [\tilde{a} - \tilde{b}]_{\gamma} = [L_{\tilde{a}}^{\rho}(\gamma) - R_{\tilde{b}}^{\rho}(\gamma), R_{\tilde{a}}^{\rho}(\gamma) - L_{\tilde{b}}^{\rho}(\gamma)],$$

$$[\tilde{a} - \tilde{b}]_{\beta} = [L_{\tilde{a}}^{\nu}(\beta) - R_{\tilde{b}}^{\nu}(\beta), R_{\tilde{a}}^{\nu}(\beta) - L_{\tilde{b}}^{\nu}(\beta)];$$

and

$$[\lambda \tilde{a}]_{\alpha} = \begin{cases} [\lambda L_{\tilde{a}}^{\mu}(\alpha), \lambda R_{\tilde{a}}^{\mu}(\alpha)], & \text{if } \lambda > 0, \\ [\lambda R_{\tilde{a}}^{\mu}(\alpha), \lambda L_{\tilde{a}}^{\mu}(\alpha)], & \text{if } \lambda < 0, \end{cases}; [\lambda \tilde{a}]_{\beta} = \begin{cases} [\lambda L_{\tilde{a}}^{\nu}(\beta), \lambda R_{\tilde{a}}^{\nu}(\beta)], & \text{if } \lambda > 0, \\ [\lambda R_{\tilde{a}}^{\nu}(\beta), \lambda L_{\tilde{a}}^{\nu}(\beta)], & \text{if } \lambda < 0, \end{cases};$$

$$[\lambda \tilde{a}]_{\gamma} = \begin{cases} [\lambda L_{\tilde{a}}^{\rho}(\gamma), \lambda R_{\tilde{a}}^{\rho}(\gamma)], & \text{if } \lambda > 0, \\ [\lambda R_{\tilde{a}}^{\rho}(\gamma), \lambda L_{\tilde{a}}^{\rho}(\gamma)], & \text{if } \lambda < 0, \end{cases}$$

respectively. Eventually, these arithmetic operations on the (α, γ, β) -cut are calculated to obtain the following expressions.

$$\tilde{a} + \tilde{b}$$

$$= \langle (a_1 + p_1, x_{0,1} + m_{0,1}, y_{0,1} + n_{0,1}, b_1 + q_1),$$

$$(a_2 + p_2, x_{0,2} + m_{0,2}, y_{0,2} + n_{0,2}, b_2 + q_2),$$

$$(a_3 + p_3, x_{0,3} + m_{0,3}, y_{0,3} + n_{0,3}, b_3 + q_3) \rangle, \tag{10}$$

$$\begin{aligned}
 \tilde{a} - \tilde{b} &= \langle (a_1 - q_1, x_{0,1} - n_{0,1}, y_{0,1} - m_{0,1}, b_1 - p_1), \\
 &\quad (a_2 - q_2, x_{0,2} - m_{0,2}, y_{0,2} - m_{0,2}, b_2 - p_2), \\
 &\quad (a_3 - q_3, x_{0,3} - n_{0,3}, y_{0,3} - m_{0,3}, b_3 - p_3) \rangle,
 \end{aligned}
 \tag{11}$$

$$\begin{aligned}
 \lambda \tilde{a} &= \begin{cases} \langle (\lambda a_1, \lambda x_{0,1}, \lambda y_{0,1}, \lambda b_1), (\lambda a_2, \lambda x_{0,2}, \lambda y_{0,2}, \lambda b_2), (\lambda a_3, \lambda x_{0,3}, \lambda y_{0,3}, \lambda b_3) \rangle, & \text{if } \lambda > 0, \\ \langle (\lambda b_1, \lambda y_{0,1}, \lambda x_{0,1}, \lambda a_1), (\lambda b_2, \lambda y_{0,2}, \lambda x_{0,2}, \lambda a_2), (\lambda b_3, \lambda y_{0,3}, \lambda x_{0,3}, \lambda a_3) \rangle, & \text{if } \lambda < 0, \end{cases}
 \end{aligned}
 \tag{12}$$

The collection of the SVNNs that follows the above defined arithmetic operations with bounded supports and convex are denoted by the set \mathcal{NF} . The collection of SVNNs means Single-valued Neutrosophic Triangular Number, Single-valued Neutrosophic Trapezoidal Numbers, Single-valued Neutrosophic Polygonal Numbers, etc.

3 The proposed method of ranking SVNN

The notions of value and ambiguity are enormously discussed in various methodology of ranking fuzzy numbers by Chutia (2017) and Chutia and Chutia (2017). Further, these quantities are also used in ranking IFNs by Chutia and Saikia (2018), and in ranking Z-numbers by Chutia (2020). Although there are various notions of capturing information which are being used in ranking methodologies, yet these two notions are reliable and robust. Hence, these notions are being used in the current methodology of ranking SVNNs. Thus, to move toward the development of the methodology, the following subsection will discuss the notions of value and ambiguity of a SVNN.

3.1 Definitions and notions essential for the discussion

In this subsection, the main definition that the proposed method of ranking SVNNs oath to stand is being discussed. Further, a few properties are also being discussed.

Definition 3.1 Let $\tilde{a} \in \mathcal{NF}$ and truth-membership function be $\mu_{\tilde{a}}(x)$, indeterminacy-membership function be $\rho_{\tilde{a}}(x)$ and falsity-membership function be $\nu_{\tilde{a}}(x)$ as defined in Definition 2.1. Let $\tilde{a}_\alpha = [L_\alpha^\mu(\alpha), R_\alpha^\mu(\alpha)]$ be the α -cut sets of truth-membership function, $\tilde{a}_\gamma = [L_\gamma^\rho(\gamma), R_\gamma^\rho(\gamma)]$ be the γ -cut sets of indeterminacy-membership function and $\tilde{a}_\beta = [L_\beta^\nu(\beta), R_\beta^\nu(\beta)]$ be the β -cut sets of falsity-membership function of \tilde{a} . Then, the quantities values and ambiguities of truth-membership, indeterminacy-membership and falsity-membership functions are denoted as $\mathcal{V}(\mu_{\tilde{a}})$, $\mathcal{V}(\rho_{\tilde{a}})$, $\mathcal{V}(\nu_{\tilde{a}})$ and $\mathcal{A}(\mu_{\tilde{a}})$, $\mathcal{A}(\rho_{\tilde{a}})$, $\mathcal{A}(\nu_{\tilde{a}})$, respectively. Then, these quantities are defined as

$$\begin{cases} \mathcal{V}(\mu_{\tilde{a}}) = \int_0^1 (R_\alpha^\mu(r) + L_\alpha^\mu(r))f(r)dr, \\ \mathcal{V}(\rho_{\tilde{a}}) = \int_0^1 (R_\alpha^\rho(r) + L_\alpha^\rho(r))g(r)dr, \\ \mathcal{V}(\nu_{\tilde{a}}) = \int_0^1 (R_\alpha^\nu(r) + L_\alpha^\nu(r))g(r)dr, \end{cases}
 \tag{13}$$

$$\begin{cases} \mathcal{A}(\mu_{\tilde{a}}) = \int_0^1 (R_{\tilde{a}}^{\mu}(r) - L_{\tilde{a}}^{\mu}(r))f(r)dr, \\ \mathcal{A}(\rho_{\tilde{a}}) = \int_0^1 (R_{\tilde{a}}^{\rho}(r) - L_{\tilde{a}}^{\rho}(r))g(r)dr, \\ \mathcal{A}(\nu_{\tilde{a}}) = \int_0^1 (R_{\tilde{a}}^{\nu}(r) - L_{\tilde{a}}^{\nu}(r))g(r)dr, \end{cases} \tag{14}$$

where, the function $f(\alpha)$ is non-negative and non-decreasing function on the interval $[0, 1]$ with $f(0) = 0, f(1) = 1$ and $\int_0^1 f(\alpha)d\alpha = \frac{1}{2}$; the function $g(\beta)$ is a non-negative and non-increasing function on the interval $[0, 1]$ with $g(1) = 0, g(0) = 1$ and $\int_0^1 g(\beta)d\beta = \frac{1}{2}$.

Let $\tilde{a} = \langle (a_1, x_{0,1}, y_{0,1}, b_1), (a_2, x_{0,2}, y_{0,2}, b_2), (a_3, x_{0,3}, y_{0,3}, b_3) \rangle$ be a trapezoidal SVNN defined in Definition 2.2. Let truth-membership, indeterminacy-membership and falsity-membership functions denoted as $\mu_{\tilde{a}}(x), \rho_{\tilde{a}}(x)$ and $\nu_{\tilde{a}}(x)$ as given in Eqs. 4, 5 and 6, respectively. Let α -cut, γ -cut and β -cut sets of the truth-membership, the indeterminacy-membership and the falsity-membership functions of \tilde{a} be given by Eqs. 7, 8 and 9, respectively. Choosing $f(\alpha)$ and $g(\beta)$ as $f(\alpha) = \alpha$ and $g(\beta) = 1 - \beta$, respectively. Then, values and ambiguities of truth-membership function, indeterminacy-membership function, falsity-membership function are $\mathcal{V}(\mu_{\tilde{a}}), \mathcal{V}(\rho_{\tilde{a}}), \mathcal{V}(\nu_{\tilde{a}})$ and $\mathcal{A}(\mu_{\tilde{a}}), \mathcal{A}(\rho_{\tilde{a}}), \mathcal{A}(\nu_{\tilde{a}})$ of \tilde{a} can be derived using the definitions of values and ambiguities defined in the Definition 3.1 as

$$\begin{cases} \mathcal{V}(\mu_{\tilde{a}}) = \frac{1}{6}[a_1 + 2(x_{0,1} + y_{0,1}) + b_1], \\ \mathcal{V}(\rho_{\tilde{a}}) = \frac{1}{6}[a_2 + 2(x_{0,2} + y_{0,2}) + b_2], \\ \mathcal{V}(\nu_{\tilde{a}}) = \frac{1}{6}[a_3 + 2(x_{0,3} + y_{0,3}) + b_3], \end{cases} \tag{15}$$

and

$$\begin{cases} \mathcal{A}(\mu_{\tilde{a}}) = \frac{1}{6}[b_1 + 2(y_{0,1} - x_{0,1}) - a_1], \\ \mathcal{A}(\rho_{\tilde{a}}) = \frac{1}{6}[b_2 + 2(y_{0,2} - x_{0,2}) - a_2], \\ \mathcal{A}(\nu_{\tilde{a}}) = \frac{1}{6}[b_3 + 2(y_{0,3} - x_{0,3}) - a_3], \end{cases} \tag{16}$$

respectively.

Now, a few properties of the quantities values and ambiguities of truth-membership, indeterminacy-membership and falsity-membership functions are being discussed through a few propositions which will be essential for further discussion about the proposed methodology. The above Definition 3.1 of the values and the ambiguities are the basic definitions based on which the proposed method of ranking SVNNs is being formulated.

Proposition 3.1 *Let $\tilde{a} \in \mathcal{NF}$. Then the inequalities $\sup \text{supp}(\mu_{\tilde{a}}) \geq \mathcal{V}(\mu_{\tilde{a}}) \geq \inf \text{supp}(\mu_{\tilde{a}})$, $\sup \text{supp}(\rho_{\tilde{a}}) \geq \mathcal{V}(\rho_{\tilde{a}}) \geq \inf \text{supp}(\rho_{\tilde{a}})$ and $\sup \text{supp}(\nu_{\tilde{a}}) \geq \mathcal{V}(\nu_{\tilde{a}}) \geq \inf \text{supp}(\nu_{\tilde{a}})$ hold, that is, the value of truth-membership function lies in the support of truth-membership function, the value of indeterminacy-membership function lies in the support of indeterminacy-membership function and the value of falsity-membership function lies in the support of the falsity-membership function.*

Proof Let $\tilde{a} \in \mathcal{NF}$ and $\tilde{a}_{\alpha} = [L_{\tilde{a}}^{\mu}(\alpha), R_{\tilde{a}}^{\mu}(\alpha)]$ be the α -cut sets of truth-membership function, $\tilde{a}_{\gamma} = [L_{\tilde{a}}^{\rho}(\gamma), R_{\tilde{a}}^{\rho}(\gamma)]$ be the γ -cut sets of indeterminacy-membership function and $\tilde{a}_{\beta} = [L_{\tilde{a}}^{\nu}(\beta), R_{\tilde{a}}^{\nu}(\beta)]$ be the β -cut sets of falsity-membership function. It is true that $[L_{\tilde{a}}^{\mu}(\alpha), R_{\tilde{a}}^{\mu}(\alpha)] \subseteq \text{supp}(\mu_{\tilde{a}}) = [L_{\tilde{a}}^{\mu}(0), R_{\tilde{a}}^{\mu}(0)]$. Therefore, it follows that $R_{\tilde{a}}^{\mu}(0) \geq R_{\tilde{a}}^{\mu}(\alpha) \geq L_{\tilde{a}}^{\mu}(\alpha) \geq L_{\tilde{a}}^{\mu}(0)$, which implies that

$$R_a^\mu(0) \geq \frac{1}{2} [L_a^\mu(\alpha) + R_a^\mu(\alpha)] \geq L_a^\mu(0)$$

$$\text{or, } R_a^\mu(0) \int_0^1 f(r)dr \geq \frac{1}{2} \int_0^1 (L_a^\mu(\alpha) + R_a^\mu(\alpha))f(r)dr \geq L_a^\mu(0) \int_0^1 f(r)dr.$$

Thus, it implies that $\sup \text{supp}(\mu_{\tilde{a}}) \geq \mathcal{V}(\mu_{\tilde{a}}) \geq \inf \text{supp}(\mu_{\tilde{a}})$. Similarly, $[L_a^\rho(\gamma), R_a^\rho(\gamma)] \subseteq \text{supp}(\rho_{\tilde{a}}) = [L_a^\rho(1), R_a^\rho(1)]$. Then, it follows that $R_a^\rho(1) \geq R_a^\rho(\gamma) \geq L_a^\rho(\gamma) \geq L_a^\rho(1)$, which implies that

$$R_a^\rho(1) \geq \frac{1}{2} [L_a^\rho(\gamma) + R_a^\rho(\gamma)] \geq L_a^\rho(1)$$

$$\text{or, } R_a^\rho(1) \int_0^1 g(r)dr \geq \frac{1}{2} \int_0^1 (L_a^\rho(\gamma) + R_a^\rho(\gamma))g(r)dr \geq L_a^\rho(1) \int_0^1 g(r)dr.$$

Thus, it implies that $\sup \text{supp}(\rho_{\tilde{a}}) \geq \mathcal{V}(\rho_{\tilde{a}}) \geq \inf \text{supp}(\rho_{\tilde{a}})$. Similarly, $[L_a^\nu(\beta), R_a^\nu(\beta)] \subseteq \text{supp}(\nu_{\tilde{a}}) = [L_a^\nu(1), R_a^\nu(1)]$. So, it follows that $R_a^\nu(1) \geq R_a^\nu(\beta) \geq L_a^\nu(\beta) \geq L_a^\nu(1)$, which implies that

$$R_a^\nu(1) \geq \frac{1}{2} [L_a^\nu(\beta) + R_a^\nu(\beta)] \geq L_a^\nu(1)$$

$$\text{or, } R_a^\nu(1) \int_0^1 g(r)dr \geq \frac{1}{2} \int_0^1 (L_a^\nu(\beta) + R_a^\nu(\beta))g(r)dr \geq L_a^\nu(1) \int_0^1 g(r)dr.$$

Hence, it implies that $\sup \text{supp}(\nu_{\tilde{a}}) \geq \mathcal{V}(\nu_{\tilde{a}}) \geq \inf \text{supp}(\nu_{\tilde{a}})$. □

Proposition 3.2 Let $\tilde{a}, \tilde{b} \in \mathcal{NF}$. Then

$$\mathcal{V}(\mu_{\tilde{a}+\tilde{b}}) = \mathcal{V}(\mu_{\tilde{a}}) + \mathcal{V}(\mu_{\tilde{b}}), \mathcal{V}(\rho_{\tilde{a}+\tilde{b}}) = \mathcal{V}(\rho_{\tilde{a}}) + \mathcal{V}(\rho_{\tilde{b}}), \mathcal{V}(\nu_{\tilde{a}+\tilde{b}}) = \mathcal{V}(\nu_{\tilde{a}}) + \mathcal{V}(\nu_{\tilde{b}})$$

and

$$\mathcal{V}(\mu_{\tilde{a}-\tilde{b}}) = \mathcal{V}(\mu_{\tilde{a}}) - \mathcal{V}(\mu_{\tilde{b}}), \mathcal{V}(\rho_{\tilde{a}-\tilde{b}}) = \mathcal{V}(\rho_{\tilde{a}}) - \mathcal{V}(\rho_{\tilde{b}}), \mathcal{V}(\nu_{\tilde{a}-\tilde{b}}) = \mathcal{V}(\nu_{\tilde{a}}) - \mathcal{V}(\nu_{\tilde{b}}).$$

Proof Let $\tilde{a}, \tilde{b} \in \mathcal{NF}$, $\tilde{a}_\alpha = [L_a^\mu(\alpha), R_a^\mu(\alpha)]$ and $\tilde{b}_\alpha = [L_b^\mu(\alpha), R_b^\mu(\alpha)]$ be the α -cut sets of truth-membership functions of \tilde{a} and \tilde{b} respectively, $\tilde{a}_\gamma = [L_a^\rho(\gamma), R_a^\rho(\gamma)]$ and $\tilde{b}_\gamma = [L_b^\rho(\gamma), R_b^\rho(\gamma)]$ be the γ -cut sets of indeterminacy-membership functions of \tilde{a} and \tilde{b} respectively, $\tilde{a}_\beta = [L_a^\nu(\beta), R_a^\nu(\beta)]$ and $\tilde{b}_\beta = [L_b^\nu(\beta), R_b^\nu(\beta)]$ be the β -cut sets of falsity-membership functions of \tilde{a} and \tilde{b} , respectively. Then, it follows that

$$\begin{aligned}
 \mathcal{V}(\mu_{\tilde{a}+\tilde{b}}) &= \int_0^1 f(r) \left[(R_{\tilde{a}}^{\mu}(r) + R_{\tilde{b}}^{\mu}(r)) + (L_{\tilde{a}}^{\mu}(r) + L_{\tilde{b}}^{\mu}(r)) \right] dr \\
 &= \int_0^1 f(r)(R_{\tilde{a}}^{\mu}(r) + L_{\tilde{a}}^{\mu}(r))dr + \int_0^1 g(r)(R_{\tilde{b}}^{\mu}(r) + L_{\tilde{b}}^{\mu}(r))dr \\
 &= \mathcal{V}(\mu_{\tilde{a}}) + \mathcal{V}(\mu_{\tilde{b}}), \\
 \mathcal{V}(\rho_{\tilde{a}+\tilde{b}}) &= \int_0^1 g(r) \left[(R_{\tilde{a}}^{\rho}(r) + R_{\tilde{b}}^{\rho}(r)) + (L_{\tilde{a}}^{\rho}(r) + L_{\tilde{b}}^{\rho}(r)) \right] dr \\
 &= \int_0^1 g(r)(R_{\tilde{a}}^{\rho}(r) + L_{\tilde{a}}^{\rho}(r))dr + \int_0^1 g(r)(R_{\tilde{b}}^{\rho}(r) + L_{\tilde{b}}^{\rho}(r))dr \\
 &= \mathcal{V}(\rho_{\tilde{a}}) + \mathcal{V}(\rho_{\tilde{b}}), \\
 \mathcal{V}(v_{\tilde{a}+\tilde{b}}) &= \int_0^1 g(r) \left[(R_{\tilde{a}}^{\nu}(r) + R_{\tilde{b}}^{\nu}(r)) + (L_{\tilde{a}}^{\nu}(r) + L_{\tilde{b}}^{\nu}(r)) \right] dr \\
 &= \int_0^1 g(r)(R_{\tilde{a}}^{\nu}(r) + L_{\tilde{a}}^{\nu}(r))dr + \int_0^1 g(r)(R_{\tilde{b}}^{\nu}(r) + L_{\tilde{b}}^{\nu}(r))dr \\
 &= \mathcal{V}(v_{\tilde{a}}) + \mathcal{V}(v_{\tilde{b}}).
 \end{aligned}$$

Similarly, it can be proved that the equalities $\mathcal{V}(\mu_{\tilde{a}-\tilde{b}}) = \mathcal{V}(\mu_{\tilde{a}}) - \mathcal{V}(\mu_{\tilde{b}})$, $\mathcal{V}(\rho_{\tilde{a}-\tilde{b}}) = \mathcal{V}(\rho_{\tilde{a}}) - \mathcal{V}(\rho_{\tilde{b}})$ and $\mathcal{V}(v_{\tilde{a}-\tilde{b}}) = \mathcal{V}(v_{\tilde{a}}) - \mathcal{V}(v_{\tilde{b}})$ hold. □

Proposition 3.3 Let $\tilde{a}, \tilde{b} \in \mathcal{NF}$. Then

$$\mathcal{A}(\mu_{\tilde{a}+\tilde{b}}) = \mathcal{A}(\mu_{\tilde{a}}) + \mathcal{A}(\mu_{\tilde{b}}), \mathcal{A}(\rho_{\tilde{a}+\tilde{b}}) = \mathcal{A}(\rho_{\tilde{a}}) + \mathcal{A}(\rho_{\tilde{b}}), \mathcal{A}(v_{\tilde{a}+\tilde{b}}) = \mathcal{A}(v_{\tilde{a}}) + \mathcal{A}(v_{\tilde{b}})$$

and

$$\mathcal{A}(\mu_{\tilde{a}-\tilde{b}}) = \mathcal{A}(\mu_{\tilde{a}}) - \mathcal{A}(\mu_{\tilde{b}}), \mathcal{A}(\rho_{\tilde{a}-\tilde{b}}) = \mathcal{A}(\rho_{\tilde{a}}) - \mathcal{A}(\rho_{\tilde{b}}), \mathcal{A}(v_{\tilde{a}-\tilde{b}}) = \mathcal{A}(v_{\tilde{a}}) - \mathcal{A}(v_{\tilde{b}}).$$

Proof Let $\tilde{a}, \tilde{b} \in \mathcal{NF}$, $\tilde{a}_{\alpha} = [L_{\tilde{a}}^{\mu}(\alpha), R_{\tilde{a}}^{\mu}(\alpha)]$ and $\tilde{b}_{\alpha} = [L_{\tilde{b}}^{\mu}(\alpha), R_{\tilde{b}}^{\mu}(\alpha)]$ be the α -cut sets of truth-membership functions of \tilde{a} and \tilde{b} , respectively, $\tilde{a}_{\gamma} = [L_{\tilde{a}}^{\rho}(\gamma), R_{\tilde{a}}^{\rho}(\gamma)]$ and $\tilde{b}_{\gamma} = [L_{\tilde{b}}^{\rho}(\gamma), R_{\tilde{b}}^{\rho}(\gamma)]$ be the γ -cut sets of indeterminacy-membership functions of \tilde{a} and \tilde{b} , respectively and $\tilde{a}_{\beta} = [L_{\tilde{a}}^{\nu}(\beta), R_{\tilde{a}}^{\nu}(\beta)]$ and $\tilde{b}_{\beta} = [L_{\tilde{b}}^{\nu}(\beta), R_{\tilde{b}}^{\nu}(\beta)]$ be the β -cut sets of falsity-membership functions of \tilde{a} and \tilde{b} , respectively. Then, it follows that

$$\begin{aligned}
 \mathcal{A}(\mu_{\tilde{a}+\tilde{b}}) &= \int_0^1 f(r) \left[(R_a^\mu(r) + R_b^\mu(r)) - (L_a^\mu(r) + L_b^\mu(r)) \right] dr \\
 &= \int_0^1 f(r)(R_a^\mu(r) - L_a^\mu(r))dr + \int_0^1 g(r)(R_b^\mu(r) - L_b^\mu(r))dr \\
 &= \mathcal{A}(\mu_{\tilde{a}}) + \mathcal{A}(\mu_{\tilde{b}}), \\
 \mathcal{A}(\rho_{\tilde{a}+\tilde{b}}) &= \int_0^1 g(r) \left[(R_a^\rho(r) + R_b^\rho(r)) - (L_a^\rho(r) + L_b^\rho(r)) \right] dr \\
 &= \int_0^1 g(r)(R_a^\rho(r) - L_a^\rho(r))dr + \int_0^1 g(r)(R_b^\rho(r) - L_b^\rho(r))dr \\
 &= \mathcal{A}(\rho_{\tilde{a}}) + \mathcal{A}(\rho_{\tilde{b}}) \\
 \mathcal{A}(v_{\tilde{a}+\tilde{b}}) &= \int_0^1 g(r) \left[(R_a^v(r) + R_b^v(r)) - (L_a^v(r) + L_b^v(r)) \right] dr \\
 &= \int_0^1 g(r)(R_a^v(r) - L_a^v(r))dr + \int_0^1 g(r)(R_b^v(r) - L_b^v(r))dr \\
 &= \mathcal{A}(v_{\tilde{a}}) + \mathcal{A}(v_{\tilde{b}}).
 \end{aligned}$$

Similarly, it can be proved that the equalities $\mathcal{A}(\mu_{\tilde{a}-\tilde{b}}) = \mathcal{A}(\mu_{\tilde{a}}) + \mathcal{A}(\mu_{\tilde{b}})$, $\mathcal{A}(\rho_{\tilde{a}-\tilde{b}}) = \mathcal{A}(\rho_{\tilde{a}}) + \mathcal{A}(\rho_{\tilde{b}})$ and $\mathcal{A}(v_{\tilde{a}-\tilde{b}}) = \mathcal{A}(v_{\tilde{a}}) + \mathcal{A}(v_{\tilde{b}})$ hold. □

Proposition 3.4 Let $\tilde{a} \in \mathcal{NF}$, $k \in \mathbb{R} - \{0\}$ be any real number. Then the values and the ambiguities of truth-membership, indeterminacy-membership and falsity-membership functions hold the following equalities, that is, $\mathcal{V}(\mu_{k\tilde{a}}) = k\mathcal{V}(\mu_{\tilde{a}})$, $\mathcal{V}(\rho_{k\tilde{a}}) = k\mathcal{V}(\rho_{\tilde{a}})$, $\mathcal{V}(v_{k\tilde{a}}) = k\mathcal{V}(v_{\tilde{a}})$ and

$$\begin{aligned}
 \mathcal{A}(\mu_{k\tilde{a}}) &= \begin{cases} k\mathcal{A}(\mu_{\tilde{a}}) & \text{if } k > 0 \\ -k\mathcal{A}(\mu_{\tilde{a}}) & \text{if } k < 0 \end{cases}, \\
 \mathcal{A}(v_{k\tilde{a}}) &= \begin{cases} k\mathcal{A}(v_{\tilde{a}}) & \text{if } k > 0 \\ -k\mathcal{A}(v_{\tilde{a}}) & \text{if } k < 0 \end{cases}, \\
 \mathcal{A}(\rho_{k\tilde{a}}) &= \begin{cases} k\mathcal{A}(\rho_{\tilde{a}}) & \text{if } k > 0 \\ -k\mathcal{A}(\rho_{\tilde{a}}) & \text{if } k < 0 \end{cases}.
 \end{aligned}$$

Proof Let $\tilde{a} \in \mathcal{NF}$ and $\tilde{a}_\alpha = [L_a^\mu(\alpha), R_a^\mu(\alpha)]$ be the α -cut sets of truth-membership function, $\tilde{a}_\gamma = [L_a^\rho(\gamma), R_a^\rho(\gamma)]$ be the γ -cut sets of indeterminacy-membership function and $\tilde{a}_\beta = [L_a^v(\beta), R_a^v(\beta)]$ be the β -cut sets of falsity-membership function. Now, for $k(> 0) \in \mathbb{R} - \{0\}$ it follows immediately from the Definition 3.1 and the definition of scalar multiplication that $\mathcal{V}(\mu_{k\tilde{a}}) = k\mathcal{V}(\mu_{\tilde{a}})$, $\mathcal{V}(\rho_{k\tilde{a}}) = k\mathcal{V}(\rho_{\tilde{a}})$, $\mathcal{V}(v_{k\tilde{a}}) = k\mathcal{V}(v_{\tilde{a}})$ and $\mathcal{A}(\mu_{k\tilde{a}}) = k\mathcal{A}(\mu_{\tilde{a}})$, $\mathcal{A}(\rho_{k\tilde{a}}) = k\mathcal{A}(\rho_{\tilde{a}})$, $\mathcal{A}(v_{k\tilde{a}}) = k\mathcal{A}(v_{\tilde{a}})$. Let $k < 0$. Assume $k = -m < 0$. Then it follows the Definition 3.1 and the definition of scalar multiplication that $\mathcal{V}(\mu_{-m\tilde{a}}) = -m\mathcal{V}(\mu_{\tilde{a}})$, $\mathcal{V}(\rho_{-m\tilde{a}}) = -m\mathcal{V}(\rho_{\tilde{a}})$, $\mathcal{V}(v_{-m\tilde{a}}) = -m\mathcal{V}(v_{\tilde{a}})$ and $\mathcal{A}(\mu_{-m\tilde{a}}) = m\mathcal{A}(\mu_{\tilde{a}})$, $\mathcal{A}(\rho_{-m\tilde{a}}) = m\mathcal{A}(\rho_{\tilde{a}})$, $\mathcal{A}(v_{-m\tilde{a}}) = m\mathcal{A}(v_{\tilde{a}})$. Hence, the proposition holds. □

Proposition 3.5 Let $\tilde{a} \in \mathcal{NF}$, $-\tilde{a} \in \mathcal{NF}$ be its image. Then $\mathcal{V}(\mu_{-\tilde{a}}) = -\mathcal{V}(\mu_{\tilde{a}})$, $\mathcal{V}(\rho_{-\tilde{a}}) = -\mathcal{V}(\rho_{\tilde{a}})$, $\mathcal{V}(v_{-\tilde{a}}) = -\mathcal{V}(v_{\tilde{a}})$ and $\mathcal{A}(\mu_{-\tilde{a}}) = \mathcal{A}(\mu_{\tilde{a}})$, $\mathcal{A}(\rho_{-\tilde{a}}) = \mathcal{A}(\rho_{\tilde{a}})$, $\mathcal{A}(v_{-\tilde{a}}) = \mathcal{A}(v_{\tilde{a}})$.

Proof The proof is very trivial, as this proposition is a particular case of the above Proposition 3.4. Thus, the proof follows immediately taking $k = -1$ in its proof. \square

Proposition 3.6 Let $\tilde{a}, \tilde{b} \in \mathcal{NF}$, such that $\inf \text{supp}(\mu_{\tilde{a}}) > \sup \text{supp}(\mu_{\tilde{b}})$, $\inf \text{supp}(\rho_{\tilde{a}}) > \sup \text{supp}(\rho_{\tilde{b}})$ and $\inf \text{supp}(v_{\tilde{a}}) > \sup \text{supp}(v_{\tilde{b}})$, then $\mathcal{V}(\mu_{\tilde{a}}) > \mathcal{V}(\mu_{\tilde{b}})$, $\mathcal{V}(\rho_{\tilde{a}}) > \mathcal{V}(\rho_{\tilde{b}})$ and $\mathcal{V}(v_{\tilde{a}}) > \mathcal{V}(v_{\tilde{b}})$, respectively.

Proof Let $\tilde{a}, \tilde{b} \in \mathcal{NF}$, $\tilde{a}_\alpha = [L_\alpha^\mu(\tilde{a}), R_\alpha^\mu(\tilde{a})]$ and $\tilde{b}_\alpha = [L_\alpha^\mu(\tilde{b}), R_\alpha^\mu(\tilde{b})]$ be the α -cut sets of truth-membership functions of \tilde{a} and \tilde{b} , respectively, $\tilde{a}_\gamma = [L_\gamma^\rho(\tilde{a}), R_\gamma^\rho(\tilde{a})]$ and $\tilde{b}_\gamma = [L_\gamma^\rho(\tilde{b}), R_\gamma^\rho(\tilde{b})]$ be the γ -cut sets of indeterminacy-membership functions of \tilde{a} and \tilde{b} , respectively and $\tilde{a}_\beta = [L_\beta^\nu(\tilde{a}), R_\beta^\nu(\tilde{a})]$ and $\tilde{b}_\beta = [L_\beta^\nu(\tilde{b}), R_\beta^\nu(\tilde{b})]$ be the β -cut sets of falsity-membership functions of \tilde{a} and \tilde{b} , respectively. Now, if $\inf \text{supp}(\mu_{\tilde{a}}) > \sup \text{supp}(\mu_{\tilde{b}})$, $\inf \text{supp}(\rho_{\tilde{a}}) > \sup \text{supp}(\rho_{\tilde{b}})$ and $\inf \text{supp}(v_{\tilde{a}}) > \sup \text{supp}(v_{\tilde{b}})$, then $L_\alpha^\mu(\tilde{a}) > R_\alpha^\mu(\tilde{b})$, $L_\gamma^\rho(\tilde{a}) > R_\gamma^\rho(\tilde{b})$ and $L_\beta^\nu(\tilde{a}) > R_\beta^\nu(\tilde{b})$. Thus, it implies that $R_\alpha^\mu(\tilde{a}) \geq L_\alpha^\mu(\tilde{a}) > R_\beta^\mu(\tilde{a}) \geq L_\beta^\mu(\tilde{a})$, $R_\alpha^\rho(\tilde{a}) \geq L_\alpha^\rho(\tilde{a}) > R_\beta^\rho(\tilde{a}) \geq L_\beta^\rho(\tilde{a})$ and $R_\alpha^\nu(\tilde{a}) \geq L_\alpha^\nu(\tilde{a}) > R_\beta^\nu(\tilde{a}) \geq L_\beta^\nu(\tilde{a})$. So, it follows immediately that

$$R_\alpha^\mu(\tilde{a}) + L_\alpha^\mu(\tilde{a}) > R_\beta^\mu(\tilde{a}) + L_\beta^\mu(\tilde{a})$$

or,
$$\int_0^1 f(r)(R_\alpha^\mu(\tilde{a})(r) + L_\alpha^\mu(\tilde{a})(r))dr > \int_0^1 f(r)(R_\beta^\mu(\tilde{a})(r) + L_\beta^\mu(\tilde{a})(r))dr \tag{17}$$

$$R_\alpha^\rho(\tilde{a}) + L_\alpha^\rho(\tilde{a}) > R_\beta^\rho(\tilde{a}) + L_\beta^\rho(\tilde{a})$$

or,
$$\int_0^1 g(r)(R_\alpha^\rho(\tilde{a})(r) + L_\alpha^\rho(\tilde{a})(r))dr > \int_0^1 g(r)(R_\beta^\rho(\tilde{a})(r) + L_\beta^\rho(\tilde{a})(r))dr \tag{18}$$

and

$$R_\alpha^\nu(\tilde{a}) + L_\alpha^\nu(\tilde{a}) > R_\beta^\nu(\tilde{a}) + L_\beta^\nu(\tilde{a})$$

or,
$$\int_0^1 h(r)(R_\alpha^\nu(\tilde{a})(r) + L_\alpha^\nu(\tilde{a})(r))dr > \int_0^1 h(r)(R_\beta^\nu(\tilde{a})(r) + L_\beta^\nu(\tilde{a})(r))dr \tag{19}$$

Hence, from the inequalities 17, 18 and 19, the result follows immediately. \square

Proposition 3.7 If $\tilde{a} \in \mathcal{NF}$ be a SVN such that it is symmetric about the y-axis, then $\mathcal{V}(\mu_{\tilde{a}}) = 0$, $\mathcal{V}(\rho_{\tilde{a}}) = 0$ and $\mathcal{V}(v_{\tilde{a}}) = 0$.

Proof Let $\tilde{a} \in \mathcal{NF}$ and $\tilde{a}_\alpha = [L_\alpha^\mu(\tilde{a}), R_\alpha^\mu(\tilde{a})]$ be the α -cut sets of truth-membership function, $\tilde{a}_\gamma = [L_\gamma^\rho(\tilde{a}), R_\gamma^\rho(\tilde{a})]$ be the γ -cut sets of indeterminacy-membership function and $\tilde{a}_\beta = [L_\beta^\nu(\tilde{a}), R_\beta^\nu(\tilde{a})]$ be the β -cut sets of falsity-membership function. Since, \tilde{a} is symmetric about the y-axis, it follows that $-L_\alpha^\mu(\tilde{a}) = R_\alpha^\mu(\tilde{a})$, $-L_\gamma^\rho(\tilde{a}) = R_\gamma^\rho(\tilde{a})$ and $-L_\beta^\nu(\tilde{a}) = R_\beta^\nu(\tilde{a})$. Then, it is evident that $\mathcal{V}(\mu_{\tilde{a}}) = 0$, $\mathcal{V}(\rho_{\tilde{a}}) = 0$ and $\mathcal{V}(v_{\tilde{a}}) = 0$. \square

Proposition 3.8 For an arbitrary SVN $\tilde{a} \in \mathcal{NF}$, $\mathcal{A}(\mu_{\tilde{a}}) \geq 0$, $\mathcal{A}(\rho_{\tilde{a}}) \geq 0$ and $\mathcal{A}(v_{\tilde{a}}) \geq 0$.

Proof Let $\tilde{a} \in \mathcal{NF}$. Then the α -cut sets, γ -cut sets and the β -cut sets of truth-membership, indeterminacy-membership and falsity-membership functions of \tilde{a} be $\tilde{a}_\alpha = [L_\alpha^\mu(\alpha), R_\alpha^\mu(\alpha)]$, $\tilde{a}_\gamma = [L_\alpha^\rho(\gamma), R_\alpha^\rho(\gamma)]$ and $\tilde{a}_\beta = [L_\alpha^\nu(\beta), R_\alpha^\nu(\beta)]$, respectively. As $R_\alpha^\mu(\alpha) - L_\alpha^\mu(\alpha) \geq 0$, $R_\alpha^\rho(\gamma) - L_\alpha^\rho(\gamma) \geq 0$ and $R_\alpha^\nu(\beta) - L_\alpha^\nu(\beta) \geq 0$, it follows that $\int_0^1 f(r)(R_\alpha^\mu(r) - L_\alpha^\mu(r))dr \geq 0$, $\int_0^1 g(r)(R_\alpha^\rho(r) - L_\alpha^\rho(r))dr \geq 0$ and $\int_0^1 g(r)(R_\alpha^\nu(r) - L_\alpha^\nu(r))dr \geq 0$. Hence, the result $\mathcal{A}(\mu_{\tilde{a}}) \geq 0$, $\mathcal{A}(\rho_{\tilde{a}}) \geq 0$ and $\mathcal{A}(\nu_{\tilde{a}}) \geq 0$. \square

3.2 The proposed method

Let $\tilde{a}, \tilde{b} \in \mathcal{NF}$, $\tilde{a}_\alpha = [L_\alpha^\mu(\alpha), R_\alpha^\mu(\alpha)]$ and $\tilde{b}_\alpha = [L_\alpha^\mu(\alpha), R_\alpha^\mu(\alpha)]$ be the α -cut sets of truth-membership functions of \tilde{a} and \tilde{b} , respectively, $\tilde{a}_\gamma = [L_\alpha^\rho(\gamma), R_\alpha^\rho(\gamma)]$ and $\tilde{b}_\gamma = [L_\alpha^\rho(\gamma), R_\alpha^\rho(\gamma)]$ be the γ -cut sets of indeterminacy-membership functions of \tilde{a} and \tilde{b} , respectively, $\tilde{a}_\beta = [L_\alpha^\nu(\beta), R_\alpha^\nu(\beta)]$ and $\tilde{b}_\beta = [L_\alpha^\nu(\beta), R_\alpha^\nu(\beta)]$ be the β -cut sets of falsity-membership functions of \tilde{a} and \tilde{b} , respectively. Let, $\mathcal{V}(\mu_{\tilde{a}})$, $\mathcal{V}(\rho_{\tilde{a}})$, $\mathcal{V}(\nu_{\tilde{a}})$ and $\mathcal{V}(\mu_{\tilde{b}})$, $\mathcal{V}(\rho_{\tilde{b}})$, $\mathcal{V}(\nu_{\tilde{b}})$ be the values of truth-membership, indeterminacy-membership and falsity-membership functions of \tilde{a} and \tilde{b} , respectively; and $\mathcal{A}(\mu_{\tilde{a}})$, $\mathcal{A}(\rho_{\tilde{a}})$, $\mathcal{A}(\nu_{\tilde{a}})$ and $\mathcal{A}(\mu_{\tilde{b}})$, $\mathcal{A}(\rho_{\tilde{b}})$, $\mathcal{A}(\nu_{\tilde{b}})$ be the ambiguities of truth-membership, indeterminacy-membership, falsity-membership functions of \tilde{a} and \tilde{b} , respectively. Let $\lambda \in [0, 1]$ be the index of optimism. Then the ranking index \mathcal{R}_λ is defined as

$$\mathcal{R}_\lambda(\tilde{a}, \theta_1, \theta_2, \theta_3) = \lambda\{\mathcal{V}(\mu_{\tilde{a}}) + \theta_1\mathcal{A}(\mu_{\tilde{a}})\} + (1 - \lambda)\{\mathcal{V}(\rho_{\tilde{a}}) + \theta_2\mathcal{A}(\rho_{\tilde{a}}) + \mathcal{V}(\nu_{\tilde{a}}) + \theta_3\mathcal{A}(\nu_{\tilde{a}})\} \tag{20}$$

where $\theta_1, \theta_2, \theta_3 : \mathcal{NF} \rightarrow \{0, -1, 1\}$ are the ambiguity inclusion function of truth-membership, indeterminacy-membership, falsity-membership functions such that

$$\theta_1 = \begin{cases} 0, & \text{if } \mathcal{V}(\mu_{\tilde{a}}) \neq \mathcal{V}(\mu_{\tilde{b}}) \\ -1, & \text{if } \mathcal{V}(\mu_{\tilde{a}}) = \mathcal{V}(\mu_{\tilde{b}}) \text{ and } t_{\theta_1} \geq 0 \\ 1, & \text{if } \mathcal{V}(\mu_{\tilde{a}}) = \mathcal{V}(\mu_{\tilde{b}}) \text{ and } t_{\theta_1} < 0 \end{cases}$$

$$\theta_2 = \begin{cases} 0, & \text{if } \mathcal{V}(\rho_{\tilde{a}}) \neq \mathcal{V}(\rho_{\tilde{b}}) \\ -1, & \text{if } \mathcal{V}(\rho_{\tilde{a}}) = \mathcal{V}(\rho_{\tilde{b}}) \text{ and } t_{\theta_2} \geq 0 \\ 1, & \text{if } \mathcal{V}(\rho_{\tilde{a}}) = \mathcal{V}(\rho_{\tilde{b}}) \text{ and } t_{\theta_2} < 0 \end{cases}$$

$$\theta_3 = \begin{cases} 0, & \text{if } \mathcal{V}(\nu_{\tilde{a}}) \neq \mathcal{V}(\nu_{\tilde{b}}) \\ -1, & \text{if } \mathcal{V}(\nu_{\tilde{a}}) = \mathcal{V}(\nu_{\tilde{b}}) \text{ and } t_{\theta_3} \geq 0 \\ 1, & \text{if } \mathcal{V}(\nu_{\tilde{a}}) = \mathcal{V}(\nu_{\tilde{b}}) \text{ and } t_{\theta_3} < 0 \end{cases}$$

where $t_{\theta_1} = \frac{1}{2}[L_\alpha^\mu(0) + R_\alpha^\mu(0)]$ or $t_{\theta_1} = \frac{1}{2}[L_\alpha^\mu(0) + R_\alpha^\mu(0)]$ and $t_{\theta_2} = \frac{1}{2}[L_\alpha^\rho(1) + R_\alpha^\rho(1)]$ or $t_{\theta_2} = \frac{1}{2}[L_\alpha^\rho(1) + R_\alpha^\rho(1)]$ and $t_{\theta_3} = \frac{1}{2}[L_\alpha^\nu(1) + R_\alpha^\nu(1)]$ or $t_{\theta_3} = \frac{1}{2}[L_\alpha^\nu(1) + R_\alpha^\nu(1)]$.

The ordering of SVNNS, $\tilde{a}, \tilde{b} \in \mathcal{NF}$, based on the ranking index \mathcal{R}_λ for $0 \leq \lambda \leq 1$ is defined by relations $>$, $<$ and \sim as;

- $\tilde{a} > \tilde{b}$ if, and only if, $\mathcal{R}_\lambda(\tilde{a}, \theta_1, \theta_2, \theta_3) > \mathcal{R}_\lambda(\tilde{b}, \theta_1, \theta_2, \theta_3)$;
- $\tilde{a} < \tilde{b}$ if, and only if, $\mathcal{R}_\lambda(\tilde{a}, \theta_1, \theta_2, \theta_3) < \mathcal{R}_\lambda(\tilde{b}, \theta_1, \theta_2, \theta_3)$;
- $\tilde{a} \sim \tilde{b}$ if, and only if, $\mathcal{R}_\lambda(\tilde{a}, \theta_1, \theta_2, \theta_3) = \mathcal{R}_\lambda(\tilde{b}, \theta_1, \theta_2, \theta_3)$.

The order relations \geq and \leq are formulated as

- $\tilde{a} \succeq \tilde{b}$ if, and only if, $\tilde{a} > \tilde{b}$ or $\tilde{a} \sim \tilde{b}$.
- $\tilde{a} \preceq \tilde{b}$ if, and only if, $\tilde{a} < \tilde{b}$ or $\tilde{a} \sim \tilde{b}$.

The index of optimism $\lambda(0 \leq \lambda \leq 1)$ represents the decision-maker's attitude towards the uncertainty. An optimistic decision-maker ($\lambda = 1$) ranks the SVNNs based on truth-membership function without taking into account of indeterminacy-membership and falsity-membership functions. A pessimistic decision-maker ($\lambda = 0$) ranks the SVNNs based on indeterminacy-membership and falsity-membership functions without taking into account of the truth-membership function. Finally, moderate decision-maker ($\lambda = 0.5$) ranks the SVNNs taking into account of all the membership functions. Further, the θ_i 's take care of the ranking index by deciding whether and how to include the ambiguities into the ranking index. If values are unequal, then the decision is based on values, in which case, $\theta_i = 0$. If values are equal, then the decision is based on ambiguities, in which case, $\theta_i = \pm 1$ depending upon positivity or negativity of t_{θ_i} 's.

Next theorem discusses the linearity property of the ranking index \mathcal{R}_λ . This linearity property will be further helpful in discussing the properties of the current method of ordering SVNNs.

Theorem 3.1 *Let $\tilde{a}, \tilde{b} \in \mathcal{NF}$. Then*

$$\mathcal{R}_\lambda(\tilde{a} + \tilde{b}, \theta_1, \theta_2, \theta_3) = \mathcal{R}_\lambda(\tilde{a}, \theta_1, \theta_2, \theta_3) + \mathcal{R}_\lambda(\tilde{b}, \theta_1, \theta_2, \theta_3).$$

Hence, it follows that

$$\mathcal{R}_\lambda(\tilde{a} - \tilde{b}, \theta_1, \theta_2, \theta_3) = \mathcal{R}_\lambda(\tilde{a}, \theta_1, \theta_2, \theta_3) + \mathcal{R}_\lambda(-\tilde{b}, \theta_1, \theta_2, \theta_3).$$

Proof Let $\tilde{a}, \tilde{b} \in \mathcal{NF}$. Then it follows from the Propositions 3.2 and 3.3 that

$$\mathcal{V}(\mu_{\tilde{a}+\tilde{b}}) = \mathcal{V}(\mu_{\tilde{a}}) + \mathcal{V}(\mu_{\tilde{b}}), \mathcal{V}(\rho_{\tilde{a}+\tilde{b}}) = \mathcal{V}(\rho_{\tilde{a}}) + \mathcal{V}(\rho_{\tilde{b}}), \mathcal{V}(v_{\tilde{a}+\tilde{b}}) = \mathcal{V}(v_{\tilde{a}}) + \mathcal{V}(v_{\tilde{b}}) \quad (21)$$

and

$$\mathcal{A}(\mu_{\tilde{a}+\tilde{b}}) = \mathcal{A}(\mu_{\tilde{a}}) + \mathcal{A}(\mu_{\tilde{b}}), \mathcal{A}(\rho_{\tilde{a}+\tilde{b}}) = \mathcal{A}(\rho_{\tilde{a}}) + \mathcal{A}(\rho_{\tilde{b}}), \mathcal{A}(v_{\tilde{a}+\tilde{b}}) = \mathcal{A}(v_{\tilde{a}}) + \mathcal{A}(v_{\tilde{b}}). \quad (22)$$

Thus, the results follows as

$$\begin{aligned} \mathcal{R}_\lambda(\tilde{a} + \tilde{b}, \theta_1, \theta_2, \theta_3) = & \lambda\{\mathcal{V}(\mu_{\tilde{a}+\tilde{b}}) + \theta_1\mathcal{A}(\mu_{\tilde{a}+\tilde{b}})\} \\ & + (1 - \lambda)\{\mathcal{V}(\rho_{\tilde{a}+\tilde{b}}) + \theta_2\mathcal{A}(\rho_{\tilde{a}+\tilde{b}}) + \mathcal{V}(v_{\tilde{a}+\tilde{b}}) + \theta_3\mathcal{A}(v_{\tilde{a}+\tilde{b}})\} \end{aligned}$$

So, using the Eqs. 21 and 22 in the above equality, it can be derived easily that $\mathcal{R}_\lambda(\tilde{a} + \tilde{b}, \theta_1, \theta_2, \theta_3) = \mathcal{R}_\lambda(\tilde{a}, \theta_1, \theta_2, \theta_3) + \mathcal{R}_\lambda(\tilde{b}, \theta_1, \theta_2, \theta_3)$. Eventually, it is true that $\mathcal{R}_\lambda(\tilde{a} - \tilde{b}, \theta_1, \theta_2, \theta_3) = \mathcal{R}_\lambda(\tilde{a} + (-\tilde{b}), \theta_1, \theta_2, \theta_3) = \mathcal{R}_\lambda(\tilde{a}, \theta_1, \theta_2, \theta_3) + \mathcal{R}_\lambda(-\tilde{b}, \theta_1, \theta_2, \theta_3)$. □

Next a few theorems are being discussed. Eventually, from these discussion it will be evident that the current ranking index abide by the reasonable properties of Wang and Kerre (2001a, 2001b). Further, these theorems will give some light to newer properties of ranking fuzzy numbers as well as SVNNs.

Theorem 3.2 Let $\tilde{a}, \tilde{b}, \tilde{c} \in \mathcal{NF}$. Then the order relations $>$ and \sim satisfy the following properties:

1. The order relation is reflexive, that is, $\tilde{a} \geq \tilde{a}$.
2. The order relation is transitive, that is, if $\tilde{a} > \tilde{b}$ and $\tilde{b} > \tilde{c}$, then $\tilde{a} > \tilde{c}$. The same holds for the order relation \geq .
3. The order relation follows the law of trichotomy, that is, $\tilde{a} > \tilde{b}$ or $\tilde{b} \geq \tilde{a}$.
4. $\tilde{a} = \tilde{b}$ if and only if $\tilde{a} \sim \tilde{b}$.

The detailed proof of this theorem is available in Appendix A.1. This theorem establishes the reflexivity, transitivity and the trichotomy properties of the current method.

Theorem 3.3 Let $\tilde{a}, \tilde{b} \in \mathcal{NF}$ and $\inf \text{supp}(\mu_{\tilde{a}}) > \sup \text{supp}(\mu_{\tilde{b}})$, $\inf \text{supp}(\rho_{\tilde{a}}) > \sup \text{supp}(\rho_{\tilde{b}})$ and $\inf \text{supp}(v_{\tilde{a}}) > \sup \text{supp}(v_{\tilde{b}})$. Then $\tilde{a} \geq \tilde{b}$.

Proof Let, $\inf \text{supp}(\mu_{\tilde{a}}) > \sup \text{supp}(\mu_{\tilde{b}})$, $\inf \text{supp}(\rho_{\tilde{a}}) > \sup \text{supp}(\rho_{\tilde{b}})$ and $\inf \text{supp}(v_{\tilde{a}}) > \sup \text{supp}(v_{\tilde{b}})$. Then by the Propositions 3.1 and 3.6, it is evident that $\mathcal{V}(\mu_{\tilde{a}}) > \mathcal{V}(\mu_{\tilde{b}})$, $\mathcal{V}(\rho_{\tilde{a}}) > \mathcal{V}(\rho_{\tilde{b}})$ and $\mathcal{V}(v_{\tilde{a}}) > \mathcal{V}(v_{\tilde{b}})$. Thus, $\theta_i = 0$, which implies that $\mathcal{R}_\lambda(\tilde{a}, 0, 0, 0) > \mathcal{R}_\lambda(\tilde{b}, 0, 0, 0)$. So, it follows that $\tilde{a} > \tilde{b}$, in fact by definition of \geq , $\tilde{a} \geq \tilde{b}$. □

Theorem 3.4 Let $\tilde{a}, \tilde{b} \in \mathcal{NF}$ and $\inf \text{supp}(\mu_{\tilde{a}}) > \sup \text{supp}(\mu_{\tilde{b}})$, $\inf \text{supp}(\rho_{\tilde{a}}) > \sup \text{supp}(\rho_{\tilde{b}})$ and $\inf \text{supp}(v_{\tilde{a}}) > \sup \text{supp}(v_{\tilde{b}})$. Then $\tilde{a} > \tilde{b}$.

Proof Let, $\inf \text{supp}(\mu_{\tilde{a}}) > \sup \text{supp}(\mu_{\tilde{b}})$, $\inf \text{supp}(\rho_{\tilde{a}}) > \sup \text{supp}(\rho_{\tilde{b}})$ and $\inf \text{supp}(v_{\tilde{a}}) > \sup \text{supp}(v_{\tilde{b}})$. Then by the Propositions 3.1 and 3.6, trivially it follows that $\mathcal{V}(\mu_{\tilde{a}}) > \mathcal{V}(\mu_{\tilde{b}})$ and $\mathcal{V}(v_{\tilde{a}}) > \mathcal{V}(v_{\tilde{b}})$. Thus, $\theta_i = 0$, which implies that $\mathcal{R}_\lambda(\tilde{a}, 0, 0, 0) > \mathcal{R}_\lambda(\tilde{b}, 0, 0, 0)$. So, it follows that $\tilde{a} > \tilde{b}$. □

Theorem 3.5 Let $\tilde{a}, \tilde{b}, \tilde{c} \in \mathcal{NF}$. If $\tilde{a} \geq \tilde{b}$, then $\tilde{a} + \tilde{c} \geq \tilde{b} + \tilde{c}$.

The detailed proof of this theorem is available in Appendix A.2.

Theorem 3.6 Let $\tilde{a}, \tilde{b}, \tilde{c} \in \mathcal{NF}$. If $\tilde{a} + \tilde{c} \geq \tilde{b} + \tilde{c}$, then $\tilde{a} \geq \tilde{b}$.

Proof Let $\tilde{a}, \tilde{b}, \tilde{c} \in \mathcal{NF}$ and $\tilde{a} + \tilde{c} \geq \tilde{b} + \tilde{c}$. Then, it follows that $\mathcal{R}_\lambda(\tilde{a} + \tilde{c}, \theta_1, \theta_2, \theta_3) \geq \mathcal{R}_\lambda(\tilde{b} + \tilde{c}, \theta_1, \theta_2, \theta_3)$. Thus, by the Theorem 3.1, it follows that $\mathcal{R}_\lambda(\tilde{a}, \theta_1, \theta_2, \theta_3) + \mathcal{R}_\lambda(\tilde{c}, \theta_1, \theta_2, \theta_3) \geq \mathcal{R}_\lambda(\tilde{b}, \theta_1, \theta_2, \theta_3) + \mathcal{R}_\lambda(\tilde{c}, \theta_1, \theta_2, \theta_3)$. Eventually, it leads to $\mathcal{R}_\lambda(\tilde{a}, \theta_1, \theta_2, \theta_3) \geq \mathcal{R}_\lambda(\tilde{b}, \theta_1, \theta_2, \theta_3)$. Hence, the result follows immediately. □

Theorem 3.7 Let $\tilde{a}, \tilde{b}, \tilde{c} \in \mathcal{NF}$. If $\tilde{a} > \tilde{b}$, then $\tilde{a} + \tilde{c} > \tilde{b} + \tilde{c}$.

Proof The proof is very trivial by taking into account ‘>’ in the proof of the Theorem 3.5. □

Theorem 3.8 Let $\tilde{a}, \tilde{b}, \tilde{c} \in \mathcal{NF}$. If $\tilde{a} + \tilde{c} > \tilde{b} + \tilde{c}$, then $\tilde{a} > \tilde{b}$.

Proof The proof is very trivial by taking into account ‘>’ in the proof of the Theorem 3.6. □

Theorem 3.9 Let $\tilde{a}, \tilde{b} \in \mathcal{NF}$ and $k \in \mathbb{R} - \{0\}$. If $\tilde{a} \geq \tilde{b}$, then $k\tilde{a} \geq k\tilde{b}$ if $k > 0$, and $k\tilde{a} \leq k\tilde{b}$ if $k < 0$.

The detailed proof of this theorem is available in Appendix A.3.

Theorem 3.10 Let $\tilde{a}, \tilde{b} \in \mathcal{NF}$ and $k \in \mathbb{R} - \{0\}$. If $k\tilde{a} \geq k\tilde{b}$, then $\tilde{a} \geq \tilde{b}$ if $k > 0$, and $\tilde{a} \leq \tilde{b}$ if $k < 0$.

The detailed proof of this theorem is available in Appendix A.4.

Theorem 3.11 Let $\tilde{a}, \tilde{b} \in \mathcal{NF}$ and $k \in \mathbb{R} - \{0\}$. If $\tilde{a} > \tilde{b}$, then $k\tilde{a} > k\tilde{b}$ if $k > 0$, and $k\tilde{a} < k\tilde{b}$ if $k < 0$.

Proof The proof is very trivial by taking into account ‘>’ in the proof of the Theorem 3.9. □

Theorem 3.12 Let $\tilde{a}, \tilde{b} \in \mathcal{NF}$ and $k \in \mathbb{R} - \{0\}$. If $k\tilde{a} > k\tilde{b}$, then $\tilde{a} > \tilde{b}$ if $k > 0$, and $\tilde{a} < \tilde{b}$ if $k < 0$.

Proof The proof is very trivial by taking into account ‘>’ in the proof of the Theorem 3.10. □

Theorem 3.13 Let $\tilde{a}, \tilde{b}, \tilde{c} \in \mathcal{NF}$. If $\tilde{a} \geq \tilde{b}$, then $\tilde{a} - \tilde{c} \geq \tilde{b} - \tilde{c}$.

The detailed proof of this theorem is available in Appendix A.5.

Theorem 3.14 Let $\tilde{a}, \tilde{b}, \tilde{c} \in \mathcal{NF}$. If $\tilde{a} > \tilde{b}$, then $\tilde{a} - \tilde{c} > \tilde{b} - \tilde{c}$.

Proof Taking into account the proof of the Theorem 3.13 and the definition of \geq , the result follows immediately. □

Theorem 3.15 Let $\tilde{a}, \tilde{b}, \tilde{c}, \tilde{d} \in \mathcal{NF}$. If $\tilde{a} > \tilde{b}$ and $\tilde{c} > \tilde{d}$, then $\tilde{a} + \tilde{c} > \tilde{b} + \tilde{d}$.

The detailed proof of this theorem is available in Appendix A.6.

Theorem 3.16 Let $\tilde{a}, \tilde{b}, \tilde{c}, \tilde{d} \in \mathcal{NF}$. If $\tilde{a} \geq \tilde{b}$ and $\tilde{c} \geq \tilde{d}$, then $\tilde{a} + \tilde{c} \geq \tilde{b} + \tilde{d}$.

Proof Taking into account the proof of the Theorem 3.14 and the definition of \geq , the result follows immediately. □

Theorem 3.17 Let $\tilde{a}, \tilde{b} \in \mathcal{NF}$ such that \tilde{a} and \tilde{b} are not symmetric about y-axis. If $\tilde{a} \geq \tilde{b}$, then $-\tilde{a} \leq -\tilde{b}$.

Proof The proof follows immediately, taking $k = -1$ in the Theorem 3.10. □

Theorem 3.18 Let $\tilde{a}, \tilde{b} \in \mathcal{NF}$ such that \tilde{a} and \tilde{b} are not symmetric about y-axis. If $\tilde{a} > \tilde{b}$, then $-\tilde{a} < -\tilde{b}$.

Proof Taking into account the proof of the Theorem 3.17 and the definition of \geq , the result follows immediately. □

Theorem 3.19 Let $\tilde{a}, \tilde{b} \in \mathcal{NF}$ and symmetric about y-axis. If $\tilde{a} \geq \tilde{b}$, then $-\tilde{a} \geq -\tilde{b}$.

Proof If $\tilde{a}, \tilde{b} \in \mathcal{NF}$ be two symmetric SVNNs about the y-axis, then from the Proposition 3.7 it implies $\mathcal{V}(\mu_{\tilde{a}}) = 0 = \mathcal{V}(\mu_{\tilde{b}})$, $\mathcal{V}(\rho_{\tilde{a}}) = 0 = \mathcal{V}(\rho_{\tilde{b}})$ and also $\mathcal{V}(v_{\tilde{a}}) = 0 = \mathcal{V}(v_{\tilde{b}})$. Since, $\tilde{a} \geq \tilde{b}$, then $\theta_i = -1$. Thus, it follows that $\mathcal{R}_\lambda(\tilde{a}, -1, -1, -1) \geq \mathcal{R}_\lambda(\tilde{b}, -1, -1, -1)$. This inequality leads to the fact $-\mathcal{A}(\mu_{\tilde{a}}) \geq -\mathcal{A}(\mu_{\tilde{b}})$, $-\mathcal{A}(\rho_{\tilde{a}}) \geq -\mathcal{A}(\rho_{\tilde{b}})$ and $-\mathcal{A}(v_{\tilde{a}}) \geq -\mathcal{A}(v_{\tilde{b}})$. Equivalently, $-\mathcal{A}(\mu_{-\tilde{a}}) \geq -\mathcal{A}(\mu_{-\tilde{b}})$, $-\mathcal{A}(\rho_{-\tilde{a}}) \geq -\mathcal{A}(\rho_{-\tilde{b}})$ and $-\mathcal{A}(v_{-\tilde{a}}) \geq -\mathcal{A}(v_{-\tilde{b}})$. So, it is true that $\mathcal{R}_\lambda(-\tilde{a}, -1, -1, -1) \geq \mathcal{R}_\lambda(-\tilde{b}, -1, -1, -1)$. Hence, the result follows immediately. □

Theorem 3.20 Let $\tilde{a}, \tilde{b} \in \mathcal{F}$ and symmetric about y-axis. If $\tilde{a} > \tilde{b}$, then $-\tilde{a} > -\tilde{b}$.

Proof Taking into account the proof of the Theorem 3.19 and the definition of \geq , the result follows immediately. □

3.3 Properties and validation of the proposed method

In this subsection, the properties that the present method follow are being stated. The properties includes the reasonable properties of Wang and Kerre (2001a, 2001b). Further, newer properties are also stated which can be considered as reasonable in developing a ranking method. The properties are as follows. Let $\tilde{a}, \tilde{b}, \tilde{c}, \tilde{d} \in \mathcal{NF}$. Then the order relation \geq satisfies the following properties.

- \mathbb{A}_1 : $\tilde{a} \geq \tilde{a}$
- \mathbb{A}_2 : If $\tilde{a} \geq \tilde{b}$ and $\tilde{a} \leq \tilde{b}$, then $\tilde{a} \sim \tilde{b}$.
- \mathbb{A}_3 : If $\tilde{a} \geq \tilde{b}$ and $\tilde{b} \geq \tilde{c}$, then $\tilde{a} \geq \tilde{c}$.
- \mathbb{A}_4 : If $\inf \text{supp}(\mu_{\tilde{a}}) > \sup \text{supp}(\mu_{\tilde{b}})$, $\inf \text{supp}(\rho_{\tilde{a}}) > \sup \text{supp}(\rho_{\tilde{b}})$ and $\inf \text{supp}(v_{\tilde{a}}) > \sup \text{supp}(v_{\tilde{b}})$, then $\tilde{a} \geq \tilde{b}$.
- \mathbb{A}'_4 : If $\inf \text{supp}(\mu_{\tilde{a}}) > \sup \text{supp}(\mu_{\tilde{b}})$, $\inf \text{supp}(\rho_{\tilde{a}}) > \sup \text{supp}(\rho_{\tilde{b}})$ and $\inf \text{supp}(v_{\tilde{a}}) > \sup \text{supp}(v_{\tilde{b}})$, then $\tilde{a} > \tilde{b}$.
- \mathbb{A}_5 : Let \mathcal{NF} and \mathcal{NF}' be two arbitrary finite sets of fuzzy quantities in which \mathcal{R}_λ can be applied and \tilde{a} and \tilde{b} are in $\mathcal{NF} \cap \mathcal{NF}'$, then the ranking order $\tilde{a} > \tilde{b}$ by \mathcal{R}_λ on \mathcal{NF}' if and only if $\tilde{a} > \tilde{b}$ by \mathcal{R}_λ on \mathcal{NF} .
- \mathbb{A}_6 : If $\tilde{a} \geq \tilde{b}$, then $\tilde{a} + \tilde{c} \geq \tilde{b} + \tilde{c}$.
- \mathbb{B}_6 : If $\tilde{a} + \tilde{c} \geq \tilde{b} + \tilde{c}$, then $\tilde{a} \geq \tilde{b}$.
- \mathbb{A}'_6 : If $\tilde{a} > \tilde{b}$, then $\tilde{a} + \tilde{c} > \tilde{b} + \tilde{c}$.
- \mathbb{B}'_6 : If $\tilde{a} + \tilde{c} > \tilde{b} + \tilde{c}$, then $\tilde{a} > \tilde{b}$.
- \mathbb{A}_7 : Let $k \in \mathbb{R} - \{0\}$. If $\tilde{a} \geq \tilde{b}$, then $k\tilde{a} \geq k\tilde{b}$ if $k > 0$, and $k\tilde{a} \leq k\tilde{b}$ if $k < 0$.
- \mathbb{B}_7 : Let $k \in \mathbb{R} - \{0\}$. If $k\tilde{a} \geq k\tilde{b}$, then $\tilde{a} \geq \tilde{b}$ if $k > 0$, and $\tilde{a} \leq \tilde{b}$ if $k < 0$.
- \mathbb{A}'_7 : Let $k \in \mathbb{R} - \{0\}$. If $\tilde{a} > \tilde{b}$, then $k\tilde{a} > k\tilde{b}$ if $k > 0$, and $k\tilde{a} < k\tilde{b}$ if $k < 0$.
- \mathbb{B}'_7 : Let $k \in \mathbb{R} - \{0\}$. If $k\tilde{a} > k\tilde{b}$, then $\tilde{a} > \tilde{b}$ if $k > 0$, and $\tilde{a} < \tilde{b}$ if $k < 0$.

- \mathbb{B}_8 : If $\tilde{a} \geq \tilde{b}$, then $\tilde{a} - \tilde{c} \geq \tilde{b} - \tilde{c}$.
- \mathbb{B}'_8 : If $\tilde{a} > \tilde{b}$, then $\tilde{a} - \tilde{c} > \tilde{b} - \tilde{c}$.
- \mathbb{B}_9 : If $\tilde{a} \geq \tilde{b}$ and $\tilde{c} \geq \tilde{d}$, then $\tilde{a} + \tilde{c} \geq \tilde{b} + \tilde{d}$.
- \mathbb{B}'_9 : If $\tilde{a} > \tilde{b}$ and $\tilde{c} > \tilde{d}$, then $\tilde{a} + \tilde{c} > \tilde{b} + \tilde{d}$.
- \mathbb{B}_{10} : If $\tilde{a} \geq \tilde{b}$, then $-\tilde{a} \leq -\tilde{b}$, provided \tilde{a} and \tilde{b} are not symmetric about y-axis.
- \mathbb{B}'_{10} : If $\tilde{a} > \tilde{b}$, then $-\tilde{a} < -\tilde{b}$, provided \tilde{a} and \tilde{b} are not symmetric about y-axis.
- \mathbb{B}_{11} : Let $\tilde{a}, \tilde{b} \in \mathcal{NF}$ and symmetric about y-axis; if $\tilde{a} \geq \tilde{b}$, then $-\tilde{a} \geq -\tilde{b}$.
- \mathbb{B}'_{11} : Let $\tilde{a}, \tilde{b} \in \mathcal{NF}$ and symmetric about y-axis; if $\tilde{a} > \tilde{b}$, then $-\tilde{a} > -\tilde{b}$.

The proofs of the theorems stated and proved in the Sect. 3.2 depicts that the present method follows all these reasonable properties of a ranking method. Hence, it is claimed that the current method is reasonable and logical. Further, the consistency in ordering the images with the corresponding SVNNs is also depicted through these properties. However, it is to mentioned that the property \mathbb{A}_7 is a particular case of the property \mathbb{A}_7 of Wang and Kerre (2001a). This property \mathbb{A}_7 of Wang and Kerre (2001a) is not obeyed by the proposed method as $\mathcal{V}(\mu_{\tilde{a}}\mu_{\tilde{b}}) \neq \mathcal{V}(\mu_{\tilde{a}})\mathcal{V}(\mu_{\tilde{b}})$, $\mathcal{V}(\rho_{\tilde{a}}\rho_{\tilde{b}}) \neq \mathcal{V}(\rho_{\tilde{a}})\mathcal{V}(\rho_{\tilde{b}})$ and $\mathcal{V}(v_{\tilde{a}}v_{\tilde{b}}) \neq \mathcal{V}(v_{\tilde{a}})\mathcal{V}(v_{\tilde{b}})$, and $\mathcal{A}(\mu_{\tilde{a}}\mu_{\tilde{b}}) \neq \mathcal{A}(\mu_{\tilde{a}})\mathcal{A}(\mu_{\tilde{b}})$, $\mathcal{A}(\rho_{\tilde{a}}\rho_{\tilde{b}}) \neq \mathcal{A}(\rho_{\tilde{a}})\mathcal{A}(\rho_{\tilde{b}})$ and $\mathcal{A}(v_{\tilde{a}}v_{\tilde{b}}) \neq \mathcal{A}(v_{\tilde{a}})\mathcal{A}(v_{\tilde{b}})$.

4 Numerical examples

In this section, the method is demonstrated by two numerical examples, which highlight its robustness.

Example 4.1 Consider the SVNNs $\tilde{a} = \langle (2, 4, 4, 5), (0, 1, 4, 7), (1, 4, 4, 6) \rangle$ and $\tilde{b} = \langle (2, 3, 3, 5), (0, 1, 4, 7), (1, 3, 3, 6) \rangle$. Firstly, the values of truth-membership, indeterminacy-membership and falsity-membership of \tilde{a} and \tilde{b} are obtained as $\mathcal{V}(\mu_{\tilde{a}}) = 3.8333$, $\mathcal{V}(\rho_{\tilde{a}}) = 2.8333$ and $\mathcal{V}(v_{\tilde{a}}) = 3.8333$, and $\mathcal{V}(\mu_{\tilde{b}}) = 3.1667$, $\mathcal{V}(\rho_{\tilde{b}}) = 2.8333$ and $\mathcal{V}(v_{\tilde{b}}) = 3.1667$ respectively. Further, the ambiguities of truth-membership, indeterminacy-membership and falsity-membership of \tilde{a} and \tilde{b} are obtained as $\mathcal{A}(\mu_{\tilde{a}}) = 0.5000 = \mathcal{A}(\mu_{\tilde{b}})$, $\mathcal{A}(\rho_{\tilde{a}}) = 2.1667 = \mathcal{A}(\rho_{\tilde{b}})$ and $\mathcal{A}(v_{\tilde{a}}) = 0.8333 = \mathcal{A}(v_{\tilde{b}})$, respectively. Now, it is seen that $\mathcal{V}(\mu_{\tilde{a}}) \neq \mathcal{V}(\mu_{\tilde{b}})$, $\mathcal{V}(\rho_{\tilde{a}}) = \mathcal{V}(\rho_{\tilde{b}})$ and $\mathcal{V}(v_{\tilde{a}}) \neq \mathcal{V}(v_{\tilde{b}})$. Then, $\theta_1 = 0$ and $\theta_3 = 0$, however $\theta_2 = -1$. Thus,

$$\begin{aligned} \mathcal{R}_\lambda(\tilde{a}, 0, -1, 0) &= \lambda\{\mathcal{V}(\mu_{\tilde{a}}) + 0 \cdot \mathcal{A}(\mu_{\tilde{a}})\} + (1 - \lambda)\{\mathcal{V}(\rho_{\tilde{a}}) - \mathcal{A}(\rho_{\tilde{a}}) + \mathcal{V}(v_{\tilde{a}}) + 0 \cdot \mathcal{A}(v_{\tilde{a}})\} \\ &= \lambda\{3.8333\} + (1 - \lambda)\{2.8333 - 2.1666 + 3.8333\} \\ &= 4.5000 - 0.6667\lambda, \end{aligned}$$

and

$$\begin{aligned} \mathcal{R}_\lambda(\tilde{b}, 0, -1, 0) &= \lambda\{\mathcal{V}(\mu_{\tilde{b}}) + 0 \cdot \mathcal{A}(\mu_{\tilde{b}})\} + (1 - \lambda)\{\mathcal{V}(\rho_{\tilde{b}}) - \mathcal{A}(\rho_{\tilde{b}}) + \mathcal{V}(v_{\tilde{b}}) + 0 \cdot \mathcal{A}(v_{\tilde{b}})\} \\ &= \lambda\{3.1667\} + (1 - \lambda)\{2.8333 - 2.1666 + 3.1667\} \\ &= 3.8000 - 0.6667\lambda. \end{aligned}$$

So, for all decision-makers $\tilde{a} > \tilde{b}$. Consider the images of \tilde{a} and \tilde{b} . Now, the values of truth-membership, indeterminacy-membership and falsity-membership of $-\tilde{a}$ and $-\tilde{b}$ are obtained as $\mathcal{V}(\mu_{-\tilde{a}}) = -3.8333$, $\mathcal{V}(\rho_{-\tilde{a}}) = -2.8333$ and $\mathcal{V}(v_{-\tilde{a}}) = -3.8333$, and $\mathcal{V}(\mu_{-\tilde{b}}) = -3.1667$, $\mathcal{V}(\rho_{-\tilde{b}}) = -2.8333$ and $\mathcal{V}(v_{-\tilde{b}}) = -3.1667$, respectively by

Proposition 3.5. Further, the ambiguities of truth-membership, indeterminacy-membership and falsity-membership of $-\tilde{a}$ and $-\tilde{b}$ are obtained as $\mathcal{A}(\mu_{-\tilde{a}}) = 0.5000 = \mathcal{A}(\mu_{-\tilde{b}})$, $\mathcal{A}(\rho_{-\tilde{a}}) = 2.1667 = \mathcal{A}(\rho_{-\tilde{b}})$ and $\mathcal{A}(\nu_{-\tilde{a}}) = 0.8333 = \mathcal{A}(\nu_{-\tilde{b}})$ respectively by Proposition 3.5. Now, it is seen that $\mathcal{V}(\mu_{-\tilde{a}}) \neq \mathcal{V}(\mu_{-\tilde{b}})$, $\mathcal{V}(\rho_{-\tilde{a}}) = \mathcal{V}(\rho_{-\tilde{b}})$ and $\mathcal{V}(\nu_{-\tilde{a}}) \neq \mathcal{V}(\nu_{-\tilde{b}})$. Then, $\theta_1 = 0$ and $\theta_3 = 0$, however $\theta_2 = 1$. Thus,

$$\begin{aligned} \mathcal{R}_\lambda(-\tilde{a}, 0, 1, 0) &= \lambda\{\mathcal{V}(\mu_{-\tilde{a}}) + 0 \cdot \mathcal{A}(\mu_{-\tilde{a}})\} + (1 - \lambda)\{\mathcal{V}(\rho_{-\tilde{a}}) + \mathcal{A}(\rho_{-\tilde{a}}) + \mathcal{V}(\nu_{-\tilde{a}}) + 0 \cdot \mathcal{A}(\nu_{-\tilde{a}})\} \\ &= \lambda\{-3.8333\} + (1 - \lambda)\{-2.8333 + 2.1666 - 3.8333\} \\ &= -4.5000 + 0.6667\lambda, \end{aligned}$$

and

$$\begin{aligned} \mathcal{R}_\lambda(-\tilde{b}, 0, 1, 0) &= \lambda\{\mathcal{V}(\mu_{-\tilde{b}}) + 0 \cdot \mathcal{A}(\mu_{-\tilde{b}})\} + (1 - \lambda)\{\mathcal{V}(\rho_{-\tilde{b}}) + \mathcal{A}(\rho_{-\tilde{b}}) + \mathcal{V}(\nu_{-\tilde{b}}) + 0 \cdot \mathcal{A}(\nu_{-\tilde{b}})\} \\ &= \lambda\{-3.1667\} + (1 - \lambda)\{-2.8333 + 2.1666 - 3.1667\} \\ &= -3.8000 + 0.6667\lambda. \end{aligned}$$

So, for all decision-makers $-\tilde{a} < -\tilde{b}$. This numerical example depicts that the current method consistently and logically ranks the SVNNs as well as their corresponding images.

For a comparative study, the current method is compared with the methods of Deli and Subas (2017) and Biswas et al. (2016). The results depicted in Table 1 of the methods by Deli and Subas (2017) and Biswas et al. (2016) are the value index. The current method tallies with the methods by Deli and Subas (2017) and Biswas et al. (2016).

Example 4.2 Consider the SVNNs $\tilde{a} = \langle(-1, 0, 0, 1), (-1, 0, 0, 1), (-2, 0, 0, 2)\rangle$ and $\tilde{b} = \langle(-2, 0, 0, 2), (-2, 0, 0, 2), (-3, 0, 0, 3)\rangle$ such that they are symmetric about the y-axis.

Table 1 Ranking of SVNNs in Examples 4.1

Methods	\tilde{a}	\tilde{b}	$-\tilde{a}$	$-\tilde{b}$	Decision result
Deli and Subas (2017)'s value					
Optimistic $\alpha = 1.0$	3.8333	3.1667	-3.8333	-3.1667	$\tilde{a} > \tilde{b}, -\tilde{a} < -\tilde{b}$
Moderate $\alpha = 0.5$	5.2500	4.5833	-5.2500	-4.5833	$\tilde{a} > \tilde{b}, -\tilde{a} < -\tilde{b}$
Pessimistic $\alpha = 0.0$	6.6667	6.0000	-6.6667	-6.0000	$\tilde{a} > \tilde{b}, -\tilde{a} < -\tilde{b}$
Biswas et al. (2016)'s value					
Optimistic $\alpha = 1.0$	3.8333	3.1667	-3.8333	-3.1667	$\tilde{a} > \tilde{b}, -\tilde{a} < -\tilde{b}$
Moderate $\alpha = 0.5$	5.2500	4.5833	-5.2500	-4.5833	$\tilde{a} > \tilde{b}, -\tilde{a} < -\tilde{b}$
Pessimistic $\alpha = 0.0$	6.6667	6.0000	-6.6667	-6.0000	$\tilde{a} > \tilde{b}, -\tilde{a} < -\tilde{b}$
Current method					
Optimistic $\alpha = 1.0$	3.8333	3.1667	-3.8333	-3.1667	$\tilde{a} > \tilde{b}, -\tilde{a} < -\tilde{b}$
Moderate $\alpha = 0.5$	4.1667	3.5000	-4.1667	-3.5000	$\tilde{a} > \tilde{b}, -\tilde{a} < -\tilde{b}$
Pessimistic $\alpha = 0.0$	4.5000	3.8333	-4.5000	-3.8333	$\tilde{a} > \tilde{b}, -\tilde{a} < -\tilde{b}$

Then, by the Proposition 3.7, $\mathcal{V}(\mu_{\tilde{a}}) = 0 = \mathcal{V}(\mu_{\tilde{b}})$, $\mathcal{V}(\rho_{\tilde{a}}) = 0 = \mathcal{V}(\rho_{\tilde{b}})$ and $\mathcal{V}(v_{\tilde{a}}) = 0 = \mathcal{V}(v_{\tilde{b}})$. Thus, $\theta_i = -1$. Further, the ambiguities of truth-membership, indeterminacy-membership and falsity-membership of \tilde{a} and \tilde{b} are obtained as $\mathcal{A}(\mu_{\tilde{a}}) = 0.3333$, $\mathcal{A}(\rho_{\tilde{a}}) = 0.3333$ and $\mathcal{A}(v_{\tilde{a}}) = 0.6667$, and $\mathcal{A}(\mu_{\tilde{a}}) = 0.6667$, $\mathcal{A}(\rho_{\tilde{a}}) = 0.6667$ and $\mathcal{A}(v_{\tilde{a}}) = 1.0000$, respectively. So,

$$\begin{aligned} \mathcal{R}_\lambda(\tilde{a}, -1, -1, -1) &= \lambda\{\mathcal{V}(\mu_{\tilde{a}}) - \mathcal{A}(\mu_{\tilde{a}})\} + (1 - \lambda)\{\mathcal{V}(\rho_{\tilde{a}}) - \mathcal{A}(\rho_{\tilde{a}}) + \mathcal{V}(v_{\tilde{a}}) - \mathcal{A}(v_{\tilde{a}})\} \\ &= \lambda\{-0.3333\} + (1 - \lambda)\{-0.3333 - 0.6667\} \\ &= 1.0000 - 1.3333\lambda \end{aligned}$$

and

$$\begin{aligned} \mathcal{R}_\lambda(\tilde{b}, -1, -1, -1) &= \lambda\{\mathcal{V}(\mu_{\tilde{b}}) - \mathcal{A}(\mu_{\tilde{b}})\} + (1 - \lambda)\{\mathcal{V}(\rho_{\tilde{b}}) - \mathcal{A}(\rho_{\tilde{b}}) + \mathcal{V}(v_{\tilde{b}}) - \mathcal{A}(v_{\tilde{b}})\} \\ &= \lambda\{-0.6667\} + (1 - \lambda)\{-0.6667 - 1.0000\} \\ &= -1.6667 + \lambda. \end{aligned}$$

Hence, it can be concluded that $\tilde{a} < \tilde{b}$ for all decision-makers. Consider the images of \tilde{a} and \tilde{b} , it can be seen that $-\tilde{a} = \tilde{a}$ and $-\tilde{b} = \tilde{b}$. Therefore, by Theorem 3.20, it can be concluded that $-\tilde{a} < -\tilde{b}$ for all decision-makers.

For a comparative study, the current method is compared with the methods of Deli and Subas (2017) and Biswas et al. (2016). The results depicted in Table 2 of the methods by Deli and Subas (2017) and Biswas et al. (2016) are the ambiguity index as the value index are equal. The current method tallies with the methods by Biswas et al. (2016). However, Deli and Subas (2017) depicts irrational results.

Table 2 Ranking of SVNNs in Examples 4.2

Methods	\tilde{a}	\tilde{b}	$-\tilde{a}$	$-\tilde{b}$	Decision result
Deli and Subas (2017)'s ambiguity					
Optimistic $\alpha = 1.0$	0.3333	0.6667	0.3333	0.6667	$\tilde{a} < \tilde{b}, -\tilde{a} < -\tilde{b}$
Moderate $\alpha = 0.5$	0.6667	1.0000	0.6667	1.6667	$\tilde{a} < \tilde{b}, -\tilde{a} < -\tilde{b}$
Pessimistic $\alpha = 0.0$	1.0000	1.3333	1.0000	1.3333	$\tilde{a} < \tilde{b}, -\tilde{a} < -\tilde{b}$
Biswas et al. (2016)'s ambiguity					
Optimistic $\alpha = 1.0$	0.3333	0.6667	0.3333	0.6667	$\tilde{a} > \tilde{b}, -\tilde{a} > -\tilde{b}$
Moderate $\alpha = 0.5$	0.6667	1.0000	0.6667	1.6667	$\tilde{a} > \tilde{b}, -\tilde{a} > -\tilde{b}$
Pessimistic $\alpha = 0.0$	1.0000	1.3333	1.0000	1.3333	$\tilde{a} > \tilde{b}, -\tilde{a} > -\tilde{b}$
Current method					
Optimistic $\alpha = 1.0$	-0.3333	-0.6667	-0.3333	-0.6667	$\tilde{a} > \tilde{b}, -\tilde{a} > -\tilde{b}$
Moderate $\alpha = 0.5$	-0.6667	-1.1667	-0.6667	-1.1667	$\tilde{a} > \tilde{b}, -\tilde{a} > -\tilde{b}$
Pessimistic $\alpha = 0.0$	-1.0000	-1.6667	-1.0000	-1.6667	$\tilde{a} > \tilde{b}, -\tilde{a} > -\tilde{b}$

Example 4.3 Consider the SVNNS $\tilde{a} = \langle (1, 4, 4, 7), (0, 4, 4, 8), (1, 4, 4, 7) \rangle$ and $\tilde{b} = \langle (2, 4, 4, 6), (1, 4, 4, 7), (2, 4, 4, 6) \rangle$. For comparison the results of ranking index of the methods by Deli and Subas (2017), Biswas et al. (2016) and the current method are depicted in Table 3. Biswas et al. (2016) ordering of the SVNNS are logical as the ranking are based on the ambiguity index. The SVNNS with low ambiguity is chosen to be greater in their approach. However, the ordering of the images of SVNNS in their approach is illogical. That is, their method depicts inconsistency in ordering the images of SVNNS in some situations. Deli and Subas (2017) method is illogical as the SVNNS with low ambiguity is smaller. Further, it is to be mentioned and also evident from the Table 3 that the existing methods could not rank the corresponding images of the SVNNS consistently. The current approach is logical; further its rank consistently the corresponding images of the SVNNS.

The above numerical examples highlight the fact that the current method is more robust and reasonable. Thus, this methodology of ranking SVNNS will be reasonable to apply in various decision-making problems.

5 Discussions and conclusions

In this paper, an innovative method of ranking SVNNS has been developed based on the concept of values and ambiguities of truth-membership, indeterminacy-membership and falsity-membership functions. The index of optimism is also utilized which reflects the decision-makers attitude towards the uncertainty. That is, the convex combination of value and ambiguity of truth-membership function with the sum of values and ambiguities of indeterminacy-membership and falsity-membership functions. The parameters θ_i 's decides inclusion or exclusion of ambiguities in the decision-making process. An optimistic decision-maker ($\lambda = 1$) considers the value and θ_1 multiple of the ambiguity of truth-membership function. A pessimistic decision-maker ($\lambda = 0$) considers the values and θ_2, θ_3

Table 3 Ranking of SVNNS in Examples 4.3

Methods	\tilde{a}	\tilde{b}	$-\tilde{a}$	$-\tilde{b}$	Decision result
Deli and Subas (2017)'s ambiguity					
Optimistic $\alpha = 1.0$	1.0000	0.6667	1.0000	0.6667	$\tilde{a} > \tilde{b}, -\tilde{a} > -\tilde{b}$
Moderate $\alpha = 0.5$	1.6667	1.3333	1.6667	1.3333	$\tilde{a} > \tilde{b}, -\tilde{a} > -\tilde{b}$
Pessimistic $\alpha = 0.0$	2.3333	2.0000	2.3333	2.0000	$\tilde{a} > \tilde{b}, -\tilde{a} > -\tilde{b}$
Biswas et al. (2016)'s ambiguity					
Optimistic $\alpha = 1.0$	1.0000	0.6667	1.0000	0.6667	$\tilde{a} < \tilde{b}, -\tilde{a} < -\tilde{b}$
Moderate $\alpha = 0.5$	1.6667	1.3333	1.6667	1.3333	$\tilde{a} < \tilde{b}, -\tilde{a} < -\tilde{b}$
Pessimistic $\alpha = 0.0$	2.3333	2.0000	2.3333	2.0000	$\tilde{a} < \tilde{b}, -\tilde{a} < -\tilde{b}$
Current method					
Optimistic $\alpha = 1.0$	3.0000	3.3333	-3.0000	-3.3333	$\tilde{a} < \tilde{b}, -\tilde{a} > -\tilde{b}$
Moderate $\alpha = 0.5$	4.3333	4.8333	-4.3333	-4.8333	$\tilde{a} < \tilde{b}, -\tilde{a} > -\tilde{b}$
Pessimistic $\alpha = 0.0$	5.6667	6.3333	-5.6667	-6.3333	$\tilde{a} < \tilde{b}, -\tilde{a} > -\tilde{b}$

multiples of the ambiguities of indeterminacy-membership and falsity-membership functions respectively. Further, the moderate decision-maker considers the contributions from all the membership functions. It should be mentioned that the proofs of the Theorems 3.2 and 3.15 are cut short. The proofs are very simple but very lengthy as it involves a discussion of 8×8 cases, which will make this work lengthy. A shorter and logical proof can be a future study.

An attractive feature of the current method is that it completely comply with the reasonable properties of Wang and Kerre (2001a) which were never investigated in the existing methods. This establishes the rationality validity of the current approach. Apart from it, newer properties are also be investigated in this study. Another way to establish the rationality validity of a ranking method is to investigate the consistency in ordering the corresponding images of the SVNNS. Apparently, the properties $\mathbb{B}_{10} - \mathbb{B}'_{10}$ establish this fact. It is to mentioned that the property \mathbb{A}_7 is a particular case of the property \mathbb{A}_7 of Wang and Kerre (2001a). This property \mathbb{A}_7 of Wang and Kerre (2001a) is not obeyed by the proposed method as $\mathcal{V}(\mu_{\tilde{a}}\mu_{\tilde{b}}) \neq \mathcal{V}(\mu_{\tilde{a}})\mathcal{V}(\mu_{\tilde{b}})$, $\mathcal{V}(\rho_{\tilde{a}}\rho_{\tilde{b}}) \neq \mathcal{V}(\rho_{\tilde{a}})\mathcal{V}(\rho_{\tilde{b}})$ and $\mathcal{V}(v_{\tilde{a}}v_{\tilde{b}}) \neq \mathcal{V}(v_{\tilde{a}})\mathcal{V}(v_{\tilde{b}})$, and $\mathcal{A}(\mu_{\tilde{a}}\mu_{\tilde{b}}) \neq \mathcal{A}(\mu_{\tilde{a}})\mathcal{A}(\mu_{\tilde{b}})$, $\mathcal{A}(\rho_{\tilde{a}}\rho_{\tilde{b}}) \neq \mathcal{A}(\rho_{\tilde{a}})\mathcal{A}(\rho_{\tilde{b}})$ and $\mathcal{A}(v_{\tilde{a}}v_{\tilde{b}}) \neq \mathcal{A}(v_{\tilde{a}})\mathcal{A}(v_{\tilde{b}})$.

Proofs of the theorems

Proof of the Theorem 3.2

The proof of the above statements are as follows.

1. The proof of this statement is followed immediately.
2. Consider the cases when $\tilde{a} > \tilde{b}$ happens, that is,

$$\tilde{a} > \tilde{b} \text{ happens for } \left\{ \begin{array}{l} \mathcal{R}_\lambda(\tilde{a}, 0, 0, 0) > \mathcal{R}_\lambda(\tilde{b}, 0, 0, 0) \\ \mathcal{R}_\lambda(\tilde{a}, 0, 0, \pm 1) > \mathcal{R}_\lambda(\tilde{b}, 0, 0, \pm 1) \\ \mathcal{R}_\lambda(\tilde{a}, 0, \pm 1, 0) > \mathcal{R}_\lambda(\tilde{b}, 0, \pm 1, 0) \\ \mathcal{R}_\lambda(\tilde{a}, 0, \pm 1, \pm 1) > \mathcal{R}_\lambda(\tilde{b}, 0, \pm 1, \pm 1) \\ \mathcal{R}_\lambda(\tilde{a}, \pm 1, 0, 0) > \mathcal{R}_\lambda(\tilde{b}, \pm 1, 0, 0) \\ \mathcal{R}_\lambda(\tilde{a}, \pm 1, 0, \pm 1) > \mathcal{R}_\lambda(\tilde{b}, \pm 1, 0, \pm 1) \\ \mathcal{R}_\lambda(\tilde{a}, \pm 1, \pm 1, 0) > \mathcal{R}_\lambda(\tilde{b}, \pm 1, \pm 1, 0) \\ \mathcal{R}_\lambda(\tilde{a}, \pm 1, \pm 1, \pm 1) > \mathcal{R}_\lambda(\tilde{b}, \pm 1, \pm 1, \pm 1) \end{array} \right.$$

Consider the cases when $\tilde{b} > \tilde{c}$ happens, that is,

$$\tilde{b} > \tilde{c} \text{ happens for } \left\{ \begin{array}{l} \mathcal{R}_\lambda(\tilde{b}, 0, 0, 0) > \mathcal{R}_\lambda(\tilde{c}, 0, 0, 0) \\ \mathcal{R}_\lambda(\tilde{b}, 0, 0, \pm 1) > \mathcal{R}_\lambda(\tilde{c}, 0, 0, \pm 1) \\ \mathcal{R}_\lambda(\tilde{b}, 0, \pm 1, 0) > \mathcal{R}_\lambda(\tilde{c}, 0, \pm 1, 0) \\ \mathcal{R}_\lambda(\tilde{b}, 0, \pm 1, \pm 1) > \mathcal{R}_\lambda(\tilde{c}, 0, \pm 1, \pm 1) \\ \mathcal{R}_\lambda(\tilde{b}, \pm 1, 0, 0) > \mathcal{R}_\lambda(\tilde{c}, \pm 1, 0, 0) \\ \mathcal{R}_\lambda(\tilde{b}, \pm 1, 0, \pm 1) > \mathcal{R}_\lambda(\tilde{c}, \pm 1, 0, \pm 1) \\ \mathcal{R}_\lambda(\tilde{b}, \pm 1, \pm 1, 0) > \mathcal{R}_\lambda(\tilde{c}, \pm 1, \pm 1, 0) \\ \mathcal{R}_\lambda(\tilde{b}, \pm 1, \pm 1, \pm 1) > \mathcal{R}_\lambda(\tilde{c}, \pm 1, \pm 1, \pm 1) \end{array} \right.$$

Now, to proof this property, it need to discuss these 8×8 cases, which will make the proof tedious. However, one can see the proof trivially, if following claims can be established. **Claim 1:** Let $\theta_i = 0$ in ordering \tilde{a} and \tilde{b} , and $\theta_i = 0$ in ordering \tilde{b} and \tilde{c} . Then $\theta_i = 0$ in ordering \tilde{a} and \tilde{c} . The proof of this claim is as follows. Let $\theta_i = 0$ in ordering \tilde{a} and \tilde{b} . Then $\mathcal{V}(\mu_{\tilde{a}}) \neq \mathcal{V}(\mu_{\tilde{b}})$, $\mathcal{V}(\rho_{\tilde{a}}) \neq \mathcal{V}(\rho_{\tilde{b}})$ and $\mathcal{V}(v_{\tilde{a}}) \neq \mathcal{V}(v_{\tilde{b}})$. Similarly, if $\theta_i = 0$ in ordering \tilde{b} and \tilde{c} , then $\mathcal{V}(\mu_{\tilde{b}}) \neq \mathcal{V}(\mu_{\tilde{c}})$, $\mathcal{V}(\rho_{\tilde{b}}) \neq \mathcal{V}(\rho_{\tilde{c}})$ and $\mathcal{V}(v_{\tilde{b}}) \neq \mathcal{V}(v_{\tilde{c}})$. Thus, it follows that $\mathcal{V}(\mu_{\tilde{a}}) \neq \mathcal{V}(\mu_{\tilde{c}})$, $\mathcal{V}(\rho_{\tilde{a}}) \neq \mathcal{V}(\rho_{\tilde{c}})$ and $\mathcal{V}(v_{\tilde{a}}) \neq \mathcal{V}(v_{\tilde{c}})$. So, $\theta_i = 0$ in ordering \tilde{a} and \tilde{c} . **Claim 2:** Let $\theta_i = \pm 1$ in ordering \tilde{a} and \tilde{b} , and $\theta_i = \pm 1$ in ordering \tilde{b} and \tilde{c} . Then $\theta_i = \pm 1$ in ordering \tilde{a} and \tilde{c} . The proof of this claim is as follows. Let $\theta_i = \pm 1$ in ordering \tilde{a} and \tilde{b} . Then $\mathcal{V}(\mu_{\tilde{a}}) = \mathcal{V}(\mu_{\tilde{b}})$, $\mathcal{V}(\rho_{\tilde{a}}) = \mathcal{V}(\rho_{\tilde{b}})$ and $\mathcal{V}(v_{\tilde{a}}) = \mathcal{V}(v_{\tilde{b}})$. Similarly, if $\theta_i = \pm 1$ in ordering \tilde{b} and \tilde{c} , then $\mathcal{V}(\mu_{\tilde{b}}) = \mathcal{V}(\mu_{\tilde{c}})$, $\mathcal{V}(\rho_{\tilde{b}}) = \mathcal{V}(\rho_{\tilde{c}})$ and $\mathcal{V}(v_{\tilde{b}}) = \mathcal{V}(v_{\tilde{c}})$. Thus, it follows that $\mathcal{V}(\mu_{\tilde{a}}) = \mathcal{V}(\mu_{\tilde{c}})$, $\mathcal{V}(\rho_{\tilde{a}}) = \mathcal{V}(\rho_{\tilde{c}})$ and $\mathcal{V}(v_{\tilde{a}}) = \mathcal{V}(v_{\tilde{c}})$. So, $\theta_i = \pm 1$ in ordering \tilde{a} and \tilde{c} . **Claim 3:** Let $\theta_i = 0$ in ordering \tilde{a} and \tilde{b} , and $\theta_i = \pm 1$ in ordering \tilde{b} and \tilde{c} . then $\theta_i = 0$ in ordering \tilde{a} and \tilde{c} . The proof of this claim is as follows. Let $\theta_i = 0$ in ordering \tilde{a} and \tilde{b} . Then $\mathcal{V}(\mu_{\tilde{a}}) \neq \mathcal{V}(\mu_{\tilde{b}})$, $\mathcal{V}(\rho_{\tilde{a}}) \neq \mathcal{V}(\rho_{\tilde{b}})$ and $\mathcal{V}(v_{\tilde{a}}) \neq \mathcal{V}(v_{\tilde{b}})$. Similarly, if $\theta_i = \pm 1$ in ordering \tilde{b} and \tilde{c} , then $\mathcal{V}(\mu_{\tilde{b}}) = \mathcal{V}(\mu_{\tilde{c}})$, $\mathcal{V}(\rho_{\tilde{b}}) = \mathcal{V}(\rho_{\tilde{c}})$ and $\mathcal{V}(v_{\tilde{b}}) = \mathcal{V}(v_{\tilde{c}})$. Thus, it follows that $\mathcal{V}(\mu_{\tilde{a}}) \neq \mathcal{V}(\mu_{\tilde{c}})$, $\mathcal{V}(\rho_{\tilde{a}}) \neq \mathcal{V}(\rho_{\tilde{c}})$ and $\mathcal{V}(v_{\tilde{a}}) \neq \mathcal{V}(v_{\tilde{c}})$. So, $\theta_i = 0$ in ordering \tilde{a} and \tilde{c} . **Claim 4:** Let $\theta_i = \pm 1$ in ordering \tilde{a} and \tilde{b} , and $\theta_i = 0$ in ordering \tilde{b} and \tilde{c} . Then $\theta_i = 0$ in ordering \tilde{a} and \tilde{c} . The proof of this claim is as follows. Let $\theta_i = \pm 1$ in ordering \tilde{a} and \tilde{b} . Then $\mathcal{V}(\mu_{\tilde{a}}) = \mathcal{V}(\mu_{\tilde{b}})$, $\mathcal{V}(\rho_{\tilde{a}}) = \mathcal{V}(\rho_{\tilde{b}})$ and $\mathcal{V}(v_{\tilde{a}}) = \mathcal{V}(v_{\tilde{b}})$. Similarly, if $\theta_i = 0$ in ordering \tilde{b} and \tilde{c} , then $\mathcal{V}(\mu_{\tilde{b}}) \neq \mathcal{V}(\mu_{\tilde{c}})$, $\mathcal{V}(\rho_{\tilde{b}}) \neq \mathcal{V}(\rho_{\tilde{c}})$ and $\mathcal{V}(v_{\tilde{b}}) \neq \mathcal{V}(v_{\tilde{c}})$. Thus, it follows that $\mathcal{V}(\mu_{\tilde{a}}) \neq \mathcal{V}(\mu_{\tilde{c}})$, $\mathcal{V}(\rho_{\tilde{a}}) \neq \mathcal{V}(\rho_{\tilde{c}})$ and $\mathcal{V}(v_{\tilde{a}}) \neq \mathcal{V}(v_{\tilde{c}})$. So, $\theta_i = 0$ in ordering \tilde{a} and \tilde{c} . From these four claims, it is trivial enough to show that if $\tilde{a} > \tilde{b}$ and $\tilde{b} > \tilde{c}$, then $\tilde{a} > \tilde{c}$. Further, from the definition of \succeq , it follows that transitivity also holds for the order relation \succeq .

3. This statement is followed immediately, as the order relations \succ and \sim particularly based on order relation $>$ and $=$ of real numbers.
4. If $\tilde{a} = \tilde{b}$, then $\mathcal{R}_\lambda(\tilde{a}, \theta_1, \theta_2, \theta_3) = \mathcal{R}_\lambda(\tilde{b}, \theta_1, \theta_2, \theta_3)$. Thus, the statement is followed.

Proof of the Theorem 3.5

The proof of this theorem, follows immediately if the invariance of θ_i in ordering \tilde{a} , \tilde{b} and $\tilde{a} + \tilde{c}$, $\tilde{b} + \tilde{c}$ can be established. Hence, a claim has to be made. The claim is as follows.

Claim : The value of θ_i in ordering \tilde{a} and \tilde{b} are invariant in ordering $\tilde{a} + \tilde{c}$ and $\tilde{b} + \tilde{c}$. The proof of the claim follows from the following eight cases:

- Case 1:** Let $\theta_i = 0$ in ordering \tilde{a} and \tilde{b} . Then, $\mathcal{V}(\mu_{\tilde{a}}) \neq \mathcal{V}(\mu_{\tilde{b}})$, $\mathcal{V}(\rho_{\tilde{a}}) \neq \mathcal{V}(\rho_{\tilde{b}})$ and $\mathcal{V}(v_{\tilde{a}}) \neq \mathcal{V}(v_{\tilde{b}})$. Thus, it follows that $\mathcal{V}(\mu_{\tilde{a}+\tilde{c}}) \neq \mathcal{V}(\mu_{\tilde{b}+\tilde{c}})$, $\mathcal{V}(\rho_{\tilde{a}+\tilde{c}}) \neq \mathcal{V}(\rho_{\tilde{b}+\tilde{c}})$ and $\mathcal{V}(v_{\tilde{a}+\tilde{c}}) \neq \mathcal{V}(v_{\tilde{b}+\tilde{c}})$. So, $\theta_i = 0$ in ordering $\tilde{a} + \tilde{c}$ and $\tilde{b} + \tilde{c}$.
- Case 2:** Let $\theta_1 = 0$, $\theta_2 = 0$ and $\theta_3 = \pm 1$ in ordering \tilde{a} and \tilde{b} . Then, $\mathcal{V}(\mu_{\tilde{a}}) \neq \mathcal{V}(\mu_{\tilde{b}})$, $\mathcal{V}(\rho_{\tilde{a}}) \neq \mathcal{V}(\rho_{\tilde{b}})$ and $\mathcal{V}(v_{\tilde{a}}) = \mathcal{V}(v_{\tilde{b}})$. Thus, it follows that $\mathcal{V}(\mu_{\tilde{a}+\tilde{c}}) \neq \mathcal{V}(\mu_{\tilde{b}+\tilde{c}})$, $\mathcal{V}(\rho_{\tilde{a}+\tilde{c}}) \neq \mathcal{V}(\rho_{\tilde{b}+\tilde{c}})$ and $\mathcal{V}(v_{\tilde{a}+\tilde{c}}) = \mathcal{V}(v_{\tilde{b}+\tilde{c}})$. So, $\theta_1 = 0$, $\theta_2 = 0$ and $\theta_3 = \pm 1$ in ordering $\tilde{a} + \tilde{c}$ and $\tilde{b} + \tilde{c}$.
- Case 3:** Let $\theta_1 = 0$, $\theta_2 = \pm 1$ and $\theta_3 = 0$ in ordering \tilde{a} and \tilde{b} . Then, $\mathcal{V}(\mu_{\tilde{a}}) \neq \mathcal{V}(\mu_{\tilde{b}})$, $\mathcal{V}(\rho_{\tilde{a}}) = \mathcal{V}(\rho_{\tilde{b}})$ and $\mathcal{V}(v_{\tilde{a}}) \neq \mathcal{V}(v_{\tilde{b}})$. Thus, it follows that $\mathcal{V}(\mu_{\tilde{a}+\tilde{c}}) \neq \mathcal{V}(\mu_{\tilde{b}+\tilde{c}})$, $\mathcal{V}(\rho_{\tilde{a}+\tilde{c}}) = \mathcal{V}(\rho_{\tilde{b}+\tilde{c}})$ and $\mathcal{V}(v_{\tilde{a}+\tilde{c}}) \neq \mathcal{V}(v_{\tilde{b}+\tilde{c}})$. So, $\theta_1 = 0$, $\theta_2 = \pm 1$ and $\theta_3 = 0$ in ordering $\tilde{a} + \tilde{c}$ and $\tilde{b} + \tilde{c}$.

- Case 4:** Let $\theta_1 = 0, \theta_2 = \pm 1$ and $\theta_3 = \pm 1$ in ordering \tilde{a} and \tilde{b} . Then, $\mathcal{V}(\mu_{\tilde{a}}) \neq \mathcal{V}(\mu_{\tilde{b}}), \mathcal{V}(\rho_{\tilde{a}}) = \mathcal{V}(\rho_{\tilde{b}})$ and $\mathcal{V}(v_{\tilde{a}}) = \mathcal{V}(v_{\tilde{b}})$. Thus, it follows that $\mathcal{V}(\mu_{\tilde{a}+\tilde{c}}) \neq \mathcal{V}(\mu_{\tilde{b}+\tilde{c}}), \mathcal{V}(\rho_{\tilde{a}+\tilde{c}}) = \mathcal{V}(\rho_{\tilde{b}+\tilde{c}})$ and $\mathcal{V}(v_{\tilde{a}+\tilde{c}}) = \mathcal{V}(v_{\tilde{b}+\tilde{c}})$. So, $\theta_1 = 0, \theta_2 = \pm 1$ and $\theta_3 = \pm 1$ in ordering $\tilde{a} + \tilde{c}$ and $\tilde{b} + \tilde{c}$.
- Case 5:** Let $\theta_1 = \pm 1, \theta_2 = 0$ and $\theta_3 = 0$ in ordering \tilde{a} and \tilde{b} . Then, $\mathcal{V}(\mu_{\tilde{a}}) = \mathcal{V}(\mu_{\tilde{b}}), \mathcal{V}(\rho_{\tilde{a}}) \neq \mathcal{V}(\rho_{\tilde{b}})$ and $\mathcal{V}(v_{\tilde{a}}) \neq \mathcal{V}(v_{\tilde{b}})$. Thus, it follows that $\mathcal{V}(\mu_{\tilde{a}+\tilde{c}}) = \mathcal{V}(\mu_{\tilde{b}+\tilde{c}}), \mathcal{V}(\rho_{\tilde{a}+\tilde{c}}) \neq \mathcal{V}(\rho_{\tilde{b}+\tilde{c}})$ and $\mathcal{V}(v_{\tilde{a}+\tilde{c}}) \neq \mathcal{V}(v_{\tilde{b}+\tilde{c}})$. So, $\theta_1 = \pm 1, \theta_2 = 0$ and $\theta_3 = 0$ in ordering $\tilde{a} + \tilde{c}$ and $\tilde{b} + \tilde{c}$.
- Case 6:** Let $\theta_1 = \pm 1, \theta_2 = 0$ and $\theta_3 = \pm 1$ in ordering \tilde{a} and \tilde{b} . Then, $\mathcal{V}(\mu_{\tilde{a}}) = \mathcal{V}(\mu_{\tilde{b}}), \mathcal{V}(\rho_{\tilde{a}}) \neq \mathcal{V}(\rho_{\tilde{b}})$ and $\mathcal{V}(v_{\tilde{a}}) = \mathcal{V}(v_{\tilde{b}})$. Thus, it follows that $\mathcal{V}(\mu_{\tilde{a}+\tilde{c}}) = \mathcal{V}(\mu_{\tilde{b}+\tilde{c}}), \mathcal{V}(\rho_{\tilde{a}+\tilde{c}}) \neq \mathcal{V}(\rho_{\tilde{b}+\tilde{c}})$ and $\mathcal{V}(v_{\tilde{a}+\tilde{c}}) = \mathcal{V}(v_{\tilde{b}+\tilde{c}})$. So, $\theta_1 = \pm 1, \theta_2 = 0$ and $\theta_3 = \pm 1$ in ordering $\tilde{a} + \tilde{c}$ and $\tilde{b} + \tilde{c}$.
- Case 7:** Let $\theta_1 = \pm 1, \theta_2 = \pm 1$ and $\theta_3 = 0$ in ordering \tilde{a} and \tilde{b} . Then, $\mathcal{V}(\mu_{\tilde{a}}) = \mathcal{V}(\mu_{\tilde{b}}), \mathcal{V}(\rho_{\tilde{a}}) = \mathcal{V}(\rho_{\tilde{b}})$ and $\mathcal{V}(v_{\tilde{a}}) \neq \mathcal{V}(v_{\tilde{b}})$. Thus, it follows that $\mathcal{V}(\mu_{\tilde{a}+\tilde{c}}) = \mathcal{V}(\mu_{\tilde{b}+\tilde{c}}), \mathcal{V}(\rho_{\tilde{a}+\tilde{c}}) = \mathcal{V}(\rho_{\tilde{b}+\tilde{c}})$ and $\mathcal{V}(v_{\tilde{a}+\tilde{c}}) \neq \mathcal{V}(v_{\tilde{b}+\tilde{c}})$. So, $\theta_1 = \pm 1, \theta_2 = \pm 1$ and $\theta_3 = 0$ in ordering $\tilde{a} + \tilde{c}$ and $\tilde{b} + \tilde{c}$.
- Case 8:** Let $\theta_i = \pm 1$ in ordering \tilde{a} and \tilde{b} . Then, $\mathcal{V}(\mu_{\tilde{a}}) = \mathcal{V}(\mu_{\tilde{b}}), \mathcal{V}(\rho_{\tilde{a}}) = \mathcal{V}(\rho_{\tilde{b}})$ and $\mathcal{V}(v_{\tilde{a}}) = \mathcal{V}(v_{\tilde{b}})$. Thus, it follows that $\mathcal{V}(\mu_{\tilde{a}+\tilde{c}}) = \mathcal{V}(\mu_{\tilde{b}+\tilde{c}}), \mathcal{V}(\rho_{\tilde{a}+\tilde{c}}) = \mathcal{V}(\rho_{\tilde{b}+\tilde{c}})$ and $\mathcal{V}(v_{\tilde{a}+\tilde{c}}) = \mathcal{V}(v_{\tilde{b}+\tilde{c}})$. So, $\theta_i = \pm 1$ in ordering $\tilde{a} + \tilde{c}$ and $\tilde{b} + \tilde{c}$.

The above eight cases suggest that θ_1 and θ_2 are invariant in ordering \tilde{a}, \tilde{b} and $\tilde{a} + \tilde{c}, \tilde{b} + \tilde{c}$. Hence, the claim.

Now, by the Theorem 3.1 it follows that

$$\mathcal{R}_\lambda(\tilde{a} + \tilde{c}, \theta_1, \theta_2, \theta_3) = \mathcal{R}_\lambda(\tilde{a}, \theta_1, \theta_2, \theta_3) + \mathcal{R}_\lambda(\tilde{c}, \theta_1, \theta_2, \theta_3),$$

and

$$\mathcal{R}_\lambda(\tilde{b} + \tilde{c}, \theta_1, \theta_2, \theta_3) = \mathcal{R}_\lambda(\tilde{b}, \theta_1, \theta_2, \theta_3) + \mathcal{R}_\lambda(\tilde{c}, \theta_1, \theta_2, \theta_3),$$

Hence, if $\tilde{a} \geq \tilde{b}$, then it is obvious that $\mathcal{R}_\lambda(\tilde{a}, \theta_1, \theta_2, \theta_3) \geq \mathcal{R}_\lambda(\tilde{b}, \theta_1, \theta_2, \theta_3)$. This leads to the inequality $\mathcal{R}_\lambda(\tilde{a}, \theta_1, \theta_2, \theta_3) + \mathcal{R}_\lambda(\tilde{c}, \theta_1, \theta_2, \theta_3) \geq \mathcal{R}_\lambda(\tilde{b}, \theta_1, \theta_2, \theta_3) + \mathcal{R}_\lambda(\tilde{c}, \theta_1, \theta_2, \theta_3)$, which evidently follows the inequality $\mathcal{R}_\lambda(\tilde{a} + \tilde{c}, \theta_1, \theta_2, \theta_3) \geq \mathcal{R}_\lambda(\tilde{b} + \tilde{c}, \theta_1, \theta_2, \theta_3)$. Thus, the result follows immediately.

Proof of the Theorem 3.9

Let $\tilde{a} \geq \tilde{b}$. Then $\mathcal{R}_\lambda(\tilde{a}, \theta_1, \theta_2, \theta_3) \geq \mathcal{R}_\lambda(\tilde{b}, \theta_1, \theta_2, \theta_3)$. Let $k > 0$. Then using the Proposition 3.4, it follows that

$$\begin{aligned} \mathcal{R}_\lambda(k\tilde{a}, \theta_1, \theta_2, \theta_3) &= \lambda\{\mathcal{V}(\mu_{k\tilde{a}}) + \theta_1\mathcal{A}(\mu_{k\tilde{a}})\} \\ &\quad + (1 - \lambda)\{\mathcal{V}(\rho_{k\tilde{a}}) + \theta_2\mathcal{A}(\rho_{k\tilde{a}}) + \mathcal{V}(v_{k\tilde{a}}) + \theta_3\mathcal{A}(v_{k\tilde{a}})\} \\ &= k\lambda\{\mathcal{V}(\mu_{\tilde{a}}) + \theta_1\mathcal{A}(\mu_{\tilde{a}})\} \\ &\quad + k(1 - \lambda)\{\mathcal{V}(\rho_{\tilde{a}}) + \theta_2\mathcal{A}(\rho_{\tilde{a}}) + \mathcal{V}(v_{\tilde{a}}) + \theta_3\mathcal{A}(v_{\tilde{a}})\} \\ &= k\mathcal{R}_\lambda(\tilde{a}, \theta_1, \theta_2, \theta_3). \end{aligned}$$

Thus, when $\tilde{a} \geq \tilde{b}$, it follows that $\mathcal{R}_\lambda(\tilde{a}, \theta_1, \theta_2, \theta_3) \geq \mathcal{R}_\lambda(\tilde{b}, \theta_1, \theta_2, \theta_3)$. Equivalently, it follows that $k\mathcal{R}_\lambda(\tilde{a}, \theta_1, \theta_2, \theta_3) \geq k\mathcal{R}_\lambda(\tilde{b}, \theta_1, \theta_2, \theta_3)$, which can be trivially expressed as $\mathcal{R}_\lambda(k\tilde{a}, \theta_1, \theta_2, \theta_3) \geq \mathcal{R}_\lambda(k\tilde{b}, \theta_1, \theta_2, \theta_3)$. So, the result, $k\tilde{a} \geq k\tilde{b}$, follows immediately.

Let $k < 0$, assume $k = -m < 0$, then the following cases arise.

Case 1: Let $\tilde{a} \geq \tilde{b}$ for $\theta_i = 0$. Then $\mathcal{V}(\mu_{\tilde{a}}) \neq \mathcal{V}(\mu_{\tilde{b}})$, $\mathcal{V}(\rho_{\tilde{a}}) \neq \mathcal{V}(\rho_{\tilde{b}})$ and $\mathcal{V}(v_{\tilde{a}}) \neq \mathcal{V}(v_{\tilde{b}})$ and $\mathcal{R}_\lambda(\tilde{a}, 0, 0) \geq \mathcal{R}_\lambda(\tilde{b}, 0, 0)$. Now, as $\tilde{a} \geq \tilde{b}$ it follows that $\mathcal{V}(\mu_{\tilde{a}}) \geq \mathcal{V}(\mu_{\tilde{b}})$, $\mathcal{V}(\rho_{\tilde{a}}) \geq \mathcal{V}(\rho_{\tilde{b}})$ and $\mathcal{V}(v_{\tilde{a}}) \geq \mathcal{V}(v_{\tilde{b}})$. Clearly, $\mathcal{V}(\mu_{-m\tilde{a}}) \neq \mathcal{V}(\mu_{-m\tilde{b}})$, $\mathcal{V}(\rho_{-m\tilde{a}}) \neq \mathcal{V}(\rho_{-m\tilde{b}})$ and $\mathcal{V}(v_{-m\tilde{a}}) \neq \mathcal{V}(v_{-m\tilde{b}})$. Thus, $\theta_i = 0$ in ordering $-m\tilde{a}$ and $-m\tilde{b}$. Further, it follows that $\mathcal{V}(\mu_{-m\tilde{a}}) \leq \mathcal{V}(\mu_{-m\tilde{b}})$, $\mathcal{V}(\rho_{-m\tilde{a}}) \leq \mathcal{V}(\rho_{-m\tilde{b}})$ and $\mathcal{V}(v_{-m\tilde{a}}) \leq \mathcal{V}(v_{-m\tilde{b}})$. So, $\mathcal{R}_\lambda(-m\tilde{a}, 0, 0, 0) \leq \mathcal{R}_\lambda(-m\tilde{b}, 0, 0, 0)$. Hence, the result $-m\tilde{a} \leq -m\tilde{b}$ follows immediately.

Case 2: Let $\tilde{a} \geq \tilde{b}$ for $\theta_1 = 0$, $\theta_2 = 0$ and $\theta_3 = \pm 1$. Then $\mathcal{V}(\mu_{\tilde{a}}) \neq \mathcal{V}(\mu_{\tilde{b}})$, $\mathcal{V}(\rho_{\tilde{a}}) \neq \mathcal{V}(\rho_{\tilde{b}})$ and $\mathcal{V}(v_{\tilde{a}}) = \mathcal{V}(v_{\tilde{b}})$ and $\mathcal{R}_\lambda(\tilde{a}, 0, 0, \pm 1) \geq \mathcal{R}_\lambda(\tilde{b}, 0, 0, \pm 1)$. Now, as $\tilde{a} \geq \tilde{b}$ it follows that $\mathcal{V}(\mu_{\tilde{a}}) \geq \mathcal{V}(\mu_{\tilde{b}})$, $\mathcal{V}(\rho_{\tilde{a}}) \geq \mathcal{V}(\rho_{\tilde{b}})$ and $\mathcal{V}(v_{\tilde{a}}) \pm \mathcal{A}(v_{\tilde{a}}) \geq \mathcal{V}(v_{\tilde{b}}) \pm \mathcal{A}(v_{\tilde{b}})$. Clearly, $\mathcal{V}(\mu_{-m\tilde{a}}) \neq \mathcal{V}(\mu_{-m\tilde{b}})$, $\mathcal{V}(\rho_{-m\tilde{a}}) \neq \mathcal{V}(\rho_{-m\tilde{b}})$ and $\mathcal{V}(v_{-m\tilde{a}}) = \mathcal{V}(v_{-m\tilde{b}})$. Thus, $\theta_1 = 0$, $\theta_2 = 0$ and $\theta_3 = \mp 1$ in ordering $-m\tilde{a}$ and $-m\tilde{b}$. Further, it follows that $\mathcal{V}(\mu_{-m\tilde{a}}) \leq \mathcal{V}(\mu_{-m\tilde{b}})$, $\mathcal{V}(\rho_{-m\tilde{a}}) \leq \mathcal{V}(\rho_{-m\tilde{b}})$ and $\mathcal{V}(v_{-m\tilde{a}}) \mp \mathcal{A}(v_{-m\tilde{a}}) \leq \mathcal{V}(v_{-m\tilde{b}}) \mp \mathcal{A}(v_{-m\tilde{b}})$. So, $\mathcal{R}_\lambda(-m\tilde{a}, 0, 0, \mp 1) \leq \mathcal{R}_\lambda(-m\tilde{b}, 0, 0, \mp 1)$. Hence, the result $-m\tilde{a} \leq -m\tilde{b}$ follows immediately.

Case 3: Let $\tilde{a} \geq \tilde{b}$ for $\theta_1 = 0$, $\theta_2 = \pm 1$ and $\theta_3 = 0$. Then $\mathcal{V}(\mu_{\tilde{a}}) \neq \mathcal{V}(\mu_{\tilde{b}})$, $\mathcal{V}(\rho_{\tilde{a}}) = \mathcal{V}(\rho_{\tilde{b}})$ and $\mathcal{V}(v_{\tilde{a}}) \neq \mathcal{V}(v_{\tilde{b}})$ and $\mathcal{R}_\lambda(\tilde{a}, 0, \pm 1, 0) \geq \mathcal{R}_\lambda(\tilde{b}, 0, \pm 1, 0)$. Now, as $\tilde{a} \geq \tilde{b}$ it follows that $\mathcal{V}(\mu_{\tilde{a}}) \geq \mathcal{V}(\mu_{\tilde{b}})$, $\mathcal{V}(\rho_{\tilde{a}}) \pm \mathcal{A}(\rho_{\tilde{a}}) \geq \mathcal{V}(\rho_{\tilde{b}}) \pm \mathcal{A}(\rho_{\tilde{b}})$ and $\mathcal{V}(v_{\tilde{a}}) \geq \mathcal{V}(v_{\tilde{b}})$. Clearly, $\mathcal{V}(\mu_{-m\tilde{a}}) \neq \mathcal{V}(\mu_{-m\tilde{b}})$, $\mathcal{V}(\rho_{-m\tilde{a}}) = \mathcal{V}(\rho_{-m\tilde{b}})$ and $\mathcal{V}(v_{-m\tilde{a}}) \neq \mathcal{V}(v_{-m\tilde{b}})$. Thus, $\theta_1 = 0$, $\theta_2 = \mp 1$ and $\theta_3 = 0$ in ordering $-m\tilde{a}$ and $-m\tilde{b}$. Further, it follows that $\mathcal{V}(\mu_{-m\tilde{a}}) \leq \mathcal{V}(\mu_{-m\tilde{b}})$, $\mathcal{V}(\rho_{-m\tilde{a}}) \mp \mathcal{A}(\rho_{-m\tilde{a}}) \leq \mathcal{V}(\rho_{-m\tilde{b}}) \mp \mathcal{A}(\rho_{-m\tilde{b}})$ and $\mathcal{V}(v_{-m\tilde{a}}) \leq \mathcal{V}(v_{-m\tilde{b}})$. So, $\mathcal{R}_\lambda(-m\tilde{a}, 0, \mp 1, 0) \leq \mathcal{R}_\lambda(-m\tilde{b}, 0, \mp 1, 0)$. Hence, the result $-m\tilde{a} \leq -m\tilde{b}$ follows immediately.

Case 4: Let $\tilde{a} \geq \tilde{b}$ for $\theta_1 = 0$, $\theta_2 = \pm 1$ and $\theta_3 = \pm 1$. Then $\mathcal{V}(\mu_{\tilde{a}}) \neq \mathcal{V}(\mu_{\tilde{b}})$, $\mathcal{V}(\rho_{\tilde{a}}) = \mathcal{V}(\rho_{\tilde{b}})$ and $\mathcal{V}(v_{\tilde{a}}) = \mathcal{V}(v_{\tilde{b}})$ and $\mathcal{R}_\lambda(\tilde{a}, 0, \pm 1, \pm 1) \geq \mathcal{R}_\lambda(\tilde{b}, 0, \pm 1, \pm 1)$. Now, as $\tilde{a} \geq \tilde{b}$ it follows that $\mathcal{V}(\mu_{\tilde{a}}) \geq \mathcal{V}(\mu_{\tilde{b}})$, $\mathcal{V}(\rho_{\tilde{a}}) \pm \mathcal{A}(\rho_{\tilde{a}}) \geq \mathcal{V}(\rho_{\tilde{b}}) \pm \mathcal{A}(\rho_{\tilde{b}})$ and $\mathcal{V}(v_{\tilde{a}}) \pm \mathcal{A}(v_{\tilde{a}}) \geq \mathcal{V}(v_{\tilde{b}}) \pm \mathcal{A}(v_{\tilde{b}})$. Clearly, $\mathcal{V}(\mu_{-m\tilde{a}}) \neq \mathcal{V}(\mu_{-m\tilde{b}})$, $\mathcal{V}(\rho_{-m\tilde{a}}) = \mathcal{V}(\rho_{-m\tilde{b}})$ and $\mathcal{V}(v_{-m\tilde{a}}) = \mathcal{V}(v_{-m\tilde{b}})$. Thus, $\theta_1 = 0$, $\theta_2 = \mp 1$ and $\theta_3 = \mp 1$ in ordering $-m\tilde{a}$ and $-m\tilde{b}$. Further, it follows that $\mathcal{V}(\mu_{-m\tilde{a}}) \leq \mathcal{V}(\mu_{-m\tilde{b}})$, $\mathcal{V}(\rho_{-m\tilde{a}}) \mp \mathcal{A}(\rho_{-m\tilde{a}}) \leq \mathcal{V}(\rho_{-m\tilde{b}}) \mp \mathcal{A}(\rho_{-m\tilde{b}})$ and $\mathcal{V}(v_{-m\tilde{a}}) \mp \mathcal{A}(v_{-m\tilde{a}}) \leq \mathcal{V}(v_{-m\tilde{b}}) \mp \mathcal{A}(v_{-m\tilde{b}})$. So, $\mathcal{R}_\lambda(-m\tilde{a}, 0, \mp 1, \mp 1) \leq \mathcal{R}_\lambda(-m\tilde{b}, 0, \mp 1, \mp 1)$. Hence, the result $-m\tilde{a} \leq -m\tilde{b}$ follows immediately.

Case 5: Let $\tilde{a} \geq \tilde{b}$ for $\theta_1 = \pm 1$, $\theta_2 = 0$ and $\theta_3 = 0$. Then $\mathcal{V}(\mu_{\tilde{a}}) = \mathcal{V}(\mu_{\tilde{b}})$, $\mathcal{V}(\rho_{\tilde{a}}) \neq \mathcal{V}(\rho_{\tilde{b}})$ and $\mathcal{V}(v_{\tilde{a}}) \neq \mathcal{V}(v_{\tilde{b}})$ and $\mathcal{R}_\lambda(\tilde{a}, \pm 1, 0, 0) \geq \mathcal{R}_\lambda(\tilde{b}, \pm 1, 0, 0)$. Now, as $\tilde{a} \geq \tilde{b}$ it follows that $\mathcal{V}(\mu_{\tilde{a}}) \pm \mathcal{A}(\mu_{\tilde{a}}) \geq \mathcal{V}(\mu_{\tilde{b}}) \pm \mathcal{A}(\mu_{\tilde{b}})$, $\mathcal{V}(\rho_{\tilde{a}}) \geq \mathcal{V}(\rho_{\tilde{b}})$ and $\mathcal{V}(v_{\tilde{a}}) \geq \mathcal{V}(v_{\tilde{b}})$. Clearly, $\mathcal{V}(\mu_{-m\tilde{a}}) = \mathcal{V}(\mu_{-m\tilde{b}})$, $\mathcal{V}(\rho_{-m\tilde{a}}) \neq \mathcal{V}(\rho_{-m\tilde{b}})$ and $\mathcal{V}(v_{-m\tilde{a}}) \neq \mathcal{V}(v_{-m\tilde{b}})$. Thus, $\theta_1 = \mp 1$, $\theta_2 = 0$ and $\theta_3 = 0$ in ordering $-m\tilde{a}$ and $-m\tilde{b}$. Further, it follows that $\mathcal{V}(\mu_{-m\tilde{a}}) \mp \mathcal{A}(\mu_{-m\tilde{a}}) \leq \mathcal{V}(\mu_{-m\tilde{b}}) \mp \mathcal{A}(\mu_{-m\tilde{b}})$, $\mathcal{V}(\rho_{-m\tilde{a}}) \leq \mathcal{V}(\rho_{-m\tilde{b}})$ and $\mathcal{V}(v_{-m\tilde{a}}) \leq \mathcal{V}(v_{-m\tilde{b}})$. So, $\mathcal{R}_\lambda(-m\tilde{a}, \mp 1, 0, 0) \leq \mathcal{R}_\lambda(-m\tilde{b}, \mp 1, 0, 0)$. Hence, the result $-m\tilde{a} \leq -m\tilde{b}$ follows immediately.

- Case 6:** Let $\tilde{a} \geq \tilde{b}$ for $\theta_1 = \pm 1, \theta_2 = 0$ and $\theta_3 = \pm 1$. Then $\mathcal{V}(\mu_{\tilde{a}}) = \mathcal{V}(\mu_{\tilde{b}}), \mathcal{V}(\rho_{\tilde{a}}) \neq \mathcal{V}(\rho_{\tilde{b}})$ and $\mathcal{V}(v_{\tilde{a}}) = \mathcal{V}(v_{\tilde{b}})$ and $\mathcal{R}_\lambda(\tilde{a}, \pm 1, 0, \pm 1) \geq \mathcal{R}_\lambda(\tilde{b}, \pm 1, 0, \pm 1)$. Now, as $\tilde{a} \geq \tilde{b}$ it follows that $\mathcal{V}(\mu_{\tilde{a}}) \pm \mathcal{A}(\mu_{\tilde{a}}) \geq \mathcal{V}(\mu_{\tilde{b}}) \pm \mathcal{A}(\mu_{\tilde{b}}), \mathcal{V}(\rho_{\tilde{a}}) \geq \mathcal{V}(\rho_{\tilde{b}})$ and $\mathcal{V}(v_{\tilde{a}}) \pm \mathcal{A}(v_{\tilde{a}}) \geq \mathcal{V}(v_{\tilde{b}}) \pm \mathcal{A}(v_{\tilde{b}})$. Clearly, $\mathcal{V}(\mu_{-\tilde{m}\tilde{a}}) = \mathcal{V}(\mu_{-\tilde{m}\tilde{b}}), \mathcal{V}(\rho_{-\tilde{m}\tilde{a}}) \neq \mathcal{V}(\rho_{-\tilde{m}\tilde{b}})$ and $\mathcal{V}(v_{-\tilde{m}\tilde{a}}) = \mathcal{V}(v_{-\tilde{m}\tilde{b}})$. Thus, $\theta_1 = \mp 1, \theta_2 = 0$ and $\theta_3 = \mp 1$ in ordering $-\tilde{m}\tilde{a}$ and $-\tilde{m}\tilde{b}$. Further, it follows that $\mathcal{V}(\mu_{-\tilde{m}\tilde{a}}) \mp \mathcal{A}(\mu_{-\tilde{m}\tilde{a}}) \leq \mathcal{V}(\mu_{-\tilde{m}\tilde{b}}) \mp \mathcal{A}(\mu_{-\tilde{m}\tilde{b}}), \mathcal{V}(\rho_{-\tilde{m}\tilde{a}}) \leq \mathcal{V}(\rho_{-\tilde{m}\tilde{b}})$ and $\mathcal{V}(v_{-\tilde{m}\tilde{a}}) \mp \mathcal{A}(v_{-\tilde{m}\tilde{a}}) \leq \mathcal{V}(v_{-\tilde{m}\tilde{b}}) \mp \mathcal{A}(v_{-\tilde{m}\tilde{b}})$. So, $\mathcal{R}_\lambda(-\tilde{m}\tilde{a}, \mp 1, 0, \mp 1) \leq \mathcal{R}_\lambda(-\tilde{m}\tilde{b}, \mp 1, 0, \mp 1)$. Hence, the result $-\tilde{m}\tilde{a} \leq -\tilde{m}\tilde{b}$ follows immediately.
- Case 7:** Let $\tilde{a} \geq \tilde{b}$ for $\theta_1 = \pm 1, \theta_2 = \pm 1$ and $\theta_3 = 0$. Then $\mathcal{V}(\mu_{\tilde{a}}) = \mathcal{V}(\mu_{\tilde{b}}), \mathcal{V}(\rho_{\tilde{a}}) = \mathcal{V}(\rho_{\tilde{b}})$ and $\mathcal{V}(v_{\tilde{a}}) \neq \mathcal{V}(v_{\tilde{b}})$ and $\mathcal{R}_\lambda(\tilde{a}, \pm 1, \pm 1, 0) \geq \mathcal{R}_\lambda(\tilde{b}, \pm 1, \pm 1, 0)$. Now, as $\tilde{a} \geq \tilde{b}$ it follows that $\mathcal{V}(\mu_{\tilde{a}}) \pm \mathcal{A}(\mu_{\tilde{a}}) \geq \mathcal{V}(\mu_{\tilde{b}}) \pm \mathcal{A}(\mu_{\tilde{b}}), \mathcal{V}(\rho_{\tilde{a}}) \pm \mathcal{A}(\rho_{\tilde{a}}) \geq \mathcal{V}(\rho_{\tilde{b}}) \pm \mathcal{A}(\rho_{\tilde{b}})$ and $\mathcal{V}(v_{\tilde{a}}) \geq \mathcal{V}(v_{\tilde{b}})$. Clearly, $\mathcal{V}(\mu_{-\tilde{m}\tilde{a}}) = \mathcal{V}(\mu_{-\tilde{m}\tilde{b}}), \mathcal{V}(\rho_{-\tilde{m}\tilde{a}}) = \mathcal{V}(\rho_{-\tilde{m}\tilde{b}})$ and $\mathcal{V}(v_{-\tilde{m}\tilde{a}}) \neq \mathcal{V}(v_{-\tilde{m}\tilde{b}})$. Thus, $\theta_1 = \mp 1, \theta_2 = \mp 1$ and $\theta_3 = 0$ in ordering $-\tilde{m}\tilde{a}$ and $-\tilde{m}\tilde{b}$. Further, it follows that $\mathcal{V}(\mu_{-\tilde{m}\tilde{a}}) \mp \mathcal{A}(\mu_{-\tilde{m}\tilde{a}}) \leq \mathcal{V}(\mu_{-\tilde{m}\tilde{b}}) \mp \mathcal{A}(\mu_{-\tilde{m}\tilde{b}}), \mathcal{V}(\rho_{-\tilde{m}\tilde{a}}) \mp \mathcal{A}(\rho_{-\tilde{m}\tilde{a}}) \leq \mathcal{V}(\rho_{-\tilde{m}\tilde{b}}) \mp \mathcal{A}(\rho_{-\tilde{m}\tilde{b}})$ and $\mathcal{V}(v_{-\tilde{m}\tilde{a}}) \leq \mathcal{V}(v_{-\tilde{m}\tilde{b}})$. So, $\mathcal{R}_\lambda(-\tilde{m}\tilde{a}, \mp 1, \mp 1, 0) \leq \mathcal{R}_\lambda(-\tilde{m}\tilde{b}, \mp 1, \mp 1, 0)$. Hence, the result $-\tilde{m}\tilde{a} \leq -\tilde{m}\tilde{b}$ follows immediately.
- Case 8:** Let $\tilde{a} \geq \tilde{b}$ for $\theta_i = \pm 1$. Then $\mathcal{V}(\mu_{\tilde{a}}) = \mathcal{V}(\mu_{\tilde{b}}), \mathcal{V}(\rho_{\tilde{a}}) = \mathcal{V}(\rho_{\tilde{b}})$ and $\mathcal{V}(v_{\tilde{a}}) = \mathcal{V}(v_{\tilde{b}})$ and $\mathcal{R}_\lambda(\tilde{a}, \pm 1, \pm 1, \pm 1) \geq \mathcal{R}_\lambda(\tilde{b}, \pm 1, \pm 1, \pm 1)$. Now, as $\tilde{a} \geq \tilde{b}$ it follows that $\mathcal{V}(\mu_{\tilde{a}}) \pm \mathcal{A}(\mu_{\tilde{a}}) \geq \mathcal{V}(\mu_{\tilde{b}}) \pm \mathcal{A}(\mu_{\tilde{b}}), \mathcal{V}(\rho_{\tilde{a}}) \pm \mathcal{A}(\rho_{\tilde{a}}) \geq \mathcal{V}(\rho_{\tilde{b}}) \pm \mathcal{A}(\rho_{\tilde{b}})$ and $\mathcal{V}(v_{\tilde{a}}) \pm \mathcal{A}(v_{\tilde{a}}) \geq \mathcal{V}(v_{\tilde{b}}) \pm \mathcal{A}(v_{\tilde{b}})$. Clearly, $\mathcal{V}(\mu_{-\tilde{m}\tilde{a}}) = \mathcal{V}(\mu_{-\tilde{m}\tilde{b}}), \mathcal{V}(\rho_{-\tilde{m}\tilde{a}}) = \mathcal{V}(\rho_{-\tilde{m}\tilde{b}})$ and $\mathcal{V}(v_{-\tilde{m}\tilde{a}}) = \mathcal{V}(v_{-\tilde{m}\tilde{b}})$. Thus, $\theta_i = \mp 1$ in ordering $-\tilde{m}\tilde{a}$ and $-\tilde{m}\tilde{b}$. Further, it follows that $\mathcal{V}(\mu_{-\tilde{m}\tilde{a}}) \mp \mathcal{A}(\mu_{-\tilde{m}\tilde{a}}) \leq \mathcal{V}(\mu_{-\tilde{m}\tilde{b}}) \mp \mathcal{A}(\mu_{-\tilde{m}\tilde{b}}), \mathcal{V}(\rho_{-\tilde{m}\tilde{a}}) \mp \mathcal{A}(\rho_{-\tilde{m}\tilde{a}}) \leq \mathcal{V}(\rho_{-\tilde{m}\tilde{b}}) \mp \mathcal{A}(\rho_{-\tilde{m}\tilde{b}})$ and $\mathcal{V}(v_{-\tilde{m}\tilde{a}}) \mp \mathcal{A}(v_{-\tilde{m}\tilde{a}}) \leq \mathcal{V}(v_{-\tilde{m}\tilde{b}}) \mp \mathcal{A}(v_{-\tilde{m}\tilde{b}})$. So, $\mathcal{R}_\lambda(-\tilde{m}\tilde{a}, \mp 1, \mp 1, \mp 1) \leq \mathcal{R}_\lambda(-\tilde{m}\tilde{b}, \mp 1, \mp 1, \mp 1)$. Hence, the result $-\tilde{m}\tilde{a} \leq -\tilde{m}\tilde{b}$ follows immediately.

Proof of the Theorem 3.10

Let $k > 0$ and $k\tilde{a} \geq k\tilde{b}$. Then $\mathcal{R}_\lambda(k\tilde{a}, \theta_1, \theta_2, \theta_3) \geq \mathcal{R}_\lambda(k\tilde{b}, \theta_1, \theta_2, \theta_3)$. However, by Proposition 3.4, it follows that $k\mathcal{R}_\lambda(\tilde{a}, \theta_1, \theta_2, \theta_3) \geq k\mathcal{R}_\lambda(\tilde{b}, \theta_1, \theta_2, \theta_3)$. Thus, the result follows immediately. If $k < 0$, let $k = -m < 0$, then $-\tilde{m}\tilde{a} \geq -\tilde{m}\tilde{b}$ implies that $\mathcal{R}_\lambda(-\tilde{m}\tilde{a}, \theta_1, \theta_2, \theta_3) \geq \mathcal{R}_\lambda(-\tilde{m}\tilde{b}, \theta_1, \theta_2, \theta_3)$. Now, eight cases arise.

- Case 1:** Let $-\tilde{m}\tilde{a} \geq -\tilde{m}\tilde{b}$ for $\theta_i = 0$. Then $\mathcal{V}(\mu_{-\tilde{m}\tilde{a}}) \neq \mathcal{V}(\mu_{-\tilde{m}\tilde{b}}), \mathcal{V}(\rho_{-\tilde{m}\tilde{a}}) \neq \mathcal{V}(\rho_{-\tilde{m}\tilde{b}})$ and $\mathcal{V}(v_{-\tilde{m}\tilde{a}}) \neq \mathcal{V}(v_{-\tilde{m}\tilde{b}})$ and $\mathcal{R}_\lambda(-\tilde{m}\tilde{a}, 0, 0, 0) \geq \mathcal{R}_\lambda(-\tilde{m}\tilde{b}, 0, 0, 0)$. Now, as $-\tilde{m}\tilde{a} \geq -\tilde{m}\tilde{b}$ it follows that $\mathcal{V}(\mu_{-\tilde{m}\tilde{a}}) \geq \mathcal{V}(\mu_{-\tilde{m}\tilde{b}}), \mathcal{V}(\rho_{-\tilde{m}\tilde{a}}) \geq \mathcal{V}(\rho_{-\tilde{m}\tilde{b}})$ and $\mathcal{V}(v_{-\tilde{m}\tilde{a}}) \geq \mathcal{V}(v_{-\tilde{m}\tilde{b}})$. Clearly, $\mathcal{V}(\mu_{\tilde{a}}) \neq \mathcal{V}(\mu_{\tilde{b}}), \mathcal{V}(\rho_{\tilde{a}}) \neq \mathcal{V}(\rho_{\tilde{b}})$ and $\mathcal{V}(v_{\tilde{a}}) \neq \mathcal{V}(v_{\tilde{b}})$. Thus, $\theta_i = 0$ in ordering \tilde{a} and \tilde{b} . Further, it follows that $\mathcal{V}(\mu_{\tilde{a}}) \leq \mathcal{V}(\mu_{\tilde{b}}), \mathcal{V}(\rho_{\tilde{a}}) \leq \mathcal{V}(\rho_{\tilde{b}})$ and $\mathcal{V}(v_{\tilde{a}}) \leq \mathcal{V}(v_{\tilde{b}})$. So, $\mathcal{R}_\lambda(\tilde{a}, 0, 0, 0) \leq \mathcal{R}_\lambda(\tilde{b}, 0, 0, 0)$. Hence, the result $\tilde{a} \leq \tilde{b}$ follows immediately.
- Case 2:** Let $-\tilde{m}\tilde{a} \geq -\tilde{m}\tilde{b}$ for $\theta_1 = 0, \theta_2 = 0$ and $\theta_3 = \pm 1$ then $\mathcal{V}(\mu_{-\tilde{m}\tilde{a}}) \neq \mathcal{V}(\mu_{-\tilde{m}\tilde{b}}), \mathcal{V}(\rho_{-\tilde{m}\tilde{a}}) \neq \mathcal{V}(\rho_{-\tilde{m}\tilde{b}})$ and $\mathcal{V}(v_{-\tilde{m}\tilde{a}}) = \mathcal{V}(v_{-\tilde{m}\tilde{b}})$ and $\mathcal{R}_\lambda(-\tilde{m}\tilde{a}, 0, 0, \pm 1) \geq \mathcal{R}_\lambda(-\tilde{m}\tilde{b}, 0, 0, \pm 1)$. Now, as $-\tilde{m}\tilde{a} \geq -\tilde{m}\tilde{b}$ it follows that $\mathcal{V}(\mu_{-\tilde{m}\tilde{a}}) \geq \mathcal{V}(\mu_{-\tilde{m}\tilde{b}}), \mathcal{V}(\rho_{-\tilde{m}\tilde{a}}) \geq \mathcal{V}(\rho_{-\tilde{m}\tilde{b}})$ and

Case 8: Let $-m\tilde{a} \geq -m\tilde{b}$ for $\theta_i = \pm 1$. Then $\mathcal{V}(\mu_{-m\tilde{a}}) = \mathcal{V}(\mu_{-m\tilde{b}})$, $\mathcal{V}(\rho_{-m\tilde{a}}) = \mathcal{V}(\rho_{-m\tilde{b}})$ and $\mathcal{V}(v_{-m\tilde{a}}) = \mathcal{V}(v_{-m\tilde{b}})$ and $\mathcal{R}_\lambda(-m\tilde{a}, \pm 1, \pm 1, \pm 1) \geq \mathcal{R}_\lambda(-m\tilde{b}, \pm 1, \pm 1, \pm 1)$. Now, as $-m\tilde{a} \geq -m\tilde{b}$ it follows that $\mathcal{V}(\mu_{-m\tilde{a}}) \pm \mathcal{A}(\mu_{-m\tilde{a}}) \geq \mathcal{V}(\mu_{-m\tilde{b}}) \pm \mathcal{A}(\mu_{-m\tilde{b}})$, $\mathcal{V}(\rho_{-m\tilde{a}}) \pm \mathcal{A}(\rho_{-m\tilde{a}}) \geq \mathcal{V}(\rho_{-m\tilde{b}}) \pm \mathcal{A}(\rho_{-m\tilde{b}})$ and $\mathcal{V}(v_{-m\tilde{a}}) \pm \mathcal{A}(v_{-m\tilde{a}}) \geq \mathcal{V}(v_{-m\tilde{b}}) \pm \mathcal{A}(v_{-m\tilde{b}})$. Clearly, $\mathcal{V}(\mu_{\tilde{a}}) = \mathcal{V}(\mu_{\tilde{b}})$, $\mathcal{V}(\rho_{\tilde{a}}) = \mathcal{V}(\rho_{\tilde{b}})$ and $\mathcal{V}(v_{\tilde{a}}) = \mathcal{V}(v_{\tilde{b}})$. Thus, $\theta_i = \mp 1$ in ordering \tilde{a} and \tilde{b} . Further, it follows that $\mathcal{V}(\mu_{\tilde{a}}) \mp \mathcal{A}(\mu_{\tilde{a}}) \leq \mathcal{V}(\mu_{\tilde{b}}) \mp \mathcal{A}(\mu_{\tilde{b}})$, $\mathcal{V}(\rho_{\tilde{a}}) \mp \mathcal{A}(\rho_{\tilde{a}}) \leq \mathcal{V}(\rho_{\tilde{b}}) \mp \mathcal{A}(\rho_{\tilde{b}})$ and $\mathcal{V}(v_{\tilde{a}}) \mp \mathcal{A}(v_{\tilde{a}}) \leq \mathcal{V}(v_{\tilde{b}}) \mp \mathcal{A}(v_{\tilde{b}})$. So, $\mathcal{R}_\lambda(\tilde{a}, \mp 1, \mp 1, \mp 1) \leq \mathcal{R}_\lambda(\tilde{b}, \mp 1, \mp 1, \mp 1)$. Hence, the result $\tilde{a} \leq \tilde{b}$ follows immediately.

Proof of the Theorem 3.13

The proof of this theorem, follows immediately if the invariance of θ_1 and θ_2 in ordering \tilde{a} , \tilde{b} and $\tilde{a} - \tilde{c}$, $\tilde{b} - \tilde{c}$ can be established. Hence, a claim has to be made. The claim is as follows.

Claim : The value of θ_1 and θ_2 in ordering \tilde{a} and \tilde{b} are invariant in ordering $\tilde{a} - \tilde{c}$ and $\tilde{b} - \tilde{c}$. The proof of the claim follows from the following eight cases:

- Case 1:** Let $\theta_i = 0$ in ordering \tilde{a} and \tilde{b} . Then, $\mathcal{V}(\mu_{\tilde{a}}) \neq \mathcal{V}(\mu_{\tilde{b}})$, $\mathcal{V}(\rho_{\tilde{a}}) \neq \mathcal{V}(\rho_{\tilde{b}})$ and $\mathcal{V}(v_{\tilde{a}}) \neq \mathcal{V}(v_{\tilde{b}})$. Thus, it follows that $\mathcal{V}(\mu_{\tilde{a}-\tilde{c}}) \neq \mathcal{V}(\mu_{\tilde{b}-\tilde{c}})$, $\mathcal{V}(\rho_{\tilde{a}-\tilde{c}}) \neq \mathcal{V}(\rho_{\tilde{b}-\tilde{c}})$ and $\mathcal{V}(v_{\tilde{a}-\tilde{c}}) \neq \mathcal{V}(v_{\tilde{b}-\tilde{c}})$. So, $\theta_i = 0$ in ordering $\tilde{a} - \tilde{c}$ and $\tilde{b} - \tilde{c}$.
- Case 2:** Let $\theta_1 = 0$, $\theta_2 = 0$ and $\theta_3 = \pm 1$ in ordering \tilde{a} and \tilde{b} . Then, $\mathcal{V}(\mu_{\tilde{a}}) \neq \mathcal{V}(\mu_{\tilde{b}})$, $\mathcal{V}(\rho_{\tilde{a}}) \neq \mathcal{V}(\rho_{\tilde{b}})$ and $\mathcal{V}(v_{\tilde{a}}) = \mathcal{V}(v_{\tilde{b}})$. Thus, it follows that $\mathcal{V}(\mu_{\tilde{a}-\tilde{c}}) \neq \mathcal{V}(\mu_{\tilde{b}-\tilde{c}})$, $\mathcal{V}(\rho_{\tilde{a}-\tilde{c}}) \neq \mathcal{V}(\rho_{\tilde{b}-\tilde{c}})$ and $\mathcal{V}(v_{\tilde{a}-\tilde{c}}) = \mathcal{V}(v_{\tilde{b}-\tilde{c}})$. So, $\theta_1 = 0$, $\theta_2 = 0$ and $\theta_3 = \pm 1$ in ordering $\tilde{a} - \tilde{c}$ and $\tilde{b} - \tilde{c}$.
- Case 3:** Let $\theta_1 = 0$, $\theta_2 = \pm 1$ and $\theta_3 = 0$ in ordering \tilde{a} and \tilde{b} . Then, $\mathcal{V}(\mu_{\tilde{a}}) \neq \mathcal{V}(\mu_{\tilde{b}})$, $\mathcal{V}(\rho_{\tilde{a}}) = \mathcal{V}(\rho_{\tilde{b}})$ and $\mathcal{V}(v_{\tilde{a}}) \neq \mathcal{V}(v_{\tilde{b}})$. Thus, it follows that $\mathcal{V}(\mu_{\tilde{a}-\tilde{c}}) \neq \mathcal{V}(\mu_{\tilde{b}-\tilde{c}})$, $\mathcal{V}(\rho_{\tilde{a}-\tilde{c}}) = \mathcal{V}(\rho_{\tilde{b}-\tilde{c}})$ and $\mathcal{V}(v_{\tilde{a}-\tilde{c}}) \neq \mathcal{V}(v_{\tilde{b}-\tilde{c}})$. So, $\theta_1 = 0$, $\theta_2 = \pm 1$ and $\theta_3 = 0$ in ordering $\tilde{a} - \tilde{c}$ and $\tilde{b} - \tilde{c}$.
- Case 4:** Let $\theta_1 = 0$, $\theta_2 = \pm 1$ and $\theta_3 = \pm 1$ in ordering \tilde{a} and \tilde{b} . Then, $\mathcal{V}(\mu_{\tilde{a}}) \neq \mathcal{V}(\mu_{\tilde{b}})$, $\mathcal{V}(\rho_{\tilde{a}}) = \mathcal{V}(\rho_{\tilde{b}})$ and $\mathcal{V}(v_{\tilde{a}}) = \mathcal{V}(v_{\tilde{b}})$. Thus, it follows that $\mathcal{V}(\mu_{\tilde{a}-\tilde{c}}) \neq \mathcal{V}(\mu_{\tilde{b}-\tilde{c}})$, $\mathcal{V}(\rho_{\tilde{a}-\tilde{c}}) = \mathcal{V}(\rho_{\tilde{b}-\tilde{c}})$ and $\mathcal{V}(v_{\tilde{a}-\tilde{c}}) = \mathcal{V}(v_{\tilde{b}-\tilde{c}})$. So, $\theta_1 = 0$, $\theta_2 = \pm 1$ and $\theta_3 = \pm 1$ in ordering $\tilde{a} - \tilde{c}$ and $\tilde{b} - \tilde{c}$.
- Case 5:** Let $\theta_1 = \pm 1$, $\theta_2 = 0$ and $\theta_3 = 0$ in ordering \tilde{a} and \tilde{b} . Then, $\mathcal{V}(\mu_{\tilde{a}}) = \mathcal{V}(\mu_{\tilde{b}})$, $\mathcal{V}(\rho_{\tilde{a}}) \neq \mathcal{V}(\rho_{\tilde{b}})$ and $\mathcal{V}(v_{\tilde{a}}) \neq \mathcal{V}(v_{\tilde{b}})$. Thus, it follows that $\mathcal{V}(\mu_{\tilde{a}-\tilde{c}}) = \mathcal{V}(\mu_{\tilde{b}-\tilde{c}})$, $\mathcal{V}(\rho_{\tilde{a}-\tilde{c}}) \neq \mathcal{V}(\rho_{\tilde{b}-\tilde{c}})$ and $\mathcal{V}(v_{\tilde{a}-\tilde{c}}) \neq \mathcal{V}(v_{\tilde{b}-\tilde{c}})$. So, $\theta_1 = \pm 1$, $\theta_2 = 0$ and $\theta_3 = 0$ in ordering $\tilde{a} - \tilde{c}$ and $\tilde{b} - \tilde{c}$.
- Case 6:** Let $\theta_1 = \pm 1$, $\theta_2 = 0$ and $\theta_3 = \pm 1$ in ordering \tilde{a} and \tilde{b} . Then, $\mathcal{V}(\mu_{\tilde{a}}) = \mathcal{V}(\mu_{\tilde{b}})$, $\mathcal{V}(\rho_{\tilde{a}}) \neq \mathcal{V}(\rho_{\tilde{b}})$ and $\mathcal{V}(v_{\tilde{a}}) = \mathcal{V}(v_{\tilde{b}})$. Thus, it follows that $\mathcal{V}(\mu_{\tilde{a}-\tilde{c}}) = \mathcal{V}(\mu_{\tilde{b}-\tilde{c}})$, $\mathcal{V}(\rho_{\tilde{a}-\tilde{c}}) \neq \mathcal{V}(\rho_{\tilde{b}-\tilde{c}})$ and $\mathcal{V}(v_{\tilde{a}-\tilde{c}}) = \mathcal{V}(v_{\tilde{b}-\tilde{c}})$. So, $\theta_1 = \pm 1$, $\theta_2 = 0$ and $\theta_3 = \pm 1$ in ordering $\tilde{a} - \tilde{c}$ and $\tilde{b} - \tilde{c}$.
- Case 7:** Let $\theta_1 = \pm 1$, $\theta_2 = \pm 1$ and $\theta_3 = 0$ in ordering \tilde{a} and \tilde{b} . Then, $\mathcal{V}(\mu_{\tilde{a}}) = \mathcal{V}(\mu_{\tilde{b}})$, $\mathcal{V}(\rho_{\tilde{a}}) = \mathcal{V}(\rho_{\tilde{b}})$ and $\mathcal{V}(v_{\tilde{a}}) \neq \mathcal{V}(v_{\tilde{b}})$. Thus, it follows that $\mathcal{V}(\mu_{\tilde{a}-\tilde{c}}) = \mathcal{V}(\mu_{\tilde{b}-\tilde{c}})$, $\mathcal{V}(\rho_{\tilde{a}-\tilde{c}}) = \mathcal{V}(\rho_{\tilde{b}-\tilde{c}})$ and $\mathcal{V}(v_{\tilde{a}-\tilde{c}}) \neq \mathcal{V}(v_{\tilde{b}-\tilde{c}})$. So, $\theta_1 = \pm 1$, $\theta_2 = \pm 1$ and $\theta_3 = 0$ in ordering $\tilde{a} - \tilde{c}$ and $\tilde{b} - \tilde{c}$.
- Case 8:** Let $\theta_i = \pm 1$ in ordering \tilde{a} and \tilde{b} . Then, $\mathcal{V}(\mu_{\tilde{a}}) = \mathcal{V}(\mu_{\tilde{b}})$, $\mathcal{V}(\rho_{\tilde{a}}) = \mathcal{V}(\rho_{\tilde{b}})$ and $\mathcal{V}(v_{\tilde{a}}) = \mathcal{V}(v_{\tilde{b}})$. Thus, it follows that $\mathcal{V}(\mu_{\tilde{a}-\tilde{c}}) = \mathcal{V}(\mu_{\tilde{b}-\tilde{c}})$, $\mathcal{V}(\rho_{\tilde{a}-\tilde{c}}) = \mathcal{V}(\rho_{\tilde{b}-\tilde{c}})$ and $\mathcal{V}(v_{\tilde{a}-\tilde{c}}) = \mathcal{V}(v_{\tilde{b}-\tilde{c}})$. So, $\theta_i = \pm 1$ in ordering $\tilde{a} - \tilde{c}$ and $\tilde{b} - \tilde{c}$.

The above eight cases suggest that θ_1 and θ_2 are invariant in ordering \tilde{a} , \tilde{b} and $\tilde{a} - \tilde{c}$, $\tilde{b} - \tilde{c}$. Hence, the claim.

Now, by the Theorem 3.1 it follows that it follows that

$$\mathcal{R}_\lambda(\tilde{a} - \tilde{c}, \theta_1, \theta_2, \theta_3) = \mathcal{R}_\lambda(\tilde{a}, \theta_1, \theta_2, \theta_3) + \mathcal{R}_\lambda(-\tilde{c}, \theta_1, \theta_2, \theta_3),$$

and

$$\mathcal{R}_\lambda(\tilde{b} - \tilde{c}, \theta_1, \theta_2, \theta_3) = \mathcal{R}_\lambda(\tilde{b}, \theta_1, \theta_2, \theta_3) + \mathcal{R}_\lambda(-\tilde{c}, \theta_1, \theta_2, \theta_3),$$

Then, if $\tilde{a} \geq \tilde{b}$, then it is obvious that $\mathcal{R}_\lambda(\tilde{a}, \theta_1, \theta_2, \theta_3) \geq \mathcal{R}_\lambda(\tilde{b}, \theta_1, \theta_2, \theta_3)$. Eventually, it leads to the inequality $\mathcal{R}_\lambda(\tilde{a}, \theta_1, \theta_2, \theta_3) + \mathcal{R}_\lambda(-\tilde{c}, \theta_1, \theta_2, \theta_3) \geq \mathcal{R}_\lambda(\tilde{b}, \theta_1, \theta_2, \theta_3) + \mathcal{R}_\lambda(-\tilde{c}, \theta_1, \theta_2, \theta_3)$. Thus, evidently it follows that $\mathcal{R}_\lambda(\tilde{a} + (-\tilde{c}), \theta_1, \theta_2, \theta_3) \geq \mathcal{R}_\lambda(\tilde{b} + (-\tilde{c}), \theta_1, \theta_2, \theta_3)$. So, the result follows immediately.

Proof of the Theorem 3.15

Consider the cases when $\tilde{a} > \tilde{b}$ happens, that is,

$$\tilde{a} > \tilde{b} \text{ happens for } \left\{ \begin{array}{l} \mathcal{R}_\lambda(\tilde{a}, 0, 0, 0) > \mathcal{R}_\lambda(\tilde{b}, 0, 0, 0) \\ \mathcal{R}_\lambda(\tilde{a}, 0, 0, \pm 1) > \mathcal{R}_\lambda(\tilde{b}, 0, 0, \pm 1) \\ \mathcal{R}_\lambda(\tilde{a}, 0, \pm 1, 0) > \mathcal{R}_\lambda(\tilde{b}, 0, \pm 1, 0) \\ \mathcal{R}_\lambda(\tilde{a}, 0, \pm 1, \pm 1) > \mathcal{R}_\lambda(\tilde{b}, 0, \pm 1, \pm 1) \\ \mathcal{R}_\lambda(\tilde{a}, \pm 1, 0, 0) > \mathcal{R}_\lambda(\tilde{b}, \pm 1, 0, 0) \\ \mathcal{R}_\lambda(\tilde{a}, \pm 1, 0, \pm 1) > \mathcal{R}_\lambda(\tilde{b}, \pm 1, 0, \pm 1) \\ \mathcal{R}_\lambda(\tilde{a}, \pm 1, \pm 1, 0) > \mathcal{R}_\lambda(\tilde{b}, \pm 1, \pm 1, 0) \\ \mathcal{R}_\lambda(\tilde{a}, \pm 1, \pm 1, \pm 1) > \mathcal{R}_\lambda(\tilde{b}, \pm 1, \pm 1, \pm 1) \end{array} \right.$$

Consider the cases when $\tilde{c} > \tilde{d}$ happens, that is,

$$\tilde{c} > \tilde{d} \text{ happens for } \left\{ \begin{array}{l} \mathcal{R}_\lambda(\tilde{c}, 0, 0, 0) > \mathcal{R}_\lambda(\tilde{d}, 0, 0, 0) \\ \mathcal{R}_\lambda(\tilde{c}, 0, 0, \pm 1) > \mathcal{R}_\lambda(\tilde{d}, 0, 0, \pm 1) \\ \mathcal{R}_\lambda(\tilde{c}, 0, \pm 1, 0) > \mathcal{R}_\lambda(\tilde{d}, 0, \pm 1, 0) \\ \mathcal{R}_\lambda(\tilde{c}, 0, \pm 1, \pm 1) > \mathcal{R}_\lambda(\tilde{d}, 0, \pm 1, \pm 1) \\ \mathcal{R}_\lambda(\tilde{c}, \pm 1, 0, 0) > \mathcal{R}_\lambda(\tilde{d}, \pm 1, 0, 0) \\ \mathcal{R}_\lambda(\tilde{c}, \pm 1, 0, \pm 1) > \mathcal{R}_\lambda(\tilde{d}, \pm 1, 0, \pm 1) \\ \mathcal{R}_\lambda(\tilde{c}, \pm 1, \pm 1, 0) > \mathcal{R}_\lambda(\tilde{d}, \pm 1, \pm 1, 0) \\ \mathcal{R}_\lambda(\tilde{c}, \pm 1, \pm 1, \pm 1) > \mathcal{R}_\lambda(\tilde{d}, \pm 1, \pm 1, \pm 1) \end{array} \right.$$

Now, to proof this property, it need to discuss these 8×8 cases, which will make the proof tedious. However, one can see the proof trivially, if following claims can be established.

Claim 1: Let $\theta_i = 0$ in ordering \tilde{a} and \tilde{b} , and $\theta_i = 0$ in ordering \tilde{c} and \tilde{d} . Then $\theta_i = 0$ in ordering $\tilde{a} + \tilde{c}$ and $\tilde{b} + \tilde{d}$. The proof of this claim is as follows. Let $\theta_i = 0$ in ordering \tilde{a} and \tilde{b} . Then $\mathcal{V}(\mu_{\tilde{a}}) \neq \mathcal{V}(\mu_{\tilde{b}})$, $\mathcal{V}(\rho_{\tilde{a}}) \neq \mathcal{V}(\rho_{\tilde{b}})$ and $\mathcal{V}(v_{\tilde{a}}) \neq \mathcal{V}(v_{\tilde{b}})$. Similarly, if $\theta_i = 0$ in ordering \tilde{c} and \tilde{d} . Then $\mathcal{V}(\mu_{\tilde{c}}) \neq \mathcal{V}(\mu_{\tilde{d}})$, $\mathcal{V}(\rho_{\tilde{c}}) \neq \mathcal{V}(\rho_{\tilde{d}})$ and $\mathcal{V}(v_{\tilde{c}}) \neq \mathcal{V}(v_{\tilde{d}})$. Thus, it follows that $\mathcal{V}(\mu_{\tilde{a}+\tilde{c}}) \neq \mathcal{V}(\mu_{\tilde{b}+\tilde{d}})$, $\mathcal{V}(\rho_{\tilde{a}+\tilde{c}}) \neq \mathcal{V}(\rho_{\tilde{b}+\tilde{d}})$ and $\mathcal{V}(v_{\tilde{a}+\tilde{c}}) \neq \mathcal{V}(v_{\tilde{b}+\tilde{d}})$. So, $\theta_i = 0$ in ordering $\tilde{a} + \tilde{c}$ and $\tilde{b} + \tilde{d}$.

Claim 2: Let $\theta_i = \pm 1$ in ordering \tilde{a} and \tilde{b} , and $\theta_i = \pm 1$ in ordering \tilde{c} and \tilde{d} . Then $\theta_i = \pm 1$ in ordering $\tilde{a} + \tilde{c}$ and $\tilde{b} + \tilde{d}$. The proof of this claim is as follows. Let $\theta_i = \pm 1$ in ordering \tilde{a} and \tilde{b} . Then $\mathcal{V}(\mu_{\tilde{a}}) = \mathcal{V}(\mu_{\tilde{b}})$, $\mathcal{V}(\rho_{\tilde{a}}) = \mathcal{V}(\rho_{\tilde{b}})$ and $\mathcal{V}(v_{\tilde{a}}) = \mathcal{V}(v_{\tilde{b}})$. Similarly, if $\theta_i = \pm 1$ in ordering \tilde{c} and \tilde{d} , then $\mathcal{V}(\mu_{\tilde{c}}) = \mathcal{V}(\mu_{\tilde{d}})$, $\mathcal{V}(\rho_{\tilde{c}}) = \mathcal{V}(\rho_{\tilde{d}})$ and $\mathcal{V}(v_{\tilde{c}}) = \mathcal{V}(v_{\tilde{d}})$. Thus, it follows that $\mathcal{V}(\mu_{\tilde{a}+\tilde{c}}) = \mathcal{V}(\mu_{\tilde{b}+\tilde{d}})$, $\mathcal{V}(\rho_{\tilde{a}+\tilde{c}}) = \mathcal{V}(\rho_{\tilde{b}+\tilde{d}})$ and $\mathcal{V}(v_{\tilde{a}+\tilde{c}}) = \mathcal{V}(v_{\tilde{b}+\tilde{d}})$. So, $\theta_i = \pm 1$ in ordering $\tilde{a} + \tilde{c}$ and $\tilde{b} + \tilde{d}$.

Claim 3: Let $\theta_i = 0$ in ordering \tilde{a} and \tilde{b} , and $\theta_i = \pm 1$ in ordering \tilde{b} and \tilde{c} . Then $\theta_i = 0$ in ordering $\tilde{a} + \tilde{c}$ and $\tilde{b} + \tilde{d}$. The proof of this claim is as follows. Let $\theta_i = 0$ in ordering \tilde{a} and \tilde{b} . Then $\mathcal{V}(\mu_{\tilde{a}}) \neq \mathcal{V}(\mu_{\tilde{b}})$, $\mathcal{V}(\rho_{\tilde{a}}) \neq \mathcal{V}(\rho_{\tilde{b}})$ and $\mathcal{V}(v_{\tilde{a}}) \neq \mathcal{V}(v_{\tilde{b}})$. Similarly, if $\theta_i = \pm 1$ in ordering \tilde{c} and \tilde{d} , then $\mathcal{V}(\mu_{\tilde{c}}) = \mathcal{V}(\mu_{\tilde{d}})$, $\mathcal{V}(\rho_{\tilde{c}}) = \mathcal{V}(\rho_{\tilde{d}})$ and $\mathcal{V}(v_{\tilde{c}}) = \mathcal{V}(v_{\tilde{d}})$. Thus, it follows that $\mathcal{V}(\mu_{\tilde{a}+\tilde{c}}) \neq \mathcal{V}(\mu_{\tilde{b}+\tilde{d}})$, $\mathcal{V}(\rho_{\tilde{a}+\tilde{c}}) \neq \mathcal{V}(\rho_{\tilde{b}+\tilde{d}})$ and $\mathcal{V}(v_{\tilde{a}+\tilde{c}}) \neq \mathcal{V}(v_{\tilde{b}+\tilde{d}})$. So, $\theta_i = 0$ in ordering $\tilde{a} + \tilde{c}$ and $\tilde{b} + \tilde{d}$.

Claim 4: Let $\theta_i = \pm 1$ in ordering \tilde{a} and \tilde{b} , and $\theta_i = 0$ in ordering \tilde{c} and \tilde{d} . Then $\theta_i = 0$ in ordering $\tilde{a} + \tilde{c}$ and $\tilde{b} + \tilde{d}$. The proof of this claim is as follows. Let $\theta_i = \pm 1$ in ordering \tilde{a} and \tilde{b} . Then $\mathcal{V}(\mu_{\tilde{a}}) = \mathcal{V}(\mu_{\tilde{b}})$, $\mathcal{V}(\rho_{\tilde{a}}) = \mathcal{V}(\rho_{\tilde{b}})$ and $\mathcal{V}(v_{\tilde{a}}) = \mathcal{V}(v_{\tilde{b}})$. Similarly, if $\theta_i = 0$ in ordering \tilde{c} and \tilde{d} , then $\mathcal{V}(\mu_{\tilde{c}}) \neq \mathcal{V}(\mu_{\tilde{d}})$, $\mathcal{V}(\rho_{\tilde{c}}) \neq \mathcal{V}(\rho_{\tilde{d}})$ and $\mathcal{V}(v_{\tilde{c}}) \neq \mathcal{V}(v_{\tilde{d}})$. Thus, it follows that $\mathcal{V}(\mu_{\tilde{a}+\tilde{c}}) \neq \mathcal{V}(\mu_{\tilde{b}+\tilde{d}})$, $\mathcal{V}(\rho_{\tilde{a}+\tilde{c}}) \neq \mathcal{V}(\rho_{\tilde{b}+\tilde{d}})$ and $\mathcal{V}(v_{\tilde{a}+\tilde{c}}) \neq \mathcal{V}(v_{\tilde{b}+\tilde{d}})$. So, $\theta_i = 0$ in ordering $\tilde{a} + \tilde{c}$ and $\tilde{b} + \tilde{d}$.

From these four claims, it is trivial enough to show that if $\tilde{a} > \tilde{b}$ and $\tilde{b} > \tilde{c}$, then $\tilde{a} + \tilde{c} > \tilde{b} + \tilde{d}$.

References

- Aal SIA, Ellatif MAA, Hassan MM (2018) Two ranking methods of single valued triangular neutrosophic numbers to rank and evaluate information systems quality. *Neutrosophic Sets Syst* 19:131–141
- Atanassov KT (1989) More on intuitionistic fuzzy sets. *Fuzzy Sets Syst* 33(1):37–45
- Atanassov KT (1999) *Intuitionistic fuzzy sets*. Springer, Berlin, pp 1–137
- Atanassov KT (2000) Two theorems for intuitionistic fuzzy sets. *Fuzzy Sets Syst* 110(2):267–269
- Biswas P, Pramanik S, Giri BC (2016) Value and ambiguity index based ranking method of single-valued trapezoidal neutrosophic numbers and its application to multi-attribute decision making. *Neutrosophic Sets Syst* 12:127–138
- Chakraborty D, Jana DK, Roy TK (2015) Arithmetic operations on generalized intuitionistic fuzzy number and its applications to transportation problem. *Opsearch* 52:431–471
- Chutia R (2017) Ranking of fuzzy numbers by using value and angle in the epsilon-deviation degree method. *Appl Soft Comput* 60:706–721
- Chutia R (2020) Ranking of Z-numbers based on value and ambiguity at levels of decision making. *Int J Intell Syst* 36(1):313–331
- Chutia R, Chutia B (2017) A new method of ranking parametric form of fuzzy numbers using value and ambiguity. *Appl Soft Comput* 52(Supplement C):1154–1168
- Chutia R, Saikia S (2018) Ranking intuitionistic fuzzy numbers at levels of decision-making and its application. *Expert Syst* 35(5):e12292
- Deli I (2018) Operators on single valued trapezoidal neutrosophic numbers and SVTN-group decision making. *Neutrosophic Sets Syst* 22:131–150
- Deli I, Subas Y (2017) A ranking method of single valued neutrosophic numbers and its applications to multi-attribute decision making problems. *Int J Mach Learn Cybern* 8(4):1309–1322
- Edalatpanah SA (2020a) Neutrosophic structured element. *Expert Syst* 37(5):e12542
- Edalatpanah SA (2020b) Systems of neutrosophic linear equations. *Neutrosophic Sets Syst* 33(1):92–104
- Edalatpanah SA (2020) Data envelopment analysis based on triangular neutrosophic numbers. *CAAI Trans Intell Technol* 5(2):94–98
- Edalatpanah SA (2020) A direct model for triangular neutrosophic linear programming. *Int J Neutrosophic Sci* 1(1):19–28

- Edalatpanah SA, Smarandache F (2019) Data envelopment analysis for simplified neutrosophic sets. *Neutrosophic Sets Syst* 29:215–226
- Giri B, Molla MU, Biswas P (2018) Topsis method for MADM based on interval trapezoidal neutrosophic number. *Neutrosophic Sets Syst* 22:151–167
- Jana C, Pal M, Karaaslan F, Wang JQ (2020) Trapezoidal neutrosophic aggregation operators and their application to the multi-attribute decision-making process. *Sci Iran* 27(3):1655–1673
- Karaaslan F (2018a) Gaussian single-valued neutrosophic numbers and its application in multi-attribute decision making. *Neutrosophic Sets Syst* 22(1):101–117
- Karaaslan F (2018b) Multi-criteria decision-making method based on similarity measures under single-valued neutrosophic refined and interval neutrosophic refined environments. *Int J Intell Syst* 33(5):928–952
- Karaaslan F, Davvaz B (2018) Properties of single-valued neutrosophic graphs. *J Intell Fuzzy Syst* 34(1):57–79
- Karaaslan F, Hayat K (2018) Some new operations on single-valued neutrosophic matrices and their applications in multi-criteria group decision making. *Appl Intell* 48(12):4594–4614
- Karaaslan F, Hunu F (2020) Type-2 single-valued neutrosophic sets and their applications in multi-criteria group decision making based on topsis method. *J Ambient Intell Humaniz Comput* 11:4113–4132
- Lee JG, Senel G, Lim PK, Kim J, Hur K (2020) Octahedron sets. *Ann Fuzzy Math Inform* 19(3):211–238
- Mao X, Guoxi Z, Fallah M, Edalatpanah SA (2020) A neutrosophic-based approach in data envelopment analysis with undesirable outputs. *Math Probl Eng*
- Nancy Garg H (2016) An improved score function for ranking neutrosophic sets and its application to decision-making process. *Int J Uncertain Quantif* 6(5):377–385
- Peng JJ, Wang JQ, Zhang HY, Chen XH (2014) An outranking approach for multi-criteria decision-making problems with simplified neutrosophic sets. *Appl Soft Comput* 25:336–346
- Smarandache F (1998) A unifying field in logics neutrosophy: neutrosophic probability, set and logic. American Research Press, Rehoboth
- Smarandache F (1999) A unifying field in logics: Neutrosophic logic. In: *Philosophy*. American Research Press, Rehoboth, pp 1–141
- Smarandache F (2006) Neutrosophic set - a generalization of the intuitionistic fuzzy set. In: *2006 IEEE International Conference on Granular Computing*, pp 38–42
- Ulucay V, Kilic A, Yildiz I, Sahin M (2018) A new approach for multi-attribute decision-making problems in bipolar neutrosophic sets. *Neutrosophic Sets Syst* 23(1):142–159
- Ulucay V, Kilic A, Yildiz I, Sahin M (2019) An outranking approach for MCDM-problems with neutrosophic multi-sets. *Neutrosophic Sets Syst* 30(1):213–224
- Wang X, Kerre EE (2001a) Reasonable properties for the ordering of fuzzy quantities (I). *Fuzzy Sets Syst* 118(3):375–385
- Wang X, Kerre EE (2001b) Reasonable properties for the ordering of fuzzy quantities (II). *Fuzzy Sets Syst* 118(3):387–405
- Wang H, Smarandache F, Zhang Y, Sunderraman R (2010) Single valued neutrosophic sets. *Multispace Multistruct* 4:410–413
- Yang W, Cai L, Edalatpanah SA, Smarandache F (2020) Triangular single valued neutrosophic data envelopment analysis: application to hospital performance measurement. *Symmetry* 12(4):588
- Zadeh LA (1965) Fuzzy sets. *Inf Control* 8(3):338–353

Compactness on Single-Valued Neutrosophic Ideal Topological Spaces

Fahad Alsharari, Florentin Smarandache, Yaser Saber

Fahad Alsharari, Florentin Smarandache, Yaser Saber (2021). Compactness on Single-Valued Neutrosophic Ideal Topological Spaces. *Neutrosophic Sets and Systems* 41: 127-145

Abstract: In the current paper, particular achievements of single-valued neutrosophic continuity on a single-valued neutrosophic topological space $(\tilde{\mathfrak{X}}, \tilde{\tau}^{\tilde{\gamma}}, \tilde{\tau}^{\tilde{\eta}}, \tilde{\tau}^{\tilde{\mu}})$ are introduced. Some necessary implications between them are illustrated. The theories of r -single-valued neutrosophic compact, r -single-valued neutrosophic ideal compact, r -single-valued neutrosophic quasi H-closed and r -single-valued neutrosophic compact modulo an single-valued neutrosophic ideal $\tilde{\mathcal{J}}$ are presented and investigated.

Keywords: single-valued neutrosophic (almost; weakly) continuous mapping; single-valued neutrosophic ideal (compact; quasi H-closed) and r -single-valued neutrosophic compact modulo.

1. Introduction

Using a fuzzy ideal $\tilde{\mathcal{J}}$ defined on a fuzzy topological space (FTS) $(\tilde{\mathfrak{X}}, \tilde{\tau})$, a fuzzy ideal topological space (FITS) $(\tilde{\mathfrak{X}}, \tilde{\tau}, \tilde{\mathcal{J}})$ is generated. It is a way of generalizing so many notions and results in $(\tilde{\mathfrak{X}}, \tilde{\tau})$. The main definition of fuzzy topology that is related to the results in this article was established by Šostak in [1]. The notion of fuzzy ideal was created in [2]. Tripathy et al. in [3 - 6] introduced different valuable research studies on (FITS) and gave several forms of fuzzy continuities. Saber and others [7 - 11] have considered several r -fuzzy compactnesses in (FITS) $(\tilde{\mathfrak{X}}, \tilde{\tau}, \tilde{\mathcal{J}})$ and several types of fuzzy continuity.

Smarandache established the idea of the neutrosophic sets [12] in 1998. In terms of neutrosophic sets, there are a membership score ($\tilde{\gamma}$), an indeterminacy score ($\tilde{\eta}$) and a non-membership score ($\tilde{\mu}$) and a neutrosophic value is in the form $(\tilde{\gamma}, \tilde{\eta}, \tilde{\mu})$. In other meaning, in explaining an event or finding of a solution to a problem, a condition is handled according to its truth, not truth and resolution. Hence, the study of neutrosophic sets and neutrosophic logic are useful for decision-making applications in neutrosophic theories and led to too many researches and studies in the field as in [12-25]. It also gives the opportunity to others to establish some approaches in decision-making for neutrosophic theory as in [26-31]. Wang et al, [32] and Kim et al, [33] presented the theory of the neutrosophic equivalence relation single-valued. Single-valued neutrosophic

ideal (\mathcal{SVNT}) aspects in single-valued neutrosophic topological spaces (\mathcal{SVNTS}) , have been introduced and considered by several authors from diverse viewpoints such as in [34-37].

In this research, we foreground the idea of r -single-valued neutrosophic (compact, ideal compact and quasi H-closed) in (\mathcal{SVNTS}) in the sense of Šostak. We are working on getting some of its important characteristics and results. Moreover, we investigate some properties of single-valued neutrosophic continuous mappings. Finally, some fascinating application of neutrosophic topology in reverse logistics arises could be found as in Abdel-Baset paper articles and others [38-41].

2. Preliminaries

Definition 2.1 [22] Suppose that $\tilde{\mathfrak{X}}$ is a non-empty set. We mean by a neutrosophic set (briefly, \mathcal{NS}) \mathcal{S} the objects having the form

$$\mathcal{S} = \{(\omega, \tilde{\gamma}_S, \tilde{\eta}_S, \tilde{\mu}_S) : \omega \in \tilde{\mathfrak{X}}\}.$$

Anywhere $\tilde{\mu}_S$, $\tilde{\eta}_S$ and $\tilde{\gamma}_S$ indicate the degree of non-membership, the degree of indeterminacy, and the degree of membership, respectively of any element $\omega \in \tilde{\mathfrak{X}}$ to the set \mathcal{S} .

Definition 2.2 [32] Suppose that $\tilde{\mathfrak{X}}$ is a universal set. For $\forall \omega \in \tilde{\mathfrak{X}}$, $0 \leq \tilde{\gamma}_S(\omega) + \tilde{\eta}_S(\omega) + \tilde{\mu}_S(\omega) \leq 3$, by the meanings $\tilde{\gamma}_S: \mathcal{S} \rightarrow [0,1]$, $\tilde{\eta}_S: \mathcal{S} \rightarrow [0,1]$ and $\tilde{\mu}_S: \mathcal{S} \rightarrow [0,1]$, a single-valued neutrosophic set (briefly, \mathcal{SVNS}) on $\tilde{\mathfrak{X}}$ is defined by

$$\mathcal{S} = \{(\omega, \tilde{\gamma}_S, \tilde{\eta}_S, \tilde{\mu}_S) : \omega \in \tilde{\mathfrak{X}}\}.$$

Now, $\tilde{\mu}_S$, $\tilde{\eta}_S$ and $\tilde{\gamma}_S$ are the degrees of falsity, indeterminacy and trueness of $\omega \in \tilde{\mathfrak{X}}$, respectively. We will convey the set of all \mathcal{SVNS} in \mathcal{S} as $I^{\tilde{\mathfrak{X}}}$.

Definition 2.3 [32] The accompaniment of a \mathcal{SVNS} \mathcal{S} is indicated by \mathcal{S}^c and is cleared by

$$\tilde{\gamma}_{\mathcal{S}^c}(\omega) = \tilde{\mu}_S(\omega), \quad \tilde{\eta}_{\mathcal{S}^c}(\omega) = 1 - \tilde{\eta}_S(\omega) \text{ and } \tilde{\mu}_{\mathcal{S}^c}(\omega) = \tilde{\gamma}_S(\omega).$$

for any $\omega \in \tilde{\mathfrak{X}}$,

Definition 2.4 [41] Let $\mathcal{S}, \mathcal{E} \in I^{\tilde{\mathfrak{X}}}$. Then,

1. $\mathcal{S} \subseteq \mathcal{E}$, if, for every $\omega \in \tilde{\mathfrak{X}}$,

$$\tilde{\gamma}_S(\omega) \leq \tilde{\gamma}_E(\omega), \quad \tilde{\eta}_S(\omega) \geq \tilde{\eta}_E(\omega), \quad \tilde{\mu}_S(\omega) \geq \tilde{\mu}_E(\omega)$$
2. $\mathcal{S} = \mathcal{E}$ if $\mathcal{S} \subseteq \mathcal{E}$ and $\mathcal{S} \supseteq \mathcal{E}$.
3. $\tilde{0} = \langle 0,1,1 \rangle$ and $\tilde{1} = \langle 1,0,0 \rangle$

Definition 2.5 [42] Let $\mathcal{S}, \mathcal{E} \in I^{\tilde{\mathfrak{X}}}$. Then,

1. $\mathcal{S} \cap \mathcal{E}$ is a \mathcal{SVNS} in $\tilde{\mathfrak{X}}$ defined as:

$$\mathcal{S} \cap \mathcal{E} = (\tilde{\gamma}_S \cap \tilde{\gamma}_E, \tilde{\eta}_S \cup \tilde{\eta}_E, \tilde{\mu}_S \cup \tilde{\mu}_E).$$

Where, $(\tilde{\mu}_S \cup \tilde{\mu}_E)(\omega) = \tilde{\mu}_S(\omega) \cup \tilde{\mu}_E(\omega)$ and $(\tilde{\gamma}_S \cap \tilde{\gamma}_E)(\omega) = \tilde{\gamma}_S(\omega) \cap \tilde{\gamma}_E(\omega)$, for all $\omega \in \tilde{\mathfrak{X}}$,

1. $\mathcal{S} \cup \mathcal{E}$ is an \mathcal{SVNS} on $\tilde{\mathfrak{X}}$ defined as:

$$S \cup \mathcal{E} = (\check{\gamma}_S \cup \check{\gamma}_\mathcal{E}, \check{\eta}_S \cap \check{\eta}_\mathcal{E}, \check{\mu}_S \cap \check{\mu}_\mathcal{E}).$$

Definition 2.6 [21] Suppose that $\tilde{\mathfrak{X}}$ is a nonempty set and $\mathcal{S} \in I^{\tilde{\mathfrak{X}}}$ is having the form $\mathcal{S} = \{(\omega, \check{\gamma}_\mathcal{S}, \check{\eta}_\mathcal{S}, \check{\mu}_\mathcal{S}) : \omega \in \tilde{\mathfrak{X}}\}$ on $\tilde{\mathfrak{X}}$. Then,

1. $(\bigcap_{j \in \Delta} \mathcal{S}_j)(\omega) = \left(\bigcap_{j \in \Delta} \check{\gamma}_{\mathcal{S}_j}(\omega), \bigcup_{j \in \Delta} \check{\eta}_{\mathcal{S}_j}(\omega), \bigcup_{j \in \Delta} \check{\mu}_{\mathcal{S}_j}(\omega) \right),$
2. $(\bigcup_{j \in \Delta} \mathcal{S}_j)(\omega) = \left(\bigcup_{j \in \Delta} \check{\gamma}_{\mathcal{S}_j}(\omega), \bigcap_{j \in \Delta} \check{\eta}_{\mathcal{S}_j}(\omega), \bigcap_{j \in \Delta} \check{\mu}_{\mathcal{S}_j}(\omega) \right).$

Definition 2.7 [34] Let $s, t, k \in I_0$ and $s + t + k \leq 3$. A single-valued neutrosophic point (\mathcal{SVNP}) $x_{s,t,k}$ of $\tilde{\mathfrak{X}}$ is the \mathcal{SVNS} in $I^{\tilde{\mathfrak{X}}}$ for every $\omega \in \mathcal{S}$, defined by

$$x_{s,t,k}(\omega) = \begin{cases} (s, t, k), & \text{if } x = \omega, \\ (0, 1, 1), & \text{if } x \neq \omega. \end{cases}$$

A \mathcal{SVNP} $x_{s,t,k}$ is supposed to belong to a \mathcal{SVNS} $\mathcal{S} = \{(\omega, \check{\gamma}_\mathcal{S}, \check{\eta}_\mathcal{S}, \check{\mu}_\mathcal{S}) : \omega \in \tilde{\mathfrak{X}}\} \in I^{\tilde{\mathfrak{X}}}$, (notion: $x_{s,t,k} \in \mathcal{S}$ iff $s < \check{\gamma}_\mathcal{S}$, $t \geq \check{\eta}_\mathcal{S}$ and $k \geq \check{\mu}_\mathcal{S}$), and the set off all \mathcal{SVNP} in $\tilde{\mathfrak{X}}$ indicated by $\mathcal{SVNP}(\tilde{\mathfrak{X}})$. $x_{s,t,k} \in \mathcal{SVNP}(\tilde{\mathfrak{X}})$ quasi-coincident with a \mathcal{SVNS} $\mathcal{S} \in I^{\tilde{\mathfrak{X}}}$ denoted by $x_{s,t,k}q\mathcal{S}$, if

$$s + \check{\gamma}_\mathcal{S} > 1, t + \check{\eta}_\mathcal{S} \leq 1, k + \check{\mu}_\mathcal{S} \leq 1.$$

For every $\mathcal{S}, \mathcal{E} \in I^{\tilde{\mathfrak{X}}}$ \mathcal{S} is quasi-coincident with \mathcal{E} indicated by $\mathcal{S}q\mathcal{E}$, if there exists $x_{s,t,k} \in I^{\tilde{\mathfrak{X}}}$ s.t

$$\check{\gamma}_\mathcal{E} + \check{\gamma}_\mathcal{S} > 1, \check{\eta}_\mathcal{E} + \check{\eta}_\mathcal{S} \leq 1 \text{ and } \check{\mu}_\mathcal{E} + \check{\mu}_\mathcal{S} \leq 1.$$

Definition 2.8 [25] Let $\check{\tau}^{\check{\gamma}}, \check{\tau}^{\check{\eta}}, \check{\tau}^{\check{\mu}} : I^{\tilde{\mathfrak{X}}} \rightarrow I$ be mappings satisfying the following conditions:

1. $\check{\tau}^{\check{\gamma}}(\mathbf{0}) = \check{\tau}^{\check{\gamma}}(\mathbf{1}) = 1$ and $\check{\tau}^{\check{\eta}}(\mathbf{0}) = \check{\tau}^{\check{\eta}}(\mathbf{1}) = \check{\tau}^{\check{\mu}}(\mathbf{0}) = \check{\tau}^{\check{\mu}}(\mathbf{1}) = 0,$
2. $\check{\tau}^{\check{\gamma}}(\mathcal{S} \cap \mathcal{E}) \geq \check{\tau}^{\check{\gamma}}(\mathcal{S}) \cap \check{\tau}^{\check{\gamma}}(\mathcal{E}), \check{\tau}^{\check{\eta}}(\mathcal{S} \cap \mathcal{E}) \leq \check{\tau}^{\check{\eta}}(\mathcal{S}) \cup \check{\tau}^{\check{\eta}}(\mathcal{E})$ and $\check{\tau}^{\check{\mu}}(\mathcal{S} \cap \mathcal{E}) \leq \check{\tau}^{\check{\mu}}(\mathcal{S}) \cup \check{\tau}^{\check{\mu}}(\mathcal{E}),$ for every $\mathcal{S}, \mathcal{E} \in I^{\tilde{\mathfrak{X}}},$
3. $\check{\tau}^{\check{\gamma}}(\bigcup_{j \in \Gamma} \mathcal{S}_j) \geq \bigcap_{j \in \Gamma} \check{\tau}^{\check{\gamma}}(\mathcal{S}_j), \check{\tau}^{\check{\eta}}(\bigcup_{j \in \Gamma} \mathcal{S}_j) \leq \bigcup_{j \in \Gamma} \check{\tau}^{\check{\eta}}(\mathcal{S}_j)$ and $\check{\tau}^{\check{\mu}}(\bigcup_{j \in \Gamma} \mathcal{S}_j) \leq \bigcup_{j \in \Gamma} \check{\tau}^{\check{\mu}}(\mathcal{S}_j),$ for every $\{\mathcal{S}_j, j \in \Gamma\} \in I^{\tilde{\mathfrak{X}}}.$

Then $(\check{\tau}^{\check{\gamma}}, \check{\tau}^{\check{\eta}}, \check{\tau}^{\check{\mu}})$ is called single valued neutrosophic topology \mathcal{SVNT} . Usually, we will write $\check{\tau}^{\check{\gamma}\check{\eta}\check{\mu}}$ for $(\check{\tau}^{\check{\gamma}}, \check{\tau}^{\check{\eta}}, \check{\tau}^{\check{\mu}})$ and it will cause no indistinctness.

Definition 2.9 [34] Let $(\tilde{\mathfrak{X}}, \check{\tau}^{\check{\gamma}\check{\eta}\check{\mu}})$ be an \mathcal{SVNTS} . Then, for all $\mathcal{S} \in I^{\tilde{\mathfrak{X}}}$ and $r \in I_0$, the single valued neutrosophic)closure and interior(of \mathcal{S} are define by:

$$C_{\check{\tau}^{\check{\gamma}\check{\eta}\check{\mu}}}(\mathcal{S}, r) = \bigcap \{ \mathcal{E} \in I^{\tilde{\mathfrak{X}}} : \mathcal{S} \leq \mathcal{E}, \quad \check{\tau}^{\check{\gamma}}(\mathcal{E}^c) \geq r, \quad \check{\tau}^{\check{\eta}}(\mathcal{E}^c) \leq 1 - r, \quad \check{\tau}^{\check{\mu}}(\mathcal{E}^c) \leq 1 - r \}$$

$$int_{\check{\tau}^{\check{\gamma}\check{\eta}\check{\mu}}}(\mathcal{S}, r) = \bigcup \{ \mathcal{E} \in I^{\tilde{\mathfrak{X}}} : \mathcal{S} \geq \mathcal{E}, \quad \check{\tau}^{\check{\gamma}}(\mathcal{E}) \geq r, \quad \check{\tau}^{\check{\eta}}(\mathcal{E}) \leq 1 - r, \quad \check{\tau}^{\check{\mu}}(\mathcal{E}) \leq 1 - r \}.$$

Definition 2.10 [34] A mapping $\check{\mathcal{J}}^{\check{\gamma}}, \check{\mathcal{J}}^{\check{\eta}}, \check{\mathcal{J}}^{\check{\mu}} : I^{\tilde{\mathfrak{X}}} \rightarrow I$ is said to be \mathcal{SVNTI} on $\tilde{\mathfrak{X}}$ if it satisfies the next three conditions for $\mathcal{S}, \mathcal{E} \in I^{\tilde{\mathfrak{X}}}$:

1. $\check{\mathcal{J}}^{\check{\eta}}(\mathbf{0}) = \check{\mathcal{J}}^{\check{\mu}}(\mathbf{0}) = 0, \check{\mathcal{J}}^{\check{\gamma}}(\mathbf{0}) = 1,$
2. If $\mathcal{S} \leq \mathcal{E}$ then $\check{\mathcal{J}}^{\check{\eta}}(\mathcal{E}) \geq \check{\mathcal{J}}^{\check{\eta}}(\mathcal{S}), \check{\mathcal{J}}^{\check{\mu}}(\mathcal{E}) \geq \check{\mathcal{J}}^{\check{\mu}}(\mathcal{S})$ and $\check{\mathcal{J}}^{\check{\gamma}}(\mathcal{E}) \leq \check{\mathcal{J}}^{\check{\gamma}}(\mathcal{S}).$
3. $\check{\mathcal{J}}^{\check{\eta}}(\mathcal{S} \cup \mathcal{E}) \leq \check{\mathcal{J}}^{\check{\eta}}(\mathcal{S}) \cup \check{\mathcal{J}}^{\check{\eta}}(\mathcal{E}), \check{\mathcal{J}}^{\check{\mu}}(\mathcal{S} \cup \mathcal{E}) \leq \check{\mathcal{J}}^{\check{\mu}}(\mathcal{S}) \cup \check{\mathcal{J}}^{\check{\mu}}(\mathcal{E})$ and $\check{\mathcal{J}}^{\check{\gamma}}(\mathcal{S} \cup \mathcal{E}) \geq \check{\mathcal{J}}^{\check{\gamma}}(\mathcal{S}) \cap \check{\mathcal{J}}^{\check{\gamma}}(\mathcal{E}).$

Then, $(\tilde{\mathfrak{X}}, \check{\tau}^{\check{\gamma}\check{\eta}\check{\mu}}, \check{\mathcal{J}}^{\check{\gamma}\check{\eta}\check{\mu}})$ is said to be a single-valued neutrosophic ideal topological space (\mathcal{SVNTIS}).

Definition 2.12 [36] A mapping $f: (\tilde{\mathfrak{X}}_1, \tilde{\tau}_1^{\tilde{\gamma}\tilde{\eta}\tilde{\mu}}) \rightarrow (\tilde{\mathfrak{X}}_2, \tilde{\tau}_2^{\tilde{\gamma}\tilde{\eta}\tilde{\mu}})$ from an $\mathcal{SVN}\mathcal{TS}$ $(\tilde{\mathfrak{X}}_1, \tilde{\tau}_1^{\tilde{\gamma}\tilde{\eta}\tilde{\mu}})$ into another $\mathcal{SVN}\mathcal{TS}$ $(\tilde{\mathfrak{X}}_2, \tilde{\tau}_2^{\tilde{\gamma}\tilde{\eta}\tilde{\mu}})$ is said to be single-valued neutrosophic continuous (briefly, \mathcal{SVN} -continuous) if and only if $\tilde{\tau}_2^{\tilde{\gamma}}(\mathcal{S}) \leq \tilde{\tau}_1^{\tilde{\gamma}}(f^{-1}(\mathcal{S}))$, $\tilde{\tau}_2^{\tilde{\eta}}(\mathcal{S}) \geq \tilde{\tau}_1^{\tilde{\eta}}(f^{-1}(\mathcal{S}))$ and $\tilde{\tau}_2^{\tilde{\mu}}(\mathcal{S}) \geq \tilde{\tau}_1^{\tilde{\mu}}(f^{-1}(\mathcal{S}))$, for every $\mathcal{S} \in I^{\tilde{\mathfrak{X}}_2}$.

3. Single-Valued Neutrosophic (almost , weakly) Continuous Mappings

This section is dedicated to present the concepts of the single-valued neutrosophic (almost and weakly) mappings (briefly \mathcal{SVN} – almost continuous, \mathcal{SVN} – *weakly continuous*) mappings, respectively. It is also devoted to mark out the concepts of single-valued neutrosophic (preopen , regular-open) sets (briefly, r – \mathcal{SVNPO} , r – \mathcal{SVNRO}) sets, respectively.

Definition 3.1. Let $(\tilde{\mathfrak{X}}, \tilde{\tau}^{\tilde{\gamma}\tilde{\eta}\tilde{\mu}})$ be an $\mathcal{SVN}\mathcal{TS}$ and $r \in I_0$. Then, $\mathcal{S} \in I^{\tilde{\mathfrak{X}}}$ is said to be:

1. r – \mathcal{SVNPO} set iff $\mathcal{S} \leq \text{int}_{\tilde{\tau}^{\tilde{\gamma}\tilde{\eta}\tilde{\mu}}}(C_{\tilde{\tau}^{\tilde{\gamma}\tilde{\eta}\tilde{\mu}}}(\mathcal{S}, r), r)$,
2. r – \mathcal{SVNRO} set if $\mathcal{S} = \text{int}_{\tilde{\tau}^{\tilde{\gamma}\tilde{\eta}\tilde{\mu}}}(C_{\tilde{\tau}^{\tilde{\gamma}\tilde{\eta}\tilde{\mu}}}(\mathcal{S}, r), r)$.

The complement of r – \mathcal{SVNPO} (resp, r – \mathcal{SVNRO}) are said to be r – \mathcal{SVNPC} (resp, r – \mathcal{SVNRC}), respectively.

Remark 3.2. Let $(\tilde{\mathfrak{X}}, \tilde{\tau}^{\tilde{\gamma}\tilde{\eta}\tilde{\mu}})$ be an $\mathcal{SVN}\mathcal{TS}$ and $r \in I_0$, if \mathcal{S} is an r – \mathcal{SVNRO} set, then \mathcal{S} is r – \mathcal{SVNPO} .

Example 3.3. Let $\tilde{\mathfrak{X}} = \{a, b\}$. Define $\mathcal{E}_1, \mathcal{E}_2 \in I^{\tilde{\mathfrak{X}}}$ as follows:

$$\mathcal{E}_1 = \langle (0 \cdot 5, 0.4, 0 \cdot 5), (0 \cdot 5, 0.4, 0 \cdot 5), (0 \cdot 5, 0.5, 0 \cdot 5) \rangle, \mathcal{E}_2 = \langle (0 \cdot 4, 0 \cdot 4, 0.4), (0 \cdot 5, 0 \cdot 4, 0.4), (0 \cdot 5, 0 \cdot 5, 4) \rangle.$$

Define $\tilde{\tau}^{\tilde{\gamma}\tilde{\eta}\tilde{\mu}} : I^{\tilde{\mathfrak{X}}} \rightarrow I$ as follows:

$$\tilde{\tau}^{\tilde{\gamma}}(\mathcal{S}) = \begin{cases} 1, & \text{if } \mathcal{S} = \tilde{0}, \\ 1, & \text{if } \mathcal{S} = \tilde{1}, \\ \frac{1}{2}, & \text{if } \mathcal{S} = \mathcal{E}_1, \\ 0, & \text{otherwise} \end{cases} \quad \tilde{\tau}^{\tilde{\eta}}(\mathcal{S}) = \begin{cases} 0, & \text{if } \mathcal{S} = \tilde{0}, \\ 0, & \text{if } \mathcal{S} = \tilde{1}, \\ \frac{1}{2}, & \text{if } \mathcal{S} = \{\mathcal{E}_1, \mathcal{E}_2\}, \\ 1, & \text{otherwise} \end{cases}$$

$$\tilde{\tau}^{\tilde{\mu}}(\mathcal{S}) = \begin{cases} 0, & \text{if } \mathcal{S} = \tilde{0}, \\ 0, & \text{if } \mathcal{S} = \tilde{1}, \\ \frac{1}{2}, & \text{if } \mathcal{S} = \{\mathcal{E}_1, \mathcal{E}_2\}, \\ 1, & \text{otherwise} \end{cases}$$

Let, $\mathcal{E}_3 = \{(\omega, (0 \cdot 5, 0.5, 0 \cdot 1), (0 \cdot 6, 0.3, 0 \cdot 1), (0 \cdot 6, 0.3, 0 \cdot 1)) : \omega \in \tilde{\mathfrak{X}}\}$. Then, \mathcal{E}_3 is $\frac{1}{2}$ – \mathcal{SVNPO} set but it is not $\frac{1}{2}$ – \mathcal{SVNRO} set because, $\mathcal{E}_3 \neq \text{int}_{\tilde{\tau}^{\tilde{\gamma}\tilde{\eta}\tilde{\mu}}}(C_{\tilde{\tau}^{\tilde{\gamma}\tilde{\eta}\tilde{\mu}}}(\mathcal{E}_3, \frac{1}{2}), \frac{1}{2}) = \tilde{1}$.

Lemma 3.4. Let \mathcal{S} be an $\mathcal{SVN}\mathcal{S}$ in an $\mathcal{SVN}\mathcal{TS}$ $(\tilde{\mathfrak{X}}, \tilde{\tau}^{\tilde{\gamma}\tilde{\eta}\tilde{\mu}})$. Then, for each $r \in I_0$.

1. If \mathcal{S} is r – \mathcal{SVNRO} set (resp, r – \mathcal{SVNRC} set), then $[\tilde{\tau}^{\tilde{\gamma}}(\mathcal{S}) \geq r, \tilde{\tau}^{\tilde{\eta}}(\mathcal{S}) \leq 1 - r, \tilde{\tau}^{\tilde{\mu}}(\mathcal{S}) \leq 1 - r]$ (resp, $[\tilde{\tau}^{\tilde{\gamma}}(\mathcal{S}^c) \geq r, \tilde{\tau}^{\tilde{\eta}}(\mathcal{S}^c) \leq 1 - r, \tilde{\tau}^{\tilde{\mu}}(\mathcal{S}^c) \leq 1 - r]$),
2. \mathcal{S} is r – \mathcal{SVNRO} set if and only if \mathcal{S}^c is r – \mathcal{SVNRC} set.

Proof. Follows directly from Definition 3.1.

Lemma 3.5. Let $(\tilde{\mathfrak{X}}, \tilde{\tau}^{\tilde{\gamma}\tilde{\eta}\tilde{\mu}})$ be an $\mathcal{SVN}\mathcal{TS}$. Then,

1. the union of two r – \mathcal{SVNRC} sets is r – \mathcal{SVNRC} ,
2. the intersection of two r – \mathcal{SVNRO} sets, is r – \mathcal{SVNRO} .

Proof. (1) Let \mathcal{S}, \mathcal{E} be any two $r - SVNRC$ sets. By Lemma 3.4, $[\tilde{\tau}^{\tilde{Y}}(\mathcal{S}^c) \geq r, \tilde{\tau}^{\tilde{\eta}}(\mathcal{S}^c) \leq 1 - r, \tilde{\tau}^{\tilde{\mu}}(\mathcal{S}^c) \leq 1 - r]$ and $[\tilde{\tau}^{\tilde{Y}}(\mathcal{E}^c) \geq r, \tilde{\tau}^{\tilde{\eta}}(\mathcal{E}^c) \leq 1 - r, \tilde{\tau}^{\tilde{\mu}}(\mathcal{E}^c) \leq 1 - r]$. Then,

$$\tilde{\tau}^{*\tilde{Y}}(\mathcal{S} \cup \mathcal{E}) \geq \tilde{\tau}^{*\tilde{Y}}(\mathcal{S}) \cap \tilde{\tau}^{*\tilde{Y}}(\mathcal{E}), \tilde{\tau}^{*\tilde{\eta}}(\mathcal{S} \cup \mathcal{E}) \leq \tilde{\tau}^{*\tilde{\eta}}(\mathcal{S}) \cup \tilde{\tau}^{*\tilde{\eta}}(\mathcal{E}), \tilde{\tau}^{*\tilde{\mu}}(\mathcal{S} \cup \mathcal{E}) \leq \tilde{\tau}^{*\tilde{\mu}}(\mathcal{S}) \cup \tilde{\tau}^{*\tilde{\mu}}(\mathcal{E}),$$

but $int_{\tilde{\tau}^{\tilde{Y}\tilde{\eta}\tilde{\mu}}}(\mathcal{S} \cup \mathcal{E}, r) \leq \mathcal{S} \cup \mathcal{E}$, this suggests that

$$C_{\tilde{\tau}^{\tilde{Y}\tilde{\eta}\tilde{\mu}}} (int_{\tilde{\tau}^{\tilde{Y}\tilde{\eta}\tilde{\mu}}}(\mathcal{S} \cup \mathcal{E}, r), r) \leq C_{\tilde{\tau}^{\tilde{Y}\tilde{\eta}\tilde{\mu}}}(\mathcal{S} \cup \mathcal{E}, r) = \mathcal{S} \cup \mathcal{E}.$$

Now,

$$\mathcal{S} = C_{\tilde{\tau}^{\tilde{Y}\tilde{\eta}\tilde{\mu}}} (int_{\tilde{\tau}^{\tilde{Y}\tilde{\eta}\tilde{\mu}}}(\mathcal{S}, r), r) \leq C_{\tilde{\tau}^{\tilde{Y}\tilde{\eta}\tilde{\mu}}} (int_{\tilde{\tau}^{\tilde{Y}\tilde{\eta}\tilde{\mu}}}(\mathcal{S} \cup \mathcal{E}, r), r),$$

and

$$\mathcal{E} = C_{\tilde{\tau}^{\tilde{Y}\tilde{\eta}\tilde{\mu}}} (int_{\tilde{\tau}^{\tilde{Y}\tilde{\eta}\tilde{\mu}}}(\mathcal{E}, r), r) \leq C_{\tilde{\tau}^{\tilde{Y}\tilde{\eta}\tilde{\mu}}} (int_{\tilde{\tau}^{\tilde{Y}\tilde{\eta}\tilde{\mu}}}(\mathcal{S} \cup \mathcal{E}, r), r).$$

Thus, $\mathcal{S} \cup \mathcal{E} \leq C_{\tilde{\tau}^{\tilde{Y}\tilde{\eta}\tilde{\mu}}} (int_{\tilde{\tau}^{\tilde{Y}\tilde{\eta}\tilde{\mu}}}(\mathcal{S} \cup \mathcal{E}, r), r)$. So, $\mathcal{S} \cup \mathcal{E} = C_{\tilde{\tau}^{\tilde{Y}\tilde{\eta}\tilde{\mu}}} (int_{\tilde{\tau}^{\tilde{Y}\tilde{\eta}\tilde{\mu}}}(\mathcal{S} \cup \mathcal{E}, r), r)$. Hence, $\mathcal{S} \cup \mathcal{E}$ $r - SVNRC$ set.

(2) It can be ascertained by the same method.

Theorem 3.6. Let $(\tilde{\mathfrak{X}}, \tilde{\tau}^{\tilde{Y}\tilde{\eta}\tilde{\mu}})$ be an $SVNTS$, Then,

1. If $\mathcal{S} \in I^{\tilde{\mathfrak{X}}}$ s.t. $\tilde{\tau}^{\tilde{Y}}(\mathcal{S}^c) \geq r, \tilde{\tau}^{\tilde{\eta}}(\mathcal{S}^c) \leq 1 - r, \tilde{\tau}^{\tilde{\mu}}(\mathcal{S}^c) \leq 1 - r$, then, $int_{\tilde{\tau}^{\tilde{Y}\tilde{\eta}\tilde{\mu}}}(\mathcal{S}, r)$ is $r - SVNRO$ set,
2. If $\mathcal{S} \in I^{\tilde{\mathfrak{X}}}$ s.t. $\tilde{\tau}^{\tilde{Y}}(\mathcal{S}) \geq r, \tilde{\tau}^{\tilde{\eta}}(\mathcal{S}) \leq 1 - r$ and $\tilde{\tau}^{\tilde{\mu}}(\mathcal{S}) \leq 1 - r$, then, $C_{\tilde{\tau}^{\tilde{Y}\tilde{\eta}\tilde{\mu}}}(\mathcal{S}, r)$ is $r - SVNRC$ set.

Proof. (1) Suppose that $\mathcal{S} \in I^{\tilde{\mathfrak{X}}}$ such that, $\tilde{\tau}^{\tilde{Y}}(\mathcal{S}^c) \geq r, \tilde{\tau}^{\tilde{\eta}}(\mathcal{S}^c) \leq 1 - r, \tilde{\tau}^{\tilde{\mu}}(\mathcal{S}^c) \leq 1 - r$. Clearly,

$$int_{\tilde{\tau}^{\tilde{Y}\tilde{\eta}\tilde{\mu}}}(\mathcal{S}, r) \leq int_{\tilde{\tau}^{\tilde{Y}\tilde{\eta}\tilde{\mu}}}(C_{\tilde{\tau}^{\tilde{Y}\tilde{\eta}\tilde{\mu}}}(\mathcal{S}, r), r),$$

this denotes that, $int_{\tilde{\tau}^{\tilde{Y}\tilde{\eta}\tilde{\mu}}}(\mathcal{S}, r) \leq int_{\tilde{\tau}^{\tilde{Y}\tilde{\eta}\tilde{\mu}}}(C_{\tilde{\tau}^{\tilde{Y}\tilde{\eta}\tilde{\mu}}}(int_{\tilde{\tau}^{\tilde{Y}\tilde{\eta}\tilde{\mu}}}(\mathcal{S}, r), r), r)$. Now, since,

$$\tilde{\tau}^{\tilde{Y}}(\mathcal{S}^c) \geq r, \tilde{\tau}^{\tilde{\eta}}(\mathcal{S}^c) \leq 1 - r, \tilde{\tau}^{\tilde{\mu}}(\mathcal{S}^c) \leq 1 - r,$$

then $C_{\tilde{\tau}^{\tilde{Y}\tilde{\eta}\tilde{\mu}}}(int_{\tilde{\tau}^{\tilde{Y}\tilde{\eta}\tilde{\mu}}}(\mathcal{S}, r), r) \leq \mathcal{S}$; therefore,

$$int_{\tilde{\tau}^{\tilde{Y}\tilde{\eta}\tilde{\mu}}}(\mathcal{S}, r) \geq int_{\tilde{\tau}^{\tilde{Y}\tilde{\eta}\tilde{\mu}}}(C_{\tilde{\tau}^{\tilde{Y}\tilde{\eta}\tilde{\mu}}}(int_{\tilde{\tau}^{\tilde{Y}\tilde{\eta}\tilde{\mu}}}(\mathcal{S}, r), r), r).$$

Then, $int_{\tilde{\tau}^{\tilde{Y}\tilde{\eta}\tilde{\mu}}}(\mathcal{S}, r) = int_{\tilde{\tau}^{\tilde{Y}\tilde{\eta}\tilde{\mu}}}(C_{\tilde{\tau}^{\tilde{Y}\tilde{\eta}\tilde{\mu}}}(int_{\tilde{\tau}^{\tilde{Y}\tilde{\eta}\tilde{\mu}}}(\mathcal{S}, r), r), r)$. Hence, $int_{\tilde{\tau}^{\tilde{Y}\tilde{\eta}\tilde{\mu}}}(\mathcal{S}, r)$ is $r - SVNRO$ set.

(2) Similar to the proof of (1).

Definition 3.7. A mapping $f: (\tilde{\mathfrak{X}}_1, \tilde{\tau}_1^{\tilde{Y}\tilde{\eta}\tilde{\mu}}) \rightarrow (\tilde{\mathfrak{X}}_2, \tilde{\tau}_2^{\tilde{Y}\tilde{\eta}\tilde{\mu}})$ from an $SVNTS$ $(\tilde{\mathfrak{X}}_1, \tilde{\tau}_1^{\tilde{Y}\tilde{\eta}\tilde{\mu}})$ into another $SVNTS$ $(\tilde{\mathfrak{X}}_2, \tilde{\tau}_2^{\tilde{Y}\tilde{\eta}\tilde{\mu}})$ is called:

1. $SVN - almost\ continuous$ iff $\tilde{\tau}_1^{\tilde{Y}}(f^{-1}(\mathcal{S})) \geq r, \tilde{\tau}_1^{\tilde{\eta}}(f^{-1}(\mathcal{S})) \leq 1 - r, \tilde{\tau}_1^{\tilde{\mu}}(f^{-1}(\mathcal{S})) \leq 1 - r$, for each $r - SVNRO$ set \mathcal{S} of $\tilde{\mathfrak{X}}_2$,
2. $SVN - weakly\ continuous$ iff $\tilde{\tau}_2^{\tilde{Y}}(\mathcal{S}) \geq r, \tilde{\tau}_2^{\tilde{\eta}}(\mathcal{S}) \leq 1 - r$ and $\tilde{\tau}_2^{\tilde{\mu}}(\mathcal{S}) \leq 1 - r$, implies $\tilde{\tau}_1^{\tilde{Y}}(f^{-1}(\mathcal{S})) \geq r, \tilde{\tau}_1^{\tilde{\eta}}(f^{-1}(\mathcal{S})) \leq 1 - r, \tilde{\tau}_1^{\tilde{\mu}}(f^{-1}(\mathcal{S})) \leq 1 - r$, for each $\mathcal{S} \in I^{\tilde{\mathfrak{X}}_2}$.

Remark 3.8. From Definition 3.7, it is clear that the next implications are correct for $r \in I_0$:

$SVN - almost\ continuous\ mapping$

↑

$SVN - continuous\ mapping$

↓

$SVN - weakly\ continuous\ mapping$

However, the one-sided suggestions are not correct in general, as presented by the next example.

Example 3.9. Suppose that $\tilde{\mathfrak{X}} = \{a, b, c\}$. Define $\mathcal{E}_1, \mathcal{E}_2 \in I^{\tilde{\mathfrak{X}}}$ as follows:

$$\mathcal{E}_1 = \langle (0 \cdot 5, 0.4, 0 \cdot 5), (0 \cdot 5, 0.4, 0 \cdot 5), (0 \cdot 5, 0.5, 0 \cdot 5) \rangle, \quad \mathcal{E}_2 = \langle (0 \cdot 5, 0 \cdot 4, 0.4), (0 \cdot 5, 0 \cdot 4, 0.4), (0 \cdot 5, 0 \cdot 5, .4) \rangle,$$

$$\mathcal{E}_3 = \langle (0 \cdot 3, 0.6, 0 \cdot 5), (0 \cdot 3, 0.6, 0 \cdot 5), 0 \cdot 3, 0.6, 0 \cdot 5 \rangle, \quad \mathcal{E}_4 = \langle (0 \cdot 4, 0 \cdot 4, 0.4), (0 \cdot 5, 0 \cdot 4, 0.4), (0 \cdot 5, 0 \cdot 5, .4) \rangle.$$

We define an $\tilde{\tau}_1^{\tilde{\gamma}\tilde{\eta}\tilde{\mu}}, \tilde{\tau}_2^{\tilde{\gamma}\tilde{\eta}\tilde{\mu}} : I^{\tilde{\mathfrak{X}}} \rightarrow I$ as follows:

$$\tilde{\tau}_1^{\tilde{\gamma}}(\mathcal{S}) = \begin{cases} 1, & \text{if } \mathcal{S} = \tilde{0}, \\ 1, & \text{if } \mathcal{S} = \tilde{1}, \\ \frac{1}{2}, & \text{if } \mathcal{S} = \mathcal{E}_2, \\ 0, & \text{otherwise} \end{cases} \quad \tilde{\tau}_2^{\tilde{\gamma}}(\mathcal{S}) = \begin{cases} 1, & \text{if } \mathcal{S} = \tilde{0}, \\ 1, & \text{if } \mathcal{S} = \tilde{1}, \\ \frac{1}{2}, & \text{if } \mathcal{S} = \{\mathcal{E}_2, \mathcal{E}_4\}, \\ 0, & \text{otherwise} \end{cases}$$

$$\tilde{\tau}_1^{\tilde{\eta}}(\mathcal{S}) = \begin{cases} 0, & \text{if } \mathcal{S} = \tilde{0}, \\ 0, & \text{if } \mathcal{S} = \tilde{1}, \\ \frac{1}{2}, & \text{if } \mathcal{S} = \{\mathcal{E}_1, \mathcal{E}_2\}, \\ 1, & \text{otherwise} \end{cases} \quad \tilde{\tau}_2^{\tilde{\eta}}(\mathcal{S}) = \begin{cases} 0, & \text{if } \mathcal{S} = \tilde{0}, \\ 0, & \text{if } \mathcal{S} = \tilde{1}, \\ \frac{1}{2}, & \text{if } \mathcal{S} = \{\mathcal{E}_2, \mathcal{E}_4\}, \\ 1, & \text{otherwise} \end{cases}$$

$$\tilde{\tau}_1^{\tilde{\mu}}(\mathcal{S}) = \begin{cases} 0, & \text{if } \mathcal{S} = \tilde{0}, \\ 0, & \text{if } \mathcal{S} = \tilde{1}, \\ \frac{1}{2}, & \text{if } \mathcal{S} = \{\mathcal{E}_2, \mathcal{E}_3\}, \\ 1, & \text{otherwise} \end{cases} \quad \tilde{\tau}_2^{\tilde{\mu}}(\mathcal{S}) = \begin{cases} 0, & \text{if } \mathcal{S} = \tilde{0}, \\ 0, & \text{if } \mathcal{S} = \tilde{1}, \\ \frac{1}{2}, & \text{if } \mathcal{S} = \{\mathcal{E}_2, \mathcal{E}_4\}, \\ 1, & \text{otherwise} \end{cases}$$

Then, the identity mapping, $f: (\tilde{\mathfrak{X}}_1, \tilde{\tau}_1^{\tilde{\gamma}\tilde{\eta}\tilde{\mu}}) \rightarrow (\tilde{\mathfrak{X}}_2, \tilde{\tau}_2^{\tilde{\gamma}\tilde{\eta}\tilde{\mu}})$ is *SVN* – almost continuous, but it is not *SVN* – continuou. Since, $\tilde{\tau}_2^{\tilde{\gamma}}(\mathcal{E}_4) = \frac{1}{2}$ and \mathcal{E}_4 is not $\frac{1}{2}$ – *SVNO* set in $\tilde{\mathfrak{X}}_1$, because, $\tilde{\tau}_1^{\tilde{\gamma}}(f^{-1}(\mathcal{E}_4)) = 0 \not\geq \frac{1}{2}$, $\tilde{\tau}_1^{\tilde{\eta}}(f^{-1}(\mathcal{E}_4)) = 1 \not\leq \frac{1}{2}$ and $\tilde{\tau}_1^{\tilde{\mu}}(f^{-1}(\mathcal{E}_4)) = 1 \not\geq \frac{1}{2}$. Hence, $[\tilde{\tau}_2^{\tilde{\gamma}}(\mathcal{E}_4) = \frac{1}{2} \not\leq 0 = \tilde{\tau}_1^{\tilde{\gamma}}(f^{-1}(\mathcal{E}_4)) , \tilde{\tau}_2^{\tilde{\eta}}(\mathcal{E}_4) = \frac{1}{2} \not\geq 1 = \tilde{\tau}_1^{\tilde{\eta}}(f^{-1}(\mathcal{E}_4)) , \tilde{\tau}_2^{\tilde{\mu}}(\mathcal{E}_4) = \frac{1}{2} \not\geq 1 = \tilde{\tau}_1^{\tilde{\mu}}(f^{-1}(\mathcal{E}_4))]$.

Theorem 3.10. Let $f: (\tilde{\mathfrak{X}}_1, \tilde{\tau}_1^{\tilde{\gamma}\tilde{\eta}\tilde{\mu}}) \rightarrow (\tilde{\mathfrak{X}}_2, \tilde{\tau}_2^{\tilde{\gamma}\tilde{\eta}\tilde{\mu}})$ be a mapping from an *SVNTS* $(\tilde{\mathfrak{X}}_1, \tilde{\tau}_1^{\tilde{\gamma}\tilde{\eta}\tilde{\mu}})$ into another *SVNTS* $(\tilde{\mathfrak{X}}_2, \tilde{\tau}_2^{\tilde{\gamma}\tilde{\eta}\tilde{\mu}})$. Then the next statements are equivalent:

1. f is *SVN* – almost continuous,
2. $\tilde{\tau}_1^{\tilde{\gamma}}((f^{-1}(\mathcal{S}))^c) \geq r, \tilde{\tau}_1^{\tilde{\eta}}((f^{-1}(\mathcal{S}))^c) \leq 1 - r, \tilde{\tau}_1^{\tilde{\mu}}((f^{-1}(\mathcal{S}))^c) \leq 1 - r$, for any r – *SVNRC* set \mathcal{S} of $\tilde{\mathfrak{X}}_2$,
3. $f^{-1}(\mathcal{S}) \leq \text{int}_{\tilde{\tau}_1^{\tilde{\gamma}\tilde{\eta}\tilde{\mu}}}(f^{-1}(\text{int}_{\tilde{\tau}_2^{\tilde{\gamma}\tilde{\eta}\tilde{\mu}}}(C_{\tilde{\tau}_2^{\tilde{\gamma}\tilde{\eta}\tilde{\mu}}}(\mathcal{S}, r), r)), r)$, for any \mathcal{S} of $\tilde{\mathfrak{X}}_2$ such that $\tilde{\tau}_2^{\tilde{\gamma}}(\mathcal{S}) \geq r, \tilde{\tau}_2^{\tilde{\eta}}(\mathcal{S}) \leq 1 - r$ and $\tilde{\tau}_2^{\tilde{\mu}}(\mathcal{S}) \leq 1 - r$,
4. $C_{\tilde{\tau}_1^{\tilde{\gamma}\tilde{\eta}\tilde{\mu}}}(f^{-1}(C_{\tilde{\tau}_2^{\tilde{\gamma}\tilde{\eta}\tilde{\mu}}}(\text{int}_{\tilde{\tau}_2^{\tilde{\gamma}\tilde{\eta}\tilde{\mu}}}(\mathcal{S}, r), r)), r) \leq f^{-1}(\mathcal{S})$, for any \mathcal{S} of $\tilde{\mathfrak{X}}_2$ such that $\tilde{\tau}_2^{\tilde{\gamma}}(\mathcal{S}) \geq r, \tilde{\tau}_2^{\tilde{\eta}}(\mathcal{S}) \leq 1 - r$ and $\tilde{\tau}_2^{\tilde{\mu}}(\mathcal{S}) \leq 1 - r$.

Proof. (1) \Rightarrow (2). Let \mathcal{S} be an r – *SVNRC* set of $\tilde{\mathfrak{X}}_2$. Then by Lemma 3.4, \mathcal{S}^c is r – *SVNRO* set in $\tilde{\mathfrak{X}}_2$. By (1), we obtain

$$\tilde{\tau}_1^{\tilde{\gamma}}(f^{-1}(\mathcal{S}^c)) = \tilde{\tau}_1^{\tilde{\gamma}}((f^{-1}(\mathcal{S}))^c) \geq r, \quad \tilde{\tau}_1^{\tilde{\eta}}(f^{-1}(\mathcal{S}^c)) = \tilde{\tau}_1^{\tilde{\eta}}((f^{-1}(\mathcal{S}))^c) \leq 1 - r,$$

$$\tilde{\tau}_1^{\tilde{\mu}}(f^{-1}(\mathcal{S}^c)) = \tilde{\tau}_1^{\tilde{\mu}}((f^{-1}(\mathcal{S}))^c) \leq 1 - r.$$

(2) \Rightarrow (1). It is analogous to the proof of (1) \Rightarrow (2).

(1) \Rightarrow (3). Since, $[\tilde{\tau}_2^{\tilde{\gamma}}(\mathcal{S}) \geq r, \tilde{\tau}_2^{\tilde{\eta}}(\mathcal{S}) \leq 1 - r, \tilde{\tau}_2^{\tilde{\mu}}(\mathcal{S}) \leq 1 - r]$, then, $\mathcal{S} = \text{int}_{\tilde{\tau}_2^{\tilde{\gamma}\tilde{\eta}\tilde{\mu}}}(\mathcal{S}, r) \leq \text{int}_{\tilde{\tau}_2^{\tilde{\gamma}\tilde{\eta}\tilde{\mu}}}(C_{\tilde{\tau}_2^{\tilde{\gamma}\tilde{\eta}\tilde{\mu}}}(\mathcal{S}, r), r)$,

and hence, $f^{-1}(\mathcal{S}) = f^{-1}(\text{int}_{\tilde{\tau}_2^{\tilde{\gamma}\tilde{\eta}\tilde{\mu}}}(C_{\tilde{\tau}_2^{\tilde{\gamma}\tilde{\eta}\tilde{\mu}}}(\mathcal{S}, r), r))$, since

$$\tilde{\tau}_2^{\tilde{Y}}\left([C_{\tilde{\tau}_2^{\tilde{Y}}}(\mathcal{S}, r)]^c\right) \geq r, \quad \tilde{\tau}_2^{\tilde{\eta}}\left([C_{\tilde{\tau}_2^{\tilde{\eta}}}(\mathcal{S}, r)]^c\right) \leq 1 - r, \quad \tilde{\tau}_2^{\tilde{\mu}}\left([C_{\tilde{\tau}_2^{\tilde{\mu}}}(\mathcal{S}, r)]^c\right) \leq 1 - r,$$

then by Theorem 3.6 $int_{\tilde{\tau}_2^{\tilde{Y}\tilde{\eta}\tilde{\mu}}}(C_{\tilde{\tau}_2^{\tilde{Y}\tilde{\eta}\tilde{\mu}}}(\mathcal{S}, r), r)$ is $r - SVNRO$ set. So,

$$\tilde{\tau}_1^{\tilde{Y}}(f^{-1}(int_{\tilde{\tau}_2^{\tilde{Y}}}(C_{\tilde{\tau}_2^{\tilde{Y}}}(\mathcal{S}, r), r))) \geq r, \quad \tilde{\tau}_1^{\tilde{\eta}}(f^{-1}(int_{\tilde{\tau}_2^{\tilde{\eta}}}(C_{\tilde{\tau}_2^{\tilde{\eta}}}(\mathcal{S}, r), r))) \leq 1 - r, \quad \tilde{\tau}_1^{\tilde{\mu}}(f^{-1}(int_{\tilde{\tau}_2^{\tilde{\mu}}}(C_{\tilde{\tau}_2^{\tilde{\mu}}}(\mathcal{S}, r), r))) \leq 1 - r.$$

Therefore, $f^{-1}(\mathcal{S}) \leq f^{-1}(int_{\tilde{\tau}_2^{\tilde{Y}\tilde{\eta}\tilde{\mu}}}(C_{\tilde{\tau}_2^{\tilde{Y}\tilde{\eta}\tilde{\mu}}}(\mathcal{S}, r), r)) = int_{\tilde{\tau}_1^{\tilde{Y}\tilde{\eta}\tilde{\mu}}}(f^{-1}(int_{\tilde{\tau}_2^{\tilde{Y}\tilde{\eta}\tilde{\mu}}}(C_{\tilde{\tau}_2^{\tilde{Y}\tilde{\eta}\tilde{\mu}}}(\mathcal{S}, r), r)))$.

(3) \Rightarrow (1). Let \mathcal{S} be an $r - SVNRO$ set of $\tilde{\mathfrak{X}}_2$. Then, we get

$$f^{-1}(\mathcal{S}) \leq int_{\tilde{\tau}_1^{\tilde{Y}\tilde{\eta}\tilde{\mu}}}(f^{-1}(int_{\tilde{\tau}_2^{\tilde{Y}\tilde{\eta}\tilde{\mu}}}(C_{\tilde{\tau}_2^{\tilde{Y}\tilde{\eta}\tilde{\mu}}}(\mathcal{S}, r), r)), r) = int_{\tilde{\tau}_1^{\tilde{Y}\tilde{\eta}\tilde{\mu}}}(f^{-1}(\mathcal{S}), r);$$

this suggests that, $f^{-1}(\mathcal{S}) = int_{\tilde{\tau}_1^{\tilde{Y}\tilde{\eta}\tilde{\mu}}}(f^{-1}(\mathcal{S}), r)$, then

$$\tilde{\tau}_1^{\tilde{Y}}(f^{-1}(\mathcal{S})) = \tilde{\tau}_1^{\tilde{Y}}(int_{\tilde{\tau}_1^{\tilde{Y}\tilde{\eta}\tilde{\mu}}}(f^{-1}(\mathcal{S}), r)) \geq r, \quad \tilde{\tau}_1^{\tilde{\eta}}(f^{-1}(\mathcal{S})) = \tilde{\tau}_1^{\tilde{\eta}}(int_{\tilde{\tau}_1^{\tilde{Y}\tilde{\eta}\tilde{\mu}}}(f^{-1}(\mathcal{S}), r)) \leq 1 - r,$$

$$\tilde{\tau}_1^{\tilde{\mu}}(f^{-1}(\mathcal{S})) = \tilde{\tau}_1^{\tilde{\mu}}(int_{\tilde{\tau}_1^{\tilde{Y}\tilde{\eta}\tilde{\mu}}}(f^{-1}(\mathcal{S}), r)) \leq 1 - r.$$

Therefore, f is $\mathcal{SVN} - almost\ continuous$.

(2) \Leftrightarrow (4). Can be proved similarly.

Theorem 3.11. Let $f: (\tilde{\mathfrak{X}}_1, \tilde{\tau}_1^{\tilde{Y}\tilde{\eta}\tilde{\mu}}) \rightarrow (\tilde{\mathfrak{X}}_2, \tilde{\tau}_2^{\tilde{Y}\tilde{\eta}\tilde{\mu}})$ be a map from an \mathcal{SVNTS} $(\tilde{\mathfrak{X}}_1, \tilde{\tau}_1^{\tilde{Y}\tilde{\eta}\tilde{\mu}})$ into another \mathcal{SVNTS} $(\tilde{\mathfrak{X}}_2, \tilde{\tau}_2^{\tilde{Y}\tilde{\eta}\tilde{\mu}})$. Then the following are equivalent:

1. f is $\mathcal{SVN} - weakly\ continuous$,
2. $f(C_{\tilde{\tau}_1^{\tilde{Y}\tilde{\eta}\tilde{\mu}}}(\mathcal{S}, r)) \leq C_{\tilde{\tau}_2^{\tilde{Y}\tilde{\eta}\tilde{\mu}}}(f(\mathcal{S}), r)$ for each $\mathcal{S} \in I^{\tilde{\mathfrak{X}}_1}$

Proof. (1) \Rightarrow (2). : Let $\mathcal{S} \in I^{\tilde{\mathfrak{X}}_1}$. Then,

$$\begin{aligned} f^{-1}(C_{\tilde{\tau}_2^{\tilde{Y}\tilde{\eta}\tilde{\mu}}}(f(\mathcal{S}), r)) &= f^{-1}\left[\bigcap\left\{\mathcal{E} \in I^{\tilde{\mathfrak{X}}_2}: \tilde{\tau}_2^{\tilde{Y}}(\mathcal{E}^c) \geq r, \tilde{\tau}_2^{\tilde{\eta}}(\mathcal{E}^c) \leq 1 - r, \tilde{\tau}_2^{\tilde{\mu}}(\mathcal{E}^c) \leq 1 - r, \quad \mathcal{E} \geq f(\mathcal{S})\right\}\right] \\ &\geq f^{-1}\left[\bigcap\left\{\mathcal{E} \in I^{\tilde{\mathfrak{X}}_2}: \tilde{\tau}_1^{\tilde{Y}}(f^{-1}(\mathcal{E}^c)) \geq r, \tilde{\tau}_1^{\tilde{\eta}}(f^{-1}(\mathcal{E}^c)) \leq 1 - r, \tilde{\tau}_1^{\tilde{\mu}}(f^{-1}(\mathcal{E}^c)) \leq 1 - r, \quad \mathcal{E} \geq f(\mathcal{S})\right\}\right] \\ &\geq f^{-1}\left[\bigcap\left\{\mathcal{E} \in I^{\tilde{\mathfrak{X}}_2}: \tilde{\tau}_1^{\tilde{Y}}((f^{-1}(\mathcal{E}))^c) \geq r, \tilde{\tau}_1^{\tilde{\eta}}((f^{-1}(\mathcal{E}))^c) \leq 1 - r, \tilde{\tau}_1^{\tilde{\mu}}((f^{-1}(\mathcal{E}))^c) \leq 1 - r, \quad \mathcal{E} \geq f(\mathcal{S})\right\}\right] \\ &\geq \bigcap\left\{f^{-1}(\mathcal{E}) \in I^{\tilde{\mathfrak{X}}_1}: \tilde{\tau}_1^{\tilde{Y}}((f^{-1}(\mathcal{E}))^c) \geq r, \tilde{\tau}_1^{\tilde{\eta}}((f^{-1}(\mathcal{E}))^c) \leq 1 - r, \tilde{\tau}_1^{\tilde{\mu}}((f^{-1}(\mathcal{E}))^c) \leq 1 - r, \quad f^{-1}(\mathcal{E}) \geq \mathcal{S}\right\} \\ &\geq \bigcap\left\{\mathcal{D} \in I^{\tilde{\mathfrak{X}}_1}: \tilde{\tau}_1^{\tilde{Y}}(\mathcal{D}^c) \geq r, \tilde{\tau}_1^{\tilde{\eta}}(\mathcal{D}^c) \leq 1 - r, \tilde{\tau}_1^{\tilde{\mu}}(\mathcal{D}^c) \leq 1 - r, \quad \mathcal{D} \geq \mathcal{S}\right\} = C_{\tilde{\tau}_1^{\tilde{Y}\tilde{\eta}\tilde{\mu}}}(\mathcal{S}, r). \end{aligned}$$

Hence, $f(C_{\tilde{\tau}_1^{\tilde{Y}\tilde{\eta}\tilde{\mu}}}(\mathcal{S}, r)) \leq f(f^{-1}(C_{\tilde{\tau}_2^{\tilde{Y}\tilde{\eta}\tilde{\mu}}}(f(\mathcal{S}), r))) \leq C_{\tilde{\tau}_2^{\tilde{Y}\tilde{\eta}\tilde{\mu}}}(f(\mathcal{S}), r)$.

(2) \Rightarrow (1). It is similar to that of (1) \Rightarrow (2).

Corollary 3.12. Let $f: \tilde{\mathfrak{X}}_1 \rightarrow \tilde{\mathfrak{X}}_2$ be an $\mathcal{SVN} - continuous$ mapping with respect to the \mathcal{SVNTS} $\tilde{\tau}_1^{\tilde{Y}\tilde{\eta}\tilde{\mu}}$ and $\tilde{\tau}_2^{\tilde{Y}\tilde{\eta}\tilde{\mu}}$ respectively. Then, for each $\mathcal{S} \in I^{\tilde{\mathfrak{X}}_1}$, $f(C_{\tilde{\tau}_1^{\tilde{Y}\tilde{\eta}\tilde{\mu}}}(\mathcal{S}, r)) \leq C_{\tilde{\tau}_2^{\tilde{Y}\tilde{\eta}\tilde{\mu}}}(f(\mathcal{S}), r)$.

Theorem 3.13. Let $f: \tilde{\mathfrak{X}}_1 \rightarrow \tilde{\mathfrak{X}}_2$ be an $\mathcal{SVN} - continuous$ mapping with respect to the \mathcal{SVNT} $\tilde{\tau}_1^{\tilde{Y}\tilde{\eta}\tilde{\mu}}$ and $\tilde{\tau}_2^{\tilde{Y}\tilde{\eta}\tilde{\mu}}$, respectively. Then, for any $\mathcal{S} \in I^{\tilde{\mathfrak{X}}_2}$, $C_{\tilde{\tau}_1^{\tilde{Y}\tilde{\eta}\tilde{\mu}}}(f^{-1}(\mathcal{S}), r) \leq f^{-1}(C_{\tilde{\tau}_2^{\tilde{Y}\tilde{\eta}\tilde{\mu}}}(\mathcal{S}, r))$.

Proof. Let $\mathcal{S} \in I^{\tilde{\mathfrak{X}}_2}$. We get from Theorem 3.12, $C_{\tilde{\tau}_1^{\tilde{Y}\tilde{\eta}\tilde{\mu}}}(f^{-1}(\mathcal{S}), r) \leq f^{-1}(f(C_{\tilde{\tau}_1^{\tilde{Y}\tilde{\eta}\tilde{\mu}}}(f^{-1}(\mathcal{S}), r))) \leq f^{-1}(C_{\tilde{\tau}_2^{\tilde{Y}\tilde{\eta}\tilde{\mu}}}(\mathcal{S}, r))$.

Hence, $C_{\tilde{\tau}_1^{\tilde{\nu}\tilde{\eta}\tilde{\mu}}}(f^{-1}(\mathcal{S}), r) \leq f^{-1}(C_{\tilde{\tau}_2^{\tilde{\nu}\tilde{\eta}\tilde{\mu}}}(\mathcal{S}, r))$, for every $\mathcal{S} \in I^{\tilde{\mathfrak{X}}_2}$.

4. Compactness on Single-Valued Neutrosophic Ideal Topological Spaces

This section aims to establish new notions of r -single-valued neutrosophic aspects called (compact, ideal compact, ideal quasi H-closed, compact modulo an single-valued neutrosophic ideal) (briefly, $r - \mathcal{SVN} - compact$, $r - \mathcal{SVNI} - compact$, $r - \mathcal{SVNJ} - compact$, $r - \mathcal{SVNJ} - quasi H - closed$, $r - \mathcal{SVNC}(\mathcal{J}) - compact$) in \mathcal{SVNJTS} .

Definition 4.1. Let $(\tilde{\mathfrak{X}}, \tilde{\tau}^{\tilde{\nu}\tilde{\eta}\tilde{\mu}})$ be an \mathcal{SVNJTS} and $r \in I_0$. Then $\tilde{\mathfrak{X}}$ is called $r - \mathcal{SVN} - compact$ iff for every family $\{\mathcal{S}_j \in I^{\tilde{\mathfrak{X}}}: \tilde{\tau}^{\tilde{\nu}}(\mathcal{S}_j) \geq r, \tilde{\tau}^{\tilde{\eta}}(\mathcal{S}_j) \leq 1 - r, \tilde{\tau}^{\tilde{\mu}}(\mathcal{S}_j) \leq 1 - r, j \in \Gamma\}$ such that $\bigcup_{j \in \Gamma} \mathcal{S}_j = \tilde{\mathfrak{I}}$, there exists a finite subset $\Gamma_0 \subseteq \Gamma$ such that $\bigcup_{j \in \Gamma_0} \mathcal{S}_j = \tilde{\mathfrak{I}}$.

Definition 4.2. Let $(\tilde{\mathfrak{X}}, \tilde{\tau}^{\tilde{\nu}\tilde{\eta}\tilde{\mu}}, \tilde{\mathfrak{J}}^{\tilde{\nu}\tilde{\eta}\tilde{\mu}})$ be an \mathcal{SVNJTS} and $r \in I_0$. Then,

- (1) $\tilde{\mathfrak{X}}$ is called $r - \mathcal{SVNJ} - compact$ (resp., $r - \mathcal{SVNJ} - quasi H - closed$) iff every family, $\{\mathcal{S}_j \in I^{\tilde{\mathfrak{X}}}: \tilde{\tau}^{\tilde{\nu}}(\mathcal{S}_j) \geq r, \tilde{\tau}^{\tilde{\eta}}(\mathcal{S}_j) \leq 1 - r, \tilde{\tau}^{\tilde{\mu}}(\mathcal{S}_j) \leq 1 - r, j \in \Gamma\}$ such that $\bigcup_{j \in \Gamma} \mathcal{S}_j = \tilde{\mathfrak{I}}$, there exists a finite subse $\Gamma_0 \subseteq \Gamma$ such that $\tilde{\mathfrak{J}}^{\tilde{\nu}}([\bigcup_{j \in \Gamma_0} \mathcal{S}_j]^c) \geq r, \tilde{\mathfrak{J}}^{\tilde{\eta}}([\bigcup_{j \in \Gamma_0} \mathcal{S}_j]^c) \leq 1 - r, \tilde{\mathfrak{J}}^{\tilde{\mu}}([\bigcup_{j \in \Gamma_0} \mathcal{S}_j]^c) \leq 1 - r$ (resp., $\tilde{\mathfrak{J}}^{\tilde{\nu}}([\bigcup_{j \in \Gamma_0} C_{\tilde{\tau}^{\tilde{\nu}}}(\mathcal{S}_j, r)]^c) \geq r, \tilde{\mathfrak{J}}^{\tilde{\eta}}([\bigcup_{j \in \Gamma_0} C_{\tilde{\tau}^{\tilde{\eta}}}(\mathcal{S}_j, r)]^c) \leq 1 - r, \tilde{\mathfrak{J}}^{\tilde{\mu}}([\bigcup_{j \in \Gamma_0} C_{\tilde{\tau}^{\tilde{\mu}}}(\mathcal{S}_j, r)]^c) \leq 1 - r$).
- (2) $\tilde{\mathfrak{X}}$ is called $r - \mathcal{SVNC}(\mathcal{J}) - compact$ if for any $\tilde{\tau}^{\tilde{\nu}}(\mathcal{S}^c) \geq r, \tilde{\tau}^{\tilde{\eta}}(\mathcal{S}^c) \leq 1 - r, \tilde{\tau}^{\tilde{\mu}}(\mathcal{S}^c) \leq 1 - r$ and every family $\{\mathcal{E}_j \in I^{\tilde{\mathfrak{X}}}: \tilde{\tau}^{\tilde{\nu}}(\mathcal{E}_j) \geq r, \tilde{\tau}^{\tilde{\eta}}(\mathcal{E}_j) \leq 1 - r, \tilde{\tau}^{\tilde{\mu}}(\mathcal{E}_j) \leq 1 - r, j \in \Gamma\}$ such that $\mathcal{S} \leq \bigcup_{j \in \Gamma} \mathcal{E}_j$, there exists a finite subse $\Gamma_0 \subseteq \Gamma$ such that $\tilde{\mathfrak{J}}^{\tilde{\nu}}(\mathcal{S} \cap [\bigcup_{j \in \Gamma_0} C_{\tilde{\tau}^{\tilde{\nu}}}(\mathcal{E}_j, r)]^c) \geq r, \tilde{\mathfrak{J}}^{\tilde{\eta}}(\mathcal{S} \cap [\bigcup_{j \in \Gamma_0} C_{\tilde{\tau}^{\tilde{\eta}}}(\mathcal{E}_j, r)]^c) \leq 1 - r, \tilde{\mathfrak{J}}^{\tilde{\mu}}(\mathcal{S} \cap [\bigcup_{j \in \Gamma_0} C_{\tilde{\tau}^{\tilde{\mu}}}(\mathcal{E}_j, r)]^c) \leq 1 - r$.

Definition 4.3. Let $(\tilde{\mathfrak{X}}, \tilde{\tau}^{\tilde{\nu}\tilde{\eta}\tilde{\mu}}, \tilde{\mathfrak{J}}^{\tilde{\nu}\tilde{\eta}\tilde{\mu}})$ be an \mathcal{SVNJTS} and $\mathcal{S} \in I^{\tilde{\mathfrak{X}}}$. Then \mathcal{S} is called $r - \mathcal{SVNJ} - compact$ iff every family $\{\mathcal{E}_j \in I^{\tilde{\mathfrak{X}}}: \tilde{\tau}^{\tilde{\nu}}(\mathcal{E}_j) \geq r, \tilde{\tau}^{\tilde{\eta}}(\mathcal{E}_j) \leq 1 - r, \tilde{\tau}^{\tilde{\mu}}(\mathcal{E}_j) \leq 1 - r, j \in \Gamma\}$ such that $\mathcal{S} \leq \bigcup_{j \in \Gamma} \mathcal{E}_j$, there exists a finite subse $\Gamma_0 \subseteq \Gamma$ such that $\tilde{\mathfrak{J}}^{\tilde{\nu}}(\mathcal{S} \cap [\bigcup_{j \in \Gamma_0} \mathcal{E}_j]^c) \geq r, \tilde{\mathfrak{J}}^{\tilde{\eta}}(\mathcal{S} \cap [\bigcup_{j \in \Gamma_0} \mathcal{E}_j]^c) \leq 1 - r, \tilde{\mathfrak{J}}^{\tilde{\mu}}(\mathcal{S} \cap [\bigcup_{j \in \Gamma_0} \mathcal{E}_j]^c) \leq 1 - r$.

Theorem 4.4. Let $(\tilde{\mathfrak{X}}, \tilde{\tau}^{\tilde{\nu}\tilde{\eta}\tilde{\mu}}, \tilde{\mathfrak{J}}^{\tilde{\nu}\tilde{\eta}\tilde{\mu}})$ be an \mathcal{SVNJTS} and $r \in I_0$. Then,

- (1) $r - \mathcal{SVN} - compact \Rightarrow r - \mathcal{SVNJ} - compact$,
- (2) $r - \mathcal{SVNJ} - compact \Rightarrow r - \mathcal{SVNC}(\mathcal{J}) - compact$,
- (3) $r - \mathcal{SVNJ} - compact \Rightarrow r - \mathcal{SVNI} - quasi H - closed$.

Proof. (1) For every family $\{\mathcal{S}_j \in I^{\tilde{\mathfrak{X}}}: \tilde{\tau}^{\tilde{\nu}}(\mathcal{S}_j) \geq r, \tilde{\tau}^{\tilde{\eta}}(\mathcal{S}_j) \leq 1 - r, \tilde{\tau}^{\tilde{\mu}}(\mathcal{S}_j) \leq 1 - r, j \in \Gamma\}$ such that $\bigcup_{j \in \Gamma} \mathcal{S}_j = \tilde{\mathfrak{I}}$. By $r - \mathcal{SVN} - compactness$ of $\tilde{\mathfrak{X}}$, there exists a finite subse $\Gamma_0 \subseteq \Gamma$ such that $\bigcup_{j \in \Gamma_0} \mathcal{S}_j = \tilde{\mathfrak{I}}$. Now, since $[\bigcup_{j \in \Gamma_0} \mathcal{S}_j]^c = \tilde{\mathfrak{O}}$, we have $\tilde{\mathfrak{J}}^{\tilde{\nu}}([\bigcup_{j \in \Gamma_0} \mathcal{S}_j]^c) \geq r, \tilde{\mathfrak{J}}^{\tilde{\eta}}([\bigcup_{j \in \Gamma_0} \mathcal{S}_j]^c) \leq 1 - r, \tilde{\mathfrak{J}}^{\tilde{\mu}}([\bigcup_{j \in \Gamma_0} \mathcal{S}_j]^c) \leq 1 - r$.

(2) For every $\tilde{\tau}^{\tilde{\nu}}(\mathcal{S}^c) \geq r, \tilde{\tau}^{\tilde{\eta}}(\mathcal{S}^c) \leq 1 - r, \tilde{\tau}^{\tilde{\mu}}(\mathcal{S}^c) \leq 1 - r$ and evrey family $\{\mathcal{E}_j \in I^{\tilde{\mathfrak{X}}}: \tilde{\tau}^{\tilde{\nu}}(\mathcal{E}_j) \geq r, \tilde{\tau}^{\tilde{\eta}}(\mathcal{E}_j) \leq 1 - r, \tilde{\tau}^{\tilde{\mu}}(\mathcal{E}_j) \leq 1 - r, j \in \Gamma\}$ such that $\mathcal{S} \leq \bigcup_{j \in \Gamma} \mathcal{E}_j$. By $r - \mathcal{SVNJ} - compactness$ of \mathcal{S} , there exists a finite subse $\Gamma_0 \subseteq \Gamma$ such that $\tilde{\mathfrak{J}}^{\tilde{\nu}}(\mathcal{S} \cap [\bigcup_{j \in \Gamma_0} \mathcal{E}_j]^c) \geq r, \tilde{\mathfrak{J}}^{\tilde{\eta}}(\mathcal{S} \cap [\bigcup_{j \in \Gamma_0} \mathcal{E}_j]^c) \leq 1 - r, \tilde{\mathfrak{J}}^{\tilde{\mu}}(\mathcal{S} \cap [\bigcup_{j \in \Gamma_0} \mathcal{E}_j]^c) \leq 1 - r$. Since, $\mathcal{S} \cap [\bigcup_{j \in \Gamma_0} \mathcal{E}_j]^c \geq \mathcal{S} \cap [\bigcup_{j \in \Gamma_0} C_{\tilde{\tau}^{\tilde{\nu}\tilde{\eta}\tilde{\mu}}}(\mathcal{E}_j, r)]^c$, we have

$$\tilde{\mathfrak{J}}^{\tilde{\nu}}\left(\mathcal{S} \cap \left[\bigcup_{j \in \Gamma_0} C_{\tilde{\tau}^{\tilde{\nu}}}(\mathcal{E}_j, r)\right]^c\right) \geq r, \quad \tilde{\mathfrak{J}}^{\tilde{\eta}}\left(\mathcal{S} \cap \left[\bigcup_{j \in \Gamma_0} C_{\tilde{\tau}^{\tilde{\eta}}}(\mathcal{E}_j, r)\right]^c\right) \leq 1 - r, \quad \tilde{\mathfrak{J}}^{\tilde{\mu}}\left(\mathcal{S} \cap \left[\bigcup_{j \in \Gamma_0} C_{\tilde{\tau}^{\tilde{\mu}}}(\mathcal{E}_j, r)\right]^c\right) \leq 1 - r$$

Hence, $\tilde{\mathfrak{X}}$ is $r - \mathcal{SVNC}(\mathcal{J}) - compact$.

(3) Let $\{\mathcal{S}_j \in I^{\tilde{\mathfrak{X}}}: \tilde{\tau}^{\tilde{\nu}}(\mathcal{S}_j) \geq r, \tilde{\tau}^{\tilde{\eta}}(\mathcal{S}_j) \leq 1 - r, \tilde{\tau}^{\tilde{\mu}}(\mathcal{S}_j) \leq 1 - r: j \in \Gamma\}$ be a family such that $\bigcup_{j \in \Gamma} \mathcal{S}_j = \tilde{1}$. By $r - \mathcal{SVNJ} - compactness$ of $(\tilde{\mathfrak{X}}, \tilde{\tau}^{\tilde{\nu}\tilde{\eta}\tilde{\mu}}, \tilde{\mathfrak{J}}^{\tilde{\nu}\tilde{\eta}\tilde{\mu}})$, there exists a finite subfamily $\Gamma_0 \subseteq \Gamma$ such that $\tilde{\mathfrak{J}}^{\tilde{\nu}}([\bigcup_{j \in \Gamma_0} \mathcal{S}_j]^c) \geq r, \tilde{\mathfrak{J}}^{\tilde{\eta}}([\bigcup_{j \in \Gamma_0} \mathcal{S}_j]^c) \leq 1 - r, \tilde{\mathfrak{J}}^{\tilde{\mu}}([\bigcup_{j \in \Gamma_0} \mathcal{S}_j]^c) \leq 1 - r$. Since, $[\bigcup_{j \in \Gamma_0} \mathcal{S}_j]^c \geq [\bigcup_{j \in \Gamma_0} C_{\tilde{\tau}^{\tilde{\nu}\tilde{\eta}\tilde{\mu}}}(\mathcal{S}_j, r)]^c$, we have

$$\tilde{\mathfrak{J}}^{\tilde{\nu}}\left(\left[\bigcup_{j \in \Gamma_0} C_{\tilde{\tau}^{\tilde{\nu}\tilde{\eta}\tilde{\mu}}}(\mathcal{S}_j, r)\right]^c\right) \geq r, \quad \tilde{\mathfrak{J}}^{\tilde{\eta}}\left(\left[\bigcup_{j \in \Gamma_0} C_{\tilde{\tau}^{\tilde{\nu}\tilde{\eta}\tilde{\mu}}}(\mathcal{S}_j, r)\right]^c\right) \leq 1 - r, \quad \tilde{\mathfrak{J}}^{\tilde{\mu}}\left(\left[\bigcup_{j \in \Gamma_0} C_{\tilde{\tau}^{\tilde{\nu}\tilde{\eta}\tilde{\mu}}}(\mathcal{S}_j, r)\right]^c\right) \leq 1 - r$$

Hence, $\tilde{\mathfrak{X}}$ is $r - \mathcal{SVNI} - quasi H - closed$.

Theorem 4.5. The next statements are equivalent in an $\mathcal{SVNJTS} (\tilde{\mathfrak{X}}, \tilde{\tau}^{\tilde{\nu}\tilde{\eta}\tilde{\mu}}, \tilde{\mathfrak{J}}^{\tilde{\nu}\tilde{\eta}\tilde{\mu}})$:

- (1) $\tilde{\mathfrak{X}}$ is $r - \mathcal{SVNJ} - compact$,
- (2) For any family $\{\mathcal{S}_j \in I^{\tilde{\mathfrak{X}}}: \tilde{\tau}^{\tilde{\nu}}(\mathcal{S}_j^c) \geq r, \tilde{\tau}^{\tilde{\eta}}(\mathcal{S}_j^c) \leq 1 - r, \tilde{\tau}^{\tilde{\mu}}(\mathcal{S}_j^c) \leq 1 - r, j \in \Gamma\}$ with $\bigcap_{j \in \Gamma} \mathcal{S}_j = \tilde{0}$, there exists a finite subset $\Gamma_0 \subseteq \Gamma$ with $\tilde{\mathfrak{J}}^{\tilde{\nu}}(\bigcap_{j \in \Gamma_0} \mathcal{S}_j) \geq r, \tilde{\mathfrak{J}}^{\tilde{\eta}}(\bigcap_{j \in \Gamma_0} \mathcal{S}_j) \leq 1 - r, \tilde{\mathfrak{J}}^{\tilde{\mu}}(\bigcap_{j \in \Gamma_0} \mathcal{S}_j) \leq 1 - r$.

Proof. (1) \Rightarrow (2). For each family $\{\mathcal{S}_j \in I^{\tilde{\mathfrak{X}}}: \tilde{\tau}^{\tilde{\nu}}(\mathcal{S}_j^c) \geq r, \tilde{\tau}^{\tilde{\eta}}(\mathcal{S}_j^c) \leq 1 - r, \tilde{\tau}^{\tilde{\mu}}(\mathcal{S}_j^c) \leq 1 - r, j \in \Gamma\}$ with $\bigcap_{j \in \Gamma} \mathcal{S}_j = \tilde{0}$. Then, $\bigcup_{j \in \Gamma} \mathcal{S}_j^c = \tilde{1}$. By $r - \mathcal{SVNJ} - compactness$ of $(\tilde{\mathfrak{X}}, \tilde{\tau}^{\tilde{\nu}\tilde{\eta}\tilde{\mu}}, \tilde{\mathfrak{J}}^{\tilde{\nu}\tilde{\eta}\tilde{\mu}})$, there exists a finite subse $\Gamma_0 \subseteq \Gamma$ such that $\tilde{\mathfrak{J}}^{\tilde{\nu}}([\bigcup_{j \in \Gamma_0} \mathcal{S}_j^c]^c) \geq r, \tilde{\mathfrak{J}}^{\tilde{\eta}}([\bigcup_{j \in \Gamma_0} \mathcal{S}_j^c]^c) \leq 1 - r, \tilde{\mathfrak{J}}^{\tilde{\mu}}([\bigcup_{j \in \Gamma_0} \mathcal{S}_j^c]^c) \leq 1 - r$, this implies that,

$$\tilde{\mathfrak{J}}^{\tilde{\nu}}\left(\bigcap_{j \in \Gamma_0} \mathcal{S}_j\right) \geq r, \quad \tilde{\mathfrak{J}}^{\tilde{\eta}}\left(\bigcap_{j \in \Gamma_0} \mathcal{S}_j\right) \leq 1 - r, \quad \tilde{\mathfrak{J}}^{\tilde{\mu}}\left(\bigcap_{j \in \Gamma_0} \mathcal{S}_j\right) \leq 1 - r.$$

(2) \Rightarrow (1). Let $\{\mathcal{S}_j \in I^{\tilde{\mathfrak{X}}}: \tilde{\tau}^{\tilde{\nu}}(\mathcal{S}_j) \geq r, \tilde{\tau}^{\tilde{\eta}}(\mathcal{S}_j) \leq 1 - r, \tilde{\tau}^{\tilde{\mu}}(\mathcal{S}_j) \leq 1 - r, j \in \Gamma\}$ be a family such that $\bigcup_{j \in \Gamma} \mathcal{S}_j = \tilde{1}$. Then, $\bigcap_{j \in \Gamma} \mathcal{S}_j^c = \tilde{0}$, by (2), there exists a finite subse $\Gamma_0 \subseteq \Gamma$ such that $\tilde{\mathfrak{J}}^{\tilde{\nu}}(\bigcap_{j \in \Gamma_0} \mathcal{S}_j^c) \geq r, \tilde{\mathfrak{J}}^{\tilde{\eta}}(\bigcap_{j \in \Gamma_0} \mathcal{S}_j^c) \leq 1 - r, \tilde{\mathfrak{J}}^{\tilde{\mu}}(\bigcap_{j \in \Gamma_0} \mathcal{S}_j^c) \leq 1 - r$ this implies that $\tilde{\mathfrak{J}}^{\tilde{\nu}}([\bigcup_{j \in \Gamma_0} \mathcal{S}_j]^c) \geq r, \tilde{\mathfrak{J}}^{\tilde{\eta}}([\bigcup_{j \in \Gamma_0} \mathcal{S}_j]^c) \leq 1 - r, \tilde{\mathfrak{J}}^{\tilde{\mu}}([\bigcup_{j \in \Gamma_0} \mathcal{S}_j]^c) \leq 1 - r$. Therefore $(\tilde{\mathfrak{X}}, \tilde{\tau}^{\tilde{\nu}\tilde{\eta}\tilde{\mu}}, \tilde{\mathfrak{J}}^{\tilde{\nu}\tilde{\eta}\tilde{\mu}})$ is $r - \mathcal{SVNJ} - compact$.

Remark 4.6. Let $(\tilde{\mathfrak{X}}, \tilde{\tau}^{\tilde{\nu}\tilde{\eta}\tilde{\mu}}, \tilde{\mathfrak{J}}^{\tilde{\nu}\tilde{\eta}\tilde{\mu}})$ be an \mathcal{SVNJTS} . The simplest \mathcal{SVNJ} on $\tilde{\mathfrak{X}}$ is $\tilde{\mathfrak{J}}_0^{\tilde{\nu}\tilde{\eta}\tilde{\mu}}: I^{\tilde{\mathfrak{X}}} \rightarrow I$, where

$$\tilde{\mathfrak{J}}_0^{\tilde{\nu}}(\mathcal{S}) = \begin{cases} 1, & \text{if } \mathcal{S} = \tilde{0} \\ 0, & \text{otherwise,} \end{cases} \quad \tilde{\mathfrak{J}}_0^{\tilde{\eta}}(\mathcal{S}) = \begin{cases} 0, & \text{if } \mathcal{S} = \tilde{0} \\ 1, & \text{otherwise,} \end{cases} \quad \tilde{\mathfrak{J}}_0^{\tilde{\mu}}(\mathcal{S}) = \begin{cases} 0, & \text{if } \mathcal{S} = \tilde{0} \\ 1, & \text{otherwise,} \end{cases}$$

If $\tilde{\mathfrak{J}}^{\tilde{\nu}\tilde{\eta}\tilde{\mu}} = \tilde{\mathfrak{J}}_0^{\tilde{\nu}\tilde{\eta}\tilde{\mu}}$ then $r - \mathcal{SVN} - compact$ and $r - \mathcal{SVNJ} - compact$ are equivalent

Definition 4.7. An $\mathcal{SVNJTS} (\tilde{\mathfrak{X}}, \tilde{\tau}^{\tilde{\nu}\tilde{\eta}\tilde{\mu}})$ is said to be r -single-valued neutrosophic regular ($r - \mathcal{SVN} - regular$) iff for every $\tilde{\tau}^{\tilde{\nu}}(\mathcal{S}) \geq r, \tilde{\tau}^{\tilde{\eta}}(\mathcal{S}) \leq 1 - r, \tilde{\tau}^{\tilde{\mu}}(\mathcal{S}) \leq 1 - r$ and $r \in I_0$,

$$\mathcal{S} = \bigcup \{ \mathcal{E} \in I^{\tilde{\mathfrak{X}}}: \tilde{\tau}^{\tilde{\nu}}(\mathcal{E}) \geq r, \quad \tilde{\tau}^{\tilde{\eta}}(\mathcal{E}) \leq 1 - r, \quad \tilde{\tau}^{\tilde{\mu}}(\mathcal{E}) \leq 1 - r, \quad C_{\tilde{\tau}^{\tilde{\nu}\tilde{\eta}\tilde{\mu}}}(\mathcal{E}, r) = \mathcal{S} \}.$$

Theorem 4.8. Let $(\tilde{\mathfrak{X}}, \tilde{\tau}^{\tilde{\nu}\tilde{\eta}\tilde{\mu}}, \tilde{\mathfrak{J}}^{\tilde{\nu}\tilde{\eta}\tilde{\mu}})$ be an $r - \mathcal{SVNJ} - quasi H - closed$ and $r - \mathcal{SVN} - regular$. Then $(\tilde{\mathfrak{X}}, \tilde{\tau}^{\tilde{\nu}\tilde{\eta}\tilde{\mu}}, \tilde{\mathfrak{J}}^{\tilde{\nu}\tilde{\eta}\tilde{\mu}})$ is $r - \mathcal{SVNJ} - compact$.

Proof. For every family $\{\mathcal{S} \in I^{\tilde{\mathfrak{X}}}: \tilde{\tau}^{\tilde{\nu}}(\mathcal{S}_j) \geq r, \tilde{\tau}^{\tilde{\eta}}(\mathcal{S}_j) \leq 1 - r, \tilde{\tau}^{\tilde{\mu}}(\mathcal{S}_j) \leq 1 - r, j \in \Gamma\}$ such that $\bigcup_{j \in \Gamma} \mathcal{S}_j = \tilde{1}$. By $r - \mathcal{SVN} - regularity$ of $(\tilde{\mathfrak{X}}, \tilde{\tau}^{\tilde{\nu}\tilde{\eta}\tilde{\mu}}, \tilde{\mathfrak{J}}^{\tilde{\nu}\tilde{\eta}\tilde{\mu}})$, for any $\tilde{\tau}^{\tilde{\nu}}(\mathcal{S}_j) \geq r, \tilde{\tau}^{\tilde{\eta}}(\mathcal{S}_j) \leq 1 - r, \tilde{\tau}^{\tilde{\mu}}(\mathcal{S}_j) \leq 1 - r$, we have

$$\mathcal{S}_j = \bigcup_{j_\Delta \in \Delta_j} \{ \mathcal{S}_{j_\Delta} : \tilde{\tau}^{\tilde{\gamma}}(\mathcal{S}_{j_\Delta}) \geq r, \quad \tilde{\tau}^{\tilde{\eta}}(\mathcal{S}_{j_\Delta}) \leq 1 - r, \quad \tilde{\tau}^{\tilde{\mu}}(\mathcal{S}_{j_\Delta}) \leq 1 - r, \quad C_{\tilde{\tau}^{\tilde{\gamma}\tilde{\eta}\tilde{\mu}}}(\mathcal{S}_{j_\Delta}, r) \leq \mathcal{S}_j \}.$$

Thus, $\bigcup_{j \in \Gamma} (\bigcup_{j_\Delta \in \Delta_j} \mathcal{S}_{j_\Delta}) = \tilde{\mathcal{I}}$. Since $(\tilde{\mathcal{I}}, \tilde{\tau}^{\tilde{\gamma}\tilde{\eta}\tilde{\mu}}, \tilde{\gamma}^{\tilde{\eta}\tilde{\mu}})$ is $r - \mathcal{SVNJ}$ -quasi H-closed, there exists a finite subset $K \times \Delta_K$ such that

$$\tilde{\gamma}^{\tilde{\gamma}} \left(\left[\bigcup_{k \in K} \left(\bigcup_{k_\Delta \in \Delta_k} C_{\tilde{\tau}^{\tilde{\gamma}}}(\mathcal{S}_{k_\Delta}, r) \right) \right]^c \right) \geq r, \quad \tilde{\gamma}^{\tilde{\eta}} \left(\left[\bigcup_{k \in K} \left(\bigcup_{k_\Delta \in \Delta_k} C_{\tilde{\tau}^{\tilde{\eta}}}(\mathcal{S}_{k_\Delta}, r) \right) \right]^c \right) \leq 1 - r, \quad \tilde{\gamma}^{\tilde{\mu}} \left(\left[\bigcup_{k \in K} \left(\bigcup_{k_\Delta \in \Delta_k} C_{\tilde{\tau}^{\tilde{\mu}}}(\mathcal{S}_{k_\Delta}, r) \right) \right]^c \right) \leq 1 - r.$$

For each $k \in K$, since $\bigcup_{k_\Delta \in \Delta_k} C_{\tilde{\tau}^{\tilde{\gamma}\tilde{\eta}\tilde{\mu}}}(\mathcal{S}_{k_\Delta}, r) \leq \mathcal{S}_k$. It implies that $\left[\bigcup_{k \in K} (\bigcup_{k_\Delta \in \Delta_k} C_{\tilde{\tau}^{\tilde{\gamma}\tilde{\eta}\tilde{\mu}}}(\mathcal{S}_{k_\Delta}, r)) \right]^c \geq \left[\bigcup_{k \in K} \mathcal{S}_k \right]^c$. Thus,

$$\tilde{\gamma}^{\tilde{\gamma}} \left(\left[\bigcup_{k \in K} \mathcal{S}_k \right]^c \right) \geq \tilde{\gamma}^{\tilde{\gamma}} \left(\left[\bigcup_{k \in K} \left(\bigcup_{k_\Delta \in \Delta_k} C_{\tilde{\tau}^{\tilde{\gamma}}}(\mathcal{S}_{k_\Delta}, r) \right) \right]^c \right) \geq r, \quad \tilde{\gamma}^{\tilde{\eta}} \left(\left[\bigcup_{k \in K} \mathcal{S}_k \right]^c \right) \leq \tilde{\gamma}^{\tilde{\eta}} \left(\left[\bigcup_{k \in K} \left(\bigcup_{k_\Delta \in \Delta_k} C_{\tilde{\tau}^{\tilde{\eta}}}(\mathcal{S}_{k_\Delta}, r) \right) \right]^c \right) \leq 1 - r$$

$$\tilde{\gamma}^{\tilde{\mu}} \left(\left[\bigcup_{k \in K} \mathcal{S}_k \right]^c \right) \leq \tilde{\gamma}^{\tilde{\mu}} \left(\left[\bigcup_{k \in K} \left(\bigcup_{k_\Delta \in \Delta_k} C_{\tilde{\tau}^{\tilde{\mu}}}(\mathcal{S}_{k_\Delta}, r) \right) \right]^c \right) \leq 1 - r.$$

Hence, $(\tilde{\mathcal{I}}, \tilde{\tau}^{\tilde{\gamma}\tilde{\eta}\tilde{\mu}}, \tilde{\gamma}^{\tilde{\eta}\tilde{\mu}})$ is $r - \mathcal{SVNJ}$ -compact.

Definition 4.9. A family $\{\mathcal{S}_j\}_{j \in \Gamma}$ in $\tilde{\mathcal{I}}$ has the finite intersection property (**I-FIP**) iff the intersection of no finite sub-family $\Gamma_0 \subseteq \Gamma$ s.t $\tilde{\gamma}^{\tilde{\gamma}}(\bigcap_{j \in \Gamma_0} \mathcal{S}_j) \geq r$, $\tilde{\gamma}^{\tilde{\eta}}(\bigcap_{j \in \Gamma_0} \mathcal{S}_j) \leq 1 - r$, $\tilde{\gamma}^{\tilde{\mu}}(\bigcap_{j \in \Gamma_0} \mathcal{S}_j) \leq 1 - r$.

Theorem 4.10. An \mathcal{SVNJTS} $(\tilde{\mathcal{I}}, \tilde{\tau}^{\tilde{\gamma}\tilde{\eta}\tilde{\mu}}, \tilde{\gamma}^{\tilde{\eta}\tilde{\mu}})$ is $r - \mathcal{SVNJ}$ -compact, iff every family $\{\mathcal{S}_j \in I^{\tilde{\mathcal{I}}} : \tilde{\tau}^{\tilde{\gamma}}(\mathcal{S}_j^c) \geq r, \tilde{\tau}^{\tilde{\eta}}(\mathcal{S}_j^c) \leq 1 - r, \tilde{\tau}^{\tilde{\mu}}(\mathcal{S}_j^c) \leq 1 - r, j \in \Gamma\}$ having the finite intersection property (**I-FIP**) has a non-empty intersection.

Proof. Obvious.

Theorem 4.11. Suppose that $(\tilde{\mathcal{I}}, \tilde{\tau}^{\tilde{\gamma}\tilde{\eta}\tilde{\mu}}, \tilde{\gamma}^{\tilde{\eta}\tilde{\mu}})$ is an \mathcal{SVNJTS} , \mathcal{S} is $r - \mathcal{SVNJ}$ -compact. Then for every collection $\{\mathcal{E}_j \in I^{\tilde{\mathcal{I}}} : \mathcal{E}_j \leq \text{int}_{\tilde{\tau}^{\tilde{\gamma}\tilde{\eta}\tilde{\mu}}}(C_{\tilde{\tau}^{\tilde{\gamma}\tilde{\eta}\tilde{\mu}}}(\mathcal{E}_j, r), r), j \in \Gamma\}$ with $\mathcal{S} \leq \bigcup_{j \in \Gamma} \mathcal{E}_j$, there exists a finite subset $\Gamma_0 \subseteq \Gamma$ s.t,

$$\tilde{\gamma}^{\tilde{\gamma}} \left(\mathcal{S} \cap \left[\bigcup_{j \in \Gamma_0} \text{int}_{\tilde{\tau}^{\tilde{\gamma}}}(C_{\tilde{\tau}^{\tilde{\gamma}\tilde{\eta}\tilde{\mu}}}(\mathcal{E}_j, r), r) \right]^c \right) \geq r, \quad \tilde{\gamma}^{\tilde{\eta}} \left(\mathcal{S} \cap \left[\bigcup_{j \in \Gamma_0} \text{int}_{\tilde{\tau}^{\tilde{\eta}\tilde{\mu}}}(C_{\tilde{\tau}^{\tilde{\eta}}}(\mathcal{E}_j, r), r) \right]^c \right) \leq 1 - r$$

$$\tilde{\gamma}^{\tilde{\mu}} \left(\mathcal{S} \cap \left[\bigcup_{j \in \Gamma_0} \text{int}_{\tilde{\tau}^{\tilde{\mu}}}(C_{\tilde{\tau}^{\tilde{\eta}\tilde{\mu}}}(\mathcal{E}_j, r), r) \right]^c \right) \leq 1 - r.$$

Proof. Let $\{\mathcal{E}_j \in I^{\tilde{\mathcal{I}}} : \mathcal{E}_j \leq \text{int}_{\tilde{\tau}^{\tilde{\gamma}\tilde{\eta}\tilde{\mu}}}(C_{\tilde{\tau}^{\tilde{\gamma}\tilde{\eta}\tilde{\mu}}}(\mathcal{E}_j, r), r), j \in \Gamma\}$ with $\mathcal{S} \leq \bigcup_{j \in \Gamma} \mathcal{E}_j$. Then, $\mathcal{S} \leq \bigcup_{j \in \Gamma} \text{int}_{\tilde{\tau}^{\tilde{\gamma}\tilde{\eta}\tilde{\mu}}}(C_{\tilde{\tau}^{\tilde{\gamma}\tilde{\eta}\tilde{\mu}}}(\mathcal{E}_j, r), r)$, $[\tilde{\tau}^{\tilde{\gamma}}(\text{int}_{\tilde{\tau}^{\tilde{\gamma}}}(C_{\tilde{\tau}^{\tilde{\gamma}\tilde{\eta}\tilde{\mu}}}(\mathcal{E}_j, r), r))] \geq r$, $\tilde{\tau}^{\tilde{\eta}}(\text{int}_{\tilde{\tau}^{\tilde{\eta}\tilde{\mu}}}(C_{\tilde{\tau}^{\tilde{\eta}}}(\mathcal{E}_j, r), r)) \leq 1 - r$, $\tilde{\tau}^{\tilde{\mu}}(\text{int}_{\tilde{\tau}^{\tilde{\mu}}}(C_{\tilde{\tau}^{\tilde{\eta}\tilde{\mu}}}(\mathcal{E}_j, r), r)) \leq 1 - r$. By $r - \mathcal{SVNJ}$ -compactness of \mathcal{S} , there exists a finite subset $\Gamma_0 \subseteq \Gamma$ s.t,

$$\tilde{\gamma}^{\tilde{\gamma}} \left(\mathcal{S} \cap \left[\bigcup_{j \in \Gamma_0} \text{int}_{\tilde{\tau}^{\tilde{\gamma}}}(C_{\tilde{\tau}^{\tilde{\gamma}\tilde{\eta}\tilde{\mu}}}(\mathcal{E}_j, r), r) \right]^c \right) \geq r, \quad \tilde{\gamma}^{\tilde{\eta}} \left(\mathcal{S} \cap \left[\bigcup_{j \in \Gamma_0} \text{int}_{\tilde{\tau}^{\tilde{\eta}\tilde{\mu}}}(C_{\tilde{\tau}^{\tilde{\eta}}}(\mathcal{E}_j, r), r) \right]^c \right) \leq 1 - r$$

$$\tilde{j}^{\tilde{\mu}} \left(\mathcal{S} \cap \left[\bigcup_{j \in \Gamma_0} \text{int}_{\tilde{\tau}^{\tilde{\mu}}} (C_{\tilde{\tau}^{\tilde{\mu}} \tilde{\eta}^{\tilde{\mu}}}(\mathcal{E}_j, r), r) \right]^c \right) \leq 1 - r.$$

Definition 4.12. Let $(\tilde{\mathfrak{X}}, \tilde{\tau}^{\tilde{\nu}} \tilde{\eta}^{\tilde{\mu}})$ be an \mathcal{SVNJS} and $\mathcal{S} \in I^{\tilde{\mathfrak{X}}}$. Then \mathcal{S} is called r -single-valued neutrosophic locally closed iff $\mathcal{S} = \mathcal{E} \cap \mathcal{D}$ where $[\tilde{\tau}^{\tilde{\nu}}(\mathcal{E}) \geq r, \tilde{\tau}^{\tilde{\eta}}(\mathcal{E}) \leq 1 - r, \tilde{\tau}^{\tilde{\mu}}(\mathcal{E}) \leq 1 - r], [\tilde{\tau}^{\tilde{\nu}}(\mathcal{D}^c) \geq r, \tilde{\tau}^{\tilde{\eta}}(\mathcal{D}^c) \leq 1 - r, \tilde{\tau}^{\tilde{\mu}}(\mathcal{D}^c) \leq 1 - r]$.

Lemma 4.13. Let $(\tilde{\mathfrak{X}}, \tilde{\tau}^{\tilde{\nu}} \tilde{\eta}^{\tilde{\mu}})$ be an \mathcal{SVNJS} and $\mathcal{S} \in I^{\tilde{\mathfrak{X}}}$. Then $\tilde{\tau}^{\tilde{\nu}}(\mathcal{S}) \geq r, \tilde{\tau}^{\tilde{\eta}}(\mathcal{S}) \leq 1 - r, \tilde{\tau}^{\tilde{\mu}}(\mathcal{S}) \leq 1 - r$ iff \mathcal{S} both r -single-valued neutrosophic locally closed and $r - \mathcal{SVNPO}$ set.

Proof. It is trivial.

Lemma 4.14. If \mathcal{S} is $r - \mathcal{SVNJ}$ - compact, then for every collection $\{\mathcal{E}_j \in I^{\tilde{\mathfrak{X}}}: \mathcal{E}_j \text{ is both } r - \mathcal{SVNPO} \text{ and } r - \text{single-valued neutrosophic locally closed sets, } j \in \Gamma\}$ with $\mathcal{S} \leq \bigcup_{j \in \Gamma} \mathcal{E}_j$, there exists a finite subfamily $\Gamma_0 \subseteq \Gamma$ such that $\tilde{j}^{\tilde{\nu}}(\mathcal{S} \cap [\bigcup_{j \in \Gamma_0} \mathcal{E}_j]^c) \geq r, \tilde{j}^{\tilde{\eta}}(\mathcal{S} \cap [\bigcup_{j \in \Gamma_0} \mathcal{E}_j]^c) \leq 1 - r, \tilde{j}^{\tilde{\mu}}(\mathcal{S} \cap [\bigcup_{j \in \Gamma_0} \mathcal{E}_j]^c) \leq 1 - r$.

Proof. Follows from Lemma 4.13.

Theorem 4.15. Let $(\tilde{\mathfrak{X}}, \tilde{\tau}^{\tilde{\nu}} \tilde{\eta}^{\tilde{\mu}}, \tilde{j}^{\tilde{\nu}} \tilde{\eta}^{\tilde{\mu}})$ be an \mathcal{SVNJTS} , \mathcal{S}_1 and \mathcal{S}_2 are $r - \mathcal{SVNJ}$ - compact. Then, $\mathcal{S} \cup \mathcal{E}$ is $r - \mathcal{SVNJ}$ - compact subset relative to $\tilde{\mathfrak{X}}$.

Proof. Let $\{\mathcal{E}_j \in I^{\tilde{\mathfrak{X}}}: \tilde{\tau}^{\tilde{\nu}}(\mathcal{E}_j) \geq r, \tilde{\tau}^{\tilde{\eta}}(\mathcal{E}_j) \leq 1 - r, \tilde{\tau}^{\tilde{\mu}}(\mathcal{E}_j) \leq 1 - r, j \in \Gamma\}$ be a family such that $\mathcal{S}_1 \cup \mathcal{S}_2 \leq \bigcup_{j \in \Gamma} \mathcal{E}_j$. Then $\mathcal{S}_1 \leq \bigcup_{j \in \Gamma} \mathcal{E}_j$ and $\mathcal{S}_2 \leq \bigcup_{j \in \Gamma} \mathcal{E}_j$. Since \mathcal{S}_1 and \mathcal{S}_2 are $r - \mathcal{SVNJ}$ - compact, there exists a finite subset $\Gamma_0 \subseteq \Gamma$ such that

$$\tilde{j}^{\tilde{\nu}} \left(\mathcal{S}_k \cap \left[\bigcup_{j \in \Gamma_0} \mathcal{E}_j \right]^c \right) \geq r, \quad \tilde{j}^{\tilde{\eta}} \left(\mathcal{S}_k \cap \left[\bigcup_{j \in \Gamma_0} \mathcal{E}_j \right]^c \right) \leq 1 - r, \quad \tilde{j}^{\tilde{\mu}} \left(\mathcal{S}_k \cap \left[\bigcup_{j \in \Gamma_0} \mathcal{E}_j \right]^c \right) \leq 1 - r,$$

for $k = 1, 2$, since $(\mathcal{S}_1 \cap [\bigcup_{j \in \Gamma_0} \mathcal{E}_j]^c) \cup (\mathcal{S}_2 \cap [\bigcup_{j \in \Gamma_0} \mathcal{E}_j]^c) = (\mathcal{S}_1 \cup \mathcal{S}_2) \cap [\bigcup_{j \in \Gamma_0} \mathcal{E}_j]^c$. Then,

$$\tilde{j}^{\tilde{\nu}} \left((\mathcal{S}_1 \cup \mathcal{S}_2) \cap \left[\bigcup_{j \in \Gamma_0} \mathcal{E}_j \right]^c \right) \geq r, \quad \tilde{j}^{\tilde{\eta}} \left((\mathcal{S}_1 \cup \mathcal{S}_2) \cap \left[\bigcup_{j \in \Gamma_0} \mathcal{E}_j \right]^c \right) \leq 1 - r, \quad \tilde{j}^{\tilde{\mu}} \left((\mathcal{S}_1 \cup \mathcal{S}_2) \cap \left[\bigcup_{j \in \Gamma_0} \mathcal{E}_j \right]^c \right) \leq 1 - r.$$

This shown that $(\mathcal{S}_1 \cup \mathcal{S}_2)$ is $r - \mathcal{SVNJ}$ - compact.

Theorem 4.16. Suppose $(\tilde{\mathfrak{X}}, \tilde{\tau}^{\tilde{\nu}} \tilde{\eta}^{\tilde{\mu}}, \tilde{j}^{\tilde{\nu}} \tilde{\eta}^{\tilde{\mu}})$ be an \mathcal{SVNJTS} , $r \in I_0$. Then the next statements are equivalent:

- (1) $(\tilde{\mathfrak{X}}, \tilde{\tau}^{\tilde{\nu}} \tilde{\eta}^{\tilde{\mu}}, \tilde{j}^{\tilde{\nu}} \tilde{\eta}^{\tilde{\mu}})$ is $r - \mathcal{SVNJ}$ - quasi H - closed,
- (2) For every collection $\{\mathcal{S}_j \in I^{\tilde{\mathfrak{X}}}: \tilde{\tau}^{\tilde{\nu}}(\mathcal{S}_j^c) \geq r, \tilde{\tau}^{\tilde{\eta}}(\mathcal{S}_j^c) \leq 1 - r, \tilde{\tau}^{\tilde{\mu}}(\mathcal{S}_j^c) \leq 1 - r, j \in \Gamma\}$ with $\bigcap_{j \in \Gamma} \mathcal{S}_j = \tilde{0}$, there exists $\Gamma_0 \subseteq \Gamma$ such that $\tilde{j}^{\tilde{\nu}}(\bigcap_{j \in \Gamma_0} \text{int}_{\tilde{\tau}^{\tilde{\nu}}}(\mathcal{S}_j, r)) \geq r, \tilde{j}^{\tilde{\eta}}(\bigcap_{j \in \Gamma_0} \text{int}_{\tilde{\tau}^{\tilde{\eta}}}(\mathcal{S}_j, r)) \leq 1 - r, \tilde{j}^{\tilde{\mu}}(\bigcap_{j \in \Gamma_0} \text{int}_{\tilde{\tau}^{\tilde{\mu}}}(\mathcal{S}_j, r)) \leq 1 - r,$
- (3) $\bigcap_{j \in \Gamma} \mathcal{S}_j \neq \tilde{0}$, holds for any collection $\{\mathcal{S}_j \in I^{\tilde{\mathfrak{X}}}: \tilde{\tau}^{\tilde{\nu}}(\mathcal{S}_j^c) \geq r, \tilde{\tau}^{\tilde{\eta}}(\mathcal{S}_j^c) \leq 1 - r, \tilde{\tau}^{\tilde{\mu}}(\mathcal{S}_j^c) \leq 1 - r, j \in \Gamma\}$ such that $\{\text{int}_{\tilde{\tau}^{\tilde{\nu}} \tilde{\eta}^{\tilde{\mu}}}(\mathcal{S}_j, r): \tilde{\tau}^{\tilde{\nu}}(\mathcal{S}_j^c) \geq r, \tilde{\tau}^{\tilde{\eta}}(\mathcal{S}_j^c) \leq 1 - r, \tilde{\tau}^{\tilde{\mu}}(\mathcal{S}_j^c) \leq 1 - r, j \in \Gamma\}$ has the **I-FIP**,
- (4) For any collection $\{\mathcal{S}_j \in I^{\tilde{\mathfrak{X}}}: \mathcal{S}_j \text{ is } r - \mathcal{SVNRO} \text{ sets, } j \in \Gamma\}$ such taht $\bigcup_{j \in \Gamma} \mathcal{S}_j = \tilde{1}$, there exists $\Gamma_0 \subseteq \Gamma$ such that $\tilde{j}^{\tilde{\nu}}([\bigcup_{j \in \Gamma_0} C_{\tilde{\tau}^{\tilde{\nu}}}(\mathcal{S}_j, r)]^c) \geq r, \tilde{j}^{\tilde{\eta}}([\bigcup_{j \in \Gamma_0} C_{\tilde{\tau}^{\tilde{\eta}}}(\mathcal{S}_j, r)]^c) \leq 1 - r, \tilde{j}^{\tilde{\mu}}([\bigcup_{j \in \Gamma_0} C_{\tilde{\tau}^{\tilde{\mu}}}(\mathcal{S}_j, r)]^c) \leq 1 - r,$

- (5) For every collection $\{\mathcal{S}_j \in I^{\tilde{\mathfrak{X}}}: \mathcal{S}_j \text{ is } r - \text{SVNRC set, } j \in \Gamma\}$ such that $\bigcap_{j \in \Gamma} \mathcal{S}_j = \tilde{0}$, there exists $\Gamma_0 \subseteq \Gamma$ such that $\tilde{\mathcal{J}}^{\tilde{\mathfrak{Y}}}(\bigcap_{j \in \Gamma_0} \text{int}_{\tilde{\tau}^{\tilde{\mathfrak{Y}}}}(\mathcal{S}_j, r)) \geq r$, $\tilde{\mathcal{J}}^{\tilde{\mathfrak{N}}}(\bigcap_{j \in \Gamma_0} \text{int}_{\tilde{\tau}^{\tilde{\mathfrak{N}}}}(\mathcal{S}_j, r)) \leq 1 - r$, $\tilde{\mathcal{J}}^{\tilde{\mathfrak{M}}}(\bigcap_{j \in \Gamma_0} \text{int}_{\tilde{\tau}^{\tilde{\mathfrak{M}}}}(\mathcal{S}_j, r)) \leq 1 - r$,
- (6) $\bigcap_{j \in \Gamma} \mathcal{S}_j \neq \tilde{0}$, holds for every collection $\{\mathcal{S}_j \in I^{\tilde{\mathfrak{X}}}: \mathcal{S}_j \text{ is } r - \text{SVNRC set, } j \in \Gamma\}$ such that $\{\text{int}_{\tilde{\tau}^{\tilde{\mathfrak{Y}}}\tilde{\mathfrak{N}}\tilde{\mathfrak{M}}}(\mathcal{S}_j, r): \mathcal{S}_j \text{ is } r - \text{SVNRC set, } j \in \Gamma\}$ has the **I - FIP**.

Proof. (1) \Rightarrow (2). Let $\{\mathcal{S}_j \in I^{\tilde{\mathfrak{X}}}: \tilde{\tau}^{\tilde{\mathfrak{Y}}}(\mathcal{S}_j^c) \geq r, \tilde{\tau}^{\tilde{\mathfrak{N}}}(\mathcal{S}_j^c) \leq 1 - r, \tilde{\tau}^{\tilde{\mathfrak{M}}}(\mathcal{S}_j^c) \leq 1 - r, j \in \Gamma\}$ be a family with $\bigcap_{j \in \Gamma} \mathcal{S}_j = \tilde{0}$. Then, $\bigcup_{j \in \Gamma} \mathcal{S}_j^c = \tilde{1}$. Since, $(\tilde{\mathfrak{X}}, \tilde{\tau}^{\tilde{\mathfrak{Y}}}\tilde{\mathfrak{N}}\tilde{\mathfrak{M}}, \tilde{\mathcal{J}}^{\tilde{\mathfrak{Y}}}\tilde{\mathfrak{N}}\tilde{\mathfrak{M}})$ is $r - \text{SVNJ} - \text{quasi } H - \text{closed}$, there exists $\Gamma_0 \subseteq \Gamma$ such that $\tilde{\mathcal{J}}^{\tilde{\mathfrak{Y}}}(\left[\bigcup_{j \in \Gamma_0} C_{\tilde{\tau}^{\tilde{\mathfrak{Y}}}}(\mathcal{S}_j^c, r)\right]^c) \geq r$, $\tilde{\mathcal{J}}^{\tilde{\mathfrak{N}}}(\left[\bigcup_{j \in \Gamma_0} C_{\tilde{\tau}^{\tilde{\mathfrak{N}}}}(\mathcal{S}_j^c, r)\right]^c) \leq 1 - r$, $\tilde{\mathcal{J}}^{\tilde{\mathfrak{M}}}(\left[\bigcup_{j \in \Gamma_0} C_{\tilde{\tau}^{\tilde{\mathfrak{M}}}}(\mathcal{S}_j^c, r)\right]^c) \leq 1 - r$. Since, $\left[\bigcup_{j \in \Gamma_0} C_{\tilde{\tau}^{\tilde{\mathfrak{Y}}}\tilde{\mathfrak{N}}\tilde{\mathfrak{M}}}(\mathcal{S}_j^c, r)\right]^c = \bigcap_{j \in \Gamma_0} \text{int}_{\tilde{\tau}^{\tilde{\mathfrak{Y}}}\tilde{\mathfrak{N}}\tilde{\mathfrak{M}}}(\mathcal{S}_j, r)$, we have

$$\tilde{\mathcal{J}}^{\tilde{\mathfrak{Y}}}\left(\bigcap_{j \in \Gamma_0} \text{int}_{\tilde{\tau}^{\tilde{\mathfrak{Y}}}}(\mathcal{S}_j, r)\right) \geq r, \quad \tilde{\mathcal{J}}^{\tilde{\mathfrak{N}}}\left(\bigcap_{j \in \Gamma_0} \text{int}_{\tilde{\tau}^{\tilde{\mathfrak{N}}}}(\mathcal{S}_j, r)\right) \leq 1 - r, \quad \tilde{\mathcal{J}}^{\tilde{\mathfrak{M}}}\left(\bigcap_{j \in \Gamma_0} \text{int}_{\tilde{\tau}^{\tilde{\mathfrak{M}}}}(\mathcal{S}_j, r)\right) \leq 1 - r.$$

(2) \Rightarrow (1). Let $\{\mathcal{S}_j \in I^{\tilde{\mathfrak{X}}}: \tilde{\tau}^{\tilde{\mathfrak{Y}}}(\mathcal{S}_j) \geq r, \tilde{\tau}^{\tilde{\mathfrak{N}}}(\mathcal{S}_j) \leq 1 - r, \tilde{\tau}^{\tilde{\mathfrak{M}}}(\mathcal{S}_j) \leq 1 - r, j \in \Gamma\}$ be a family s.t $\bigcup_{j \in \Gamma} \mathcal{S}_j = \tilde{1}$. Then, $\bigcap_{j \in \Gamma} \mathcal{S}_j^c = \tilde{0}$ and by hypothesis, there exists $\Gamma_0 \subseteq \Gamma$ s.t, $\tilde{\mathcal{J}}^{\tilde{\mathfrak{Y}}}(\bigcap_{j \in \Gamma_0} \text{int}_{\tilde{\tau}^{\tilde{\mathfrak{Y}}}}(\mathcal{S}_j^c, r)) \geq r$, $\tilde{\mathcal{J}}^{\tilde{\mathfrak{N}}}(\bigcap_{j \in \Gamma_0} \text{int}_{\tilde{\tau}^{\tilde{\mathfrak{N}}}}(\mathcal{S}_j^c, r)) \leq 1 - r$, $\tilde{\mathcal{J}}^{\tilde{\mathfrak{M}}}(\bigcap_{j \in \Gamma_0} \text{int}_{\tilde{\tau}^{\tilde{\mathfrak{M}}}}(\mathcal{S}_j^c, r)) \leq 1 - r$. Since, $\bigcap_{j \in \Gamma_0} \text{int}_{\tilde{\tau}^{\tilde{\mathfrak{Y}}}\tilde{\mathfrak{N}}\tilde{\mathfrak{M}}}(\mathcal{S}_j^c, r) = \left[\bigcup_{j \in \Gamma_0} C_{\tilde{\tau}^{\tilde{\mathfrak{Y}}}\tilde{\mathfrak{N}}\tilde{\mathfrak{M}}}(\mathcal{S}_j, r)\right]^c$,

$$\tilde{\mathcal{J}}^{\tilde{\mathfrak{Y}}}\left(\left[\bigcup_{j \in \Gamma_0} C_{\tilde{\tau}^{\tilde{\mathfrak{Y}}}}(\mathcal{S}_j, r)\right]^c\right) \geq r, \quad \tilde{\mathcal{J}}^{\tilde{\mathfrak{N}}}\left(\left[\bigcup_{j \in \Gamma_0} C_{\tilde{\tau}^{\tilde{\mathfrak{N}}}}(\mathcal{S}_j, r)\right]^c\right) \leq 1 - r, \quad \tilde{\mathcal{J}}^{\tilde{\mathfrak{M}}}\left(\left[\bigcup_{j \in \Gamma_0} C_{\tilde{\tau}^{\tilde{\mathfrak{M}}}}(\mathcal{S}_j, r)\right]^c\right) \leq 1 - r.$$

Thus, $(\tilde{\mathfrak{X}}, \tilde{\tau}^{\tilde{\mathfrak{Y}}}\tilde{\mathfrak{N}}\tilde{\mathfrak{M}}, \tilde{\mathcal{J}}^{\tilde{\mathfrak{Y}}}\tilde{\mathfrak{N}}\tilde{\mathfrak{M}})$ is $r - \text{SVNJ} - \text{quasi } H - \text{closed}$,

(1) \Rightarrow (3). For any family $\{\mathcal{S}_j \in I^{\tilde{\mathfrak{X}}}: \tilde{\tau}^{\tilde{\mathfrak{Y}}}(\mathcal{S}_j^c) \geq r, \tilde{\tau}^{\tilde{\mathfrak{N}}}(\mathcal{S}_j^c) \leq 1 - r, \tilde{\tau}^{\tilde{\mathfrak{M}}}(\mathcal{S}_j^c) \leq 1 - r, j \in \Gamma\}$ such that $\{\text{int}_{\tilde{\tau}^{\tilde{\mathfrak{Y}}}\tilde{\mathfrak{N}}\tilde{\mathfrak{M}}}(\mathcal{S}_j, r): \tilde{\tau}^{\tilde{\mathfrak{Y}}}(\mathcal{S}_j^c) \geq r, \tilde{\tau}^{\tilde{\mathfrak{N}}}(\mathcal{S}_j^c) \leq 1 - r, \tilde{\tau}^{\tilde{\mathfrak{M}}}(\mathcal{S}_j^c) \leq 1 - r, j \in \Gamma\}$ has the **I - FIP**. If $\bigcap_{j \in \Gamma} \mathcal{S}_j = \tilde{0}$, then $\bigcup_{j \in \Gamma} \mathcal{S}_j^c = \tilde{1}$. Since $(\tilde{\mathfrak{X}}, \tilde{\tau}^{\tilde{\mathfrak{Y}}}\tilde{\mathfrak{N}}\tilde{\mathfrak{M}}, \tilde{\mathcal{J}}^{\tilde{\mathfrak{Y}}}\tilde{\mathfrak{N}}\tilde{\mathfrak{M}})$ is $r - \text{SVNJ} - \text{quasi } H - \text{closed}$, there exists a finite subset $\Gamma_0 \subseteq \Gamma$ such that

$$\tilde{\mathcal{J}}^{\tilde{\mathfrak{Y}}}\left(\left[\bigcup_{j \in \Gamma_0} C_{\tilde{\tau}^{\tilde{\mathfrak{Y}}}}(\mathcal{S}_j^c, r)\right]^c\right) \geq r, \quad \tilde{\mathcal{J}}^{\tilde{\mathfrak{N}}}\left(\left[\bigcup_{j \in \Gamma_0} C_{\tilde{\tau}^{\tilde{\mathfrak{N}}}}(\mathcal{S}_j^c, r)\right]^c\right) \leq 1 - r, \quad \tilde{\mathcal{J}}^{\tilde{\mathfrak{M}}}\left(\left[\bigcup_{j \in \Gamma_0} C_{\tilde{\tau}^{\tilde{\mathfrak{M}}}}(\mathcal{S}_j^c, r)\right]^c\right) \leq 1 - r.$$

Since, $\left[\bigcup_{j \in \Gamma_0} C_{\tilde{\tau}^{\tilde{\mathfrak{Y}}}\tilde{\mathfrak{N}}\tilde{\mathfrak{M}}}(\mathcal{S}_j^c, r)\right]^c = \bigcap_{j \in \Gamma_0} \text{int}_{\tilde{\tau}^{\tilde{\mathfrak{Y}}}\tilde{\mathfrak{N}}\tilde{\mathfrak{M}}}(\mathcal{S}_j, r)$, we have

$$\tilde{\mathcal{J}}^{\tilde{\mathfrak{Y}}}\left(\bigcap_{j \in \Gamma_0} \text{int}_{\tilde{\tau}^{\tilde{\mathfrak{Y}}}}(\mathcal{S}_j, r)\right) \geq r, \quad \tilde{\mathcal{J}}^{\tilde{\mathfrak{N}}}\left(\bigcap_{j \in \Gamma_0} \text{int}_{\tilde{\tau}^{\tilde{\mathfrak{N}}}}(\mathcal{S}_j, r)\right) \leq 1 - r, \quad \tilde{\mathcal{J}}^{\tilde{\mathfrak{M}}}\left(\bigcap_{j \in \Gamma_0} \text{int}_{\tilde{\tau}^{\tilde{\mathfrak{M}}}}(\mathcal{S}_j, r)\right) \leq 1 - r.$$

Which is a contradiction.

(3) \Rightarrow (1). For any family $\{\mathcal{S}_j \in I^{\tilde{\mathfrak{X}}}: \tilde{\tau}^{\tilde{\mathfrak{Y}}}(\mathcal{S}_j) \geq r, \tilde{\tau}^{\tilde{\mathfrak{N}}}(\mathcal{S}_j) \leq 1 - r, \tilde{\tau}^{\tilde{\mathfrak{M}}}(\mathcal{S}_j) \leq 1 - r, j \in \Gamma\}$ such that $\bigcup_{j \in \Gamma} \mathcal{S}_j = \tilde{1}$, with the property that for no finite $\Gamma_0 \subseteq \Gamma$ such that $\tilde{\mathcal{J}}^{\tilde{\mathfrak{Y}}}(\left[\bigcup_{j \in \Gamma_0} C_{\tilde{\tau}^{\tilde{\mathfrak{Y}}}}(\mathcal{S}_j, r)\right]^c) \geq r, \tilde{\mathcal{J}}^{\tilde{\mathfrak{N}}}(\left[\bigcup_{j \in \Gamma_0} C_{\tilde{\tau}^{\tilde{\mathfrak{N}}}}(\mathcal{S}_j, r)\right]^c) \leq 1 - r, \tilde{\mathcal{J}}^{\tilde{\mathfrak{M}}}(\left[\bigcup_{j \in \Gamma_0} C_{\tilde{\tau}^{\tilde{\mathfrak{M}}}}(\mathcal{S}_j, r)\right]^c) \leq 1 - r$. Since,

$$\left[\bigcup_{j \in \Gamma_0} C_{\tilde{\tau}^{\tilde{\mathfrak{Y}}}\tilde{\mathfrak{N}}\tilde{\mathfrak{M}}}(\mathcal{S}_j, r)\right]^c = \bigcap_{j \in \Gamma_0} \text{int}_{\tilde{\tau}^{\tilde{\mathfrak{Y}}}\tilde{\mathfrak{N}}\tilde{\mathfrak{M}}}(\mathcal{S}_j^c, r).$$

The family $\{\text{int}_{\tilde{\tau}^{\tilde{\mathfrak{Y}}}\tilde{\mathfrak{N}}\tilde{\mathfrak{M}}}(\mathcal{S}_j^c, r): \tilde{\tau}^{\tilde{\mathfrak{Y}}}(\mathcal{S}_j) \geq r, \tilde{\tau}^{\tilde{\mathfrak{N}}}(\mathcal{S}_j) \leq 1 - r, \tilde{\tau}^{\tilde{\mathfrak{M}}}(\mathcal{S}_j) \leq 1 - r, j \in \Gamma\}$ has the **I - FIP**. By (3). $\bigcap_{j \in \Gamma} \mathcal{S}_j^c \neq \tilde{0}$, Then, $\bigcup_{j \in \Gamma} \mathcal{S}_j \neq \tilde{1}$. It is a contradiction.

(1) \Rightarrow (4). Let $\{\mathcal{S}_j\}_{j \in \Gamma}$ be a family of $r - \text{SVNRO}$ set such that $\bigcup_{j \in \Gamma} \mathcal{S}_j = \tilde{1}$. Then, $\bigcup_{j \in \Gamma} \text{int}_{\tilde{\tau}^{\tilde{\mathfrak{Y}}}\tilde{\mathfrak{N}}\tilde{\mathfrak{M}}}(C_{\tilde{\tau}^{\tilde{\mathfrak{Y}}}\tilde{\mathfrak{N}}\tilde{\mathfrak{M}}}(\mathcal{S}_j, r), r) = \tilde{1}$, since, $\tilde{\mathcal{J}}^{\tilde{\mathfrak{Y}}}(\text{int}_{\tilde{\tau}^{\tilde{\mathfrak{Y}}}}(C_{\tilde{\tau}^{\tilde{\mathfrak{Y}}}}(\mathcal{S}_j, r), r)) \geq r, \tilde{\mathcal{J}}^{\tilde{\mathfrak{N}}}(\text{int}_{\tilde{\tau}^{\tilde{\mathfrak{N}}}}(C_{\tilde{\tau}^{\tilde{\mathfrak{N}}}}(\mathcal{S}_j, r), r)) \leq 1 - r, \tilde{\mathcal{J}}^{\tilde{\mathfrak{M}}}(\text{int}_{\tilde{\tau}^{\tilde{\mathfrak{M}}}}(C_{\tilde{\tau}^{\tilde{\mathfrak{M}}}}(\mathcal{S}_j, r), r)) \leq 1 - r$ and $\tilde{\mathfrak{X}}$ is $r - \text{SVNJ} - \text{quasi } H - \text{closed}$, there exists a finite subset $\Gamma_0 \subseteq \Gamma$ such that

$$\tilde{J}^{\tilde{\nu}} \left(\left[\bigcup_{j \in \Gamma_0} C_{\tilde{\tau}^{\tilde{\nu}}}(\text{int}_{\tilde{\tau}^{\tilde{\nu}}}(C_{\tilde{\tau}^{\tilde{\nu}}}(\mathcal{S}_j, r), r), r) \right]^c \right) \geq r, \quad \tilde{J}^{\tilde{\eta}} \left(\left[\bigcup_{j \in \Gamma_0} C_{\tilde{\tau}^{\tilde{\eta}}}(\text{int}_{\tilde{\tau}^{\tilde{\eta}}}(C_{\tilde{\tau}^{\tilde{\eta}}}(\mathcal{S}_j, r), r), r) \right]^c \right) \leq 1 - r,$$

$$\tilde{J}^{\tilde{\mu}} \left(\left[\bigcup_{j \in \Gamma_0} C_{\tilde{\tau}^{\tilde{\mu}}}(\text{int}_{\tilde{\tau}^{\tilde{\mu}}}(C_{\tilde{\tau}^{\tilde{\mu}}}(\mathcal{S}_j, r), r), r) \right]^c \right) \leq 1 - r.$$

Since, for $\tilde{\tau}^{\tilde{\nu}}(\mathcal{S}_j) \geq r$, $\tilde{\tau}^{\tilde{\eta}}(\mathcal{S}_j) \leq 1 - r$, $\tilde{\tau}^{\tilde{\mu}}(\mathcal{S}_j) \leq 1 - r$ we have $C_{\tilde{\tau}^{\tilde{\nu}\tilde{\eta}\tilde{\mu}}}(\text{int}_{\tilde{\tau}^{\tilde{\nu}\tilde{\eta}\tilde{\mu}}}(C_{\tilde{\tau}^{\tilde{\nu}\tilde{\eta}\tilde{\mu}}}(\mathcal{S}_j, r), r), r) = C_{\tilde{\tau}^{\tilde{\nu}\tilde{\eta}\tilde{\mu}}}(\mathcal{S}_j, r)$. Hence, $\tilde{J}^{\tilde{\nu}} \left(\left[\bigcup_{j \in \Gamma_0} C_{\tilde{\tau}^{\tilde{\nu}}}(\mathcal{S}_j, r) \right]^c \right) \geq r$, $\tilde{J}^{\tilde{\eta}} \left(\left[\bigcup_{j \in \Gamma_0} C_{\tilde{\tau}^{\tilde{\eta}}}(\mathcal{S}_j, r) \right]^c \right) \leq 1 - r$, $\tilde{J}^{\tilde{\mu}} \left(\left[\bigcup_{j \in \Gamma_0} C_{\tilde{\tau}^{\tilde{\mu}}}(\mathcal{S}_j, r) \right]^c \right) \leq 1 - r$.

(4)⇒(5). Let $\{\mathcal{S}_j \in I^{\tilde{\mathfrak{X}}}: j \in \Gamma\}$ be a family of $r - SVNRC$ sets such that $\bigcap_{j \in \Gamma} \mathcal{S}_j = \tilde{\mathfrak{O}}$. Then, $\bigcup_{j \in \Gamma} \mathcal{S}_j^c = \tilde{\mathfrak{I}}$, and $\{\mathcal{S}_j^c \in I^{\tilde{\mathfrak{X}}}: j \in \Gamma\}$ is a family of $r - SVNRO$ sets. By (4), there will be a finite subset $\Gamma_0 \subseteq \Gamma$ such that $\tilde{J}^{\tilde{\nu}} \left(\left[\bigcup_{j \in \Gamma_0} C_{\tilde{\tau}^{\tilde{\nu}}}(\mathcal{S}_j^c, r) \right]^c \right) \geq r$, $\tilde{J}^{\tilde{\eta}} \left(\left[\bigcup_{j \in \Gamma_0} C_{\tilde{\tau}^{\tilde{\eta}}}(\mathcal{S}_j^c, r) \right]^c \right) \leq 1 - r$, $\tilde{J}^{\tilde{\mu}} \left(\left[\bigcup_{j \in \Gamma_0} C_{\tilde{\tau}^{\tilde{\mu}}}(\mathcal{S}_j^c, r) \right]^c \right) \leq 1 - r$. Thus,

$$\tilde{J}^{\tilde{\nu}} \left(\bigcap_{j \in \Gamma_0} \text{int}_{\tilde{\tau}^{\tilde{\nu}}}(\mathcal{S}_j, r) \right) \geq r, \quad \tilde{J}^{\tilde{\eta}} \left(\bigcap_{j \in \Gamma_0} \text{int}_{\tilde{\tau}^{\tilde{\eta}}}(\mathcal{S}_j, r) \right) \leq 1 - r, \quad \tilde{J}^{\tilde{\mu}} \left(\bigcap_{j \in \Gamma_0} \text{int}_{\tilde{\tau}^{\tilde{\mu}}}(\mathcal{S}_j, r) \right) \leq 1 - r.$$

(5)⇒(1). Let $\{\mathcal{S}_j \in I^{\tilde{\mathfrak{X}}}: \tilde{\tau}^{\tilde{\nu}}(\mathcal{S}_j) \geq r, \tilde{\tau}^{\tilde{\eta}}(\mathcal{S}_j) \leq 1 - r, \tilde{\tau}^{\tilde{\mu}}(\mathcal{S}_j) \leq 1 - r, j \in \Gamma\}$ be a family such that $\bigcup_{j \in \Gamma} \mathcal{S}_j = \tilde{\mathfrak{I}}$. Then, $\bigcup_{j \in \Gamma} \text{int}_{\tilde{\tau}^{\tilde{\nu}\tilde{\eta}\tilde{\mu}}}(C_{\tilde{\tau}^{\tilde{\nu}\tilde{\eta}\tilde{\mu}}}(\mathcal{S}_j, r), r) = \tilde{\mathfrak{I}}$. Thus, $\bigcap_{j \in \Gamma} C_{\tilde{\tau}^{\tilde{\nu}\tilde{\eta}\tilde{\mu}}}(\text{int}_{\tilde{\tau}^{\tilde{\nu}\tilde{\eta}\tilde{\mu}}}(\mathcal{S}_j^c, r), r) = \tilde{\mathfrak{O}}$ and $C_{\tilde{\tau}^{\tilde{\nu}\tilde{\eta}\tilde{\mu}}}(\text{int}_{\tilde{\tau}^{\tilde{\nu}\tilde{\eta}\tilde{\mu}}}(\mathcal{S}_j^c, r), r)$ is $r - SVNRC$. For the hypothesis, there exists $\Gamma_0 \subseteq \Gamma$ such that

$$\tilde{J}^{\tilde{\nu}} \left(\bigcap_{j \in \Gamma_0} \text{int}_{\tilde{\tau}^{\tilde{\nu}}}(C_{\tilde{\tau}^{\tilde{\nu}}}(C_{\tilde{\tau}^{\tilde{\nu}}}(\text{int}_{\tilde{\tau}^{\tilde{\nu}}}(\mathcal{S}_j^c, r), r), r), r) \right) \geq r, \quad \tilde{J}^{\tilde{\eta}} \left(\bigcap_{j \in \Gamma_0} \text{int}_{\tilde{\tau}^{\tilde{\eta}}}(C_{\tilde{\tau}^{\tilde{\eta}}}(C_{\tilde{\tau}^{\tilde{\eta}}}(\text{int}_{\tilde{\tau}^{\tilde{\eta}}}(\mathcal{S}_j^c, r), r), r), r) \right) \leq 1 - r,$$

$$\tilde{J}^{\tilde{\mu}} \left(\bigcap_{j \in \Gamma_0} \text{int}_{\tilde{\tau}^{\tilde{\mu}}}(C_{\tilde{\tau}^{\tilde{\mu}}}(C_{\tilde{\tau}^{\tilde{\mu}}}(\text{int}_{\tilde{\tau}^{\tilde{\mu}}}(\mathcal{S}_j^c, r), r), r), r) \right) \leq 1 - r$$

Since, for $\tilde{\tau}^{\tilde{\nu}}(\mathcal{S}_j) \geq r$, $\tilde{\tau}^{\tilde{\eta}}(\mathcal{S}_j) \leq 1 - r$, $\tilde{\tau}^{\tilde{\mu}}(\mathcal{S}_j) \leq 1 - r$ we have $C_{\tilde{\tau}^{\tilde{\nu}\tilde{\eta}\tilde{\mu}}}(\text{int}_{\tilde{\tau}^{\tilde{\nu}\tilde{\eta}\tilde{\mu}}}(C_{\tilde{\tau}^{\tilde{\nu}\tilde{\eta}\tilde{\mu}}}(\mathcal{S}_j, r), r), r) = C_{\tilde{\tau}^{\tilde{\nu}\tilde{\eta}\tilde{\mu}}}(\mathcal{S}_j, r)$, and hence, $\bigcap_{j \in \Gamma_0} \text{int}_{\tilde{\tau}^{\tilde{\nu}\tilde{\eta}\tilde{\mu}}}(C_{\tilde{\tau}^{\tilde{\nu}\tilde{\eta}\tilde{\mu}}}(\text{int}_{\tilde{\tau}^{\tilde{\nu}\tilde{\eta}\tilde{\mu}}}(\mathcal{S}_j^c, r), r), r) = \left[\bigcup_{j \in \Gamma_0} C_{\tilde{\tau}^{\tilde{\nu}\tilde{\eta}\tilde{\mu}}}(\mathcal{S}_j, r) \right]^c$. Therefore, $\tilde{J}^{\tilde{\nu}} \left(\left[\bigcup_{j \in \Gamma_0} C_{\tilde{\tau}^{\tilde{\nu}}}(\mathcal{S}_j, r) \right]^c \right) \geq r$, $\tilde{J}^{\tilde{\eta}} \left(\left[\bigcup_{j \in \Gamma_0} C_{\tilde{\tau}^{\tilde{\eta}}}(\mathcal{S}_j, r) \right]^c \right) \leq 1 - r$, $\tilde{J}^{\tilde{\mu}} \left(\left[\bigcup_{j \in \Gamma_0} C_{\tilde{\tau}^{\tilde{\mu}}}(\mathcal{S}_j, r) \right]^c \right) \leq 1 - r$. Hence, $(\tilde{\mathfrak{X}}, \tilde{\tau}^{\tilde{\nu}\tilde{\eta}\tilde{\mu}}, \tilde{J}^{\tilde{\nu}\tilde{\eta}\tilde{\mu}})$ is $r - SVNJ - quasi H - closed$,

(6)⇔(4) is proved similarly like (3)⇔(1).

Theorem 4.17. Let $(\tilde{\mathfrak{X}}, \tilde{\tau}^{\tilde{\nu}\tilde{\eta}\tilde{\mu}}, \tilde{J}^{\tilde{\nu}\tilde{\eta}\tilde{\mu}})$ be an $SVNJTS$ and $r \in I_0$. Then the next statements are equivalent:

- (1) $(\tilde{\mathfrak{X}}, \tilde{\tau}^{\tilde{\nu}\tilde{\eta}\tilde{\mu}}, \tilde{J}^{\tilde{\nu}\tilde{\eta}\tilde{\mu}})$ is $r - SVNJ - quasi H - closed$,
- (2) For any family $\{\mathcal{S}_j \in I^{\tilde{\mathfrak{X}}}: \mathcal{S}_j \leq \text{int}_{\tilde{\tau}^{\tilde{\nu}\tilde{\eta}\tilde{\mu}}}(C_{\tilde{\tau}^{\tilde{\nu}\tilde{\eta}\tilde{\mu}}}(\mathcal{S}_j, r), r)\}$ with $\bigcup_{j \in \Gamma} \mathcal{S}_j = \tilde{\mathfrak{I}}$, there exists a finite subset $\Gamma_0 \subseteq \Gamma$ such that $\tilde{J}^{\tilde{\nu}} \left(\left[\bigcup_{j \in \Gamma_0} C_{\tilde{\tau}^{\tilde{\nu}}}(\mathcal{S}_j, r) \right]^c \right) \geq r$, $\tilde{J}^{\tilde{\eta}} \left(\left[\bigcup_{j \in \Gamma_0} C_{\tilde{\tau}^{\tilde{\eta}}}(\mathcal{S}_j, r) \right]^c \right) \leq 1 - r$, $\tilde{J}^{\tilde{\mu}} \left(\left[\bigcup_{j \in \Gamma_0} C_{\tilde{\tau}^{\tilde{\mu}}}(\mathcal{S}_j, r) \right]^c \right) \leq 1 - r$,
- (3) For any family $\{\mathcal{S}_j \in I^{\tilde{\mathfrak{X}}}: \tilde{\tau}^{\tilde{\nu}}(\mathcal{S}_j^c) \geq r, \tilde{\tau}^{\tilde{\eta}}(\mathcal{S}_j^c) \leq 1 - r, \tilde{\tau}^{\tilde{\mu}}(\mathcal{S}_j^c) \leq 1 - r, j \in \Gamma\}$ such that $\bigcap_{j \in \Gamma} \mathcal{S}_j = \tilde{\mathfrak{O}}$, there exists a finite subset $\Gamma_0 \subseteq \Gamma$ such that $\tilde{J}^{\tilde{\nu}}(\bigcap_{j \in \Gamma_0} \text{int}_{\tilde{\tau}^{\tilde{\nu}}}(\mathcal{S}_j, r)) \geq r$, $\tilde{J}^{\tilde{\eta}}(\bigcap_{j \in \Gamma_0} \text{int}_{\tilde{\tau}^{\tilde{\eta}}}(\mathcal{S}_j, r)) \leq 1 - r$, $\tilde{J}^{\tilde{\mu}}(\bigcap_{j \in \Gamma_0} \text{int}_{\tilde{\tau}^{\tilde{\mu}}}(\mathcal{S}_j, r)) \leq 1 - r$.

Proof. Obvious.

Theorem 4.18. Let $(\tilde{\mathfrak{X}}, \tilde{\tau}^{\tilde{\nu}\tilde{\eta}\tilde{\mu}}, \tilde{J}^{\tilde{\nu}\tilde{\eta}\tilde{\mu}})$ be an $SVNJTS$ and $r \in I_0$. Then the next statements are equivalent:

- (1) $(\tilde{\mathfrak{A}}, \tilde{\tau}^{\tilde{\gamma}\tilde{\eta}\tilde{\mu}}, \tilde{\mathfrak{J}}^{\tilde{\gamma}\tilde{\eta}\tilde{\mu}})$ is $r - SVN C(\mathcal{J}) - compact$,
- (2) For each family $\{\mathcal{E}_j \in I^{\tilde{\mathfrak{A}}}: \tilde{\tau}^{\tilde{\gamma}}(\mathcal{E}_j^c) \geq r, \tilde{\tau}^{\tilde{\eta}}(\mathcal{E}_j^c) \leq 1 - r, \tilde{\tau}^{\tilde{\mu}}(\mathcal{E}_j^c) \leq 1 - r, j \in \Gamma\}$ and every $\tilde{\tau}^{\tilde{\gamma}}(\mathcal{S}^c) \geq r, \tilde{\tau}^{\tilde{\eta}}(\mathcal{S}^c) \leq 1 - r, \tilde{\tau}^{\tilde{\mu}}(\mathcal{S}^c) \leq 1 - r$ with $\bigcap_{j \in \Gamma} \mathcal{E}_j \bar{q}\mathcal{S}$, there exists a finite subset $\Gamma_0 \subseteq \Gamma$ such that $\tilde{\mathfrak{J}}^{\tilde{\gamma}}(\mathcal{S} \cap \bigcap_{j \in \Gamma_0} \text{int}_{\tilde{\tau}^{\tilde{\gamma}}}(\mathcal{E}_j, r)) \geq r, \tilde{\mathfrak{J}}^{\tilde{\eta}}(\mathcal{S} \cap \bigcap_{j \in \Gamma_0} \text{int}_{\tilde{\tau}^{\tilde{\eta}}}(\mathcal{E}_j, r)) \leq 1 - r, \tilde{\mathfrak{J}}^{\tilde{\mu}}(\mathcal{S} \cap \bigcap_{j \in \Gamma_0} \text{int}_{\tilde{\tau}^{\tilde{\mu}}}(\mathcal{E}_j, r)) \leq 1 - r$.
- (3) $\bigcap_{j \in \Gamma} \mathcal{E}_j q\mathcal{S}$ holds for each family $\{\mathcal{E}_j \in I^{\tilde{\mathfrak{A}}}: \tilde{\tau}^{\tilde{\gamma}}(\mathcal{E}_j^c) \geq r, \tilde{\tau}^{\tilde{\eta}}(\mathcal{E}_j^c) \leq 1 - r, \tilde{\tau}^{\tilde{\mu}}(\mathcal{E}_j^c) \leq 1 - r, j \in \Gamma\}$ and any $\tilde{\tau}^{\tilde{\gamma}}(\mathcal{S}^c) \geq r, \tilde{\tau}^{\tilde{\eta}}(\mathcal{S}^c) \leq 1 - r, \tilde{\tau}^{\tilde{\mu}}(\mathcal{S}^c) \leq 1 - r$ with $\{\text{int}_{\tilde{\tau}^{\tilde{\gamma}\tilde{\eta}\tilde{\mu}}}(\mathcal{E}_j, r) q\mathcal{S}, j \in \Gamma\}$ has the **I - FIP**,
- (4) For each family $\{\mathcal{E}_j \in I^{\tilde{\mathfrak{A}}}: \mathcal{E}_j \text{ is } r - SVNRO, j \in \Gamma\}$ and any $\tilde{\tau}^{\tilde{\gamma}}(\mathcal{S}^c) \geq r, \tilde{\tau}^{\tilde{\mu}}(\mathcal{S}^c) \leq 1 - r, \tilde{\tau}^{\tilde{\eta}}(\mathcal{S}^c) \leq 1 - r$ with $\mathcal{S} \leq \bigcup_{j \in \Gamma} \mathcal{E}_j$, there exists a finite subset $\Gamma_0 \subseteq \Gamma$ such that,

$$\tilde{\mathfrak{J}}^{\tilde{\gamma}}\left(\mathcal{S} \cap \left[\bigcup_{j \in \Gamma_0} C_{\tilde{\tau}^{\tilde{\gamma}}}(\mathcal{E}_j, r)\right]^c\right) \geq r, \tilde{\mathfrak{J}}^{\tilde{\eta}}\left(\mathcal{S} \cap \left[\bigcup_{j \in \Gamma_0} C_{\tilde{\tau}^{\tilde{\eta}}}(\mathcal{E}_j, r)\right]^c\right) \leq 1 - r, \tilde{\mathfrak{J}}^{\tilde{\mu}}\left(\mathcal{S} \cap \left[\bigcup_{j \in \Gamma_0} C_{\tilde{\tau}^{\tilde{\mu}}}(\mathcal{E}_j, r)\right]^c\right) \leq 1 - r.$$

- (5) For each family $\{\mathcal{E}_j \in I^{\tilde{\mathfrak{A}}}: \mathcal{E}_j \text{ is } r - SVNRC, j \in \Gamma\}$ and any $\tilde{\tau}^{\tilde{\gamma}}(\mathcal{S}^c) \geq r, \tilde{\tau}^{\tilde{\mu}}(\mathcal{S}^c) \leq 1 - r, \tilde{\tau}^{\tilde{\eta}}(\mathcal{S}^c) \leq 1 - r$, with $\bigcap_{j \in \Gamma} \mathcal{E}_j \bar{q}\mathcal{S}$, there exists $\Gamma_0 \subseteq \Gamma$ such that,

$$\tilde{\mathfrak{J}}^{\tilde{\gamma}}\left(\bigcap_{j \in \Gamma_0} \text{int}_{\tilde{\tau}^{\tilde{\gamma}}}(\mathcal{E}_j, r) \cap \mathcal{S}\right) \geq r, \tilde{\mathfrak{J}}^{\tilde{\eta}}\left(\bigcap_{j \in \Gamma_0} \text{int}_{\tilde{\tau}^{\tilde{\eta}}}(\mathcal{E}_j, r) \cap \mathcal{S}\right) \leq 1 - r, \tilde{\mathfrak{J}}^{\tilde{\mu}}\left(\bigcap_{j \in \Gamma_0} \text{int}_{\tilde{\tau}^{\tilde{\mu}}}(\mathcal{E}_j, r) \cap \mathcal{S}\right) \leq 1 - r,$$

- (6) $\bigcap_{j \in \Gamma} \mathcal{E}_j q\mathcal{S}$ holds for each family $\{\mathcal{E}_j \in I^{\tilde{\mathfrak{A}}}: \mathcal{E}_j \text{ is } r - SVNRC, j \in \Gamma\}$ and any $\tilde{\tau}^{\tilde{\gamma}}(\mathcal{S}^c) \geq r, \tilde{\tau}^{\tilde{\eta}}(\mathcal{S}^c) \leq 1 - r, \tilde{\tau}^{\tilde{\mu}}(\mathcal{S}^c) \leq 1 - r$ such taht $\{\text{int}_{\tilde{\tau}^{\tilde{\gamma}\tilde{\eta}\tilde{\mu}}}(\mathcal{E}_j, r) \cap \mathcal{S}: j \in \Gamma\}$ has the **I - FIP**.

Proof. (1) \Rightarrow (2). Let $\{\mathcal{E}_j \in I^{\tilde{\mathfrak{A}}}: \tilde{\tau}^{\tilde{\gamma}}(\mathcal{E}_j^c) \geq r, \tilde{\tau}^{\tilde{\eta}}(\mathcal{E}_j^c) \leq 1 - r, \tilde{\tau}^{\tilde{\mu}}(\mathcal{E}_j^c) \leq 1 - r, j \in \Gamma\}$ and $\tilde{\tau}^{\tilde{\gamma}}(\mathcal{S}^c) \geq r, \tilde{\tau}^{\tilde{\eta}}(\mathcal{S}^c) \leq 1 - r$ with $\bigcap_{j \in \Gamma} \mathcal{E}_j \bar{q}\mathcal{S}$. Then, $\tilde{\gamma}_{\bigcap_{j \in \Gamma} \mathcal{E}_j} + \tilde{\gamma}_{\mathcal{S}} \leq 1, \tilde{\eta}_{\bigcap_{j \in \Gamma} \mathcal{E}_j} + \tilde{\eta}_{\mathcal{S}} \geq 1, \tilde{\mu}_{\bigcap_{j \in \Gamma} \mathcal{E}_j} + \tilde{\mu}_{\mathcal{S}} \geq 1$. It implies that $\mathcal{S} \leq \bigcup_{j \in \Gamma} \mathcal{E}_j^c$. By $r - SVN C(\mathcal{J}) - compactness$ of $(\tilde{\mathfrak{A}}, \tilde{\tau}^{\tilde{\gamma}\tilde{\eta}\tilde{\mu}}, \tilde{\mathfrak{J}}^{\tilde{\gamma}\tilde{\eta}\tilde{\mu}})$, there exists a finite subset $\Gamma_0 \subseteq \Gamma$ such that,

$$\tilde{\mathfrak{J}}^{\tilde{\gamma}}\left(\mathcal{S} \cap \left[\bigcup_{j \in \Gamma_0} C_{\tilde{\tau}^{\tilde{\gamma}}}(\mathcal{E}_j^c, r)\right]^c\right) \geq r, \tilde{\mathfrak{J}}^{\tilde{\eta}}\left(\mathcal{S} \cap \left[\bigcup_{j \in \Gamma_0} C_{\tilde{\tau}^{\tilde{\eta}}}(\mathcal{E}_j^c, r)\right]^c\right) \leq 1 - r, \tilde{\mathfrak{J}}^{\tilde{\mu}}\left(\mathcal{S} \cap \left[\bigcup_{j \in \Gamma_0} C_{\tilde{\tau}^{\tilde{\mu}}}(\mathcal{E}_j^c, r)\right]^c\right) \leq 1 - r.$$

Since, $\mathcal{S} \cap \left[\bigcup_{j \in \Gamma_0} C_{\tilde{\tau}^{\tilde{\mu}}}(\mathcal{E}_j^c, r)\right]^c = \mathcal{S} \cap \bigcap_{j \in \Gamma_0} \text{int}_{\tilde{\tau}^{\tilde{\mu}}}(\mathcal{E}_j, r)$. Then

$$\tilde{\mathfrak{J}}^{\tilde{\gamma}}\left(\mathcal{S} \cap \bigcap_{j \in \Gamma_0} \text{int}_{\tilde{\tau}^{\tilde{\gamma}}}(\mathcal{E}_j, r)\right) \geq r, \tilde{\mathfrak{J}}^{\tilde{\eta}}\left(\mathcal{S} \cap \bigcap_{j \in \Gamma_0} \text{int}_{\tilde{\tau}^{\tilde{\eta}}}(\mathcal{E}_j, r)\right) \leq 1 - r, \tilde{\mathfrak{J}}^{\tilde{\mu}}\left(\mathcal{S} \cap \bigcap_{j \in \Gamma_0} \text{int}_{\tilde{\tau}^{\tilde{\mu}}}(\mathcal{E}_j, r)\right) \leq 1 - r.$$

(2) \Rightarrow (3). It is trivial.

(3) \Rightarrow (1). Let $\{\mathcal{E}_j \in I^{\tilde{\mathfrak{A}}}: \tilde{\tau}^{\tilde{\gamma}}(\mathcal{E}_j) \geq r, \tilde{\tau}^{\tilde{\eta}}(\mathcal{E}_j) \leq 1 - r, \tilde{\tau}^{\tilde{\mu}}(\mathcal{E}_j) \leq 1 - r, j \in \Gamma\}$ be a family and $\tilde{\tau}^{\tilde{\gamma}}(\mathcal{S}^c) \geq r, \tilde{\tau}^{\tilde{\eta}}(\mathcal{S}^c) \leq 1 - r, \tilde{\tau}^{\tilde{\mu}}(\mathcal{S}^c) \leq 1 - r$ such that $\mathcal{S} \leq \bigcup_{j \in \Gamma} \mathcal{E}_j$ with property that for no finite subfamily Γ_0 of Γ one has, $\tilde{\mathfrak{J}}^{\tilde{\gamma}}(\mathcal{S} \cap \left[\bigcup_{j \in \Gamma_0} C_{\tilde{\tau}^{\tilde{\gamma}}}(\mathcal{E}_j, r)\right]^c) \geq r, \tilde{\mathfrak{J}}^{\tilde{\eta}}(\mathcal{S} \cap \left[\bigcup_{j \in \Gamma_0} C_{\tilde{\tau}^{\tilde{\eta}}}(\mathcal{E}_j, r)\right]^c) \leq 1 - r, \tilde{\mathfrak{J}}^{\tilde{\mu}}(\mathcal{S} \cap \left[\bigcup_{j \in \Gamma_0} C_{\tilde{\tau}^{\tilde{\mu}}}(\mathcal{E}_j, r)\right]^c) \leq 1 - r$. Since, $\mathcal{S} \cap \left[\bigcup_{j \in \Gamma_0} C_{\tilde{\tau}^{\tilde{\gamma}}}(\mathcal{E}_j, r)\right]^c = \bigcap_{j \in \Gamma_0} \{\text{int}_{\tilde{\tau}^{\tilde{\gamma}\tilde{\eta}\tilde{\mu}}}(\mathcal{E}_j^c, r) \cap \mathcal{S}\}$, the family $\{\bigcap_{j \in \Gamma} \{\text{int}_{\tilde{\tau}^{\tilde{\gamma}\tilde{\eta}\tilde{\mu}}}(\mathcal{E}_j^c, r) \cap \mathcal{S}, j \in \Gamma\}$ has the **I - FIP**. By (3), $\bigcap_{j \in \Gamma} \mathcal{E}_j^c q\mathcal{S}$ implies that $\bigcup_{j \in \Gamma} \mathcal{E}_j \leq \mathcal{S}$. It is a contradiction.

(1) \Rightarrow (4). Let $\{\mathcal{E}_j \in I^{\tilde{\mathfrak{A}}}: j \in \Gamma\}$ be a family of $r - SVNRO$ sets and $\tilde{\tau}^{\tilde{\gamma}}(\mathcal{S}^c) \geq r, \tilde{\tau}^{\tilde{\mu}}(\mathcal{S}^c) \leq 1 - r, \tilde{\tau}^{\tilde{\eta}}(\mathcal{S}^c) \leq 1 - r$ with $\mathcal{S} \leq \bigcup_{j \in \Gamma} \mathcal{E}_j$. Then, $\mathcal{S} \leq \bigcup_{j \in \Gamma} \text{int}_{\tilde{\tau}^{\tilde{\gamma}\tilde{\eta}\tilde{\mu}}}(C_{\tilde{\tau}^{\tilde{\gamma}\tilde{\eta}\tilde{\mu}}}(\mathcal{E}_j, r), r)$. By $r - SVN C(\mathcal{J}) - compactness$ of $(\tilde{\mathfrak{A}}, \tilde{\tau}^{\tilde{\gamma}\tilde{\eta}\tilde{\mu}}, \tilde{\mathfrak{J}}^{\tilde{\gamma}\tilde{\eta}\tilde{\mu}})$, there exists a finite subset $\Gamma_0 \subseteq \Gamma$ such that,

$$\tilde{\mathfrak{J}}^{\tilde{\gamma}}\left(\mathcal{S} \cap \left[\bigcup_{j \in \Gamma_0} C_{\tilde{\tau}^{\tilde{\gamma}}}\left(\text{int}_{\tilde{\tau}^{\tilde{\mu}}}(C_{\tilde{\tau}^{\tilde{\eta}}}(C_{\tilde{\tau}^{\tilde{\mu}}}(\mathcal{E}_j, r), r), r)\right)\right]^c\right) \geq r, \tilde{\mathfrak{J}}^{\tilde{\eta}}\left(\mathcal{S} \cap \left[\bigcup_{j \in \Gamma_0} C_{\tilde{\tau}^{\tilde{\eta}}}\left(\text{int}_{\tilde{\tau}^{\tilde{\mu}}}(C_{\tilde{\tau}^{\tilde{\eta}}}(C_{\tilde{\tau}^{\tilde{\mu}}}(\mathcal{E}_j, r), r), r)\right)\right]^c\right) \leq 1 - r,$$

$$\tilde{J}^{\tilde{\mu}} \left(\mathcal{S} \cap \left[\bigcup_{j \in \Gamma_0} C_{\tilde{\tau}^{\tilde{\mu}}}(\text{int}_{\tilde{\tau}^{\tilde{\mu}}}(\mathcal{E}_j, r), r), r \right]^c \right) \leq 1 - r$$

Since, for $\tilde{\tau}^{\tilde{\nu}}(\mathcal{E}_j) \geq r$, $\tilde{\tau}^{\tilde{\eta}}(\mathcal{E}_j) \leq 1 - r$, $\tilde{\tau}^{\tilde{\mu}}(\mathcal{E}_j) \leq 1 - r$, $C_{\tilde{\tau}^{\tilde{\nu}\tilde{\eta}\tilde{\mu}}}(\text{int}_{\tilde{\tau}^{\tilde{\nu}\tilde{\eta}\tilde{\mu}}}(\mathcal{E}_j, r), r) = C_{\tilde{\tau}^{\tilde{\nu}\tilde{\eta}\tilde{\mu}}}(\mathcal{E}_j, r)$. Therefore, $\tilde{J}^{\tilde{\nu}}(\mathcal{S} \cap [\bigcup_{j \in \Gamma_0} C_{\tilde{\tau}^{\tilde{\nu}}}(\mathcal{E}_j, r)]^c) \geq r$, $\tilde{J}^{\tilde{\eta}}(\mathcal{S} \cap [\bigcup_{j \in \Gamma_0} C_{\tilde{\tau}^{\tilde{\eta}}}(\mathcal{E}_j, r)]^c) \leq 1 - r$, $\tilde{J}^{\tilde{\mu}}(\mathcal{S} \cap [\bigcup_{j \in \Gamma_0} C_{\tilde{\tau}^{\tilde{\mu}}}(\mathcal{E}_j, r)]^c) \leq 1 - r$.

(4) \Rightarrow (1). It is trivial.

(4) \Rightarrow (5). Let $\{\mathcal{E}_j\}_{j \in \Gamma}$ be a family of $r - SVNRC$ sets and every $\tilde{\tau}^{\tilde{\nu}}(\mathcal{S}^c) \geq r$, $\tilde{\tau}^{\tilde{\mu}}(\mathcal{S}^c) \leq 1 - r$, $\tilde{\tau}^{\tilde{\eta}}(\mathcal{S}^c) \leq 1 - r$ such that $\bigcap_{j \in \Gamma} \mathcal{E}_j \bar{q} \mathcal{S}$. Then, $\mathcal{S} \leq \bigcup_{j \in \Gamma} \mathcal{E}_j^c$ and $\{\mathcal{E}_j^c \in I^{\tilde{\tau}^{\tilde{\nu}}}: j \in \Gamma\}$ be a family of $r - SVNRO$ sets. By (4), there exists a finite subset $\Gamma_0 \subseteq \Gamma$ such that $\tilde{J}^{\tilde{\nu}}(\mathcal{S} \cap [\bigcup_{j \in \Gamma_0} C_{\tilde{\tau}^{\tilde{\nu}}}(\mathcal{E}_j^c, r)]^c) \geq r$, $\tilde{J}^{\tilde{\eta}}(\mathcal{S} \cap [\bigcup_{j \in \Gamma_0} C_{\tilde{\tau}^{\tilde{\eta}}}(\mathcal{E}_j^c, r)]^c) \leq 1 - r$, $\tilde{J}^{\tilde{\mu}}(\mathcal{S} \cap [\bigcup_{j \in \Gamma_0} C_{\tilde{\tau}^{\tilde{\mu}}}(\mathcal{E}_j^c, r)]^c) \leq 1 - r$ implies that

$$\tilde{J}^{\tilde{\nu}} \left(\mathcal{S} \cap \bigcap_{j \in \Gamma_0} \text{int}_{\tilde{\tau}^{\tilde{\nu}}}(\mathcal{E}_j, r) \right) \geq r, \quad \tilde{J}^{\tilde{\eta}} \left(\mathcal{S} \cap \bigcap_{j \in \Gamma_0} \text{int}_{\tilde{\tau}^{\tilde{\eta}}}(\mathcal{E}_j, r) \right) \leq 1 - r, \quad \tilde{J}^{\tilde{\mu}} \left(\mathcal{S} \cap \bigcap_{j \in \Gamma_0} \text{int}_{\tilde{\tau}^{\tilde{\mu}}}(\mathcal{E}_j, r) \right) \leq 1 - r.$$

(5) \Rightarrow (6). Let $\{\mathcal{E}_j\}_{j \in \Gamma}$ be a family of $r - SVNRC$ sets and every $\tilde{\tau}^{\tilde{\nu}}(\mathcal{S}^c) \geq r$, $\tilde{\tau}^{\tilde{\mu}}(\mathcal{S}^c) \leq 1 - r$, $\tilde{\tau}^{\tilde{\eta}}(\mathcal{S}^c) \leq 1 - r$ such that $\{\text{int}_{\tilde{\tau}^{\tilde{\nu}\tilde{\eta}\tilde{\mu}}}(\mathcal{E}_j, r) \cap \mathcal{S}: j \in \Gamma\}$ has the **I - FIP**. If $\bigcap_{j \in \Gamma} \mathcal{E}_j \bar{q} \mathcal{S}$. By (5), there exists a finite subset $\Gamma_0 \subseteq \Gamma$ such that $\tilde{J}^{\tilde{\nu}}(\bigcap_{j \in \Gamma_0} \text{int}_{\tilde{\tau}^{\tilde{\nu}}}(\mathcal{E}_j, r) \cap \mathcal{S}) \geq r$, $\tilde{J}^{\tilde{\eta}}(\bigcap_{j \in \Gamma_0} \text{int}_{\tilde{\tau}^{\tilde{\eta}}}(\mathcal{E}_j, r) \cap \mathcal{S}) \leq 1 - r$, $\tilde{J}^{\tilde{\mu}}(\bigcap_{j \in \Gamma_0} \text{int}_{\tilde{\tau}^{\tilde{\mu}}}(\mathcal{E}_j, r) \cap \mathcal{S}) \leq 1 - r$. It is a contradiction.

(6) \Rightarrow (4). It is trivial.

Theorem 4.19. Let $(\tilde{\mathfrak{X}}_1, \tilde{\tau}_1^{\tilde{\nu}\tilde{\eta}\tilde{\mu}}, \tilde{J}_1^{\tilde{\nu}\tilde{\eta}\tilde{\mu}})$, $(\tilde{\mathfrak{X}}_2, \tilde{\tau}_2^{\tilde{\nu}\tilde{\eta}\tilde{\mu}}, \tilde{J}_2^{\tilde{\nu}\tilde{\eta}\tilde{\mu}})$ be two $SVNJTS$'s and $f: \tilde{\mathfrak{X}}_1 \rightarrow \tilde{\mathfrak{X}}_2$ a surjective SVN -continuous. If $(\tilde{\mathfrak{X}}_1, \tilde{\tau}_1^{\tilde{\nu}\tilde{\eta}\tilde{\mu}}, \tilde{J}_1^{\tilde{\nu}\tilde{\eta}\tilde{\mu}})$ is $r - SVNJ_1 - compact$ and $\tilde{J}_1^{\tilde{\nu}}(\mathcal{S}) \leq \tilde{J}_2^{\tilde{\nu}}(f(\mathcal{S}))$, $\tilde{J}_1^{\tilde{\eta}}(\mathcal{S}) \geq \tilde{J}_2^{\tilde{\eta}}(f(\mathcal{S}))$, $\tilde{J}_1^{\tilde{\mu}}(\mathcal{S}) \geq \tilde{J}_2^{\tilde{\mu}}(f(\mathcal{S}))$. Then, $(\tilde{\mathfrak{X}}_2, \tilde{\tau}_2^{\tilde{\nu}\tilde{\eta}\tilde{\mu}}, \tilde{J}_2^{\tilde{\nu}\tilde{\eta}\tilde{\mu}})$ is $r - SVNJ_2 - compact$.

Proof. Let $\{\mathcal{E}_j \in I^{\tilde{\tau}^{\tilde{\nu}}}: \tilde{\tau}_2^{\tilde{\nu}}(\mathcal{E}_j) \geq r, \tilde{\tau}_2^{\tilde{\eta}}(\mathcal{E}_j) \leq 1 - r, \tilde{\tau}_2^{\tilde{\mu}}(\mathcal{E}_j) \leq 1 - r, j \in \Gamma\}$ be a family such that $\bigcup_{j \in \Gamma} \mathcal{E}_j = \tilde{I}$. Then, $\bigcup_{j \in \Gamma} f^{-1}(\mathcal{E}_j) = \tilde{I}$. Since, f is SVN -continuous, for each $j \in \Gamma$, $\tilde{\tau}_1^{\tilde{\nu}}(f^{-1}(\mathcal{E}_j)) \geq r$, $\tilde{\tau}_1^{\tilde{\eta}}(f^{-1}(\mathcal{E}_j)) \leq 1 - r$, $\tilde{\tau}_1^{\tilde{\mu}}(f^{-1}(\mathcal{E}_j)) \leq 1 - r$. By $r - SVNJ_1 - compactness$ of $(\tilde{\mathfrak{X}}_1, \tilde{\tau}_1^{\tilde{\nu}\tilde{\eta}\tilde{\mu}}, \tilde{J}_1^{\tilde{\nu}\tilde{\eta}\tilde{\mu}})$, there exists a finite $\Gamma_0 \subseteq \Gamma$ such that $\tilde{J}_1^{\tilde{\nu}}([\bigcup_{j \in \Gamma_0} f^{-1}(\mathcal{E}_j)]^c) \geq r$, $\tilde{J}_1^{\tilde{\eta}}([\bigcup_{j \in \Gamma_0} f^{-1}(\mathcal{E}_j)]^c) \leq 1 - r$, $\tilde{J}_1^{\tilde{\mu}}([\bigcup_{j \in \Gamma_0} f^{-1}(\mathcal{E}_j)]^c) \leq 1 - r$. Since $\tilde{J}_1^{\tilde{\nu}}(\mathcal{S}) \leq \tilde{J}_2^{\tilde{\nu}}(f(\mathcal{S}))$, $\tilde{J}_1^{\tilde{\eta}}(\mathcal{S}) \geq \tilde{J}_2^{\tilde{\eta}}(f(\mathcal{S}))$, $\tilde{J}_1^{\tilde{\mu}}(\mathcal{S}) \geq \tilde{J}_2^{\tilde{\mu}}(f(\mathcal{S}))$, for $j \in \Gamma_0$, $\tilde{J}_2^{\tilde{\nu}}(f([\bigcup_{j \in \Gamma_0} f^{-1}(\mathcal{E}_j)]^c)) \geq r$, $\tilde{J}_2^{\tilde{\eta}}(f([\bigcup_{j \in \Gamma_0} f^{-1}(\mathcal{E}_j)]^c)) \leq 1 - r$, $\tilde{J}_2^{\tilde{\mu}}(f([\bigcup_{j \in \Gamma_0} f^{-1}(\mathcal{E}_j)]^c)) \leq 1 - r$. From the surjectivity of f we obtain $f([\bigcup_{j \in \Gamma_0} f^{-1}(\mathcal{E}_j)]^c) = [\bigcup_{j \in \Gamma_0} \mathcal{E}_j]^c$. Hence, $\tilde{J}_2^{\tilde{\nu}}([\bigcup_{j \in \Gamma_0} \mathcal{E}_j]^c) \geq r$, $\tilde{J}_2^{\tilde{\eta}}([\bigcup_{j \in \Gamma_0} \mathcal{E}_j]^c) \leq 1 - r$, $\tilde{J}_2^{\tilde{\mu}}([\bigcup_{j \in \Gamma_0} \mathcal{E}_j]^c) \leq 1 - r$. Thus, $(\tilde{\mathfrak{X}}_2, \tilde{\tau}_2^{\tilde{\nu}\tilde{\eta}\tilde{\mu}}, \tilde{J}_2^{\tilde{\nu}\tilde{\eta}\tilde{\mu}})$ is $r - SVNJ_2 - compact$.

Theorem 4.20. Let $(\tilde{\mathfrak{X}}_1, \tilde{\tau}_1^{\tilde{\nu}\tilde{\eta}\tilde{\mu}}, \tilde{J}_1^{\tilde{\nu}\tilde{\eta}\tilde{\mu}})$, $(\tilde{\mathfrak{X}}_2, \tilde{\tau}_2^{\tilde{\nu}\tilde{\eta}\tilde{\mu}}, \tilde{J}_2^{\tilde{\nu}\tilde{\eta}\tilde{\mu}})$ be two $SVNJTS$'s and $f: \tilde{\mathfrak{X}}_1 \rightarrow \tilde{\mathfrak{X}}_2$ a surjective SVN -continuous. If $(\tilde{\mathfrak{X}}_1, \tilde{\tau}_1^{\tilde{\nu}\tilde{\eta}\tilde{\mu}}, \tilde{J}_1^{\tilde{\nu}\tilde{\eta}\tilde{\mu}})$ is $r - SVNC(\mathcal{J})_1 - compact$ and $\tilde{J}_1^{\tilde{\nu}}(\mathcal{S}) \leq \tilde{J}_2^{\tilde{\nu}}(f(\mathcal{S}))$, $\tilde{J}_1^{\tilde{\eta}}(\mathcal{S}) \geq \tilde{J}_2^{\tilde{\eta}}(f(\mathcal{S}))$, $\tilde{J}_1^{\tilde{\mu}}(\mathcal{S}) \geq \tilde{J}_2^{\tilde{\mu}}(f(\mathcal{S}))$. Then, $(\tilde{\mathfrak{X}}_2, \tilde{\tau}_2^{\tilde{\nu}\tilde{\eta}\tilde{\mu}}, \tilde{J}_2^{\tilde{\nu}\tilde{\eta}\tilde{\mu}})$ is $r - SVNC(\mathcal{J})_2 - compact$.

Proof. Let $\tilde{\tau}_2^{\tilde{\nu}}(\mathcal{S}) \geq r$, $\tilde{\tau}_2^{\tilde{\eta}}(\mathcal{S}) \leq 1 - r$, $\tilde{\tau}_2^{\tilde{\mu}}(\mathcal{S}) \leq 1 - r$ and every family $\{\mathcal{E}_j \in I^{\tilde{\tau}^{\tilde{\nu}}}: \tilde{\tau}_2^{\tilde{\nu}}(\mathcal{E}_j) \geq r, \tilde{\tau}_2^{\tilde{\eta}}(\mathcal{E}_j) \leq 1 - r\}$ with $\mathcal{S} \leq \bigcup_{j \in \Gamma} \mathcal{E}_j$. Then, $f^{-1}(\mathcal{S}) \leq \bigcup_{j \in \Gamma} f^{-1}(\mathcal{E}_j)$. Since, f is SVN -continuous for each $j \in \Gamma$, $\tilde{\tau}_1^{\tilde{\nu}}(f^{-1}(\mathcal{E}_j)) \geq r$, $\tilde{\tau}_1^{\tilde{\eta}}(f^{-1}(\mathcal{E}_j)) \leq 1 - r$, $\tilde{\tau}_1^{\tilde{\mu}}(f^{-1}(\mathcal{E}_j)) \leq 1 - r$. By $r - SVNC(\mathcal{J})_1 - compactness$ of $(\tilde{\mathfrak{X}}_1, \tilde{\tau}_1^{\tilde{\nu}\tilde{\eta}\tilde{\mu}}, \tilde{J}_1^{\tilde{\nu}\tilde{\eta}\tilde{\mu}})$, there exists a finite $\Gamma_0 \subseteq \Gamma$ such that

$$\begin{aligned} \tilde{J}_1^{\tilde{Y}} \left(f^{-1}(\mathcal{S}) \cap \left[\bigcup_{j \in \Gamma_0} C_{\tilde{\tau}_1^{\tilde{Y}}}(f^{-1}(\mathcal{E}_j), r) \right]^c \right) \geq r, \quad \tilde{J}_1^{\tilde{N}} \left(f^{-1}(\mathcal{S}) \cap \left[\bigcup_{j \in \Gamma_0} C_{\tilde{\tau}_1^{\tilde{N}}}(f^{-1}(\mathcal{E}_j), r) \right]^c \right) \leq 1 - r, \\ \tilde{J}_1^{\tilde{\mu}} \left(f^{-1}(\mathcal{S}) \cap \left[\bigcup_{j \in \Gamma_0} C_{\tilde{\tau}_1^{\tilde{\mu}}}(f^{-1}(\mathcal{E}_j), r) \right]^c \right) \leq 1 - r. \end{aligned}$$

Since, f is \mathcal{SVN} -continuous mapping, $C_{\tilde{\tau}_1^{\tilde{Y}\tilde{\mu}}}(f^{-1}(\mathcal{S}_j), r) \leq f^{-1}(C_{\tilde{\tau}_2^{\tilde{Y}\tilde{\mu}}}(\mathcal{S}_j), r)$ for every $\mathcal{S} \in I^{\tilde{\mathfrak{X}}_2}$. Therefore, $f^{-1}(\mathcal{S}) \cap \left[\bigcup_{j \in \Gamma_0} C_{\tilde{\tau}_1^{\tilde{Y}\tilde{\mu}}}(f^{-1}(\mathcal{E}_j), r) \right]^c = f^{-1}(\mathcal{S}) \cap \left[\bigcup_{j \in \Gamma_0} f^{-1}(C_{\tilde{\tau}_2^{\tilde{Y}\tilde{\mu}}}(\mathcal{E}_j, r)) \right]^c$. Hence,

$$\begin{aligned} \tilde{J}_1^{\tilde{Y}} \left(f^{-1}(\mathcal{S}_j) \cap \left[\bigcup_{j \in \Gamma_0} f^{-1}(C_{\tilde{\tau}_2^{\tilde{Y}}}(\mathcal{S}, r)) \right]^c \right) \geq r, \quad \tilde{J}_1^{\tilde{N}} \left(f^{-1}(\mathcal{S}_j) \cap \left[\bigcup_{j \in \Gamma_0} f^{-1}(C_{\tilde{\tau}_2^{\tilde{N}}}(\mathcal{S}, r)) \right]^c \right) \leq 1 - r, \\ \tilde{J}_1^{\tilde{\mu}} \left(f^{-1}(\mathcal{S}_j) \cap \left[\bigcup_{j \in \Gamma_0} f^{-1}(C_{\tilde{\tau}_2^{\tilde{\mu}}}(\mathcal{S}, r)) \right]^c \right) \leq 1 - r. \end{aligned}$$

Since, $\tilde{J}_1^{\tilde{Y}}(\mathcal{S}) \leq \tilde{J}_2^{\tilde{Y}}(f(\mathcal{S}))$, $\tilde{J}_1^{\tilde{N}}(\mathcal{S}) \geq \tilde{J}_2^{\tilde{N}}(f(\mathcal{S}))$, $\tilde{J}_1^{\tilde{\mu}}(\mathcal{S}) \geq \tilde{J}_2^{\tilde{\mu}}(f(\mathcal{S}))$, for each $j \in \Gamma_0$ we have,

$$\begin{aligned} \tilde{J}_2^{\tilde{Y}} \left(f[f^{-1}(\mathcal{S}_j) \cap \left[\bigcup_{j \in \Gamma_0} f^{-1}(C_{\tilde{\tau}_2^{\tilde{Y}}}(\mathcal{S}, r)) \right]^c] \right) \geq r, \quad \tilde{J}_2^{\tilde{N}} \left(f[f^{-1}(\mathcal{S}_j) \cap \left[\bigcup_{j \in \Gamma_0} f^{-1}(C_{\tilde{\tau}_2^{\tilde{N}}}(\mathcal{S}, r)) \right]^c] \right) \leq 1 - r, \\ \tilde{J}_2^{\tilde{\mu}} \left(f[f^{-1}(\mathcal{S}_j) \cap \left[\bigcup_{j \in \Gamma_0} f^{-1}(C_{\tilde{\tau}_2^{\tilde{\mu}}}(\mathcal{S}, r)) \right]^c] \right) \leq 1 - r. \end{aligned}$$

Since, f is surjective,

$$\tilde{J}_2^{\tilde{Y}} \left(\mathcal{S}_j \cap \left[\bigcup_{j \in \Gamma_0} C_{\tilde{\tau}_2^{\tilde{Y}}}(\mathcal{S}, r) \right]^c \right) \geq r, \quad \tilde{J}_2^{\tilde{N}} \left(\mathcal{S}_j \cap \left[\bigcup_{j \in \Gamma_0} C_{\tilde{\tau}_2^{\tilde{N}}}(\mathcal{S}, r) \right]^c \right) \leq 1 - r, \quad \tilde{J}_2^{\tilde{\mu}} \left(\mathcal{S}_j \cap \left[\bigcup_{j \in \Gamma_0} C_{\tilde{\tau}_2^{\tilde{\mu}}}(\mathcal{S}, r) \right]^c \right) \leq 1 - r.$$

Thus, $(\tilde{\mathfrak{X}}_2, \tilde{\tau}_2^{\tilde{Y}\tilde{\mu}}, \tilde{J}_2^{\tilde{Y}\tilde{\mu}})$ is $r - \mathcal{SVN}(\mathcal{J})_2 - compact$.

Theorem 4.21. The image of an $r - \mathcal{SVN}\mathcal{J}_1 - compact$ under a surjective $\mathcal{SVN} - almost\ continuous$ mapping and $\tilde{J}_1^{\tilde{Y}}(\mathcal{S}) \leq \tilde{J}_2^{\tilde{Y}}(f(\mathcal{S}))$, $\tilde{J}_1^{\tilde{N}}(\mathcal{S}) \geq \tilde{J}_2^{\tilde{N}}(f(\mathcal{S}))$, $\tilde{J}_1^{\tilde{\mu}}(\mathcal{S}) \geq \tilde{J}_2^{\tilde{\mu}}(f(\mathcal{S}))$ is $r - \mathcal{SVN}\mathcal{C}(\mathcal{J})_2 - compact$.

Proof. Let $\mathcal{S} \in I^{\tilde{\mathfrak{X}}_1}$ be an $r - \mathcal{SVN}\mathcal{J}_1 - compact$ in $(\tilde{\mathfrak{X}}_1, \tilde{\tau}_1^{\tilde{Y}\tilde{\mu}}, \tilde{J}_1^{\tilde{Y}\tilde{\mu}})$ and $f: (\tilde{\mathfrak{X}}_1, \tilde{\tau}_1^{\tilde{Y}\tilde{\mu}}, \tilde{J}_1^{\tilde{Y}\tilde{\mu}}) \rightarrow (\tilde{\mathfrak{X}}_2, \tilde{\tau}_2^{\tilde{Y}\tilde{\mu}}, \tilde{J}_2^{\tilde{Y}\tilde{\mu}})$ a surjective $\mathcal{SVN} - almost\ continuous$. If $\tilde{\tau}_2^{\tilde{Y}}(\mathcal{S}^c) \geq r$, $\tilde{\tau}_2^{\tilde{N}}(\mathcal{S}^c) \leq 1 - r$, $\tilde{\tau}_2^{\tilde{\mu}}(\mathcal{S}^c) \leq 1 - r$ and each family $\{\mathcal{E}_j \in I^{\tilde{\mathfrak{X}}}: \tilde{\tau}_2^{\tilde{Y}}(\mathcal{E}_j) \geq r, \tilde{\tau}_2^{\tilde{N}}(\mathcal{E}_j) \leq 1 - r, \tilde{\tau}_2^{\tilde{\mu}}(\mathcal{E}_j) \leq 1 - r\}$ with $f(\mathcal{S}) \leq \bigcup_{j \in \Gamma} \mathcal{E}_j$, then $f(\mathcal{S}) \leq \bigcup_{j \in \Gamma} int_{\tilde{\tau}_2^{\tilde{Y}\tilde{\mu}}}(C_{\tilde{\tau}_2^{\tilde{Y}\tilde{\mu}}}(\mathcal{E}_j, r), r)$ and

since for $j \in \Gamma$,

$$int_{\tilde{\tau}_2^{\tilde{Y}\tilde{\mu}}}(C_{\tilde{\tau}_2^{\tilde{Y}\tilde{\mu}}}(int_{\tilde{\tau}_2^{\tilde{Y}\tilde{\mu}}}(C_{\tilde{\tau}_2^{\tilde{Y}\tilde{\mu}}}(\mathcal{E}_j, r), r), r) = int_{\tilde{\tau}_2^{\tilde{Y}\tilde{\mu}}}(C_{\tilde{\tau}_2^{\tilde{Y}\tilde{\mu}}}(\mathcal{E}_j, r), r).$$

By $\mathcal{SVN} - almost\ continuous$ of f we have $\mathcal{S} \leq \bigcup_{j \in \Gamma} f^{-1}(int_{\tilde{\tau}_2^{\tilde{Y}\tilde{\mu}}}(C_{\tilde{\tau}_2^{\tilde{Y}\tilde{\mu}}}(\mathcal{E}_j, r), r))$ and

$$\tilde{\tau}_1^{\tilde{Y}}(f^{-1}(int_{\tilde{\tau}_2^{\tilde{Y}}}(\mathcal{E}_j, r), r)) \geq r, \quad \tilde{\tau}_1^{\tilde{N}}(f^{-1}(int_{\tilde{\tau}_2^{\tilde{N}}}(\mathcal{E}_j, r), r)) \leq 1 - r,$$

$$\tilde{\tau}_1^{\tilde{\mu}} \left(f^{-1}(\text{int}_{\tilde{\tau}_2^{\tilde{\mu}}}(C_{\tilde{\tau}_2^{\tilde{\mu}}}(\mathcal{E}_j, r), r)) \right) \leq 1 - r.$$

By $r - \mathcal{SVNJ}_1 - compactness$ of \mathcal{S} in $(\tilde{\mathfrak{X}}_1, \tilde{\tau}_1^{\tilde{\gamma}\tilde{\eta}\tilde{\mu}}, \tilde{\mathfrak{J}}_1^{\tilde{\gamma}\tilde{\eta}\tilde{\mu}})$, there exists a finite $\Gamma_0 \subseteq \Gamma$ such that

$$\tilde{\mathfrak{J}}_1^{\tilde{\gamma}} \left(\mathcal{S}_j \cap \left[\bigcup_{j \in \Gamma_0} f^{-1}(\text{int}_{\tilde{\tau}_2^{\tilde{\gamma}}}(C_{\tilde{\tau}_2^{\tilde{\gamma}}}(\mathcal{E}_j, r), r)) \right]^c \right) \geq r, \quad \tilde{\mathfrak{J}}_1^{\tilde{\eta}} \left(\mathcal{S}_j \cap \left[\bigcup_{j \in \Gamma_0} f^{-1}(\text{int}_{\tilde{\tau}_2^{\tilde{\eta}}}(C_{\tilde{\tau}_2^{\tilde{\eta}}}(\mathcal{E}_j, r), r)) \right]^c \right) \leq 1 - r,$$

$$\tilde{\mathfrak{J}}_1^{\tilde{\mu}} \left(\mathcal{S}_j \cap \left[\bigcup_{j \in \Gamma_0} f^{-1}(\text{int}_{\tilde{\tau}_2^{\tilde{\mu}}}(C_{\tilde{\tau}_2^{\tilde{\mu}}}(\mathcal{E}_j, r), r)) \right]^c \right) \leq 1 - r.$$

Since $\tilde{\mathfrak{J}}_1^{\tilde{\gamma}}(\mathcal{S}) \leq \tilde{\mathfrak{J}}_2^{\tilde{\gamma}}(f(\mathcal{S}))$, $\tilde{\mathfrak{J}}_1^{\tilde{\eta}}(\mathcal{S}) \geq \tilde{\mathfrak{J}}_2^{\tilde{\eta}}(f(\mathcal{S}))$, $\tilde{\mathfrak{J}}_1^{\tilde{\mu}}(\mathcal{S}) \geq \tilde{\mathfrak{J}}_2^{\tilde{\mu}}(f(\mathcal{S}))$, we have

$$\tilde{\mathfrak{J}}_2^{\tilde{\gamma}} \left(f(\mathcal{S}_j \cap \left[\bigcup_{j \in \Gamma_0} f^{-1}(\text{int}_{\tilde{\tau}_2^{\tilde{\gamma}}}(C_{\tilde{\tau}_2^{\tilde{\gamma}}}(\mathcal{E}_j, r), r)) \right]^c) \right) \geq r, \quad \tilde{\mathfrak{J}}_2^{\tilde{\eta}} \left(f(\mathcal{S}_j \cap \left[\bigcup_{j \in \Gamma_0} f^{-1}(\text{int}_{\tilde{\tau}_2^{\tilde{\eta}}}(C_{\tilde{\tau}_2^{\tilde{\eta}}}(\mathcal{E}_j, r), r)) \right]^c) \right) \leq 1 - r,$$

$$\tilde{\mathfrak{J}}_2^{\tilde{\mu}} \left(f(\mathcal{S}_j \cap \left[\bigcup_{j \in \Gamma_0} f^{-1}(\text{int}_{\tilde{\tau}_2^{\tilde{\mu}}}(C_{\tilde{\tau}_2^{\tilde{\mu}}}(\mathcal{E}_j, r), r)) \right]^c) \right) \leq 1 - r.$$

By surjectively of f , $f(\mathcal{S}_j \cap \left[\bigcup_{j \in \Gamma_0} f^{-1}(\text{int}_{\tilde{\tau}_2^{\tilde{\gamma}\tilde{\eta}\tilde{\mu}}}(C_{\tilde{\tau}_2^{\tilde{\gamma}\tilde{\eta}\tilde{\mu}}}(\mathcal{E}_j, r), r)) \right]^c) = f(\mathcal{S}_j) \cap \left[\bigcup_{j \in \Gamma_0} (C_{\tilde{\tau}_2^{\tilde{\gamma}\tilde{\eta}\tilde{\mu}}}(\mathcal{E}_j, r)) \right]^c$. Thus,

$$\tilde{\mathfrak{J}}_2^{\tilde{\gamma}} \left(f(\mathcal{S}_j) \cap \left[\bigcup_{j \in \Gamma_0} (C_{\tilde{\tau}_2^{\tilde{\gamma}}}(\mathcal{E}_j, r)) \right]^c \right) \geq r, \quad \tilde{\mathfrak{J}}_2^{\tilde{\eta}} \left(f(\mathcal{S}_j) \cap \left[\bigcup_{j \in \Gamma_0} (C_{\tilde{\tau}_2^{\tilde{\eta}}}(\mathcal{E}_j, r)) \right]^c \right) \leq 1 - r,$$

$$\tilde{\mathfrak{J}}_2^{\tilde{\mu}} \left(f(\mathcal{S}_j) \cap \left[\bigcup_{j \in \Gamma_0} (C_{\tilde{\tau}_2^{\tilde{\mu}}}(\mathcal{E}_j, r)) \right]^c \right) \leq 1 - r.$$

and hence, $f(\mathcal{S})$ is $r - \mathcal{SVNC}(\mathcal{J})_2 - compact$.

Theorem 4.22. The image of an $r - \mathcal{SVNJ}_1 - compact$ under a surjective $\mathcal{SVN} - weakly\ continuous$ mapping and $\tilde{\mathfrak{J}}_1^{\tilde{\gamma}}(\mathcal{S}) \leq \tilde{\mathfrak{J}}_2^{\tilde{\gamma}}(f(\mathcal{S}))$, $\tilde{\mathfrak{J}}_1^{\tilde{\eta}}(\mathcal{S}) \geq \tilde{\mathfrak{J}}_2^{\tilde{\eta}}(f(\mathcal{S}))$, $\tilde{\mathfrak{J}}_1^{\tilde{\mu}}(\mathcal{S}) \geq \tilde{\mathfrak{J}}_2^{\tilde{\mu}}(f(\mathcal{S}))$, is $r - \mathcal{SVNJ}_2 - quasi\ H\text{-closed}$.

Proof. Similar to proof of Theorem 4.21.

5. Conclusions

In the current research paper, we found some results of single-valued neutrosophic continuous mappings called almost continuous and weakly continuous. These instances are kinds of some generalizations of fuzzy continuity in view of the definition of Šostak. We brought counterexamples whenever such properties fail to be preserved. We also introduced and studied several kinds of r -single-valued neutrosophic compactness defined on the single-valued neutrosophic ideal topological spaces.

References

1. Šostak, A. P. On a fuzzy topological structure. Suppl. Rend. Circ. Matm. Palerms Ser.II. 1985, vol. 11, pp. 89-103

2. Saber, Y. M.; Abdel-Sattar, M. A. Ideals on fuzzy topological spaces. *Applied Mathematical Sciences*, 2014, vol. 8, pp. 1667-1691.
3. Tripathy, B. C.; Ray, G. C. On Mixed fuzzy topological spaces and countability. *Soft Computing*, 2012, vol. 16, no. 10. pp. 1691–1695.
4. Tripathy, B. C.; Ray, G. C. Mixed fuzzy ideal topological spaces. *Applied Mathematics and Computations*. 2013, vol. 220, pp. 602–607.
5. Tripathy, B. C.; Ray, G. C. On δ -continuity in mixed fuzzy topological spaces, *Boletim da Sociedade Paranaense de Matematica*. 2014, vol. 32, no. 2, pp. 175–187.
6. Tripathy, B. C.; Ray, G. C. Weakly continuous functions on mixed fuzzy topological spaces. *Acta Scientiarum. Technology*. 2014, vol. 36, no. 2. pp. 331–335.
7. Saber, Y. M.; Abdel-Sattar, M. A. Ideals on fuzzy topological spaces. *Applied Mathematical Sciences*, 2014, vol. 8, pp. 1667-1691.
8. Zahran, A. M.; Abd El-baki S. A.; Saber Y. M. Decomposition of fuzzy ideal continuity via fuzzy idealization. *International Journal of Fuzzy Logic and Intelligent Systems*. 2009, vol. 9, no. 2. pp. 83-93.
9. Abd El-baki S. A.; Saber Y. M. Fuzzy extremally disconnected ideal topological spaces. *International Journal of Fuzzy Logic and Intelligent Systems*. 2010, vol. 10, no. 1, pp. 1-6.
10. Saber, Y. M.; Alsharari F. Generalized fuzzy ideal closed sets on fuzzy topological spaces in Sostak sense. *International Journal of Fuzzy Logic and Intelligent Systems*. 2018, vol. 18, pp. 161-166.
11. Alsharari, F.; Saber, Y. M. $\mathcal{G}\theta_{\tau_i}^{*rj}$ -Fuzzy closure operator. *New Mathematics and Natural Computation*. 2020, vol. 16, pp. 123-141.
12. Smarandache, F. *Neutrosophy, Neutrosophic Property, Sets, and Logic*. American Research Press: Rehoboth, DE, US. 1998.
13. Fatimah M.; Sarah W. Generalized b Closed Sets and Generalized b Open Sets in Fuzzy Neutrosophic bi-Topological Spaces, *Neutrosophic Sets and Systems*. 2020, vol. 35, pp. 188-197.
14. Riaz, M.; Smarandache, F.; Karaaslan, F.; Hashmi, M.; Nawaz, I. Neutrosophic Soft Rough Topology and its Applications to Multi-Criteria Decision-Making. *Neutrosophic Sets and Systems*. 2020, vol. 35, pp.198-219.
15. Porselvi, K.; Elavarasan, B.; Smarandache F.; Jun, Y. B. Neutrosophic N-bi-ideals in semigroups. *Neutrosophic Sets and Systems*,. 2020, vol. 35, pp. 422-434.
16. Singh, N.; Chakraborty, A.; Biswas, S. B.; Majumdar, M. Impact of Social Media in Banking Sector under Triangular Neutrosophic Arena Using MCGDM Technique. *Neutrosophic Sets and Systems*. 2020, vol. 35, pp.153-176.
17. Salama, A. A.; Broumi, S.; Smarandache, F. Some types of neutrosophic crisp sets and neutrosophic crisp relations. *I. J. Inf. Eng. Electron. Bus.* 2014, Available online: <http://fs.unm.edu/Neutro-SomeTypeNeutrosophicCrisp.pdf> (accessed on 10 February 2019).
18. Salama, A. A.; Smarandache, F. *Neutrosophic Crisp Set Theory*. The Educational Publisher Columbus: Columbus, OH, USA, 2015.
19. Hur, K.; Lim, P.K.; Lee, J.G.; Kim, J. The category of neutrosophic crisp sets. *Ann. Fuzzy Math. Inform.* 2017, vol. 14, pp. 43-54.
20. Hur, K.; Lim, P.K.; Lee, J.G.; Kim, J. The category of neutrosophic sets. *Neutrosophic Sets and Syst.* 2016, vol. 14, 12-20.
21. Salama, A.A.; Alblowi, S.A. Neutrosophic set and neutrosophic topological spaces. *IOSR J. Math.* 2012, vol. 3, pp. 31-35.
22. Smarandache, F. *A Unifying Field in Logics: Neutrosophic Logic. Neutrosophy, Neutrosophic Set, Neutrosophic Probability and Statistics*. 6th ed.; Info Learn Quest: Ann Arbor, MI, USA, 2007.
23. Ye, J. A multicriteria decision-making method using aggregation operators for simplified neutrosophic sets. *J. Intell. Fuzzy Syst.* 2014, vol. 26, pp. 2450-2466
24. Yang, H.L.; Guo, Z.L.; Liao, X. On single valued neutrosophic relations. *J. Intell. Fuzzy Syst.* 2016, vol. 30, pp. 1045-1056.
25. El-Gayyar, M. Smooth Neutrosophic Topological Spaces. *Neutrosophic Sets Syst.* 2016, vol. 65, pp. 65-72.

26. Broumi, S., Topal, S., Bakali, A., Talea, M., & Smarandache, F. A Novel Python Toolbox for Single and Interval-Valued Neutrosophic Matrixs. In *Neutrosophic Sets in Decision Analysis and Operations Research*. (2020) (pp. 281-330). IGI Global,
27. Ye J. Similarity measures between interval neutrosophic sets and their applications in multicriteria decision – making. *J. Intell. Fuzzy Syst.*, (2012), 26 (1) 165 – 172
28. Bakbak D, Uluçay V. Chapter Eight Multiple Criteria Decision Making in Architecture Based on QNeutrosophic Soft Expert Multiset. In *Neutrosophic Triplet Structures*, Pons Editions Brussels, Belgium, EU, 2019 vol. 9, 108 - 124
29. Şahin M., Ecemiş O., Uluçay V. and Kargin A. Some new generalized aggregation operators based on centroid single valued triangular neutrosophic numbers and their applications in multi-attribute decision making, *Asian Journal of Mathematics and Computer Research*. (2017) , 16(2): 63-84
30. Uluçay, V., Kiliç, A., Yildiz, I., & Sahin, M. A new approach for multi-attribute decision-making problems in bipolar neutrosophic sets. *Neutrosophic Sets and Systems*. 2018, 23(1), 12.
31. Bakbak, D., Uluçay, V., & Şahin, M. Neutrosophic soft expert multi set and their application to multiple criteria decision making. *Mathematics*. (2019), 7(1), 50.
32. Wang, H.; Smarandache, F.; Zhang, Y.Q.; Sunderraman, R. Single valued neutrosophic sets. *Multispace Multistruct*. 2010, vol. 4, pp. 410-413.
33. Kim, J.; Lim, P.K.; Lee, J.G.; Hur, K. Single valued neutrosophic relations. *Ann. Fuzzy Math. Inform*. 2018, vol. 16, pp. 201–221.
34. Saber, Y. M.; Alsharari, F.; Smarandache, F. On Single-valued neutrosophic ideals in Šostak sense. *Symmetry*. 2020, vol. 12, 194.
35. Saber Y. M.; Alsharari, F.; Smarandache, F.; Abdel-Sattar M. Connectedness and stratification of single-valued neutrosophic topological spaces. *Symmetry*. 2020, vol. 12, 1464.
36. Alsharari, F. ϵ -Single valued extremally disconnected ideal neutrosophic topological spaces. *Symmetry*. 2021, 13(1), 53
37. Alsharari, F. Decomposition of single-valued neutrosophic ideal continuity via fuzzy idealization. *Neutrosophic Sets Syst*. 2020, vol. 38, pp. 145-163
38. Abdel-Basst, M., Mohamed, R., & Elhoseny, M. (2020). A model for the effective COVID-19 identification in uncertainty environment using primary symptoms and CT scans. *Health Informatics Journal*, 1460458220952918.
39. Abdel-Basst, M.; Mohamed, R.; Abd El-Nasser, H.; Gamal, A.; Smarandache, F. Solving the supply chain problem using the best-worst method based on a novel Plithogenic model. *Optimization Theory Based on Neutrosophic and Plithogenic Sets*. 2020, (pp. 1-19). Academic Press.
40. Abdel-Basst, M., Mohamed, R., & Elhoseny, M. A novel framework to evaluate innovation value proposition for smart product-service systems. *Environmental Technology & Innovation*. 2020, vol. 20, 101036.
41. Abdel-Basst, M., Gamal, A., Chakraborty, R. K., & Ryan, M. A new hybrid multi-criteria decision-making approach for location selection of sustainable offshore wind energy stations: A case study. *Journal of Cleaner Production*, 280, 124462.
42. Ye, J. A multicriteria decision-making method using aggregation operators for simplified neutrosophic sets. *J. Intell. Fuzzy Syst*. 2014, vol. 26, pp. 2450-2466.
43. Yang, H.L.; Guo, Z.L.; Liao, X. On single valued neutrosophic relations. *J. Intell. Fuzzy Syst*. 2016, vol. 30, pp. 1045-1056.

This seventh volume of *Collected Papers* includes 70 papers comprising 974 pages on (theoretic and applied) neutrosophics, written between 2013-2021 by the author alone or in collaboration with the following 122 co-authors from 22 countries: Mohamed Abdel-Basset, Abdel-Nasser Hussian, C. Alexander, Mumtaz Ali, Yaman Akbulut, Amir Abdullah, Amira S. Ashour, Assia Bakali, Kousik Bhattacharya, Kainat Bibi, R. N. Boyd, Ümit Budak, Lulu Cai, Cenap Özel, Chang Su Kim, Victor Christianto, Chunlai Du, Chunxin Bo, Rituparna Chutia, Cu Nguyen Giap, Dao The Son, Vinayak Devvrat, Arindam Dey, Partha Pratim Dey, Fahad Alsharari, Feng Yongfei, S. Ganesan, Shivam Ghildiyal, Bibhas C. Giri, Masooma Raza Hashmi, Ahmed Refaat Hawas, Hoang Viet Long, Le Hoang Son, Hongbo Wang, Hongnian Yu, Mihaiela Iliescu, Saeid Jafari, Temitope Gbolahan Jaiyeola, Naeem Jan, R. Jeevitha, Jun Ye, Anup Khan, Madad Khan, Salma Khan, Ilanthenral Kandasamy, W.B. Vasantha Kandasamy, Darjan Karabašević, Kifayat Ullah, Kishore Kumar P.K., Sujit Kumar De, Prasun Kumar Nayak, Malayalan Lathamaheswari, Luong Thi Hong Lan, Anam Luqman, Luu Quoc Dat, Tahir Mahmood, Hafsa M. Malik, Nivetha Martin, Mai Mohamed, Parimala Mani, Mingcong Deng, Mohammed A. Al Shumrani, Mohammad Hamidi, Mohamed Talea, Kalyan Mondal, Muhammad Akram, Muhammad Gulistan, Farshid Mofidnakhaei, Muhammad Shoab, Muhammad Riaz, Karthika Muthusamy, Nabeela Ishfaq, Deivanayagampillai Nagarajan, Sumera Naz, Nguyen Dinh Hoa, Nguyen Tho Thong, Nguyen Xuan Thao, Noor ul Amin, Dragan Pamučar, Gabrijela Popović, S. Krishna Prabha, Surapati Pramanik, Priya R, Qiaoyan Li, Yaser Saber, Said Broumi, Saima Anis, Saleem Abdullah, Ganeshsree Selvachandran, Abdulkadir Sengür, Seyed Ahmad Edalatpanah, Shahbaz Ali, Shahzaib Ashraf, Shouzhen Zeng, Shio Gai Quek, Shuangwu Zhu, Shumaiza, Sidra Sayed, Sohail Iqbal, Songtao Shao, Sundas Shahzadi, Dragiša Stanujkić, Željko Stević, Udhayakumar Ramalingam, Zunaira Rashid, Hossein Rashmanlou, Rajkumar Verma, Luige Vlădăreanu, Victor Vlădăreanu, Desmond Jun Yi Tey, Selçuk Topal, Naveed Yaqoob, Yanhui Guo, Yee Fei Gan, Yingcang Ma, Young Bae Jun, Yuping Lai, Hafiz Abdul Wahab, Wei Yang, Xiaohong Zhang, Edmundas Kazimieras Zavadskas, Lemnaouar Zedam.

