

University of New Mexico

UNM Digital Repository

Branch Mathematics and Statistics Faculty and
Staff Publications

Branch Academic Departments

2020

Quadruple Neutrosophic Theory And Applications Volume I

Florentin Smarandache

University of New Mexico, smarand@unm.edu

Memet Şahin

Vakkas Uluçay

Abdullah Kargin

Follow this and additional works at: https://digitalrepository.unm.edu/math_fsp



Part of the [Logic and Foundations Commons](#), [Number Theory Commons](#), [Other Physical Sciences and Mathematics Commons](#), and the [Physics Commons](#)

Recommended Citation

Smarandache, Florentin; Memet Şahin; Vakkas Uluçay; and Abdullah Kargin. "Quadruple Neutrosophic Theory And Applications Volume I." (2020). https://digitalrepository.unm.edu/math_fsp/293

This Book is brought to you for free and open access by the Branch Academic Departments at UNM Digital Repository. It has been accepted for inclusion in Branch Mathematics and Statistics Faculty and Staff Publications by an authorized administrator of UNM Digital Repository. For more information, please contact disc@unm.edu.

Quadruple Neutrosophic Theory And Applications Volume I

Prof. Dr. Florentin Smarandache

Prof. Dr. Memet Şahin

Assistant Prof. Dr. Vakkas Uluçay

Phd Abdullah Kargin

Neutrosophic Science International Association



T

I

F

Quadruple Neutrosophic Theory And Applications-Volume I

Editors:

Prof. Dr. Florentin Smarandache
University of New Mexico, USA

Prof. Dr. Memet Şahin
Gaziantep University, Turkey

Assistant Prof. Dr. Vakkas Uluçay
Kilis 7 Aralık Universit, Turkey

PhD Abdullah Kargin
Gaziantep University, Turkey

List of Reviewers

Said Broumi, Hassan II University, Morocco
Nasruddin Hassan, Universiti Kebangsaan Malaysia
Adil Kılıç, Gaziantep University, Turkey
Florentin Smarandache, University of New Mexico, USA
İsmet Yıldız, Düzce University, Turkey
Muhammad Akram, University of the Punjab, Pakistan
İhsan Ünvar, Avrasya University, Turkey
Muhammad Gulistan, Hazara University, Pakistan
Mehmet Bektaş, Fırat University, Turkey
Mohamed Abdel-Baset, Zagazig University, Egypt
Ziya Yapar, Avrasya University, Turkey
Xiaohong Zhang, Shaanxi University of Science & Technology, China
Memet Şahin, Gaziantep University, Turkey
Mustafa Dede, Kilis 7 Aralık University, Turkey
Vakkas Uluçay, Kilis 7 Aralık University, Turkey
Necati Olgun, Gaziantep University, Turkey
Abdullah Kargın, Gaziantep University, Turkey

Neutrosophic Science International Association
President: Florentin Smarandache

Pons asbl
5, Quai du Batelage, Brussels, Belgium, European Union
President: Georgiana Antonescu
DTP: George Lukacs

ISBN:978-1-59973-647-1

Quadruple Neutrosophic Theory And Applications

Volume I



Pons Editions
Brussels, Belgium, EU
2020

Aims and Scope

Neutrosophic theory and its applications have been expanding in all directions at an astonishing rate especially after of the introduction the journal entitled “Neutrosophic Sets and Systems”. New theories, techniques, algorithms have been rapidly developed. One of the most striking trends in the neutrosophic theory is the hybridization of neutrosophic set with other potential sets such as rough set, bipolar set, soft set, hesitant fuzzy set, etc. The different hybrid structures such as rough neutrosophic set, single valued neutrosophic rough set, bipolar neutrosophic set, single valued neutrosophic hesitant fuzzy set, etc. are proposed in the literature in a short period of time. Neutrosophic set has been an important tool in the application of various areas such as data mining, decision making, e-learning, engineering, medicine, social science, and some more.

Florentin Smarandache, Memet Şahin, Vakkas Uluçay and Abdullah Kargin

CONTENTS

Aims and Scope

Preface

Acknowledgment

SECTION ONE- NEUTROSOPHIC QUADRUPLE

Chapter One

Generalized Neutrosophic Quadruple Sets and Numbers11

Memet Şahin, Abdullah Kargın, Adil Kılıç

Chapter Two

Generalized Set Valued Neutrosophic Quadruple Sets and Numbers.....23

Memet Şahin, Abdullah Kargın, Adil Kılıç

Chapter Three

Neutrosophic Quadruple Goal Programming by using Excel Solver.....41

N. Gayathri, M. Helen

Chapter Four

Neutrosophic Triplet Field and Neutrosophic Triplet Vector Space Based on Set Valued Neutrosophic Quadruple Number52

Memet Şahin, Abdullah Kargın, İsmet Yıldız

Chapter Five

Neutrosophic Triplet Metric Space Based on Set Valued Neutrosophic Quadruple Number.....61

Memet Şahin, Abdullah Kargın

Chapter Six

Transportation Problem using Neutrosophic Quadruple Numbers.....71

N. Gayathri, M. Helen

SECTION TWO-DECISION MAKING

Chapter Seven

To Solve Assignment Problem by Centroid Method in Neutrosophic Environment84

Tuhin Bera, Nirmal Kumar Mahapatra

Chapter Eight

Comparison of Cooking Methods in the Scope of Cuisine Dynamics: An Assessment From the Views of the Chefs in Neutrosophic Environment.....94

Ece Doğantan, Ezgi Demir, Bahri Baran Koçak, Çağlar Karamaşa

Chapter Nine

A Theoretic Approach to Decision Making Problems in Architecture with Neutrosophic Soft Set.....113

Derya Bakbak, Vakkas Uluçay

Chapter Ten

Neutrosophic Sets in Multiple Objectives Decision Analysis127

Willem K. M. Brauers

SECTION THREE- NEUTROSOPHIC RELATED OTHER PAPERS

Chapter Eleven

Neutrosophic Triplet Bipolar Metric Spaces150

Memet Şahin, Abdullah Kargin, Merve Sena Uz, Adil Kılıç

Chapter Twelve

Neutrosophic Measures of Central Tendency and Dispersion164

Muhammad Aslam, Rehan A. K. Sherwani, M.Waseem, Saeed A. Dobbah

Chapter Thirteen

Neutrosophic Triplet g - Metric Spaces181

Memet Şahin, Abdullah Kargın, Murat Yücel, Pelin Özkartepe

Chapter Fourteen

Soft Maximal Ideals on Soft Normed Rings203

Memet Şahin, Vakkas Uluçay

Chapter Fifteen

Neutrosophic Triplet m - Metric Spaces213

Memet Şahin, Abdullah Kargın, Azize Dayan, Adil Kılıç

Chapter Sixteen

N-Neutrosophic Supra Topological Sets and Operators223

M. Arockia Dasan, G. Jayaparthasarathy, V. F. Little Flower

Chapter Seventeen

The Effect Of The Neutrosophic Logic On The Decision Tree.....238

Necati Olgun, Ahmed Hatip

Chapter Eighteen

Combined Classic – Neutrosophic Sets and Numbers, Double Neutrosophic Sets and Numbers254

Memet Şahin, Abdullah Kargın, Florentin Smarandache

Chapter Nineteen

Bipolar Spherical Fuzzy Neutrosophic Cubic Graph and its Application266

Akalyadevi K, Antony Crispin Sweetey C.,Sudamani Ramaswamy A. R.

Preface

Neutrosophic set has been derived from a new branch of philosophy, namely Neutrosophy. Neutrosophic set is capable of dealing with uncertainty, indeterminacy and inconsistent information. Neutrosophic set approaches are suitable to modeling problems with uncertainty, indeterminacy and inconsistent information in which human knowledge is necessary, and human evaluation is needed.

Neutrosophic set theory firstly proposed in 1998 by Florentin Smarandache, who also developed the concept of single valued neutrosophic set, oriented towards real world scientific and engineering applications. Since then, the single valued neutrosophic set theory has been extensively studied in books and monographs introducing neutrosophic sets and its applications, by many authors around the world. Also, an international journal - Neutrosophic Sets and Systems started its journey in 2013.

Smarandache introduce for the first time the neutrosophic quadruple numbers (of the form $a + bT + cI + dF$) and the refined neutrosophic quadruple numbers. Then Smarandache define an absorbance law, based on a prevalence order, both of them in order to multiply the neutrosophic components T, I, F or their sub-components T_j, I_k, F_l and thus to construct the multiplication of neutrosophic quadruple numbers.

This first volume collects original research and applications from different perspectives covering different areas of neutrosophic studies, such as decision making, Quadruple, Metric, and some theoretical papers.

This volume contains three sections: NEUTROSOPHIC QUADRUPLE, DECISION MAKING AND NEUTROSOPHIC RELATED OTHER PAPERS.

Acknowledgment

The editors and authors of this book thank all reviewers for their comments and the Pons Editions publisher for proving us the opportunity to write this collective book.

Florentin Smarandache
University of New Mexico, USA

Memet Şahin
Gaziantep University, Turkey

Vakkas Uluçay
Kilis 7 Aralık University, Turkey

Abdullah Kargın
Gaziantep University, Turkey

SECTION ONE

Neutrosophic Quadruple

Chapter One

Generalized Neutrosophic Quadruple Sets and Numbers

Memet Şahin, Abdullah Kargin and Adil Kılıç

Department of Mathematics, Gaziantep University, Gaziantep27310-Turkey

E-mail: mesahin@gantep.edu.tr, abduallahkargin27@gmail.com, adilkilic@gantep.edu.tr

ABSTRACT

Smarandache introduce neutrosophic quadruple sets and numbers in 2016. In a neutrosophic quadruple set, the values T, I and F are same for each element. Where T, I and F have their usual neutrosophic logic means. In this chapter, we generalize neutrosophic quadruple set and number [45]. For each element in a neutrosophic quadruple set, we define new operations according to the different T, I and F values. Thus, generalized neutrosophic quadruple sets and numbers would be more useful for decision making applications. In this way, we obtain new results for neutrosophic quadruple set and number.

Keywords: neutrosophic quadruple set, neutrosophic quadruple number, generalized neutrosophic quadruple set, generalized neutrosophic quadruple number

INTRODUCTION

In 1998, neutrosophic logic and neutrosophic set [1] are defined by Smarandache. In concept of neutrosophic logic and neutrosophic sets, there is T degree of membership, I degree of indeterminacy and F degree of non-membership. These degrees are defined independently of each other. Thus, neutrosophic set is a generalized state of fuzzy set [28] and intuitionistic fuzzy set [29]. In addition, many researchers have made studies on this theory [2 – 27, 30 - 44].

Also, Smarandache introduced NQS and NQN [45]. The NQSs are generalized state of neutrosophic sets. A NQS is shown by $\{(x, yT, zI, tF): x, y, z, t \in \mathbb{R} \text{ or } \mathbb{C}\}$. Where, x is called the known part and (yT, zI, tF) is called the unknown part and T, I, F have their usual neutrosophic logic means. Recently, researchers studied NQS and NQN. Recently, Akinleye, Smarandache, Agboola studied NQ algebraic structures [46]; Jun, Song, Smarandache obtained NQ BCK/BCI-algebras [47]; Muhiuddin, Al-Kenani, Roh, Jun introduced implicative NQ BCK-algebras and ideals [48]; Li, Ma, Zhang, Zhang studied NT extended group based on NQNs [49]; Şahin and Kargin obtained SVNQN and NTG based on SVNQN [50]; Şahin and Kargin studied single valued NQ graphs [51].

In this chapter, for each element in a neutrosophic quadruple set, we define new operations according to the different T, I and F values. Thus, generalized neutrosophic quadruple sets and numbers would be more useful for decision making applications. In this way, we obtain new results for neutrosophic quadruple set and number. in Section 2, we give definitions and properties for NQS and NQN [45]. In Section 3, we generalize NQS and NQN. Also, we define new structures according to the different T, I and F values using the NQS and NQN. In Section 4, we give conclusions.

BACKGROUND

Definition 1: [45] A NQN is a number of the form (x, yT, zI, tF) , where T, I, F have their usual neutrosophic logic means and $x, y, z, t \in \mathbb{R}$ or \mathbb{C} . The NQS defined by

$$NQ = \{(x, yT, zI, tF) : x, y, z, t \in \mathbb{R} \text{ or } \mathbb{C}\}.$$

For a NQN (x, yT, zI, tF) , representing any entity which may be a number, an idea, an object, etc., x is called the known part and (yT, zI, tF) is called the unknown part.

Definition 2: [45] Let $a = (a_1, a_2T, a_3I, a_4F)$ and $b = (b_1, b_2T, b_3I, b_4F) \in NQ$ be NQNs. We define the following:

$$a + b = (a_1 + b_1, (a_2 + b_2)T, (a_3 + b_3)I, (a_4 + b_4)F)$$

$$a - b = (a_1 - b_1, (a_2 - b_2)T, (a_3 - b_3)I, (a_4 - b_4)F)$$

Definition 3: [45] Consider the set $\{T, I, F\}$. Suppose in an optimistic way we consider the prevalence order $T > I > F$. Then we have:

$$TI = IT = \max\{T, I\} = T,$$

$$TF = FT = \max\{T, F\} = T,$$

$$FI = IF = \max\{F, I\} = I,$$

$$TT = T^2 = T,$$

$$II = I^2 = I,$$

$$FF = F^2 = F.$$

Analogously, suppose in a pessimistic way we consider the prevalence order $T < I < F$. Then we have:

$$TI = IT = \max\{T, I\} = I,$$

$$TF = FT = \max\{T, F\} = F,$$

$$FI = IF = \max\{F, I\} = F,$$

$$TT = T^2 = T,$$

$$II = I^2 = I,$$

$$FF = F^2 = F.$$

Definition 4: [45] Let $a = (a_1, a_2T, a_3I, a_4F)$, $b = (b_1, b_2T, b_3I, b_4F) \in NQ$ and $T < I < F$. Then

$$a * b = (a_1, a_2T, a_3I, a_4F) * (b_1, b_2T, b_3I, b_4F) = (a_1b_1, (a_1b_2 + a_2b_1 + a_2b_2)T, (a_1b_3 + a_2b_3 + a_3b_1 + a_3b_2 + a_3b_3)I, (a_1b_4 + a_2b_4 + a_3b_4 + a_4b_1 + a_4b_2 + a_4b_3 + a_4b_4)F)$$

Definition 5: [45] Let $a = (a_1, a_2T, a_3I, a_4F)$, $b = (b_1, b_2T, b_3I, b_4F) \in NQ$ and $T > I > F$. Then

$$a \# b = (a_1, a_2T, a_3I, a_4F) \# (b_1, b_2T, b_3I, b_4F)$$

$$= (a_1b_1, (a_1b_2 + a_2b_1 + a_2b_2 + a_3b_2 + a_4b_2 + a_2b_3 + a_2b_4)T, (a_1b_3 + a_3b_3 + a_3b_4 + a_4b_3)I, (a_1b_4 + a_4b_1 + a_4b_4)F)$$

GENERALIZED NEUTROSOPHIC QUADRUPLE SET AND NUMBER

Definition 6: A generalized NQS (GNQS) is a set of the form

$$G_{S_i} = \{(a_{S_i}, b_{S_i}T_{S_i}, c_{S_i}I_{S_i}, d_{S_i}F_{S_i}) : a_{S_i}, b_{S_i}, c_{S_i}, d_{S_i} \in \mathbb{R} \text{ or } \mathbb{C}; i = 1, 2, 3, \dots, n\},$$

where T_i , I_i and F_i have their usual neutrosophic logic means and a generalized NQN (GNQN) defined by

$$G_{N_i} = (a_{S_i}, b_{S_i}T_{S_i}, c_{S_i}I_{S_i}, d_{S_i}F_{S_i}).$$

As in NQN, for a GNQN $(a_{S_i}, b_{S_i}T_{S_i}, c_{S_i}I_{S_i}, d_{S_i}F_{S_i})$, representing any entity which may be a number, an idea, an object, etc.; a_{S_i} is called the known part and $(b_{S_i}T_{S_i}, c_{S_i}I_{S_i}, d_{S_i}F_{S_i})$ is called the unknown part.

Also, we can show that $G_{S_i} = \{G_{N_i}; i = 1, 2, 3, \dots, n\}$.

Corollary 1: From Definition 1 and Definition 6, each NQS is a GNQN. However, the opposite is not always true.

Now, we define new operations for GNQN and GNQS.

Definition 7: Let

$$\begin{aligned} G_{S^1_i} &= \{(a_{S^1_i}, b_{S^1_i}T_{S^1_i}, c_{S^1_i}I_{S^1_i}, d_{S^1_i}F_{S^1_i}) : a_{S^1_i}, b_{S^1_i}, c_{S^1_i}, d_{S^1_i} \in \mathbb{R} \text{ or } \mathbb{C}; i = 1, 2, 3, \dots, n\} \\ &= \{G_{N^1_i}; i = 1, 2, 3, \dots, n\}, \end{aligned}$$

$$\begin{aligned} G_{S^2_i} &= \{(a_{S^2_i}, b_{S^2_i}T_{S^2_i}, c_{S^2_i}I_{S^2_i}, d_{S^2_i}F_{S^2_i}) : a_{S^2_i}, b_{S^2_i}, c_{S^2_i}, d_{S^2_i} \in \mathbb{R} \text{ or } \mathbb{C}; i = 1, 2, 3, \dots, n\} \\ &= \{G_{N^2_i}; i = 1, 2, 3, \dots, n\} \end{aligned}$$

be GNQSs and $G_{N^1_i}, G_{N^2_i}$ be GNQNs. We define the “average +” and “average –” operations for and GNQNs such that

$$G_{N^m_k} +_A G_{N^n_l} = (a_{S^m_k} + a_{S^n_l}, (b_{S^m_k} + b_{S^n_l})T_{m,n_{k,l}}, (c_{S^m_k} + c_{S^n_l})I_{m,n_{k,l}}, (d_{S^m_k} + d_{S^n_l})F_{m,n_{k,l}}),$$

$$G_{N^m_k} -_A G_{N^n_l} = (a_{S^m_k} - a_{S^n_l}, (b_{S^m_k} - b_{S^n_l})T_{m,n_{k,l}}, (c_{S^m_k} - c_{S^n_l})I_{m,n_{k,l}}, (d_{S^m_k} - d_{S^n_l})F_{m,n_{k,l}}),$$

$$\text{where, } n, m = 1, 2; k, l \in \{1, 2, \dots, n\}; T_{m,n_{k,l}} = \frac{T_{S^m_k} + T_{S^n_l}}{2}, I_{m,n_{k,l}} = \frac{I_{S^m_k} + I_{S^n_l}}{2} \text{ and } F_{m,n_{k,l}} = \frac{F_{S^m_k} + F_{S^n_l}}{2}.$$

We define the “average +” and “average –” operations for and GNQNs such that

$$G_{S^1_i} +_A G_{S^2_i} = \{G_{N^1_i} +_A G_{N^2_i}; i = 1, 2, 3, \dots, n\},$$

$$G_{S^1_i} -_A G_{S^2_i} = \{G_{N^1_i} -_A G_{N^2_i}; i = 1, 2, 3, \dots, n\}.$$

Definition 8: Let $G_{S^1_i} = \{(a_{S^1_i}, b_{S^1_i}T_{S^1_i}, c_{S^1_i}I_{S^1_i}, d_{S^1_i}F_{S^1_i}) : a_{S^1_i}, b_{S^1_i}, c_{S^1_i}, d_{S^1_i} \in \mathbb{R} \text{ or } \mathbb{C}; i = 1, 2, 3, \dots, n\}$

$$= \{G_{N^1_i}; i = 1, 2, 3, \dots, n\},$$

$$G_{S^2_i} = \{(a_{S^2_i}, b_{S^2_i}T_{S^2_i}, c_{S^2_i}I_{S^2_i}, d_{S^2_i}F_{S^2_i}): a_{S^2_i}, b_{S^2_i}, c_{S^2_i}, d_{S^2_i} \in \mathbb{R} \text{ or } \mathbb{C}; i = 1, 2, 3, \dots, n\}$$

$$= \{G_{N^2_i}; i = 1, 2, 3, \dots, n\}$$

be GNQSS and $G_{N^1_i}, G_{N^2_i}$ be GNQNs. We define the “optimistic +” and “optimistic –” operations for and GNQNs such that

$$G_{N^m_k} +_O G_{N^n_l} = (a_{S^m_k} + a_{S^n_l}, (b_{S^m_k} + b_{S^n_l})T_{m,n_{k,l}}, (c_{S^m_k} + c_{S^n_l})I_{m,n_{k,l}}, (d_{S^m_k} + d_{S^n_l})F_{m,n_{k,l}}),$$

$$G_{N^m_k} -_O G_{N^n_l} = (a_{S^m_k} - a_{S^n_l}, (b_{S^m_k} - b_{S^n_l})T_{m,n_{k,l}}, (c_{S^m_k} - c_{S^n_l})I_{m,n_{k,l}}, (d_{S^m_k} - d_{S^n_l})F_{m,n_{k,l}}),$$

where, $n, m = 1, 2$; $k, l \in \{1, 2, \dots, n\}$; $T_{m,n_{k,l}} = \max\{T_{S^m_k}, T_{S^n_l}\}$; $I_{m,n_{k,l}} = \min\{I_{S^m_k}, I_{S^n_l}\}$ and $F_{m,n_{k,l}} = \min\{F_{S^m_k}, F_{S^n_l}\}$.

We define the “optimistic +” and “optimistic –” operations for and GNQNs such that

$$G_{S^1_i} +_O G_{S^2_i} = \{G_{N^1_i} +_O G_{N^2_i}; i = 1, 2, 3, \dots, n\},$$

$$G_{S^1_i} -_O G_{S^2_i} = \{G_{N^1_i} -_O G_{N^2_i}; i = 1, 2, 3, \dots, n\}.$$

Definition 9: Let

$$G_{S^1_i} = \{(a_{S^1_i}, b_{S^1_i}T_{S^1_i}, c_{S^1_i}I_{S^1_i}, d_{S^1_i}F_{S^1_i}): a_{S^1_i}, b_{S^1_i}, c_{S^1_i}, d_{S^1_i} \in \mathbb{R} \text{ or } \mathbb{C}; i = 1, 2, 3, \dots, n\}$$

$$= \{G_{N^1_i}; i = 1, 2, 3, \dots, n\},$$

$$G_{S^2_i} = \{(a_{S^2_i}, b_{S^2_i}T_{S^2_i}, c_{S^2_i}I_{S^2_i}, d_{S^2_i}F_{S^2_i}): a_{S^2_i}, b_{S^2_i}, c_{S^2_i}, d_{S^2_i} \in \mathbb{R} \text{ or } \mathbb{C}; i = 1, 2, 3, \dots, n\}$$

$$= \{G_{N^2_i}; i = 1, 2, 3, \dots, n\}$$

be GNQSS and $G_{N^1_i}, G_{N^2_i}$ be GNQNs. We define the “pessimistic +” and “pessimistic –” operations for and GNQNs such that

$$G_{N^m_k} +_P G_{N^n_l} = (a_{S^m_k} + a_{S^n_l}, (b_{S^m_k} + b_{S^n_l})T_{m,n_{k,l}}, (c_{S^m_k} + c_{S^n_l})I_{m,n_{k,l}}, (d_{S^m_k} + d_{S^n_l})F_{m,n_{k,l}}),$$

$$G_{N^m_k} -_P G_{N^n_l} = (a_{S^m_k} - a_{S^n_l}, (b_{S^m_k} - b_{S^n_l})T_{m,n_{k,l}}, (c_{S^m_k} - c_{S^n_l})I_{m,n_{k,l}}, (d_{S^m_k} - d_{S^n_l})F_{m,n_{k,l}}),$$

where, $n, m = 1, 2$; $k, l \in \{1, 2, \dots, n\}$; $T_{m,n_{k,l}} = \min\{T_{S^m_k}, T_{S^n_l}\}$; $I_{m,n_{k,l}} = \max\{I_{S^m_k}, I_{S^n_l}\}$ and $F_{m,n_{k,l}} = \max\{F_{S^m_k}, F_{S^n_l}\}$.

We define the “pessimistic +” and “pessimistic –” operations for and GNQNs such that

$$G_{S^1_i} +_P G_{S^2_i} = \{G_{N^1_i} +_P G_{N^2_i}; i = 1, 2, 3, \dots, n\},$$

$$G_{S^1_i} -_P G_{S^2_i} = \{G_{N^1_i} -_P G_{N^2_i}; i = 1, 2, 3, \dots, n\}.$$

Definition 10: Let

$$G_{S^1_i} = \{(a_{S^1_i}, b_{S^1_i}T_{S^1_i}, c_{S^1_i}I_{S^1_i}, d_{S^1_i}F_{S^1_i}): a_{S^1_i}, b_{S^1_i}, c_{S^1_i}, d_{S^1_i} \in \mathbb{R} \text{ or } \mathbb{C}; i = 1, 2, 3, \dots, n\}$$

$$= \{G_{N^1_i}; i = 1, 2, 3, \dots, n\},$$

$$G_{S^2_i} = \{(a_{S^2_i}, b_{S^2_i}T_{S^2_i}, c_{S^2_i}I_{S^2_i}, d_{S^2_i}F_{S^2_i}): a_{S^2_i}, b_{S^2_i}, c_{S^2_i}, d_{S^2_i} \in \mathbb{R} \text{ or } \mathbb{C}; i = 1, 2, 3, \dots, n\}$$

$$= \{G_{N^2_i} : i = 1, 2, 3, \dots, n\}$$

be GNQSS and $G_{N^1_i}, G_{N^2_i}$ be GNQNs. We define the “average .” operation for GNQNs such that

$$G_{N^m_k} \cdot_A G_{N^n_l} = (a_{S^m_k} \cdot a_{S^n_l}, (b_{S^m_k} \cdot b_{S^n_l})T_{m,n_{k,l}}, (c_{S^m_k} \cdot c_{S^n_l}) I_{m,n_{k,l}}, (d_{S^m_k} \cdot d_{S^n_l}) F_{m,n_{k,l}}),$$

$$\text{where, } n, m = 1, 2; k, l \in \{1, 2, \dots, n\}; T_{m,n_{k,l}} = \frac{T_{S^m_k} + T_{S^n_l}}{2}; I_{m,n_{k,l}} = \frac{I_{S^m_k} + I_{S^n_l}}{2} \text{ and } F_{m,n_{k,l}} = \frac{F_{S^m_k} + F_{S^n_l}}{2}.$$

We define the “average .” operations for GNQSSs such that

$$G_{S^1_i} \cdot_A G_{S^2_i} = \{G_{N^1_i} \cdot_A G_{N^2_i} : i = 1, 2, 3, \dots, n\}.$$

Definition 11: Let

$$\begin{aligned} G_{S^1_i} &= \{(a_{S^1_i}, b_{S^1_i}T_{S^1_i}, c_{S^1_i}I_{S^1_i}, d_{S^1_i}F_{S^1_i}) : a_{S^1_i}, b_{S^1_i}, c_{S^1_i}, d_{S^1_i} \in \mathbb{R} \text{ or } \mathbb{C}; i = 1, 2, 3, \dots, n\} \\ &= \{G_{N^1_i} : i = 1, 2, 3, \dots, n\}, \end{aligned}$$

$$\begin{aligned} G_{S^2_i} &= \{(a_{S^2_i}, b_{S^2_i}T_{S^2_i}, c_{S^2_i}I_{S^2_i}, d_{S^2_i}F_{S^2_i}) : a_{S^2_i}, b_{S^2_i}, c_{S^2_i}, d_{S^2_i} \in \mathbb{R} \text{ or } \mathbb{C}; i = 1, 2, 3, \dots, n\} \\ &= \{G_{N^2_i} : i = 1, 2, 3, \dots, n\} \end{aligned}$$

be GNQSSs and $G_{N^1_i}, G_{N^2_i}$ be GNQNs. We define the “optimistic .” operation for GNQNs such that

$$G_{N^m_k} \cdot_O G_{N^n_l} = (a_{S^m_k} \cdot a_{S^n_l}, (b_{S^m_k} \cdot b_{S^n_l})T_{m,n_{k,l}}, (c_{S^m_k} \cdot c_{S^n_l}) I_{m,n_{k,l}}, (d_{S^m_k} \cdot d_{S^n_l}) F_{m,n_{k,l}}),$$

$$\text{where, } n, m = 1, 2; k, l \in \{1, 2, \dots, n\}; T_{m,n_{k,l}} = \max\{T_{S^m_k}, T_{S^n_l}\}; I_{m,n_{k,l}} = \min\{I_{S^m_k}, I_{S^n_l}\} \text{ and } F_{m,n_{k,l}} = \min\{F_{S^m_k}, F_{S^n_l}\}.$$

We define the “optimistic .” operations for GNQSSs such that

$$G_{S^1_i} \cdot_O G_{S^2_i} = \{G_{N^1_i} \cdot_O G_{N^2_i} : i = 1, 2, 3, \dots, n\}.$$

Definition 12: Let

$$\begin{aligned} G_{S^1_i} &= \{(a_{S^1_i}, b_{S^1_i}T_{S^1_i}, c_{S^1_i}I_{S^1_i}, d_{S^1_i}F_{S^1_i}) : a_{S^1_i}, b_{S^1_i}, c_{S^1_i}, d_{S^1_i} \in \mathbb{R} \text{ or } \mathbb{C}; i = 1, 2, 3, \dots, n\} \\ &= \{G_{N^1_i} : i = 1, 2, 3, \dots, n\}, \end{aligned}$$

$$\begin{aligned} G_{S^2_i} &= \{(a_{S^2_i}, b_{S^2_i}T_{S^2_i}, c_{S^2_i}I_{S^2_i}, d_{S^2_i}F_{S^2_i}) : a_{S^2_i}, b_{S^2_i}, c_{S^2_i}, d_{S^2_i} \in \mathbb{R} \text{ or } \mathbb{C}; i = 1, 2, 3, \dots, n\} \\ &= \{G_{N^2_i} : i = 1, 2, 3, \dots, n\} \end{aligned}$$

be GNQSSs and $G_{N^1_i}, G_{N^2_i}$ be GNQNs. We define the “pessimistic .” operation for GNQNs such that

$$G_{N^m_k} \cdot_P G_{N^n_l} = (a_{S^m_k} \cdot a_{S^n_l}, (b_{S^m_k} \cdot b_{S^n_l})T_{m,n_{k,l}}, (c_{S^m_k} \cdot c_{S^n_l}) I_{m,n_{k,l}}, (d_{S^m_k} \cdot d_{S^n_l}) F_{m,n_{k,l}}),$$

$$\text{where, } n, m = 1, 2; k, l \in \{1, 2, \dots, n\}; T_{m,n_{k,l}} = \min\{T_{S^m_k}, T_{S^n_l}\}; I_{m,n_{k,l}} = \max\{I_{S^m_k}, I_{S^n_l}\} \text{ and } F_{m,n_{k,l}} = \max\{F_{S^m_k}, F_{S^n_l}\}.$$

We define the “pessimistic .” operations for GNQSSs such that

$$G_{S^1_i} \cdot_O G_{S^2_i} = \{G_{N^1_i} \cdot_A G_{N^2_i}; i = 1, 2, 3, \dots, n\}.$$

Properties 1: Let

$$\begin{aligned} G_{S^1_i} &= \{(a_{S^1_i}, b_{S^1_i} T_{S^1_i}, c_{S^1_i} I_{S^1_i}, d_{S^1_i} F_{S^1_i}); a_{S^1_i}, b_{S^1_i}, c_{S^1_i}, d_{S^1_i} \in \mathbb{R} \text{ or } \mathbb{C}; i = 1, 2, 3, \dots, n\} \\ &= \{G_{N^1_i}; i = 1, 2, 3, \dots, n\}, \end{aligned}$$

$$\begin{aligned} G_{S^2_i} &= \{(a_{S^2_i}, b_{S^2_i} T_{S^2_i}, c_{S^2_i} I_{S^2_i}, d_{S^2_i} F_{S^2_i}); a_{S^2_i}, b_{S^2_i}, c_{S^2_i}, d_{S^2_i} \in \mathbb{R} \text{ or } \mathbb{C}; i = 1, 2, 3, \dots, n\} \\ &= \{G_{N^2_i}; i = 1, 2, 3, \dots, n\}, \end{aligned}$$

$$\begin{aligned} G_{S^3_i} &= \{(a_{S^3_i}, b_{S^3_i} T_{S^3_i}, c_{S^3_i} I_{S^3_i}, d_{S^3_i} F_{S^3_i}); a_{S^3_i}, b_{S^3_i}, c_{S^3_i}, d_{S^3_i} \in \mathbb{R} \text{ or } \mathbb{C}; i = 1, 2, 3, \dots, n\} \\ &= \{G_{N^3_i}; i = 1, 2, 3, \dots, n\} \end{aligned}$$

be GNQSS; $G_{N^1_i}$, $G_{N^2_i}$ and $G_{N^3_i}$ be GNQNS; $+_A$ be average + operation; $+_O$ be optimistic + operation; $+_P$ be pessimistic + operation; $-_A$ be average - operation; $-_O$ be optimistic - operation; $-_P$ be pessimistic - operation; \cdot_A be average . operation; \cdot_O be optimistic . operation; \cdot_P be pessimistic . operation.

i) $G_{N^m_k} +_A G_{N^n_l} = G_{N^n_l} +_A G_{N^m_k}$; $G_{N^m_k} +_O G_{N^n_l} = G_{N^n_l} +_O G_{N^m_k}$; $G_{N^m_k} +_P G_{N^n_l} = G_{N^n_l} +_P G_{N^m_k}$, where, $n, m = 1, 2, 3$; $k, l \in \{1, 2, \dots, n\}$.

ii) $G_{S^m_i} +_A G_{S^n_i} = G_{S^n_i} +_A G_{S^m_i}$; $G_{S^m_i} +_O G_{S^n_i} = G_{S^n_i} +_O G_{S^m_i}$; $G_{S^m_i} +_P G_{S^n_i} = G_{S^n_i} +_P G_{S^m_i}$,

where, $n, m = 1, 2, 3$.

iii) $G_{N^t_s} +_A (G_{N^m_k} +_A G_{N^n_l}) = (G_{N^t_s} +_A G_{N^m_k}) +_A G_{N^n_l}$,

$$G_{N^t_s} +_O (G_{N^m_k} +_O G_{N^n_l}) = (G_{N^t_s} +_O G_{N^m_k}) +_O G_{N^n_l},$$

$$G_{N^t_s} +_P (G_{N^m_k} +_P G_{N^n_l}) = (G_{N^t_s} +_P G_{N^m_k}) +_P G_{N^n_l},$$

where, $n, m, t = 1, 2, 3$ and $k, l, s \in \{1, 2, \dots, n\}$.

iv) $G_{S^t_i} +_A (G_{S^m_i} +_A G_{S^n_i}) = (G_{S^t_i} +_A G_{S^m_i}) +_A G_{S^n_i}$,

$$G_{S^t_i} +_O (G_{S^m_i} +_O G_{S^n_i}) = (G_{S^t_i} +_O G_{S^m_i}) +_O G_{S^n_i},$$

$$G_{S^t_i} +_P (G_{S^m_i} +_P G_{S^n_i}) = (G_{S^t_i} +_P G_{S^m_i}) +_P G_{S^n_i},$$

where, $n, m, t = 1, 2, 3$ and $i = 1, 2, \dots, n$.

v) $G_{N^t_s} -_A (G_{N^m_k} -_A G_{N^n_l}) = (G_{N^t_s} -_A G_{N^m_k}) -_A G_{N^n_l}$,

$$G_{N^t_s} -_O (G_{N^m_k} -_O G_{N^n_l}) = (G_{N^t_s} -_O G_{N^m_k}) -_O G_{N^n_l},$$

$$G_{N^t_s} -_P (G_{N^m_k} -_P G_{N^n_l}) = (G_{N^t_s} -_P G_{N^m_k}) -_P G_{N^n_l},$$

where, $n, m, t = 1, 2, 3$ and $k, l, s \in \{1, 2, \dots, n\}$.

vi) $G_{S^t_i} -_A (G_{S^m_i} -_A G_{S^n_i}) = (G_{S^t_i} -_A G_{S^m_i}) -_A G_{S^n_i}$,

$$G_{S^t_i} -_O (G_{S^m_i} -_O G_{S^n_i}) = (G_{S^t_i} -_O G_{S^m_i}) -_O G_{S^n_i},$$

$$G_{S^t_i} -_P (G_{S^m_i} -_P G_{S^n_i}) = (G_{S^t_i} -_P G_{S^m_i}) -_P G_{S^n_i},$$

where, $n, m, t = 1, 2, 3$ and $i = 1, 2, \dots, n$.

$$\text{vii) } G_{N^t_s} \cdot_A (G_{N^m_k} \cdot_A G_{N^n_l}) = (G_{N^t_s} \cdot_A G_{N^m_k}) \cdot_A G_{N^n_l},$$

$$G_{N^t_s} \cdot_O (G_{N^m_k} \cdot_O G_{N^n_l}) = (G_{N^t_s} \cdot_O G_{N^m_k}) \cdot_O G_{N^n_l},$$

$$G_{N^t_s} \cdot_P (G_{N^m_k} \cdot_P G_{N^n_l}) = (G_{N^t_s} \cdot_P G_{N^m_k}) \cdot_P G_{N^n_l},$$

where, $n, m, t = 1, 2, 3$ and $k, l, s \in \{1, 2, \dots, n\}$.

$$\text{viii) } G_{S^t_i} \cdot_A (G_{S^m_i} \cdot_A G_{S^n_i}) = (G_{S^t_i} \cdot_A G_{S^m_i}) \cdot_A G_{S^n_i},$$

$$G_{S^t_i} \cdot_O (G_{S^m_i} \cdot_O G_{S^n_i}) = (G_{S^t_i} \cdot_O G_{S^m_i}) \cdot_O G_{S^n_i},$$

$$G_{S^t_i} \cdot_P (G_{S^m_i} \cdot_P G_{S^n_i}) = (G_{S^t_i} \cdot_P G_{S^m_i}) \cdot_P G_{S^n_i},$$

where, $n, m, t = 1, 2, 3$ and $i = 1, 2, \dots, n$.

$$\text{ix) } G_{N^t_s} \cdot_A (G_{N^m_k} +_A G_{N^n_l}) = (G_{N^t_s} \cdot_A G_{N^m_k}) +_A (G_{N^t_s} \cdot_A G_{N^n_l}),$$

$$G_{N^t_s} \cdot_O (G_{N^m_k} +_O G_{N^n_l}) = (G_{N^t_s} \cdot_O G_{N^m_k}) +_O (G_{N^t_s} \cdot_O G_{N^n_l}),$$

$$G_{N^t_s} \cdot_P (G_{N^m_k} +_P G_{N^n_l}) = (G_{N^t_s} \cdot_P G_{N^m_k}) +_P (G_{N^t_s} \cdot_P G_{N^n_l}),$$

where, $n, m, t = 1, 2, 3$ and $k, l, s \in \{1, 2, \dots, n\}$.

$$\text{x) } G_{S^t_i} \cdot_A (G_{S^m_i} +_A G_{S^n_i}) = (G_{S^t_i} \cdot_A G_{S^m_i}) +_A (G_{S^t_i} \cdot_A G_{S^n_i}),$$

$$G_{S^t_i} \cdot_O (G_{S^m_i} +_O G_{S^n_i}) = (G_{S^t_i} \cdot_O G_{S^m_i}) +_O (G_{S^t_i} \cdot_O G_{S^n_i}),$$

$$G_{S^t_i} \cdot_P (G_{S^m_i} +_P G_{S^n_i}) = (G_{S^t_i} \cdot_P G_{S^m_i}) +_P (G_{S^t_i} \cdot_P G_{S^n_i}),$$

where, $n, m, t = 1, 2, 3$ and $i = 1, 2, \dots, n$.

Definition 13: Let

$$G_{S^1_i} = \{(a_{S^1_i}, b_{S^1_i} T_{S^1_i}, c_{S^1_i} I_{S^1_i}, d_{S^1_i} F_{S^1_i}) : a_{S^1_i}, b_{S^1_i}, c_{S^1_i}, d_{S^1_i} \in \mathbb{R} \text{ or } \mathbb{C}; i = 1, 2, 3, \dots, n\}$$

$$= \{G_{N^1_i} : i = 1, 2, 3, \dots, n\},$$

$$G_{S^2_i} = \{(a_{S^2_i}, b_{S^2_i} T_{S^2_i}, c_{S^2_i} I_{S^2_i}, d_{S^2_i} F_{S^2_i}) : a_{S^2_i}, b_{S^2_i}, c_{S^2_i}, d_{S^2_i} \in \mathbb{R} \text{ or } \mathbb{C}; i = 1, 2, 3, \dots, n\}$$

$$= \{G_{N^2_i} : i = 1, 2, 3, \dots, n\}$$

be GNQSS; $G_{N^1_i}, G_{N^2_i}$ be GNQNs. We define “optimistic *” operation for GNQNs such that

$$\text{i) } G_{N^1_k} * O G_{N^2_l} = (a_{S^1_k} a_{S^2_l} , (b_{S^1_k} b_{S^2_l} + b_{S^1_k} c_{S^2_l} + b_{S^1_k} d_{S^2_l} + c_{S^1_k} b_{S^2_l} + d_{S^1_k} b_{S^2_l}) T_{1,2_{k,l}} ,$$

$$(c_{S^1_k} c_{S^2_l} + c_{S^1_k} d_{S^2_l} + d_{S^1_k} c_{S^2_l}) I_{1,2_{k,l}} , d_{S^1_k} d_{S^2_l} F_{1,2_{k,l}}),$$

where,

$$T_{1,2k,l} = \max\{T_{S^1_k}, T_{S^2_l}\}; I_{1,2k,l} = \min\{I_{S^2_k}, I_{S^2_l}\} \text{ and } F_{1,2k,l} = \min\{F_{S^1_k}, F_{S^2_l}\},$$

$$T_{S^1_i} T_{S^2_i} = T_{S^2_i} T_{S^1_i} = \max\{T_{S^1_k}, T_{S^2_l}\},$$

$$T_{S^1_i} I_{S^2_i} = I_{S^2_i} T_{S^1_i} = \max\{T_{S^1_k}, T_{S^2_l}\}, T_{S^2_i} I_{S^1_i} = I_{S^1_i} T_{S^2_i} = \max\{T_{S^1_k}, T_{S^2_l}\},$$

$$T_{S^1_i} F_{S^2_i} = F_{S^2_i} T_{S^1_i} = \max\{T_{S^1_k}, T_{S^2_l}\}, T_{S^2_i} F_{S^1_i} = F_{S^1_i} T_{S^2_i} = \max\{T_{S^1_k}, T_{S^2_l}\},$$

$$I_{S^1_i} I_{S^2_i} = I_{S^2_i} I_{S^1_i} = \min\{I_{S^1_k}, I_{S^2_l}\},$$

$$F_{S^1_i} I_{S^2_i} = I_{S^2_i} F_{S^1_i} = \min\{I_{S^1_k}, I_{S^2_l}\}, F_{S^2_i} I_{S^1_i} = I_{S^1_i} F_{S^2_i} = \min\{I_{S^1_k}, I_{S^2_l}\},$$

$$F_{S^1_i} F_{S^2_i} = F_{S^2_i} F_{S^1_i} = \min\{F_{S^1_k}, F_{S^2_l}\}.$$

Also, we define “optimistic *” operation for GNQSs such that

$$G_{S^1_i} *_O G_{S^2_i} = \{G_{N^1_i} *_O G_{N^2_i}; \dot{i} = 1, 2, \dots, n\}.$$

Definition 14: Let

$$G_{S^1_i} = \{(a_{S^1_i}, b_{S^1_i} T_{S^1_i}, c_{S^1_i} I_{S^1_i}, d_{S^1_i} F_{S^1_i}); a_{S^1_i}, b_{S^1_i}, c_{S^1_i}, d_{S^1_i} \in \mathbb{R} \text{ or } \mathbb{C}; i = 1, 2, 3, \dots, n\}$$

$$= \{G_{N^1_i}; i = 1, 2, 3, \dots, n\},$$

$$G_{S^2_i} = \{(a_{S^2_i}, b_{S^2_i} T_{S^2_i}, c_{S^2_i} I_{S^2_i}, d_{S^2_i} F_{S^2_i}); a_{S^2_i}, b_{S^2_i}, c_{S^2_i}, d_{S^2_i} \in \mathbb{R} \text{ or } \mathbb{C}; i = 1, 2, 3, \dots, n\}$$

$$= \{G_{N^2_i}; i = 1, 2, 3, \dots, n\}$$

be GNQSs; $G_{N^1_i}, G_{N^2_i}$ be GNQNs. We define “pessimistic *” operation for GNQNs such that

$$i) G_{N^1_k} *_P G_{N^2_l} = (a_{S^1_k} a_{S^2_l}, b_{S^1_k} b_{S^2_l} T_{1,2k,l}, (c_{S^1_k} c_{S^2_l} + c_{S^1_k} b_{S^2_l} + b_{S^1_k} c_{S^2_l}) I_{1,2k,l}, (b_{S^1_k} d_{S^2_l} + c_{S^1_k} d_{S^2_l} + d_{S^1_k} b_{S^2_l} + d_{S^1_k} c_{S^2_l} + d_{S^1_k} c_{S^2_l}) F_{1,2k,l}),$$

where,

$$T_{1,2k,l} = \min\{T_{S^1_k}, T_{S^2_l}\}; I_{1,2k,l} = \max\{I_{S^2_k}, I_{S^2_l}\} \text{ and } F_{1,2k,l} = \max\{F_{S^1_k}, F_{S^2_l}\},$$

$$T_{S^1_i} T_{S^2_i} = T_{S^2_i} T_{S^1_i} = \min\{T_{S^1_k}, T_{S^2_l}\},$$

$$T_{S^1_i} I_{S^2_i} = I_{S^2_i} T_{S^1_i} = \max\{I_{S^1_k}, I_{S^2_l}\}, T_{S^2_i} I_{S^1_i} = I_{S^1_i} T_{S^2_i} = \max\{I_{S^1_k}, I_{S^2_l}\},$$

$$T_{S^1_i} F_{S^2_i} = F_{S^2_i} T_{S^1_i} = \max\{F_{S^1_k}, F_{S^2_l}\}, T_{S^2_i} F_{S^1_i} = F_{S^1_i} T_{S^2_i} = \max\{F_{S^1_k}, F_{S^2_l}\},$$

$$I_{S^1_i} I_{S^2_i} = I_{S^2_i} I_{S^1_i} = \max\{I_{S^1_k}, I_{S^2_l}\},$$

$$F_{S^1_i} I_{S^2_i} = I_{S^2_i} F_{S^1_i} = \max\{F_{S^1_k}, F_{S^2_l}\}, F_{S^2_i} I_{S^1_i} = I_{S^1_i} F_{S^2_i} = \max\{F_{S^1_k}, F_{S^2_l}\},$$

$$F_{S^1_i} F_{S^2_i} = F_{S^2_i} F_{S^1_i} = \max\{F_{S^1_k}, F_{S^2_l}\}.$$

Also, we define “pessimistic *” operation for GNQSs such that

$$G_{S^1_i} *_P G_{S^2_i} = \{G_{N^1_i} *_P G_{N^2_i}; \dot{i} = 1, 2, \dots, n\}.$$

Definition 15: Let

$$G_{S^1_i} = \{(a_{S^1_i}, b_{S^1_i}T_{S^1_i}, c_{S^1_i}I_{S^1_i}, d_{S^1_i}F_{S^1_i}): a_{S^1_i}, b_{S^1_i}, c_{S^1_i}, d_{S^1_i} \in \mathbb{R} \text{ or } \mathbb{C}; i = 1, 2, 3, \dots, n\}$$

$$= \{G_{N^1_i}; i = 1, 2, 3, \dots, n\},$$

$$G_{S^2_i} = \{(a_{S^2_i}, b_{S^2_i}T_{S^2_i}, c_{S^2_i}I_{S^2_i}, d_{S^2_i}F_{S^2_i}): a_{S^2_i}, b_{S^2_i}, c_{S^2_i}, d_{S^2_i} \in \mathbb{R} \text{ or } \mathbb{C}; i = 1, 2, 3, \dots, n\}$$

$$= \{G_{N^2_i}; i = 1, 2, 3, \dots, n\}$$

be GNQSS; $G_{N^1_i}, G_{N^2_i}$ be GNQNs. We define “average optimistic *” operation for GNQNs such that

$$i) G_{N^1_k} *_{AO} G_{N^2_l} = (a_{S^1_k}a_{S^2_l} , (b_{S^1_k}b_{S^2_l} + b_{S^1_k}c_{S^2_l} + b_{S^1_k}d_{S^2_l} + c_{S^1_k}b_{S^2_l} + d_{S^1_k}b_{S^2_l})T_{1,2k,l} , (c_{S^1_k}c_{S^2_l} + c_{S^1_k}d_{S^2_l} + d_{S^1_k}c_{S^2_l})I_{1,2k,l}, d_{S^1_k}d_{S^2_l}F_{1,2k,l},$$

where,

$$T_{1,2k,l} = \frac{T_{S^1_k} + T_{S^2_l}}{2}, I_{1,2k,l} = \frac{I_{S^1_k} + I_{S^2_l}}{2} \text{ and } F_{1,2k,l} = \frac{F_{S^1_k} + F_{S^2_l}}{2},$$

$$T_{S^1_i}T_{S^2_i} = T_{S^2_i}T_{S^1_i} = \frac{T_{S^1_k} + T_{S^2_l}}{2},$$

$$T_{S^1_i}I_{S^2_i} = I_{S^2_i}T_{S^1_i} = \frac{T_{S^1_k} + T_{S^2_l}}{2}, T_{S^2_i}I_{S^1_i} = I_{S^1_i}T_{S^2_i} = \frac{T_{S^1_k} + T_{S^2_l}}{2},$$

$$T_{S^1_i}F_{S^2_i} = F_{S^2_i}T_{S^1_i} = \frac{T_{S^1_k} + T_{S^2_l}}{2}, T_{S^2_i}F_{S^1_i} = F_{S^1_i}T_{S^2_i} = \frac{T_{S^1_k} + T_{S^2_l}}{2},$$

$$I_{S^1_i}I_{S^2_i} = I_{S^2_i}I_{S^1_i} = \frac{I_{S^1_k} + I_{S^2_l}}{2},$$

$$F_{S^1_i}I_{S^2_i} = I_{S^2_i}F_{S^1_i} = \frac{I_{S^1_k} + I_{S^2_l}}{2}, F_{S^2_i}I_{S^1_i} = I_{S^1_i}F_{S^2_i} = \frac{I_{S^1_k} + I_{S^2_l}}{2},$$

$$F_{S^1_i}F_{S^2_i} = F_{S^2_i}F_{S^1_i} = \frac{F_{S^1_k} + F_{S^2_l}}{2}.$$

Also, we define “average optimistic *” operation for GNQSSs such that

$$G_{S^1_i} *_{AO} G_{S^2_i} = \{G_{N^1_i} *_{AO} G_{N^2_i}; i = 1, 2, \dots, n\}.$$

Definition 16: Let

$$G_{S^1_i} = \{(a_{S^1_i}, b_{S^1_i}T_{S^1_i}, c_{S^1_i}I_{S^1_i}, d_{S^1_i}F_{S^1_i}): a_{S^1_i}, b_{S^1_i}, c_{S^1_i}, d_{S^1_i} \in \mathbb{R} \text{ or } \mathbb{C}; i = 1, 2, 3, \dots, n\}$$

$$= \{G_{N^1_i}; i = 1, 2, 3, \dots, n\},$$

$$G_{S^2_i} = \{(a_{S^2_i}, b_{S^2_i}T_{S^2_i}, c_{S^2_i}I_{S^2_i}, d_{S^2_i}F_{S^2_i}): a_{S^2_i}, b_{S^2_i}, c_{S^2_i}, d_{S^2_i} \in \mathbb{R} \text{ or } \mathbb{C}; i = 1, 2, 3, \dots, n\}$$

$$= \{G_{N^2_i}; i = 1, 2, 3, \dots, n\}$$

be GNQSS; $G_{N^1_i}, G_{N^2_i}$ be GNQNs. We define “ average pessimistic *” operation for GNQNs such that

$$i) G_{N^1_k} *_{AP} G_{N^2_l} = (a_{S^1_k}a_{S^2_l}, b_{S^1_k}b_{S^2_l}T_{1,2k,l}, (c_{S^1_k}c_{S^2_l} + c_{S^1_k}b_{S^2_l} + b_{S^1_k}c_{S^2_l})I_{1,2k,l}, (b_{S^1_k}d_{S^2_l} + c_{S^1_k}d_{S^2_l} + d_{S^1_k}b_{S^2_l} + d_{S^1_k}c_{S^2_l})F_{1,2k,l}),$$

where,

$$T_{1,2k,l} = \frac{T_{S^1_k} + T_{S^2_l}}{2}, I_{1,2k,l} = \frac{I_{S^1_k} + I_{S^2_l}}{2} \text{ and } F_{1,2k,l} = \frac{F_{S^1_k} + F_{S^2_l}}{2},$$

$$T_{S^1_i} T_{S^2_i} = T_{S^2_i} T_{S^1_i} = \frac{T_{S^1_k} + T_{S^2_l}}{2},$$

$$T_{S^1_i} I_{S^2_i} = I_{S^2_i} T_{S^1_i} = \frac{I_{S^1_k} + I_{S^2_l}}{2}, T_{S^2_i} I_{S^1_i} = I_{S^1_i} T_{S^2_i} = \frac{I_{S^1_k} + I_{S^2_l}}{2},$$

$$T_{S^1_i} F_{S^2_i} = F_{S^2_i} T_{S^1_i} = \frac{F_{S^1_k} + F_{S^2_l}}{2}, T_{S^2_i} F_{S^1_i} = F_{S^1_i} T_{S^2_i} = \frac{F_{S^1_k} + F_{S^2_l}}{2},$$

$$I_{S^1_i} I_{S^2_i} = I_{S^2_i} I_{S^1_i} = \frac{I_{S^1_k} + I_{S^2_l}}{2},$$

$$F_{S^1_i} I_{S^2_i} = I_{S^2_i} F_{S^1_i} = \frac{F_{S^1_k} + F_{S^2_l}}{2}, F_{S^2_i} I_{S^1_i} = I_{S^1_i} F_{S^2_i} = \frac{F_{S^1_k} + F_{S^2_l}}{2},$$

$$F_{S^1_i} F_{S^2_i} = F_{S^2_i} F_{S^1_i} = \frac{F_{S^1_k} + F_{S^2_l}}{2}.$$

Also, we define “average pessimistic *” operation for GNQSs such that

$$G_{S^1_i} *_{AP} G_{S^2_i} = \{G_{N^1_i} *_{AP} G_{N^2_i}; i = 1, 2, \dots, n\}.$$

Conclusions

In this chapter, we generalize NQS and NQN. For each element in a NQS, we define new operations according to the different T, I and F values. Thus, NQS and NQN would be more useful for decision making applications. Also, Thanks to GNQN, researcher can obtain refined GNQN, single valued GNQN, interval valued GNQN, similarity measure for single valued GNQN, similarity measure for interval valued GNQN.

Abbreviations

NQ: Neutrosophic quadruple

NQS: Neutrosophic quadruple set

NQN: Neutrosophic quadruple number

GNQS: Generalized neutrosophic quadruple set

GNQN: Generalized neutrosophic quadruple number

References

- [1] Smarandache F. (1998) Neutrosophy: Neutrosophic Probability, Set and Logic, Rehoboth, Amer. Research Press
- [2] Kandasamy W. B. V. and Smarandache F. (2004) Basic neutrosophic algebraic structures and their applications to fuzzy and neutrosophic models, Hexis, Frontigan p 219
- [3] Kandasamy W. B. V. and Smarandache F. (2006) Some neutrosophic algebraic structures and neutrosophic n-algebraic structures, Hexis, Frontigan p 219
- [4] Smarandache F. and Ali M. (2016) Neutrosophic triplet as extension of matter plasma, unmatter plasma and antimatter plasma, APS Gaseous Electronics Conference doi: 10.1103/BAPS.2016.GEC.HT6.110

- [5] Smarandache F. and Ali M. (2014) The Neutrosophic Triplet Group and its Application to Physics, presented by F. S. to Universidad Nacional de Quilmes, Department of Science and Technology, Bernal, Buenos Aires, Argentina (02 June 2014)
- [6] Smarandache F. and Ali M. (2016) Neutrosophic triplet group. *Neural Computing and Applications*, 1- 7
- [7] Smarandache F. and Ali M. (2017) Neutrosophic Triplet Field Used in Physical Applications, (Log Number: NWS17-2017-000061), 18th Annual Meeting of the APS Northwest Section, Pacific University, Forest Grove, OR, USA (June 1-3, 2017)
- [8] Smarandache F. and Ali M. (2017) Neutrosophic Triplet Ring and its Applications, (Log Number: NWS17-2017-000062), 18th Annual Meeting of the APS Northwest Section, Pacific University, Forest Grove, OR, USA (June 1-3, 2017).
- [9] Şahin M. and Kargın A. (2017) Neutrosophic triplet normed space, *Open Physics*, 15:697-704
- [10] Broumi A., Bakali A., Talea M. and Smarandache F. (2016) Single Valued Neutrosophic Graphs: Degree, Order and Size. *IEEE International Conference on Fuzzy Systems*, pp. 2444-2451.
- [11] Broumi A., Bakali A., Talea M. and Smarandache F. (2016) Decision-Making Method Based On the Interval Valued Neutrosophic Graph, *Future Technologies, IEEE International Conference on Fuzzy Systems* pp 44-50.
- [12] Ulucay, V.; Şahin, M.; Olgun, N. Time-Neutrosophic Soft Expert Sets and Its Decision Making Problem. *Matematika*, 2018 34(2), 246-260.
- [13] Uluçay, V.; Kılıç, A.; Yıldız, I.; Şahin, M. (2018). A new approach for multi-attribute decision-making problems in bipolar neutrosophic sets. *Neutrosophic Sets and Systems*, 2018, 23(1), 142-159.
- [14] Ulucay, V., Kılıç, A., Şahin, M., & Deniz, H. (2019). A New Hybrid Distance-Based Similarity Measure for Refined Neutrosophic sets and its Application in Medical Diagnosis. *MATEMATIKA: Malaysian Journal of Industrial and Applied Mathematics*, 35(1), 83-94.
- [15] Broumi, S., Bakali, A., Talea, M., Smarandache, F., Singh, P. K., Uluçay, V., & Khan, M. (2019). Bipolar complex neutrosophic sets and its application in decision making problem. In *Fuzzy Multi-criteria Decision-Making Using Neutrosophic Sets* (pp. 677-710). Springer, Cham.
- [16] Bakbak, D., Uluçay, V., & Şahin, M. (2019). Neutrosophic soft expert multiset and their application to multiple criteria decision making. *Mathematics*, 7(1), 50.
- [17] Uluçay, V., & Şahin, M. (2020). Decision-Making Method based on Neutrosophic Soft Expert Graphs. In *Neutrosophic Graph Theory and Algorithms* (pp. 33-76). IGI Global.
- [18] Uluçay, V., Kılıç, A., Yıldız, İ., & Şahin, M. (2019). An Outranking Approach for MCDM-Problems with Neutrosophic Multi-Sets. *Neutrosophic Sets & Systems*, 30.
- [19] Uluçay, V., Şahin, M., & Hassan, N. (2018). Generalized neutrosophic soft expert set for multiple-criteria decision-making. *Symmetry*, 10(10), 437.
- [20] Şahin M., Deli I. and Ulucay V. (2016) Similarity measure of bipolar neutrosophic sets and their application to multiple criteria decision making, *Neural Comput & Applic.* DOI 10. 1007/S00521
- [21] Wang H., Smarandache F., Zhang Y. Q., Sunderraman R. (2010) Single valued neutrosophic sets. *Multispace Multistructure* 4, 410–413.
- [22] Şahin M., Olgun N, Uluçay V., Kargın A. and Smarandache F. (2017) A new similarity measure on falsity value between single valued neutrosophic sets based on the centroid points of transformed single valued neutrosophic numbers with applications to pattern recognition, *Neutrosophic Sets and Systems*, 15, 31-48, doi: org/10.5281/zenodo570934
- [23] Şahin M., Ecemiş O., Uluçay V. and Kargın A. (2017) Some new generalized aggregation operators based on centroid single valued triangular neutrosophic numbers and their applications in multi-attribute decision making, *Asian Journal of Mathematics and Computer Research* 16(2): 63-84
- [24] Chatterjee R., Majumdar P., and Samanta S. K. (2019) Similarity Measures in Neutrosophic Sets-I. *Fuzzy Multi-criteria Decision-Making Using Neutrosophic Sets*. Springer, Cham. 249-294.
- [25] Mohana K., and Mohanasundari M. (2019) On Some Similarity Measures of Single Valued Neutrosophic Rough Sets. *Neutrosophic Sets and Systems*, 10
- [26] Smarandache F., et al. (2019) Word-level neutrosophic sentiment similarity. *Applied Soft Computing* 80, 167-176.
- [27] Ye J. (2014) Similarity measures between interval neutrosophic sets and their applications in multicriteria decision – making. *J. Intell. Fuzzy Syst.* 26 (1) 165 – 172
- [28] Zadeh A. L. (1965) Fuzzy sets, *Information and control* ,8.3 338-353,

- [29] Atanassov T. K. (1986) Intuitionistic fuzzy sets, *Fuzzy Sets Syst*, 20:87–96
- [30] Şahin M. and Kargin A. (2019) Neutrosophic triplet metric topology, *Neutrosophic Set and Systems*, 27, 154 -162
- [31] Ali M., Smarandache F., Khan M. (2018) Study on the development of neutrosophic triplet ring and neutrosophic triplet field, *Mathematics-MDPI*, 6(4), 46
- [32] Şahin M. and Kargin A. (2017) Neutrosophic triplet normed space, *Open Physics*, 15, 697-704
- [33] Şahin M. and Kargin A. (2017) Neutrosophic triplet inner product space, *Neutrosophic Operational Research*, 2, 193-215,
- [34] Smarandache F., Şahin M., Kargin A. (2018) Neutrosophic Triplet G- Module, *Mathematics – MDPI*, 6, 53
- [35] Şahin M. and Kargin A. (2019) Neutrosophic triplet b – metric space, *Neutrosophic Triplet Research*, 1
- [36] Şahin M., Kargin A., Çoban M. A. (2018) Fixed point theorem for neutrosophic triplet partial metric space, *Symmetry – MDPI*, 10, 240
- [37] Şahin M., Kargin A. (2018) Neutrosophic triplet v – generalized metric space, *Axioms – MDPI*, 7, 67
- [38] Şahin M. and Kargin A., Smarandache F. (2019) Neutrosophic triplet topology, *Neutrosophic Triplet Research* 1,
- [39] Şahin M., Kargin A. (2018) Neutrosophic triplet normed ring space, *Neutrosophic Set and Systems*, 21, 20 – 27
- [40] Şahin M., Kargin A. (2019), Neutrosophic triplet partial inner product space, *Neutrosophic Triplet Research* 1, 10 - 21
- [41] Şahin M., Kargin A. (2019), Neutrosophic triplet groups Based on set valued neutrosophic quadruple numbers, *Neutrosophic Set and Systems*, 30, 122 -131
- [42] Şahin M., Kargin A. (2019) Neutrosophic triplet partial v – generalized metric space, *Neutrosophic Triplet Research* 1, 22 - 34
- [43] Şahin M., Kargin A. (2019) Neutrosophic triplet Lie Algebra, *Neutrosophic Triplet Research* 1, 68 -78
- [44] Şahin M., Kargin A. (2019) Isomorphism theorems for Neutrosophic triplet G - module, *Neutrosophic Triplet Research* 1, 54- 67
- [45] Smarandache F. (2015) Neutrosophic quadruple numbers, refined neutrosophic quadruple numbers, absorbance law, and the multiplication of neutrosophic quadruple numbers, *Neutrosophic Set and Systems*, 10, 96 -98
- [46] Akinleye, S. A., Smarandache, F. (2016) Agboola, A. A. A. On neutrosophic quadruple algebraic structures. *Neutrosophic Sets and Systems*, 12, 122-126.
- [47] Jun, Y., Song, S. Z., Smarandache, F., & Bordbar, H. Neutrosophic quadruple BCK/BCI-algebras. *Axioms*, (2018) 7(2), 41.
- [48] Muhiuddin, G., Al-Kenani, A. N., Roh, E. H., & Jun, Y. B. (2019) Implicative neutrosophic quadruple BCK-algebras and ideals. *Symmetry*, 11(2), 277.
- [49] Li, Q., Ma, Y., Zhang, X., & Zhang, J. (2019) Neutrosophic Extended Triplet Group Based on Neutrosophic Quadruple Numbers. *Symmetry*, 11(5), 696.
- [50] Şahin, M., Kargin A. (2019), Neutrosophic triplet groups based on set valued neutrosophic quadruple numbers, *Neutrosophic Set and Systems*, 30, 122 - 131
- [51] Şahin, M., Kargin A. (2019), Single valued neutrosophic quadruple graphs, *Asian Journal of Mathematics and Computer Research*, 26(4): 243–250

Chapter Two

Generalized Set Valued Neutrosophic Quadruple Sets and Numbers

Memet Şahin, Abdullah Kargin and Adil Kılıç

Department of Mathematics, Gaziantep University, Gaziantep27310-Turkey

E-mail: mesahin@gantep.edu.tr, abduallahkargin27@gmail.com, adilkilic@gantep.edu.tr

ABSTRACT

Smarandache introduce neutrosophic quadruple sets and numbers [45] in 2015. Also, Şahin and Kargin studied set valued quadruple sets and numbers [50] in 2019. In a neutrosophic quadruple set or set valued neutrosophic quadruple set, the values T, I and F are same for each element. Where T, I and F have their usual neutrosophic logic means. In this chapter, we generalize set valued neutrosophic quadruple set and number. For each element in a set valued neutrosophic quadruple set, we define new operations according to the different T, I and F values. Thus, generalized set valued neutrosophic quadruple sets and numbers would be more useful for decision making applications. In this way, we obtain new results for generalized set valued neutrosophic quadruple set and number.

Keywords: neutrosophic quadruple set, neutrosophic quadruple number, set valued neutrosophic quadruple set, set valued neutrosophic quadruple number, generalized set valued neutrosophic quadruple set, generalized set valued neutrosophic quadruple number

INTRODUCTION

Fuzzy logic and fuzzy set [28] were obtained by Zadeh in 1965. In the concept of fuzzy logic and fuzzy sets, there is only a degree of membership. In addition, intuitionistic fuzzy logic and intuitionistic fuzzy set [29] were obtained by Atanassov in 1986. The concept of intuitionistic fuzzy logic and intuitionistic fuzzy set includes membership degree, degree of undeterminacy and degree of non-membership. But these degrees are defined dependently of each other. Also, Smarandache defined neutrosophic logic and neutrosophic set [1] in 1998. In neutrosophic logic and neutrosophic sets, there is T degree of membership, I degree of undeterminacy and F degree of non-membership. These degrees are defined independently of each other. It has a neutrosophic value (T, I, F) form. In other words, a condition is handled according to both its accuracy and its inaccuracy and its uncertainty. Therefore, neutrosophic logic and neutrosophic set help us to explain many uncertainties in our lives. In addition, many researchers have made studies on this theory [2 – 27, 30 - 44]. Therefore, neutrosophic set is a generalized state of fuzzy and intuitionistic fuzzy set.

Also, Smarandache introduced NQS and NQN [45]. The NQSs are generalized state of neutrosophic sets. A NQS is shown by $\{(x, yT, zI, tF): x, y, z, t \in \mathbb{R} \text{ or } \mathbb{C}\}$. Where, x is called the known part and (yT, zI, tF) is

called the unknown part and T, I, F have their usual neutrosophic logic means. Recently, researchers studied NQS and NQN. Recently, Akinleye, Smarandache, Agboola studied NQ algebraic structures [46]; Jun, Song, Smarandache obtained NQ BCK/BCI-algebras [47]; Muhiuddin, Al-Kenani, Roh, Jun introduced implicative NQ BCK-algebras and ideals [48]; Li, Ma, Zhang, Zhang studied NT extended group based on NQNs [49]; Şahin and Kargin obtained SVNQN and NTG based on SVNQN [50]; Şahin and Kargin studied single valued NQ graphs [51].

In this chapter, we generalize set valued neutrosophic quadruple set and number. For each element in a set valued neutrosophic quadruple set, we define new operations according to the different T, I and F values. Thus, generalized set valued neutrosophic quadruple sets and numbers would be more useful for decision making applications. In this way, we obtain new results for generalized set valued neutrosophic quadruple set and number. In Section 2, we give definitions and properties for NQS, NQN [45] and SVNQS, SVNQN [50]. In Section 3, we generalize SVNQS and SVNQN. Also, we define new structures using the SVNQS and SVNQN. In Section 4, we give conclusions.

BACKGROUND

Definition 1: [45] A NQN is a number of the form (x, yT, zI, tF) , where T, I, F have their usual neutrosophic logic means and $x, y, z, t \in \mathbb{R}$ or \mathbb{C} . The NQS defined by

$$NQ = \{(x, yT, zI, tF) : x, y, z, t \in \mathbb{R} \text{ or } \mathbb{C}\}.$$

For a NQN (x, yT, zI, tF) , representing any entity which may be a number, an idea, an object, etc., x is called the known part and (yT, zI, tF) is called the unknown part.

Definition 2: [50] Let N be a set and $P(N)$ be power set of N . A SVNQN is shown by the form (A_1, A_2T, A_3I, A_4F) . Where, T, I and F are degree of membership, degree of undeterminacy, degree of non-membership in neutrosophic theory, respectively. Also, $A_1, A_2, A_3, A_4 \in P(N)$. Then, a SVNQS shown by

$$N_q = \{(A_1, A_2T, A_3I, A_4F) : A_1, A_2, A_3, A_4 \in P(N)\}$$

where, similar to NQS, A_1 is called the known part and (A_1, A_2T, A_3I, A_4F) is called the unknown part.

Definition 3: [50] Let $A = (A_1, A_2T, A_3I, A_4F)$ and $B = (B_1, B_2T, B_3I, B_4F)$ be SVNQNs. We define the following operations, well known operators in set theory, such that

$$A \cup B = (A_1 \cup B_1, (A_2 \cup B_2)T, (A_3 \cup B_3)I, (A_4 \cup B_4)F)$$

$$A \cap B = (A_1 \cap B_1, (A_2 \cap B_2)T, (A_3 \cap B_3)I, (A_4 \cap B_4)F)$$

$$A \setminus B = (A_1 \setminus B_1, (A_2 \setminus B_2)T, (A_3 \setminus B_3)I, (A_4 \setminus B_4)F)$$

$$A' = (A'_1, A'_2T, A'_3I, A'_4F)$$

Definition 4: [50] Let $A = (A_1, A_2T, A_3I, A_4F)$, $B = (B_1, B_2T, B_3I, B_4F)$ be SVNQNs and $T < I < F$. We define the following operations

$$A *_1 B = (A_1, A_2T, A_3I, A_4F) *_1 (B_1, B_2T, B_3I, B_4F)$$

$$= (A_1 \cap B_1, ((A_1 \cap B_2) \cup (A_2 \cap B_1) \cup (A_2 \cap B_2))T, ((A_1 \cap B_3) \cup (A_2 \cap B_3) \cup (A_3 \cap B_1) \cup (A_3 \cap B_2) \cup (A_3 \cap B_3))I, ((A_1 \cap B_4) \cup (A_2 \cap B_4) \cup (A_3 \cap B_4) \cup (A_4 \cap B_1) \cup (A_4 \cap B_2) \cup (A_4 \cap B_3) \cup (A_4 \cap B_4))F)$$

and

$$A *_2 B = (A_1, A_2 T, A_3 I, A_4 F) *_2 (B_1, B_2 T, B_3 I, B_4 F)$$

$$= (A_1 \cup B_1, ((A_1 \cup B_2) \cap (A_2 \cup B_1) \cap (A_2 \cup B_2)) T, ((A_1 \cup B_3) \cap (A_2 \cup B_3) \cap (A_3 \cup B_1) \cap (A_3 \cup B_2) \cap (A_3 \cup B_3)) I, ((A_1 \cup B_4) \cap (A_2 \cup B_4) \cap (A_3 \cup B_4) \cap (A_4 \cup B_1) \cap (A_4 \cup B_2) \cap (A_4 \cup B_3) \cap (A_4 \cup B_4)) F).$$

Definition 5: [50]

Let $A = (A_1, A_2 T, A_3 I, A_4 F)$, $B = (B_1, B_2 T, B_3 I, B_4 F)$ be SVNQNs and $T > I > F$. We define the following operations

$$A \#_1 B = (A_1, A_2 T, A_3 I, A_4 F) \#_1 (B_1, B_2 T, B_3 I, B_4 F)$$

$$= (A_1 \cap B_1, ((A_1 \cap B_2) \cup (A_2 \cap B_1) \cup (A_2 \cap B_2) \cup (A_3 \cap B_2) \cup (A_4 \cap B_2) \cup (A_2 \cap B_3) \cup (A_2 \cap B_4)) T, ((A_1 \cap B_3) \cup (A_3 \cap B_3) \cup (A_3 \cap B_4) \cup (A_4 \cap B_3)) I, ((A_1 \cap B_4) \cup (A_4 \cap B_2) \cup (A_4 \cap B_4)) F)$$

and

$$A \#_2 B = (A_1, A_2 T, A_3 I, A_4 F) \#_2 (B_1, B_2 T, B_3 I, B_4 F)$$

$$= (A_1 \cup B_1, ((A_1 \cup B_2) \cap (A_2 \cup B_1) \cap (A_2 \cup B_2) \cap (A_3 \cup B_2) \cap (A_4 \cup B_2) \cap (A_2 \cup B_3) \cap (A_2 \cup B_4)) T, ((A_1 \cup B_3) \cap (A_3 \cup B_3) \cap (A_3 \cup B_4) \cap (A_4 \cup B_3)) I, ((A_1 \cup B_4) \cap (A_4 \cup B_2) \cap (A_4 \cup B_4)) F).$$

Definition 6: [50] Let $A = (A_1, A_2 T, A_3 I, A_4 F)$, $B = (B_1, B_2 T, B_3 I, B_4 F)$ be SVNQNs. If $A_1 \subset B_1, A_2 \subset B_2, A_3 \subset B_3, A_4 \subset B_4$, then it is called that A is subset of B. It is shown by $A \subset B$.

Definition 7: [50] Let $A = (A_1, A_2 T, A_3 I, A_4 F)$, $B = (B_1, B_2 T, B_3 I, B_4 F)$ be SVNQNs. If $A \subset B$ and $B \subset A$, then it is called that A is equal to B. It is shown by $A = B$.

GENERALIZED SET VALUED NEUTROSOPHIC QUADRUPLE SET AND NUMBER

Definition 8: Let X be a set and P(X) be power set of X. A generalized SVNQS (GSVNQS) is a set of the form

$$G_{S_i} = \{(A_{S_i}, B_{S_i} T_{S_i}, C_{S_i} I_{S_i}, D_{S_i} F_{S_i}) : A_{S_i}, B_{S_i}, C_{S_i}, D_{S_i} \in P(X); i = 1, 2, 3, \dots, n\},$$

where, T_i, I_i and F_i have their usual neutrosophic logic means and a generalized SVNQN (GSVNQN) defined by

$$G_{N_i} = (A_{S_i}, B_{S_i} T_{S_i}, C_{S_i} I_{S_i}, D_{S_i} F_{S_i}).$$

As in NQN, for a GNQN $(A_{S_i}, B_{S_i} T_{S_i}, C_{S_i} I_{S_i}, D_{S_i} F_{S_i})$, representing any entity which may be a number, an idea, an object, etc.; A_{S_i} is called the known part and $(B_{S_i} T_{S_i}, C_{S_i} I_{S_i}, D_{S_i} F_{S_i})$ is called the unknown part.

Also, we can show that $G_{S_i} = \{G_{N_i} : i = 1, 2, 3, \dots, n\}$.

Corollary 1: From Definition 1 and Definition 7, each SVNQS is a GSVNQN. However, the opposite is not always true.

Now, we define new operations for GSVNQN and GSVNQS.

Definition 9: Let

$$G_{S^1_i} = \{(A_{S^1_i}, B_{S^1_i} T_{S^1_i}, C_{S^1_i} I_{S^1_i}, D_{S^1_i} F_{S^1_i}) : A_{S^1_i}, B_{S^1_i}, C_{S^1_i}, D_{S^1_i} \in P(X); i = 1, 2, 3, \dots, n\}$$

$$= \{G_{N^1_i}; i = 1, 2, 3, \dots, n\},$$

$$G_{S^2_i} = \{(A_{S^2_i}, B_{S^2_i}, T_{S^2_i}, C_{S^2_i}, I_{S^2_i}, D_{S^2_i}, F_{S^2_i}): A_{S^2_i}, B_{S^2_i}, C_{S^2_i}, D_{S^2_i} \in P(X); i = 1, 2, 3, \dots, n\}$$

$$= \{G_{N^2_i}; i = 1, 2, 3, \dots, n\}$$

be GSVNQSs and $G_{N^1_i}, G_{N^2_i}$ be GSVNQN. We define the “average \cup ” and “average \cap ” operations for and GSVNQN such that

$$G_{N^m_k} \cup_A G_{N^n_l} = (A_{S^m_k} \cup A_{S^n_l}, (B_{S^m_k} \cup B_{S^n_l})T_{m,n_{k,l}}, (C_{S^m_k} \cup C_{S^n_l}) I_{m,n_{k,l}}, (D_{S^m_k} \cup D_{S^n_l}) F_{m,n_{k,l}}),$$

$$G_{N^m_k} \cap_A G_{N^n_l} = (A_{S^m_k} \cap A_{S^n_l}, (B_{S^m_k} \cap B_{S^n_l})T_{m,n_{k,l}}, (C_{S^m_k} \cap C_{S^n_l}) I_{m,n_{k,l}}, (D_{S^m_k} \cap D_{S^n_l}) F_{m,n_{k,l}}),$$

$$\text{where, } n, m = 1, 2; k, l \in \{1, 2, \dots, n\}; T_{m,n_{k,l}} = \frac{T_{S^m_k} + T_{S^n_l}}{2}; I_{m,n_{k,l}} = \frac{I_{S^m_k} + I_{S^n_l}}{2} \text{ and } F_{m,n_{k,l}} = \frac{F_{S^m_k} + F_{S^n_l}}{2}.$$

We define the “average \cup ” and “average \cap ” operations for and GSVNQN such that

$$G_{S^1_i} \cup_A G_{S^2_i} = \{G_{N^1_i} \cup_A G_{N^2_i}; i = 1, 2, 3, \dots, n\}.$$

$$G_{S^1_i} \cap_A G_{S^2_i} = \{G_{N^1_i} \cap_A G_{N^2_i}; i = 1, 2, 3, \dots, n\}.$$

Definition 10: Let

$$G_{S^1_i} = \{(A_{S^1_i}, B_{S^1_i}, T_{S^1_i}, C_{S^1_i}, I_{S^1_i}, D_{S^1_i}, F_{S^1_i}): A_{S^1_i}, B_{S^1_i}, C_{S^1_i}, D_{S^1_i} \in P(X); i = 1, 2, 3, \dots, n\}$$

$$= \{G_{N^1_i}; i = 1, 2, 3, \dots, n\},$$

$$G_{S^2_i} = \{(A_{S^2_i}, B_{S^2_i}, T_{S^2_i}, C_{S^2_i}, I_{S^2_i}, D_{S^2_i}, F_{S^2_i}): A_{S^2_i}, B_{S^2_i}, C_{S^2_i}, D_{S^2_i} \in P(X); i = 1, 2, 3, \dots, n\}$$

$$= \{G_{N^2_i}; i = 1, 2, 3, \dots, n\}$$

be GSVNQSs and $G_{N^1_i}, G_{N^2_i}$ be GSVNQN. We define the “optimistic \cup ” and “optimistic \cap ” operations for and GSVNQN such that

$$G_{N^m_k} \cup_O G_{N^n_l} = (A_{S^m_k} \cup A_{S^n_l}, (B_{S^m_k} \cup B_{S^n_l})T_{m,n_{k,l}}, (C_{S^m_k} \cup C_{S^n_l}) I_{m,n_{k,l}}, (D_{S^m_k} \cup D_{S^n_l}) F_{m,n_{k,l}}),$$

$$G_{N^m_k} \cap_O G_{N^n_l} = (A_{S^m_k} \cap A_{S^n_l}, (B_{S^m_k} \cap B_{S^n_l})T_{m,n_{k,l}}, (C_{S^m_k} \cap C_{S^n_l}) I_{m,n_{k,l}}, (D_{S^m_k} \cap D_{S^n_l}) F_{m,n_{k,l}}),$$

$$\text{where, } n, m = 1, 2; k, l \in \{1, 2, \dots, n\}; T_{m,n_{k,l}} = \max\{T_{S^m_k}, T_{S^n_l}\}; I_{m,n_{k,l}} = \min\{I_{S^m_k}, I_{S^n_l}\} \text{ and } F_{m,n_{k,l}} = \min\{F_{S^m_k}, F_{S^n_l}\}.$$

We define the “optimistic \cup ” and “optimistic \cap ” operations for and GSVNQN such that

$$G_{S^1_i} \cup_O G_{S^2_i} = \{G_{N^1_i} \cup_O G_{N^2_i}; i = 1, 2, 3, \dots, n\}.$$

$$G_{S^1_i} \cap_O G_{S^2_i} = \{G_{N^1_i} \cap_O G_{N^2_i}; i = 1, 2, 3, \dots, n\}.$$

Definition 11: Let

$$G_{S^1_i} = \{(A_{S^1_i}, B_{S^1_i}, T_{S^1_i}, C_{S^1_i}, I_{S^1_i}, D_{S^1_i}, F_{S^1_i}): A_{S^1_i}, B_{S^1_i}, C_{S^1_i}, D_{S^1_i} \in P(X); i = 1, 2, 3, \dots, n\}$$

$$= \{G_{N^1_i}; i = 1, 2, 3, \dots, n\},$$

$$G_{S^2_i} = \{(A_{S^2_i}, B_{S^2_i} T_{S^2_i}, C_{S^2_i} I_{S^2_i}, D_{S^2_i} F_{S^2_i}): A_{S^2_i}, B_{S^2_i}, C_{S^2_i}, D_{S^2_i} \in P(X); i = 1, 2, 3, \dots, n\}$$

$$= \{G_{N^2_i}; i = 1, 2, 3, \dots, n\}$$

be GSVNQs and $G_{N^1_i}, G_{N^2_i}$ be GSVNQNs. We define the “pessimistic \cup ” and “pessimistic \cap ” operations for and GNQNs such that

$$G_{N^m_k} \cup_P G_{N^n_l} = (A_{S^m_k} \cup A_{S^n_l}, (B_{S^m_k} \cup B_{S^n_l}) T_{m,n_{k,l}}, (C_{S^m_k} \cup C_{S^n_l}) I_{m,n_{k,l}}, (D_{S^m_k} \cup D_{S^n_l}) F_{m,n_{k,l}}),$$

$$G_{N^m_k} \cap_P G_{N^n_l} = (A_{S^m_k} \cap A_{S^n_l}, (B_{S^m_k} \cap B_{S^n_l}) T_{m,n_{k,l}}, (C_{S^m_k} \cap C_{S^n_l}) I_{m,n_{k,l}}, (D_{S^m_k} \cap D_{S^n_l}) F_{m,n_{k,l}}),$$

where, $n, m = 1, 2$; $k, l \in \{1, 2, \dots, n\}$; $T_{m,n_{k,l}} = \min\{T_{S^m_k}, T_{S^n_l}\}$; $I_{m,n_{k,l}} = \max\{I_{S^m_k}, I_{S^n_l}\}$ and $F_{m,n_{k,l}} = \max\{F_{S^m_k}, F_{S^n_l}\}$.

We define the “pessimistic \cup ” and “pessimistic \cap ” operations for and GNQNs such that

$$G_{S^1_i} \cup_P G_{S^2_i} = \{G_{N^1_i} \cup_P G_{N^2_i}; i = 1, 2, 3, \dots, n\}.$$

$$G_{S^1_i} \cap_P G_{S^2_i} = \{G_{N^1_i} \cap_P G_{N^2_i}; i = 1, 2, 3, \dots, n\}.$$

Definition 12: Let

$$G_{S^1_i} = \{(A_{S^1_i}, B_{S^1_i} T_{S^1_i}, C_{S^1_i} I_{S^1_i}, D_{S^1_i} F_{S^1_i}): A_{S^1_i}, B_{S^1_i}, C_{S^1_i}, D_{S^1_i} \in P(X); i = 1, 2, 3, \dots, n\}$$

$$= \{G_{N^1_i}; i = 1, 2, 3, \dots, n\},$$

$$G_{S^2_i} = \{(A_{S^2_i}, B_{S^2_i} T_{S^2_i}, C_{S^2_i} I_{S^2_i}, D_{S^2_i} F_{S^2_i}): A_{S^2_i}, B_{S^2_i}, C_{S^2_i}, D_{S^2_i} \in P(X); i = 1, 2, 3, \dots, n\}$$

$$= \{G_{N^2_i}; i = 1, 2, 3, \dots, n\}$$

be GSVNQs and $G_{N^1_i}, G_{N^2_i}$ be GSVNQNs. We define the “average \setminus ” operation for and GSVNQNs such that

$$G_{N^m_k} \setminus_A G_{N^n_l} = (A_{S^m_k} \setminus A_{S^n_l}, (B_{S^m_k} \setminus B_{S^n_l}) T_{m,n_{k,l}}, (C_{S^m_k} \setminus C_{S^n_l}) I_{m,n_{k,l}}, (D_{S^m_k} \setminus D_{S^n_l}) F_{m,n_{k,l}}),$$

where, $n, m = 1, 2$; $k, l \in \{1, 2, \dots, n\}$; $T_{m,n_{k,l}} = \frac{T_{S^m_k} + T_{S^n_l}}{2}$; $I_{m,n_{k,l}} = \frac{I_{S^m_k} + I_{S^n_l}}{2}$ and $F_{m,n_{k,l}} = \frac{F_{S^m_k} + F_{S^n_l}}{2}$.

We define the “average \setminus ” operations for GSVNQNs such that

$$G_{S^1_i} \setminus_A G_{S^2_i} = \{G_{N^1_i} \setminus_A G_{N^2_i}; i = 1, 2, 3, \dots, n\}.$$

Definition 13: Let

$$G_{S^1_i} = \{(A_{S^1_i}, B_{S^1_i} T_{S^1_i}, C_{S^1_i} I_{S^1_i}, D_{S^1_i} F_{S^1_i}): A_{S^1_i}, B_{S^1_i}, C_{S^1_i}, D_{S^1_i} \in P(X); i = 1, 2, 3, \dots, n\}$$

$$= \{G_{N^1_i}; i = 1, 2, 3, \dots, n\},$$

$$G_{S^2_i} = \{(A_{S^2_i}, B_{S^2_i} T_{S^2_i}, C_{S^2_i} I_{S^2_i}, D_{S^2_i} F_{S^2_i}): A_{S^2_i}, B_{S^2_i}, C_{S^2_i}, D_{S^2_i} \in P(X); i = 1, 2, 3, \dots, n\}$$

$$= \{G_{N^2_i}; i = 1, 2, 3, \dots, n\}$$

be GSVNQs and $G_{N^1_i}, G_{N^2_i}$ be GSVNQNs. We define the “optimistic \setminus ” operation for and GSVNQNs such that

$$G_{N^m_k} \setminus_O G_{N^n_l} = (A_{S^m_k} \setminus A_{S^n_l}, (B_{S^m_k} \setminus B_{S^n_l})T_{m,n_k,l}, (C_{S^m_k} \setminus C_{S^n_l})I_{m,n_k,l}, (D_{S^m_k} \setminus D_{S^n_l})F_{m,n_k,l}),$$

where, $n, m = 1, 2$; $k, l \in \{1, 2, \dots, n\}$; $T_{m,n_k,l} = \max\{T_{S^m_k}, T_{S^n_l}\}$; $I_{m,n_k,l} = \min\{I_{S^m_k}, I_{S^n_l}\}$ and $F_{m,n_k,l} = \min\{F_{S^m_k}, F_{S^n_l}\}$.

We define the “optimistic \setminus ” operation for and GSVNQN such that

$$G_{S^1_i} \setminus_O G_{S^2_i} = \{G_{N^1_i} \setminus_O G_{N^2_i}; i = 1, 2, 3, \dots, n\}.$$

Definition 14: Let

$$\begin{aligned} G_{S^1_i} &= \{(A_{S^1_i}, B_{S^1_i}T_{S^1_i}, C_{S^1_i}I_{S^1_i}, D_{S^1_i}F_{S^1_i}): A_{S^1_i}, B_{S^1_i}, C_{S^1_i}, D_{S^1_i} \in P(X); i = 1, 2, 3, \dots, n\} \\ &= \{G_{N^1_i}; i = 1, 2, 3, \dots, n\}, \end{aligned}$$

$$\begin{aligned} G_{S^2_i} &= \{(A_{S^2_i}, B_{S^2_i}T_{S^2_i}, C_{S^2_i}I_{S^2_i}, D_{S^2_i}F_{S^2_i}): A_{S^2_i}, B_{S^2_i}, C_{S^2_i}, D_{S^2_i} \in P(X); i = 1, 2, 3, \dots, n\} \\ &= \{G_{N^2_i}; i = 1, 2, 3, \dots, n\} \end{aligned}$$

be GSVNQSs and $G_{N^1_i}, G_{N^2_i}$ be GSVNQN. We define the “pessimistic \setminus ” operations for and GSVNQN such that

$$G_{N^m_k} \setminus_P G_{N^n_l} = (A_{S^m_k} \setminus A_{S^n_l}, (B_{S^m_k} \setminus B_{S^n_l})T_{m,n_k,l}, (C_{S^m_k} \setminus C_{S^n_l})I_{m,n_k,l}, (D_{S^m_k} \setminus D_{S^n_l})F_{m,n_k,l}),$$

where, $n, m = 1, 2$; $k, l \in \{1, 2, \dots, n\}$; $T_{m,n_k,l} = \min\{T_{S^m_k}, T_{S^n_l}\}$; $I_{m,n_k,l} = \max\{I_{S^m_k}, I_{S^n_l}\}$ and $F_{m,n_k,l} = \max\{F_{S^m_k}, F_{S^n_l}\}$.

We define the “pessimistic \setminus ” operations for and GSVNQN such that

$$G_{S^1_i} \setminus_P G_{S^2_i} = \{G_{N^1_i} \setminus_P G_{N^2_i}; i = 1, 2, 3, \dots, n\}.$$

Properties 1: Let

$$\begin{aligned} G_{S^1_i} &= \{(A_{S^1_i}, B_{S^1_i}T_{S^1_i}, C_{S^1_i}I_{S^1_i}, D_{S^1_i}F_{S^1_i}): A_{S^1_i}, B_{S^1_i}, C_{S^1_i}, D_{S^1_i} \in P(X); i = 1, 2, 3, \dots, n\} \\ &= \{G_{N^1_i}; i = 1, 2, 3, \dots, n\}, \end{aligned}$$

$$\begin{aligned} G_{S^2_i} &= \{(A_{S^2_i}, B_{S^2_i}T_{S^2_i}, C_{S^2_i}I_{S^2_i}, D_{S^2_i}F_{S^2_i}): A_{S^2_i}, B_{S^2_i}, C_{S^2_i}, D_{S^2_i} \in P(X); i = 1, 2, 3, \dots, n\} \\ &= \{G_{N^2_i}; i = 1, 2, 3, \dots, n\}, \end{aligned}$$

$$\begin{aligned} G_{S^3_i} &= \{(A_{S^3_i}, B_{S^3_i}T_{S^3_i}, C_{S^3_i}I_{S^3_i}, D_{S^3_i}F_{S^3_i}): A_{S^3_i}, B_{S^3_i}, C_{S^3_i}, D_{S^3_i} \in P(X); i = 1, 2, 3, \dots, n\} \\ &= \{G_{N^3_i}; i = 1, 2, 3, \dots, n\} \end{aligned}$$

be GSVNQSs and $G_{N^1_i}, G_{N^2_i}, G_{N^3_i}$ be GSVNQN; \cup_A be average \cup operation; \cup_O be optimistic \cup operation; \cup_P be pessimistic \cup operation; \cap_A be average \cap operation; \cap_O be optimistic \cap operation; \cap_P be pessimistic \cap operation; \setminus_A be average \setminus operation; \setminus_O be optimistic \setminus operation; \setminus_P be pessimistic \setminus operation.

i) $G_{N^m_k} \cap_A G_{N^n_l} = G_{N^n_l} \cap_A G_{N^m_k}$; $G_{N^m_k} \cap_O G_{N^n_l} = G_{N^n_l} \cap_O G_{N^m_k}$; $G_{N^m_k} \cap_P G_{N^n_l} = G_{N^n_l} \cap_P G_{N^m_k}$, where, $n, m = 1, 2, 3$; $k, l \in \{1, 2, \dots, n\}$.

ii) $G_S^{m_i} \cap_A G_S^{n_i} = G_S^{n_i} \cap_A G_S^{m_i}$; $G_S^{m_i} \cap_O G_S^{n_i} = G_S^{n_i} \cap_O G_S^{m_i}$; $G_S^{m_i} \cap_P G_S^{n_i} = G_S^{n_i} \cap_P G_S^{m_i}$, where, $n, m = 1, 2, 3$.

iii) $G_N^{m_k} \cup_A G_N^{n_l} = G_N^{n_l} \cup_A G_N^{m_k}$; $G_N^{m_k} \cup_O G_N^{n_l} = G_N^{n_l} \cup_O G_N^{m_k}$; $G_N^{m_k} \cup_P G_N^{n_l} = G_N^{n_l} \cup_P G_N^{m_k}$, where, $n, m = 1, 2, 3$; $k, l \in \{1, 2, \dots, n\}$.

iv) $G_S^{m_i} \cup_A G_S^{n_i} = G_S^{n_i} \cup_A G_S^{m_i}$; $G_S^{m_i} \cup_O G_S^{n_i} = G_S^{n_i} \cup_O G_S^{m_i}$; $G_S^{m_i} \cup_P G_S^{n_i} = G_S^{n_i} \cup_P G_S^{m_i}$, where, $n, m = 1, 2, 3$.

v) $G_N^{t_s} \cup_A (G_N^{m_k} \cup_A G_N^{n_l}) = (G_N^{t_s} \cup_A G_N^{m_k}) \cup_A G_N^{n_l}$,

$G_N^{t_s} \cup_O (G_N^{m_k} \cup_O G_N^{n_l}) = (G_N^{t_s} \cup_O G_N^{m_k}) \cup_O G_N^{n_l}$,

$G_N^{t_s} \cup_P (G_N^{m_k} \cup_P G_N^{n_l}) = (G_N^{t_s} \cup_P G_N^{m_k}) \cup_P G_N^{n_l}$,

where, $n, m, t = 1, 2, 3$ and $k, l, s \in \{1, 2, \dots, n\}$.

vi) $G_S^{t_i} \cup_A (G_S^{m_i} \cup_A G_S^{n_i}) = (G_S^{t_i} \cup_A G_S^{m_i}) \cup_A G_S^{n_i}$,

$G_S^{t_i} \cup_O (G_S^{m_i} \cup_O G_S^{n_i}) = (G_S^{t_i} \cup_O G_S^{m_i}) \cup_O G_S^{n_i}$,

$G_S^{t_i} \cup_P (G_S^{m_i} \cup_P G_S^{n_i}) = (G_S^{t_i} \cup_P G_S^{m_i}) \cup_P G_S^{n_i}$,

where, $n, m, t = 1, 2, 3$ and $i = 1, 2, \dots, n$.

vii) $G_N^{t_s} \cap_A (G_N^{m_k} \cap_A G_N^{n_l}) = (G_N^{t_s} \cap_A G_N^{m_k}) \cap_A G_N^{n_l}$,

$G_N^{t_s} \cap_O (G_N^{m_k} \cap_O G_N^{n_l}) = (G_N^{t_s} \cap_O G_N^{m_k}) \cap_O G_N^{n_l}$,

$G_N^{t_s} \cap_P (G_N^{m_k} \cap_P G_N^{n_l}) = (G_N^{t_s} \cap_P G_N^{m_k}) \cap_P G_N^{n_l}$,

where, $n, m, t = 1, 2, 3$ and $k, l, s \in \{1, 2, \dots, n\}$.

viii) $G_S^{t_i} \cap_A (G_S^{m_i} \cap_A G_S^{n_i}) = (G_S^{t_i} \cap_A G_S^{m_i}) \cap_A G_S^{n_i}$,

$G_S^{t_i} \cap_O (G_S^{m_i} \cap_O G_S^{n_i}) = (G_S^{t_i} \cap_O G_S^{m_i}) \cap_O G_S^{n_i}$,

$G_S^{t_i} \cap_P (G_S^{m_i} \cap_P G_S^{n_i}) = (G_S^{t_i} \cap_P G_S^{m_i}) \cap_P G_S^{n_i}$,

where, $n, m, t = 1, 2, 3$ and $i = 1, 2, \dots, n$.

ix) $G_N^{t_s} \cap_A (G_N^{m_k} \cup_A G_N^{n_l}) = (G_N^{t_s} \cap_A G_N^{m_k}) \cup_A (G_N^{t_s} \cap_A G_N^{n_l})$,

$G_N^{t_s} \cap_O (G_N^{m_k} \cup_O G_N^{n_l}) = (G_N^{t_s} \cap_O G_N^{m_k}) \cup_O (G_N^{t_s} \cap_O G_N^{n_l})$,

$G_N^{t_s} \cap_P (G_N^{m_k} \cup_P G_N^{n_l}) = (G_N^{t_s} \cap_P G_N^{m_k}) \cup_P (G_N^{t_s} \cap_P G_N^{n_l})$,

where, $n, m, t = 1, 2, 3$ and $k, l, s \in \{1, 2, \dots, n\}$.

x) $G_S^{t_i} \cap_A (G_S^{m_i} \cup_A G_S^{n_i}) = (G_S^{t_i} \cap_A G_S^{m_i}) \cup_A (G_S^{t_i} \cap_A G_S^{n_i})$,

$$G_{S^t_i} \cap_O (G_{S^m_i} \cup_O G_{S^n_i}) = (G_{S^t_i} \cap_O G_{S^m_i}) \cup_O (G_{S^t_i} \cap_O G_{S^n_i}),$$

$$G_{S^t_i} \cap_P (G_{S^m_i} \cup_P G_{S^n_i}) = (G_{S^t_i} \cap_P G_{S^m_i}) \cup_P (G_{S^t_i} \cap_O G_{S^n_i}),$$

where, $n, m, t = 1, 2, 3$ and $i = 1, 2, \dots, n$.

$$\mathbf{xi)} G_{N^t_s} \cup_A (G_{N^m_k} \cap_A G_{N^n_l}) = (G_{N^t_s} \cap_A G_{N^m_k}) \cup_A (G_{N^t_s} \cap_A G_{N^n_l}),$$

$$G_{N^t_s} \cup_O (G_{N^m_k} \cap_O G_{N^n_l}) = (G_{N^t_s} \cap_O G_{N^m_k}) \cup_O (G_{N^t_s} \cap_O G_{N^n_l}),$$

$$G_{N^t_s} \cup_P (G_{N^m_k} \cap_P G_{N^n_l}) = (G_{N^t_s} \cap_P G_{N^m_k}) \cup_P (G_{N^t_s} \cap_O G_{N^n_l}).$$

Where, $n, m, t = 1, 2, 3$ and $k, l, s \in \{1, 2, \dots, n\}$.

$$\mathbf{xii)} G_{S^t_i} \cup_A (G_{S^m_i} \cap_A G_{S^n_i}) = (G_{S^t_i} \cup_A G_{S^m_i}) \cap_A (G_{S^t_i} \cup_A G_{S^n_i}),$$

$$G_{S^t_i} \cup_O (G_{S^m_i} \cap_O G_{S^n_i}) = (G_{S^t_i} \cup_O G_{S^m_i}) \cap_O (G_{S^t_i} \cup_O G_{S^n_i}),$$

$$G_{S^t_i} \cup_P (G_{S^m_i} \cap_P G_{S^n_i}) = (G_{S^t_i} \cup_P G_{S^m_i}) \cap_P (G_{S^t_i} \cup_O G_{S^n_i}),$$

where, $n, m, t = 1, 2, 3$ and $i = 1, 2, \dots, n$.

Definition 15: Let

$$\begin{aligned} G_{S^1_i} &= \{(A_{S^1_i}, B_{S^1_i}, T_{S^1_i}, C_{S^1_i}, I_{S^1_i}, D_{S^1_i}, F_{S^1_i}) : A_{S^1_i}, B_{S^1_i}, C_{S^1_i}, D_{S^1_i} \in P(X); i = 1, 2, 3, \dots, n\} \\ &= \{G_{N^1_i}; i = 1, 2, 3, \dots, n\}, \end{aligned}$$

$$\begin{aligned} G_{S^2_i} &= \{(A_{S^2_i}, B_{S^2_i}, T_{S^2_i}, C_{S^2_i}, I_{S^2_i}, D_{S^2_i}, F_{S^2_i}) : A_{S^2_i}, B_{S^2_i}, C_{S^2_i}, D_{S^2_i} \in P(X); i = 1, 2, 3, \dots, n\} \\ &= \{G_{N^2_i}; i = 1, 2, 3, \dots, n\} \end{aligned}$$

be GSVNQSs and $G_{N^1_i}, G_{N^2_i}$ be GSVNQN. We define “optimistic *” operation for GSVNQN. We define “optimistic *” operation for GSVNQN. We define “optimistic *” operation for GSVNQN. We define “optimistic *” operation for GSVNQN such that

$$\mathbf{i)} G_{N^1_k} *_O G_{N^2_l} = ((A_{S^1_k} \cap A_{S^2_l}), ((B_{S^1_k} \cap B_{S^2_l}) \cup (B_{S^1_k} \cap C_{S^2_l}) \cup (B_{S^1_k} \cap D_{S^2_l}) \cup (C_{S^1_k} \cap B_{S^2_l}) \cup (D_{S^1_k} \cap B_{S^2_l}))T_{1,2,k,l}, ((C_{S^1_k} \cap C_{S^2_l}) \cup (C_{S^1_k} \cap D_{S^2_l}) \cup (D_{S^1_k} \cap C_{S^2_l}))I_{1,2,k,l}, (D_{S^1_k} \cap D_{S^2_l})F_{1,2,k,l},$$

where,

$$T_{1,2,k,l} = \max\{T_{S^1_k}, T_{S^2_l}\}; I_{1,2,k,l} = \min\{I_{S^2_k}, I_{S^2_l}\} \text{ and } F_{1,2,k,l} = \min\{F_{S^1_k}, F_{S^2_l}\},$$

$$T_{S^1_i} T_{S^2_i} = T_{S^2_i} T_{S^1_i} = \max\{T_{S^1_k}, T_{S^2_l}\},$$

$$T_{S^1_i} I_{S^2_i} = I_{S^2_i} T_{S^1_i} = \max\{T_{S^1_k}, T_{S^2_l}\}, T_{S^2_i} I_{S^1_i} = I_{S^1_i} T_{S^2_i} = \max\{T_{S^1_k}, T_{S^2_l}\},$$

$$T_{S^1_i} F_{S^2_i} = F_{S^2_i} T_{S^1_i} = \max\{T_{S^1_k}, T_{S^2_l}\}, T_{S^2_i} F_{S^1_i} = F_{S^1_i} T_{S^2_i} = \max\{T_{S^1_k}, T_{S^2_l}\},$$

$$I_{S^1_i} I_{S^2_i} = I_{S^2_i} I_{S^1_i} = \min\{I_{S^1_k}, I_{S^2_l}\},$$

$$F_{S^1_i} I_{S^2_i} = I_{S^2_i} F_{S^1_i} = \min\{I_{S^1_k}, I_{S^2_l}\}, F_{S^2_i} I_{S^1_i} = I_{S^1_i} F_{S^2_i} = \min\{I_{S^1_k}, I_{S^2_l}\},$$

$$F_{S^1_i} F_{S^2_i} = F_{S^2_i} F_{S^1_i} = \min\{F_{S^1_k}, F_{S^2_l}\}.$$

Also, we define “optimistic *” operation for GSVNQSs such that

$$G_{S^1_i} *_{O} G_{S^2_i} = \{G_{N^1_i} *_{O} G_{N^2_i}; \dot{I} = 1, 2, \dots, n\}.$$

Definition 16: Let

$$\begin{aligned} G_{S^1_i} &= \{(A_{S^1_i}, B_{S^1_i}, T_{S^1_i}, C_{S^1_i}, I_{S^1_i}, D_{S^1_i}, F_{S^1_i}); A_{S^1_i}, B_{S^1_i}, C_{S^1_i}, D_{S^1_i} \in P(X); i = 1, 2, 3, \dots, n\} \\ &= \{G_{N^1_i}; i = 1, 2, 3, \dots, n\}, \end{aligned}$$

$$\begin{aligned} G_{S^2_i} &= \{(A_{S^2_i}, B_{S^2_i}, T_{S^2_i}, C_{S^2_i}, I_{S^2_i}, D_{S^2_i}, F_{S^2_i}); A_{S^2_i}, B_{S^2_i}, C_{S^2_i}, D_{S^2_i} \in P(X); i = 1, 2, 3, \dots, n\} \\ &= \{G_{N^2_i}; i = 1, 2, 3, \dots, n\} \end{aligned}$$

be GSVNQSs and $G_{N^1_i}, G_{N^2_i}$ be GSVNQNs. We define “pessimistic *” operation for GSVNQNs such that

$$\begin{aligned} i) G_{N^1_k} *_{P} G_{N^2_l} &= ((A_{S^1_k} \cap A_{S^2_l}), (B_{S^1_k} \cap B_{S^2_l})T_{1,2k,l}, ((C_{S^1_k} \cap C_{S^2_l}) \cup (C_{S^1_k} \cap B_{S^2_l}) \cup (B_{S^1_k} \cap C_{S^2_l}))I_{1,2k,l}, \\ &((B_{S^1_k} \cap D_{S^2_l}) \cup (C_{S^1_k} \cap D_{S^2_l}) \cup (D_{S^1_k} \cap B_{S^2_l}) \cup (D_{S^1_k} \cap C_{S^2_l}) \cup (D_{S^1_k} \cap C_{S^2_l}))F_{1,2k,l}, \end{aligned}$$

where,

$$T_{1,2k,l} = \min\{T_{S^1_k}, T_{S^2_l}\}; I_{1,2k,l} = \max\{I_{S^2_k}, I_{S^2_l}\} \text{ and } F_{1,2k,l} = \max\{F_{S^1_k}, F_{S^2_l}\},$$

$$T_{S^1_i} T_{S^2_i} = T_{S^2_i} T_{S^1_i} = \min\{T_{S^1_k}, T_{S^2_l}\},$$

$$T_{S^1_i} I_{S^2_i} = I_{S^2_i} T_{S^1_i} = \max\{I_{S^1_k}, I_{S^2_l}\}, T_{S^2_i} I_{S^1_i} = I_{S^1_i} T_{S^2_i} = \max\{I_{S^1_k}, I_{S^2_l}\},$$

$$T_{S^1_i} F_{S^2_i} = F_{S^2_i} T_{S^1_i} = \max\{F_{S^1_k}, F_{S^2_l}\}, T_{S^2_i} F_{S^1_i} = F_{S^1_i} T_{S^2_i} = \max\{F_{S^1_k}, F_{S^2_l}\},$$

$$I_{S^1_i} I_{S^2_i} = I_{S^2_i} I_{S^1_i} = \max\{I_{S^1_k}, I_{S^2_l}\},$$

$$F_{S^1_i} I_{S^2_i} = I_{S^2_i} F_{S^1_i} = \max\{F_{S^1_k}, F_{S^2_l}\}, F_{S^2_i} I_{S^1_i} = I_{S^1_i} F_{S^2_i} = \max\{F_{S^1_k}, F_{S^2_l}\},$$

$$F_{S^1_i} F_{S^2_i} = F_{S^2_i} F_{S^1_i} = \max\{F_{S^1_k}, F_{S^2_l}\}.$$

Also, we define “pessimistic *” operation for GSVNQSs such that

$$G_{S^1_i} *_{P} G_{S^2_i} = \{G_{N^1_i} *_{P} G_{N^2_i}; \dot{I} = 1, 2, \dots, n\}.$$

Definition 17: Let

$$\begin{aligned} G_{S^1_i} &= \{(A_{S^1_i}, B_{S^1_i}, T_{S^1_i}, C_{S^1_i}, I_{S^1_i}, D_{S^1_i}, F_{S^1_i}); A_{S^1_i}, B_{S^1_i}, C_{S^1_i}, D_{S^1_i} \in P(X); i = 1, 2, 3, \dots, n\} \\ &= \{G_{N^1_i}; i = 1, 2, 3, \dots, n\}, \end{aligned}$$

$$\begin{aligned} G_{S^2_i} &= \{(A_{S^2_i}, B_{S^2_i}, T_{S^2_i}, C_{S^2_i}, I_{S^2_i}, D_{S^2_i}, F_{S^2_i}); A_{S^2_i}, B_{S^2_i}, C_{S^2_i}, D_{S^2_i} \in P(X); i = 1, 2, 3, \dots, n\} \\ &= \{G_{N^2_i}; i = 1, 2, 3, \dots, n\} \end{aligned}$$

be GSVNQSs and $G_{N^1_i}, G_{N^2_i}$ be GSVNQNs. We define “average optimistic *” operation for GSVNQNs such that

$$\begin{aligned} i) G_{N^1_k} *_{AO} G_{N^2_l} &= ((A_{S^1_k} \cap A_{S^2_l}), ((B_{S^1_k} \cap B_{S^2_l}) \cup (B_{S^1_k} \cap C_{S^2_l}) \cup (B_{S^1_k} \cap D_{S^2_l}) \cup (C_{S^1_k} \cap B_{S^2_l}) \cup \\ &(D_{S^1_k} \cap B_{S^2_l}))T_{1,2k,l}, ((C_{S^1_k} \cap C_{S^2_l}) \cup (C_{S^1_k} \cap D_{S^2_l}) \cup (D_{S^1_k} \cap C_{S^2_l}))I_{1,2k,l}, (D_{S^1_k} \cap D_{S^2_l})F_{1,2k,l}, \end{aligned}$$

$$F_{S^1_i} I_{S^2_i} = I_{S^2_i} F_{S^1_i} = \frac{F_{S^1_k} + F_{S^2_l}}{2}, F_{S^2_i} I_{S^1_i} = I_{S^1_i} F_{S^2_i} = \frac{F_{S^1_k} + F_{S^2_l}}{2},$$

$$F_{S^1_i} F_{S^2_i} = F_{S^2_i} F_{S^1_i} = \frac{F_{S^1_k} + F_{S^2_l}}{2}.$$

Also, we define “average pessimistic *” operation for GSVNQs such that

$$G_{S^1_i} *_{AP} G_{S^2_i} = \{G_{N^1_i} *_{AP} G_{N^2_i}; i = 1, 2, \dots, n\}.$$

Definition 19: Let

$$G_{S^1_i} = \{(A_{S^1_i}, B_{S^1_i} T_{S^1_i}, C_{S^1_i} I_{S^1_i}, D_{S^1_i} F_{S^1_i}); A_{S^1_i}, B_{S^1_i}, C_{S^1_i}, D_{S^1_i} \in P(X); i = 1, 2, 3, \dots, n\}$$

$$= \{G_{N^1_i}; i = 1, 2, 3, \dots, n\},$$

$$G_{S^2_i} = \{(A_{S^2_i}, B_{S^2_i} T_{S^2_i}, C_{S^2_i} I_{S^2_i}, D_{S^2_i} F_{S^2_i}); A_{S^2_i}, B_{S^2_i}, C_{S^2_i}, D_{S^2_i} \in P(X); i = 1, 2, 3, \dots, n\}$$

$$= \{G_{N^2_i}; i = 1, 2, 3, \dots, n\}$$

be GSVNQs and $G_{N^1_i}, G_{N^2_i}$ be GSVNQs. We define “optimistic #” operation for GSVNQs such that

$$i) G_{N^1_k} \#_O G_{N^2_l} = ((A_{S^1_k} \cup A_{S^2_l}), ((B_{S^1_k} \cup B_{S^2_l}) \cap (B_{S^1_k} \cup C_{S^2_l}) \cap (B_{S^1_k} \cup D_{S^2_l}) \cap (C_{S^1_k} \cup B_{S^2_l}) \cap (D_{S^1_k} \cup B_{S^2_l})) T_{1,2,k,l}, ((C_{S^1_k} \cup C_{S^2_l}) \cap (C_{S^1_k} \cup D_{S^2_l}) \cap (D_{S^1_k} \cup C_{S^2_l})) I_{1,2,k,l}, (D_{S^1_k} \cup D_{S^2_l}) F_{1,2,k,l},$$

where,

$$T_{1,2,k,l} = \max\{T_{S^1_k}, T_{S^2_l}\}; I_{1,2,k,l} = \min\{I_{S^2_k}, I_{S^2_l}\} \text{ and } F_{1,2,k,l} = \min\{F_{S^1_k}, F_{S^2_l}\},$$

$$T_{S^1_i} T_{S^2_i} = T_{S^2_i} T_{S^1_i} = \max\{T_{S^1_k}, T_{S^2_l}\},$$

$$T_{S^1_i} I_{S^2_i} = I_{S^2_i} T_{S^1_i} = \max\{T_{S^1_k}, T_{S^2_l}\}, T_{S^2_i} I_{S^1_i} = I_{S^1_i} T_{S^2_i} = \max\{T_{S^1_k}, T_{S^2_l}\},$$

$$T_{S^1_i} F_{S^2_i} = F_{S^2_i} T_{S^1_i} = \max\{T_{S^1_k}, T_{S^2_l}\}, T_{S^2_i} F_{S^1_i} = F_{S^1_i} T_{S^2_i} = \max\{T_{S^1_k}, T_{S^2_l}\},$$

$$I_{S^1_i} I_{S^2_i} = I_{S^2_i} I_{S^1_i} = \min\{I_{S^1_k}, I_{S^2_l}\},$$

$$F_{S^1_i} I_{S^2_i} = I_{S^2_i} F_{S^1_i} = \min\{I_{S^1_k}, I_{S^2_l}\}, F_{S^2_i} I_{S^1_i} = I_{S^1_i} F_{S^2_i} = \min\{I_{S^1_k}, I_{S^2_l}\},$$

$$F_{S^1_i} F_{S^2_i} = F_{S^2_i} F_{S^1_i} = \min\{F_{S^1_k}, F_{S^2_l}\}.$$

Also, we define “optimistic #” operation for GSVNQs such that

$$G_{S^1_i} \#_O G_{S^2_i} = \{G_{N^1_i} \#_O G_{N^2_i}; i = 1, 2, \dots, n\}.$$

Definition 20: Let

$$G_{S^1_i} = \{(A_{S^1_i}, B_{S^1_i} T_{S^1_i}, C_{S^1_i} I_{S^1_i}, D_{S^1_i} F_{S^1_i}); A_{S^1_i}, B_{S^1_i}, C_{S^1_i}, D_{S^1_i} \in P(X); i = 1, 2, 3, \dots, n\}$$

$$= \{G_{N^1_i}; i = 1, 2, 3, \dots, n\},$$

$$G_{S^2_i} = \{(A_{S^2_i}, B_{S^2_i} T_{S^2_i}, C_{S^2_i} I_{S^2_i}, D_{S^2_i} F_{S^2_i}); A_{S^2_i}, B_{S^2_i}, C_{S^2_i}, D_{S^2_i} \in P(X); i = 1, 2, 3, \dots, n\}$$

$$= \{G_{N^2_i}; i = 1, 2, 3, \dots, n\}$$

be GSVNQSs and $G_{N^1_i}, G_{N^2_i}$ be GSVNQN. We define “pessimistic #” operation for GSVNQN such that

$$i) G_{N^1_k} \#_P G_{N^2_l} = ((A_{S^1_k} \cup A_{S^2_l}), (B_{S^1_k} \cup B_{S^2_l})T_{1,2k,l}, ((C_{S^1_k} \cup C_{S^2_l}) \cap (C_{S^1_k} \cup B_{S^2_l}) \cap (B_{S^1_k} \cup C_{S^2_l}))I_{1,2k,l}, ((B_{S^1_k} \cup D_{S^2_l}) \cap (C_{S^1_k} \cup D_{S^2_l}) \cap (D_{S^1_k} \cup B_{S^2_l}) \cap (D_{S^1_k} \cup C_{S^2_l}) \cap (D_{S^1_k} \cup C_{S^2_l}))F_{1,2k,l}),$$

where,

$$T_{1,2k,l} = \min\{T_{S^1_k}, T_{S^2_l}\}; I_{1,2k,l} = \max\{I_{S^2_k}, I_{S^2_l}\} \text{ and } F_{1,2k,l} = \max\{F_{S^1_k}, F_{S^2_l}\},$$

$$T_{S^1_i} T_{S^2_i} = T_{S^2_i} T_{S^1_i} = \min\{T_{S^1_k}, T_{S^2_l}\},$$

$$T_{S^1_i} I_{S^2_i} = I_{S^2_i} T_{S^1_i} = \max\{I_{S^1_k}, I_{S^2_l}\}, T_{S^2_i} I_{S^1_i} = I_{S^1_i} T_{S^2_i} = \max\{I_{S^1_k}, I_{S^2_l}\},$$

$$T_{S^1_i} F_{S^2_i} = F_{S^2_i} T_{S^1_i} = \max\{F_{S^1_k}, F_{S^2_l}\}, T_{S^2_i} F_{S^1_i} = F_{S^1_i} T_{S^2_i} = \max\{F_{S^1_k}, F_{S^2_l}\},$$

$$I_{S^1_i} I_{S^2_i} = I_{S^2_i} I_{S^1_i} = \max\{I_{S^1_k}, I_{S^2_l}\},$$

$$F_{S^1_i} I_{S^2_i} = I_{S^2_i} F_{S^1_i} = \max\{F_{S^1_k}, F_{S^2_l}\}, F_{S^2_i} I_{S^1_i} = I_{S^1_i} F_{S^2_i} = \max\{F_{S^1_k}, F_{S^2_l}\},$$

$$F_{S^1_i} F_{S^2_i} = F_{S^2_i} F_{S^1_i} = \max\{F_{S^1_k}, F_{S^2_l}\}.$$

Also, we define “pessimistic #” operation for GSVNQSs such that

$$G_{S^1_i} \#_P G_{S^2_i} = \{G_{N^1_i} \#_P G_{N^2_i}; i = 1, 2, \dots, n\}.$$

Definition 21: Let

$$G_{S^1_i} = \{(A_{S^1_i}, B_{S^1_i} T_{S^1_i}, C_{S^1_i} I_{S^1_i}, D_{S^1_i} F_{S^1_i}); A_{S^1_i}, B_{S^1_i}, C_{S^1_i}, D_{S^1_i} \in P(X); i = 1, 2, 3, \dots, n\}$$

$$= \{G_{N^1_i}; i = 1, 2, 3, \dots, n\},$$

$$G_{S^2_i} = \{(A_{S^2_i}, B_{S^2_i} T_{S^2_i}, C_{S^2_i} I_{S^2_i}, D_{S^2_i} F_{S^2_i}); A_{S^2_i}, B_{S^2_i}, C_{S^2_i}, D_{S^2_i} \in P(X); i = 1, 2, 3, \dots, n\}$$

$$= \{G_{N^2_i}; i = 1, 2, 3, \dots, n\}$$

be GSVNQSs and $G_{N^1_i}, G_{N^2_i}$ be GSVNQN. We define “average optimistic #” operation for GSVNQN such that

$$i) G_{N^1_k} \#_{AO} G_{N^2_l} = ((a_{S^1_k} \cup a_{S^2_l}), ((b_{S^1_k} \cup b_{S^2_l}) \cap (b_{S^1_k} \cup c_{S^2_l}) \cap (b_{S^1_k} \cup d_{S^2_l}) \cap (c_{S^1_k} \cup b_{S^2_l}) \cap (d_{S^1_k} \cup b_{S^2_l}))T_{1,2k,l}, ((c_{S^1_k} \cup c_{S^2_l}) \cap (c_{S^1_k} \cup d_{S^2_l}) \cap (d_{S^1_k} \cup c_{S^2_l}))I_{1,2k,l}, (d_{S^1_k} \cup d_{S^2_l})F_{1,2k,l}),$$

where,

$$T_{1,2k,l} = \frac{T_{S^1_k} + T_{S^2_l}}{2}, I_{1,2k,l} = \frac{I_{S^1_k} + I_{S^2_l}}{2} \text{ and } F_{1,2k,l} = \frac{F_{S^1_k} + F_{S^2_l}}{2},$$

$$T_{S^1_i} T_{S^2_i} = T_{S^2_i} T_{S^1_i} = \frac{T_{S^1_k} + T_{S^2_l}}{2},$$

$$T_{S^1_i} I_{S^2_i} = I_{S^2_i} T_{S^1_i} = \frac{T_{S^1_k} + T_{S^2_l}}{2}, T_{S^2_i} I_{S^1_i} = I_{S^1_i} T_{S^2_i} = \frac{T_{S^1_k} + T_{S^2_l}}{2},$$

$$T_{S^1_i} F_{S^2_i} = F_{S^2_i} T_{S^1_i} = \frac{T_{S^1_k} + T_{S^2_l}}{2}, T_{S^2_i} F_{S^1_i} = F_{S^1_i} T_{S^2_i} = \frac{T_{S^1_k} + T_{S^2_l}}{2},$$

$$G_{S^1_i} = \{(A_{S^1_i}, B_{S^1_i}T_{S^1_i}, C_{S^1_i}I_{S^1_i}, D_{S^1_i}F_{S^1_i}): A_{S^1_i}, B_{S^1_i}, C_{S^1_i}, D_{S^1_i} \in P(X); i = 1, 2, 3, \dots, n\}$$

$$= \{G_{N^1_i}; i = 1, 2, 3, \dots, n\},$$

$$G_{S^2_i} = \{(A_{S^2_i}, B_{S^2_i}T_{S^2_i}, C_{S^2_i}I_{S^2_i}, D_{S^2_i}F_{S^2_i}): A_{S^2_i}, B_{S^2_i}, C_{S^2_i}, D_{S^2_i} \in P(X); i = 1, 2, 3, \dots, n\}$$

$$= \{G_{N^2_i}; i = 1, 2, 3, \dots, n\},$$

$$G_{S^3_i} = \{(A_{S^3_i}, B_{S^3_i}T_{S^3_i}, C_{S^3_i}I_{S^3_i}, D_{S^3_i}F_{S^3_i}): A_{S^3_i}, B_{S^3_i}, C_{S^3_i}, D_{S^3_i} \in P(X); i = 1, 2, 3, \dots, n\}$$

$$= \{G_{N^3_i}; i = 1, 2, 3, \dots, n\}$$

be GSVNQs and $G_{N^1_i}, G_{N^2_i}, G_{N^3_i}$ be GSVNQNs; $*_O$ be optimistic $*$ operation; $*_P$ be pessimistic $*$ operation; $*_{AO}$ be average optimistic $*$ operation; $*_{AP}$ be average pessimistic $*$ operation; $\#_O$ be optimistic $\#$ operation; $\#_P$ be pessimistic $\#$ operation; $\#_{AO}$ be average optimistic $\#$ operation; $\#_{AP}$ be average pessimistic $\#$ operation;

i) $G_{N^m_k} *_O G_{N^n_l} = G_{N^n_l} *_O G_{N^m_k},$

$$G_{N^m_k} *_P G_{N^n_l} = G_{N^n_l} *_P G_{N^m_k},$$

$$G_{N^m_k} *_{AO} G_{N^n_l} = G_{N^n_l} *_{AO} G_{N^m_k},$$

$$G_{N^m_k} *_{AP} G_{N^n_l} = G_{N^n_l} *_{AP} G_{N^m_k},$$

where, $n, m = 1, 2, 3; k, l \in \{1, 2, \dots, n\}.$

ii) $G_{S^m_i} *_O G_{S^n_i} = G_{S^n_i} *_O G_{S^m_i},$

$$G_{S^m_i} *_P G_{S^n_i} = G_{S^n_i} *_P G_{S^m_i},$$

$$G_{S^m_i} *_{AO} G_{S^n_i} = G_{S^n_i} *_{AO} G_{S^m_i},$$

$$G_{S^m_i} *_{AP} G_{S^n_i} = G_{S^n_i} *_{AP} G_{S^m_i},$$

where, $n, m = 1, 2, 3.$

iii) $G_{N^m_k} \#_O G_{N^n_l} = G_{N^n_l} \#_O G_{N^m_k},$

$$G_{N^m_k} \#_P G_{N^n_l} = G_{N^n_l} \#_P G_{N^m_k},$$

$$G_{N^m_k} \#_{AO} G_{N^n_l} = G_{N^n_l} \#_{AO} G_{N^m_k},$$

$$G_{N^m_k} \#_{AP} G_{N^n_l} = G_{N^n_l} \#_{AP} G_{N^m_k},$$

where, $n, m = 1, 2, 3; k, l \in \{1, 2, \dots, n\}.$

iv) $G_{S^m_i} \#_O G_{S^n_i} = G_{S^n_i} \#_O G_{S^m_i},$

$$G_{S^m_i} \#_P G_{S^n_i} = G_{S^n_i} \#_P G_{S^m_i},$$

$$G_{S^m_i} \#_{AO} G_{S^n_i} = G_{S^n_i} \#_{AO} G_{S^m_i},$$

$$G_S^{m_i} \#_{AP} G_S^{n_i} = G_S^{n_i} \#_{AP} G_S^{m_i},$$

where, $n, m = 1, 2, 3$.

$$\text{v)} G_{N^t_s} *_{O} (G_{N^m_k} *_{O} G_{N^n_l}) = (G_{N^t_s} *_{O} G_{N^m_k}) *_{O} G_{N^n_l},$$

$$G_{N^t_s} *_{P} (G_{N^m_k} *_{P} G_{N^n_l}) = (G_{N^t_s} *_{P} G_{N^m_k}) *_{P} G_{N^n_l}.$$

$$G_{N^t_s} *_{AO} (G_{N^m_k} *_{AO} G_{N^n_l}) = (G_{N^t_s} *_{AO} G_{N^m_k}) *_{AO} G_{N^n_l},$$

$$G_{N^t_s} *_{AP} (G_{N^m_k} *_{AP} G_{N^n_l}) = (G_{N^t_s} *_{AP} G_{N^m_k}) *_{AP} G_{N^n_l},$$

where, $n, m, t = 1, 2, 3$ and $k, l, s \in \{1, 2, \dots, n\}$.

$$\text{vi)} G_{S^t_i} *_{O} (G_S^{m_i} *_{O} G_S^{n_i}) = (G_{S^t_i} *_{O} G_S^{m_i}) *_{O} G_S^{n_i},$$

$$G_{S^t_i} *_{P} (G_S^{m_i} *_{P} G_S^{n_i}) = (G_{S^t_i} *_{P} G_S^{m_i}) *_{P} G_S^{n_i}.$$

$$G_{S^t_i} *_{AO} (G_S^{m_i} *_{AO} G_S^{n_i}) = (G_{S^t_i} *_{AO} G_S^{m_i}) *_{AO} G_S^{n_i},$$

$$G_{S^t_i} *_{AP} (G_S^{m_i} *_{AP} G_S^{n_i}) = (G_{S^t_i} *_{AP} G_S^{m_i}) *_{AP} G_S^{n_i},$$

where, $n, m, t = 1, 2, 3$ and $i = 1, 2, \dots, 3$.

$$\text{vii)} G_{N^t_s} \#_{O} (G_{N^m_k} \#_{O} G_{N^n_l}) = (G_{N^t_s} \#_{O} G_{N^m_k}) \#_{O} G_{N^n_l},$$

$$G_{N^t_s} \#_{P} (G_{N^m_k} \#_{P} G_{N^n_l}) = (G_{N^t_s} \#_{P} G_{N^m_k}) \#_{P} G_{N^n_l}.$$

$$G_{N^t_s} \#_{AO} (G_{N^m_k} \#_{AO} G_{N^n_l}) = (G_{N^t_s} \#_{AO} G_{N^m_k}) \#_{AO} G_{N^n_l},$$

$$G_{N^t_s} \#_{AP} (G_{N^m_k} \#_{AP} G_{N^n_l}) = (G_{N^t_s} \#_{AP} G_{N^m_k}) \#_{AP} G_{N^n_l},$$

where, $n, m, t = 1, 2, 3$ and $k, l, s \in \{1, 2, \dots, n\}$.

$$\text{viii)} G_{S^t_i} \#_{O} (G_S^{m_i} \#_{O} G_S^{n_i}) = (G_{S^t_i} \#_{O} G_S^{m_i}) \#_{O} G_S^{n_i},$$

$$G_{S^t_i} \#_{P} (G_S^{m_i} \#_{P} G_S^{n_i}) = (G_{S^t_i} \#_{P} G_S^{m_i}) \#_{P} G_S^{n_i}.$$

$$G_{S^t_i} \#_{AO} (G_S^{m_i} \#_{AO} G_S^{n_i}) = (G_{S^t_i} \#_{AO} G_S^{m_i}) \#_{AO} G_S^{n_i},$$

$$G_{S^t_i} \#_{AP} (G_S^{m_i} \#_{AP} G_S^{n_i}) = (G_{S^t_i} \#_{AP} G_S^{m_i}) \#_{AP} G_S^{n_i},$$

where, $n, m, t = 1, 2, 3$ and $i = 1, 2, \dots, 3$.

Conclusions

In this chapter, we generalize SVNQS and SVNQN. For each element in a GSVNQS, we define new operations according to the different T, I and F values. Thus, SVNQS and SVNQN would be more useful for decision making applications. Also, Thanks to GSVNQN, researcher can obtain refined GSVNQN, single valued GSVNQN, interval valued GSVNQN, similarity measure for single valued GSVNQN, similarity measure for interval valued GSVNQN.

Abbreviations

NQ: Neutrosophic quadruple

NQS: Neutrosophic quadruple set

NQN: Neutrosophic quadruple number

GSVNQS: Generalized set valued neutrosophic quadruple set

GSVNQN: Generalized set valued neutrosophic quadruple number

References

- [1] Smarandache F. (1998) Neutrosophy: Neutrosophic Probability, Set and Logic, Rehoboth, Amer. Research Press
- [2] Kandasamy W. B. V. and Smarandache F. (2004) Basic neutrosophic algebraic structures and their applications to fuzzy and neutrosophic models, Hexis, Frontigan p 219
- [3] Kandasamy W. B. V. and Smarandache F. (2006) Some neutrosophic algebraic structures and neutrosophic n-algebraic structures, Hexis, Frontigan p 219
- [4] Smarandache F. and Ali M. (2016) Neutrosophic triplet as extension of matter plasma, unmatter plasma and antimatter plasma, APS Gaseous Electronics Conference doi: 10.1103/BAPS.2016.GEC.HT6.110
- [5] Smarandache F. and Ali M. (2014) The Neutrosophic Triplet Group and its Application to Physics, presented by F. S. to Universidad Nacional de Quilmes, Department of Science and Technology, Bernal, Buenos Aires, Argentina (02 June 2014)
- [6] Smarandache F. and Ali M. (2016) Neutrosophic triplet group. Neural Computing and Applications, 1-7.
- [7] Smarandache F. and Ali M. (2017) Neutrosophic Triplet Field Used in Physical Applications, (Log Number: NWS17-2017-000061), 18th Annual Meeting of the APS Northwest Section, Pacific University, Forest Grove, OR, USA (June 1-3, 2017)
- [8] Smarandache F. and Ali M. (2017) Neutrosophic Triplet Ring and its Applications, (Log Number: NWS17-2017-000062), 18th Annual Meeting of the APS Northwest Section, Pacific University, Forest Grove, OR, USA (June 1-3, 2017).
- [9] Ecemiş, O., Şahin, M., and Kargin, A. (2018). Single valued neutrosophic number valued generalized neutrosophic triplet groups and its applications for decision making applications, Asian Journal of Mathematics and Computer Research 25(4): 205-218
- [10] Broumi S., Bakali A., Talea M. and Smarandache F. (2016) Single Valued Neutrosophic Graphs: Degree, Order and Size. IEEE International Conference on Fuzzy Systems, pp. 2444-2451.
- [11] Broumi S., Bakali A., Talea M. and Smarandache F. (2016) Decision-Making Method Based On the Interval Valued Neutrosophic Graph, Future Technologies, IEEE International Conference on Fuzzy Systems pp 44-50.
- [12] Uluçay, V.; Şahin, M.; Olgun, N. Time-Neutrosophic Soft Expert Sets and Its Decision Making Problem. Matematika, 2018 34(2), 246-260.
- [13] Uluçay, V.; Kiliç, A.; Yıldız, I.; Şahin, M. (2018). A new approach for multi-attribute decision-making problems in bipolar neutrosophic sets. Neutrosophic Sets and Systems, 2018, 23(1), 142-159.

- [14] Ulucay, V., Kılıç, A., Şahin, M., & Deniz, H. (2019). A New Hybrid Distance-Based Similarity Measure for Refined Neutrosophic sets and its Application in Medical Diagnosis. *MATEMATIKA: Malaysian Journal of Industrial and Applied Mathematics*, 35(1), 83-94.
- [15] Broumi, S., Bakali, A., Talea, M., Smarandache, F., Singh, P. K., Uluçay, V., & Khan, M. (2019). Bipolar complex neutrosophic sets and its application in decision making problem. In *Fuzzy Multi-criteria Decision-Making Using Neutrosophic Sets* (pp. 677-710). Springer, Cham.
- [16] Bakbak, D., Uluçay, V., & Şahin, M. (2019). Neutrosophic soft expert multiset and their application to multiple criteria decision making. *Mathematics*, 7(1), 50.
- [17] Uluçay, V., & Şahin, M. (2020). Decision-Making Method based on Neutrosophic Soft Expert Graphs. In *Neutrosophic Graph Theory and Algorithms* (pp. 33-76). IGI Global.
- [18] Uluçay, V., Kılıç, A., Yıldız, İ., & Şahin, M. (2019). An Outranking Approach for MCDM-Problems with Neutrosophic Multi-Sets. *Neutrosophic Sets & Systems*, 30.
- [19] Uluçay, V., Şahin, M., & Hassan, N. (2018). Generalized neutrosophic soft expert set for multiple-criteria decision-making. *Symmetry*, 10(10), 437.
- [20] Şahin M., Deli I. and Ulucay V. (2016) Similarity measure of bipolar neutrosophic sets and their application to multiple criteria decision making, *Neural Comput & Applic.* DOI 10. 1007/S00521
- [21] Wang H., Smarandache F., Zhang Y. Q., Sunderraman R. (2010) Single valued neutrosophic sets. *Multispace Multistructure* 4, 410–413.
- [22] Şahin M., Olgun N, Uluçay V., Kargın A. and Smarandache F. (2017) A new similarity measure on falsity value between single valued neutrosophic sets based on the centroid points of transformed single valued neutrosophic numbers with applications to pattern recognition, *Neutrosophic Sets and Systems*, 15, 31-48, doi: org/10.5281/zenodo570934
- [23] Şahin M., Ecemiş O., Uluçay V. and Kargın A. (2017) Some new generalized aggregation operators based on centroid single valued triangular neutrosophic numbers and their applications in multi-attribute decision making, *Asian Journal of Mathematics and Computer Research* 16(2): 63-84
- [24] Chatterjee R., Majumdar P., and Samanta S. K. (2019) Similarity Measures in Neutrosophic Sets-I. *Fuzzy Multi-criteria Decision-Making Using Neutrosophic Sets*. Springer, Cham. 249-294.
- [25] Mohana K., and Mohanasundari M. (2019) On Some Similarity Measures of Single Valued Neutrosophic Rough Sets. *Neutrosophic Sets and Systems*, 10
- [26] Smarandache F., et al. (2019) Word-level neutrosophic sentiment similarity. *Applied Soft Computing* 80, 167-176.
- [27] Ye J. (2014) Similarity measures between interval neutrosophic sets and their applications in multicriteria decision – making. *J. Intell. Fuzzy Syst.* 26 (1) 165 – 172
- [28] Zadeh A. L. (1965) Fuzzy sets, *Information and control* ,8.3 338-353,
- [29] Atanassov T. K. (1986) Intuitionistic fuzzy sets, *Fuzzy Sets Syst*, 20:87–96
- [30] Şahin M. and Kargın A. (2019) Neutrosophic triplet metric topology, *Neutrosophic Set and Systems*, 27, 154 -162
- [31] Ali M., Smarandache F., Khan M. (2018) Study on the development of neutrosophic triplet ring and neutrosophic triplet field, *Mathematics-MDPI*, 6(4), 46
- [32] Şahin M. and Kargın A. (2017) Neutrosophic triplet normed space, *Open Physics*, 15, 697-704
- [33] Şahin M. and Kargın A. (2017) Neutrosophic triplet inner product space, *Neutrosophic Operational Research*, 2, 193-215,

- [34] Smarandache F., Şahin M., Kargın A. (2018) Neutrosophic Triplet G- Module, Mathematics – MDPI, 6, 53
- [35] Şahin M. and Kargın A. (2019) Neutrosophic triplet b – metric space, Neutrosophic Triplet Research, 1
- [36] Şahin M., Kargın A., Çoban M. A. (2018) Fixed point theorem for neutrosophic triplet partial metric space, Symmetry – MDPI, 10, 240
- [37] Şahin M., Kargın A. (2018) Neutrosophic triplet v – generalized metric space, Axioms – MDPI, 7, 67
- [38] Şahin M. and Kargın A., Smarandache F. (2019) Neutrosophic triplet topology, Neutrosophic Triplet Research 1,
- [39] Şahin M., Kargın A. (2018) Neutrosophic triplet normed ring space, Neutrosophic Set and Systems, 21, 20 – 27
- [40] Şahin M., Kargın A. (2019), Neutrosophic triplet partial inner product space, Neutrosophic Triplet Research 1, 10 - 21
- [41] Şahin M., Kargın A. (2019), Neutrosophic triplet groups Based on set valued neutrosophic quadruple numbers, Neutrosophic Set and Systems, 30, 122 -131
- [42] Şahin M., Kargın A. (2019) Neutrosophic triplet partial v – generalized metric space, Neutrosophic Triplet Research 1, 22 - 34
- [43] Şahin M., Kargın A. (2019) Neutrosophic triplet Lie Algebra, Neutrosophic Triplet Research 1, 68 -78
- [44] Şahin M., Kargın A. (2019) Isomorphism theorems for Neutrosophic triplet G - module, Neutrosophic Triplet Research 1, 54- 67
- [45] Smarandache F. (2015) Neutrosophic quadruple numbers, refined neutrosophic quadruple numbers, absorbance law, and the multiplication of neutrosophic quadruple numbers, Neutrosophic Set and Systems, 10, 96 -98
- [46] Akinleye, S. A., Smarandache, F. (2016) Agboola, A. A. A. On neutrosophic quadruple algebraic structures. Neutrosophic Sets and Systems, 12, 122-126.
- [47] Jun, Y., Song, S. Z., Smarandache, F., & Bordbar, H. Neutrosophic quadruple BCK/BCI-algebras. Axioms, (2018) 7(2), 41.
- [48] Muhiuddin, G., Al-Kenani, A. N., Roh, E. H., & Jun, Y. B. (2019) Implicative neutrosophic quadruple BCK-algebras and ideals. Symmetry, 11(2), 277.
- [49] Li, Q., Ma, Y., Zhang, X., & Zhang, J. (2019) Neutrosophic Extended Triplet Group Based on Neutrosophic Quadruple Numbers. Symmetry, 11(5), 696.
- [50] Şahin, M., Kargın A. (2019), Neutrosophic triplet groups based on set valued neutrosophic quadruple numbers, Neutrosophic Set and Systems, 30, 122 - 131
- [51] Şahin, M., Kargın A. (2019), Single valued neutrosophic quadruple graphs, Asian Journal of Mathematics and Computer Research, 26(4): 243–250

Chapter Three

Neutrosophic Quadruple Goal Programming by using Excel Solver

N. Gayathri^[1], Dr. M. Helen^[2],

^[1]Research Scholar, Department of Mathematics, Nirmala College for women, Coimbatore, India.

^[2]Associate Professor, Department of Mathematics, Nirmala College for women, Coimbatore,
India.

E-mail: ^[1]gayupadmagayu@gmail.com, ^[2]helvic63@yahoo.co.in

ABSTRACT

Real world problems are mainly based on multiple objectives rather than single objective. Today, in management sectors, most of the producers are more concerned about their own sense than the economic issues. It is necessary for all the managers to do their best to make as much effort as possible to increase the products. It is obvious that one of the ways is to apply mathematical programming model for the management systems. Application of a multi-objective programming model like goal programming model is an important tool for studying various aspects of management systems. To deal with undecidedness in real life, neutrosophic quadruple numbers are used as the coefficients of the problem in this paper. Moreover, we present a digital approach to solve linear goal programming by using Microsoft Excel Solver.

Keywords: Neutrosophic sets, Neutrosophic Quadruple numbers, Goal programming, weights method, excel solver.

INTRODUCTION

Goal programming is one of the most widely used methodologies in operations research and management science, and encompasses most classes of multiple objective programming models. In traditional linear programming models we optimize the single quantifiable objective such as profit, output, cost etc. However, setting clear-cut targets instead of simple maximization or minimization of objectives is always advantages in the pursuit of business problems. Unclear data is well go with fuzzy sets which were introduced by Zadeh [29] in 1965. Fuzzy goal programming was achieved by L. Azzabi [2] (2014). The same method was introduce to stochastic LPP M. Mahmoud, et., al [12] in 2019. Goal programming problem [13 & 17], was solved with Intuitionistic fuzzy sets [1], which are the extension of fuzzy sets. Not many researchers have studied goal programming. Neutrosophic sets are the special sets which were introduced by [20] (2015). It has a wide application in real life business and decision-making problems. In all branches of mathematics, neutrosophic set played a major role. Single valued neutrosophic set[7] and neutrosophic multi-sets [22] are broadly used. Using neutrosophic multisets MCDM problems were solved by Ulucay [25]. Decision making by neutrosophic soft expert sets were procured by [3 & 8 & 26 & 27]. Decision making based on neutrosophic soft expert sets in graph theory was done by [23]. Whereas multi-attribute decision making in bipolar neutrosophic sets were proposed by [4 & 28] and in centroid single valued triangular

neutrosophic numbers was proposed by [15 & 16]. Distance-Based Similarity Measure [24], were also studied in neutrosophic environment.

In modern business world each and every business unit, however small may be, definitely will have multiple goals. Achievements of multiple goal objectives often create difficulties especially when goals are conflicting. In a situation with diversified objectives the complexity of the problem gets multiplied. Goal programming techniques are often useful in solving such problems with multiple and diversified goals. In such models the solution heavily depends upon the listed out priorities to the diversified objectives. Given the clearly established priority goals, the goal programming technique [5& 6 & 9 & 10 & 11 & 14 & 18 & 19] tries to minimize the deviation of each one of them from their respective target levels according to their listed out priorities. In such models, the goals are satisfied in a given sequential order, higher goals taking priorities, lower goals are pushed to lower levels. In the final solution, some goals may be over-satisfied and some others may be under-satisfied. Thus compromising rather than optimizing is the correct approach in goal programming. In the model formation, therefore, we incorporate all goals and try to solve them having the priority in mind.

Thus in goal programming, all the objects are assigned to specific target levels for achievement. Goal programming treats these targets as goals to aspire for and not as absolute constraints. It then attempts to find an optimal solution that comes as “close as possible” to the targets in the order of specified priorities.

The concept of Goal programming was introduced by Charles and Cooper[3] in 1961 by incorporating a method for solving infeasible linear programming problem involving various conflicting constraints. In 1965 [jiri[8] developed the model based on appropriate priorities for various goals and in the form of weightage for the same priority goals. Thus it is very much clear that the objective function formulation is not for optimum, as in the case of linear programming, but as far as possible very near to it. The latter work of Ignizio[7] (1972) shows several applications of goal programming business world. The goal programming is solved either by graphical method or by a suitably modified Simplex method.

Microsoft Excel is a well-built excel application that solves many optimization problems. From simple to complicated problems, this solver can be processed in a tabular grid manner. The solver helps to solve problems in linear algebra and it can handle much larger data also.

BACKGROUND

Definition 1. [20] Let X be a space of points (objects), with a generic element in X denoted by x . A neutrosophic set A in X is characterized by a truth-membership function T_A , an indeterminacy membership function I_A and a falsity-membership function F_A . $T_A(x)$, $I_A(x)$ and $F_A(x)$ are real standard or non-standard subsets of $]0-,1+[$. That is

$$T_A: X \rightarrow]0-,1+[, I_A: X \rightarrow]0-,1+[, F_A: X \rightarrow]0-,1+[$$

There is no restriction on the sum of $T_A(x)$, $I_A(x)$ and $F_A(x)$, so $0- \leq \sup T_A(x) + \sup I_A(x) + \sup F_A(x) \leq 3^+$.

Definition 2. [7] Let X be a space of points (objects), with a generic element in X denoted by x . A single valued neutrosophic set (SVNS) A in X is characterized by truth-membership function T_A , indeterminacy-membership function I_A and falsity-membership function F_A . For each point x in X , $T_A(x)$, $I_A(x)$, $F_A(x) \in [0,1]$.

When X is continuous, a SVNS A can be written as $A = \int \langle T(x), I(x), F(x) \rangle / x, x \in X$.

When X is discrete, a SVNS A can be written as $A = \sum \langle T(x_i), I(x_i), F(x_i) \rangle / x_i, x_i \in X$.

Definition 3. [21] Let's consider an entity (i.e. a number, an idea, an object, etc.) which is represented by a known part (a) and an unknown part ($bT + cI + dF$).

Numbers of the form, $NQ = a + bT + cI + dF$,

where a, b, c, d are real (or complex) numbers (or intervals or in general subsets), and

T = truth / membership / probability,

I = indeterminacy,

F = false / membership / improbability,

are called Neutrosophic Quadruple (Real respectively Complex) Numbers (or Intervals, or in general Subsets). “ a ” is called the known part of NQ , while “ $bT + cI + dF$ ” is called the unknown part of NQ .

Definition 4. [21] Let $NQ1 = a1 + b1T + c1I + d1F$, $NQ2 = a2 + b2T + c2I + d2F$, and $\alpha \in \mathbb{R}$ (or $\alpha \in \mathbb{C}$) a real (or complex) scalar. Then,

- i) $NQ1 + NQ2 = (a1 + a2) + (b1 + b2)T + (c1 + c2)I + (d1 + d2)F$. (Addition)
- ii) $NQ1 - NQ2 = (a1 - a2) + (b1 - b2)T + (c1 - c2)I + (d1 - d2)F$. (Subtraction)
- iii) $\alpha \cdot NQ = NQ \cdot \alpha = \alpha a + \alpha bT + \alpha cI + \alpha dF$. (scalar Multiplication)
- iv) $0 \cdot T = 0 \cdot I = 0 \cdot F = 0$.
- v) $mT + nT = (m + n)T$.
- vi) $mI + nI = (m + n)I$.
- vii) $mF + nF = (m + n)F$.

In the next section, we will define the score function and accuracy function of neutrosophic quadruple numbers and some basic operations.

Comparison of neutrosophic quadruple numbers by using score and accuracy function

Definition 5: Let $NQ = a + bT + cI + dF$, be a neutrosophic quadruple number, then

- (i) Score function: $\tilde{S}(NQ) = \frac{1}{4} \left(a + \left(\frac{aT+2bI+cF}{3} \right) \right)$
- (ii) Accuracy function: $\tilde{A}(NQ) = \frac{1}{4} \{x - aT(1 + bI) - cF(1 + bI)\}$.

Definition 6: Let $NQ1 = a1 + b1T + c1I + d1F$ and $NQ2 = a2 + b2T + c2I + d2F$ be two neutrosophic quadruple numbers. Then we have either of the following:

- a) If $\tilde{S}(NQ1) < \tilde{S}(NQ2)$, then $NQ1 < NQ2$.
- b) If $\tilde{S}(NQ1) > \tilde{S}(NQ2)$, then $NQ1 > NQ2$.
- c) If $\tilde{S}(NQ1) = \tilde{S}(NQ2)$, then
 - 1) If $\tilde{A}(NQ1) < \tilde{A}(NQ2)$, then $NQ1 < NQ2$.
 - 2) If $\tilde{A}(NQ1) > \tilde{A}(NQ2)$, then $NQ > NQ2$.
 - 3) If $\tilde{A}(NQ1) = \tilde{A}(NQ2)$, then $NQ1 = NQ2$.

Note: i) We will use the notation $NQ = \langle x, aT, bI, cF \rangle$ instead of $NQ = a + bT + cI + dF$.

ii) The values x, a, b, c are real numbers as the problem deals with day-to-day life.

GOAL PROGRAMMING:

The formulation of goal programming is same as the formulation of linear programming problem. It contains three major steps: Multiple objective, Goal constraints and system constraints.

STEPS IN FORMULATION:

Step 1: Determine decision variables.

Step 2: Select the priority level of each goal.

Step 3: Use deviation variables for most important priority sequence.

Step 4: Decide the system constraints.

Step 5: Construct the objective function.

Step 6: Solve all constraints and find the objective value which minimizes the objective function.

The general form of goal programming is

$$\text{Minimize} = \sum_{i=1}^m w_i (d_i^- + d_i^+)$$

Subject to the constraints,

$$\sum_{j=1}^n a_{ij} X_j + d_i^- - d_i^+ = b_i; i = 1, 2, \dots, m,$$

and $X_j, d_i^-, d_i^+ \geq 0$ for all i, j .

The deviational variables d_i^-, d_i^+ denote the goal or sub goal.

WEIGHTS METHOD:

In the weights method, a single objective function is formed as the weighted sum of the function representing the goals of the problem. Suppose that the goal programming model has n goals and that the i th goal is given as

$$\text{Minimize } G_i, i = 1, 2, \dots, n$$

The combined objective function used in the weights method is then defined as

$$\text{Minimize } z = w_1 G_1 + w_2 G_2 + \dots + w_n G_n$$

The parameters $w_i, i = 1, 2, \dots, n$, are positive weights that reflect the decision maker's preferences regarding the relative importance of each goal. The determination of the specific values of these weights is subjective. Indeed, the apparently sophisticated analytic procedures developed in the literature are still rooted in subjective assessments.

EXCEL SOLVER:

In Excel, Solver is part of a suite of commands sometimes called what-if analysis tools. With Solver, you can find an optimal (maximum or minimum) value for a formula in one cell — called the **objective** cell — subject to **constraints**, or limits, on the values of other formula cells on a worksheet. Solver works with a group of cells — called **decision variable** cells — that participate in computing the formulas in the objective and constraint cells. Solver adjusts the values in the decision variable cells to satisfy the limits on constraint cells and produce the result you want for the objective cell.

Solver works with a group of cells, called decision variables or simply variable cells that are used in computing the formulas in the objective and constraint cells. Solver adjusts the values in the decision variable cells to satisfy the limits on constraint cells and produce the result you want for the objective cell. The objective, constraint and decision variable cells and the formulas inter-relating them form a **Solver model**; the final values found by Solver are a **solution** for this model. Solver uses a variety of methods, from linear programming and nonlinear optimization to genetic and evolutionary algorithms, to find solutions.

PROBLEM:

A Project manager is trying to determine the quantities of three types of products to produce. Producing one unit of products 1 & 2, he needs raw materials A & B, which will bring the company 5 crores of profit for product 1 and 8 crores of profit for the product 2 and 4 crores of profit for product 3. The manager wants to meet three goals

- i. There are 100 tons of raw materials A and 10 tons of raw materials B in the Warehouse. The Manager wants to consume them all, no more or no less.
- ii. The total profit is expected to be at least 30 crores.

The manager realizes that it probably will not be possible to attain these goals simultaneously. Therefore he sets some penalty weights for unmet goals. If the project needs more than 100 tons of raw materials A, each extra ton is associated with a penalty of 5. The penalty weight is unit less. If the total raw material B needed is different from 10 tons, each ton that is below this goal is associated with a penalty of 8, and each ton that is above this goal is associated with a penalty of 12. If the profit is less than 30 crores, each crore under the goal is associated with a penalty of 15. So, the manager wants to minimize the total penalty.

Solution – Problem formulation:

In this problem, we use neutrosophic quadruple numbers for the raw materials A and B, as they are formed with the composition of many chemicals. The composition ratios are taken for neutrosophic quadruple components.

Factors	Unit contribution			Goals	Unit Penalty
	Product 1	Product 2	Product 3		
Raw Material A	< 150,8,12,8 >	< 107,1,16,3.2 >	< 74,3,1,2.8 >	= 100 tons	5
Raw Material B	< 2,3,4,5 >	< 12,1,3,0.4 >	< 9,1,0.2,1 >	= 10 tons	8(-), 12(+)
Profit	5	8	4	≥ 30crores	15

The neutrosophic quadruple numbers are converted into crisp numbers by using the score function.

Factors	Unit contribution			Goals	Unit Penalty
	Product 1	Product 2	Product 3		
Raw Material A	40	30	20	= 100 tons	5
Raw Material B	2	4	3	= 10 tons	8(-) , 12(+)
Profit	5	8	4	≥ 30crores	15

Variables:

X_i is the amount of product i , $i=1,2,3$

$$40x_1 + 30x_2 + 20x_3 \leq 100 \text{ \{Material\}}$$

$$2x_1 + 4x_2 + 3x_3 = 10 \text{ \{Material\}}$$

$$5x_1 + 8x_2 + 4x_3 \geq 30 \text{ \{Profit\}}$$

Introduce three variables y_1 , y_2 , and y_3 to represent the deviations from the goals

$$y_1 = 40x_1 + 30x_2 + 20x_3 - 100 \text{ (Material)}$$

$$y_2 = 2x_1 + 4x_2 + 3x_3 - 10 \text{ (Material)}$$

$$y_3 = 5x_1 + 8x_2 + 4x_3 - 30 \text{ (Profit)}$$

y_i^+ represents the amount over the goal

y_i^- represents the amount under the goal

$$y_i = y_i^+ - y_i^- \quad (y_i^+, y_i^- \geq 0)$$

$$40x_1 + 30x_2 + 20x_3 - (y_1^+ - y_1^-) = 100 \text{ (Material)}$$

$$2x_1 + 4x_2 + 3x_3 - (y_2^+ - y_2^-) = 10 \text{ (Material)}$$

$$5x_1 + 8x_2 + 4x_3 - (y_3^+ - y_3^-) = 30 \text{ (Profit)}$$

$$\text{Min } z = p_1^+ y_1^+ + p_1^- y_1^- + p_2^+ y_2^+ + p_2^- y_2^- + p_3^+ y_3^+ + p_3^- y_3^-$$

$$40x_1 + 30x_2 + 20x_3 - (y_1^+ - y_1^-) = 100 \text{ (Material)}$$

$$2x_1 + 4x_2 + 3x_3 - (y_2^+ - y_2^-) = 10 \text{ (Material)}$$

$$5x_1 + 8x_2 + 4x_3 - (y_3^+ - y_3^-) = 30 \text{ (Profit)}$$

$$x_j \geq 0 \quad (j = 1,2,3); \quad y_i^+, y_i^- \geq 0 \quad (i = 1,2,3)$$

$$\text{Min } z = 0^* y_1^+ + p_1^- y_1^- + p_2^+ y_2^+ + p_2^- y_2^- + p_3^+ y_3^+ + 0^* y_3^-$$

$$40x_1 + 30x_2 + 20x_3 - (y_1^+ - y_1^-) = 100 \text{ (Material)}$$

$$2x_1 + 4x_2 + 3x_3 - (y_2^+ - y_2^-) = 10 \text{ (Material)}$$

$$5x_1 + 8x_2 + 4x_3 - (y_3^+ - y_3^-) = 30 \text{ (Profit)}$$

$$x_j \geq 0 \quad (j = 1,2,3); \quad y_i^+, y_i^- \geq 0 \quad (i = 1,2,3)$$

SOLVING USING EXCEL SOLVER:

Step 1:

Select the data menu from the menu bar in Microsoft Excel. Click the **Solver** command to display the **Solver Parameters** dialog.

Step 2:

In the Set Objective box, enter a cell reference or name for the objective cell. The objective cell must contain a formula.

Do one of the following:

- If you want the value of the objective cell to be as large as possible, click Max.
- If you want the value of the objective cell to be as small as possible, click Min.
- If you want the objective cell to be a certain value, click Value Of, and then type the value in the box.

You may leave the Set Objective box empty. In this case Solver finds values for the decision variables that satisfy the constraints. Using the Value Of option has the same effect as defining a constraint (see below) where the objective cell must be equal to the specified value.

Step 3: In the **Subject to the Constraints** box, enter any constraints that you want to apply. Enter the first constraint and click Add.

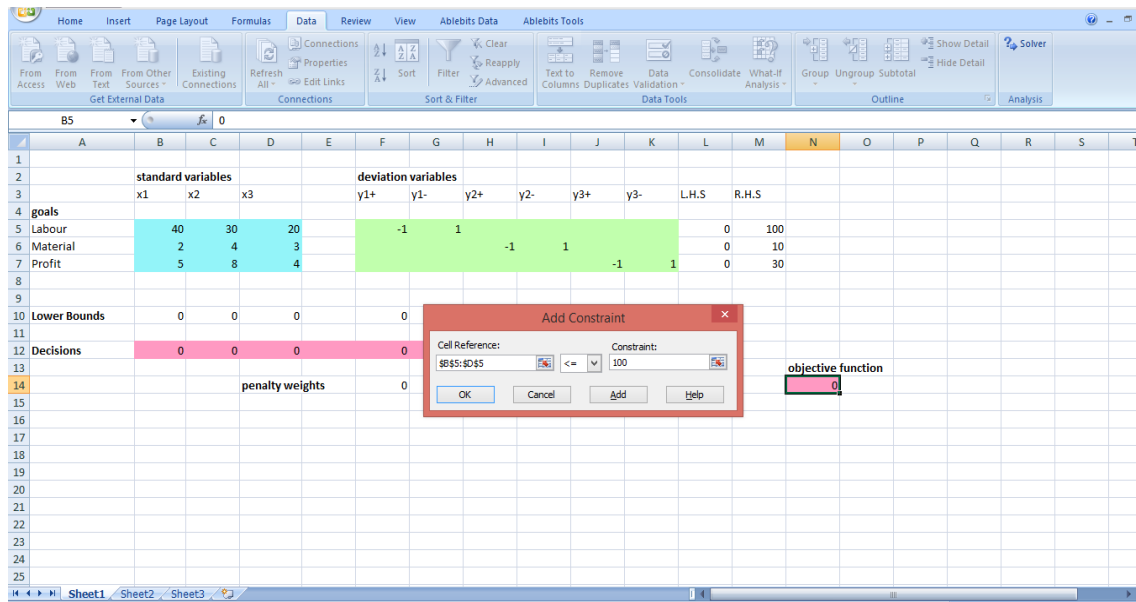

Enter the second constraint and click Add.

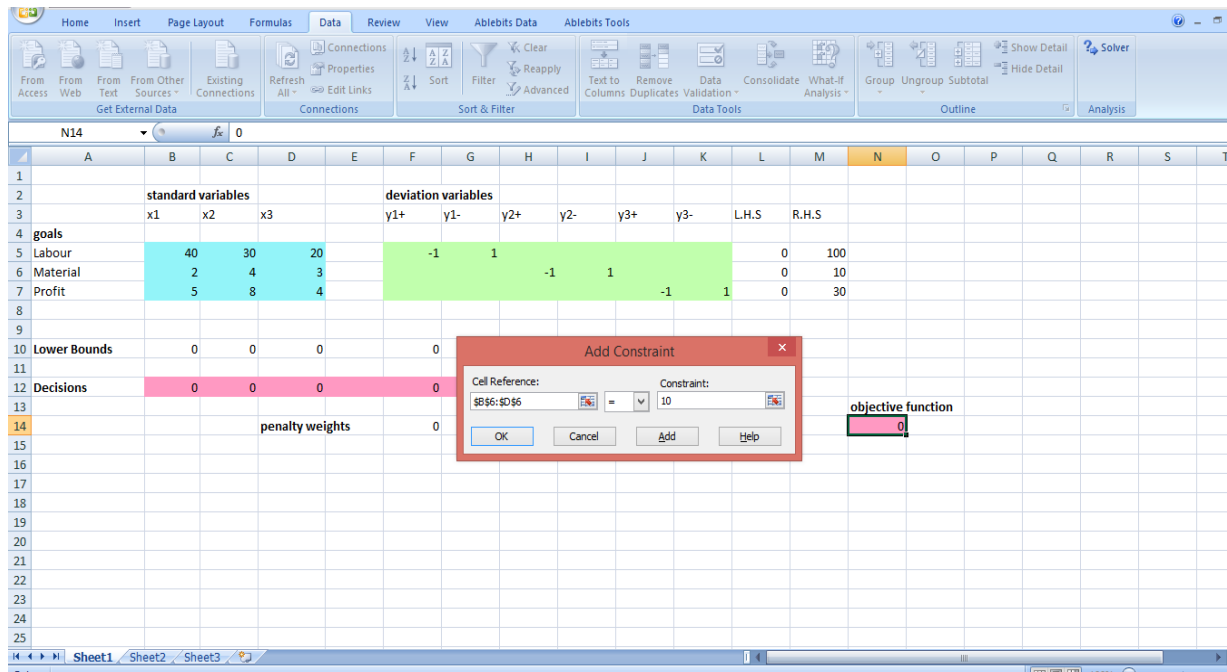

Enter the third constraint and click Add.

Any changes can be made to the constraints by selecting Change or Delete.

Step 4:

Click **Solve** and in the **Solver Results** dialog box, **read the message** at the top and the more detailed explanation at the bottom of this dialog.

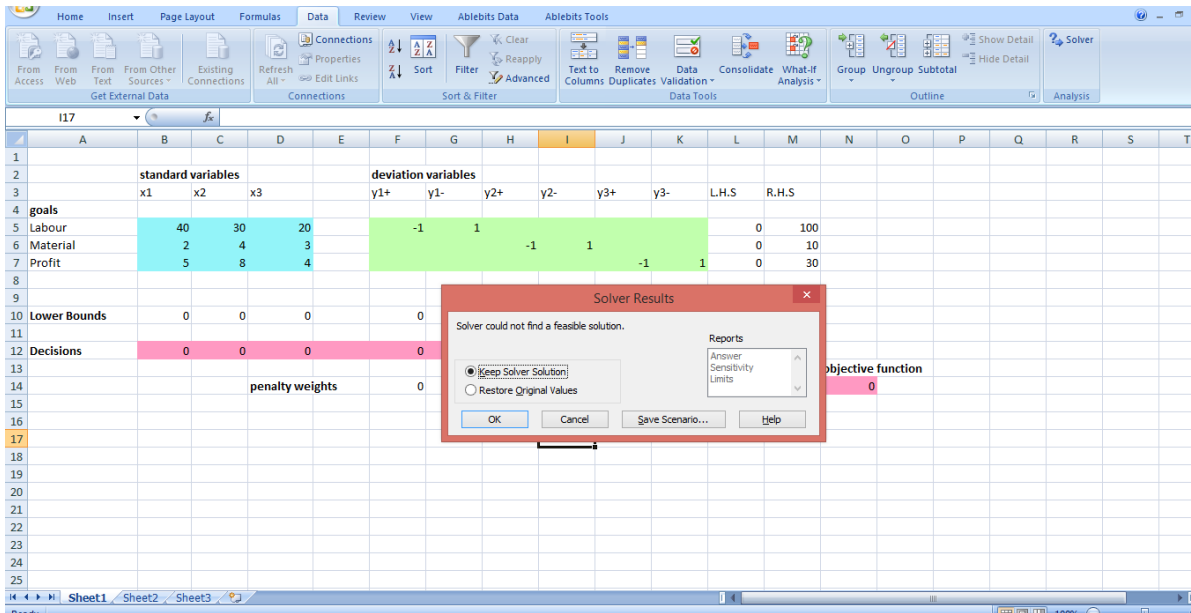

After reading these messages, do one of the following:

- To keep the final values in the decision variable cells, click Keep Solver Solution.
- To restore the values of the decision variable cells at the time you clicked Solve, click Restore Original Values. Select the Return to Solver Parameters Dialog check box if you want to modify the Solver model or re-solve as your next step. Click OK or Cancel.

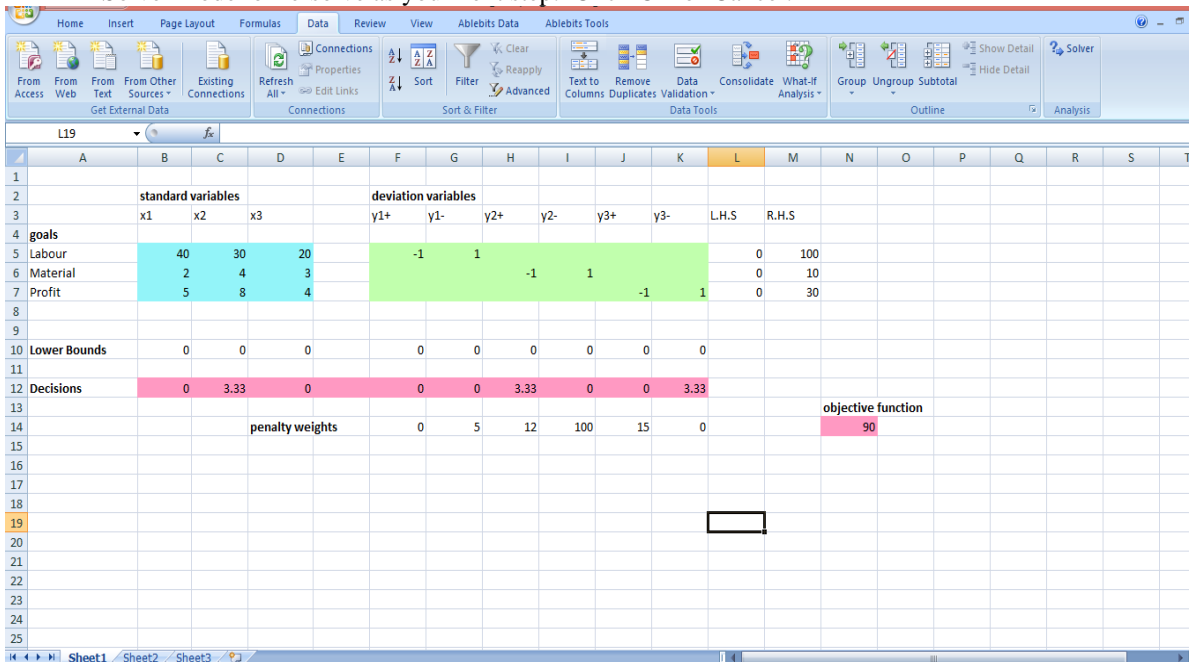

Optimal solution:

$$x_1 = 0, x_2 = 3.33, x_3 = 0$$

$$y_1 = y_1^+ - y_1^- = 0 - 0 = 0$$

$$y_2 = y_2^+ - y_2^- = 3.33 - 0 = 3.33$$

$$y_3 = y_3^+ - y_3^- = 0 - 3.33 = -3.33$$

$$z = 90$$

CONCLUSION:

This paper presented an easy method to solve the goal programming by using Excel solver. Optimization problems in many fields can be modelled and solved using Excel Solver. It does not require knowledge of complex mathematical concepts behind the solution algorithms. This way is particularly helpful for students who are non-math majors and still want to take these courses.

Future Research Directions

As a future work this article can be extended to preemptive goal programming which deals with many priority levels.

REFERENCE:

1. Atanassov. K. T. (1986). Intuitionistic fuzzy sets. *Fuzzy Sets and Systems*. vol.20, no.1 .87–96.
2. Azzabi Lotfi, Ayadi Dorra, Bachar Kaddour, Kobi Abdessamad. (2014). Fuzzy goal programming to optimization the multi-objective problem. *Science Journal of Applied Mathematics and Statistics*. 2014; 2(1): 14-19
3. Bakbak, D., Uluçay, V., & Şahin, M. (2019). Neutrosophic soft expert multiset and their application to multiple criteria decision making. *Mathematics*, 7(1), 50.
4. Broumi, S., Bakali, A., Talea, M., Smarandache, F., Singh, P. K., Uluçay, V., & Khan, M. (2019). Bipolar complex neutrosophic sets and its application in decision making problem. In *Fuzzy Multi-criteria Decision-Making Using Neutrosophic Sets* (pp. 677-710). Springer, Cham.
5. Charnes, A. and Cooper, W. W., *Management Models and Industrial Applications of Linear Programming*, Vols. 1 & 2, John Wiley and Sons, New York, NY, 1961.
6. Frederick S. Hilliee, Gerald J. Lieberman. (2017). *Introduction to Operations Research*. Calcutta. Mc Graw Hill Education.
7. Haibin Wang, Smarandache. F, Zhang. Y.Q., and Sunder raman. R. (2010). Single valued neutrosophic sets. *Multi space and Multi structure*, vol. 4, 410–413.
8. Hassan, N.; Uluçay, V.; Şahin, M. (2018). Q-neutrosophic soft expert set and its application in decision making. *International Journal of Fuzzy System Applications (IJFSA)*. 7(4), 37-61.
9. Ignizio, J. P. (1994). “Who Killed Goal Programming and Why?,” paper presentation, 1st International Conference, Multi-Objective Programming and Goal Programming: Theories and Applications, University of Portsmouth, England.
10. Ijiri, Y. (1965). *Management Goals and Accounting for Control*, Rand Mc Nally, Chicago, IL.
11. Kalavathy, S. (2012). *Operations Research*, 4th edition. Vikas.
12. Mahmoud Masoud, H. A. Khalifa, Shi Qiang Liu, Mohammed Elhenawy and Peng Wu. (2019). A fuzzy goal programming approach for solving fuzzy multi-objective stochastic linear programming problem The 8th International Conference on Industrial Engineering and Systems. DOI:10.1109/IESM45758.2019.8948204
13. Payel Ghosh, Tapan Kumar Roy. (2014). Intuitionistic fuzzy goal geometric programming problem. *Notes on Intuitionistic Fuzzy Sets*. Vol. 20. No. 1, 63–78.
14. Ravi Ravindran. A. (2016). *Operations Research and Management Science*. USA. CRC Press.
15. Şahin. M, Ecemiş. O, Uluçay. V, and Kargın. A. (2017). Some new generalized aggregation operators based on centroid single valued triangular neutrosophic numbers and their applications in multi-tribute decision making, *Asian Journal of Mathematics and Computer Research* 16(2): 63-84
16. Şahin. M, Olgun. N, Uluçay. V, Kargın. A and Smarandache, F. (2017). A new similarity measure on falsity value between single valued neutrosophic sets based on the centroid points of transformed single valued neutrosophic numbers with applications to pattern recognition, *Neutrosophic Sets and*

- Systems, 15, 31-48.
17. Samir Dey, Tapan Kumar Roy. Intuitionistic Fuzzy Goal Programming Technique for Solving Non-Linear Multi-objective Structural Problem. *Journal of Fuzzy Set Valued Analysis*. No.3. 179-193
 18. Sharma, J K. (2006). *Operations Research Theory and Applications*, 5th Edition. New Delhi: Macmillian India Ltd.
 19. Singh. T.P. (2016). *Operations Research Theory and Applications*.
 20. Smarandache, F. (2015). (T, I, F)-Neutrosophic Structures. *Neutrosophic Sets Syst.* 8, 3–10. [Cross Ref]
 21. Smarandache, F. (2015). Neutrosophic Quadruple Numbers, Refined Neutrosophic Quadruple Number, Absorbance Law, and the Multiplication of Neutrosophic Quadruple Numbers. *Neutrosophic Sets Syst.* 10, 96–98.
 22. Smarandache. F. (2017). Neutrosophic perspectives: Triplets, Duplets, Multisets, Hybrid operators, Modal logic, Hedge Algebras. And applications. Pons Editions, Bruxellers, 323p. Chapter X: 115 – 123.
 23. Uluçay, V., & Şahin, M. (2020). Decision-Making Method based on Neutrosophic Soft Expert Graphs. In *Neutrosophic Graph Theory and Algorithms* (pp. 33-76). IGI Global.
 24. Ulucay, V., Kılıç, A., Şahin, M., & Deniz, H. (2019). A New Hybrid Distance-Based Similarity Measure for Refined Neutrosophic sets and its Application in Medical Diagnosis. *MATEMATIKA: Malaysian Journal of Industrial and Applied Mathematics*, 35(1), 83-94.
 25. Uluçay, V., Kılıç, A., Yıldız, İ., & Şahin, M. (2019). An Outranking Approach for MCDM-Problems with Neutrosophic Multi-Sets. *Neutrosophic Sets & Systems*, 30.
 26. Uluçay, V., Şahin, M., & Hassan, N. (2018). Generalized neutrosophic soft expert set for multiple-criteria decision-making. *Symmetry*, 10(10), 437.
 27. Ulucay, V.; Şahin, M.; Olgun, N. (2018). Time-Neutrosophic Soft Expert Sets and Its Decision Making Problem. *Matematika*. 34(2), 246-260.
 28. Uluçay, V.; Kılıç, A.; Yıldız, İ.; Şahin, M. (2018). A new approach for multi-attribute decision-making problems in bipolar neutrosophic sets. *Neutrosophic Sets and Systems*. 23(1), 142-159.
 29. Zadeh. L. A. (1965). Fuzzy sets. *Information and Control*, vol.8, no.3. 338–353.

Chapter Four

Neutrosophic Triplet Field and Neutrosophic Triplet Vector Space Based on Set Valued Neutrosophic Quadruple Number

Memet Şahin¹, Abdullah Kargin² and İsmet Yıldız³

^{1,2}Department of Mathematics, Gaziantep University, Gaziantep27310-Turkey

³Department of Mathematics, Düzce University, Düzce-Turkey

E-mail: mesahin@gantep.edu.tr, abduallahkargin27@gmail.com, ismetyildiz@duzce.edu.tr.

ABSTRACT

In this chapter, we obtain neutrosophic triplet field and neutrosophic triplet vector space based set valued neutrosophic quadruple number thanks to operations for set valued neutrosophic quadruple numbers. In this way, we define new structures using the together set valued neutrosophic quadruple number and neutrosophic triplet field and neutrosophic triplet vector space. Thus, we obtain new results for neutrosophic triplet field and neutrosophic triplet vector spaces with set valued neutrosophic quadruple number.

Keywords: Neutrosophic triplet set, neutrosophic triplet field, neutrosophic triplet vector space, neutrosophic quadruple set, neutrosophic quadruple number, set valued neutrosophic quadruple set, set valued neutrosophic quadruple number.

INTRODUCTION

Zadeh obtain fuzzy logic and fuzzy set [28], Atanassov introduced intuitionistic fuzzy logic and intuitionistic fuzzy set [29]. The concept of intuitionistic fuzzy logic and intuitionistic fuzzy set includes membership degree, degree of undeterminacy and degree of non-membership. But these degrees are defined dependently of each other. Also, Smarandache obtain neutrosophic logic and neutrosophic set [1] in 1998. In concept of neutrosophic logic and neutrosophic sets, these degrees are defined independently of each other. Hence, neutrosophic set is a generalized state of fuzzy and intuitionistic fuzzy set. Also, a lot of researchers obtain new structures and new applications in neutrosophic theory [2 -27].

Then, Smarandache and Ali obtained NTS and NTG [6]. For every element “x” in NTS A, there exist a neutral of “x” and an opposite of “x”. Also, neutral of “x” must different from the classical neutral element. Therefore, the NTS is different from the classical set. Furthermore, a NT “x” is showed by $\langle x, neut(x), anti(x) \rangle$. Also, many researchers have introduced NT structures [30 - 44].

Furthermore, Smarandache introduced NQS and NQN [45]. The NQs are generalized state of NS. A NQS is shown by $\{(x, yT, zI, tF) : x, y, z, t \in \mathbb{R} \text{ or } \mathbb{C}\}$. Where, x is called the known part and (yT, zI, tF) is called the

unknown part and T, I, F have their usual neutrosophic logic means. Recently, researchers studied NQS and NQN. Recently, Akinleye, Smarandache, Agboola studied NQ algebraic structures [46]; Jun, Song, Smarandache obtained NQ BCK/BCI-algebras [47]; Muhiuddin, Al-Kenani, Roh, Jun introduced implicative NQ BCK-algebras and ideals [48]; Li, Ma, Zhang, Zhang studied NT extended group based on NQNs [49]; Şahin and Kargin obtained SVNQN and NTG based on SVNQN [50].

In this chapter, we give NTF based on SVNQN and NTVS based on SVNQN. In Section 2, we give definitions and properties for NQS, NQN [45]; NTS [30]; NTF [31]; NTVS [32] and SVNQS, SVNQN some operations SVNQN [50]. In Section 3, we obtain new operations for SVNQN. Also, we define NTF based on SVNQN thanks to new operations for SVNQN. In section 4, we define NTVS based on SVNQN thanks to new operations for SVNQN and NTF based on SVNQN. In this way, we define new structures using the together with SVNQN, NTF and NTVS.

BACKGROUND

Definition 1: [6]: Let # be a binary operation. A NTS $(X, #)$ is a set such that for $x \in X$,

- i) There exists neutral of “x” such that $x\#neut(x) = neut(x)\#x = x$,
- ii) There exists anti of “x” such that $x\#anti(x) = anti(x)\#x = neut(x)$.

Also, a NT “x” is showed with $(x, neut(x), anti(x))$.

Definition 2: [6] Let $(X, #)$ be a NT set. Then, X is called a NTG such that

- a) for all $a, b \in X$, $a\#b \in X$.
- b) for all $a, b, c \in X$, $(a\#b)\#c = a\#(b\#c)$

Definition 3: [31] Let $(F, *, #)$ be a NTS together with two binary operations * and #. Then $(F, *, #)$ is called NTF if the following conditions are satisfied.

1. $(F, *)$ is a commutative NT group with respect to *.
2. $(F, #)$ is a NT group with respect to #.
3. $k\#(l*m) = (k\#l)*(k\#m)$; $(l*m)\#k = (l\#k)*(m\#k)$ for all $k, l, m \in F$.

Definition 4: [32] Let $(F, *_1, \#_1)$ be a NTF and let $(V, *_2, \#_2)$ be a NTS together with binary operations “*_2” and “#_2”. Then $(V, *_2, \#_2)$ is called a NTVS if the following conditions are satisfied.

- i) $m*_2n \in V$ and $m\#_2s \in V$; $m, n \in V$ and $s \in F$;
- ii) $(m*_2n) *_2l = m*_2(n*_2l)$; $m, n, l \in V$;
- iii) $m*_2n = n*_2m$; $m, n \in V$;
- iv) $(m*_2n) \#_2s = (m\#_2s) *_2(n\#_2s)$; $s \in F$ and $m, n \in V$;
- v) $(s*_1p) \#_2m = (s\#_2m) *_1(p\#_2m)$; $s, p \in F$ and $m \in V$;
- vi) $(s\#_1p) \#_2m = s\#_1(p\#_2m)$; $s, p \in F$ and $m \in V$;
- vii) there exists at least an element $s \in F$ for each element m such that

$m \#_2 \text{ neut}(s) = \text{neut}(s) \#_2 m = m; m \in V.$

Definition 5: [45] A NQN is a number of the form (x, yT, zI, tF) , where T, I, F have their usual neutrosophic logic means and $x, y, z, t \in \mathbb{R}$ or \mathbb{C} . The NQS defined by

$$NQ = \{(x, yT, zI, tF): x, y, z, t \in \mathbb{R} \text{ or } \mathbb{C}\}.$$

For a NQN (x, yT, zI, tF) , representing any entity which may be a number, an idea, an object, etc., x is called the known part and (yT, zI, tF) is called the unknown part.

Definition 6: [50] Let N be a set and $P(N)$ be power set of N . A SVNQN shown by the form (A_1, A_2T, A_3I, A_4F) . Where, T, I and F are degree of membership, degree of indeterminacy, degree of non-membership in neutrosophic theory, respectively. Also, $A_1, A_2, A_3, A_4 \in P(N)$. Then, a SVNQS shown by

$$N_q = \{(A_1, A_2T, A_3I, A_4F): A_1, A_2, A_3, A_4 \in P(N)\}$$

where, similar to NQS, A_1 is called the known part and (A_1, A_2T, A_3I, A_4F) is called the unknown part.

Definition 7: [50] Let $A = (A_1, A_2T, A_3I, A_4F)$ and $B = (B_1, B_2T, B_3I, B_4F)$ be SVNQNs. We define the following operations, well known operators in set theory, such that

$$A \cup B = (A_1 \cup B_1, (A_2 \cup B_2)T, (A_3 \cup B_3)I, (A_4 \cup B_4)F)$$

$$A \cap B = (A_1 \cap B_1, (A_2 \cap B_2)T, (A_3 \cap B_3)I, (A_4 \cap B_4)F)$$

$$A \setminus B = (A_1 \setminus B_1, (A_2 \setminus B_2)T, (A_3 \setminus B_3)I, (A_4 \setminus B_4)F)$$

$$A' = (A'_1, A'_2T, A'_3I, A'_4F)$$

Definition 8: [50] Let $A = (A_1, A_2T, A_3I, A_4F)$, $B = (B_1, B_2T, B_3I, B_4F)$ be SVNQNs. If $A_1 \subset B_1, A_2 \subset B_2, A_3 \subset B_3, A_4 \subset B_4$, then it is called that A is subset of B . It is shown by $A \subset B$.

Definition 9: [50] Let $A = (A_1, A_2T, A_3I, A_4F)$, $B = (B_1, B_2T, B_3I, B_4F)$ be SVNQNs. If $A \subset B$ and $B \subset A$, then it is called that A is equal to B . It is shown by $A = B$.

NEUTROSOPHIC TRIPLET FIELD BASED ON SET VALUED NEUTROSOPHIC QUADRUPLE NUMBER

Theorem 10: Let N be a set and $N_q = \{(N_1, N_2T, N_3I, N_4F): N_1, N_2, N_3, N_4 \in P(N)\}$ be a SVNQS and K, L be SVNQNs. Then,

$$a) (N_q, *_\cup) \text{ is a NTS such that } K *_\cup L = \begin{cases} K \cup L, & \text{if } K, L \in P(N) \setminus \emptyset \\ \emptyset, & \text{if } K = \emptyset \text{ or } L = \emptyset \end{cases}.$$

$$b) (N_q, *_\cap) \text{ is a NTS such that } K *_\cap L = \begin{cases} K \cap L, & \text{if } K, L \in P(N) \setminus N \\ N, & \text{if } K = N \text{ or } L = N \end{cases}.$$

Proof:

a) Let $K = (N_1, N_2T, N_3I, N_4F)$ be a SVNQN in N_q . From Definition 7, we obtain that

i) If $K \in P(N) \setminus \emptyset$, from Definition 7, we obtain that

$$K *_\cup K = (N_1, N_2T, N_3I, N_4F) \cup (N_1, N_2T, N_3I, N_4F) = (N_1, N_2T, N_3I, N_4F) = K.$$

ii) If $K = \emptyset$ or $L = \emptyset$, then we obtain that $K *_\cup L = \emptyset$.

Thus, $\text{neut}(K) = K$ for all $K \in P(N)$. Also, we obtain that $\text{anti}(K) = K$. Therefore, $(N_q, *_\cup)$ is a NTS.

b) Let $K = (N_1, N_2T, N_3I, N_4F)$ be a SVNQN in N_q . From Definition 7, we obtain that

i) If $K \in P(N) \setminus N$, from Definition 7, we obtain that

$$K *_\cap K = (N_1, N_2T, N_3I, N_4F) \cap (N_1, N_2T, N_3I, N_4F) = (N_1, N_2T, N_3I, N_4F) = K.$$

ii) If $K = N$ or $K = \emptyset$, then we obtain $A *_\cap B = K$.

Thus, $\text{neut}(K) = K$ for all $K \in P(N)$. Also, we obtain that $\text{anti}(K) = K$. Therefore, $(N_q, *_\cap)$ is a NTS.

Theorem 11: Let $N_q = \{(N_1, N_2T, N_3I, N_4F) : N_1, N_2, N_3, N_4 \in P(N)\}$ be a SVNQS and K, L, M be SVNQNs. Then,

$$\text{a) } (N_q, *_\cup) \text{ is a NTG such that } K *_\cup L = \begin{cases} K \cup L, & \text{if } K, L \in P(N) \setminus \emptyset \\ \emptyset, & \text{if } K = \emptyset \text{ or } L = \emptyset \end{cases}.$$

$$\text{b) } (N_q, *_\cap) \text{ is a NTG such that } K *_\cap L = \begin{cases} K \cap L, & \text{if } K, L \in P(N) \setminus N \\ N, & \text{if } K = N \text{ or } L = N \end{cases}.$$

Proof:

a) Let $K = (K_1, K_2T, K_3I, K_4F)$, $L = (L_1, L_2T, L_3I, L_4F)$ and $M = (M_1, M_2T, M_3I, M_4F)$ be a SVNQNs in N_q . From Theorem 10, $(N_q, *_\cup)$ is a NTS.

i) From Definition 7, it is clear that $K *_\cup L \in N_q$, for all $K, L \in N_q$.

ii) From Definition 7, it is clear that $K *_\cup (L *_\cup M) = (K *_\cup L) *_\cup M$ for all $K, L, M \in N_q$.

Therefore, $(N_q, *_\cup)$ is a NTG. Also, $(N_q, *_\cup)$ is an abelian NTG.

b) Let $K = (K_1, K_2T, K_3I, K_4F)$, $L = (L_1, L_2T, L_3I, L_4F)$ and $M = (M_1, M_2T, M_3I, M_4F)$ be a SVNQNs in N_q . From Theorem 10, $(N_q, *_\cap)$ is a NTS.

i) From Definition 7, it is clear that $K *_\cap L \in N_q$, for all $K, L \in N_q$.

ii) From Definition 7, it is clear that $K *_\cap (L *_\cap M) = (K *_\cap L) *_\cap M$ for all $K, L, M \in N_q$.

Therefore, $(N_q, *_\cap)$ is a NTG. Also, $(N_q, *_\cap)$ is an abelian NTG.

Definition 12: Let $N_q = \{(N_1, N_2T, N_3I, N_4F) : N_1, N_2, N_3, N_4 \in P(N)\}$ be a SVNQS; $(N_q, *)$ be a NTS and $(N_q, \#)$ be a NTS. If $(N_q, *, \#)$ is a NTF, then $(N_q, *, \#)$ is called NTF based on SVNQN.

Theorem 13: Let $N_q = \{(N_1, N_2T, N_3I, N_4F) : N_1, N_2, N_3, N_4 \in P(N)\}$ be a SVNQS. Then, $(N_q, *_\cup, *_\cap)$ is a NTF based on SVNQN.

Proof: Let $K = (K_1, K_2T, K_3I, K_4F)$, $L = (L_1, L_2T, L_3I, L_4F)$ and $M = (M_1, M_2T, M_3I, M_4F)$ be a SVNQNs in N_q . From Theorem 11, $(N_q, *_\cup)$ and $(N_q, *_\cap)$ is a NTG. Thus, we show that

$$K *_\cap (L *_\cup M) = (K *_\cap L) *_\cup (K *_\cap M). \quad (1)$$

and

$$(L *_\cup M) *_\cap K = (L *_\cap K) *_\cup (M *_\cap K). \quad (2)$$

Also, from Definition 7, (1) is satisfied. Then, from (1) and Theorem 11; (2) is satisfied.

Corollary 14: Let $N_q = \{(N_1, N_2T, N_3I, N_4F) : N_1, N_2, N_3, N_4 \in P(N)\}$ be a SVNQS and $M_q \subset N_q$. Then, $(M_q, *_U, *_\cap)$ is a NTF based on SVNQN.

Theorem 15: Let $N_q = \{(N_1, N_2T, N_3I, N_4F) : N_1, N_2, N_3, N_4 \in P(N)\}$ be a SVNQS. Then, $(N_q, *_\cap, *_U)$ is a NTF based on SVNQN.

Proof: Let $K = (K_1, K_2T, K_3I, K_4F)$, $L = (L_1, L_2T, L_3I, L_4F)$ and $M = (M_1, M_2T, M_3I, M_4F)$ be a SVNQNs in N_q . From Theorem 11, $(N_q, *_\cap)$ and $(N_q, *_U)$ is a NTG. Thus, we show that

$$K *_U (L *_\cap M) = (K *_U L) *_\cap (K *_U M). \quad (3)$$

and

$$(L *_\cap M) *_U K = (L *_U K) *_\cap (M *_U K). \quad (4)$$

Also, from Definition 7, (3) is satisfied. Then, from (3) and Theorem 11; (4) is satisfied.

Corollary 16: Let $N_q = \{(N_1, N_2T, N_3I, N_4F) : N_1, N_2, N_3, N_4 \in P(N)\}$ be a SVNQS and $M_q \subset N_q$. Then, $(M_q, *_\cap, *_U)$ is a NTF based on SVNQN.

NEUTROSOPHIC TRIPLET VECTOR SPACE BASED ON SET VALUED NEUTROSOPHIC QUADRUPLE NUMBER

Definition 17: Let $N_q = \{(N_1, N_2T, N_3I, N_4F) : N_1, N_2, N_3, N_4 \in P(N)\}$ be a SVNQS, $V_q = \{(V_1, V_2T, V_3I, V_4F) : V_1, V_2, V_3, V_4 \in P(N)\}$ be a SVNQSS; $(N_q, *_1, \#_1)$ be a NTF based on SVNQN; $(V_q, *_2)$ be a NTS and $(V_q, \#_2)$ be a NTS. If $(V_q, *_2, \#_2)$ is a NTVS on $(N_q, *_1, \#_1)$, then $(V_q, *_2, \#_2)$ is called NTVS based on SVNQN.

Definition 18: Let $N_q = \{(N_1, N_2T, N_3I, N_4F) : N_1, N_2, N_3, N_4 \in P(N)\}$ be a SVNQS, $V_q = \{(V_1, V_2T, V_3I, V_4F) : V_1, V_2, V_3, V_4 \in P(N)\}$ be a SVNQSS; $(N_q, *_1, \#_1)$ be a NTF based on SVNQN; $(V_q, *_2, \#_2)$ be a NTVS on $(N_q, *_1, \#_1)$ and $M_q \subset V_q$. If $(M_q, *_2, \#_2)$ be a NTVS on $(N_q, *_1, \#_1)$ then, $(M_q, *_2, \#_2)$ is called NT subvector space based on SVNQN.

Theorem 19: Let $N_q = \{(N_1, N_2T, N_3I, N_4F) : N_1, N_2, N_3, N_4 \in P(N)\}$ be a SVNQS. Then, $(N_q, *_U, *_\cap)$ is a NTVS based on SVNQN.

Proof: From Theorem 13, $(N_q, *_U, *_\cap)$ is a NTF based on SVNQN. We show that $(N_q, *_U, *_\cap)$ is a NTVS on $(N_q, *_U, *_\cap)$.

Let $K = (K_1, K_2T, K_3I, K_4F)$, $L = (L_1, L_2T, L_3I, L_4F)$, $M = (M_1, M_2T, M_3I, M_4F)$, $S = (S_1, S_2T, S_3I, S_4F)$, $P = (P_1, P_2T, P_3I, P_4F)$ be a SVNQNs in N_q . From Theorem 11, $(N_q, *_U)$ and $(N_q, *_\cap)$ is a NTG. Thus, $(N_q, *_U, *_\cap)$ is satisfies conditions i, ii, iii, vi, vii.

Also, since $(N_q, *_U, *_\cap)$ is a NTF based on SVNQN, $(N_q, *_U, *_\cap)$ is satisfies conditions iv and v.

Thus, $(N_q, *_U, *_\cap)$ is a NTVS based on SVNQN.

Corollary 20: Let $N_q = \{(N_1, N_2T, N_3I, N_4F) : N_1, N_2, N_3, N_4 \in P(N)\}$ be a SVNQS, $N_q \subset V_q$. Then, $(V_q, *_U, *_\cap)$ is NT subvector space based on SVNQN of $(N_q, *_U, *_\cap)$.

Theorem 21: Let $N_q = \{(N_1, N_2T, N_3I, N_4F) : N_1, N_2, N_3, N_4 \in P(N)\}$ be a SVNQS. Then, $(N_q, *_\cap, *_U)$ is a NTVS based on SVNQN.

Proof: From Theorem 15, $(N_q, *_\cap, *_U)$ is a NTF based on SVNQN. We show that $(N_q, *_\cap, *_U)$ is a NTVS on $(N_q, *_\cap, *_U)$.

Let $K = (K_1, K_2T, K_3I, K_4F)$, $L = (L_1, L_2T, L_3I, L_4F)$, $M = (M_1, M_2T, M_3I, M_4F)$, $S = (S_1, S_2T, S_3I, S_4F)$, $P = (P_1, P_2T, P_3I, P_4F)$ be a SVNQNs in N_q . From Theorem 11, $(N_q, *_\rho)$ and $(N_q, *_\cup)$ is a NTG. Thus, $(N_q, *_\rho, *_\cup)$ is satisfies conditions i, ii, iii, vi, vii.

Also, since $(N_q, *_\rho, *_\cup)$ is a NTF based on SVNQN, $(N_q, *_\rho, *_\cup)$ is satisfies conditions iv and v.

Thus, $(N_q, *_\rho, *_\cup)$ is a NTVS based on SVNQN.

Corollary 22: Let $N_q = \{(N_1, N_2T, N_3I, N_4F): N_1, N_2, N_3, N_4 \in P(N)\}$ be a SVNQS, $N_q \subset V_q$. Then, $(V_q, *_\rho, *_\cup)$ is NT subvector space based on SVNQN of $(N_q, *_\rho, *_\cup)$.

Conclusions

In this study, we give some NTF based on SVNQN and NTVS based on SVNQN thanks to operations for SVNQN. Thus, we have added a new structure to NT structures and NQ structures. Thanks to NTF based on SVNQN and NTVS based on SVNQN, NT normed spaces and NT inner product space can be defined similar to this study.

Abbreviations

NT: Neutrosophic triplet

NTS: Neutrosophic triplet set

NTG: Neutrosophic triplet group

NTF: Neutrosophic triplet field

NTVS: Neutrosophic triplet vector space

NQ: Neutrosophic quadruple

NQS: Neutrosophic quadruple set

NQN: Neutrosophic quadruple number

SVNQS: Set valued neutrosophic quadruple set

SVNQN: Set valued neutrosophic quadruple number

References

- [1] Smarandache F. (1998) Neutrosophy: Neutrosophic Probability, Set and Logic, Rehoboth, Amer. Research Press
- [2] Kandasamy W. B. V. and Smarandache F. (2004) Basic neutrosophic algebraic structures and their applications to fuzzy and neutrosophic models, Hexis, Frontigan p 219
- [3] Kandasamy W. B. V. and Smarandache F. (2006) Some neutrosophic algebraic structures and neutrosophic n-algebraic structures, Hexis, Frontigan p 219
- [4] Smarandache F. and Ali M. (2016) Neutrosophic triplet as extension of matter plasma, unmatter plasma and antimatter plasma, APS Gaseous Electronics Conference doi: 10.1103/BAPS.2016.GEC.HT6.110

- [5] Smarandache F. and Ali M. (2014) The Neutrosophic Triplet Group and its Application to Physics, presented by F. S. to Universidad Nacional de Quilmes, Department of Science and Technology, Bernal, Buenos Aires, Argentina (02 June 2014)
- [6] Smarandache F. and Ali M. (2016) Neutrosophic triplet group. *Neural Computing and Applications*, 1-7.
- [7] Smarandache F. and Ali M. (2017) Neutrosophic Triplet Field Used in Physical Applications, (Log Number: NWS17-2017-000061), 18th Annual Meeting of the APS Northwest Section, Pacific University, Forest Grove, OR, USA (June 1-3, 2017)
- [8] Smarandache F. and Ali M. (2017) Neutrosophic Triplet Ring and its Applications, (Log Number: NWS17-2017-000062), 18th Annual Meeting of the APS Northwest Section, Pacific University, Forest Grove, OR, USA (June 1-3, 2017).
- [9] Şahin, M., & Kargin, A. (2019). Single valued neutrosophic quadruple graphs. *Asian Journal of Mathematics and Computer Research*, 243-250.
- [10] Broumi S., Bakali A., Talea M. and Smarandache F. (2016) Single Valued Neutrosophic Graphs: Degree, Order and Size. *IEEE International Conference on Fuzzy Systems*, pp. 2444-2451.
- [11] Broumi S., Bakali A., Talea M. and Smarandache F. (2016) Decision-Making Method Based On the Interval Valued Neutrosophic Graph, *Future Technologies, IEEE International Conference on Fuzzy Systems* pp 44-50.
- [12] Uluçay, V.; Şahin, M.; Olgun, N. Time-Neutrosophic Soft Expert Sets and Its Decision Making Problem. *Matematika*, 2018 34(2), 246-260.
- [13] Uluçay, V.; Kılıç, A.; Yıldız, I.; Şahin, M. (2018). A new approach for multi-attribute decision-making problems in bipolar neutrosophic sets. *Neutrosophic Sets and Systems*, 2018, 23(1), 142-159.
- [14] Uluçay, V., Kılıç, A., Şahin, M., & Deniz, H. (2019). A New Hybrid Distance-Based Similarity Measure for Refined Neutrosophic sets and its Application in Medical Diagnosis. *MATEMATIKA: Malaysian Journal of Industrial and Applied Mathematics*, 35(1), 83-94.
- [15] Broumi, S., Bakali, A., Talea, M., Smarandache, F., Singh, P. K., Uluçay, V., & Khan, M. (2019). Bipolar complex neutrosophic sets and its application in decision making problem. In *Fuzzy Multi-criteria Decision-Making Using Neutrosophic Sets* (pp. 677-710). Springer, Cham.
- [16] Bakbak, D., Uluçay, V., & Şahin, M. (2019). Neutrosophic soft expert multiset and their application to multiple criteria decision making. *Mathematics*, 7(1), 50.
- [17] Uluçay, V., & Şahin, M. (2020). Decision-Making Method based on Neutrosophic Soft Expert Graphs. In *Neutrosophic Graph Theory and Algorithms* (pp. 33-76). IGI Global.
- [18] Uluçay, V., Kılıç, A., Yıldız, İ., & Şahin, M. (2019). An Outranking Approach for MCDM-Problems

with Neutrosophic Multi-Sets. *Neutrosophic Sets & Systems*, 30.

[19] Uluçay, V., Şahin, M., & Hassan, N. (2018). Generalized neutrosophic soft expert set for multiple-criteria decision-making. *Symmetry*, 10(10), 437.

[20] Sahin M., Deli I. and Ulucay V. (2016) Similarity measure of bipolar neutrosophic sets and their application to multiple criteria decision making, *Neural Comput & Applic.* DOI 10. 1007/S00521

[21] Wang H., Smarandache F., Zhang Y. Q., Sunderraman R. (2010) Single valued neutrosophic sets. *Multispace Multistructure* 4, 410–413.

[22] Şahin M., Olgun N, Uluçay V., Kargın A. and Smarandache F. (2017) A new similarity measure on falsity value between single valued neutrosophic sets based on the centroid points of transformed single valued neutrosophic numbers with applications to pattern recognition, *Neutrosophic Sets and Systems*, 15, 31-48, doi: org/10.5281/zenodo570934

[23] Şahin M., Ecemiş O., Uluçay V. and Kargın A. (2017) Some new generalized aggregation operators based on centroid single valued triangular neutrosophic numbers and their applications in multi-attribute decision making, *Asian Journal of Mathematics and Computer Research* 16(2): 63-84

[24] Chatterjee R., Majumdar P., and Samanta S. K. (2019) Similarity Measures in Neutrosophic Sets-I. Fuzzy Multi-criteria Decision-Making Using Neutrosophic Sets. Springer, Cham. 249-294.

[25] Mohana K., and Mohanasundari M. (2019) On Some Similarity Measures of Single Valued Neutrosophic Rough Sets. *Neutrosophic Sets and Systems*, 10

[26] Smarandache F., et al. (2019) Word-level neutrosophic sentiment similarity. *Applied Soft Computing* 80, 167-176.

[27] Ye J. (2014) Similarity measures between interval neutrosophic sets and their applications in multicriteria decision – making. *J. Intell. Fuzzy Syst.* 26 (1) 165 – 172

[28] Zadeh A. L. (1965) Fuzzy sets, *Information and control* ,8,3 338-353,

[29] Atanassov T. K. (1986) Intuitionistic fuzzy sets, *Fuzzy Sets Syst*, 20:87–96

[30] Şahin M. and Kargın A. (2019) Neutrosophic triplet metric topology, *Neutrosophic Set and Systems*, 27, 154 -162

[31] Ali M., Smarandache F., Khan M. (2018) Study on the development of neutrosophic triplet ring and neutrosophic triplet field, *Mathematics-MDPI*, 6(4), 46

[32] Şahin M. and Kargın A. (2017) Neutrosophic triplet normed space, *Open Physics*, 15, 697-704

[33] Şahin M. and Kargın A. (2017) Neutrosophic triplet inner product space, *Neutrosophic Operational Research*, 2, 193-215,

- [34] Smarandache F., Şahin M., Kargin A. (2018) Neutrosophic Triplet G- Module, Mathematics – MDPI, 6, 53
- [35] Şahin M. and Kargin A. (2019) Neutrosophic triplet b – metric space, Neutrosophic Triplet Research, 1
- [36] Şahin M., Kargin A., Çoban M. A. (2018) Fixed point theorem for neutrosophic triplet partial metric space, Symmetry – MDPI, 10, 240
- [37] Şahin M., Kargin A. (2018) Neutrosophic triplet v – generalized metric space, Axioms – MDPI, 7, 67
- [38] Şahin M. and Kargin A., Smarandache F. (2019) Neutrosophic triplet topology, Neutrosophic Triplet Research 1,
- [39] Şahin M., Kargin A. (2018) Neutrosophic triplet normed ring space, Neutrosophic Set and Systems, 21, 20 – 27
- [40] Şahin M., Kargin A. (2019), Neutrosophic triplet partial inner product space, Neutrosophic Triplet Research 1, 10 - 21
- [41] Şahin M., Kargin A. (2019), Neutrosophic triplet groups Based on set valued neutrosophic quadruple numbers, Neutrosophic Set and Systems, 30, 122 -131
- [42] Şahin M., Kargin A. (2019) Neutrosophic triplet partial v – generalized metric space, Neutrosophic Triplet Research 1, 22 - 34
- [43] Şahin M., Kargin A. (2019) Neutrosophic triplet Lie Algebra, Neutrosophic Triplet Research 1, 68 -78
- [44] Şahin M., Kargin A. (2019) Isomorphism theorems for Neutrosophic triplet G - module, Neutrosophic Triplet Research 1, 54- 67
- [45] Smarandache F. (2015) Neutrosophic quadruple numbers, refined neutrosophic quadruple numbers, absorbance law, and the multiplication of neutrosophic quadruple numbers, Neutrosophic Set and Systems, 10, 96 -98
- [46] Akinleye, S. A., Smarandache, F. (2016) Agboola, A. A. A. On neutrosophic quadruple algebraic structures. Neutrosophic Sets and Systems, 12, 122-126.
- [47] Jun, Y., Song, S. Z., Smarandache, F., & Bordbar, H. Neutrosophic quadruple BCK/BCI-algebras. Axioms, (2018) 7(2), 41.
- [48] Muhiuddin, G., Al-Kenani, A. N., Roh, E. H., & Jun, Y. B. (2019) Implicative neutrosophic quadruple BCK-algebras and ideals. Symmetry, 11(2), 277.
- [49] Li, Q., Ma, Y., Zhang, X., & Zhang, J. (2019) Neutrosophic Extended Triplet Group Based on Neutrosophic Quadruple Numbers. Symmetry, 11(5), 696.
- [50] Şahin, M., Kargin A. (2019), Neutrosophic triplet groups based on set valued neutrosophic quadruple numbers, Neutrosophic Set and Systems, 30, 122 - 131

Chapter Five

Neutrosophic Triplet Metric Space Based on Set Valued Neutrosophic Quadruple Number

Memet Şahin and Abdullah Kargin

Department of Mathematics, Gaziantep University, Gaziantep27310-Turkey

E-mail: mesahin@gantep.edu.tr, abduallahkargin27@gmail.com

ABSTRACT

In this chapter, we obtain neutrosophic triplet metric space based set valued neutrosophic quadruple number thanks to operations for set valued neutrosophic quadruple numbers. In this way, we define new structures using the together set valued neutrosophic quadruple number and neutrosophic triplet metric space. Thus, we obtain new results for neutrosophic triplet metric spaces with set valued neutrosophic quadruple number.

Keywords: Neutrosophic triplet set, neutrosophic triplet metric space, neutrosophic quadruple set, neutrosophic quadruple number, set valued neutrosophic quadruple set, set valued neutrosophic quadruple number.

INTRODUCTION

Smarandache and Ali obtained NTS and NTG [1] in 2018. For every element “x” in NTS A, there exist a neutral of “x” and an opposite of “x”. Also, neutral of “x” must different from the classical neutral element. Therefore, the NTS is different from the classical set. Furthermore, a NT “x” is showed by $\langle x, neut(x), anti(x) \rangle$. Also, many researchers have introduced NT structures [2 – 16, 23-30].

Also, Smarandache introduced NQS and NQN [17]. The NQs are generalized state of NS. A NQS is shown by $\{(x, yT, zI, tF) : x, y, z, t \in \mathbb{R} \text{ or } \mathbb{C}\}$. Where, x is called the known part and (yT, zI, tF) is called the unknown part and T, I, F have their usual neutrosophic logic means. Recently, researchers studied NQS and NQN. Recently, Akinleye, Smarandache, Agboola studied NQ algebraic structures [18]; Jun, Song, Smarandache obtained NQ BCK/BCI-algebras [19]; Muhiuddin, Al-Kenani, Roh, Jun introduced implicative NQ BCK-algebras and ideals [20]; Li, Ma, Zhang, Zhang studied NT extended group based on NQNs [21]; Şahin and Kargin obtained SVNQN and NTG based on SVNQN [22].

In this chapter, we give NTMS based on SVNQN. In Section 2, we give definitions and properties for NQS, NQN [17]; NTS, NTG [1]; NTMS [4] and SVNQS, SVNQN, some operations SVNQN [22]. In Section 3, we obtain some NTMS based on SVNQN thanks to operations for SVNQN. In this way, we define new structures using the together with SVNQN and NTMS.

BACKGROUND

Definition 1: [1]: Let # be a binary operation. A NTS $(X, #)$ is a set such that for $x \in X$,

- i) There exists neutral of “x” such that $x\#\text{neut}(x) = \text{neut}(x)\#x = x$,
- ii) There exists anti of “x” such that $x\#\text{anti}(x) = \text{anti}(x)\#x = \text{neut}(x)$.

Also, a NT “x” is showed with $(x, \text{neut}(x), \text{anti}(x))$.

Definition 2: [1] Let $(X, #)$ be a NT set. Then, X is called a NTG such that

- a) for all $a, b \in X$, $a\#b \in X$.
- b) for all $a, b, c \in X$, $(a\#b)\#c = a\#(b\#c)$

Definition 3: [4] Let $(N, *)$ be a NTS and $d_N: N \times N \rightarrow \mathbb{R}^+ \cup \{0\}$ be a function. If $d_N: N \times N \rightarrow \mathbb{R}^+ \cup \{0\}$ and $(N, *)$ satisfies the following conditions, then d_N is called NTM.

- a) $x*y \in N$;
- b) $d_N(x, y) \geq 0$;
- c) If $x = y$, then $d_N(x, y) = 0$;
- d) $d_N(x, y) = d_N(y, x)$;
- e) If there exists at least a $y \in N$ for each $x, z \in N$ such that $d_N(x, z) \leq d_N(x, z*\text{neut}(y))$, then $d_N(x, z*\text{neut}(y)) \leq d_N(x, y) + d_N(y, z)$.

Also, $((N, *), d_N)$ is called a NTMS.

Definition 4: [17] A NQN is a number of the form (x, yT, zI, tF) , where T, I, F have their usual neutrosophic logic means and $x, y, z, t \in \mathbb{R}$ or \mathbb{C} . The NQS defined by

$$NQ = \{(x, yT, zI, tF): x, y, z, t \in \mathbb{R} \text{ or } \mathbb{C}\}.$$

For a NQN (x, yT, zI, tF) , representing any entity which may be a number, an idea, an object, etc., x is called the known part and (yT, zI, tF) is called the unknown part.

Definition 5: [22] Let N be a set and P(N) be power set of N. A SVNQN shown by the form (A_1, A_2T, A_3I, A_4F) . Where, T, I and F are degree of membership, degree of undeterminacy, degree of non-membership in neutrosophic theory, respectively. Also, $A_1, A_2, A_3, A_4 \in P(N)$. Then, a SVNQS shown by

$$N_q = \{(A_1, A_2T, A_3I, A_4F): A_1, A_2, A_3, A_4 \in P(N)\},$$

where, similar to NQS, A_1 is called the known part and (A_1, A_2T, A_3I, A_4F) is called the unknown part.

Definition 6: [22] Let $A = (A_1, A_2T, A_3I, A_4F)$ and $B = (B_1, B_2T, B_3I, B_4F)$ be SVNQNs. We define the following operations, well known operators in set theory, such that

$$A \cup B = (A_1 \cup B_1, (A_2 \cup B_2)T, (A_3 \cup B_3)I, (A_4 \cup B_4)F)$$

$$A \cap B = (A_1 \cap B_1, (A_2 \cap B_2)T, (A_3 \cap B_3)I, (A_4 \cap B_4)F)$$

$$A \setminus B = (A_1 \setminus B_1, (A_2 \setminus B_2)T, (A_3 \setminus B_3)I, (A_4 \setminus B_4)F)$$

$$A' = (A'_1, A'_2T, A'_3I, A'_4F)$$

Definition 7: [22] Let $A = (A_1, A_2T, A_3I, A_4F)$, $B = (B_1, B_2T, B_3I, B_4F)$ be SVNQNs and $T < I < F$. We define the following operations

$$A *_1 B = (A_1, A_2T, A_3I, A_4F) *_1 (B_1, B_2T, B_3I, B_4F)$$

$$= (A_1 \cap B_1, ((A_1 \cap B_2) \cup (A_2 \cap B_1) \cup (A_2 \cap B_2))T, ((A_1 \cap B_3) \cup (A_2 \cap B_3) \cup (A_3 \cap B_1) \cup (A_3 \cap B_2) \cup (A_3 \cap B_3))I, ((A_1 \cap B_4) \cup (A_2 \cap B_4) \cup (A_3 \cap B_4) \cup (A_4 \cap B_1) \cup (A_4 \cap B_2) \cup (A_4 \cap B_3) \cup (A_4 \cap B_4))F)$$

and

$$A *_2 B = (A_1, A_2T, A_3I, A_4F) *_2 (B_1, B_2T, B_3I, B_4F)$$

$$= (A_1 \cup B_1, ((A_1 \cup B_2) \cap (A_2 \cup B_1) \cap (A_2 \cup B_2))T, ((A_1 \cup B_3) \cap (A_2 \cup B_3) \cap (A_3 \cup B_1) \cap (A_3 \cup B_2) \cap (A_3 \cup B_3))I, ((A_1 \cup B_4) \cap (A_2 \cup B_4) \cap (A_3 \cup B_4) \cap (A_4 \cup B_1) \cap (A_4 \cup B_2) \cap (A_4 \cup B_3) \cap (A_4 \cup B_4))F).$$

Definition 8: [22]

Let $A = (A_1, A_2T, A_3I, A_4F)$, $B = (B_1, B_2T, B_3I, B_4F)$ be SVNQNs and $T > I > F$. We define the following operations

$$A \#_1 B = (A_1, A_2T, A_3I, A_4F) \#_1 (B_1, B_2T, B_3I, B_4F)$$

$$= (A_1 \cap B_1, ((A_1 \cap B_2) \cup (A_2 \cap B_1) \cup (A_2 \cap B_2) \cup (A_3 \cap B_2) \cup (A_4 \cap B_2) \cup (A_2 \cap B_3) \cup (A_2 \cap B_4))T, ((A_1 \cap B_3) \cup (A_3 \cap B_3) \cup (A_3 \cap B_4) \cup (A_4 \cap B_3))I, ((A_1 \cap B_4) \cup (A_4 \cap B_2) \cup (A_4 \cap B_4))F)$$

and

$$A \#_2 B = (A_1, A_2T, A_3I, A_4F) \#_2 (B_1, B_2T, B_3I, B_4F)$$

$$= (A_1 \cup B_1, ((A_1 \cup B_2) \cap (A_2 \cup B_1) \cap (A_2 \cup B_2) \cap (A_3 \cup B_2) \cap (A_4 \cup B_2) \cap (A_2 \cup B_3) \cap (A_2 \cup B_4))T, ((A_1 \cup B_3) \cap (A_3 \cup B_3) \cap (A_3 \cup B_4) \cap (A_4 \cup B_3))I, ((A_1 \cup B_4) \cap (A_4 \cup B_2) \cap (A_4 \cup B_4))F).$$

Definition 9: [22] Let $A = (A_1, A_2T, A_3I, A_4F)$, $B = (B_1, B_2T, B_3I, B_4F)$ be SVNQNs. If $A_1 \subset B_1, A_2 \subset B_2, A_3 \subset B_3, A_4 \subset B_4$, then it is called that A is subset of B. It is shown by $A \subset B$.

Definition 10: [22] Let $A = (A_1, A_2T, A_3I, A_4F)$, $B = (B_1, B_2T, B_3I, B_4F)$ be SVNQNs. If $A \subset B$ and $B \subset A$, then it is called that A is equal to B. It is shown by $A = B$.

Theorem 1: [22] Let N be a set and $N_q = \{(A_1, A_2T, A_3I, A_4F) : A_1, A_2, A_3, A_4 \in P(N)\}$ be a SVNQS. Then,

a) $(N_q, *_1)$ is a NTS

b) $(N_q, *_2)$ is a NTS

Theorem 2: [22] Let N be a set and $N_q = \{(A_1, A_2T, A_3I, A_4F) : A_1, A_2, A_3, A_4 \in P(N)\}$ be a SVNQS. Then,

a) $(N_q, *_1)$ is a NTG

b) $(N_q, *_2)$ is a NTG

Theorem 3: [22] Let N be a set and $N_q = \{(A_1, A_2T, A_3I, A_4F) : A_1, A_2, A_3, A_4 \in P(N)\}$ be a SVNQS. Then,

a) $(N_q, \#_1)$ is a NTS

b) $(N_q, \#_2)$ is a NTS

Theorem 4: [22] Let N be a set and $N_q = \{(A_1, A_2T, A_3I, A_4F) : A_1, A_2, A_3, A_4 \in P(N)\}$ be a SVNQS. Then,

a) $(N_q, \#_1)$ is a NTG

b) $(N_q, \#_2)$ is a NTG

NEUTROSOPHIC TRIPLET METRIC SPACE BASED ON SET VALUED NEUTROSOPHIC QUADRUPLE NUMBER

Definition 11: Let $N_q = \{(A_1, A_2 T, A_3 I, A_4 F) : A_1, A_2, A_3, A_4 \in P(N)\}$ be a SVNQS and $A = (A_1, A_2 T, A_3 I, A_4 F)$, $B = (B_1, B_2 T, B_3 I, B_4 F) \in N_q$; $(N_q, *)$ be a NTS; $d_N : N_q \times N_q \rightarrow \mathbb{R}^+ \cup \{0\}$ be a function. If d_N is a NTM, then $((N_q, *), d_N)$ is called NTMS based on SVNQN.

Theorem 5: Let $N_q = \{(A_1, A_2 T, A_3 I, A_4 F) : A_1, A_2, A_3, A_4 \in P(N) \setminus \emptyset\}$ be a SVNQS and $A = (A_1, A_2 T, A_3 I, A_4 F)$, $B = (B_1, B_2 T, B_3 I, B_4 F) \in N_q$; $d_N : N_q \times N_q \rightarrow \mathbb{R}^+ \cup \{0\}$ be a function such that

$$d_N(A, B) = |[s(A_1 \cup A_2) - s(A_3 \cup A_4)] - [s(B_1 \cup B_2) - s(B_3 \cup B_4)]|. \text{ Then, } d_N \text{ is a NTM on } (N_q, \cup).$$

Proof:

It is clear that (N_q, \cup) is a NTS such that $\text{neut}(A) = A$, $\text{anti}(A) = A$. Now, we show that

$$d_N(A, B) = |[s(A_1 \cup A_2) - s(A_3 \cup A_4)] - [s(B_1 \cup B_2) - s(B_3 \cup B_4)]| \text{ is a NTM.}$$

a) Since $A = (A_1, A_2 T, A_3 I, A_4 F)$, $B = (B_1, B_2 T, B_3 I, B_4 F) \in N_q$, it is clear that $A \cup B \in N_q$.

$$b) d_N(A, B) = |[s(A_1 \cup A_2) - s(A_3 \cup A_4)] - [s(B_1 \cup B_2) - s(B_3 \cup B_4)]| \geq 0.$$

c) If $A = B$, then from Definition 10, $A_1 = B_1$, $A_2 = B_2$, $A_3 = B_3$, $A_4 = B_4$. Thus,

$$\begin{aligned} d_N(A, B) &= |[s(A_1 \cup A_2) - s(A_3 \cup A_4)] - [s(B_1 \cup B_2) - s(B_3 \cup B_4)]| \\ &= |[s(A_1 \cup A_2) - s(A_3 \cup A_4)] - [s(A_1 \cup A_2) - s(A_3 \cup A_4)]| = 0. \end{aligned}$$

$$\begin{aligned} d) d_N(A, B) &= |[s(A_1 \cup A_2) - s(A_3 \cup A_4)] - [s(B_1 \cup B_2) - s(B_3 \cup B_4)]| \\ &= |-[s(A_1 \cup A_2) - s(A_3 \cup A_4)] - [s(B_1 \cup B_2) - s(B_3 \cup B_4)]| \\ &= |[s(B_1 \cup B_2) - s(B_3 \cup B_4)] - [s(A_1 \cup A_2) - s(A_3 \cup A_4)]| \\ &= d_N(B, A) \end{aligned}$$

e) Let $C = (C_1, C_2 T, C_3 I, C_4 F) \in N_q$. If $C \subset B$, then $d_N(A, B) = d_N(A, B \cup \text{neut}(C))$. Because $C = \text{neut}(C)$ and

$$d_N(A, B) = |[s(A_1 \cup A_2) - s(A_3 \cup A_4)] - [s(B_1 \cup B_2) - s(B_3 \cup B_4)]|.$$

Also,

$$\begin{aligned} d_N(A, B \cup \text{neut}(C)) &= |[s(A_1 \cup A_2) - s(A_3 \cup A_4)] - [s((B_1 \cup C_1) \cup (B_2 \cup C_2) - s((B_3 \cup C_3) \cup (B_4 \cup C_4)))]| \\ &= |[s(A_1 \cup A_2) - s(A_3 \cup A_4)] - [s(B_1 \cup B_2) - s(B_3 \cup B_4)]| \\ &\leq |[s(A_1 \cup A_2) - s(A_3 \cup A_4)] - [s(C_1 \cup C_2) - s(C_3 \cup C_4)]| + \\ &\quad |[s(C_1 \cup C_2) - s(C_3 \cup C_4)] - [s(B_1 \cup B_2) - s(B_3 \cup B_4)]|. \end{aligned}$$

Thus,

$$d_N(A, B \cup \text{neut}(C)) \leq d_N(A, C) + d_N(C, B).$$

Therefore $((N_q, \cup), d_N)$ is a NTMS.

Also, d_N is a NTM based on SVNQN. $((N_q, \cup), d_N)$ is a NTMS based on SVNQN.

Theorem 6: Let $N_q = \{(A_1, A_2 T, A_3 I, A_4 F) : A_1, A_2, A_3, A_4 \in P(N) \setminus \{N\}\}$ be a SVNQS and $A = (A_1, A_2 T, A_3 I, A_4 F), B = (B_1, B_2 T, B_3 I, B_4 F) \in N_q$; $d_N : N_q \times N_q \rightarrow \mathbb{R}^+ \cup \{0\}$ be a function such that

$d_N(A, B) = |[s(A_1 \cap A_2) - s(A_3 \cap A_4)] - [s(B_1 \cap B_2) - s(B_3 \cap B_4)]|$. Then, d_N is a NTM on (N_q, \cap) .

Proof: It is clear that (N_q, \cap) is a NTS such that $\text{neut}(A) = A$, $\text{anti}(A) = A$. Now, we show that

$d_N(A, B) = |[s(A_1 \cap A_2) - s(A_3 \cap A_4)] - [s(B_1 \cap B_2) - s(B_3 \cap B_4)]|$ is a NTM.

a) Since $A = (A_1, A_2 T, A_3 I, A_4 F), B = (B_1, B_2 T, B_3 I, B_4 F) \in N_q$, it is clear that $A \cap B \in N_q$.

b) $d_N(A, B) = |[s(A_1 \cap A_2) - s(A_3 \cap A_4)] - [s(B_1 \cap B_2) - s(B_3 \cap B_4)]| \geq 0$.

c) If $A = B$, then from Definition 10, $A_1 = B_1, A_2 = B_2, A_3 = B_3, A_4 = B_4$. Thus,

$$\begin{aligned} d_N(A, B) &= |[s(A_1 \cap A_2) - s(A_3 \cap A_4)] - [s(B_1 \cap B_2) - s(B_3 \cap B_4)]| \\ &= |[s(A_1 \cap A_2) - s(A_3 \cap A_4)] - [s(A_1 \cap A_2) - s(A_3 \cap A_4)]| = 0. \end{aligned}$$

$$\begin{aligned} \text{d) } d_N(A, B) &= |[s(A_1 \cap A_2) - s(A_3 \cap A_4)] - [s(B_1 \cap B_2) - s(B_3 \cap B_4)]| \\ &= |-[s(A_1 \cap A_2) - s(A_3 \cap A_4)] - [s(B_1 \cap B_2) - s(B_3 \cap B_4)]| \\ &= |[s(B_1 \cap B_2) - s(B_3 \cap B_4)] - [s(A_1 \cap A_2) - s(A_3 \cap A_4)]| \\ &= d_N(B, A) \end{aligned}$$

e) Let $C = (C_1, C_2 T, C_3 I, C_4 F) \in N_q$. If $C \supset B$, then

$d_N(A, B) = d_N(A, B \cap \text{neut}(C))$. Because $C = \text{neut}(C)$ and

$d_N(A, B) = |[s(A_1 \cap A_2) - s(A_3 \cap A_4)] - [s(B_1 \cap B_2) - s(B_3 \cap B_4)]|$. Also,

$$\begin{aligned} d_N(A, B \cap \text{neut}(C)) &= |[s(A_1 \cap A_2) - s(A_3 \cap A_4)] - [s((B_1 \cap C_1) \cap (B_2 \cap C_2) - s((B_3 \cap C_3) \cap (B_4 \cap C_4)))]| \\ &= |[s(A_1 \cap A_2) - s(A_3 \cap A_4)] - [s(B_1 \cap B_2) - s(B_3 \cap B_4)]| \\ &\leq |[s(A_1 \cap A_2) - s(A_3 \cap A_4)] - [s(C_1 \cap C_2) - s(C_3 \cap C_4)]| + \\ &\quad |[s(C_1 \cap C_2) - s(C_3 \cap C_4)] - [s(B_1 \cap B_2) - s(B_3 \cap B_4)]|. \end{aligned}$$

Thus,

$$d_N(A, B \cap \text{neut}(C)) \leq d_N(A, C) + d_N(C, B).$$

Therefore $((N_q, \cap), d_N)$ is a NTMS.

Also, d_N is a NTM based on SVNQN. $((N_q, \cap), d_N)$ is a NTMS based on SVNQN.

Theorem 7: Let $N_q = \{(A_1, A_2 T, A_3 I, A_4 F) : A_1, A_2, A_3, A_4 \in P(N)\}$ be a SVNQS and $A = (A_1, A_2 T, A_3 I, A_4 F), B = (B_1, B_2 T, B_3 I, B_4 F) \in N_q$; $d_N : N_q \times N_q \rightarrow \mathbb{R}^+ \cup \{0\}$ be a function such that

$d_N(A, B) = |[s(A_1 \cup A_2) - s(A_3 \cup A_4)] - [s(B_1 \cup B_2) - s(B_3 \cup B_4)]|$. Then, d_N is a NTM on $(N_q, *_1)$.

Proof: From Theorem 1, $(N_q, *_1)$ is a NTS such that $\text{neut}(A) = A$, $\text{anti}(A) = A$. Now, we show that

$d_N(A, B) = |[s(A_1 \cup A_2) - s(A_3 \cup A_4)] - [s(B_1 \cup B_2) - s(B_3 \cup B_4)]|$ is a NTM.

a) For $A = (A_1, A_2 T, A_3 I, A_4 F), B = (B_1, B_2 T, B_3 I, B_4 F) \in N_q$, from Theorem 2, $A *_1 B \in N_q$.

b), c) and d) are shown similar to Theorem 5.

e) Let $C = (C_1, C_2T, C_3I, C_4F) \in N_q$. If $C \supset B$, B_1 and $B_2 \subset B_3$, B_1 and $B_2 \subset B_4$; then $d_N(A, B) = d_N(A, B *_1 \text{neut}(C))$. Because $C = \text{neut}(C)$ and

$$\begin{aligned} A *_1 B &= (A_1, A_2T, A_3I, A_4F) *_1 (B_1, B_2T, B_3I, B_4F) \\ &= (A_1 \cap B_1, ((A_1 \cap B_2) \cup (A_2 \cap B_1)) \cup (A_2 \cap B_2))T, ((A_1 \cap B_3) \cup (A_2 \cap B_3) \cup (A_3 \cap B_1) \cup (A_3 \cap B_2) \\ &\cup (A_3 \cap B_3))I, ((A_1 \cap B_4) \cup (A_2 \cap B_4) \cup (A_3 \cap B_4) \cup (A_4 \cap B_1) \cup (A_4 \cap B_2) \cup (A_4 \cap B_3) \cup (A_4 \cap B_4))F \end{aligned}$$

Also,

$$\begin{aligned} d_N(A, B *_1 \text{neut}(C)) &= d_N(A, B) = |[s(A_1 \cup A_2) - s(A_3 \cup A_4)] - [s(B_1 \cup B_2) - s(B_3 \cup B_4)]| \\ &\leq |[s(A_1 \cup A_2) - s(A_3 \cup A_4)] - [s(C_1 \cup C_2) - s(C_3 \cup C_4)]| + \\ &\quad |[s(C_1 \cup C_2) - s(C_3 \cup C_4)] - [s(B_1 \cup B_2) - s(B_3 \cup B_4)]|. \end{aligned}$$

Thus,

$$d_N(A, B *_1 \text{neut}(C)) \leq d_N(A, C) + d_N(C, B).$$

Therefore $((N_q, *_1), d_N)$ is a NTMS.

Also, d_N is a NTM based on SVNQN. $((N_q, *_1), d_N)$ is a NTMS based on SVNQN.

Theorem 8: Let $N_q = \{(A_1, A_2T, A_3I, A_4F) : A_1, A_2, A_3, A_4 \in P(N)\}$ be a SVNQS and $A = (A_1, A_2T, A_3I, A_4F)$, $B = (B_1, B_2T, B_3I, B_4F) \in N_q$; $d_N: N_q \times N_q \rightarrow \mathbb{R}^+ \cup \{0\}$ be a function such that

$d_N(A, B) = |[s(A_1 \cup A_2) - s(A_3 \cup A_4)] - [s(B_1 \cup B_2) - s(B_3 \cup B_4)]|$. Then, d_N is a NTM on $(N_q, \#_1)$.

Proof: From Theorem 3, $(N_q, \#_1)$ is a NTS such that $\text{neut}(A) = A$, $\text{anti}(A) = A$. Now, we show that

$d_N(A, B) = |[s(A_1 \cup A_2) - s(A_3 \cup A_4)] - [s(B_1 \cup B_2) - s(B_3 \cup B_4)]|$ is a NTM.

a) For $A = (A_1, A_2T, A_3I, A_4F)$, $B = (B_1, B_2T, B_3I, B_4F) \in N_q$, from Theorem 4, $A \#_1 B \in N_q$.

b), c) and d) are shown similar to Theorem 5.

e) Let $C = (C_1, C_2T, C_3I, C_4F) \in N_q$. If $C \supset B$, $B_3 \subset B_2$ and $B_4 = B_2$; then $d_N(A, B) = d_N(A, B \#_1 \text{neut}(C))$. Because $C = \text{neut}(C)$ and

$$\begin{aligned} A \#_1 B &= (A_1, A_2T, A_3I, A_4F) \#_1 (B_1, B_2T, B_3I, B_4F) \\ &= (A_1 \cap B_1, ((A_1 \cap B_2) \cup (A_2 \cap B_1)) \cup (A_2 \cap B_2) \cup (A_3 \cap B_2) \cup (A_4 \cap B_2) \cup (A_2 \cap B_3) \cup (A_2 \cap B_4))T, \\ &((A_1 \cap B_3) \cup (A_3 \cap B_3) \cup (A_3 \cap B_4) \cup (A_4 \cap B_3))I, ((A_1 \cap B_4) \cup (A_4 \cap B_2) \cup (A_4 \cap B_4))F \end{aligned}$$

Also,

$$\begin{aligned} d_N(A, B \#_1 \text{neut}(C)) &= d_N(A, B) = |[s(A_1 \cup A_2) - s(A_3 \cup A_4)] - [s(B_1 \cup B_2) - s(B_3 \cup B_4)]| \\ &\leq |[s(A_1 \cup A_2) - s(A_3 \cup A_4)] - [s(C_1 \cup C_2) - s(C_3 \cup C_4)]| + \\ &\quad |[s(C_1 \cup C_2) - s(C_3 \cup C_4)] - [s(B_1 \cup B_2) - s(B_3 \cup B_4)]|. \end{aligned}$$

Thus,

$$d_N(A, B \#_1 \text{neut}(C)) \leq d_N(A, C) + d_N(C, B).$$

Therefore $((N_q, \#_1), d_N)$ is a NTMS.

Also, d_N is a NTM based on SVNQN. $((N_q, \#_1), d_N)$ is a NTMS based on SVNQN.

Corollary 1: Let $N_q = \{(A_1, A_2 T, A_3 I, A_4 F): A_1, A_2, A_3, A_4 \in P(N)\}$ be a SVNQS and $A = (A_1, A_2 T, A_3 I, A_4 F), B = (B_1, B_2 T, B_3 I, B_4 F) \in N_q$; $d_N: N_q \times N_q \rightarrow \mathbb{R}^+ \cup \{0\}$ be a function. $d_N(A, B) = |[s(A_1 * A_2) - s(A_3 * A_4)] - [s(B_1 * B_2) - s(B_3 * B_4)]|$. If $* = *_1$ or $* = \#_1$, then from Theorem 7 and Theorem 8,

$d_N(A, B) = |[s(A_1 \cup A_2) - s(A_3 \cup A_4)] - [s(B_1 \cup B_2) - s(B_3 \cup B_4)]|$ is a NTM on $(N_q, *)$.

Theorem 9: Let $N_q = \{(A_1, A_2 T, A_3 I, A_4 F): A_1, A_2, A_3, A_4 \in P(N)\}$ be a SVNQS and $A = (A_1, A_2 T, A_3 I, A_4 F), B = (B_1, B_2 T, B_3 I, B_4 F) \in N_q$; $d_N: N_q \times N_q \rightarrow \mathbb{R}^+ \cup \{0\}$ be a function such that

$d_N(A, B) = |[s(A_1 \cap A_2) - s(A_3 \cap A_4)] - [s(B_1 \cap B_2) - s(B_3 \cap B_4)]|$. Then, d_N is a NTM on $(N_q, *_2)$.

Proof: From Theorem 1, $(N_q, *_2)$ is a NTS such that $\text{neut}(A) = A$, $\text{anti}(A) = A$. Now, we show that

$d_N(A, B) = |[s(A_1 \cap A_2) - s(A_3 \cap A_4)] - [s(B_1 \cap B_2) - s(B_3 \cap B_4)]|$ is a NTM.

a) For $A = (A_1, A_2 T, A_3 I, A_4 F), B = (B_1, B_2 T, B_3 I, B_4 F) \in N_q$, from Theorem 2, $A *_2 B \in N_q$.

b), c) and d) are shown similar to Theorem 6.

e) Let $C = (C_1, C_2 T, C_3 I, C_4 F) \in N_q$. If $C \subset B$, $B_1 \subset B_3$ and $B_4, B_2 \subset B_3$ and B_4 , then $d_N(A, B) = d_N(A, B *_2 \text{neut}(C))$. Because $C = \text{neut}(C)$ and

$$A *_2 B = (A_1, A_2 T, A_3 I, A_4 F) *_2 (B_1, B_2 T, B_3 I, B_4 F)$$

$$= (A_1 \cup B_1, ((A_1 \cup B_2) \cap (A_2 \cup B_1) \cap (A_2 \cup B_2))T, ((A_1 \cup B_3) \cap (A_2 \cup B_3) \cap (A_3 \cup B_1) \cap (A_3 \cup B_2) \cap (A_3 \cup B_3))I, ((A_1 \cup B_4) \cap (A_2 \cup B_4) \cap (A_3 \cup B_4) \cap (A_4 \cup B_1) \cap (A_4 \cup B_2) \cap (A_4 \cup B_3) \cap (A_4 \cup B_4))F).$$

Also,

$$\begin{aligned} d_N(A, B *_2 \text{neut}(C)) &= d_N(A, B) = |[s(A_1 \cap A_2) - s(A_3 \cap A_4)] - [s(B_1 \cap B_2) - s(B_3 \cap B_4)]| \\ &\leq |[s(A_1 \cap A_2) - s(A_3 \cap A_4)] - [s(C_1 \cap C_2) - s(C_3 \cap C_4)]| + \\ &\quad |[s(C_1 \cap C_2) - s(C_3 \cap C_4)] - [s(B_1 \cap B_2) - s(B_3 \cap B_4)]|. \end{aligned}$$

Thus,

$$d_N(A, B *_2 \text{neut}(C)) \leq d_N(A, C) + d_N(C, B).$$

Therefore $((N_q, *_2), d_N)$ is a NTMS.

Also, d_N is a NTM based on SVNQN. $((N_q, *_2), d_N)$ is a NTMS based on SVNQN.

Theorem 10: Let $N_q = \{(A_1, A_2 T, A_3 I, A_4 F): A_1, A_2, A_3, A_4 \in P(N)\}$ be a SVNQS and $A = (A_1, A_2 T, A_3 I, A_4 F), B = (B_1, B_2 T, B_3 I, B_4 F) \in N_q$; $d_N: N_q \times N_q \rightarrow \mathbb{R}^+ \cup \{0\}$ be a function such that

$d_N(A, B) = |[s(A_1 \cap A_2) - s(A_3 \cap A_4)] - [s(B_1 \cap B_2) - s(B_3 \cap B_4)]|$. Then, d_N is a NTM on $(N_q, \#_2)$.

Proof: From Theorem 3, $(N_q, \#_2)$ is a NTS such that $\text{neut}(A) = A$, $\text{anti}(A) = A$. Now, we show that

$d_N(A, B) = |[s(A_1 \cap A_2) - s(A_3 \cap A_4)] - [s(B_1 \cap B_2) - s(B_3 \cap B_4)]|$ is a NTM.

a) For $A = (A_1, A_2 T, A_3 I, A_4 F), B = (B_1, B_2 T, B_3 I, B_4 F) \in N_q$, from Theorem 5, $A \#_2 B \in N_q$.

b), c) and d) are shown similar to Theorem 6.

e) Let $C = (C_1, C_2T, C_3I, C_4F) \in N_q$. If $C \subset B, B_2 \subset B_4$; then $d_N(A, B) = d_N(A, B\#_2\text{neut}(C))$. Because $C = \text{neut}(C)$ and

$$\begin{aligned} A\#_2B &= (A_1, A_2T, A_3I, A_4F) \#_2 (B_1, B_2T, B_3I, B_4F) \\ &= (A_1 \cup B_1, ((A_1 \cup B_2) \cap (A_2 \cup B_1) \cap (A_2 \cup B_2) \cap (A_3 \cup B_2) \cap (A_4 \cup B_2) \cap (A_2 \cup B_3) \cap (A_2 \cup B_4))T, ((A_1 \cup B_3) \cap (A_3 \cup B_3) \cap (A_3 \cup B_4) \cap (A_4 \cup B_3))I, ((A_1 \cup B_4) \cap (A_4 \cup B_2) \cap (A_4 \cup B_4))F). \end{aligned}$$

Also,

$$\begin{aligned} d_N(A, B\#_2\text{neut}(C)) &= d_N(A, B) = |[s(A_1 \cap A_2) - s(A_3 \cap A_4)] - [s(B_1 \cap B_2) - s(B_3 \cap B_4)]| \\ &\leq |[s(A_1 \cap A_2) - s(A_3 \cap A_4)] - [s(C_1 \cap C_2) - s(C_3 \cap C_4)]| + \\ &\quad |[s(C_1 \cap C_2) - s(C_3 \cap C_4)] - [s(B_1 \cap B_2) - s(B_3 \cap B_4)]|. \end{aligned}$$

Thus,

$$d_N(A, B\#_2\text{neut}(C)) \leq d_N(A, C) + d_N(C, B).$$

Therefore $((N_q, \#_2), d_N)$ is a NTMS.

Also, d_N is a NTM based on SVNQN. $((N_q, \#_2), d_N)$ is a NTMS based on SVNQN.

Corollary 2: Let $N_q = \{(A_1, A_2T, A_3I, A_4F) : A_1, A_2, A_3, A_4 \in P(N)\}$ be a SVNQS and $A = (A_1, A_2T, A_3I, A_4F), B = (B_1, B_2T, B_3I, B_4F) \in N_q$; $d_N: N_q \times N_q \rightarrow \mathbb{R}^+ \cup \{0\}$ be a function. $d_N(A, B) = |[s(A_1 * A_2) - s(A_3 * A_4)] - [s(B_1 * B_2) - s(B_3 * B_4)]|$. If $* = *_2$ or $\#_2$, then from Theorem 9 and Theorem 10,

$$d_N(A, B) = |[s(A_1 \cap A_2) - s(A_3 \cap A_4)] - [s(B_1 \cap B_2) - s(B_3 \cap B_4)]| \text{ is a NTM on } (N_q, *).$$

Conclusions

In this study, we give some NTM based on SVNQN thanks to operations for SVNQN. Thus, we have added a new structure to NT structures and NQ structures. Thanks to SVNQN, other NTMS can be defined similar to this study. Also, Thanks to SVNQN, NT normed spaces can be defined similar to this study.

Abbreviations

NT: Neutrosophic triplet

NTS: Neutrosophic triplet set

NTG: Neutrosophic triplet group

NTM: Neutrosophic triplet metric

NTMS: Neutrosophic triplet metric space

NQ: Neutrosophic quadruple

NQS: Neutrosophic quadruple set

NQN: Neutrosophic quadruple number

SVNQS: Set valued neutrosophic quadruple set

SVNQN: Set valued neutrosophic quadruple number

References

- [1] Smarandache F. and Ali M. (2016) Neutrosophic triplet group. *Neural Computing and Applications*, 1-7.
- [2] Şahin M. and Kargın A. (2019) Neutrosophic triplet metric topology, *Neutrosophic Set and Systems*, 27, 154 -162
- [3] Ali M., Smarandache F., Khan M. (2018) Study on the development of neutrosophic triplet ring and neutrosophic triplet field, *Mathematics-MDPI*, 6(4), 46
- [4] Şahin M. and Kargın A. (2017) Neutrosophic triplet normed space, *Open Physics*, 15, 697-704
- [5] Şahin M. and Kargın A. (2017) Neutrosophic triplet inner product space, *Neutrosophic Operational Research*, 2, 193-215,
- [6] Smarandache F., Şahin M., Kargın A. (2018) Neutrosophic Triplet G- Module, *Mathematics – MDPI*, 6, 53
- [7] Şahin M. and Kargın A. (2019) Neutrosophic triplet b – metric space, *Neutrosophic Triplet Research*, 1
- [8] Şahin M., Kargın A., Çoban M. A. (2018) Fixed point theorem for neutrosophic triplet partial metric space, *Symmetry – MDPI*, 10, 240
- [9] Şahin M., Kargın A. (2018) Neutrosophic triplet v – generalized metric space, *Axioms – MDPI*, 7, 67
- [10] Şahin M. and Kargın A., Smarandache F. (2019) Neutrosophic triplet topology, *Neutrosophic Triplet Research* 1,
- [11] Şahin M., Kargın A. (2018) Neutrosophic triplet normed ring space, *Neutrosophic Set and Systems*, 21, 20 – 27
- [12] Şahin M., Kargın A. (2019), Neutrosophic triplet partial inner product space, *Neutrosophic Triplet Research* 1, 10 - 21
- [13] Şahin M., Kargın A. (2019), Neutrosophic triplet groups Based on set valued neutrosophic quadruple numbers, *Neutrosophic Set and Systems*, 30, 122 -131
- [14] Şahin M., Kargın A. (2019) Neutrosophic triplet partial v – generalized metric space, *Neutrosophic Triplet Research* 1, 22 - 34
- [15] Şahin M., Kargın A. (2019) Neutrosophic triplet Lie Algebra, *Neutrosophic Triplet Research* 1, 68 -78
- [16] Şahin M., Kargın A. (2019) Isomorphism theorems for Neutrosophic triplet G - module, *Neutrosophic Triplet Research* 1, 54- 67
- [17] Smarandache F. (2015) Neutrosophic quadruple numbers, refined neutrosophic quadruple numbers, absorbance law, and the multiplication of neutrosophic quadruple numbers, *Neutrosophic Set and Systems*, 10, 96 -98
- [18] Akinleye, S. A., Smarandache, F. (2016) Agboola, A. A. A. On neutrosophic quadruple algebraic structures. *Neutrosophic Sets and Systems*, 12, 122-126.
- [19] Jun, Y., Song, S. Z., Smarandache, F., & Bordbar, H. Neutrosophic quadruple BCK/BCI-algebras. *Axioms*, (2018) 7(2), 41.
- [20] Muhiuddin, G., Al-Kenani, A. N., Roh, E. H., & Jun, Y. B. (2019) Implicative neutrosophic quadruple BCK-algebras and ideals. *Symmetry*, 11(2), 277.
- [21] Li, Q., Ma, Y., Zhang, X., & Zhang, J. (2019) Neutrosophic Extended Triplet Group Based on Neutrosophic Quadruple Numbers. *Symmetry*, 11(5), 696.
- [22] Şahin, M., Kargın A. (2019), Neutrosophic triplet groups based on set valued neutrosophic quadruple numbers, *Neutrosophic Set and Systems*, 30, 122 – 131

- [23] Uluçay, V.; Şahin, M.; Olgun, N. Time-Neutrosophic Soft Expert Sets and Its Decision Making Problem. *Matematika*, 2018 34(2), 246-260.
- [24] Uluçay, V.; Kılıç, A.; Yıldız, I.; Şahin, M. (2018). A new approach for multi-attribute decision-making problems in bipolar neutrosophic sets. *Neutrosophic Sets and Systems*, 2018, 23(1), 142-159.
- [25] Uluçay, V., Kılıç, A., Şahin, M., & Deniz, H. (2019). A New Hybrid Distance-Based Similarity Measure for Refined Neutrosophic sets and its Application in Medical Diagnosis. *MATEMATIKA: Malaysian Journal of Industrial and Applied Mathematics*, 35(1), 83-94.
- [26] Broumi, S., Bakali, A., Talea, M., Smarandache, F., Singh, P. K., Uluçay, V., & Khan, M. (2019). Bipolar complex neutrosophic sets and its application in decision making problem. In *Fuzzy Multi-criteria Decision-Making Using Neutrosophic Sets* (pp. 677-710). Springer, Cham.
- [27] Bakbak, D., Uluçay, V., & Şahin, M. (2019). Neutrosophic soft expert multiset and their application to multiple criteria decision making. *Mathematics*, 7(1), 50.
- [28] Uluçay, V., & Şahin, M. (2020). Decision-Making Method based on Neutrosophic Soft Expert Graphs. In *Neutrosophic Graph Theory and Algorithms* (pp. 33-76). IGI Global.
- [29] Uluçay, V., Kılıç, A., Yıldız, İ., & Şahin, M. (2019). An Outranking Approach for MCDM-Problems with Neutrosophic Multi-Sets. *Neutrosophic Sets & Systems*, 30.
- [30] Uluçay, V., Şahin, M., & Hassan, N. (2018). Generalized neutrosophic soft expert set for multiple-criteria decision-making. *Symmetry*, 10(10), 437.

Chapter Six

Transportation Problem using Neutrosophic Quadruple Numbers

N. Gayathri^[1], Dr. M. Helen^[2],

^[1]Research Scholar, Department of Mathematics, Nirmala College for women, Coimbatore, India.

^[2]Associate Professor, Department of Mathematics, Nirmala College for women, Coimbatore, India.

E-mail: ^[1]gayupadmagayu@gmail.com, ^[2]helvic63@yahoo.co.in

ABSTRACT

This paper deals with finding an optimal solution for Neutrosophic Quadruple transportation problem which is achieved by using stepping stone method. Moreover, the optimal solution is verified with Excel solver to validate the optimal solution.

Keywords: Neutrosophic sets, Neutrosophic Quadruple numbers, Transportation Problem, optimal solution, stepping stone method, MS - excel solver.

INTRODUCTION

In business industries and business organizations, the main goal is to transfer goods/products from the industry or organization to the destination, with minimum cost, which is tagged as Transportation problem. Having perception into mathematical models and knowledge is not enough to solve the real life problems with indeterminacy. The perceptive should able to solve the modern world economically oriented issues. As far as the Transportation problem is considered, the key is to take decisions to minimize the cost. Many researchers have solved transportation problems in crisp numbers. But some actuality problem cannot be solved by the traditional method. To interpret cloudy or unclear, hazy data, researchers commenced transportation problem with fuzzy numbers. Zadeh [13] (1965) introduced fuzzy set theory, which has a membership value. Fuzzy set theory is a generalization of classical set theory. Membership value denotes the degree of truthfulness. To describe higher possibility, intuitionistic fuzzy sets were found by Atanassov [1] (1986). It comprises of membership and non-membership values. Both sets were utilized in many decision making problems.

To deal with uncertain data, Smarandache [9] (2005), introduced neutrosophic set which is an extension of fuzzy set. This set has three degrees namely, truth membership, false membership and indeterminacy membership. After this, Wang. et, [12] (2010) al. introduced single valued neutrosophic set. This set is useful in many decision making problems in real life situations. Many researchers have worked on transportation problem in fuzzy numbers, intuitionistic fuzzy numbers and neutrosophic numbers. Chanas and Kutcha [2] (1996), solved fuzzy transportation problem with cost as fuzzy numbers. Triangular fuzzy

numbers and trapezoidal fuzzy numbers were also used in transportation problem. OhEigeartaigh [7] (1982) worked on fuzzy transportation problem with triangular fuzzy demand and supply. Transportation problem with trapezoidal fuzzy numbers was solved by Jimenez and Verdegay [3] (1999). Intuitionistic fuzzy transportation problem was solved by many researchers[4, 5]. Thamaraiselvi and santhi[6] (2016) proposed a method for solving transportation problem in neutrosophic environment. Sathya geetha and selvakumari [8] (2019) came up with a new algorithm for solving transportation problem by using zero suffix method. In this paper, transportation problem with neutrosophic quadruple numbers is initiated. Digital approach is employed here, as computer technologies can also be reflect real life situations.

The paper is structured as follows: In Background section, the basic definitions and operations are recalled. In the next section, score function and accuracy function are defined to compare the neutrosophic quadruple numbers. Mathematical formulation of transportation problem and the methods to find IBFS and optimal solution are given in next sections. Two transportation problems are illustrated with neutrosophic quadruple numbers. MS – excel 2007 version is used to compute. Finally, Conclusions and further research are given.

BACKGROUND

Definition 1. [1] Let X be a space of points (objects), with a generic element in X denoted by x . A neutrosophic set A in X is characterized by a truth-membership function T_A , an indeterminacy membership function I_A and a falsity-membership function F_A . $T_A(x)$, $I_A(x)$ and $F_A(x)$ are real standard or non-standard subsets of $]0-,1+[$. That is

$$T_A: X \rightarrow]0-,1+[, I_A: X \rightarrow]0-,1+[, F_A: X \rightarrow]0-,1+[$$

There is no restriction on the sum of $T_A(x)$, $I_A(x)$ and $F_A(x)$, so $0- \leq \sup T_A(x) + \sup I_A(x) + \sup F_A(x) \leq 3^+$.

Definition 2 [1] Let X be a space of points (objects), with a generic element in X denoted by x . A single valued neutrosophic set (SVNS) A in X is characterized by truth-membership function T_A , indeterminacy-membership function I_A and falsity-membership function F_A . For each point x in X , $T_A(x)$, $I_A(x)$, $F_A(x) \in [0,1]$.

When X is continuous, a SVNS A can be written as $A = \int \langle T(x), I(x), F(x) \rangle / x, x \in X$.

When X is discrete, a SVNS A can be written as $A = \sum \langle T(x_i), I(x_i), F(x_i) \rangle / x_i, x_i \in X$.

Definition 3. [2] Let's consider an entity (i.e. a number, an idea, an object, etc.) which is represented by a known part (a) and an unknown part ($bT + cI + dF$).

Numbers of the form,
$$NQ = a + bT + cI + dF,$$

where a, b, c, d are real (or complex) numbers (or intervals or in general subsets), and

T = truth / membership / probability,

I = indeterminacy,

F = false / membership / improbability,

are called Neutrosophic Quadruple (Real respectively Complex) Numbers (or Intervals, or in general Subsets). “ a ” is called the known part of NQ , while “ $bT + cI + dF$ ” is called the unknown part of NQ .

Definition 4. [2] Let $1 = a1 + b1T + c1I + d1F$, $NQ2 = a2 + b2T + c2I + d2F$, and $\alpha \in \mathbb{R}$ (or $\alpha \in \mathbb{C}$) a real (or complex) scalar. Then,

- viii) $NQ1 + NQ2 = (a1 + a2) + (b1 + b2)T + (c1 + c2)I + (d1 + d2)F$.(Addition)
- ix) $NQ1 - NQ2 = (a1 - a2) + (b1 - b2)T + (c1 - c2)I + (d1 - d2)F$.(Subtraction)
- x) $\alpha \cdot NQ = NQ \cdot \alpha = \alpha a + \alpha bT + \alpha cI + \alpha dF$. (scalar Multiplication)
- xi) $0 \cdot T = 0 \cdot I = 0 \cdot F = 0$.
- xii) $mT + nT = (m + n)T$.
- xiii) $mI + nI = (m + n)I$.
- xiv) $mF + nF = (m + n)F$.

In the next section, we will define the score function and accuracy function of neutrosophic quadruple numbers and some basic operations.

Comparison of neutrosophic quadruple numbers by using score and accuracy function

Definition 5: Let $NQ = a + bT + cI + dF$, be a neutrosophic quadruple number, then

- (iii) Score function: $\tilde{S}(NQ) = \frac{1}{4} \left(a + \left(\frac{aT+2bI+cF}{3} \right) \right)$
- (iv) Accuracy function: $\tilde{A}(NQ) = \frac{1}{4} \{x - aT(1 + bI) - cF(1 + bI)\}$.

Definition 6: Let $NQ1 = a1 + b1T + c1I + d1F$ and $NQ2 = a2 + b2T + c2I + d2F$ be two neutrosophic quadruple numbers. Then we have either of the following:

- d) If $\tilde{S}(NQ1) < \tilde{S}(NQ2)$, then $NQ1 < NQ2$.
- e) If $\tilde{S}(NQ1) > \tilde{S}(NQ2)$, then $NQ1 > NQ2$.
- f) If $\tilde{S}(NQ1) = \tilde{S}(NQ2)$, then
 - 4) If $\tilde{A}(NQ1) < \tilde{A}(NQ2)$, then $NQ1 < NQ2$.
 - 5) If $\tilde{A}(NQ1) > \tilde{A}(NQ2)$, then $NQ > NQ2$.
 - 6) If $\tilde{A}(NQ1) = \tilde{A}(NQ2)$, then $NQ1 = NQ2$.

Note: i) We will use the notation $NQ = \langle x, aT, bI, cF \rangle$ instead of $NQ = a + bT + cI + dF$.

ii) The values x, a, b, c are real numbers as the problem deals with real life.

Example 7: Let $A = \langle 100, 12, 4, 1.8 \rangle$ and $B = \langle 56, 3.2, 6, 2.4 \rangle$ be two neutrosophic quadruple numbers, then

$$\tilde{S}(A) = 26.82 \text{ and } \tilde{S}(B) = 15.47, \text{ so } \tilde{S}(A) < \tilde{S}(B).$$

That is, $A < B$.

In the forthcoming section we define algorithm for finding Initial Basic feasible solution and Optimal solution by using stepping stone method.

Mathematical Formulation of neutrosophic quadruple transportation problem.

The Transportation problem is a special type of Linear Programming problem in which the purpose is to minimize the cost of transporting goods from ‘m’ sources to the demand of ‘n’ destinations. The origin of a TP (Transportation Problem) is the point from where the goods are despatched. The destination of a TP is locality where the goods are transported. The unit transportation cost is the cost of sending one unit of goods from the origin to the destination. The objective of the problem is to determine the quantity of goods to be shifted from each source to each destination so as to sustain the supply and demand requirements at the lowest transportation cost. Unlike simplex method, this needs a significant method of solution.

In this paper, transportation problem in neutrosophic quadruple number coefficients are discussed. The Major objective to define this problem is, in real life, there are many factors affecting transportation cost like the demand, supply, etc., To deal with the uncertainties in the transportation cost, this problem is developed. Let us suppose there are $S_i(i=1,2,\dots,m)$, sources and $D_j(j=1,2,\dots,n)$ destinations. Let C_{ij} be the cost of transporting one unit product from i^{th} source to j^{th} destination. Assume that the cost of shifting one unit product from i^{th} source is directly proportional to the j^{th} destination. Let X_{ij} be the number of units transferred from i^{th} source to j^{th} destination. The problem is to determine transportation cost so that $\sum_{i=1}^m \sum_{j=1}^n X_{ij}C_{ij}$ is minimum. The total supply is equal to the total demand for a balanced transportation problem.

The tabular representation of a transportation problem is given below.

Source/origin	Destination						Capacity	
	D1	D2	Dj		Dn
S1	C11(X11)	C12(X12)	C1j(X1j)	C1n(X1n)	a1
S2	C21(X21)	C22(X22)	C2j(X2j)	C2n(X2n)	a2
...								
S_i	$C_{i1}(X_{i1})$	$C_{i2}(X_{i2})$	$C_{ij}(X_{ij})$	$C_{in}(X_{in})$	a_i
...								
S_m	$C_{m1}(X_{m1})$	$C_{m2}(X_{m2})$	$C_{mj}(X_{mj})$	$C_{mn}(X_{mn})$	a_m
Product Requirement	b_1	b_2			b_j		b_n	

Here,

- ✓ Total supply = total demand.(i.e) $\sum_{i=1}^m a_i = \sum_{j=1}^n b_j$, where
- ✓ Capacity constraint: $\sum_{i=1}^m x_{ij} = a_i$.
- ✓ Product requirement constraint: $\sum_{i=1}^m x_{ij} = b_j$.
- ✓ Both supply and demand must satisfy the non-negativity conditions.
- ✓ The cost c_{ij} are assumed to be neutrosophic quadruple numbers so as to meet the uncertainty.
- ✓ The solution should satisfy the rim conditions.
- ✓ If the number of positive allocations must be $m + n - 1$, where
(m – number of rows, n – number of columns.)
then TP has non-degenerate solution. Otherwise it has a degenerate solution.
- ✓ The method of finding Initial basic feasible solution and optimal solution is given below.

Procedure for finding Initial Basic feasible solution and optimal solution for neutrosophic quadruple transportation problem.

Method 1: (Initial Basic feasible solution)

Initial basic feasible solution is achieved by Vogel’s approximation procedure. In this method, the costs are under uncertainty whereas the demand and supply are known.

Step 1: Convert the Neutrosophic quadruple transportation problem into a classical crisp transportation problem by using the score function and check whether the TP is balanced.

Step 2: Determine the smallest and the next smallest cost in each row and column, to find the penalty for each row and column. If there are two smallest costs, then the penalty value is zero.

Step 3: Pick the highest penalty value and make the allocation in the row/column where the corresponding cell having the minimum cost.

Step 4: If there is a tie in choosing the penalty or allocating, then pick random penalty or cost.

Step 5: After allocating, delete the row/column. Repeat this procedure until a single cell with same demand and supply values, is obtained.

Step 6: Calculate the transportation cost, which is the Initial basic feasible solution.

Method 2:

In this method, the costs are known and fixed, whereas the demand and supply values are under uncertainty. The Initial basic feasible solution is obtained by VAM. The operations on demand and supply are established using definition [4] and definition [6].

Procedure for optimal solution to NQTP:

The optimal solution is obtained by using stepping stone method. This method is applied for checking whether the IBFS obtained in Method 1 and Method 2 are optimal. It uses the non-basic variables to find the optimal solution.

Step 1: Find IBFS solution and check whether it has $m+n-1$ positive allocations.

Step 2: Select any cell which is not allocated and form a closed loop, which starts and ends with the occupied cell.

Step 3: To form the closed loop, the rules are

- Horizontal movements and vertical movements are only allowed.
- There must be only two occupied cells for any side of the loop.
- The corners of the closed loop should be of allocated cells.

Step 4: After creating the loop, starting with '+', allot alternatively '+' and '-' to all the corners of the closed loop.

Step 5: For all the unoccupied cells, create the closed loop. Add all the transportation cost in the loop to get the Net change in terms of cost.

Step 6: If all the net cost change is positive or equal to zero, then Optimal solution has been obtained.

Step 7: If not, select the most negative net cost change and repeat step 4. The negative net cost change denotes that the optimal cost can be reduced.

Step 8: Now, in the closed loop select the minimum allocated value and add & subtract it to the remaining corners of the loops marked with '+' & '-' respectively.

Step 9: The demand and supply are now balanced. Repeat step 3 – step 6.

Step 10: Compute the Optimal transportation cost.

Step 11: For Method I, the optimal solution is verified with MS – Excel solver.

Illustrative example 1:

A company needs to supply sugarcane juice from three industries E1, E2, E3 to four departmental stores F1, F2, F3, F4. The possible number of juice packets that can be transported and the requirements of the four departmental store are given in table. Determine the minimum transportation cost.

	F1	F2	F3	F4	Supply
E1	<180,1.8,1,4>	<280,1.2,6,3>	<130,1.2,16,3>	<290,14,24,12>	19
E2	<190,2.8,4,3.6>	<240,18,12,1.6>	<120,64,36,4>	<270,24,3,6>	21
E3	< 250,4.5,7,7.5 >	< 110,15,6,1.2 >	< 150,4,12,12 >	< 190,6,16,7 >	10
Demand	11	15	14	10	

Table 1

Solution: Given problem is a balanced neutrosophic quadruple transportation problem, Now, by using Score function, the neutrosophic quadruple numbers are converted into crisp numbers. If the score value is a decimal, then it can be round up to the nearest integer. In Table 2, the crisp values are given. In the next

table, the penalties for each row and each column are given. By using VAM, let us choose the highest penalty (given in bracket), which corresponds to column 2. Allot the minimum supply value 10 to the cell (3,2) and update the remaining demand units (Table 4). Continuing this procedure until a single cell with equal demand units and supply units left out, which is given in table. The resulting solution is called as Initial Basic feasible solution for the given neutrosopic quadruple transportation problem.

	F1	F2	F3	F4	Supply
E1	46	71	35	77	19
E2	49	63	39	71	21
E3	64	30	40	50	10
Demand	11	15	14	10	

Table 2

	F1	F2	F3	F4	Supply	Row penalty
E1	46	71	35	77	19	11
E2	49	63	39	71	21	10
E3	64	30	40	50	10	10
Demand	11	15	14	10		
Column penalty	3	(33)	4	21		

Table 3

	F1	F2	F3	F4	Supply	Row penalty
E1	46	71	35	77	19	11
E2	49	63	39	71	21	10
E3	64	30¹⁰	40	50	10	10
Demand	11	15	14	10		
Column penalty	3	(33)	4	21		

Table 4

	F1	F2	F3	F4	Supply	Row penalty
E1	46	71	35 ¹⁴	77	19	(11)
E2	49	63	39	71	21	10
Demand	11	5	14	10		
Column penalty	3	8	4	6		

Table 5

	F1	F2	F4	Supply	Row penalty
E1	46⁵	71	77	5	(25)
E2	49	63	71	21	14

Demand	11	5	10		
Column penalty	3	8	6		

Table 6

Proceeding like this, the Initial basic feasible solution is given by the table,

	F1	F2	F3	F4	Supply	Row penalty
E1	46 ⁵	71	35 ¹⁴	77	19	11 11 25 - -
E2	49 ⁶	63 ⁵	39	71 ¹⁰	21	10 10 14 14 14 49
E3	64	30 ¹⁰	40	50	10	10 - - - -
Demand	11	15	14	10		
Column penalty	3	33	4	21		
	3	8	4	6		
	3	8	-	6		
	49	63	-	71		
	49	63	-	-		
	49	-	-	-		

Table 7

Total number of allocated cells = m+n-1 = 6.

This solution is non-degenerate.

Minimum transportation cost = (46*5)+(35*14)+(63*5)+(71*10)+(49*6)+(30*10) = 2339.

The optimal solution is obtained by stepping stone method which is given in algorithm.

The allocation table is

	F1	F2	F3	F4	Supply
E1	46 ⁵	71	35 ¹⁴	77	19
E2	49 ⁶	63 ⁵	39	71 ¹⁰	21
E3	64	30 ¹⁰	40	50	10
Demand	11	15	14	10	

By step 2, draw closed loop for unoccupied cells, with the corners as allocated cells and calculate the net change of cost.

For example, for the cell a_{22} , the closed loop is a_{22} - a_{11} - a_{21} - a_{22} and the cost is 11. Similarly, the closed loops for other unallocated cells are created.

$$\mathbf{a_{14}:} a_{14}-a_{11}-a_{21}-a_{24} = 77-46+49-71 = 9$$

$$\mathbf{a_{23}:} a_{23}-a_{21}-a_{11}-a_{13} = 39-49+46-35 = 1$$

$$\mathbf{a_{31}:} a_{31}-a_{32}-a_{22}-a_{21} = 64-30+63-49 = 48$$

$$\mathbf{a_{33}:} a_{33}-a_{32}-a_{22}-a_{21}-a_{11}-a_{13} = 40-30+63-49+46-35 = 35$$

$$\mathbf{a_{34}:} a_{34}-a_{32}-a_{22}-a_{24} = 50-30+63-71 = 12.$$

Here, all the net cost changes are positive. So the optimal solution has been arrived, with the allocation $a_{11} \rightarrow 5$, $a_{13} \rightarrow 14$, $a_{21} \rightarrow 6$, $a_{22} \rightarrow 5$, $a_{24} \rightarrow 10$, $a_{32} \rightarrow 10$.

Therefore, the minimum transportation cost = Rs. 2339.

Comparison with excel solver:

Step 1: The problem is given into MS – excel.

Cost	F1	F2	F3	F4	Supply
E1	46	71	35	77	19
E2	49	63	39	71	21
E3	64	30	40	50	10
Demand	11	15	14	10	

Step 2: Using the “sum” function, the “Total In” and ”Total Out” values are computed. This calculates the total number of sugarcane packet juices shipped from each industry to each departmental store.

	F1	F2	F3	F4	Total out		Supply
E1	0	0	0	0	0.00	SUM(M5:P5)	19
E2	0	0	0	0	0.00	SUM(M6:P6)	21
E3	0	0	0	0	0.00	SUM(M6:P7)	10
Total in	0.00	0.00	0.00	0.00			
Demand	SUM(M5:M7)	SUM(N5:N7)	SUM(O5:O7)	SUM(P5:P7)			
	11	15	14	10			

Step 3: Total cost is found by using “Sumproduct” function. In solver, “Simplex LP” is chosen so that the global optimal solution will be obtained. “GRG nonlinear” is utilized to find local optimal solution.

Total cost =

Step 4: After entering the solver parameters, we get,

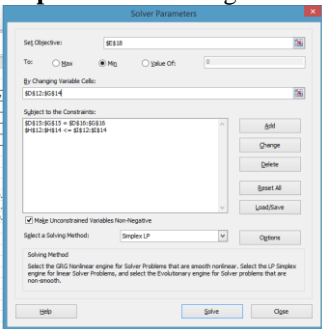

Step 5: The solver result is displayed in a box.

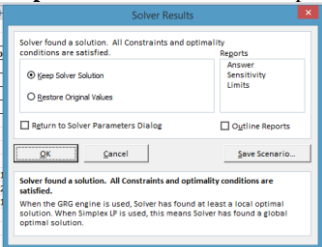

Step 6: The transportation cost is calculated now, which is same as the cost that we havw computed. So, the optimal solution is the minimum transportation cost.

Transportation cost =

Therefore, Optimal solution calculated by stepping stone method is same as the MS – Excel solver solution.

Illustrative example 2:

An agency exports regular icecream and premium Icecream in three flavours X,Y,Z to four states A,B,C,D. As the season is winter, the agency could not predict the supply units. There arises a uncertainty due to

environmental factors. So, this problem can be formed as NQTP to deal with the issue. The costs are given in crisp values whereas the demand & supply values are taken as NQ numbers.

Solution:

	A	B	C	D	Supply
X	60	40	45	55	$\langle 82,7.8,8,12.2 \rangle$
Y	70	55	65	60	$\langle 86,30,4.2,10 \rangle$
Z	80	60	55	75	$\langle 114,18.6,8.2,4.4 \rangle$
Demand	$\langle 60,4.8,7,32 \rangle$	$\langle 80,32,6.6,4 \rangle$	$\langle 46,20,5,10.2 \rangle$	$\langle 80,38,3.6,12 \rangle$	

Table 1

The row penalty and column penalty are computed.

	A	B	C	D	Supply	Row penalty
X	60	40$\langle 82,7.8,8,12.2 \rangle$	45	55	$\langle 82,7.8,8,12.2 \rangle$	5
Y	70	55	65	60	$\langle 86,30,4.2,10 \rangle$	5
Z	80	60	55	75	$\langle 114,18.6,8.2,4.4 \rangle$	5
Demand	$\langle 60,4.8,7,32 \rangle$	$\langle 80,32,6.6,4 \rangle$	$\langle 46,20,5,10.2 \rangle$	$\langle 80,38,3.6,12 \rangle$		
Column penalty	10	(15)	10	5		

Table 2

The minimum value in the column is 40. To find the minimum value between supply & demand, score function is used. The crisp value for the supply value $\langle 82,7.8,8,12.2 \rangle$ is 24 and for demand value $\langle 80,32,6.6,4 \rangle$ is 25. Allocate the minimum value to the cell a12 and proceed to the next step.

	A	B	C	D	Supply	Row penalty
Y	70	55	65	60$\langle 80,38,3.6,12 \rangle$	$\langle 86,30,4.2,10 \rangle$	5
Z	80	60	55	75	$\langle 114,18.6,8.2,4.4 \rangle$	5
Demand	$\langle 60,4.8,7,32 \rangle$	$\langle -2,24.2, -1.4, -8.2 \rangle$	$\langle 46,20,5,10.2 \rangle$	$\langle 80,38,3.6,12 \rangle$		
Column penalty	10	5	10	(15)		

Table 3

	A	B	C	Supply	Row penalty
Y	70$\langle 6,-8,0.6,-2 \rangle$	55	65	$\langle 6,-8,0.6,-2 \rangle$	10
Z	80	60	55	$\langle 114,18.6,8.2,4.4 \rangle$	5
Demand	$\langle 60,4.8,7,32 \rangle$	$\langle -2,24.2, -1.4, -8.2 \rangle$	$\langle 46,20,5,10.2 \rangle$		
Column penalty	(10)	5	10		

Table 4

The final allocated table is

	A	B	C	D	Supply
X	60	$40_{\langle 82,7.8,8,12.2 \rangle}$	45	55	$\langle 82,7.8,8,12.2 \rangle$
Y	$70_{\langle 6,-8,0.6,-2 \rangle}$	55	65	$60_{\langle 80,38,3.6,12 \rangle}$	$\langle 86,30,4.2,10 \rangle$
Z	$80_{\langle 32,4.8,3.2,0.6 \rangle}$	$60_{\langle -2,2,4.2,-1.4,-8 \rangle}$	$55_{\langle 46,20,5,10.2 \rangle}$	75	$\langle 114,18.6,8.2,4.4 \rangle$
Demand	$\langle 60,4.8,7,32 \rangle$	$\langle 80,32,6.6,4 \rangle$	$\langle 46,20,5,10.2 \rangle$	$\langle 80,38,3.6,12 \rangle$	

Table 5

Total number of allocated cells = $m+n-1 = 6$.

This solution is non-degenerate.

Minimum transportation cost = $(40 * \langle 82,7.8,8,12.2 \rangle) + (70 * \langle 6,-8,0.6,-2 \rangle) +$

$(60 * \langle 6,-8,0.6,-2 \rangle) + (80 * \langle 32,4.8,3.2,0.6 \rangle) + (60 * \langle 32,4.8,3.2,0.6 \rangle) + (55 * \langle 32,4.8,3.2,0.6 \rangle)$

$= \langle 13470,4968,1025,1617 \rangle$

Conclusions

In this article, transportation problem is dealt with neutrosophic quadruple numbers. In Method 1 costs are considered in neutrosophic quadruple numbers, whereas in Method 2, the demand and supply values are given in neutrosophic quadruple numbers to meet the indeterminacy with uncertainty. The optimal solution in Method 1 is compared with MS – Excel solver to find whether the optimal solution is local or global.

Future Research Directions

In future, this research would be built up with computer coding. Also, neutrosophic quadruple number can be put into all methodologies in resource management systems, as many indeterminacy factors are there in any business. For method 2, comparison of optimal solution with excel solver will be done as a future work.

References

1. Atanassov. K. T. (1986). Intuitionistic fuzzy sets. *Fuzzy Sets and Systems*. vol.20, no.1 .87–96.
2. Bakbak, D., Uluçay, V., & Şahin, M. (2019). Neutrosophic soft expert multiset and their application to multiple criteria decision making. *Mathematics*, 7(1), 50.
3. Broumi, S., Bakali, A., Talea, M., Smarandache, F., Singh, P. K., Uluçay, V., & Khan, M. (2019). Bipolar complex neutrosophic sets and its application in decision making problem. In *Fuzzy Multi-criteria Decision-Making Using Neutrosophic Sets* (pp. 677-710). Springer, Cham.
4. Chanas. S. and Kuchta. D. (1996). A concept of the optimal solution of the transportation problem with fuzzy cost coefficient. *Fuzzy Sets and Systems*. vol.82,no.3. 299–305.
5. Jimenez. F. and Verdegay. J. L. (1999). Solving fuzzy solid transportation problems by an evolutionary algorithm based parametric approach. *European Journal of Operational Research*, vol.117, no.3, 485–510.
6. Jianqiang. W. and Zhong. Z. (2009). Aggregation operators on intuitionistic trapezoidal fuzzy number and its application to multi-criteria decision making problems. *Journal of Systems Engineering and Electronics*. vol.20, no.2 .321–326. .
7. Hassan, N.; Uluçay, V.; Şahin, M. (2018). Q-neutrosophic soft expert set and its application in decision making. *International Journal of Fuzzy System Applications (IJFSA)*. 7(4), 37-61.

8. Li, D. F. (2010). A ratio ranking method of triangular intuitionistic fuzzy numbers and its application to MADM problems., *Computers & Mathematics with Applications*. vol.60, no.6 .1557–1570.
9. Thamaraiselvi, A and Santhi, R. (2016). A new approach for optimization of real life transportation problem in neutrosophic environment. *Mathematical Problems in Engineering*. Vol 2, Article ID 5950747, 1-9.
10. OhEigeartaigh, M. (1982). A fuzzy transportation algorithm. *Fuzzy Sets and Systems*. vol.8, no.3. 235–243.
11. Şahin M. and Kargin A., Smarandache F. (2019) Neutrosophic triplet topology, *Neutrosophic Triplet Research* 1,
12. Şahin M., Kargin A. (2018) Neutrosophic triplet normed ring space, *Neutrosophic Set and Systems*, 21, 20 – 27
13. Şahin M., Kargin A. (2018) Neutrosophic triplet v – generalized metric space, *Axioms – M DPI*, 7, 67
14. Şahin M., Kargin A. (2019) Neutrosophic triplet partial v – generalized metric space, *Neutrosophic Triplet Research* 1, 22 - 34
15. Şahin M., Kargin A. (2019) Isomorphism theorems for Neutrosophic triplet G - module, *Neutrosophic Triplet Research* 1, 54- 67.
16. Şahin M., Kargin A. (2019) Neutrosophic triplet Lie Algebra, *Neutrosophic Triplet Research* 1, 68 -78
17. Şahin M., Kargin A. (2019), Neutrosophic triplet groups Based on set valued neutrosophic quadruple numbers, *Neutrosophic Set and Systems*, 30, 122 -131
18. Şahin M., Kargin A. (2019), Neutrosophic triplet partial inner product space, *Neutrosophic Triplet Research* 1, 10 - 21
19. Şahin, M, Ecemiş, O, Uluçay, V, and Kargin, A. (2017). Some new generalized aggregation operators based on centroid single valued triangular neutrosophic numbers and their applications in multi-attribute decision making, *Asian Journal of Mathematics and Computer Research*. 16(2): 63-84
20. Şahin, M, Olgun, N, Uluçay, V, Kargin, A and Smarandache, F. (2017). A new similarity measure on falsity value between single valued neutrosophic sets based on the centroid points of transformed single valued neutrosophic numbers with applications to pattern recognition, *Neutrosophic Sets and Systems*. 15, 31-48.
21. Sathya geetha, S and Selvakumari, K. (2019). Neutrosophic transportation problems using zero suffix method. *Journal of Physics: Conference series*. 1362, 1-6.
22. Smarandache, F. (2015). Neutrosophic Quadruple Numbers, Refined Neutrosophic Quadruple Numbers, Absorbance Law, and the Multiplication of Neutrosophic Quadruple Numbers. *Neutrosophic Sets Syst*. Vol-10, 96–98.
23. Smarandache, F. (2005). Neutrosophic set, a generalization of the intuitionistic fuzzy set. *International Journal of Pure and Applied Mathematics*. vol.24, no.3. 287–297.
24. Smarandache, F. (2015). (T, I, F)-Neutrosophic Structures. *Neutrosophic Sets Syst*. Vol- 8, 3–10.
24. Uluçay, V., & Şahin, M. (2020). Decision-Making Method based on Neutrosophic Soft Expert Graphs. In *Neutrosophic centroid Theory and Algorithms* (pp. 33-76). IGI Global.
25. Uluçay, V., Kılıç, A., Şahin, M., & Deniz, H. (2019). A New Hybrid Distance-Based Similarity Measure for Refined Neutrosophic sets and its Application in Medical Diagnosis. *MATEMATIKA: Malaysian Journal of Industrial and Applied Mathematics*, 35(1), 83-94.
26. Uluçay, V., Kılıç, A., Yıldız, İ., & Şahin, M. (2019). An Outranking Approach for MCDM-Problems with Neutrosophic Multi-Sets. *Neutrosophic Sets & Systems*, 30.

27. Uluçay, V., Şahin, M., & Hassan, N. (2018). Generalized neutrosophic soft expert set for multiple-criteria decision-making. *Symmetry*, 10(10), 437.
28. Ulucay, V.; Şahin, M.;Olgun, N. (2018). Time-Neutrosophic Soft Expert Sets and Its Decision Making Problem. *Matematika*. 34(2), 246-260.
29. Uluçay, V.;Kiliç, A.;Yildiz, I.;Sahin, M. (2018). A new approach for multi-attribute decision-making problems in bipolar neutrosophic sets. *Neutrosophic Sets and Systems*. 23(1), 142-159.
30. Wang. H, Smarandache. F, Zhang. Y.Q., and Sunder raman. R. (2010). Single valued neutrosophic sets. *Multi space and Multi structure*, vol. 4, 410–413.
31. Zadeh. L. A. (1965). Fuzzy sets. *Information and Control*, vol.8, no.3. 338–353.

SECTION TWO

Decision Making

Chapter Seven

To Solve Assignment Problem by Centroid Method in Neutrosophic Environment

Tuhin Bera ¹ and Nirmal Kumar Mahapatra ²

¹ Department of Mathematics, Boror S. S. High School, Bagnan, Howrah-711312, WB, India.

E-mail : tuhin78bera@gmail.com

² Department of Mathematics, Panskura Banamali College, Panskura RS-721152, WB, India.

E-mail : nirmal_hridoy@yahoo.co.in

ABSTRACT

The motivation of the present work is to solve an assignment problem in an uncertain atmosphere where each entry of the cost matrix is a single valued triangular neutrosophic number (SVTrN-number). Using the co-ordinates of centroids of three triangles in the geometrical configuration of an SVTrN-number, a parameter (graded in $[0,1]$) based linear ranking function is newly constructed for ranking of SVTrN-numbers. Adopting this ranking function, an assignment problem is solved by developing an efficient solution algorithm. Here, decision maker (i.e., manager of a farm house, management supervisor of an industry, etc) will have a flexibility to optimise a problem with respect to the different grades of a parameter (This grade may be referred as a hidden state of optimisation problem to be solved as applicable in various situation). This is the key feature of this study and such approach is essential in the present socio-economic scenario. Finally, a real life problem is demonstrated and solved by practicing the newly developed algorithm.

Keywords : Neutrosophic set; Single valued triangular neutrosophic number; Ranking function; Assignment problem.

INTRODUCTION

The fuzzy set and intuitionistic fuzzy set theory were adopted effectively from their initiation to solve optimization problems at vague and uncertain situation in our daily life activities. The intuitionistic fuzzy set theory introduced by Atanassov [3] deals the degree of belongingness and the degree of non-belongingness of an object to a set simultaneously. Thus it is the more generalisation concept than fuzzy set theory which can provide only the degree of belongingness of an object to a set. Both the theories can only handle incomplete information not indeterminate. To access both incomplete and indeterminate information, Smarandache [15,16] generalised the intuitionistic fuzzy set to neutrosophic set (NS) where each proposition is estimated by three independent parameters namely truth-membership value (T), indeterminacy-membership value (I) and falsity-membership value (F) with $T, I, F \in]-0, 1+[$ and $-0 \leq \sup T + \sup I +$

$\sup F \leq 3^+$. Smarandache used to practice the standard or nonstandard subsets of $]^{-0}, 1^+[$ in philosophical ground. So, to incorporate this concept in real life scenario, Wang et al. [19] brought the concept of single valued neutrosophic set which takes the value from real standard subset of $[0,1]$ only. Bera and Mahapatra [4-6] have developed some optimisation techniques in neutrosophic view and have applied these in real life. Recently, neutrosophic theory are being practiced successfully for decision making [8,13,14,17,18] in a progressive way.

The notion of fuzzy number, intuitionistic fuzzy number and finally neutrosophic number as well as their ranking plays a key role to develop the multi-attributive decision making and optimization theory in uncertain environment. So, researchers adopted several ranking techniques in fuzzy and intuitionistic fuzzy environment in different time. Lin and Wen [10] solved an assignment problem with fuzzy interval number costs. Chen [7] proposed a fuzzy assignment model and proved some related theorems. Mukherjee and Basu [11] took an attempt to solve fuzzy assignment problem by transforming it into a crisp assignment problem in linear programming form on the basis of Yager's ranking method [20]. Angellov [2] studied the principles of fuzzy optimization problems critically and proposed intuitionistic fuzzy programming. Some different ranking techniques [1,9,12,21] of fuzzy and intuitionistic fuzzy number are reported in this literature.

Decision making is a process of solving the problem and achieving goals under asset of some constraints but it is very difficult in some cases due to incomplete and imprecise information. The hidden characters in several cases (e.g., degree of road condition for driving a bus to get a profit, the different maintenance costs of a bus to have a maximum profit, degree of expenditure of a business farm in a financial year to meet a maximum profit, awareness level of nearer society to attain the smooth run of a clinical pharmacy etc) are not considered by decision makers. Then the result of decision making may not be fruitful as a whole. In this study, we have tried to emphasize all these in decision making process to have a fair output. Decision maker may apply the method innovated here in different atmosphere successfully. Thus the asset of constraints provided and hidden criterions are allowed together to reach a conclusion and it is the novelty of this work.

In the present work, the basic goal is to solve an assignment problem in an uncertain atmosphere where each entry of the cost matrix is an SVTrN-number. For that, a parameter (graded in $[0,1]$) based linear ranking function is constructed (for the first time) by use of centroids of three triangles in the geometrical configuration of an SVTrN-number. The parameter of ranking function and its grade are respectively referred as a hidden criteria and the degree of hidden criteria of a problem. The concept of centroid based ranking function used here is a completely new idea. Adopting this ranking function, an efficient solution algorithm is developed. Here, decision makers (i.e., manager of a farm house, management supervisor of an industry, etc) will have a flexibility to optimise a problem with respect to the different grades of a hidden state of optimisation problem as applicable in various situations. Such approach is essential in the present socio-economic scenario. The efficiency of newly developed algorithm is examined by solving a real life problem.

The contents are organized as follows. Some useful definitions and results related to neutrosophic set, fuzzy number are placed in Section 2. The concept of SVTrN-number, its structural characteristics and the ranking of two or more SVTrN-numbers are introduced in Section 3. Section 4 deals with the concept of assignment problem in neutrosophic environment and its solution approach. In Section 5, the concept is demonstrated to solve a real problem. Finally, the present study is briefly drawn in Section 6.

BACKGROUND

We shall now remember some definitions related to fuzzy set and neutrosophic set for completeness.

Definition 1. [15] Let U be a space of points and $u \in U$ be an arbitrary element. Then an NS B over U is defined by a triplet namely truth-membership function T_B , an indeterminacy-membership function I_B and a falsity-membership function F_B which are real standard or non-standard subsets of $]^{-0}, 1^+[$ i.e., $T_B, I_B, F_B: U \rightarrow]^{-0}, 1^+[$. Thus an NS on U is defined as : $B = \{ \langle u, T_B(u), I_B(u), F_B(u) \rangle : u \in U \}$ so that $^{-0} \leq \sup T_B(u) + \sup I_B(u) + \sup F_B(u) \leq 3^+$. Here $1^+ = 1 + \epsilon$, where 1 is its standard part and ϵ is its non-standard part. Similarly $^{-0} = 0 - \epsilon$, where 0 is its standard part and ϵ is its non-standard part. The non-standard subset of $]^{-0}, 1^+[$ is basically practiced in philosophical ground but it is difficult to adopt in real field. So, the standard subset of $]^{-0}, 1^+[$ i.e., $[0,1]$ is used in real neutrosophic environment.

Definition 2. [19] A single valued neutrosophic set B over a universe U is a special type of NS where

$T_B(\mathbf{u}), I_B(\mathbf{u})$ and $F_B(\mathbf{u})$ are real standard elements of $[0, 1]$ for $\mathbf{u} \in U$. Thus a single valued neutrosophic set B is defined as : $B = \{ \langle \mathbf{u}, T_B(\mathbf{u}), I_B(\mathbf{u}), F_B(\mathbf{u}) \rangle : \mathbf{u} \in U \}$ with $T_B(\mathbf{u}), I_B(\mathbf{u}), F_B(\mathbf{u}) \in [0, 1]$ and $0 \leq \sup T_B(\mathbf{u}) + \sup I_B(\mathbf{u}) + \sup F_B(\mathbf{u}) \leq 3$.

Definition 3. [1] A trapezoidal fuzzy number is expressed as $A = (x_0, y_0, \sigma, \eta)$ where $[x_0, y_0]$ is interval defuzzifier and $\sigma(> 0), \eta(> 0)$ are respectively called left fuzziness, right fuzziness. The support of A is $(x_0 - \sigma, y_0 + \eta)$ and the membership function is given as :

$$A(x) = \begin{cases} \frac{1}{\sigma}(x - x_0 + \sigma), & x_0 - \sigma \leq x \leq x_0, \\ 1, & x \in [x_0, y_0], \\ \frac{1}{\eta}(y_0 - x + \eta), & y_0 \leq x \leq y_0 + \eta, \\ 0, & \text{otherwise.} \end{cases}$$

Thus A consists of a pair (A_L, A_R) of functions so that $A_L(x) = \frac{1}{\sigma}(x - x_0 + \sigma)$ is bounded monotone increasing left continuous function and $A_R(x) = \frac{1}{\eta}(y_0 - x + \eta)$ is bounded monotone decreasing right continuous function.

Single valued triangular neutrosophic number

Here, an SVTrN-number is constructed in a different way with the study of its characteristics. Then a ranking function is defined to compare such numbers.

Definition 4. A single valued neutrosophic set \tilde{m} of the form $\langle [p_1, q_1, \varsigma_1, \delta_1], [p_2, q_2, \varsigma_2, \delta_2], [p_3, q_3, \varsigma_3, \delta_3] \rangle$ defined on the set of real numbers R where $\varsigma_i(> 0), \delta_i(> 0)$ are respectively called left spreads, right spreads and $[p_i, q_i]$ are the modal intervals of truth-membership, indeterminacy-membership and the falsity-membership functions for $i = 1, 2, 3$, respectively in \tilde{m} is called a single valued neutrosophic number (SVN-number). The truth-membership, indeterminacy-membership and the falsity-membership functions of \tilde{m} are given as follows :

$$T_{\tilde{m}}(x) = \begin{cases} \frac{1}{\varsigma_1}(x - p_1 + \varsigma_1), & p_1 - \varsigma_1 \leq x \leq p_1, \\ 1, & x \in [p_1, q_1], \\ \frac{1}{\delta_1}(q_1 - x + \delta_1), & q_1 \leq x \leq q_1 + \delta_1, \\ 0, & \text{otherwise.} \end{cases}$$

$$I_{\tilde{m}}(x) = \begin{cases} \frac{1}{\varsigma_2}(p_2 - x), & p_2 - \varsigma_2 \leq x \leq p_2, \\ 0, & x \in [p_2, q_2], \\ \frac{1}{\delta_2}(x - q_2), & q_2 \leq x \leq q_2 + \delta_2, \\ 1, & \text{otherwise.} \end{cases}$$

$$F_{\tilde{m}}(x) = \begin{cases} \frac{1}{\varsigma_3}(p_3 - x), & p_3 - \varsigma_3 \leq x \leq p_3, \\ 0, & x \in [p_3, q_3], \\ \frac{1}{\delta_3}(x - q_3), & q_3 \leq x \leq q_3 + \delta_3, \\ 1, & \text{otherwise.} \end{cases}$$

Thus an SVN-number \tilde{m} consists of three pairs $(T_{\tilde{m}}^l, T_{\tilde{m}}^u), (I_{\tilde{m}}^l, I_{\tilde{m}}^u), (F_{\tilde{m}}^l, F_{\tilde{m}}^u)$ of functions satisfying the following requirements.

(i) $T_{\tilde{m}}^l(x) = \frac{1}{\varsigma_1}(x - p_1 + \varsigma_1), I_{\tilde{m}}^u(x) = \frac{1}{\delta_2}(x - q_2), F_{\tilde{m}}^u(x) = \frac{1}{\delta_3}(x - q_3)$ are bounded monotone increasing continuous function.

(ii) $T_{\tilde{m}}^u(x) = \frac{1}{\delta_1}(q_1 - x + \delta_1), I_{\tilde{m}}^l(x) = \frac{1}{\varsigma_2}(p_2 - x), F_{\tilde{m}}^l(x) = \frac{1}{\varsigma_3}(p_3 - x)$ are bounded monotone decreasing continuous function.

Definition 5 If three modal intervals in an SVN-number \tilde{p} are replaced by a point, then \tilde{p} is called an

SVTrN-number. Thus $\tilde{c} = \langle [c_0, \sigma_1, \eta_1], [c_0, \sigma_2, \eta_2], [c_0, \sigma_3, \eta_3] \rangle$ is an SVTrN-number.

Let $\tilde{p} = \langle [p, \varsigma_1, \eta_1], [p, \varsigma_2, \eta_2], [p, \varsigma_3, \eta_3] \rangle$ and $\tilde{q} = \langle [q, \xi_1, \delta_1], [q, \xi_2, \delta_2], [q, \xi_3, \delta_3] \rangle$ be two SVTrN-numbers. Then for any real number λ ,

(i) Addition :

$$\tilde{p} + \tilde{q} = \langle [p + q, \varsigma_1 + \xi_1, \eta_1 + \delta_1], [p + q, \varsigma_2 + \xi_2, \eta_2 + \delta_2], [p + q, \varsigma_3 + \xi_3, \eta_3 + \delta_3] \rangle.$$

(ii) Scalar multiplication :

$$\lambda \tilde{p} = \langle ([\lambda p, \lambda \varsigma_1, \lambda \eta_1], [\lambda p, \lambda \varsigma_2, \lambda \eta_2], [\lambda p, \lambda \varsigma_3, \lambda \eta_3]) \text{ for } \lambda > 0.$$

$$\lambda \tilde{p} = \langle ([\lambda p, -\lambda \eta_1, -\lambda \varsigma_1], [\lambda p, -\lambda \eta_2, -\lambda \varsigma_2], [\lambda p, -\lambda \eta_3, -\lambda \varsigma_3]) \text{ for } \lambda < 0.$$

Graphical mode 6 By Definition 5, we consider different support (i.e. bases of triangles formed) for truth-membership, indeterminacy-membership and falsity-membership functions. Thus, the supports and heights are allowed together to differ the value of truth-membership, indeterminacy-membership and falsity-membership functions in the present study. Then decision maker has a scope of flexibility to choose and compare different SVTrN-numbers in their study. The fact is shown by the graphical presentation (Figure : SVTrN-number).

Definition 7 The zero SVTrN-number is denoted by $\tilde{0}$ and is defined as : $\tilde{0} = \langle [0, 0, 0], [0, 0, 0], [0, 0, 0] \rangle$.

Ranking function 8 The co-ordinate of different points corresponding to an SVTrN-number $\tilde{a} = \langle [a, \sigma_1, \eta_1], [a, \sigma_2, \eta_2], [a, \sigma_3, \eta_3] \rangle$ in the graphical presentation are $J(a - \sigma_1, 0), E(a, 1), P(a + \eta_1, 0)$ for truth membership function, $D(a - \sigma_2, 0), M(a, 0), S(a + \eta_2, 0)$ for indeterminacy membership function and $C(a - \sigma_3, 0), M(a, 0), G(a + \eta_3, 0)$ for falsity membership function. Divide each triangle along the perpendicular line EM .

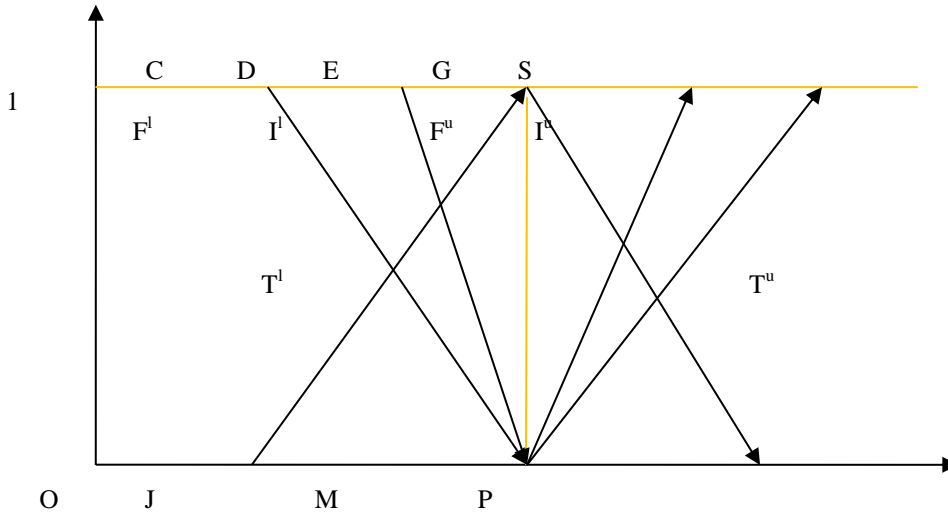

Figure : SVTrN-number

Thus we get another two triangles namely JEM and PEM corresponding to truth membership function. The centroid of triangles JEM and PEM are $G_1 = (a_0 - \frac{\sigma_1}{3}, \frac{1}{3})$ and $G_2 = (a_0 + \frac{\eta_1}{3}, \frac{1}{3})$ respectively. The center of the centroids G_1 and G_2 is the midpoint i.e., $(\frac{6a_0 - \sigma_1 + \eta_1}{6}, \frac{1}{3})$. Define the value of \tilde{a} corresponding to truth membership function as $V_T(\tilde{a}) = \frac{1}{3}(\frac{6a_0 - \sigma_1 + \eta_1}{6})$. The centroids are obviously balancing points of triangles JEM and PEM respectively. But their center is chosen to construct a ranking function as it is more balancing point for these triangles.

Corresponding to indeterminacy membership function, we get two triangles DME and SME . The centroid of triangles DME and SME are $G_3 = (a_0 - \frac{\sigma_2}{3}, \frac{2}{3})$ and $G_4 = (a_0 + \frac{\eta_2}{3}, \frac{2}{3})$ respectively. Their center is

$(\frac{6a_0 - \sigma_2 + \eta_2}{6}, \frac{2}{3})$. Define the value of \tilde{a} corresponding to indeterminacy membership function as $V_I(\tilde{a}) = \frac{2}{3}(\frac{6a_0 - \sigma_2 + \eta_2}{6})$.

Finally, the triangle for falsity membership function is divided into two triangles *CME* and *GME*. Their centroid are $G_5 = (a_0 - \frac{\sigma_3}{3}, \frac{2}{3})$ and $G_6 = (a_0 + \frac{\eta_3}{3}, \frac{2}{3})$ respectively. The center of G_5 and G_6 is $(\frac{6a_0 - \sigma_3 + \eta_3}{6}, \frac{2}{3})$. Define the value of \tilde{a} corresponding to falsity membership function as $V_F(\tilde{a}) = \frac{2}{3}(\frac{6a_0 - \sigma_3 + \eta_3}{6})$.

For an arbitrary parameter ρ graded in $[0,1]$, the ρ - weighted value of an SVTrN- number \tilde{a} is denoted by $V_\rho(\tilde{a})$ and is defined as :

$$\begin{aligned} V_\rho(\tilde{a}) &= V_T(\tilde{a})\rho^n + V_I(\tilde{a})(1 - \rho^n) + V_F(\tilde{a})(1 - \rho^n), \quad n \text{ being any natural number} \\ &= \frac{1}{18}[(6a_0 - \sigma_1 + \eta_1)\rho^n + 2\{(6a_0 - \sigma_2 + \eta_2) + (6a_0 - \sigma_3 + \eta_3)\}(1 - \rho^n)]. \end{aligned}$$

Proposition 9 The ρ - weighted value obeys the following disciplines for two SVTrN-numbers \tilde{a}, \tilde{b} .

- (i) $V_\rho(\tilde{a} \pm \tilde{b}) = V_\rho(\tilde{a}) \pm V_\rho(\tilde{b})$.
- (ii) $V_\rho(\mu\tilde{a}) = \mu V_\rho(\tilde{a})$, μ being any real number.
- (iii) $V_\rho(\tilde{a} - \tilde{a}) = V_\rho(\tilde{0})$.
- (iv) $V_\rho(\tilde{a})$ is monotone increasing or decreasing or constant according as $V_T(\tilde{a}) > V_I(\tilde{a}) + V_F(\tilde{a})$ or $V_T(\tilde{a}) < V_I(\tilde{a}) + V_F(\tilde{a})$ or $V_T(\tilde{a}) = V_I(\tilde{a}) + V_F(\tilde{a})$ respectively.

Definition 10 Let $SVTrN(\mathbf{R})$ be the set of all SVTrN-numbers defined over \mathbf{R} . For $\rho \in [0, 1]$, a mapping $\mathfrak{R}_\rho: SVTrN(\mathbf{R}) \rightarrow \mathbf{R}$ is called a ranking function and it is defined as : $\mathfrak{R}_\rho(\tilde{m}) = V_\rho(\tilde{m})$ for $\tilde{m} \in SVTrN(\mathbf{R})$. For $\tilde{m}, \tilde{s} \in SVTrN(\mathbf{R})$, their order is defined as follows :

$$V_\rho(\tilde{m}) > V_\rho(\tilde{s}) \Leftrightarrow \tilde{m} >_{\mathfrak{R}_\rho} \tilde{s}, \quad V_\rho(\tilde{m}) < V_\rho(\tilde{s}) \Leftrightarrow \tilde{m} <_{\mathfrak{R}_\rho} \tilde{s}, \quad V_\rho(\tilde{m}) = V_\rho(\tilde{s}) \Leftrightarrow \tilde{m} =_{\mathfrak{R}_\rho} \tilde{s}.$$

Corollary 11 Consider two SVTrN-numbers $\tilde{c} = \langle [x, \sigma_1, \eta_1], [x, \sigma_2, \eta_2], [x, \sigma_3, \eta_3] \rangle$ and $\tilde{d} = \langle [p, \omega_1, \xi_1], [p, \omega_2, \xi_2], [p, \omega_3, \xi_3] \rangle$ with $x = p$. Then $\tilde{c} >_{\mathfrak{R}_\rho} \tilde{d}$ iff the followings hold.

- (i) $(\eta_1 + \omega_1) > (\sigma_1 + \xi_1)$ for $\rho = 1$.
- (ii) $(\eta_2 + \eta_3) + (\omega_2 + \omega_3) > (\sigma_2 + \sigma_3) + (\xi_2 + \xi_3)$ for $\rho = 0$.

Proof. (i) $\tilde{c} >_{\mathfrak{R}_\rho} \tilde{d} \Leftrightarrow V_\rho(\tilde{c}) > V_\rho(\tilde{d})$

$$\begin{aligned} &\Leftrightarrow \frac{1}{18}[(6x - \sigma_1 + \eta_1)\rho^n + 2\{(6x - \sigma_2 + \eta_2) + (6x - \sigma_3 + \eta_3)\}(1 - \rho^n)] \\ &> \frac{1}{18}[(6p - \omega_1 + \xi_1)\rho^n + 2\{(6p - \omega_2 + \xi_2) + (6p - \omega_3 + \xi_3)\}(1 - \rho^n)] \\ &\Leftrightarrow (\eta_1 - \sigma_1)\rho^n + 2\{(\eta_2 - \sigma_2) + (\eta_3 - \sigma_3)\}(1 - \rho^n) \\ &> (\xi_1 - \omega_1)\rho^n + 2\{(\xi_2 - \omega_2) + (\xi_3 - \omega_3)\}(1 - \rho^n) \quad (as \quad x = p) \\ &\Leftrightarrow (\eta_1 - \sigma_1)\rho^n > (\xi_1 - \omega_1)\rho^n \quad (as \quad \rho = 1) \\ &\Leftrightarrow \eta_1 + \omega_1 > \sigma_1 + \xi_1 \quad (as \quad \rho = 1) \end{aligned}$$

(ii) $\tilde{c} >_{\mathfrak{R}_\rho} \tilde{d} \Leftrightarrow V_\rho(\tilde{c}) > V_\rho(\tilde{d})$

$$\begin{aligned} &\Leftrightarrow \frac{1}{18}[(6x - \sigma_1 + \eta_1)\rho^n + 2\{(6x - \sigma_2 + \eta_2) + (6x - \sigma_3 + \eta_3)\}(1 - \rho^n)] \\ &> \frac{1}{18}[(6p - \omega_1 + \xi_1)\rho^n + 2\{(6p - \omega_2 + \xi_2) + (6p - \omega_3 + \xi_3)\}(1 - \rho^n)] \\ &\Leftrightarrow (\eta_1 - \sigma_1)\rho^n + 2\{(\eta_2 - \sigma_2) + (\eta_3 - \sigma_3)\}(1 - \rho^n) \\ &> (\xi_1 - \omega_1)\rho^n + 2\{(\xi_2 - \omega_2) + (\xi_3 - \omega_3)\}(1 - \rho^n) \quad (as \quad x = p) \\ &\Leftrightarrow \{(\eta_2 - \sigma_2) + (\eta_3 - \sigma_3)\}(1 - \rho^n) > \{(\xi_2 - \omega_2) + (\xi_3 - \omega_3)\}(1 - \rho^n) \quad (as \quad \rho = 0) \\ &\Leftrightarrow (\eta_2 + \eta_3) + (\omega_2 + \omega_3) > (\sigma_2 + \sigma_3) + (\xi_2 + \xi_3) \quad (as \quad \rho = 0) \end{aligned}$$

Assignment problem in neutrosophic environment

In classical sense, an assignment problem is defined by an $n \times n$ cost matrix of real numbers as given in Table 1 which assigns men to offices, jobs to machines, cars to routes, drivers to cars, problems to different research teams etc. It is assumed that one person can perform one job at a time and thus all the jobs will be assigned to all available persons and so on in other cases. The problem is optimal if it minimizes the total cost or maximizes the profit of performing all the jobs.

Table 1 : Cost matrix for crisp assignment problem
JOBS

		J_1	J_2	J_3	\dots	J_n
PERSONS	P_1	c_{11}	c_{12}	c_{13}	\dots	c_{1n}
	P_2	c_{21}	c_{22}	c_{23}	\dots	c_{2n}
	\dots	\dots	\dots	\dots	\dots	\dots
	P_n	c_{n1}	c_{n2}	c_{n3}	\dots	c_{nn}

where c_{ij} is the cost of assigning the j^{th} job to the i^{th} person. Mathematically, the problem can be put as :

$$\begin{aligned}
 &\text{Determine } x_{ij} \geq 0, \quad i, j = 1, 2, \dots, n \text{ which optimize } z = \sum_{i=1}^n \sum_{j=1}^n c_{ij} x_{ij} \\
 &\text{such that } \sum_{j=1}^n x_{ij} = 1, \quad 1 \leq i \leq n \\
 &\quad \text{and } \sum_{i=1}^n x_{ij} = 1, \quad 1 \leq j \leq n \\
 &\text{with } x_{ij} = \begin{cases} 1, & \text{if the } j^{th} \text{ job is assigned to the } i^{th} \text{ person} \\ 0, & \text{otherwise.} \end{cases}
 \end{aligned}$$

In the present context, we consider the costs c_{ij} as SVTrN-numbers (we write \tilde{a}_{ij}), then the total cost $\tilde{z} = \sum_{i=1}^n \sum_{j=1}^n \tilde{a}_{ij} x_{ij}$ becomes an SVTrN-number. Then, we can not apply the crisp concept directly to optimize it. We shall adopt the following technique for that.

Proposed method 12 The following steps are proposed to solve an assignment problem in neutrosophic environment.

Step 1. From the given problem, form a neutrosophic cost matrix $[\tilde{a}_{ij}]$ (say) whose each entry is SVTrN-number.

Step 2. Find out the least cost in each row from ρ -weighted value functions using a pre-assigned ρ and subtract that least cost from all costs in respective row. Proceed the fact in each column also.

Step 3. Mark those cells where subtraction results are equivalent to $V_\rho(\tilde{0})$.

Step 4. Draw the least number of horizontal and vertical lines to cover all the marked cells of present matrix.

Step 5. If the number of lines drawn is equal to the order of matrix, optimality arises. Then go to Step 6, otherwise go to Step 8.

Step 6. Specify a number of marked cells equal to the order of matrix such that each column and each row contains exactly one marked cell.

Step 7. Add the costs of neutrosophic cost matrix $[\tilde{a}_{ij}]$ corresponding to the position of specified marked cells and calculate the ρ -weighted value function of that sum. This gives the optimal numeric value for the pre-assigned ρ .

Step 8. Find the smallest SVTrN-number among the uncovered SVTrN-numbers left after drawing the lines as in Step 4 using ρ -weighted value function for the pre-assigned ρ . Subtract it from all uncovered SVTrN-numbers of the present matrix and add it with the SVTrN-number lying at the intersection of horizontal and vertical lines. Keep intact all remaining SVTrN-numbers.

Step 9. Repeat the steps from 3 to 5.

Remark 13

1. The algorithm developed here is applied for only the minimization problem. For the maximization problem (e.g. the cost matrix is profit matrix), before to go to Step 2, we need to multiply each cost by (-1). Thus the maximum profit is equivalent to minimum cost. Our effort will be then find the solution to get the minimum

cost which will attain the maximum profit of the primary problem.

2. If the neutrosophic cost matrix of an assignment problem contains some costs \tilde{a}_{ij} such that $\tilde{a}_{ij} <_{\mathfrak{R}_\rho} \tilde{0}$ then we add a constant SVTrN-number of large value with each cost to make all the costs non-negative. Then we proceed Step 2.

3. If the neutrosophic cost matrix is not square i.e., if the number of persons and number of jobs are not equal, the problem is then an unbalanced problem. We add a fictitious job or person, whichever has the deficiency, with zero SVTrN-number as the respective costs. Then the resulting problem is a balanced one and we therefore apply the algorithm.

Definition 14 An SVTrN-number is said to be constant if it is ρ independent after transforming it into a ρ -weighted value function.

Thus $\tilde{b} = \langle [5,3,89], [5,4,1], [5,1,2] \rangle$ is a constant SVTrN-number as $V_\rho(\tilde{b}) = 6.44$ (approx) whatever the value of ρ may be.

Theorem 15 If a constant SVTrN-number be added to any row and / or any column of the cost matrix of an assignment problem in neutrosophic environment, then the optimal solution is unique for both the new problem and the original problem.

Proof. Let $[\tilde{a}_{ij}]$ be the cost matrix and suppose two constant SVTrN-numbers $\tilde{\chi}_i, \tilde{\lambda}_j$ be added to the i -th row and j -th column respectively for $i, j = 1, \dots, n$. Let $[\tilde{a}'_{ij}]$ be the new cost matrix where $\tilde{a}'_{ij} = \tilde{a}_{ij} + \tilde{\chi}_i + \tilde{\lambda}_j$ and the two objective functions be $\tilde{z} =_{\mathfrak{R}_\rho} \sum_{i=1}^n \sum_{j=1}^n \tilde{a}_{ij}x_{ij}$, $\tilde{z}' =_{\mathfrak{R}_\rho} \sum_{i=1}^n \sum_{j=1}^n \tilde{a}'_{ij}x_{ij}$. Now,

$$\begin{aligned} \tilde{z}' &=_{\mathfrak{R}_\rho} \sum_{i=1}^n \sum_{j=1}^n \tilde{a}'_{ij}x_{ij} \\ \Rightarrow V_\rho(\tilde{z}') &= V_\rho(\sum_{i=1}^n \sum_{j=1}^n \tilde{a}'_{ij}x_{ij}) \\ \Rightarrow V_\rho(\tilde{z}') &= \sum_{i=1}^n \sum_{j=1}^n V_\rho(\tilde{a}'_{ij}x_{ij}) \quad [\text{by Proposition 9}] \\ \Rightarrow V_\rho(\tilde{z}') &= \sum_{i=1}^n \sum_{j=1}^n V_\rho[(\tilde{a}_{ij} + \tilde{\chi}_i + \tilde{\lambda}_j)x_{ij}] \\ \Rightarrow V_\rho(\tilde{z}') &= \sum_{i=1}^n \sum_{j=1}^n V_\rho(\tilde{a}_{ij}x_{ij}) + \sum_{i=1}^n \sum_{j=1}^n V_\rho(\tilde{\chi}_i x_{ij}) + \sum_{i=1}^n \sum_{j=1}^n V_\rho(\tilde{\lambda}_j x_{ij}) \\ \Rightarrow V_\rho(\tilde{z}') &= V_\rho(\sum_{i=1}^n \sum_{j=1}^n \tilde{a}_{ij}x_{ij}) + V_\rho(\sum_{i=1}^n \sum_{j=1}^n \tilde{\chi}_i x_{ij}) + V_\rho(\sum_{i=1}^n \sum_{j=1}^n \tilde{\lambda}_j x_{ij}) \\ \Rightarrow V_\rho(\tilde{z}') &= V_\rho(\tilde{z}) + V_\rho(\sum_{i=1}^n \tilde{\chi}_i \sum_{j=1}^n x_{ij}) + V_\rho(\sum_{j=1}^n \tilde{\lambda}_j \sum_{i=1}^n x_{ij}) \\ \Rightarrow V_\rho(\tilde{z}') - V_\rho(\tilde{z}) &= V_\rho(\sum_{i=1}^n \tilde{\chi}_i) + V_\rho(\sum_{j=1}^n \tilde{\lambda}_j) \quad [\text{as } \sum_{i=1}^n x_{ij} = \sum_{j=1}^n x_{ij} = 1] \\ \Rightarrow V_\rho(\tilde{z}' - \tilde{z}) &= \sum_{i=1}^n V_\rho(\tilde{\chi}_i) + \sum_{j=1}^n V_\rho(\tilde{\lambda}_j) \\ \Rightarrow V_\rho(\tilde{z}' - \tilde{z}) &= \alpha + \beta \quad [\text{for } \sum_{i=1}^n V_\rho(\tilde{\chi}_i) = \alpha, \sum_{j=1}^n V_\rho(\tilde{\lambda}_j) = \beta] \end{aligned}$$

Thus the two objective functions \tilde{z}' and \tilde{z} differ by a constant not involving any decision variable x_{ij} and so the original problem as well as the new problem both attain same optimal solution.

Theorem 16 If all costs $\tilde{a}_{ij} \geq_{\mathfrak{R}_\rho} \tilde{0}$ and there be found a set $x_{ij} = x_{ij}^*$ so that $\sum_{i=1}^n \sum_{j=1}^n \tilde{a}_{ij}x_{ij}^* =_{\mathfrak{R}_\rho} \tilde{0}$ hold for a minimization problem, then this solution is optimal.

Proof. Since $\tilde{a}_{ij} \geq_{\mathfrak{R}_\rho} \tilde{0}$ and $x_{ij} \geq 0$, then $\sum_{i=1}^n \sum_{j=1}^n \tilde{a}_{ij}x_{ij} \geq_{\mathfrak{R}_\rho} \tilde{0}$. This implies $\min(\sum_{i=1}^n \sum_{j=1}^n \tilde{a}_{ij}x_{ij}) =_{\mathfrak{R}_\rho} \tilde{0}$ for $x_{ij} = x_{ij}^*$. Hence, it is an optimal solution.

Theorem 17 Let the value of SVTrN-number in some cells of a matrix B of order $(n \times n)$ are equivalent to $V_\rho(\tilde{0})$. Suppose, these cells be covered by k lines and let \tilde{p} be the least SVTrN-number among all uncovered numbers of matrix B . If \tilde{p} be subtracted from every SVTrN-number of B and added to the SVTrN-numbers of all columns covered by a line, resulting a new matrix D , then the sum of SVTrN-numbers of D is $n(n - k)\tilde{p}$ less than the sum of SVTrN-numbers of B .

Proof. Adding \tilde{p} to every SVTrN-number covered by both horizontal and vertical lines (i.e., lying at the intersection of horizontal and vertical lines) results the increment of an SVTrN-number by a total of $2\tilde{p}$ and remaining increases by \tilde{p} only. Now, subtraction by \tilde{p} from every SV TrN-number finally results the increment of an SVTrN-number lying at the intersection of horizontal and vertical lines by \tilde{p} only and the decrement of all uncovered SVTrN-numbers by \tilde{p} . All others covered by one line remains unchanged.

If each number in B be decreased by \tilde{p} then the decrease of the sum of elements is $n^2\tilde{p}$. By adding \tilde{p} to each numbers in every line, the total increase is $n\tilde{p}$ per line. For k lines, it is $nk\tilde{p}$. Hence the net decrease in

the sum of SVTrN-numbers in D is $n^2\tilde{p}-nk\tilde{p} = n(n - k) \tilde{p}$.

Clearly, this net decrease is a positive SVTrN-number if $n > k$ (as $\tilde{p} \neq_{\mathfrak{R}_\rho} \tilde{0}$) i.e., when the number of lines required to cover all the cells with SVTrN-number (whose value is equivalent to $V_\rho(\tilde{0})$) is less than the order of matrix. Now since all the costs of B are non-negative, we can decrease the sum of costs up to zero (i.e., $n(n - k) \tilde{p} =_{\mathfrak{R}_\rho} \tilde{0}$). Maximum decrease occurs when the number of lines required to cover all such cells is equal to the order of matrix. As a result, each optimal assignment is trivial ($\tilde{0}$) at maximum point.

Numerical Example

Here, an assignment problem with the cost as SVTrN-number is solved by proposed method. For simplicity, we define the ρ - weighted value function for $n = 1$.

Example 18 A bus owner wishes to drive his four buses (B_1, B_2, B_3, B_4) in four different routes (R_1, R_2, R_3, R_4). The neutrosophic cost matrix $[\tilde{a}_{ij}]$ given in Table 2 refers the expected profit (taken as multiple of hundred) per day from each bus in each route after applying the maintenance cost. Allot the route to each bus so that the profit in aggregate becomes maximum.

Table 2 : Expected profit of buses in different routes.

	R_1	R_2	R_3	R_4
B_1	\tilde{a}_{11}	\tilde{a}_{12}	\tilde{a}_{13}	\tilde{a}_{14}
B_2	\tilde{a}_{21}	\tilde{a}_{22}	\tilde{a}_{23}	\tilde{a}_{24}
B_3	\tilde{a}_{31}	\tilde{a}_{32}	\tilde{a}_{33}	\tilde{a}_{34}
B_4	\tilde{a}_{41}	\tilde{a}_{42}	\tilde{a}_{43}	\tilde{a}_{44}

where

$$\begin{aligned} \tilde{a}_{11} &= \langle [10,3,6], [10,8,5], [10,2,9] \rangle, & \tilde{a}_{12} &= \langle [8,4,6], [8,6,9], [8,5,10] \rangle, \\ \tilde{a}_{13} &= \langle [9,3,5], [9,2,9], [9,1,12] \rangle, & \tilde{a}_{14} &= \langle [5,1,11], [5,4,8], [5,3,13] \rangle, \\ \tilde{a}_{21} &= \langle [7,3,9], [7,1,6], [7,2,8] \rangle, & \tilde{a}_{22} &= \langle [6,5,12], [6,4,8], [6,3,10] \rangle, \\ \tilde{a}_{23} &= \langle [5,2,7], [5,4,12], [5,4,5] \rangle, & \tilde{a}_{24} &= \langle [3,1,9], [3,2,14], [3,1,11] \rangle, \\ \tilde{a}_{31} &= \langle [8,1,4], [8,2,7], [8,7,2] \rangle, & \tilde{a}_{32} &= \langle [7,6,9], [7,5,5], [7,2,6] \rangle, \\ \tilde{a}_{33} &= \langle [6,2,10], [6,5,9], [6,4,7] \rangle, & \tilde{a}_{34} &= \langle [4,3,4], [4,1,10], [4,2,7] \rangle, \\ \tilde{a}_{41} &= \langle [5,4,2], [5,3,6], [5,2,10] \rangle, & \tilde{a}_{42} &= \langle [9,7,7], [9,3,13], [9,2,6] \rangle, \\ \tilde{a}_{43} &= \langle [6,2,6], [6,5,9], [6,1,7] \rangle, & \tilde{a}_{44} &= \langle [7,6,2], [7,5,4], [7,3,10] \rangle. \end{aligned}$$

Solution. The problem can be put in the following form :

$$\begin{aligned} \text{Max } \tilde{z} =_{\mathfrak{R}_\rho} & \tilde{a}_{11}x_{11} + \tilde{a}_{12}x_{12} + \tilde{a}_{13}x_{13} + \tilde{a}_{14}x_{14} + \tilde{a}_{21}x_{21} + \tilde{a}_{22}x_{22} + \tilde{a}_{23}x_{23} + \tilde{a}_{24}x_{24} + \\ & \tilde{a}_{31}x_{31} + \tilde{a}_{32}x_{32} + \tilde{a}_{33}x_{33} + \tilde{a}_{34}x_{34} + \tilde{a}_{41}x_{41} + \tilde{a}_{42}x_{42} + \tilde{a}_{43}x_{43} + \tilde{a}_{44}x_{44} \end{aligned}$$

such that

$$\begin{aligned} x_{11} + x_{12} + x_{13} + x_{14} &= 1, & x_{11} + x_{21} + x_{31} + x_{41} &= 1, \\ x_{21} + x_{22} + x_{23} + x_{24} &= 1, & x_{12} + x_{22} + x_{32} + x_{42} &= 1, \\ x_{31} + x_{32} + x_{33} + x_{34} &= 1, & x_{13} + x_{23} + x_{33} + x_{43} &= 1, \\ x_{41} + x_{42} + x_{43} + x_{44} &= 1, & x_{14} + x_{24} + x_{34} + x_{44} &= 1, \end{aligned} \text{ with } x_{ij} \in \{0,1\}.$$

The ρ - weighted value for the SVTrN-numbers are calculated as :

$$\begin{aligned} V_\rho(\tilde{a}_{11}) &= \frac{1}{18}(248 - 185\rho), & V_\rho(\tilde{a}_{12}) &= \frac{1}{18}(208 - 158\rho), & V_\rho(\tilde{a}_{13}) &= \frac{1}{18}(252 - 196\rho) \\ V_\rho(\tilde{a}_{14}) &= \frac{1}{18}(148 - 108\rho), & V_\rho(\tilde{a}_{21}) &= \frac{1}{18}(190 - 142\rho), & V_\rho(\tilde{a}_{22}) &= \frac{1}{18}(166 - 123\rho), \\ V_\rho(\tilde{a}_{23}) &= \frac{1}{18}(138 - 103\rho), & V_\rho(\tilde{a}_{24}) &= \frac{1}{18}(116 - 90\rho), & V_\rho(\tilde{a}_{31}) &= \frac{1}{18}(192 - 141\rho), \end{aligned}$$

$$\begin{aligned}
 V_\rho(\tilde{a}_{32}) &= \frac{1}{18}(176 - 131\rho), \quad V_\rho(\tilde{a}_{33}) = \frac{1}{18}(158 - 114\rho), \quad V_\rho(\tilde{a}_{34}) = \frac{1}{18}(124 - 99\rho), \\
 V_\rho(\tilde{a}_{41}) &= \frac{1}{18}(142 - 114\rho), \quad V_\rho(\tilde{a}_{42}) = \frac{1}{18}(186 - 132\rho), \quad V_\rho(\tilde{a}_{43}) = \frac{1}{18}(164 - 124\rho), \\
 V_\rho(\tilde{a}_{44}) &= \frac{1}{18}(180 - 142\rho).
 \end{aligned}$$

Assuming $\rho = 0.6$ and applying the computational procedure for maximization problem, we find the allocation of busses in different route with the maximum profit attained as follows.

$$B_1 \rightarrow R_3, \quad B_2 \rightarrow R_1, \quad B_3 \rightarrow R_2, \quad B_4 \rightarrow R_4.$$

The optimal solutions are :

$x_{13} = x_{21} = x_{32} = x_{44} = 1$, $x_{11} = x_{12} = x_{14} = x_{22} = x_{23} = x_{24} = x_{31} = x_{33} = x_{34} = x_{41} = x_{42} = x_{43} = 0$ and $Max \ \tilde{z} = \sum_{\rho} \tilde{a}_{13} + \tilde{a}_{21} + \tilde{a}_{32} + \tilde{a}_{44}$ which becomes 23.97 i.e., Rs. 2397 using ρ -weighted value function for $\rho = 0.6$.

Sensitivity analysis 19 Depending on ρ chosen , the number of iteration in computational procedure to reach at optimality stage may vary only but the optimal solution will remain unchange. However, ρ plays an important role to produce the aggregate optimal value of an assignment problem in neutrosophic environment. Since the total profit from a bus depends on so many factors, we assume ρ as the degree of maintenance cost of busses in the present problem. Following table (Table 3) shows the variation of optimal value with respect to different ρ in the Example 5.1. Here $V_\rho(\tilde{z}) = \frac{1}{18}(798 - 611\rho)$.

Table 3 : Profit of buses with respect to different maintenance cost

ρ	0	0.1	0.2	0.3	0.4	0.5	0.6	0.7	0.8	0.9	1
$V_\rho(\tilde{z})$	44.33	40.94	37.54	34.15	30.75	27.36	23.97	20.57	17.18	13.78	10.39

Conclusion

The present study deals with a solution approach of an assignment problem in neutrosophic environment. The basic motivation of this study is to incorporate the provided asset of constraints of a problem to be optimised with the hidden criterions, generally ignored by decision makers, so that a most fair result is achieved. Using the centroids of triangles in the geometrical configuration of an SVTrN-number, a parameter (graded in [0,1]) based linear ranking function is constructed for ranking of SVTrN-numbers. This ranking function plays a key role to develop an efficient solution algorithm and thus helps the decision makers to draw a nice conclusion in several situations . The efficiency of this concept is executed by solving a practical problem.

The industrial data are not always precise, rather neutrosophic (imprecise with truth, falsity and indeterminacy values) in nature. The newly developed algorithm will help the industrialists, corporate houses, researchers and many more to solve such type of practical assignment problem involving neutrosophic parameters.

Future Research Directions

Here, we have presented and solved a single objective assignment problem. In future, it can be extended to multiobjective assignment problem with different types of parameters namely crisp, fuzzy, stochastic, etc. It is expected that this model of assignment problem and its solution methodology will bring an opportunity for future research in linear and non-linear programming problem. Especially, the ranking function adopted here may be practiced to solve several decision making problems. Moreover we may try to extend this concept over 'Refined neutrosophic set' [Smarandache, 2013] and 'Plithogenic set' [Smarandache, 2018].

References

- [1] Abbasbandy, S. & Asady, B. (2006). Ranking of fuzzy numbers by sign distance, *Information Sciences*, 176, 2405-2416.
- [2] Angelov, P. (1997). Optimization in an intuitionistic fuzzy environment, *Fuzzy Sets and Systems* 86, 299-306.
- [3] Atanassov, K. (1986). Intuitionistic fuzzy sets, *Fuzzy sets and systems*, 20(1), 87-96.
- [4] Bera, T. & Mahapatra, N. K. (2018). Assignment problem with neutrosophic costs and its solution methodology, *Asia Matematika*, 2(2) , 11 -12.
- [5] Bera, T. & Mahapatra, N. K. (2019). Optimisation by dual simplex approach in neutrosophic environment, *Int. J. Fuzzy Computation and Modelling*, 2(4), 334 -352.
- [6] Bera, T. & Mahapatra, N. K. (2019). Generalised single valued neutrosophic number and its application to neutrosophic linear programming, Accepted, Book chapter for 'Neutrosophic Sets in decision analysis and operation research', IGI Global.
- [7] Chen, M. S. (1985). On a fuzzy assignment problem, *Tamkang J.*, 22, 407-411.
- [8] Hassan, N., Uluçay, V. & Şahin, M. (2018). Q-neutrosophic soft expert set and its application in decision making. *International Journal of Fuzzy System Applications (IJFSA)*, 7(4), 37-61.
- [9] Li, D. F. (2010). A ratio ranking method of triangular intuitionistic fuzzy numbers and its application to MADM problems, *Comput. Math. Appl.*, 60, 1557-1570.
- [10] Lin, C. J. & Wen, U. P. (2004). A labeling algorithm for the fuzzy assignment problem, *Fuzzy sets and systems*, 142, 373-391.
- [11] Mukherjee, S. & Basu, K. (2010). Application of fuzzy ranking method for solving assignment problems with fuzzy costs, *Int. J. of Computational and App. Math.*, 5(3), 359-368.
- [12] Rao, P. P. B. & Shankar, N. R. (2013). Ranking fuzzy numbers with an area method using circumference of centroid, *Fuzzy Information and Engineering*, 1, 3-18.
- [13] Şahin, M., Olgun, N., Uluçay, V., Kargin, A. & Smarandache, F. (2017). A new similarity measure on falsity value between single valued neutrosophic sets based on the centroid points of transformed single valued neutrosophic numbers with applications to pattern recognition, *Neutrosophic Sets and Systems*, 15, 31-48, doi: org/10.5281/zenodo570934.
- [14] Şahin, M., Ecemiş, O., Uluçay, V. & Kargin, A. (2017). Some new generalized aggregation operators based on centroid single valued triangular neutrosophic numbers and their applications in multi-attribute decision making, *Asian Journal of Mathematics and Computer Research* , 16(2), 63-84.
- [15] Smarandache, F. (1998). *Neutrosophy, neutrosophic probability, set and logic*, Amer. Res. Press, Rehoboth, USA., p. 105, <http://fs.gallup.unm.edu/eBook-neutrosophics6.pdf> (sixth version).
- [16] Smarandache, F. (2005). Neutrosophic set, A generalisation of the intuitionistic fuzzy sets, *Inter. J. Pure Appl. Math.*, 24, 287-297.
- [17] Uluçay, V., Şahin, M. & Olgun, N. (2018). Time-Neutrosophic Soft Expert Sets and its decision making problem. *Matematika*, 34(2), 246-260.
- [18] Uluçay, V., Kiliç, A., Yildiz, I. & Sahin, M. (2018). A new approach for multi-attribute decision-making problems in bipolar neutrosophic sets. *Neutrosophic Sets and Systems*, 23(1), 142-159.
- [19] Wang, H., Zhang, Y., Sunderraman, R. & Smarandache, F. (2011). Single valued neutrosophic sets, *Fuzzy Sets, Rough Sets and Multivalued Operations and Applications*, 3(1), 33-39.
- [20] Yager, R. R. (1981). A procedure for ordering fuzzy subsets of the unit interval, *Information sciences*, 24, 143-161.
- [21] Yao, J. S. & Wu, K. (2000). Ranking of fuzzy numbers based on decomposition principle and signed distance, *Fuzzy Sets and System*, 16, 275-288.

Chapter Eight

Comparison of Cooking Methods in the Scope of Cuisine Dynamics: An Assessment From the Views of the Chefs in Neutrosophic Environment

Ece Doğantan¹, Ezgi Demir², Bahri Baran Koçak³, Çağlar Karamaşa⁴

¹Department of Hospitality Management, Anadolu University, Eskişehir-Turkey

²Department of Management Information Systems, Piri Reis University, İstanbul-Turkey

³Department of Civil Aviation Management, Dicle University, Diyarbakır-Turkey

⁴Department of Business Administration, Anadolu University, Eskişehir-Turkey

E-mail: edogantan@anadolu.edu.tr, edemir@pirireis.edu.tr, bahribarankocak@gmail.com, ckaramasa@anadolu.edu.tr

ABSTRACT

In this study, dry heat cooking methods have been evaluated and compared from the chefs point of view. For this purpose, grilled, boiled, sautéing and baking alternatives cuisine dynamics (maintaining the nutrition facts, food safety, use creativity, ease of cooking, pre-cooking, cooking speed, appearance, cost and flavor) have been taken into account. In the analysis, the dynamics of the cuisine have been firstly considered. The weighting of these criteria has been based on the single valued neutrosophic AHP method which better modeled the uncertain views of the chefs as the decision-makers. After the determination of the criteria weights, the cooking methods have been alternatively listed with single value neutrosophic COPRAS which is one of the multi-criteria decision making techniques.

Keywords: Cooking methods, cuisine dynamics, Neutrosophic AHP, Neutrosophic COPRAS

INTRODUCTION

Although it has not been known exactly when cooking has been considered as the first scientific revolution, it has been estimated to begin with the discovery of fire [5]. Thus, the heat source required for cooking food has been discovered and the first transformation from raw foods to cooked foods has started in food and culinary culture. With the help of the transition to settled life, tools and equipment used in farming, feeding methods, food preparation and storage methods have changed rapidly. Food has not become only a physical requirement, but also a pleasure situation [19]. According to archaeological data, it has been observed that the first cooking methods had been dry heat cooking techniques such as broiling and roasting on fire. During the Neolithic Age, fire-resistant, waterproof pottery had been built and methods of cooking at humid temperatures had emerged [22,27].

Industrial food production has started in the world with the establishment of large industrial plants and factories in the process of industrial transformation. New technologies and cooking methods have been developed to provide the increasing demands [18]. New cooking methods have been the subject of different researches over time. Especially, in the field of gastronomy, different groupings have been made. In this context, cooking methods have been examined under three groups as aqueous, dry and micro oven cooking methods. In another study, humid heat and dry heat have been divided into two groups. In another study, cooking has been classified as grilling, broiling, roasting, panfrying, sautéing, stir-frying, covered sautéing, boiling, steaming, canning, pot-roasting and stewing, baking, cooking in oil and smoking [20]. Microwave, infrared, induction, solar cooking and sous-vide cooking (vacuum cooking) methods, which has been developing rapidly today, have been grouped as modern cooking techniques because of the intensive use of technology. Especially, cook-cool and cook-freeze food production systems that have been used in industrial kitchens but have been also widely used in retail, have been also considered within the scope of contemporary technologies. It has been noteworthy that some authors also discuss cooking methods without making a classification [14]. When the researches on these cooking techniques have been examined, it has been seen that the effects of cooking techniques on various diseases such as cancer [3], the effects of various foods such as vegetables [7,16,29] and meat on the nutrition facts have been focused on food safety [13,15,24], food quality [8,9,10] and food chemistry [4,18,21,23]. The purpose of cooking foods is to increase their taste and to facilitate digestion. Another purpose is to ensure that foods do not lose their unique taste, smell and nutrients while cooking. In the study, the dynamics of cuisine have been compared and the sautéing, grilling oven, roasting, baking and boiling methods, which are the most preferred dry cooking methods of the cooks, have been evaluated.

DYNAMICS OF CUISINE

Maintaining Nutrition Facts

Nutritional quality has been determined by the value of the product for the physical health, growth, development, reproduction and overall well-being of the consumer. Nutritional quality has defined the biological or health value of the product, including the ratio of harmful substances to harmful substances, taste, odor, freshness, shelf life, and risk of pathogen contamination as important quality characteristics governing consumer behavior. Pre-harvest strategies to ensure the microbiological safety of fruit and vegetables from manure-based production systems.

Food Safety

As a concept, food safety was emerged in the mid-1970s during the Global Food Crisis in the discussions of international food problems. Initially, the term food safety was used to describe whether a country had access to sufficient food to meet dietary energy requirements. At the World Food Summit in 1996, it has been argued that food security would exist when the people had access to safe and nutritious food, both physically and economically, to meet the dietary needs of all people to ensure their healthy lives [12]. In this context, some of the factors that threaten food safety are; chemical pharmaceuticals, fertilizers, artificial additives. Residues on food produced as a result of the use of preservatives, bird flu, mad cow etc. animal diseases, natural toxins, environmental metals such as lead and mercury, bacteria, viruses and biological risk factors are sourced from microbiological contamination that can cause interference [11].

Using Creativity

Creativity is related with creating an original, valuable and applicable idea or product. Creativity in the kitchen is related with the emergence of new, more delicious and better food ideas than the present. It has been suggested that a good chef should develop her/his artistic point of view by focusing on customer needs and it has been stated that focusing on customer needs might have an impact on creativity. Culinary activities have been created by cooking and preparing various food and beverage products grown and produced in

many different regions. In this context, creativity will bring innovative results in the cooks cooking process. The use of chefs' potentials of creativity will affect the process.

Ease of Cooking

Ease of cooking has been evaluated that the cooking method used does not stick to the cooked cup, does not cool down quickly, and does not tire the chef physically while cooking.

Preparation Before Cooking

This part is consisted of, the marination before cooking, saucing, resting, thawing, chopping and so on. Additionally, the part also involves processes, to reach the food to the appropriate temperature and cleaning.

Cooking Speed and Appearance

Cooking speed and appearance are among the variables to be considered when evaluating the dynamics of the cuisine.

Cost

Losses during production, creativity and design in the cooking process, the type and amount of energy used (electricity, gas, coal, etc.), the amount of material used in cooking, etc. elements have been evaluated among the factors that increase the costs in the cooking process. Cooking is an important process for flavor development as well as improving the digestibility of food.

Neutrosophic Sets

Smarandache [25] introduced the concept of Neutrosophic Sets (NS) having with degree of truth, indeterminacy and falsity membership functions in which all of them are totally independent. Let U be a universe of discourse and $x \in U$. The neutrosophic set (NS) N can be expressed by a truth membership function $T_N(x)$, an indeterminacy membership function $I_N(x)$ and a falsity membership function $F_N(x)$, and is represented as $N = \{ \langle x : T_N(x), I_N(x), F_N(x) \rangle, x \in U \}$. Also the functions of $T_N(x)$, $I_N(x)$ and $F_N(x)$ are real standard or real nonstandard subsets of $]0^-, 1^+[$, and can be presented as $T, I, F : U \rightarrow]0^-, 1^+[$. There is not any restriction on the sum of the functions of $T_N(x)$, $I_N(x)$ and $F_N(x)$, so $0^- \leq \sup T_N(x) + \sup I_N(x) + \sup F_N(x) \leq 3^+$.

The complement of a NS N is represented by N^C and described as below:

$$T_N^C(x) = 1^+ \ominus T_N(x) \quad (1)$$

$$I_N^C(x) = 1^+ \ominus I_N(x) \quad (2)$$

$$F_N^C(x) = 1^+ \ominus F_N(x) \quad \text{for all } x \in U \quad (3)$$

A NS, N is contained in other NS P in other words, $N \subseteq P$ if and only if $\inf T_N(x) \leq \inf T_P(x)$, $\sup T_N(x) \leq \sup T_P(x)$, $\inf I_N(x) \geq \inf I_P(x)$, $\sup I_N(x) \geq \sup I_P(x)$, $\inf F_N(x) \geq \inf F_P(x)$, $\sup F_N(x) \geq \sup F_P(x)$ for all $x \in U$ [6].

Single Valued Neutrosophic Sets (SVNS)

Wang [28] developed the term of Single Valued Neutrosophic Set (SVNS) which is a case of NS in order to deal with indeterminate, inconsistent and incomplete information. They handle the interval $[0,1]$ instead of $[0^-,1^+]$ in order to better apply in real world problems. Let U be a universe of discourse and $x \in U$. A single valued neutrosophic set B in U is described by a truth membership function $T_B(x)$, an indeterminacy membership function $I_B(x)$ and a falsity membership function $F_B(x)$. When U is continuous a SVNS, B is

$$B = \int_x \langle T_B(x), I_B(x), F_B(x) \rangle : x \in U$$

depicted as . When U is discrete a SVNS B can be represented as

$$B = \sum_{i=1}^n \frac{\langle T_B(x_i), I_B(x_i), F_B(x_i) \rangle}{x_i} : x_i \in U$$

[17]. The functions of $T_B(x)$, $I_B(x)$ and $F_B(x)$ are real standard subsets of $[0,1]$ that is $T_B(x):U \rightarrow [0,1]$, $I_B(x):U \rightarrow [0,1]$ and $F_B(x):U \rightarrow [0,1]$. Also the sum of $T_B(x)$, $I_B(x)$ and $F_B(x)$ are in $[0,3]$ that $0 \leq T_B(x) + I_B(x) + F_B(x) \leq 3$ [6].

Let a single valued neutrosophic triangular number $\tilde{b} = \langle (b_1, b_2, b_3); \alpha_{\tilde{b}}, \theta_{\tilde{b}}, \beta_{\tilde{b}} \rangle$ is a special neutrosophic set on R . Additionally $\alpha_{\tilde{b}}, \theta_{\tilde{b}}, \beta_{\tilde{b}} \in [0,1]$ and $b_1, b_2, b_3 \in R$ where $b_1 \leq b_2 \leq b_3$. Truth, indeterminacy and falsity membership functions of this number can be computed as below [2].

$$T_{\tilde{b}}(x) = \begin{cases} \alpha_{\tilde{b}} \left(\frac{x-b_1}{b_2-b_1} \right) & (b_1 \leq x \leq b_2) \\ \alpha_{\tilde{b}} & (x = b_2) \\ \alpha_{\tilde{b}} \left(\frac{b_3-x}{b_3-b_2} \right) & (b_2 < x \leq b_3) \\ 0 & \text{otherwise} \end{cases} \quad (4)$$

$$I_{\tilde{b}}(x) = \begin{cases} \left(\frac{b_2-x+\theta_{\tilde{b}}(x-b_1)}{b_2-b_1} \right) & (b_1 \leq x \leq b_2) \\ \theta_{\tilde{b}} & (x = b_2) \\ \left(\frac{x-b_2+\theta_{\tilde{b}}(b_3-x)}{b_3-b_2} \right) & (b_2 < x \leq b_3) \\ 1 & \text{otherwise} \end{cases} \quad (5)$$

$$F_{\tilde{b}}(x) = \begin{cases} \left(\frac{b_2-x+\beta_{\tilde{b}}(x-b_1)}{b_2-b_1} \right) & (b_1 \leq x \leq b_2) \\ \beta_{\tilde{b}} & (x = b_2) \\ \left(\frac{x-b_2+\beta_{\tilde{b}}(b_3-x)}{b_3-b_2} \right) & (b_2 < x \leq b_3) \\ 1 & \text{otherwise} \end{cases} \quad (6)$$

According to the Eqs.(4)-(6) $\alpha_{\tilde{b}}, \theta_{\tilde{b}}$, and $\beta_{\tilde{b}}$ denote maximum truth membership, minimum indeterminacy membership and minimum falsity membership degrees respectively.

Suppose $\tilde{b} = \langle (b_1, b_2, b_3); \alpha_{\tilde{b}}, \theta_{\tilde{b}}, \beta_{\tilde{b}} \rangle$ and $\tilde{c} = \langle (c_1, c_2, c_3); \alpha_{\tilde{c}}, \theta_{\tilde{c}}, \beta_{\tilde{c}} \rangle$ as two single valued triangular neutrosophic numbers and $\lambda \neq 0$ as a real number. Considering abovementioned conditions addition of two single valued triangular neutrosophic numbers are denoted as follows [2].

$$\tilde{b} + \tilde{c} = \langle (b_1 + c_1, b_2 + c_2, b_3 + c_3); \alpha_{\tilde{b}} \wedge \alpha_{\tilde{c}}, \theta_{\tilde{b}} \vee \theta_{\tilde{c}}, \beta_{\tilde{b}} \vee \beta_{\tilde{c}} \rangle \quad (7)$$

Subtraction of two single valeued triangular neutrosophic numbers are defined as Eq.(8):

$$\tilde{b} - \tilde{c} = \langle (b_1 - c_3, b_2 - c_2, b_3 - c_1); \alpha_{\tilde{b}} \wedge \alpha_{\tilde{c}}, \theta_{\tilde{b}} \vee \theta_{\tilde{c}}, \beta_{\tilde{b}} \vee \beta_{\tilde{c}} \rangle \quad (8)$$

Inverse of a single valued triangular neutrosophic number ($\tilde{b} \neq 0$) can be denoted as below:

$$\tilde{b}^{-1} = \langle (\frac{1}{b_3}, \frac{1}{b_2}, \frac{1}{b_1}); \alpha_{\tilde{b}}, \theta_{\tilde{b}}, \beta_{\tilde{b}} \rangle \quad (9)$$

Multiplication of a single valued triangular neutrosophic number by a constant value are represented as follows:

$$\lambda \tilde{b} = \begin{cases} \langle (\lambda b_1, \lambda b_2, \lambda b_3); \alpha_{\tilde{b}}, \theta_{\tilde{b}}, \beta_{\tilde{b}} \rangle \text{ if } (\lambda > 0) \\ \langle (\lambda b_3, \lambda b_2, \lambda b_1); \alpha_{\tilde{b}}, \theta_{\tilde{b}}, \beta_{\tilde{b}} \rangle \text{ if } (\lambda < 0) \end{cases} \quad (10)$$

Division of a single valued triangular neutrosophic number by a constant value are denoted as Eq.(11):

$$\frac{\tilde{b}}{\lambda} = \begin{cases} \langle (\frac{b_1}{\lambda}, \frac{b_2}{\lambda}, \frac{b_3}{\lambda}); \alpha_{\tilde{b}}, \theta_{\tilde{b}}, \beta_{\tilde{b}} \rangle \text{ if } (\lambda > 0) \\ \langle (\frac{b_3}{\lambda}, \frac{b_2}{\lambda}, \frac{b_1}{\lambda}); \alpha_{\tilde{b}}, \theta_{\tilde{b}}, \beta_{\tilde{b}} \rangle \text{ if } (\lambda < 0) \end{cases} \quad (11)$$

Multiplication of two single valued triangular neutrosophic numbers can be seen as follows:

$$\tilde{b} \tilde{c} = \begin{cases} \langle (b_1 c_1, b_2 c_2, b_3 c_3); \alpha_{\tilde{b}} \wedge \alpha_{\tilde{c}}, \theta_{\tilde{b}} \vee \theta_{\tilde{c}}, \beta_{\tilde{b}} \vee \beta_{\tilde{c}} \rangle \text{ if } (b_3 > 0, c_3 > 0) \\ \langle (b_1 c_3, b_2 c_2, b_3 c_1); \alpha_{\tilde{b}} \wedge \alpha_{\tilde{c}}, \theta_{\tilde{b}} \vee \theta_{\tilde{c}}, \beta_{\tilde{b}} \vee \beta_{\tilde{c}} \rangle \text{ if } (b_3 < 0, c_3 > 0) \\ \langle (b_3 c_3, b_2 c_2, b_1 c_1); \alpha_{\tilde{b}} \wedge \alpha_{\tilde{c}}, \theta_{\tilde{b}} \vee \theta_{\tilde{c}}, \beta_{\tilde{b}} \vee \beta_{\tilde{c}} \rangle \text{ if } (b_3 < 0, c_3 < 0) \end{cases} \quad (12)$$

Division of two single valued triangular neutrosophic numbers can be denoted as Eq.(13):

$$\frac{\tilde{b}}{\tilde{c}} = \begin{cases} \langle (\frac{b_1}{c_3}, \frac{b_2}{c_2}, \frac{b_3}{c_1}); \alpha_{\tilde{b}} \wedge \alpha_{\tilde{c}}, \theta_{\tilde{b}} \vee \theta_{\tilde{c}}, \beta_{\tilde{b}} \vee \beta_{\tilde{c}} \rangle \text{ if } (b_3 > 0, c_3 > 0) \\ \langle (\frac{b_3}{c_3}, \frac{b_2}{c_2}, \frac{b_1}{c_1}); \alpha_{\tilde{b}} \wedge \alpha_{\tilde{c}}, \theta_{\tilde{b}} \vee \theta_{\tilde{c}}, \beta_{\tilde{b}} \vee \beta_{\tilde{c}} \rangle \text{ if } (b_3 < 0, c_3 > 0) \\ \langle (\frac{b_3}{c_1}, \frac{b_2}{c_2}, \frac{b_1}{c_3}); \alpha_{\tilde{b}} \wedge \alpha_{\tilde{c}}, \theta_{\tilde{b}} \vee \theta_{\tilde{c}}, \beta_{\tilde{b}} \vee \beta_{\tilde{c}} \rangle \text{ if } (b_3 < 0, c_3 < 0) \end{cases} \quad (13)$$

Score function (S_b) for a single valued triangular neutrosophic number $b = (b_1, b_2, b_3)$ can be found as below [26].

$$S_b = (1 + b_1 - 2 * b_2 - b_3)/2 \quad (14)$$

where $S_b \in [-1, 1]$.

There are a lot of studies ([6,9,17,30,31,33,34,35,36]) integrating neutrosophic sets with mcdm methods in recent years. New trend of neutrosophic theory is especially based on neutrosophic soft expert sets, refined neutrosophic sets and bipolar complex neutrosophic sets.

Neutrosophic AHP

Steps of neutrosophic AHP can be explained as follows [2]:

1- Decision problem is constructed as hierarchical view consisting of goal, criteria, sub-criteria and alternatives respectively.

2-Pairwise comparisons are made to form neutrosophic evaluation matrix composed of triangular neutrosophic numbers representing decision makers' views. Neutrosophic pairwise evaluation matrix (\tilde{D}) is seen as below:

$$\tilde{D} = \begin{bmatrix} \tilde{1} & \tilde{d}_{12} & \cdots & \tilde{d}_{1n} \\ \vdots & \vdots & \vdots & \vdots \\ \tilde{d}_{n1} & \tilde{d}_{n2} & \cdots & \tilde{1} \end{bmatrix} \quad (15)$$

According to Eq(1) $\tilde{d}_{ji} = \tilde{d}_{ij}^{-1}$ is valid.

3-Neutrosophic pairwise evaluation matrix is constructed by using scale arranged for neutrosophic environment such as Table 1:

Table 1. AHP scale transformed for neutrosophic triangular numbers

Value	Explanation	Neutrosophic triangular scale
1	Equally influential	$\tilde{1} = \langle (1,1,1); 0.5,0.5,0.5 \rangle$
3	Slightly influential	$\tilde{3} = \langle (2,3,4); 0.3,0.75,0.7 \rangle$
5	Strongly influential	$\tilde{5} = \langle (4,5,6); 0.8,0.15,0.2 \rangle$
7	Very strongly influential	$\tilde{7} = \langle (6,7,8); 0.9,0.1,0.1 \rangle$
9	Absolutely influential	$\tilde{9} = \langle (9,9,9); 1,0,0 \rangle$
2	Intermediate values between two close scales	$\tilde{2} = \langle (1,2,3); 0.4,0.65,0.6 \rangle$
4		$\tilde{4} = \langle (3,4,5); 0.6,0.35,0.4 \rangle$
6		$\tilde{6} = \langle (5,6,7); 0.7,0.25,0.3 \rangle$
8		$\tilde{8} = \langle (7,8,9); 0.85,0.1,0.15 \rangle$

Resource: Abdel-Basset [1]

4-Neutrosophic pairwise evaluation matrix is transformed into deterministic pairwise evaluation matrix for obtaining the weights of criterion as follows:

Let $\tilde{d}_{ij} = \langle (d_1, e_1, f_1), \alpha_{\tilde{d}}, \theta_{\tilde{d}}, \beta_{\tilde{d}} \rangle$ be a single valued neutrosophic number, then the score and accuracy degrees of \tilde{d}_{ij} are computed as following equations:

$$S(\tilde{d}_{ij}) = \frac{1}{16} [d_1 + e_1 + f_1] x (2 + \alpha_{\tilde{a}} - \theta_{\tilde{a}} - \beta_{\tilde{a}})$$

(16)

$$A(\tilde{d}_{ij}) = \frac{1}{16} [d_1 + e_1 + f_1] x (2 + \alpha_{\tilde{a}} - \theta_{\tilde{a}} + \beta_{\tilde{a}})$$

(17)

In order to obtain the score and accuracy degree of \tilde{d}_{ij} following equations are used.

$$S(\tilde{d}_{ji}) = 1/S(\tilde{d}_{ij})$$

(18)

$$A(\tilde{d}_{ji}) = 1/A(\tilde{d}_{ij})$$

(19)

Deterministic pairwise evaluation matrix is constructed with compensation by score value of each triangular neutrosophic number in neutrosophic pairwise evaluation matrix. Obtained deterministic matrix can be seen as follows:

$$D = \begin{bmatrix} 1 & d_{12} & \cdots & d_{1n} \\ \vdots & \vdots & \vdots & \vdots \\ d_{n1} & d_{n2} & \cdots & 1 \end{bmatrix}$$

(20)

Ranking of priorities as eigen vector X is obtained according to following steps:

- a) Firstly column entries are normalized by dividing each entry to the sum of column
- b) Then row averages are summed.

5-Consistency index (CI) and consistency ratio (CR) values are computed to measure the inconsistency for decision makers' judgments in entire pairwise evaluation matrix. If CR is greater than 0.1, process should be repeated due to unreliable decision makers' judgments.

CI is computed according to following steps:

- a) Each value in first column of the pairwise evaluation matrix is multiplied by the priority of first criterion and this process is applied for all columns. Values are summed across the rows to construct the weighted sum vector.
- b) The elements of weighted sum vector are divided by corresponding the priority of each criterion. Then the average of values are acquired and represented by λ_{max} .
- c) The value of CI is calculated as Eq.(21):

$$CI = \frac{\lambda_{max} - n}{n - 1}$$

(21)

According to Eq.(7) number of elements being compared are denoted by n.

After the value of CI is found, CR is computed as follows:

$$CR = \frac{CI}{RI}$$

(22)

where RI denotes the consistency index for randomly generated pairwise evaluation matrix and can be shown as Table 2.

Table 2. RI table used for computing CR value

Order of random matrix (n)	0	2	3	4	5	6	7	8	9	10
Related RI value	0	0	0.58	0.9	1.12	1.24	1.32	1.4	1.45	1.49

Resource: Abdel-Basset [2]

6-Overall priority values for each alternative are computed and ranking process is applied.

COPRAS

Therefore, Eqs. (2) and (3) are the special cases of Eq. (1). Then, for the distance measure, we have the following proposition. The complex proportional assessment method (COPRAS) was developed by Zavadskas [30] and the steps of this method can be summarized as follows:

1-Determine k alternatives and l criteria that are assessed by decision makers.

2-Construct decision matrix Y composed of elements namely y_{ij} that is identified as the value of ith ($i = 1, 2, \dots, k$) alternative jth ($j = 1, 2, \dots, l$) criterion.

$$Y = \begin{bmatrix} y_{11} & y_{12} & \cdots & y_{1l} \\ y_{21} & y_{22} & \cdots & y_{2l} \\ \vdots & \vdots & \ddots & \vdots \\ y_{k1} & y_{k2} & \cdots & y_{kl} \end{bmatrix}_{k \times l} \quad (23)$$

3- Criteria weights cw_j are determined and considered for analysis.

4- Decision matrix Y is normalized according to Eq. (24) shown as below:

$$\bar{y}_{ij} = \frac{y_{ij}}{\sum_{i=1}^k y_{ij}} \quad i = 1, 2, \dots, k; \quad j = 1, 2, \dots, l \quad (24)$$

5- Weighted normalized decision matrix Z is constructed and elements of this matrix (z_{ij}) are obtained as follows:

$$z_{ij} = \bar{y}_{ij} \cdot cw_j \quad i = 1, 2, \dots, k; \quad j = 1, 2, \dots, l \quad (25)$$

6- Criterion values are computed as summation according to the optimization way for each alternative and shown as Eq. (26):

$$R_{+i} = \sum_{j=1}^{M_{max}} z_{+ij}; \quad R_{-i} = \sum_{j=1}^{M_{min}} z_{-ij} \quad (26)$$

Where maximized criteria are represented by the value of Z_{+ij} and minimized criteria are shown by the value of Z_{-ij} .

7-Minimal constituent of the R_{-i} is founded according to Eq.(27):

$$R_{-min} = \min_i R_{-i}; \quad i = 1, 2, \dots, M_{min} \quad (27)$$

8- Score value of each alternative SV_i is obtained as follows:

$$SV_i = R_{+i} + \frac{(R_{-min} \sum_{i=1}^{M_{min}} R_{-i})}{(R_{-min} \sum_{i=1}^{M_{min}} \frac{R_{-min}}{R_{-i}})} \quad (28)$$

9- Optimality criterion for the alternatives T is identified as Eq.(29):

$$T = \max_i SV_i; \quad i = 1, 2, \dots, k \quad (29)$$

10- Alternatives are ranked according to descending value of score value SV_i . Thus alternative having greater score value gets higher rank than others.

COPRAS for Single Valued Neutrosophic Sets

In this study evaluations of decision makers related to the importance of alternatives in terms of attributes are firstly converted from linguistic terms to single valued neutrosophic sets by using scale given as Table 3.

Table 3. Scale composed of linguistic terms related to rating importance of alternatives

Linguistic terms	Single valued neutrosophic numbers
Extremely good	(1,0,0)
Very very good	(0.9,0.1,0.1)
Very good	(0.8,0.15,0.2)
Good	(0.7,0.25,0.3)
Medium good	(0.6,0.35,0.4)
Medium	(0.5,0.5,0.5)
Medium bad	(0.4,0.65,0.6)
Bad	(0.3,0.75,0.7)
Very bad	(0.2,0.85,0.8)
Very very bad	(0.1,0.9,0.9)
Extremely bad	(0,1,1)

Steps of COPRAS for single valued neutrosophic sets are summarized as below:

1- Importance weight of each decision maker (θ_d) is determined and taking into the account for making analysis. By the way $\theta_d \geq 0$ and $\sum_{d=1}^D \theta_d = 1$.

2- Decision matrix Y^d is constructed by taking each decision maker's views into the account. Elements of decision matrix (y_{ij}^d) represent the d th decision maker's judgment for the i th alternative by the j th criterion. This matrix can be shown as below:

$$Y^d = \begin{bmatrix} y_{11}^d & y_{12}^d & \cdots & y_{1l}^d \\ y_{21}^d & y_{22}^d & \cdots & y_{2l}^d \\ \vdots & \vdots & \ddots & \vdots \\ y_{k1}^d & y_{k2}^d & \cdots & y_{kl}^d \end{bmatrix}_{k \times l} \quad (30)$$

3- Aggregated weights of the criteria are found as Eq.(31):

$$cw_j = \theta_1 cw_j^1 \cup \theta_2 cw_j^2 \cup \dots \cup \theta_d cw_j^d = \quad (31)$$

$$\langle (1 - \prod_{d=1}^D (1 - t_j^{cw_d})^{\theta_d}), \prod_{d=1}^D (i_j^{cw_d})^{\theta_d}, \prod_{d=1}^D (f_j^{cw_d})^{\theta_d} \rangle$$

4- Aggregated weighted single valued decision matrix is formed and shown as follows:

$$\tilde{Y} = \begin{bmatrix} \tilde{y}_{11} & \tilde{y}_{12} & \cdots & \tilde{y}_{1l} \\ \tilde{y}_{21} & \tilde{y}_{22} & \cdots & \tilde{y}_{2l} \\ \vdots & \vdots & \ddots & \vdots \\ \tilde{y}_{k1} & \tilde{y}_{k2} & \cdots & \tilde{y}_{kl} \end{bmatrix}_{k \times l} \quad (32)$$

Elements of the aggregated weighted single valued decision matrix can be described as $\tilde{y}_{ij} = (\tilde{t}_{ij}, \tilde{l}_{ij}, \tilde{f}_{ij})$ that shows the rating of i th alternative related to j th criterion and are calculated as Eq. (33):

$$\tilde{y}_{ij} = \theta_1 y_{ij}^1 \cup \theta_2 y_{ij}^2 \cup \dots \cup \theta_d y_{ij}^d = \quad (33)$$

$$\langle (1 - \prod_{d=1}^D (1 - t_{ij}^{y_d})^{\theta_d}), \prod_{d=1}^D (l_{ij}^{y_d})^{\theta_d}, \prod_{d=1}^D (f_{ij}^{y_d})^{\theta_d} \rangle$$

5- Weighted decision matrix Z is constructed and elements of weighted decision matrix $Z_{ij} = \tilde{y}_{ij} \cdot cw_j$ $i = 1, 2, \dots, k; j = 1, 2, \dots, l$ can be computed as below:

$$z_{ij} = (t_{ij}^{\tilde{y}} t_j^{cw}, l_{ij}^{\tilde{y}} + l_j^{cw} - l_{ij}^{\tilde{y}} l_j^{cw}, f_{ij}^{\tilde{y}} + f_j^{cw} - f_{ij}^{\tilde{y}} f_j^{cw}) \quad (34)$$

6- Summation of the values in terms of benefit is calculated. Assume $M_+ = \{1, 2, \dots, M_{max}\}$ as a set of criteria that will be maximized and the benefit index for each alternative is found as Eq.(35):

$$R_{+i} = \sum_{j=1}^{M_{max}} z_{+ij} \quad (35)$$

7- Summation of the values in terms of cost is calculated. Assume $M_- = \{1, 2, \dots, M_{min}\}$ as a set of criteria that will be minimized and the cost index for each alternative is found as Eq.(36):

$$R_{-i} = \sum_{j=1}^{M_{min}} z_{-ij} \quad (36)$$

8- Minimal value for R_{-i} is obtained as R_{-min} .

9-Score values related to aggregated values for benefit and cost ($S(R_{+i})$ and $S(R_{-i})$) are computed by using Eq. (37). Then the score value of each alternative SV_i is obtained as follow:

$$SV_i = S(R_{+i}) + \frac{(S(R_{-min}) \sum_{i=1}^{M_{min}} S(R_{-i}))}{(S(R_{-min}) \sum_{i=1}^{M_{min}} \frac{S(R_{-min})}{S(R_{-i})})} \quad (37)$$

10- Optimality criterion for the alternatives T is identified as Eq.(38):

$$T = \max_i SV_i ; i = 1, 2, \dots, k \quad (38)$$

11- Alternatives are ranked according to descending value of score value SV_i . Thus alternative having greater score value gets higher rank than others.

Analysis

In this study nine criteria considered for cooking techniques are weighted via neutrosophic AHP firstly. For this purpose evaluations of 21 decision makers related to cooking techniques are considered.

Neutrosophic evaluation matrix in terms of criteria considered for cooking techniques is constructed through decision makers' linguistic judgments which are seen as Table 1. A part of the neutrosophic evaluation matrix for criteria can be shown as Table 4.

Table 4. Neutrosophic evaluation matrix for criteria

Criteria	Maintaining Nutrition Fact	Food Safety	Using Creativity	Ease of Cooking	Preparation Before Cooking	Cooking Speed	Apperance	Cost	Flavor
Maintaining Nutrition Fact	$\langle(1,1,1); 0,5,0,5,0,5\rangle$	$\langle(2,3,4); 0,3,0,75,0,7\rangle$	$\langle(4,5,6); 0,8,0,15,0,2\rangle$	$\langle(2,3,4); 0,3,0,75,0,7\rangle$	$\langle(2,3,4); 0,3,0,75,0,7\rangle$	$\langle(6,7,8); 0,9,0,1,0,1\rangle$	$\langle(1,1,1); 0,5,0,5,0,5\rangle$	$\langle(4,5,6); 0,8,0,15,0,2\rangle$	$\langle(1,2,3); 0,4,0,65,0,6\rangle$
Food Safety	$\langle(\frac{1}{4}, \frac{1}{3}, \frac{1}{2}); 0,3,0,75,0,7\rangle$	$\langle(1,1,1); 0,5,0,5,0,5\rangle$	$\langle(9,9,9); 1,0,0\rangle$	$\langle(6,7,8); 0,9,0,1,0,1\rangle$	$\langle(6,7,8); 0,9,0,1,0,1\rangle$	$\langle(6,7,8); 0,9,0,1,0,1\rangle$	$\langle(6,7,8); 0,9,0,1,0,1\rangle$	$\langle(1,1,1); 0,5,0,5,0,5\rangle$	$\langle(2,3,4); 0,3,0,75,0,7\rangle$

Using Creativity	$\langle\langle\frac{1}{6}, \frac{1}{5}, \frac{1}{4}\rangle\rangle; 0.8, 0.15, 0.2$	$\langle\langle\frac{1}{9}, \frac{1}{9}, \frac{1}{9}\rangle\rangle; 1, 0, 0$	$\langle(1, 1, 1); 0.5, 0.5, 0.5\rangle$	$\langle(6, 7, 8); 0.9, 0.1, 0.1\rangle$	$\langle(4, 5, 6); 0.8, 0.15, 0.2\rangle$	$\langle(1, 1, 1); 0.5, 0.5, 0.5\rangle$	$\langle(1, 1, 1); 0.5, 0.5, 0.5\rangle$	$\langle(1, 2, 3); 0.4, 0.65, 0.6\rangle$	$\langle(3, 4, 5); 0.6, 0.35, 0.4\rangle$
Ease of Cooking	$\langle\langle\frac{1}{4}, \frac{1}{3}, \frac{1}{2}\rangle\rangle; 0.3, 0.75, 0.7$	$\langle\langle\frac{1}{8}, \frac{1}{7}, \frac{1}{6}\rangle\rangle; 0.9, 0.1, 0.1$	$\langle\langle\frac{1}{8}, \frac{1}{7}, \frac{1}{6}\rangle\rangle; 0.9, 0.1, 0.1$	$\langle(1, 1, 1); 0.5, 0.5, 0.5\rangle$	$\langle(4, 5, 6); 0.8, 0.15, 0.2\rangle$	$\langle(4, 5, 6); 0.8, 0.15, 0.2\rangle$	$\langle(1, 1, 1); 0.5, 0.5, 0.5\rangle$	$\langle(2, 3, 4); 0.3, 0.75, 0.7\rangle$	$\langle(2, 3, 4); 0.3, 0.75, 0.7\rangle$
Preparation Before Cooking	$\langle\langle\frac{1}{4}, \frac{1}{3}, \frac{1}{2}\rangle\rangle; 0.3, 0.75, 0.7$	$\langle\langle\frac{1}{8}, \frac{1}{7}, \frac{1}{6}\rangle\rangle; 0.9, 0.1, 0.1$	$\langle\langle\frac{1}{6}, \frac{1}{5}, \frac{1}{4}\rangle\rangle; 0.8, 0.15, 0.2$	$\langle\langle\frac{1}{6}, \frac{1}{5}, \frac{1}{4}\rangle\rangle; 0.8, 0.15, 0.2$	$\langle(1, 1, 1); 0.5, 0.5, 0.5\rangle$	$\langle(6, 7, 8); 0.9, 0.1, 0.1\rangle$	$\langle(1, 1, 1); 0.5, 0.5, 0.5\rangle$	$\langle(4, 5, 6); 0.8, 0.15, 0.2\rangle$	$\langle(4, 5, 6); 0.8, 0.15, 0.2\rangle$
Cooking Speed	$\langle\langle\frac{1}{8}, \frac{1}{7}, \frac{1}{6}\rangle\rangle; 0.9, 0.1, 0.1$	$\langle\langle\frac{1}{8}, \frac{1}{7}, \frac{1}{6}\rangle\rangle; 0.9, 0.1, 0.1$	$\langle(1, 1, 1); 0.5, 0.5, 0.5\rangle$	$\langle\langle\frac{1}{6}, \frac{1}{5}, \frac{1}{4}\rangle\rangle; 0.8, 0.15, 0.2$	$\langle\langle\frac{1}{8}, \frac{1}{7}, \frac{1}{6}\rangle\rangle; 0.9, 0.1, 0.1$	$\langle(1, 1, 1); 0.5, 0.5, 0.5\rangle$	$\langle(5, 6, 7); 0.7, 0.25, 0.3\rangle$	$\langle(4, 5, 6); 0.8, 0.15, 0.2\rangle$	$\langle(6, 7, 8); 0.9, 0.1, 0.1\rangle$
Appearance	$\langle(1, 1, 1); 0.5, 0.5, 0.5\rangle$	$\langle\langle\frac{1}{8}, \frac{1}{7}, \frac{1}{6}\rangle\rangle; 0.9, 0.1, 0.1$	$\langle(1, 1, 1); 0.5, 0.5, 0.5\rangle$	$\langle(1, 1, 1); 0.5, 0.5, 0.5\rangle$	$\langle(1, 1, 1); 0.5, 0.5, 0.5\rangle$	$\langle\langle\frac{1}{7}, \frac{1}{6}, \frac{1}{5}\rangle\rangle; 0.7, 0.25, 0.3$	$\langle(1, 1, 1); 0.5, 0.5, 0.5\rangle$	$\langle(4, 5, 6); 0.8, 0.15, 0.2\rangle$	$\langle(6, 7, 8); 0.9, 0.1, 0.1\rangle$
Cost	$\langle\langle\frac{1}{6}, \frac{1}{5}, \frac{1}{4}\rangle\rangle; 0.8, 0.15, 0.2$	$\langle(1, 1, 1); 0.5, 0.5, 0.5\rangle$	$\langle\langle\frac{1}{3}, \frac{1}{2}, 1\rangle\rangle; 0.4, 0.65, 0.6$	$\langle\langle\frac{1}{4}, \frac{1}{3}, \frac{1}{2}\rangle\rangle; 0.3, 0.75, 0.7$	$\langle\langle\frac{1}{6}, \frac{1}{5}, \frac{1}{4}\rangle\rangle; 0.8, 0.15, 0.2$	$\langle\langle\frac{1}{6}, \frac{1}{5}, \frac{1}{4}\rangle\rangle; 0.8, 0.15, 0.2$	$\langle\langle\frac{1}{6}, \frac{1}{5}, \frac{1}{4}\rangle\rangle; 0.8, 0.15, 0.2$	$\langle(1, 1, 1); 0.5, 0.5, 0.5\rangle$	$\langle(4, 5, 6); 0.8, 0.15, 0.2\rangle$
Flavor	$\langle\langle\frac{1}{3}, \frac{1}{2}, 1\rangle\rangle; 0.4, 0.65, 0.6$	$\langle\langle\frac{1}{4}, \frac{1}{3}, \frac{1}{2}\rangle\rangle; 0.3, 0.75, 0.7$	$\langle\langle\frac{1}{5}, \frac{1}{4}, \frac{1}{3}\rangle\rangle; 0.6, 0.35, 0.4$	$\langle\langle\frac{1}{4}, \frac{1}{3}, \frac{1}{2}\rangle\rangle; 0.3, 0.75, 0.7$	$\langle\langle\frac{1}{6}, \frac{1}{5}, \frac{1}{4}\rangle\rangle; 0.8, 0.15, 0.2$	$\langle\langle\frac{1}{8}, \frac{1}{7}, \frac{1}{6}\rangle\rangle; 0.9, 0.1, 0.1$	$\langle\langle\frac{1}{8}, \frac{1}{7}, \frac{1}{6}\rangle\rangle; 0.9, 0.1, 0.1$	$\langle\langle\frac{1}{6}, \frac{1}{5}, \frac{1}{4}\rangle\rangle; 0.8, 0.15, 0.2$	$\langle(1, 1, 1); 0.5, 0.5, 0.5\rangle$

After that neutrosophic evaluation matrix is transformed to crisp one by using Equation (16) and taking the geometric means of 21 decision makers' judgments. Crisp evaluation matrix for criteria is presented in Table 5.

Table 5. The crisp evaluation matrix for criteria

Criteria	Maintaining Nutrition Fact	Food Safety	Using Creativity	Ease of Cooking	Preparation Before Cooking	Cooking Speed	Appearance	Cost	Flavor
Maintaining Nutrition Fact	1	0.727796	1.25014	1.527633	1.315727	1.036983	0.695737	0.899589	0.603949
Food Safety	1.374011	1	1.353279	1.701836	1.751794	1.598556	1.223622	1.003063	0.751704
Using Creativity	0.79991	0.738946	1	1.033799	0.894755	0.968991	0.524114	0.672649	0.662644

Ease of Cooking	0.654607	0.587601	0.967306	1	0.859487	0.873294	0.878775	0.618077	1.214862
Preparation Before Cooking	0.760036	0.570843	1.117624	1.163485	1	0.870216	0.960695	0.642382	0.952786
Cooking Speed	0.964336	0.625565	1.032001	1.14509	1.14914	1	0.913409	0.720211	1.05269
Apperance	1.437325	0.817246	1.907981	1.137948	1.040913	1.0948	1	0.838522	1.094613
Cost	1.111619	0.996946	1.486659	1.617921	1.556706	1.388482	1.192575	1	0.961737
Flavor	1.655769	1.330311	1.509105	0.823139	1.049554	0.949947	0.913565	1.039785	1

Normalized evaluation matrix for criteria is formed as Table 6.

Table 6. The normalized evaluation matrix for criteria

Criteria	Maintaining Nutrition Fact	Food Safety	Using Creativity	Ease of Cooking	Preparation Before Cooking	Cooking Speed	Apperance	Cost	Flavor
Maintaining	0.102484	0.098414	0.107547	0.136997	0.123914	0.106017	0.083799	0.121006	0.072809
Food Safety	0.140814	0.135222	0.116420	0.152619	0.164982	0.16343	0.14738	0.134924	0.090622
Using Creativity	0.081978	0.099922	0.086028	0.09271	0.084267	0.099066	0.063127	0.090479	0.079885
Ease of Cooking	0.067087	0.079456	0.083215	0.089679	0.080946	0.089282	0.105845	0.083139	0.146457
Preparation Before	0.077892	0.077191	0.096147	0.10434	0.094179	0.088968	0.115712	0.086408	0.114863
Cooking Speed	0.098829	0.08459	0.088781	0.102691	0.108225	0.102236	0.110016	0.096877	0.126907

Apperance	0.147303	0.11051	0.164140	0.10205	0.098032	0.111928	0.120446	0.112791	0.131961
Cost	0.113923	0.134809	0.127894	0.145094	0.146609	0.141953	0.143641	0.134512	0.115942
Flavor	0.16969	0.179887	0.129825	0.073818	0.098846	0.097119	0.110035	0.139864	0.120555

Finally the priorities for criteria as the eigen vector X can be calculated by taking the overall row averages and seen as below:

$$X = \begin{bmatrix} 0.105887 \\ 0.13849 \\ 0.086385 \\ 0.091679 \\ 0.095078 \\ 0.102128 \\ 0.122129 \\ 0.13382 \\ 0.124404 \end{bmatrix}$$

According to the eigen vector X while cost was found as the most important criterion having the value of 0.13382, using creativity was obtained as the least important one having the value of 0.086385.

Then the consistency of decision makers' judgments is checked by computing CI and CR values. CI value is found as 0.016 and by using Equation (22) CR value is acquired as 0.011. Decision makers' evaluations are consistent because of having CR value smaller than 0.1.

After obtaining criteria weights four alternatives as cooking techniques (oven, grill) are ranked via single valued neutrosophic sets based Copras method.

Firstly neutrosophic evaluations of four cooking techniques obtained by taking the geometric means of 21 decision makers' judgments are presented as Table 7.

Table 7. Neutrosophic evaluation matrix for four cooking techniques obtained from 21 decision makers

Criteria	Maintaining Nutrition Fact	Food Safety	Using Creativity	Ease of Cooking	Preparation Before Cooking	Cooking Speed	Apperance	Cost	Flavor
Baking	⟨0.69,0.27,0.31⟩	⟨0.78,0.19,0.22⟩	⟨0.66,0.32,0.34⟩	⟨0.84,0.15,0.16⟩	⟨0.75,0.24,0.25⟩	⟨0.71,0.26,0.29⟩	⟨0.73,0.25,0.27⟩	⟨0.68,0.31,0.32⟩	⟨0.8,0.18,0.2⟩

Boiling	(0.72,0.26,0.28)	(0.8,0.18,0.2)	(0.57,0.43,0.43)	(0.76,0.22,0.24)	(0.76,0.22,0.24)	(0.7,0.29,0.3)	(0.59,0.39,0.41)	(0.8,0.18,0.2)	(0.72,0.26,0.28)
Grill	(0.76,0.21,0.24)	(0.72,0.26,0.28)	(0.77,0.2,0.23)	(0.76,0.23,0.24)	(0.72,0.26,0.28)	(0.75,0.22,0.25)	(0.86,0.13,0.14)	(0.7,0.28,0.3)	(0.88,0.11,0.12)
Sauteing	(0.69,0.26,0.31)	(0.73,0.23,0.27)	(0.79,0.18,0.21)	(0.79,0.18,0.21)	(0.68,0.29,0.32)	(0.81,0.17,0.19)	(0.77,0.21,0.23)	(0.69,0.27,0.31)	(0.83,0.15,0.17)

Then the cells in Table 7 are transformed to crisp one by using Equation (14) as score functions and obtained deterministic pairwise matrix for four cooking techniques are seen as Table 8.

Table 8. Deterministic pairwise matrix for four cooking techniques

Criteria	Maintaining Nutrition Fact	Food Safety	Using Creativity	Ease of Cooking	Preparation Before Cooking	Cooking Speed	Görünüm	Cost	Flavor
Baking	0.420435	0.594285	0.340704	0.687115	0.510115	0.448391	0.481008	0.369066	0.627965
Boiling	0.45638	0.617556	0.143355	0.541296	0.538664	0.408671	0.203095	0.611895	0.458623
Grill	0.55452	0.465339	0.56583	0.5283	0.462035	0.527789	0.722915	0.414642	0.767978
Sauteing	0.430835	0.495965	0.61226	0.601243	0.390446	0.63546	0.558783	0.420307	0.675659

Weighted pairwise matrix is constructed and presented as Table 9.

Table 9. Weighted pairwise matrix for four cooking techniques

Criteria	Maintaining Nutrition Fact	Food Safety	Using Creativity	Ease of Cooking	Preparation Before Cooking	Cooking Speed	Apperance	Cost	Flavor

Baking	0.044519	0.082303	0.029431	0.062994	0.048501	0.045793	0.058745	0.049388	0.078121
Boiling	0.048325	0.085525	0.012383	0.049625	0.051215	0.041737	0.024804	0.081884	0.057055
Grill	0.058716	0.064445	0.048879	0.048434	0.043929	0.053902	0.088289	0.055487	0.09554
Sauteing	0.04562	0.068686	0.052890	0.055121	0.037123	0.064898	0.068244	0.056245	0.084055

The values of R_{+i} , R_{-i} , SV_i and ranking of four cooking techniques are presented as Table 10.

Table 10. The values of R_{+i} , R_{-i} , SV_i and ranking of four cooking techniques

Criteria	R_{+i}	R_{-i}	SV_i	Ranking
Baking	0.450407	0.049388	0.522487	3
Boiling	0.370669	0.081884	0.442749	4
Grill	0.502134	0.055487	0.574214	1
Sauteing	0.476637	0.056245	0.548717	2

According to Table 10 while grill technique was found as the most important cooking alternative having the SV_i value of 0.574214, boiling technique was obtained as the least important one having the SV_i value of 0.442749.

Conclusions

In this study cooking techniques are ranked by using neutrosophic AHP based neutrosophic Copras approach. For this aim firstly criteria for selecting the cooking techniques are determined according to extensive literature review process and weighted via single valued neutrosophic sets based AHP approach. Then the four cooking techniques as alternatives are ranked by using single valued neutrosophic sets based Copras method. Single valued neutrosophic sets are preferred compared to crisp, fuzzy, interval-valued and intuitionistic sets due to efficiency, flexibility and easiness for explaining decision makers' indeterminate judgments. Furthermore selection of cooking technique as a complex real world decision making problem can be efficiently solved under neutrosophic sets based environment.

For further researches criteria related to cooking technique selection can be expanded and results can be compared with different multi criteria decision making methods. Also various hybrid techniques can be proposed and applied for real world complex decision making problems.

Restrictions of Research

This research has been limited to the dry heat cooking method. In the future research, apart from the dry and wet heat cooking methods, modern cooking methods such as sou-vide can also be examined and compared within the framework of cuisine dynamics.

In this research, cooking methods have been evaluated from the chefs' point of view, who can be described as cuisine producers. The comparison of cooking methods within the framework of variables being important for consumers such as taste, presentation and price may bring a more comprehensive perspective to the issue.

References

- [1] Abdel-Basset, M., Mohamed, M., Smarandache, F. (2018). An Extension of Neutrosophic AHP SWOT Analysis for Strategic Planning and Decision Making. *Symmetry*, 1-18.
- [2] Abdel-Basset, M., Mohamed, M., Zhou, Y., Hezam, I. (2017). Multi-Criteria Group Decision Making Based on Neutrosophic Analytic Hierarchy Process. *Journal of Intelligent & Fuzzy Systems*, 4055-4066.
- [3] Anderson, K. E., Sinha, R., Kulldorff, M., Gross, M., Lang, N. P., Barber, C., Kadlubar, F. F. (2002). Meat Intake and Cooking Techniques: Associations with Pancreatic Cancer. *Mutation Research/Fundamental and Molecular Mechanisms of Mutagenesis*, 225-231.
- [4] Appel, D., Löfqvist, B. (1978). Meat Cooking Techniques—Part 1: A Preliminary Study of the Effect of the Rate of Heating in Water. *Meat Science*, 251-262.
- [5] Armesto, F. F. (2007). *Yemek İçin Yaşamak-Yiyeceklerle Dünya Tarihi*. İstanbul: İletişim Yayınları.
- [6] Bakbak, D., Uluçay, V. & Şahin, M. (2019). Neutrosophic soft expert multiset and their application to multiple criteria decision making. *Mathematics*, 7(1), 50.
- [7] Biswas, P., Pramanik, S., Giri, B. (2016). Some Distance Measures of Single Valued Neutrosophic Hesitant Fuzzy Sets and Their Applications to Multiple Attribute Decision Making. F. Smarandache, & S. Pramanik içinde, *In New Trends in Neutrosophic Theory and Applications* (s. 27-34). Brussels: Pons Publishing House.
- [8] Bogнар, A. (1998). Comparative Study of Frying to Other Cooking Techniques Influence on the Nutritive Value. *Grasas y Aceites*, 250-260.
- [9] Broumi, S., Bakali, A., Talea, M., Smarandache, F., Singh, P.K., Uluçay, V. & Khan, M. (2019). Bipolar complex neutrosophic sets and its application in decision making problem. In *Fuzzy Multi-criteria Decision-Making Using Neutrosophic Sets* (pp. 677-710). Springer, Cham.
- [10] Ceylan, Z., Şengör, Ü. (2017). Sous-Vide Teknolojisi ile Muamele Edilen Balıkların Kalite Parametrelerinin İncelenmesi . *Turkish Journal of Aquatic Sciences* , 8-20.
- [11] Chiavaro, E., Maezzo, T., Visconti, A., Manzi, C., Fogliano, V., Pellegrini, N. (2012). Nutritional Quality of Sous vide Cooked Carrots and Brussel Sprouts . *Journal of Agricultural and Food Chemistry* , 6019-6025.
- [12] Çağlak, E., Karşlı, B., Şişmanlar Altınkaya, E. (2017). Farklı Sıcaklık Kombinasyonlarında Sous-Vide Tekniği Uygulanarak +2+1°C'de Depolanan Sudak Balığının (Sander lucioperca Linnaeus, 1758) Kalite Değişimlerinin İncelenmesi. *Yunus Araştırma Bülteni*, 71-81.
- [13] Ersoy, B., Özeren, A. (2009). The Effect of Cooking Methods on Mineral and Vitamin Contents of African Catfish. . *Food Chemistry* , 419-422.
- [14] FAO. (2000). Handbook for Defining and Setting up a Food Security Information and Early Warning System . Retrieved from FSIEWS: <http://www.fao.org/nr/climpag/pub/Manual%20of%20FSIEWS.pdf>
- [15] Gutiérrez-Praena, D., Jos, Á., Pichardo, S., Moreno, I. M., Cameán, A. M. (2013). Presence and Bioaccumulation of Microcystins and Cylindrospermopsin in Food and the Effectiveness of Some Cooking Techniques at Decreasing Their Concentrations: A Review. *Food and Chemical Toxicology*, 139-152.
- [16] Gürman, Ü. (2006). *Yemek Pişirme Teknikleri ve Uygulaması 1*. İstanbul: MEB Yayınları.
- [17] Hassan, N., Uluçay, V. & Şahin, M. (2018). Q-neutrosophic soft expert set and its application in decision making. *International Journal of Fuzzy System Applications (IJFSA)*, 7(4), 37-61.

- [18] Hyytia-Trees, E., Skytta, E., Morkkila, M., Kinnunen, A., Lindström, M. (2000). Safety Evaluations of Sous Vide-Processes Products with Respect to Nonproteolytic Clostridium Botulinum by Use of Challenge Studies and Predictive Microbiological Models . *Journal of Applied and Environmental Microbiology*, 223-229.
- [19] Martínez-Hernández, G. B., Artés-Hernández, F., Colares-Souza, F., Gómez, P. A., García-Gómez, P., Artés, F. (2013). Innovative Cooking Techniques for Improving the Overall Quality of a Kailan-Hybrid Broccoli. *Food and Bioprocess Technology*, 2135-2149.
- [20] Mondal, K., Pramanik, S., Smarandache, F. (2016). Several Trigonometric Hamming Similarity Measures of Rough Neutrosophic Sets and Their Applications in Decision Making. F. Smarandache, & S. Pramanik içinde, In *New Trends in Neutrosophic Theory and Applications* (s. 93-103). Brussels: Pons Publishing House.
- [21] Murador, D. C., Mercadante, A. Z., De Rosso, V. V. (2016). Cooking Techniques Improve the Levels of Bioactive Compounds and Antioxidant Activity in Kale and Red Cabbage. *Food Chemistry*, 1101-1107.
- [22] Mutlu, A. S. (2018). Sabit Menü Sunumlarında Farklı Pişirme Yöntemlerine Göre Tabak Artığı Oluşumu. Afyon: Unpublished MSc Thesis, Afyon Kocatepe University.
- [23] Myhrvold, N., Young, C., Bilet, M. (2011). *Modernist Cuisine* . Cologne: Germany: Taschen.
- [24] Oz, F., Kaban, G., Kaya, M. (2010). Effects of Cooking Techniques and Levels on the Formation of Heterocyclic Aromatic Amines in Chicken and Fish. *Journal of Animal and Veterinary Advances*, 1259-1264.
- [25] Özgen, I. (2015). Uluslararası Gastronomi . M. Sarıışık içinde, *Uluslararası Gastronomiye Genel Bakış* (s. 1-32). Ankara : Detay Yayıncılık.
- [26] Ramírez-Anaya, P. J., Samaniego-Sánchez, C., Castañeda-Saucedo, M. C., Villalón-Mir, M. (2015). Phenols and the Antioxidant Capacity of Mediterranean Vegetables Prepared with Extra Virgin Olive Oil Using Different Domestic Cooking Techniques. *Food Chemistry*, 430-438.
- [27] Sinha, R., Peters, U., Cross, A. J., Kulldorff, M., Weissfeld, J. L., Pinsky, P. F., Hayes, R. B. (2005). Meat, Meat Cooking Methods and Preservation, and Risk for Colorectal Adenoma. *Cancer Research*, 8034-8041.
- [28] Smarandache, F. (1998) *A Unifying Field in Logics Neutrosophy: Neutrosophic Probability, Set and Logic*. Rehoboth: American Research Press.
- [29] Stanujkic, D., Zavadskas, E., Smarandache, F., Brauers, W., Karabasevic, D. (2017). A Neutrosophic Extension of the Multimoora Method. *Informatica*, 181-192.
- [30] Şahin, M., Ecemiş, O., Uluçay, V. & Kargın, A. (2017). Some new generalized aggregation operators based on centroid single valued triangular neutrosophic numbers and their applications in multi-attribute decision making, *Asian Journal of Mathematics and Computer Research* , 16(2), 63-84.
- [31] Şahin, M., Olgun, N., Uluçay, V., Kargın, A. & Smarandache, F. (2017). A new similarity measure on falsity value between single valued neutrosophic sets based on the centroid points of transformed single valued neutrosophic numbers with applications to pattern recognition, *Neutrosophic Sets and Systems*, 15, 31-48.
- [32] Uhri, A. (2016). *Gastronomi Tarihi* . H. Yılmaz içinde, *İnsanlığın Şafağında Beslenme* (s. 2-25). Eskişehir: Anadolu Üniversitesi Basımevi.
- [33] Uluçay, V., Kılıç, A., Şahin, M. & Deniz, H. (2019). A New Hybrid Distance-Based Similarity Measure for Refined Neutrosophic sets and its Application in Medical Diagnosis. *MATEMATIKA: Malaysian Journal of Industrial and Applied Mathematics*, 35(1), 83-94.
- [34] Uluçay, V., Kılıç, A., Yıldız, I. & Şahin, M. (2018). A new approach for multi-attribute decision-making problems in bipolar neutrosophic sets. *Neutrosophic Sets and Systems*, 2018, 23(1), 142-159.
- [35] Uluçay, V. & Şahin, M. (2020). Decision-Making Method based on Neutrosophic Soft Expert Graphs. In *Neutrosophic Graph Theory and Algorithms* (pp. 33-76). IGI Global.
- [36] Uluçay, V., Şahin, M. & Olgun, N. (2018). Time-Neutrosophic Soft Expert Sets and Its Decision Making Problem. *Matematika*, 34(2), 246-260.
- [37] Wang, H., Smarandache, F., Zhang, Y., Sunderraman, R. (2010). Single Valued Neutrosophic Sets. *Multispace and Multistructure*, 410-413.

[38] Yang, J., Sulaeman, A., Setiawan, B., Atughonu, A., Giraud, D., Hamouz, F. L. (1994). Sensory and Nutritive Qualities Of Pork Strips Prepared by Three Household Cooking Techniques 1. *Journal of Food Quality*, 33-40.

[39] Zavadskas, E.K., Kaklauskas, A., Sarka, V. (1994). The new method of multi-criteria complex proportional assessment of projects. *Technological and Economic Development of Economy*, 1(3), 131-139.

Chapter Nine

A Theoretic Approach to Decision Making Problems in Architecture with Neutrosophic Soft Set

¹Derya BAKBAK, ²Vakkas ULUÇAY

¹TBMM Public relations building 2nd Floor, B206 room Ministries, Ankara06543-Turkey;

²Department of Mathematics, Kilis 7 Aralık University, Kilis-Turkey

E-mail: derya.bakbak@tbmm.gov.tr,

*Correspondence: vulucay27@gmail.com

ABSTRACT

It becomes even more complex with complex architectural problems, and decision-making methods are needed, and it is understood how important decision-making methods are. While the use of decision-making methods in the field of engineering is dominant, their use in the field of architecture is becoming more and more widespread. It can be listed as reaching an optimum solution with the targeted and designed alternatives with these methods, evolving the design process, allowing recycling, controlling these processes and creating data for architecture in the future. In this chapter, we developed construction method of converting intuitionistic fuzzy set into neutrosophic set to intuitionistic fuzzy soft set into neutrosophic soft set. Here we consider a problem of decision making the application of architecture in fuzzy soft set and presented a method to generalize it into neutrosophic soft set based decision making problem for modelling the problem in a better way. In the process we used the construction method and score function of neutrosophic number.

Keywords: intuitionistic fuzzy soft set, neutrosophic soft set, decision making, architecture.

INTRODUCTION

For proper description of objects in uncertain and ambiguous environment, indeterminate and incomplete information has to be properly handled. Intuitionistic fuzzy sets were introduced by Atanassov [1], followed by Molodtsov [2] on soft set and neutrosophy logic [3] and neutrosophic sets [4] by Smarandache. The term neutro-sophy

means knowledge of neutral thought and this neutral represents the main distinction between fuzzy and intuitionistic fuzzy logic and set. Presently, work on soft set theory is progressing rapidly. Various operations and applications of soft sets were developed rapidly including neutrosophic soft expert multiset [5], on neutrosophic soft lattices [6], isomorphism theorems for soft G-modules [7], time-neutrosophic soft expert sets [8], a new approach for multi-attribute decision-making problems in bipolar neutrosophic sets [9], generalized neutrosophic soft expert set for multiple-criteria decision-making [10], A new similarity measure based on falsity value between single valued neutrosophic sets based on the centroid points of transformed single valued neutrosophic numbers with applications to pattern recognition [11]. The above set theories have been applied to many different areas including real decision making problems [12-29].

Bakbak [30] the properties, future expectations and plans of the houses in Syria were evaluated. Bakbak, [31] has evaluated sports fields, recreation areas, playgrounds, car parks, parking lots, shopping areas, resting facilities, pedestrian roads, mosques, condolences, parks, cafes and tea gardens. Therefore, the proposed method in this study will help to make the most appropriate decision for housing construction.

In this chapter, we have presented a neutrosophic soft set theoretic approach towards solution of the above decision making problem in architecture.

In the Section 2 we have presented a brief note on the preliminaries related to soft sets definitions centered around our problem. Section 3 deals with again the basics of neutrosophic soft sets and some relevant definitions. A decision making problem has been discussed and solved in the Section 4 and Section 5. We have some conclusions in the concluding Section 6.

BACKGROUND

Definition 1. [4] Let T be a universe of discourse, with a generic element in T denoted by t , then a neutrosophic (NS) set A is an object having the form

$$A = \left\{ \left\langle t, (\mu_A(t), \nu_A(t), \omega_A(t)) \right\rangle, t \in T \right\}$$

where the functions $\mu_A(t), \nu_A(t), \omega_A(t) : T \rightarrow [0, 1]$ define respectively the degree of membership (or Truth), the degree of indeterminacy, and the degree of non-membership (or Falsehood) of the element $t \in T$ to the set A with the condition.

$$0 \leq \mu_A(t) + \nu_A(t) + \omega_A(t) \leq 3.$$

Definition 2. [17] Let T be an initial universe set and E be a set of parameters. Consider $T \subseteq E$. Let $NS(T)$ denotes the set of all neutrosophic sets of T . The collection (F, A) is termed to be the neutrosophic soft set (NSS) over T , where F is a mapping given by $F: A \rightarrow NS(T)$.

Definition 3. [22] The complement of a NSS (F, A) denoted by $(F, A)^c$ and is defined as $(F, A)^c = (F^c, \neg A)$ where $F^c = \neg A \rightarrow P(T)$ is mapping given by $F^c(x) =$ neutrosophic soft complement with $\mu_{F^c(x)} = w_{F(x)}$, $v_{F^c(x)} = v_{F(x)}$, $w_{F^c(x)} = \mu_{F(x)}$.

Definition 4. [22] Let (H, A) and (G, B) be two NSSs over the common universe T . Then the union of (H, A) and (G, B) is denoted by “ $(H, A) \cup (G, B)$ ” and is defined by $(H, A) \cup (G, B) = (K, C)$, where $C = A \cup B$ and the truth-membership, indeterminacy-membership and falsity-membership of (K, C) are as follows:

$$\mu_{K(e)}(t) = \begin{cases} \mu_{H(e)}(t) & , & \text{if } e \in A - B, \\ \mu_{G(e)}(t) & , & \text{if } e \in B - A, \\ \max(\mu_{H(e)}(t), \mu_{G(e)}(t)) & , & \text{if } e \in A \cap B. \end{cases}$$

$$v_{K(e)}(m) = \begin{cases} v_{H(e)}(t) & , & \text{if } e \in A - B, \\ v_{H(e)}(t) & , & \text{if } e \in B - A, \\ \frac{v_{H(e)}(t) + v_{G(e)}(t)}{2} & , & \text{if } e \in A \cap B. \end{cases}$$

$$w_{K(e)}(m) = \begin{cases} w_{H(e)}(t) & , & \text{if } e \in A - B, \\ w_{G(e)}(t) & , & \text{if } e \in B - A, \\ \min(w_{H(e)}(t), w_{G(e)}(t)) & , & \text{if } e \in A \cap B. \end{cases}$$

Definition 5. [22] Let (H, A) and (G, B) be two NSSs over the common universe T . Then the intersection of (H, A) and (G, B) is denoted by “ $(H, A) \cap (G, B)$ ” and is defined by $(H, A) \cap (G, B) = (K, C)$, where $C = A \cap B$ and the truth-membership, indeterminacy-membership and falsity-membership of (K, C) are as follows:

$$\mu_{K(e)}(t) = \min(\mu_{H(e)}(t), \mu_{G(e)}(t))$$

$$v_{K(e)}(t) = \frac{v_{H(e)}(t) + v_{G(e)}(t)}{2}$$

$$w_{K(e)}(t) = \max(w_{H(e)}(t), w_{G(e)}(t)), \text{ if } e \in A \cap B.$$

Definition 6. [27] Let $\alpha_1 = \langle \mu_{\alpha_1}, v_{\alpha_1}, w_{\alpha_1} \rangle$ be a single valued neutrosophic number. Then, the score function $S(\alpha_1)$, accuracy function $a(\alpha_1)$ and certainty function $C(\alpha_1)$ of an SNN are defined as below;

i. $s(\alpha_1) = (\mu + 1 - v + 1 - w) / 3;$

- ii. $a(\alpha_1) = \mu - v$;
- iii. $c(\alpha_1) = \mu$.

Definition 7. [27] Let $\alpha_1 = \langle \mu_{\alpha_1}, \nu_{\alpha_1}, w_{\alpha_1} \rangle$ and $\alpha_2 = \langle \mu_{\alpha_2}, \nu_{\alpha_2}, w_{\alpha_2} \rangle$ be two single valued neutrosophic numbers. The comparison method can be defined as follows:

- i. If $s(\alpha_1) > s(\alpha_2)$, then α_1 is greater than α_2 , that is, α_1 is superior to α_2 , denoted by $\alpha_1 > \alpha_2$;
- ii. If $s(\alpha_1) = s(\alpha_2)$ and $a(\alpha_1) > a(\alpha_2)$, then α_1 is greater than α_2 , that is, α_1 is superior to α_2 , denoted by $\alpha_1 < \alpha_2$;
- iii. If $s(\alpha_1) = s(\alpha_2)$, $a(\alpha_1) = a(\alpha_2)$ and $c(\alpha_1) > c(\alpha_2)$ then α_1 is greater than α_2 , that is, α_1 is superior to α_2 , denoted by $\alpha_1 > \alpha_2$;
- iv. If $s(\alpha_1) = s(\alpha_2)$, $a(\alpha_1) = a(\alpha_2)$ and $c(\alpha_1) = c(\alpha_2)$ then α_1 is equal to α_2 , that is, α_1 is indifferent to α_2 , denoted by $\alpha_1 = \alpha_2$.

Neutrosophic Soft Set with Construction method

In this section, a method of construction of neutrosophic set from fuzzy set given by Jurio et al. [28] is presented. In this method we represent the truth-membership, indeterminacy-membership and falsity-membership degrees of each element.

Let $A_F \in FS_s(T)$ where $FS_s(T)$ denotes the set of all fuzzy sets in the universal set T and let $\sigma, \gamma : T \rightarrow [0,1]$ be three mappings. Then

$$N = \left\{ \left\langle t_i, f(\mu_{A_F}(t_i), \sigma(t_i), \gamma(t_i)) \right\rangle : t_i \in T \right\}$$

is a neutrosophic set corresponding fuzzy set A_F , where the mapping

$$f : [0,1]^2 \times [0,1] \rightarrow L^*$$

given by $f(x, y, \gamma) = (f_\mu(x, y, \gamma), f_\nu(x, y, \gamma), f_w(x, y, \gamma))$, where

$$f_\mu(x, y, \gamma) = x(1 - \gamma y),$$

$$f_\nu(x, y, \gamma) = 1 - x(1 - \gamma y) - \gamma y$$

$$f_w(x, y, \gamma) = 1 - f_\mu(x, y, \gamma),$$

$$L^* = \{(x, y) : x, y \in [0, 1] \times [0, 1] \text{ and } x + y \leq 1\},$$

(The smallest element of L^* is $0_{L^*} = (0, 0, 1)$ and the greatest one is $1_{L^*} = (1, 0, 0)$.)

satisfies that

- i. If $y_1 \leq y_2$ then $\sigma(f_\mu(x, y_1, \gamma)) \leq \sigma(f_\mu(x, y_2, \gamma))$ for all $x, \gamma \in [0, 1]$
- ii. $f_\mu(x, y, \gamma) \leq x \leq 1 - f_\mu(x, y, \gamma)$ for all $x \in [0, 1]$
- iii. $f(x, 0, \gamma) = (x, 1 - x)$
- iv. $f(0, y, \gamma) = (0, 1 - \gamma y)$
- v. $f(x, y, 0) = (x, 1 - x)$
- vi. $\sigma(f(x, y, \gamma)) = \gamma y$

Example 8 Let $T = \{t_1, t_2, t_3, t_4\}$ and let $A_F \in FSs(T)$ given by

$$A_F = \left\{ x, \frac{t_1}{0.4}, \frac{t_2}{0.6}, \frac{t_3}{0.5}, \frac{t_4}{1} \right\}$$

and $\sigma(t_i) = 0.4$, $\gamma(t_i) = 1$ for all $t_i \in T$. By using the above method fuzzy soft set converted in neutrosophic soft set given as follows:

$$f_\mu(x, y, \gamma) = x(1 - \gamma y) = 0.4(1 - 0.4) = 0.24,$$

$$f_\nu(x, y, \gamma) = 1 - x(1 - \gamma y) - \gamma y = 1 - 0.24 - 0.4 = 0.36,$$

$$f_w(x, y, \gamma) = 1 - f_\mu(x, y, \gamma) = 1 - 0.24 = 0.76,$$

$$A_{SVNSs} = \left\{ x_1, \frac{t_1}{(0.24, 0.36, 0.76)}, \frac{t_2}{(0.24, 0.16, 0.76)}, \frac{t_3}{(0.25, 0.25, 0.75)}, \frac{t_4}{(0.6, 0.0, 0.4)} \right\}.$$

Decision Making based on NSs

In this section we present neutrosophic soft set and some results of it. We discussed and extended the approach to fuzzy soft sets based decision making presented by Roy and Maji [29].

Let $T = \{t_1, t_2, t_3, \dots, t_k\}$ be set of k -objects, which may be characterized by a set of parameters $\{F_1, F_2, F_3, \dots, F_i\}$. The parameters space E may be written as $E \supseteq \{F_1 \cup F_2 \cup F_3 \cup \dots \cup F_i\}$. Let each parameter set F_i represent the i th class of parameters and elements of F_i represent a specific property set. Comparison table is a square table in which columns both are labeled by the objects names $t_1, t_2, t_3, \dots, t_n$ of the universe and the entries $c_{ij}, ij = 1, 2, \dots, n$ given by $c_{ij} =$ the number of parameters for which the NSN of t_i exceeds or equal to the SVNSN of t_j .

Clearly, $0 \leq c_{ij} \leq k$ and $c_{ij} = k, \forall i, j$ where k is the number of parameters present in a NSS.

Thus c_{ij} indicates a numerical measure, which integer number and t_i dominates t_j in c_{ij} number of parameters out of k parameters.

The row sum of an object t_i is denoted by r_i and is calculated by using the formula,

$$r_i = \sum_{j=1}^n c_{ij}$$

Clearly, r_i indicates the total number of parameters in which t_i dominates all the members of T .

The column sum of an object t_i is denoted by c_i and is calculated by using the formula,

$$c_i = \sum_{j=1}^n c_{ij}$$

Clearly, \mathcal{C}_i indicates the total number of parameters in which t_i dominates all the members of T .

The score of an object t_i is \mathcal{S}_i may be given as

$$\mathcal{S}_i = r_i - \mathcal{C}_i.$$

The algorithm consists of the following steps:

- A. Identify the parameters and alternatives of NSSs
- B. Input the neutrosophic soft set (F^{NS}, A) , (G^{NS}, B) and (H^{NS}, C) with the appropriate parameter set P as observed by observer.
- C. Compute the corresponding resultant neutrosophic soft set (S, P) from the neutrosophic soft sets (F^{NS}, A) , (G^{NS}, B) and (H^{NS}, C) and place it in tabular form.
- D. Construct the comparison table of neutrosophic soft set (S, P) and compute r_i and \mathcal{C}_i for $t_i, \forall i$.
- E. Compute the score of $t_i, \forall i$.
- F. The optimal decision is to select t_k if $\mathcal{S}_k = \mathcal{S}_i$.
- G. If k has more than one value then any one of t_k may be chosen.

Application in a decision making problem

In this section we discussed the problem taken by Roy and Maji [29] in neutrosophic soft set by using the method construction of neutrosophic number from fuzzy number.

Let $T = \{t_1, t_2, t_3, t_4, t_5, t_6\}$, be the set of objects having different foundation, walls and roofs. The set of parameters is given by

$$E = \{e_1, e_2, e_3, e_4, e_5, e_6, e_7, e_8, e_9, e_{10}, e_{11}, e_{12}, e_{13}\},$$

where e_i stand for concrete e_1 , ground concrete e_2 , lean concrete e_3 , crushed rock blockage e_4 , mudbrick e_5 , Plasterboard e_6 , Wall Ceramic e_7 , Plaster holder e_8 , Straw

Panel e_9 , Membrane e_{10} , Crushed Rock e_{11} , Straw Panel e_{12} , Extruded Polystyrene e_{13} .

Let $A = \{e_1, e_2, e_3, e_4\}$, $B = \{e_5, e_6, e_7, e_8, e_9\}$ and $C = \{e_{10}, e_{11}, e_{12}, e_{13}\}$ be three subsets of the set of parameter E . A , B and C represent the foundation, walls and roofs respectively.

Consider the neutrosophic soft set (F^{NS}, A) , (G^{NS}, B) and (H^{NS}, C) describe the objects having the foundation, walls and roofs of the architectural structure. The problem is to identify an unknown structure from the multi observes neutrosophic data, specified by different decision maker in terms of neutrosophic soft sets (F^{NS}, A) , (G^{NS}, B) and (H^{NS}, C) . The neutrosophic soft sets may be computed as follows. The neutrosophic soft set (F^{NS}, A) is defined as

$$(F^{NS}, A) = \left(\begin{array}{l} e_1 = \left\{ \langle t_1, 0.18, 0.52, 0.82 \rangle, \langle t_2, 0.18, 0.52, 0.82 \rangle, \langle t_3, 0.2, 0.3, 0.8 \rangle \right\} \\ \left\{ \langle t_4, 0.08, 0.02, 0.92 \rangle, \langle t_5, 0.14, 0.06, 0.86 \rangle, \langle t_6, 0.0, 0.0, 1 \rangle \right\} \\ e_2 = \left\{ \langle t_1, 0.2, 0.3, 0.8 \rangle, \langle t_2, 0.0, 0.0, 1 \rangle, \langle t_3, 0.2, 0.2, 0.8 \rangle \right\} \\ \left\{ \langle t_4, 0.14, 0.56, 0.86 \rangle, \langle t_5, 0.18, 0.52, 0.82 \rangle, \langle t_6, 0.14, 0.56, 0.86 \rangle \right\} \\ e_3 = \left\{ \langle t_1, 0.18, 0.12, 0.82 \rangle, \langle t_2, 0.18, 0.52, 0.82 \rangle, \langle t_3, 0.08, 0.02, 0.92 \rangle \right\} \\ \left\{ \langle t_4, 0.2, 0.3, 0.8 \rangle, \langle t_5, 0.18, 0.12, 0.82 \rangle, \langle t_6, 0.2, 0.3, 0.8 \rangle \right\} \\ e_4 = \left\{ \langle t_1, 0.0, 0.0, 1 \rangle, \langle t_2, 0.2, 0.2, 0.8 \rangle, \langle t_3, 0.14, 0.06, 0.86 \rangle \right\} \\ \left\{ \langle t_4, 0.08, 0.02, 0.92 \rangle, \langle t_5, 0.2, 0.2, 0.8 \rangle, \langle t_6, 0.18, 0.52, 0.82 \rangle \right\} \end{array} \right)$$

$$(G^{NS}, B) = \left(\begin{array}{l} e_5 = \left\{ \langle t_1, 0.2, 0.3, 0.8 \rangle, \langle t_2, 0.08, 0.02, 0.92 \rangle, \langle t_3, 0.18, 0.12, 0.82 \rangle \right\} \\ \left\{ \langle t_4, 0.0, 0.0, 1 \rangle, \langle t_5, 0.14, 0.56, 0.86 \rangle, \langle t_6, 0.18, 0.52, 0.82 \rangle \right\} \\ e_6 = \left\{ \langle t_1, 0.14, 0.56, 0.86 \rangle, \langle t_2, 0.18, 0.12, 0.82 \rangle, \langle t_3, 0.2, 0.3, 0.8 \rangle \right\} \\ \left\{ \langle t_4, 0.08, 0.02, 0.92 \rangle, \langle t_5, 0.08, 0.72, 0.92 \rangle, \langle t_6, 0.14, 0.56, 0.86 \rangle \right\} \\ e_7 = \left\{ \langle t_1, 0.08, 0.02, 0.92 \rangle, \langle t_2, 0.18, 0.52, 0.82 \rangle, \langle t_3, 0.2, 0.3, 0.8 \rangle \right\} \\ \left\{ \langle t_4, 0.14, 0.56, 0.86 \rangle, \langle t_5, 0.08, 0.72, 0.92 \rangle, \langle t_6, 0.08, 0.02, 0.92 \rangle \right\} \\ e_8 = \left\{ \langle t_1, 0.18, 0.12, 0.82 \rangle, \langle t_2, 0.08, 0.72, 0.92 \rangle, \langle t_3, 0.08, 0.72, 0.92 \rangle \right\} \\ \left\{ \langle t_4, 0.08, 0.72, 0.92 \rangle, \langle t_5, 0.08, 0.02, 0.92 \rangle, \langle t_6, 0.18, 0.12, 0.82 \rangle \right\} \\ e_9 = \left\{ \langle t_1, 0.2, 0.3, 0.8 \rangle, \langle t_2, 0.14, 0.06, 0.86 \rangle, \langle t_3, 0.14, 0.06, 0.86 \rangle \right\} \\ \left\{ \langle t_4, 0.18, 0.12, 0.82 \rangle, \langle t_5, 0.14, 0.06, 0.86 \rangle, \langle t_6, 0.2, 0.3, 0.8 \rangle \right\} \end{array} \right)$$

$$(H^{NS}, C) = \left(\begin{array}{l} e_{10} = \left\{ \langle t_1, 0.18, 0.42, 0.82 \rangle, \langle t_2, 0.18, 0.12, 0.82 \rangle, \langle t_3, 0.2, 0.2, 0.8 \rangle \right. \\ \left. \langle t_4, 0.14, 0.56, 0.86 \rangle, \langle t_5, 0.18, 0.12, 0.82 \rangle, \langle t_6, 0.08, 0.02, 0.92 \rangle \right\}, \\ e_{11} = \left\{ \langle t_1, 0.2, 0.3, 0.8 \rangle, \langle t_2, 0.2, 0.2, 0.8 \rangle, \langle t_3, 0.18, 0.12, 0.82 \rangle \right. \\ \left. \langle t_4, 0.18, 0.12, 0.82 \rangle, \langle t_5, 0.18, 0.12, 0.82 \rangle, \langle t_6, 0.14, 0.56, 0.86 \rangle \right\}, \\ e_{12} = \left\{ \langle t_1, 0.08, 0.02, 0.92 \rangle, \langle t_2, 0.2, 0.3, 0.8 \rangle, \langle t_3, 0.18, 0.42, 0.82 \rangle \right\} \\ \left. \langle t_4, 0.18, 0.12, 0.82 \rangle, \langle t_5, 0.2, 0.2, 0.8 \rangle, \langle t_6, 0.14, 0.06, 0.86 \rangle \right\}, \\ e_{13} = \left\{ \langle t_1, 0.0, 0.0, 1 \rangle, \langle t_2, 0.2, 0.2, 0.8 \rangle, \langle t_3, 0.18, 0.12, 0.82 \rangle \right\} \\ \left. \langle t_4, 0.18, 0.42, 0.82 \rangle, \langle t_5, 0.2, 0.3, 0.8 \rangle, \langle t_6, 0.0, 0.0, 1 \rangle \right\} \end{array} \right)$$

The tabular representations of the neutrosophic soft set (F^{NS}, A) , (G^{NS}, B) and (H^{NS}, C) are shown in Table 1, Table 2 and Table 3 respectively.

Table 1: Tabular Representation of the Neutrosophic Soft Set (F^{NS}, A)

T	concrete a_1	ground concrete a_2	lean concrete a_3	crushed rock blockage a_4
t_1	$\langle 0.18, 0.52, 0.82 \rangle$	$\langle 0.2, 0.3, 0.8 \rangle$	$\langle 0.18, 0.12, 0.82 \rangle$	$\langle 0.0, 0.0, 1 \rangle$
t_2	$\langle 0.18, 0.52, 0.82 \rangle$	$\langle 0.0, 0.0, 1 \rangle$	$\langle 0.18, 0.52, 0.82 \rangle$	$\langle 0.2, 0.2, 0.8 \rangle$
t_3	$\langle 0.2, 0.3, 0.8 \rangle$	$\langle 0.2, 0.2, 0.8 \rangle$	$\langle 0.08, 0.02, 0.92 \rangle$	$\langle 0.14, 0.06, 0.86 \rangle$
t_4	$\langle 0.08, 0.02, 0.92 \rangle$	$\langle 0.14, 0.56, 0.86 \rangle$	$\langle 0.2, 0.3, 0.8 \rangle$	$\langle 0.08, 0.02, 0.92 \rangle$
t_5	$\langle 0.14, 0.06, 0.86 \rangle$	$\langle 0.18, 0.52, 0.82 \rangle$	$\langle 0.18, 0.12, 0.82 \rangle$	$\langle 0.2, 0.2, 0.8 \rangle$
t_6	$\langle 0.0, 0.0, 1 \rangle$	$\langle 0.08, 0.02, 0.92 \rangle$	$\langle 0.2, 0.3, 0.8 \rangle$	$\langle 0.18, 0.52, 0.82 \rangle$

Table 2: Tabular Representation of the Neutrosophic Soft Set (G^{NS}, B)

T	mudbrick b_1	Plasterboard b_2	Wall Ceramic b_3	Plaster holder b_4	Straw Panel b_5
t_1	$\langle 0.2, 0.3, 0.8 \rangle$	$\langle 0.14, 0.56, 0.86 \rangle$	$\langle 0.08, 0.02, 0.92 \rangle$	$\langle 0.18, 0.12, 0.82 \rangle$	$\langle 0.2, 0.3, 0.8 \rangle$
t_2	$\langle 0.08, 0.02, 0.92 \rangle$	$\langle 0.18, 0.12, 0.82 \rangle$	$\langle 0.18, 0.52, 0.82 \rangle$	$\langle 0.08, 0.72, 0.92 \rangle$	$\langle 0.14, 0.06, 0.86 \rangle$
t_3	$\langle 0.18, 0.12, 0.82 \rangle$	$\langle 0.2, 0.3, 0.8 \rangle$	$\langle 0.2, 0.3, 0.8 \rangle$	$\langle 0.08, 0.72, 0.92 \rangle$	$\langle 0.14, 0.06, 0.86 \rangle$
t_4	$\langle 0.0, 0.0, 1 \rangle$	$\langle 0.08, 0.02, 0.92 \rangle$	$\langle 0.14, 0.56, 0.86 \rangle$	$\langle 0.08, 0.72, 0.92 \rangle$	$\langle 0.18, 0.12, 0.82 \rangle$
t_5	$\langle 0.14, 0.56, 0.86 \rangle$	$\langle 0.18, 0.52, 0.82 \rangle$	$\langle 0.08, 0.72, 0.92 \rangle$	$\langle 0.08, 0.02, 0.92 \rangle$	$\langle 0.14, 0.06, 0.86 \rangle$

t_6	$\langle 0.18, 0.52, 0.82 \rangle$	$\langle 0.14, 0.56, 0.86 \rangle$	$\langle 0.08, 0.02, 0.92 \rangle$	$\langle 0.18, 0.12, 0.82 \rangle$	$\langle 0.2, 0.3, 0.8 \rangle$
-------	------------------------------------	------------------------------------	------------------------------------	------------------------------------	---------------------------------

Table 3: Tabular Representation of the Neutrosophic Soft Set (H^{NS}, C)

T	Membrane c_1	Crushed Rock c_2	Straw Panel c_3	Extruded Polystyrene c_4
t_1	$\langle 0.18, 0.42, 0.82 \rangle$	$\langle 0.2, 0.3, 0.8 \rangle$	$\langle 0.08, 0.02, 0.92 \rangle$	$\langle 0.0, 0.0, 1 \rangle$
t_2	$\langle 0.08, 0.52, 0.92 \rangle$	$\langle 0.2, 0.2, 0.8 \rangle$	$\langle 0.2, 0.3, 0.8 \rangle$	$\langle 0.2, 0.2, 0.8 \rangle$
t_3	$\langle 0.2, 0.2, 0.8 \rangle$	$\langle 0.18, 0.12, 0.82 \rangle$	$\langle 0.18, 0.42, 0.82 \rangle$	$\langle 0.18, 0.12, 0.82 \rangle$
t_4	$\langle 0.14, 0.56, 0.86 \rangle$	$\langle 0.18, 0.12, 0.82 \rangle$	$\langle 0.18, 0.12, 0.82 \rangle$	$\langle 0.18, 0.42, 0.82 \rangle$
t_5	$\langle 0.18, 0.12, 0.82 \rangle$	$\langle 0.18, 0.12, 0.82 \rangle$	$\langle 0.2, 0.2, 0.8 \rangle$	$\langle 0.2, 0.3, 0.8 \rangle$
t_6	$\langle 0.08, 0.02, 0.92 \rangle$	$\langle 0.14, 0.56, 0.86 \rangle$	$\langle 0.14, 0.06, 0.86 \rangle$	$\langle 0.18, 0.52, 0.82 \rangle$

Considering the above two neutrosophic sets (F^{NS}, A) and (G^{NS}, B) if we perform " $(F^{NS}, A) \wedge (G^{NS}, B)$ " (like AND, OR etc.) then we have will $4 \times 5 = 20$ parameters of the form $e_{ij} = a_i \wedge b_j$ for all $i = 1, 2, 3, 4$ and $j = 1, 2, 3, 4, 5$. If we require the neutrosophic soft set for the parameters $P = \{e_{11}, e_{14}, e_{22}, e_{23}, e_{45}\}$, then the resultant neutrosophic soft sets (F^{NS}, A) and (G^{NS}, B) will be (K^{NS}, P) , say.

So, after performing the " $(F^{NS}, A) \wedge (G^{NS}, B)$ " for some parameters the tabular representation of the resultant neutrosophic soft set, say, will take the form as

Table 4: Tabular Representation of the Resultant Neutrosophic Soft Set (K^{NS}, P)

T	e_{11}	e_{14}	e_{22}	e_{23}	e_{45}
t_1	$\langle 0.18, 0.52, 0.82 \rangle$	$\langle 0.0, 0.52, 1 \rangle$	$\langle 0.14, 0.56, 0.86 \rangle$	$\langle 0.08, 0.3, 0.92 \rangle$	$\langle 0, 0.3, 1 \rangle$
t_2	$\langle 0.08, 0.02, 0.92 \rangle$	$\langle 0.18, 0.52, 0.82 \rangle$	$\langle 0.0, 0.12, 1 \rangle$	$\langle 0.0, 0.52, 1 \rangle$	$\langle 0.14, 0.2, 0.86 \rangle$
t_3	$\langle 0.18, 0.12, 0.82 \rangle$	$\langle 0.14, 0.3, 0.86 \rangle$	$\langle 0.2, 0.3, 0.8 \rangle$	$\langle 0.2, 0.3, 0.8 \rangle$	$\langle 0.14, 0.06, 0.86 \rangle$
t_4	$\langle 0.0, 0.56, 1 \rangle$	$\langle 0.08, 0.02, 0.92 \rangle$	$\langle 0.14, 0.56, 0.86 \rangle$	$\langle 0.08, 0.72, 0.92 \rangle$	$\langle 0.08, 0.12, 0.92 \rangle$
t_5	$\langle 0.14, 0.56, 0.86 \rangle$	$\langle 0.14, 0.2, 0.86 \rangle$	$\langle 0.18, 0.52, 0.82 \rangle$	$\langle 0.08, 0.52, 0.92 \rangle$	$\langle 0.14, 0.2, 0.86 \rangle$

t_6	$\langle 0.0, 0.52, 0.92 \rangle$	$\langle 0.0, 0.52, 1 \rangle$	$\langle 0.08, 0.56, 0.92 \rangle$	$\langle 0.08, 0.12, 0.92 \rangle$	$\langle 0.18, 0.52, 0.82 \rangle$
-------	-----------------------------------	--------------------------------	------------------------------------	------------------------------------	------------------------------------

Let us now see how the algorithm may be used to solve our original problem. Let

$$P = \{e_{11} \wedge c_1, e_{14} \wedge c_3, e_{22} \wedge c_2, e_{23} \wedge c_4, e_{45} \wedge c_2\}$$

be the set of choice parameters of an observer. Then the resultant neutrosophic soft set with parameters P is (S, P) placed in Table 5.

Table 5: Tabular Representation of the Resultant Neutrosophic Soft Set (S, P)

T	$e_{11} \wedge c_1$	$e_{14} \wedge c_3$	$e_{22} \wedge c_2$	$e_{23} \wedge c_4$	$e_{45} \wedge c_2$
t_1	$\langle 0.18, 0.42, 0.82 \rangle$	$\langle 0.0, 0.52, 1 \rangle$	$\langle 0.14, 0.56, 0.86 \rangle$	$\langle 0.0, 0.3, 1 \rangle$	$\langle 0, 0.3, 1 \rangle$
t_2	$\langle 0.08, 0.52, 0.92 \rangle$	$\langle 0.18, 0.52, 0.82 \rangle$	$\langle 0.0, 0.2, 1 \rangle$	$\langle 0.0, 0.52, 1 \rangle$	$\langle 0.14, 0.2, 0.86 \rangle$
t_3	$\langle 0.18, 0.2, 0.82 \rangle$	$\langle 0.14, 0.42, 0.86 \rangle$	$\langle 0.18, 0.3, 0.82 \rangle$	$\langle 0.18, 0.3, 0.82 \rangle$	$\langle 0.14, 0.06, 0.86 \rangle$
t_4	$\langle 0.0, 0.56, 1 \rangle$	$\langle 0.08, 0.12, 0.92 \rangle$	$\langle 0.14, 0.56, 0.86 \rangle$	$\langle 0.08, 0.72, 0.92 \rangle$	$\langle 0.08, 0.12, 0.92 \rangle$
t_5	$\langle 0.14, 0.56, 0.86 \rangle$	$\langle 0.14, 0.2, 0.86 \rangle$	$\langle 0.18, 0.52, 0.82 \rangle$	$\langle 0.08, 0.52, 0.92 \rangle$	$\langle 0.14, 0.2, 0.86 \rangle$
t_6	$\langle 0.0, 0.52, 0.92 \rangle$	$\langle 0.0, 0.52, 1 \rangle$	$\langle 0.08, 0.56, 0.92 \rangle$	$\langle 0.08, 0.52, 0.92 \rangle$	$\langle 0.14, 0.56, 0.86 \rangle$

The comparison table of the above resultant neutrosophic soft set is shown in Table 6.

Table 6: Comparison Table of the Neutrosophic Soft Set (S, P)

	t_1	t_2	t_3	t_4	t_5	t_6
t_1	7	3	1	2	1	3
t_2	2	7	2	3	2	3
t_3	5	4	7	5	5	5
t_4	4	2	0	7	1	4
t_5	4	4	3	3	7	5
t_6	3	3	1	3	2	7

We compute the row-sum, column-sum and the score for each t_i as shown in Table 7.

Table 7: Score Table of the Neutrosophic Soft Set (S,P)

	Row-sum	Column-sum	Score
t_1	17	25	-8
t_2	19	23	-4
t_3	31	14	17
t_4	18	23	-5
t_5	26	18	8
t_6	19	27	-8

From the above score table, it is clear that the maximum score is 17, scored by t_3 and the decision is in favour of selecting t_5 .

Comparison Analysis

In order to verify the feasibility and effectiveness of the proposed decision-making approach, a comparison analysis with neutrosophic soft decision method, used by Roy and Maji et al. [29], is given, based on the same illustrative example.

Clearly, the ranking order results are consistent with the result obtained in [29]; however, the best alternative is the same as t_3 , because the ranking principle is different, these two methods produced the same best and worst alternatives.

Conclusion

In this chapter, in his pioner work [2] originated the soft set theory as a general mathematical tool for dealing with uncertain, fuzzy, intuitionistic, neutrosophic or vague objects. We consider a problem of decision making in fuzzy soft set theory and presented a method to generalize it into neutrosophic soft set based decision making problem for modelling the problem in a better way. This new extension will provide a significant addition to existing theories for handling indeterminacy, and spurs more developments of further research and pertinent applications.

Future Research Directions

This study can be extended by using other type of neutrosophic decision making approaches, including interval valued neutrosophic soft sets, bipolar neutrosophic soft sets.

References

- [1] Atanassov K (1986) Intuitionistic fuzzy sets. *Fuzzy Set Syst* 20(1): 87–96
- [2] Molodtsov D (1999) Soft set theory-first results, *Comput and Math Appl* 37(2): 19–31
- [3] Smarandache F (2005) Neutrosophic set – A generalization of the intuitionistic fuzzy sets. *International Journal of Pure and Applied Mathematics* 24(3): 287–297
- [4] Smarandache F (1998) A Unifying Field in Logics. *Neutrosophy: Neutrosophic Probability, Set and Logic*. Rehoboth: American Research Press.
- [5] Bakbak, D., Uluçay, V., & Şahin, M. (2019). Neutrosophic Soft Expert Multiset and Their Application to Multiple Criteria Decision Making. *Mathematics*, 7(1), 50. <https://doi.org/10.3390/math7010050>.
- [6] Uluçay, V., Şahin, M., Olgun, N., & Kilicman, A. (2017). On neutrosophic soft lattices. *Afrika Matematika*, 28(3-4), 379-388.
- [7] Şahin, M., Olgun, N., Kargin, A., & Uluçay, V. (2018). Isomorphism theorems for soft G-modules. *Afrika Matematika*, 29(7-8), 1237-1244.
- [8] Uluçay, V., Şahin, M., & Olgun, N. (2018). Time-Neutrosophic Soft Expert Sets and Its Decision Making Problem. *Matematika*, 34(2), 246-260.
- [9] Uluçay, V., Kılıç, A., Yıldız, İ., Şahin, M. (2018). A new approach for multi-attribute decision-making problems in bipolar neutrosophic sets. *Neutrosophic Sets and Systems*, 23(1), 142-159.
- [10] Uluçay, V., Şahin, M., Hassan, N. (2018). Generalized neutrosophic soft expert set for multiple-criteria decision-making. *Symmetry*, 10(10), 437. <https://doi.org/10.3390/sym10100437>.
- [11] Şahin, M., Olgun, N., Uluçay, V., Kargin, A., & Smarandache, F. (2017). A new similarity measure based on falsity value between single valued neutrosophic sets based on the centroid points of transformed single valued neutrosophic numbers with applications to pattern recognition. *Infinite Study*. 2018.
- [12] Şahin, M., Uluçay, V., & Acioğlu, H. Some weighted arithmetic operators and geometric operators with SVNSs and their application to multi-criteria decision making problems. *Infinite Study*. 2018.
- [13] Şahin, M., Uluçay, V., & Broumi, S. Bipolar Neutrosophic Soft Expert Set Theory. *Infinite Study*. 2018.
- [14] Şahin, M., Alkhazaleh, S., & Uluçay, V. (2015). Neutrosophic soft expert sets. *Applied Mathematics*, 6(1), 116.
- [15] Uluçay, V., Deli, I., & Şahin, M. (2018). Similarity measures of bipolar neutrosophic sets and their application to multiple criteria decision making. *Neural Computing and Applications*, 29(3), 739-748.
- [16] Şahin, M., Deli, I., & Uluçay, V. (2016). Jaccard vector similarity measure of bipolar neutrosophic set based on multi-criteria decision making. *Infinite Study*.
- [17] Hassan, N., Uluçay, V., & Şahin, M. (2018). Q-neutrosophic soft expert set and its application in decision making. *International Journal of Fuzzy System Applications (IJFSA)*, 7(4), 37-61.

- [18] Broumi, S., Bakali, A., Talea, M., Smarandache, F., Singh, P. K., Uluçay, V., & Khan, M. (2019). Bipolar complex neutrosophic sets and its application in decision making problem. In: *Fuzzy Multi-criteria Decision-Making Using Neutrosophic Sets* (pp. 677-710). Springer, Cham.
- [19] Uluçay, V., Kılıç, A., Şahin, M., & Deniz, H. (2019). A New Hybrid Distance-Based Similarity Measure for Refined Neutrosophic sets and its Application in Medical Diagnosis. *MATEMATIKA: Malaysian Journal of Industrial and Applied Mathematics*, 35(1), 83-94.
- [20] Şahin, M., Uluçay, V., & Menekşe, M. (2018). Some new operations of (α, β, γ) interval cut set of interval valued neutrosophic sets. *Journal of Mathematical and Fundamental Sciences*, 50(2), 103-120.
- [21] Broumi, S., Bakali, A., Talea, M., Smarandache, F., Singh, P. K., Uluçay, V., & Khan, M. (2019). Bipolar complex neutrosophic sets and its application in decision making problem. In: *Fuzzy Multi-criteria Decision-Making Using Neutrosophic Sets* (pp. 677-710). Springer, Cham.
- [22] Şahin, M., Uluçay, V., & Ecemiş, O. Çıngı, B. An outperforming approach for multi-criteria decision-making problems with interval-valued Bipolar neutrosophic sets. *Neutrosophic Triplet Structures*, 108.
- [23] Bakbak, D., Uluçay, V. (2019). Chapter Eight Multiple Criteria Decision Making in Architecture Based on Q-Neutrosophic Soft Expert Multiset. *Neutrosophic Triplet Structures*, 90.
- [24] J.J. Peng, J.Q. Wang, J. Wang, H.Y. Zhang and X.H. Chen, Simplified neutrosophic sets and their applications in multi-criteria group decision-making problems, *Int. J. Syst. Sci.* (2015) DOI:10.1080/00207721.2014.994050.
- [25] Jurio A, Paternain D, Bustince H, Guerra C, Beliakov G. A construction method of Atanassov's intuitionistic fuzzy sets for image processing. In *Proceedings of the fifth IEEE conference on intelligent systems*. 2010. 337–342.
- [26] Roy, A. R. and Maji, P. K. A fuzzy soft set theoretic approach to decision making problems. *Journal of Computational and Applied Mathematics*. 2007. 203(2): 412–418.
- [27] Bakbak, D . "AN INVESTIGATION OF SYRIAN ASYLUM-SEEKERS' OPINIONS ABOUT THE PLACES THEY LIVE IN GAZIANTEP". *Uluslararası Türk Kültür Coğrafyasında Sosyal Bilimler Dergisi*3 (2018): 69-87.
- [28] Bakbak, D.(2018).Compulsory Migration From Syria to Gaziantep and Reviews About Residences. *Sociology*, 8(2), 49-67.
- [29] Uluçay, V., & Şahin, M. (2020). Decision-Making Method based on Neutrosophic Soft Expert Graphs. In *Neutrosophic Graph Theory and Algorithms* (pp. 33-76). IGI Global.
- [30] Bakbak, D.(2018).Suriyeli Sığınmacıların Konteyner Kamplarına İlişkin Bir Araştırma. *Gazi Akademik Bakış*, 11(23), 249-287.
- [31] Bakbak,D.(2018).Forced Migration and Coexistence. *Philosophy*, 8(3), 130-141.

Chapter Ten

Neutrosophic Sets in Multiple Objectives Decision Analysis

Willem K. M. Brauers

*University of Antwerp, Department of Economics, Prinsstraat, 13, BE Antwerp, Belgium
willem.brauers@uantwerpen.be*

ABSTRACT

Inside the Neutrosophic Philosophy, a Neutrosophic Set counts three components: Truth, Indeterminacy and Falsehood. In this study the link will be made between Neutrosophic Sets and Multiple Objectives Decision Analysis. In other words, which method of Multiple Objectives Decision Analysis does respond the best to a Neutrosophic Set?

First an overview is brought of the forerunners and pioneers of Multiple Objectives Decision Analysis. The choice for a Multiple Objectives Decision Analysis Method is a function of reading a Decision Matrix, either horizontally or vertically. The horizontal reading is brought by the SAW methods, the vertical reading by methods more or less related to a Reference Point.

The methods which are proved to be entirely false on a first glance are automatically excluded. Some methods are partly True or/and Indeterminate and partly false. Finally, the best methods will be True or/and Indeterminate but not at all False.

Keywords: Neutrosophic Set; True; Indeterminate; False; Electre; MOORA; MULTIMOORA.

INTRODUCTION

In 1998 Smarandache defined a Neutrosophic Set as composed of three components: Truth, Indeterminacy and Falsehood (T, I, F - Concept), which is T% true, I% indeterminate and F% false, or more general a more refined concept: $(T_1, T_2, \dots; I_1, I_2, \dots; F_1, F_2, \dots)$ [49].

After Webster's Dictionary "indeterminate data" mean: "having inexact limits; indefinite; indistinct; vague" [66].

Neutrosophic Statistics may have indeterminate (imprecise, ambiguous, vague, incomplete, unknown) data. In economics the term "Indifference" is rather used.

Following references illustrate a new trend in Neutrosophic theory: Şahin, Olgun et al. [47]; Şahin, Ecemiş et al. [48].

Other studies make the connection with the Decision Making Process: Broumi et al. [18]; Hassan et al. [26]; Sahin et al. [48]; Uluçay & Şahin [59]; Uluçay et al. [61] and [63].

From now on the link will be made between Neutrosophic Sets and Multiple Objectives or Criteria Decision Analysis (MODA). Bakbak et al. study the Neutrosophic Multiset Applied to MODA [5]. Uluçay et al. present neutrosophic expert set for MODA [62].

In a first part several Multi-Objective Decision Analysis methods, in regard to Neutrosophy, will be mentioned. Uluçay et al. present an Outranking Approach for MODA-Problems with Neutrosophic Multi-Sets [60].

In a second part, linked to Neutrosophy, the Indifference Method of MODA is discussed. Thirdly, the MOORA method and in a fourth Part MULTIMOORA, in relation to Neutrosophy, are explained. The fifth part brings the Choice of Alternatives and Objectives and the Final Choice for the Most Robust Neutrosophic Solution with the Conclusion as a sixth part.

The Relation between some Methods of Multiple Objective Decision Analysis and Neutrosophic Sets

The Forerunners and Pioneers

- **Cost-Benefit Analysis** is a method with a monetary unit as the common unit of measurement of benefits and costs. Even benefits are expressed in the chosen monetary unit, either in a direct or in an indirect way. Ipso facto the net benefit, is either positive or negative. The proposed solution is then, or the acceptance of the project, or the status quo, which sometimes go hand in hand with deteriorating circumstances. Some comments are useful.

- The Money Illusion: for instance, changes in prices of electricity can influence costs and benefits differently.
- Its Materialistic Approach: cost-benefit presents a materialistic approach, whereby for instance unemployment and health care are degraded to monetary items.

People are more easily solution-minded rather than objective-oriented: Cost-Benefit analysis is a product of this way of thinking. For instance, cost-benefit about a new underground railway in London starts with thinking of an eventual construction of that railway [24] and not of objectives such as: slimming of London, diminishing of transport flows: home-work, home-supplies, home-entertainment and home-office. At that moment, entirely other solutions interfere, such as teleworking, teleshopping and teleconferences.

As the world is getting more and more objective-minded, such as thinking of ecology, cost-benefit studies will have fewer and fewer chances today than before. Conclusion: **Cost-Benefit Analysis is for a high percentage False.**

- **Cost-Effectiveness:** several projects are taken into account simultaneously. The analysis is bi-objective: costs expressed in a common monetary unit on the one side and a single effectiveness-indicator on the other. For instance, in defense a weapon system could balance costs against the rate of kill, expressed in one or another military indicator [9].

As initially optimality was absent in cost-effectiveness, several addenda were proposed. Lange launched his Economic Principle. The *Economic Principle of Lange* runs like this: either costs are kept constant with maximization of an objective (*Effectiveness*), or an objective is kept constant with minimization of costs (*Efficiency*) [32]. From linear programming it is known that for such a dual the solution is identical, only an assumption for nonlinear systems. At that moment, the question remains if an optimal solution is found. Conclusion: **Cost-Effectiveness is for a high % True**, partly as the existence of a single optimal solution is missing.

- **Fractional Programming** forms a substitute for the dual problem:

$$\max. E / C = \max. \text{effectiveness} / \min. \text{costs}.$$

Fractional Programming is True, but effectiveness defined as a single component can be difficult to determine.

- **The Condorcet Paradox**, against Binary Comparisons [20]:

FALSE (with T% =0; I% = 0): beer preferred to milk; milk preferred to wine is in contradiction with wine preferred to beer [12].

In the 1963-edition of his book Arrow maintains that in the first edition of 1951 he was not aware of the work of Condorcet:

"when I first studied the problem and developed the contradictions in the majority rule system, I was sure that this was no original discovery, although I had no explicit reference, and sought to express this knowledge by referring to the well known 'paradox of voting'" [3].

Nevertheless, the whole MODA method of Saaty, called AHP, *The Analytic Hierarchy Process*, is based on these **False** binary comparisons [44-45]. AHP/ANP is the most typical example of "comparing alternatives in pairs" [46].

- **Minkowski** [38, 39]: **T = 100%**: "a convex set has the characteristic that all points on a line between two points of that set have to belong to that set".

- **Pareto Optimum and Indifference Curves Analysis:** Pareto [41] (the editions of 1906 and 1927 are not similar).

- **Indifference Curve Analysis:** Pareto following Minkowski: “all points on an Indifference Curve or Surface have the same importance towards the objectives considered”.

- **Pareto Optimum**

False (100%): a Pareto Optimum represents the Absolute Maximum.

Instead, Pareto called a point an optimum (*Pareto Optimum*) when it is not possible to move away from that point without hurting one or another party. Much confusion exists about the Pareto Optimum. In order to make this clear the French translation of the original Italian text by Pareto himself runs as follows:

"Nous dirons que les membres d'une collectivité jouissent, dans une certaine position, du maximum d'ophélimité, quand il est impossible de trouver un moyen de s'éloigner très peu de cette position, de telle sorte que l'ophélimité dont jouit chacun des individus de cette collectivité augmente ou diminue. C'est-à-dire que tout petit déplacement à partir de cette position a nécessairement pour effet d'augmenter l'ophélimité dont jouissent certains individus, et de diminuer celle dont jouissent d'autres : d'être agréable aux uns, désagréable aux autres".

False (100%): Mostly, it was accepted that for each set of data only one single Pareto Optimum existed.

True (100%): if the *Indifference Loci* (indifference curve, surface or manifold) show the aspiration level of the stakeholders, each point belonging to the highest possible *Indifference Locus*, given limited resources, represents a Pareto optimum.

Consequently, for a given set of data, several Pareto Optima are possible simultaneously.

MODA goes even further: a situation is considered better if the total of the advantages of the winners is larger than the total of the advantages of the losers striving to an optimum situation. This general rule may hurt the defenders of democracy, but here some limits are built in such as:” Democracy represents the point of view of the majority respecting this one of the minorities. Therefore, important decisions, like changing the Constitution, the form of government, like the change of a Kingdom for a Presidency, would ask for a 2/3 or even a 3/4 majority vote.

Moreover, the maximum and minimum optima have only a relative and not an absolute meaning; an absolute meaning could be a utopian optimum reference point (see therefore underneath the definition of a Reference Point under MOORA).

In addition, the number of objectives and solutions considered could be incomplete. Therefore, some authors speak of the relative meaning as a satisficing result or of bounded rationality [67, 1, 25, 21].

- **True** (100%): Minkowski puts the basis of the Reference Point Theory.

The *Minkowski Metric* brings the most general synthesis for measuring the distances between the coordinates of the alternatives and the reference point coordinates (Minkowski, [38,39]; Pogorelov, [42]):

$$MinM_j = \left\{ \sum_{i=1}^{i=n} (r_i - x_{ij}^*)^\alpha \right\}^{1/\alpha} \quad (1)$$

with: M_j = Minkowski metric for alternative j ,
 where $j = 1, 2, \dots, m$; m : the number of alternatives
 $i = 1, 2, \dots, n$; n : the number of objectives
 r_i = the i^{th} co-ordinate of the reference point
 x_{ij}^* = a dimensionless number representing the response of alternative j on objective i .

From the Minkowski formula, the different forms of Reference Point Theory are deduced. The metric shows these forms depending on the values given to α .

With the *rectangular distance metric* $\alpha = 1$, the results are very unsatisfactory. Assume a reference point (100;100), then all the points, (100;0), (0;100), (50;50), (60;40), (40;60), (30;70), and (70;30), show the same rectangular distance. Ipso facto, a midway solution like (50;50) takes the same ranking as the extreme positions (100;0) and (0;100). In addition, the points: (30;30), (20;40), (40;20), (50;10), (25;35), (0;60) and (60;0), show the same rectangular distance to a reference point (50;40). Even worse, theoretically for each line, an infinite number of points will result in the same ranking, meaning a weak robustness. A problem arises for the method VIKOR as VIKOR is based on Rectangular distances [40] (for the method VIKOR see underneath).

With $\alpha = 2$, radii of concentric circles, with the reference point as central point, will represent the *Euclidean Distance Metric*. Applying the Euclidean distance metric for the first example, which is given above, the outcome is very unusual. The midway solution (50;50) is ranked with symmetry in ranking for the extreme positions: (100;0) and (0;100); the same for (60;40) and (40;60), for (30;70) and (70;30) etc. meaning a weak robustness. A problem arises for the method TOPSIS as TOPSIS is based on Euclidean distances: ([27] pp. 128-134) (for the method TOPSIS see underneath).

Radii of concentric spheres represent the *Euclidean Distance Metric characterized by three coordinates*, with the reference point for center.

For more than three coordinates the corresponding manifolds are geometrically not possible to demonstrate. It is also not clear if many solutions do or do not try to go for optimality.

With $\alpha = 3$, negative results are possible if some co-ordinates of the alternatives exceed the corresponding co-ordinate of the reference point, however neutralized by the squared root applied afterwards.

It is also not clear if many solutions do or do not try to fight for optimality in the case of: $\alpha > 3$, with exception for $\alpha \rightarrow \infty$. Indeed, in this special case of the Minkowski metric only one distance per point is kept in the running, an increase in robustness. The Minkowski metric becomes the Tchebycheff *Min-Max Metric* [28] (p. 280). If the following matrix is given:

$$(\mathbf{r}_i \quad - \quad \mathbf{x}_{ij}^*) \tag{2}$$

with: $i = 1, 2, \dots, n$ as the attributes
 $j = 1, 2, \dots, m$ as the alternatives
 r_i = the i^{th} co-ordinate of the reference point
 x_{ij}^* = a dimensionless number representing the response of alternative j on objective i

then this matrix is subject to the Min-Max Metric of Tchebycheff:

$$\underset{(j)}{\text{Min}} \max \underset{(i)}{| r_i - x_{ij}^* |} \tag{3}$$

$| r_i - x_{ij}^* |$ means the absolute value if x_{ij}^* is larger than r_i for instance by minimization.

1.1. *The Method of Correlation of Ranks*

• **False (100%): The Method of Correlation of Ranks** consists of totalizing ranks. Rank Correlation was introduced first by psychologists such as Spearman [52, 53, 54] and later taken over by the statistician Kendall in 1948. he argues [30] (p. 1): “we shall often operate with these numbers as if they were the cardinals of **ordinary** arithmetic, adding them, subtracting them and even multiplying them,” but he never gives a proof of this statement. in his later work this statement is dropped [31].

In ordinal ranking 3 is farther away from 1 than 2 from 1, but Kendal [30] (p. 1) goes too far (table 1).

Table 1 Ordinal versus cardinal: comparing the price of one commodity

	ordinal	cardinal
	1	
	2	
	3	
	4	
a	5	6.03\$
	6	6.02\$
	7	6.01\$
b	8	6\$

For Kendall b is far away from a as it has 7 ranks before and a only 4, whereas it is not true cardinally.

In addition, a supplemental notion, the statistical term of correlation, is introduced. Suppose the statistical universe is just represented by two experts, it could be two methods. If they both rank in a same order different items to reach a certain goal, it is said that the correlation is perfect. however, perfect correlation is a rather exceptional situation. The problem is then posited: how in another situation correlation is measured. Therefore, the following Spearman's coefficient is used (Kendall [30], (p.8); Spearman [52, 53, 54]):

$$\rho = 1 - \frac{6\sum D^2}{N(N^2 - 1)}, \tag{4}$$

where D stands for the difference between paired ranks, and N for the number of items ranked.

According to this formula, perfect correlation yields the coefficient of one. An acceptable correlation reaches the coefficient of one as much as possible. No correlation at all yields a coefficient of zero. If the series are exactly in reverse order, there will be a negative correlation of minus one, as shown in the following example (table 2).

Table 2. – Negative rank order correlations

items	expert 1	expert 2	sum of ranks	d	d ²
1	1	7	8	-6	36
2	2	6	8	-4	16
3	3	5	8	-2	4
4	4	4	8	0	0
5	5	3	8	2	4
6	6	2	8	4	16
7	7	1	8	6	36
					112

This table shows that the sum of ranks in the case of an ordinal scale has no sense. Correlation leads to:

$$\rho = 1 - \frac{6 \times 112}{7(49 - 1)} = -1$$

However, as a sum of ranks is not allowed also a subtraction in the differences D is not permitted.

The full multiplicative method with its huge outcomes illustrates the best the trend break between cardinal and ordinal numbers as shown in next table 3.

Table 3. – Ranking of scenarios for the Belgian Regions by the full-multiplicative method in 1996.

	scenario	name	total/100000 (a)
1	scenario ix	optimal economic policy in Wallonia and Brussels	203267
2	scenario x	optimal economic policy in Wallonia and Brussels even agreeing on the partition of the national public debt	196306
3	scenario vii	Flanders asks for the partition of the national public debt	164515
4	scenario viii	no solidarity at all	158881
5	scenario ii	unfavorable growth rate for Flanders	90
6	scenario iv	an unfavorable growth rate for Flanders and at that moment asks also for the partition of the national public debt	87
7	scenario iii	partition of the national public debt	54
8	scenario i	the average Belgian	51
9	scenario v	average Belgian, but as compensation Flanders asks for the partition of the national public debt	49
10	scenario o	status quo	43
11	scenario vi	Flanders asks for the partition of the national public debt	42

(a) max. private income in Bef per capita (Wallonia*Brussels*Flanders); min transfer payments in Bef per capita from Flanders to Wallonia; min in % of public debt to GRP (Wallonia*Brussels*Flanders). substitution of one Bef from transfer payments to private income in not possible.
Previously 1 Bef = 0.0247893€.
Source: [11], (p. 15).

In a usual arithmetical progression: 1, 2, 3, 4, 5, ... the distance from the rank 4 to 5 would be the same as from 3 to 4 which is certainly not the case here.

In addition, an ordinal ranking fails to discover a Trend Break, such as demonstrated in Table 3.

Arbitrary methods to go from an ordinal scale to a cardinal scale

1) Arithmetical Progression e.g.: 1, 2, 3, 4, 5.

the ordinal scale 5 gets 1 cardinal point

the ordinal scale 4 gets 2 cardinal points etc.

2) Geometric progression: 1, 2, 4, 8, 16...

3) The fundamental scale of Saaty [44]: 1, 3, 5, 7, 9

4) The normal scale of Lootsma [33]:

$$e^0 = 1$$

$$e^1 = 2.7$$

$$e^2 = 7.4$$

$$e^3 = 20.1\dots\dots\dots$$

5) The stretched scale of Lootsma [33]:

$$e^0 = 1$$

$$e^2 = 7.4$$

$$e^4 = 54.6$$

$$e^6 = 403.4\dots\dots$$

6) The point of view of the psychologists [36]:

Ordinal scales: 1, 2, 3, 4, 5, 6, 7. after 7 an individual would no more know the cardinal significance compared to the previous seven numbers.

In fact, infinite variations are possible. All stress an acceleration or a dis-acceleration process but are not aware of a possible trend break.

The Impossibility Theorem of Arrow

“Obviously, a cardinal utility implies an ordinal preference but not *vice versa*” [4].

Axioms on Ordinal and Cardinal Scales

1. A deduction of an Ordinal Scale, a ranking, from cardinal data is always possible.
2. An Ordinal Scale can never produce a series of cardinal numbers.
3. An Ordinal Scale of a certain kind, a ranking, can be translated in an ordinal scale of another kind.

If a cardinal scale is absolutely missing, for instance for quality, after the opinion of the author quality as a cardinal number has to remain moderate. E.g.

- Quality “Good” gets 4 cardinal points
- Quality “Moderate” gets 3 cardinal points
- Quality “Bad” gets 2 cardinal points, i.e. Good is only the double from Bad.

1.3. SAW as a basis for MODA Methods:

In order to understand SAW one has to refer to the Decision Matrix of MODA (Table 4).

Table 4. Decision Matrix with the Multiple Objectives as Columns and the Alternative Solutions as Row

	Obj. 1	Obj. 2	Obj. I	Obj. N
Alternative 1	x ₁₁	x ₂₁	x _{i1}	x _{n1}
Alternative 2	x ₁₂	x ₂₂	x _{i2}		x _{n2}
.....
Alternative J	x _{1j}	x _{2j}	x _{ij}		x _{nj}
.....

Alternative M	x_{1m}	x_{2m}	x_{im}		x_{nm}
---------------	----------	----------	-------	----------	--	----------

All the objectives have different denominations. Consequently, there is a question of uniformness, composed of normalization and importance. Therefore, a method has to be chosen to respond to this necessity.

The Additive Weighting Procedure [34] (pp. 29–33) which was called SAW, Simple Additive Weighting Method by Hwang and Yoon [27] (p. 99) starts from the Horizontal Reading of the Decision Matrix with use of the following formula:

$$Max. x_j = w_1 x_{1j} + w_2 x_{2j} + \dots + w_i x_{ij} + \dots + w_n x_{nj} \tag{5}$$

with:

$$\sum_{i=1}^n w_i = 1 \tag{6}$$

creates a Super-Objective on basis of the sum of weights = 1

Weights: mixture of normalization and importance. What is what?

Numerous Number of objectives would ask for many, many weights, how to choose?

For instance: Brauers and Zavadskas [17] studied the 27 EU-countries as a preparation for 2020 on basis of 22 objectives expressed in 22 different units. How would it be possible to find weights (subjective?) for these 22 different units? **Normalization mixed with importance of the 22 objectives have to be estimated (True, 100%).**

ELECTRE is one of the first developed methods of MODA [43], ELECTRE follows SAW.

- There are many versions of ELECTRE such as Electre I, Electre Iv, Electre Is, Electre TRI, Electre II, Electre III and Electre IV. Schärilig [50, 51] calls them “Methods of Partial Aggregation”.
- Uses terminology comparable to the Neutrosophic Set:
 - TRUE :
 - Outranking (surclassement)
 - Preference
 - Transitivity
 - Concordance and discordance,
 - Dominance, etc.
 - INDETERMINATE
 - Indifference
 - Thresholds, etc.

- FALSE
Non preference
Incomparability
Intransitivity

From the school of ELECTRE several other Methods can be mentioned, such as:

- Promethee since 1984 [6, 7],
- Qualiflex (see therefore: Schärliig, [50]).

1.4. The Reference Point Methods

1.4.1. TOPSIS, Hwang and Yoon [27] (pp. 128-134).

A problem arises for TOPSIS as TOPSIS is based on Euclidean distances (see above under Minkowski). However, Euclidean distances would lead to an infinite number of solutions. In order to come to a single solution Hwang and Yoon introduce weights.

TOPSIS works with two solutions:

M_j^+ gives per objective to be maximized the highest value and per objective to be minimized the lowest value

M_j^- gives per objective to be maximized the lowest value and per objective to be minimized the highest.

TOPSIS considers the importance of both in an aggregation:

$$Max. M_j^* = \frac{M_j^-}{M_j^+ + M_j^-} \quad (7)$$

False (100%): is extremely arbitrarily between M_j^+ and M_j^-

1.4.2. VIKOR, Opricovic, Tzeng, 2004 [40].

Being a Reference Point Method and in order to satisfy Minkowski, VIKOR works with weights, with as basic formula after weights:

$$Min M_j = \sum_{i=1}^n (r_i - x_{ij}^*) \quad (8)$$

In the example of the mountain climber [40] (p. 452) the risk factor, a *Subjective Evaluation* from 1 till 5, has to be increased with 5 and the altitude in meters to be divided by 1000 and then

diminished by one in order to make the two criteria more or less comparable, i.e. introduction of weights.

Table 5. The example of a mountain climber in VIKOR

	A ₁	A ₂	A ₃
<u>Before normalization</u>			
<u>Risk</u>	1	2	5
<u>Altitude in meters</u>	3000	3750	4500
<u>After normalization</u>			
<u>Risk</u>	6	7	10
<u>Altitude in meters</u>	2	2.75	3.5

Conclusion: False (100%): weights being extremely arbitrarily.

The Indifference Method

In 1965 Brauers introduced the Indifference Method in a study for the Belgian Department of Defense concerning the procurement of a heavy truck of six tons [8] (pp. 2-3).

The candidate trucks had to undergo heavy tests: to climb slopes of 70%, to drive through 1.60m of water, to stay in water for some time, to overcome a lot of obstacles, to use consecutively petrol and light fuel, etc. The characteristics of the trucks were written down before and after the tests. Finally, the military specialists were indifferent among a limited number of types (I of Neutrosophy).

In a next step, economists will interfere, and in that case, the lowest macro-cost will decide the choice (T of Neutrosophy). In that way the German MAN heavy truck was chosen. A good choice! Though the Belgian Army has the name to keep material a long time it is admirable that some MAN trucks were still in operation in 2019.

Next application concerned the choice in the tank renewal program ending in a competition between the German Leopard tank and the French AMX 30 [10].

Finally; The Indifference Approach was also used in Belgium for procurement of other imported heavy military equipment such as rockets, tactical aircraft and escort vessels.

Though the given examples only concern military defense the Indifference Method is applicable in all fields of the public or private domain [8] (pp. 8-11).

This indifference approach has the intention to solve the problem of optimizing several objectives if several alternatives are possible and the stakeholders are indifferent.

Conclusion: The Indifference Method is **True**.

The MOORA Method

Ratio Analysis of MOORA (Multiple Objectives Optimization by Ratio Analysis)

Simple averages are taken by column when the Decision Matrix (table4) is read vertically:

$$x_{ij}^* = x_{ij} / \sum x_{ij} \quad (9)$$

Table 6. An example with 2 objectives and 2 solutions

	MAX. Employment in person years	MAX. Value Added in million €
Solution 1 (chemical)	20	70
Solution 2 (retail)	80	30
	100	100

When the percentages are compared, they become **Dimensionless Measurements**.

However, simple averages are inconsistent as they may change the sign and even lead to no sense results. A study of 2006 showed several other solutions [15] but concluding as the best one:

$$x_{ij}^* = \frac{x_{ij}}{\sqrt{\sum_{j=i}^m x_{ij}^2}} \quad (10)$$

with no problem for the number of objectives and with all objectives of the same importance leading to:

$$y_j^* = \sum_{i=1}^{i=g} x_{ij}^* - \sum_{i=g+1}^{i=n} x_{ij}^*$$

(11)

i = 1,2,...,g, objectives to maximized
i = g+1, g+2,..., n objectives to minimized

y_j^* = alternative j concerning all objectives and showing the final preference

3.2. Second Part of MOORA: the Method of Reference Point

Which Reference Point?

1) Maximal Objective Reference Point

Suppose 2 points: A(100,20) and B (50,100)

Dominating coordinates $Rm(100;100)$

2) *Utopian Objective Reference Point*

is farther away than the Maximal Objective Reference Point

3) *Aspiration Objective Reference Point* is more nearby than the Maximal Objective Reference Point

As said earlier the Minkowski Metric is the most General Synthesis of the Reference Point (see formula 1). Moving farther away than the Rectangular or the Euclidean position until infinity, the Minkowski metric becomes the Tchebycheff *Min-Max Metric* (formula 3).

From its side the outcome of MOORA will not change if linked to significance coefficients (see proof in [13]). Instead introduction of **Sub-Objectives** is possible like:

- the significance coefficient 2 of employment is replaced by the objectives direct and indirect employment
- the significance coefficient 3 of pollution is replaced by three kind of pollution instead of a single one.

The conclusion is extremely important: in MOORA it is only necessary to determine alternatives and objectives instead of the original five conditions, including also normalization, importance, large number of objectives and of alternatives.

3.3. *Some Examples of Practical Experience with Competing Methods*

Chakraborty [19] (p. 1165) studying Machine Manufacturing presents more information on all above-mentioned methods concerning: computational time, simplicity, mathematical calculation involved, stability and informative type.

Table 7. Comparative performance of some popular MODM methods

MODM method	Computational time	Simplicity	Mathematical calculation involved	Stability	Information Type
MOORA	Very less	Very simple	Minimum	Good	Quantitative
AHP	Very high	Very critical	Maximum	Poor	Mixed
TOPSIS	Moderate	Moderately critical	Moderate	Medium	Quantitative
VIKOR	Less	Simple	Moderate	Medium	Quantitative
ELECTRE	High	Moderately critical	Moderate	Medium	Mixed
PROMETHEE	High	Moderately critical	Moderate	Medium	Mixed

Karuppanna and Sekar [29] (p. 61), studying Manufacturing but also Service Sectors, looked after computational time, calculation and simplicity.

Table 8. Comparison of MOORA with other Approaches

MADM method	Computational Time	Simplicity	Mathematical calculations
MOORA	very less	very simple	Minimum
AHP	very high	very critical	Maximum
ANP	Moderate	Moderately critical	Moderate
VIKOR	Less	Simple	Moderate
TOPSIS	Moderate	Moderately critical	Moderate
ELECTRE	High	Moderately critical	Moderate
PROMOTHEE	High	Moderately critical	Moderate

Conclusion: to MOORA the True 100% of Neutrosophic Theory may be given. The same qualification could be attributed to MOORA with Interval Grey Numbers [55].

The MULTIMOORA Method

Adding a Full Multiplicative Form MOORA becomes MULTIMOORA

The Full Multiplicative Form adds a third method to MOORA, by simply multiplying all objectives per alternative. In this way **MULTIMOORA** is born, all together composed of three methods controlling each other.

Mathematical economics is familiar with the multiplicative models like in production functions (e.g. Cobb-Douglas and Input-Output formulas) and demand functions [58], but the multiplicative form for multi-objectives was introduced in 1969 by Miller and Starr [37] and further developed by Brauers [12].

The following n -power form for multi-objectives is called from now on a *full-multiplicative form* in order to distinguish it from mixed forms:

$$(12) \quad U_j = \prod_{i=1}^n x_{ij}$$

with:

- $j = 1, 2, \dots, m$; m the number of alternatives,
- $i = 1, 2, \dots, n$; n being the number of objectives,
- x_{ij} = response of alternative j on objective i ,
- U_j = overall utility of alternative j .

The overall utilities (U_j), obtained by multiplication of different units of measurement, become dimensionless.

Stressing the importance of an objective can be done as indicated under 3.2. on condition that it occurs with unanimity or at least with a strong convergence in opinion of all the stakeholders concerned.

How is it possible to combine a minimization problem with the maximization of the other objectives? Therefore, the objectives to be minimized are denominators in the formula:

(13)

$$U_j = \frac{A_j}{B_j}$$

(14)

$$A_j = \prod_{g=1}^i x_{gj}$$

with:

$j = 1, 2, \dots, m$; m the number of alternatives,
 i = the number of objectives to be maximized.

(15)

$$B_j = \prod_{k=i+1}^n x_{kj}$$

with:

$n-i$ = the number of objectives to be minimized,
 U_j' = the utility of alternative j with objectives to be maximized and objectives to be minimized.

The Full Multiplicative Form is read horizontally in the Decision Matrix of *Table 1*. Nevertheless, with the full-multiplicative form, the overall utilities, obtained by multiplication of different units of measurement, become dimensionless measures. This situation would not bias the outcomes amidst the several alternatives as the last ones are “formally independent of the choice of units” [22].

In the Full Multiplicative Form per row of an alternative all objectives are simply multiplied, but the objectives to be minimized are parts of the multiplication process as denominators. A single zero or a negative number for one of the objectives would make the final product zero or entirely negative. In order to escape of this nonsense solution, 0.001 replaces zero and for instance -2 becomes 0.0002 and -269 becomes 0.00000269 but only for the objective under consideration.

The Ordinal Dominance Theory

For MOORA the ranking for the two methods is done on view, no more possible for MULTIMOORA with its three methods. Therefore, the Ordinal Dominance Theory will interfere.

Adding of ranks, ranks mean an ordinal scale (1st, 2nd, 3rd etc.) signifies a return to a cardinal operation ($1 + 2 + 3 + \dots$). Is this allowed? The answer is “no” following the Noble prize Winner Arrow:

The Impossibility Theorem of Arrow

“Obviously, a cardinal utility implies an ordinal preference but not *vice versa*” [3].

Axioms on Ordinal and Cardinal Scales

1. A deduction of an Ordinal Scale, a ranking, from cardinal data is always possible.
2. An Ordinal Scale can never produce a series of cardinal numbers.
3. An Ordinal Scale of a certain kind, a ranking, can be translated in an ordinal scale of another kind.

In application of axiom 3 the rankings of three methods of MULTIMOORA are translated into another ordinal scale based on *Dominance, being Dominated, Transitivity and Equability*.

Dominance. *Absolute Dominance* means that an alternative, solution or project is dominating in ranking all other alternatives, solutions or projects which all are being dominated. This absolute dominance shows as rankings for MULTIMOORA: (1–1–1). *General Dominance in two of the three methods* is of the form with $a < b < c < d$:

(d–a–a) is generally dominating (c–b–b);

(a–d–a) is generally dominating (b–c–b);

(a–a–d) is generally dominating (b–b–c);

and further transitivity plays fully.

Transitivity. If a dominates b and b dominates c than also a will dominate c .

Overall Dominance of one alternative on the next one. For instance (a–a–a) is overall dominating (b–b–b) which is overall being dominated.

Equability. *Absolute Equability* has the form: for instance (e–e–e) for 2 alternatives. *Partial Equability* of 2 on 3 exists e. g. (5–e–7) and (6–e–3).

4.2. *Combination of Methods*

Recently researchers are getting more and more convinced that ensemble methods perform better than individual methods [57, 65; 68]. Other maintain that averaging predictions from different methods lead to more accurate forecasts [56].

MULTIMOORA is such a combination of three methods: Ratio Analysis of MOORA, Reference Point Method of MOORA and the Multiplicative Form. In addition, the Ordinal Dominance Theory leads to a single solution.

The Choice of Alternatives and Objectives and the Final Choice for the Most Robust Neutrosophic Solution

The Choice of Alternative Solutions

For MOORA it is only necessary to determine alternatives and objectives instead of the original five conditions, mostly needed for a full multi-objective optimization, including normalization, importance and no limit on the number of objectives and alternatives. This situation does not change for MULTIMOORA. Also, for MULTIMOORA only Alternative Solutions and Objectives have to be formulated.

For the greatest part no problems will arrive for alternatives. For instance, in the building industry the choice of contractors with propositions will be principally more than enough.

Sometimes project management forms the basis of the choice of alternatives. Project Management assumes “that the project to be analyzed will constitute a new economic activity. In practice, however, many projects will only modify an existing economic activity” [69] (p. 5). At the end, different competing projects are taken into account, and a final choice is made by Multiple Objective Optimization.

5.2. The Choice of Objectives

The choice of objectives is much more difficult as all stakeholders, everybody involved in an issue, have to be contacted. Indeed, these stakeholders can be very numerous. Nevertheless, the following example mentions a case where the effort was rather simple.

In 2002 the Facilities Sector was only a very small sector in Lithuania, composed of a limited number of small firms, which even performed other tasks outside facilities management, such as waste management. The largest firm in the sector counted only 179 employees. Official statistics were not separately available for the Facilities Sector.

In theory the facilities sector could include the entire management of Corporate Real Estate. This means the effective management, which is called the *Fifth Resource*. Indeed, in the report of “The Industrial Development Research Foundation of the United States” the corporate real estate assets are indicated as a *fifth resource*, after the resources of people, technology, information and capital [35].

A panel was formed around the Vilnius Gediminas Technical University to study the impact of the Facilities Sector on the general wellbeing of Lithuania considering possible economic, technical, political, social, medical and other events for the period 2003-2012.

To find “the stakeholders concerned” was not too complicated. Given the small firms in the sector, no trade unions were involved. In addition, at that moment, no representative consumer union existed in Lithuania. A delegation from the academic world, specialists in the field, was assumed to represent the general wellbeing. A further delegation came from the facilities sector itself and finally from the ministerial departments concerned, altogether 15 persons [12].

Once the stakeholders known, the objectives were not formulated in an open discussion, given the doubtful conclusions of such meetings [8] (pp. 38-39). Preference was given to the “Ameliorated Nominal Group Technique” as formulated in Brauers and Zavadskas [16].

If there is a discussion about the breakdown of an objective in several sub-objectives the Delphi Technique could be helpful (see: [11] (pp. 40-44).

5.3. The Final Choice for the Most Robust Neutrosophic Solution

Already in 1983 at least 96 methods for Multi-Objective Optimization existed [23]. Since then numerous other methods appeared. Therefore, only the probably most used methods for Multi-Objective Optimization are mentioned. In comparison, also the most recent book on Multi-Objective Decision Analysis limits the discussion to 27 most used methods [2].

Which is the Final Choice for the Most Robust Neutrosophic Solution? The methods MOORA and MULTIMOORA, the Indifference Method and the Electre Methods are total or partially Neutrosophic True. All other methods are from the Neutrosophic point of view not acceptable.

Conclusion

Inside the Neutrosophic Philosophy, a Neutrosophic Set counts three components: Truth, Indeterminacy and Falsehood. In this study the link is made between Neutrosophic Sets and Multiple Objectives Decision Analysis. In other words: which method of Multiple Objectives Decision Analysis does respond the best to a Neutrosophic Set? Therefore, the methods which are proved to be entirely false are automatically excluded. Some methods are acceptable partly True or/and Indeterminate and partly false. Finally, the best methods will be these one being True or/and Indeterminate but not at all false. The methods MOORA and MULTIMOORA are T, 100%: one hundred percent Neutrosophic True. The Indifference Method is 100% True or Indifferent. The

Electre Methods are partially Neutrosophic True. All other methods are from the Neutrosophic point of view not acceptable.

Funding and Conflict of Interests

This research received no external Funding. The author declares no conflict of interests.

References

- [1] Ahituv, N.; Spector, Y. *Evaluating Information under two Criteria: Expected Payoff and Risk*, 1990, Working Paper N° 70/90, I.I.B.R., Tel Aviv University, Israel, 5.
- [2] Alinezhad A., Khalili J., *New Methods and Applications in Multiple Attribute Decision Making*, Springer International Publishing, 2019, Wiesbaden.
- [3] Arrow K.J., *Social Choice and Individual Values*, 2nd edit. Yale University Press, 1963, New Haven (First ed. Wiley, New York, 1951).
- [4] Arrow K.J., General Economic Equilibrium: Purpose, Analytic Techniques, Collective Choice, *American Economic Review*, June 1974, 253-272.
- [5] Bakbak, D., Uluçay, V., & Şahin, M. (2019). Neutrosophic soft expert multiset and their application to multiple criteria decision making, *Mathematics*, 7(1), 50.
- [6] Brans J.P., Mareschal B., Vincke P., Prométhée: A New Family of Outranking Methods in Multicriteria Analysis, in Brans (Ed.) *Proceedings of the Ifors 84 Conference*, 1984, Washington. 408-421.
- [7] Brans J.P., Mareschal B., Vincke P., How to Select and how to Rank Projects: The Promethee Method, *Ejor*, 1986, Volume 24, Issue 2, 228-238.
- [8] Brauers W.K., *The Indifference Approach in Multiple Criteria Decision Making*, Institute for Developing Countries, University of Antwerp, 1988, pp.2-3.
- [9] Brauers W.K., *Systems Analysis, Planning and Decision Models*, Elsevier, 1976, Amsterdam.
- [10] Brauers W.K., *Ons leger waakt! Waakt ons leger wel?* (Dutch for: our Army is awake! Is it true?), 1993, Antwerp, de Vries-Brouwers.
- [11] Brauers, W.K., Een optimaal economisch beleid voor België en zijn gewesten volgens de multiplele effectiviteitsanalyse (An Optimal Economic Policy for Belgium using a Multi-Objective Analysis), *Documentatieblad*, Department of Finance of Belgium, studie en documentatiedienst, 1999, LIX, N°5, pp. 3-24.
- [12] Brauers, W. K., 2004, *Optimization Methods for a Stakeholder Society, a Revolution in Economic Thinking by Multi-Objective Optimization*, Springer and Kluwer, 2004, Boston.
- [13] Brauers, W. K. M., Location Theory and Multi-Criteria Decision Making, An application of the MOORA Method, *Contemporary Economics*, 2018, vol. 12, 3, 240-252.
- [14] Brauers, W. K. M., and Lepkova, N., The Application of the Nominal Group Technique to the Business Outlook of The Facilities Sector of Lithuania over the Period 2003-2012. *International Journal of Strategic Property Management*, 2003, 7(1): 1-9.
- [15] Brauers, W. K. M. and Zavadskas, E. K., The MOORA method and its application to privatization in a transition economy, 2006, *Control and Cybernetics* 35(2): 445-469.
- [16] Brauers, W. K. M. and Zavadskas, E. K., Is Robustness real Robust? In: *Multiple Criteria Decision Aiding*, Nova, 2010, Chapter 2, 17-42.
- [17] Brauers W. K. M. and Zavadskas E. K. *Multi-Objective Decision Making with a Large Number of Objectives. An Application for Europe 2020* IJOR; 2013.Vol. 10, No. 2, 67–79.
- [18] Broumi, S., Bakali, A., Talea, M., Smarandache, F., Singh, P. K., Uluçay, V., & Khan, M. (2019). Bipolar complex neutrosophic sets and its application in decision making problem. In *Fuzzy Multi-criteria Decision-Making Using Neutrosophic Sets* (pp. 677-710). Springer, Cham.
- [19] Chakraborty, S., Applications of the MOORA method for decision making in manufacturing environment, *International Journal Advanced Manufacturing Technology*, 2011, 54; 1155-1166, Springer, DOI 10.1007/s00170-010-2972-0.
- [20] Condorcet, Marquis de, *essai sur l'application de l'analyse à la probabilité des décisions rendues à la pluralité des voix*, l'imprimerie royale, 1785, Paris.
- [21] Crawford V. P. Boundedly rational versus optimization-based models of strategic thinking and learning in games, *journal of economic literature*, 2013, 51(2), 512-527.
- [22] De Jong F.J., *Dimensional Analysis for Economists*, 1967, North-Holland, Amsterdam.
- [23] Despontin M., Moscarola J. and Spronk J., A user-oriented Listing of Multiple Criteria Decision Methods,

- Revue belge de Statistique, d'Informatique et de Recherche Operationnelle*, 1983, Vol. 23, 4.
- [24] Foster, C.D.; Beesley M.E., Estimating the Social Benefit of Constructing an Underground Railway in London, *Journal of The Royal Statistical Society*, 1963, pp. 46-92.
- [25] Harstad, R.M., Selten, R., Bounded-Rationality Models: Tasks to become Intellectually Competitive, *Journal of Economic Literature*, 2013, 51(2), 496-511.
- [26] Hassan, N.; Uluçay, V.; Şahin, M. Q-neutrosophic soft expert set and its application in decision making. *International Journal of Fuzzy System Applications (IJFSA)*, 2018, 7(4), 37-61.
- [27] Hwang, C.-L.; Yoon, K. Multiple Attribute Decision Making, Methods and Applications, *Lecture Notes in Economics and Mathematical Systems*, Springer, 186, 1981, Berlin.
- [28] Karlin, S.; Studden, W. J., *Tchebycheff Systems: with Applications in Analysis and Statistics*. Interscience Publishers, 1966, New York.
- [29] Karuppana, P. N. & Sekar, K., Selection of Best Alternative in Manufacturing and Service Sector using Multigrade Decision Approach, A Review, *Computer Science and Information Technology*, 2016, 57-74.
- [30] Kendall, M. G., *Rank Correlation Methods*, Griffin, 1948, London.
- [31] Kendall, M.G., Gibbons, J.D. *Rank Correlation Methods*, Edward Arnold, 1990, London.
- [32] Lange, O., *On the Functioning of the Socialist Economy*, Szkola Glowna Planowania I Statystyki, 1968, Warsaw.
- [33] Lootsma F.A., *Numerical Scaling of Human Judgement in Pairwise-Comparison Methods for Fuzzy Multi-Criteria Decision Analysis*. In: Nato Advanced Study Institute, Val D'isere (F), July 26, 1987, Thu 39.
- [34] MacCrimmon, K. R. *Decisionmaking among Multiple Attribute Alternatives. A Survey and Consolidated Approach*, 1968, Rm-4823- Arpa, The Rand Corporation, Santa Monica (Cal).
- [35] McGregor, W.; Shiem-Shim Then, D., *Facilities management and the business of space*. Butterworth-Heinemann, 1999, London.
- [36] Miller G.A. The magical number seven plus or minus two: some limits on our capacity for processing information, *Psychological Review*, 1965, 63, pp. 81-97.
- [37] Miller, D.W. and M.K. Starr M.K., *Executive Decisions and Operations Research*, 2nd Edition, 1969, Prentice-Hall Inc. Englewood Cliffs (N.J.), pp. 237-239.
- [38] Minkowsky, H., *Geometrie der Zahlen*, Teubner, 1896, Leipzig.
- [39] Minkowsky, H. *Gesammelte Abhandlungen*, Teubner, 1911, Leipzig.
- [40] Opricovic S., Tzeng G-H.. Compromise solution by MCDM methods: a comparative analysis of VIKOR and TOPSIS, *EJOR*, 2004, (156), pp. 445-455.
- [41] Pareto, V. *Manuale di Economia Politica*, 1906. Translation Revised by Pareto Himself: *Manuel d'Economie Politique*, Second Ed., Paris, 1927.
- [42] Pogorelov A.V., *The Minkowski Multidimensional Problem*, Winston and Sons, 1978, Washington D.C.
- [43] Roy, B., Benayoun, R. and Sussman B., *ELECTRE*, Société d'Economie et de Mathématique appliquées, 1966, Paris.
- [44] Saaty T.L., *What is the Analytic Hierarchy Process?* In: Mathematical Models for Decision Support, Nato Advanced Study Institute, Val D'Isere (F), July 26, 1987, Mon 82.
- [45] Saaty, T. L., *The Analytic Hierarchy Process*, McGraw-Hill, 1988, New York.
- [46] Saaty, T. L.; Kulakowski, K., *Axioms of the Analytic Hierarchy Process (AHP) and its generalization to dependence and feedback: the Analytic Network Process (ANP)*, Research Gate, 2016, New York.
- [47] Şahin M., Olgun N., Uluçay, V. Kargin A., Smarandache, F., A new similarity measure on falsity value between single valued neutrosophic sets based on the centroid points of transformed single valued neutrosophic numbers with applications to pattern recognition, *Neutrosophic Sets and Systems*, (2017) 15, 31-48, doi: org/10.5281/zenodo570934.
- [48]. Şahin, M., Ecemiş, O , Uluçay, V , Kargin, A. Some new generalized aggregation operators based on centroid single valued triangular neutrosophic numbers and their applications in multi-attribute decision making, *Asian Journal of Mathematics and Computer Research* (2017) 16(2): 63-84.
- [49] Smarandache, F., *Neutrosophy / Neutrosophic Probability, Set and Logic*, Proquest, Michigan, USA, 1998.
- [50] Schärliig, A., *Décider sur plusieurs critères*, 1985, Presses polytechniques romandes, Lausanne
- [51] Schärliig, A., *Pratiquer Electre et Prométhée*, Presses polytechniques et universitaires romandes, 1996, Lausanne.

- [52] Spearman, C., The proof and measurement of association between two things, *American Journal of Psychology* 1904, 15, pp. 72–101.
- [53] Spearman, C., A footrule for measuring correlation, *British Journal of Psychology* 1906, 2, pp. 89–108.
- [54] Spearman, C., Correlation calculated from faulty data, *British Journal of Psychology*, 1910, 3, pp. 271–295.
- [55] Stanujkic, D., An extension of the MOORA method for solving fuzzy decision making problems *Technological and Economic Development of Economy*, 01/2014; 19.
- [56] Stock J.; Watson M., Forecasting with many Predictors, *Handbook of Economic Forecasting*, Vol. 1, Elsevier, 2006, Amsterdam.
- [57] Surowiecki J., *the Wisdom of Crowds*, Anchor, 2005, New York.
- [58] Teekens, R., Koerts, J., some statistical implications of the log transformation of multiplicative models, *Econometrica*, 1972, vol. 40, n°5, 793-819.
- [59] Uluçay, V., & Şahin, M. (2020). Decision-Making Method based on Neutrosophic Soft Expert Graphs. In *Neutrosophic Graph Theory and Algorithms* (pp. 33-76). IGI Global.
- [60] Uluçay, V., Kılıç, A., Yıldız, İ., & Şahin, M. (2019). An Outranking Approach for MCDM-Problems with Neutrosophic Multi-Sets. *Neutrosophic Sets & Systems*, 30.
- [61] Uluçay, V., Kılıç, A., Şahin, M., & Deniz, H. (2019). A New Hybrid Distance-Based Similarity Measure for Refined Neutrosophic sets and its Application in Medical Diagnosis. *MATEMATIKA: Malaysian Journal of Industrial and Applied Mathematics*, 35(1), 83-94.
- [62] Uluçay, V., Şahin, M., & Hassan, N. (2018). Generalized neutrosophic soft expert set for multiple-criteria decision-making. *Symmetry*, 10(10), 437.
- [63] Uluçay, V.; Şahin, M.; Olgun, N. Time-Neutrosophic Soft Expert Sets and its Decision Making Problem. *Matematika*, 2018 34(2), 246-260.
- [64] Uluçay, V.; Kılıç, A.; Yıldız, İ.; Şahin, M. (2018). A new approach for multi-attribute decision-making problems in bipolar neutrosophic sets. *Neutrosophic Sets and Systems*, 2018, 23(1), 142-159.
- [65] Varian H. R., Big data: New Tricks for Econometrics, *Journal of Economic Perspectives*, 2014, 28 (2).
- [66] *Webster's New Universal Unabridged Dictionary*, Dorset and Baber, second edition, 1997, p. 929.
- [67] Wierzbicki, A.P. A Mathematical Basis for Satisficing Decision Making, *Mathematical Modelling*, 1982, vol. 3, N°5, 391-405
- [68] Zhou Z-H, Ensemble Methods, *Foundations and Algorithms*, CRC Press, 2012, Boca Raton.
- [69] United Nations Industrial Development Organization, *Guide to Practical Project Appraisal*, 1978, United Nations, New York.

SECTION THREE
NEUTROSOPHIC RELATED
OTHER PAPERS

Chapter Eleven

Neutrosophic Triplet Bipolar Metric Spaces

Memet Şahin, Abdullah Kargin, Merve Sena Uz and Adil Kılıç

Department of Mathematics, Gaziantep University, Gaziantep27310-Turkey

E-mail: mesahin@gantep.edu.tr, abduallahkargin27@gmail.com, evrem_anes@yahoo.com

adilkilic@gantep.edu.tr.

ABSTRACT

In this chapter, neutrosophic triplet bipolar metric spaces are studied. Then, some definitions and examples are given for neutrosophic triplet bipolar metric space. Based on these definitions, new theorems are given and proved. In addition, it is shown that neutrosophic triplet bipolar metric spaces are different from the classical bipolar metric spaces and the neutrosophic triplet metric spaces.

Keywords: neutrosophic triplet set, neutrosophic triplet metric space, bipolar metric space, neutrosophic triplet bipolar metric space

INTRODUCTION

Smarandache defined neutrosophic logic and neutrosophic set [1] in 1998. In neutrosophic logic and neutrosophic sets, there are T degree of membership, I degree of indeterminacy and F degree of non-membership. These degrees are defined independently of each other. It has a neutrosophic value (T, I, F) form. In other words, a condition is handled according to both its accuracy and its inaccuracy and its uncertainty. Therefore, neutrosophic logic and neutrosophic set help us to explain many uncertainties in our lives. In addition, many researchers have made studies on this theory [2-27].

In fact, fuzzy logic and fuzzy set [28] were obtained by Zadeh in 1965. In the concept of fuzzy logic and fuzzy sets, there is only a degree of membership. In addition, intuitionistic fuzzy logic and intuitionistic fuzzy set [29] were obtained by Atanassov in 1986. The concept of intuitionistic fuzzy logic and intuitionistic fuzzy set include membership degree, degree of indeterminacy and degree of non-membership. But these degrees are defined dependently of each other. Therefore, neutrosophic set is a generalized state of fuzzy and intuitionistic fuzzy set.

Furthermore, Smarandache and Ali obtained neutrosophic triplet set (NTS) and neutrosophic triplet groups (NTG) [6]. For every element "x" in NTS A, there exist a neutral of "x" and an opposite of "x". Also, neutral of "x" must different from the classical neutral element. Therefore, the NTS is different from the classical set. Furthermore, a neutrosophic triplet (NT) "x" is showed by $\langle x, \text{neut}(x), \text{anti}(x) \rangle$. Also, many researchers have introduced NT structures [30 - 44].

Mutlu and Gürdal introduced bipolar metric space [45] in 2016. Bipolar metric space is generalized of metric space. Also, bipolar metric spaces have an important role in fixed point theory. Recently, Mutlu, Özkan and Gürdal studied fixed point theorems on bipolar metric spaces [46]; Kishore, Agarwal, Rao, and Rao introduced contraction and fixed point theorems in bipolar metric spaces with applications [47]; Rao, Kishore and Kumar obtained Geraghty type contraction and common coupled fixed point theorems in bipolar metric spaces with applications to homotopy [48].

In this chapter, we introduce neutrosophic triplet bipolar metric space. In Section 2, we give definitions and properties for bipolar metric space [45], neutrosophic triplet sets [30], neutrosophic triplet metric spaces [32]. In Section 3, we define neutrosophic triplet bipolar metric space and we give some properties for neutrosophic triplet bipolar metric space. Also, we show that neutrosophic triplet bipolar metric spaces are different from the classical bipolar metric spaces and the neutrosophic triplet metric spaces. Then, we examine relationship between neutrosophic triplet bipolar metric spaces and neutrosophic triplet metric spaces. In Section 4, we give conclusions.

BACKGROUND

Definition 1: [6] Let # be a binary operation. A NTS $(X, #)$ is a set such that for $x \in X$,

- i) There exists neutral of “x” such that $x\#\text{neut}(x) = \text{neut}(x)\#x = x$,
- ii) There exists anti of “x” such that $x\#\text{anti}(x) = \text{anti}(x)\#x = \text{neut}(x)$.

Also, a neutrosophic triplet “x” is showed with $(x, \text{neut}(x), \text{anti}(x))$.

Definition 2: [32] Let $(N, *)$ be a NTS and $d_N: N \times N \rightarrow \mathbb{R}^+ \cup \{0\}$ be a function. If $d_N: N \times N \rightarrow \mathbb{R}^+ \cup \{0\}$ and $(N, *)$ satisfies the following conditions, then d_N is called NTM.

- a) $x*y \in N$;
- b) $d_N(x, y) \geq 0$;
- c) If $x = y$, then $d_N(x, y) = 0$;
- d) $d_N(x, y) = d_N(y, x)$;
- e) If there exists at least a $y \in N$ for each $x, z \in N$ such that $d_N(x, z) \leq d_N(x, z*\text{neut}(y))$, then $d_N(x, z*\text{neut}(y)) \leq d_N(x, y) + d_N(y, z)$.

Also, $((N, *), d_N)$ is called a NTMS.

Definition 3: [45] Let X and Y be nonempty sets and $d: N \times N \rightarrow \mathbb{R}^+ \cup \{0\}$ be a function. If d satisfies the following conditions, then d is called bipolar metric (bM).

- i) For $\forall (x, y) \in X \times Y$, if $d(x, y) = 0$, then $x = y$
- ii) For $\forall u \in X \cap Y$, $d(u, u) = 0$
- iii) For $\forall u \in X \cap Y$, $d(u, v) = d(v, u)$
- iv) For $(x, y), (x', y') \in X \times Y$, $d(x, y) \leq d(x, y') + d(x', y') + d(x', y)$

Also, (X, Y, d) is called bipolar metric space (bMS).

Definition 4: [45] Let (X, Y, d) be a bMS. Then the points of the sets X , Y and $X \cap Y$ are named as left, right and central points, respectively, and any sequence, that is consisted of only left (or right, or central) points is called a left (or right, or central) sequence in (X, Y, d) .

Definition 5: [45] Let (X, Y, d) be a bMS. A left sequence (x_n) converges to a right point y (symbolically $(x_n) \rightarrow y$ or $\lim_{n \rightarrow \infty} (x_n) = y$) if and only if for every $\varepsilon > 0$ there exists an $n_0 \in \mathbb{N}$, such that $d(x_n, y) < \varepsilon$ for all $n \geq n_0$. Similarly, a right sequence (y_n) converges to a left point x (denoted as $y_n \rightarrow x$ or

$\lim_{n \rightarrow \infty} (y_n) = x$ if and only if, for every $\varepsilon > 0$ there exists an $n_0 \in \mathbb{N}$ such that, whenever $n \geq n_0$, $d(x, y_n) < \varepsilon$. Also, If it is written $(u_n) \rightarrow u$ and $(u_n) \rightarrow u$, then (u_n) converges to point u ((u_n) is a central sequence).

Definition 6: [45] Let (X, Y, d) be a bMS, (x_n) be a left sequence and (y_n) be a right sequence in this space. (x_n, y_n) is called bisequence. Furthermore, If (x_n) and (y_n) are convergent, then (x_n, y_n) is called convergent bipolar sequence. Also, if (x_n) and (y_n) converge to same point, then (x_n, y_n) is called biconvergent.

Definition 7: [45] Let (X, Y, d) be a bMS and (x_n, y_n) be a bisequence. (x_n, y_n) is called Cauchy bisequence if and only if for every $\varepsilon > 0$ there exists an $n_0 \in \mathbb{N}$, such that $d(x_n, y_n) < \varepsilon$ for all $n \geq n_0$.

Neutrosophic Triplet Bipolar Metric Space

Definition 8: Let $(X, *)$ and $(Y, *)$ be NTSs, $d: X \times Y \rightarrow \mathbb{R}^+ \cup \{0\}$ be a function. If d , $(X, *)$ and $(Y, *)$ satisfy the following conditions, then d is called neutrosophic triplet bipolar metric (NTbM).

i) For $\forall a, b \in X, a * b \in X$;

for $\forall c, d \in Y$ için $c * d \in Y$;

ii) For $\forall a \in X$ and $\forall b \in Y$, if $d(a, b) = 0$, then $a = b$;

iii) For $\forall u \in X \cap Y, d(u, u) = 0$;

iv) For $\forall u, v \in X \cap Y, d(u, v) = d(v, u)$

v) Let $(x, y), (x', y') \in X \times Y$. For each (x, y) , if there is at least a (x', y') such that

$$d(x, y) \leq d(x, y * neut(y')) \leq d(x * neut(x'), y * neut(y'))$$

$$d(x, y) \leq d(x * neut(x'), y) \leq d(x * neut(x'), y * neut(y')),$$

then

$$d(x * neut(x'), y * neut(y')) \leq d(x, y') + d(x', y') + d(x', y).$$

Also, $((X, Y, *) , d)$ is called neutrosophic triplet bipolar metric space (NTbMS).

Example 1: Let $X = \{0, 2, 4, 6, 8\}$ and $Y = \{0, 4, 5, 6\}$. We show that $(X, .)$ and $(Y, .)$ are NTS in $(\mathbb{Z}_{10}, .)$.

For $(X, .)$, NTs are $(0, 0, 0), (2, 6, 8), (4, 6, 4), (6, 6, 6), (8, 6, 2)$.

Also, For $(Y, .)$, NTs are $(0, 0, 0), (4, 6, 4), (5, 5, 5), (6, 6, 6)$.

Thus, $(X, .)$ and $(Y, .)$ are NTS.

Furthermore, we define the $d: X \times Y \rightarrow \mathbb{R}^+ \cup \{0\}$ function such that $d(k, m) = |2^k - 2^m|$. We show that d is a NTbM.

i) $0.0 = 0 \in X, 0.2 = 0 \in X, 0.4 = 0 \in X, 0.6 = 0 \in X, 0.8 = 0 \in X, 2.2 = 4 \in X, 2.4 = 8 \in X, 2.6 = 2 \in X, 2.8 = 6 \in X, 4.4 = 6 \in X, 4.6 = 4 \in X, 4.8 = 2 \in X, 6.6 = 6 \in X, 6.8 = 8 \in X, 8.8 = 8 \in X$.

Thus, for $\forall a, b \in X, a . b \in X$.

Also, $0.0 = 0 \in Y$, $0.4 = 0 \in Y$, $0.5 = 0 \in Y$, $0.6 = 0 \in Y$, $4.4 = 6 \in Y$, $4.5 = 0 \in Y$, $4.6 = 4 \in Y$,
 $5.5 = 5 \in Y$, $5.6 = 0 \in Y$, $6.6 = 6 \in Y$

Thus, for $\forall c, d \in Y, c. d \in Y$.

ii) For $\forall a \in X, \forall b \in Y$, if $d(a, b) = |2^a - 2^b| = 0$, then it is clear that $a = b$.

iii) For $\forall u \in X \cap Y$, it is clear that $d(u, u) = |2^u - 2^u| = 0$.

iv) For $\forall u, v \in X \cap Y$, $d(u, v) = |2^u - 2^v| = |2^v - 2^u| = d(v, u)$.

v) It is clear that

$$d(0,0) = 0 \leq d(0,0. neut(5)) = 0,$$

$$d(0,0) = 0 \leq d(0. neut(2), 0) = 0,$$

$$d(0,0) = 0 \leq d(0. neut(2), 0. neut(5)) = 0.$$

Also,

$$d(0. neut(2), 0. neut(5)) = d(0,0) = |2^0 - 2^0| = 0 \leq d(0,5) + d(2,5) + d(2,0) =$$

$$|2^0 - 2^5| + |2^2 - 2^5| + |2^2 - 2^0| = 31+28+3=62.$$

It is clear that

$$d(0,4) = 15 \leq d(0,4. neut(6)) = 15 \leq d(0. neut(2), 4. neut(6)) = 15,$$

$$d(0,4) = 15 \leq d(0. neut(2), 4) = 15 \leq d(0. neut(2), 4. neut(6)) = 15.$$

$$\text{Also, } d(0. neut(2), 4. neut(6)) = d(0,4) = |2^0 - 2^4| = 15 \leq d(0,6) + d(2,6) + d(2,4) =$$

$$|2^0 - 2^6| + |2^2 - 2^6| + |2^2 - 2^4| = 63 + 60 + 12 = 135.$$

It is clear that

$$d(0,5) = 31 \leq d(0,5. neut(5)) = 31 \leq d(0. neut(8), 5. neut(5)) = 31,$$

$$d(0,5) = 31 \leq d(0. neut(8), 5) = 31 \leq d(0. neut(8), 5. neut(5)) = 31.$$

$$\text{Also, } d(0. neut(8), 5. neut(5)) = d(0,5) = |2^0 - 2^5| = 31 \leq d(0,5) + d(8,5) + d(8,5) =$$

$$|2^0 - 2^5| + |2^8 - 2^5| + |2^8 - 2^5| = 31 + 224 + 224 = 479.$$

It is clear that

$$d(0,6) = 63 \leq d(0,6. neut(4)) = 63 \leq d(0. neut(8), 6. neut(4)) = 63,$$

$$d(0,6) = 63 \leq d(0. neut(8), 6)=63 \leq d(0. neut(8), 6. neut(4)) = 63.$$

$$\text{Also, } d(0. neut(8), 6. neut(4)) = d(0,6) = |2^0 - 2^6| = 63 \leq d(0,4) + d(8,4) + d(8,6) =$$

$$|2^0 - 2^4| + |2^8 - 2^4| + |2^8 - 2^6| = 15 + 240 + 192 = 447.$$

It is clear that

$$d(2,0) = 3 \leq d(2,0. neut(6))=3 \leq d(2. neut(4), 0. neut(6)) = 3,$$

$$d(2,0) = 3 \leq d(2.\text{neut}(4), 0)=3 \leq d(2.\text{neut}(4), 0.\text{neut}(6)) = 3.$$

$$\text{Also, } d(2.\text{neut}(4), 0.\text{neut}(6)) = d(2,0) = |2^2 - 2^0| = 3 \leq d(2,6) + d(4,6) + d(4,0) = |2^2 - 2^6| + |2^4 - 2^6| + |2^4 - 2^0| = 60 + 48 + 15 = 123.$$

It is clear that

$$d(2,4) = 12 \leq d(2,4.\text{neut}(6)) = 12 \leq d(2.\text{neut}(8), 4.\text{neut}(6)) = 12,$$

$$d(2,4) = 12 \leq d(2.\text{neut}(8), 4)=12 \leq d(2.\text{neut}(8), 4.\text{neut}(6)) = 12.$$

$$\text{Also, } d(2.\text{neut}(8), 4.\text{neut}(6)) = d(2,4) = |2^2 - 2^4| = 12 \leq d(2,6) + d(8,6) + d(8,4) = |2^2 - 2^6| + |2^8 - 2^6| + |2^8 - 2^4| = 60 + 192 + 240 = 492.$$

It is clear that

$$d(2,5) = 28 \leq d(2,5.\text{neut}(5)) = 28 \leq d(2.\text{neut}(0), 5.\text{neut}(5)) = 31,$$

$$d(2,5) = 28 \leq d(2.\text{neut}(0), 5) = 31 \leq d(2.\text{neut}(0), 5.\text{neut}(5)) = 31.$$

$$\text{Also, } d(2.\text{neut}(0), 5.\text{neut}(5)) = d(0,5) = |2^0 - 2^5| = 31 \leq d(2,5) + d(0,5) + d(0,5) = |2^2 - 2^5| + |2^0 - 2^5| + |2^0 - 2^5| = 28 + 31 + 31 = 90.$$

It is clear that

$$d(2,6) = 60 \leq d(2,6.\text{neut}(4)) = 60 \leq d(2.\text{neut}(0), 6.\text{neut}(4)) = 63,$$

$$d(2,6) = 60 \leq d(2.\text{neut}(0), 6)=63 \leq d(2.\text{neut}(0), 6.\text{neut}(4)) = 63.$$

$$\text{Also, } d(2.\text{neut}(0), 6.\text{neut}(4)) = d(0,6) = |2^0 - 2^6| = 63 \leq d(2,4) + d(0,4) + d(0,6) = |2^2 - 2^4| + |2^0 - 2^4| + |2^0 - 2^6| = 12 + 15 + 63 = 90.$$

It is clear that

$$d(4,0) = 15 \leq d(4,0.\text{neut}(6)) = 15 \leq d(4.\text{neut}(2), 0.\text{neut}(6)) = 15,$$

$$d(4,0) = 15 \leq d(4.\text{neut}(2), 0)=15 \leq d(4.\text{neut}(2), 0.\text{neut}(6)) = 15.$$

$$\text{Also, } d(4.\text{neut}(2), 0.\text{neut}(6)) = d(4,0) = |2^4 - 2^0| = 15 \leq d(4,6) + d(2,6) + d(2,0) = |2^4 - 2^6| + |2^2 - 2^6| + |2^2 - 2^0| = 48 + 60 + 3 = 111.$$

It is clear that

$$d(4,4) = 0 \leq d(4,4.\text{neut}(0)) = 15 \leq d(4.\text{neut}(8), 4.\text{neut}(0)) = 15,$$

$$d(4,4) = 0 \leq d(4.\text{neut}(8), 4) = 0 \leq d(4.\text{neut}(8), 4.\text{neut}(0)) = 15.$$

$$\text{Also, } d(4.\text{neut}(8), 4.\text{neut}(0)) = d(4,0) = |2^4 - 2^0| = 15 \leq d(4,0) + d(8,0) + d(8,4) = |2^4 - 2^0| + |2^8 - 2^0| + |2^8 - 2^4| = 15 + 255 + 240 = 510.$$

It is clear that

$$d(4,5) = 16 \leq d(4,5.\text{neut}(5)) = 16 \leq d(4.\text{neut}(8), 5.\text{neut}(5)) = 16,$$

$$d(4,5) = 16 \leq d(4.\text{neut}(8), 5) = 16 \leq d(4.\text{neut}(8), 5.\text{neut}(5)) = 16.$$

$$\text{Also, } d(4.\text{neut}(8), 5.\text{neut}(5)) = d(4,5) = |2^4 - 2^5| = 16 \leq d(4,5) + d(8,5) + d(8,5) = |2^4 - 2^5| + |2^8 - 2^5| + |2^8 - 2^5| = 16 + 224 + 224 = 464.$$

It is clear that

$$d(4,6) = 48 \leq d(4,6.\text{neut}(2)) = 48 \leq d(4.\text{neut}(8), 6.\text{neut}(2)) = 48,$$

$$d(4,6) = 48 \leq d(4.\text{neut}(8), 6) = 48 \leq d(4.\text{neut}(8), 6.\text{neut}(2)) = 48.$$

$$\text{Also, } d(4.\text{neut}(8), 6.\text{neut}(2)) = d(4,6) = |2^4 - 2^6| = 48 \leq d(4,2) + d(8,2) + d(8,6) = |2^4 - 2^2| + |2^8 - 2^2| + |2^8 - 2^6| = 12 + 252 + 192 = 456.$$

It is clear that

$$d(6,0) = 63 \leq d(6,0.\text{neut}(5)) = 63 \leq d(6.\text{neut}(4), 0.\text{neut}(5)) = 63,$$

$$d(6,0) = 63 \leq d(6.\text{neut}(4), 0) = 63 \leq d(6.\text{neut}(4), 0.\text{neut}(5)) = 63.$$

$$\text{Also, } d(6.\text{neut}(4), 0.\text{neut}(5)) = d(6,0) = |2^6 - 2^0| = 63 \leq d(6,5) + d(4,5) + d(4,0) = |2^6 - 2^5| + |2^4 - 2^5| + |2^4 - 2^0| = 32 + 16 + 15 = 63.$$

It is clear that

$$d(6,4) = 48 \leq d(6,4.\text{neut}(0)) = 63 \leq d(6.\text{neut}(8), 4.\text{neut}(0)) = 63,$$

$$d(6,4) = 48 \leq d(6.\text{neut}(8), 4) = 48 \leq d(6.\text{neut}(8), 4.\text{neut}(0)) = 63.$$

$$\text{Also, } d(6.\text{neut}(8), 4.\text{neut}(0)) = d(6,0) = |2^6 - 2^0| = 63 \leq d(6,0) + d(8,0) + d(8,4) = |2^6 - 2^0| + |2^8 - 2^0| + |2^8 - 2^4| = 63 + 255 + 240 = 558.$$

It is clear that

$$d(6,5) = 32 \leq d(6,5.\text{neut}(4)) = 63 \leq d(6.\text{neut}(2), 5.\text{neut}(4)) = 63,$$

$$d(6,5) = 32 \leq d(6.\text{neut}(2), 5) = 32 \leq d(6.\text{neut}(2), 5.\text{neut}(4)) = 63.$$

$$\text{Also, } d(6.\text{neut}(2), 5.\text{neut}(4)) = d(6,0) = |2^6 - 2^0| = 63 \leq d(6,4) + d(2,4) + d(2,5) = |2^6 - 2^4| + |2^2 - 2^4| + |2^2 - 2^5| = 48 + 12 + 28 = 88.$$

It is clear that

$$d(6,6) = 0 \leq d(6,6.\text{neut}(4)) = 0 \leq d(6.\text{neut}(8), 6.\text{neut}(4)) = 0,$$

$$d(6,6) = 0 \leq d(6.\text{neut}(8), 6) = 0 \leq d(6.\text{neut}(8), 6.\text{neut}(4)) = 0.$$

$$\text{Also, } d(6.\text{neut}(8), 6.\text{neut}(4)) = d(6,6) = |2^6 - 2^6| = 0 \leq d(6,4) + d(8,4) + d(8,6) = |2^6 - 2^4| + |2^8 - 2^4| + |2^8 - 2^6| = 48 + 240 + 192 = 480.$$

It is clear that

$$d(8,0) = 255 \leq d(8,0.\text{neut}(5)) = 255 \leq d(8.\text{neut}(4), 0.\text{neut}(5)) = 255,$$

$$d(8,0) = 255 \leq d(8.\text{neut}(4), 0)=255 \leq d(8.\text{neut}(4), 0.\text{neut}(5)) = 255.$$

$$\text{Also, } d(8.\text{neut}(4), 0.\text{neut}(5)) = d(8,0) = |2^8 - 2^0| = 255 \leq d(8,5) + d(4,5) + d(4,0) = |2^8 - 2^5| + |2^4 - 2^5| + |2^4 - 2^0| = 224 + 16 + 15 = 255.$$

It is clear that

$$d(8,4) = 240 \leq d(8,4.\text{neut}(0)) = 255 \leq d(8.\text{neut}(6), 4.\text{neut}(0)) = 255,$$

$$d(8,4) = 240 \leq d(8.\text{neut}(6), 4)=240 \leq d(8.\text{neut}(6), 4.\text{neut}(0)) = 255.$$

$$\text{Also, } d(8.\text{neut}(6), 4.\text{neut}(0)) = d(8,0) = |2^8 - 2^0| = 255 \leq d(8,0) + d(6,0) + d(6,4) = |2^8 - 2^0| + |2^6 - 2^0| + |2^6 - 2^4| = 255 + 63 + 48 = 366.$$

It is clear that

$$d(8,5) = 224 \leq d(8,5.\text{neut}(0))=255 \leq d(8.\text{neut}(4), 5.\text{neut}(0)) = 255,$$

$$d(8,5) = 224 \leq d(8.\text{neut}(4), 5) = 224 \leq d(8.\text{neut}(4), 5.\text{neut}(0)) = 255.$$

$$\text{Also, } d(8.\text{neut}(4), 5.\text{neut}(0)) = d(8,0) = |2^8 - 2^0| = 255 \leq d(8,0) + d(4,0) + d(4,5) = |2^8 - 2^0| + |2^4 - 2^0| + |2^4 - 2^5| = 255 + 15 + 16 = 286.$$

It is clear that

$$d(8,6) = 192 \leq d(8,6.\text{neut}(5)) = 255 \leq d(8.\text{neut}(2), 6.\text{neut}(5)) = 255,$$

$$d(8,6) = 192 \leq d(8.\text{neut}(2), 6)=192 \leq d(8.\text{neut}(2), 6.\text{neut}(5)) = 255.$$

$$\text{Also, } d(8.\text{neut}(2), 6.\text{neut}(5)) = d(8,0) = |2^8 - 2^0| = 255 \leq d(8,5) + d(2,5) + d(2,6) = |2^8 - 2^5| + |2^2 - 2^5| + |2^2 - 2^6| = 224 + 28 + 60 = 312.$$

Thus, for each (x, y) , if there is at least a (x', y') such that

$$d(x, y) \leq d(x, y * \text{neut}(y')) \leq d(x * \text{neut}(x'), y * \text{neut}(y'))$$

$$d(x, y) \leq d(x * \text{neut}(x'), y) \leq d(x * \text{neut}(x'), y * \text{neut}(y')),$$

then

$$d(x * \text{neut}(x'), y * \text{neut}(y')) \leq d(x, y') + d(x', y') + d(x', y).$$

Therefore, d is a NTbM and $((X, Y), *, d)$ is a NTbMS.

Example 2: Let $X = \{x, y, z\}$ and $P(X)$ be power set of X , $Y = \{k, l, m\}$ and $P(Y)$ be power set of Y and $s(A)$ be number of elements in A . We show that $(P(X) \setminus X, \cup)$ and $(P(Y) \setminus Y, \cup)$ are NTS.

It is clear that $A \cup A = A \cup A = A$. Thus, we can take $\text{neut}(A) = A$ and $\text{anti}(A) = A$ for all $A \in P(X) \setminus X$ and for all $A \in P(Y) \setminus Y$.

We define $d: P(X) \setminus X \times P(Y) \setminus Y \rightarrow \mathbb{R}^+ \cup \{0\}$ such that $d(A, B) = |3^{s(A)} - 3^{s(B)}|$. d is not a NTbMS. Because, for $A = \{x, y\}$, $B = \{k, l\}$;

$$d(A, B) = |3^{s(A)} - 3^{s(B)}| = |3^2 - 3^2| = 0, \text{ but } A \neq B.$$

Corollary 1: From Definition 8 and Definition 3, a NTbMS is different from a bMS. Because, there is not a $*$ binary operation in Definition 3. Also, triangle inequalities are different in definitions.

Corollary 2: From Definition 8 and Definition 2, a NTbMS is different from a NTMS. Because, there is only one NTS in Definition 3. Also, triangle inequalities are different in definitions.

Theorem 1: Let $((X, Y), *, d)$ be a NTbMS. If the following conditions are satisfied, then $((X, *), d)$ is a NTMS.

- a) $Y = X$
- b) $y' = x'$, in Definition 8 at triangle inequality.

Proof:

i) Since $((X, Y), *, d)$ is a NTbMS, we can write that for $\forall x, z \in X, x * z \in X$ and for $\forall y, t \in Y, y * t \in Y$. Also, from condition a) it is clear that for $\forall x, y \in X = Y, x * y \in X = Y$.

ii) Since $((X, Y), *, d)$ is a NTbMS, we can write for $\forall a \in X$ and $\forall b \in Y, d(a, b) \geq 0$.

iii) Since $((X, Y), *, d)$ is a NTbMS, we can write for $\forall u \in X \cap Y, d(u, u) = 0$. Also, from condition a), if $y = x$, then $d(x, y) = 0$.

iv) Since $((X, Y), *, d)$ is a NTbMS, we can write for $\forall u, v \in X \cap Y, d(u, v) = d(v, u)$. Also, from condition a), we can write $X \cap Y = X$. Thus, for $\forall x, y \in X, d(x, y) = d(y, x)$.

v) Since $((X, Y), *, d)$ is a NTbMS, we can write that

For each (x, y) , if there is at least a (x', y') such that

$$d(x, y) \leq d(x, y * neut(y')) \leq d(x * neut(x'), y * neut(y'))$$

$$d(x, y) \leq d(x * neut(x'), y) \leq d(x * neut(x'), y * neut(y')),$$

then

$$d(x * neut(x'), y * neut(y')) \leq d(x, y') + d(x', y') + d(x', y).$$

From condition b), we can write that

$$d(x, y) \leq d(x, y * neut(y')) \leq d(x * neut(x'), y * neut(y')) \leq d(x, y') + d(x', x') + d(x', y) = d(x, y') + d(x', y).$$

Also, from condition a), we can write that

If there exists at least a $y' \in X = Y$ for each $x, y \in X = Y$ such that $d(x, y) \leq d_N(x, y * neut(y'))$, then

$$d(x, y * neut(y')) \leq d(x, y') + d(y', y).$$

Thus, $((X, *), d)$ is a NTMS.

Theorem 2: Let $((X, Y), *, d)$ be a NTbMS. If $(X \cap Y, *)$ is a NTS, then $((X \cap Y, X \cap Y), *, d)$ is a NTbMS.

Proof: We suppose that $(X \cap Y, *)$ is a NTS.

i) Since $((X, Y), *, d)$ is a NTbMS, we can write that for $\forall x, z \in X$, $x * z \in X$ and for $\forall y, t \in Y$, $y * t \in Y$. Thus, it is clear that $\forall a, b \in X \cap Y$, $a * b \in X \cap Y$.

ii) Since $((X, Y), *, d)$ is a NTbMS, we can write that for $\forall a \in X$ and $\forall b \in Y$, if $d(a, b) = 0$, then $a = b$. Thus, it is clear that for $\forall a \in X \cap Y$, $\forall b \in X \cap Y$; $d(a, b) = 0 \Rightarrow a = b$.

iii) Since $((X, Y), *, d)$ is a NTbMS, we can write that for $\forall u \in X \cap Y$, $d(u, u) = 0$. Thus, it is clear that for $\forall u \in (X \cap Y) \cap (X \cap Y) = X \cap Y$, $d(u, u) = 0$.

iv) Since $((X, Y), *, d)$ is a NTbMS, we can write that for $\forall u, v \in X \cap Y$, $d(u, v) = d(v, u)$. Thus, it is clear that for $\forall u, v \in (X \cap Y) \cap (X \cap Y) = X \cap Y$, $d(u, v) = d(v, u)$.

v) Since $((X, Y), *, d)$ is a NTbMS, we can write that let $(x, y), (x', y') \in X \times Y$. For each (x, y) , if there is at least a (x', y') such that

$$d(x, y) \leq d(x, y * neut(y')) \leq d(x * neut(x'), y * neut(y'))$$

$$d(x, y) \leq d(x * neut(x'), y) \leq d(x * neut(x'), y * neut(y')),$$

then

$$d(x * neut(x'), y * neut(y')) \leq d(x, y') + d(x', y') + d(x', y).$$

Thus, it is clear that

For each $(a, b) \in (X \cap Y) \times (X \cap Y)$, if there is at least a $(a', b') \in (X \cap Y) \times (X \cap Y)$ such that

$$d(a, b) \leq d(a, b * neut(b'))$$

$$d(a, b) \leq d(a * neut(a'), b)$$

$$d(a, b) \leq d(a * neut(a'), b * neut(b')),$$

then

$$d(a * neut(a'), b * neut(b')) \leq d(a, b') + d(a', b') + d(a', b).$$

Thus, $((X \cap Y, X \cap Y), *, d)$ is a NTbMS.

Theorem 3: Let $((X, Y), *, d)$ be a NTbMS, A be a NT subset of X, and B be a NT subset of Y. $((A, B), *, d)$ is a NTbMS.

Proof: We suppose that $((X, Y), *, d)$ is a NTbMS, A is a NT subset of X, and B is a NT subset of Y.

i) Since $((X, Y), *, d)$ is a NTbMS, for $\forall a, c \in X$, $a * c \in X$ and for $\forall b, d \in Y$, $b * d \in Y$. Also, since $A \subset X$ and $B \subset Y$, we can write that $\forall a, c \in A$, $a * c \in A$ and for $\forall b, d \in B$, $b * d \in B$.

ii) Since $((X, Y), *, d)$ is a NTbMS, we can write that for $\forall a \in X$ and $\forall b \in Y$, if $d(a, b) = 0$, then $a = b$. Thus, it is clear that for $\forall a \in A \subset X$, $\forall b \in B \subset Y$; $d(a, b) = 0 \Rightarrow a = b$.

iii) Since $((X, Y), *, d)$ is a NTbMS, we can write that for $\forall u \in X \cap Y$, $d(u, u) = 0$. Thus, it is clear that for $\forall u \in (A \subset X) \cap (B \subset Y)$, $d(u, u) = 0$.

iv) Since $((X, Y), *, d)$ is a NTbMS, we can write that for $\forall u, v \in X \cap Y$, $d(u, v) = d(v, u)$. Thus, it is clear that for $\forall u, v \in (A \subset X) \cap (B \subset Y)$, $d(u, v) = d(v, u)$.

v) Since $((X, Y), *, d)$ is a NTbMS, we can write that let $(x, y), (x', y') \in X \times Y$. For each (x, y) , if there is at least a (x', y') such that

$$d(x, y) \leq d(x, y * neut(y')) \leq d(x * neut(x'), y * neut(y'))$$

$$d(x, y) \leq d(x * neut(x'), y) \leq d(x * neut(x'), y * neut(y')),$$

then

$$d(x * neut(x'), y * neut(y')) \leq d(x, y') + d(x', y') + d(x', y).$$

Thus, it is clear that

For each $(a, b) \in (A \subset X) \times (B \subset Y)$, if there is at least a $(a', b') \in (A \subset X) \times (B \subset Y)$ such that

$$d(a, b) \leq d(a, b * neut(b'))$$

$$d(a, b) \leq d(a * neut(a'), b)$$

$$d(a, b) \leq d(a * neut(a'), b * neut(b')),$$

then

$$d(a * neut(a'), b * neut(b')) \leq d(a, b') + d(a', b') + d(a', b).$$

Thus, $((A, B), *, d)$ is a NTbMS.

Definition 9: Let $((X, Y), *, d)$ be a NTbMS. A left sequence (x_n) converges to a right point y (symbolically $(x_n) \rightarrow y$ or $\lim_{n \rightarrow \infty} (x_n) = y$) if and only if for every $\varepsilon > 0$ there exists an $n_0 \in \mathbb{N}$, such that $d(x_n, y) < \varepsilon$ for all $n \geq n_0$. Similarly, a right sequence (y_n) converges to a left point x (denoted as $y_n \rightarrow x$ or $\lim_{n \rightarrow \infty} (y_n) = x$) if and only if, for every $\varepsilon > 0$ there exists an $n_0 \in \mathbb{N}$ such that, whenever $n \geq n_0$, $d(x, y_n) < \varepsilon$. Also, If it is written $(u_n) \rightarrow u$ and $(u_n) \rightarrow u$, then (u_n) converges to point u ((u_n) is a central sequence).

Definition 10: Let $((X, Y), *, d)$ be a NTbMS, (x_n) be a left sequence and (y_n) be a right sequence in this space. (x_n, y_n) is called NT bisequence. Furthermore, If (x_n) and (y_n) are convergent, then (x_n, y_n) is called NT convergent bisequence. Also, if (x_n) and (y_n) converge to same point, then (x_n, y_n) is called NT biconvergent bisequence.

Definition 11: Let $((X, Y), *, d)$ be a NTbMS and (x_n, y_n) be a NT bisequence. (x_n, y_n) is called NT Cauchy bisequence if and only if for every $\varepsilon > 0$ there exists an $n_0 \in \mathbb{N}$, such that $d(x_n, y_n) < \varepsilon$ for all $n \geq n_0$.

Theorem 4: Let $((X, Y), *, d)$ be a NTbMS and (x_n, y_n) be a NT bisequence. If the following conditions are satisfied, then (x_n, y_n) is a NT Cauchy bisequence.

a) (x_n, y_n) is NT biconvergent bisequence such that $(x_n) \rightarrow x$ and $y_n \rightarrow x$

b) There is at least a (x, x) such that

$$d(x_n, y_n) \leq d(x_n, y_n * neut(x)) \leq d(x_n * neut(x), y_n * neut(x)),$$

$$d(x_n, y_n) \leq d(x_n * neut(x), y_n) \leq d(x_n * neut(x), y_n * neut(x)).$$

Proof: Since $(x_n) \rightarrow x$ and $y_n \rightarrow x$, we can write that

$$\text{for } \forall n, m \geq n_0, d(x_n, x) < \varepsilon \text{ and } d(y_n, x) < \varepsilon. \tag{1}$$

Also, From Definition 8 (triangle inequality) and condition b), we can write

$$d(x_n, y_n) \leq d(x_n * neut(x), y_n * neut(y)) \leq d(x_n, y) + d(x, y) + d(y_n, x).$$

From (1), we can write

$$d(x_n, y_n) \leq d(x_n * neut(x), y_n * neut(y)) \leq d(x_n, y) + d(x, y) + d(y_n, x) = \frac{\varepsilon}{2} + 0 + \frac{\varepsilon}{2} = \varepsilon.$$

Thus, (x_n, y_n) is a NT Cauchy bisequence.

Definition 12: Let $((X, Y), *, d)$ be a NTbMS. If each NT Cauchy bisequence is NT convergent, then $((X, Y), *, d)$ is called NT bicomplete space.

Conclusions

In this study, we firstly obtain NTbMS. We show that NTbMS is different from bMS and NTMS. Also, we show that a NTbMS will provide the properties of a NTMS under which conditions are met. Thus, we have added a new structure to neutrosophic triplet structures. Also, thanks to NTbMS, we can obtain new theory for fixed point theory, we can define partial NTbMS and we can obtain their properties.

Abbreviations

bM: bipolar metric

bMS: bipolar metric space

NT: Neutrosophic triplet

NTS: Neutrosophic triplet set

NTM: Neutrosophic triplet metric

NTMS: Neutrosophic triplet metric space

NTbM: Neutrosophic triplet bipolar metric

NTbMS: Neutrosophic triplet bipolar metric space

References

- [1] Smarandache F. (1998) Neutrosophy: Neutrosophic Probability, Set and Logic, Rehoboth, Amer. Research Press
- [2] Kandasamy W. B. V. and Smarandache F. (2004) Basic neutrosophic algebraic structures and their applications to fuzzy and neutrosophic models, Hexis, Frontigan p 219
- [3] Kandasamy W. B. V. and Smarandache F. (2006) Some neutrosophic algebraic structures and neutrosophic n-algebraic structures, Hexis, Frontigan p 219
- [4] Smarandache F. and Ali M. (2016) Neutrosophic triplet as extension of matter plasma, unmatter plasma and antimatter plasma, APS Gaseous Electronics Conference doi: 10.1103/BAPS.2016.GEC.HT6.110

- [5] Smarandache F. and Ali M. (2014) The Neutrosophic Triplet Group and its Application to Physics, presented by F. S. to Universidad Nacional de Quilmes, Department of Science and Technology, Bernal, Buenos Aires, Argentina (02 June 2014)
- [6] Smarandache F. and Ali M. (2016) Neutrosophic triplet group. *Neural Computing and Applications*, 1-7.
- [7] Smarandache F. and Ali M. (2017) Neutrosophic Triplet Field Used in Physical Applications, (Log Number: NWS17-2017-000061), 18th Annual Meeting of the APS Northwest Section, Pacific University, Forest Grove, OR, USA (June 1-3, 2017)
- [8] Smarandache F. and Ali M. (2017) Neutrosophic Triplet Ring and its Applications, (Log Number: NWS17-2017-000062), 18th Annual Meeting of the APS Northwest Section, Pacific University, Forest Grove, OR, USA (June 1-3, 2017).
- [9] Şahin, M., & Kargın, A. (2019). Single valued neutrosophic quadruple graphs. *Asian Journal of Mathematics and Computer Research*, 243-250.
- [10] Broumi S., Bakali A., Talea M. and Smarandache F. (2016) Single Valued Neutrosophic Graphs: Degree, Order and Size. *IEEE International Conference on Fuzzy Systems*, pp. 2444-2451.
- [11] Broumi S., Bakali A., Talea M. and Smarandache F. (2016) Decision-Making Method Based On the Interval Valued Neutrosophic Graph, *Future Technologies, IEEE International Conference on Fuzzy Systems* pp 44-50.
- [12] Uluçay, V.; Şahin, M.; Olgun, N. Time-Neutrosophic Soft Expert Sets and Its Decision Making Problem. *Matematika*, 2018 34(2), 246-260.
- [13] Uluçay, V.; Kiliç, A.; Yıldız, I.; Şahin, M. (2018). A new approach for multi-attribute decision-making problems in bipolar neutrosophic sets. *Neutrosophic Sets and Systems*, 2018, 23(1), 142-159.
- [14] Uluçay, V., Kılıç, A., Şahin, M., & Deniz, H. (2019). A New Hybrid Distance-Based Similarity Measure for Refined Neutrosophic sets and its Application in Medical Diagnosis. *MATEMATIKA: Malaysian Journal of Industrial and Applied Mathematics*, 35(1), 83-94.
- [15] Broumi, S., Bakali, A., Talea, M., Smarandache, F., Singh, P. K., Uluçay, V., & Khan, M. (2019). Bipolar complex neutrosophic sets and its application in decision making problem. In *Fuzzy Multi-criteria Decision-Making Using Neutrosophic Sets* (pp. 677-710). Springer, Cham.
- [16] Bakbak, D., Uluçay, V., & Şahin, M. (2019). Neutrosophic soft expert multiset and their application to multiple criteria decision making. *Mathematics*, 7(1), 50.
- [17] Uluçay, V., & Şahin, M. (2020). Decision-Making Method based on Neutrosophic Soft Expert Graphs. In *Neutrosophic Graph Theory and Algorithms* (pp. 33-76). IGI Global.

- [18] Uluçay, V., Kılıç, A., Yıldız, İ., & Şahin, M. (2019). An Outranking Approach for MCDM-Problems with Neutrosophic Multi-Sets. *Neutrosophic Sets & Systems*, 30.
- [19] Uluçay, V., Şahin, M., & Hassan, N. (2018). Generalized neutrosophic soft expert set for multiple-criteria decision-making. *Symmetry*, 10(10), 437.
- [20] Sahin M., Deli I. and Ulucay V. (2016) Similarity measure of bipolar neutrosophic sets and their application to multiple criteria decision making, *Neural Comput & Applic.* DOI 10. 1007/S00521
- [21] Wang H., Smarandache F., Zhang Y. Q., Sunderraman R. (2010) Single valued neutrosophic sets. *Multispace Multistructure* 4, 410–413.
- [22] Şahin M., Olgun N, Uluçay V., Kargin A. and Smarandache F. (2017) A new similarity measure on falsity value between single valued neutrosophic sets based on the centroid points of transformed single valued neutrosophic numbers with applications to pattern recognition, *Neutrosophic Sets and Systems*, 15, 31-48, doi: org/10.5281/zenodo570934
- [23] Şahin M., Ecemiş O., Uluçay V. and Kargin A. (2017) Some new generalized aggregation operators based on centroid single valued triangular neutrosophic numbers and their applications in multi-attribute decision making, *Asian Journal of Mathematics and Computer Research* 16(2): 63-84
- [24] Chatterjee R., Majumdar P., and Samanta S. K. (2019) Similarity Measures in Neutrosophic Sets-I. *Fuzzy Multi-criteria Decision-Making Using Neutrosophic Sets*. Springer, Cham. 249-294.
- [25] Mohana K., and Mohanasundari M. (2019) On Some Similarity Measures of Single Valued Neutrosophic Rough Sets. *Neutrosophic Sets and Systems*, 10
- [26] Smarandache F., et al. (2019) Word-level neutrosophic sentiment similarity. *Applied Soft Computing* 80, 167-176.
- [27] Ye J. (2014) Similarity measures between interval neutrosophic sets and their applications in multicriteria decision – making. *J. Intell. Fuzzy Syst.* 26 (1) 165 – 172
- [28] Zadeh A. L. (1965) Fuzzy sets, *Information and control* ,8.3 338-353,
- [29] Atanassov T. K. (1986) Intuitionistic fuzzy sets, *Fuzzy Sets Syst*, 20:87–96
- [30] Şahin M. and Kargin A. (2019) Neutrosophic triplet metric topology, *Neutrosophic Set and Systems*, 27, 154 -162
- [31] Ali M., Smarandache F., Khan M. (2018) Study on the development of neutrosophic triplet ring and neutrosophic triplet field, *Mathematics-MDPI*, 6(4), 46
- [32] Şahin M. and Kargin A. (2017) Neutrosophic triplet normed space, *Open Physics*, 15, 697-704

- [33] Şahin M. and Kargın A. (2017) Neutrosophic triplet inner product space, *Neutrosophic Operational Research*, 2, 193-215,
- [34] Smarandache F., Şahin M., Kargın A. (2018) Neutrosophic Triplet G- Module, *Mathematics – MDPI*, 6, 53
- [35] Şahin M. and Kargın A. (2019) Neutrosophic triplet b – metric space, *Neutrosophic Triplet Research*, 1
- [36] Şahin M., Kargın A., Çoban M. A. (2018) Fixed point theorem for neutrosophic triplet partial metric space, *Symmetry – MDPI*, 10, 240
- [37] Şahin M., Kargın A. (2018) Neutrosophic triplet ν – generalized metric space, *Axioms – MDPI*, 7, 67
- [38] Şahin M. and Kargın A., Smarandache F. (2019) Neutrosophic triplet topology, *Neutrosophic Triplet Research* 1,
- [39] Şahin M., Kargın A. (2018) Neutrosophic triplet normed ring space, *Neutrosophic Set and Systems*, 21, 20 – 27
- [40] Şahin M., Kargın A. (2019), Neutrosophic triplet partial inner product space, *Neutrosophic Triplet Research* 1, 10 - 21
- [41] Şahin M., Kargın A. (2019), Neutrosophic triplet groups Based on set valued neutrosophic quadruple numbers, *Neutrosophic Set and Systems*, 30, 122 -131
- [42] Şahin M., Kargın A. (2019) Neutrosophic triplet partial ν – generalized metric space, *Neutrosophic Triplet Research* 1, 22 - 34
- [43] Şahin M., Kargın A. (2019) Neutrosophic triplet Lie Algebra, *Neutrosophic Triplet Research* 1, 68 -78
- [44] Şahin M., Kargın A. (2019) Isomorphism theorems for Neutrosophic triplet G - module, *Neutrosophic Triplet Research* 1, 54- 67
- [45] Mutlu, A., Gürdal, U., Bipolar metric spaces and some fixed point theorems. *Journal of Nonlinear Sciences & Applications*, 2016, 9(9), 5362–5373.
- [46] Mutlu, A., Özkan, K., & Gürdal, U. (2017). Coupled fixed point theorems on bipolar metric spaces. *European Journal of Pure and Applied Mathematics*, 10(4), 655-667
- [47] Kishore, G. N. V., Agarwal, R. P., Rao, B. S., & Rao, R. S. (2018). Caristi type cyclic contraction and common fixed point theorems in bipolar metric spaces with applications. *Fixed Point Theory and Applications*, 1, 21.
- [48] Rao, B. S., Kishore, G. N. V., & Kumar, G. K. (2018). Geraghty type contraction and common coupled fixed point theorems in bipolar metric spaces with applications to homotopy. *International Journal of Mathematics Trends and Technology (IJMTT)*, 63.

Chapter Twelve

Neutrosophic Measures of Central Tendency and Dispersion

**¹Muhammad Aslam, Rehan Ahmad Khan Sherwani², Mishal Waseem²
and ¹Saeed A. Dobbah**

¹Department of Statistics, Faculty of Science, King Abdulaziz University, Jeddah 21551, Saudi Arabia. Email: aslam_ravian@hotmail.com; saalghamdy@kau.edu.sa

⁴College of Statistical and Actuarial Sciences, University of the Punjab, Lahore, Pakistan.

Email: rehan.stat@pu.edu.pk; mishalbutt46@gmail.com

ABSTRACT

In this chapter, we will introduce the important measures for summarizing and describing neutrosophic data which include measures of central tendency, position, dispersion and shape under the neutrosophic statistics (NS). These measures are the extension of the central tendency, position, dispersion and shape under classical statistics (CS). The main purpose of this chapter is to introduce some important measures for exploring the data under uncertain environment. We will focus on the basic ideas of these measures such as neutrosophic arithmetic mean, neutrosophic geometric mean, neutrosophic harmonic mean, neutrosophic mode, neutrosophic median, relationship between these measures and quantiles, neutrosophic range, neutrosophic variance, etc., under the NS.

Keywords: Neutrosophic Statistics, Indeterminacy, Measures of Central Tendency, Measures of Dispersion.

2.1 INTRODUCTION

For any data obtained under the uncertainty environment, the data analysts are always interested in exploring the data by determining and interpreting some measurements that summarize and describe the characteristics of the neutrosophic data [1-5]. Such measurements include the neutrosophic measures of central tendency, neutrosophic measures of position, neutrosophic measures of dispersion and neutrosophic measures of shape. Neutrosophic statistics are based on the logic of neutrosophic sets and theory and for details readers may consider [5]. The neutrosophic measures of central tendency are one of the important aspects of summarizing the data under the NS. The measures of central tendency are used to summarize a data set with a single value that represent the middle, center or location of the data's distribution under CS. Under NS, the neutrosophic measures of central tendency are neutrosophic values that represent the middle, center or location of the whole neutrosophic data. The neutrosophic measures of position are another aspect of the neutrosophic data analysis under the NS. The measures of position are used to show where a specific value falls within a data's distribution under CS. Under NS, the neutrosophic measures of position are neutrosophic values that show where specific values fall within the whole neutrosophic data values. The neutrosophic measures of dispersion are another important aspect of describing the neutrosophic data under the NS. The measures of dispersion are used to describe a data set with a single value that represent the

spread of data's distribution under CS. Under NS, the neutrosophic measures of dispersion are neutrosophic values that show how the whole neutrosophic data values are clustered or spread. The measures of shape are another important aspect of describing the neutrosophic data under NS. The measures of shape are used to show the pattern of a data set under CS. Also under NS, the neutrosophic measures of shape are used to show the pattern of the whole neutrosophic data values under study.

2.2 NEUTROSOPHIC MEASURES OF CENTRAL TENDENCY

The neutrosophic numbers that expressed in the indeterminacy interval that show where the majority of the neutrosophic data clustered are called the neutrosophic measures of central tendency. Note here that, the values of the neutrosophic measure of central tendency are not necessary to be always at the center of the data. Therefore, such as neutrosophic measures may called neutrosophic measure of location.

Some important neutrosophic measures of central tendency that will be explained here are the neutrosophic arithmetic mean (NAM), see also [5], the neutrosophic weighted mean (NWM), the neutrosophic geometric mean (NGM), the neutrosophic harmonic mean (NHM), the neutrosophic median (NME) and the neutrosophic mode (NMO).

2.2.1 Neutrosophic Arithmetic Mean (NAM)

Suppose that $X_{iN} \in \{X_L, X_U\}$; $i = 1, 2, 3, \dots, n_N$ be a neutrosophic random variable (nrv) of sample size n_N , where X_L and X_U denote a lower value and an upper value of indeterminacy interval respectively. The sum of all neutrosophic observations divided by the neutrosophic sample size is known as neutrosophic arithmetic mean (NAM). The NAM is defined as follows

$$\bar{X}_N \in \left[\frac{\sum_{i=1}^{n_L} X_{iL}}{n_L}, \frac{\sum_{i=1}^{n_U} X_{iU}}{n_U} \right]; \bar{X}_N \in [\bar{X}_L, \bar{X}_U]; n_N \in [n_L, n_U] \quad (2.2.1)$$

Note here that \bar{X}_L and \bar{X}_U represent the arithmetic mean (AM) of lower values and upper values in the indeterminacy interval respectively. In addition, when $n_L = n_U$ the NAM is given in Eq. (2.2.1) reduces to AM under CS.

Example 2.2.1: Saudi's students spending money on their lunch.

The following neutrosophic data is the daily expenditure in Saudi Riyal (SR) of five Saudi students on their lunch at King Abdulaziz University (KAU) campus. Calculate the NAM.

$$[10, 10], [5, 7], [8, 9], [15, 15], [12, 15].$$

Solution:

We will apply the direct method to calculate the NAM for this neutrosophic data.

$$\bar{X}_N \in \left[\frac{\sum_{i=1}^{n_L} X_{iL}}{n_L}, \frac{\sum_{i=1}^{n_U} X_{iU}}{n_U} \right]$$

$$\bar{X}_N \in \left[\frac{10 + 5 + 8 + 15 + 12}{5}, \frac{10 + 7 + 9 + 15 + 15}{5} \right] = \left[\frac{50}{5}, \frac{56}{5} \right] = [10, 11.2]$$

Thus, the NAM is $\bar{X}_N \in [10SR, 11.2SR]$

It means that the Saudi's students spent between 10 to 11.2 SR on their daily lunch at the campus.

The NAM can be computed for grouped or ungrouped data. Table 2.2.1 shows some formulas used to compute NAM for grouped and ungrouped data.

Table 2.2.1: Methods to compute NAM

Methods under NS	Types of neutrosophic data	
	Ungrouped neutrosophic data	Grouped neutrosophic data
Direct under NS	$\bar{X}_N \in \left[\frac{\sum_{i=1}^{n_L} X_{iL}}{n_L}, \frac{\sum_{i=1}^{n_U} X_{iU}}{n_U} \right]$	$\bar{X}_N \in \left[\frac{\sum_{i=1}^{n_L} f_L X_{iL}}{\sum_{i=1}^{n_L} f_L}, \frac{\sum_{i=1}^{n_U} f_U X_{iU}}{\sum_{i=1}^{n_U} f_U} \right]$
Indirect under NS	$\bar{X}_N = A_N + \frac{\sum_{i=1}^{n_N} D_N}{n_N}$ Where $\bar{X}_N \in [\bar{X}_L, \bar{X}_U]$ Here $D_N = X_N - A_N$ and A_N is any assumed neutrosophic mean. $A_N \neq \bar{X}_N$	$\bar{X}_N = A_N + \frac{\sum_{i=1}^{n_N} f_N D_N}{\sum_{i=1}^{n_N} f_N}$ Where $\bar{X}_N \in [\bar{X}_L, \bar{X}_U]$ Here $D_N = X_N - A_N$ and A_N is any assumed neutrosophic mean. $A_N \neq \bar{X}_N$
Step-division under NS	$\bar{X}_N = A_N + \frac{\sum_{i=1}^{n_N} U_N}{n_N} \times c_N$ Where $\bar{X}_N \in [\bar{X}_L, \bar{X}_U]$ Note here $U_N = \frac{X_N - A_N}{c_N \text{ or } h_N}$; where c_N is common divisor and h_N is class interval.	$\bar{X}_N = A_N + \frac{\sum_{i=1}^{n_N} f_N U_N}{\sum_{i=1}^{n_N} f_N} \times c_N$ Where $\bar{X}_N \in [\bar{X}_L, \bar{X}_U]$ Note here $U_N = \frac{X_N - A_N}{c_N \text{ or } h_N}$; where c_N is common divisor and h_N is class interval.

Note that the NAM is the most important neutrosophic measure of central tendency since it is computed by using all the numerical values of the neutrosophic data set and varies less than the other neutrosophic measures of central tendency.

2.2.2 Neutrosophic Weighted Mean (NWM)

In classical statistics, weighted mean is calculated by assigning weights to the observations according to importance. NWM is calculated in the same way but the weights assigned in this case will be neutrosophic. If $X_{iN} \in \{X_L, X_U\}; i = 1, 2, 3, \dots, n_N$ be a neutrosophic random variable (nrv) and the $W_{iN} \in \{W_L, W_U\}; i = 1, 2, 3, \dots, n_N$ be the neutrosophic weights assigned to the values of neutrosophic random variable, then the formula for calculating NWM is as follow:

$$\bar{X}_{W_N} = \frac{\sum_{i=1}^{n_N} X_{iN} W_{iN}}{\sum_{i=1}^{n_N} W_{iN}}; \bar{X}_{W_N} \in [\bar{X}_{W_L}, \bar{X}_{W_U}] \quad (2.2.2)$$

Example 2.2.2 Punjab university’s students taking Panadol, tea or nap for headache.

The neutrosophic data of the student’s preference of Panadol (1), tea (2) or nap (3) along with their priority are as follows:

{1,2}, {2,3}, {3,1}, {1,2}, {3,2} with weights [1,1], [2,4], [3,2], [2,4], [1,6] respectively.

Calculate the NWM.

Solution:

Using formula (2.2.2)

$$\begin{aligned}\bar{X}_{WN} &= \frac{[1 \times 1 + 2 \times 2 + 3 \times 3 + 1 \times 2 + 3 \times 1, 2 \times 1 + 3 \times 4 + 1 \times 2 + 2 \times 4 + 2 \times 6]}{[9, 17]} \\ &= \frac{[19, 36]}{[9, 17]} = [2.1, 2.12] \\ \bar{X}_{WN} &\in [2.1, 2.12]\end{aligned}$$

2.2.3 Neutrosophic Geometric Mean (NGM)

The neutrosophic geomantic mean (NGM) is another measure of central tendency which is applied when the neutrosophic data is expressed in rates, ratios or percentages.

The neutrosophic geomantic mean is the n^{th} positive root of the product of n_N neutrosophic observations. Mathematically, it is defined for ungrouped neutrosophic data as follows:

$$GM_N = \sqrt[n_N]{X_{1N} \times X_{2N} \dots \times X_{n_N}}; GM_N \in [GM_L, GM_U] \quad (2.2.3)$$

Similarly, when the frequency is given for the corresponding neutrosophic data, the NGM is defined as follows:

$$GM_N = \sqrt[n_N]{X_{1N}^{f_{1n}} \times X_{2N}^{f_{2n}} \times \dots \times X_{n_N}^{f_{n_N}}}; GM_N \in [GM_L, GM_U] \quad (2.2.4)$$

Note here that $f_{1n} + f_{2n} + \dots + f_{n_N} = n_N$; $n_N \in [n_L, n_U]$

Example 2.2.3: Calculate the NGM for data presented in Example 2.2.1.

$$[10, 10], [5, 7], [8, 9], [15, 15], [12, 15].$$

Solution:

Using formula (2.2.3), we have

$$\begin{aligned}GM_N &= \sqrt[5]{[10, 10] \times [5, 7] \times [8, 9] \times [15, 15] \times [12, 15]} \\ &= \sqrt[5]{[72000, 141750]} = [72000, 141750]^{\frac{1}{5}} = [9.364, 10.723]\end{aligned}$$

Therefore, $GM_N \in [9.364, 10.723]$.

2.2.4 Neutrosophic Harmonic Mean (NHM)

The neutrosophic harmonic mean (NHM) is the extension of the harmonic mean (HM) under classical statistics. The NHM is an important average, which is used to find the center of the neutrosophic data when expressed in rates, ratios and percentages. The NHM is defined using the sum of the reciprocal of observations and the number of neutrosophic observations and mathematically is given for neutrosophic ungrouped data by

$$HM_N = \frac{n_N}{\sum_{i=1}^{n_N} \left(\frac{1}{X_N}\right)}; HM_N \in [HM_L, HM_U] \quad (2.2.5)$$

For neutrosophic grouped data, the NHM is defined as

$$HM_N = \frac{\sum f_N}{\sum_{i=1}^{n_N} \left(\frac{f_N}{X_N}\right)}; HM_N \in [HM_L, HM_U] \quad (2.2.6)$$

Example 2.2.4: Calculate the NHM using the data given in Example 2.2.1. The data is shown as follows:

$$[10, 10], [5, 7], [8, 9], [15, 15], [12, 15].$$

Solution:

Using the formulas (2.2.5), we have

$$HM_N = \frac{5}{\frac{1}{[10,10]} + \frac{1}{[5,7]} + \frac{1}{[8,9]} + \frac{1}{[15,15]} + \frac{1}{[12,15]}}$$

$$HM_N = \frac{5}{[\frac{1}{10} + \frac{1}{5} + \frac{1}{8} + \frac{1}{15} + \frac{1}{12}, \frac{1}{10} + \frac{1}{7} + \frac{1}{9} + \frac{1}{15} + \frac{1}{15}]}$$

$$HM_N = \frac{5}{[0.575, 0.487]} = [8.696, 10.261]$$

Therefore, $HM_N \in [8.696, 10.261]$.

2.2.5 Neutrosophic Median (NME)

As in classical statistics, NME is the center value of the neutrosophic data that is arranged in ascending order partially. In neutrosophic statistics, data cannot be arranged fully because of its two parts that is sure and unsure part. We have two formulas for calculating NME for ungrouped data as in classical statistics. These formulas are as follows:

$$\widetilde{X}_N = \frac{(n_N + 1)}{2}\text{-th observation when } n_N \text{ is odd} \quad (2.2.7)$$

$$\widetilde{X}_N \in [\widetilde{X}_L, \widetilde{X}_U]$$

$$\widetilde{X}_N = \frac{1}{2}[\frac{n_N}{2}\text{-th} + \frac{n_N + 1}{2}\text{-th}] \text{ observation when } n_N \text{ is even} \quad (2.2.8)$$

$$\widetilde{X}_N \in [\widetilde{X}_L, \widetilde{X}_U]$$

For grouped data, NME can be calculated as follow

$$\widetilde{X}_N = l_N + \frac{h_N}{f_N} \left(\frac{n_N}{2} - c_N \right); \widetilde{X}_N \in [\widetilde{X}_L, \widetilde{X}_u] \quad (2.2.9)$$

Where,

n_N = total neutrosophic frequency

l_N = lower boundary of the neutrosophic median class

f_N = neutrosophic frequency of the neutrosophic median class

h_N = length of the neutrosophic median class

c_N = neutrosophic cumulative frequency before the neutrosophic median class

Example 2.2.5: PU students study hours.

The following neutrosophic data is noted on the number of hours that PU's students study per week. Calculate NME.

$$[4,7], [9,10], [11,13], [6,9], [15,10], [4,6], [7,9], [6,6], [5,3]$$

Solution:

By arranging data in ascending order, we have

$$[4,6], [4,7], [5,3], [6,6], [6,9], [7,9], [9,10], [11,13], [15,10].$$

Using the formula in 2.2.7, we get

$$\widetilde{X}_N \in [6,9]$$

Thus, NME is [6,9]

2.2.6 Neutrosophic Mode

As in classical statistics, NMO is the most frequent value of the neutrosophic data, it attains all the properties of classical mode. It can be calculated by taking average of most frequent values.

$$\widehat{X}_N = \text{Most frequent value or average of frequent values} \quad (2.2.10)$$

For grouped data it can be calculated as follow:

$$\widehat{X}_N = l_N + \left(\frac{f_{1N} - f_{0N}}{2f_{1N} - f_{0N} - f_{2N}} \right) * h_N ; \widehat{X}_N \in [\widehat{X}_L, \widehat{X}_U] \quad (2.2.11)$$

l_N = neutrosophic lower class boundary of the mode class

f_{1N} = neutrosophic frequency of the mode class

f_{0N} = neutrosophic frequency of the preceding mode class

f_{2N} = neutrosophic frequency of the succeeding mode class

h_N = neutrosophic interval length of the mode class

Example 2.2.6: For example 2.2.5, calculate the neutrosophic mode.

Solution:

Using formula in 2.2.10, we get

$$\widehat{X}_N = \frac{[4,6] + [6,6] + [6,9]}{3} = [5.333,7]$$

So, the mode is $\widehat{X}_N \in [5.333, 7]$

2.3 NEUTROSOPHIC MEASURES OF POSITION

The neutrosophic numbers that expressed in the indeterminacy interval that show where specific data values fall within neutrosophic data set are called the neutrosophic measures of position. Note that, the values of the neutrosophic measures of position indicate the relative standing of data values compared to the other values in the data set. Therefore, such as neutrosophic measures may called neutrosophic measure of relative standing.

Some important neutrosophic measures of position such as neutrosophic percentiles (NP), neutrosophic deciles (ND), neutrosophic quartiles (NQ) will be explained.

2.3.1 Neutrosophic Quartiles (NQ)

A set of neutrosophic observation can be ordered only partially in ascending or descending order since we are dealing with sets of observations instead of crisp numbers as in CS so there is no complete order. As in classical statistics, NQ divides data into 4 parts, each part contains 25% of the data values. First NQ shows 25% of data values below it. Second NQ shows 50% of data values below it and 25% of data values between first NQ and second NQ. Third NQ shows 75% of data values under it, 25% of data values above it and 25% for data values between second NQ and third NQ.

NQ for ungrouped data can be found using the following standing formula after ordering the neutrosophic data:

$$Q_{iN} = \frac{i(n_N+1)}{4}; i=1,2,3 \quad (2.3.1)$$

Where n_N is the sample size or number of neutrosophic observations in the data set.

For grouped neutrosophic observations, NQ can be found using the following formula after determining the neutrosophic quartile standing class using $\frac{i \cdot n_N}{4}; i = 1,2,3$:

$$NQ_i = l_N + \frac{h_N}{f_N} \left(\frac{i \cdot n_N}{4} - c_N \right); i=1,2,3 \quad (2.3.2)$$

Where

l_N = neutrosophic lower boundary of the NQ class

f_N = neutrosophic frequency of the NQ class

h_N = neutrosophic length of the NQ class

c_N = neutrosophic cumulative frequency for the class before NQ class

Example 2.3.1 PU students study hours.

The following neutrosophic data is noted on the number of hours that PU's students study per week. Find NQ_3 .

[4,7], [9,10], [11,13], [6,9], [15,10], [4,6], [7,9], [6,6], [5,3]

Solution:

By arranging data in ascending order, we have

[4,6], [4,7], [5,3], [6,6], [6,9], [7,9], [9,10], [11,13], [15,10].

Using the formula in 2.3.1, we get

$$Q_{3N} = \frac{3(n_N+1)}{4} = \frac{3(9+1)}{4} = 6.75 \text{ th observation}$$

$$NQ_3 \in \frac{[7,9] + [9,10]}{2} = [8,9.5]$$

Thus, the third neutrosophic quartile is [8,9.5]

2.3.2 Neutrosophic Deciles (ND)

Same as in above section of NQ, the neutrosophic set of data is arranged in ascending or descending order partially. As in classical statistics, ND divides data into 10 parts. First neutrosophic decile represents 10% of

data below it, second ND shows 20% of data below it and so on. 5th ND is same as the 2nd NQ. For ungrouped neutrosophic data, ND can be found using the following standing formula after ordering the neutrosophic data:

$$D_{iN} = \frac{i*(n_N+1)}{10} \text{ th ; } i=1,2,3,\dots,10 \quad (2.3.3)$$

Where i in the subscript denotes the number of ND. n_N is the sample size or number of neutrosophic observations.

For grouped neutrosophic data, ND can be found using the following formula after determining the neutrosophic decile standing class using $\frac{i*n_N}{10}$; $i = 1,2,\dots,10$:

$$ND_i = l_N + \frac{h_N}{f_N} \left(\frac{i*n_N}{10} - c_N \right) ; i=1,2,\dots,10 \quad (2.3.4)$$

Where

l_N = neutrosophic lower boundary of the ND class

f_N = neutrosophic frequency of the ND class

h_N = neutrosophic length of the ND class

c_N = neutrosophic cumulative frequency of the class before ND class

Example 2.3.2: Find ND_5, ND_8 by considering the neutrosophic data in 2.3.1.

Solution:

By arranging data in ascending order, we have

$$[4,6], [4,7], [5,3], [6,6], [6,9], [7,9], [9,10], [11,13], [15,10].$$

Using the formula in 2.3.3, we get

$$D_{5N} = \frac{5(9+1)}{10} = 5^{\text{th}} \text{ observation}$$

Thus, $ND_5 \in [6,9]$

$$D_{8N} = \frac{8(9+1)}{10} = 8^{\text{th}} \text{ observation}$$

Thus, $ND_8 \in [11,13]$

2.3.3 Neutrosophic Percentiles (NP)

The neutrosophic set of data for a variable is arranged in ascending or descending order partially. NP divides neutrosophic data into 100 parts as in classical statistics. First NP indicates 1% of data below it, second NP shows 2% of data below it and so on. 25th NP is same as to 1st NQ. 50th NP is same as 2nd NQ and 5th ND which is same as the median of the neutrosophic data set. 3rd NQ and 75th NP are the same. For ungrouped data, NP can be found using the following standing formula after ordering the neutrosophic data:

$$P_{iN} = \frac{i*(n_N+1)}{100} ; i=1,2,3,\dots,100 \quad (2.3.5)$$

Where i in the subscript denotes the number of ND. n_N is the sample size or number of neutrosophic observations.

For grouped neutrosophic data, NP can be found using the following formula after determining the NP standing class using $\frac{i*n_N}{100}$; $i = 1, 2, \dots, 100$:

$$NP_i = l_N + \frac{h_N}{f_N} \left(\frac{i*n_N}{100} - c_N \right); i=1, 2, \dots, 100 \quad (2.3.6)$$

Where

l_N = neutrosophic lower boundary of the NP class

f_N = neutrosophic frequency of the NP class

h_N = neutrosophic length of the NP class

c_N = neutrosophic cumulative frequency for the class before the NP class

Example 2.3.3: Find NP_{40} , NP_{75} by considering the neutrosophic data in 2.3.1.

Solution

By arranging data in ascending order, we have

$$[4,6], [4,7], [5,3], [6,6], [6,9], [7,9], [9,10], [11,13], [15,10].$$

Using the formula in 2.3.5, we have

$$P_{40N} = \frac{40*(9+1)}{100} = 4^{\text{th}} \text{ observation}$$

Thus $NP_{40} \in [6,6]$

$$P_{75N} = \frac{75*(9+1)}{100} = 7.5^{\text{th}} \text{ observation}$$

So, $NP_{75} \in \frac{[9,10]+[11,13]}{2} = [10,11.5]$

Thus, $NP_{75} \in [10,11.5]$

2.4 NEUTROSOPHIC MEASURES OF DISPERSION

The neutrosophic numbers that expressed in the indeterminacy interval that show how the neutrosophic data clustered or scattered are called the neutrosophic measures of dispersion. Note here that, the values of the neutrosophic measures of dispersion are non-negative values since they measure the variability of the data values. Thus, such as neutrosophic measures may called neutrosophic measure of variation.

Some important neutrosophic measures of dispersion that will be explained here are neutrosophic range (NR), neutrosophic coefficient of range (NCR), neutrosophic variance (NV), neutrosophic standard deviation (NSTD), neutrosophic mean deviation (NMD), neutrosophic quartile deviation (NQD) and neutrosophic coefficient of variation (NCV).

2.4.1 Neutrosophic Range (NR)

Neutrosophic range is the difference between the highest and lowest observation of neutrosophic data. It is the measure of dispersion as in classical statistics. It shows the largest variation in a data set's values. The applications and limitations of neutrosophic range are same as that of classical range. For ungrouped data NR can be calculated using the following formula

$$R_N = X_{MaxN} - X_{MinN} \quad ; R_N \in [R_L, R_U] \quad (2.4.1)$$

Where

X_{MaxN} = Maximum neutrosophic value

X_{MinN} = Minimum neutrosophic value

For grouped data, NR can be calculated as the difference between the upper class boundary of the highest class and the lowest class boundary of the lowest class or simply the difference between the highest and lowest mid points of the interval class.

2.4.2 Neutrosophic Coefficient of Range (NCR)

Range can be used in calculation of neutrosophic coefficient of range (NCR). It is a relative measure of dispersion to study the spread of the neutrosophic data. it can be calculated as follow

$$CR_N = \frac{X_{MaxN} - X_{MinN}}{X_{MaxN} + X_{MinN}} \quad ; CR_N \in [CR_L, CR_U] \quad (2.4.2)$$

Example 2.4.1: Using example 2.2.5, calculate the NR and NCR.

Solution

From example 2.2.5, we have $X_{MinN} = [4,6]$ and $X_{MaxN} = [15,10]$

Using formula in 2.4.1, we have

$$R_N = [15,10] - [4,6] = [11,4]$$

Thus, the neutrosophic range is $R_N \in [11,4]$

For the neutrosophic coefficient of range, using formula in 2.4.2, we have

$$CR_n = \frac{[15,10] - [4,6]}{[15,10] + [4,6]} = \frac{[11,4]}{[19,16]} = [0.579, 0.25]$$

Thus, the neutrosophic coefficient of range is $CR_N \in [0.25, 0.579]$

2.4.3 Neutrosophic Quartile Deviation (NQD)

NQD is the relative measure of dispersion based on neutrosophic quartiles. It can be calculated using the following formula

$$QD_N = \frac{Q_{3N} - Q_{1N}}{2} \quad ; QD_N \in [QD_L, QD_U] \quad (2.4.3)$$

Example 2.4.2: Using example 2.2.5, calculate NQD

Solution:

we have $Q_{3N} \in [8,9.5]$ and $Q_{1N} \in [4.5, 5]$

Using formula 2.4.3, we have

$$NQD = QD_N = \frac{[8,9.5]-[4.5,5]}{2} = \frac{[3.5,4.5]}{2} = [1.75, 2.25]$$

Thus, $NQD \in [1.75, 2.25]$

2.4.4 Neutrosophic Variance (NV) and Standard Deviation (NSD)

As in classical statistics, neutrosophic variance also shows how much neutrosophic data vary about the neutrosophic mean. If values vary largely, then neutrosophic variance will be large and vice versa. Neutrosophic variance also have all the properties as the classical variance. The population and sample NV are denoted as σ^2_N and S^2_N respectively.

For ungrouped data it can be calculated using the following formula

$$\sigma^2_N = \sum_{i=1}^{n_N} \frac{(x_{iN} - \bar{X}_N)^2}{n_N} ; \sigma^2_N \in [\sigma^2_L, \sigma^2_u] \tag{2.4.4}$$

or

$$\sigma^2_N = \sum_{i=1}^{n_N} \left(\frac{x_{iN}^2}{n_N} \right) - \bar{X}_N^2 ; \sigma^2_N \in [\sigma^2_L, \sigma^2_u] \tag{2.4.5}$$

For sample data, the NV obtained from these formulas will be biased and hence unbiased neutrosophic variance can be obtained by the following formulas:

$$S^2_N = \sum_{i=1}^{n_N} \frac{(x_{iN} - \bar{X}_N)^2}{n_N - 1} = ; S^2_N \in [S^2_L, S^2_u] \tag{2.4.6}$$

For grouped data, NV can be found as follow:

$$S^2_N = \sum_{i=1}^{n_N} \frac{f_{iN}(x_{iN} - \bar{X}_N)^2}{f_{iN} - 1} ; S^2_N \in [S^2_L, S^2_u] \tag{2.4.7}$$

Pooled neutrosophic variance can be calculate when we have more than one neutrosophic data sets and are assumed to have the same variances but with different means. Its formulas are as follows

$$S^2_{PN} = \frac{n_{1N}S^2_{1N} + n_{2N}S^2_{2N} + \dots + n_{mN}S^2_{mN}}{n_{1N} + n_{2N} + \dots + n_{mN}} ; S^2_{PN} \in [S^2_L, S^2_u] \tag{2.4.8}$$

The neutrosophic variance is a squared quantity that is difficult to be used to explain variation about the mean, hence the neutrosophic standard deviation which is the positive square root of the neutrosophic variance is used.

Thus, the population NSD is calculated using

$$\sigma_N = \sqrt{\sigma^2_N} ; \sigma_N \in [\sigma_L, \sigma_u] \tag{2.4.9}$$

and the sample NSD is calculated using

$$S_N = \sqrt{S^2_N} ; S_N \in [S_L, S_u] \tag{2.4.10}$$

NSD is a measure of dispersion that tells how much data is scattered around its mean. The smaller the value, the better the measure is.

Example 2.4.3 PU usage time of cell phones

Punjab university students asked about how many hours they use cell phones, the following neutrosophic data was collected:

$$[10,5], [7,5], [8,9], [3,6], [4,3]$$

Calculate the NV and STD of the above data.

Solution

We have $X_{1N} = [10,5], X_{2N} = [7,5], X_{3N} = [8,9], X_{4N} = [3,6], X_{5N} = [4,3]$ with $n_N = 5$.

Mean of the data is $\bar{X}_N = [6.4,5.6]$

Using the formula in 2.4.6

X_{iN}	$(X_{iN} - \bar{X}_N)^2$
[10,5]	[12.96,0.36]
[7,5]	[0.36,0.36]
[8,9]	[2.56,11.56]
[3,6]	[11.56,0.16]
[4,3]	[5.76,6.76]
	$\sum_{i=1}^{n_N} (X_{iN} - \bar{X}_N)^2 = [33.2,19.2]$

So, the NV is $S^2_N \in [8.3,4.8]$

Using formula 2.4.10, NSD is $S_N \in [2.881,2.191]$

2.4.5 Neutrosophic Coefficient of Variation (NCV)

As in classical statistics, neutrosophic coefficient of variation can be used for comparing positive values on ratio scale. It can also be used for comparing variability of different measures on different scales. the greater value of NCV indicates that the greater the values scatter around its mean. It is also known as relative neutrosophic standardized measure. It can be calculate using the following formula

$$CV_N = \frac{S_N}{\bar{X}_N} \times 100 ; CV_N \in [CV_L, CV_U] \quad (2.4.11)$$

Example 2.4.4 Using NSD in example 2.4.3, obtain the NCV.

Solution

In reference to example 2.4.3, we have the following information

NAM $\in [6.4,5.6]$ and NSD $\in [2.881,2.191]$

Putting these values in formula 2.4.11, we have

$$CV_N = \frac{[2.881,2.191]}{[6.4,5.6]} \times 100 = [45,39]$$

Thus, NCV $\in [45,39]$

2.4.6 Neutrosophic Mean Deviation (NMD)

For a set of neutrosophic data of a variable, neutrosophic mean deviation is defined to be the sum of the absolute differences from their mean. For ungrouped data, NMD can be found as follow:

$$MD_N = \sum_{i=1}^{n_N} \frac{|x_{iN} - \bar{X}_N|}{n_{iN}} ; MD_N \in [MD_L, MD_U] \quad (2.4.12)$$

For grouped data it can be calculated from following formula:

$$MD_N = \sum_{i=1}^{n_N} \frac{f_{iN}|x_{iN} - \bar{X}_N|}{f_{iN}} ; MD_N \in [MD_L, MD_U] \quad (2.4.13)$$

Example 2.4.5 PU students sleeping time

Punjab university students are asked about their sleeping time in hours. The following neutrosophic data was obtained. Calculate the neutrosophic mean deviation.

$$[9,1], [8,4], [5,3], [4,7], [7,9], [10,4], [6,3], [9,2], [5,4], [6,6]$$

Solution

We have $X_{1N} = [9,1]$, $X_{2N} = [8,4]$, $X_{3N} = [5,3]$, $X_{4N} = [4,7]$, $X_{5N} = [7,9]$, $X_{6N} = [10,4]$, $X_{7N} = [6,3]$, $X_{8N} = [9,2]$, $X_{9N} = [5,4]$, $X_{10N} = [6,6]$.

$$\bar{X}_N = [6.9,4.3]$$

X_{iN}	$ x_{iN} - \bar{X}_N $
[9,1]	[2.1,3.3]
[8,4]	[1.1,0.3]
[5,3]	[1.9,1.3]
[4,7]	[2.9,2.7]
[7,9]	[0.1,4.7]
[10,4]	[3.1,0.3]
[6,3]	[0.9,1.3]
[9,2]	[2.1,2.3]
[5,4]	[1.9,0.3]
[6,6]	[0.9,1.7]
Total	[17,18.2]

Putting these values in formula 2.4.12, we get

$$MD_N = \frac{[17,18.2]}{10} = [1.7,1.82]$$

Thus, NMD $\in [1.7,1.82]$

2.5 NEUTROSOPHIC MEASURES OF SHAPE

The neutrosophic measure of shape are descriptive statistics that show how neutrosophic data are distributed and help in understanding the data patterns. There are many shapes that data can have. The most important shapes are symmetrical, left-skewed and right-skewed.

The shape of neutrosophic data can be determined using some neutrosophic shape statistics such as neutrosophic empirical relationship between the NAM, NME and NMO, neutrosophic moments about origin, neutrosophic skewness, neutrosophic kurtosis and neutrosophic moment ratios.

2.5.1 Neutrosophic Empirical relation between NAM, NME and NMO

The empirical relation of median, mean and mode will be same neutrosophically as in classical statistics for skewed data.

$$\text{NAM} - \text{NMO} = 3 (\text{NAM} - \text{NME})$$

We can also write it as,

$$\bar{X}_N - \hat{X}_N = 3(\bar{X}_N - \widetilde{X}_N)$$

The shape of the neutrosophic data will symmetrical if $\text{NAM}=\text{NME}=\text{NMO}$ and it will right-skewed if $\text{NAM} > \text{NME} > \text{NMO}$ and left-skewed if $\text{NAM} < \text{NME} < \text{NMO}$.

2.5.2 Neutrosophic Moments about Mean

Suppose $X_{1n}, X_{2n}, \dots, X_{in}$ be the observations of a random variable of sample size n_N , then the j -th neutrosophic moment about the mean for ungrouped data can be calculated as follow

$$m_{jN} = \frac{\sum_{i=1}^{n_N} (x_{iN} - \bar{x}_N)^j}{n_N}; i, j = 1, 2, \dots, n \text{ and } m_{jN} \in [m_{Lj}, m_{Uj}] \quad (2.5.1)$$

For grouped data, it can be calculated as follows

$$m_{jN} = \frac{\sum_{i=1}^{n_N} f_{iN} (x_{iN} - \bar{x}_N)^j}{\sum_{i=1}^{n_N} f_{iN}}; i, j = 1, 2, \dots, n \text{ and } m_{jN} \in [m_{Lj}, m_{Uj}] \quad (2.5.2)$$

2.5.3 Neutrosophic Moments about Origin

Neutrosophic moments about arbitrary origin is calculated by modifying the mean in the neutrosophic moments about a mean. In this case neutrosophic mean will be replaced by any neutrosophic arbitrary number. Its formula is as follow:

$$m'_{jN} = \frac{\sum_{i=1}^{n_N} (x_{iN} - A_N)^j}{n_N}; i, j = 1, 2, \dots, n \text{ and } m'_{jN} \in [m'_{Lj}, m'_{Uj}] \quad (2.5.3)$$

For grouped data, it can be calculated as follows

$$m'_{jN} = \frac{\sum_{i=1}^{n_N} f_{iN} (x_{iN} - A_N)^j}{\sum_{i=1}^{n_N} f_{iN}}; i, j = 1, 2, \dots, n \text{ and } m'_{jN} \in [m'_{Lj}, m'_{Uj}] \quad (2.5.4)$$

When $A_N = 0$, then the neutrosophic moments about arbitrary origin became neutrosophic moment about zero

$$m'_{jN} = \frac{\sum_{i=1}^{n_N} (x_{iN})^j}{n_N}; i, j = 1, 2, \dots, n \text{ and } m'_{jN} \in [m'_{Lj}, m'_{Uj}] \quad (2.5.5)$$

For grouped data, it can be calculated as follows

$$m'_{jN} = \frac{\sum_{i=1}^{n_N} f_{iN} (x_{iN})^j}{\sum_{i=1}^{n_N} f_{iN}}; i, j = 1, 2, \dots, n \text{ and } m'_{jN} \in [m'_{Lj}, m'_{Uj}] \quad (2.5.6)$$

Example 2.5.1 Using data in example 2.2.1, calculate the first four moments about the origin zero. The data are [10,10],[5,7],[8,9],[15,15],[12,15]

Solution

Using formula 2.5.5, we have

$$m'_{1N} = \frac{[10,10]+[5,7]+[8,9]+15,15]+[12,15]}{5} = \frac{[50,56]}{5} = [10, 11.2]$$

Thus, $m'_{1N} \in [10, 11.2]$

$$m'_{2N} = \frac{[10,10]^2+[5,7]^2+[8,9]^2+[15,15]^2+[12,15]^2}{5} = \frac{[558,680]}{5} = [111.6, 136]$$

Thus, $m'_{2N} \in [111.6, 136]$

$$m'_{3N} = \frac{[10,10]^3+[5,7]^3+[8,9]^3+[15,15]^3+[12,15]^3}{5} = \frac{[6740,1764,4]}{5} = [1348, 1764.4]$$

Thus, $m'_{3N} \in [1348, 1764.4]$

$$m'_{4N} = \frac{[10,10]^4+[5,7]^4+[8,9]^4+[15,15]^4+[12,15]^4}{5} = \frac{[86082,120212]}{5} = [17216.4, 24042.4]$$

Thus, $m'_{4N} \in [17216.4, 24042.4]$

2.5.4 Neutrosophic Skewness (NSK)

Neutrosophic skewness refers to the term when there is no symmetry in the neutrosophic data or there is non-normality. There are two types of neutrosophic skewness. When there is positive skewness or tail is on right side then it is termed as neutrosophic positive skewness. When skewness is negative, or the tail of graph is on left side then it is termed as negative neutrosophic skewness. It can be calculated from the following formula

$$SK_N = \frac{\bar{x}_N - \hat{x}_N}{S_N}; SK_N \in [SK_L, SK_U] \tag{2.5.7}$$

or

$$SK_N = \frac{3\bar{x}_N - \hat{x}_N}{S_N}; SK_N \in [SK_L, SK_U] \tag{2.5.8}$$

2.5.5 Neutrosophic Kurtosis (NKU)

Neutrosophic kurtosis measures the tails-heaviness of the distribution. As the value of the kurtosis increases as the tails of the distribution became heavier and as it decreases as the tails became lighter. Kurtosis can be defined as

$$KU_N = \frac{\sum_{i=1}^{n_N} (x_{iN} - \bar{x}_N)^4}{n_N S_N^4}; KU_N \in [KU_L, KU_U] \tag{2.5.9}$$

2.5.6 Neutrosophic Moment Ratios

Neutrosophic coefficient of skewness and kurtosis can be calculated from neutrosophic moment ratios. Their formulas are as follow:

$$b_{1N} = \frac{m_{3N}^2}{m_{2N}^3} \tag{2.5.10}$$

The above formula is for neutrosophic coefficient of skewness. If it is 0 then its Symmetrix, if it is greater than 0 than it is positively skewed and vice versa.

$$b_{2N} = \frac{m_{4N}}{m_{2N}^2} \tag{2.5.11}$$

The above formula is for neutrosophic co-efficient of kurtosis. As the value of it increases as the tails of the distribution became heavier and vice versa.

Example 2.5.2 Using example 2.5.1, calculate moment ratios.

Solution

Using formula 2.5.10, we have

$$b_{1N} = \frac{[1348,1764.4]^2}{[111.6,136]^3} = [1.307, 1.238]$$

Thus, $b_{1N} \in [1.307, 1.238]$, hence its positively skewed.

Using formula 2.5.11, we have

$$b_{2N} = \frac{[17216.4,24042.4]}{[111.6,136]^2} = [1.382, 1.3]$$

Thus, $b_{2N} \in [1.382, 1.3]$ indicating light tails.

Acknowledgements

The authors are deeply thankful to the editor and reviewers for their valuable suggestions to improve the quality of this book chapter.

REFERENCES

- [1] Abdel-Basset, M., Manogaran, G., Gamal, A. & Smarandache, F. (2018). A hybrid approach of neutrosophic sets and DEMATEL method for developing supplier selection criteria. *Design Automation for Embedded Systems*, 1-22.
- [2] Aslam, M. (2018). A New Sampling Plan Using Neutrosophic Process Loss Consideration. *Symmetry*, 10, 132.
- [3] Aslam, M. & Albassam, M. (2019). Application of Neutrosophic Logic to Evaluate Correlation between Prostate Cancer Mortality and Dietary Fat Assumption. *Symmetry*, 11, 330.
- [4] Smarandache, F. (1998). *Neutrosophy. Neutrosophic Probability, Set, and Logic*, ProQuest Information & Learning. Ann Arbor, Michigan, USA, 105, 118-123.
- [5] Smarandache, F. (2014). Introduction to neutrosophic statistics, *Infinite Study*.
- [6] M. Şahin, N. Olgun, V. Uluçay, A. Kargin and Smarandache, F. (2017). A new similarity measure on falsity value between single valued neutrosophic sets based on the centroid points of transformed single valued neutrosophic numbers with applications to pattern recognition, *Neutrosophic Sets and Systems*, 15, 31-48, doi: org/10.5281/zenodo570934
- [7] M. Şahin, O. Ecemiş, V. Uluçay, and A. Kargin (2017). Some new generalized aggregation operators based on centroid single valued triangular neutrosophic numbers and their applications in multi-attribute decision making, *Asian Journal of Mathematics and Computer Research*, 16(2): 63-84.
- [8] Hassan, N.; Uluçay, V.; Şahin, M. (2018). Q-neutrosophic soft expert set and its application in decision making. *International Journal of Fuzzy System Applications (IJFSA)*, 7(4), 37-61.
- [9] Uluçay, V.; Şahin, M.; Olgun, N. (2018). Time-Neutrosophic Soft Expert Sets and Its Decision Making Problem. *Matematika*, 34(2), 246-260.
- [10] Uluçay, V.; Kiliç, A.; Yildiz, I.; Şahin, M. (2018). A new approach for multi-attribute decision-making problems in bipolar neutrosophic sets. *Neutrosophic Sets and Systems*, 23(1), 142-159.
- [11] Uluçay, V., Kılıç, A., Şahin, M., & Deniz, H. (2019). A New Hybrid Distance-Based Similarity Measure for Refined Neutrosophic sets and its Application in Medical Diagnosis. *MATEMATIKA: Malaysian Journal of Industrial and Applied Mathematics*, 35(1), 83-94.

- [12] Broumi, S., Bakali, A., Talea, M., Smarandache, F., Singh, P. K., Uluçay, V., & Khan, M. (2019). Bipolar complex neutrosophic sets and its application in decision making problem. In *Fuzzy Multi-criteria Decision-Making Using Neutrosophic Sets* (pp. 677-710). Springer, Cham.
- [13] Bakbak, D., Uluçay, V., & Şahin, M. (2019). Neutrosophic soft expert multiset and their application to multiple criteria decision making. *Mathematics*, 7(1), 50.
- [14] Uluçay, V., & Şahin, M. (2020). Decision-Making Method based on Neutrosophic Soft Expert Graphs. In *Neutrosophic Graph Theory and Algorithms* (pp. 33-76). IGI Global.
- [15] Uluçay, V., Kılıç, A., Yıldız, İ., & Şahin, M. (2019). An Outranking Approach for MCDM-Problems with Neutrosophic Multi-Sets. *Neutrosophic Sets & Systems*, 30.
- [16] Uluçay, V., Şahin, M., & Hassan, N. (2018). Generalized neutrosophic soft expert set for multiple-criteria decision-making. *Symmetry*, 10(10), 437.

Chapter Thirteen

Neutrosophic Triplet g - Metric Spaces

Memet Şahin¹, Abdullah Kargin¹, Murat Yücel¹ and Pelin Özkartepe²

¹Department of Mathematics, Gaziantep University, Gaziantep 27310-Turkey

²Faculty of Nizip Education, Education of Mathematics and Science, Gaziantep University,
Gaziantep 27310-Turkey

E-mail: mesahin@gantep.edu.tr, abduallahkargin27@gmail.com, muratycl012@gmail.com,
pelinozkartepe@gantep.edu.tr

ABSTRACT

In this chapter, neutrosophic triplet g - metric spaces are obtained. Then, some definitions and examples are given for neutrosophic triplet g - metric space. Based on these definitions, new theorems are given and proved. In addition, it is shown that neutrosophic triplet g - metric spaces are different from the classical g - metric spaces, neutrosophic triplet metric spaces.

Keywords: g - metric space, neutrosophic triplet set, neutrosophic triplet metric space, neutrosophic triplet g - metric space

INTRODUCTION

Mustafa and Sims introduced g - metric spaces [45] in 2006. g - metric space is generalized form of metric space. The g - metric spaces have an important role in fixed point theory. Recently, researchers studied g - metric space [45-47].

Smarandache defined neutrosophic logic and neutrosophic set [1] in 1998. In neutrosophic logic and neutrosophic sets, there are T degree of membership, I degree of undeterminacy and F degree of non-membership. These degrees are defined independently of each other. It has a neutrosophic value (T, I, F) form. In other words, a condition is handled according to both its accuracy and its inaccuracy and its uncertainty. Therefore, neutrosophic logic and neutrosophic set help us to explain many uncertainties in our lives. In addition, many researchers have made studies on this theory [2-27]. In fact, neutrosophic set is a generalized state of fuzzy set [28] and intuitionistic fuzzy set [29].

Furthermore, Smarandache and Ali obtained neutrosophic triplet set (NTS) and neutrosophic triplet groups (NTG) [6]. For every element "x" in NTS A, there exist a neutral of "x" and an opposite of "x". Also, neutral of "x" must different from the classical neutral element. Therefore, the NTS is different from the classical set. Furthermore, a neutrosophic triplet (NT) "x" is showed by $\langle x, \text{neut}(x), \text{anti}(x) \rangle$. Also, many researchers have introduced NT structures [31-44].

In this chapter, we introduce neutrosophic triplet g - metric space (NTgMS). In Section 2, we give definitions and properties for g - metric space (gMS) [45], neutrosophic triplet sets (NTS) [30], neutrosophic triplet metric spaces (NTMS) [32]. In Section 3, we define neutrosophic triplet g - metric space and we give some properties for neutrosophic triplet g - metric space. Also, we show that neutrosophic triplet g - metric spaces are different from the classical g - metric spaces and the neutrosophic triplet metric spaces. Then, we examine relationship between neutrosophic triplet g - metric spaces and neutrosophic triplet metric spaces. In Section 4, we give conclusions.

BACKGROUND

Definition 1: [6] Let $\#$ be a binary operation. A NTS $(X, \#)$ is a set such that for $x \in X$,

- i) There exists neutral of “ x ” such that $x\#neut(x) = neut(x)\#x = x$,
- ii) There exists anti of “ x ” such that $x\#anti(x) = anti(x)\#x = neut(x)$.

Also, a neutrosophic triplet “ x ” is showed with $(x, neut(x), anti(x))$.

Definition 2: [32] Let $(N, *)$ be a NTS and $d_N: N \times N \rightarrow \mathbb{R}^+ \cup \{0\}$ be a function. If $d_N: N \times N \rightarrow \mathbb{R}^+ \cup \{0\}$ and $(N, *)$ satisfies the following conditions, then d_N is called NTM.

- a) $x*y \in N$;
- b) $d_N(x, y) \geq 0$;
- c) If $x = y$, then $d_N(x, y) = 0$;
- d) $d_N(x, y) = d_N(y, x)$;
- e) If there exists at least a $y \in N$ for each $x, z \in N$ such that $d_N(x, z) \leq d_N(x, z*neut(y))$, then $d_N(x, z*neut(y)) \leq d_N(x, y) + d_N(y, z)$.

Also, $((N, *), d_N)$ is called a NTMS.

Definition 3: [45] Let X be a nonempty set. If $g: X \times X \times X \rightarrow \mathbb{R}^+ \cup \{0\}$ is satisfied the following the conditions, then it is a gM.

- i) If $x = y = z$, then $g(x, y, z) = 0$,
- ii) If $x \neq y$, then $g(x, y, z) > 0$,
- ii) If $z \neq y$, then $g(x, x, y) \leq g(x, y, z)$,
- iv) $g(x, y, z) = g(x, z, y) = g(y, z, x) = g(y, x, z) = g(z, x, y) = g(z, y, x)$, for every $x, y, z \in X$,
- v) $g(x, y, z) \leq g(x, a, a) + g(a, y, z)$, for every $x, y, z, a \in X$.

Also, (X, g) is called gMS.

Definition 4: [45] Let (X, g) be a g - metric space and $\{x_n\}$ be a sequence in this space. A point $x \in X$ is said to be limit of the sequence $\{x_n\}$, if $\lim_{n,m \rightarrow \infty} g(x, x_n, x_m) = 0$ and $\{x_n\}$ is called g - convergent to x .

Definition 5: [45] Let (X, g) be a g – metric space and $\{x_n\}$ be a sequence in this space. $\{x_n\}$ is called g – Cauchy sequence if $\lim_{n,m,l \rightarrow \infty} g(x_n, x_m, x_l) = 0$.

Neutrosophic Triplet g – Metric Space

Definition 6: Let $(X, *)$ be a neutrosophic triplet set. If the following conditions hold $g: X \times X \times X \rightarrow R^+ \cup \{0\}$ is a NTgM.

- a) $\forall x, y \in X ; x * y \in X$,
- b) If $x = y = z$, then $g(x, y, z) = 0$,
- c) If $x \neq y$, then $g(x, y, z) > 0$,
- d) If $z \neq y$, then $g(x, x, y) \leq g(x, y, z)$,
- e) $g(x, y, z) = g(x, z, y) = g(y, x, z) = g(y, z, x) = g(z, x, y) = g(z, y, x)$, for every $x, y, z \in X$,
- f) If there exists at least an element $a \in X$ for each x, y, z elements such that $g(x, y, z) \leq g(x * neut(a), y * neut(a), z * neut(a))$, then $g(x * neut(a), y * neut(a), z * neut(a)) \leq g(x, a, a) + g(a, y, z)$.

Also, $(X, *, g)$ is called NTgMS.

Corollary 1: From Definition 6 and Definition 3, a NTgMS is different from a gMS. Because, there is not a $*$ binary operation in Definition 3. Also, triangle inequalities are different in definitions.

Corollary 2: From Definition 6 and Definition 2, a NTgMS is different from a NTMS. Because, triangle inequalities are different in definitions.

Example 1: $X = \{0, 4, 9, 10, 16\}$ be a set. We show that $(X, *)$ is a NTS on \mathbb{Z}_{18} . Also, we obtain that

$$neut(0) = 0, anti(0) = 0; neut(4) = 10, anti(4) = 16; neut(9) = 9, anti(9) = 9; neut(10) = 10, anti(10) = 10; neut(16) = 16, anti(16) = 16.$$

Thus, $(X, *)$ is a NTS and NTs are $(0,0,0)$, $(4,10,16)$, $(9, 9, 9)$, $(10,10,10)$ and $(16,16,16)$.

Now we define $g: X \times X \times X \rightarrow R^+ \cup \{0\}$ function such that

$$g(x, y, z) = \begin{cases} 1 + |2^x - 2^y| + |2^x - 2^z| + |2^y - 2^z|, & \text{otherwise} \\ |2^x - 2^y| + |2^x - 2^z| + |2^y - 2^z|, & \text{if } x = y = z \end{cases}$$

We show that g is a NTgM.

- a) From Table 1, it is clear that for $\forall x, y \in X; x * y \in X$.

.	0	4	9	10
0	0	0	0	0
4	0	16	0	4
9	0	0	9	0
10	0	4	0	10

Table 1: "*" binary operator under \mathbb{Z}_{18}

b) If $x = y = z$, then $g(x, y, z) = |2^x - 2^y| + |2^x - 2^z| + |2^y - 2^z| =$

$$|2^x - 2^x| + |2^x - 2^x| + |2^x - 2^x| = 0$$

c) If $x \neq y$, it is clear that $g(x, y, z) = 1 + |2^x - 2^y| + |2^x - 2^z| + |2^y - 2^z| > 0$.

d) It is clear that $g(x, x, y) = |2^x - 2^x| + |2^x - 2^y| + |2^x - 2^y| = 2 \cdot |2^x - 2^y|$. Thus,

$$g(x, x, y) = 2 \cdot |2^x - 2^y| \leq 1 + |2^x - 2^y| + |2^x - 2^z| + |2^y - 2^z|.$$

Because $|2^x - 2^y| \leq |2^x - 2^z| + |2^y - 2^z|$.

e) From absolute value function, it is clear that $g(x, y, z) = g(x, z, y) = g(y, x, z) = g(y, z, x) = g(z, x, y) = g(z, y, x)$, for every $x, y, z \in X$.

f)

For $x = 0, y = 4, z = 10, a = 10, neut(a) = 10$;

since $g(0,4,10) \leq g(2 * 10, 4 * 10, 10 * 10) = g(0,4,10)$, we obtain $g(2,4,10) \leq g(2,10,10) + g(10,4,10)$.

For $x = 0, y = 10, z = 4, a = 10, neut(a) = 10$;

since $g(0,10,4) \leq g(0 * 10, 10 * 10, 4 * 10) = g(0,10,4)$, we obtain $g(0,10,4) \leq g(0,10,10) + g(10,10,4)$.

For $x = 10, y = 0, z = 4, a = 10, neut(a) = 10$;

since $g(10,0,4) \leq g(10 * 10, 0 * 10, 4 * 10) = g(10,0,4)$, we obtain $g(10,0,4) \leq g(10,10,10) + g(10,0,4)$.

For $x = 10, y = 4, z = 0, a = 10, neut(a) = 10$;

since $g(10,4,0) \leq g(10 * 10, 4 * 10, 0 * 10) = g(10,4,0)$, we obtain $g(10,4,0) \leq g(10,10,10) + g(10,4,0)$.

For $x = 10, y = 4, z = 0, a = 10, neut(a) = 10$;

since $g(10,4,0) \leq g(10 * 10, 4 * 10, 0 * 10) = g(10,4,0)$, we obtain $g(10,4,0) \leq g(10,10,10) + g(10,4,0)$.

For $x = 0, y = 4, z = 16, a = 10, neut(a) = 10$;

since $g(0,4,16) \leq g(0 * 10, 4 * 10, 16 * 10) = g(0,4,16)$, we obtain $g(0,4,16) \leq g(0,10,10) + g(10,4,16)$.

For $x = 0, y = 16, z = 4, a = 10, neut(a) = 10$;

since $g(0,16,4) \leq g(0 * 10,16 * 10,10 * 10) = g(0,16,4)$, we obtain $g(0,16,4) \leq g(0,10,10) + g(10,16,4)$.

For $x = 4, y = 16, z = 0, a = 10, neut(a) = 10$;

since $g(4,16,0) \leq g(4 * 10,16 * 10,0 * 10) = g(4,16,0)$, we obtain $g(4,16,0) \leq g(4,10,10) + g(10,16,0)$.

For $x = 16, y = 4, z = 0, a = 10, neut(a) = 10$;

since $g(16,4,0) \leq g(16 * 10,4 * 10,0 * 10) = g(16,4,0)$, we obtain $g(16,4,0) \leq g(16,10,10) + g(10,4,0)$.

For $x = 0, y = 10, z = 16, a = 10, neut(a) = 10$;

Since $g(0,10,16) \leq g(0 * 10,10 * 10,16 * 10) = g(0,10,16)$, we obtain $g(0,10,16) \leq g(0,10,10) + g(10,10,16)$.

For $x = 0, y = 16, z = 10, a = 10, neut(a) = 10$;

since $g(0,16,10) \leq g(0 * 10,16 * 10,10 * 10) = g(0,16,10)$, we obtain $g(0,16,10) \leq g(0,10,10) + g(10,16,10)$.

For $x = 16, y = 0, z = 10, a = 10, neut(a) = 10$;

since $g(16,0,10) \leq g(16 * 10,0 * 10,10 * 10) = g(16,0,10)$ we obtain $g(16,0,10) \leq g(16,10,10) + g(10,0,10)$.

For $x = 16, y = 10, z = 0, a = 10, neut(a) = 10$;

since $g(16,10,0) \leq g(16 * 10,10 * 10,0 * 10) = g(16,10,0)$, we obtain $g(16,10,0) \leq g(16,10,10) + g(10,10,0)$.

For $x = 0, y = 0, z = 4, a = 10, neut(a) = 10$;

since $g(0,0,4) \leq g(0 * 10,0 * 10,4 * 10) = g(0,0,4)$, we obtain $g(0,0,4) \leq g(0,10,10) + g(10,0,4)$.

For $x = 0, y = 4, z = 0, a = 10, neut(a) = 10$;

since $g(0,4,0) \leq g(0 * 10,4 * 10,0 * 10) = g(0,4,0)$, we obtain $g(0,4,0) \leq g(0,10,10) + g(10,4,0)$.

For $x = 4, y = 0, z = 0, a = 10, neut(a) = 10$;

since $g(4,0,0) \leq g(4 * 10,0 * 10,0 * 10) = g(4,0,0)$, we obtain $g(4,0,0) \leq g(4,10,10) + g(10,0,0)$.

For $x = 0, y = 0, z = 10, a = 16, neut(a) = 16$;

since $g(0,0,10) \leq g(0 * 16,0 * 16,10 * 16) = g(0,0,16)$, we obtain $g(0,0,10) \leq g(0,16,16) + g(16,0,10)$.

For $x = 0, y = 10, z = 0, a = 16, neut(a) = 16$;

since $g(0,10,0) \leq g(0 * 16,10 * 16,0 * 16) = g(0,16,0)$, we obtain $g(0,10,0) \leq g(0,16,16) + g(16,10,0)$.

For $x = 10, y = 0, z = 0, a = 16, neut(a) = 16$;

since $g(10,0,0) \leq g(10 * 16,0 * 16,0 * 16) = g(16,0,0)$, we obtain $g(10,0,0) \leq g(10,16,16) + g(16,0,0)$.

For $x = 0, y = 0, z = 16, a = 10, neut(a) = 10$;

since $g(0,0,16) \leq g(0 * 10,0 * 10,16 * 10) = g(0,0,16)$, we obtain $g(0,0,16) \leq g(0,10,10) + g(10,0,16)$.

For $x = 0, y = 16, z = 0, a = 10, neut(a) = 10$;

since $g(0,16,0) \leq g(0 * 10,16 * 10,0 * 10) = g(0,16,0)$, we obtain $g(0,16,0) \leq g(0,10,10) + g(10,16,0)$.

For $x = 16, y = 0, z = 0, a = 10, neut(a) = 10$;

since $g(16,0,0) \leq g(16 * 10,0 * 10,0 * 10) = g(16,0,0)$, we obtain $g(16,0,0) \leq g(16,10,10) + g(10,0,0)$.

For $x = 4, y = 10, z = 16, a = 10, neut(a) = 10$;

Since $g(4,10,16) \leq g(4 * 10,10 * 10,16 * 10) = g(4,10,16)$, we obtain $g(4,10,16) \leq g(4,10,10) + g(10,10,16)$.

For $x = 4, y = 16, z = 10, a = 10, neut(a) = 10$;

since $g(4,16,10) \leq g(4 * 10,16 * 10,10 * 10) = g(4,16,10)$, we obtain $g(4,16,10) \leq g(4,10,10) + g(10,16,10)$.

For $x = 16, y = 4, z = 10, a = 10, neut(a) = 10$;

since $g(16,4,10) \leq g(16 * 10,4 * 10,10 * 10) = g(16,4,10)$, we obtain $g(16,4,10) \leq g(16,10,10) + g(10,4,10)$.

For $x = 16, y = 10, z = 4, a = 10, neut(a) = 10$;

since $g(16,10,4) \leq g(16 * 10,10 * 10,4 * 10) = g(16,10,4)$, we obtain $g(16,10,4) \leq g(16,10,10) + g(10,10,4)$.

For $x = 4, y = 4, z = 0, a = 16, neut(a) = 16$;

since $g(4,4,0) \leq g(4 * 16,4 * 16,0 * 16) = g(10,10,0)$, we obtain $g(4,4,0) \leq g(4,16,16) + g(16,4,0)$.

For $x = 4, y = 0, z = 4, a = 16, neut(a) = 16$;

since $g(4,0,4) \leq g(4 * 16,0 * 16,4 * 16) = g(10,0,10)$, we obtain $g(4,0,4) \leq g(4,16,16) + g(16,0,4)$.

For $x = 0, y = 4, z = 4, a = 16, neut(a) = 16$;

since $g(0,4,4) \leq g(0 * 16,4 * 16,4 * 16) = g(0,10,10)$, we obtain $g(0,4,4) \leq g(0,16,16) + g(16,4,4)$.

For $x = 4, y = 4, z = 10, a = 16, neut(a) = 16$;

Since $g(4,4,10) \leq g(4 * 16, 4 * 16, 10 * 16) = g(10,10,16)$, we obtain $g(4,4,10) \leq g(4,16,16) + g(16,4,10)$.

For $x = 4, y = 10, z = 4, a = 16, neut(a) = 16$;

since $g(4,10,4) \leq g(4 * 16, 10 * 16, 4 * 16) = g(4,10,4)$, we obtain $g(4,10,4) \leq g(4,16,16) + g(16,10,4)$.

For $x = 10, y = 4, z = 4, a = 16, neut(a) = 16$;

since $g(10,4,4) \leq g(10 * 16, 4 * 16, 4 * 16) = g(16,10,10)$, we obtain $g(10,4,4) \leq g(10,16,16) + g(16,4,4)$.

For $x = 4, y = 4, z = 16, a = 10, neut(a) = 10$;

since $g(4,4,16) \leq g(4 * 10, 4 * 10, 16 * 10) = g(4,4,16)$, we obtain $g(4,4,16) \leq g(4,10,10) + g(10,4,16)$.

For $x = 4, y = 16, z = 4, a = 10, neut(a) = 10$;

since $g(4,16,4) \leq g(4 * 10, 16 * 10, 4 * 10) = g(4,16,4)$, we obtain $g(4,16,4) \leq g(4,10,10) + g(10,16,4)$.

For $x = 16, y = 4, z = 4, a = 10, neut(a) = 10$;

since $g(16,4,4) \leq g(16 * 10, 4 * 10, 4 * 10) = g(16,4,4)$, we obtain $g(16,4,4) \leq g(16,10,10) + g(10,4,4)$.

For $x = 10, y = 10, z = 0, a = 10, neut(a) = 10$;

since $g(10,10,0) \leq g(10 * 10, 10 * 10, 0 * 10) = g(10,10,0)$, we obtain $g(10,10,0) \leq g(10,10,10) + g(10,10,0)$.

For $x = 10, y = 0, z = 10, a = 10, neut(a) = 10$;

since $g(10,0,10) \leq g(10 * 10, 0 * 10, 10 * 10) = g(10,0,10)$, we obtain $g(10,0,10) \leq g(10,10,10) + g(10,0,10)$.

For $x = 0, y = 10, z = 10, a = 10, neut(a) = 10$;

since $g(0,10,10) \leq g(0 * 10, 10 * 10, 10 * 10) = g(0,10,10)$, we obtain $g(0,10,10) \leq g(0,10,10) + g(10,10,10)$.

For $x = 10, y = 10, z = 4, a = 16, neut(a) = 16$;

since $g(10,10,4) \leq g(10 * 16, 10 * 16, 4 * 16) = g(16,16,10)$, we obtain $g(10,10,4) \leq g(10,16,16) + g(16,10,4)$.

For $x = 10, y = 4, z = 10, a = 16, neut(a) = 16$;

since $g(10,4,10) \leq G(10 * 16,4 * 16,10 * 16) = g(16,10,16)$, we obtain $g(10,4,10) \leq g(10,16,16) + g(16,4,10)$.

For $x = 4, y = 10, z = 10, a = 16, neut(a) = 16$;

since $g(4,10,10) \leq g(4 * 16,10 * 16,10 * 16) = g(10,16,16)$, we obtain $g(4,10,10) \leq g(4,16,16) + g(16,10,10)$.

For $x = 10, y = 10, z = 16, a = 10, neut(a) = 10$;

since $g(10,10,16) \leq g(10 * 10,10 * 10,16 * 10) = g(10,10,16)$, we obtain $g(10,10,16) \leq g(10,10,10) + g(10,10,16)$.

For $x = 10, y = 16, z = 10, a = 10, neut(a) = 10$;

since $g(10,16,10) \leq g(10 * 10,16 * 10,10 * 10) = g(10,16,10)$, we obtain $g(10,16,10) \leq g(10,10,10) + g(10,16,10)$.

For $x = 16, y = 10, z = 10, a = 10, neut(a) = 10$;

since $g(16,10,10) \leq g(16 * 10,10 * 10,10 * 10) = g(16,10,10)$, we obtain $g(16,10,10) \leq g(16,10,10) + g(10,10,10)$.

For $x = 16, y = 16, z = 0, a = 10, neut(a) = 10$;

since $g(16,16,0) \leq g(16 * 10,16 * 10,0 * 10) = g(16,16,0)$, we obtain $g(16,16,0) \leq g(16,10,10) + g(10,16,0)$.

For $x = 16, y = 0, z = 16, a = 10, neut(a) = 10$;

since $g(16,0,16) \leq g(16 * 10,0 * 10,16 * 10) = g(16,0,16)$, we obtain $g(16,0,16) \leq g(16,10,10) + g(10,0,16)$.

For $x = 16, y = 16, z = 0, a = 10, neut(a) = 10$;

since $g(16,16,0) \leq g(16 * 10,16 * 10,0 * 10) = g(16,16,0)$, we obtain $g(16,16,0) \leq g(16,10,10) + g(10,16,0)$.

For $x = 16, y = 16, z = 4, a = 10, neut(a) = 10$;

since $g(16,16,4) \leq g(16 * 10,16 * 10,4 * 10) = g(16,16,4)$, we obtain $g(16,16,4) \leq g(16,10,10) + g(10,16,4)$.

For $x = 16, y = 4, z = 16, a = 10, neut(a) = 10$;

since $g(16,4,16) \leq g(16 * 10,4 * 10,16 * 10) = g(16,4,16)$, we obtain $g(16,4,16) \leq g(16,10,10) + g(10,4,16)$.

For $x = 4, y = 16, z = 16, a = 10, neut(a) = 10$;

since $g(4,16,16) \leq g(4 * 10, 16 * 10, 16 * 10) = g(4,16,16)$, we obtain $g(4,16,16) \leq g(4,10,10) + g(10,16,16)$.

For $x = 16, y = 16, z = 10, a = 10, neut(a) = 10$;

since $g(16,16,10) \leq g(16 * 10, 16 * 10, 10 * 10) = g(16,16,10)$, we obtain $g(16,16,10) \leq g(16,10,10) + g(10,16,10)$.

For $x = 16, y = 10, z = 16, a = 10, neut(a) = 10$;

since $g(16,10,16) \leq g(16 * 10, 10 * 10, 16 * 10) = g(16,10,16)$, we obtain $g(16,10,16) \leq g(16,10,10) + g(10,10,16)$.

For $x = 10, y = 16, z = 16, a = 10, neut(a) = 10$;

since $g(10,16,16) \leq g(10 * 10, 16 * 10, 16 * 10) = g(10,16,16)$, we obtain $g(10,16,16) \leq g(10,10,10) + g(10,16,16)$.

For $x = 0, y = 0, z = 0, a = 10, neut(a) = 10$;

since $g(0,0,0) \leq g(0 * 10, 0 * 10, 0 * 10) = g(0,0,0)$, we obtain $g(0,0,0) \leq g(0,10,10) + g(10,0,0)$.

For $x = 4, y = 4, z = 4, a = 10, neut(a) = 10$;

since $g(4,4,4) \leq g(4 * 10, 4 * 10, 4 * 10) = g(4,4,4)$, we obtain $g(4,4,4) \leq g(4,10,10) + g(10,4,4)$.

For $x = 10, y = 10, z = 10, a = 16, neut(a) = 16$;

since $g(10,10,10) \leq g(10 * 16, 10 * 16, 10 * 16) = g(16,16,16)$, we obtain $g(10,10,10) \leq g(10,16,16) + g(16,10,10)$.

For $x = 16, y = 16, z = 16, a = 10, neut(a) = 10$;

since $g(16,16,16) \leq g(16 * 10, 16 * 10, 16 * 10) = g(16,16,16)$, we obtain $g(16,16,16) \leq g(16,10,10) + g(10,16,16)$.

For $x = 9, y = 0, z = 0, a = 9, neut(a) = 9$;

since $g(9,0,0) \leq g(9 * 9, 0 * 9, 0 * 9) = g(9,0,0)$, we obtain $g(9,0,0) \leq g(9,9,9) + g(9,0,0)$.

For $x = 0, y = 9, z = 0, a = 9, neut(a) = 9$;

since $g(0,9,0) \leq g(0 * 9, 9 * 9, 0 * 9) = g(0,9,0)$, we obtain $g(0,9,0) \leq g(0,9,9) + g(9,9,0)$.

For $x = 0, y = 0, z = 9, a = 9, neut(a) = 9$;

since $g(0,0,9) \leq g(0 * 9,0 * 9,9 * 9) = g(0,0,9)$, we obtain $g(0,0,9) \leq g(0,9,9) + g(9,0,9)$.

For $x = 9, y = 0, z = 4, a = 16, neut(a) = 16$;

since $g(9,0,4) \leq g(9 * 16,0 * 16,4 * 16) = g(0,0,10)$, we obtain $g(0,0,10) \leq g(0,16,16) + g(16,0,10)$.

For $x = 9, y = 4, z = 0, a = 16, neut(a) = 16$;

since $g(9,4,0) \leq g(9 * 16,4 * 16,0 * 16) = g(0,10,0)$, we obtain $g(0,10,0) \leq g(0,16,16) + g(16,10,0)$.

For $x = 0, y = 9, z = 4, a = 16, neut(a) = 16$;

since $g(0,9,4) \leq g(0 * 16,9 * 16,4 * 16) = g(0,0,10)$, we obtain $g(0,0,10) \leq g(0,16,16) + g(16,0,10)$.

For $x = 0, y = 4, z = 9, a = 16, neut(a) = 16$;

since $g(0,4,9) \leq g(0 * 16,4 * 16,9 * 16) = g(0,10,0)$, we obtain $g(0,10,0) \leq g(0,16,16) + g(16,10,0)$.

For $x = 4, y = 9, z = 0, a = 16, neut(a) = 16$;

since $g(4,9,0) \leq g(4 * 16,9 * 16,0 * 16) = g(10,0,0)$, we obtain $g(10,0,0) \leq g(10,16,16) + g(16,0,0)$.

For $x = 4, y = 0, z = 9, a = 16, neut(a) = 16$;

since $g(4,0,9) \leq g(4 * 16,0 * 16,9 * 16) = g(10,0,0)$, we obtain $g(10,0,0) \leq g(10,16,16) + g(16,0,0)$.

For $x = 9, y = 0, z = 9, a = 9, neut(a) = 9$;

since $g(9,0,9) \leq g(9 * 9,0 * 9,9 * 9) = g(9,0,9)$, we obtain $g(9,0,9) \leq g(9,9,9) + g(9,0,9)$.

For $x = 9, y = 9, z = 0, a = 9, neut(a) = 9$;

since $g(9,9,0) \leq g(9 * 9,9 * 9,0 * 9) = g(9,9,0)$, we obtain $g(9,9,0) \leq g(9,9,9) + g(9,9,0)$.

For $x = 0, y = 9, z = 9, a = 9, neut(a) = 9$;

since $g(0,9,9) \leq g(0 * 9,9 * 9,9 * 9) = g(0,9,9)$, we obtain $g(0,9,9) \leq g(0,9,9) + g(9,9,9)$.

For $x = 9, y = 0, z = 10, a = 16, neut(a) = 16$;

since $g(9,0,10) \leq g(9 * 16,0 * 16,10 * 16) = g(0,0,16)$, we obtain $g(0,0,16) \leq g(0,16,16) + g(16,0,16)$.

For $x = 9, y = 10, z = 0, a = 16, neut(a) = 16$;

since $g(9,10,0) \leq g(9 * 16,10 * 16,0 * 16) = g(0,16,0)$, we obtain $g(0,16,0) \leq g(0,16,16) + g(16,16,0)$.

For $x = 10, y = 9, z = 0, a = 16, neut(a) = 16$;

since $g(10,9,0) \leq g(10 * 16,9 * 16,0 * 16) = g(16,0,0)$, we obtain $g(16,0,0) \leq g(16,16,16) + g(16,0,0)$.

For $x = 10, y = 0, z = 9, a = 16, neut(a) = 16$;

since $g(10,0,9) \leq g(10 * 16,0 * 16,9 * 16) = g(16,0,0)$, we obtain $g(16,0,0) \leq g(16,16,16) + g(16,0,0)$.

For $x = 0, y = 10, z = 9, a = 16, neut(a) = 16$;

since $g(0,10,9) \leq g(0 * 16,10 * 16,9 * 16) = g(0,16,0)$, we obtain $g(0,16,0) \leq g(0,16,16) + g(16,16,0)$.

For $x = 0, y = 9, z = 10, a = 16, neut(a) = 16$;

since $g(0,9,10) \leq g(0 * 16,9 * 16,10 * 16) = g(0,0,16)$, we obtain $g(0,0,16) \leq g(0,16,16) + g(16,0,16)$.

For $x = 9, y = 0, z = 16, a = 10, neut(a) = 10$;

since $g(9,0,16) \leq g(9 * 10,0 * 10,16 * 10) = g(0,0,16)$, we obtain $g(0,0,16) \leq g(0,10,10) + g(10,0,16)$.

For $x = 9, y = 16, z = 0, a = 10, neut(a) = 10$;

since $g(9,16,0) \leq g(9 * 10,16 * 10,0 * 10) = g(0,16,0)$, we obtain $g(0,16,0) \leq g(0,10,10) + g(10,16,0)$.

For $x = 16, y = 9, z = 0, a = 10, neut(a) = 10$;

since $g(16,9,0) \leq g(16 * 10,9 * 10,0 * 10) = g(16,0,0)$, we obtain $g(16,0,0) \leq g(16,10,10) + g(10,0,0)$.

For $x = 16, y = 0, z = 9, a = 10, neut(a) = 10$;

since $g(16,0,9) \leq g(16 * 10,0 * 10,9 * 10) = g(16,0,0)$, we obtain $g(16,0,0) \leq g(16,10,10) + g(10,0,0)$.

For $x = 0, y = 9, z = 16, a = 10, neut(a) = 10$;

since $g(0,9,16) \leq g(0 * 10,9 * 10,16 * 10) = g(0,0,16)$, we obtain $g(0,0,16) \leq g(0,10,10) + g(10,0,16)$.

For $x = 0, y = 16, z = 9, a = 10, neut(a) = 10$;

since $g(0,16,9) \leq g(0 * 10,16 * 10,9 * 10) = g(0,16,0)$, we obtain $g(0,16,0) \leq g(0,10,10) + g(10,16,0)$.

For $x = 9, y = 4, z = 4, a = 16, neut(a) = 16$;

since $g(9,4,4) \leq g(9 * 16,4 * 16,4 * 16) = g(0,10,10)$, we obtain $g(0,10,10) \leq g(0,16,16) + g(16,10,10)$.

For $x = 4, y = 9, z = 4, a = 16, neut(a) = 16$;

since $g(4,9,4) \leq g(4 * 16,9 * 16,4 * 16) = g(10,0,10)$, we obtain $g(10,0,10) \leq g(10,16,16) + g(16,0,10)$.

For $x = 4, y = 4, z = 9, a = 16, neut(a) = 16$;

since $g(4,4,9) \leq g(4 * 16,4 * 16,9 * 16) = g(10,10,0)$, we obtain $g(10,10,0) \leq g(10,16,16) + g(16,10,0)$.

For $x = 9, y = 4, z = 9, a = 16, neut(a) = 16$;

since $g(9,4,9) \leq g(9 * 16,4 * 16,9 * 16) = g(0,10,0)$, we obtain $g(0,10,0) \leq g(0,16,16) + g(16,10,0)$.

For $x = 9, y = 9, z = 4, a = 16, neut(a) = 16$;

since $g(9,9,4) \leq g(9 * 16,9 * 16,4 * 16) = g(0,0,10)$, we obtain $g(0,0,10) \leq g(0,16,16) + g(16,0,10)$.

For $x = 4, y = 9, z = 9, a = 16, neut(a) = 16$;

since $g(4,9,9) \leq g(4 * 16,9 * 16,9 * 16) = g(10,0,0)$, we obtain $g(10,0,0) \leq g(10,16,16) + g(16,0,0)$.

For $x = 9, y = 4, z = 10, a = 16, neut(a) = 16$;

since $g(9,4,10) \leq g(9 * 16,4 * 16,10 * 16) = g(0,10,16)$, we obtain $g(0,10,16) \leq g(0,16,16) + g(16,10,16)$.

For $x = 9, y = 10, z = 4, a = 16, neut(a) = 16$;

since $g(9,10,4) \leq g(9 * 16,10 * 16,4 * 16) = g(0,16,10)$, we obtain $g(0,16,10) \leq g(0,16,16) + g(16,16,10)$.

For $x = 10, y = 9, z = 4, a = 16, neut(a) = 16$;

since $g(10,9,4) \leq g(10 * 16,9 * 16,4 * 16) = g(16,0,10)$, we obtain $g(16,0,10) \leq g(16,16,16) + g(16,0,10)$.

For $x = 10, y = 4, z = 9, a = 16, neut(a) = 16$;

since $g(10,4,9) \leq g(10 * 16,4 * 16,9 * 16) = g(16,10,0)$, we obtain $g(16,10,0) \leq g(16,16,16) + g(16,10,0)$.

For $x = 4, y = 9, z = 10, a = 16, neut(a) = 16$;

since $g(4,9,10) \leq g(4 * 16,9 * 16,10 * 16) = g(10,0,16)$, we obtain $g(10,0,16) \leq g(10,16,16) + g(16,0,16)$.

For $x = 4, y = 10, z = 9, a = 16, neut(a) = 16$;

since $g(4,10,9) \leq g(4 * 16,10 * 16,9 * 16) = g(10,16,0)$, we obtain $g(10,16,0) \leq g(10,16,16) + g(16,16,0)$.

For $x = 9, y = 4, z = 16, a = 10, neut(a) = 10$;

since $g(9,4,16) \leq g(9 * 10,4 * 10,16 * 10) = g(0,4,16)$, we obtain $g(0,4,16) \leq g(0,10,10) + g(10,4,16)$.

For $x = 9, y = 16, z = 4, a = 10, neut(a) = 10$;

since $g(9,16,4) \leq g(9 * 10,16 * 10,4 * 10) = g(0,16,4)$, we obtain $g(0,16,4) \leq g(0,10,10) + g(10,16,4)$.

For $x = 16, y = 9, z = 4, a = 10, neut(a) = 10$;

since $g(16,9,4) \leq g(16 * 10,9 * 10,4 * 10) = g(16,0,4)$, we obtain $g(16,0,4) \leq g(16,10,10) + g(10,0,4)$.

For $x = 16, y = 4, z = 9, a = 10, neut(a) = 10$;

since $g(16,4,9) \leq g(16 * 10, 4 * 10, 9 * 10) = g(16,4,0)$, we obtain $g(16,4,0) \leq g(16,10,10) + g(10,4,0)$.

For $x = 4, y = 16, z = 9, a = 10, neut(a) = 10$;

since $g(4,16,9) \leq g(4 * 10, 16 * 10, 9 * 10) = g(4,16,0)$, we obtain $g(4,16,0) \leq g(4,10,10) + g(10,16,0)$.

For $x = 4, y = 9, z = 16, a = 10, neut(a) = 10$;

since $g(4,9,16) \leq g(4 * 10, 9 * 10, 16 * 10) = g(4,0,16)$, we obtain $g(4,0,16) \leq g(4,10,10) + g(10,0,16)$.

For $x = 9, y = 9, z = 9, a = 9, neut(a) = 9$;

since $g(9,9,9) \leq g(9 * 9, 9 * 9, 9 * 9) = g(9,9,9)$, we obtain $g(9,9,9) \leq g(9,9,9) + g(9,9,9)$.

For $x = 9, y = 9, z = 10, a = 10, neut(a) = 10$;

since $g(9,9,10) \leq g(9 * 10, 9 * 10, 10 * 10) = g(0,0,10)$, we obtain $g(0,0,10) \leq g(0,10,10) + g(10,0,10)$.

For $x = 10, y = 9, z = 9, a = 10, neut(a) = 10$;

since $g(10,9,9) \leq g(10 * 10, 9 * 10, 9 * 10) = g(10,0,0)$, we obtain $g(10,0,0) \leq g(10,10,10) + g(10,0,0)$.

For $x = 9, y = 10, z = 9, a = 10, neut(a) = 10$;

since $g(9,10,9) \leq g(9 * 10, 10 * 10, 9 * 10) = g(0,10,0)$, we obtain $g(0,10,0) \leq g(0,10,10) + g(10,10,0)$.

For $x = 9, y = 9, z = 16, a = 10, neut(a) = 10$;

since $g(9,9,16) \leq g(9 * 10, 9 * 10, 16 * 10) = g(0,0,16)$, we obtain $g(0,0,16) \leq g(0,10,10) + g(10,0,16)$.

For $x = 9, y = 16, z = 9, a = 10, neut(a) = 10$;

since $g(9,16,9) \leq g(9 * 10, 16 * 10, 9 * 10) = g(0,16,0)$, we obtain $g(0,16,0) \leq g(0,10,10) + g(10,16,0)$.

For $x = 16, y = 9, z = 9, a = 10, neut(a) = 10$;

since $g(16,9,9) \leq g(16 * 10, 9 * 10, 9 * 10) = g(16,0,0)$, we obtain $g(16,0,0) \leq g(16,10,10) + g(10,0,0)$.

For $x = 9, y = 10, z = 10, a = 10, neut(a) = 10$;

since $g(9,10,10) \leq g(9 * 10, 10 * 10, 10 * 10) = g(0,10,10)$, we obtain $g(0,10,10) \leq g(0,10,10) + g(10,10,10)$.

For $x = 10, y = 9, z = 10, a = 10, neut(a) = 10$;

since $g(10,9,10) \leq g(10 * 10, 9 * 10, 10 * 10) = g(10,0,10)$, we obtain $g(10,0,10) \leq g(10,10,10) + g(10,0,10)$.

For $x = 10, y = 10, z = 9, a = 10, neut(a) = 10$;

since $g(10,10,9) \leq g(10 * 10, 10 * 10, 9 * 10) = g(10,10,0)$, we obtain $g(10,10,0) \leq g(10,10,10) + g(10,10,0)$.

For $x = 9, y = 10, z = 16, a = 10, neut(a) = 10$;

since $g(9,10,16) \leq g(9 * 10, 10 * 10, 16 * 10) = g(0,10,16)$, we obtain $g(0,10,16) \leq g(0,10,10) + g(10,10,16)$.

For $x = 9, y = 16, z = 10, a = 10, neut(a) = 10$;

since $g(9,16,10) \leq g(9 * 10, 16 * 10, 10 * 10) = g(0,16,10)$, we obtain $g(0,16,10) \leq g(0,10,10) + g(10,16,10)$.

For $x = 10, y = 16, z = 9, a = 10, neut(a) = 10$;

since $g(10,16,9) \leq g(10 * 10, 16 * 10, 9 * 10) = g(10,16,0)$, we obtain $g(10,16,0) \leq g(10,10,10) + g(10,16,0)$.

For $x = 10, y = 9, z = 16, a = 10, neut(a) = 10$;

since $g(10,9,16) \leq g(10 * 10, 9 * 10, 16 * 10) = g(10,0,16)$, we obtain $g(10,0,16) \leq g(10,10,10) + g(10,0,16)$.

For $x = 16, y = 10, z = 9, a = 10, neut(a) = 10$;

since $g(16,10,9) \leq g(16 * 10, 10 * 10, 9 * 10) = g(16,10,0)$, we obtain $g(16,10,0) \leq g(16,10,10) + g(10,10,0)$.

For $x = 16, y = 9, z = 10, a = 10, neut(a) = 10$;

since $g(16,9,10) \leq g(16 * 10, 9 * 10, 10 * 10) = g(16,0,10)$, we obtain $g(16,0,10) \leq g(16,10,10) + g(10,0,10)$.

For $x = 9, y = 16, z = 16, a = 10, neut(a) = 10$;

since $g(9,16,16) \leq g(9 * 10, 16 * 10, 16 * 10) = g(0,16,16)$, we obtain $g(0,16,16) \leq g(0,10,10) + g(10,16,16)$.

For $x = 16, y = 9, z = 16, a = 10, neut(a) = 10$;

since $g(16,9,16) \leq g(16 * 10, 9 * 10, 16 * 10) = g(16,0,16)$, we obtain $g(16,0,16) \leq g(16,10,10) + g(10,0,16)$.

For $x = 16, y = 16, z = 9, a = 10, neut(a) = 10$;

since $g(16,16,9) \leq g(16 * 10,16 * 10,9 * 10) = g(16,16,0)$, we obtain $g(16,16,0) \leq g(16,10,10) + g(10,16,0)$.

Therefore, g is NTgM.

Example 2: Let $X = \{x, y, z\}$ and $P(X)$ be power set of X and $s(A)$ be number of elements in A . We show that $(P(X)\setminus X, \cup)$ is a NTS.

It is clear that $A \cup A = A \cup A = A$. Thus, we can take $neut(A) = A$ and $anti(A) = A$ for all $A \in P(X)\setminus X$.

We define $g: P(X) \setminus X \times P(X) \setminus X \times P(X) \setminus X \rightarrow \mathbb{R}^+ \cup \{0\}$ such that

$$g(A, B, C) = |S(A) - S(B)| + |S(A) - S(C)| + |S(B) - S(C)|.$$

g is not a NTgM. Because, for $A=\{x, y\}$, $B=\{x, z\}$, $C=\{y, z\}$; $G(A, B, C) = 0$. But, $A \neq B \neq C$.

Corollary 1: Let $(X, *, g)$ be a TNgMS and $d: X \times X \rightarrow \mathbb{R}^+ \cup \{0\}$ be a function such that $d(x, y) = G(x, y, y)$. Then,

- i) If $x = y$, then $d(x, y) = 0$,
- ii) $d(x, y) \leq d(x, z) + d(z, y)$ for every $x, y, z \in X$.

Proof:

i) If $x = y$, then $d(y, y) = g(y, y, y) = 0$. Because, $(X, *, g)$ is a TNgMS.

ii) We assume that there exists at least an element $a \in X$ for each x, y, z elements such that $g(x, y, z) \leq g(x * neut(a), y * neut(a), z * neut(a))$. Since $(X, *, g)$ is a TNgMS, we can write that $g(x, y, y) \leq g(x * neut(a), y * neut(a), y * neut(a)) \leq g(x, a, a) + g(a, y, y)$. Thus,

$$d(x, y) \leq d(x, a) + d(a, y). \text{ If we assume that } a = z, \text{ then } d(x, y) \leq d(x, z) + d(z, y).$$

Theorem 1: Let $(X, *, d)$ be a NTMS. $g_s(x, y, z) = \frac{1}{3}[d(x, y) + d(y, z) + d(x, z)]$ is a NTgM.

Proof:

a) Since d is a NTM, it is clear that for $\forall x, y \in X; x * y \in X$.

b) Since d is a NTM, if $x = y = z$, then $d(x, y) = d(y, z) = d(x, z) = 0$. Thus,

$$g_s(x, y, z) = \frac{1}{3}[d(x, y) + d(y, z) + d(x, z)] = 0.$$

c) Since d is a NTM, If $x \neq y; d(x, y) > 0$. Thus,

$$g_s(x, y, z) = \frac{1}{3}[d(x, y) + d(y, z) + d(x, z)] > 0.$$

$$d) g_s(x, x, y) = \frac{1}{3}[d(x, x) + d(x, y) + d(x, y)] = \frac{2}{3} d(x, y), \text{ since } d \text{ is a NTM.} \quad (1)$$

Also, we suppose that there exists at least a $z \in X$ for each $x, y \in X$ such that $d(x, y) \leq d(x, y * neut(z))$ and $y \neq z$. Since d is a NTM, we can write that

$$d(x, y) \leq d(x, z * neut(y)) \leq d(x, z) + d(z, y). \quad (2)$$

From (2), we can write that

$$g_s(x, y, z) = \frac{1}{3}[d(x, y) + d(y, z) + d(x, z)] \geq \frac{1}{3}[d(x, y) + d(x, y)] = \frac{2}{3} d(x, y). \quad (3)$$

Furthermore, from (1) and (3); we can write $g_s(x, x, y) \leq g_s(x, y, z)$.

e) Since d is a NTM, $d(x, y) = d(y, x)$, $d(y, z) = d(z, y)$, $d(x, z) = d(z, x)$. Thus, it is clear that

$$g_s(x, y, z) = g_s(x, z, y) = g_s(y, x, z) = g_s(y, z, x) = g_s(z, x, y) = g_s(z, y, x), \text{ for every } x, y, z \in X.$$

$$f) g_s(x * neut(a), y * neut(a), z * neut(a)) =$$

$$= \frac{1}{3}[d(x * neut(a), y * neut(a)) + d(y * neut(a), z * neut(a)) + d(x * neut(a), z * neut(a))]. \quad (4)$$

Also,

$$\text{we suppose that there exists at least a } a \in X \text{ for each } x, y \in X \text{ such that } d(x, y) \leq d(x, y * neut(a)). \quad (5)$$

From (5), we can write that

$$d(x, y) \leq d(x * neut(a), y) \leq d(x * neut(a), y * neut(a)). \quad (6)$$

From (5) and (6), we can write that

$$g_s(x, y, z) \leq g_s(x * neut(a), y * neut(a), z * neut(a)) \quad (7)$$

Since d is a NTM, from (5); we can write that

$$d(x, z) \leq d(x, z * neut(a)) \leq d(x, a) + d(a, z) \text{ and } d(x, z) \leq d(x, y * neut(a)) \leq d(x, a) + d(a, y) \quad (8)$$

From, (7) and (8); we can write that if there exists at least an element $a \in X$ for each x, y, z elements such that $g_s(x, y, z) \leq g_s(x * neut(a), y * neut(a), z * neut(a))$, then

$$g_s(x * neut(a), y * neut(a), z * neut(a)) \leq g_s(x, a, a) + g_s(a, y, z).$$

$$\text{Where, } g_s(x, a, a) = \frac{1}{3}[d(x, a) + d(a, a) + d(a, a)] \text{ and } g_s(a, y, z) = \frac{1}{3}[d(a, y) + d(y, z) + d(a, z)].$$

Thus, g_s is NTgM.

Theorem 2: Let $(X, *, d)$ be a NTMS. $g_m(x, y, z) = \max\{d(x, y), d(x, z), d(y, z)\}$ is a NTgM.

Proof:

a) Since d is a NTM, it is clear that for $\forall x, y \in X; x * y \in X$

b) Since d is a NTM, if $x = y = z$, then $d(x, y) = d(y, z) = d(x, z) = 0$. Thus,

$$g_m(x, y, z) = \max\{d(x, y), d(x, z), d(y, z)\} = 0.$$

c) Since d is a NTM, If $x \neq y$; $d(x, y) > 0$. Thus,

$$g_m(x, y, z) = \max\{d(x, y), d(x, z), d(y, z)\} > 0.$$

d)

$$g_m(x, x, y) = \max\{d(x, x), d(x, y), d(x, y)\} = \max\{d(x, x), d(x, y)\} \text{ since } d \text{ is a NTM.} \quad (9)$$

Also, we suppose that there exists at least a $z \in X$ for each $x, y \in X$ such that $d(x, y) \leq d(x, y * \text{neut}(z))$ and $y \neq z$. Since d is a NTM, we can write that

$$d(x, y) \leq d(x, z * \text{neut}(y)) \leq d(x, z) + d(z, y). \quad (10)$$

From (10), we can write that

$$g_m(x, y, z) = \max\{d(x, y), d(x, z), d(y, z)\} \geq \max\{d(x, y), d(x, z)\}. \quad (11)$$

Furthermore, from (1) and (3); we can write, $g_m(x, x, y) \leq g_m(x, y, z)$.

e) Since d is a NTM, $d(x, y) = d(y, x)$, $d(y, z) = d(z, y)$, $d(x, z) = d(z, x)$. Thus, it is clear that

$$g_m(x, y, z) = g_m(x, z, y) = g_m(y, x, z) = g_m(y, z, x) = g_m(z, x, y) = g_m(z, y, x), \text{ for every } x, y, z \in X.$$

$$f) g_m(x * \text{neut}(a), y * \text{neut}(a), z * \text{neut}(a)) =$$

$$= \frac{1}{3} [d(x * \text{neut}(a), y * \text{neut}(a)) + d(y * \text{neut}(a), z * \text{neut}(a)) + d(x * \text{neut}(a), z * \text{neut}(a))]. \quad (12)$$

Also,

$$\text{we suppose that there exists at least a } a \in X \text{ for each } x, y \in X \text{ such that } d(x, y) \leq d(x, y * \text{neut}(a)). \quad (13)$$

From (13), we can write that

$$d(x, y) \leq d(x * \text{neut}(a), y) \leq d(x * \text{neut}(a), y * \text{neut}(a)). \quad (14)$$

From (13) and (14), we can write that

$$g_m(x, y, z) \leq g_m(x * \text{neut}(a), y * \text{neut}(a), z * \text{neut}(a)). \quad (15)$$

Since d is a NTM, from (13); we can write that

$$d(x, z) \leq d(x, z * \text{neut}(a)) \leq d(x, a) + d(a, z) \text{ and } d(x, z) \leq d(x, y * \text{neut}(a)) \leq d(x, a) + d(a, y) \quad (16)$$

From, (15) and (16); we can write that if there exists at least an element $a \in X$ for each x, y, z elements such that

$$g_m(x, y, z) \leq g_m(x * \text{neut}(a), y * \text{neut}(a), z * \text{neut}(a)), \text{ then}$$

$$g_m(x * \text{neut}(a), y * \text{neut}(a), z * \text{neut}(a)) \leq g_m(x, a, a) + g_m(a, y, z).$$

Where, $g_m(x, a, a) = \max\{d(x, a), d(x, a), d(a, a)\}$ and $g_m(a, y, z) = \max\{d(a, y), d(a, z), d(y, z)\}$.

Thus, g_5 is NTgM.

Example 3: Let $X \subset \mathbb{R}$ be set, $(X, *)$ be a neutrosophic triplet set and d be a NTM such that

$d(x, y) = |2^x - 2^y|$. Then from Theorem 1 and Theorem 2,

$$g_s(x, y, z) = \frac{1}{3}[|2^x - 2^y| + |2^x - 2^z| + |2^y - 2^z|]$$

and

$$g_m(x, y, z) = \max\{|2^x - 2^y|, |2^x - 2^z|, |2^y - 2^z|\} \text{ are NTgMs.}$$

Theorem 3: Let $(X, *, g)$ be a NTgMS. For $k > 0$, $g_1(x, y, z) = \min\{k, g(x, y, z)\}$ is a NTgM.

Proof:

i) We assume that $G_1(x, y, z) = \min\{k, G(x, y, z)\} = G(x, y, z)$. Since $(X, *, G)$ is a NTgMS, it is clear that $G_1(x, y, z)$ is a NTgM.

i) It is clear that if $x = y = z$, then $g_1(x, y, z) = \min\{k, g(x, y, z)\} = 0$. (17)

Because $(X, *, g)$ is a NTgMS.

We assume that $x \neq y \neq z$ and $g_1(x, y, z) = \min\{k, g(x, y, z)\} = k$.

We show that $g_1(x, y, z)$ is a NTgM.

a) Since $(X, *, g)$ is a NTgMS, it is clear that for $\forall x, y \in X; x * y \in X$.

b) From (17), if $x = y = z$, then $g_1(x, y, z) = 0$,

c) If $x \neq y$, then $g_1(x, y, z) = k > 0$.

d) If $z \neq y$, then $g_1(x, x, y) = k \leq g_1(x, y, z) = k$.

e) $g_1(x, y, z) = k = g_1(x, z, y) = k = g_1(y, x, z) = k = g_1(y, z, x) = k = g_1(z, x, y) = k = g_1(z, y, x)$, for every $x, y, z \in X$.

f) $g_1(x, y, z) = k \leq g_1(x * \text{neut}(a), y * \text{neut}(a), z * \text{neut}(a)) = k$. Also,

$$g_1(x * \text{neut}(a), y * \text{neut}(a), z * \text{neut}(a)) = k \leq g_1(x, a, a) + g_1(a, y, z) = k.$$

Thus, g_1 is NTgM.

Definition 7: Let $(X, *, g)$ be a NTgMS and $\{x_n\}$ be a sequence in this space. A point $x \in X$ is said to be limit of the sequence $\{x_n\}$, if $\lim_{n,m \rightarrow \infty} g(x, x_n, x_m) = 0$ and $\{x_n\}$ is called NT g - convergent to x .

Definition 8: Let $(X, *, g)$ be a NTgMS and $\{x_n\}$ be a sequence in this space. $\{x_n\}$ is called NT g - Cauchy sequence if $\lim_{n,m,l \rightarrow \infty} g(x_n, x_m, x_l) = 0$.

Definition 9: Let $(X, *, g)$ be a NTgMS. If every $\{x_n\}$ NT g - Cauchy sequence is NT g - convergent, then $(X, *, g)$ is called NT complete NTgMS.

Conclusions

In this study, we firstly obtain NTgMS. We show that NTgMS is different from gMS, NTMS. Also, we show that a NTgMS will provide the properties of a NTMS under which conditions are met. Thus, we have added a new structure to neutrosophic triplet structures. Also, thanks to NTgMS, we can obtain new theory for fixed point theory, we can define NT partial g –metric space and we can obtain their properties.

Abbreviations

gM: g - metric

gMS: g – metric space

NT: Neutrosophic triplet

NTS: Neutrosophic triplet set

NTMS: Neutrosophic triplet metric space

NTgM: Neutrosophic triplet g - metric

NTgMS: Neutrosophic triplet g - metric space

References

- [1] Smarandache F. (1998) Neutrosophy: Neutrosophic Probability, Set and Logic, Rehoboth, Amer. Research Press
- [2] Kandasamy W. B. V. and Smarandache F. (2004) Basic neutrosophic algebraic structures and their applications to fuzzy and neutrosophic models, Hexis, Frontigan p 219
- [3] Kandasamy W. B. V. and Smarandache F. (2006) Some neutrosophic algebraic structures and neutrosophic n-algebraic structures, Hexis, Frontigan p 219
- [4] Smarandache F. and Ali M. (2016) Neutrosophic triplet as extension of matter plasma, unmatter plasma and antimatter plasma, APS Gaseous Electronics Conference doi: 10.1103/BAPS.2016.GEC.HT6.110
- [5] Smarandache F. and Ali M. (2014) The Neutrosophic Triplet Group and its Application to Physics, presented by F. S. to Universidad Nacional de Quilmes, Department of Science and Technology, Bernal, Buenos Aires, Argentina (02 June 2014)
- [6] Smarandache F. and Ali M. (2016) Neutrosophic triplet group. Neural Computing and Applications, 1-7.
- [7] Smarandache F. and Ali M. (2017) Neutrosophic Triplet Field Used in Physical Applications, (Log Number: NWS17-2017-000061), 18th Annual Meeting of the APS Northwest Section, Pacific University, Forest Grove, OR, USA (June 1-3, 2017)

- [8] Smarandache F. and Ali M. (2017) Neutrosophic Triplet Ring and its Applications, (Log Number: NWS17-2017-000062), 18th Annual Meeting of the APS Northwest Section, Pacific University, Forest Grove, OR, USA (June 1-3, 2017).
- [9] Şahin, M., & Kargin, A. (2019). Single valued neutrosophic quadruple graphs. *Asian Journal of Mathematics and Computer Research*, 243-250.
- [10] Broumi S., Bakali A., Talea M. and Smarandache F. (2016) Single Valued Neutrosophic Graphs: Degree, Order and Size. *IEEE International Conference on Fuzzy Systems*, pp. 2444-2451.
- [11] Broumi S., Bakali A., Talea M. and Smarandache F. (2016) Decision-Making Method Based On the Interval Valued Neutrosophic Graph, *Future Technologies, IEEE International Conference on Fuzzy Systems* pp 44-50.
- [12] Uluçay, V.; Şahin, M.; Olgun, N. Time-Neutrosophic Soft Expert Sets and Its Decision Making Problem. *Matematika*, 2018 34(2), 246-260.
- [13] Uluçay, V.; Kılıç, A.; Yıldız, I.; Şahin, M. (2018). A new approach for multi-attribute decision-making problems in bipolar neutrosophic sets. *Neutrosophic Sets and Systems*, 2018, 23(1), 142-159.
- [14] Uluçay, V., Kılıç, A., Şahin, M., & Deniz, H. (2019). A New Hybrid Distance-Based Similarity Measure for Refined Neutrosophic sets and its Application in Medical Diagnosis. *MATEMATIKA: Malaysian Journal of Industrial and Applied Mathematics*, 35(1), 83-94.
- [15] Broumi, S., Bakali, A., Talea, M., Smarandache, F., Singh, P. K., Uluçay, V., & Khan, M. (2019). Bipolar complex neutrosophic sets and its application in decision making problem. In *Fuzzy Multi-criteria Decision-Making Using Neutrosophic Sets* (pp. 677-710). Springer, Cham.
- [16] Bakbak, D., Uluçay, V., & Şahin, M. (2019). Neutrosophic soft expert multiset and their application to multiple criteria decision making. *Mathematics*, 7(1), 50.
- [17] Uluçay, V., & Şahin, M. (2020). Decision-Making Method based on Neutrosophic Soft Expert Graphs. In *Neutrosophic Graph Theory and Algorithms* (pp. 33-76). IGI Global.
- [18] Uluçay, V., Kılıç, A., Yıldız, İ., & Şahin, M. (2019). An Outranking Approach for MCDM-Problems with Neutrosophic Multi-Sets. *Neutrosophic Sets & Systems*, 30.
- [19] Uluçay, V., Şahin, M., & Hassan, N. (2018). Generalized neutrosophic soft expert set for multiple-criteria decision-making. *Symmetry*, 10(10), 437.
- [20] Şahin M., Deli I. and Uluçay V. (2016) Similarity measure of bipolar neutrosophic sets and their application to multiple criteria decision making, *Neural Comput & Applic.* DOI 10. 1007/S00521
- [21] Wang H., Smarandache F., Zhang Y. Q., Sunderraman R. (2010) Single valued neutrosophic sets. *Multispace Multistructure* 4, 410–413.

- [22] Şahin M., Olgun N, Uluçay V., Kargın A. and Smarandache F. (2017) A new similarity measure on falsity value between single valued neutrosophic sets based on the centroid points of transformed single valued neutrosophic numbers with applications to pattern recognition, *Neutrosophic Sets and Systems*, 15, 31-48, doi: [org/10.5281/zenodo570934](https://doi.org/10.5281/zenodo570934)
- [23] Şahin M., Ecemiş O., Uluçay V. and Kargın A. (2017) Some new generalized aggregation operators based on centroid single valued triangular neutrosophic numbers and their applications in multi-attribute decision making, *Asian Journal of Mathematics and Computer Research* 16(2): 63-84
- [24] Chatterjee R., Majumdar P., and Samanta S. K. (2019) Similarity Measures in Neutrosophic Sets- I. Fuzzy Multi-criteria Decision-Making Using Neutrosophic Sets. Springer, Cham. 249-294.
- [25] Mohana K., and Mohanasundari M. (2019) On Some Similarity Measures of Single Valued Neutrosophic Rough Sets. *Neutrosophic Sets and Systems*, 10
- [26] Smarandache F., et al. (2019) Word-level neutrosophic sentiment similarity. *Applied Soft Computing* 80, 167-176.
- [27] Ye J. (2014) Similarity measures between interval neutrosophic sets and their applications in multicriteria decision – making. *J. Intell. Fuzzy Syst.* 26 (1) 165 – 172
- [28] Zadeh A. L. (1965) Fuzzy sets, *Information and control* ,8.3 338-353,
- [29] Atanassov T. K. (1986) Intuitionistic fuzzy sets, *Fuzzy Sets Syst*, 20:87–96
- [30] Şahin M. and Kargın A. (2019) Neutrosophic triplet metric topology, *Neutrosophic Set and Systems*, 27, 154 -162
- [31] Ali M., Smarandache F., Khan M. (2018) Study on the development of neutrosophic triplet ring and neutrosophic triplet field, *Mathematics-MDPI*, 6(4), 46
- [32] Şahin M. and Kargın A. (2017) Neutrosophic triplet normed space, *Open Physics*, 15, 697-704
- [33] Şahin M. and Kargın A. (2017) Neutrosophic triplet inner product space, *Neutrosophic Operational Research*, 2, 193-215,
- [34] Smarandache F., Şahin M., Kargın A. (2018) Neutrosophic Triplet G- Module, *Mathematics – MDPI*, 6, 53
- [35] Şahin M. and Kargın A. (2019) Neutrosophic triplet b – metric space, *Neutrosophic Triplet Research*, 1
- [36] Şahin M., Kargın A., Çoban M. A. (2018) Fixed point theorem for neutrosophic triplet partial metric space, *Symmetry – MDPI*, 10, 240
- [37] Şahin M., Kargın A. (2018) Neutrosophic triplet ν – generalized metric space, *Axioms – MDPI*, 7, 67

- [38] Şahin M. and Kargin A., Smarandache F. (2019) Neutrosophic triplet topology, *Neutrosophic Triplet Research* 1,
- [39] Şahin M., Kargin A. (2018) Neutrosophic triplet normed ring space, *Neutrosophic Set and Systems*, 21, 20 – 27
- [40] Şahin M., Kargin A. (2019), Neutrosophic triplet partial inner product space, *Neutrosophic Triplet Research* 1, 10 - 21
- [41] Şahin M., Kargin A. (2019), Neutrosophic triplet groups based on set valued neutrosophic quadruple numbers, *Neutrosophic Set and Systems*, 30, 122 -131
- [42] Şahin M., Kargin A. (2019) Neutrosophic triplet partial v – generalized metric space, *Neutrosophic Triplet Research* 1, 22 - 34
- [43] Şahin M., Kargin A. (2019) Neutrosophic triplet Lie Algebra, *Neutrosophic Triplet Research* 1, 68 -78
- [44] Şahin M., Kargin A. (2019) Isomorphism theorems for Neutrosophic triplet G - module, *Neutrosophic Triplet Research* 1, 54- 67
- [45] Mustafa, Z., & Sims, B. (2006). A new approach to generalized metric spaces. *Journal of Nonlinear and convex Analysis*, 7(2), 289-297.
- [46] Mustafa, Z., Obiedat, H., & Awawdeh, F. (2008). Some fixed point theorem for mapping on complete G -metric spaces. *Fixed point theory and Applications*, 2008(1), 189870.
- [47] Mustafa, Z., Shatanawi, W., & Bataineh, M. (2009). Existence of fixed point results in G -metric spaces. *International Journal of Mathematics and Mathematical Sciences*, doi:10.1155/2009/283028

Chapter Fourteen

Soft Maximal Ideals on Soft Normed Rings

Memet Şahin¹, Vakkas Uluçay²

¹Department of Mathematics, Gaziantep University, Gaziantep27310-Turkey

²Department of Mathematics, Kilis 7 Aralık University, Kilis-Turkey

E-mail: mesahin@gantep.edu.tr, vulucay27@gmail.com.

ABSTRACT

In this chapter, we deal with the algebraic structure of normed rings by applying soft set theory. We define the notion of a soft ideal and focus on the algebraic properties of soft normed rings. We introduce the notions of soft proper ideal, soft maximal ideal and extension of soft maximal ideal and give several theorems and illustrating examples.

Keywords: soft set, soft normed rings, soft ideal, soft maximal ideal

INTRODUCTION

Most of our traditional tools for formal modeling, reasoning, and computing are crisp, deterministic, and precise in character. However, there are many complicated problems in economics, engineering, environment, social science, medical science, etc., that involve data which are not always all crisp. We cannot successfully use classical methods because of various types of uncertainties present in these problems. There are theories: theory of probability, theory of fuzzy sets, and the interval mathematics, (intuitionistic) fuzzy sets, the theory of vague sets and the theory of rough sets which we can consider as mathematical tools for dealing with uncertainties. But all these theories have their own difficulties. Consequently, Molodtsov [1] proposed a completely new approach for modeling vagueness and uncertainty. This so-called soft set theory is free from the difficulties affecting existing methods. Maji et al.[2] studied several operations on the theory of soft sets.

At present, works on the soft set theory are progressing rapidly with wide-range applications especially in the mean of algebraic structures as in [3, 4, 5, 6, 9]. Moreover, Atagun and Sezgin [7] defined the concepts of soft subrings and ideals of a ring, soft subfields of a field and soft submodules of a module and studied their related properties with respect to soft set operations. Sezgin et al.[8] defined union soft subnear-rings (ideals) of a near-ring and union soft N-subgroups (N-ideals) of an N-group by using Molodtsov's definition of soft sets and investigated their related properties with respect to soft set operations, soft anti-image and lower a inclusion of soft sets. Jun et al.[11] defined the notion of soft p-ideals and p-idealistic soft BCI-algebras, and then investigate their basic properties. Using soft sets, we give characterizations of (fuzzy) p-ideals in BCI algebras. Acar et al.[10] defined the notions of soft irreducible, prime and maximal soft ideals, irreducible, prime and maximal soft idealistic over on BCK/BCI algebras. Shilov, Georgii Evgen'evich.[12] defined on decomposition of a commutative normed ring in a direct sums of ideals. Gel'fand, Izrail' Moiseevich, et al. [13] defined commutative normed rings. Freundlich, Marianne [14] introduced completely continuous elements of a normed ring. Raikov, D. A. [15] defined to the theory of normed rings with involution. Naimark, et al. [16] defined normed rings. Shilov, Georgii Evgen'evich [17] defined analytic functions in a normed ring. Jarden, M. [18] defined normed rings in 2011 and studied norms $\| \cdot \|$ of associative rings which

are generalizations of absolute values $|\cdot|$ of integral domains. The main purpose of this chapter is to introduce the algebraic structure of normed rings by applying soft set theory. Our definition of soft ideals on soft sets is similar to the definition of soft ideals on soft normed rings, but is constructed using different methods. We define the concept of a soft ideal and focus on the algebraic properties of soft normed rings. We introduce the concepts of soft proper ideal and soft maximal ideal, and give several illustrating examples. The organization of this chapter is as follows: In section 2, we brief present some basic definitions and preliminary results are given which will be used in the rest of the chapter. In section 3, soft maximal ideal on a soft normed ring is presented. Section 4 consists of the extension of a soft maximal ideal. In section 5, we conclude the chapter.

BACKGROUND

In this section, we site the fundamental definitions that will be used in the results.

Definition 1 [1] Let U be an initial universe set and E be set of parameters. Consider $A \subset E$. Let $P(U)$ denote the set of all soft sets U . The collection (F, A) is termed to be the soft set over U where F is a mapping given by $F : A \rightarrow P(U)$.

Definition 2 [2] For two soft sets (F, A) and (G, B) over U , (F, A) is called a soft subsets of (G, B) if:

- $A \subseteq B$
- for all $\varepsilon \in B$, $G(\varepsilon) \subseteq F(\varepsilon)$

The relationship is denoted by $(F, A) \subseteq (G, B)$. In this case (G, B) is called a soft superset of (F, A) .

Definition 3[2] The union of two soft sets (F, A) and (G, B) over U denoted by $(F, A) \sim \cup (G, B)$ is the soft set (H, C) , where $C = A \cup B$, and for all $e \in C$,

$$H(e) = \begin{cases} F(e), & \text{if } e \in A - B; \\ G(e), & \text{if } e \in B - A; \\ F(e) \cup G(e), & \text{if } e \in F(e) \cap G(e). \end{cases}$$

we express it as $(F, A) \sim \cup (G, B) = (H, C)$.

Definition 4 [2] The intersection of two soft sets (F, A) and (G, B) over U denoted by $(F, A) \sim \cap (G, B)$ is the soft set (H, C) , where $C = A \cap B$, and for all $e \in C$,

$$H(e) = \begin{cases} F(e), & \text{if } e \in A - B; \\ G(e), & \text{if } e \in B - A; \\ F(e) \cap G(e), & \text{if } e \in F(e) \cap G(e). \end{cases}$$

we express it as $(F, A) \sim \cap (G, B) = (H, C)$.

Definition 5 [19] Let R be the set of real numbers and $B(R)$ the collection of all non-empty bounded subsets of R and A taken as a set of parameters. then a mapping $F : A \rightarrow B(R)$ is called a soft real set. It is denoted by (F, A) . If specifically (F, A) is a singleton soft set, then after identifying (F, A) with the corresponding soft element, it will be called a soft real number.

We use nations $\tilde{r}, \tilde{s}, \tilde{t}$ to denote soft real numbers whereas r, s, t will denote a particular type of soft real numbers such that $r(\lambda) = r$, for all $\lambda \in A$ etc. For example 0 is the soft real number where $0(\lambda) = 0$, for all $\lambda \in A$.

Definition 6 [18] Let A be commutative ring with 1. An ultrametric absolute value of A is a function $|| : A \rightarrow \mathbb{R}$ satisfying the following conditions:

- $|a| \geq 0$ and $|a| = 0 \Leftrightarrow a = 0$,
- There exists $a \in A$ such that $0 < |a| < 1$,
- $|a.b| = |a|.|b|$
- $|a + b| \leq \max(|a|, |b|)$.

Definition 7 [18] Let R be commutative ring with 1. A norm on R is a function $||. || : R \rightarrow \mathbb{R}$ that satisfies the following conditions for all $a, b \in R$:

- i. $||a|| \geq 0$ and $||a|| = 0 \Leftrightarrow a = 0$, further $||1|| = ||-1|| = 1$.
- ii. $\exists x \in R, 0 \leq ||x|| \leq 1$.
- iii. $||a.b|| \leq ||a||.||b||$
- iv. $||a + b|| \leq \max(||a||, ||b||)$

Soft Maximal Ideals

Definition 8 A soft set $F(I, A)$ (or $I(A)$) of soft elements of a soft normed ring is called a soft ideal if it has the following properties:

- i. If $\forall \tilde{x} \in F(I, A)$ and $\tilde{y} \in F(I, A)$, then $\tilde{x} + \tilde{y} \in F(I, A)$;
- ii. If $\forall \tilde{x} \in F(I, A), \forall \tilde{z} \in F(R, A)$, then $\tilde{z}.\tilde{x} \in F(I, A)$
- iii. $F(I, A) \neq F(R, A)$

Example 9 Let C be the space of all soft complex function that are defined and continuous on the interval $[0, 1]$ with the soft norm given by $||\tilde{x}|| = \max_{0 \leq t \leq 1} |\tilde{x}(t)|$. C is a soft normed ring under ordinary multiplication (with the unit soft element $\tilde{x}(t) \equiv 1$.)

A soft element of a soft normed ring $F(R, A)$ (or $R(A)$) that has an inverse soft element cannot be contained in any soft proper ideal. In particular, if the soft normed ring $F(R, A)$ contains no soft proper ideals other than the soft zero ideal (consisting only of the soft element 0.), then $F(R, A)$ is a soft field. It is easy to verify that the closure $F(I, A)$ of a soft ideal $F(I, A)$ satisfies the conditions 1 and 2 of Definition 8

Definition 10 A soft maximal ideal is a soft proper ideal that is not contained in any other soft proper ideal.

Example 11 Let C be the space of all soft complex function that are defined and continuous on the interval $[0, 1]$ with the soft norm given by $\|\tilde{x}\| = \max_{0 \leq \tilde{t} \leq 1} |\tilde{x}(\tilde{t})|$. The soft set of all soft functions of C that vanish at an arbitrary fixed point of an interval in $[0, 1]$ is a soft maximal ideal of C .

The soft set $F(M_\tau, A)$ of all function $\tilde{x}(\tilde{t}) \in C$ for which $\tilde{x}(\tau) = 0$ is a soft proper ideal of C . Let $\tilde{y}(\tilde{t})$ be any soft function of C not belonging to $F(M_\tau, A)$. What we have to show is that there exists no soft proper ideal containing $F(M_\tau, A)$ and $\tilde{y}(\tilde{t})$. But this follows from the fact that every soft function $\tilde{z}(\tilde{t}) \in C$ can be represented in the form

$$\begin{aligned} \tilde{z}(\tilde{t}) &= \frac{\tilde{z}(\tau)}{\tilde{y}(\tau)} \cdot \tilde{y}(\tilde{t}) + (\tilde{z}(\tilde{t}) - \frac{\tilde{z}(\tilde{t})}{\tilde{y}(\tau)} \cdot \tilde{z}(\tau)) \\ \tilde{z}(\tilde{t}) - \frac{\tilde{z}(\tilde{t})}{\tilde{y}(\tau)} \cdot \tilde{z}(\tau) &\in F(M_\tau, A) \end{aligned}$$

and the first summand is a multiple of $\tilde{y}(\tilde{t})$. Now let $F(M, A)$ be any soft maximal ideal of C . We shall show that all the functions that occur in this soft maximal ideal vanish at same fixed point of the interval $[0, 1]$.

Indeed, if this were not so, then for every soft point $\tau \in [0, 1]$, we could find a function $\tilde{x}_\tau(\tilde{t}) \in F(M, A)$ such that $\tilde{x}_\tau(\tau) = 0$ and hence

$$\tilde{x}_\tau(\tilde{t}) \succ \delta_\tau \succ \bar{0}$$

in some interval containing τ . Let $\tau_1, \tau_2, \dots, \tau_n$ be the soft points corresponding to each of these intervals. The function

$$\begin{aligned} \tilde{x}(\tilde{t}) &= \tilde{x}_{\tau_1}(\tilde{t}) \cdot \overline{\tilde{x}_{\tau_1}(\tilde{t})} + \dots + \tilde{x}_{\tau_n}(\tilde{t}) \cdot \overline{\tilde{x}_{\tau_n}(\tilde{t})} \\ &= |\tilde{x}_{\tau_1}(\tilde{t})|^2 + \dots + |\tilde{x}_{\tau_n}(\tilde{t})|^2 \end{aligned}$$

is contained in $F(M, A)$. But on the other hand

$$\tilde{x}(\tilde{t}) \succ \min_{1 \leq k \leq n} \delta_{\tau_k}^2 \succ \bar{0}$$

and hence the soft function 1 exists in C so that in this case $\tilde{x}(\tilde{t})$, as we have seen, cannot belong to any $\tilde{x}(\tilde{t})$ soft proper ideal in particular, it cannot belong to soft maximal ideal $F(M, A)$. This contradiction shows that there exists a soft point τ such that $\tilde{x}(\tau) = 0$ for all $\tilde{x}(\tau) \in F(M, A)$. But then $F(M, A)$, being soft maximal, is the soft ideal $F(M_\tau, A)$ consisting of all the soft functions of C that vanish at the soft point τ . Soft elements $\tilde{x}, \tilde{y} \in R(A)$ are called soft congruent module the soft ideal $F(I, A)$ if $\tilde{x} - \tilde{y} \in F(I, A)$. Since the soft relation of congruence is soft reflexive, soft symmetric and soft transitive, $R(A)$ splits into soft classes of soft congruent elements \tilde{x}, \tilde{y} from $F(X, A)$, $F(Y, A)$ and denoting by $\lambda.F(X, A)$ (where λ is soft complex number) the soft class formed by the soft elements $\lambda\tilde{x}$ ($\tilde{x} \in F(X, A)$), we obtain the soft ring $R(A)/I(A)$ of residue soft classes of $R(A)$ with respect to $I(A)$. The zero soft element of this residue soft class ring is the soft class formed by all the soft elements $\tilde{x} \in I(A)$ and the soft unit element E is the soft class containing the soft unit element e of $R(A)$. In $R(A)/I(A)$ we introduce the soft norm

$$\|F(X, A)\| = \inf_{\infty \in F(X, A)} \|\tilde{x}\|$$

Theorem 12 If $I(A)$ is a closed soft proper ideal, then $R(A)/I(A)$ is a soft normed ring.

Proof 13 *i.* $\|\lambda \cdot \bar{F}(X, A)\| = |\lambda| \cdot \|F(X, A)\|$ obvious.

ii. $\|F(X, A) + F(Y, A)\| \lesssim \|F(X, A)\| + \|F(Y, A)\|$.

we have

$$\begin{aligned} \|F(X, A)\| + \|F(Y, A)\| &= \inf_{\tilde{z} \in F(X, A) + F(Y, A)} \|\tilde{z}\| = \inf_{\infty \in F(X, A), \tilde{y} \in F(Y, A)} \|\tilde{x} + \tilde{y}\| \\ &\lesssim \inf_{\infty \in F(X, A), \tilde{y} \in F(Y, A)} \{\|\tilde{x} + \tilde{y}\|\} \\ &= \inf_{\infty \in F(X, A)} \|\tilde{x}\| + \inf_{\tilde{y} \in F(Y, A)} \|\tilde{y}\| \\ &= \|F(X, A)\| + \|F(Y, A)\|. \end{aligned}$$

there exists a soft sequence $\tilde{x}_n \in F(X, A)$ such that $\tilde{x}_n \rightarrow \bar{0}$ for $n \rightarrow \infty$. Let \tilde{x} be an arbitrary soft element of $F(X, A)$. We have $\tilde{x} - \tilde{x}_n \in I(A)$, and since $\tilde{x}_n \rightarrow \bar{0}$, we have

$$\tilde{x} = \lim_{n \rightarrow \infty} (\tilde{x} - \tilde{x}_n) \in \overline{I(A)}.$$

But, by assumption, the soft ideal is closed: $\overline{I(A)} = I(A)$

Thus $F(X, A)$ coincides with $I(A)$, i.e., it is soft zero class.

vi. $R(A)/I(A)$ is complete in the soft norm. ($\|F(X, A)\| = \inf_{\infty \in F(X, A)} \|\tilde{x}\|$)

Let $\{X(A)_n\}$ be a fundamental soft sequence of soft classes, that is $\|X(A)_n - X(A)_m\| \rightarrow \bar{0}$ for $n, m \rightarrow \infty$.

Then we can choose a soft subsequence $\{X(A)_{n_k}\}$ from it such that the series $\sum_k \|X(A)_{n_{k+1}} - X(A)_{n_k}\|$ converges. By $\|F(X, A)\| = \inf_{\infty \in F(X, A)} \|\tilde{x}\|$ for an arbitrary soft element $\tilde{x}_1 \in X(A)_{n_1}$ we can find a soft element $\tilde{x}_2 \in X(A)_{n_2}$ such that

$$\|\tilde{x}_2 - \tilde{x}_1\| \lesssim \|X(A)_{n_2} - X(A)_{n_1}\|;$$

furthermore, for this \tilde{x}_2 we can find soft element $\tilde{x}_3 \in X(A)_{n_3}$ such that

$$\|\tilde{x}_3 - \tilde{x}_2\| \lesssim 2 \|X(A)_{n_3} - X(A)_{n_2}\|;$$

and so forth obviously, $\{X(A)_n\}$ is a fundamental sequence and therefore converges to some $\tilde{x} \in R(A)$. But

$$iii. \|F(X, A)\| \cdot \|F(Y, A)\| \stackrel{\sim}{=} \|F(X, A)\| \cdot \|F(Y, A)\|$$

we have

$$\begin{aligned} \|F(X, A)\| \cdot \|F(Y, A)\| &= \inf_{z \in F(X, A), F(Y, A)} \|z\| = \inf_{\infty \in F(X, A), \tilde{y} \in F(Y, A)} \|\tilde{x} \cdot \tilde{y}\| \\ &\stackrel{\sim}{\leq} \inf_{\infty \in F(X, A), \tilde{y} \in F(Y, A)} \{\|\tilde{x} \cdot \tilde{y}\|\} \\ &= \inf_{\infty \in F(X, A)} \|\tilde{x}\| \cdot \inf_{\tilde{y} \in F(Y, A)} \|\tilde{y}\| \\ &= \|F(X, A)\| \cdot \|F(Y, A)\|. \end{aligned}$$

$$iv. \|E\| = \bar{1}$$

Since $e \in E$, we have $\|E\| \stackrel{\sim}{\leq} \bar{1}$. Let \tilde{y} be an arbitrary soft element of E . We have $\tilde{y} = e + \tilde{x}$, where $\tilde{x} \in I(A)$. Now if $\|\tilde{y}\|$ were less than $\bar{1}$, then by what has been proved at the beginning of this section, \tilde{x} would have an inverse and hence could not belong to the soft proper ideal $I(A)$.

Thus $\|E\| \stackrel{\sim}{\geq} \bar{1}$ and hence $\|E\| = \bar{1}$.

v. If $\|F(X, A)\| = \bar{0}$ then $F(X, A)$ is the soft zero class. By

$$\|F(X, A)\| = \inf_{\infty \in F(X, A)} \|\tilde{x}\|$$

then the soft sequence $\{X(A)_{n_k}\}$, and hence the whole soft sequence $\{X(A)_n\}$ converges to the soft class $F(X, A)$ containing \tilde{x} .

Remark 14 *There is one-to-one correspondence between the closed soft ideals $J(A)$ of the soft ring $R(A)$ containing the closed soft ideal $I(A)$ and the closed soft ideals $J'(A)$ of the soft ring $R(A)/I(A)$ under which every soft ideal $J(A)$ corresponds to its image $J'(A)$ in $R(A)/I(A)$.*

For by the soft continuity of the soft mapping $R(A) \rightarrow R(A)/I(A)$ the complete inverse image $J(A)$ of every closed soft ideal $J'(A)$ of $R(A)/I(A)$ is a closed soft ideal of $R(A)$, and from $J'_1(A) \neq J'_2(A)$ it follows that $J_1(A) \neq J_2(A)$. Conversely, the image $J'(A)$ of every soft ideal $J(A)$ containing $I(A)$ is a soft ideal in $R(A)/I(A)$ furthermore, $J(A)$ is the complete inverse image of $J'(A)$, since if $J(A)$ contains \tilde{x} module $I(A)$; and in as much as $R(A) \rightarrow R(A)/I(A)$ is an open soft mapping and, for an open soft mapping, the fact

that the complete inverse image is closed implies that the image is closed, we have that the image $J'(A)$ of every closed soft ideal $J(A)$ containing $I(A)$ is a closed soft ideal in $R(A)/I(A)$.

Obviously, the soft proper ideal of $R(A)/I(A)$ are the images of soft proper ideal of $R(A)$. In particular, the maximal soft ideals of $R(A)/I(A)$ are the images of the soft maximal ideals of $R(A)$ containing $I(A)$.

Theorem 15 *The soft ring of residue soft classes $R(A)/M(A)$ of a soft normed ring $R(A)$ with respect to a soft maximal ideal $M(A)$ is a soft field.*

Proof 16 Every soft proper ideal $I(A)$ is contained in a soft maximal ideal. In particular, if the soft ring does not contain any non-zero soft maximal ideal, then it is a soft field. But if there were such a soft ideal $J(A)$ in $R(A)/I(A)$, then its inverse image in $R(A)$ would be a soft proper ideal containing with it, in contradiction to the soft maximality of $M(A)$. Note that, by Theorem 12, $R(A)/M(A)$ is a soft normed ring, because-as we have seen above-a soft maximal ideal is always closed.

It is easy to see that the converse of Theorem 12 is also true.

Theorem 17 If the residue soft class ring $R(A)/I(A)$ of $R(A)$ with respect to a soft proper ideal $I(A)$ is a soft field, then $I(A)$ is a soft maximal ideal. It need not be assumed here that $I(A)$ is closed.

Proof 18 If $R(A)$ were to contain a soft proper ideal $J(A)$ containing $I(A)$ and not coinciding with it, then its image $R(A)/I(A)$ would be a non-zero soft proper ideal; and this is impossible since, by assumption $R(A)/I(A)$ is a soft field.

Example 19 Let us consider the residue class soft ring of $C(A)$ with respect to a soft maximal ideal $M(A)$. Since $M(A)$ consists of all soft functions $\tilde{x}(t) \in C(A)$ that vanish at some soft point τ , every residue soft class $F(X, A)$ consists of all the soft functions $\tilde{x}(t) \in C(A)$ that assume the some value $\lambda_{\tilde{x}}$ at this soft point.

Furthermore $\lambda_{\tilde{x}+\tilde{y}} = \lambda_{\tilde{x}} + \lambda_{\tilde{y}}$, $\lambda_{\tilde{x} \cdot \tilde{y}} = \lambda_{\tilde{x}} \cdot \lambda_{\tilde{y}}$ and $\lambda_{\mu \tilde{x}} = \mu \cdot \lambda_{\tilde{x}}$

Moreover, $\|(F, A)\| = |\lambda_{\tilde{x}}|$; for it $\tilde{x}(\bar{t}) \in (F, A)$, then $\|\tilde{x}\| \geq |\tilde{x}(\bar{t})| = |\lambda_{\tilde{x}}|$ and, on other hand, the function $\tilde{x}(\bar{t}) \equiv |\lambda_{\tilde{x}}|$ belong to the soft class $F(X, A)$. Thus $C(A)/M(A)$ is isomorphic to the soft field of complex number.

Extension of Soft Maximal Ideals

In soft normed rings the analogous question can be asked, whether it is possible to extend multiplicative linear soft functionals, i.e., linear soft functional $f(\tilde{x})$ satisfying the additional condition $f(\tilde{x}\tilde{y}) = f(\tilde{x}) \cdot f(\tilde{y})$ for all \tilde{x}, \tilde{y} . In general the answer to this question is in the negative. For example, let $F(N, A)$ be the soft space of all soft function of a complex variable, γ that are defined and soft continuous in the circle $\gamma \leq 1$ and soft regular throughout the interior of this circle, with the soft norm given by

$F(N, A)$ is soft normed rings under ordinary multiplication. The multiplicative soft linear functional $f(\tilde{x}) = (\tilde{0})$ cannot be extend with preservation of multiplication to the soft ring of all soft continuous functions on the circle $\gamma = 1$, which contains $F(N, A)$ as a closed soft subring. But it does turn out that in every soft commutative normed ring $SR_1(A)$ there is a set of multiplicative soft linear functionals that can be extended with preservation of multiplication to every soft commutative normed ring $SR(A)$ containing $R_1(A)$ as a closed soft subring. These soft functionals are precisely the multiplicative soft linear functionals $Y(R_1(A))$ of soft maximal ideals of $R_1(A)$.

Before proceeding to a proof of this statement, let us note the following. Suppose that a multiplicative soft linear functional $f(\tilde{x})$ is extended from a soft normed ring $SR_1(A)$ to a larger ring $SR(A)$. Then, in particular the set $SM_1(A)$ of those $\tilde{x}_1 \in SR_1(A)$ for which $f(\tilde{x}_1) = 0$. But $SM_1(A)$ is a soft maximal ideal of $SR_1(A)$ and $SM(A)$ a soft maximal ideal of $SR(A)$. Thus, the extension of the multiplicative soft functional $f(\tilde{x}_1)$ goes hand in hand with an extension of the soft maximal ideal $SM_1(A)$ of $SR_1(A)$ to a soft maximal ideal $SM(A)$ of $SR(A)$. Conversely, if the soft maximal ideal $SM_1(A)$ of $SR_1(A)$ is extended to the soft maximal ideal

$SM(A)$ of $SR(A)$, then the multiplicative soft linear functional $SM(A)(\tilde{x}) = \tilde{x} \cdot [SM(A)]$ on $SR(A)$ is an extension of the multiplicative soft linear functional $SM_1(A)(\tilde{x})$ given on $SR_1(A)$. Let $\tilde{x}_0 \in SR_1(A)$ and $SM_1(A)(\tilde{x}_0) = \lambda_0$. Then $SM_1(A)(\tilde{x}_0 - \lambda_0 \cdot e) = 0$, so that $\tilde{x}_0 - \lambda_0 \cdot e \in SM_1(A) \subset SM(A)$, and hence we also have that $SM(A)(\tilde{x}_0) = \lambda_0$. Consequently, the problem of extending a multiplicative soft linear functional is equivalent to that of extending the corresponding soft maximal ideal.

Theorem 20 In an arbitrary soft normed ring $SR(A)$ containing $SR_1(A)$ as a closed soft normed subring, every soft maximal ideal of the boundary Λ_1 of the space $Y(SM_1(A))$ can be extended to a soft maximal ideal of $SR(A)$.

Proof 21 First of all, observe that if $\tilde{x} \in SR_1(A)$, then

$$\max_{SM(A) \subset SR(A)} |\tilde{x} \cdot [SM(A)]| = \max_{SM_1(A) \subset SR_1(A)} |\tilde{x} \cdot [SM_1(A)]|.$$

This follows immediately from the formula

$$\max |\tilde{x} \cdot [SM(A)]| = \lim_{n \rightarrow \infty} \sqrt[n]{\|\tilde{x}^n\|}$$

when we bear in mind that all \tilde{x}^n are contained simultaneously in $SR_1(A)$ and in $SR(A)$ and that their soft norms in the two soft normed rings coincide. Let us suppose now that there is a soft maximal ideal of $SM_1(A) \in \Lambda_1$ not contained in any soft maximal ideal of $SR(A)$ containing all the soft elements of $SM_1(A)$, i.e., that the totality of all sums of the form

$$\sum_{i=1}^n \tilde{x}_i \cdot \tilde{z}_i,$$

($\tilde{x}_i \in SM_1(A)$, $\tilde{z}_i \in SR_1(A)$) coincides with the whole soft ring $SR(A)$; in particular, one of these sums yields the soft unit element of the soft ring $SR(A)$:

$$e = \sum_{i=1}^n \tilde{x}_i \cdot \tilde{z}_i.$$

We may suppose here without loss of generality that $\max |\tilde{x} \cdot [SM(A)]| \leq \bar{1}$. Assume that

$$\mu \succ \max_i \{ \max_{SM(A)} |\tilde{z}_i \cdot [SM(A)]| \};$$

we consider the neighborhood of $SM_1(A)$ defined by the inequalities:

$$|\tilde{x}_i \cdot [SM(A)]| < \frac{\bar{1}}{2n\mu}$$

$i = 1, 2, 3, \dots, n$; $SM(A) \subset SR_1(A)$ and soft function $\tilde{y} \cdot [SM(A)](\tilde{y} \cdot [SR_1(A)])$ whose absolute value assumes its maximum $\bar{1}$ with in this neighborhood and does not exceed $\frac{\bar{1}}{2n\mu}$ outside. By the remark made above, the product

$$\tilde{y} \cdot \sum_{i=1}^n \tilde{x}_i \cdot \tilde{z}_i = \tilde{y} \cdot e = \tilde{y}$$

also assumes the absolute value $\bar{1}$ on the soft maximal ideals of $SR(A)$. But on the other hand

$$\begin{aligned} \max_{SM(A) \tilde{c} SR(A)} |(\tilde{y} \cdot \sum_{i=1}^n \tilde{x}_i \cdot \tilde{z}_i)(SM(A))| &\leq \sum_{i=1}^n \max |\tilde{y}(SM(A)) \tilde{x}_i(SM(A))| \max \tilde{z}_i(SM(A)) \\ &\leq \sum_{i=1}^n \bar{1} \cdot \frac{\bar{1}}{2n\mu} \cdot \mu \\ &= \frac{\bar{1}}{2} \end{aligned}$$

This contradiction proves the theorem.

Corollary 22 Every soft maximal ideal of symmetric soft ring $SR_1(A)$, can be extended to a soft maximal ideal of every larger soft ring $SR_1(A)$.

Example 23 If $\|\tilde{x}\| = \max |\tilde{x}(SM(A))|$ in $SR_1(A)$, then we can state that there exists a soft ring $SR_1(A) \tilde{c} SR(A)$ for which only those $SM(A) \tilde{c} SR_1(A)$ can be extended to soft maximal ideals that belong to the boundary Λ of the soft space $\Upsilon(SR_1(A))$. This soft ring $SR(A)$ can be chosen as the soft ring of all soft continuous functions defined on Λ ; it contains $SR_1(A)$ as a soft normed subring and since Λ is a soft compact space, the soft set of all soft maximal ideals of $SR(A)$ coincides with Λ .

Conclusions

In this chapter, unlike before, we define the notion of a soft ideal and focus on the algebraic properties of soft normed rings. Later, we introduce the notions of soft proper ideal, soft maximal ideal and extension of a soft maximal ideal and give several theorems and illustrating examples. To extend this work one can investigate the properties of soft normed rings in other algebraic structures and fields. This may lead to an ample scope on soft normed rings in soft set theory.

References

- [1] D.Molodtsov, (1999). Soft set theoryfirst results. Computers Mathematics with Applications 37.4 : 19–31.
- [2] P. K. Maji, R. Biswas and A.R. Roy, (2003).Soft set theory. Computers Mathematics with Applications 45.4: 555–562.
- [3] H. Aktas and N. Cagman,(2007). Soft sets and soft groups. Information Sciences 177.13 : 2726–2735.
- [4] J.B. Young. (2008).Soft BCK/BCI-algebras. Computers Mathematics with Applications 56.5 : 1408–1413.
- [5] F.Feng, Y. B. Jun, and X. Zhao. (2008) Soft semirings. Computers Mathematics with Applications 56.10 : 2621–2628
- [6] SUN, Qiu-Mei; ZHANG, Zi-Long; LIU, Jing.2008. Soft sets and soft modules. In:Rough Sets and Knowl-edge Technology. Springer Berlin Heidelberg, p. 403–409.
- [7] Atagun AO, Sezgin A (2011) Soft substructures of rings, fields and modules. Comput Math Appl 61(3):592-601.
- [8] Sezgin, A., Atagn, A. O., aman, N. (2012). Union soft substructures of near-rings and N-groups. Neural Computing and Applications, 21(1), 133–143.

- [9] U. Acar, F. Koyuncu, and B. Tanay. Soft sets and soft rings. *Computers Mathematics with Applications* 59.11 (2010): 3458–3463.
- [10] Acar, U., ZTRK, Y. (2015). Maximal, irreducible and prime soft ideals of BCK/BCI-algebra. *Hacettepe Journal of Mathematics and Statistics*, 1.
- [11] Jun, Y. B., Lee, K. J., Zhan, J. (2009). Soft p-ideals of soft BCI-algebras. *Computers Mathematics with Applications*, 58(10), 2060–2068.
- [12] G. Shilov, (1953). On decomposition of a commutative normed ring in a direct sums of ideals. *Matem-aticheskii Sbornik* 74.2 : 353–364.
- [13] I.M. Gel'fand, D.A. Raikov, and G. E. Silov. 1957. *Commutative normed rings*. American Mathematical Society.
- [14] M. Freundlich, (1949). Completely continuous elements of a normed ring. *Duke Math. J* 16.1 : 949.
- [15] Raikov, D. A. 1946. "To the theory of normed rings with involution." *CR (Doklady) Acad. Sci. URSS (NS)*. Vol.54.
- [16] M.A. Naimark, *Normed rings*. P. Noordhoff, 1964
- [17] G.E. Shilov. "Analytic functions in a normed ring." *Uspekhi Matematicheskikh Nauk* 15.3 (1960): 181–183.
- [18] M. Jarden, 2011. "Normed Rings." *Algebraic Patching*. Springer Berlin Heidelberg, 10–30.
- [19] S. Das, S.K. Samanta, (2012). Soft Real Sets, Soft Real Numbers and Their Properties, *J. Fuzzy Math.* 20 (3) 551–576

Chapter Fifteen

Neutrosophic Triplet m - Metric Spaces

Memet Şahin, Abdullah Kargin, Azize Dayan and Adil Kılıç

Department of Mathematics, Gaziantep University, Gaziantep27310-Turkey

E-mail: mesahin@gantep.edu.tr, abduallahkargin27@gmail.com, azizedayan853@gmail.com

adilkilic@gantep.edu.tr

ABSTRACT

In this chapter, neutrosophic triplet m - metric spaces are obtained. Then, some definitions and examples are given for neutrosophic triplet m - metric space. Based on these definitions, new theorems are given and proved. In addition, it is shown that neutrosophic triplet m - metric spaces are different from the classical m - metric spaces, neutrosophic triplet metric spaces and the neutrosophic triplet partial metric spaces.

Keywords: neutrosophic triplet set, neutrosophic triplet metric space, neutrosophic triplet m - metric space

INTRODUCTION

Asadi, Karapinar and Salimi introduced m - metric spaces [45] in 2014. m - metric space is generalized form of metric space and partial metric space. The m - metric spaces have an important role in fixed point theory. Recently, researchers studied m - metric space [45-47].

Neutrosophic logic and neutrosophic set [1] are obtained by Smarandache in 1998. In neutrosophic logic and neutrosophic sets, there are T degree of membership, I degree of indeterminacy and F degree of non-membership. These degrees are defined independently of each other. It has a neutrosophic value (T, I, F) form. In other words, a condition is handled according to both its accuracy and its inaccuracy and its uncertainty. Therefore, neutrosophic logic and neutrosophic set help us to explain many uncertainties in our lives. In addition, many researchers have made studies on this theory [2-27]. Also, fuzzy logic and fuzzy set [28] were obtained by Zadeh in 1965. In the concept of fuzzy logic and fuzzy sets, there is only a degree of membership. In addition, intuitionistic fuzzy logic and intuitionistic fuzzy set [29] were obtained by Atanassov in 1986. The concept of intuitionistic fuzzy logic and intuitionistic fuzzy set include membership degree, degree of indeterminacy and degree of non-membership. But these degrees are defined dependently of each other. Therefore, neutrosophic set is a generalized state of fuzzy and intuitionistic fuzzy set.

Furthermore, Smarandache and Ali obtained neutrosophic triplet set (NTS) and neutrosophic triplet groups (NTG) [6]. For every element "x" in NTS A, there exist a neutral of "x" and an opposite of "x". Also, neutral of "x" must different from the classical neutral element. Therefore, the NTS is different from the classical set. Furthermore, a neutrosophic triplet (NT) "x" is showed by $\langle x, \text{neut}(x), \text{anti}(x) \rangle$. Also, many researchers have introduced NT structures [30 - 44].

In this chapter, we introduce neutrosophic triplet m - metric space (NTmMS). In Section 2, we give definitions and properties for m - metric space (mMS) [45], neutrosophic triplet sets (NTS) [30], neutrosophic

triplet metric spaces (NTMS) [32], neutrosophic triplet partial metric spaces (NTPMS) [36]. In Section 3, we define neutrosophic triplet m - metric space and we give some properties for neutrosophic triplet m - metric space. Also, we show that neutrosophic triplet m - metric spaces are different from the classical m - metric spaces and the neutrosophic triplet metric spaces. Then, we examine relationship between neutrosophic triplet m - metric spaces and neutrosophic triplet metric spaces. In Section 4, we give conclusions.

BACKGROUND

Definition 1: [6] Let $\#$ be a binary operation. A NTS $(X, \#)$ is a set such that for $x \in X$,

- i) There exists neutral of “ x ” such that $x\#\text{neut}(x) = \text{neut}(x)\#x = x$,
- ii) There exists anti of “ x ” such that $x\#\text{anti}(x) = \text{anti}(x)\#x = \text{neut}(x)$.

Also, a neutrosophic triplet “ x ” is showed with $(x, \text{neut}(x), \text{anti}(x))$.

Definition 2: [32] Let $(N, *)$ be a NTS and $d_N: N \times N \rightarrow \mathbb{R}^+ \cup \{0\}$ be a function. If $d_N: N \times N \rightarrow \mathbb{R}^+ \cup \{0\}$ and $(N, *)$ satisfies the following conditions, then d_N is called NTM.

- a) $x*y \in N$;
- b) $d_N(x, y) \geq 0$;
- c) If $x = y$, then $d_N(x, y) = 0$;
- d) $d_N(x, y) = d_N(y, x)$;
- e) If there exists at least a $y \in N$ for each $x, z \in N$ such that $d_N(x, z) \leq d_N(x, z*\text{neut}(y))$, then $d_N(x, z*\text{neut}(y)) \leq d_N(x, y) + d_N(y, z)$.

Also, $((N, *), d_N)$ is called a NTMS.

Definition 3:[36] Let $(N, *)$ be a NTS and $p: N \times N \rightarrow \mathbb{R}^+ \cup \{0\}$ be a function. If p and N satisfy following conditions, then p is called a NTPM.

- a) For all $x, y \in N$, $x*y \in N$;
- b) If $p(x, x) = p(y, y) = p(x, y) = 0$, then $x = y$;
- c) $p(x, x) \leq p(x, y)$;
- d) $p(x, y) = p(y, x)$;
- e) If there is at least an element $y \in N$ for each $x, z \in N$ pair of element such that $p(x, z) \leq p(x, z*\text{neut}(y))$, then

$$p(x, z*\text{neut}(y)) \leq p(x, y) + p(y, z) - p(y, y).$$

Furthermore, $((N, *), p)$ is called a NTPMS.

Definition 4:[45] Let X be a nonempty set and $m: X \times X \rightarrow \mathbb{R}^+ \cup \{0\}$ be a function. Then,

- (i) $m_{xy} = \min\{m(x, x), m(y, y)\} = m(x, x) \vee m(y, y)$,
- (ii) $M_{xy} = \max\{m(x, x), m(y, y)\} = m(x, x) \wedge m(y, y)$.

Definition 5:[45] Let X be a nonempty set and $m: X \times X \rightarrow \mathbb{R}^+ \cup \{0\}$ be a function. If m satisfies the following conditions, then m is called a m – metric (mM). For, $x, y, z \in X$;

- (m_1) $m(x, x) = m(y, y) = m(x, y)$ if and only if $x = y$,
- (m_2) $m_{xy} \leq m(x, y)$,
- (m_3) $m(x, y) = m(y, x)$,
- (m_4) $(m(x, z) - m_{xz}) \leq (m(x, y) - m_{xy}) + (m(y, z) - m_{yz})$.

Also, (X, m) is called a m – metric space (mMS).

Definition 6:[45] Let (X, m) be a mMS and $\{x_n\}$ be a sequence in this space. For all $\varepsilon > 0$, $m(x_n, x) - m_{x_n, x} < \varepsilon$ if and only if $\{x_n\}$ is called m - convergent to $x \in X$. It is shown by $\lim_{n \rightarrow \infty} x_n = x$ or $x_n \rightarrow x$.

Definition 7:[45] Let (X, m) be a mMS and $\{x_n\}$ be a sequence in this space. $\{x_n\}$ is called m -Cauchy sequence, if for all $\varepsilon > 0$, $m(x_n, x_m) - m_{x_n, x_m} < \varepsilon$ and $M_{x_n, x_m} - m_{x_n, x_m} < \varepsilon$.

Neutrosophic Triplet m – Metric Space

Definition 8: Let $(N, *)$ be a NTS and $m: N \times N \rightarrow \mathbb{R}^+ \cup \{0\}$ be a function. If $(N, *)$ and m satisfy the following properties. Then m is called neutrosophic triplet m – metric (MTmM).

- a) For all $x, y \in N$, $x * y \in N$;
- b) If $m(x, x) = m(y, y) = m(x, y) = 0$, then $x = y$;
- c) $m_{xy} \leq m(x, y)$;
- d) $m(x, y) = m(y, x)$;
- e) If there is at least an element $y \in N$ for each $x, z \in N$ pair of element such that $m(x, z) \leq m(x, z * \text{neut}(y))$, then

$$(m(x, z * \text{neut}(y))) - m_{xz} \leq (m(x, y) - m_{xy}) + (m(y, z) - m_{yz}).$$

Furthermore, $((N, *), m)$ is called neutrosophic triplet m – metric space (NTmMS).

Note 1: m_{xy} , in Definition 8, is equal to m_{xy} in Definition 4.

Corollary 1: From Definition 8 and Definition 5, a NTmMS is different from a mMS. Because, there is not a $*$ binary operation in Definition 5. Also, triangle inequalities are different in definitions.

Corollary 2: From Definition 8 and Definition 2, a NTmMS is different from a NTMS. Because, triangle inequalities are different in definitions and in NTMS, $d(x, x)$ must equal to 0.

Corollary 3: From Definition 8 and Definition 3, a NTmMS is different from a NTPMS. Because, triangle inequalities are different in definitions and in NTPMS, there is not a m_{xy} locution.

Example 1: We take $N = \{0, 2, 4\}$. We show that $(N, .)$ is a NTS in \mathbb{Z}_6 .

For 0, $\text{neut}(0) = 0$ and $\text{anti}(0) = 0$;

For 2, $\text{neut}(2) = 4$ and $\text{anti}(2) = 2$;

For 4, neut(4)=4 and anti(4)=4.

Thus, (N, .) in \mathbb{Z}_6 is a NTS and NTs are (0, 0, 0), (2, 4, 2), (4, 4, 4).

Now, we define $m: N \times N \rightarrow \mathbb{R}^+ \cup \{0\}$ function such that $m(x, y) = |3^x - 3^y|$. We show that m is NTmM.

- a) $0.0 = 0 \in N, 0.2 = 0 \in N, 0.4 = 0 \in N, 2.2 = 4 \in N, 2.4 = 8 = 2 \in N, 4.4 = 16 = 4 \in N$
- b) If $m(x, x) = |3^x - 3^x| = m(y, y) = |3^y - 3^y| = m(x, y) = |3^x - 3^y| = 0$, it is clear that $x=y$.
- c) $m_{xy} = \min\{|3^x - 3^x|, |3^y - 3^y|\} = 0$ and $m(x, y) = |3^x - 3^y| \geq 0$. Thus, $0 = m_{xy} \leq m(x, y)$.
- d) $m(x, y) = |3^x - 3^y| = |3^y - 3^x| = m(y, x)$.
- e) For $m(0, 0) = 0 \leq m(0, 0 * \text{neut}(2)) = m(0, 4) = 80$,

$$(m(0, 0 * \text{neut}(2))) - m_{0,0} = |3^0 - 3^0| - |0 - 0| = 0 \leq (m(0, 2) - m_{0,2}) + (m(2, 0) - m_{2,0}) =$$

$$(|3^0 - 3^2| - |3^0 - 3^0|) + (|3^2 - 3^0| - |3^0 - 3^0|) = 18.$$

$$\text{For } m(0, 2) = 8 \leq m(0, 2 * \text{neut}(4)) = 8,$$

$$(m(0, 2 * \text{neut}(4))) - m_{0,2} = |3^0 - 3^2| - 0 = 9 \leq (m(0, 4) - m_{0,4}) + (m(4, 2) - m_{4,2}) =$$

$$(|3^0 - 3^4| - |3^0 - 3^0|) + (|3^4 - 3^2| - |3^2 - 3^2|) = 153$$

$$\text{For } m(0, 4) = 80 \leq m(0, 4 * \text{neut}(2)) = 80$$

$$(m(0, 4 * \text{neut}(2))) - m_{0,4} = |3^0 - 3^2| - 0 = 9 \leq (m(0, 2) - m_{0,2}) + (m(2, 4) - m_{2,4}) =$$

$$(|3^0 - 3^2| - |3^0 - 3^0|) + (|3^2 - 3^4| - |3^2 - 3^2|) = 81$$

$$\text{For } m(2, 0) = 8 \leq m(2, 0 * \text{neut}(4)) = 8,$$

$$(m(2, 0 * \text{neut}(4))) - m_{2,0} = |3^2 - 3^0| - 0 = 9 \leq (m(2, 4) - m_{2,4}) + (m(0, 4) - m_{0,4}) =$$

$$(|3^2 - 3^4| - |3^2 - 3^2|) + (|3^0 - 3^4| - |3^0 - 3^0|) = 153$$

$$\text{For } m(2, 4) = 72 \leq m(2, 4 * \text{neut}(2)) = 72,$$

$$(m(2, 4 * \text{neut}(2))) - m_{2,4} = |3^2 - 3^4| - 0 = 72 \leq (m(2, 2) - m_{2,2}) + (m(2, 4) - m_{2,4}) =$$

$$(|3^2 - 3^2| - |3^2 - 3^2|) + (|3^2 - 3^4| - |3^4 - 3^4|) = 72$$

$$\text{For } m(2, 2) = 0 \leq m(2, 2 * \text{neut}(4)) = 0,$$

$$(m(2, 2 * \text{neut}(4))) - m_{2,2} = |3^2 - 3^2| - 0 = 0 \leq (m(2, 4) - m_{2,4}) + (m(4, 2) - m_{4,2}) =$$

$$(|3^2 - 3^4| - |3^2 - 3^2|) + (|3^4 - 3^2| - |3^2 - 3^2|) = 72$$

$$\text{For } m(4, 0) = 80 \leq m(4, 0 * \text{neut}(2)) = 80,$$

$$(m(4, 0 * \text{neut}(2))) - m_{4,0} = |3^4 - 3^0| - 0 = 80 \leq (m(4, 2) - m_{4,2}) + (m(4, 2) - m_{4,2}) =$$

$$(|3^4 - 3^2| - |3^2 - 3^2|) + (|3^4 - 3^2| - |3^2 - 3^2|) = 144$$

$$\text{For } m(4, 2) = 72 \leq m(4, 2 * \text{neut}(0)) = 80$$

$$(m(4, 2 * \text{neut}(0))) - m_{4,2} = |3^4 - 3^0| - 0 = 80 \leq (m(4, 0) - m_{4,0}) + (m(0, 2) - m_{0,2}) =$$

$$(|3^4 - 3^0| - |3^0 - 3^0|) + (|3^0 - 3^2| - |3^0 - 3^0|) = 88.$$

Thus, m is a NTmMS.

Example 2: Let $X = \{0, 2, 3\}$ and $P(X)$ be power set of X and $s(A)$ be number of elements in A . We show that $(P(X)\setminus X, \cup)$ is a NTS.

It is clear that $A \cup A = A \cup A = A$. Thus, we can take $\text{neut}(A) = A$ and $\text{anti}(A) = A$ for all $A \in P(X)\setminus X$.

We define $m: P(X)\setminus X \times P(X)\setminus X \rightarrow \mathbb{R}^+ \cup \{0\}$ such that $m(A, B) = |s(A) - s(B)|$. m is not a NTmMS. Because, for $A = \{0, 2\}$, $B = \{0, 3\}$;

$$m(A, A) = |s(A) - s(A)| = |2 - 2| = 0,$$

$$m(B, B) = |s(B) - s(B)| = |2 - 2| = 0,$$

$$m(A, B) = |s(A) - s(B)| = |2 - 2| = 0.$$

But $A \neq B$.

Theorem 1: Let $((N, *, p))$ be a NTPMS. If the following condition satisfies, then $((N, *, p))$ is a NTmMS.

i) If there is at least an element $y \in N$ for each $x, z \in N$ pair of element such that $p(x, z) \leq p(x, z * \text{neut}(y))$, then $p(x, x) \leq p(y, y) \vee p(z, z) \leq p(y, y)$.

Proof: We suppose that $(N, *)$ is a NTS and $((N, *, p))$ is a NTPMS.

a) Since $((N, *, p))$ is a NTPMS, for all $x, y \in N$; $x * y \in N$;

b) From Definition 3, if $p(x, x) = p(y, y) = p(x, y) = 0$, then $x = y$;

c) From Definition 3, we can take $p(x, x) \leq p(x, y)$ and $p(y, y) \leq p(x, y)$. Thus, $m_{xy} = \min\{p(x, x), p(y, y)\} \leq p(x, y)$.

d) From Definition 3, $p(x, y) = p(y, x)$;

e) From Definition 3, we suppose that there is at least an element $y \in N$ for each $x, z \in N$ pair of element such that $p(x, z) \leq p(x, z * \text{neut}(y))$, then

$$p(x, z * \text{neut}(y)) \leq p(x, y) + p(y, z) - p(y, y). \quad (1)$$

$$\text{From condition i), } p(x, x) \leq p(y, y) \vee p(z, z) \leq p(y, y). \quad (2)$$

We suppose that $p(x, x) \leq p(z, z) \leq p(y, y)$. Thus,

$$m_{xz} = p(x, x), m_{xy} = p(x, x) \text{ and } m_{yz} = p(z, z). \text{ From (1), we can write}$$

$$p(x, z * \text{neut}(y)) - m_{xz} \leq p(x, y) - m_{xy} + p(y, z) - m_{yz}.$$

We suppose that $p(z, z) \leq p(x, x) \leq p(y, y)$. Thus,

$$m_{xz} = p(z, z), m_{xy} = p(x, x) \text{ and } m_{yz} = p(z, z). \text{ From (1), we can write}$$

$$p(x, z * \text{neut}(y)) - m_{xz} \leq p(x, y) - m_{xy} + p(y, z) - m_{yz}.$$

We suppose that $p(z, z) \leq p(y, y) \leq p(x, x)$. Thus,

$$m_{xz} = p(z, z), m_{xy} = p(y, y) \text{ and } m_{yz} = p(z, z). \text{ From (1), we can write}$$

$$p(x, z * \text{neut}(y)) - m_{xz} \leq p(x, y) - m_{xy} + p(y, z) - m_{yz}.$$

We suppose that $p(x, x) \leq p(y, y) \leq p(z, z)$. Thus,

$$m_{xz} = p(x, x), m_{xy} = p(x, x) \text{ and } m_{yz} = p(y, y). \text{ From (1), we can write}$$

$$p(x, z^*neut(y)) - m_{xz} \leq p(x, y) - m_{xy} + p(y, z) - m_{yz}.$$

Therefore, from Definition 8, $((N, *), p)$ is a NTmMS.

Theorem 2: Let $((N, *), m)$ be a NTmMS. If the following condition satisfies, then $((N, *), m)$ is a NTPMS.

i) If there is at least an element $y \in N$ for each $x, z \in N$ pair of element such that $m(x, z) \leq m(x, z^*neut(y))$, then $m_{xy} = m(y, y)$ and $m_{yz} \leq m_{xz}$.

Proof: We suppose that $(N, *)$ is a NTS and $((N, *), m)$ is a NTmMS.

a) Since $((N, *), m)$ is a NTmMS, for all $x, y \in N$; $x*y \in N$;

b) From Definition 8, if $m(x, x) = m(y, y) = m(x, y) = 0$, then $x = y$;

c) From Definition 8, we can take, $m_{xy} = \min\{m(x, x), m(y, y)\} \leq m(x, y)$. Thus,

$$m(x, x) \leq m(x, y) \text{ and } m(y, y) \leq m(x, y).$$

d) From Definition 8, $m(x, y) = m(y, x)$;

e) From Definition 8, we suppose that there is at least an element $y \in N$ for each $x, z \in N$ pair of element such that $m(x, z) \leq m(x, z^*neut(y))$, then

$$m(x, z^*neut(y)) - m_{xz} \leq m(x, y) - m_{xy} + m(y, z) - m_{yz}. \quad (3)$$

$$\text{From condition i), } m_{xy} = m(y, y) \text{ and } m_{yz} \leq m_{xz}. \quad (4)$$

From (3) and (4), we can write $m(x, z^*neut(y)) \leq m(x, y) + m(y, z) - m(y, y)$.

Therefore, from Definition 3, $((N, *), m)$ is a NTPMS.

Theorem 3: Let $((N, *), m)$ be a NTmMS. If $m(x, x) = 0$, for all $x \in N$, then $((N, *), m)$ is a NTMS.

Proof: We suppose that $(N, *)$ is a NTS and $((N, *), m)$ is a NTmMS.

a) Since $((N, *), m)$ is a NTmMS, for all $x, y \in N$; $x*y \in N$;

b) Since $m(x, x) = 0$, for all $x \in N$, we can write that if $x = y$, then $m(x, y) = 0$.

c) From Definition 8, we can take, $m_{xy} = \min\{m(x, x), m(y, y)\} \leq m(x, y)$. Thus, $m_{xy} = 0 \leq m(x, y)$.

d) From Definition 8, $m(x, y) = m(y, x)$;

e) From Definition 8, we suppose that there is at least an element $y \in N$ for each $x, z \in N$ pair of element such that $m(x, z) \leq m(x, z^*neut(y))$, then

$$m(x, z^*neut(y)) - m_{xz} \leq m(x, y) - m_{xy} + m(y, z) - m_{yz}. \quad (5)$$

Where, $m_{xz} = m_{xy} = m_{yz} = 0$. Thus, from (5), we can write

$$m(x, z^*neut(y)) \leq m(x, y) + m(y, z).$$

Therefore, from Definition 2, $((N, *), m)$ is a NTMS.

Definition 9: Let $((N, *), m)$ be a NTmMS and $\{x_n\}$ be a sequence in this space. For all $\varepsilon > 0$,

$m(x_n, x) - m_{x_n, x} < \varepsilon$ if and only if $\{x_n\}$ is called neutrosophic triplet m - convergent to $x \in N$. It is shown by $\lim_{n \rightarrow \infty} x_n = x$ or $x_n \rightarrow x$.

Definition 10: Let $((N, *), m)$ be a NTmMS and $\{x_n\}$ be a sequence in this space. $\{x_n\}$ is called neutrosophic triplet m-Cauchy sequence, if for all $\varepsilon > 0$, $m(x_n, x_m) - m_{x_n, x_m} < \varepsilon$ and $M_{x_n, x_m} - m_{x_n, x_m} < \varepsilon$.

Definition 11: Let $((N, *), m)$ be a NTmMS. If every neutrosophic triplet m-Cauchy sequence is convergent in this space, then $((N, *), m)$ is called m- complete NTmMS.

Theorem 4: Let $((N, *), m)$ be a NTmMS and $\{x_n\}$ be a neutrosophic triplet m - convergent sequence in this space. If there is at least an element $x \in N$ for each $x_n, x_m \in N$ pair of element such that

$m(x_n, x_m) \leq m(x_n, x_m * \text{neut}(x))$, then $\{x_n\}$ is a neutrosophic triplet m – Cauchy sequence.

Proof: Since $\{x_n\}$ is a neutrosophic triplet m – convergent sequence, we can take $m(x, x_n) - m_{x, x_n} < \varepsilon/2$. Also, from Definition 8, If there is at least an element $x \in N$ for each $x_n, x_m \in N$ pair of element such that $m(x_n, x_m) \leq m(x_n, x_m * \text{neut}(x))$, then

$m(x_n, x_m * \text{neut}(x)) - m_{x_n, x_m} \leq m(x, x_n) - m_{x, x_n} + m(x, x_m) - m_{x, x_m}$. Thus,

$m(x_n, x_m * \text{neut}(x)) - m_{x_n, x_m} \leq \varepsilon/2 + \varepsilon/2 = \varepsilon$.

Also, since $\{x_n\}$ is a neutrosophic triplet m – convergent sequence, it is clear that and $M_{x_n, x_m} - m_{x_n, x_m} < \varepsilon$. Therefore, $\{x_n\}$ is a neutrosophic triplet m – Cauchy sequence.

Conclusions

In this study, we firstly obtain NTmMS. We show that NTmMS is different from mMS, NTMS and NTPMS. Also, we show that a NTmMS will provide the properties of a NTMS and NTPMS under which conditions are met. Thus, we have added a new structure to neutrosophic triplet structures. Also, thanks to NTmMS, we can obtain new theory for fixed point theory, we can define NT m – normed space and we can obtain their properties.

Abbreviations

mMS: m – metric space

NT: Neutrosophic triplet

NTS: Neutrosophic triplet set

NTMS: Neutrosophic triplet metric space

NTPMS: Neutrosophic triplet partial metric space

NTmMS: Neutrosophic triplet m - metric space

References

- [1] Smarandache F. (1998) Neutrosophy: Neutrosophic Probability, Set and Logic, Rehoboth, Amer. Research Press
- [2] Kandasamy W. B. V. and Smarandache F. (2004) Basic neutrosophic algebraic structures and their applications to fuzzy and neutrosophic models, Hexis, Frontigan p 219

- [3] Kandasamy W. B. V. and Smarandache F. (2006) Some neutrosophic algebraic structures and neutrosophic n-algebraic structures, Hexis, Frontigan p 219
- [4] Smarandache F. and Ali M. (2016) Neutrosophic triplet as extension of matter plasma, unmatter plasma and antimatter plasma, APS Gaseous Electronics Conference doi: 10.1103/BAPS.2016.GEC.HT6.110
- [5] Smarandache F. and Ali M. (2014) The Neutrosophic Triplet Group and its Application to Physics, presented by F. S. to Universidad Nacional de Quilmes, Department of Science and Technology, Bernal, Buenos Aires, Argentina (02 June 2014)
- [6] Smarandache F. and Ali M. (2016) Neutrosophic triplet group. Neural Computing and Applications, 1-7.
- [7] Smarandache F. and Ali M. (2017) Neutrosophic Triplet Field Used in Physical Applications, (Log Number: NWS17-2017-000061), 18th Annual Meeting of the APS Northwest Section, Pacific University, Forest Grove, OR, USA (June 1-3, 2017)
- [8] Smarandache F. and Ali M. (2017) Neutrosophic Triplet Ring and its Applications, (Log Number: NWS17-2017-000062), 18th Annual Meeting of the APS Northwest Section, Pacific University, Forest Grove, OR, USA (June 1-3, 2017).
- [9] Şahin, M., & Kargin, A. (2019). Single valued neutrosophic quadruple graphs. Asian Journal of Mathematics and Computer Research, 243-250.
- [10] Broumi S., Bakali A., Talea M. and Smarandache F. (2016) Single Valued Neutrosophic Graphs: Degree, Order and Size. IEEE International Conference on Fuzzy Systems, pp. 2444-2451.
- [11] Broumi S., Bakali A., Talea M. and Smarandache F. (2016) Decision-Making Method Based On the Interval Valued Neutrosophic Graph, Future Technologies, IEEE International Conference on Fuzzy Systems pp 44-50.
- [12] Uluçay, V.; Şahin, M., Olgun, N. Time-Neutrosophic Soft Expert Sets and Its Decision Making Problem. Matematika, 2018 34(2), 246-260.
- [13] Uluçay, V., Kiliç, A., Yildiz, I., Sahin, M. (2018). A new approach for multi-attribute decision-making problems in bipolar neutrosophic sets. Neutrosophic Sets and Systems, 2018, 23(1), 142-159.
- [14] Uluçay, V., Kılıç, A., Şahin, M., & Deniz, H. (2019). A New Hybrid Distance-Based Similarity Measure for Refined Neutrosophic sets and its Application in Medical Diagnosis. *MATEMATIKA: Malaysian Journal of Industrial and Applied Mathematics*, 35(1), 83-94.
- [15] Broumi, S., Bakali, A., Talea, M., Smarandache, F., Singh, P. K., Uluçay, V., & Khan, M. (2019). Bipolar complex neutrosophic sets and its application in decision making problem. In *Fuzzy Multi-criteria Decision-Making Using Neutrosophic Sets* (pp. 677-710). Springer, Cham.

- [16] Bakbak, D., Uluçay, V., & Şahin, M. (2019). Neutrosophic soft expert multiset and their application to multiple criteria decision making. *Mathematics*, 7(1), 50.
- [17] Uluçay, V., & Şahin, M. (2020). Decision-Making Method based on Neutrosophic Soft Expert Graphs. In *Neutrosophic Graph Theory and Algorithms* (pp. 33-76). IGI Global.
- [18] Uluçay, V., Kılıç, A., Yıldız, İ., & Şahin, M. (2019). An Outranking Approach for MCDM-Problems with Neutrosophic Multi-Sets. *Neutrosophic Sets & Systems*, 30.
- [19] Uluçay, V., Şahin, M., & Hassan, N. (2018). Generalized neutrosophic soft expert set for multiple-criteria decision-making. *Symmetry*, 10(10), 437.
- [20] Sahin M., Deli I. and Uluçay V. (2016) Similarity measure of bipolar neutrosophic sets and their application to multiple criteria decision making, *Neural Comput & Applic.* DOI 10. 1007/S00521
- [21] Wang H., Smarandache F., Zhang Y. Q., Sunderraman R. (2010) Single valued neutrosophic sets. *Multispace Multistructure* 4, 410–413.
- [22] Şahin M., Olgun N, Uluçay V., Kargın A. and Smarandache F. (2017) A new similarity measure on falsity value between single valued neutrosophic sets based on the centroid points of transformed single valued neutrosophic numbers with applications to pattern recognition, *Neutrosophic Sets and Systems*, 15, 31-48, doi: org/10.5281/zenodo570934
- [23] Şahin M., Ecemiş O., Uluçay V. and Kargın A. (2017) Some new generalized aggregation operators based on centroid single valued triangular neutrosophic numbers and their applications in multi-attribute decision making, *Asian Journal of Mathematics and Computer Research* 16(2): 63-84
- [24] Chatterjee R., Majumdar P., and Samanta S. K. (2019) Similarity Measures in Neutrosophic Sets-I. Fuzzy Multi-criteria Decision-Making Using Neutrosophic Sets. Springer, Cham. 249-294.
- [25] Mohana K., and Mohanasundari M. (2019) On Some Similarity Measures of Single Valued Neutrosophic Rough Sets. *Neutrosophic Sets and Systems*, 10
- [26] Smarandache F., et al. (2019) Word-level neutrosophic sentiment similarity. *Applied Soft Computing* 80, 167-176.
- [27] Ye J. (2014) Similarity measures between interval neutrosophic sets and their applications in multicriteria decision – making. *J. Intell. Fuzzy Syst.* 26 (1) 165 – 172
- [28] Zadeh A. L. (1965) Fuzzy sets, *Information and control* ,8.3 338-353,
- [29] Atanassov T. K. (1986) Intuitionistic fuzzy sets, *Fuzzy Sets Syst*, 20:87–96
- [30] Şahin M. and Kargın A. (2019) Neutrosophic triplet metric topology, *Neutrosophic Set and Systems*, 27, 154 -162

- [31] Ali M., Smarandache F., Khan M. (2018) Study on the development of neutrosophic triplet ring and neutrosophic triplet field, *Mathematics-MDPI*, 6(4), 46
- [32] Şahin M. and Kargin A. (2017) Neutrosophic triplet normed space, *Open Physics*, 15, 697-704
- [33] Şahin M. and Kargin A. (2017) Neutrosophic triplet inner product space, *Neutrosophic Operational Research*, 2, 193-215,
- [34] Smarandache F., Şahin M., Kargin A. (2018) Neutrosophic Triplet G- Module, *Mathematics – MDPI*, 6, 53
- [35] Şahin M. and Kargin A. (2019) Neutrosophic triplet b – metric space, *Neutrosophic Triplet Research*, 1
- [36] Şahin M., Kargin A., Çoban M. A. (2018) Fixed point theorem for neutrosophic triplet partial metric space, *Symmetry – MDPI*, 10, 240
- [37] Şahin M., Kargin A. (2018) Neutrosophic triplet ν – generalized metric space, *Axioms – MDPI*, 7, 67
- [38] Şahin M. and Kargin A., Smarandache F. (2019) Neutrosophic triplet topology, *Neutrosophic Triplet Research* 1,
- [39] Şahin M., Kargin A. (2018) Neutrosophic triplet normed ring space, *Neutrosophic Set and Systems*, 21, 20 – 27
- [40] Şahin M., Kargin A. (2019), Neutrosophic triplet partial inner product space, *Neutrosophic Triplet Research* 1, 10 - 21
- [41] Şahin M., Kargin A. (2019), Neutrosophic triplet groups Based on set valued neutrosophic quadruple numbers, *Neutrosophic Set and Systems*, 30, 122 -131
- [42] Şahin M., Kargin A. (2019) Neutrosophic triplet partial ν – generalized metric space, *Neutrosophic Triplet Research* 1, 22 - 34
- [43] Şahin M., Kargin A. (2019) Neutrosophic triplet Lie Algebra, *Neutrosophic Triplet Research* 1, 68 -78
- [44] Şahin M., Kargin A. (2019) Isomorphism theorems for Neutrosophic triplet G - module, *Neutrosophic Triplet Research* 1, 54- 67
- [45] Asadi, A, Karapınar, E, Salimi, P. (2014) New extension of p-metric spaces with some fixed point results on M-metric spaces. *J. Inequal. Appl.* 18
- [46] Souayah, N.; Mlaiki, N.; Mrad, M. (2018) The GM–Contraction Principle for Mappings on M–Metric Spaces Endowed With a Graph and Fixed Point Theorems. *IEEE Access* 6, 25178–25184.
- [47] Patle, P. R., Kumar Patel, D., Aydi, H., Gopal, D., & Mlaiki, N. Nadler and Kannan (2019), Type Set Valued Mappings in M-Metric Spaces and an Application. *Mathematics*, 7(4), 373

Chapter Sixteen

***N*-Neutrosophic Supra Topological Sets and Operators**

M. Arockia Dasan, G. Jayaparthasarathy and V. F. Little Flower

Department of Mathematics, St.Jude's College, Thoothoor, Kanyakumari-629176, Tamil Nadu,
India (Manonmaniam Sundaranar University, Tirunelveli-627012, Tamil Nadu, India)

E-mail: dassfredy@gmail.com, jparthasarathy123@gmail.com, visjoy05796@gmail.com

ABSTRACT

The neutrosophic set is a set consists of three independent objects called truth-membership, indeterminacy-membership and falsity-membership to deal the concepts of uncertainty, incomplete and inconsistency. The *N*-neutrosophic supra topological space is a set equipped with *N*-neutrosophic supra topologies. The main focus of this chapter is to define regular-open sets in *N*-neutrosophic supra topological spaces and prove the collection of all *N*-neutrosophic supra topological regular-open sets need not forms a *N*-neutrosophic supra topology. Further some new *N*-neutrosophic supra topological operators with its properties are discussed.

Keywords: $N\tau_n^*$ -open sets, $N\tau_n^*$ regular-open sets, $N\tau_n^*$ *k*-open sets, $kcl_{N\tau_n^*}(A)$, $kint_{N\tau_n^*}(A)$.

INTRODUCTION

The fuzzy set theory was developed by A. Zadeh [1] to analyze with imprecise, vagueness, ambiguity information. This theory [2, 3, 4, 5] has been used in the fields of medical diagnosis, artificial intelligence, biology, control systems, probability and economics. C. L. Chang [6] was the first one to introduce the concept of fuzzy topological space. R. Lowen [7] further developed the properties of compactness in fuzzy topological spaces. Fuzzy supra topological spaces and its continuous functions were defined by Abd El-monsef and Ramadan [8]. K. Atanassov [9] introduced intuitionistic fuzzy sets by considering both the degree of membership and the degree of non-membership at the same time. Several researchers [10, 11, 12, 13] turned their attentions to the applications of intuitionistic fuzzy sets in medical diagnosis. J. Srikiruthika and A. Kalaichelvi [14] were introduced a kind of fuzzy supra topological open set namely fuzzy supra regular-open set. Dogan Coker [15] extended the concept of fuzzy topological spaces into intuitionistic fuzzy topological spaces and derived its properties. In intuitionistic fuzzy supra topological spaces, intuitionistic fuzzy supra regular-open sets was defined by N.Turnal [16]. Neutrosophic set is the generalization of fuzzy set and intuitionistic fuzzy set which is developed by Florentin Samarandache [17, 18, 19] which is a set considering the degree of membership, the degree of indeterminacy-membership and the degree of falsity-membership whose values are real standard or non-standard subset of unit interval $]0^-; 1^+[$. Recently many researchers [20, 21, 22, 23, 24, 25, 26, 27, 28, 29, 30, 31, 32, 33, 34, 35, 36, 37, 38, 39, 40] introduced several similarity measures, single-valued neutrosophic sets, neutrosophic numbers, neutrosophic multi-sets and neutrosophic soft sets in data analysis, pattern recognition, medical diagnosis. Salama et al. [41, 42] defined the neutrosophic crisp set and neutrosophic topological space. In 1963, Norman Levine [43] introduced semi-open sets and semi-continuous functions in classical topological spaces. O.Njastad [44]

introduced the α -open sets which form a topology. Mashhour et al. [45] investigated the properties of pre-open sets. Andrijevic [46] discussed the behavior of β -open sets in classical topology. Mashhour et al. [47] initiated the concept of supra topological spaces by removing one topological condition and apart from this, they discussed the basic properties of the supra semi open set and supra semi continuous function. Devi et al. [48] introduced the properties of α -open sets and α -continuous functions in supra topological spaces. Supra topological pre-open sets and its continuous functions are defined by O.R.Sayed [49]. Saeid Jafari et al. [50] investigated the properties of supra β -open sets and its continuity. In 2016, Lellis Thivagar et al. [51] developed the concept of N -topological space and its open sets namely $N\tau$ -open sets. After this, Lellis Thivagar and Arockia Dasan [52] derived some new N -topologies by the help of weak open sets and mappings in N -topological spaces. Recently, G. Jayaparthasarathy et al. [53] introduced the concept of neutrosophic supra topological space and proposed a numerical method to solve medical diagnosis problems by using single valued neutrosophic score function. Moreover, G. Jayaparthasarathy et al. [54] extended the neutrosophic supra topological space to N -neutrosophic supra topological space and established the behavior of some weak open sets in N -neutrosophic supra topological space.

The second section of this chapter deals some basic properties of N -neutrosophic supra topological spaces. The third section introduces new open sets in N -neutrosophic supra topological space called regular-open sets and establish the relations between them. In the fourth section, we discuss some N -neutrosophic supra topological weak operators and their properties. At last some of the future work of the present chapter is stated in the conclusion section.

BACKGROUND

Definition 1. [17] Let X be a non empty set. A neutrosophic set A having the form $A = \{(x, \mu_A(x), \sigma_A(x), \gamma_A(x)) : x \in X\}$, where $\mu_A(x), \sigma_A(x)$ and $\gamma_A(x) \in]0^-, 1^+[$ represent the degree of membership (namely $\mu_A(x)$), the degree of indeterminacy (namely $\sigma_A(x)$) and the degree of non membership (namely $\gamma_A(x)$) respectively for each $x \in X$ to the set A such that $0^- \leq \mu_A(x) + \sigma_A(x) + \gamma_A(x) \leq 3^+$ for all $x \in X$. For a non empty set X , $N(X)$ denotes the collection of all neutrosophic sets of X .

Definition 2. [18] The following statements are true for neutrosophic sets A and B on X :

- (1) $\mu_A(x) \leq \mu_B(x)$, $\sigma_A(x) \leq \sigma_B(x)$ and $\gamma_A(x) \geq \gamma_B(x)$ for all $x \in X$ if and only if $A \subseteq B$.
- (2) $A \subseteq B$ and $B \subseteq A$ if and only if $A = B$.
- (3) $A \cap B = \{(x, \min\{\mu_A(x), \mu_B(x)\}, \min\{\sigma_A(x), \sigma_B(x)\}, \max\{\gamma_A(x), \gamma_B(x)\}) : x \in X\}$.
- (4) $A \cup B = \{(x, \max\{\mu_A(x), \mu_B(x)\}, \max\{\sigma_A(x), \sigma_B(x)\}, \min\{\gamma_A(x), \gamma_B(x)\}) : x \in X\}$.

More generally, the intersection and the union of a collection of neutrosophic sets $\{A_i\}_{i \in \Lambda}$, are defined by $\bigcap_{i \in \Lambda} A_i = \{(x, \inf_{i \in \Lambda} \{\mu_{A_i}(x)\}, \inf_{i \in \Lambda} \{\sigma_{A_i}(x)\}, \sup_{i \in \Lambda} \{\gamma_{A_i}(x)\}) : x \in X\}$ and $\bigcup_{i \in \Lambda} A_i = \{(x, \sup_{i \in \Lambda} \{\mu_{A_i}(x)\}, \sup_{i \in \Lambda} \{\sigma_{A_i}(x)\}, \inf_{i \in \Lambda} \{\gamma_{A_i}(x)\}) : x \in X\}$.

Definition 3. [53] Let A, B be two neutrosophic sets of X , then the difference of A and B is a neutrosophic set on X , defined as $A \setminus B = \{(x, |\mu_A(x) - \mu_B(x)|, |\sigma_A(x) - \sigma_B(x)|, 1 - |\gamma_A(x) - \gamma_B(x)|) : x \in X\}$. Clearly $X^c = X \setminus X = (x, 0, 0, 1) = \emptyset$ and $\emptyset^c = X \setminus \emptyset = (x, 1, 1, 0) = X$.

Notation [53]: Let X be a non empty set. We consider the neutrosophic empty set as $\emptyset = \{(x, 0, 0, 1) : x \in X\}$ and the neutrosophic whole set as $X = \{(x, 1, 1, 0) : x \in X\}$.

Definition 4. [41] Let X be a non empty set. A subfamily τ_n of $N(X)$ is said to be a neutrosophic topology on X if the neutrosophic sets X and \emptyset belong to τ_n , τ_n is closed under arbitrary union and τ_n is closed under finite intersection. Then (X, τ_n) is called neutrosophic topological space (for short nts), members of τ_n are known as neutrosophic open sets and their complements are neutrosophic closed sets. For a neutrosophic set A of X , the interior and closure of A are respectively defined as $int_{\tau_n}(A) = \cup \{G : G \subseteq A, G \in \tau_n\}$ and $cl_{\tau_n}(A) = \cap \{F : A \subseteq F, F^c \in \tau_n\}$.

Definition 5. [53] Let X be a non empty set. A sub collection $\tau_n^* \subseteq N(X)$ is said to be a neutrosophic supra topology on X if the sets $\emptyset, X \in \tau_n^*$ and τ_n^* is closed under arbitrary union. Then the ordered pair (X, τ_n^*) is called neutrosophic supra topological space on X (for short nsts). The elements of τ_n^* are known as neutrosophic supra open sets and its complement is called neutrosophic supra closed. Every neutrosophic topology on X is neutrosophic supra topology on X .

Definition 6. [53] Let A be a neutrosophic set on nsts (X, τ_n^*) , then $int_{\tau_n^*}(A)$ and $cl_{\tau_n^*}(A)$ are respectively defined as: $int_{\tau_n^*}(A) = \cup \{G : G \subseteq A \text{ and } G \in \tau_n^*\}$ and $cl_{\tau_n^*}(A) = \cap \{F : A \subseteq F \text{ and } F^c \in \tau_n^*\}$.

Definition 7. [54] Let X be a non empty set $\tau_{n_1}^*, \tau_{n_2}^*, \dots, \tau_{n_N}^*$ be N -arbitrary neutrosophic supra topologies defined on X . Then the collection $N\tau_n^* = \{S \in N(X) : S = \cup_{i=1}^N A_i, A_i \in \tau_{n_i}^*\}$ is said to be a N -neutrosophic supra topology on X if this collection satisfies the following axioms:

- (1) $X, \emptyset \in N\tau_n^*$
- (2) $\cup_{i=1}^{\infty} S_i \in N\tau_n^*$ for all $S_i \in N\tau_n^*$

Then the N -neutrosophic supra topological space is the non empty set X together with the collection $N\tau_n^*$, denoted by $(X, N\tau_n^*)$ and its elements are known as $N\tau_n^*$ -open sets on X . A neutrosophic subset A of X is said to be $N\tau_n^*$ -closed on X if $X \setminus A$ is $N\tau_n^*$ -open on X . The set of all $N\tau_n^*$ -open sets on X and the set of all $N\tau_n^*$ -closed sets on X are respectively denoted by $N\tau_n^*O(X)$ and $N\tau_n^*C(X)$.

Definition 8. [54] Let $(X, N\tau_n^*)$ be a N -neutrosophic supra topological space and A be a neutrosophic set of X . Then

- (1) the $N\tau_n^*$ -interior of A is defined by $int_{N\tau_n^*}(A) = \cup \{G : G \subseteq A \text{ and } G \text{ is } N\tau_n^*\text{-open}\}$.
- (2) the $N\tau_n^*$ -closure of A is defined by $cl_{N\tau_n^*}(A) = \cap \{F : A \subseteq F \text{ and } F \text{ is } N\tau_n^*\text{-closed}\}$.

Definition 9. [54] A neutrosophic set A of a N -neutrosophic supra topological space $(X, N\tau_n^*)$ is called

- (1) N -neutrosophic supra α -open set if $A \subseteq int_{N\tau_n^*}(cl_{N\tau_n^*}(int_{N\tau_n^*}(A)))$.
- (2) N -neutrosophic supra semi-open set if $A \subseteq cl_{N\tau_n^*}(int_{N\tau_n^*}(A))$.
- (3) N -neutrosophic supra pre-open set if $A \subseteq int_{N\tau_n^*}(cl_{N\tau_n^*}(A))$.
- (4) N -neutrosophic supra β -open set if $A \subseteq cl_{N\tau_n^*}(int_{N\tau_n^*}(cl_{N\tau_n^*}(A)))$.

The set of all N -neutrosophic supra α -open (resp. N -neutrosophic supra semi-open, N -neutrosophic supra pre-open and N -neutrosophic supra β -open) sets of $(X, N\tau_n^*)$ is denoted by $N\tau_n^*\alpha O(X)$ (resp. $N\tau_n^*SO(X), N\tau_n^*PO(X)$ and $N\tau_n^*\beta O(X)$). The complement of set of all N -neutrosophic supra α -open (resp. N -neutrosophic supra semi-open, N -neutrosophic supra pre-open and N -neutrosophic supra β -open) sets of $(X, N\tau_n^*)$ is called N -neutrosophic supra α -closed (resp. N -neutrosophic supra semi-closed, N -

neutrosophic supra pre-closed and N -neutrosophic supra β -closed)sets, denoted by $N\tau_n^* \alpha C(X)$ (resp. $N\tau_n^* SC(X)$, $N\tau_n^* PC(X)$ and $N\tau_n^* \beta C(X)$).

Definition 10. [14] A fuzzy set A of a fuzzy supra topological space (X, τ_f^*) is called a fuzzy supra regular-open if $int_{\tau_f^*}(cl_{\tau_f^*}(A)) = A$. The complement of fuzzy supra regular-open set is called fuzzy supra regular-closed.

Definition 11. [16] An intuitionistic fuzzy set A of a intuitionistic fuzzy supra topological space (X, τ_i^*) is called intuitionistic fuzzy supra regular-open if $int_{\tau_i^*}(cl_{\tau_i^*}(A)) = A$. The complement of intuitionistic fuzzy supra regular-open set is called intuitionistic fuzzy supra regular-closed.

REGULAR-OPEN SETS IN N -NEUTROSOPHIC SUPRA TOPOLOGICAL SPACES

Definition 12. Let $(X, N\tau_n^*)$ be a N -neutrosophic supra topological space. Then a neutrosophic set A is said to be

- (1) N -neutrosophic supra regular-open (shortly $N\tau_n^* r$ -open) if $A = int_{N\tau_n^*}(cl_{N\tau_n^*}(A))$.
- (2) N -neutrosophic supra regular-closed (shortly $N\tau_n^* r$ -closed) if $A = cl_{N\tau_n^*}(int_{N\tau_n^*}(A))$.

The set of all N -neutrosophic supra regular-open sets is denoted by $N\tau_n^* rO(X)$ and the set of all N -neutrosophic supra regular-closed sets is denoted by $N\tau_n^* rC(X)$.

Theorem 13. Let $(X, N\tau_n^*)$ be a N -neutrosophic supra topological space and $A \subseteq X$. Then A is $N\tau_n^* r$ -open set if and only if A^c is $N\tau_n^* r$ -closed.

Proof: Let A be a $N\tau_n^* r$ -open set, then $A = int_{N\tau_n^*}(cl_{N\tau_n^*}(A))$, $A^c = (int_{N\tau_n^*}(cl_{N\tau_n^*}(A)))^c = cl_{N\tau_n^*}(int_{N\tau_n^*}(A^c))$. Therefore A^c is $N\tau_n^* r$ -closed. Conversely, assume that A^c is $N\tau_n^* r$ -closed. The $A^c = cl_{N\tau_n^*}(int_{N\tau_n^*}(A^c))$, $(A^c)^c = (cl_{N\tau_n^*}(int_{N\tau_n^*}(A^c)))^c = int_{N\tau_n^*}(cl_{N\tau_n^*}(A))$. Therefore $A = int_{N\tau_n^*}(cl_{N\tau_n^*}(A))$ and A is $N\tau_n^* r$ -open.

Theorem 14. Every $N\tau_n^* r$ -open set is $N\tau_n^*$ -open.

Proof: Assume that A is $N\tau_n^* r$ -open, then $A = int_{N\tau_n^*}(cl_{N\tau_n^*}(A))$ which is a $N\tau_n^*$ -open set contained in $cl_{N\tau_n^*}(A)$.

Example 15: The converse of the above theorem need not be true: Let $X = \{a, b\}$, for $N = 6$, consider the neutrosophic supra topologies $\tau_{n_1}^* O(X) = \{\emptyset, X, ((0.5, 0.6), (0.5, 0.6), (0.6, 0.5))\}$ and $\tau_{n_2}^* O(X) =$

$\{\emptyset, X, ((0.7, 0.7), (0.8, 0.7), (0.9, 0.3))\}$, $\tau_{n_3}^* O(X) = \{\emptyset, X, ((0.6, 0.3), (0.5, 0.2), (0.4, 0))\}$, $\tau_{n_4}^* O(X) = \{\emptyset, X, ((0.7, 0.7), (0.8, 0.7), (0.6, 0.3))\}$, $\tau_{n_5}^* O(X) = \{\emptyset, X, ((0.7, 0.7), (0.8, 0.7), (0.4, 0))\}$, $\tau_{n_6}^* O(X) = \{\emptyset, X, ((0.6, 0.6), (0.6, 0.6), (0.4, 0))\}$. Then the 6-neutrosophic supra topological open sets are $6\tau_n^* O(X) = \{\emptyset, X, ((0.5, 0.6), (0.5, 0.6), (0.6, 0.5)), ((0.7, 0.7), (0.8, 0.7), (0.9, 0.3)), ((0.6, 0.3), (0.5, 0.2), (0.4, 0)), ((0.7, 0.7), (0.8, 0.7), (0.6, 0.3)), ((0.7, 0.7), (0.8, 0.7), (0.4, 0)), ((0.6, 0.6), (0.6, 0.6), (0.4, 0))\}$, the 6-neutrosophic supra topological closed sets are $6\tau_n^* C(X) = \{\emptyset, X, ((0.5, 0.4), (0.5, 0.4), (0.4, 0.5)), ((0.3, 0.3), (0.2, 0.3),$

$(0.1, 0.7)), ((0.4, 0.7), (0.5, 0.8), (0.6, 1)), ((0.3, 0.3), (0.2, 0.3), (0.4, 0.7)), ((0.3, 0.3), (0.2, 0.3), (0.6, 1)), ((0.4, 0.4), (0.4, 0.4), (0.6, 1))\}$. Here the neutrosophic set $A = ((0.6, 0.6), (0.6, 0.6), (0.4, 0))$ is $6\tau_n^*$ -open in $(X, 6\tau_n^*)$, but it is not $6\tau_n^* r$ -open.

Theorem 16. Every $N\tau_n^*r$ -closed set is $N\tau_n^*$ -closed.

Proof: Assume that A is $N\tau_n^*r$ -closed, then $A = cl_{N\tau_n^*}(int_{N\tau_n^*}(A))$ which is a $N\tau_n^*$ -closed set containing $int_{N\tau_n^*}(A)$.

Example 17: The converse of the above theorem need not be true: Consider the example 15, here the neutrosophic set $A = ((0.4, 0.4), (0.4, 0.4), (0.6, 1))$ is α -closed in $(X, 6\tau_n^*)$, but it is not $6\tau_n^*r$ -closed.

Theorem 18. Let $(X, N\tau_n^*)$ be a N -neutrosophic supra topological space and A be a neutrosophic subset of X . Then the following statements are true:

- (1) $N\tau_n^*r$ -open set is $N\tau_n^*\alpha$ -open.
- (2) $N\tau_n^*r$ -open set is $N\tau_n^*$ semi-open.
- (3) $N\tau_n^*r$ -open set is $N\tau_n^*$ pre-open.
- (4) $N\tau_n^*r$ -open set is $N\tau_n^*\beta$ -open.

Proof: The proof follows from the fact that every $N\tau_n^*r$ -open set is $N\tau_n^*$ -open, every $N\tau_n^*$ -open set is $N\tau_n^*\alpha$ -open, $N\tau_n^*$ semi-open, $N\tau_n^*$ pre-open and $N\tau_n^*\beta$ -open.

Example 19: The converse of the above theorem need not be true: For example, let $X = \{a, b\}$, $N = 4$, consider the neutrosophic supra topologies are $\tau_{n_1}^*O(X) = \{\emptyset, X\}$, $\tau_{n_2}^*O(X) = \{\emptyset, X, ((0.7, 0.3), (0.4, 0.4), (0.2, 0))\}$, $\tau_{n_3}^*O(X) = \{\emptyset, X, ((0, 0.2), (0, 0), (1, 1))\}$, $\tau_{n_4}^*O(X) = \{\emptyset, X, ((0.5, 0.5), (0.2, 0.2), (0.1, 0.1))\}$. Then the quad-neutrosophic supra topological open sets are $4\tau_n^*O(X) = \{\emptyset, X, ((0.7, 0.3), (0.4, 0.4), (0.2, 0)), ((0, 0.2), (0, 0), (1, 1)), ((0.5, 0.5), (0.2, 0.2), (0.1, 0.1)), ((0.7, 0.5), (0.4, 0.4), (0, 0))\}$. Here the neutrosophic set $A = ((0.5, 0.5), (0.2, 0.2), (0.1, 0.1))$ is $4\tau_n^*\alpha$ -open, $4\tau_n^*$ semi-open, $4\tau_n^*$ pre-open, $4\tau_n^*\beta$ -open but not $4\tau_n^*r$ -open.

Remark: The following diagram shows the relationship between the N -neutrosophic supra topological open sets.

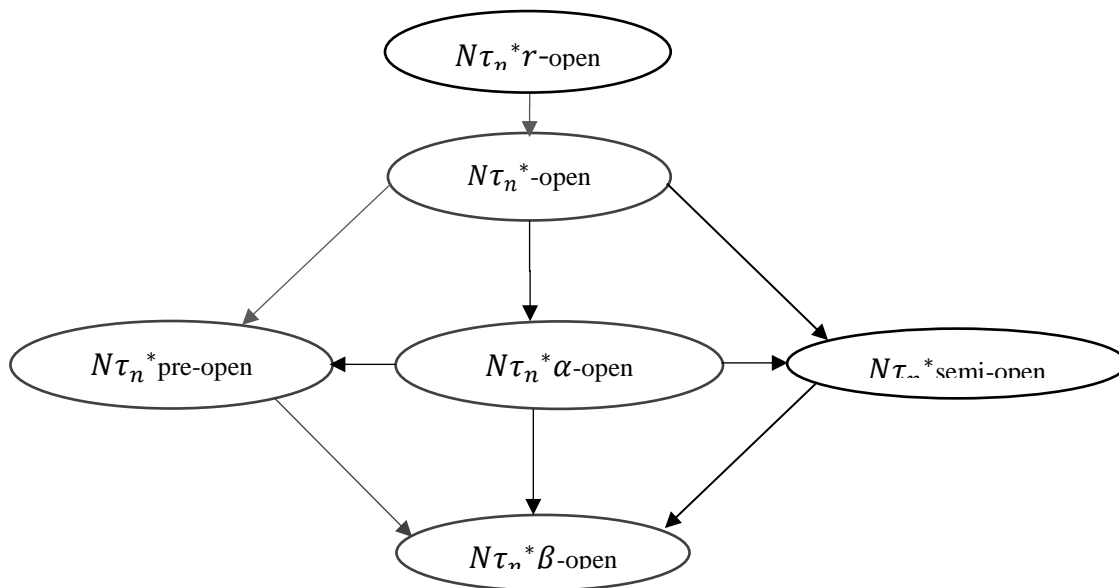

Theorem 20. Let $(X, N\tau_n^*)$ be a N -neutrosophic supra topological space and A be a neutrosophic subset of X . Then

- (1) The N -neutrosophic supra closure of a N -neutrosophic supra-open set is a N -neutrosophic supra regular-closed set.
- (2) The N -neutrosophic supra interior of a N -neutrosophic supra-closed set is a N -neutrosophic supra regular-open set.

Proof:

- (1) Assume that the neutrosophic set A is neutrosophic supra-open set and $int_{N\tau_n^*}(cl_{N\tau_n^*}(A)) \subseteq cl_{N\tau_n^*}(A)$. Then $cl_{N\tau_n^*}(int_{N\tau_n^*}(cl_{N\tau_n^*}(A))) \subseteq cl_{N\tau_n^*}(A)$. Since $A \subseteq cl_{N\tau_n^*}(A)$, $int_{N\tau_n^*}(cl_{N\tau_n^*}(A)) \supseteq int_{N\tau_n^*}(A)$ and $cl_{N\tau_n^*}(int_{N\tau_n^*}(cl_{N\tau_n^*}(A))) \supseteq cl_{N\tau_n^*}(A)$. Thus $cl_{N\tau_n^*}(int_{N\tau_n^*}(cl_{N\tau_n^*}(A))) = cl_{N\tau_n^*}(A)$. Therefore N -neutrosophic supra closure of a N -neutrosophic supra-open set is a N -neutrosophic supra regular-closed set.
- (2) Assume that the neutrosophic set A is neutrosophic supra-closed set and $cl_{N\tau_n^*}(int_{N\tau_n^*}(A)) \supseteq int_{N\tau_n^*}(A)$. Then $int_{N\tau_n^*}(cl_{N\tau_n^*}(int_{N\tau_n^*}(A))) \supseteq int_{N\tau_n^*}(A)$. Since $int_{N\tau_n^*}(A) \subseteq A$, $cl_{N\tau_n^*}(int_{N\tau_n^*}(A)) \subseteq cl_{N\tau_n^*}(A)$. Then $int_{N\tau_n^*}(cl_{N\tau_n^*}(int_{N\tau_n^*}(A))) \subseteq int_{N\tau_n^*}(A)$. Thus $int_{N\tau_n^*}(cl_{N\tau_n^*}(int_{N\tau_n^*}(A))) = int_{N\tau_n^*}(A)$. Therefore N -neutrosophic supra interior of a N -neutrosophic supra-closed set is a N -neutrosophic supra regular-open set.

Remark: Union of two N -neutrosophic supra regular-open set is need not be a N -neutrosophic supra regular-open set.

Example 21: Let $X = \{a, b\}$. For $N = 3$, consider $\tau_{n_1}^*O(X) = \{\emptyset, X, ((0.3, 0.2), (0.4, 0.3), (0.6, 0))\}$, $\tau_{n_2}^*O(X) = \{\emptyset, X, ((0.7, 0.8), (0.6, 0.7), (0.4, 1))\}$ and $\tau_{n_3}^*O(X) = \{\emptyset, X, ((0.7, 0.8), (0.6, 0.7), (0.4, 0))\}$. Then we have $3\tau_n^*O(X) = \{\emptyset, X, ((0.3, 0.2), (0.4, 0.3), (0.6, 0)), ((0.7, 0.8), (0.6, 0.7), (0.4, 1)), ((0.7, 0.8), (0.6, 0.7), (0.4, 0))\}$. Here the neutrosophic sets $A = ((0.3, 0.2), (0.4, 0.3), (0.6, 0))$ and $B = ((0.7, 0.8), (0.6, 0.7), (0.4, 1))$ are $3\tau_n^*r$ -open sets on $(X, 3\tau_n^*)$, but $A \cup B$ is not $3\tau_n^*r$ -open set.

Observation: The collection of all N -neutrosophic α -open (resp. N -neutrosophic semi-open, N -neutrosophic pre-open, N -neutrosophic β -open) sets forms a N -neutrosophic supra topology on X , but the collection of all N -neutrosophic supra regular-open set need not form a N -neutrosophic supra topology, that is, $N\tau_n^*rO(X)$ need not be a N -neutrosophic supra topology on X .

SOME OPERATORS IN N -NEUTROSOPHIC SUPRA TOPOLOGY

Definition 22. Let $(X, N\tau_n^*)$ be a N -Neutrosophic supra topological space and A be a neutrosophic subset of X .

- (1) The $N\tau_n^*$ - α closure of A , denoted by $\alpha cl_{N\tau_n^*}(A)$, and defined by $\alpha cl_{N\tau_n^*}(A) = \cap \{F : A \subseteq F \text{ and } F \in N\tau_n^*\alpha C(X)\}$.
- (2) The $N\tau_n^*$ -semi closure of A , denoted by $scl_{N\tau_n^*}(A)$, and defined by $scl_{N\tau_n^*}(A) = \cap \{F : A \subseteq F \text{ and } F \in N\tau_n^*SC(X)\}$.
- (3) The $N\tau_n^*$ -pre closure of A , denoted by $pcl_{N\tau_n^*}(A)$, and defined by $pcl_{N\tau_n^*}(A) = \cap \{F : A \subseteq F \text{ and } F \in N\tau_n^*PC(X)\}$.
- (4) The $N\tau_n^*$ - β closure of A , denoted by $\beta cl_{N\tau_n^*}(A)$, and defined by $\beta cl_{N\tau_n^*}(A) = \cap \{F : A \subseteq F \text{ and } F \in N\tau_n^*\beta C(X)\}$.
- (5) The $N\tau_n^*$ regular closure of A is defined by $rcl_{N\tau_n^*}(A) = \cap \{F : A \subseteq F \text{ and } F \text{ is } N\tau_n^*r\text{-closed}\}$.

Notation: N -neutrosophic supra k -closed set (shortly $N\tau_n^*k$ -closed) is can be any one of the following: $N\tau_n^*\alpha$ -closed set, $N\tau_n^*$ semi-closed set, $N\tau_n^*$ pre-closed set, $N\tau_n^*\beta$ -closed set and $N\tau_n^*r$ -closed set.

Theorem 23. Let $(X, N\tau_n^*)$ be a $N\tau_n^*$ -topological space on X and let $A, B \in N(X)$. Let $kcl_{N\tau_n^*}(A)$ is the intersection of all $N\tau_n^*k$ -closed sets containing A . Then

- (1) $kcl_{N\tau_n^*}(A)$ is the smallest $N\tau_n^*k$ -closed set which containing A .

- (2) A is $N\tau_n^*k$ -closed if and only if $kcl_{N\tau_n^*}(A) = A$.
 In particular, $kcl_{N\tau_n^*}(\emptyset) = \emptyset$ and $kcl_{N\tau_n^*}(X) = X$.
- (3) $A \subseteq B \Rightarrow kcl_{N\tau_n^*}(A) \subseteq kcl_{N\tau_n^*}(B)$.
- (4) $kcl_{N\tau_n^*}(A \cup B) \supseteq kcl_{N\tau_n^*}(A) \cup kcl_{N\tau_n^*}(B)$.
- (5) $kcl_{N\tau_n^*}(A \cap B) \subseteq kcl_{N\tau_n^*}(A) \cap kcl_{N\tau_n^*}(B)$.
- (6) $kcl_{N\tau_n^*}(kcl_{N\tau_n^*}(A)) = kcl_{N\tau_n^*}(A)$.

Proof:

- (1) Since the intersection of any collection of $N\tau_n^*k$ -closed set is also $N\tau_n^*k$ -closed, then $kcl_{N\tau_n^*}(A)$ is a $N\tau_n^*k$ -closed set. By definition 22, $A \subseteq kcl_{N\tau_n^*}(A)$. Now let B be any $N\tau_n^*k$ -closed set containing A . Then $kcl_{N\tau_n^*}(A) = \cap \{F : A \subseteq F \text{ and } F \text{ is } N\tau_n^*k \text{-closed}\} \subseteq B$. Therefore, $kcl_{N\tau_n^*}(A)$ is the smallest $N\tau_n^*k$ -closed set containing A .
- (2) Assume A is $N\tau_n^*k$ -closed, then A is the only smallest $N\tau_n^*k$ -closed set containing itself and therefore, $kcl_{N\tau_n^*}(A) = A$. Conversely, assume $kcl_{N\tau_n^*}(A) = A$. Then A is the smallest $N\tau_n^*k$ -closed set containing itself. Therefore, A is $N\tau_n^*k$ -closed. In particular, since \emptyset and X are $N\tau_n^*k$ -closed sets, then $kcl_{N\tau_n^*}(\emptyset) = \emptyset$ and $kcl_{N\tau_n^*}(X) = X$.
- (3) Assume $A \subseteq B$, and since $B \subseteq kcl_{N\tau_n^*}(B)$, then $A \subseteq kcl_{N\tau_n^*}(B)$. Since $kcl_{N\tau_n^*}(A)$ is the smallest $N\tau_n^*k$ -closed set containing A . Therefore, $kcl_{N\tau_n^*}(A) \subseteq kcl_{N\tau_n^*}(B)$.
- (4) Since $A \subseteq A \cup B$ and $B \subseteq A \cup B$. Then by (3), we have $kcl_{N\tau_n^*}(A) \cup kcl_{N\tau_n^*}(B) \subseteq kcl_{N\tau_n^*}(A \cup B)$.
- (5) Since $A \cap B \subseteq A$ and $A \cap B \subseteq B$, then $kcl_{N\tau_n^*}(A \cap B) \subseteq kcl_{N\tau_n^*}(A) \cap kcl_{N\tau_n^*}(B)$.
- (6) Since $kcl_{N\tau_n^*}(A)$ is a $N\tau_n^*k$ -closed set, then $kcl_{N\tau_n^*}(kcl_{N\tau_n^*}(A)) = kcl_{N\tau_n^*}(A)$.

Remark: The first two conditions of the above theorem need not be true for $rcl_{N\tau_n^*}(A)$ because intersection of two $N\tau_n^*r$ -closed sets need not be a $N\tau_n^*r$ -closed. The equalities (4) and (5) of the above theorem are not true in N -neutrosophic supra topological spaces as shown in the following examples.

Example 24: Let $X = \{a, b\}$, $N = 2$, $\tau_{n_1}^*O(X) = \{\emptyset, X, ((0.3, 0.4), (0.3, 0.4), (0.4, 0.5))\}$ and $\tau_{n_2}^*O(X) = \{\emptyset, X, ((0.4, 0.2), (0.4, 0.2), (0.5, 0.4))\}$. Then the bi-neutrosophic supra topology is $2\tau_n^*O(X) = \{\emptyset, X, ((0.3, 0.4), (0.3, 0.4), (0.4, 0.5)), ((0.4, 0.2), (0.4, 0.2), (0.5, 0.4)), ((0.4, 0.4), (0.4, 0.4), (0.4, 0.4))\}$, $2\tau_n^*C(X) = \{\emptyset, X, ((0.7, 0.6), (0.7, 0.6), (0.6, 0.5)), ((0.6, 0.8), (0.6, 0.8), (0.5, 0.6)), ((0.6, 0.6), (0.6, 0.6), (0.6, 0.6))\}$. Let $A = ((0.6, 0.4), (0.6, 0.4), (0.7, 0.4))$ and $B = ((0.6, 0.4), (0.6, 0.4), (0.3, 0.6))$ be two neutrosophic sets on X , then $scl_{2\tau_n^*}(A \cap B) = ((0.6, 0.4), (0.6, 0.4), (0.7, 0.6)) = \alpha cl_{2\tau_n^*}(A \cap B)$ and $scl_{2\tau_n^*}(A) \cap scl_{2\tau_n^*}(B) = X = \alpha cl_{2\tau_n^*}(A) \cap \alpha cl_{2\tau_n^*}(B)$. Therefore $scl_{2\tau_n^*}(A \cap B) \neq scl_{2\tau_n^*}(A) \cap scl_{2\tau_n^*}(B)$ and $\alpha cl_{2\tau_n^*}(A \cap B) \neq \alpha cl_{2\tau_n^*}(A) \cap \alpha cl_{2\tau_n^*}(B)$. Also $pcl_{2\tau_n^*}(A \cup B) = X = \beta cl_{2\tau_n^*}(A \cup B)$ and $pcl_{2\tau_n^*}(A) \cup pcl_{2\tau_n^*}(B) = ((0.6, 0.4), (0.6, 0.4), (0.3, 0.4)) = \beta cl_{2\tau_n^*}(A) \cup \beta cl_{2\tau_n^*}(B)$. Therefore $pcl_{2\tau_n^*}(A \cup B) \neq pcl_{2\tau_n^*}(A) \cup pcl_{2\tau_n^*}(B)$ and $\beta cl_{2\tau_n^*}(A \cup B) \neq \beta cl_{2\tau_n^*}(A) \cup \beta cl_{2\tau_n^*}(B)$.

Example 25: Consider the example 24, if we take the neutrosophic sets $C = ((0.6, 0.5), (0.7, 0.4), (0.3, 0.5))$ and $D = ((0.7, 0.4), (0.6, 0.5), (0.3, 0.6))$, then $pcl_{2\tau_n^*}(C \cap D) = ((0.6, 0.4), (0.6, 0.4), (0.3, 0.6)) = \beta cl_{2\tau_n^*}(C \cap D)$ and $pcl_{2\tau_n^*}(C) \cap pcl_{2\tau_n^*}(D) = ((0.7, 0.4), (0.6, 0.5), (0.3, 0.6)) = \beta cl_{2\tau_n^*}(C) \cap \beta cl_{2\tau_n^*}(D)$.

Therefore $pcl_{2\tau_n^*}(C \cap D) \neq pcl_{2\tau_n^*}(C) \cap pcl_{2\tau_n^*}(D)$ and $\beta cl_{2\tau_n^*}(C \cap D) \neq \beta cl_{2\tau_n^*}(C) \cap \beta cl_{2\tau_n^*}(D)$.

Example 26: Consider the example 24, let $E = ((0.7, 0.6), (0.7, 0.6), (0.6, 0.5))$ and $F = ((0.6, 0.8), (0.6, 0.8), (0.5, 0.6))$ be neutrosophic sets on X , then $scl_{2\tau_n^*}(E \cup F) = X = \alpha cl_{2\tau_n^*}(E \cup F)$ and $scl_{2\tau_n^*}(E) \cup scl_{2\tau_n^*}(F) = ((0.7, 0.8), (0.7, 0.8), (0.5, 0.5)) = \alpha cl_{2\tau_n^*}(E) \cup \alpha cl_{2\tau_n^*}(F)$. Therefore $scl_{2\tau_n^*}(E \cup F) \neq scl_{2\tau_n^*}(E) \cup scl_{2\tau_n^*}(F)$ and $\alpha cl_{2\tau_n^*}(E \cup F) \neq \alpha cl_{2\tau_n^*}(E) \cup \alpha cl_{2\tau_n^*}(F)$.

Example 27: Let $X = \{a, b\}$, $N = 3$, $\tau_{n_1}^*O(X) = \{\emptyset, X, ((0.3, 0.2), (0.4, 0.3), (0.6, 0))\}$, $\tau_{n_2}^*O(X) = \{\emptyset, X, ((0.7, 0.8), (0.6, 0.7), (0.4, 1))\}$, and $\tau_{n_3}^*O(X) = \{\emptyset, X, ((0.7, 0.8), (0.6, 0.7), (0.4, 0))\}$. Then the tri-neutrosophic supra topology is $3\tau_n^*O(X) = \{\emptyset, X, ((0.3, 0.2), (0.4, 0.3), (0.6, 0)), ((0.7, 0.8), (0.6, 0.7), (0.4, 1)), ((0.7, 0.8), (0.6, 0.7), (0.4, 0))\}$, $3\tau_n^*C(X) = \{\emptyset, X, ((0.7, 0.8), (0.6, 0.7), (0.4, 1)), ((0.3, 0.2), (0.4, 0.3), (0.6, 0)), ((0.3, 0.2), (0.4, 0.3), (0.6, 1))\}$. Let $A = ((0.3, 0.2), (0.4, 0.3), (0.6, 0))$ and $B = ((0.7, 0.8), (0.6, 0.7), (0.4, 1))$ be two neutrosophic sets on X . Then $rcl_{3\tau_n^*}(A \cup B) = X$ and $rcl_{3\tau_n^*}(A) \cup rcl_{3\tau_n^*}(B) = ((0.7, 0.8), (0.6, 0.7), (0.4, 0))$. Therefore $rcl_{3\tau_n^*}(A \cup B) \neq rcl_{3\tau_n^*}(A) \cup rcl_{3\tau_n^*}(B)$.

Example 28: Consider the example 27, let $C = ((0.9, 0.8), (0.6, 0.8), (0.4, 1))$ and $D = ((0.7, 0.9), (0.7, 0.7), (0.4, 1))$. Then $rcl_{3\tau_n^*}(C \cap D) = ((0.7, 0.8), (0.6, 0.7), (0.4, 1))$ and $rcl_{3\tau_n^*}(C) \cap rcl_{3\tau_n^*}(D) = X$. Therefore $rcl_{3\tau_n^*}(C \cap D) \neq rcl_{3\tau_n^*}(C) \cap rcl_{3\tau_n^*}(D)$.

Theorem 29. Let $(X, N\tau_n^*)$ be a N -neutrosophic supra topological space on X and let A be a neutrosophic subset of X . Then $\alpha cl_{N\tau_n^*}(A) \supseteq A \cup cl_{N\tau_n^*}(int_{N\tau_n^*}(cl_{N\tau_n^*}(A)))$.

Proof: Since $\alpha cl_{N\tau_n^*}(A)$ is $N\tau_n^*$ -closed, then $cl_{N\tau_n^*}(int_{N\tau_n^*}(cl_{N\tau_n^*}(A))) \subseteq \alpha cl_{N\tau_n^*}(int_{N\tau_n^*}(cl_{N\tau_n^*}(A)))$.

$(cl_{N\tau_n^*}(\alpha cl_{N\tau_n^*}(A))) \subseteq \alpha cl_{N\tau_n^*}(A)$. Therefore $\alpha cl_{N\tau_n^*}(A) \supseteq A \cup cl_{N\tau_n^*}(int_{N\tau_n^*}(cl_{N\tau_n^*}(A)))$.

Theorem 30. Let $(X, N\tau_n^*)$ be a N -neutrosophic supra topological space on X and let A be a neutrosophic subset of X . Then $scl_{N\tau_n^*}(A) \supseteq A \cup int_{N\tau_n^*}(cl_{N\tau_n^*}(A))$.

Proof: Since $scl_{N\tau_n^*}(A)$ is $N\tau_n^*$ -semi-closed, then $int_{N\tau_n^*}(cl_{N\tau_n^*}(A)) \subseteq int_{N\tau_n^*}(cl_{N\tau_n^*}(scl_{N\tau_n^*}(A))) \subseteq scl_{N\tau_n^*}(A)$. Therefore $scl_{N\tau_n^*}(A) \supseteq A \cup int_{N\tau_n^*}(cl_{N\tau_n^*}(A))$.

Theorem 31. Let $(X, N\tau_n^*)$ be a N -neutrosophic supra topological space on X and let A be a neutrosophic subset of X . Then $pcl_{N\tau_n^*}(A) \supseteq A \cup cl_{N\tau_n^*}(int_{N\tau_n^*}(A))$.

Proof: Since $pcl_{N\tau_n^*}(A)$ is $N\tau_n^*$ -pre-closed, then $cl_{N\tau_n^*}(int_{N\tau_n^*}(A)) \subseteq cl_{N\tau_n^*}(int_{N\tau_n^*}(pcl_{N\tau_n^*}(A))) \subseteq pcl_{N\tau_n^*}(A)$ and hence $A \cup cl_{N\tau_n^*}(int_{N\tau_n^*}(A)) \subseteq pcl_{N\tau_n^*}(A)$.

Theorem 32. Let $(X, N\tau_n^*)$ be a N -neutrosophic supra topological space on X and let A be a neutrosophic subset of X . Then $\beta cl_{N\tau_n^*}(A) \supseteq A \cup int_{N\tau_n^*}(cl_{N\tau_n^*}(int_{N\tau_n^*}(A)))$.

Proof: Since $\beta cl_{N\tau_n^*}(A)$ is $N\tau_n^*$ - β -closed, $int_{N\tau_n^*}(cl_{N\tau_n^*}(int_{N\tau_n^*}(A))) \subseteq int_{N\tau_n^*}(cl_{N\tau_n^*}(int_{N\tau_n^*}(\beta cl_{N\tau_n^*}(A)))) \subseteq \beta cl_{N\tau_n^*}(A)$ and hence $A \cup int_{N\tau_n^*}(cl_{N\tau_n^*}(int_{N\tau_n^*}(A))) \subseteq \beta cl_{N\tau_n^*}(A)$.

Definition 33. Let $(X, N\tau_n^*)$ be a N -Neutrosophic supra topological space and A be a neutrosophic set of X .

- (1) The $N\tau_n^*$ α interior of A , is defined by
 $\alpha \text{ int}_{N\tau_n^*}(A) = \cup \{G : G \subseteq A \text{ and } G \in N\tau_n^* \alpha O(X)\}.$
- (2) The $N\tau_n^*$ semi interior of A , is defined by
 $\text{sint}_{N\tau_n^*}(A) = \cup \{G : G \subseteq A \text{ and } G \in N\tau_n^* SO(X)\}.$
- (3) The $N\tau_n^*$ pre interior of A , is defined by
 $\text{pint}_{N\tau_n^*}(A) = \cup \{G : G \subseteq A \text{ and } G \in N\tau_n^* PO(X)\}.$
- (4) The $N\tau_n^*$ β interior of A , is defined by
 $\beta \text{ int}_{N\tau_n^*}(A) = \cup \{G : G \subseteq A \text{ and } G \in N\tau_n^* \beta O(X)\}.$
- (5) The $N\tau_n^*$ regular interior of A is defined by
 $\text{rint}_{N\tau_n^*}(A) = \cup \{G : G \subseteq A \text{ and } G \text{ is } N\tau_n^* r \text{-open}\}.$

Notation: N -neutrosophic supra k -open set (shortly $N\tau_n^*k$ -open) is can be any one of the following: $N\tau_n^*\alpha$ -open set, $N\tau_n^*$ semi-open set, $N\tau_n^*$ pre-open set, $N\tau_n^*\beta$ -open set and $N\tau_n^*r$ -open set.

Theorem 34. Let $(X, N\tau_n^*)$ be a $N\tau_n^*$ -topological space on X and let $A, B \in N(X)$. Let $\text{kint}_{N\tau_n^*}(A)$ is the union of all $N\tau_n^*k$ -open sets contained in A . Then

- (1) $\text{kint}_{N\tau_n^*}(A)$ is the largest $N\tau_n^*k$ -open set which contained in A .
- (2) A is $N\tau_n^*k$ -open if and only if $\text{kint}_{N\tau_n^*}(A) = A$. In particular, $\text{kint}_{N\tau_n^*}(\emptyset) = \emptyset$ and $\text{kint}_{N\tau_n^*}(X) = X$.
- (3) $A \subseteq B \Rightarrow N\tau_n^* \text{-kint}_{N\tau_n^*}(A) \subseteq N\tau_n^* \text{-kint}_{N\tau_n^*}(B)$.
- (4) $\text{kint}_{N\tau_n^*}(A \cup B) \supseteq \text{kint}_{N\tau_n^*}(A) \cup \text{kint}_{N\tau_n^*}(B)$.
- (5) $\text{kint}_{N\tau_n^*}(A \cap B) \subseteq \text{kint}_{N\tau_n^*}(A) \cap \text{kint}_{N\tau_n^*}(B)$.
- (6) $\text{kint}_{N\tau_n^*}(\text{kint}_{N\tau_n^*}(A)) = \text{kint}_{N\tau_n^*}(A)$.

Proof:

- (1) Since the union of any collection of $N\tau_n^*k$ -open set is also $N\tau_n^*k$ -open, then $\text{kint}_{N\tau_n^*}(A)$ is a $N\tau_n^*k$ -open set. By definition 33, $A \supseteq \text{kint}_{N\tau_n^*}(A)$. Now let B be any $N\tau_n^*k$ -open set contained in A . Then $\text{kint}_{N\tau_n^*}(A) = \cup \{G : G \subseteq A \text{ and } G \text{ is } N\tau_n^*k\text{-open}\} \supseteq B$. Therefore, $\text{kint}_{N\tau_n^*}(A)$ is the largest $N\tau_n^*k$ -open set contained in A .
- (2) Assume A is $N\tau_n^*k$ -open, then A is the only largest $N\tau_n^*k$ -open set contained in itself and therefore, $\text{kint}_{N\tau_n^*}(A) = A$. Conversely, assume $\text{kint}_{N\tau_n^*}(A) = A$. Then A is the largest $N\tau_n^*k$ -open set contained in itself. Therefore, A is $N\tau_n^*k$ -open. In particular, since \emptyset and X are $N\tau_n^*k$ -open sets, then $\text{kint}_{N\tau_n^*}(\emptyset) = \emptyset$ and $\text{kint}_{N\tau_n^*}(X) = X$.
- (3) Assume $A \subseteq B$ and since $\text{kint}_{N\tau_n^*}(B) \subseteq B$, then $\text{kint}_{N\tau_n^*}(A) \subseteq A$. Since $\text{kint}_{N\tau_n^*}(B)$ is the largest $N\tau_n^*k$ -open set contained in B . Therefore, $\text{kint}_{N\tau_n^*}(A) \subseteq \text{kint}_{N\tau_n^*}(B)$.
- (4) Since $A \subseteq A \cup B$ and $B \subseteq A \cup B$. Then $\text{kint}_{N\tau_n^*}(A) \cup \text{kint}_{N\tau_n^*}(B) \subseteq \text{kint}_{N\tau_n^*}(A \cup B)$.
- (5) Since $A \cap B \subseteq A$ and $A \cap B \subseteq B$, then $\text{kint}_{N\tau_n^*}(A \cap B) \subseteq \text{kint}_{N\tau_n^*}(A) \cap \text{kint}_{N\tau_n^*}(B)$.
- (6) Since $\text{kint}_{N\tau_n^*}(A)$ is a $N\tau_n^*k$ -open set, then $\text{kint}_{N\tau_n^*}(\text{kint}_{N\tau_n^*}(A)) = \text{kint}_{N\tau_n^*}(A)$.

Remark: The first two conditions of the above theorem need not be true for $\text{rint}_{N\tau_n^*}(A)$, because union of two $N\tau_n^*r$ -open sets need not be a $N\tau_n^*r$ -open. The following examples shows the equalities (4) and (5) of the above theorem are not true in N -neutrosophic supra topological spaces.

Example 35: Let $X = \{a, b\}$, $N = 3$, $\tau_{n_1}^*O(X) = \{\emptyset, X, ((0.3, 0.4), (0.3, 0.4), (0.4, 0.5))\}$, $\tau_{n_2}^*O(X) = \{\emptyset, X, ((0.4, 0.2), (0.4, 0.2), 0.5, 0.4)\}$ and $\tau_{n_3}^*O(X) =$

$\{\emptyset, X, ((0.4, 0.4), (0.4, 0.4), (0.4, 0.4))\}$. Then tri-neutrosophic supra topology $3\tau_n^*O(X) = \{\emptyset, X, ((0.3, 0.4), (0.3, 0.4), (0.4, 0.5)), ((0.4, 0.2), (0.4, 0.2), (0.5, 0.4)), ((0.4, 0.4), (0.4, 0.4), (0.4, 0.4))\}$ $3\tau_n^*C(X) = \{\emptyset, X, ((0.7, 0.6), (0.7, 0.6), (0.6, 0.5)), ((0.6, 0.8), (0.6, 0.8), (0.5, 0.6)), ((0.6, 0.6), (0.6, 0.6), (0.6, 0.6))\}$. Let $A = ((0.4, 0.6), (0.4, 0.6), (0.3, 0.6))$ and $B = ((0.4, 0.6), (0.4, 0.6), (0.7, 0.4))$ be two neutrosophic sets on X . Then $sint_{3\tau_n^*}(A \cup B) = ((0.4, 0.6), (0.4, 0.6), (0.3, 0.4)) = \alpha int_{3\tau_n^*}(A \cup B)$ and $sint_{3\tau_n^*}(A) \cup sint_{3\tau_n^*}(B) = \emptyset = \alpha int_{3\tau_n^*}(A) \cup \alpha int_{3\tau_n^*}(B)$. Therefore $sint_{3\tau_n^*}(A \cup B) \neq sint_{3\tau_n^*}(A) \cup sint_{3\tau_n^*}(B)$ and $\alpha int_{3\tau_n^*}(A \cup B) \neq \alpha int_{3\tau_n^*}(A) \cup \alpha int_{3\tau_n^*}(B)$. We also have $pint_{3\tau_n^*}(A \cap B) = \emptyset = \beta int_{3\tau_n^*}(A \cap B)$ and $pint_{3\tau_n^*}(A) \cap pint_{3\tau_n^*}(B) = ((0.4, 0.6), (0.4, 0.6), (0.7, 0.6)) = \beta int_{3\tau_n^*}(A) \cap \beta int_{3\tau_n^*}(B)$. Therefore $pint_{3\tau_n^*}(A \cap B) \neq pint_{3\tau_n^*}(A) \cap pint_{3\tau_n^*}(B)$ and $\beta int_{3\tau_n^*}(A \cap B) \neq \beta int_{3\tau_n^*}(A) \cap \beta int_{3\tau_n^*}(B)$.

Example 36: Consider the example 35, let $C = ((0.4, 0.5), (0.3, 0.6), (0.7, 0.5))$ and $D = ((0.3, 0.6), (0.4, 0.5), (0.7, 0.4))$ be two neutrosophic sets on X . Then $pint_{3\tau_n^*}(C \cup D) = ((0.4, 0.6), (0.4, 0.6), (0.7, 0.4)) = \beta int_{3\tau_n^*}(C \cup D)$ and $pint_{3\tau_n^*}(C) \cup pint_{3\tau_n^*}(D) = ((0.3, 0.6), (0.4, 0.5), (0.7, 0.4)) = \beta int_{3\tau_n^*}(C) \cup \beta int_{3\tau_n^*}(D)$. Therefore $pint_{3\tau_n^*}(C \cup D) \neq pint_{3\tau_n^*}(C) \cup pint_{3\tau_n^*}(D)$ and $\beta int_{3\tau_n^*}(C \cup D) \neq \beta int_{3\tau_n^*}(C) \cup \beta int_{3\tau_n^*}(D)$.

Example 37: Consider the example 35, let $E = ((0.3, 0.4), (0.3, 0.4), (0.4, 0.5))$ and $F = ((0.4, 0.2), (0.4, 0.2), (0.5, 0.4))$ be two neutrosophic sets on X . Then $sint_{3\tau_n^*}(E \cap F) = \emptyset = \alpha int_{3\tau_n^*}(E \cap F)$ and $sint_{3\tau_n^*}(E) \cap sint_{3\tau_n^*}(F) = ((0.3, 0.2), (0.3, 0.2), (0.5, 0.5)) = \alpha int_{3\tau_n^*}(E) \cap \alpha int_{3\tau_n^*}(F)$. Therefore $sint_{3\tau_n^*}(E \cap F) \neq sint_{3\tau_n^*}(E) \cap sint_{3\tau_n^*}(F)$ and $\alpha int_{3\tau_n^*}(E \cap F) \neq \alpha int_{3\tau_n^*}(E) \cap \alpha int_{3\tau_n^*}(F)$.

Example 38: Consider the example 35, $rint_{3\tau_n^*}(A \cap B) = \emptyset \neq rint_{3\tau_n^*}(A) \cap rint_{3\tau_n^*}(B) = ((0.3, 0.2), (0.4, 0.3), (0.6, 1))$.

Example 39: Consider the example 35, let $E = ((0.3, 0.1), (0.3, 0.3), (0.6, 0))$ and $F = ((0.2, 0.2), (0.4, 0.2), (0.6, 0))$ be a neutrosophic set on X . Then $rint_{3\tau_n^*}(E \cup F) = ((0.3, 0.2), (0.4, 0.3), (0.6, 0)) \neq rint_{3\tau_n^*}(E) \cup rint_{3\tau_n^*}(F) = \emptyset$.

Theorem 40. Let $(X, N\tau_n^*)$ be a N -neutrosophic supra topological space on X and let A be a neutrosophic subset of X . Then

- (1) $kint_{N\tau_n^*}(X - A) = X - kcl_{N\tau_n^*}(A)$.
- (2) $kcl_{N\tau_n^*}(X - A) = X - kint_{N\tau_n^*}(A)$.

Proof: (1). We know that $kcl_{N\tau_n^*}(A) = \cap \{G : G^c \in N\tau_n^*kO(X), G \supseteq A\}$, $(kcl_{N\tau_n^*}(A))^c = \cup \{G^c :$

G^c is a N -neutrosophic supra k -open in X and $G^c \subseteq A^c\} = kint_{N\tau_n^*}(A^c)$. Thus, $(kcl_{N\tau_n^*}(A))^c = kint_{N\tau_n^*}(A^c)$.

(2). We also know that $kint_{N\tau_n^*}(A) = \cup \{G : G \in N\tau_n^*kO(X), G \subseteq A\}$, $(kint_{N\tau_n^*}(A))^c = \cap \{G^c : G^c$ is a N -neutrosophic supra k -closed in X and $G^c \supseteq A^c\} = kcl_{N\tau_n^*}(A^c)$. Thus, $(kint_{N\tau_n^*}(A))^c = kcl_{N\tau_n^*}(A^c)$.

Remark: If we take the complement of either side of part (1) and part (2) of the previous theorems, we get

- (1) $kint_{N\tau_n^*}(A) = X - kcl_{N\tau_n^*}(X - A).$
- (2) $kcl_{N\tau_n^*}(A) = X - kint_{N\tau_n^*}(X - A).$

Theorem 41. Let $(X, N\tau_n^*)$ be a N -neutrosophic supra topological space on X and let A be a neutrosophic subset of X . Then $\alpha int_{N\tau_n^*}(A) \subseteq A \cap int_{N\tau_n^*}(cl_{N\tau_n^*}(int_{N\tau_n^*}(A)))$.

Proof: $\alpha cl_{N\tau_n^*}(X - A) \supseteq (X - A) \cup cl_{N\tau_n^*}(int_{N\tau_n^*}(cl_{N\tau_n^*}(X - A)))$, then $X - \alpha cl_{N\tau_n^*}(X - A) \subseteq (X - (X - A)) \cap (X - cl_{N\tau_n^*}(int_{N\tau_n^*}(cl_{N\tau_n^*}(X - A))))$. Hence $\alpha int_{N\tau_n^*}(A) \subseteq A \cap int_{N\tau_n^*}(cl_{N\tau_n^*}(int_{N\tau_n^*}(A)))$.

Theorem 42. Let $(X, N\tau_n^*)$ be a N -neutrosophic supra topological space on X and let A be a neutrosophic subset of X . Then $sint_{N\tau_n^*}(A) \subseteq A \cap cl_{N\tau_n^*}(int_{N\tau_n^*}(A))$.

Proof: $scl_{N\tau_n^*}(X - A) \supseteq (X - A) \cup int_{N\tau_n^*}(cl_{N\tau_n^*}(X - A))$, then $X - scl_{N\tau_n^*}(X - A) \subseteq (X - (X - A)) \cap (X - int_{N\tau_n^*}(cl_{N\tau_n^*}(X - A)))$. Hence $sint_{N\tau_n^*}(A) \subseteq A \cap cl_{N\tau_n^*}(int_{N\tau_n^*}(A))$.

Theorem 43. Let $(X, N\tau_n^*)$ be a N -neutrosophic supra topological space on X and let A be a neutrosophic subset of X . Then $pint_{N\tau_n^*}(A) \subseteq A \cap int_{N\tau_n^*}(cl_{N\tau_n^*}(A))$.

Proof: $pcl_{N\tau_n^*}(X - A) \supseteq (X - A) \cup cl_{N\tau_n^*}(int_{N\tau_n^*}(X - A))$, then $X - pcl_{N\tau_n^*}(X - A) \subseteq (X - (X - A)) \cap (X - cl_{N\tau_n^*}(int_{N\tau_n^*}(X - A)))$. Hence $pint_{N\tau_n^*}(A) \subseteq A \cap int_{N\tau_n^*}(cl_{N\tau_n^*}(A))$.

Theorem 44. Let $(X, N\tau_n^*)$ be a N -neutrosophic supra topological space on X and let A be a neutrosophic subset of X . Then $\beta int_{N\tau_n^*}(A) \subseteq A \cap cl_{N\tau_n^*}(int_{N\tau_n^*}(cl_{N\tau_n^*}(A)))$.

Proof: $\beta cl_{N\tau_n^*}(X - A) \supseteq (X - A) \cup int_{N\tau_n^*}(cl_{N\tau_n^*}(int_{N\tau_n^*}(X - A)))$, then $X - \beta cl_{N\tau_n^*}(X - A) \subseteq (X - (X - A)) \cap (X - int_{N\tau_n^*}(cl_{N\tau_n^*}(int_{N\tau_n^*}(X - A))))$. Hence $\beta int_{N\tau_n^*}(A) \subseteq A \cap cl_{N\tau_n^*}(int_{N\tau_n^*}(cl_{N\tau_n^*}(A)))$.

Theorem 45. Let $(X, N\tau_n^*)$ be a N -Neutrosophic supra topological space on X and let A be a neutrosophic subset of X . Then

- (1) $\beta cl_{N\tau_n^*}(A) \subseteq scl_{N\tau_n^*}(A) \subseteq \alpha cl_{N\tau_n^*}(A) \subseteq cl_{N\tau_n^*}(A) \subseteq rcl_{N\tau_n^*}(A).$
- (2) $\beta cl_{N\tau_n^*}(A) \subseteq pcl_{N\tau_n^*}(A) \subseteq \alpha cl_{N\tau_n^*}(A) \subseteq cl_{N\tau_n^*}(A) \subseteq rcl_{N\tau_n^*}(A).$

Proof: The proof follows from the fact that every $N\tau_n^*$ - r -closed set is $N\tau_n^*$ -closed, every $N\tau_n^*$ -closed set is $N\tau_n^*$ - α -closed, every $N\tau_n^*$ - α -closed set is $N\tau_n^*$ -semi-closed as well as every $N\tau_n^*$ -pre-closed, every $N\tau_n^*$ -semi-closed set is $N\tau_n^*$ - β -closed and every $N\tau_n^*$ -pre-closed set is $N\tau_n^*$ - β -closed.

Theorem 46. Let A be a $N\tau_n^*$ - k -closed set of $(X, N\tau_n^*)$. Then $cl_{N\tau_n^*}(A) - A$ does not contain any non-empty $N\tau_n^*$ -closed set.

Proof: Assume that $F \in N\tau_n^*C(X)$ such that $F \subseteq cl_{N\tau_n^*}(A) - A$. Since $X - F$ is $N\tau_n^*$ -open, $A \subseteq X - F$ and A is $N\tau_n^*$ - k -closed set, then $cl_{N\tau_n^*}(A) \subseteq X - F$ and so $F \subseteq X - cl_{N\tau_n^*}(A)$. This implies that $F \subseteq (X - cl_{N\tau_n^*}(A)) \cap (cl_{N\tau_n^*}(A) - A) = \emptyset$ and hence $F = \emptyset$.

Corollary 47. Let A be a $N\tau_n^*k$ -closed set of $(X, N\tau_n^*)$, then A is $N\tau_n^*$ -closed if and only if $cl_{N\tau_n^*}(A) - A$ is $N\tau_n^*$ -closed.

Proof: Let A be $N\tau_n^*k$ -closed set and assume that A is $N\tau_n^*$ -closed, then $cl_{N\tau_n^*}(A) - A = \emptyset$ which is $N\tau_n^*$ -closed. Conversely, assume that $cl_{N\tau_n^*}(A) - A$ is $N\tau_n^*$ -closed. Then by the theorem 46, $cl_{N\tau_n^*}(A) - A$ does not contain any non-empty $N\tau_n^*$ -closed set and implies $cl_{N\tau_n^*}(A) - A = \emptyset$ and so A is $N\tau_n^*$ -closed.

Theorem 48. Let A be a $N\tau_n^*k$ -closed set of $(X, N\tau_n^*)$. Then $kcl_{N\tau_n^*}(A) - A$ does not contain any non-empty $N\tau_n^*$ -closed set.

Proof: Assume that $F \in N\tau_n^*C(X)$ such that $F \subseteq kcl_{N\tau_n^*}(A) - A$. Since $X - F$ is $N\tau_n^*$ -open, $A \subseteq X - F$ and A is $N\tau_n^*k$ -closed set, then $kcl_{N\tau_n^*}(A) \subseteq X - F$ and so $F \subseteq X - kcl_{N\tau_n^*}(A)$. This implies that $F \subseteq (X - kcl_{N\tau_n^*}(A)) \cap (kcl_{N\tau_n^*}(A) - A) = \emptyset$ and hence $F = \emptyset$.

Corollary 49. A neutrosophic set A of $(X, N\tau_n^*)$ is $N\tau_n^*k$ -closed if and only if $kcl_{N\tau_n^*}(A) - A$ is $N\tau_n^*$ -closed.

Proof: Assume that A is $N\tau_n^*k$ -closed, then $kcl_{N\tau_n^*}(A) - A = \emptyset$ which is $N\tau_n^*$ -closed. Conversely, assume that $kcl_{N\tau_n^*}(A) - A$ is $N\tau_n^*$ -closed. Then by the theorem 48, $kcl_{N\tau_n^*}(A) - A$ does not contain any non-empty $N\tau_n^*$ -closed set and implies $kcl_{N\tau_n^*}(A) - A = \emptyset$ and so A is $N\tau_n^*k$ -closed.

Theorem 50. Let A be a $N\tau_n^*k$ -closed set of $(X, N\tau_n^*)$. Then $kcl_{N\tau_n^*}(A) - A$ does not contain any non-empty $N\tau_n^*k$ -closed set.

Proof: Assume that $F \in N\tau_n^*kC(X)$ such that $F \subseteq kcl_{N\tau_n^*}(A) - A$. Since $X - F$ is $N\tau_n^*k$ -open, $A \subseteq X - F$ and A is $N\tau_n^*k$ -closed set, then $kcl_{N\tau_n^*}(A) \subseteq X - F$ and so $F \subseteq X - kcl_{N\tau_n^*}(A)$. This implies that $F \subseteq (X - kcl_{N\tau_n^*}(A)) \cap (kcl_{N\tau_n^*}(A) - A) = \emptyset$ and hence $F = \emptyset$.

Theorem 51. A neutrosophic set A of $(X, N\tau_n^*)$ is $N\tau_n^*k$ -closed, then $kcl_{N\tau_n^*}(A) - A$ is $N\tau_n^*k$ -closed but converse need not be true.

Proof: Let A be a $N\tau_n^*k$ -closed set, then $kcl_{N\tau_n^*}(A) - A = \emptyset$ which is $N\tau_n^*k$ -closed.

Example 52: Consider the example 24, if $A = ((0.4, 0.2), (0.4, 0.2), (0.3, 0.4))$ then $scl_{2\tau_n^*}(A) - A = ((0.6, 0.8), (0.6, 0.8), (0.7, 0.6)) = \alpha cl_{2\tau_n^*}(A) - A$ is $2\tau_n^*$ semi-closed and $2\tau_n^*\alpha$ -closed. But A is not $2\tau_n^*$ semi-closed and not $2\tau_n^*\alpha$ -closed. Let $B = ((0.6, 0.5), (0.7, 0.4), (0.3, 0.5))$ the $pcl_{2\tau_n^*}(B) - B = ((0.4, 0.5), (0.3, 0.6), (0.7, 0.5)) = \beta cl_{2\tau_n^*}(B) - B$ is $2\tau_n^*$ pre-closed and $2\tau_n^*\beta$ -closed. But B is not $2\tau_n^*$ pre-closed and not $2\tau_n^*\beta$ -closed.

Conclusions

This chapter introduced a new kind of open sets in a N -neutrosophic supra topological spaces called a N -neutrosophic supra regular-open set. Furthermore, we derived some of the properties of N -neutrosophic supra topological weak closure operator such as $\alpha cl_{N\tau_n^*}(A)$, $scl_{N\tau_n^*}(A)$, $pcl_{N\tau_n^*}(A)$, $\beta cl_{N\tau_n^*}(A)$, and $rcl_{N\tau_n^*}(A)$. In addition to this, the relations between these and other existing sets are discussed with suitable examples.

Future Research Directions

The literal meaning of topology is the study of position which grew out of geometry, expanding and loosening some of the ideas and structures appearing therein. It is often described as rubber-sheet geometry. The theory of N -neutrosophic supra topological open sets and operators can be use to other applicable research areas such as Data mining process, Medical diagnosis, Rough topology, Fuzzy topology, intuitionistic topology, Digital topology and so on.

References

- [1] Zadeh, L.A. (1968). Probability measures of fuzzy events. *Journal of Mathematical Analysis and Applications*, 23, 421–427.
- [2] Adlassnig, K.P. (1986). Fuzzy set theory in medical diagnosis. *IEEE Transactions on Systems, Man, and Cybernetics*, 16 (2), 260–265.
- [3] Sugeno, M. (2004). An Introductory survey of fuzzy control. *Information sciences*, 36, 59–83.
- [4] Innocent, P. R., & John, R.I. (2004). Computer aided fuzzy medical diagnosis. *Information Sciences*, 162, 81–104.
- [5] Roos, T.J. (1994). *Fuzzy Logic with Engineering Applications*. McGraw Hill P.C., New York.
- [6] Chang, C.L. (1968). Fuzzy topological spaces. *J. Math. Anal. and Appl.*, 24, 182–190.
- [7] Lowen, R. (1976). Fuzzy topological spaces and fuzzy compactness. *J. Math. Anal. Appl.*, 56, 621–633.
- [8] Abd El-monsef, M.E., & Ramadan, A.E. (1987). On fuzzy supra topological spaces. *Indian J. Pure and Appl.Math.*, 18(4), 322–329.
- [9] Atanassov, K. (1986). Intuitionistic fuzzy sets. *Fuzzy Sets and Systems*, 20, 87–96.
- [10] De, S.K., Biswas, A., & Roy, R. (2001). An application of intuitionistic fuzzy sets in medical diagnosis. *Fuzzy Sets and System*, 117(2) (2001), 209–213.
- [11] Szmids, E., & Kacprzyk, J. (2001). Intuitionistic fuzzy sets in some medical applications. In *International Conference on Computational Intelligence*, Springer, Berlin, Heidelberg, 148–151.
- [12] Biswas, P., Pramanik, S., & Giri, B.C. (2014). A study on information technology professionals' health problem based on intuitionistic fuzzy cosine similarity measure. *Swiss Journal of Statistical and Applied Mathematics*, 2(1), 44–50.
- [13] Khatibi, V., & Montazer, G.A. (2009). Intuitionistic fuzzy set vs. fuzzy set application in medical pattern recognition. *Artificial Intelligence in Medicine*, 47(1) (2009), 43–52.
- [14] Srikiruthika, J., & Kalaichelvi, A. (2018). Fuzzy supra regular open sets. *International Journal of Pure and Applied Mathematics*, 119(15), 731-735.
- [15] Dogan Coker. (1997). An introduction to intuitionistic Fuzzy topological spaces. *Fuzzy sets and system*, 88(1), 81–89.
- [16] Turnal, N. (2003). An over view of Intuitionistic fuzzy Supra topological Spaces. *Hacettepe Journal of Mathematics and statistics*, 32, 17-26.
- [17] Smarandache, F. (1998). *A unifying field of logics. Neutrosophy: neutrosophic probability, set and logic*. American Research Press, Rehoboth.
- [18] Smarandache, F., & Pramanik, S. (2016). *New trends in neutrosophic theory and applications*. Brussels, Belgium, EU: Pons Editions.
- [19] Smarandache, F. (2005). Neutrosophic set, a generalization of the intuitionistic fuzzy sets. *Int. J. Pure. Appl. Math.*, 24, 287–297.
- [20] Wang, H., Smarandache, F., Zhang, Y., & Sunderraman, R. (2010). Single valued neutrosophic sets. *Multi-space and Multi-structure*, 4, 410–413.

- [21] Ye, J. (2015). Neutrosophic tangent similarity measure and its application to multiple attribute decision making. *Neutrosophic Sets and Systems*, 9, 85–92.
- [22] Ye, J., & Ye, S. (2015). Medical diagnosis using distance-based similarity measures of single valued neutrosophic multisets. *Neutrosophic Sets and Systems*, 7, 47–54.
- [23] Broumi, S., & Smarandache, F. (2013). Several similarity measures of neutrosophic sets. *Neutrosophic Sets and Systems*, 1, 54–62.
- [24] Pramanik, S., & Mondal, K. (2015). Cotangent similarity measure of rough neutrosophic sets and its application to medical diagnosis. *Journal of New Theory*, 4, 90–102.
- [25] Abdel-Basset, M., Saleh, M., Gamal, A., & Smarandache, F. (2019). An approach of TOPSIS technique for developing supplier selection with group decision making under type-2 neutrosophic number. *Applied Soft Computing*, 77, 438–452.
- [26] Abdel-Basset, M., Manogaran, G., Gamal, A., & Smarandache, F. (2019). A group decision making framework based on neutrosophic TOPSIS approach for smart medical device selection. *Journal of medical systems*, 43(2), 1–13.
- [27] Abdel-Baset, M., Chang, V., & Gamal, A. (2019). Evaluation of the green supply chain management practices: A novel neutrosophic approach. *Computers in Industry*, 108, 210–220.
- [28] Karaaslan, F. (2018). Gaussian single-valued neutrosophic numbers and its application in multi-attribute decision making. *Neutrosophic Sets and Systems*, 22, 101–117.
- [29] Giri, B. C., Molla, M. U., & Biswas, P. (2018). TOPSIS Method for MADM based on Interval Trapezoidal Neutrosophic Number, *Neutrosophic Sets and Systems*, 22, 151-167.
- [30] Aal, S. I. A., Ellatif, A.M.A.A., & Hassan, M.M. (2018). Two Ranking Methods of Single Valued Triangular Neutrosophic Numbers to Rank and Evaluate Information Systems Quality, *Neutrosophic Sets and Systems*, 19, 132-141.
- [31] Şahin, M., Olgun, N., Uluçay, V., Kargin, A., & Smarandache, F. (2017). A new similarity measure on falsity value between single valued neutrosophic sets based on the centroid points of transformed single valued neutrosophic numbers with applications to pattern recognition. *Neutrosophic Sets and Systems*, 15, 31– 48.
- [32] Şahin, M., Ecemiş, O., Uluçay, V., & Kargin, A. (2017). Some new generalized aggregation operators based on centroid single valued triangular neutrosophic numbers and their applications in multi-attribute decision making. *Asian Journal of Mathematics and Computer Research*, 16(2), 63– 84.
- [33] Uluçay, V., Şahin, M., & Olgun, N. (2018). Time-Neutrosophic Soft Expert Sets and Its Decision Making Problem. *Matematika*, 34(2), 246– 260.
- [34] Uluçay, V., Kiliç, A., Yıldız, İ., & Şahin, M. (2018). A new approach for multi-attribute decision-making problems in bipolar neutrosophic sets. *Neutrosophic Sets and Systems*, 23, 142– 159.
- [35] Uluçay, V., Kiliç, A., Şahin, M., & Deniz, H. (2019). A New Hybrid Distance-Based Similarity Measure for Refined Neutrosophic sets and its Application in Medical Diagnosis. *Mathematika: Malaysian Journal of Industrial And Applied Mathematics*, 35(1), 83– 94.
- [36] Broumi, S., Bakali, A., Talea, M., Smarandache, F., Singh, P. K., Uluçay, V., & Khan, M. (2019). Bipolar complex neutrosophic sets and its application in decision making problem. *Fuzzy Multi-criteria Decision-Making Using Neutrosophic Sets*. Springer, Cham, 677– 710.
- [37] Bakbak, D., Uluçay, V., & Şahin, M. (2019). Neutrosophic soft expert multiset and their application to multiple criteria decision making. *Mathematics*, 7(1), 50.
- [38] Uluçay, V., & Şahin, M. (2020). Decision-Making Method based on Neutrosophic Soft Expert Graphs. *Neutrosophic Graph Theory and Algorithms*, IGI Global, 33– 76.
- [39] Uluçay, V., Kiliç, A., Yıldız, İ., & Şahin, M. (2019). An Outranking Approach for MCDM-Problems with Neutrosophic Multi-Sets. *Neutrosophic Sets and Systems*, 30, 213–224.
- [40] Uluçay, V., Şahin, M., & Hassan, N. (2018). Generalized neutrosophic soft expert set for multiple-criteria decision-making. *Symmetry*, 10(10), 437.

- [41] Salama, A. A., & Alblowi, S.A. (2012). Neutrosophic Set and Neutrosophic Topological Spaces. IOSR Journal of Mathematics, 3(4), 31–35.
- [42] Salama, A.A., Smarandach, F., & Valeri Kroumov. (2014). Neutrosophic Crisp Sets and Neutrosophic Crisp Topological Spaces. Neutrosophic Sets and Systems, 2, 25–30.
- [43] Levine, N. (1963). Semi-open sets and semi-continuity in topological spaces. Amer. Math. Monthly, 70, 36 – 41.
- [44] Njastad, O. (1965). On some classes of nearly open sets. Pacific J. Math., 15, 961 – 970.
- [45] Mashhour, A.S., Abd El-Monsef, M.E., El-Deeb, S.N. (1982). On pre continuous and weak pre continuous mappings. Proc. Math. Phys. Soc., Egypt, 53, 47 – 53.
- [46] Andrijevic, D. (1986). Semi-pre open sets. Math. Vesnik, 38(1), 24 – 32.
- [47] Mashhour, A.S., Allam, A.A., Mohmoud, F.S. & Khedr, F.H. (1983). On supra topological spaces. Indian J. Pure and Appl.Math., 14(4), 502–510.
- [48] Devi, R., Sampathkumar, S., & Caldas, M. On supra α -open sets and supr α -continuous functions. General Mathematics, 16 (2), 77– 84.
- [49] Sayed, O. R. (2010). Supra pre open sets and supra pre-continuity on topological spaces. VasileAlecsandri University of Bacau Faculty of Sciences, Scientific Studies and Research Series Mathematics and Informatics, 20(2), 79– 88.
- [50] Saeid Jafari., & Sanjay Tahiliani. (2013). supra β -open sets and supra β -continuity on topological spaces. Annales Univ. SCI. Budapest., 56, 1–9.
- [51] Lellis Thivagar, M., Ramesh, V., & Arockia Dasan, M. (2016). On new structure of N -topology. Cogent Mathematics, 3, 1204104.
- [52] LellisThivagar, M., & Arockia Dasan, M. (2019). New Topologies via Weak N -Topological Open Sets and Mappings. Journal of New Theory, 29, 49–57.
- [53] Jayaparthasarathy, G., Little Flower, V. F., & Arockia Dasan, M. (2019). Neutrosophic Supra Topological Applications in Data Mining Process. Neutrosophic Sets and System, 27, 80–97.
- [54] Jayaparthasarathy, G., Arockia Dasan, M., Little Flower, V. F & Ribin Christal, R. (2020). New Open Sets in N -Neutrosophic Supra Topological Spaces. Neutrosophic Sets and Systems, 31, 44–62.

Chapter Seventeen

The Effect Of The Neutrosophic Logic On The Decision Tree

Necati Olgun, Ahmed Hatip

Department of Mathematics, Gaziantep University

E-mail: olgun@gantep.edu.tr, kollnaar5@gmail.com

ABSTRACT

In this research, we present neutrosophic decision-making, which is an extension of the classical decision-making process by expanding the data to cover the non-specific cases ignored by the classical logic which, in fact, supports the decision-making problem. The lack of information besides its inaccuracy is an important constraint that affects the effectiveness of the decision-making process, and we will rely on the decision tree model, which is one of the most powerful mathematical methods used to analyze many decision-making problems where we extend it according to the neutrosophic logic by adding some indeterminate data (in the absence of probability) or by substituting the classical probabilities with the neutrosophic probabilities (in case of probability). We call this extended model the neutrosophic decision tree, which results in reaching the best decision among the available alternatives because it is based on data that is more general and accurate than the classical model.

Keywords: Decision-making process, Neutrosophic logic, Neutrosophic Decision-making, Neutrosophic Expected Monetary Value (NEMV).

1. Introduction

In our life, there are three kinds of logic. The first is a classical logic which gives the form "true or false, 0 or 1" to the values. The second is fuzzy logic was first advanced by Zadeh in 1960 [1]. It recognizes more than true and false values, which are considered simple. With fuzzy logic, propositions can be represented with degrees of truth and falseness. And the third is neutrosophic logic, which is an extension fuzzy logic in which indeterminacy is included I . Since the world is full of indeterminacy, the Neutrosophic found their place into contemporary research. Neutrosophic Science means development and applications of Neutrosophic Logic / Set / Measure / Integral / Probability etc. And their applications in any field. It is possible to define the Neutrosophic Measure and consequently the Neutrosophic Integral and Neutrosophic Probability in many ways, because there are various types of indeterminacies, depending on the problem we need to solve. Indeterminacy is different from randomness. Indeterminacy can be caused by physical space, materials and type of construction, by items involved in the space, or by other factors.

Florentin smarandanche introduced the notion of neutrosophy as a new branch of philosophy in 1995. After he introduced the concept of neutrosophic logic and neutrosophic set where each proposition in neutrosophic logic is approximated to have the percentage of truth in a subset T, the percentage of indeterminacy in subset I and the percentage of falsity in a subset F where T, I, F are a subset of $]0^-, 1^+[$ [2] so that this neutrosophic logic is called an extension of fuzzy logic especially to intuitionistic fuzzy logic.

For more explanation, we can give these simple examples:

If there are two candidates A and B for the presidency, and the probability that A wins are 0.46, it does not mean that the probability that B wins is 0.54, since there may be blank votes (from the voters not choosing any candidate) or black votes (from the voters that reject both candidates). For example, the probability that B wins could be 0.45, while the difference $1 - 0.46 - 0.45 = 0.09$ would be the probability of blank and black votes together. Therefore, we have a neutrosophic probability: $NP(A) = (0.46, 0.09, 0.45)$.

If a meteorology center reports that the chance of rain tomorrow is 60%, it does not mean that the chance of not raining is 40%, since there might be hidden parameters (weather factors) that the meteorology center is not aware of. There might be an unclear weather, for example, cloudy and humid day, that some people can interpret as rainy day and others as non-rainy day. The ambiguity arouses indeterminacy.

Probability in a soccer game. Classical probability is incomplete, because it computes for a team the chance of winning, or the chance of not winning, but not all three chances as in neutrosophic probability: winning, having tie game, or losing.

An urn with two types of votes: A-ballots and B-ballots, but some votes are deteriorating, and we can't determine if it's written A or B. Therefore, we have indeterminate votes. In many practical applications, we may not even know the exact number of indeterminate votes, of A-ballots, or of B-ballots. Therefore, the indeterminacy is even bigger.

In fact neutrosophic sets are the generalization of classical sets, neutrosophic groups, neutrosophic ring, neutrosophic fields, neutrosophic vector spaces... etc [3] [5] [6] [7][8] [9] [10] [14] [15] [17] [18] .

Using the idea of neutrosophic theory, Vasantha Kanasamy and Florentin Samarandanche studied neutrosophic algebraic structures in by inserting an indeterminate element I in the algebraic structure and then combine I with each element of the structure with respect to the corresponding binary operation [10].

The indeterminate element I is such that if ordinary multiplication $I * I = I^2 = I, I * I * \dots * I = I^n = I, I^{-1}$ the inverse of I is not defined and hence does not exist. Moreover, if $*$ is ordinary addition, then $I * I * \dots * I = nI$ for $n \in \mathbb{N}$ [4]. They call it neutrosophic element and the generated algebraic structure. Is then termed as neutrosophic algebraic structure.

Both M Shain and N Olgun also contributed to the definition of Isomorphism theorems for soft G-modules , neutrosophic soft lattices and Direct and Semi-Direct Product Of Neutrosophic Extended Triplet Group[13] [14] [16] [19] .

Neutrosophic logic has wide applications in science, engineering, politics, economics, etc. Therefore, neutrosophic structures are very important and a broad area of study.

Classical Decision Tree

We know from the definition of the Classical Decision Tree that it is a graphic in the form of a tree gives options and is used in choosing options in the case of one scale. Its root starts from the left and its branches spreads into the right showing the options and the possibilities of the natural causes (events). It is considered to be a suitable method to make a decision if one is not sure, and it is one of the strongest mathematical methods that is used to analyze many problems [11] [12].

To build the classical decision tree we can follow this step:

- i. Expected Monetary Value (EMV)
- ii. Calculate the future monetary value for each option

- iii. Choose the option with the highest EMV.

2.1 Example

You need to travel from one city to another to attend an important business meeting. Failure to attend the meeting will cost you 4000\$

You can take either airline X or airline Y.

Knowing the following information, which airline would you choose?

- 1- Airline X costs 900\$ and the give you a 90 % chance of arriving on time
- 2- Airline Y costs 300\$ and the give you a 70 % chance of arriving on time

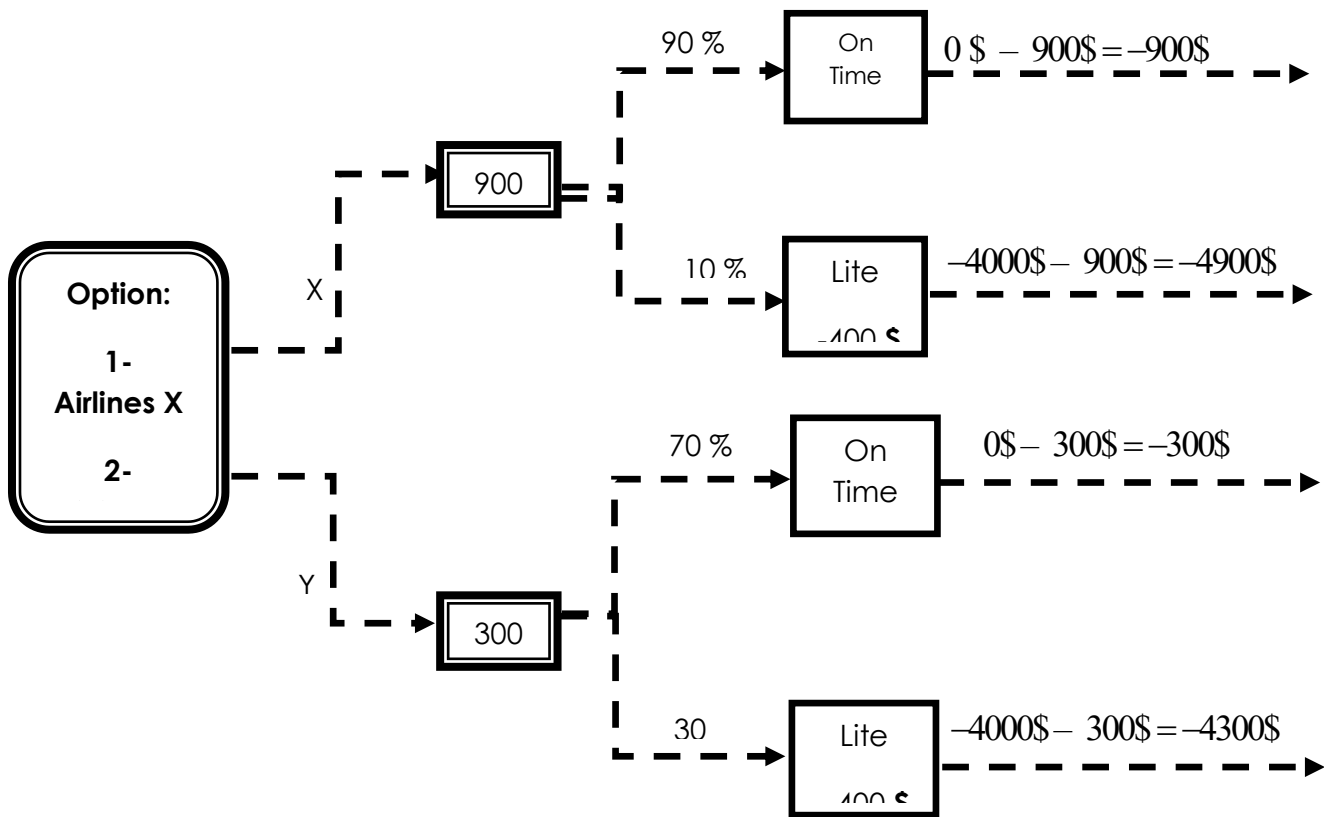

Graph (1)

$$EMV_1 = [0,1 \cdot (-4900\$)] + [0,9 \cdot (-900\$)] = -1300\$$$

$$EMV_2 = [0,7 \cdot (-300\$)] + [0,3 \cdot (-4300\$)] = -1500\$$$

According to The graphic above, traveling in Airlines X is the best option because it includes the highest Expected Monetary Value (EMV).

The Neutrosophic Decisions Tree is the Classical Decision Tree with adding some indetermination to the data or by exchanging the classical probabilities with neutrosophical probabilities.

Neutrosophic Decision Tree

Building the neutrosophic tree of decisions without including the probabilities is considered to be a suitable option when the decision makers don't have enough information that can make them estimate the probability of the events that built up the tree of decisions. It is also suitable at analyzing the best or the worst options away from probabilities. This theory agrees with the concept of the classical tree of decision. However, what the neutrosophic logic adds to the tree of decision without probabilities is that the expected benefits that matches each option, which is usually evaluated by the decision makers, according to their expertise or by related skills, will be evaluated more accurately and generally with less possible mistakes.

From another side, we may see that the expected values of the benefits whether good or bad are agreed on by some experts but others disagree. Therefore, the best solution to face this problem that absolutely affects the quality of the taken decision is to take the expected benefits with adding and reducing a value interval between (0) and another determinate value, for example (a). (0) which represents the minimum value in this interval means that there is no disagreement on the expected values among the experts or with the decision makers. (a) Which represents the maximum value in this interval means that there is a disagreement among the experts or between them and the decision makers about the expected values of benefits and (a) is the highest estimated value.

Therefore, we will present the expected value of benefits with adding and reducing the interval [0,a] not forgetting that all the various opinions about the expected values will be contained in the [0,a] interval. So that, the expected value of benefits will become an interval of values containing all the opinions.

By doing this, we move from the classical form that gives a determinant value of benefits in the neutrosophic form that doesn't do that, but gives an interval of expected values of benefits [20] .

For example, we can consider three options d_1, d_2 and d_3 by the best and the worst expectations as it is clarified in the following table(1):

	High turnout	Low turnout
d_1	$A \pm i_1$	$B \pm i_2$
d_2	$C \pm i_3$	$D \pm i_4$
d_3	$E \pm i_5$	$F \pm i_6$

Table (1)

A, B, C, D, E, F Represents the determinate part of the expected values.

$i_1, i_2, i_3, i_4, i_5, i_6$, Represents the indeterminate part of the expected values.

$$i_k \in [0, a_k]: k = 1, 2, 3, 4, 5, 6$$

3.1 Numerical Example

If the decision maker faces three options to invest in Education. These options are Science Institute, Languages Institute and Kindergarten. And for each option we have two natural causes (High turnout) and (Low turnout) depending on the following data, the benefits will change according to two variables (the options and the natural causes).

The experts evaluated the benefits saying that the Science Institute in case of (High turnout) will give the benefits of (55000) with an indeterminate value of estimation interval between [0,4000], and in case of (Low turnout) it will give the benefits of (8000) with an indeterminate value of estimation interval between [0,2000]. They also say that the Languages Institute in case of (High turnout) will give the benefits of (5000) with an indeterminate value of estimation interval between [0,18000], and in case of (Low turnout) it will give the benefits of (20000) with an indeterminate value of estimation interval between [0,1000].

And the Kindergarten in case of (High turnout) will give the benefits of (40000) with an indeterminate value of estimation interval between [0,3000], and in case of (Low turnout) it will give the benefits of (18000) with an indeterminate value of estimation interval between [0,2500].

	High turnout	Low turnout
Science Institute	$55000 \pm [0, 4000]$	$8000 \pm [0, 2000]$
Languages Institute	$50000 \pm [0, 18000]$	$20000 \pm [0, 1000]$
Kindergarten	$40000 \pm [0, 3000]$	$18000 \pm [0, 2500]$

Table (2)

	High turnout	Low turnout
Science Institute	[41000, 61000]	[6000, 10000]
Languages Institute	[32000, 68000]	[19000, 21000]
Kindergarten	[37000, 43000]	[12000, 22000]

Table (3)

The studying of approaches:

4.1 The Optimistic Approach

We know that this approach depends on evaluating the options paving the way to choose the option that guarantee the best possible benefits under the optimistic natural cases without taking the pessimistic cases for this option into consideration. This case is referred to as (Max Max) as the first (Max) refers to the highest monetary value and the second (Max) the optimistic natural case.

Max Max	
Science Institute	$\max[41000, 61000] = 61000$
Languages Institute	$\max[32000, 68000] = 68000$
Kindergarten	$\max[37000, 43000] = 43000$

Table (4)

According to The Optimistic Approach, investing in Languages Institute is the best option because it includes the most possible benefit (680000).

We notice that if we put $i_1 = i_3 = i_5 = 0$ (in the table (2)) we returns to the classical case of the tree of decisions according to The Optimistic Approach and we notice the following:

High turnout	
Science Institute	55000
Languages Institute	50000
Kindergarten	40000

Table (5)

We notice that the highest monetary value in the classical optimistic case with high turnout is (55000). This leads us to take a decision that the investment in the Science Institute is the best option.

Consequently, we notice that there is a differentiation in the taken decisions when we widen the data (that represents the expected values of benefits) neutrosophically. Moreover, it is normal to see that the resulted decision that comes from the neutrosophic form is better for investing than the classical one, because it is built upon more data including all the opinions and then the resulted decision is highly agreed on.

4.2 The pessimistic Approach

Know that this approach depends on adjusting the options paving the way to choose the option that guarantee the best possible benefits under the pessimistic normal cases without taking the optimistic cases for this option into consideration. This case is referred to as (Max, Min) as the first (Max) refers to the highest monetary value, but it is related to the second part (Min) which is the pessimistic natural case.

	Max Min
Science Institute	$\max[6000, 10000] = 10000$
Languages Institute	$\max[19000, 21000] = 21000$
Kindergarten	$\max[12000, 22000] = 22000$

Table (6)

According to The Pessimistic Approach, investing in the Kindergarten is the best option because it includes the most possible benefit (22000).

We notice that if we put $i_2 = i_4 = i_6 = 0$ (in the table (2)) we returns to the classical case of the tree of decisions according to The Pessimistic Approach and we notice the following:

	Low turnout
Science Institute	8000
Languages Institute	20000
Kindergarten	18000

Table (7)

We notice that the highest monetary value in the natural pessimistic case with low turnout is (20000). This leads us to take a decision that the investment in the Languages Institute is the best option.

By comparing this classical form with neutrosophic form, we find that the decision of choosing an option is changed. According to the neutrosophic form, this approach leads us to invest in The Kindergarten, but according to the classical form, it leads us to invest in The Languages Institute. However, when the data are defined accurately, it will absolutely lead us to the correct and best option.

4.3 The Caution Approach

This approach is not an optimistic nor a pessimistic one. It is a moderate approach that depends on adjusting the options too in order to choose the best option without losing any possible opportunity.

And choosing the most suitable option according to this approach demands to build a new matrix as the following by exchanging the option that makes the highest monetary value of zero (after taking the high value of the interval) taking into consideration that there is no lost opportunities for this option:

	High turnout	Low turnout
Science Institute	$[32000, 68000] -$ $[41000, 61000]$	$[12000, 32000] -$ $[6000, 10000]$
Languages Institute	$[32000, 680000] -$ $[32000, 680000]$	$[12000, 32000] -$ $[19000, 21000]$
Kindergarten	$[32000, 68000]$ $-[37000, 43000]$	$[12000, 32000] -$ $[12000, 32000]$

Table (8)

	High turnout	Low turnout
Science Institute	$[-9000, 7000]$	$[6000, 22000]$
Languages Institute	$[0, 0]$	$[-7000, 11000]$
Kindergarten	$[-5000, 25000]$	$[0, 0]$

Table (9)

We reduced the highest monetary value in the High turnout case from the other available monetary values in this natural case. Also, we reduced the highest monetary value in the Low turnout case from the other available monetary values in this case. Now we make a concise matrix that includes the highest values of the lost opportunities for each option as the following:

Lost opportunities	
Science Institute	[6000, 22000]
Languages Institute	[-7000, 11000]
Kindergarten	[-5000, 25000]

Table (10)

Consequently, according to this approach, The Languages Institute is the best option because it leads to less lost opportunities.

When working according to this approach in the case of the classic logic, we will come to the same decision that The Languages Institute is the best option, but this does not happen always.

When $i_1 = i_2 = i_3 = i_4 = i_5 = i_6 = 0$ we get the following table:

	High turnout	Low turnout
Science Institute	55000	8000
Languages Institute	50000	20000
Kindergarten	40000	18000

Table (11)

We built up the Caution matrix:

	High turnout	Low turnout
Science Institute	0	12000
Languages Institute	5000	0

Kindergarten	15000	2000
---------------------	--------------	-------------

Table (12)

We take the (Max) and get:

Lost opportunities	
Science Institute	12000
Languages Institute	5000
Kindergarten	15000

Table (13)

Taking into consideration that this approach has, the less lost opportunities, the most suitable option is The Languages Institute.

We notice that the classical form may agree with the neutrosophic form in the taken decision, but this does not happen always. However, it is better to depend on the method that has accurate data that leads us to choose the best option.

By studying the three approaches according the neutrosophic form we find that in most cases we get different options from the classical logic form.

In addition, we get different options according to the approaches. We look to this positively because it enriches the decision-making process and it reflects the circumstances of the decision maker and the opinions that affects him.

5. The Neutrosophic Decisions Tree in View of the Neutrosophic Probabilities

In the case of decision trees in view of the classical probabilities, the decision maker has the opportunity to evaluate the possibility of each event of the normal cases. Therefore, the monetary value approach EMV is used in order to choose the best options.

However, it is not logical to see that the possibility of the High Turnout of three options the same. For example, it is not possible to see that the probability of the Science Institute, the Languages Institute and the Kindergarten in the High Turnout to be 0.4 because that doesn't agree with the logic that says that each option has conditions and cases that differs from the other options.

We will discuss another method through the Neutrosophic Logic to discuss the decision tree in the review of probabilities depending on the Neutrosophic probabilities, and we will define another form of indeterminate data through this method.

We will clarify it as the following:

First, we will define the Neutrosophic expected monetary value and refer to it as (NEMV) depending on the expected Neutrosophic value as:

In the natural case (n) and the indeterminate case (m) we write:

$$NEMV(d_i) = \sum_{j=1}^n p(s_j) \cdot v(d_i, s_j) + \sum_{l=1}^m p(s_l) \cdot v(d_i, s_l)$$

$P(S_j)$ Refers to the probability of getting a high or low turnout

(S represents the natural cases)

$P(S_l)$ Refers to the probability of getting the indeterminate case. (I represent the indeterminacy)

$V(d_i, S_j)$ Represents the expected monetary value of the option d_i in the S_j case.

$V(d_i, S_l)$ Represents the expected monetary value of the option d_i in the S_l case.

And in our dealt example, it becomes:

$$NEMV(d_i) = p(s_{j=1}) \cdot v(d_i, s_{j=1}) + p(s_{j=2}) \cdot v(d_i, s_{j=2}) + p(s_{l=1}) \cdot v(d_i, s_{l=1})$$

$P(s_{j=1})$ The probability of high turnout

$P(s_{j=2})$ The probability of low turnout

Assuming that the neutrosophic probability in case of the high turnout for the Educational Science Institute is $NP(0.65, 0.05, 0.30)$ that means that there are three probabilities:

$P(S_{j=1}) = 0.65$ The probability of high turnout for the Science Institute

$P(S_{j=2}) = 0.30$ The probability of low turnout for the Science Institute

$P(S_{I=1}) = 0.05$ The probability of indeterminacy, which means that turnout for the Science Institute not high and not low but between the both. (We get these probabilities from research and expertise centers).

The matrix will be:

	High turnout	Low turnout	Indeterminate turnout
Science Institute	55000	8000	25000
Languages Institute	50000	20000	27000
Kindergarten	40000	18000	22000

Table (14)

The values in the matrix are expected values of options by the experts. In this case, we recognized another form of indeterminacy, which is the turnout, is neither high nor low, but between the two possibilities and we called it indeterminate turnout (and the indeterminate turnout may be gradual).

Now let us calculate the Neutrosophic expected monetary value of the first option d_1 the Science Institute as:

$$n = 2, m = 1$$

$$\begin{aligned} NEMV(d_1) &= p(s_{j=1}) \cdot v(d_1, s_{j=1}) + p(s_{j=2}) \cdot v(d_1, s_{j=2}) + p(s_{I=1}) \cdot v(d_1, s_{I=1}) \\ &= (0.65)(55000) + (0.30)(8000) + (0.05)(25000) = 39400 \end{aligned}$$

Now let us calculate the neutrosophic expected monetary value of the Languages Institute d_2

If we know that the neutrosophic probability of the high turnout of the Languages Institute are:

$$NP(0.46, 0.09, 0.45)$$

$P(S_{j=1}) = 0.46$ the probability of high turnout for the Languages Institute $P(S_{j=2}) = 0.45$ the probability of low turnout for the Languages Institute $P(S_{I=1}) = 0.09$ the probability of indeterminacy which means that turnout for the Languages Institute not high and not low but between the both.

$$NEMV (d_2) = (0.46)(50000) + (0.45)(20000) + (0.09)(27000) = 34430$$

Now let us calculate the neutrosophic expected monetary value of the Kindergarten d_3

If we know that the neutrosophic probability of the high turnout of the Kindergarten are:

$$NP(0.50, 0.08, 0.42)$$

$$P(S_{j=1}) = 0.50 \text{ The probability of high turnout for the Kindergarten}$$

$$P(S_{j=2}) = 0.42 \text{ The probability of low turnout for the Kindergarten}$$

$$P(S_{I=1}) = 0.08 \text{ The probability of indeterminacy, which means that turnout for the Kindergarten not high and not low but between the both.}$$

$$NEMV (d_3) = (0.50)(40000) + (0.42)(18000) + (0.08)(22000) = 29320$$

By calculating the neutrosophic expected monetary value we see that the first option d_1 (the Science Institute) is the suitable opt. On because it presents. Highest monetary value (39400).

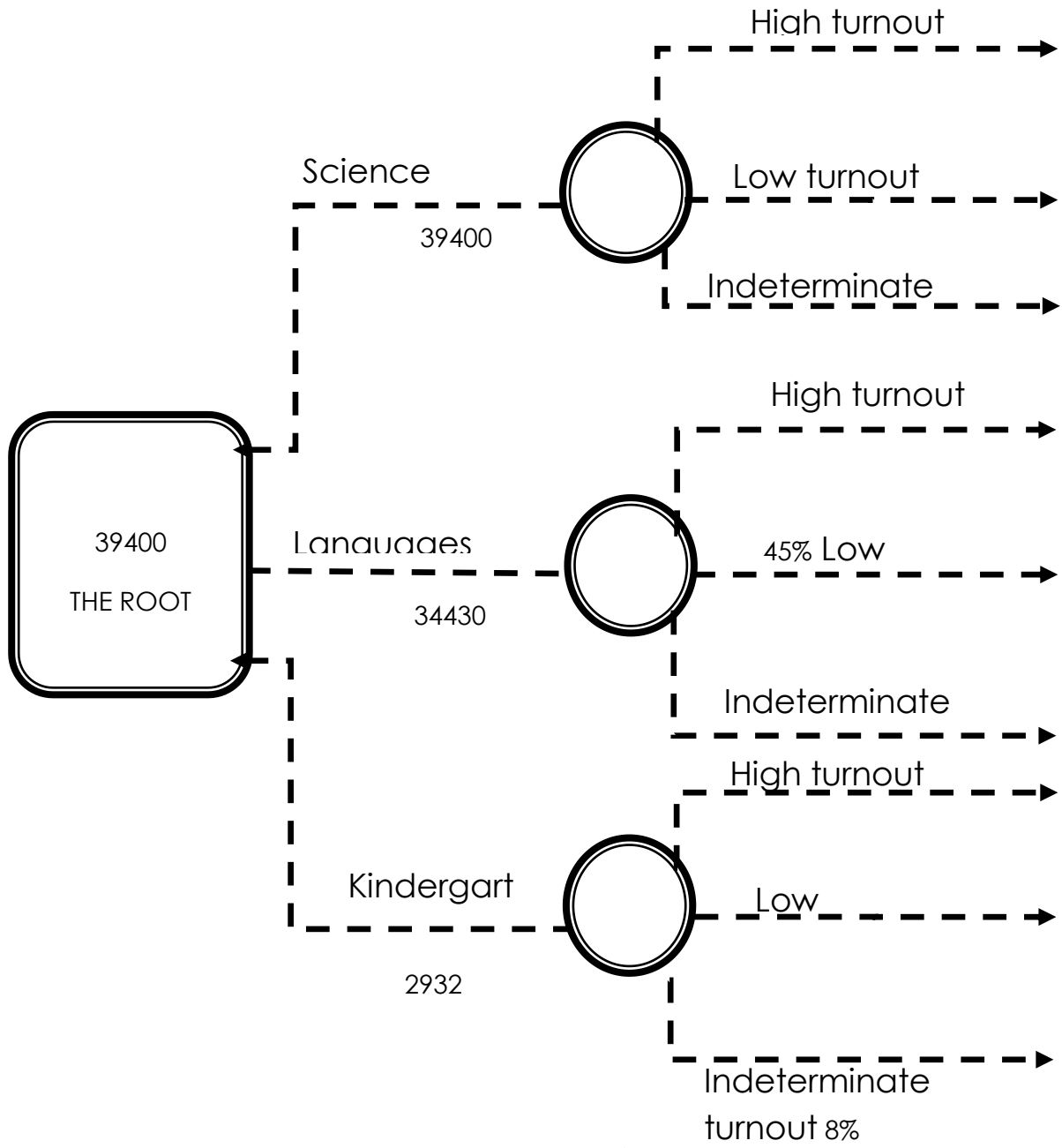

CONCLUSION

1- Dealing with the samples of the decision making process according to the Neutrosophic logic provides us with a comprehensive and complete study for the problem that we are studying. So that, we don't miss any data just because it is clearly indeterminate. This makes us to choose the best option .

2- The existence of indeterminacy in the problem actually affects the process of taking the suitable decision. Therefore, the indeterminate values can't be ignored while studying in order to get more accurate results that leads us to the best options.

3- Nowadays, the classical logic is not sufficient to deal with all the data that we study. Therefore, we had to expand the data of the study and name it accurately to get more real possibilities and, therefore, make decision more accurate. And here appears the role of the Neutrosophic logic that generalizes the classical logic and gives us a wider horizon in interpreting the data in the study and expand it and then make correct decisions with the least possible mistakes.

REFERENCES

- [1] Zadeh, L., Fuzzy sets, Inform and Control, 8, 1965, pp.338-353;
- [2] Atanassov, K. (1986). Intuitionistic fuzzy sets. Fuzzy Sets and Systems, 20 87-96.
- [3] Athar, K. (2014). A neutrosophic multi-criteria decision making method. New Mathematics and Natural Computation, 10(02), 143-162.
- [4] Broumi S. and F. Smarandache, (2013). Several similarity measures of neutrosophic sets, Neutrosophic Sets and Systems 1(1) 54-62.
- [5] Chatterjee, R. P. Majumdar, S. K. Samanta, Single valued neutrosophic multisets, Annals of Fuzzy Mathematics and Informatics, x/x (2015) xx-xx.
- [6] Deli, I., Broumi, S., Ali, M. (2014). Neutrosophic Soft Multi-Set Theory and Its Decision Making. Neutrosophic Sets and Systems, 5, 65-76.
- [7] Deli, I. (2016). Refined Neutrosophic Sets and Refined Neutrosophic Soft Sets: Theory and Applications. Handbook of Research on Generalized and Hybrid Set Structures and Applications for Soft Computing, 321-343.
- [8] Deli, I., Broumi S (2015) Neutrosophic Soft Matrices and NSM-decision Making. Journal of Intelligent and Fuzzy Systems, 28: 2233-2241.
- [9] Deli, I., S. Broumi, F. Smarandache, On neutrosophic refined sets and their applications in medical diagnosis, Journal of New Theory, 6 (2015) 88-98.
- [10] W.B. Vasantha Kandasamy and F. Smarandache. Neutrosophic Rings, Hexis, Phoenix, Arizona, 2006.
- [11] Hastie TJ, Tibshirani RJ, Friedman JH. The Elements of Statistical Learning: Data Mining Inference and Prediction. Second Edition. Springer; 2009. ISBN 978-0-387-84857-0
- [12] Fallon B, Ma J, Allan K, Pillhofer M, Trocmé N, Jud A. Opportunities for prevention and intervention with young children: lessons from the Canadian incidence study of reported child abuse and neglect. Child Adolesc Psychiatry Ment Health. 2013;7: 4

- [13] M Şahin, N Olgun, A Kargin, V Uluçay. «Isomorphism theorems for soft G-modules.» *Afrika Matematika* (2018): 7-8.
- [14] M Şahin, N Olgun, V Uluçay, A Kargin, F Smarandache. «Neutrosophic Sets and Systems.» whith..., A new similarity measure based on falsity value single valued neutrosophic sets based on the centroid points of transformed single valued neutrosophic numbers. 2017. 31-48.
- [15] M Sahin, N Olgun, V Uluçay A Kargin, F Smarandache. «A new similarity measure based on falsity value single valued neutrosophic sets based on the centroid points of transformed single valued neutrosophic numbers whith...» *Infinite Study* (2017).
- [16] MM Shalla, N Olgun. «Direct and Semi-Direct Product Of Neutrosophic Extended Triplet Group.» *Neutrosophic Sets & systems* (2019): 29.
- [17] NO Mehmet Çelik, Moges Mekonnen Shalla. «Fundamental Homomorphism Theorems for Neutrosophic Extended Triplet Groups.» *Symmetry* (2018).
- [18] V Ulucay, M Sahin, N Olgun. «Time-neutrosophic soft expert sers and its descision making problem.» *infinite study* (2018).
- [19] V Uluçay, M Şahin, N Olgun, A Kilicman. «On neutrosophic soft lattices.» *Afrika Matematika* (2017): 3-4.
- [20] V Ulucay, M Shain, N Olgun. «Time-neutrosophic soft expert sets and its decision making problem.» *Infinite Study* (2018).

Chapter Eighteen

Combined Classic – Neutrosophic Sets and Numbers, Double Neutrosophic Sets and Numbers

Memet Şahin¹, Abdullah Kargin¹ and Florentin Smarandache²

¹Department of Mathematics, Gaziantep University, Gaziantep27310-Turkey

²Department of Mathematics, University of New Mexico, Gallup, NM 87301, USA

E-mail: mesahin@gantep.edu.tr, abduhlahkargin27@gmail.com, smarand@unm.edu

ABSTRACT

Smarandache introduce neutrosophic set in 1998 and neutrosophic quadruple sets in 2016. Şahin and Kargin obtain set valued neutrosophic quadruple set and number in 2019. In this chapter, we define combined classic - neutrosophic sets, double neutrosophic sets, set valued combined classic - neutrosophic sets and set valued double neutrosophic sets. These sets contain exact true value and exact false value, unlike neutrosophic set and neutrosophic quintet set. Also, these sets contain T, I, F, like neutrosophic set and neutrosophic quintet set. Thus, these sets are generalized of neutrosophic sets, neutrosophic quadruple sets and set valued neutrosophic quadruple sets. Furthermore, we give new definitions and new results for combined classic - neutrosophic sets, double neutrosophic sets, set valued combined classic - neutrosophic sets and set valued double neutrosophic sets.

Keywords: neutrosophic quadruple set, set valued neutrosophic quadruple set, combined classic - neutrosophic sets, double neutrosophic sets

INTRODUCTION

Smarandache defined neutrosophic logic and neutrosophic set [1] in 1998. In neutrosophic logic and neutrosophic sets, there is T degree of membership, I degree of undeterminacy and F degree of non-membership. These degrees are defined independently of each other. It has a neutrosophic value (T, I, F) form. Also, many researchers have made studies on this theory [2 - 27]. In fact, neutrosophic set is a generalized state of fuzzy set [28] and intuitionistic fuzzy set [29].

Furthermore, Smarandache introduced NQS and NQN [30]. The NQs are generalized state of neutrosophic sets. A NQS is shown by $\{(x, y_T, z_I, t_F): x, y, z, t \in \mathbb{R} \text{ or } \mathbb{C}\}$. Where, x is called the known part and (y_T, z_I, t_F) is called the unknown part and T, I, F have their usual neutrosophic logic means. Recently, researchers

studied NQS and NQN. Recently, Akinleye, Smarandache, Agboola studied NQ algebraic structures [31]; Jun, Song, Smarandache obtained NQ BCK/BCI-algebras [32]; Muhiuddin, Al-Kenani, Roh, Jun introduced implicative NQ BCK-algebras and ideals [33]; Li, Ma, Zhang, Zhang studied NT extended group based on NQNs [34]; Şahin and Kargin obtained SVNQN and NTG based on SVNQN [35]; Şahin and Kargin studied single valued NQ graphs [36].

In this chapter, in Section 2, we give definitions and properties for NQS and NQN [30], SVNQS and SVNQN [35]. In Section 3, we define combined classic - neutrosophic sets and numbers, set valued combined classic - neutrosophic sets and numbers. We give definitions, operations and results for combined classic - neutrosophic sets and number, set valued combined classic - neutrosophic sets and numbers. In combined classic - neutrosophic sets and number, similar to NQS and NQN, there are T, I, F values. Also, other components are real number or complex number. In set combined classic - neutrosophic sets and number, similar to SVNQS and SVNQN, there are T, I, F values. Also, other components are sets. In Section 4, we define double neutrosophic set and number, set valued double neutrosophic set and number. Actually, in double neutrosophic set and number, set valued double neutrosophic set and number; there are two neutrosophic set and number. First neutrosophic set is known part and second neutrosophic set is unknown part. Also, we give definitions, operations and results for set valued neutrosophic quintet sets and number. In double neutrosophic sets and number, similar to NQS and NQN, there are T, I, F values. Also, other components are real number or complex number. In set valued double neutrosophic sets and number, similar to SVNQS and SVNQN, there are T, I, F values. Also, other components are sets. In Section 5, we give conclusions.

BACKGROUND

Definition 1: [30] A NQN is a number of the form (x, yT, zI, tF) , where T, I, F have their usual neutrosophic logic means and $x, y, z, t \in \mathbb{R}$ or \mathbb{C} . The NQS defined by

$$NQ = \{(x, yT, zI, tF) : x, y, z, t \in \mathbb{R} \text{ or } \mathbb{C}\}.$$

For a NQN (x, yT, zI, tF) , representing any entity which may be a number, an idea, an object, etc., x is called the known part and (yT, zI, tF) is called the unknown part.

Definition 2: [30] Let $a = (a_1, a_2T, a_3I, a_4F)$ and $b = (b_1, b_2T, b_3I, b_4F) \in NQ$ be NQNs. We define the following:

$$a + b = (a_1 + b_1, (a_2 + b_2)T, (a_3 + b_3)I, (a_4 + b_4)F)$$

$$a - b = (a_1 - b_1, (a_2 - b_2)T, (a_3 - b_3)I, (a_4 - b_4)F)$$

Definition 3: [30] Consider the set $\{T, I, F\}$. Suppose in an optimistic way we consider the prevalence order $T > I > F$. Then we have:

$$TI = IT = \max\{T, I\} = T,$$

$$TF = FT = \max\{T, F\} = T,$$

$$FI = IF = \max\{F, I\} = I,$$

$$TT = T^2 = T,$$

$$II = I^2 = I,$$

$$FF = F^2 = F.$$

Analogously, suppose in a pessimistic way we consider the prevalence order $T < I < F$. Then we have:

$$TI = IT = \max\{T, I\} = I,$$

$$TF = FT = \max\{T, F\} = F,$$

$$FI = IF = \max\{F, I\} = F,$$

$$TT = T^2 = T,$$

$$II = I^2 = I,$$

$$FF = F^2 = F.$$

Definition 4: [30] Let $a = (a_1, a_2T, a_3I, a_4F)$, $b = (b_1, b_2T, b_3I, b_4F) \in NQ$ and $T < I < F$. Then

$$\begin{aligned} a*b &= (a_1, a_2T, a_3I, a_4F) * (b_1, b_2T, b_3I, b_4F) \\ &= (a_1b_1, (a_1b_2 + a_2b_1 + a_2b_2)T, (a_1b_3 + a_2b_3 + a_3b_1 + a_3b_2 + a_3b_3)I, \\ &\quad (a_1b_4 + a_2b_4 + a_3b_4 + a_4b_1 + a_4b_2 + a_4b_3 + a_4b_4)F) \end{aligned}$$

Definition 5: [30] Let $a = (a_1, a_2T, a_3I, a_4F)$, $b = (b_1, b_2T, b_3I, b_4F) \in NQ$ and $T > I > F$. Then

$$\begin{aligned} a\#b &= (a_1, a_2T, a_3I, a_4F) \# (b_1, b_2T, b_3I, b_4F) \\ &= (a_1b_1, (a_1b_2 + a_2b_1 + a_2b_2 + a_3b_2 + a_4b_2 + a_2b_3 + a_2b_4)T, \\ &\quad (a_1b_3 + a_3b_3 + a_3b_4 + a_4b_3)I, (a_1b_4 + a_4b_1 + a_4b_4)F) \end{aligned}$$

Definition 6: [35] Let N be a non – empty set and $P(N)$ be power set of N . A SVNQN shown by the form (A_1, A_2T, A_3I, A_4F) . Where, T, I and F are degree of membership, degree of undeterminacy, degree of non-membership in neutrosophic theory, respectively. Also, $A_1, A_2, A_3, A_4 \in P(N)$. Then, a SVNQS shown by

$$N_q = \{(A_1, A_2T, A_3I, A_4F) : A_1, A_2, A_3, A_4 \in P(N)\}.$$

Where, similar to NQS, A_1 is called the known part and (A_1, A_2T, A_3I, A_4F) is called the unknown part.

Definition 7: [35] Let $A = (A_1, A_2T, A_3I, A_4F)$ and $B = (B_1, B_2T, B_3I, B_4F)$ be SVNQNs. We define the following operations, well known operators in set theory, such that

$$A \cup B = (A_1 \cup B_1, (A_2 \cup B_2)T, (A_3 \cup B_3)I, (A_4 \cup B_4)F)$$

$$A \cap B = (A_1 \cap B_1, (A_2 \cap B_2)T, (A_3 \cap B_3)I, (A_4 \cap B_4)F)$$

$$A \setminus B = (A_1 \setminus B_1, (A_2 \setminus B_2)T, (A_3 \setminus B_3)I, (A_4 \setminus B_4)F)$$

$$A' = (A'_1, A'_2T, A'_3I, A'_4F)$$

Now, we define specific operations for SVNQN.

Definition 8: [35] Let $A = (A_1, A_2T, A_3I, A_4F)$, $B = (B_1, B_2T, B_3I, B_4F)$ be SVNQNs and $T < I < F$. We define the following operations

$$A*_1B = (A_1, A_2T, A_3I, A_4F) *_1 (B_1, B_2T, B_3I, B_4F)$$

$$=(A_1 \cap B_1, ((A_1 \cap B_2) \cup (A_2 \cap B_1) \cup (A_2 \cap B_2))T, ((A_1 \cap B_3) \cup (A_2 \cap B_3) \cup (A_3 \cap B_1) \cup (A_3 \cap B_2) \cup (A_3 \cap B_3))I, ((A_1 \cap B_4) \cup (A_2 \cap B_4) \cup (A_3 \cap B_4) \cup (A_4 \cap B_1) \cup (A_4 \cap B_2) \cup (A_4 \cap B_3) \cup (A_4 \cap B_4))F)$$

and

$$A *_2 B = (A_1, A_2 T, A_3 I, A_4 F) *_2 (B_1, B_2 T, B_3 I, B_4 F)$$

$$=(A_1 \cup B_1, ((A_1 \cup B_2) \cap (A_2 \cup B_1) \cap (A_2 \cup B_2))T, ((A_1 \cup B_3) \cap (A_2 \cup B_3) \cap (A_3 \cup B_1) \cap (A_3 \cup B_2) \cap (A_3 \cup B_3))I, ((A_1 \cup B_4) \cap (A_2 \cup B_4) \cap (A_3 \cup B_4) \cap (A_4 \cup B_1) \cap (A_4 \cup B_2) \cap (A_4 \cup B_3) \cap (A_4 \cup B_4))F).$$

Definition 9: [35] Let $A = (A_1, A_2 T, A_3 I, A_4 F)$, $B = (B_1, B_2 T, B_3 I, B_4 F)$ be SVNQNs and $T > I > F$. We define the following operations

$$A \#_1 B = (A_1, A_2 T, A_3 I, A_4 F) \#_1 (B_1, B_2 T, B_3 I, B_4 F)$$

$$=(A_1 \cap B_1, ((A_1 \cap B_2) \cup (A_2 \cap B_1) \cup (A_2 \cap B_2) \cup (A_3 \cap B_2) \cup (A_4 \cap B_2) \cup (A_2 \cap B_3) \cup (A_2 \cap B_4))T, ((A_1 \cap B_3) \cup (A_3 \cap B_3) \cup (A_3 \cap B_4) \cup (A_4 \cap B_3))I, ((A_1 \cap B_4) \cup (A_4 \cap B_2) \cup (A_4 \cap B_4))F)$$

and

$$A \#_2 B = (A_1, A_2 T, A_3 I, A_4 F) \#_2 (B_1, B_2 T, B_3 I, B_4 F)$$

$$=(A_1 \cup B_1, ((A_1 \cup B_2) \cap (A_2 \cup B_1) \cap (A_2 \cup B_2) \cap (A_3 \cup B_2) \cap (A_4 \cup B_2) \cap (A_2 \cup B_3) \cap (A_2 \cup B_4))T, ((A_1 \cup B_3) \cap (A_3 \cup B_3) \cap (A_3 \cup B_4) \cap (A_4 \cup B_3))I, ((A_1 \cup B_4) \cap (A_4 \cup B_2) \cap (A_4 \cup B_4))F).$$

Definition 10: [35] Let $A = (A_1, A_2 T, A_3 I, A_4 F)$, $B = (B_1, B_2 T, B_3 I, B_4 F)$ be SVNQNs. If $A_1 \subset B_1, A_2 \subset B_2, A_3 \subset B_3, A_4 \subset B_4$, then it is called that A is subset of B. It is shown by $A \subset B$.

Definition 11: [35] Let $A = (A_1, A_2 T, A_3 I, A_4 F)$, $B = (B_1, B_2 T, B_3 I, B_4 F)$ be SVNQNs If $A \subset B$ and $B \subset A$, then it is called that A is equal to B. It is shown by $A = B$.

COMBINED CLASSIC - NEUTROSOPHIC SETS AND NUMBERS

Definition 12: A combined classical - neutrosophic number N is a number of the form $((a, b), cT, dI, eF)$, where T, I, F have their usual neutrosophic logic means and $a, b, c, d, e \in \mathbb{R}$ or \mathbb{C} . The combined classical - neutrosophic set Q defined by

$$Q = \{((a, b), cT, dI, eF): a, b, c, d, e \in \mathbb{R} \text{ or } \mathbb{C}\}.$$

For N, $((a, b), cT, dI, eF)$ representing any entity which may be a number, an idea, an object, etc., (a, b) is called the known part (classical set), a is exact true value and b is exact false value; (cT, dI, eF) is called the unknown part (neutrosophic set).

Corollary 1: From Definition 12 and Definition 1, combined classical - neutrosophic set are generalized of neutrosophic sets and neutrosophic quadruple sets.

Definition 13: Let $Q = \{((a, b), cT, dI, eF): a, b, c, d, e \in \mathbb{R} \text{ or } \mathbb{C}\}$ be a combined classical - neutrosophic set and $A = ((a_1, a_2), a_3 T, a_4 I, a_5 F)$ and $B = ((b_1, b_2), b_3 T, b_4 I, b_5 F)$ be combined classical - neutrosophic numbers in Q. We define the $+, -, \cdot, \setminus$ operations for combined classical - neutrosophic numbers such that

$$A + B = ((a_1 + b_1, a_2 + b_2), (a_3 + b_3)T, (a_4 + b_4)I, (a_5 + b_5)F).$$

$$A - B = ((a_1 - b_1, a_2 - b_2), (a_3 - b_3)T, (a_4 - b_4)I, (a_5 - b_5)F).$$

$$A \cdot B = ((a_1 \cdot b_1, a_2 \cdot b_2), (a_3 \cdot b_3)T, (a_4 \cdot b_4)I, (a_5 \cdot b_5)F).$$

$$A \setminus B = ((a_1 \setminus b_1, a_2 \setminus b_2), (a_3 \setminus b_3)T, (a_4 \setminus b_4)I, (a_5 \setminus b_5)F), \text{ where; } b_1, b_2, b_3, b_4, b_5 \neq 0.$$

Definition 14: Let $Q = \{((a, b), cT, dI, eF): a, b, c, d, e \in \mathbb{R} \text{ or } \mathbb{C}\}$ be a combined classical - neutrosophic set, $T < I < F$ (in Definition 3, pessimistic way), $A = ((a_1, a_2), a_3T, a_4I, a_5F)$ and $B = ((b_1, b_2), b_3T, b_4I, b_5F)$ be combined classical - neutrosophic numbers in Q . We define the $*_1$ operation for combined classical - neutrosophic numbers such that

$$\begin{aligned} A *_1 B &= ((a_1, a_2), a_3T, a_4I, a_5F) *_1 ((b_1, b_2), b_3T, b_4I, b_5F) \\ &= ((a_1b_1 + a_1b_2 + a_2b_1 + a_2b_2), (a_1b_3 + a_2b_3 + a_3b_1 + a_3b_2 + a_3b_3)T, \\ &\quad (a_1b_4 + a_2b_4 + a_3b_4 + a_4b_1 + a_4b_2 + a_4b_3 + a_4b_4)I, \\ &\quad (a_1b_5 + a_2b_5 + a_3b_5 + a_4b_5 + a_5b_1 + a_5b_2 + a_5b_3 + a_5b_4 + a_5b_5)F). \end{aligned}$$

Definition 15: Let $Q = \{((a, b), cT, dI, eF): a, b, c, d, e \in \mathbb{R} \text{ or } \mathbb{C}\}$ be a combined classical - neutrosophic set, $T > I > F$ (in Definition 3, optimistic way), $A = ((a_1, a_2), a_3T, a_4I, a_5F)$ and $B = ((b_1, b_2), b_3T, b_4I, b_5F)$ be combined classical - neutrosophic numbers in Q . We define the $*_2$ operation for combined classical - neutrosophic numbers such that

$$\begin{aligned} A *_2 B &= ((a_1, a_2), a_3T, a_4I, a_5F) *_2 ((b_1, b_2), b_3T, b_4I, b_5F) \\ &= ((a_1b_1 + a_1b_2 + a_2b_1 + a_2b_2), \\ &\quad (a_1b_3 + a_2b_3 + a_3b_1 + a_3b_2 + a_3b_3 + a_3b_4 + a_3b_5 + a_4b_3 + a_5b_3)T, \\ &\quad (a_1b_4 + a_2b_4 + a_4b_4 + a_4b_5 + a_4b_1 + a_4b_2 + a_5b_4)I, \\ &\quad (a_1b_5 + a_2b_5 + a_5b_1 + a_5b_2 + a_5b_5)F). \end{aligned}$$

SET VALUED COMBINED CLASSICAL - NEUTROSOPHIC SETS AND NUMBERS

Definition 16: A set valued combined classical - neutrosophic number N_s is a number of the form $((A, B), CT, DI, EF)$, where T, I, F have their usual neutrosophic logic means and $A, B, C, D, E \in P(N_s), P(N_s)$ is power set of N_s . The set valued combined classical - neutrosophic set Q_s defined by

$$Q_s = \{((A, B), CT, DI, EF): A, B, C, D, E \in P(N_s)\}.$$

For a $N_s, ((A, B), CT, DI, EF)$ representing any entity which may be a number, an idea, an object, etc., (A, B) is called the known part, A is exact true value and B is exact false value, (CT, DI, EF) is called the unknown part.

Corollary 2: From Definition 16 and Definition 6, set valued combined classical - neutrosophic sets are generalized of neutrosophic sets and set valued neutrosophic quadruple sets.

Definition 17: Let $Q_s = \{((A, B), CT, DI, EF): A, B, C, D, E \in P(N_s)\}$ be a set valued combined classical - neutrosophic set and $A_s = ((A_1, A_2), A_3T, A_4I, A_5F)$ and $B_s = ((B_1, B_2), B_3T, B_4I, B_5F)$ be set valued combined classical - neutrosophic numbers in Q_s . If $A_1 \subset B_1, A_2 \subset B_2, A_3 \subset B_3, A_4 \subset B_4, A_5 \subset B_5$ then it is called that A_s is subset of B_s . It is shown by $A_s \subset B_s$.

Definition 18: Let $Q_s = \{(A, B), CT, DI, EF) : A, B, C, D, E \in P(N_s)\}$ be a set valued combined classical - neutrosophic set and $A_s = ((A_1, A_2), A_3T, A_4I, A_5F)$ and $B_s = ((B_1, B_2), B_3T, B_4I, B_5F)$ be set valued combined classical - neutrosophic numbers in Q_s . If $A_s \subset B_s$ and $B_s \subset A_s$, then it is called that A_s is equal to B_s . It is shown by $A_s = B_s$.

Definition 19: Let $Q_s = \{(A, B), CT, DI, EF) : A, B, C, D, E \in P(N_s)\}$ be a set valued combined classical - neutrosophic set and $A_s = ((A_1, A_2), A_3T, A_4I, A_5F)$ and $B_s = ((B_1, B_2), B_3T, B_4I, B_5F)$ be set valued combined classical - neutrosophic numbers in Q_s . We define the $\cup, \cap, \setminus, '$ operations for set valued combined classical - neutrosophic numbers such that

$$A_s \cup B_s = ((A_1 \cup B_1, A_2 \cup B_2), (A_3 \cup B_3)T, (A_4 \cup B_4)I, (A_5 \cup B_5)F).$$

$$A_s \cap B_s = ((A_1 \cap B_1, A_2 \cap B_2), (A_3 \cap B_3)T, (A_4 \cap B_4)I, (A_5 \cap B_5)F).$$

$$A_s \setminus B_s = ((A_1 \setminus B_1, A_2 \setminus B_2), (A_3 \setminus B_3)T, (A_4 \setminus B_4)I, (A_5 \setminus B_5)F).$$

$$A_s ' = ((A_1 ', A_2 '), A_3 'T, A_4 'I, A_5 'F)$$

Definition 20: Let $Q_s = \{(A, B), CT, DI, EF) : A, B, C, D, E \in P(N_s)\}$ be a set valued combined classical - neutrosophic set, $A_s = ((A_1, A_2), A_3T, A_4I, A_5F)$, $B_s = ((B_1, B_2), B_3T, B_4I, B_5F)$ be set valued combined classical - neutrosophic numbers in Q_s and $T < I < F$ (in Definition 3, pessimistic way). We define the $\#_1$ and $\#_2$ operations for set valued combined classical - neutrosophic numbers such that

$$\begin{aligned} A_s \#_1 B_s &= ((A_1, A_2), A_3T, A_4I, A_5F) \#_1 ((B_1, B_2), B_3T, B_4I, B_5F) \\ &= (((A_1 \cup B_1) \cap (A_1 \cup B_2) \cap (A_2 \cup B_1) \cap (A_2 \cup B_2)), \\ &\quad ((A_1 \cup B_3) \cap (A_2 \cup B_3) \cap (A_3 \cup B_1) \cap (A_3 \cup B_2) \cap (A_3 \cup B_3))T, \\ &\quad ((A_1 \cup B_4) \cap (A_2 \cup B_4) \cap (A_3 \cup B_4) \cap (A_4 \cup B_1) \cap (A_4 \cup B_2) \cap (A_4 \cup B_3) \cap (A_4 \cup B_4))I, \\ &\quad ((A_1 \cup B_5) \cap (A_2 \cup B_5) \cap (A_3 \cup B_5) \cap (A_4 \cup B_5) \cap (A_5 \cup B_1) \cap (A_5 \cup B_2) \cap (A_5 \cup B_3) \cap \\ &\quad (A_5 \cup B_4) \cap (A_5 \cup B_5))F). \end{aligned}$$

$$\begin{aligned} A_s \#_2 B_s &= ((A_1, A_2), A_3T, A_4I, A_5F) \#_2 ((B_1, B_2), B_3T, B_4I, B_5F) \\ &= (((A_1 \cap B_1) \cup (A_1 \cap B_2) \cup (A_2 \cap B_1) \cup (A_2 \cap B_2)), \\ &\quad ((A_1 \cap B_3) \cup (A_2 \cap B_3) \cup (A_3 \cap B_1) \cup (A_3 \cap B_2) \cup (A_3 \cap B_3))T, \\ &\quad ((A_1 \cap B_4) \cup (A_2 \cap B_4) \cup (A_3 \cap B_4) \cup (A_4 \cap B_1) \cup (A_4 \cap B_2) \cup (A_4 \cap B_3) \cup (A_4 \cap B_4))I, \\ &\quad ((A_1 \cap B_5) \cup (A_2 \cap B_5) \cup (A_3 \cap B_5) \cup (A_4 \cap B_5) \cup (A_5 \cap B_1) \cup (A_5 \cap B_2) \cup (A_5 \cap B_3) \cup \\ &\quad (A_5 \cap B_4) \cup (A_5 \cap B_5))F). \end{aligned}$$

Definition 21: Let $Q_s = \{(A, B), CT, DI, EF) : A, B, C, D, E \in P(N_s)\}$ be a set valued combined classical - neutrosophic set, $A_s = ((A_1, A_2), A_3T, A_4I, A_5F)$, $B_s = ((B_1, B_2), B_3T, B_4I, B_5F)$ be set valued combined classical - neutrosophic numbers in Q_s and $T < I < F$ (in Definition 3, optimistic way). We define the $\#_3$ and $\#_4$ operations for set valued combined classical - neutrosophic numbers such that

$$\begin{aligned} A_s \#_3 B_s &= ((A_1, A_2), A_3T, A_4I, A_5F) \#_3 ((B_1, B_2), B_3T, B_4I, B_5F) \\ &= (((A_1 \cup B_1) \cap (A_1 \cup B_2) \cap (A_2 \cup B_1) \cap (A_2 \cup B_2)), \end{aligned}$$

$$\begin{aligned}
 & ((A_1 \cup B_3) \cap (A_2 \cup B_3) \cap (A_3 \cup B_1) \cap (A_3 \cup B_2) \cap (A_3 \cup B_3) \cap (A_3 \cup B_4) \cap (A_3 \cup B_5) \cap \\
 & (A_4 \cup B_3) \cap (A_5 \cup B_3))T, \\
 & ((A_1 \cup B_4) \cap (A_2 \cup B_4) \cap (A_4 \cup B_4) \cap (A_4 \cup B_5) \cap (A_4 \cup B_1) \cap (A_4 \cup B_2) \cap (A_5 \cup B_4))I, \\
 & ((A_1 \cup B_5) \cap (A_2 \cup B_5) \cap (A_5 \cup B_1) \cap (A_5 \cup B_2) \cap (A_5 \cup B_5))F). \\
 A_s \#_4 B_s = & ((A_1, A_2), A_3T, A_4I, A_5F) \#_4 ((B_1, B_2), B_3T, B_4I, B_5F) \\
 = & (((A_1 \cap B_1) \cup (A_1 \cap B_2) \cup (A_2 \cup B_1) \cup (A_2 \cup B_2)), \\
 & ((A_1 \cap B_3) \cup (A_2 \cap B_3) \cup (A_3 \cap B_1) \cup (A_3 \cap B_2) \cup (A_3 \cap B_3) \cup (A_3 \cap B_4) \cup (A_3 \cap B_5) \cup \\
 & (A_4 \cap B_3) \cup (A_5 \cap B_3))T, \\
 & ((A_1 \cap B_4) \cup (A_2 \cap B_4) \cup (A_4 \cap B_4) \cup (A_4 \cap B_5) \cup (A_4 \cap B_1) \cup (A_4 \cap B_2) \cup (A_5 \cap B_4))I, \\
 & ((A_1 \cap B_5) \cup (A_2 \cap B_5) \cup (A_5 \cap B_1) \cup (A_5 \cap B_2) \cup (A_5 \cap B_5))F).
 \end{aligned}$$

DOUBLE NEUTROSOPHIC SETS AND NUMBERS

Definition 22: A double neutrosophic number N is a number of the form $((aT_k, bI_k, cF_k), (dT_u, eI_u, fF_u))$, where T, I, F have their usual neutrosophic logic means and $a, b, c, d, e \in \mathbb{R}$ or \mathbb{C} . The double neutrosophic set Q defined by

$$Q = \{((aT_k, bI_k, cF_k), (dT_u, eI_u, fF_u)): a, b, c, d, e, f \in \mathbb{R} \text{ or } \mathbb{C}\}.$$

For $N, ((aT_k, bI_k, cF_k), (dT_u, eI_u, fF_u))$ representing any entity which may be a number, an idea, an object, etc., (aT_k, bI_k, cF_k) is called the known part, (dT_u, eI_u, fF_u) is called the unknown part.

Corollary 3: From Definition 22 and Definition 1, double neutrosophic sets are generalized of neutrosophic sets and neutrosophic quadruple sets.

Definition 23: Let $Q = \{((aT_k, bI_k, cF_k), (dT_u, eI_u, fF_u)): a, b, c, d, e, f \in \mathbb{R} \text{ or } \mathbb{C}\}$ be a double neutrosophic set and $A = ((a_1T_k, a_2I_k, a_3F_k), a_4T_u, a_5I_u, a_6F_u)$ and $B = ((b_1T_k, b_2I_k, b_3F_k), b_4T_u, b_5I_u, b_6F_u)$ be double neutrosophic numbers in Q . We define the $+, -, \cdot, \setminus$ operations for double neutrosophic numbers such that

$$A + B = ((a_1 + b_1)T_k, (a_2 + b_2)I_k, (a_3 + b_3)F_k), (a_4 + b_4)T_u, (a_5 + b_5)I_u, (a_6 + b_6)F_u).$$

$$A - B = ((a_1 - b_1)T_k, (a_2 - b_2)I_k, (a_3 - b_3)F_k), (a_4 - b_4)T_u, (a_5 - b_5)I_u, (a_6 - b_6)F_u).$$

$$A \cdot B = ((a_1 \cdot b_1)T_k, (a_2 \cdot b_2)I_k, (a_3 \cdot b_3)F_k), (a_4 \cdot b_4)T_u, (a_5 \cdot b_5)I_u, (a_6 \cdot b_6)F_u).$$

$A \setminus B = ((a_1 \setminus b_1)T_k, (a_2 \setminus b_2)I_k, (a_3 \setminus b_3)F_k), (a_4 \setminus b_4)T_u, (a_5 \setminus b_5)I_u, (a_6 \setminus b_6)F_u)$, where; $b_1, b_2, b_3, b_4, b_5, b_6 \neq 0$.

Definition 24: Let $Q = \{((aT_k, bI_k, cF_k), (dT_u, eI_u, fF_u)): a, b, c, d, e, f \in \mathbb{R} \text{ or } \mathbb{C}\}$ be a double neutrosophic set, $T_k < I_k < F_k, T_u < I_u < F_u$ (in Definition 3, pessimistic way) $A = ((a_1T_k, a_2I_k, a_3F_k), a_4T_u, a_5I_u, a_6F_u)$ and $B = ((b_1T_k, b_2I_k, b_3F_k), b_4T_u, b_5I_u, b_6F_u)$ be double neutrosophic numbers in Q . We define the $*_1$ operation for double neutrosophic numbers such that

$$\begin{aligned}
 A *_1 B = & ((a_1T_k, a_2I_k, a_3F_k), a_4T_u, a_5I_u, a_6F_u) *_1 ((b_1T_k, b_2I_k, b_3F_k), b_4T_u, b_5I_u, b_6F_u) \\
 = & (a_1b_1)T_k, (a_1b_2 + a_2b_1 + a_2b_2)I_k, (a_1b_3 + a_2b_3 + a_3b_1 + a_3b_2 + a_3b_3)F_k, \\
 & (a_4b_4)T_u, (a_4b_5 + a_5b_4 + a_5b_5)I_u, (a_4b_6 + a_5b_6 + a_6b_4 + a_6b_5 + a_6b_6)F_u)
 \end{aligned}$$

Definition 25: Let $Q = \{((aT_k, bI_k, cF_k), (dT_u, eI_u, fF_u)) : a, b, c, d, e, f \in \mathbb{R} \text{ or } \mathbb{C}\}$ be a double neutrosophic set, $T_k > I_k > F_k, T_u > I_u > F_u$ (in Definition 3, optimistic way) $A = ((a_1T_k, a_2I_k, a_3F_k), a_4T_u, a_5I_u, a_6F_u)$ and $B = ((b_1T_k, b_2I_k, b_3F_k), b_4T_u, b_5I_u, b_6F_u)$ be double neutrosophic numbers in Q . We define the $*_2$ operation for double neutrosophic numbers such that

$$\begin{aligned} A *_2 B &= ((a_1T_k, a_2I_k, a_3F_k), a_4T_u, a_5I_u, a_6F_u) *_2 ((b_1T_k, b_2I_k, b_3F_k), b_4T_u, b_5I_u, b_6F_u) \\ &= (a_1b_1 + a_1b_2 + a_1b_3 + a_2b_1 + a_3b_1)T_k, (a_2b_2 + a_2b_3 + a_3b_2)I_k, (a_3b_3)F_k, \\ &\quad (a_4b_4 + a_4b_5 + a_4b_6 + a_5b_4 + a_6b_4)T_u, (a_5b_5 + a_5b_6 + a_6b_5)I_u, (a_6b_6)F_u. \end{aligned}$$

SET VALUED COMBINED CLASSICAL - NEUTROSOPHIC SETS AND NUMBERS

Definition 26: A set valued double neutrosophic number N_s is a number of the form $((AT_k, BI_k, CF_k), (DT_u, EI_u, FF_u))$, where T, I, F have their usual neutrosophic logic means and $A, B, C, D, E, F \in P(N_s)$, $P(N_s)$ is power set of N_s . The set valued double neutrosophic set Q_s defined by

$$Q_s = \{((AT_k, BI_k, CF_k), (DT_u, EI_u, FF_u)) : A, B, C, D, E, F \in P(N_s)\}.$$

For $N_s, ((AT_k, BI_k, CF_k), (DT_u, EI_u, FF_u))$ representing any entity which may be a number, an idea, an object, etc., $((AT_k, BI_k, CF_k))$ is called the known part, (DT_u, EI_u, FF_u) is called the unknown part.

Corollary 4: From Definition 26 and Definition 6, set valued double neutrosophic sets are generalized of neutrosophic sets and set valued neutrosophic quadruple sets.

Definition 27: Let $Q_s = \{((AT_k, BI_k, CF_k), (DT_u, EI_u, FF_u)) : A, B, C, D, E, F \in P(N_s)\}$ be a set valued double neutrosophic set and $A_s = ((A_1 T_k, A_2 I_k, A_3 F_k), (A_4 T_u, A_5 I_u, A_6 F_u))$ and $B_s = ((B_1 T_k, B_2 I_k, B_3 F_k), (B_4 T_u, B_5 I_u, B_6 F_u))$ be set valued double neutrosophic numbers in Q_s . If $A_1 \subset B_1, A_2 \subset B_2, A_3 \subset B_3, A_4 \subset B_4, A_5 \subset B_5, A_6 \subset B_6$ then it is called that A_s is subset of B_s . It is shown by $A_s \subset B_s$.

Definition 28: Let $Q_s = \{((AT_k, BI_k, CF_k), (DT_u, EI_u, FF_u)) : A, B, C, D, E, F \in P(N_s)\}$ be a set valued double neutrosophic set and $A_s = ((A_1 T_k, A_2 I_k, A_3 F_k), (A_4 T_u, A_5 I_u, A_6 F_u))$ and $B_s = ((B_1 T_k, B_2 I_k, B_3 F_k), (B_4 T_u, B_5 I_u, B_6 F_u))$ be set valued double neutrosophic numbers in Q_s . If $A_s \subset B_s$ and $B_s \subset A_s$, then it is called that A_s is equal to B_s . It is shown by $A_s = B_s$.

Definition 29: Let $Q_s = \{((AT_k, BI_k, CF_k), (DT_u, EI_u, FF_u)) : A, B, C, D, E, F \in P(N_s)\}$ be a set valued double neutrosophic set and $A_s = ((A_1 T_k, A_2 I_k, A_3 F_k), (A_4 T_u, A_5 I_u, A_6 F_u))$ and $B_s = ((B_1 T_k, B_2 I_k, B_3 F_k), (B_4 T_u, B_5 I_u, B_6 F_u))$ be set valued double neutrosophic numbers in Q_s . We define the $\cup, \cap, \setminus, '$ operations for set valued double neutrosophic numbers such that

$$A_s \cup B_s = ((A_1 \cup B_1)T_k, (A_2 \cup B_2)I_k, (A_3 \cup B_3)F_k, (A_4 \cup B_4)T_u, (A_5 \cup B_5)I_u, (A_6 \cup B_6)F_u).$$

$$A_s \cap B_s = ((A_1 \cap B_1)T_k, (A_2 \cap B_2)I_k, (A_3 \cap B_3)F_k, (A_4 \cap B_4)T_u, (A_5 \cap B_5)I_u, (A_6 \cap B_6)F_u).$$

$$A_s \setminus B_s = ((A_1 \setminus B_1)T_k, (A_2 \setminus B_2)I_k, (A_3 \setminus B_3)F_k, (A_4 \setminus B_4)T_u, (A_5 \setminus B_5)I_u, (A_6 \setminus B_6)F_u).$$

$$A_s ' = ((A_1 ' T_k, A_2 ' I_k, A_3 ' F_k), (A_4 ' T_u, A_5 ' I_u, A_6 ' F_u))$$

Definition 30: Let $Q_s = \{((AT_k, BI_k, CF_k), (DT_u, EI_u, FF_u)) : A, B, C, D, E, F \in P(N_s)\}$ be a set valued double neutrosophic set and $A_s = ((A_1 T_k, A_2 I_k, A_3 F_k), (A_4 T_u, A_5 I_u, A_6 F_u))$ and

$B_s = ((B_1 T_k, B_2 I_k, B_3 F_k), (B_4 T_u, B_5 I_u, B_6 F_u))$ be set valued double neutrosophic numbers in Q_s ; $T_k < I_k < F_k$, $T_u < I_u < F_u$ (in Definition 3, pessimistic way). We define the $\#_1$ and $\#_2$ operations for set valued double neutrosophic numbers such that

$$\begin{aligned} A_s \#_1 B_s &= ((A_1 T_k, A_2 I_k, A_3 F_k), (A_4 T_u, A_5 I_u, A_6 F_u)) \#_1 ((B_1 T_k, B_2 I_k, B_3 F_k), (B_4 T_u, B_5 I_u, B_6 F_u)) \\ &= (A_1 \cup B_1) T_k, ((A_1 \cup B_2) \cap (A_2 \cup B_1) \cap (A_2 \cup B_2)) I_k, \\ &\quad ((A_1 \cup B_3) \cap (A_2 \cup B_3) \cap (A_3 \cup B_1) \cap (A_3 \cup B_2) \cap (A_3 \cup B_3)) F_k, \\ &\quad (A_4 \cup B_4) T_u, ((A_4 \cup B_5) \cap (A_5 \cup B_4) \cap (A_5 \cup B_5)) I_u, \\ &\quad ((A_4 \cup B_6) \cap (A_5 \cup B_6) \cap A_6 \cup B_4) \cap (A_6 \cup B_5) \cap (A_6 \cup B_6)) F_u. \end{aligned}$$

$$\begin{aligned} A_s \#_2 B_s &= ((A_1 T_k, A_2 I_k, A_3 F_k), (A_4 T_u, A_5 I_u, A_6 F_u)) \#_2 ((B_1 T_k, B_2 I_k, B_3 F_k), (B_4 T_u, B_5 I_u, B_6 F_u)) \\ &= (A_1 \cap B_1) T_k, ((A_1 \cap B_2) \cup (A_2 \cap B_1) \cup (A_2 \cap B_2)) I_k, \\ &\quad ((A_1 \cap B_3) \cup (A_2 \cap B_3) \cup (A_3 \cap B_1) \cup (A_3 \cap B_2) \cup (A_3 \cap B_3)) F_k, \\ &\quad (A_4 \cap B_4) T_u, ((A_4 \cap B_5) \cup (A_5 \cap B_4) \cup (A_5 \cap B_5)) I_u, \\ &\quad ((A_4 \cap B_6) \cup (A_5 \cap B_6) \cup (A_6 \cap B_4) \cup (A_6 \cap B_5) \cup (A_6 \cap B_6)) F_u. \end{aligned}$$

Definition 31: Let $Q_s = \{((AT_k, BI_k, CF_k), (DT_u, EI_u, FF_u)): A, B, C, D, E, F \in P(N_s)\}$ be a set valued double neutrosophic set and $A_s = ((A_1 T_k, A_2 I_k, A_3 F_k), (A_4 T_u, A_5 I_u, A_6 F_u))$ and $B_s = ((B_1 T_k, B_2 I_k, B_3 F_k), (B_4 T_u, B_5 I_u, B_6 F_u))$ be set valued double neutrosophic numbers in Q_s ; $T_k < I_k < F_k$, $T_u < I_u < F_u$ (in Definition 3, pessimistic way). We define the $\#_3$ and $\#_4$ operations for set valued double neutrosophic numbers such that

$$\begin{aligned} A_s \#_3 B_s &= ((A_1 T_k, A_2 I_k, A_3 F_k), (A_4 T_u, A_5 I_u, A_6 F_u)) \#_3 ((B_1 T_k, B_2 I_k, B_3 F_k), (B_4 T_u, B_5 I_u, B_6 F_u)) \\ &= ((A_1 \cup B_1) \cap (A_1 \cup B_2) \cap (A_1 \cup B_3) \cap (A_2 \cup B_1) \cap (A_3 \cup B_1)) T_k, \\ &\quad ((A_2 \cup B_2) \cap (A_2 \cup B_3) \cap (A_3 \cup B_2)) I_k, (A_3 \cup B_3) F_k, \\ &\quad ((A_4 \cup B_4) \cap (A_4 \cup B_5) \cap (A_4 \cup B_6) \cap (A_5 \cup B_4) \cap (A_6 \cup B_4)) T_u, \\ &\quad ((A_5 \cup B_5) \cap (A_5 \cup B_6) \cap (A_6 \cup B_5)) I_u, (A_6 \cup B_6) F_u. \end{aligned}$$

$$\begin{aligned} A_s \#_4 B_s &= ((A_1 T_k, A_2 I_k, A_3 F_k), (A_4 T_u, A_5 I_u, A_6 F_u)) \#_4 ((B_1 T_k, B_2 I_k, B_3 F_k), (B_4 T_u, B_5 I_u, B_6 F_u)) \\ &= (((A_1 \cap B_1) \cup (A_1 \cap B_2) \cup (A_1 \cap B_3) \cup (A_2 \cap B_1) \cup (A_3 \cap B_1)) T_k, \\ &\quad ((A_2 \cap B_2) \cup (A_2 \cap B_3) \cup (A_3 \cap B_2)) I_k, (A_3 \cap B_3) F_k, \\ &\quad ((A_4 \cap B_4) \cup (A_4 \cap B_5) \cup (A_4 \cap B_6) \cup (A_5 \cap B_4) \cup (A_6 \cap B_4)) T_u, \\ &\quad ((A_5 \cap B_5) \cup (A_5 \cap B_6) \cup (A_6 \cap B_5)) I_u, (A_6 \cap B_6) F_u. \end{aligned}$$

Conclusions

In this chapter, we define combined classic - neutrosophic sets, double neutrosophic sets, set valued combined classic - neutrosophic sets and set valued double neutrosophic sets.

Combined classic - neutrosophic sets and set valued combined classic - neutrosophic sets contain exact true value and exact false value, unlike neutrosophic set and neutrosophic quintet set. Also, these sets

contain T, I, F, like neutrosophic set and neutrosophic quintet set. Thus, these sets are generalized of neutrosophic sets, neutrosophic quadruple sets and set valued neutrosophic quadruple sets. Furthermore, researchers obtain neutrosophic quintet algebraic structures and set valued neutrosophic quintet algebraic structures. Thus, researchers can obtain new structures thanks to neutrosophic quintet sets and set valued neutrosophic quintet sets.

Double neutrosophic sets and set valued double neutrosophic sets contain two neutrosophic set. First neutrosophic set is known part and second neutrosophic set is unknown part. Hence, there are six components. Thus, these sets are generalized of neutrosophic sets, neutrosophic quadruple sets and set valued neutrosophic quadruple sets. Furthermore, researchers obtain double neutrosophic algebraic structures and set valued double neutrosophic algebraic structures. Thus, researchers can obtain new structures thanks to double neutrosophic sets and set valued double neutrosophic sets.

In combined classic - neutrosophic sets, double neutrosophic sets, set valued combined classic - neutrosophic sets and set valued double neutrosophic sets; the values T, I and F are same for each element. If we define new operations according to the different T, I and F values for combined classic - neutrosophic sets, double neutrosophic sets, set valued combined classic - neutrosophic sets and set valued double neutrosophic sets, then combined classic - neutrosophic sets, double neutrosophic sets, set valued combined classic - neutrosophic sets and set valued double neutrosophic sets can be used decision making problems. Also, neutrosophic quintet sets and set valued neutrosophic quintet sets can be useful according to other sets.

Abbreviations

NQ: Neutrosophic quadruple

NQS: Neutrosophic quadruple set

NQN: Neutrosophic quadruple number

SVNQS: Set valued neutrosophic quadruple set

SVNQN: Set valued neutrosophic quadruple number

References

- [1] Smarandache F. (1998) *Neutrosophy: Neutrosophic Probability, Set and Logic*, Rehoboth, Amer. Research Press
- [2] Kandasamy W. B. V. and Smarandache F. (2004) Basic neutrosophic algebraic structures and their applications to fuzzy and neutrosophic models, *Hexis, Frontigan* p 219
- [3] Kandasamy W. B. V. and Smarandache F. (2006) Some neutrosophic algebraic structures and neutrosophic n-algebraic structures, *Hexis, Frontigan* p 219
- [4] Smarandache F. and Ali M. (2016) Neutrosophic triplet as extension of matter plasma, unmatter plasma and antimatter plasma, *APS Gaseous Electronics Conference* doi: 10.1103/BAPS.2016.GEC.HT6.110
- [5] Smarandache F. and Ali M. (2014) *The Neutrosophic Triplet Group and its Application to Physics*, presented by F. S. to Universidad Nacional de Quilmes, Department of Science and Technology, Bernal, Buenos Aires, Argentina (02 June 2014)
- [6] Smarandache F. and Ali M. (2016) Neutrosophic triplet group. *Neural Computing and Applications*, 1-7.

- [7] Smarandache F. and Ali M. (2017) Neutrosophic Triplet Field Used in Physical Applications, (Log Number: NWS17-2017-000061), 18th Annual Meeting of the APS Northwest Section, Pacific University, Forest Grove, OR, USA (June 1-3, 2017)
- [8] Smarandache F. and Ali M. (2017) Neutrosophic Triplet Ring and its Applications, (Log Number: NWS17-2017-000062), 18th Annual Meeting of the APS Northwest Section, Pacific University, Forest Grove, OR, USA (June 1-3, 2017).
- [9] Ecemiş, O., Şahin, M., and Kargın, A. (2018). Single valued neutrosophic number valued generalized neutrosophic triplet groups and its applications for decision making applications, *Asian Journal of Mathematics and Computer Research* 25(4): 205-218
- [10] Broumi S., Bakali A., Talea M. and Smarandache F. (2016) Single Valued Neutrosophic Graphs: Degree, Order and Size. *IEEE International Conference on Fuzzy Systems*, pp. 2444-2451.
- [11] Broumi S., Bakali A., Talea M. and Smarandache F. (2016) Decision-Making Method Based On the Interval Valued Neutrosophic Graph, *Future Technologies, IEEE International Conference on Fuzzy Systems* pp 44-50.
- [12] Uluçay, V.; Şahin, M.; Olgun, N. Time-Neutrosophic Soft Expert Sets and Its Decision Making Problem. *Matematika*, 2018 34(2), 246-260.
- [13] Uluçay, V.; Kılıç, A.; Yıldız, I.; Şahin, M. (2018). A new approach for multi-attribute decision-making problems in bipolar neutrosophic sets. *Neutrosophic Sets and Systems*, 2018, 23(1), 142-159.
- [14] Uluçay, V., Kılıç, A., Şahin, M., & Deniz, H. (2019). A New Hybrid Distance-Based Similarity Measure for Refined Neutrosophic sets and its Application in Medical Diagnosis. *MATEMATIKA: Malaysian Journal of Industrial and Applied Mathematics*, 35(1), 83-94.
- [15] Broumi, S., Bakali, A., Talea, M., Smarandache, F., Singh, P. K., Uluçay, V., & Khan, M. (2019). Bipolar complex neutrosophic sets and its application in decision making problem. In *Fuzzy Multi-criteria Decision-Making Using Neutrosophic Sets* (pp. 677-710). Springer, Cham.
- [16] Bakbak, D., Uluçay, V., & Şahin, M. (2019). Neutrosophic soft expert multiset and their application to multiple criteria decision making. *Mathematics*, 7(1), 50.
- [17] Uluçay, V., & Şahin, M. (2020). Decision-Making Method based on Neutrosophic Soft Expert Graphs. In *Neutrosophic Graph Theory and Algorithms* (pp. 33-76). IGI Global.
- [18] Uluçay, V., Kılıç, A., Yıldız, İ., & Şahin, M. (2019). An Outranking Approach for MCDM-Problems with Neutrosophic Multi-Sets. *Neutrosophic Sets & Systems*, 30.
- [19] Uluçay, V., Şahin, M., & Hassan, N. (2018). Generalized neutrosophic soft expert set for multiple-criteria decision-making. *Symmetry*, 10(10), 437.
- [20] Şahin M., Deli I. and Uluçay V. (2016) Similarity measure of bipolar neutrosophic sets and their application to multiple criteria decision making, *Neural Comput & Applic.* DOI 10. 1007/S00521
- [21] Wang H., Smarandache F., Zhang Y. Q., Sunderraman R. (2010) Single valued neutrosophic sets. *Multispace Multistructure* 4, 410–413.
- [22] Şahin M., Olgun N, Uluçay V., Kargın A. and Smarandache F. (2017) A new similarity measure on falsity value between single valued neutrosophic sets based on the centroid points of transformed single valued neutrosophic numbers with applications to pattern recognition, *Neutrosophic Sets and Systems*, 15, 31-48, doi: org/10.5281/zenodo570934
- [23] Şahin M., Ecemiş O., Uluçay V. and Kargın A. (2017) Some new generalized aggregation operators based on centroid single valued triangular neutrosophic numbers and their applications in multi-attribute decision making, *Asian Journal of Mathematics and Computer Research* 16(2): 63-84
- [24] Chatterjee R., Majumdar P., and Samanta S. K. (2019) Similarity Measures in Neutrosophic Sets-I. *Fuzzy Multi-criteria Decision-Making Using Neutrosophic Sets*. Springer, Cham. 249-294.

- [25] Mohana K., and Mohanasundari M. (2019) On Some Similarity Measures of Single Valued Neutrosophic Rough Sets. *Neutrosophic Sets and Systems*, 10
- [26] Smarandache F., et al. (2019) Word-level neutrosophic sentiment similarity. *Applied Soft Computing* 80, 167-176.
- [27] Ye J. (2014) Similarity measures between interval neutrosophic sets and their applications in multicriteria decision – making. *J. Intell. Fuzzy Syst.* 26 (1) 165 – 172
- [28] Zadeh A. L. (1965) Fuzzy sets, *Information and control* ,8.3 338-353,
- [29] Atanassov T. K. (1986) Intuitionistic fuzzy sets, *Fuzzy Sets Syst*, 20:87–96
- [30] Smarandache F. (2015) Neutrosophic quadruple numbers, refined neutrosophic quadruple numbers, absorbance law, and the multiplication of neutrosophic quadruple numbers, *Neutrosophic Set and Systems*, 10, 96 -98
- [31] Akinleye, S. A., Smarandache, F. (2016) Agboola, A. A. A. On neutrosophic quadruple algebraic structures. *Neutrosophic Sets and Systems*, 12, 122-126.
- [32] Jun, Y., Song, S. Z., Smarandache, F., & Bordbar, H. Neutrosophic quadruple BCK/BCI-algebras. *Axioms*, (2018) 7(2), 41.
- [33] Muhiuddin, G., Al-Kenani, A. N., Roh, E. H., & Jun, Y. B. (2019) Implicative neutrosophic quadruple BCK-algebras and ideals. *Symmetry*, 11(2), 277.
- [34] Li, Q., Ma, Y., Zhang, X., & Zhang, J. (2019) Neutrosophic Extended Triplet Group Based on Neutrosophic Quadruple Numbers. *Symmetry*, 11(5), 696.
- [35] Şahin, M., Kargin A. (2019), Neutrosophic triplet groups based on set valued neutrosophic quadruple numbers, *Neutrosophic Set and Systems*, 30, 122 - 131
- [36] Şahin, M., Kargin A. (2019), Single valued neutrosophic quadruple graphs, *Asian Journal of Mathematics and Computer Research*, 26(4): 243–250

Chapter Nineteen

Bipolar Spherical Fuzzy Neutrosophic Cubic Graph and its Application

Akalyadevi K, Antony Crispin Sweety C and Sudamani Ramaswamy A. R.

Department of Mathematics, Avinashilingam Institute for Home Science and Higher Education for women, Coimbatore-641 043-India.

E-mail: akalyadevi91@gmail.com, riosweety@gmail.com, arsudamanimaths12@gmail.com

ABSTRACT

Compared to fuzzy set and all other versions of fuzzy set, neutrosophic sets can handle imprecise information in a more effective way. Neutrosophic cubic sets, which is the generalization of neutrosophic set are more flexible as well as compatible to the system compared to other existing fuzzy models. On other hand, graph is a very easy way to understand and handle a problem physically in the form of diagrams. We introduce spherical fuzzy neutrosophic cubic graph and single-valued neutrosophic spherical cubic graphs in bipolar setting and discuss some of their properties such as Cartesian product, composition, m-join, n-join, m-union, n-union. We also present a numerical example of the defined model which depicts the advantage of the same. Finally, we define a score function and minimum spanning tree algorithm of an undirected bipolar single-valued neutrosophic spherical cubic graph with a numerical example.

Keywords: Neutrosophic Cubic Sets, Bipolar Spherical Fuzzy Neutrosophic Cubic Graph, single-valued neutrosophic spherical cubic graphs, Minimum Spanning Tree

INTRODUCTION

The idea of fuzzy set theory, proposed by Zadeh [76], plays a significant role as it handles uncertain or vague information in decision making, characterized by a membership function which assigns a membership value ranging between zero and one. However, in some actual environment, the fuzzy set theory has some limitations when the decision maker deals with some uncertain information or vagueness. Intuitionistic Fuzzy Set (IFS), proposed by Atanassov [10], is characterized by a membership and non-membership function satisfies the condition that the sum of membership and non-membership is less than or equal to one.

Yager [71,72] proposed a brand-new extension of fuzzy set called Pythagorean fuzzy set (PFS), which has been successfully applied in many fields for decision making procedures. PFS is characterized by a membership and non-membership function satisfies the condition that the square sum of membership and non-membership is less than or equal to one. It is noted that not all Pythagorean fuzzy set are intuitionistic fuzzy set but an intuitionistic fuzzy set must be a Pythagorean fuzzy set.

Spherical fuzzy set is a generalization of picture fuzzy set and Pythagorean fuzzy set. There is a need of spherical fuzzy set to tackle an interesting scenario emerge when picture fuzzy sets and Pythagorean fuzzy sets both failed to handle. We can study the neutral degree in spherical fuzzy set where as in Pythagorean fuzzy sets and picture fuzzy sets it doesn't. In spherical fuzzy set, membership degrees are gratifying the condition $0 \leq P^2(x) + I^2(x) + N^2(x) \leq 1$. [9,37,38].

The idea of neutrosophic set is introduced by Smarandache [28,32,33,55,56], which is a generalization of the fuzzy set, intuitionistic fuzzy set. The neutrosophic sets are characterized by a truth function (T), an indeterminate function (I) and a false function (F) independently. Smarandache [63] introduced the new concepts of neutrosophic perspectives: Triplets, Duplets, Multisets, Hybrid Operators, Modal Logic, Hedge Algebras. And Applications. The neutrosophic set and its extensions plays a vital role to deal with incomplete and inconsistent information that exist in real world. Smarandache introduced neutrosophic quadruple sets and neutrosophic quadruple numbers. Furthermore special operations for set valued neutrosophic quadruple numbers other triplet structures also defined and also applied in the medical field [46-49].

The concept of cubic set is characterized by fuzzy set and interval valued fuzzy set, which is an important tool to deal with uncertainty and vagueness. The hybrid platform of cubic set contains more information than a fuzzy set. Neutrosophic set combined with cubic sets gave the new concept of neutrosophic cubic set introduced by Jun et.al [32-34]. Further Smarandache et.al [60-63] introduced the new idea of neutrosophic cubic graphs and their fundamental operations such as Cartesian product, union and join of neutrosophic cubic graphs, composition, degree and order of neutrosophic cubic graphs and some results. Recently, the new concept of bipolar neutrosophic cubic graphs and single-valued bipolar neutrosophic cubic graphs is introduced and discuss some of their algebraic properties and present minimum spanning tree algorithm with numerical example [8].

Bipolar fuzzy sets is an extension of fuzzy sets, in which positive information represents the possible and negative information represents the impossible or surely false [77]. In bipolar fuzzy sets, the elements are irrelevant are indicated by membership degree zero, the elements are satisfy the corresponding property by $(0,1]$ and the elements are satisfy implicit counter property by $[-1,0)$. On the other hand graphical representation is a convenient way of representing the data in which the objects are vertices and their relations are edges. Fuzzy graph models were developed to describe the uncertain elements but their extension fails if the relation between the nodes in the problem is indeterminate [12-22]. The neutrosophic graphs were designed to overcome this failure. . In the book of neutrosophic graphs Kandasamy et.al [35]

introduced the concept of neutrosophic graphs. The different aspects of neutrosophic graphs is discussed by Akram and others [1-7]

Recently, neutrosophic methods is used to find minimum spanning tree of a graph, introduced by Ye [73], where nodes are represented by single valued neutrosophic set and distance between two nodes represents the dissimilarity between the corresponding samples has been derived. A double-valued neutrosophic minimum spanning tree clustering algorithm is used to cluster double-valued neutrosophic information is introduced by Kandasamy [36].

In this paper, we propose the idea of spherical fuzzy neutrosophic cubic graph in bipolar setting and discuss some of its properties. We also test its applicability of the same based on present and future time prediction. We also define minimum cost spanning tree of bipolar spherical fuzzy neutrosophic cubic graph.

BACKGROUND

In this section, we study some basic definitions required to define bipolar spherical fuzzy neutrosophic cubic graph.

Definition 1. [10] Intuitionistic Fuzzy Set

Let P be an IFS in the universe of discourse X , shown as follows:

$$P = \{ \langle x, \mu_P(x), \nu_P(x) \rangle \mid x \in X \},$$

where $\mu_P(x): X \rightarrow [0,1]$ and $\nu_P(x): X \rightarrow [0,1]$ satisfy $0 \leq \mu_P(x) + \nu_P(x) \leq 1$ for all $x \in X$, $\mu_P(x)$ and $\nu_P(x)$ denote the membership degree and non-membership degree of element x belonging to the IFS P , respectively. Moreover, $\pi_P(x) = 1 - \mu_P(x) - \nu_P(x)$ is called the hesitancy degree of element x belonging to the IFS P .

Definition 2. [71] Pythagorean Fuzzy Set

Let P be an PFS in the universe of discourse X , shown as follows:

$$P = \{ \langle x, \mu_P(x), \nu_P(x) \rangle \mid x \in X \},$$

where $\mu_P(x): X \rightarrow [0,1]$ and $\nu_P(x): X \rightarrow [0,1]$ satisfy $0 \leq (\mu_P(x))^2 + (\nu_P(x))^2 \leq 1$ for all $x \in X$, $\mu_P(x)$ and $\nu_P(x)$ denote the membership degree and non-membership degree of element x belonging to the PFS P , respectively. Moreover, $\pi_P(x) = \sqrt{1 - \mu_P^2(x) - \nu_P^2(x)}$ is called the hesitancy degree of element x belonging to the PFS P . For convenience, we introduce a Pythagorean fuzzy number denoted by $\beta = P(\mu_\beta, \nu_\beta)$, where $\mu_\beta, \nu_\beta \in [0,1]$ and $0 \leq (\mu_\beta)^2 + (\nu_\beta)^2 \leq 1$.

Definition 3. [55] Neutrosophic Set

Let X be a universe. A neutrosophic set A over X is defined by

$$P = \{ \langle x, (T_P(x), I_P(x), F_P(x)) \rangle \mid x \in X \},$$

where $T_P(x), I_P(x)$ and $F_P(x)$ are called truth-membership function, indeterminacy membership function and falsity-membership function, respectively. They are, respectively, defined by $T_P(x): X \rightarrow [0, 1^+]$, $I_P(x): X \rightarrow [0, 1^+]$, $F_P(x): X \rightarrow [0, 1^+]$ such that $0 \leq T_P(x) + I_P(x) + F_P(x) \leq 3^+$.

Definition 4. [70] Single Valued Neutrosophic Set

Let X be a universe. A single-valued neutrosophic set A over X is defined by

$$P = \{ \langle x, (T_P(x), I_P(x), F_P(x)) \rangle \mid x \in X \},$$

where $T_P(x), I_P(x)$ and $F_P(x)$ are called truth-membership function, indeterminacy membership function and falsity-membership function, respectively. They are, respectively, defined by $T_P(x): X \rightarrow [0, 1]$, $I_P(x): X \rightarrow [0, 1]$, $F_P(x): X \rightarrow [0, 1]$ such that $0 \leq T_P(x) + I_P(x) + F_P(x) \leq 3$.

Definition 5. [28] Bipolar Neutrosophic Set

A bipolar neutrosophic set A in X is defined as an object of the form

$$P = \{ \langle x, (T_P^+(x), I_P^+(x), F_P^+(x), T_P^-(x), I_P^-(x), F_P^-(x)) \rangle \mid x \in X \},$$

where $T_P^+, I_P^+, F_P^+ : X \rightarrow [0, 1]$, $T_P^-, I_P^-, F_P^- : X \rightarrow [0, 1]$.

Definition 6. [32] Neutrosophic Cubic Set

Let X be a non-empty set. A neutrosophic cubic set in X is a pair $A = (A, P)$ where $A = \{ \langle x, (A_T(x), A_I(x), A_F(x)) \rangle \mid x \in X \}$ is an interval neutrosophic set in X and $P = \{ \langle x, (\lambda_T(x), \lambda_I(x), \lambda_F(x)) \rangle \mid x \in X \}$ is a neutrosophic set in X .

Definition 7. [37] Spherical Fuzzy Set

Let X be a universe. Then the set

$$P = \{ \langle x, (T_P(x), I_P(x), F_P(x)) \rangle \mid x \in X \},$$

is said to be spherical fuzzy set, where $T_P(x): X \rightarrow [0,1]$, $I_P(x): X \rightarrow [0,1]$ and $F_P(x): X \rightarrow [0,1]$ are said to be degree of positive-membership function of x in X , degree of neutral-membership function of x in X and degree of negative-membership function of x in X , respectively. Also T_P , I_P and F_P satisfy the following condition:

$$(\forall x \in X) \quad (0 \leq (T_P(x))^2 + (I_P(x))^2 + (F_P(x))^2 \leq 1).$$

Definition 8. [8] Neutrosophic Cubic Graph

Let $G^* = (V, E)$ be a graph. By neutrosophic cubic graph of G^* , we mean a pair $G = (M, N)$ where $M = (A, B) = ((\tilde{T}_A, \tilde{T}_B), (\tilde{I}_A, \tilde{I}_B), (\tilde{F}_A, \tilde{F}_B))$ is the neutrosophic cubic set representation of vertex set V and $N = (C, D) = ((\tilde{T}_C, \tilde{T}_D), (\tilde{I}_C, \tilde{I}_D), (\tilde{F}_C, \tilde{F}_D))$ is the neutrosophic cubic set representation of edges set E such that:

- (i) $(\tilde{T}_C(u_i v_i) \leq r \min\{\tilde{T}_A(u_i), \tilde{T}_A(v_i)\}, \tilde{T}_D(u_i v_i) \leq \max\{T_B(u_i), T_B(v_i)\}),$
- (ii) $(\tilde{I}_C(u_i v_i) \leq r \min\{\tilde{I}_A(u_i), \tilde{I}_A(v_i)\}, I_D(u_i v_i) \leq \max\{I_B(u_i), I_B(v_i)\}),$
- (iii) $(\tilde{F}_C(u_i v_i) \leq r \max\{\tilde{F}_A(u_i), \tilde{F}_A(v_i)\}, F_D(u_i v_i) \leq \min\{F_B(u_i), F_B(v_i)\}).$

Bipolar Spherical Fuzzy Neutrosophic Cubic Graph

In this section, we develop bipolar spherical fuzzy neutrosophic cubic graph and its algebraic operations such as degree, order, union, join, composition and some other results related with bipolar spherical fuzzy neutrosophic cubic graph with examples.

Definition 9.

Let X be a non-empty set. A Bipolar Spherical Fuzzy Neutrosophic Cubic Set (BSFNCS)

$$A = \{ x, (T_A^{P+}, I_A^{P+}, F_A^{P+}), (T_A^{P-}, I_A^{P-}, F_A^{P-}), \lambda_A \mid x \in X \}$$

where $T_A^{P+}, I_A^{P+}, F_A^{P+} : X \rightarrow [0,1]$, $(T_A^{P-}, I_A^{P-}, F_A^{P-}) : X \rightarrow [-1,0]$, $\lambda_A : X \rightarrow [0,1]$ are the mappings such that $0 \leq ((T_A^{P+})^2 + (I_A^{P+})^2 + (F_A^{P+})^2) \leq \sqrt{3}$ and $0 \leq ((T_A^{P-})^2 + (I_A^{P-})^2 + (F_A^{P-})^2) \leq \sqrt{3}$ and T_A^{P+} denote the positive truth membership function, I_A^{P+} denote the positive indeterminacy membership function, F_A^{P+} denote the positive falsity membership function, T_A^{P-} denote the negative truth membership function, I_A^{P-} denote the negative indeterminacy membership function, F_A^{P-} denote the negative falsity membership function and λ_A denote the fuzzy membership function.

Definition 10.

Let $G^* = (V, E)$ be a graph and $G(P, Q)$ is a Bipolar Spherical Fuzzy Neutrosophic Cubic Graph (BSFNCG) of G^* , if

$$P = (A, \lambda) = \{ V, (T_A^{P+}, I_A^{P+}, F_A^{P+}), (T_A^{P-}, I_A^{P-}, F_A^{P-}), \lambda_A \}$$

is the BSFNCS representation of vertex set V and

$$Q = (B, \mu) = \{ E, (T_B^{P+}, I_B^{P+}, F_B^{P+}), (T_B^{P-}, I_B^{P-}, F_B^{P-}), \mu_B \}$$

is the BSFNCS representation of edge set E such that

1. $T_B^{P+}(u_i v_i) \leq r \min\{T_A^{P+}(u_i), T_A^{P+}(v_i)\}, T_\mu^{P+}(u_i v_i) \geq r \max\{T_\mu^{P+}(u_i), T_\mu^{P+}(v_i)\}$
 $T_B^{P-}(u_i v_i) \geq r \max\{T_A^{P-}(u_i), T_A^{P-}(v_i)\}, T_\mu^{P-}(u_i v_i) \geq r \min\{T_\mu^{P-}(u_i), T_\mu^{P-}(v_i)\}$
2. $I_B^{P+}(u_i v_i) \leq r \min\{I_A^{P+}(u_i), I_A^{P+}(v_i)\}, I_\mu^{P+}(u_i v_i) \geq r \max\{I_\mu^{P+}(u_i), I_\mu^{P+}(v_i)\}$
 $I_B^{P-}(u_i v_i) \geq r \max\{I_A^{P-}(u_i), I_A^{P-}(v_i)\}, I_\mu^{P-}(u_i v_i) \geq r \min\{I_\mu^{P-}(u_i), I_\mu^{P-}(v_i)\}$
3. $F_B^{P+}(u_i v_i) \leq r \max\{F_A^{P+}(u_i), F_A^{P+}(v_i)\}, F_\mu^{P+}(u_i v_i) \geq r \min\{F_\mu^{P+}(u_i), F_\mu^{P+}(v_i)\}$
 $F_B^{P-}(u_i v_i) \geq r \min\{F_A^{P-}(u_i), F_A^{P-}(v_i)\}, F_\mu^{P-}(u_i v_i) \geq r \max\{F_\mu^{P-}(u_i), F_\mu^{P-}(v_i)\}$

Let $G^* = (V, E)$ be a graph and $G(P, Q)$ is a Bipolar Spherical Fuzzy Neutrosophic Cubic Graph (BSFNCG) of G^* , if

$$P = (A, \lambda) = \{ V, (T_A^{P+}, I_A^{P+}, F_A^{P+}), (T_A^{P-}, I_A^{P-}, F_A^{P-}), \lambda_A \}$$

is the BSFNCG representation of vertex set V and

$$Q = (B, \mu) = \{ E, (T_B^{P+}, I_B^{P+}, F_B^{P+}), (T_B^{P-}, I_B^{P-}, F_B^{P-}), \mu_B \}$$

is the BSFNCG representation of edge set E and λ and μ are bipolar spherical fuzzy neutrosophic cubic sets.

Example 11.

Let $G^* = (V, E)$ be a graph where $V = \{a, b, c, d\}$ and $E = \{ab, ac, ad, bc, bd, cd\}$ where P and Q are as follows:

$$P = \left\{ \begin{array}{l} \left\{ a, ([0.3, 0.5], 0.2), ([0.8, 0.9], 0.5), ([0.2, 0.4], 0.5), \right. \\ \left. [(-0.4, -0.3], -0.2), [(-0.6, -0.5], -0.8), [(-0.9, -0.8], -0.6) \right\} \\ \left\{ b, ([0.9, 0.1], 0.7), ([0.6, 0.8], 0.1), ([0.4, 0.7], 0.1), \right. \\ \left. [(-0.8, -0.7], -0.5), [(-0.5, -0.2], -0.1), [(-0.3, -0.2], -0.1) \right\} \\ \left\{ c, ([0.3, 0.6], 0.8), ([0.4, 0.6], 0.7), ([0.5, 0.6], 0.4), \right. \\ \left. [(-0.5, -0.4], -0.1), [(-0.6, -0.3], -0.1), [(-0.7, -0.6], -0.3) \right\} \\ \left\{ d, ([0.1, 0.3], 0.5), ([0.2, 0.3], 0.6), ([0.6, 0.7], 0.8), \right. \\ \left. [(-0.8, -0.6], -0.2), [(-0.7, -0.3], -0.2), [(-0.9, -0.6], -0.4) \right\} \end{array} \right.$$

$$Q = \left\{ \begin{array}{l} \left\{ ab, ([0.3, 0.1], 0.7), ([0.6, 0.8], 0.5), ([0.4, 0.7], 0.1), \right. \\ \left. [(-0.4, -0.3], -0.5), ([-0.5, -0.2], -0.8), ([-0.9, -0.8], -0.1) \right\} \\ \left\{ ac, ([0.3, 0.5], 0.8), ([0.4, 0.6], 0.7), ([0.5, 0.6], 0.4), \right. \\ \left. [(-0.4, -0.3], -0.2), ([-0.6, -0.3], -0.8), ([-0.9, -0.8], -0.3) \right\} \\ \left\{ ad, ([0.1, 0.3], 0.5), ([0.2, 0.3], 0.6), ([0.6, 0.7], 0.5), \right. \\ \left. [(-0.4, -0.3], -0.2), ([-0.6, -0.3], -0.8), ([-0.9, -0.8], -0.4) \right\} \\ \left\{ bc, ([0.3, 0.1], 0.8), ([0.4, 0.6], 0.7), ([0.5, 0.7], 0.1), \right. \\ \left. [(-0.5, -0.4], -0.5), ([-0.5, -0.2], -0.1), ([-0.7, -0.6], -0.1) \right\} \\ \left\{ bd, ([0.1, 0.1], 0.7), ([0.2, 0.3], 0.6), ([0.6, 0.7], 0.1), \right. \\ \left. [(-0.8, -0.6], -0.5), ([-0.5, -0.2], -0.2), ([-0.9, -0.6], -0.1) \right\} \\ \left\{ cd, ([0.1, 0.3], 0.8), ([0.2, 0.3], 0.7), ([0.6, 0.7], 0.4), \right. \\ \left. [(-0.5, -0.4], -0.2), ([-0.6, -0.3], -0.2), ([-0.9, -0.6], -0.3) \right\} \end{array} \right\}$$

Figure 1. The vertex set in P and the edge set in Q are represented for the graph $G^*=(V,E)$

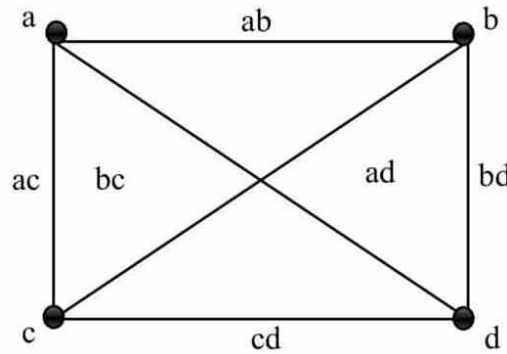

Remark

1. If $n \geq 3$ in the vertex set and $n \geq 3$ in the set of edges then the graphs is a bipolar neutrosophic cubic polygon only when we join each vertex to the corresponding vertex through an edge.
2. If we have infinite elements in the vertex set and by joining the edge and every edge with each other we get a bipolar neutrosophic cubic curve.

Definition 12.

Let $G=(P,Q)$ be a bipolar spherical fuzzy neutrosophic cubic graph. The order of bipolar spherical fuzzy neutrosophic cubic graph is defined by

$$O(G) = \sum_{u \in V} \left\{ (T_A^{P+}, T_\lambda^{P+})(u), (I_A^{P+}, I_\lambda^{P+})(u), (F_A^{P+}, F_\lambda^{P+})(u), \right. \\ \left. (T_A^{P-}, T_\lambda^{P-})(u), (I_A^{P-}, I_\lambda^{P-})(u), (F_A^{P-}, F_\lambda^{P-})(u) \right\}$$

and the degree of a vertex u and G is defined by

$$\deg(u) = \sum_{uv \in E} \left\{ (T_B^{P+}, T_\mu^{P+})(uv), (I_B^{P+}, I_\mu^{P+})(uv), (F_B^{P+}, F_\mu^{P+})(uv), \right. \\ \left. (T_B^{P-}, T_\mu^{P-})(uv), (I_B^{P-}, I_\mu^{P-})(uv), (F_B^{P-}, F_\mu^{P-})(uv) \right\}$$

Example 13.

In the above example, the order of a bipolar spherical fuzzy neutrosophic cubic graph is

$$\begin{aligned} \deg(a) &= \left\{ ([0.7, 0.9], 2), ([1.2, 1.7], 1.8), ([1.5, 2], 1), \right. \\ &\quad \left. ([-1.2, -0.9], -0.9), ([-1.7, -0.8], -2.4), ([-2.7, -2.4], -0.8) \right\} \\ \deg(b) &= \left\{ ([0.7, 0.3], 2.2), ([1.2, 1.7], 1.8), ([1.5, 2.1], 0.3), \right. \\ &\quad \left. ([-1.7, -1.3], -1.5), ([-1.5, -0.6], -1.1), ([-2.5, -2], -0.3) \right\} \\ \deg(c) &= \left\{ ([0.7, 0.9], 2.4), ([1.5], 2.1), ([1.6, 2], 0.9), \right. \\ &\quad \left. ([-1.4, -1.1], -0.9), ([-1.7, -0.8], -1.1), ([-2.5, -2], -0.7) \right\} \\ \deg(d) &= \left\{ ([0.3, 0.7], 2), ([0.6, 0.9], 1.9), ([1.8, 2.1], 1), \right. \\ &\quad \left. ([-1.7, -1.3], -0.9), ([-1.7, -0.8], -1.2), ([-2.7, -2], -0.8) \right\} \end{aligned}$$

Definition 14.

Let $G_1 = (P_1, Q_1)$ be a bipolar spherical fuzzy neutrosophic cubic graph of $G_1^* = (V_1, E_1)$ and $G_2 = (P_2, Q_2)$ be a bipolar spherical fuzzy neutrosophic cubic graph of $G_2^* = (V_2, E_2)$. Then Cartesian product of G_1 and G_2 is denoted by

$$\begin{aligned} G_1 \times G_2 &= (P_1 \times P_2, Q_1 \times Q_2) \\ &= \left((A_1^{P+}, \lambda_1^{P+}) \times (A_2^{P+}, \lambda_2^{P+}), (A_1^{P-}, \lambda_1^{P-}) \times (A_2^{P-}, \lambda_2^{P-}), \right. \\ &\quad \left. (B_1^{P+}, \mu_1^{P+}) \times (B_2^{P+}, \mu_2^{P+}), (B_1^{P-}, \mu_1^{P-}) \times (B_2^{P-}, \mu_2^{P-}) \right) \\ &= \left((A_1^{P+} \times A_2^{P+}, \lambda_1^{P+} \times \lambda_2^{P+}), (A_1^{P-} \times A_2^{P-}, \lambda_1^{P-} \times \lambda_2^{P-}), \right. \\ &\quad \left. (B_1^{P+} \times B_2^{P+}, \mu_1^{P+} \times \mu_2^{P+}), (B_1^{P-} \times B_2^{P-}, \mu_1^{P-} \times \mu_2^{P-}) \right) \\ G_1 \times G_2 &= \left\langle \begin{aligned} &(T_{A_1 \times A_2}^{P+}, T_{\lambda_1 \times \lambda_2}^{P+}), (I_{A_1 \times A_2}^{P+}, I_{\lambda_1 \times \lambda_2}^{P+}), (F_{A_1 \times A_2}^{P+}, F_{\lambda_1 \times \lambda_2}^{P+}) \\ &(T_{A_1 \times A_2}^{P-}, T_{\lambda_1 \times \lambda_2}^{P-}), (I_{A_1 \times A_2}^{P-}, I_{\lambda_1 \times \lambda_2}^{P-}), (F_{A_1 \times A_2}^{P-}, F_{\lambda_1 \times \lambda_2}^{P-}) \\ &(T_{B_1 \times B_2}^{P+}, T_{\mu_1 \times \mu_2}^{P+}), (I_{B_1 \times B_2}^{P+}, I_{\mu_1 \times \mu_2}^{P+}), (F_{B_1 \times B_2}^{P+}, F_{\mu_1 \times \mu_2}^{P+}) \\ &(T_{B_1 \times B_2}^{P-}, T_{\mu_1 \times \mu_2}^{P-}), (I_{B_1 \times B_2}^{P-}, I_{\mu_1 \times \mu_2}^{P-}), (F_{B_1 \times B_2}^{P-}, F_{\mu_1 \times \mu_2}^{P-}) \end{aligned} \right\rangle \end{aligned}$$

and is defined as follows:

$$\begin{aligned} 1. & \left(\begin{aligned} &T_{A_1 \times A_2}^{P+}(u, v) = r \min\{T_{A_1}^{P+}(u), T_{A_2}^{P+}(v)\}, T_{\lambda_1 \times \lambda_2}^{P+}(u, v) = r \max\{T_{\lambda_1}^{P+}(u), T_{\lambda_2}^{P+}(v)\}, \\ &T_{A_1 \times A_2}^{P-}(u, v) = r \max\{T_{A_1}^{P-}(u), T_{A_2}^{P-}(v)\}, T_{\lambda_1 \times \lambda_2}^{P-}(u, v) = r \min\{T_{\lambda_1}^{P-}(u), T_{\lambda_2}^{P-}(v)\} \end{aligned} \right) \\ 2. & \left(\begin{aligned} &I_{A_1 \times A_2}^{P+}(u, v) = r \min\{I_{A_1}^{P+}(u), I_{A_2}^{P+}(v)\}, I_{\lambda_1 \times \lambda_2}^{P+}(u, v) = r \max\{I_{\lambda_1}^{P+}(u), I_{\lambda_2}^{P+}(v)\}, \\ &I_{A_1 \times A_2}^{P-}(u, v) = r \max\{I_{A_1}^{P-}(u), I_{A_2}^{P-}(v)\}, I_{\lambda_1 \times \lambda_2}^{P-}(u, v) = r \min\{I_{\lambda_1}^{P-}(u), I_{\lambda_2}^{P-}(v)\} \end{aligned} \right) \\ 3. & \left(\begin{aligned} &F_{A_1 \times A_2}^{P+}(u, v) = r \max\{F_{A_1}^{P+}(u), F_{A_2}^{P+}(v)\}, F_{\lambda_1 \times \lambda_2}^{P+}(u, v) = r \min\{F_{\lambda_1}^{P+}(u), F_{\lambda_2}^{P+}(v)\}, \\ &F_{A_1 \times A_2}^{P-}(u, v) = r \min\{F_{A_1}^{P-}(u), F_{A_2}^{P-}(v)\}, F_{\lambda_1 \times \lambda_2}^{P-}(u, v) = r \max\{F_{\lambda_1}^{P-}(u), F_{\lambda_2}^{P-}(v)\} \end{aligned} \right) \end{aligned}$$

$$4. \left(\begin{array}{l} T_{B_1 \times B_2}^{P+}((u, v_1)(u, v_2)) = r \min\{T_{A_1}^{P+}(u), T_{B_2}^{P+}(v_1 v_2)\}, \\ T_{B_1 \times B_2}^{P-}((u, v_1)(u, v_2)) = r \max\{T_{A_1}^{P-}(u), T_{B_2}^{P+}(v_1 v_2)\}, \\ T_{\mu_1 \times \mu_2}^{P+}((u, v_1)(u, v_2)) = r \max\{T_{\lambda_1}^{P+}(u), T_{\mu_2}^{P+}(v_1 v_2)\}, \\ T_{\mu_1 \times \mu_2}^{P-}((u, v_1)(u, v_2)) = r \min\{T_{\lambda_1}^{P-}(u), T_{\mu_2}^{P+}(v_1 v_2)\} \end{array} \right)$$

$$5. \left(\begin{array}{l} I_{B_1 \times B_2}^{P+}((u, v_1)(u, v_2)) = r \min\{I_{A_1}^{P+}(u), I_{B_2}^{P+}(v_1 v_2)\}, \\ I_{B_1 \times B_2}^{P-}((u, v_1)(u, v_2)) = r \max\{I_{A_1}^{P-}(u), I_{B_2}^{P+}(v_1 v_2)\}, \\ I_{\mu_1 \times \mu_2}^{P+}((u, v_1)(u, v_2)) = r \max\{I_{\lambda_1}^{P+}(u), I_{\mu_2}^{P+}(v_1 v_2)\}, \\ I_{\mu_1 \times \mu_2}^{P-}((u, v_1)(u, v_2)) = r \min\{I_{\lambda_1}^{P-}(u), I_{\mu_2}^{P+}(v_1 v_2)\} \end{array} \right)$$

$$6. \left(\begin{array}{l} F_{B_1 \times B_2}^{P+}((u, v_1)(u, v_2)) = r \max\{F_{A_1}^{P+}(u), F_{B_2}^{P+}(v_1 v_2)\}, \\ F_{B_1 \times B_2}^{P-}((u, v_1)(u, v_2)) = r \min\{F_{A_1}^{P-}(u), F_{B_2}^{P+}(v_1 v_2)\}, \\ F_{\mu_1 \times \mu_2}^{P+}((u, v_1)(u, v_2)) = r \min\{F_{\lambda_1}^{P+}(u), F_{\mu_2}^{P+}(v_1 v_2)\}, \\ F_{\mu_1 \times \mu_2}^{P-}((u, v_1)(u, v_2)) = r \max\{F_{\lambda_1}^{P-}(u), F_{\mu_2}^{P+}(v_1 v_2)\} \end{array} \right)$$

$$7. \left(\begin{array}{l} T_{B_1 \times B_2}^{P+}((u_1, v)(u_2, v)) = r \min\{T_{B_1}^{P+}(u_1, u_2), T_{\lambda_2}^{P+}(v)\}, \\ T_{B_1 \times B_2}^{P-}((u_1, v)(u_2, v)) = r \max\{T_{B_1}^{P-}(u_1, u_2), T_{\lambda_2}^{P+}(v)\}, \\ T_{\mu_1 \times \mu_2}^{P+}((u_1, v)(u_2, v)) = r \max\{T_{\mu_1}^{P+}(u_1, u_2), T_{\lambda_2}^{P+}(v)\}, \\ T_{\mu_1 \times \mu_2}^{P-}((u_1, v)(u_2, v)) = r \min\{T_{\mu_1}^{P-}(u_1, u_2), T_{\lambda_2}^{P+}(v)\} \end{array} \right)$$

$$8. \left(\begin{array}{l} I_{B_1 \times B_2}^{P+}((u_1, v)(u_2, v)) = r \min\{I_{B_1}^{P+}(u_1, u_2), I_{\lambda_2}^{P+}(v)\}, \\ I_{B_1 \times B_2}^{P-}((u_1, v)(u_2, v)) = r \max\{I_{B_1}^{P-}(u_1, u_2), I_{\lambda_2}^{P+}(v)\}, \\ I_{\mu_1 \times \mu_2}^{P+}((u_1, v)(u_2, v)) = r \max\{I_{\mu_1}^{P+}(u_1, u_2), I_{\lambda_2}^{P+}(v)\}, \\ I_{\mu_1 \times \mu_2}^{P-}((u_1, v)(u_2, v)) = r \min\{I_{\mu_1}^{P-}(u_1, u_2), I_{\lambda_2}^{P+}(v)\} \end{array} \right)$$

$$9. \left(\begin{array}{l} F_{B_1 \times B_2}^{P+}((u_1, v)(u_2, v)) = r \max\{F_{B_1}^{P+}(u_1, u_2), F_{\lambda_2}^{P+}(v)\}, \\ F_{B_1 \times B_2}^{P-}((u_1, v)(u_2, v)) = r \min\{F_{B_1}^{P-}(u_1, u_2), F_{\lambda_2}^{P+}(v)\}, \\ F_{\mu_1 \times \mu_2}^{P+}((u_1, v)(u_2, v)) = r \min\{F_{\mu_1}^{P+}(u_1, u_2), F_{\lambda_2}^{P+}(v)\}, \\ F_{\mu_1 \times \mu_2}^{P-}((u_1, v)(u_2, v)) = r \max\{F_{\mu_1}^{P-}(u_1, u_2), F_{\lambda_2}^{P+}(v)\} \end{array} \right)$$

Example 15.

Let $G_1 = (P_1, Q_1)$ be a bipolar spherical fuzzy neutrosophic cubic graph of $G_1^* = (V_1, E_1)$ as shown in figure 2, Where $V_1 = \{a, b, c\}$, $E_1 = \{ab, bc, ac\}$.

$$P_1 = \left\langle \left\{ \begin{array}{l} a, ([0.3,0.6],0.8), ([0.4,0.6],0.7), ([0.5,0.6],0.4), \\ ([-0.8,-0.6],-0.2), ([-0.7,-0.3],-0.2), ([-0.9,-0.6],-0.4) \end{array} \right\} \right\rangle$$

$$P_1 = \left\langle \left\{ \begin{array}{l} b, ([0.1,0.3],0.5), ([0.2,0.3],0.6), ([0.6,0.7],0.8), \\ ([-0.4,-0.3],-0.2), ([-0.6,-0.5],-0.8), ([-0.9,-0.8],-0.6) \end{array} \right\} \right\rangle$$

$$P_1 = \left\langle \left\{ \begin{array}{l} c, ([0.3,0.5],0.2), ([0.8,0.9],0.5), ([0.2,0.4],0.5), \\ ([-0.8,-0.7],-0.5), ([-0.5,-0.2],-0.1), ([-0.3,-0.2],-0.1) \end{array} \right\} \right\rangle$$

$$Q_1 = \left\langle \left\{ \begin{array}{l} ab, ([0.1,0.3],0.8), ([0.2,0.3],0.7), ([0.6,0.7],0.4), \\ ([-0.4,-0.3],-0.2), ([-0.6,-0.3],-0.8), ([-0.9,-0.8],-0.4) \end{array} \right\} \right\rangle$$

$$Q_1 = \left\langle \left\{ \begin{array}{l} ac, ([0.3,0.5],0.8), ([0.4,0.6],0.7), ([0.5,0.6],0.4), \\ ([-0.8,-0.6],-0.5), ([-0.5,-0.2],-0.2), ([-0.9,-0.6],-0.1) \end{array} \right\} \right\rangle$$

$$Q_1 = \left\langle \left\{ \begin{array}{l} bc, ([0.1,0.3],0.5), ([0.2,0.3],0.6), ([0.6,0.7],0.4), \\ ([-0.4,-0.3],-0.5), ([-0.5,-0.2],-0.8), ([-0.9,-0.8],-0.1) \end{array} \right\} \right\rangle$$

and $G_2 = (P_2, Q_2)$ be a bipolar spherical fuzzy neutrosophic cubic graph if $G_2^* = (V_2, E_2)$ as shown in figure 3, where $V_2 = \{x, y, z\}$ and $E_2 = \{xy, yz, xz\}$

$$P_2 = \left\langle \left\{ \begin{array}{l} x, ([0.5,0.6],0.3), ([0.4,0.7],0.1), ([0.2,0.3],0.5), \\ ([-0.7,-0.6],-0.1), ([-0.4,-0.2],-0.5), ([-0.5,-0.4],-0.3) \end{array} \right\} \right\rangle$$

$$P_2 = \left\langle \left\{ \begin{array}{l} y, ([0.1,0.2],0.4), ([0.7,0.3],0.9), ([0.2,0.4],0.1), \\ ([-0.3,-0.2],-0.1), ([-0.5,-0.3],-0.2), ([-0.7,-0.5],-0.3) \end{array} \right\} \right\rangle$$

$$P_2 = \left\langle \left\{ \begin{array}{l} z, ([0.3,0.5],0.2), ([0.5,0.6],0.7), ([0.2,0.6],0.8), \\ ([-0.8,-0.7],-0.5), ([-0.7,-0.4],-0.3), ([-0.9,-0.4],-0.2) \end{array} \right\} \right\rangle$$

$$Q_2 = \left\langle \left\{ \begin{array}{l} xy, ([0.1,0.2],0.4), ([0.4,0.3],0.9), ([0.2,0.4],0.1), \\ ([-0.3,-0.2],-0.1), ([-0.4,-0.2],-0.5), ([-0.7,-0.5],-0.3) \end{array} \right\} \right\rangle$$

$$Q_2 = \left\langle \left\{ \begin{array}{l} xz, ([0.3,0.5],0.3), ([0.4,0.6],0.7), ([0.2,0.6],0.5), \\ ([-0.7,-0.6],-0.5), ([-0.4,-0.2],-0.5), ([-0.9,-0.4],-0.2) \end{array} \right\} \right\rangle$$

$$Q_2 = \left\langle \left\{ \begin{array}{l} yz, ([0.1,0.2],0.4), ([0.5,0.3],0.9), ([0.2,0.6],0.1), \\ ([-0.3,-0.2],-0.5), ([-0.5,-0.3],-0.3), ([-0.9,-0.5],-0.2) \end{array} \right\} \right\rangle$$

Then $G_1 \times G_2$ is a bipolar spherical fuzzy neutrosophic cubic graph of $G_1^* \times G_2^*$ as shown in Figure 4, where $V_1 \times V_2 = \{(a,x), (a,y), (a,z), (b,x), (b,y), (b,z), (c,x), (c,y), (c,z)\}$ and

$$P_1 \times P_2 = \left\{ \begin{array}{l} \left\{ (a, x), ([0.3, 0.6], 0.8), ([0.4, 0.6], 0.7), ([0.5, 0.6], 0.4), \right. \\ \left. [(-0.7, -0.6], -0.2), [(-0.4, -0.2], -0.5), [(-0.9, -0.6], -0.3) \right\} \\ \left\{ (a, y), ([0.1, 0.2], 0.8), ([0.4, 0.3], 0.9), ([0.5, 0.6], 0.1), \right. \\ \left. [(-0.3, -0.2], -0.2), [(-0.5, -0.3], -0.2), [(-0.9, -0.6], -0.3) \right\} \\ \left\{ (a, z), ([0.3, 0.5], 0.8), ([0.4, 0.6], 0.7), ([0.5, 0.6], 0.4), \right. \\ \left. [(-0.8, -0.6], -0.5), [(-0.7, -0.3], -0.3), [(-0.9, -0.6], -0.2) \right\} \\ \left\{ (b, x), ([0.1, 0.3], 0.5), ([0.2, 0.3], 0.6), ([0.6, 0.7], 0.5), \right. \\ \left. [(-0.4, -0.3], -0.2), [(-0.4, -0.2], -0.8), [(-0.9, -0.8], -0.3) \right\} \\ \left\{ (b, y), ([0.1, 0.2], 0.5), ([0.2, 0.3], 0.9), ([0.6, 0.7], 0.1), \right. \\ \left. [(-0.3, -0.2], -0.2), [(-0.5, -0.3], -0.8), [(-0.9, -0.8], -0.3) \right\} \\ \left\{ (b, z), ([0.1, 0.3], 0.5), ([0.2, 0.3], 0.7), ([0.6, 0.7], 0.8), \right. \\ \left. [(-0.4, -0.3], -0.5), [(-0.6, -0.4], -0.8), [(-0.9, -0.8], -0.2) \right\} \\ \left\{ (c, x), ([0.3, 0.5], 0.3), ([0.4, 0.7], 0.5), ([0.2, 0.4], 0.5), \right. \\ \left. [(-0.7, -0.6], -0.5), [(-0.4, -0.2], -0.5), [(-0.5, -0.4], -0.1) \right\} \\ \left\{ (c, y), ([0.1, 0.2], 0.4), ([0.7, 0.3], 0.9), ([0.2, 0.4], 0.1), \right. \\ \left. [(-0.3, -0.2], -0.5), [(-0.5, -0.2], -0.2), [(-0.7, -0.5], -0.1) \right\} \\ \left\{ (c, z), ([0.3, 0.5], 0.2), ([0.5, 0.6], 0.7), ([0.2, 0.6], 0.5), \right. \\ \left. [(-0.8, -0.7], -0.5), [(-0.5, -0.2], -0.3), [(-0.9, -0.4], -0.1) \right\} \end{array} \right\}$$

$$Q_1 \times Q_2 = \left\{ \begin{array}{l} \left\{ ((a, x)(a, y)), ([0.1, 0.2], 0.8), ([0.4, 0.3], 0.9), ([0.5, 0.6], 0.1), \right. \\ \left. [(-0.3, -0.2], -0.2), [(-0.4, -0.2], -0.5), [(-0.9, -0.6], -0.3) \right\} \\ \left\{ ((a, y)(a, z)), ([0.1, 0.2], 0.8), ([0.4, 0.3], 0.9), ([0.5, 0.6], 0.1), \right. \\ \left. [(-0.3, -0.2], -0.5), [(-0.5, -0.3], -0.3), [(-0.9, -0.6], -0.2) \right\} \\ \left\{ ((a, z)(b, z)), ([0.1, 0.3], 0.8), ([0.2, 0.3], 0.7), ([0.6, 0.7], 0.4), \right. \\ \left. [(-0.4, -0.3], -0.5), [(-0.6, -0.3], -0.8), [(-0.9, -0.8], -0.2) \right\} \\ \left\{ ((b, x)(b, y)), ([0.1, 0.2], 0.5), ([0.2, 0.3], 0.9), ([0.6, 0.7], 0.1), \right. \\ \left. [(-0.3, -0.2], -0.2), [(-0.4, -0.2], -0.8), [(-0.9, -0.8], -0.3) \right\} \\ \left\{ ((b, x)(b, z)), ([0.1, 0.3], 0.5), ([0.2, 0.3], 0.7), ([0.6, 0.7], 0.5), \right. \\ \left. [(-0.4, -0.3], -0.5), [(-0.4, -0.2], -0.8), [(-0.9, -0.8], -0.2) \right\} \\ \left\{ ((c, y)(c, z)), ([0.1, 0.2], 0.4), ([0.5, 0.3], 0.9), ([0.2, 0.6], 0.1), \right. \\ \left. [(-0.3, -0.2], -0.5), [(-0.5, -0.2], -0.3), [(-0.9, -0.5], -0.1) \right\} \\ \left\{ ((c, x)(c, z)), ([0.3, 0.5], 0.3), ([0.4, 0.6], 0.7), ([0.2, 0.6], 0.5), \right. \\ \left. [(-0.7, -0.6], -0.5), [(-0.4, -0.2], -0.5), [(-0.9, -0.4], -0.1) \right\} \\ \left\{ ((a, x)(c, x)), ([0.3, 0.5], 0.8), ([0.4, 0.6], 0.7), ([0.5, 0.6], 0.4), \right. \\ \left. [(-0.7, -0.6], -0.5), [(-0.4, -0.2], -0.5), [(-0.9, -0.6], -0.1) \right\} \end{array} \right\}$$

Figure 2: The vertex set in P_1 and the edge set in Q_1 are represented for the graph $G_1=(P_1, Q_1)$

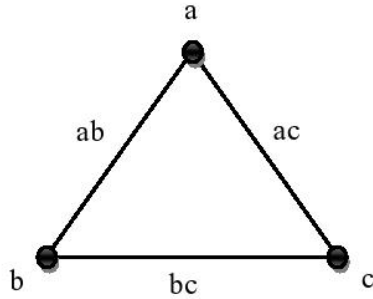
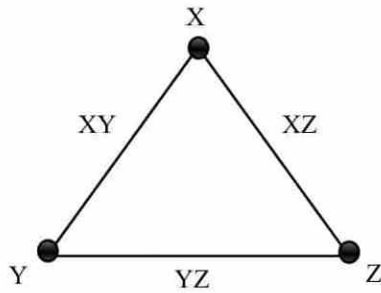

Figure 3: The vertex set in P_2 and the edge set in Q_2 are represented for the graph $G_2=(P_2, Q_2)$



Proposition 16.

The Cartesian product of two bipolar spherical fuzzy neutrosophic cubic graphs is again a bipolar spherical fuzzy neutrosophic cubic graph.

Proof:

For $P_1 \times P_2$ the condition is obvious. Now we verify the conditions only for $Q_1 \times Q_2$,

where

$$Q_1 \times Q_2 = \left\{ (T_{B_1 \times B_2}^{P+}, T_{\mu_1 \times \mu_2}^{P+}), (I_{B_1 \times B_2}^{P+}, I_{\mu_1 \times \mu_2}^{P+}), (F_{B_1 \times B_2}^{P+}, F_{\mu_1 \times \mu_2}^{P+}), (T_{B_1 \times B_2}^{P-}, T_{\mu_1 \times \mu_2}^{P-}), (I_{B_1 \times B_2}^{P-}, I_{\mu_1 \times \mu_2}^{P-}), (F_{B_1 \times B_2}^{P-}, F_{\mu_1 \times \mu_2}^{P-}) \right\}$$

Then

$$\left(\begin{aligned} T_{B_1 \times B_2}^{P+}((u, u_2)(u, v_2)) &= r \min\{T_{A_1}^{P+}(u), T_{B_2}^{P+}(u_2 v_2)\}, \\ &\leq r \min\{T_{A_1}^{P+}(u), (r \min\{T_{A_2}^{P+}(u_2), T_{A_2}^{P+}(v_2)\})\} \\ &= r \min\{r \min\{T_{A_1}^{P+}(u), T_{A_2}^{P+}(u_2)\}, r \min\{T_{A_1}^{P+}(u), T_{A_2}^{P+}(v_2)\}\} \\ &= r \min\{((T_{A_1}^{P+} \times T_{A_2}^{P+})(uu_2)), ((T_{A_1}^{P+} \times T_{A_2}^{P+})(uv_2))\} \end{aligned} \right)$$

$$\left(\begin{aligned} T_{B_1 \times B_2}^{P-}((u, u_2)(u, v_2)) &= r \max\{T_{A_1}^{P-}(u), T_{B_2}^{P-}(u_2 v_2)\}, \\ &\geq r \max\{(T_{A_1}^{P-}(u)), (r \max(T_{A_2}^{P-}(u_2), T_{A_2}^{P-}(v_2)))\} \\ &= r \max\{r \max(T_{A_1}^{P-}(u), T_{A_2}^{P-}(u_2)), r \max(T_{A_1}^{P-}(u), T_{A_2}^{P-}(v_2))\} \\ &= r \max\{(T_{A_1}^{P-} \times T_{A_2}^{P-})(uu_2), (T_{A_1}^{P-} \times T_{A_2}^{P-})(uv_2)\} \end{aligned} \right)$$

$$\left(\begin{aligned} T_{\mu_1 \times \mu_2}^{P+}((u, u_2)(u, v_2)) &= r \max\{T_{\lambda_1}^{P+}(u), T_{\mu_2}^{P+}(u_2 v_2)\}, \\ &\leq r \max\{(T_{\lambda_1}^{P+}(u)), (r \max(T_{\lambda_2}^{P+}(u_2), T_{\lambda_2}^{P+}(v_2)))\} \\ &= r \max\{r \max(T_{\lambda_1}^{P+}(u), T_{\lambda_2}^{P+}(u_2)), r \max(T_{\lambda_1}^{P+}(u), T_{\lambda_2}^{P+}(v_2))\} \\ &= r \max\{(T_{\lambda_1}^{P+} \times T_{\lambda_2}^{P+})(uu_2), (T_{\lambda_1}^{P+} \times T_{\lambda_2}^{P+})(uv_2)\} \end{aligned} \right)$$

$$\left(\begin{aligned} T_{\mu_1 \times \mu_2}^{P-}((u, u_2)(u, v_2)) &= r \min\{T_{\lambda_1}^{P-}(u), T_{\mu_2}^{P-}(u_2 v_2)\}, \\ &\geq r \min\{(T_{\lambda_1}^{P-}(u)), (r \min(T_{\lambda_2}^{P-}(u_2), T_{\lambda_2}^{P-}(v_2)))\} \\ &= r \min\{r \min(T_{\lambda_1}^{P-}(u), T_{\lambda_2}^{P-}(u_2)), r \min(T_{\lambda_1}^{P-}(u), T_{\lambda_2}^{P-}(v_2))\} \\ &= r \min\{(T_{\lambda_1}^{P-} \times T_{\lambda_2}^{P-})(uu_2), (T_{\lambda_1}^{P-} \times T_{\lambda_2}^{P-})(uv_2)\} \end{aligned} \right)$$

$$\left(\begin{aligned} I_{B_1 \times B_2}^{P+}((u, u_2)(u, v_2)) &= r \min\{I_{A_1}^{P+}(u), I_{B_2}^{P+}(u_2 v_2)\}, \\ &\leq r \min\{(I_{A_1}^{P+}(u)), (r \min(I_{A_2}^{P+}(u_2), I_{A_2}^{P+}(v_2)))\} \\ &= r \min\{r \min(I_{A_1}^{P+}(u), I_{A_2}^{P+}(u_2)), r \min(I_{A_1}^{P+}(u), I_{A_2}^{P+}(v_2))\} \\ &= r \min\{(I_{A_1}^{P+} \times I_{A_2}^{P+})(uu_2), (I_{A_1}^{P+} \times I_{A_2}^{P+})(uv_2)\} \end{aligned} \right)$$

$$\left(\begin{aligned} I_{B_1 \times B_2}^{P-}((u, u_2)(u, v_2)) &= r \max\{I_{A_1}^{P-}(u), I_{B_2}^{P-}(u_2 v_2)\}, \\ &\geq r \max\{(I_{A_1}^{P-}(u)), (r \max(I_{A_2}^{P-}(u_2), I_{A_2}^{P-}(v_2)))\} \\ &= r \max\{r \max(I_{A_1}^{P-}(u), I_{A_2}^{P-}(u_2)), r \max(I_{A_1}^{P-}(u), I_{A_2}^{P-}(v_2))\} \\ &= r \max\{(I_{A_1}^{P-} \times I_{A_2}^{P-})(uu_2), (I_{A_1}^{P-} \times I_{A_2}^{P-})(uv_2)\} \end{aligned} \right)$$

$$\left(\begin{aligned} I_{\mu_1 \times \mu_2}^{P+}((u, u_2)(u, v_2)) &= r \max\{I_{\lambda_1}^{P+}(u), I_{\mu_2}^{P+}(u_2 v_2)\}, \\ &\leq r \max\{(I_{\lambda_1}^{P+}(u)), (r \max(I_{\lambda_2}^{P+}(u_2), I_{\lambda_2}^{P+}(v_2)))\} \\ &= r \max\{r \max(I_{\lambda_1}^{P+}(u), I_{\lambda_2}^{P+}(u_2)), r \max(I_{\lambda_1}^{P+}(u), I_{\lambda_2}^{P+}(v_2))\} \\ &= r \max\{(I_{\lambda_1}^{P+} \times I_{\lambda_2}^{P+})(uu_2), (I_{\lambda_1}^{P+} \times I_{\lambda_2}^{P+})(uv_2)\} \end{aligned} \right)$$

$$\left(\begin{aligned} I_{\mu_1 \times \mu_2}^{P-}((u, u_2)(u, v_2)) &= r \min\{I_{\lambda_1}^{P-}(u), I_{\mu_2}^{P-}(u_2 v_2)\}, \\ &\geq r \min\{(I_{\lambda_1}^{P-}(u)), (r \min(I_{\lambda_2}^{P-}(u_2), I_{\lambda_2}^{P-}(v_2)))\} \\ &= r \min\{r \min(I_{\lambda_1}^{P-}(u), I_{\lambda_2}^{P-}(u_2)), r \min(I_{\lambda_1}^{P-}(u), I_{\lambda_2}^{P-}(v_2))\} \\ &= r \min\{(I_{\lambda_1}^{P-} \times I_{\lambda_2}^{P-})(uu_2), (I_{\lambda_1}^{P-} \times I_{\lambda_2}^{P-})(uv_2)\} \end{aligned} \right)$$

$$\left(\begin{aligned} F_{B_1 \times B_2}^{P+}((u, u_2)(u, v_2)) &= r \max\{F_{A_1}^{P+}(u), F_{B_2}^{P+}(u_2 v_2)\}, \\ &\leq r \max\{(F_{A_1}^{P+}(u)), (r \max(F_{A_2}^{P+}(u_2), F_{A_2}^{P+}(v_2)))\} \\ &= r \max\{r \max(F_{A_1}^{P+}(u), F_{A_2}^{P+}(u_2)), r \max(F_{A_1}^{P+}(u), F_{A_2}^{P+}(v_2))\} \\ &= r \max\{((F_{A_1}^{P+} \times F_{A_2}^{P+})(uu_2)), ((F_{A_1}^{P+} \times F_{A_2}^{P+})(uv_2))\} \end{aligned} \right)$$

$$\left(\begin{aligned} F_{B_1 \times B_2}^{P-}((u, u_2)(u, v_2)) &= r \min\{F_{A_1}^{P-}(u), F_{B_2}^{P-}(u_2 v_2)\}, \\ &\geq r \min\{(F_{A_1}^{P-}(u)), (r \min(F_{A_2}^{P-}(u_2), F_{A_2}^{P-}(v_2)))\} \\ &= r \min\{r \min(F_{A_1}^{P-}(u), F_{A_2}^{P-}(u_2)), r \min(F_{A_1}^{P-}(u), F_{A_2}^{P-}(v_2))\} \\ &= r \min\{((F_{A_1}^{P-} \times F_{A_2}^{P-})(uu_2)), ((F_{A_1}^{P-} \times F_{A_2}^{P-})(uv_2))\} \end{aligned} \right)$$

$$\left(\begin{aligned} F_{\mu_1 \times \mu_2}^{P+}((u, u_2)(u, v_2)) &= r \min\{F_{\lambda_1}^{P+}(u), F_{\lambda_2}^{P+}(u_2 v_2)\}, \\ &\leq r \min\{(F_{\lambda_1}^{P+}(u)), (r \min(F_{\lambda_2}^{P+}(u_2), F_{\lambda_2}^{P+}(v_2)))\} \\ &= r \min\{r \min(F_{\lambda_1}^{P+}(u), F_{\lambda_2}^{P+}(u_2)), r \min(F_{\lambda_1}^{P+}(u), F_{\lambda_2}^{P+}(v_2))\} \\ &= r \min\{((F_{\lambda_1}^{P+} \times F_{\lambda_2}^{P+})(uu_2)), ((F_{\lambda_1}^{P+} \times F_{\lambda_2}^{P+})(uv_2))\} \end{aligned} \right)$$

$$\left(\begin{aligned} F_{\mu_1 \times \mu_2}^{P-}((u, u_2)(u, v_2)) &= r \max\{F_{\lambda_1}^{P-}(u), F_{\lambda_2}^{P-}(u_2 v_2)\}, \\ &\geq r \max\{(F_{\lambda_1}^{P-}(u)), (r \max(F_{\lambda_2}^{P-}(u_2), F_{\lambda_2}^{P-}(v_2)))\} \\ &= r \max\{r \max(F_{\lambda_1}^{P-}(u), F_{\lambda_2}^{P-}(u_2)), r \max(F_{\lambda_1}^{P-}(u), F_{\lambda_2}^{P-}(v_2))\} \\ &= r \max\{((F_{\lambda_1}^{P-} \times F_{\lambda_2}^{P-})(uu_2)), ((F_{\lambda_1}^{P-} \times F_{\lambda_2}^{P-})(uv_2))\} \end{aligned} \right)$$

Similarly, we can prove it for $w \in V_2$ and $u_1, u_2 \in E_2$

Definition 17.

Let $G_1 = (P_1, Q_1)$ and $G_2 = (P_2, Q_2)$ be two bipolar spherical fuzzy neutrosophic cubic graphs. The degree of a vertex in $G_1 \times G_2$ can be defined as follows for any $(u_1 \times u_2) \in v_1 \times v_2$

$$\begin{aligned} \text{deg}(T_{A_1}^{P+} \times T_{A_2}^{P+})(u_1, u_2) &= \sum_{(u_1 u_2)(v_1 v_2) \in E_2} r \max(T_{B_1}^{P+} \times T_{B_2}^{P+})(u_1, u_2)(v_1, v_2) = \sum_{u_1=v_1=u, u_2=v_2 \in E_2} r \max(T_{A_1}^{P+}(u), T_{B_2}^{P+}(u_2, v_2)) \\ &+ \sum_{u_2=v_2=w, u_1 v_1 \in E} r \max(T_{A_2}^{P+}(w), T_{B_1}^{P+}(u_1, v_1)) + \sum_{u_1=v_1 \in E, u_2 v_2 \in E_2} r \max(T_{B_1}^{P+}(u_1, v_1), T_{B_2}^{P+}(u_2, v_2)) \end{aligned}$$

$$\begin{aligned} \text{deg}(T_{A_1}^{P-} \times T_{A_2}^{P-})(u_1, u_2) &= \sum_{(u_1 u_2)(v_1 v_2) \in E_2} r \min(T_{B_1}^{P-} \times T_{B_2}^{P-})(u_1, u_2)(v_1, v_2) = \sum_{u_1=v_1=u, u_2=v_2 \in E_2} r \max(T_{A_1}^{P-}(u), T_{B_2}^{P-}(u_2, v_2)) \\ &+ \sum_{u_2=v_2=w, u_1 v_1 \in E} r \max(T_{A_2}^{P-}(w), T_{B_1}^{P-}(u_1, v_1)) + \sum_{u_1=v_1 \in E, u_2 v_2 \in E_2} r \max(T_{B_1}^{P-}(u_1, v_1), T_{B_2}^{P-}(u_2, v_2)) \end{aligned}$$

$$\begin{aligned} & \deg(T_{\lambda_1}^{P+} \times T_{\lambda_2}^{P+})(u_1, u_2) \\ &= \sum_{(u_1, u_2)(v_1, v_2) \in E_2} r \min(T_{\mu_1}^{P+} \times T_{\mu_2}^{P+})(u_1, u_2)(v_1, v_2) = \sum_{u_1=v_1=u, u_2, v_2 \in E_2} r \min(T_{\lambda_1}^{P+}(u), T_{\mu_2}^{P+}(u_2, v_2)) \\ &+ \sum_{u_2=v_2=w, u_1, v_1 \in E} r \min(T_{\lambda_2}^{P+}(w), T_{\mu_1}^{P+}(u_1, v_1)) + \sum_{u_1=v_1 \in E, u_2, v_2 \in E_2} r \min(T_{\mu_1}^{P+}(u_1, v_1), T_{\mu_2}^{P+}(u_2, v_2)) \end{aligned}$$

$$\begin{aligned} & \deg(T_{\lambda_1}^{P-} \times T_{\lambda_2}^{P-})(u_1, u_2) \\ &= \sum_{(u_1, u_2)(v_1, v_2) \in E_2} r \max(T_{\mu_1}^{P-} \times T_{\mu_2}^{P-})(u_1, u_2)(v_1, v_2) = \sum_{u_1=v_1=u, u_2, v_2 \in E_2} r \max(T_{\lambda_1}^{P-}(u), T_{\mu_2}^{P-}(u_2, v_2)) \\ &+ \sum_{u_2=v_2=w, u_1, v_1 \in E} r \max(T_{\lambda_2}^{P-}(w), T_{\mu_1}^{P-}(u_1, v_1)) + \sum_{u_1=v_1 \in E, u_2, v_2 \in E_2} r \max(T_{\mu_1}^{P-}(u_1, v_1), T_{\mu_2}^{P-}(u_2, v_2)) \end{aligned}$$

$$\begin{aligned} & \deg(I_{A_1}^{P+} \times I_{A_2}^{P+})(u_1, u_2) \\ &= \sum_{(u_1, u_2)(v_1, v_2) \in E_2} r \max(I_{B_1}^{P+} \times I_{B_2}^{P+})(u_1, u_2)(v_1, v_2) = \sum_{u_1=v_1=u, u_2, v_2 \in E_2} r \max(I_{A_1}^{P+}(u), I_{B_2}^{P+}(u_2, v_2)) \\ &+ \sum_{u_2=v_2=w, u_1, v_1 \in E} r \max(I_{A_2}^{P+}(w), I_{B_1}^{P+}(u_1, v_1)) + \sum_{u_1=v_1 \in E, u_2, v_2 \in E_2} r \max(I_{B_1}^{P+}(u_1, v_1), I_{B_2}^{P+}(u_2, v_2)) \end{aligned}$$

$$\begin{aligned} & \deg(I_{A_1}^{P-} \times I_{A_2}^{P-})(u_1, u_2) \\ &= \sum_{(u_1, u_2)(v_1, v_2) \in E_2} r \min(I_{B_1}^{P-} \times I_{B_2}^{P-})(u_1, u_2)(v_1, v_2) = \sum_{u_1=v_1=u, u_2, v_2 \in E_2} r \max(I_{A_1}^{P-}(u), I_{B_2}^{P-}(u_2, v_2)) \\ &+ \sum_{u_2=v_2=w, u_1, v_1 \in E} r \max(I_{A_2}^{P-}(w), I_{B_1}^{P-}(u_1, v_1)) + \sum_{u_1=v_1 \in E, u_2, v_2 \in E_2} r \max(I_{B_1}^{P-}(u_1, v_1), I_{B_2}^{P-}(u_2, v_2)) \end{aligned}$$

$$\begin{aligned} & \deg(I_{\lambda_1}^{P+} \times I_{\lambda_2}^{P+})(u_1, u_2) \\ &= \sum_{(u_1, u_2)(v_1, v_2) \in E_2} r \min(I_{\mu_1}^{P+} \times I_{\mu_2}^{P+})(u_1, u_2)(v_1, v_2) = \sum_{u_1=v_1=u, u_2, v_2 \in E_2} r \min(I_{\lambda_1}^{P+}(u), I_{\mu_2}^{P+}(u_2, v_2)) \\ &+ \sum_{u_2=v_2=w, u_1, v_1 \in E} r \min(I_{\lambda_2}^{P+}(w), I_{\mu_1}^{P+}(u_1, v_1)) + \sum_{u_1=v_1 \in E, u_2, v_2 \in E_2} r \min(I_{\mu_1}^{P+}(u_1, v_1), I_{\mu_2}^{P+}(u_2, v_2)) \end{aligned}$$

$$\begin{aligned} & \deg(I_{\lambda_1}^{P-} \times I_{\lambda_2}^{P-})(u_1, u_2) \\ &= \sum_{(u_1, u_2)(v_1, v_2) \in E_2} r \max(I_{\mu_1}^{P-} \times I_{\mu_2}^{P-})(u_1, u_2)(v_1, v_2) = \sum_{u_1=v_1=u, u_2, v_2 \in E_2} r \max(I_{\lambda_1}^{P-}(u), I_{\mu_2}^{P-}(u_2, v_2)) \\ &+ \sum_{u_2=v_2=w, u_1, v_1 \in E} r \max(I_{\lambda_2}^{P-}(w), I_{\mu_1}^{P-}(u_1, v_1)) + \sum_{u_1=v_1 \in E, u_2, v_2 \in E_2} r \max(I_{\mu_1}^{P-}(u_1, v_1), I_{\mu_2}^{P-}(u_2, v_2)) \end{aligned}$$

$$\begin{aligned} & \deg(F_{A_1}^{P+} \times F_{A_2}^{P+})(u_1, u_2) \\ &= \sum_{(u_1, u_2)(v_1, v_2) \in E_2} r \min(F_{B_1}^{P+} \times F_{B_2}^{P+})(u_1, u_2)(v_1, v_2) = \sum_{u_1=v_1=u, u_2, v_2 \in E_2} r \min(F_{A_1}^{P+}(u), F_{B_2}^{P+}(u_2, v_2)) \\ &+ \sum_{u_2=v_2=w, u_1, v_1 \in E} r \min(F_{A_2}^{P+}(w), F_{B_1}^{P+}(u_1, v_1)) + \sum_{u_1=v_1 \in E, u_2, v_2 \in E_2} r \min(F_{B_1}^{P+}(u_1, v_1), F_{B_2}^{P+}(u_2, v_2)) \end{aligned}$$

$$\begin{aligned} & \text{deg}(F_{A_1}^{P-} \times F_{A_2}^{P-})(u_1, u_2) \\ &= \sum_{(u_1, u_2)(v_1, v_2) \in E_2} r \max(F_{B_1}^{P-} \times F_{B_2}^{P-})(u_1, u_2)(v_1, v_2) = \sum_{u_1=v_1=u, u_2=v_2 \in E_2} r \min(F_{A_1}^{P-}(u), F_{B_2}^{P-}(u_2, v_2)) \\ &+ \sum_{u_2=v_2=w, u_1v_1 \in E} r \min(F_{A_2}^{P-}(w), F_{B_1}^{P-}(u_1, v_1)) + \sum_{u_1=v_1 \in E, u_2v_2 \in E_2} r \min(F_{B_1}^{P-}(u_1, v_1), F_{B_2}^{P-}(u_2, v_2)) \end{aligned}$$

$$\begin{aligned} & \text{deg}(F_{\lambda_1}^{P+} \times F_{\lambda_2}^{P+})(u_1, u_2) \\ &= \sum_{(u_1, u_2)(v_1, v_2) \in E_2} r \max(F_{\mu_1}^{P+} \times F_{\mu_2}^{P+})(u_1, u_2)(v_1, v_2) = \sum_{u_1=v_1=u, u_2=v_2 \in E_2} r \max(F_{\lambda_1}^{P+}(u), F_{\mu_2}^{P+}(u_2, v_2)) \\ &+ \sum_{u_2=v_2=w, u_1v_1 \in E} r \max(F_{\lambda_2}^{P+}(w), F_{\mu_1}^{P+}(u_1, v_1)) + \sum_{u_1=v_1 \in E, u_2v_2 \in E_2} r \max(F_{\mu_1}^{P+}(u_1, v_1), F_{\mu_2}^{P+}(u_2, v_2)) \end{aligned}$$

$$\begin{aligned} & \text{deg}(F_{\lambda_1}^{P-} \times F_{\lambda_2}^{P-})(u_1, u_2) \\ &= \sum_{(u_1, u_2)(v_1, v_2) \in E_2} r \min(F_{\mu_1}^{P-} \times F_{\mu_2}^{P-})(u_1, u_2)(v_1, v_2) = \sum_{u_1=v_1=u, u_2=v_2 \in E_2} r \min(F_{\lambda_1}^{P-}(u), F_{\mu_2}^{P-}(u_2, v_2)) \\ &+ \sum_{u_2=v_2=w, u_1v_1 \in E} r \min(F_{\lambda_2}^{P-}(w), F_{\mu_1}^{P-}(u_1, v_1)) + \sum_{u_1=v_1 \in E, u_2v_2 \in E_2} r \min(F_{\mu_1}^{P-}(u_1, v_1), F_{\mu_2}^{P-}(u_2, v_2)) \end{aligned}$$

Definition 18.

Let $G_1 = (P_1, Q_1)$ be a bipolar spherical fuzzy neutrosophic cubic graph of $G_1^* = (V_1^*, E_1^*)$ and $G_2 = (P_2, Q_2)$ be a bipolar spherical fuzzy neutrosophic cubic graph of $G_2^* = (V_2^*, E_2^*)$. Then the composition of G_1 and G_2 is denoted by $G_1[G_2]$ and defined as follows:

$$\begin{aligned} G_1[G_2] &= (P_1, Q_1)[P_2, Q_2] \\ &= \{(P_1[P_2], Q_1[Q_2])\} \\ &= \{(A_1, \lambda_1)[A_2, \lambda_2], (B_1, \mu_1)[B_2, \mu_2]\} \\ &= \{(A_1[A_2], \lambda_1[\lambda_2]), (B_1[B_2], \mu_1[\mu_2])\} \end{aligned}$$

$$= \left\langle \left\langle \begin{aligned} & ((T_{A_1}^{P+} \circ T_{A_2}^{P+}), (T_{\lambda_1}^{P+} \circ T_{\lambda_2}^{P+})), ((I_{A_1}^{P+} \circ I_{A_2}^{P+}), (I_{\lambda_1}^{P+} \circ I_{\lambda_2}^{P+})), ((F_{A_1}^{P+} \circ F_{A_2}^{P+}), (F_{\lambda_1}^{P+} \circ F_{\lambda_2}^{P+})), \\ & ((T_{A_1}^{P-} \circ T_{A_2}^{P-}), (T_{\lambda_1}^{P-} \circ T_{\lambda_2}^{P-})), ((I_{A_1}^{P-} \circ I_{A_2}^{P-}), (I_{\lambda_1}^{P-} \circ I_{\lambda_2}^{P-})), ((F_{A_1}^{P-} \circ F_{A_2}^{P-}), (F_{\lambda_1}^{P-} \circ F_{\lambda_2}^{P-})) \end{aligned} \right\rangle \right\rangle$$

$$= \left\langle \left\langle \begin{aligned} & ((T_{B_1}^{P+} \circ T_{B_2}^{P+}), (T_{\mu_1}^{P+} \circ T_{\mu_2}^{P+})), ((I_{B_1}^{P+} \circ I_{B_2}^{P+}), (I_{\mu_1}^{P+} \circ I_{\mu_2}^{P+})), ((F_{B_1}^{P+} \circ F_{B_2}^{P+}), (F_{\mu_1}^{P+} \circ F_{\mu_2}^{P+})), \\ & ((T_{B_1}^{P-} \circ T_{B_2}^{P-}), (T_{\mu_1}^{P-} \circ T_{\mu_2}^{P-})), ((I_{B_1}^{P-} \circ I_{B_2}^{P-}), (I_{\mu_1}^{P-} \circ I_{\mu_2}^{P-})), ((F_{B_1}^{P-} \circ F_{B_2}^{P-}), (F_{\mu_1}^{P-} \circ F_{\mu_2}^{P-})) \end{aligned} \right\rangle \right\rangle$$

1. $\forall (u, v) \in (v_1, v_2) = V$

$$(T_{A_1}^{P+} \circ T_{A_2}^{P+})(u, v) = r \min(T_{A_1}^{P+}(u), T_{A_2}^{P+}(v)), (T_{\lambda_1}^{P+} \circ T_{\lambda_2}^{P+})(u, v) = \max(T_{\lambda_1}^{P+}(u), T_{\lambda_2}^{P+}(v))$$

$$(T_{A_1}^{P-} \circ T_{A_2}^{P-})(u, v) = r \max(T_{A_1}^{P-}(u), T_{A_2}^{P-}(v)), (T_{\lambda_1}^{P-} \circ T_{\lambda_2}^{P-})(u, v) = \min(T_{\lambda_1}^{P-}(u), T_{\lambda_2}^{P-}(v))$$

$$(I_{A_1}^{P+} \circ I_{A_2}^{P+})(u, v) = r \min(I_{A_1}^{P+}(u), I_{A_2}^{P+}(v)), (I_{\lambda_1}^{P+} \circ I_{\lambda_2}^{P+})(u, v) = \max(I_{\lambda_1}^{P+}(u), I_{\lambda_2}^{P+}(v))$$

$$(I_{A_1}^{P-} \circ I_{A_2}^{P-})(u, v) = r \max(I_{A_1}^{P-}(u), I_{A_2}^{P-}(v)), (I_{\lambda_1}^{P-} \circ I_{\lambda_2}^{P-})(u, v) = \min(I_{\lambda_1}^{P-}(u), I_{\lambda_2}^{P-}(v))$$

$$(F_{A_1}^{P+} \circ F_{A_2}^{P+})(u, v) = r \max(F_{A_1}^{P+}(u), F_{A_2}^{P+}(v)), (F_{\lambda_1}^{P+} \circ F_{\lambda_2}^{P+})(u, v) = \min(F_{\lambda_1}^{P+}(u), F_{\lambda_2}^{P+}(v))$$

$$(F_{A_1}^{P-} \circ F_{A_2}^{P-})(u, v) = r \min(F_{A_1}^{P-}(u), F_{A_2}^{P-}(v)), (F_{\lambda_1}^{P-} \circ F_{\lambda_2}^{P-})(u, v) = \max(F_{\lambda_1}^{P-}(u), F_{\lambda_2}^{P-}(v))$$

2. $\forall u \in V_1$ and $v_1 v_2 \in E$

$$(T_{B_1}^{P+} \circ T_{B_2}^{P+})(u, v_1)(u, v_2) = r \min(T_{A_1}^{P+}(u), T_{B_2}^{P+}(v_1 v_2)),$$

$$(T_{\mu_1}^{P+} \circ T_{\mu_2}^{P+})(u, v_1)(u, v_2) = \max(T_{\lambda_1}^{P+}(u), T_{\mu_2}^{P+}(v_1 v_2))$$

$$(T_{B_1}^{P-} \circ T_{B_2}^{P-})(u, v_1)(u, v_2) = r \max(T_{A_1}^{P-}(u), T_{B_2}^{P-}(v_1 v_2)),$$

$$(T_{\mu_1}^{P-} \circ T_{\mu_2}^{P-})(u, v_1)(u, v_2) = \min(T_{\lambda_1}^{P-}(u), T_{\mu_2}^{P-}(v_1 v_2))$$

$$(I_{B_1}^{P+} \circ I_{B_2}^{P+})(u, v_1)(u, v_2) = r \min(I_{A_1}^{P+}(u), I_{B_2}^{P+}(v_1 v_2)),$$

$$(I_{\mu_1}^{P+} \circ I_{\mu_2}^{P+})(u, v_1)(u, v_2) = \max(I_{\lambda_1}^{P+}(u), I_{\mu_2}^{P+}(v_1 v_2))$$

$$(I_{B_1}^{P-} \circ I_{B_2}^{P-})(u, v_1)(u, v_2) = r \max(I_{A_1}^{P-}(u), I_{B_2}^{P-}(v_1 v_2)),$$

$$(I_{\mu_1}^{P-} \circ I_{\mu_2}^{P-})(u, v_1)(u, v_2) = \min(I_{\lambda_1}^{P-}(u), I_{\mu_2}^{P-}(v_1 v_2))$$

$$(F_{B_1}^{P+} \circ F_{B_2}^{P+})(u, v_1)(u, v_2) = r \max(F_{A_1}^{P+}(u), F_{B_2}^{P+}(v_1 v_2)),$$

$$(F_{\mu_1}^{P+} \circ F_{\mu_2}^{P+})(u, v_1)(u, v_2) = \min(F_{\lambda_1}^{P+}(u), F_{\mu_2}^{P+}(v_1 v_2))$$

$$(F_{B_1}^{P-} \circ F_{B_2}^{P-})(u, v_1)(u, v_2) = r \min(F_{A_1}^{P-}(u), F_{B_2}^{P-}(v_1 v_2)),$$

$$(F_{\mu_1}^{P-} \circ F_{\mu_2}^{P-})(u, v_1)(u, v_2) = \max(F_{\lambda_1}^{P-}(u), F_{\mu_2}^{P-}(v_1 v_2))$$

3. $\forall v \in V_2$ and $u_1 u_2 \in E_1$

$$(T_{B_1}^{P+} \circ T_{B_2}^{P+})(u_1, v)(u_2, v) = r \min(T_{B_1}^{P+}(u_1 u_2), T_{A_2}^{P+}(v)),$$

$$(T_{\mu_1}^{P+} \circ T_{\mu_2}^{P+})(u_1, v)(u_2, v) = \max(T_{\mu_1}^{P+}(u_1 u_2), T_{\lambda_2}^{P+}(v))$$

$$(T_{B_1}^{P-} \circ T_{B_2}^{P-})(u_1, v)(u_2, v) = r \max(T_{B_1}^{P-}(u_1 u_2), T_{A_2}^{P-}(v)),$$

$$(T_{\mu_1}^{P-} \circ T_{\mu_2}^{P-})(u_1, v)(u_2, v) = \min(T_{\mu_1}^{P-}(u_1 u_2), T_{\lambda_2}^{P-}(v))$$

$$(I_{B_1}^{P+} \circ I_{B_2}^{P+})(u_1, v)(u_2, v) = r \min(I_{B_1}^{P+}(u_1 u_2), I_{A_2}^{P+}(v)),$$

$$(I_{\mu_1}^{P+} \circ I_{\mu_2}^{P+})(u_1, v)(u_2, v) = \max(I_{\mu_1}^{P+}(u_1 u_2), I_{\lambda_2}^{P+}(v))$$

$$\begin{aligned}
 (I_{B_1}^{P-} \circ I_{B_2}^{P-})(u_1, v)(u_2, v) &= r \max(I_{B_1}^{P-}(u_1 u_2), I_{A_2}^{P-}(v)), \\
 (I_{\mu_1}^{P-} \circ I_{\mu_2}^{P-})(u_1, v)(u_2, v) &= \min(I_{\mu_1}^{P-}(u_1 u_2), I_{\lambda_2}^{P-}(v)) \\
 (F_{B_1}^{P+} \circ F_{B_2}^{P+})(u_1, v)(u_2, v) &= r \max(F_{B_1}^{P+}(u_1 u_2), F_{A_2}^{P+}(v)), \\
 (F_{\mu_1}^{P+} \circ F_{\mu_2}^{P+})(u_1, v)(u_2, v) &= \min(F_{\mu_1}^{P+}(u_1 u_2), F_{\lambda_2}^{P+}(v)) \\
 (F_{B_1}^{P-} \circ F_{B_2}^{P-})(u_1, v)(u_2, v) &= r \min(F_{B_1}^{P-}(u_1 u_2), F_{A_2}^{P-}(v)), \\
 (F_{\mu_1}^{P-} \circ F_{\mu_2}^{P-})(u_1, v)(u_2, v) &= \max(F_{\mu_1}^{P-}(u_1 u_2), F_{\lambda_2}^{P-}(v))
 \end{aligned}$$

4. $\forall (u_1, v_1)(u_2, v_2) \in E^O - E$

$$\begin{aligned}
 (T_{B_1}^{P+} \circ T_{B_2}^{P+})(u_1, v_1)(u_2, v_2) &= r \min(T_{A_2}^{P+}(v_1), T_{A_2}^{P+}(v_2), T_{B_1}^{P+}(u_1, u_2)), \\
 (T_{\mu_1}^{P+} \circ T_{\mu_2}^{P+})(u_1, v_1)(u_2, v_2) &= \max(T_{\lambda_2}^{P+}(v_1), T_{\lambda_2}^{P+}(v_2), T_{\mu_1}^{P+}(u_1, u_2)) \\
 (T_{B_1}^{P-} \circ T_{B_2}^{P-})(u_1, v_1)(u_2, v_2) &= r \max(T_{A_2}^{P-}(v_1), T_{A_2}^{P-}(v_2), T_{B_1}^{P-}(u_1, u_2)), \\
 (T_{\mu_1}^{P-} \circ T_{\mu_2}^{P-})(u_1, v_1)(u_2, v_2) &= \min(T_{\lambda_2}^{P-}(v_1), T_{\lambda_2}^{P-}(v_2), T_{\mu_1}^{P-}(u_1, u_2)) \\
 (I_{B_1}^{P+} \circ I_{B_2}^{P+})(u_1, v_1)(u_2, v_2) &= r \min(I_{A_2}^{P+}(v_1), I_{A_2}^{P+}(v_2), I_{B_1}^{P+}(u_1, u_2)), \\
 (I_{\mu_1}^{P+} \circ I_{\mu_2}^{P+})(u_1, v_1)(u_2, v_2) &= \max(I_{\lambda_2}^{P+}(v_1), I_{\lambda_2}^{P+}(v_2), I_{\mu_1}^{P+}(u_1, u_2)) \\
 (I_{B_1}^{P-} \circ I_{B_2}^{P-})(u_1, v_1)(u_2, v_2) &= r \max(I_{A_2}^{P-}(v_1), I_{A_2}^{P-}(v_2), I_{B_1}^{P-}(u_1, u_2)), \\
 (I_{\mu_1}^{P-} \circ I_{\mu_2}^{P-})(u_1, v_1)(u_2, v_2) &= \min(I_{\lambda_2}^{P-}(v_1), I_{\lambda_2}^{P-}(v_2), I_{\mu_1}^{P-}(u_1, u_2)) \\
 (F_{B_1}^{P+} \circ F_{B_2}^{P+})(u_1, v_1)(u_2, v_2) &= r \max(F_{A_2}^{P+}(v_1), F_{A_2}^{P+}(v_2), F_{B_1}^{P+}(u_1, u_2)), \\
 (F_{\mu_1}^{P+} \circ F_{\mu_2}^{P+})(u_1, v_1)(u_2, v_2) &= \min(F_{\lambda_2}^{P+}(v_1), F_{\lambda_2}^{P+}(v_2), F_{\mu_1}^{P+}(u_1, u_2)) \\
 (F_{B_1}^{P-} \circ F_{B_2}^{P-})(u_1, v_1)(u_2, v_2) &= r \min(F_{A_2}^{P-}(v_1), F_{A_2}^{P-}(v_2), F_{B_1}^{P-}(u_1, u_2)), \\
 (F_{\mu_1}^{P-} \circ F_{\mu_2}^{P-})(u_1, v_1)(u_2, v_2) &= \max(F_{\lambda_2}^{P-}(v_1), F_{\lambda_2}^{P-}(v_2), F_{\mu_1}^{P-}(u_1, u_2))
 \end{aligned}$$

Example 19.

Let $G_1^* = (V_1, E_1)$ and $G_2^* = (V_2, E_2)$ be two bipolar spherical fuzzy neutrosophic cubic graphs, where $V_1 = (a, b)$ and $V_2 = (c, d)$. Suppose P_1 and P_2 be the bipolar spherical fuzzy neutrosophic cubic set representations of V_1 and V_2 . Also Q_1 and Q_2 be the bipolar spherical fuzzy neutrosophic cubic set representations of E_1 and E_2 defined as follows:

$$P_1 = \left\langle \left\{ \begin{aligned} &a, ([0.4, 0.7], 0.3), ([0.3, 0.5], 0.6), ([0.8, 0.4], 0.7), \\ &([[-0.4, -0.3], -0.1], [[-0.6, -0.5], -0.2], [[-0.8, -0.6], -0.2]) \end{aligned} \right\} \right\rangle$$

$$Q_1 = \left\langle \left\{ \begin{array}{l} ab, ([0.4, 0.5], 0.3), ([0.3, 0.4], 0.6), ([0.8, 0.8], 0.7), \\ ([-0.4, -0.3], -0.2), ([-0.6, -0.5], -0.5), ([-0.8, -0.6], -0.2) \end{array} \right\} \right\rangle$$

$$P_2 = \left\langle \left\{ \begin{array}{l} c, ([0.3, 0.6], 0.9), ([0.4, 0.7], 0.5), ([1.0, 0.2], 0.3), \\ ([-0.5, -0.6], -0.3), ([-0.4, -0.5], -0.2), ([-0.8, -0.6], -0.1) \end{array} \right\} \right\rangle$$

$$\left\langle \left\{ \begin{array}{l} d, ([0.5, 0.1], 0.2), ([0.8, 0.3], 0.4), ([0.9, 0.4], 0.1), \\ ([-0.8, -0.7], -0.3), ([-0.7, -0.4], -0.2), ([-0.6, -0.5], -0.4) \end{array} \right\} \right\rangle$$

$$Q_2 = \left\langle \left\{ \begin{array}{l} cd, ([0.3, 0.1], 0.9), ([0.4, 0.3], 0.5), ([0.9, 0.4], 0.1), \\ ([-0.5, -0.6], -0.3), ([-0.4, -0.4], -0.2), ([-0.8, -0.6], -0.1) \end{array} \right\} \right\rangle$$

Figure 4: For the two bipolar spherical fuzzy neutrosophic cubic graphs $G_1^* = (V_1, E_1)$ and $G_2^* = (V_2, E_2)$ the vertex sets $V_1 = (a, b)$ and $V_2 = (c, d)$ and the edge sets E_1 and E_2 are represented

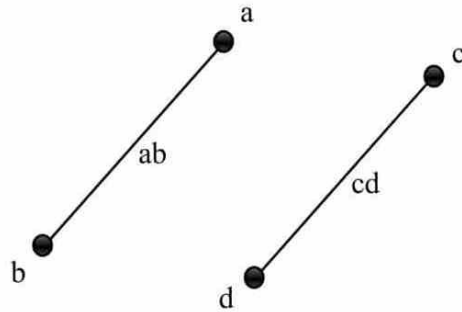

The composition of two bipolar spherical fuzzy neutrosophic cubic graphs G_1 and G_2 is again a bipolar spherical fuzzy neutrosophic cubic graph, where

$$P_1[P_2] = \left\langle \left\{ \begin{array}{l} (a, c), ([0.3, 0.6], 0.9), ([0.3, 0.5], 0.6), ([1.0, 0.4], 0.3), \\ ([-0.4, -0.3], -0.3), ([-0.4, -0.5], -0.2), ([-0.8, -0.6], -0.1) \end{array} \right\} \right\rangle$$

$$\left\langle \left\{ \begin{array}{l} (a, d), ([0.4, 0.1], 0.3), ([0.3, 0.3], 0.6), ([0.9, 0.4], 0.1), \\ ([-0.4, -0.3], -0.3), ([-0.6, -0.4], -0.2), ([-0.8, -0.6], -0.2) \end{array} \right\} \right\rangle$$

$$\left\langle \left\{ \begin{array}{l} (b, c), ([0.3, 0.5], 0.9), ([0.4, 0.4], 0.5), ([1.0, 0.8], 0.3), \\ ([-0.5, -0.3], -0.3), ([-0.4, -0.5], -0.5), ([-0.8, -0.6], -0.1) \end{array} \right\} \right\rangle$$

$$\left\langle \left\{ \begin{array}{l} (b, d), ([0.5, 0.1], 0.2), ([0.8, 0.3], 0.4), ([0.9, 0.8], 0.1), \\ ([-0.8, -0.3], -0.3), ([-0.7, -0.4], -0.5), ([-0.6, -0.5], -0.2) \end{array} \right\} \right\rangle$$

$$Q_1[Q_2] = \left\{ \begin{array}{l} \left\{ ((a,c)(a,d)), ([0.3,0.1],0.9), ([0.3,0.3],0.6), ([1.0,0.4],0.1), \right. \\ \left. [(-0.4,-0.3],-0.3), [(-0.4,-0.4],-0.2), [(-0.8,-0.6],-0.1) \right\} \\ \left\{ ((a,d)(b,d)), ([0.4,0.1],0.3), ([0.3,0.3],0.6), ([0.9,0.8],0.1), \right. \\ \left. [(-0.4,-0.3],-0.3), [(-0.6,-0.4],-0.5), [(-0.8,-0.6],-0.2) \right\} \\ \left\{ ((b,d)(b,c)), ([0.3,0.1],0.9), ([0.4,0.3],0.5), ([1.0,0.8],0.1), \right. \\ \left. [(-0.5,-0.3],-0.3), [(-0.4,-0.4],-0.5), [(-0.8,-0.6],-0.1) \right\} \\ \left\{ ((b,c)(a,c)), ([0.3,0.5],0.9), ([0.3,0.4],0.6), ([1.0,0.8],0.3), \right. \\ \left. [(-0.4,-0.3],-0.3), [(-0.4,-0.5],-0.5), [(-0.8,-0.6],-0.1) \right\} \\ \left\{ ((a,c)(b,d)), ([0.3,0.1],0.9), ([0.3,0.3],0.6), ([1.0,0.8],0.1), \right. \\ \left. [(-0.4,-0.3],-0.3), [(-0.4,-0.4],-0.5), [(-0.8,-0.6],-0.1) \right\} \\ \left\{ ((a,d)(b,c)), ([0.3,0.1],0.9), ([0.3,0.3],0.6), ([1.0,0.8],0.1), \right. \\ \left. [(-0.4,-0.3],-0.3), [(-0.4,-0.4],-0.5), [(-0.8,-0.6],-0.1) \right\} \end{array} \right.$$

Figure 5. The composition of two bipolar spherical fuzzy neutrosophic cubic graphs G_1 and G_2 .

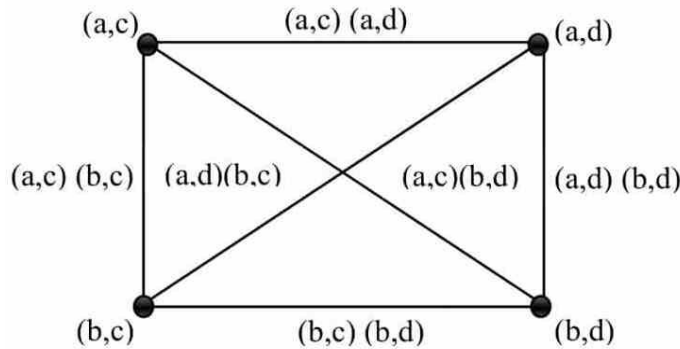

Definition 20.

Let $G_1 = (P_1, Q_1)$ and $G_2 = (P_2, Q_2)$ be two bipolar spherical fuzzy neutrosophic cubic graphs of the graph G_1^* and G_2^* respectively. Then M- union is denoted by $G_1 \cup_M G_2$ and is defined as

$$G_1 \cup_M G_2 = \{(P_1, Q_1) \cup_M (P_2, Q_2)\} = \{P_1 \cup_M P_2, Q_1 \cup_M Q_2\}$$

$$= \left\{ \begin{array}{l} \left\langle ((T_{A_1}^{P+} \cup_M T_{A_2}^{P+}), (T_{\lambda_1}^{P+} \cup_M T_{\lambda_2}^{P+})), ((I_{A_1}^{P+} \cup_M I_{A_2}^{P+}), (I_{\lambda_1}^{P+} \cup_M I_{\lambda_2}^{P+})), ((F_{A_1}^{P+} \cup_M F_{A_2}^{P+}), (F_{\lambda_1}^{P+} \cup_M F_{\lambda_2}^{P+})) \right\rangle \\ \left\langle ((T_{A_1}^{P-} \cup_M T_{A_2}^{P-}), (T_{\lambda_1}^{P-} \cup_M T_{\lambda_2}^{P-})), ((I_{A_1}^{P-} \cup_M I_{A_2}^{P-}), (I_{\lambda_1}^{P-} \cup_M I_{\lambda_2}^{P-})), ((F_{A_1}^{P-} \cup_M F_{A_2}^{P-}), (F_{\lambda_1}^{P-} \cup_M F_{\lambda_2}^{P-})) \right\rangle \\ \left\langle ((T_{B_1}^{P+} \cup_M T_{B_2}^{P+}), (T_{\mu_1}^{P+} \cup_M T_{\mu_2}^{P+})), ((I_{B_1}^{P+} \cup_M I_{B_2}^{P+}), (I_{\mu_1}^{P+} \cup_M I_{\mu_2}^{P+})), ((F_{B_1}^{P+} \cup_M F_{B_2}^{P+}), (F_{\mu_1}^{P+} \cup_M F_{\mu_2}^{P+})) \right\rangle \\ \left\langle ((T_{B_1}^{P-} \cup_M T_{B_2}^{P-}), (T_{\mu_1}^{P-} \cup_M T_{\mu_2}^{P-})), ((I_{B_1}^{P-} \cup_M I_{B_2}^{P-}), (I_{\mu_1}^{P-} \cup_M I_{\mu_2}^{P-})), ((F_{B_1}^{P-} \cup_M F_{B_2}^{P-}), (F_{\mu_1}^{P-} \cup_M F_{\mu_2}^{P-})) \right\rangle \end{array} \right.$$

where

$$(T_{A_1}^{P+} \cup_M T_{A_2}^{P+})(u) = \begin{cases} T_{A_1}^{P+}(u), & \text{if } u \in v_1 - v_2 \\ T_{A_2}^{P+}(u), & \text{if } u \in v_2 - v_1 \\ r \max\{T_{A_1}^{P+}(u), T_{A_2}^{P+}(u)\}, & \text{if } u \in v_1 \cap v_2 \end{cases}$$

$$(T_{A_1}^{P-} \cup_M T_{A_2}^{P-})(u) = \begin{cases} T_{A_1}^{P-}(u), & ,if\ u \in v_1 - v_2 \\ T_{A_2}^{P-}(u), & ,if\ u \in v_2 - v_1 \\ r \min\{T_{A_1}^{P-}(u), T_{A_2}^{P-}(u)\}, & ,if\ u \in v_1 \cap v_2 \end{cases}$$

$$(T_{\lambda_1}^{P+} \cup_M T_{\lambda_2}^{P+})(u) = \begin{cases} T_{\lambda_1}^{P+}(u), & ,if\ u \in v_1 - v_2 \\ T_{\lambda_2}^{P+}(u), & ,if\ u \in v_2 - v_1 \\ \max\{T_{\lambda_1}^{P+}(u), T_{\lambda_2}^{P+}(u)\} & ,if\ u \in v_1 \cap v_2 \end{cases}$$

$$(T_{\lambda_1}^{P-} \cup_M T_{\lambda_2}^{P-})(u) = \begin{cases} T_{\lambda_1}^{P-}(u), & ,if\ u \in v_1 - v_2 \\ T_{\lambda_2}^{P-}(u), & ,if\ u \in v_2 - v_1 \\ \min\{T_{\lambda_1}^{P-}(u), T_{\lambda_2}^{P-}(u)\} & ,if\ u \in v_1 \cap v_2 \end{cases}$$

$$(I_{A_1}^{P+} \cup_M I_{A_2}^{P+})(u) = \begin{cases} I_{A_1}^{P+}(u), & ,if\ u \in v_1 - v_2 \\ I_{A_2}^{P+}(u), & ,if\ u \in v_2 - v_1 \\ r \max\{I_{A_1}^{P+}(u), I_{A_2}^{P+}(u)\} & ,if\ u \in v_1 \cap v_2 \end{cases}$$

$$(I_{A_1}^{P-} \cup_M I_{A_2}^{P-})(u) = \begin{cases} I_{A_1}^{P-}(u), & ,if\ u \in v_1 - v_2 \\ I_{A_2}^{P-}(u), & ,if\ u \in v_2 - v_1 \\ r \min\{I_{A_1}^{P-}(u), I_{A_2}^{P-}(u)\} & ,if\ u \in v_1 \cap v_2 \end{cases}$$

$$(I_{\lambda_1}^{P+} \cup_M I_{\lambda_2}^{P+})(u) = \begin{cases} I_{\lambda_1}^{P+}(u), & ,if\ u \in v_1 - v_2 \\ I_{\lambda_2}^{P+}(u), & ,if\ u \in v_2 - v_1 \\ \max\{I_{\lambda_1}^{P+}(u), I_{\lambda_2}^{P+}(u)\} & ,if\ u \in v_1 \cap v_2 \end{cases}$$

$$(I_{\lambda_1}^{P-} \cup_M I_{\lambda_2}^{P-})(u) = \begin{cases} I_{\lambda_1}^{P-}(u), & ,if\ u \in v_1 - v_2 \\ I_{\lambda_2}^{P-}(u), & ,if\ u \in v_2 - v_1 \\ \min\{I_{\lambda_1}^{P-}(u), I_{\lambda_2}^{P-}(u)\} & ,if\ u \in v_1 \cap v_2 \end{cases}$$

$$(F_{A_1}^{P+} \cup_M F_{A_2}^{P+})(u) = \begin{cases} F_{A_1}^{P+}(u), & ,if\ u \in v_1 - v_2 \\ F_{A_2}^{P+}(u), & ,if\ u \in v_2 - v_1 \\ r \min\{F_{A_1}^{P+}(u), F_{A_2}^{P+}(u)\} & ,if\ u \in v_1 \cap v_2 \end{cases}$$

$$(F_{A_1}^{P-} \cup_M F_{A_2}^{P-})(u) = \begin{cases} F_{A_1}^{P-}(u), & ,if\ u \in v_1 - v_2 \\ F_{A_2}^{P-}(u), & ,if\ u \in v_2 - v_1 \\ r \max\{F_{A_1}^{P-}(u), F_{A_2}^{P-}(u)\} & ,if\ u \in v_1 \cap v_2 \end{cases}$$

$$(F_{\lambda_1}^{P+} \cup_M F_{\lambda_2}^{P+})(u) = \begin{cases} F_{\lambda_1}^{P+}(u), & ,if\ u \in v_1 - v_2 \\ F_{\lambda_2}^{P+}(u), & ,if\ u \in v_2 - v_1 \\ \min\{F_{\lambda_1}^{P+}(u), F_{\lambda_2}^{P+}(u)\} & ,if\ u \in v_1 \cap v_2 \end{cases}$$

$$\begin{aligned}
 (F_{\lambda_1}^{P-} \cup_M F_{\lambda_2}^{P-})(u) &= \begin{cases} F_{\lambda_1}^{P-}(u), & ,if\ u \in v_1 - v_2 \\ F_{\lambda_2}^{P-}(u), & ,if\ u \in v_2 - v_1 \\ \max\{F_{\lambda_1}^{P-}(u), F_{\lambda_2}^{P-}(u)\} & ,if\ u \in v_1 \cap v_2 \end{cases} \\
 (T_{B_1}^{P+} \cup_M T_{B_2}^{P+})(u_2v_2) &= \begin{cases} T_{B_1}^{P+}(u_2v_2), & ,if\ u_2v_2 \in v_1 - v_2 \\ T_{B_2}^{P+}(u_2v_2), & ,if\ u_2v_2 \in v_2 - v_1 \\ r \max\{T_{B_1}^{P+}(u_2v_2), T_{B_2}^{P+}(u_2v_2)\} & ,if\ u_2v_2 \in E_1 \cap E_2 \end{cases} \\
 (T_{B_1}^{P-} \cup_M T_{B_2}^{P-})(u_2v_2) &= \begin{cases} T_{B_1}^{P-}(u_2v_2), & ,if\ u_2v_2 \in v_1 - v_2 \\ T_{B_2}^{P-}(u_2v_2), & ,if\ u_2v_2 \in v_2 - v_1 \\ r \min\{T_{B_1}^{P-}(u_2v_2), T_{B_2}^{P-}(u_2v_2)\} & ,if\ u_2v_2 \in E_1 \cap E_2 \end{cases} \\
 (T_{\mu_1}^{P+} \cup_M T_{\mu_2}^{P+})(u_2v_2) &= \begin{cases} T_{\mu_1}^{P+}(u_2v_2), & ,if\ u_2v_2 \in v_1 - v_2 \\ T_{\mu_2}^{P+}(u_2v_2), & ,if\ u_2v_2 \in v_2 - v_1 \\ \max\{T_{\mu_1}^{P+}(u_2v_2), T_{\mu_2}^{P+}(u_2v_2)\} & ,if\ u_2v_2 \in E_1 \cap E_2 \end{cases} \\
 (T_{\mu_1}^{P-} \cup_M T_{\mu_2}^{P-})(u_2v_2) &= \begin{cases} T_{\mu_1}^{P-}(u_2v_2), & ,if\ u_2v_2 \in v_1 - v_2 \\ T_{\mu_2}^{P-}(u_2v_2), & ,if\ u_2v_2 \in v_2 - v_1 \\ \min\{T_{\mu_1}^{P-}(u_2v_2), T_{\mu_2}^{P-}(u_2v_2)\} & ,if\ u_2v_2 \in E_1 \cap E_2 \end{cases} \\
 (I_{B_1}^{P+} \cup_M I_{B_2}^{P+})(u_2v_2) &= \begin{cases} I_{B_1}^{P+}(u_2v_2), & ,if\ u_2v_2 \in v_1 - v_2 \\ I_{B_2}^{P+}(u_2v_2), & ,if\ u_2v_2 \in v_2 - v_1 \\ r \max\{I_{B_1}^{P+}(u_2v_2), I_{B_2}^{P+}(u_2v_2)\} & ,if\ u_2v_2 \in E_1 \cap E_2 \end{cases} \\
 (I_{B_1}^{P-} \cup_M I_{B_2}^{P-})(u_2v_2) &= \begin{cases} I_{B_1}^{P-}(u_2v_2), & ,if\ u_2v_2 \in v_1 - v_2 \\ I_{B_2}^{P-}(u_2v_2), & ,if\ u_2v_2 \in v_2 - v_1 \\ r \min\{I_{B_1}^{P-}(u_2v_2), I_{B_2}^{P-}(u_2v_2)\} & ,if\ u_2v_2 \in E_1 \cap E_2 \end{cases} \\
 (I_{\mu_1}^{P+} \cup_M I_{\mu_2}^{P+})(u_2v_2) &= \begin{cases} I_{\mu_1}^{P+}(u_2v_2), & ,if\ u_2v_2 \in v_1 - v_2 \\ I_{\mu_2}^{P+}(u_2v_2), & ,if\ u_2v_2 \in v_2 - v_1 \\ \max\{I_{\mu_1}^{P+}(u_2v_2), I_{\mu_2}^{P+}(u_2v_2)\} & ,if\ u_2v_2 \in E_1 \cap E_2 \end{cases} \\
 (I_{\mu_1}^{P-} \cup_M I_{\mu_2}^{P-})(u_2v_2) &= \begin{cases} I_{\mu_1}^{P-}(u_2v_2), & ,if\ u_2v_2 \in v_1 - v_2 \\ I_{\mu_2}^{P-}(u_2v_2), & ,if\ u_2v_2 \in v_2 - v_1 \\ \min\{I_{\mu_1}^{P-}(u_2v_2), I_{\mu_2}^{P-}(u_2v_2)\} & ,if\ u_2v_2 \in E_1 \cap E_2 \end{cases}
 \end{aligned}$$

$$\begin{aligned}
 (F_{B_1}^{P+} \cup_M F_{B_2}^{P+})(u_2v_2) &= \begin{cases} F_{B_1}^{P+}(u_2v_2), & ,if\ u_2v_2 \in v_1 - v_2 \\ F_{B_2}^{P+}(u_2v_2), & ,if\ u_2v_2 \in v_2 - v_1 \\ r \min\{F_{B_1}^{P+}(u_2v_2), F_{B_2}^{P+}(u_2v_2)\} & ,if\ u_2v_2 \in E_1 \cap E_2 \end{cases} \\
 (F_{B_1}^{P-} \cup_M F_{B_2}^{P-})(u_2v_2) &= \begin{cases} F_{B_1}^{P-}(u_2v_2), & ,if\ u_2v_2 \in v_1 - v_2 \\ F_{B_2}^{P-}(u_2v_2), & ,if\ u_2v_2 \in v_2 - v_1 \\ r \max\{F_{B_1}^{P-}(u_2v_2), F_{B_2}^{P-}(u_2v_2)\} & ,if\ u_2v_2 \in E_1 \cap E_2 \end{cases} \\
 (F_{\mu_1}^{P+} \cup_M F_{\mu_2}^{P+})(u_2v_2) &= \begin{cases} F_{\mu_1}^{P+}(u_2v_2), & ,if\ u_2v_2 \in v_1 - v_2 \\ F_{\mu_2}^{P+}(u_2v_2), & ,if\ u_2v_2 \in v_2 - v_1 \\ \min\{F_{\mu_1}^{P+}(u_2v_2), F_{\mu_2}^{P+}(u_2v_2)\} & ,if\ u_2v_2 \in E_1 \cap E_2 \end{cases} \\
 (F_{\mu_1}^{P-} \cup_M F_{\mu_2}^{P-})(u_2v_2) &= \begin{cases} F_{\mu_1}^{P-}(u_2v_2), & ,if\ u_2v_2 \in v_1 - v_2 \\ F_{\mu_2}^{P-}(u_2v_2), & ,if\ u_2v_2 \in v_2 - v_1 \\ \max\{F_{\mu_1}^{P-}(u_2v_2), F_{\mu_2}^{P-}(u_2v_2)\} & ,if\ u_2v_2 \in E_1 \cap E_2 \end{cases}
 \end{aligned}$$

and the N-union is denoted by $G_1 \cup_N G_2$ and is defined as follows:

$$\begin{aligned}
 G_1 \cup_N G_2 &= \{(P_1, Q_1) \cup_N (P_2, Q_2)\} = \{P_1 \cup_N P_2, Q_1 \cup_N Q_2\} \\
 &= \left\{ \left\langle \left((T_{A_1}^{P+} \cup_N T_{A_2}^{P+}), (T_{\lambda_1}^{P+} \cup_N T_{\lambda_2}^{P+}), (I_{A_1}^{P+} \cup_N I_{A_2}^{P+}), (I_{\lambda_1}^{P+} \cup_N I_{\lambda_2}^{P+}), (F_{A_1}^{P+} \cup_N F_{A_2}^{P+}), (F_{\lambda_1}^{P+} \cup_N F_{\lambda_2}^{P+}) \right) \right\rangle \right. \\
 &= \left\{ \left\langle \left((T_{A_1}^{P-} \cup_N T_{A_2}^{P-}), (T_{\lambda_1}^{P-} \cup_N T_{\lambda_2}^{P-}), (I_{A_1}^{P-} \cup_N I_{A_2}^{P-}), (I_{\lambda_1}^{P-} \cup_N I_{\lambda_2}^{P-}), (F_{A_1}^{P-} \cup_N F_{A_2}^{P-}), (F_{\lambda_1}^{P-} \cup_N F_{\lambda_2}^{P-}) \right) \right\rangle \right. \\
 &= \left\{ \left\langle \left((T_{B_1}^{P+} \cup_N T_{B_2}^{P+}), (T_{\mu_1}^{P+} \cup_N T_{\mu_2}^{P+}), (I_{B_1}^{P+} \cup_N I_{B_2}^{P+}), (I_{\mu_1}^{P+} \cup_N I_{\mu_2}^{P+}), (F_{B_1}^{P+} \cup_N F_{B_2}^{P+}), (F_{\mu_1}^{P+} \cup_N F_{\mu_2}^{P+}) \right) \right\rangle \right. \\
 &= \left. \left\{ \left\langle \left((T_{B_1}^{P-} \cup_N T_{B_2}^{P-}), (T_{\mu_1}^{P-} \cup_N T_{\mu_2}^{P-}), (I_{B_1}^{P-} \cup_N I_{B_2}^{P-}), (I_{\mu_1}^{P-} \cup_N I_{\mu_2}^{P-}), (F_{B_1}^{P-} \cup_N F_{B_2}^{P-}), (F_{\mu_1}^{P-} \cup_N F_{\mu_2}^{P-}) \right) \right\rangle \right\}
 \end{aligned}$$

where

$$\begin{aligned}
 (T_{A_1}^{P+} \cup_N T_{A_2}^{P+})(u) &= \begin{cases} T_{A_1}^{P+}(u), & ,if\ u \in v_1 - v_2 \\ T_{A_2}^{P+}(u), & ,if\ u \in v_2 - v_1 \\ r \max\{T_{A_1}^{P+}(u), T_{A_2}^{P+}(u)\} & ,if\ u \in v_1 \cap v_2 \end{cases} \\
 (T_{A_1}^{P-} \cup_N T_{A_2}^{P-})(u) &= \begin{cases} T_{A_1}^{P-}(u), & ,if\ u \in v_1 - v_2 \\ T_{A_2}^{P-}(u), & ,if\ u \in v_2 - v_1 \\ r \min\{T_{A_1}^{P-}(u), T_{A_2}^{P-}(u)\} & ,if\ u \in v_1 \cap v_2 \end{cases} \\
 (T_{\lambda_1}^{P+} \cup_N T_{\lambda_2}^{P+})(u) &= \begin{cases} T_{\lambda_1}^{P+}(u), & ,if\ u \in v_1 - v_2 \\ T_{\lambda_2}^{P+}(u), & ,if\ u \in v_2 - v_1 \\ \max\{T_{\lambda_1}^{P+}(u), T_{\lambda_2}^{P+}(u)\} & ,if\ u \in v_1 \cap v_2 \end{cases}
 \end{aligned}$$

$$(T_{\lambda_1}^{P-} \cup_N T_{\lambda_2}^{P-})(u) = \begin{cases} T_{\lambda_1}^{P-}(u), & ,if\ u \in v_1 - v_2 \\ T_{\lambda_2}^{P-}(u), & ,if\ u \in v_2 - v_1 \\ \min\{T_{\lambda_1}^{P-}(u), T_{\lambda_2}^{P-}(u)\} & ,if\ u \in v_1 \cap v_2 \end{cases}$$

$$(I_{A_1}^{P+} \cup_N I_{A_2}^{P+})(u) = \begin{cases} I_{A_1}^{P+}(u), & ,if\ u \in v_1 - v_2 \\ I_{A_2}^{P+}(u), & ,if\ u \in v_2 - v_1 \\ r\max\{I_{A_1}^{P+}(u), I_{A_2}^{P+}(u)\} & ,if\ u \in v_1 \cap v_2 \end{cases}$$

$$(I_{A_1}^{P-} \cup_N I_{A_2}^{P-})(u) = \begin{cases} I_{A_1}^{P-}(u), & ,if\ u \in v_1 - v_2 \\ I_{A_2}^{P-}(u), & ,if\ u \in v_2 - v_1 \\ r\min\{I_{A_1}^{P-}(u), I_{A_2}^{P-}(u)\} & ,if\ u \in v_1 \cap v_2 \end{cases}$$

$$(I_{\lambda_1}^{P+} \cup_N I_{\lambda_2}^{P+})(u) = \begin{cases} I_{\lambda_1}^{P+}(u), & ,if\ u \in v_1 - v_2 \\ I_{\lambda_2}^{P+}(u), & ,if\ u \in v_2 - v_1 \\ \max\{I_{\lambda_1}^{P+}(u), I_{\lambda_2}^{P+}(u)\} & ,if\ u \in v_1 \cap v_2 \end{cases}$$

$$(I_{\lambda_1}^{P-} \cup_N I_{\lambda_2}^{P-})(u) = \begin{cases} I_{\lambda_1}^{P-}(u), & ,if\ u \in v_1 - v_2 \\ I_{\lambda_2}^{P-}(u), & ,if\ u \in v_2 - v_1 \\ \min\{I_{\lambda_1}^{P-}(u), I_{\lambda_2}^{P-}(u)\} & ,if\ u \in v_1 \cap v_2 \end{cases}$$

$$(F_{A_1}^{P+} \cup_N F_{A_2}^{P+})(u) = \begin{cases} F_{A_1}^{P+}(u), & ,if\ u \in v_1 - v_2 \\ F_{A_2}^{P+}(u), & ,if\ u \in v_2 - v_1 \\ r\min\{F_{A_1}^{P+}(u), F_{A_2}^{P+}(u)\} & ,if\ u \in v_1 \cap v_2 \end{cases}$$

$$(F_{A_1}^{P-} \cup_N F_{A_2}^{P-})(u) = \begin{cases} F_{A_1}^{P-}(u), & ,if\ u \in v_1 - v_2 \\ F_{A_2}^{P-}(u), & ,if\ u \in v_2 - v_1 \\ r\max\{F_{A_1}^{P-}(u), F_{A_2}^{P-}(u)\} & ,if\ u \in v_1 \cap v_2 \end{cases}$$

$$(F_{\lambda_1}^{P+} \cup_N F_{\lambda_2}^{P+})(u) = \begin{cases} F_{\lambda_1}^{P+}(u), & ,if\ u \in v_1 - v_2 \\ F_{\lambda_2}^{P+}(u), & ,if\ u \in v_2 - v_1 \\ \min\{F_{\lambda_1}^{P+}(u), F_{\lambda_2}^{P+}(u)\} & ,if\ u \in v_1 \cap v_2 \end{cases}$$

$$(F_{\lambda_1}^{P-} \cup_N F_{\lambda_2}^{P-})(u) = \begin{cases} F_{\lambda_1}^{P-}(u), & ,if\ u \in v_1 - v_2 \\ F_{\lambda_2}^{P-}(u), & ,if\ u \in v_2 - v_1 \\ \max\{F_{\lambda_1}^{P-}(u), F_{\lambda_2}^{P-}(u)\} & ,if\ u \in v_1 \cap v_2 \end{cases}$$

$$\begin{aligned}
 (T_{B_1}^{P+} \cup_N T_{B_2}^{P+})(u_2v_2) &= \begin{cases} T_{B_1}^{P+}(u_2v_2), & , \text{if } u_2v_2 \in v_1 - v_2 \\ T_{B_2}^{P+}(u_2v_2), & , \text{if } u_2v_2 \in v_2 - v_1 \\ r \max\{T_{B_1}^{P+}(u_2v_2), T_{B_2}^{P+}(u_2v_2)\} & , \text{if } u_2v_2 \in E_1 \cap E_2 \end{cases} \\
 (T_{B_1}^{P-} \cup_N T_{B_2}^{P-})(u_2v_2) &= \begin{cases} T_{B_1}^{P-}(u_2v_2), & , \text{if } u_2v_2 \in v_1 - v_2 \\ T_{B_2}^{P-}(u_2v_2), & , \text{if } u_2v_2 \in v_2 - v_1 \\ r \min\{T_{B_1}^{P-}(u_2v_2), T_{B_2}^{P-}(u_2v_2)\} & , \text{if } u_2v_2 \in E_1 \cap E_2 \end{cases} \\
 (T_{\mu_1}^{P+} \cup_N T_{\mu_2}^{P+})(u_2v_2) &= \begin{cases} T_{\mu_1}^{P+}(u_2v_2), & , \text{if } u_2v_2 \in v_1 - v_2 \\ T_{\mu_2}^{P+}(u_2v_2), & , \text{if } u_2v_2 \in v_2 - v_1 \\ \max\{T_{\mu_1}^{P+}(u_2v_2), T_{\mu_2}^{P+}(u_2v_2)\} & , \text{if } u_2v_2 \in E_1 \cap E_2 \end{cases} \\
 (T_{\mu_1}^{P-} \cup_N T_{\mu_2}^{P-})(u_2v_2) &= \begin{cases} T_{\mu_1}^{P-}(u_2v_2), & , \text{if } u_2v_2 \in v_1 - v_2 \\ T_{\mu_2}^{P-}(u_2v_2), & , \text{if } u_2v_2 \in v_2 - v_1 \\ \min\{T_{\mu_1}^{P-}(u_2v_2), T_{\mu_2}^{P-}(u_2v_2)\} & , \text{if } u_2v_2 \in E_1 \cap E_2 \end{cases} \\
 (I_{B_1}^{P+} \cup_N I_{B_2}^{P+})(u_2v_2) &= \begin{cases} I_{B_1}^{P+}(u_2v_2), & , \text{if } u_2v_2 \in v_1 - v_2 \\ I_{B_2}^{P+}(u_2v_2), & , \text{if } u_2v_2 \in v_2 - v_1 \\ r \max\{I_{B_1}^{P+}(u_2v_2), I_{B_2}^{P+}(u_2v_2)\} & , \text{if } u_2v_2 \in E_1 \cap E_2 \end{cases} \\
 (I_{B_1}^{P-} \cup_N I_{B_2}^{P-})(u_2v_2) &= \begin{cases} I_{B_1}^{P-}(u_2v_2), & , \text{if } u_2v_2 \in v_1 - v_2 \\ I_{B_2}^{P-}(u_2v_2), & , \text{if } u_2v_2 \in v_2 - v_1 \\ r \min\{I_{B_1}^{P-}(u_2v_2), I_{B_2}^{P-}(u_2v_2)\} & , \text{if } u_2v_2 \in E_1 \cap E_2 \end{cases} \\
 (I_{\mu_1}^{P+} \cup_N I_{\mu_2}^{P+})(u_2v_2) &= \begin{cases} I_{\mu_1}^{P+}(u_2v_2), & , \text{if } u_2v_2 \in v_1 - v_2 \\ I_{\mu_2}^{P+}(u_2v_2), & , \text{if } u_2v_2 \in v_2 - v_1 \\ \max\{I_{\mu_1}^{P+}(u_2v_2), I_{\mu_2}^{P+}(u_2v_2)\} & , \text{if } u_2v_2 \in E_1 \cap E_2 \end{cases} \\
 (I_{\mu_1}^{P-} \cup_N I_{\mu_2}^{P-})(u_2v_2) &= \begin{cases} I_{\mu_1}^{P-}(u_2v_2), & , \text{if } u_2v_2 \in v_1 - v_2 \\ I_{\mu_2}^{P-}(u_2v_2), & , \text{if } u_2v_2 \in v_2 - v_1 \\ \min\{I_{\mu_1}^{P-}(u_2v_2), I_{\mu_2}^{P-}(u_2v_2)\} & , \text{if } u_2v_2 \in E_1 \cap E_2 \end{cases} \\
 (F_{B_1}^{P+} \cup_N F_{B_2}^{P+})(u_2v_2) &= \begin{cases} F_{B_1}^{P+}(u_2v_2), & , \text{if } u_2v_2 \in v_1 - v_2 \\ F_{B_2}^{P+}(u_2v_2), & , \text{if } u_2v_2 \in v_2 - v_1 \\ r \min\{F_{B_1}^{P+}(u_2v_2), F_{B_2}^{P+}(u_2v_2)\} & , \text{if } u_2v_2 \in E_1 \cap E_2 \end{cases} \\
 (F_{B_1}^{P-} \cup_N F_{B_2}^{P-})(u_2v_2) &= \begin{cases} F_{B_1}^{P-}(u_2v_2), & , \text{if } u_2v_2 \in v_1 - v_2 \\ F_{B_2}^{P-}(u_2v_2), & , \text{if } u_2v_2 \in v_2 - v_1 \\ r \max\{F_{B_1}^{P-}(u_2v_2), F_{B_2}^{P-}(u_2v_2)\} & , \text{if } u_2v_2 \in E_1 \cap E_2 \end{cases}
 \end{aligned}$$

$$(F_{\mu_1}^{P+} \cup_N F_{\mu_2}^{P+})(u_2v_2) = \begin{cases} F_{\mu_1}^{P+}(u_2v_2), & \text{,if } u_2v_2 \in v_1 - v_2 \\ F_{\mu_2}^{P+}(u_2v_2), & \text{,if } u_2v_2 \in v_2 - v_1 \\ \min\{F_{\mu_1}^{P+}(u_2v_2), F_{\mu_2}^{P+}(u_2v_2)\} & \text{,if } u_2v_2 \in E_1 \cap E_2 \end{cases}$$

$$(F_{\mu_1}^{P-} \cup_N F_{\mu_2}^{P-})(u_2v_2) = \begin{cases} F_{\mu_1}^{P-}(u_2v_2), & \text{,if } u_2v_2 \in v_1 - v_2 \\ F_{\mu_2}^{P-}(u_2v_2), & \text{,if } u_2v_2 \in v_2 - v_1 \\ \max\{F_{\mu_1}^{P-}(u_2v_2), F_{\mu_2}^{P-}(u_2v_2)\} & \text{,if } u_2v_2 \in E_1 \cap E_2 \end{cases}$$

Example 21.

Let us consider the two bipolar spherical fuzzy neutrosophic cubic graphs as $G_1 = (P_1, Q_1)$ and $G_2 = (P_2, Q_2)$

$$P_1 = \left\langle \left\{ \begin{array}{l} a, ([0.3,0.4],0.7), ([0.7,0.5],0.1), ([0.9,0.1],0.3), \\ \{([-0.6,-0.2],-0.3), ([-0.7,-0.8],-0.1), ([-0.4,-0.7],-0.5)\} \\ b, ([0.2,0.6],0.8), ([0.4,0.6],0.3), ([0.7,0.8],0.4), \\ \{([-0.5,-0.8],-0.6), ([-0.3,-0.5],-0.2), ([-0.4,-0.9],-0.3)\} \\ c, ([0.7,0.5],0.1), ([0.8,0.3],0.7), ([0.6,0.7],0.4), \\ \{([-0.4,-0.2],-0.9), ([-0.1,-0.2],-0.9), ([-0.8,-0.5],-0.1)\} \end{array} \right\} \right\rangle$$

$$Q_1 = \left\langle \left\{ \begin{array}{l} ab, ([0.2,0.4],0.8), ([0.4,0.5],0.3), ([0.9,0.8],0.3), \\ \{([-0.5,-0.2],-0.6), ([-0.3,-0.5],-0.2), ([-0.4,-0.9],-0.3)\} \\ ac, ([0.3,0.4],0.7), ([0.7,0.3],0.7), ([0.9,0.7],0.3), \\ \{([-0.4,-0.2],-0.9), ([-0.1,-0.2],-0.9), ([-0.8,-0.7],-0.1)\} \\ bc, ([0.2,0.5],0.8), ([0.4,0.3],0.7), ([0.7,0.8],0.4), \\ \{([-0.4,-0.2],-0.9), ([-0.1,-0.2],-0.9), ([-0.8,-0.9],-0.1)\} \end{array} \right\} \right\rangle$$

$$P_2 = \left\langle \left\{ \begin{array}{l} a, ([0.5,0.7],0.3), ([0.2,0.7],0.8), ([0.2,0.4],0.3), \\ \{([-0.9,-0.8],-0.1), ([-0.6,-0.3],-0.2), ([-0.3,-0.7],-0.8)\} \\ b, ([0.5,0.4],0.3), ([0.3,0.5],0.6), ([0.7,0.5],0.3), \\ \{([-0.9,-0.4],-0.2), ([-0.7,-0.4],-0.3), ([-0.1,-0.4],-0.6)\} \\ c, ([0.2,0.4],0.8), ([0.2,0.4],0.3), ([0.3,0.5],0.3), \\ \{([-0.2,-0.5],-0.4), ([-0.7,-0.4],-0.5), ([-0.5,-0.4],-0.3)\} \end{array} \right\} \right\rangle$$

$$Q_2 = \left\langle \begin{array}{l} \left\{ ab, ([0.5,0.4],0.3), ([0.2,0.5],0.8), ([0.7,0.5],0.3), \right. \\ \left. [(-0.9,-0.4],-0.2), ([-0.6,-0.3],-0.3), ([-0.3,-0.7],-0.6) \right\} \\ \left\{ ac, ([0.2,0.4],0.8), ([0.2,0.4],0.8), ([0.3,0.5],0.3), \right. \\ \left. [(-0.2,-0.5],-0.4), ([-0.6,-0.3],-0.5), ([-0.5,-0.7],-0.3) \right\} \\ \left\{ bc, ([0.2,0.4],0.8), ([0.2,0.4],0.6), ([0.7,0.5],0.3), \right. \\ \left. [(-0.2,-0.4],-0.4), ([-0.7,-0.4],-0.5), ([-0.5,-0.4],-0.3) \right\} \end{array} \right\rangle$$

Here M-union of the bipolar spherical fuzzy neutrosophic cubic graph $G_1 \cup_M G_2$ as follows:

$$P_{1U_M P_2} = \left\langle \begin{array}{l} \left\{ a, ([0.5,0.7],0.7), ([0.7,0.7],0.8), ([0.9,0.4],0.3), \right. \\ \left. [(-0.9,-0.8],-0.3), ([-0.7,-0.8],-0.2), ([-0.4,-0.7],-0.8) \right\} \\ \left\{ b, ([0.5,0.6],0.8), ([0.4,0.6],0.6), ([0.7,0.8],0.4), \right. \\ \left. [(-0.9,-0.8],-0.6), ([-0.7,-0.5],-0.3), ([-0.4,-0.9],-0.6) \right\} \\ \left\{ a, ([0.7,0.5],0.8), ([0.8,0.4],0.7), ([0.6,0.7],0.4), \right. \\ \left. [(-0.4,-0.5],-0.9), ([-0.7,-0.4],-0.9), ([-0.8,-0.5],-0.3) \right\} \end{array} \right\rangle$$

$$Q_{1U_M Q_2} = \left\langle \begin{array}{l} \left\{ ab, ([0.5,0.4],0.8), ([0.4,0.5],0.8), ([0.9,0.8],0.3), \right. \\ \left. [(-0.9,-0.4],-0.6), ([-0.6,-0.5],-0.3), ([-0.4,-0.9],-0.6) \right\} \\ \left\{ ac, ([0.3,0.4],0.8), ([0.7,0.4],0.8), ([0.9,0.7],0.3), \right. \\ \left. [(-0.4,-0.5],-0.9), ([-0.6,-0.3],-0.9), ([-0.8,-0.7],-0.3) \right\} \\ \left\{ bc, ([0.2,0.5],0.8), ([0.4,0.4],0.7), ([0.7,0.8],0.4), \right. \\ \left. [(-0.4,-0.4],-0.9), ([-0.7,-0.4],-0.9), ([-0.8,-0.9],-0.3) \right\} \end{array} \right\rangle$$

Here N-union of the bipolar spherical fuzzy neutrosophic cubic graph $G_1 \cup_N G_2$ as follows:

$$P_{1U_N P_2} = \left\langle \begin{array}{l} \left\{ a, ([0.5,0.7],0.3), ([0.7,0.7],0.1), ([0.9,0.4],0.3), \right. \\ \left. [(-0.9,-0.1],-0.3), ([-0.7,-0.8],-0.1), ([-0.4,-0.7],-0.5) \right\} \\ \left\{ b, ([0.5,0.6],0.3), ([0.4,0.6],0.3), ([0.7,0.8],0.3), \right. \\ \left. [(-0.9,-0.8],-0.2), ([-0.7,-0.5],-0.2), ([-0.4,-0.9],-0.3) \right\} \\ \left\{ a, ([0.7,0.5],0.1), ([0.8,0.4],0.3), ([0.6,0.7],0.3), \right. \\ \left. [(-0.4,-0.5],-0.4), ([-0.7,-0.4],-0.5), ([-0.8,-0.5],-0.1) \right\} \end{array} \right\rangle$$

$$Q_{1U_N Q_2} = \left\langle \begin{array}{l} \left\{ ab, ([0.5,0.4],0.3), ([0.4,0.5],0.3), ([0.9,0.8],0.3), \right. \\ \left. [(-0.9,-0.4],-0.2), ([-0.6,-0.5],-0.2), ([-0.4,-0.9],-0.3) \right\} \\ \left\{ ac, ([0.3,0.4],0.7), ([0.7,0.4],0.7), ([0.9,0.7],0.3), \right. \\ \left. [(-0.4,-0.5],-0.4), ([-0.6,-0.3],-0.5), ([-0.8,-0.7],-0.1) \right\} \\ \left\{ bc, ([0.2,0.5],0.8), ([0.4,0.4],0.6), ([0.7,0.8],0.3), \right. \\ \left. [(-0.4,-0.4],-0.4), ([-0.7,-0.4],-0.5), ([-0.8,-0.9],-0.1) \right\} \end{array} \right\rangle$$

Proposition 22.

The M-union of the two bipolar spherical fuzzy neutrosophic cubic graphs is again a bipolar spherical fuzzy neutrosophic cubic graph.

Definition 23.

Let $G_1 = (P_1, Q_1)$ and $G_2 = (P_2, Q_2)$ be two bipolar spherical fuzzy neutrosophic cubic graphs of the graphs

G_1^* and G_2^* respectively, then M-join is denoted by $G_1 +_M G_2$ and is defined as follows:

$$G_1 +_M G_2 = (P_1, Q_1) +_M (P_2, Q_2) = (P_1 +_M P_2, Q_1 +_M Q_2)$$

$$= \left\{ \begin{array}{l} \left\langle (T_{A_1}^{P+} +_M T_{A_2}^{P+}), (T_{\lambda_1}^{P+} +_M T_{\lambda_2}^{P+}), (I_{A_1}^{P+} +_M I_{A_2}^{P+}), (I_{\lambda_1}^{P+} +_M I_{\lambda_2}^{P+}), (F_{A_1}^{P+} +_M F_{A_2}^{P+}), (F_{\lambda_1}^{P+} +_M F_{\lambda_2}^{P+}) \right\rangle \\ \left\langle (T_{A_1}^{P-} +_M T_{A_2}^{P-}), (T_{\lambda_1}^{P-} +_M T_{\lambda_2}^{P-}), (I_{A_1}^{P-} +_M I_{A_2}^{P-}), (I_{\lambda_1}^{P-} +_M I_{\lambda_2}^{P-}), (F_{A_1}^{P-} +_M F_{A_2}^{P-}), (F_{\lambda_1}^{P-} +_M F_{\lambda_2}^{P-}) \right\rangle \\ \left\langle (T_{B_1}^{P+} +_M T_{B_2}^{P+}), (T_{\mu_1}^{P+} +_M T_{\mu_2}^{P+}), (I_{B_1}^{P+} +_M I_{B_2}^{P+}), (I_{\mu_1}^{P+} +_M I_{\mu_2}^{P+}), (F_{B_1}^{P+} +_M F_{B_2}^{P+}), (F_{\mu_1}^{P+} +_M F_{\mu_2}^{P+}) \right\rangle \\ \left\langle (T_{B_1}^{P-} +_M T_{B_2}^{P-}), (T_{\mu_1}^{P-} +_M T_{\mu_2}^{P-}), (I_{B_1}^{P-} +_M I_{B_2}^{P-}), (I_{\mu_1}^{P-} +_M I_{\mu_2}^{P-}), (F_{B_1}^{P-} +_M F_{B_2}^{P-}), (F_{\mu_1}^{P-} +_M F_{\mu_2}^{P-}) \right\rangle \end{array} \right\}$$

where

(i) if $u \in v_1 \cup v_2$

$$(T_{A_1}^{P+} +_M T_{A_2}^{P+})(u) = (T_{A_1}^{P+} \cup_M T_{A_2}^{P+})(u), (T_{\lambda_1}^{P+} +_M T_{\lambda_2}^{P+})(u) = (T_{\lambda_1}^{P+} \cup_M T_{\lambda_2}^{P+})(u)$$

$$(T_{A_1}^{P-} +_M T_{A_2}^{P-})(u) = (T_{A_1}^{P-} \cup_M T_{A_2}^{P-})(u), (T_{\lambda_1}^{P-} +_M T_{\lambda_2}^{P-})(u) = (T_{\lambda_1}^{P-} \cup_M T_{\lambda_2}^{P-})(u)$$

$$(I_{A_1}^{P+} +_M I_{A_2}^{P+})(u) = (I_{A_1}^{P+} \cup_M I_{A_2}^{P+})(u), (I_{\lambda_1}^{P+} +_M I_{\lambda_2}^{P+})(u) = (I_{\lambda_1}^{P+} \cup_M I_{\lambda_2}^{P+})(u)$$

$$(I_{A_1}^{P-} +_M I_{A_2}^{P-})(u) = (I_{A_1}^{P-} \cup_M I_{A_2}^{P-})(u), (I_{\lambda_1}^{P-} +_M I_{\lambda_2}^{P-})(u) = (I_{\lambda_1}^{P-} \cup_M I_{\lambda_2}^{P-})(u)$$

$$(F_{A_1}^{P+} +_M F_{A_2}^{P+})(u) = (F_{A_1}^{P+} \cup_M F_{A_2}^{P+})(u), (F_{\lambda_1}^{P+} +_M F_{\lambda_2}^{P+})(u) = (F_{\lambda_1}^{P+} \cup_M F_{\lambda_2}^{P+})(u)$$

$$(F_{A_1}^{P-} +_M F_{A_2}^{P-})(u) = (F_{A_1}^{P-} \cup_M F_{A_2}^{P-})(u), (F_{\lambda_1}^{P-} +_M F_{\lambda_2}^{P-})(u) = (F_{\lambda_1}^{P-} \cup_M F_{\lambda_2}^{P-})(u)$$

(ii) if $uv \in E_1 \cup E_2$

$$(T_{B_1}^{P+} +_M T_{B_2}^{P+})(uv) = (T_{B_1}^{P+} \cup_M T_{B_2}^{P+})(uv), (T_{\mu_1}^{P+} +_M T_{\mu_2}^{P+})(uv) = (T_{\mu_1}^{P+} \cup_M T_{\mu_2}^{P+})(uv)$$

$$(T_{B_1}^{P-} +_M T_{B_2}^{P-})(uv) = (T_{B_1}^{P-} \cup_M T_{B_2}^{P-})(uv), (T_{\mu_1}^{P-} +_M T_{\mu_2}^{P-})(uv) = (T_{\mu_1}^{P-} \cup_M T_{\mu_2}^{P-})(uv)$$

$$(I_{B_1}^{P+} +_M I_{B_2}^{P+})(uv) = (I_{B_1}^{P+} \cup_M I_{B_2}^{P+})(uv), (I_{\mu_1}^{P+} +_M I_{\mu_2}^{P+})(uv) = (I_{\mu_1}^{P+} \cup_M I_{\mu_2}^{P+})(uv)$$

$$(I_{B_1}^{P-} +_M I_{B_2}^{P-})(uv) = (I_{B_1}^{P-} \cup_M I_{B_2}^{P-})(uv), (I_{\mu_1}^{P-} +_M I_{\mu_2}^{P-})(uv) = (I_{\mu_1}^{P-} \cup_M I_{\mu_2}^{P-})(uv)$$

$$(F_{B_1}^{P+} +_M F_{B_2}^{P+})(uv) = (F_{B_1}^{P+} \cup_M F_{B_2}^{P+})(uv), (F_{\mu_1}^{P+} +_M F_{\mu_2}^{P+})(uv) = (F_{\mu_1}^{P+} \cup_M F_{\mu_2}^{P+})(uv)$$

$$(F_{B_1}^{P-} +_M F_{B_2}^{P-})(uv) = (F_{B_1}^{P-} \cup_M F_{B_2}^{P-})(uv), (F_{\mu_1}^{P-} +_M F_{\mu_2}^{P-})(uv) = (F_{\mu_1}^{P-} \cup_M F_{\mu_2}^{P-})(uv)$$

(ii) if $uv \in E^*$, where E^* is the set of all edges joining the vertices of v_1 & v_2 .

$$(T_{B_1}^{P+} +_M T_{B_2}^{P+})(uv) = r \min\{T_{A_1}^{P+}(u), T_{A_2}^{P+}(v)\}, (T_{\mu_1}^{P+} +_M T_{\mu_2}^{P+})(uv) = \min\{T_{\lambda_1}^{P+}(u), T_{\lambda_2}^{P+}(v)\}$$

$$(T_{B_1}^{P-} +_M T_{B_2}^{P-})(uv) = r \max\{T_{A_1}^{P-}(u), T_{A_2}^{P-}(v)\}, (T_{\mu_1}^{P-} +_M T_{\mu_2}^{P-})(uv) = \max\{T_{\lambda_1}^{P-}(u), T_{\lambda_2}^{P-}(v)\}$$

$$(I_{B_1}^{P+} +_M I_{B_2}^{P+})(uv) = r \min\{I_{A_1}^{P+}(u), I_{A_2}^{P+}(v)\}, (I_{\mu_1}^{P+} +_M I_{\mu_2}^{P+})(uv) = \min\{I_{\lambda_1}^{P+}(u), I_{\lambda_2}^{P+}(v)\}$$

$$\begin{aligned}
 (I_{B_1}^{P^-} +_M I_{B_2}^{P^-})(uv) &= r \max\{I_{A_1}^{P^-}(u), I_{A_2}^{P^-}(v)\}, (I_{\mu_1}^{P^-} +_M I_{\mu_2}^{P^-})(uv) = \max\{I_{\lambda_1}^{P^-}(u), I_{\lambda_2}^{P^-}(v)\} \\
 (F_{B_1}^{P^+} +_M F_{B_2}^{P^+})(uv) &= r \min\{F_{A_1}^{P^+}(u), F_{A_2}^{P^+}(v)\}, (F_{\mu_1}^{P^+} +_M F_{\mu_2}^{P^+})(uv) = \min\{F_{\lambda_1}^{P^+}(u), F_{\lambda_2}^{P^+}(v)\} \\
 (F_{B_1}^{P^-} +_M F_{B_2}^{P^-})(uv) &= r \max\{F_{A_1}^{P^-}(u), F_{A_2}^{P^-}(v)\}, (F_{\mu_1}^{P^-} +_M F_{\mu_2}^{P^-})(uv) = \max\{F_{\lambda_1}^{P^-}(u), F_{\lambda_2}^{P^-}(v)\}
 \end{aligned}$$

Definition 24.

Let $G_1 = (P_1, Q_1)$ and $G_2 = (P_2, Q_2)$ be two bipolar spherical fuzzy neutrosophic cubic graphs of the graphs

G_1^* and G_2^* respectively, then N-join is denoted by $G_1 +_N G_2$ and is defined as follows:

$$G_1 +_N G_2 = (P_1, Q_1) +_N (P_2, Q_2) = (P_1 +_N P_2, Q_1 +_N Q_2)$$

$$= \left\{ \left\langle \begin{aligned} &((T_{A_1}^{P^+} +_N T_{A_2}^{P^+}), (T_{\lambda_1}^{P^+} +_N T_{\lambda_2}^{P^+})), ((I_{A_1}^{P^+} +_N I_{A_2}^{P^+}), (I_{\lambda_1}^{P^+} +_N I_{\lambda_2}^{P^+})), ((F_{A_1}^{P^+} +_N F_{A_2}^{P^+}), (F_{\lambda_1}^{P^+} +_N F_{\lambda_2}^{P^+})) \\ &((T_{A_1}^{P^-} +_N T_{A_2}^{P^-}), (T_{\lambda_1}^{P^-} +_N T_{\lambda_2}^{P^-})), ((I_{A_1}^{P^-} +_N I_{A_2}^{P^-}), (I_{\lambda_1}^{P^-} +_N I_{\lambda_2}^{P^-})), ((F_{A_1}^{P^-} +_N F_{A_2}^{P^-}), (F_{\lambda_1}^{P^-} +_N F_{\lambda_2}^{P^-})) \end{aligned} \right\rangle \right\}$$

where

(i) if $u \in V_1 \cup V_2$

$$\begin{aligned}
 (T_{A_1}^{P^+} +_N T_{A_2}^{P^+})(u) &= (T_{A_1}^{P^+} \cup_N T_{A_2}^{P^+})(u), (T_{\lambda_1}^{P^+} +_N T_{\lambda_2}^{P^+})(u) = (T_{\lambda_1}^{P^+} \cup_N T_{\lambda_2}^{P^+})(u) \\
 (T_{A_1}^{P^-} +_N T_{A_2}^{P^-})(u) &= (T_{A_1}^{P^-} \cup_N T_{A_2}^{P^-})(u), (T_{\lambda_1}^{P^-} +_N T_{\lambda_2}^{P^-})(u) = (T_{\lambda_1}^{P^-} \cup_N T_{\lambda_2}^{P^-})(u) \\
 (I_{A_1}^{P^+} +_N I_{A_2}^{P^+})(u) &= (I_{A_1}^{P^+} \cup_N I_{A_2}^{P^+})(u), (I_{\lambda_1}^{P^+} +_N I_{\lambda_2}^{P^+})(u) = (I_{\lambda_1}^{P^+} \cup_N I_{\lambda_2}^{P^+})(u) \\
 (I_{A_1}^{P^-} +_N I_{A_2}^{P^-})(u) &= (I_{A_1}^{P^-} \cup_N I_{A_2}^{P^-})(u), (I_{\lambda_1}^{P^-} +_N I_{\lambda_2}^{P^-})(u) = (I_{\lambda_1}^{P^-} \cup_N I_{\lambda_2}^{P^-})(u) \\
 (F_{A_1}^{P^+} +_N F_{A_2}^{P^+})(u) &= (F_{A_1}^{P^+} \cup_N F_{A_2}^{P^+})(u), (F_{\lambda_1}^{P^+} +_N F_{\lambda_2}^{P^+})(u) = (F_{\lambda_1}^{P^+} \cup_N F_{\lambda_2}^{P^+})(u) \\
 (F_{A_1}^{P^-} +_N F_{A_2}^{P^-})(u) &= (F_{A_1}^{P^-} \cup_N F_{A_2}^{P^-})(u), (F_{\lambda_1}^{P^-} +_N F_{\lambda_2}^{P^-})(u) = (F_{\lambda_1}^{P^-} \cup_N F_{\lambda_2}^{P^-})(u)
 \end{aligned}$$

(ii) if $uv \in E_1 \cup E_2$

$$\begin{aligned}
 (T_{B_1}^{P^+} +_N T_{B_2}^{P^+})(uv) &= (T_{B_1}^{P^+} \cup_N T_{B_2}^{P^+})(uv), (T_{\mu_1}^{P^+} +_N T_{\mu_2}^{P^+})(uv) = (T_{\mu_1}^{P^+} \cup_N T_{\mu_2}^{P^+})(uv) \\
 (T_{B_1}^{P^-} +_N T_{B_2}^{P^-})(uv) &= (T_{B_1}^{P^-} \cup_N T_{B_2}^{P^-})(uv), (T_{\mu_1}^{P^-} +_N T_{\mu_2}^{P^-})(uv) = (T_{\mu_1}^{P^-} \cup_N T_{\mu_2}^{P^-})(uv) \\
 (I_{B_1}^{P^+} +_N I_{B_2}^{P^+})(uv) &= (I_{B_1}^{P^+} \cup_N I_{B_2}^{P^+})(uv), (I_{\mu_1}^{P^+} +_N I_{\mu_2}^{P^+})(uv) = (I_{\mu_1}^{P^+} \cup_N I_{\mu_2}^{P^+})(uv) \\
 (I_{B_1}^{P^-} +_N I_{B_2}^{P^-})(uv) &= (I_{B_1}^{P^-} \cup_N I_{B_2}^{P^-})(uv), (I_{\mu_1}^{P^-} +_N I_{\mu_2}^{P^-})(uv) = (I_{\mu_1}^{P^-} \cup_N I_{\mu_2}^{P^-})(uv) \\
 (F_{B_1}^{P^+} +_N F_{B_2}^{P^+})(uv) &= (F_{B_1}^{P^+} \cup_N F_{B_2}^{P^+})(uv), (F_{\mu_1}^{P^+} +_N F_{\mu_2}^{P^+})(uv) = (F_{\mu_1}^{P^+} \cup_N F_{\mu_2}^{P^+})(uv) \\
 (F_{B_1}^{P^-} +_N F_{B_2}^{P^-})(uv) &= (F_{B_1}^{P^-} \cup_N F_{B_2}^{P^-})(uv), (F_{\mu_1}^{P^-} +_N F_{\mu_2}^{P^-})(uv) = (F_{\mu_1}^{P^-} \cup_N F_{\mu_2}^{P^-})(uv)
 \end{aligned}$$

(ii) if $uv \in E^*$, where E^* is the set of all edges joining the vertices of v_1 & v_2 .

$$\begin{aligned}
 (T_{B_1}^{P+} +_N T_{B_2}^{P+})(uv) &= r \min\{T_{A_1}^{P+}(u), T_{A_2}^{P+}(v)\}, (T_{\mu_1}^{P+} +_N T_{\mu_2}^{P+})(uv) = \max\{T_{\lambda_1}^{P+}(u), T_{\lambda_2}^{P+}(v)\} \\
 (T_{B_1}^{P-} +_N T_{B_2}^{P-})(uv) &= r \max\{T_{A_1}^{P-}(u), T_{A_2}^{P-}(v)\}, (T_{\mu_1}^{P-} +_N T_{\mu_2}^{P-})(uv) = \min\{T_{\lambda_1}^{P-}(u), T_{\lambda_2}^{P-}(v)\} \\
 (I_{B_1}^{P+} +_N I_{B_2}^{P+})(uv) &= r \min\{I_{A_1}^{P+}(u), I_{A_2}^{P+}(v)\}, (I_{\mu_1}^{P+} +_N I_{\mu_2}^{P+})(uv) = \max\{I_{\lambda_1}^{P+}(u), I_{\lambda_2}^{P+}(v)\} \\
 (I_{B_1}^{P-} +_N I_{B_2}^{P-})(uv) &= r \max\{I_{A_1}^{P-}(u), I_{A_2}^{P-}(v)\}, (I_{\mu_1}^{P-} +_N I_{\mu_2}^{P-})(uv) = \min\{I_{\lambda_1}^{P-}(u), I_{\lambda_2}^{P-}(v)\} \\
 (F_{B_1}^{P+} +_N F_{B_2}^{P+})(uv) &= r \min\{F_{A_1}^{P+}(u), F_{A_2}^{P+}(v)\}, (F_{\mu_1}^{P+} +_N F_{\mu_2}^{P+})(uv) = \max\{F_{\lambda_1}^{P+}(u), F_{\lambda_2}^{P+}(v)\} \\
 (F_{B_1}^{P-} +_N F_{B_2}^{P-})(uv) &= r \max\{F_{A_1}^{P-}(u), F_{A_2}^{P-}(v)\}, (F_{\mu_1}^{P-} +_N F_{\mu_2}^{P-})(uv) = \min\{F_{\lambda_1}^{P-}(u), F_{\lambda_2}^{P-}(v)\}
 \end{aligned}$$

Proposition 25.

The M-join and N-join of two bipolar spherical fuzzy neutrosophic cubic graphs is again a bipolar spherical fuzzy neutrosophic cubic graph.

APPLICATIONS OF BIOPOLAR SPHERICAL FUZZY NEUTROSOPHIC CUBIC GRAPHS

In this section, we present the real life applications of bipolar spherical fuzzy neutrosophic cubic graph.

Numerical Example 26.

Let us consider three factors that influence the e-learning effectiveness represented by the vertex set $V = \{X, Y, Z\}$. And let the truth-value denotes the e-learning material, the indeterminacy-value denotes the quality of web learning platform, the false-value denotes the e-learning course flexibility.

Let the vertex is given as follows:

$$P = \left\langle \left\{ \begin{aligned} &X, ([0.8, 0.2], 0.3), ([0.5, 0.3], 0.4), ([0.7, 0.5], 0.6), \\ &([[-0.4, -0.9], -0.2], [[-0.8, -0.4], -0.1], [[-0.5, -0.1], -0.7]) \end{aligned} \right\} \right. \\
 \left. \left\{ \begin{aligned} &Y, ([0.7, 0.1], 0.6), ([0.9, 0.1], 0.8), ([0.5, 0.6], 0.7), \\ &([[-0.2, -0.7], -0.4], [[-0.4, -0.6], -0.2], [[-0.6, -0.5], -0.3]) \end{aligned} \right\} \right. \\
 \left. \left\{ \begin{aligned} &Z, ([0.1, 0.8], 0.4), ([0.5, 0.7], 0.2), ([0.9, 0.3], 0.4), \\ &([[-0.8, -0.4], -0.2], [[-0.4, -0.3], -0.7], [[-0.7, -0.2], -0.5]) \end{aligned} \right\} \right\rangle$$

where the interval-valued membership indicates the effectiveness of an e-learning system at present and the fixed single-valued membership indicates the possibility of effectiveness of an e-learning system. So on the basis of the vertex set P we get the edge set Q defined as follows:

$$Q = \left\{ \begin{array}{l} \left\{ XY, ([0.7,0.1],0.6), ([0.5,0.1],0.8), ([0.7,0.6],0.6), \right. \\ \left. [(-0.2,-0.7],-0.4), ([-0.4,-0.4],-0.2), ([-0.6,-0.5],-0.3) \right\} \\ \left\{ XZ, ([0.1,0.2],0.4), ([0.5,0.3],0.4), ([0.9,0.5],0.4), \right. \\ \left. [(-0.4,-0.4],-0.2), ([-0.4,-0.3],-0.7), ([-0.7,-0.2],-0.5) \right\} \\ \left\{ YZ, ([0.1,0.1],0.6), ([0.5,0.1],0.8), ([0.9,0.6],0.4), \right. \\ \left. [(-0.2,-0.4],-0.4), ([-0.4,-0.3],-0.7), ([-0.7,-0.5],-0.3) \right\} \end{array} \right\}$$

Finally, we see that the effectiveness of an e-learning with other factors.

$$order(G) = \left\{ ([1.6,1.1],1.3), ([1.9,1.1],1.4), ([2.1,1.4],1.7), \right. \\ \left. [(-1.4,-2.0],-0.8), ([-1.6,-1.3],-1.0), ([-1.8,-0.8],-1.5) \right\}$$

$$deg(X) = \left\{ ([0.7,0.3],2.2), ([1.2,1.7],1.8), ([1.5,2.1],0.3), \right. \\ \left. [(-1.7,-1.3],-1.5), ([-1.5,-0.6],-1.1), ([-2.5,-2],-0.3) \right\}$$

$$deg(Y) = \left\{ ([0.7,0.9],2.4), ([1.5],2.1), ([1.6,2],0.9), \right. \\ \left. [(-1.4,-1.1],-0.9), ([-1.7,-0.8],-1.1), ([-2.5,-2],-0.7) \right\}$$

$$deg(Z) = \left\{ ([0.3,0.7],2), ([0.6,0.9],1.9), ([1.8,2.1],1), \right. \\ \left. [(-1.7,-1.3],-0.9), ([-1.7,-0.8],-1.2), ([-2.7,-2],-0.8) \right\}$$

The order of G represents the overall effectiveness of an e-learning. Degree of X represents the combination of the e-learning material and quality of web learning platform, degree of Y represents the e-learning material and e-learning course flexibility and degree of Z represents the quality of web learning platform and e-learning course flexibility.

Figure 6: The vertex set in P and the edge set in Q are represented for the graph $G=(P,Q)$

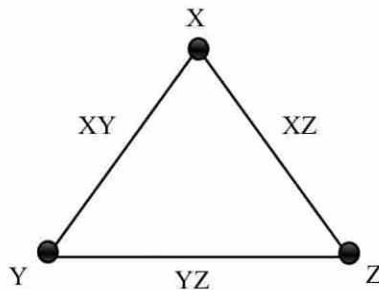

Numerical Example 27.

Let us consider the construction company and we evaluate the overall performance of the company. The important criteria considered are strong structure, having own skilled crew, innovative designs, high-quality

materials, competitive pricing. The above said criteria are taken in the form of single-valued to represent present type and in the form of interval-valued on future.

$$P = \left\{ \begin{array}{l} \left\{ A, ([0.7,0.6],0.4), ([0.9,0.5],0.8), ([0.7,0.8],0.6), \right. \\ \left. \{ [-0.4,-0.9],-0.2), ([-0.8,-0.7],-0.4), ([-0.5,-0.9],-0.1) \} \right. \\ \left\{ B, ([0.6,0.5],0.7), ([0.7,0.5],0.3), ([0.9,0.3],0.7), \right. \\ \left. \{ [-0.8,-0.6],-0.1), ([-0.5,-0.6],-0.7), ([-0.2,-0.6],-0.8) \} \right. \\ \left\{ C, ([0.1,0.7],0.6), ([0.7,0.8],0.1), ([0.2,0.5],0.9), \right. \\ \left. \{ [-0.5,-0.7],-0.9), ([-0.7,-0.4],-0.9), ([-0.5,-0.8],-0.9) \} \right. \\ \left\{ D, ([0.6,0.7],0.3), ([0.5,0.9],0.4), ([0.3,0.8],0.9), \right. \\ \left. \{ [-0.9,-0.5],-0.2), ([-0.7,-0.8],-0.7), ([-0.4,-0.5],-0.5) \} \right. \\ \left\{ E, ([0.8,0.4],0.5), ([0.6,0.7],0.6), ([0.6,0.7],0.4), \right. \\ \left. \{ [-0.6,-0.7],-0.8), ([-0.8,-0.6],-0.4), ([-0.9,-0.5],-0.3) \} \right. \end{array} \right\}$$

$$Q = \left\{ \begin{array}{l} \left\{ AB, ([0.6,0.5],0.7), ([0.7,0.5],0.8), ([0.9,0.8],0.6), \right. \\ \left. \{ [-0.4,-0.6],-0.2), ([-0.5,-0.6],-0.7), ([-0.5,-0.9],-0.1) \} \right. \\ \left\{ AC, ([0.1,0.6],0.6), ([0.7,0.5],0.8), ([0.7,0.8],0.6), \right. \\ \left. \{ [-0.4,-0.7],-0.9), ([-0.7,-0.4],-0.9), ([-0.5,-0.9],-0.1) \} \right. \\ \left\{ AD, ([0.6,0.6],0.4), ([0.5,0.5],0.8), ([0.7,0.8],0.6), \right. \\ \left. \{ [-0.4,-0.5],-0.2), ([-0.7,-0.7],-0.7), ([-0.5,-0.9],-0.1) \} \right. \\ \left\{ AE, ([0.7,0.4],0.5), ([0.6,0.5],0.8), ([0.7,0.8],0.4), \right. \\ \left. \{ [-0.4,-0.7],-0.8), ([-0.8,-0.6],-0.4), ([-0.9,-0.9],-0.1) \} \right. \\ \left\{ BC, ([0.1,0.5],0.7), ([0.7,0.5],0.3), ([0.9,0.5],0.7), \right. \\ \left. \{ [-0.5,-0.6],-0.9), ([-0.5,-0.4],-0.9), ([-0.5,-0.8],-0.8) \} \right. \\ \left\{ BD, ([0.6,0.5],0.7), ([0.5,0.5],0.4), ([0.9,0.8],0.7), \right. \\ \left. \{ [-0.8,-0.5],-0.2), ([-0.5,-0.6],-0.7), ([-0.4,-0.6],-0.5) \} \right. \\ \left\{ BE, ([0.6,0.4],0.7), ([0.6,0.5],0.6), ([0.9,0.7],0.4), \right. \\ \left. \{ [-0.6,-0.6],-0.8), ([-0.5,-0.6],-0.7), ([-0.9,-0.6],-0.3) \} \right. \\ \left\{ CD, ([0.1,0.7],0.6), ([0.5,0.8],0.4), ([0.3,0.8],0.9), \right. \\ \left. \{ [-0.5,-0.5],-0.9), ([-0.7,-0.4],-0.9), ([-0.5,-0.8],-0.5) \} \right. \\ \left\{ CE, ([0.1,0.4],0.6), ([0.6,0.7],0.6), ([0.6,0.7],0.4), \right. \\ \left. \{ [-0.5,-0.7],-0.9), ([-0.7,-0.4],-0.9), ([-0.9,-0.8],-0.3) \} \right. \\ \left\{ DE, ([0.6,0.4],0.5), ([0.5,0.7],0.6), ([0.6,0.8],0.4), \right. \\ \left. \{ [-0.6,-0.5],-0.8), ([-0.7,-0.6],-0.7), ([-0.9,-0.5],-0.3) \} \right. \end{array} \right\}$$

where the edge $\left\{ AB, ([0.6,0.5],0.7), ([0.7,0.5],0.8), ([0.9,0.8],0.6), \right.$
 $\left. \{ [-0.4,-0.6],-0.2), ([-0.5,-0.6],-0.7), ([-0.5,-0.9],-0.1) \} \right\}$ denotes the combined effect of

strong structure and company having own skilled crew.

Figure 7: Indicates the construction company and the overall performance of the company. The vertex set in P and the edge set in Q are represented for the graph $G=(P,Q)$

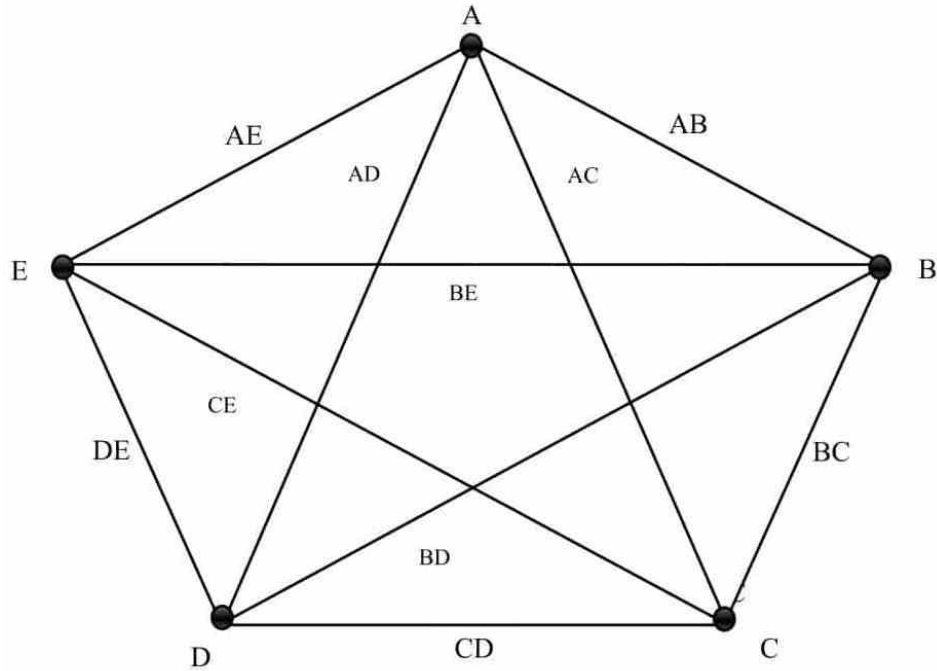

Bipolar Spherical Fuzzy Neutrosophic Cubic Graph and Minimum Spanning Tree Algorithm

In this section, we define score function of bipolar single-valued spherical fuzzy neutrosophic cubic set and present a minimum spanning tree problem and discuss it on a graph.

Definition 28.

Let A be a bipolar single-valued spherical fuzzy neutrosophic cubic set, we define a new score function as follows:

$$S(A) = \frac{1}{18} \left\{ \begin{aligned} & (T_{A_L}^{P^+} + T_{A_U}^{P^+}) + (1 - (I_{A_L}^{P^+} + I_{A_U}^{P^+})) + (1 - (F_{A_L}^{P^+} + F_{A_U}^{P^+})) + T_{\lambda}^{P^+} + I_{\lambda}^{P^+} - F_{\lambda}^{P^+} \\ & + (1 + (T_{A_L}^{P^-} + T_{A_U}^{P^-})) - (I_{A_L}^{P^-} + I_{A_U}^{P^-}) - (F_{A_L}^{P^-} + F_{A_U}^{P^-}) - T_{\lambda}^{P^-} + I_{\lambda}^{P^-} + F_{\lambda}^{P^-} \end{aligned} \right\}$$

In the following, we propose Bipolar Spherical Fuzzy Neutrosophic Cubic Minimum Spanning Tree algorithm [BSFNCMST]

Step (1): Input bipolar spherical fuzzy neutrosophic cubic adjacency matrix A.

Step (2): Interpret the bipolar spherical fuzzy neutrosophic cubic matrix into score matrix S_{ij} by using score.

Step (3): Redo Step (4) & Step (5) until all (n-1) entries of the matrix of $S(A)$ are either marked to zero or all the non-zero entries are marked.

Step (4): Find the score matrix $S(A)$ either row-wise or column-wise to find the cost of the corresponding edge e_{ij} in $S(A)$ that is the minimum entries in S_{ij} .

Step (5): Set $S_{ij} = 0$ if the edge e_{ij} of selected S_{ij} construct a cycle with the previous marked elements of the score matrix $S(A)$ else mark S_{ij} .

Step (6): Compute minimum cost spanning tree of the graph G by construct the tree T including only the marked elements from the score matrix $S(A)$.

Step (7): End

Numerical Example 29.

Assume the graph $G=(V,E)$ where V be the vertices and E be the edge of the graph. Here we have 5 vertices and 7 edges. Erection of the minimum cost spanning tree are discussed as follows

Figure (8): Undirected Graph $G=(V,E)$ with 5 vertices and 7 edges

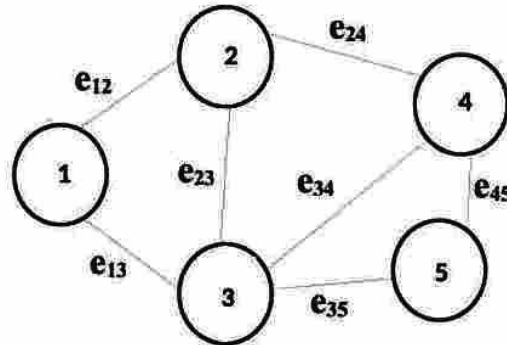

e	Edge length
e_{12}	$\left\{ \begin{aligned} &([0.3,0.5],0.6),([0.4,0.5],0.8),([0.1,0.6],0.5), \\ &([-0.2,-0.4],-0.3),([-0.6,-0.5],-0.1),([-0.8,-0.1],-0.2) \end{aligned} \right\}$
e_{13}	$\left\{ \begin{aligned} &([0.7,0.8],0.2),([0.5,0.4],0.8),([0.6,0.3],0.4), \\ &([-0.7,-0.3],-0.8),([-0.2,-0.6],-0.5),([-0.4,-0.5],-0.3) \end{aligned} \right\}$
e_{23}	$\left\{ \begin{aligned} &([0.9,0.5],0.3),([0.7,0.2],0.9),([0.4,0.2],0.5), \\ &([-0.6,-0.2],-0.7),([-0.8,-0.9],-0.5),([-0.9,-0.6],-0.6) \end{aligned} \right\}$

e_{24}	$\left\{ ([0.9,0.8],0.1),([0.6,0.1],0.7),([0.4,0.2],0.5), \right.$ $\left. [(-0.5,-0.8),-0.6],(-0.7,-0.4],-0.8),([-0.8,-0.4],-0.7) \right\}$
e_{34}	$\left\{ ([0.6,0.9],0.7),([0.6,0.1],0.9),([0.5,0.4],0.5), \right.$ $\left. [(-0.7,-0.9],-0.4),(-0.9,-0.7],-0.1),([-0.5,-0.7],-0.5) \right\}$
e_{35}	$\left\{ ([0.7,0.4],0.9),([0.7,0.8],0.9),([0.9,0.8],0.5), \right.$ $\left. [(-0.5,-0.6],-0.9),(-0.8,-0.6],-0.9),([-0.9,-0.5],-0.7) \right\}$
e_{45}	$\left\{ ([0.1,0.9],0.8),([0.3,0.7],0.9),([0.6,0.8],0.7), \right.$ $\left. [(-0.7,-0.5],-0.9),(-0.9,-0.9],-0.3),([-0.9,-0.8],-0.4) \right\}$

The bipolar spherical fuzzy neutrosophic cubic adjacency matrix A is given below

$$= \begin{bmatrix} 0 & e_{12} & e_{13} & 0 & 0 \\ e_{12} & 0 & e_{23} & e_{24} & 0 \\ e_{13} & e_{23} & 0 & e_{34} & e_{35} \\ 0 & e_{24} & e_{34} & 0 & e_{45} \\ 0 & 0 & e_{35} & e_{45} & 0 \end{bmatrix}$$

Thus, the score matrix using the score function

Figure (9): Score Matrix

$$S(A) = \begin{pmatrix} 0 & 0.25 & 0.222 & 0 & 0 \\ 0.25 & 0 & 0.311 & 0.211 & 0 \\ 0.222 & 0.311 & 0 & 0.272 & \mathbf{0.178} \\ 0 & 0.211 & 0.272 & 0 & 0.283 \\ 0 & 0 & 0.178 & 0.283 & 0 \end{pmatrix}$$

Figure (10): The selected edge (3,5) in G

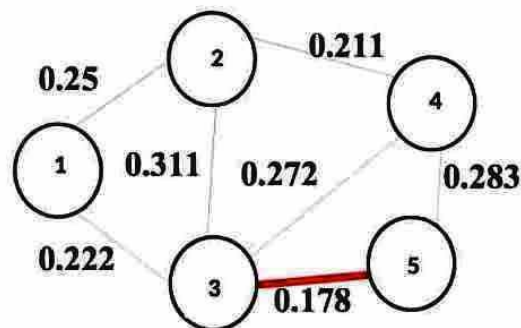

In the score matrix, the minimum entry is 0.178 is selected and the corresponding edge (3,5) is highlighted in Figure (9).

Figure (10) represents the bipolar spherical fuzzy neutrosophic cubic graph where the edge (3,5) is highlighted.

Figure (11): The next minimum entry 0.211 in score matrix

$$S(A) = \begin{pmatrix} 0 & 0.25 & 0.222 & 0 & 0 \\ 0.25 & 0 & 0.311 & \mathbf{0.211} & 0 \\ 0.222 & 0.311 & 0 & 0.272 & \mathbf{0.178} \\ 0 & 0.211 & 0.272 & 0 & 0.283 \\ 0 & 0 & 0.178 & 0.283 & 0 \end{pmatrix}$$

Figure (12): The selected edge (2,4) in G

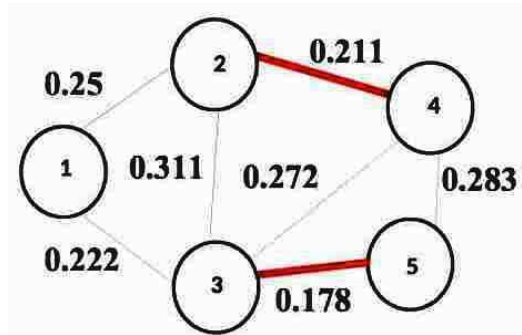

According to the Figure (11) & Figure (12), the next non-zero minimum entry is 0.211 is selected and the corresponding edge (2,4) is highlighted.

Figure (13): The next minimum entry 0.222 in score matrix

$$S(A) = \begin{pmatrix} 0 & 0.25 & \mathbf{0.222} & 0 & 0 \\ 0.25 & 0 & 0.311 & \mathbf{0.211} & 0 \\ 0.222 & 0.311 & 0 & 0.272 & \mathbf{0.178} \\ 0 & 0.211 & 0.272 & 0 & 0.283 \\ 0 & 0 & 0.178 & 0.283 & 0 \end{pmatrix}$$

Figure (14): The selected edge (1,3) in G

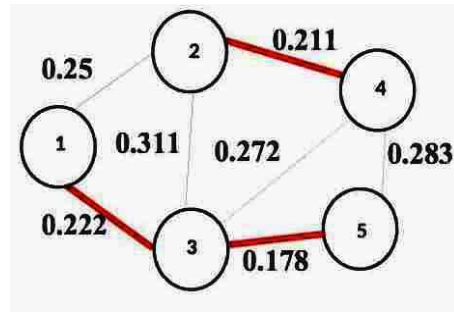

According to the Figure (13) & Figure (14), the next non-zero minimum entry is 0.222 is selected and the corresponding edge (1,3) is highlighted.

Figure (15): The next minimum entry 0.25 in score matrix

$$S(A) = \begin{pmatrix} 0 & 0.25 & 0.222 & 0 & 0 \\ 0.25 & 0 & 0.311 & 0.211 & 0 \\ 0.222 & 0.311 & 0 & 0.272 & 0.178 \\ 0 & 0.211 & 0.272 & 0 & 0.283 \\ 0 & 0 & 0.178 & 0.283 & 0 \end{pmatrix}$$

Figure (16): The selected edge (1,2) in G

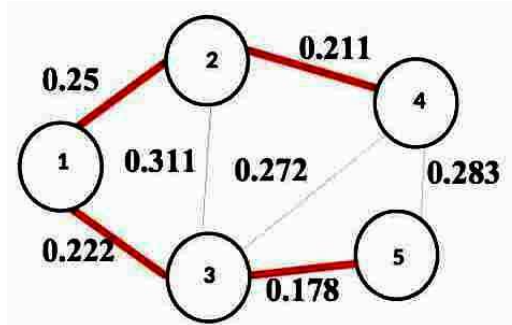

The final minimum non-zero entry is 0.25 is selected and the corresponding edge (1,2) is highlighted in the Figure (15) & Figure (16)

Figure (17): The final path of minimum spanning tree is represented

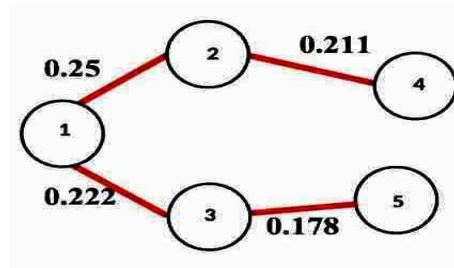

Using the above steps, the crisp minimum cost spanning tree is 0.861 and the final path of minimum spanning tree is $\{4,2\}, \{2,1\}, \{1,3\}, \{3,5\}$.

Conclusions

Neutrosophic sets are a suitable mathematical tool to handle the uncertainty along with the bipolarity ie the positivity and negativity of the information. The concept of bipolar fuzzy sets is a generalization of fuzzy set to deal with vagueness and uncertainty. Graph theory concepts are widely used to study various applications in different areas. Minimum spanning tree have direct applications in the design of networks, other practical applications include taxonomy, cluster analysis, circuit design. In this article, neutrosophic cubic graph is extended to bipolar environment and combined with spherical fuzzy set to develop a theoretical study, bipolar spherical fuzzy neutrosophic cubic graph. We also discussed some operations on bipolar spherical fuzzy neutrosophic cubic graph. Finally, application of bipolar spherical fuzzy neutrosophic cubic graph in decision making problem and minimum spanning tree problem are presented. This method is very effective in the field of computer science and medical science. In the future, we will focus on bipolar spherical fuzzy graphs in different areas where there are factors of decision making exists.

References

1. Akram, M. (2011). Bipolar fuzzy graphs. *Information Sciences*, 181(24), 5548–5564.
2. Akram, M. & Davvaz, M. (2012). Strong intuitionistic fuzzy graphs. *Filomat*, 26(1), 177– 196.
3. Akram, M. (2013). Bipolar fuzzy graphs with applications. *Knowledge Based Systems*, 39, 1–8.
4. Akram, M. (2016). Single-valued neutrosophic planar graphs. *Int. J. Algebra Stat.*, 5, 157–167.
5. Akram, M. & Nasir, M. (2017). Concepts of Interval-Valued Neutrosophic Graphs. *Int. J. Algebra Stat.*, 6, 22–41.
6. Akram, M. & Shahzadi, S. (2017) Neutrosophic soft graphs with application. *J. Intell. Fuzzy Syst.*, 32, 841–858.
7. Akram, M., Rafique, S. & Davvaz, B. (2018). New concepts in neutrosophic graphs with application. *J. Appl. Math. Comput.*, 57, 279–302.
8. Antony Crispin Sweety, C., Vaiyomathi, K. & Nirmala Irudayam, F. (2020). Bipolar Neutrosophic Cubic Graphs and its Applications. *Handbook of Research on Advanced Applications of Graph Theory in Modern Society*. 492-536.
9. Ashraf Shahzaib, Abdullah Saleem, Mahmood Tahir, Ghani Fazal, & Mahmood Tariq. (2019). Spherical fuzzy sets and their applications in multi-attribute decision making problems. *Journal of Intelligent and Fuzzy systems*. 36(3), 2829-2844.
10. Atanassov, K.T. (1986). Intuitionistic fuzzy sets. *Fuzzy Sets and Systems*, 20, 87-96.
11. Bakbak, D., Uluçay, V., & Şahin, M. (2019). Neutrosophic soft expert multiset and their application to multiple criteria decision making. *Mathematics*, 7(1), 50.

12. Broumi, S. & Smarandache, F. (2014). Single valued neutrosophic trapezoid linguistic aggregation operators based multi attribute decision making. *Bulletin of Pure and Applied Science*, 33E(2), 135–155.
13. Broumi, S., Talea, M., Bakali, A. & Smarandache, F. (2016). Single valued neutrosophic graphs. *Journal of New Theory*, 10, 86-101.
14. Broumi, S., Talea, M., Bakali, A. & Smarandache, F. (2016). Interval valued neutrosophic graphs. *Critical Review*, XII, 5-33.
15. Broumi, S., Talea, M., Smarandache, F. & Bakali, A. (2016). Single valued neutrosophic graphs: Degree, order and size,” in *Proc. the IEEE International Conference on Fuzzy Systems (FUZZ)*, 2444-2451.
16. Broumi, S., Smarandache, F., Talea, M. & Bakali, A. (2016). Decision-making method based on the interval valued neutrosophic graph. *Future Technologie*, IEEE, 44-50.
17. Broumi, S., Smarandache, F., Talea, M. & Bakali, A. (2016). Operations on interval valued neutrosophic graphs, chapter in book- new trends in neutrosophic theory and applications- florentin smarandache and surpati pramanik (editors), 231-254.
18. Broumi, S., Bakali, A., Mohamed, T., Smarandache, F. & Vladareanu, L. (2016). Shortest path problem under triangular fuzzy neutrosophic information, in *Proc. 10th International Conference on Software, Knowledge, Information Management & Applications (SKIMA)*, 169-174.
19. Broumi, S., Smarandache, F., Talea, M. & Bakali, A. (2016). An introduction to bipolar single valued neutrosophic graph theory. *Applied Mechanics and Materials*, 841, 184-191.
20. Broumi, S., Talea, M., Assia bakali & Smarandache, F. (2016). Bipolar Single Valued Neutrosophic Graphs. *New Ternds in Neutrosophic Theory and Appications*, 203-221.
21. Broumi, S., Bakali, A., Talea, M., Smarandache, F. (2016). Isolated Single Valued Neutrosophic Graphs. *Neutrosophic Sets and Systems*, 11, 74-78.
22. Broumi, S., Talea, M., Bakkali, A., & Smarandache, F. (2016). Single Valued Neutrosophic Graph. *Journal of New Theory*, 10, 68-101.
23. Broumi, S., Talea, M., Bakali, A., & Smarandache, F. (2016). On bipolar single valued neutrosophic graphs. *Journal of New Theory*, 11, 84–102.
24. Broumi, S., Bakali, A., Talea, M., Smarandache, F. & Verma R. (2017). Computing Minimum Spanning Tree in Interval Valued Bipolar Neutrosophic Environment. *International Journal of Modeling and Optimization*, 7(5), 300-304
25. Broumi, S., Bakali, A., Talea, M., & Smarandache, F. (2017). Generalized Bipolar Neutrosophic Graphs of Type 1. *20th International Conference on Information Fusion, Xi'an*, 1714-1720.
26. Broumi, S., Bakali, A., Talea, M., Smarandache, F., Singh, P. K., Uluçay, V., & Khan, M. (2019). Bipolar complex neutrosophic sets and its application in decision making problem. In *Fuzzy Multi-criteria Decision-Making Using Neutrosophic Sets* (pp. 677-710). Springer, Cham.
27. Bustince, H. & Burilloit, P. (1996). Vague sets are intuitionistic fuzzy sets. *Fuzzy sets and Systems*, 79(30), 403-405.

28. Deli, M., Ali & Smarandache, F. (2015). Bipolar neutrosophic sets and their application based on multi-criteria decision making problems. *Advanced Mechatronic Systems (ICAMEchS)*, 249- 254.
29. Gau, W. L. & Buehrer, D. J. (1993). Vague sets. *IEEE Trans. Systems, Man, and Cybernetics*, 23, 610–614.
30. Hai-Long, Y., She Yanhonge, G. & Xiuwu, L. (2015), On single valued neutrosophic relations, *Journal of Intelligent & Fuzzy Systems*, 1-12.
31. Hassan, N., Uluçay, V. & Şahin, M. (2018). Q-neutrosophic soft expert set and its application in decision making. *International Journal of Fuzzy System Applications (IJFSA)*, 7(4), 37-61.
32. Jun, Y.B., Kim, C.S. & Yang, K.O. (2012). Cubic Sets. *Ann. Fuzzy Math. Inf.*, 4, 83–98.
33. Jun, Y.B., Smarandache, F. & Kim, C.S. (2017). Neutrosophic cubic sets. *New Mathematics and Natural Computation*, 13, 41–54.
34. Jun, Y.B., Smarandache, F. & Kim, C.S. (2017). P-union and P-intersection of neutrosophic cubic sets. *Anal. Univ. Ovid. Constant. Seria Mat*, 25, 99-115.
35. Kandasamy, W.B.V., Ilanthenral, K. & Smarandache, F. (2015) Neutrosophic Graphs: A New Dimension to Graph Theory; *EuropaNova ASBL: Bruxelles*, Belgium.
36. Kandasamy, I. (2016). Double-valued neutrosophic sets, their minimum spanning trees, and clustering algorithm. *Journal of Intelligent System*, 1-17.
37. Kutlu Gündoğdu, F. & Kahraman, C. (2019). Spherical fuzzy sets and spherical fuzzy TOPSIS method. *J. Intell. Fuzzy Syst.* 36(1), 337–352.
38. Kutlu Gündoğdu, F. & Kahraman, C. (2020). Spherical Fuzzy Sets and Decision Making Applications. *Intelligent and Fuzzy Techniques in Big Data Analytics and Decision Making. INFUS 2019. Advances in Intelligent Systems and Computing.* 1029.
39. Mordeson, J.N., & Nair, P.S. (2001). Fuzzy Graphs and Fuzzy Hypergraphs, *Physica Verlag*, Heidelberg.
40. Mullai, M., Broumi, S. & Stephen, A. (2017). Shortest path problem by minimal spanning tree algorithm using bipolar neutrosophic numbers. *International Journal of Mathematic Trends and Technology*, 46, 80-87.
41. Pramanik, T., Samanta, M. & Pal, S. (2016). Interval-valued fuzzy planar graphs. *International journal of machine learning and cybernetics*, 7 (4), 653-664.
42. Parvathi, R., & Karunambigai, M.G. (2006). Intuitionistic Fuzzy Graphs. *Computational Intelligence Theory and applications*, 139-150.
43. Rosenfeld, A. (1975). Fuzzy graphs in Fuzzy sets and their applications. *Academic press Newyork*, 77-95.
44. Said Broumi, Assia Bakali, Mohamed Talea, Florentin Smarandache, & Rajkumar Verma. (2017). Computing Minimum Spanning Tree in Interval valued Bipolar Neutrosophic Environment. *International Journal of Modeling and Optimization*, 7(5), 300-304.

45. Said Broumi, Assia Bakali, Mohamed Talea, Florentin Smarandache & Venkateswara Rao, V. (2018). Interval Complex Neutrosophic Graph of Type 1. *Neutrosophic Operational Research*, 3, 87-106.
46. Sahin M., Kargin A., & Coban M. A. (2018) Fixed point theorem for neutrosophic triplet partial metric space. *Symmetry – MDPI*, 10, 240.
47. Sahin M. & Kargin A. (2018) Neutrosophic triplet v – generalized metric space. *Axioms – MDPI*, 7, 67.
48. Sahin, M. & Kargin A. (2019), Neutrosophic triplet groups based on set valued neutrosophic quadruple numbers. *Neutrosophic Set and Systems*, 30, 122 – 131.
49. Sahin, M. & Kargin A. (2019), Single valued neutrosophic quadruple graphs. *Asian Journal of Mathematics and Computer Research*, 26(4): 243–250.
50. Samanta, S., & Pal, M. (2015). Fuzzy planar graphs. *IEEE Transactions on Fuzzy Systems*, 23(6), 936-1942.
51. Samanta, S. & Pal, M. (2012). Bipolar fuzzy hypergraphs. *International Journal of Fuzzy Logic System*, 2(1), 17-28.
52. Samanta, S. & Pal, M. (2011). Fuzzy Tolerance Graphs. *International Journal of Latest trends in Mathematics*.
53. Samanta, S. & Pal, M. (2012). Irregular bipolar fuzzy graphs. *arXiv preprint arXiv*, 1209, 1682.
54. Smarandache, F. (1998). A unifying field in logics, neutrosophy: neutrosophic probability, set and logic. *Rehoboth: American Research Press*.
55. Smarandache, F. (1999). A unifying field in logics. *neutrosophy: neutrosophic probability, set and logic. Rehoboth, American Research Press*.
56. Smarandache, F. (2006). Neutrosophic set - a generalization of the intuitionistic fuzzy set, Granular Computing. *IEEE International Conference*, 38 – 42.
57. Smarandache, F. (2002a), A Unifying Field in Logics: Neutrosophic Logic, in *Multiple-Valued Logic /An International Journal*, 8(3), 385-438.
58. Smarandache, F. (2002b), Neutrosophy, A New Branch of Philosophy, in *Multiple-Valued Logic / AnInternational Journal*, 8(3), 297-384.
59. Smarandache, F. (2002c), editor, Proceedings of the First International Conference on Neutrosophy, Neutrosophic Logic, Neutrosophic Set, Neutrosophic Probability and Statistics, University of New Mexico, Gallup Campus, *Xiquan*, Phoenix, 147.
60. Smarandache, F. & Pramanik, S. (2016). *New trends in neutrosophic theory and applications*. Brussels: Pons Editions.
61. Smarandache, F. & Pramanik, S. (2018). *New trends in neutrosophic theory and applications*, Vol.2. Brussels: Pons Editions.
62. Smarandache, F. (2015). Types of Neutrosophic Graphs and Neutrosophic Algebraic Structures together with their Applications in Technology, seminar, Universitatea Transilvania din Brasov, Facultatea de Design de Produs si Mediu, Brasov, Romania.

63. Smarandache, F. (2017). Neutrosophic Perspectives: Triplets, Duplets, Multisets, Hybrid Operators, Modal Logic, Hedge Algebras. And Applications. *Second extended and improved edition*. Pons Publishing House, Brussels.
64. Ulucay, V., Şahin, M. & Olgun, N. (2018) Time-Neutrosophic Soft Expert Sets and Its Decision Making Problem. *Matematika*, 34(2), 246-260.
65. Uluçay, V., Kılıç, A., Yıldız, I. & Şahin, M. (2018). A new approach for multi-attribute decision-making problems in bipolar neutrosophic sets. *Neutrosophic Sets and Systems*, 23(1), 142-159.
66. Uluçay, V., Şahin, M., & Hassan, N. (2018). Generalized neutrosophic soft expert set for multiple-criteria decision-making. *Symmetry*, 10(10), 437.
67. Uluçay, V., Kılıç, A., Yıldız, İ., & Şahin, M. (2019). An Outranking Approach for MCDM-Problems with Neutrosophic Multi-Sets. *Neutrosophic Sets & Systems*, 30.
68. Ulucay, V., Kılıç, A., Şahin, M., & Deniz, H. (2019). A New Hybrid Distance-Based Similarity Measure for Refined Neutrosophic sets and its Application in Medical Diagnosis. *MATEMATIKA: Malaysian Journal of Industrial and Applied Mathematics*, 35(1), 83-94.
69. Uluçay, V., & Şahin, M. (2020). Decision-Making Method based on Neutrosophic Soft Expert Graphs. In *Neutrosophic Graph Theory and Algorithms* (pp. 33-76). IGI Global.
70. Wang, H., Smarandache, F., Zhang, Y. Q. & Sunderraman, R. (2010). Single-valued neutrosophic sets, *Multispace and Multistruct*, 4, 410-413.
71. Yager, R.R., Abbasov, A.M. (2013). Pythagorean membership grades, complex numbers, and decision making. *Int J Intell Syst*, 28(5), 436–452.
72. Yager, R.R. (2014). Pythagorean membership grades in multicriteria decision making. *IEEE Trans Fuzzy Syst*, 22(4), 958–965.
73. Ye, J. (2014). Single valued neutrosophic minimum spanning tree and its clustering method. *Journal of Intelligent System*, 23, 311-324.
74. Ye, J. (2016). Multiple-attribute decision-making method under a single-valued neutrosophic hesitant fuzzy environment. *Journal of Intelligent Systems*, 24(1), 23–36.
75. Ye, J. (2018). Multiple-attribute decision-making method using similarity measures of single-valued neutrosophic hesitant fuzzy sets based on least common multiple cardinality. *Journal of Intelligent & Fuzzy Systems*, 34(6), 4203-4211.
76. Zadeh, L. A. (1965). Fuzzy sets. *Information and control*, 8, 338-353.
77. Zhang, W.R. (1998). Bipolar fuzzy sets. *IEEE International Conference on fuzzy systems*, 835-840.

In 2015, Smarandache introduced the concept of neutrosophic quadruple numbers and presented some basic operations on the set of neutrosophic quadruple numbers such as, addition, subtraction, multiplication, and scalar multiplication.

<http://fs.unm.edu/NSS/NSS-10-2015.pdf>

Let's consider an entity (i.e. a number, an idea, an object, etc.) which is represented by a known part (a) and an unknown part ($bT + cI + dF$).

Numbers of the form: $NQ = a + bT + cI + dF$, (1)

where a, b, c, d are real (or complex) numbers (or intervals or in general subsets), and

T = truth / membership / probability,

I = indeterminacy,

F = false / membership / improbability,

are called Neutrosophic Quadruple (Real respectively Complex) Numbers (or Intervals, or in general Subsets). " a " is called the known part of NQ , while " $bT + cI + dF$ " is called the unknown part of NQ .

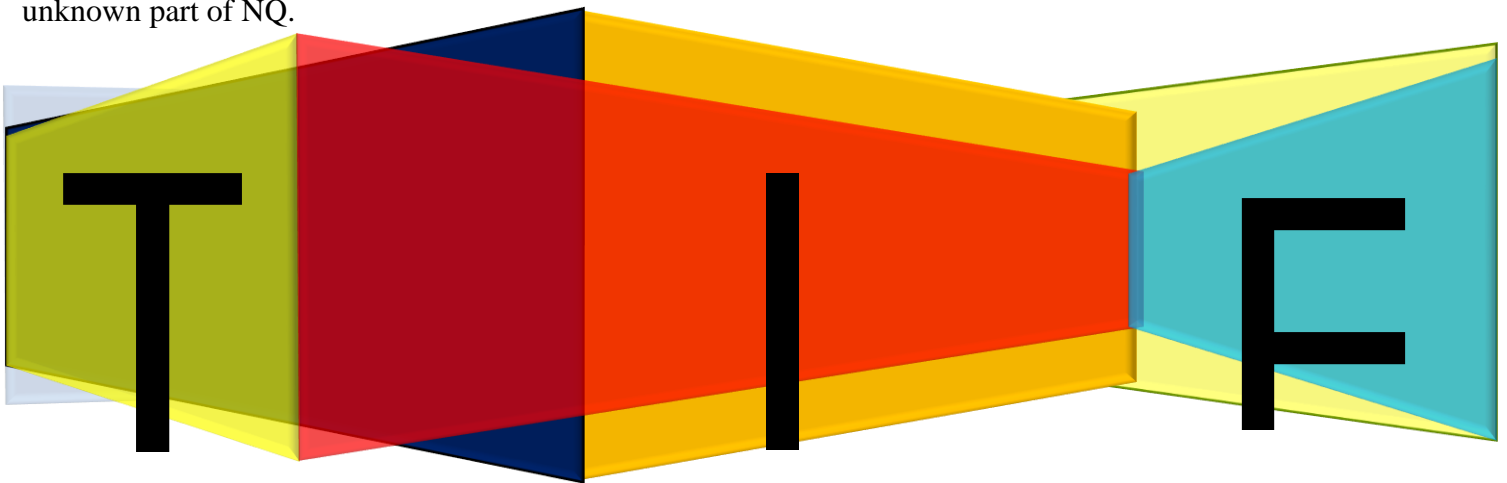

ISBN 978-1-59973-647-1

