

**Conceptual aspects  
management of  
competitiveness the  
economic entities**

**Collective monograph edited by  
M. Bezpartochnyi, I. Britchenko**

---

Higher School of Social and Economic  
Przeworsk (Poland) 2019



**Koncepcyjne aspekty  
zarządzania  
konkurencyjnością  
podmiotów gospodarczych**

**Monografia zbiorowa  
pod redakcją naukową  
M. Bezpartochno, I. Britchenko**

---

Wyższa Szkoła Społeczno-Gospodarcza  
Przeworsk (Polska) 2019

**UDK 339.137.2**

**Conceptual aspects management of competitiveness the economic entities: collective monograph / edited by M. Bezpartochnyi, I. Britchenko. / Higher School of Social and Economic. – Przeworsk: WSSG, 2019. – 274 p.**

The authors of the book have come to the conclusion that it is necessary to effectively use modern approaches the management of competitiveness the economic entities in order to increase the efficiency of using the resource potential, formation of competitive advantages and development strategies. Basic research focuses on economic diagnostics of ensuring the competitiveness of economic entities, marketing and logistics, analysis of energy-efficient potential, assessment of development potential. The research results have been implemented in the different models of inventory management, corporate social responsibility management, business process management and project management. The results of the study can be used in decision-making at the level the economic entities in different areas of activity and organizational-legal forms of ownership, ministries and departments that promote of development the economic entities and increase their competitiveness. The results can also be used by students and young scientists in modern concepts and mechanisms for management of competitiveness the economic entities in the context of efficient use the resource potential and introduction of modern innovations.

Reviewers (international scientific editorial board):

**Tetiana Cherniavska** – *Doctor of Economics, Professor, State Higher Vocational School, Konin, Poland*

**Aivars Stankevičs** – *Dr. oec., Researcher, Institute of Humanities and Social Sciences, Daugavpils University, Daugavpils, Latvia*

**Remigijus Kinderis** – *PhD, Assoc. Prof., Director Deputy for Strategic Development, Academic Council Chairman, Klaipeda State University of Applied Sciences, Lithuania*

The collective monograph is approved for publication at the meeting of the Scientific Council of the Higher School of Social and Economic in Przeworsk of 09<sup>h</sup> January 2019, *Minutes No. 02.*

Reproduction or citation reference is mandatory.

© Higher School of Social and Economic, 2019

**ISBN 978-83-937354-1-9**

**INTRODUCTION ..... 9**

**Chapter 1**

**SCIENTIFIC BASES OF FORMATION AND ENSURING OF  
COMPETITIVENESS THE ECONOMIC ENTITIES ..... 10**

**Bezpartochnyi M., Britchenko I., Jarosz P.**

Economic diagnostics in ensuring of competitiveness the economic  
entities ..... 10

**Meidutė-Kavaliauskienė I., Vasilienė-Vasiliauskienė V., Vasilis  
Vasiliauskas A.**

Analysis on barriers to a collaborative supply chain ..... 20

**Smerichevskiy S., Kniazieva T., Ramenska S.**

Methods of management by enterprise corporate social responsibility  
development: ecological component ..... 30

**Tarasenko I., Verhun A., Nefedova T., Borolis I.**

Methodological approach to the formation of the monitoring system  
for the competitiveness of institutions of higher education ..... 42

**Topleva S.**

The competition structure and social responsibility in the Bulgarian  
economy ..... 55

**Chapter 2**

**ORGANIZATIONAL-ECONOMIC MECHANISMS  
FORMATION OF COMPETITIVE ADVANTAGES THE  
ECONOMIC ENTITIES ..... 63**

**Borowska M., Zadworny W.**

Modelowanie przepływu strumieni ładunków a problem kolejek w  
systemach logistycznych ..... 63

<b>Kolbushkin U., Shevchenko A., Britchenko I.</b>	
Information environment of international marketing .....	85
<b>Kononenko A., Kugai K.</b>	
Competitive market types development and market concept for competitive position formation .....	93
<b>Olshanskiy O., Kovyakh I.</b>	
The concept of improving trade enterprises' business process management .....	102
<b>Pohludka M., Stverkova H.</b>	
A new distribution logistics network in a prism of customer satisfaction .....	111
<b>Chapter 3</b>	
<b>ENSURING COMPETITIVENESS OF RESOURCE POTENTIAL THE ECONOMIC ENTITIES .....</b>	<b>121</b>
<b>Kovalenko V., Sergeeva E., Radova N.</b>	
Deposit policy and its impact on ensuring of competitive advantages of bank .....	121
<b>Paliukas V., Savaneviciene A.</b>	
Artificial Intelligence based Human Resource development for ensuring the competitiveness of economic entities .....	131
<b>Serdyuk V., Serdyuk T., Franishyna S.</b>	
Modern management tools for increase energy efficiency level .....	140
<b>Smerichevskiy S., Byezgina O.</b>	
Coal producer's energy efficient potential assesment .....	148
<b>Trifonova O., Trushkina N.</b>	
Application of information technologies in logistic activities of enterprises .....	161

**Chapter 4**  
**PRACTICAL ASPECTS MANAGEMENT OF**  
**COMPETITIVENESS THE ECONOMIC ENTITIES IN**  
**VARIOUS SECTORS OF THE ECONOMY ..... 173**

**Ilichenko V., Bondarenko V.**

Competitiveness management of a company operating at the travel services market ..... 173

**Laptiev S., Sidak V., Mihus I., Koval Y.**

Threats to economic security of Ukrainian emitents after placement of shares on foreign markets ..... 186

**Širá E., Radvanská K.**

Competitiveness of tourism on the example of the Slovak Republic ..... 195

**Yatsiv I., Yatsiv S.**

Social functional strategy to secure competitive capacity of agricultural enterprises ..... 204

**Chapter 5**  
**DEVELOPMENT OF STRATEGIES TO ENSURE EFFECTIVE**  
**MANAGEMENT OF COMPETITIVENESS THE ECONOMIC**  
**ENTITIES ..... 213**

**Borowska M., Zadworny W.**

Strategiczne uwarunkowania zarządzania zapasami w przedsiębiorstwach produkcyjnych i handlowych ..... 213

**Dudko P.**

The ways of implementation of strategic model of higher educational institution management on the basis of competitive advantages ..... 228

**Maliuk L., Varypaiev O., Varypaieva L.**

Serviceology in the hospitality industry ..... 242

**Skachkova I., Skachkov O.**

Applying project management tools in the implementation of lean production techniques ..... 251

**Vasilienė-Vasiliauskienė V., Vasilis Vasiliauskas A., Meidutė-Kavaliauskienė I.**

Prerequisites for implementing sustainable development and its links to green logistics ..... 261

**CONCLUSION ..... 271**



## INTRODUCTION

Ensuring sustainable competitiveness of economic entities is an important component of economic security enterprises at the present stage of development. Solving this problem requires the creation of an effective competitiveness management system at enterprises. In the conditions of toughening competition on the commodity markets, increasing competitiveness becomes the main strategic goal of effective function the economic entities. There is an objective need to create a mechanism for management competitiveness at the enterprise level, providing for the search for new ways and methods for the formation of competitiveness in accordance with the conditions of competitive environment. In this regard, of particular interest is the application of concept competitiveness management in solving the problem of creating strategic competitive advantages of the economic entities. The effective use of resources potential as an instrument of optimization management the economic entities opens up broad opportunities for acquiring unique competencies and the formation on this basis of sustainable competitiveness.

The purpose of writing this collective monograph is to substantiate the theoretical-methodological foundations and develop a system for management the competitiveness of economic entities in a change market environment, taking into account the current state of resources potential and economic conditions, as well as the degree of globalization and international economic relations the economic entities.

The object of the author's research is the processes of management the competitiveness of economic entities in the context of resource constraints, the specifics and development trends of economic entities under the influence of factors the internal and external environment, a synthesis of world experience in management the competitiveness of economic entities in order to increase the efficiency of formation and use the resources potential and innovation activities of economic entities in various spheres of national economy in terms of change market conditions.

The subject of research was the various processes of formation and ensuring the competitiveness of economic entities; organizational-economic mechanisms for formation of competitive advantages of economic entities; directions of ensuring the competitiveness of resources potential the economic entities; consideration the practical aspects of management the competitiveness of economic entities in various sectors of the economy; formation and implementation of strategies to ensure effective management of competitiveness the economic entities.

## Chapter 1

# SCIENTIFIC BASES OF FORMATION AND ENSURING OF COMPETITIVENESS THE ECONOMIC ENTITIES

### **Bezpartochnyi Maksym**

*Doctor of Economics, Professor at the  
Department of Economics and  
Marketing, Faculty of Soft Engineering  
and Business*

*National Aerospace University named  
after N. Zhukovsky “Kharkiv Aviation  
Institute”*

*Official representative of Higher School  
of Social and Economic in Ukraine*

### **Britchenko Igor**

*Doctor of Economics, Professor,  
Faculty of Technical and Economic  
Sciences*

*State Higher Vocational School  
Memorial of Prof. Stanislaw Tarnowski  
in Tarnobrzeg*

### **Jarosz Piotr**

*Dr. Inz., Vice-Rector for University  
Development*

*Higher School of Social and Economic  
(Kharkiv, Ukraine; Tarnobrzeg,  
Przeworsk, Poland)*

## ECONOMIC DIAGNOSTICS IN ENSURING OF COMPETITIVENESS THE ECONOMIC ENTITIES

Modern business conditions require from economic entities to use appropriate methodological tools for assessing their activities. In economics science a fairly significant set of approaches, methods and techniques are now known that positively contribute to solving problems regarding ensure of competitiveness the economic entities. However, active influence of the

internal and external environment on their activities, as well as the specificity of economic management the economic entities, requires the use of more effective methodological tools that can identify threats of the external environment and explore the strengths of activity the economic entities.

Our studies [4-22] made it possible to establish that there is a need to improve the currently known ones and to develop new solutions of a theoretical and applied nature, aimed at ensuring high efficiency of analytical and management activities the economic entities. That is why at this time there are objective prerequisites for use in the competitiveness management system of an instrument that would allow for detailed research, to obtain reliable and complete information about the economic activities of an enterprise that would serve as the basis for developing and making effective management decisions. In our opinion, such a methodological tool is economic diagnostics.

In economic practice are often intuitively applied methods of economic diagnostics, but without mentioning it as a method of researching activities the economic entities. Changing this situation requires theoretical substantiation and develop of a scientific methodology the economic diagnostics of activities the economic entities, and on its basis to develop of an appropriate organizational-economic mechanism that will allow to investigate the state of economic entities on the consumer market, taking into account the sectoral specifics of their economic activities and to develop effective measures to ensure competitiveness and development in perspective.

Economic diagnostics of economic entities it is proposed to consider as a process of recognizing and identifying problems based on certain signs (key performance indicators, studying individual results, incomplete information) in the operation of an object in order to assess current trends and identify possible prospects for its development, analyze the best solutions to problems identified. The characteristic of economic diagnostics as a process is presented in Figure 1.1.

We offer our own approach to conducting economic diagnostics the economic entities (Figure 1.2).

Corresponding to propose on Figure 1.2 the economic diagnostics system, the initial information that come passes through the stages of collection and previous analysis, after which the diagnosis is divided into two areas: state diagnostics and process diagnostics. As a result of the first, the causes of current state the economic entities are determined, the second is the trends of its development and possible forecasts are developed, which act as an information base for develop of management decisions. Thus, economic diagnostics involves the study of not only the static state of

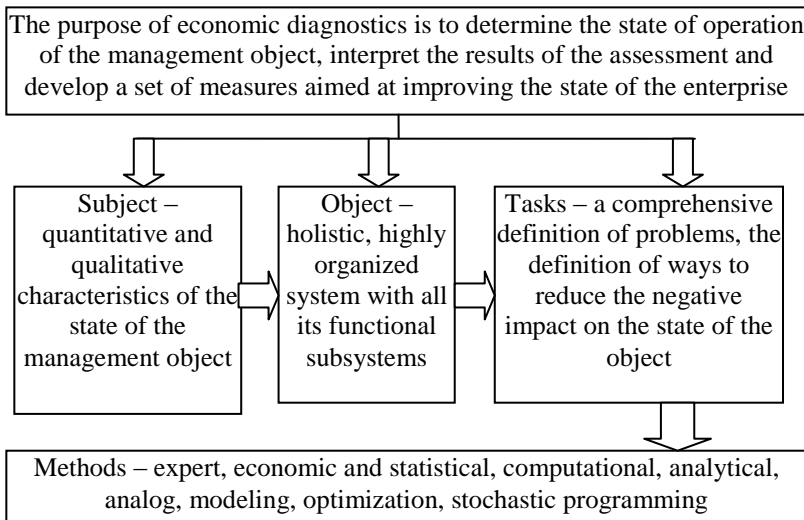

**Figure 1.1 Characteristics of economic diagnostics as a process**

*Source: developed by the authors*

economic entities, but also its development in the future.

Obtained diagnostic results together with the previous assessment of possible options for influencing to form the analytical basis for making management decisions and enter the management system. In turn, the management system through the adoption and implementation of management decisions affects to the object of management, which is the source of information for the internal environment, that is, is the entrance to the diagnostic system. These elements are in continuous relationship with the structural elements, creating a closed loop of economic diagnostics of the system selected for the study of economic activities the economic entities.

Modern economic diagnostics the economic entities is manifested simultaneously in four aspects:

1) informational – a system of knowledge, which is based on special information aimed at the subsequent use in develop and adoption processes of management decisions of economic activities the economic entities;

2) analytical – as an analytical basis, which is the basis for assessing the state of economic entities;

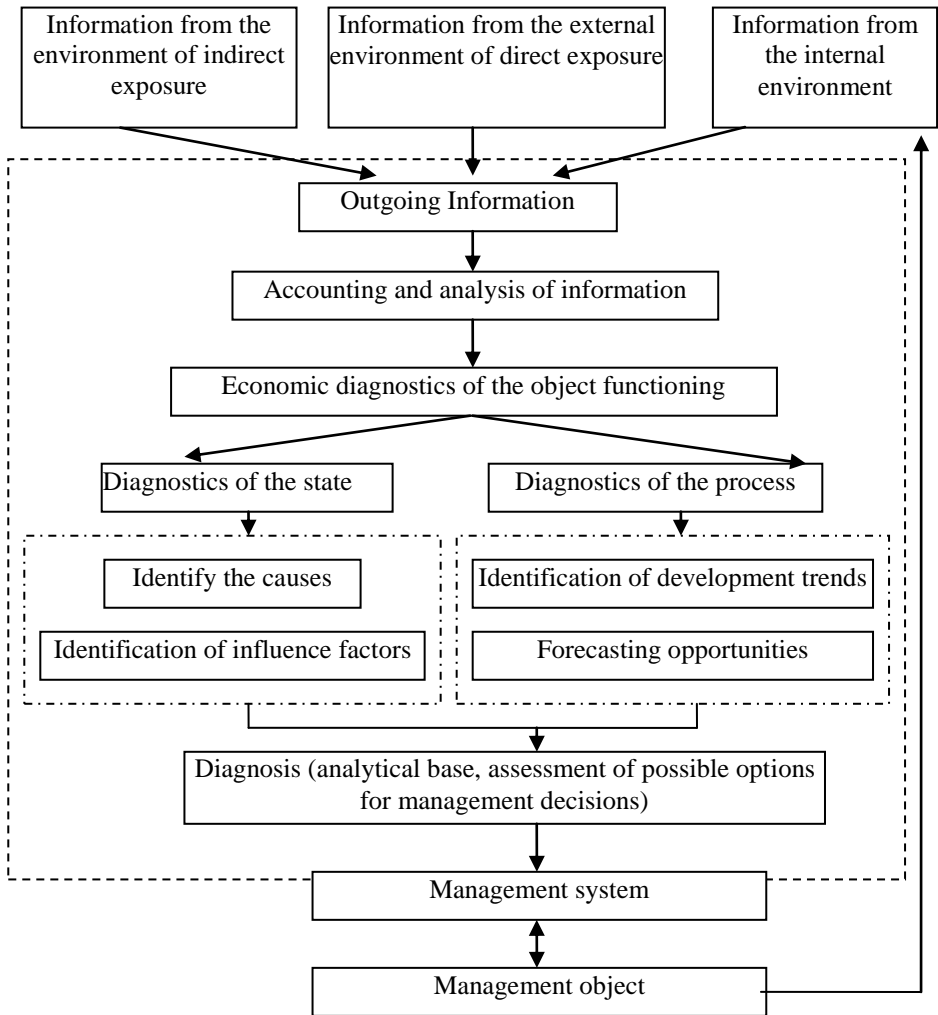

**Figure 1.2 The system of economic diagnostics the economic entities**

*Source: developed by the authors*

3) dynamic – in the form of a study of the dynamics and determination of possible trends in changing conditions of functioning and the state of economic entities;

4) functional – as a management function, which provides feedback to economic entities through the implementation of diagnostic

procedures.

In order to study the competitiveness of economic entities through economic diagnostics it is advisable to use a set of performance evaluation indicators. Such indicators must meet certain criteria, namely:

- be minimal on a set of indicators. A large number of indicators complicates calculations, introduction of new rating criteria, as a rule, is carried out at the expense of indicators interrelated with the existing ones;

- cover all directions activities. Optimal indicators cover all economic entities, that is, they can be used everywhere and have such advantages over highly specialized indicators: they can be consistently traced from the lower to the upper level of management; their changes can be analyzed from the bottom up, that is, to evaluate the effectiveness of the lower links of management; can compare them at the horizontal level between different units of economic entities;

- have adaptability to forecast. Non-financial indicators should provide for future financial results, that is, non-financial indicators become decisive performance criteria, and financial indicators – lagging ones – those that change and accumulate over time;

- be stable. Indicators should be changed gradually so that employees are aware the strategic goals of economic entities and their behavior are predicted;

- create opportunities for staff evaluation and motivation.

In contrast to the ideal indicators, only two requirements are put forward to the balanced scorecard: minimalism and the utility for forecasting. In real practical activity of economic entities, it is almost impossible to determine performance indicators that satisfy all the above mentioned criteria. This is due to several reasons, namely:

- economic entities are overloaded with various indicators, and the problem of an excess of criteria further sharpens the process of evaluating their economic activities;

- ability of researchers and practitioners to create and disseminate indicators outpaces the possibilities for ranking non-financial indicators, which include information on financial performance in the future, from those indicators that do not contain such information;

- a small number of non-financial indicators are comprehensive for economic entities, it is easier to choose universal financial indicators;

- performance indicators, especially non-financial, are constantly changing, over time when used, they lose their variability, sometimes

quite quickly, and therefore cannot indicate high or low efficiency;

motivation for several indicators of efficiency is quite complicated. If indicators are combined using a certain formula, employees will strive to achieve minimum (according to standard) results without ensuring productivity (growth). If indicators are combined subjectively, employees will not understand the relationship between estimated performance and its motivation.

Figure 1.3 shows the place and purpose of certain categories of indicators for assessing competitiveness of economic activities the economic entities.

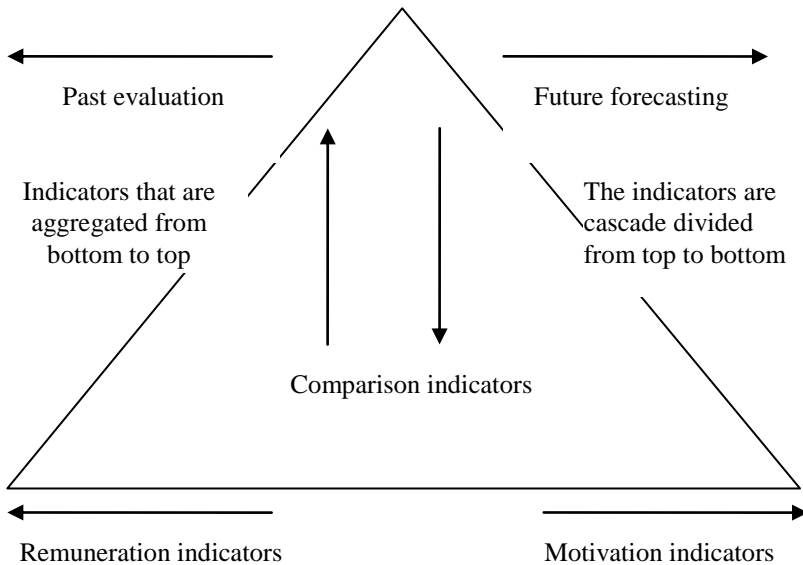

**Figure 1.3 The place and purpose of indicators economic diagnostics of the efficiency economic activity the economic entities**

*Source: developed by the authors*

The data in Figure 1.3 shows that the indicators that allow assessing the past situation, forecasting future development, as well as indicators of motivation and remuneration of employees are placed outside the organizational pyramid, since they are common for the assessment of economic entities, regardless of their activity volumes. On the contrary, indicators intended for aggregation from bottom to top, cascading distribution from top to bottom, as well as indicators that are used for the purpose of comparison and become more important with the growth

of activity the economic entities, are placed within the pyramid, as they are attributes of a economic entity. Indicators assessing the past and forecasting future are at the top of pyramid, since these indicators are used to assess economic efficiency and past achievements of economic entities in general. Indicators of the same motivation and remuneration are placed at the base of pyramid, since they are designed to motivate and stimulate the activities of individual employees the economic entities.

Indicators for assessing the state and competitiveness of economic entities we propose to allocate in four groups:

1) market assessment of economic entities (return on capital, surplus market value), is intended to assess the activities of enterprise as a whole, and not its individual structural units, functional units, employees. These indicators cannot be obtained either by aggregation from the bottom to up, or by cascading from the top down. The considered indicators are widely used to motivate and promote the management system of the highest management level;

2) financial indicators (profit value, return on assets, return on investment, return on sales) can be used to evaluate the activities of both the enterprise as a whole and its business lines. But these indicators can not be used to assess the functional units or employees. Financial indicators are directed more into the past than into the future, since the available results of economic activity are reproduced. Although it is possible to note the partial direction of these indicators in the future – higher performance results reduce the cost of attracting financial resources, increase reputation. Financial indicators can be widely used in the field of motivation and remuneration of staff at the level of management and individual areas of activities, but not on a par with departments or working groups. Accordingly, can point to the aggregation and cascading of financial indicators from the enterprise level to the level of economic areas;

3) non-financial indicators (innovation, product quality, consumer satisfaction level, consumer loyalty), which are quite complex and ambiguous character. On the one hand, these indicators can cover all aspects of functioning the economic entities (for example, production, sales, management, marketing, innovations); on the other hand, since functional units within a single economic entity are usually specialized, most non-financial indicators cannot be applied to individual units;

4) cost indicators that are of limited character use compared with other types of indicators, since they measure only one aspect of



efficiency, namely, costs. Cost estimation is based on past information. Although the trends in change these indicators provide opportunities to make forecast of the future, the inability to control current costs may lead to adverse consequences for economic entities in the future.

According to the results of selection indicators the state and competitiveness of economic entities, a model of economic diagnostics is formed, which must meet certain requirements and characteristics. The model of economic diagnostics the economic entities should reflect the organizational and economic mechanism, which includes the following elements:

1) determining the object of diagnosis – political, social, economic, technical systems, public relations and the external environment, which are divided into the external environment of direct and indirect influence on the object of study;

2) definition the boundaries of system as an object of analysis, construction of a mathematical model;

3) process of analyzing and evaluating individual factors;

4) synthesis of influence the factors on activities of economic entities;

5) formation the final results of subject management regarding the results of diagnostics and identification of solutions to the problems identified.

Thus, the organizational-economic mechanism of economic diagnostics of activities the economic entities is based on formation of an appropriate assessment model for indicators of status and efficiency. In the process of diagnostics, the internal and external environment of functioning the economic entities is investigated, as a result, factors that negatively affect the state of subject are determined and measures are being developed aimed at improving the efficiency of activities, as well as ensuring competitiveness and development in the future.

## References

1. *Lecaillon, J.-D., Le Page, J.-M. (2004). Economie contemporaine: Analyse et diagnostics, Bruxelles, De Boeck, 2-e ed, 398 p.*
2. *Bartoli, M. (1994). Diagnostic d'entreprise. L'economique a l'epreuve du social. Preface de Pirre Ferracci. Paris, InterEditions, 324 p.*
3. *Kaplan, R.S., Norton, D.P. (2001). Die strategiefokusierte Organisation: Fuhren mit der Balanced Scorecard, Stuttgart: Buch, 325 p.*
4. *Брітченко І.Г. Реальний капітал в сучасних умовах / Брітченко І.Г.,*

- Товстик В.А. // Донецьк: Схід. - №3 (27). - 1999. – С. 17-24.
5. Брітченко І.Г. *Виртуальні банки і їх зв'язь з реальною банківською системою.* – Донецьк: ДДІШ. -*Наука, релігія, суспільство* № 2, 2001. – С. 3-10.
  6. Міклова В.П., Брітченко І.Г., Кубіній Н.Ю., Дідович Ю.О. *Ефективність стратегічного управління підприємствами: сучасні проблеми та перспективи їх вирішення.* - Полтава: ПУЕТ, 2013. - 240 с.
  7. Брітченко І.Г. *Маркетинг менеджмент: новые решения / АА Шубин, РК Перепелиця, ГИ Брітченко.* - Донецьк: ДонНУЕТ ім. М. Туган-Барановського, 2007. - 326 с.
  8. Брітченко І.Г. *Стратегічне управління конкурентоспроможністю: епістемологічні підходи та практична проблематика/Міклова В.П., Брітченко І.Г., Кубіній Н.Ю., Колодинський С.Б., Ціцак Л.М.* – Полтава : ПУЕТ, 2013. – 307 с.
  9. Брітченко І.Г. *Оцінка кредитоспроможності емітента корпоративних облигацій/ І.Г. Брітченко, Р.К. Перепелиця//Вісник НБУ, 2005. – С. 32-37.*
  10. Брітченко І.Г., Князевич А.О. *Контролінг: навч. посіб.* // І.Г. Брітченко, А.О. Князевич. - Рівне: Волинські обереги, 2015. – 280 с.
  11. Брітченко І.Г. *Маркетинг у банку: навчально-методичний посібник для самостійного вивчення дисципліни / Нікітін А.В., Іванова Т.Г., Брітченко І.Г., Момот О.В.* // К.: КНЕУ, 2010. – 475 с.
  12. Брітченко І.Г. *Формирование механизма организационно-экономических методов управления предприятием // Вестник ДонГУЭТ - №8. – Донецьк: ДонГУЭТ, 2000. – С. 102 – 104.*
  13. Брітченко І.Г. *Маркетинг як чинник підвищення ефективності функціонування вищого навчального закладу / Брітченко І.Г., Чайка І.П.* // Науковий вісник УжНУ. – № 33/2011. Частина 2. – Ужгород: УжНУ, 2011. – С. 299 – 302.
  14. Bezpartochnyi M. *Use reengineering in optimization business processes the wholesale enterprises region / M. Bezpartochnyi // Регіональна економіка.* – 2018. – № 2(88). – С. 80-88.
  15. Bezpartochnyi M. *Diagnostic the innovation potential of Latvia / Mechanisms of interaction between competitiveness and innovation in modern international economic relations: collective monograph / edited by M. Bezpartochnyi, in 4 Vol. // M. Bezpartochnyi, M. Živitere, V. Riashchenko, Olesia Bezpartochna / ISMA University.* – Riga: «Landmark» SIA, 2017. – Vol. 1. – P. 62-70.
  16. Bezpartochnyi M. *Creating a marketing strategy on agriculture market / Formation of modern social, economic and organizational mechanisms development of entities agrarian business: collective monograph / edited*

- by M. Bezpartochnyi // M. Bezpartochnyi, M. Živitere, V. Riashchenko / ISMA University. – Riga: «Landmark» SIA, 2017. – P. 52-68.
17. Bezpartochnyi M. Management and strategies of financial activities of trade enterprises / Organizational and economic mechanisms of development of the financial system: collective monograph / edited by M. Bezpartochnyi // M. Bezpartochnyi, M. Živitere, V. Riashchenko / ISMA University. – Riga: «Landmark» SIA, 2016. – P. -101-117.
  18. Bezpartochnyi M. Use of cluster analysis to ensure the effective functioning and development of retail / Innovative approaches in the management of competitiveness of businesses: collective monograph / edited by A. Berezin, M. Bezpartochnyi, in 2 vol. // M. Bezpartochnyi, M. Živitere, V. Riashchenko / ISMA University. – Riga: «Landmark» SIA, 2016. – Vol. 2. – P. 51-55.
  19. Bezpartochnyi M. The modern concept of operation and development of retail / Innovative approaches in the management of competitiveness of businesses: collective monograph / edited by A. Berezin, M. Bezpartochnyi, in 2 vol. // M. Bezpartochnyi, M. Živitere, V. Riashchenko / ISMA University. – Riga: «Landmark» SIA, 2016. – Vol. 2. – P. 8-14.
  20. Bezpartochnyi M. Modern vision of effective functioning and development of tourist enterprises / Mechanisms and models of development of entities tourist business: collective monograph / edited by A. Berezin, M. Bezpartochnyi // M. Bezpartochnyi, M. Živitere, V. Riashchenko / ISMA University. – Riga: «Landmark» SIA, 2016. – P. 8-14.
  21. Bezpartochnyi M. Methodological tools for assessing suppliers of trade enterprises / Formation strategy of economic structures: the tools and practices: [Collective monograph] / edited by A. Berezin, M. Bezpartochnyi // M. Bezpartochnyi, K. Krēsliņš, V. Riashchenko. – Riga: «Landmark» SIA, 2016. – P. 110-120.
  22. Bezpartochna O. Pedagogical managements as a road to successful international teaching and learning / Transformational processes the development of economic systems in conditions of globalization: scientific bases, mechanisms, prospects: collective monograph / edited by M. Bezpartochnyi, in 2 Vol. // V. Riashchenko, M. Živitere, O. Bezpartochna / ISMA University. – Riga: «Landmark» SIA, 2018. – Vol. 1. – P. 32-344.

**Meidutė-Kavaliauskienė Ieva**

*PhD in Technological Sciences,*

*Associate Professor*

*General Jonas Žemaitis Military*

*Academy of Lithuania*

**Vasilienė-Vasiliauskienė Virgilija**

*PhD in Management Sciences,*

*Associate Professor*

*Vilnius Gediminas Technical University*

**Vasilis Vasiliauskas Aidas**

*PhD in Technological Sciences,*

*Associate Professor*

*General Jonas Žemaitis Military*

*Academy of Lithuania*

*(Vilnius, Lithuania)*

## **ANALYSIS ON BARRIERS TO A COLLABORATIVE SUPPLY CHAIN**

An effective management of the supply chain largely depends on the relationships among its participants. In this regard, it is important to seek communication at all levels of the supply chain, which is sometimes very difficult to implement due to incorrect integration of system elements. In terms of integration, it is defined as follows: partners working as a one unit with the goal of increasing the overall efficiency of the supply chain.

Singh and Power (2009) highlight the fact, that supply chain integration can be defined as a wish to improve relationships among chain members at the same time fostering and simplifying decision-making process. Therefore, authors distinguished major forces that promote integration process: rapid development of information technologies, constantly growing global competition, demanding customers and markets, emergence of the new internal types of organizational relationships within the market.

Prajogo and Olhager (2012), Raweewan and Ferrell (2018) claim that firms must obtain a greater coordination and maximum coherence of operations among supply chain partners to maintain competitiveness. According to Prajogo and Olhager (2012), supply chain integration processes are difficult to distinguish from company's strategic position. Effective supply chain integration requires effective implementation,

and implementation is impossible without a common strategy. Having this in mind, it is possible to claim, that supply chain integration in firms covers the following aspects: *major process integration, strategy adaptation, planning process integration, formation of the links between supply chain members, implementation and emerging problems.*

*Major process integration.* The following key processes can be distinguished: *integration of technology in the supply chain and integration of information.*

*Technology deployment.* Devaraj *et al.* (2007), Prajogo and Olhager (2012) state that technologies and information systems in the supply chain are integrated for the purpose of increasing information flows between process participants and facilitating integration processes that go beyond functional and organizational boundaries.

*Integration of information.* Raweewan and Ferrell (2018) draw attention to the fact that information integration determines information sharing channels and directions among supply chain participants. This might be different types of data, such as information pertaining to demand, market situation, production process, schedules, etc. Such information must be available to relevant participants in real time without putting much effort.

*Strategy adaptation.* Supply chain strategy can be understood as a decision-making model linked to material resources, demand management, communication and presentation. All participants in a supply chain should adapt their goals to overall goals of the supply chain. Sukati *et al.* (2012) claim that not only it facilitates integration processes, but also it helps to control it as well. Apart from that, Green *et al.* (2008) and Ramanathan and Gunasekaran (2014) state that a strategy must be integrated and cover the entire supply chain and its activity coordination.

*Planning process integration.* Planning is basically an answer to the question of what to do with the information shared among supply chain members. Singh and Power (2009), Raweewan and Ferrell (2018) claim that supply chain members may have their own order implementation plans, however, the goal should be one for all. Singh and Power (2009) highlight the fact that planning process itself is a vital moment as it covers such aspects as development of current plans, product demand/supply plans, as well as strategic planning, where permeability of the network, optimization processes, possible interruptions or problems are taken into account.

*Formation of the links between supply chain members.* Zhang and

Cao (2018) emphasize that establishing appropriate links among supply chain members is an important aspect of the supply chain implementation. According to Singh and Power (2009), this process involves integrating key processes through proper communication, collaboration, and cooperation.

*Implementation and emerging problems.* Sandberg and Abrahamsson (2009), Fawcett *et al.* (2008), Awad and Nassar (2010) distinguish the following problems and barriers associated with collaboration integration: technological, managerial and communicative, while Li and Lin (2006) and Ramesh *et al.* (2010) claim that collaboration is thus affected by both – internal, external and inter-organizational barriers.

In order to establish a supply chain that reflects current trends, an integration, which is perceived as a continuous process is necessary to develop. A particular attention whilst integrating a supply chain is to be paid to collaboration and coordination – major aspects for success or failure.

### **Barriers to Supply Chain Collaboration**

According to Ramesh *et al.* (2010), it is relevant to determine the recurring problems and barriers of a collaborative supply chain and identify the level of its interdependence in a timely manner. It is important to do so to prevent such problems in the future or reduce the associated damage. The analysed literature acknowledges the fact that managing supply chains involves an incredibly low degree of collaboration.

As shown by common practises (Sandberg and Abrahamsson, 2009; Fawcett *et al.*, 2008), this phenomenon is not sufficiently analysed and systematized apart from all of the benefits within a collaborative supply chain, and the reason for this are existing barriers. In regard to barriers affecting a collaboration, certain classifications for it may be diverse: some authors (Li and Lin, 2006; Ramesh *et al.*, 2010) divide barriers into internal, external and inter-organizational, while others (Sandberg and Abrahamsson, 2009, Fawcett *et al.*, 2008; Singh and Power (2009), Awad, Nassar 2010) discuss the barriers from the following perspectives: *relationship, managerial, technological and cultural*. We are going to examine this in more detail.

Relationship aspect is understood as a process of managing supply chain members and relationships among them. (Fawcett *et al.*, 2008). Technological aspect covers all perspectives of IT system coordination

and information quality. However, technological problems are perceived as problems associated with human factor, thus they become much more complex and less understandable, but no less important since an attempt to manage information and material flows in a supply chain without effective organizational relationships is hardly possible (Singh and Power, 2009). Meanwhile, the managerial perspective includes an aspect of strategic goals in collaboration and plays an important part in the supply chain relationship. Finally, a cultural aspect should not be forgiven since it functions as a moderating factor and can have a substantial impact on collaboration within a supply chain.

### **Human Relationship-Based Group of Barriers**

Human aspect covers both – internal and external processes within a company and is comprised of: *lack of trust in partners, supplier power and information sharing culture.*

*Trust.* A trust is one of the major conditions in a collaborative supply chain. According to Kwon and Suh (2005), trust includes the following two sub-dimensional constructs: honesty and benevolence. Raweewan and Ferrell (2018) claim that trust is generally linked to company's expectations, while partners behave with regard to overall supply chain interests. Renko (2012) draws attention to the fact that trust is one of the major elements of the collaboration and the absence of it might cause disruption in the effective cooperation. Beccerra and Gupta (1999) state that at a low level of trust, the time spent communicating with the suppliers is considerably longer and transaction costs are much higher. Moreover, lack of trust may impact other important elements, such as willingness or reluctance to share important information, low level involvement from top managers despite of the fact that information sharing is a basis for developing collaboration and partnership. (Raweewan and Ferrell, 2018). According to Jones (2010), relationships based on high-levels of trust are more honest and participants are more likely to share risks and rely on information being shared. As a result, results of the supply chain are better.

*Supplier power.* Other important element to impact collaborative relationships in a supply chain is the supplier power. In business context, power can be defined as a capacity of one company to affect intentions or actions of other company. (Cao and Zhang, 2011). Power can be analysed from positive or negative perspectives. Supplier power can be great, however, there are certain conditions to consider: low

competition between suppliers, limited number of substitutes and rapidly growing numbers of buyers in the market (Khoja *et al.*, 2011). Matopoulos *et al.* (2007) agrees that power can have a significant impact on co-operation, i.e., in collaborative relationships, the smaller company may have less impact on decision-making process. Firms may fear the decline in sovereignty and the likelihood for current supplier to become a competitor in the future. According to Ireland and Webb (2007) when firms perceive the risk of partner-power, the willingness to share strategically important information may be very low. Power asymmetry is detrimental to collaboration as this process increases firms' dependency on one another, affects the balance between partners, reduces confidence and, as a result, decreases the intensity of collaboration. Ireland *et al.* (2007), Hanna, (2010) claim that power is most likely to affect trust, thus it is important to determine how these elements interact and what kind of impact it has on collaboration levels.

*Information sharing culture.* Information sharing culture or in other words, willingness to share information may be defined as openness and the capability to share accurate and real-time information (Fawcett *et al.*, 2007). Under current business conditions, information becomes a great tool to obtain power and competitive advantage. As a result, firms and suppliers are reluctant to share information, thus a great amount of potentially useful information do not reach decision-makers. Organizational theory confirms that corporate culture has an impact on the extent to which employees of the firm tend to share information. Undoubtedly, the provisions for sharing information vary from company to company. The top management of the firms may have an impact on the willingness to share information by encouraging initiatives in regards to information-sharing policies. Therefore, Fawcett *et al.* (2011) state that information-sharing culture in which a reluctance to share information is detected, may have negative impacts of trust on cooperative relationships.

### **Management Group of Barriers**

Management problems are generally associated with partial involvement of top managers and a failure to determine common goals in a supply chain.

*Top management involvement.* Sandberg and Abrahamsson (2009), Ramesh *et al.* (2010); Anbanandam *et al.* (2011) claim that top management involvement is one of the key elements to establish strong



and long-standing relationships with external partners and foster collaborative intensity. Sandberg and Abrahamsson (2009), Anbanandam *et al.* (2011) draw the attention to the fact that most managers feel confident coordinating internal processes, however they are less interested in other functions of the organization; and when it comes to decision-making process in an inter-organizational environment, they are even less likely to be involved.

Li and Lin (2006) determined major areas in which top management involvement is the most important:

- firstly, it is vital for top management to understand the importance of quality-information exchange for a firm and its results;
- secondly, top management should convey vision, suggestions and support in regard to the levels at which information is to be shared.

Sandberg and Abrahamsson (2009), Hanna (2010) argue that problems in collaboration may emerge if the top management is not interested in supply chain processes, or do not convey adequate vision to select the most suitable and beneficial position with suppliers. Therefore, a poor involvement by the top management may result in a shortage of mutual goals and lower levels of collaboration.

*Shortage of common goals in the supply chain.* Common goals in the supply chain are defined as the level of similarity shared between partners (Li and Lin, 2006). Common goals facilitate understanding on actions to be taken and policy/strategy selection with suppliers. Cao and Zhang (2011) claim that collaboration in a supply chain cannot be attained if partners do not share mutual goals. Shortage of common goals may lead to a lesser degree of collaboration.

### **Technological Group of Barriers**

Real-world experience shows, that major technological obstacles in the supply chain emerge due to different development levels and the quality of the IT and information used by partners.

*Alignment of the IT development levels.* Alignment of the IT development levels is understood as the degree to which partners communicate via intranet, e-mail, internet and exchange data. (Sanders 2007; Fawcett *et al.*, 2011). The IT are important for firms as it provide opportunities to manage great flows of information, obtain real-time information in an adequate format. Different levels of IT usage among suppliers and firms may become a major obstacle for collaboration and information exchange (Matopoulos *et al.*, 2007; Ramanathan and

Gunasekaran, 2014). Wu *et al.* (2006) claim that alignment of the IT among partners is difficult to obtain as it requires a lot of resources and involvement. Such an alignment is very complex as many supply chain systems have different applications and are developed by different IT production companies. However, the benefits of aligning IT among major partners is undeniable. Sanders (2005) states that harmonizing IT levels is necessary, especially in collaborating with suppliers from overseas. Moreover, Li and Lin (2006) claim that aligning of IT levels impacts collaboration via two major collaboration elements: *coordinated and harmonized processes and decision-making mechanisms*. Aligning IT levels is paramount to information quality.

*Information quality.* Information quality is understood as the data exchanged between the firm and the suppliers, which is characterized as relevant, accurate, complete, reliable, and most importantly, transferred in a timely manner. (Wu *et al.*, 2006). Aligning IT levels may improve information quality, i.e. ensure adequate information format, accuracy, completeness, and provision in a timely manner. Meanwhile, Ramesh *et al.* (2010) argue that sharing of qualitative information in the supply chain provides operational efficiency, and may even help in building trust. However, quite often firms face information delays and not getting it into the system on time. Information delays may be very important to firms' operations, order processing and implementation, as well as ensuring adequate relationship quality in the supply chain.

### **Cultural aspect**

In addition to the above mentioned barriers to be encountered whilst collaborating in a supply chain, a cultural aspect is also of no less importance. Tan *et al.* (2006), Reyes (2009), Cheung *et al.* (2010), Jean *et al.* (2010) claim that a culture can be identified as a moderating factor affecting the relationship management in the supply chain.

According to Reyes (2009), cultural aspect in the supply chain may impact *trust building, level of information sharing, quality of information being shared and aligning IT development levels*. Other authors mainly distinguish trust as the aspect being mostly impacted by the culture (Tan *et al.*, 2006; Cheung *et al.*, 2010; Jean *et al.*, 2010).

Trust is the most important driving force in collaborative relationships and it may even act as a barrier. When it comes to maintaining global relationships in a supply chain, Cheung *et al.* (2010) claim that building trust in partners becomes even more complex due to

cultural differences and perceptions. Tan *et al.* (2006), Reyes (2009) stressed the importance of intensive communication, which has a substantial impact on trust. Intensive, uninterrupted communication is especially needed in high-context cultures as it helps to build closer relationships. Jean *et al.* (2010) argue that a personal connection is exceptionally paramount for building trust in high-context cultures. Apart from this, high-context cultures are known to be more involved and investive into long-standing relationships. Cheung *et al.* (2010) believes that effective communication and engagement can help to develop quality relationships in an international context. In this case, relationship quality is understood as close cooperation and a high level of trust leading to a willingness to share information more openly. (Lee *et al.*, 2008).

Information sharing, as a component of collaboration, promotes better understanding on supply processes, prevent material or production surplus/shortage; enables to plan and supply market with ready-made products. As high-context cultures tend to be more involved into personal relationships, Lee *et al.* (2008) and Jean *et al.* (2010) argue that suppliers from high-context countries can effectively share information with firms from high-context cultures and vice versa.

To sum up, it is possible to claim that integration process of the collaborative supply chain is challenged by diverse barriers, i.e. human-relationships, management and technological. Each of these groups generate interrelated problems. However, it is still agreed that the most important and most complex part is related to human relationships. This area can present a lot of difficulties hindering the successful integration of the supply chain. On the other hand, the cultural aspect, especially in the analysis of the supply chains, is also very important and can enhance or mitigate the impact of barriers on collaboration.

## References

1. Anbanandam, R.; Banwet D. K.; Shankar R. 2011. *Evaluation of supply chain collaboration: a case of apparel retail industry in India.* *International Journal of Productivity and Performance Management* 60 (2): p. 82–98.
2. Awad, H. A. H.; Nassar, M. O. 2010. *Supply Chain Integration: Definition and Challenges.* *Proceedings of the International Multi Conference of Engineers and Computer Scientists, Vol I. March 17-19, 2010.*
3. Beccerra, M.; Gupta, A. K. 1999. *Trust within the organization: integrating the trust literature with agency theory and transaction costs*

- economics, Public Administration Quarterly* 23(2): pp. 177-203.
4. Cao, M.; Zhang, Q. 2011. Supply chain collaboration: Impact on collaborative advantage and firm performance, *Journal of Operations Management* 29(3): pp. 163-180.
  5. Cheung, M.; Myers, M. B.; Mentzer, J. 2010. Does relationship learning lead to relationship value? A cross-national supply chain investigation. *Journal of Operations Management* 28(6): p 472-487.
  6. Devaraj, S.; Krajewski, L.; Jerry, C. 2007. Impact of eBusiness technologies on operational performance: The role of production information integration in the supply chain, *Journal of Operations Management* 25: pp. 1199–1216.
  7. Fawcett, S. E.; Magnan, G. M.; McCarter, M. W. 2008. Benefits, barriers, and bridges to effective supply chain management. *An International Journal* 13(1): p. 35-48.
  8. Fawcett, S. E.; Osterhaus, P.; Magnan, G. M.; Brau, J. C.; McCarter, M. C. 2007. Information sharing and supply chain performance: the role of connectivity and willingness. *Supply Chain Management: An International Journal* 12(5): p. 358–368.
  9. Fawcett, S. E.; Wallin, C.; Allred, C.; Fawcett, A.; Magnan, G. M. 2011. Information technology as an enabler of supply chain collaboration: a dynamic-capabilities perspective. *Journal of Supply Chain Management* 47(1): p. 38–59.
  10. Green, Jr. K. W.; Whitten, D.; Inman, R. A. 2008. The impact of logistics performance on organizational performance in a supply chain context, *An International Journal* 13(4): pp. 317–327.
  11. Hanna, J. B. 2010. Mitigating supply chain disruption: the importance of top management support to collaboration and flexibility. *International Journal of Logistics Systems and Management* 6(4): p. 397-414.
  12. Ireland, R. D.; Webb, J. W. 2007. A multi-theoretic perspective on trust and power in strategic supply chains, *Journal of operational management* 25(2): pp. 482-497.
  13. Jean, R. B.; Sinkovics, R. R.; Kim, D. 2010. Drivers and Performance Outcomes of Relationship Learning for Suppliers in Cross-Border Customer–Supplier Relationships: The Role of Communication Culture, *Journal of International Marketing* 18(1): pp. 63-85.
  14. Jones, S. L.; Fawcett, S. E.; Fawcett, A. M.; Wallin, C. 2010. Benchmarking trust signals in supply chain alliances: moving toward a robust measure of trust. *Benchmarking: An International Journal* 17(5): p. 705-727.
  15. Khoja, F.; Adams, J.; Kauffman, R. 2011. The inside story of relationship development: power asymmetry in a buyer–supplier relationship. *Int. J. Integrated Supply Management* 6(1): p. 73-91.
  16. Khoja, F.; Adams, J.; Kauffman, R. 2011. The inside story of relationship

- development: power asymmetry in a buyer–supplier relationship, Int. J. Integrated Supply Management* 6(1): pp. 73-91.
17. Kwon, I. G.; Suh, T. 2005. *Trust, commitment and relationships in supply chain management: a path analysis, Supply Chain Management: An International Journal* 10(1): pp. 26–33.
  18. Lee, D. J.; Jeong, I.; Lee, H. T.; Sung, H. J. 2008. *Developing a Model of Reciprocity in the Importer-Exporter Relationship: The Relative Efficacy of Economic Versus Social Factors, Industrial Marketing Management* 37(1): pp. 9-11.
  19. Li, S.; Lin, B. 2006. *Assessing information sharing and information quality in supply chain management, Journal of Decision support systems*, 42(3): pp. 1641-1656.
  20. Matopoulos, A.; Vlachopoulou, M.; Manthou, V.; Manos, B. 2007. *A conceptual framework for supply chain collaboration: empirical evidence from the agri-food industry, Supply Chain Management: An International Journal* 12(3): pp.177–86.
  21. Prajogo, D.; Olhager, J. 2012. *Supply chain integration and performance: The effects of long-term relationships, information technology and sharing, and logistics integration. International Journal of Production Economics* 135(1): p. 514–522.
  22. Ramanathan U.; Gunasekaran, A. 2014. *Supply chain collaboration: Impact of success in long-term partnerships, International Journal of Production Economics* 147 (B): pp. 252-259.
  23. Ramesh, A.; Banwet, D. K.; Shankar, R. 2010. *Modeling the barriers of supply chain collaboration, Journal of Modelling in Management* 5(2): pp. 176–193.
  24. Raweewan, M.; Ferrell, W. G. 2018. *Information sharing in supply chain collaboration, Computers & Industrial Engineering* 126: pp. 269-281.
  25. Renko, S. 2012. *Vertical Collaboration in the Supply Chain. Supply Chain Management - New Perspectives* pp. 183-199.
  26. Reyes, P. M. 2009. *Intercultural supply chain management: an assessment of the field and future outlook, International Journal of Intercultural Information Management* 1(2): pp. 166-176.
  27. Sandberg, E.; Abrahamsson, M. 2009. *The role of top management in supply chain management practices. International Journal of Retail & Distribution Management* 38(1): p. 57-69.
  28. Sanders, N. R. 2005. *Modeling the relationship between firm it capability, collaboration, and performance. Journal of Business Logistics* 26(1): p. 1–23.
  29. Sanders, N. R. 2007. *An empirical study of the impact of e-business technologies on organizational collaboration and performance. Journal of Operations Management* 25: p. 1332–1347.

30. Singh, P. J.; Power, D. 2009. *The nature and effectiveness of collaboration between firms, their customers and suppliers: a supply chain perspective*, *Supply Chain Management: An International Journal* 14(3): pp.189-200.
31. Sukati, I.; Bakar, A.; Rohaizat, H.; Rosman, B.; Yusoff, M. 2012. *The Study of Supply Chain Management Strategy and Practices on Supply Chain Performance*, *The 2012 International Conference on Asia Pacific Business Innovation & Technology Management* 40: pp. 225–233.
32. Tan, E. N.; Smith, G.; Saad, M. 2006: *Managing the global supply chain: a SME perspective*. *Production Planning & Control: The Management of Operations* 17(3): p. 238-246.
33. Wu, F.; Yenyurt, S.; Kim, D.; Cavusgil, T. 2006. *The impact of information technology on supply chain capabilities and firm performance: A resource-based view*, *Journal of Industrial Marketing Management* 35(4): pp. 493-504.
34. Zhang, Q.; Cao, M. 2018. *Exploring antecedents of supply chain collaboration: Effects of culture and interorganizational system appropriation*, *International Journal of Production Economics* 195: pp. 146-157.

**Smerichevskyi Serhii**

*Doctor of Economic Sciences, Professor,  
Head of the Marketing Department*

**Kniazieva Tetiana**

*Doctor of Economic Sciences, Associate  
Professor, Professor of the Marketing  
Department*

**Ramenska Svitlana**

*Candidate of Economic Sciences,  
Associate Professor, Associate Professor  
of the Marketing Department  
National Aviation University  
(Kyiv, Ukraine)*

**METHODS OF  
MANAGEMENT BY  
ENTERPRISE  
CORPORATE  
SOCIAL  
RESPONSIBILITY  
DEVELOPMENT:  
ECOLOGICAL  
COMPONENT**

**Statement of problems.** In recent years, in post-Soviet countries, including Ukraine, the focus of entrepreneurship on the theme of corporate social responsibility (CSR) has intensified. Such questions as the role,

objectives and tasks of entrepreneurial structures in the field of social responsibility, its importance for the socio-economic development of the country are widely discussed by the state, business and society. This interest is due to a number of reasons. Firstly, growing globalization increasingly stimulate domestic companies to bring their social activity to correspondence with international standards. Secondly, entrepreneurs are paying more attention to the strategic planning of their long run activities. Thirdly, the influence of local communities and nonprofit organizations that encourage businesses to comply with ethical norms of business activity is increasing.

Application of corporate social responsibility principles is rapidly developing in Ukrainian business practice. Most companies publish social reports that describe their social activity, namely: participation in charity, support for sports and environmental events, sponsorship of socially significant projects.

The ambiguity of the concept of «corporate social responsibility (CSR)» and the frequent neglect when considering the CSR of environmental component is one of the reasons for the irresponsible attitude of the business to compliance with environmental legislation and prevention of environmental pollution, which leads to irrational use of natural resources, including energy resources. Companies mainly form ecological culture through environmental «subbotniks», educational programs, leaving without attention the possibility of reducing the consumption of natural resources and reducing environmental pollution as a result of the activity. Energy efficiency issues are often dealt with CSR separately, and company's energy policy is not related to its social activity. The urgency of the research topic is determined by the lack of practical and methodological recommendations for the development of processes of formation and strengthening of environmental responsibility in Ukrainian companies, improvement of approaches to the development of corporate social responsibility, its ecological component. It will improve the efficiency of business structures management, increase their competitiveness, and contribute to improvement of the relationship of entrepreneurs with the state and society.

**Analysis of recent research and publications.** Work of such foreign and domestic scientists as A. Antonyuk, G. Bagiev, Philip Kotler, Jean-Jacques Lamben, T. Levitte, A. Mazaraki, T. Obolenskaya, B. Bratanich, A. Vičević, S. Ilyashenko, L. Melnyk and others are devoted to the theoretical and methodological issues of corporate social responsibility development. The need to manage the corporate social and environmental responsibility development, theoretical and practical significance of the of corporate social and environmental responsibility processes forecasting for

business entities, the lack of knowledge of the companies' stakeholders influence on strategic planning determined the choice of research topic.

**The research objective.** Development of methodological recommendations for the management of social and environmentally responsible entrepreneurship development.

**The statement of basic materials.** The corporate social and environmental responsibility means the company voluntary commitment to implement social and environmentally relevant programs that are related to the business development strategy, which does not contradict the principles of effective corporate governance. This definition reflects three criteria that corporate social and environmental responsibility must meet, namely: its voluntary nature, additional obligations to the society and environment, combined with traditional business orientation. The above mentioned CSR definition with an emphasis on the environmental component allows attention to be drawn to the integration of all aspects of the company's activities aimed at improving and developing the social, economic and environmental spheres, with getting a synergistic effect.

In recent years, understanding CSR has become more profound and includes the development of relationships with stakeholders. In this regard, the CSR covers the following areas (*Rymar, 2010; Stainer, 2006*):

- protection of employees' interests;
- unity of economic freedom and responsibility;
- improvement of relations with consumers;
- participation in solving socially important tasks at the local, regional and national levels;
- environmental protection.

Entrepreneurship environmental liability is actively developing if it contributes to the profits increase. Entrepreneurs consider the protection of the environment as an additional activity in relation to their strategic objectives, such as profit, income, market share, competitiveness, job creation, labor productivity and staff motivation. Thus, environmental protection is easily integrated into the decision-making process at the level of enterprise, if it relates to economic feasibility. Investing in environmental projects costs reducing can be achieved by reducing the amount of waste and other types of environmental pollution, as well as minimizing resources and energy consumption.

Environmental problems are solved quickly and efficiently when lenders, investors, buyers become the allies of environmentalists, when financial interests are combined with the corporation environmental goals. In this regard, the application of financial instruments for the business social and environmental responsibility development represents the undoubtedly



practical interest. The absence of serious and permanent financial and economic incentives for environmental production leads to a huge gap in the enterprises competition. Those companies that are open to the public or work in the foreign markets, that are subjects of foreign economic activity have effective corporate environmental programs. Otherwise, the companies are not able to enter the world stock exchanges with their shares. As a rule, they do not occupy leading positions in the domestic market, since they compete with companies that do not invest in environmental safety.

The ecological efficiency of production should be transferred into the factor of business structures capitalization for the successful implementation of environmental policy and environmental protection. A business that meets environmental requirements and is transparent should be more expensive than a business that is less environmentally oriented and more closed.

The development of the environmental responsibility system led to the creation in 1997 of the Global Reporting Initiative (GRI). The basic GRI principle is the principle of «triune», which means the unity of three sides of the company: economic, social and environmental. GRI reporting has a voluntary nature, that is, the company has the right to decide on its own, whether to participate and to what extent in this process.

In addition, the peculiarity of the new European environmental legislation in the field of environmental policy is the need to divide the environmental responsibility among economic entities, to terminate the transfer of environmental problems from one part of the product chain to other. One of the basic principles of the so-called Integrated Product Policy of the EU is to involve a wide range of stakeholders, including suppliers of raw materials, product designers, marketers, manufacturers, wholesale and retail companies, customers, consumers and other to manage environmental product safety throughout all life cycle chain.

It is possible to identify the following modern trends in the practice of corporate social and environmental responsibility (*Antoniuk, Shmygol, 2011; Kuziak, 2012*):

- the consideration and inclusion of environmental and social indicators to company's business plans as a criteria for management efficiency;
- strategies for the companies' development are developed taking into account the views of a wide range of stakeholders;
- financial and non-financial indicators are disclosed in the companies' corporate reporting;
- eco-ratings are used to improve the business competitiveness and sustainability.

Factors that influence the development of CSR in Ukraine can be divided into groups as presented in Figure 1.4.

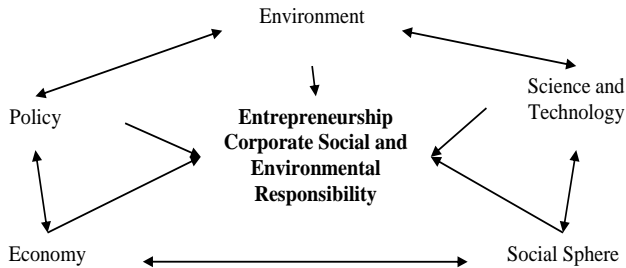

**Figure 1.4 Factors that influence the development of CSR in Ukraine**

Source: compiled by authors (Kima, Songb, Lee, 2016; Kuziak, 2012; Mahmoud, Blankson, Hinson, 2017)

*Block of factors «Politics».* Features of the political situation in the country affect the business socio-environmental responsibility development. The low level of population income and sharp social problems impede the resolution of environmental issues to the background. As a result, the lack of state policy emphasis to promote environmental initiatives in companies. Insufficient promotion of environmental innovations through market tools force companies to apply traditional management, which tend to focus not on the prevention of pollution, but on their localization and elimination. Disregard to environmental issues limits the ability of companies to enter the international market and work on favorable terms.

The lack of infrastructure and experience to solve social and environmental problems, low level of decision makers' competence lead to decrease of targeted programs efficiency and inhibit the legislative process.

*Block of factors «Economics».* The unstable economic situation forces companies to optimize their costs to ensure profitability, that inevitably reduces opportunities to develop social and environmental activities. The social package, for example, the provision of voluntary health insurance, food subsidies, the list of environmental measures, including the refusal of non-financial reporting, are decreasing. Many small and medium-sized enterprises are guided by the principles of «survival». Their main task is to stay in the market, to ensure company's

profitability. The policy of social responsibility development and public participation, mainly, is carried out by large national companies and divisions of international corporations.

Usually the managers of small and medium-sized businesses do not pay enough attention to issues of social and environmental responsibility. Small business carries out the direct financing of environmental protection measures in rare cases. The most common tools for natural resources using are tax breaks, environmental insurance, leasing of environmentally safe industrial goods, energy service contracts.

The low investment attractiveness of enterprises has led investors to no finance of social and environmental projects. To date, the enterprises themselves are the driven force of environmental innovations. The lack of strategic long-term planning, the low level of stock market development, the lack of business transparency reduces opportunities to attract investment in the implementation of social and environmental projects. Foreign financial institutions mainly support the development of foreign business.

*Block of factors «Society (social sphere)».* Problems of business corporate social and environmental responsibility development are connected with the peculiarities of the population mentality and the traditions of corporate governance. These features can be attributed, first of all, to high social expectations with a low social activity of society.

Social problems are solved either by the state or company management, the staff is not ready to take responsibility for solving social and environmental issues. In addition, there are certain traditions of labor relations, for example, the employee loyalty to the organization due to providing social guarantees (services of medical institutions, trips to the sanatorium and children's health camps, etc.) at a low level of wages. The effectiveness of employee performance is not measured by its effectiveness, but by loyalty to management.

There is a lack of «green PR» in the media and, at times, negative attitude of the press to the environment-friendly activity of environmentally-oriented companies.

*Block of factors «Technology and science».* At the moment, it is necessary to develop unified scientific principles of management of the business social and environmental responsibility development. The absence of criteria for assessing companies socio-environmental behavior complicates the definition of the vector and trajectories of business development in this area. The weakness of managerial relations

impedes the transfer of technology from science to business. The unnecessary of research for the business constrains the development of technologies.

*Block of factors «Environment».* Climatic and geographical features of the country, the presence of mono cities determine the dependence of the inhabitants on one enterprise, which solves their social problems. Despite the widespread application of the CSR principles in the world, in our country a question about the expediency of investing and efforts in social and environmental activity often arises. At times, it seems that it is easier and more efficient to invest resources in advertising, to support the image of the company through the establishment of management relations with local state authorities and local administration, and to express social responsibility by one-time charity actions.

However, the facts point the opposite, compliance with the rules of corporate behavior is becoming a global trend. International companies have developed the best world standards that meet the requirements of all stakeholders, including in the field of social and environmental responsibility. These factors are now global and universal, and their importance, and, consequently, the requirements to companies will grow. Obviously, domestic companies have to adapt to these realities in order to become or remain prominent participants in the world's capital markets, to maintain sustainable development.

Expansion of social and environmental responsibility of the business is a global trend. Companies perceive corporate social and environmental responsibility (CSER) as a tool for reducing non-financial risks, enhancing competitiveness, developing relationships with government and society. Meanwhile, in the post-Soviet countries, CSER is rapidly developed in large corporations, in particular in fuel and energy companies. The peculiarity of the domestic version of the CSER is the significant emphasis on the administrative approach, the development of social responsibility as a response to the mandatory requirement of the state.

The reasons for ineffective implementation of corporate social and environmental responsibility by domestic enterprises lay in the sphere of low level strategic planning and management. At the same time, taking into account the current geopolitical situation, conditions become increasingly rigid, the level of competition in international trade steadily increase. The rapidly growing number of transnational corporations complicates conditions for small and medium-sized businesses

development. The world economy dictates new rules for the game, when business must take on not only economic but also social functions, and social and environmental responsibility should become the norm of business conducting, one of the criteria in the business decision-making process.

From the point of view of foreign and domestic researchers in the field of strategic management, an effective innovation breakthrough in the field of creation and development of CSER requires the transition to a qualitatively new level of management, which includes a scientifically based synthesis based on strategic goals and tasks forecasting, planning and implementation.

One of the most popular strategic planning tools among large corporations is the scenario approach. An important feature of the scenario approach is its flexibility, ability to apply different tools at the stages of the scenario study. The popularity of the scenario approach largely depends on the fact that in the middle of the twentieth century events that could not have been predicted based on an analysis of past trends had a huge impact on the future in a global scale. One such event was the oil crisis of 1973. The successful outcome of the Royal Dutch Shell Corporation from this crisis has happened thanks to the application of the scenario approach and an incentive for its widespread use.

Since the spread of the scenario approach and getting popularity in a wide variety of fields until the early 1970's, academic schools of scenario approach have developed in the United States, France, as well as in the Netherlands and Sweden. For Sweden and the Netherlands qualitative approaches are typical for scenario studies, where a significant role is played by working with experts, seminars, conferences, brainstorming, and other methods for public discussions forming. The French school «La prospective» is characterized by combination of qualitative and quantitative approaches. There are also known attempts to build scenarios based solely on precise models and quantitative approaches, but they require strong simplifications and usually do not allow to consider many qualitative factors that characterize social systems.

The main types of scenario approach include forecasting, scenario forecasting, reverse forecasting and reverse forecasting with the participation of stakeholders (Figure 1.5).

Distinctive feature of the first type of forecasting scenario approach is identifying the trends, dynamics of the object of research development based on the analysis of its current state and in the past. The result of

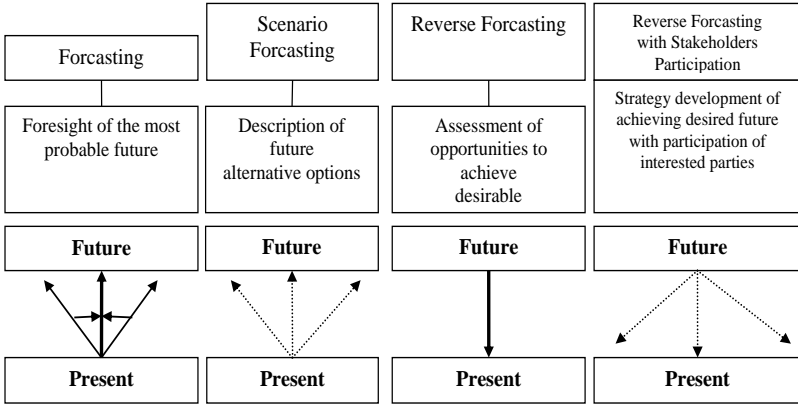

**Figure 1.5 Typology of scenario approach**

Source: improved by authors (Kima, Songb, Lee, 2016; Kuziak, 2012; Mahmoud, Blankson, Hinson, 2017; Kuziak, 2012)

forecasting is creation of the most likely picture of the future. However, this method can be used in conditions of relatively stable external environment.

Scenario Forecasting is a technology for creating strategies. It envisages the development of several scenarios for the future, each of which is implemented under certain conditions. The specificity of scenario forecasting is that this method allows you to analyze the actions being taken now, taking into account future trends. Creation of several scenarios should be result of the method application. Based on these scenarios experts make recommendations for strategy formation. The process of developing scenarios is quite long, time-consuming and resource-intensive.

The next type of scenario approach is the reverse forecasting method. In this approach, the scenarios are built in reverse order. Before the consideration there is a certain vision of the future, and in the process of the study a chain of events connected with time is built up. The realization of events will lead to a vision of the future set at the beginning of the study. The main question of this technique is: «What can we do today to achieve the desired result?» This technique is often seen as the opposite to forecasting.

Reverse forecasting with stakeholder participation (participatory backcasting) differs from the previous type by the fact that, in addition to expert opinions the views of a wide range of interested persons are

taken into account while the image of the future and the strategy for its achievement has been formulating.

All of the above scenario approach types are interconnected, and each method can be applied depending on the period of forecasting. The method of reverse forecasting is most suitable for a long-term strategy development. For medium-term planning scenario forecasting is used. Direct forecasting allows you to define a plan of measures for the near future. The short-term planning uses the «Next Steps» technique, where the next specific action is planned, taking into account the assessment of all possible risks and consequences.

Summarizing the results of research by using the method of reverse forecasting with the stakeholders participation it is possible to present this method as a general procedure consisting of six steps (Figure 1.6).

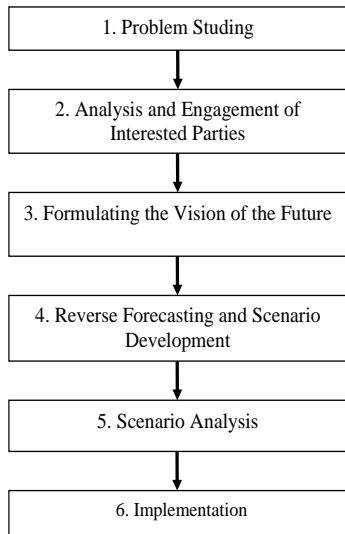

**Figure 1.6 Procedure for implementation of the reverse forecasting method with the participation of interested parties**

*Source: compiled by authors (Blankson, Hinson, 2017; Prakash, 2002; Stainer, 2006*

It should be noted that, although the general procedure is depicted as stepwise and linear, it is not definitely so. Iterative cycles are possible in those cases when there is a mutual influence between one by one two steps.

In addition, the process of reverse forecasting is dynamic because some stakeholders can exit the process and new ones can join it. The method of reverse forecasting is problem-oriented, multidisciplinary, and involvement of stakeholders makes this method transdisciplinary. Stakeholder involvement is important not only from the point of view of taking into account their specific knowledge, but also from the point of view of their approval of the reverse forecasting results and action plan for further implementation.

Thus, the use of the reverse forecasting method with the participation of interested parties most fully meets the requirements to predicting the complex economic systems in the entrepreneurship environment and the future uncertainty. This method is the most effective for managing corporate social and environmental responsibility development. The method of reverse forecasting allows you to analyze the current state of socio-environmental responsibility of domestic business structures, to identify the strengths and weaknesses, as well as to determine the trajectories of the movement to the set goal.

**Conclusions.** As noted earlier in 2012 at the United Nations Conference on Sustainable Development of «Rio + 20», the transition to a new economic development of the green or low carbon world economy should not only help to prevent the exhaustion of non-renewable natural resources, but also to ensure reduction of environmental pollution risks, increase welfare and guarantee ecological safety and social justice for the population of the planet. The need to stimulate resources efficient development of the domestic economy determines the relationship between energy efficiency and environmental responsibility within the framework of corporate social responsibility of each business entity.

The relationship between the development of corporate social and environmental responsibility and the voluntary agreement of the company to follow the principles of sustainable development and prevention of pollution, to develop and implement environmentally sound technologies, including energy efficiency, are established. The work concludes that corporate responsibility links the protection of the environment with the need to save energy resources. A systemic approach to management, a change in the thinking of top management and company staff will allow us to formulate the right strategy and energy efficiency programs to achieve set goals and tasks.

The method of reverse forecasting with the participation of stakeholders is used as a tool for managing the corporate social and



environmental responsibility development, in particular energy efficiency, as an environmental component of corporate social and environmental responsibility.

The methodical recommendations for management of corporate social and environmental responsibility development of entrepreneurship in the form of a procedure that includes the following steps: problem study, stakeholder analysis and involvement, formulation of the vision of the future, reverse forecasting and scenario development, scenario analysis, implementation, periodical programs review are developed.

## References

1. Antoniuk A.A. & Shmygol N.M. (2011). *Ekologichna skladova korporatyvnoyi socialnoyi vidpovidalnosti: zvitnist, ocinka, doxidnist [Environmental component of corporate social responsibility: reporting, assessment, profitability]. Derzhava ta regiony – State and regions, 2, pp. 124-128 [in Ukrainian].*
2. *Doklad o Tseliakh v oblasti ustoichyvoho rozvytyia, 2017 [Report on the Sustainable Development Goals, 2017] // [https://unstats.un.org/sdgs/files/report/2017/TheSustainableDevelopmentGoalsReport2017\\_Russian.pdf](https://unstats.un.org/sdgs/files/report/2017/TheSustainableDevelopmentGoalsReport2017_Russian.pdf) [in Russian].*
3. Kima, Jungsun; Songb, Hak Jun; Lee, Choong-Ki (2016). *Effects of corporate social responsibility and internal marketing on organizational commitment and turnover intentions. – International Journal of Hospitality Management (55) pp. 25–32 [in English].*
4. Kuziak, V. V. (2012). *Kontseptsii sotsialnoi vidpovidalnosti biznesu [Concepts of social responsibility of business]. Proceedings from MIIM '12: IX Mizhnarodna naukovo-praktychna konferentsiia "Marketynh ta lohistyka v systemi menedzhmentu" – The Ninth International Scientific and Practical Conference "Marketing and logistics in the management system", pp. 231-232. Lviv: Vyd-vo Lvivskoi politekhniki [in Ukrainian].*
5. Mahmoud, M. A.; Blankson, Ch.; Hinson, R. E. (2017). *Market orientation and corporate social responsibility: towards an integrated conceptual framework. – International Journal of Corporate Social Responsibility. <http://DOI.10.1186/s40991-017-0020-1> [in English].*
6. Rymar, I. A. (2010). *Sotsialna vidpovidalnist v systemi korporatyvnoho upravlinnia [Social responsibility in the corporate governance system]. Visnyk Khmelnytskoho natsionalnoho universytetu – Bulletin of the Khmelnytsky National University, 2, pp. 65-67 [in Ukrainian].*
7. Prakash, A. (2002) *Green marketing, public policy and managerial*

*strategies. – Business Strategy and the Environment Bus. Strat. Env. 11, 285–297 <https://doi.org/10.1002/bse.338> [in English].*

8. *Stainer, L. (2006). Performance management and corporate social responsibility: The strategic connection. Strategic Change. <https://doi.org/10.1002/jsc.761> [in English].*

**Tarasenko Iryna**

*Doctor of Economic Sciences, Professor*

**Verhun Antonina**

*PhD in Economics, Associate Professor*

**Nefedova Tatyana**

*PhD in Economics, Associate Professor*

**Borolis Inna**

*Senior Teacher*

*Kyiv National University of*

*Technologies and Design*

*(Kyiv, Ukraine)*

**METHODOLOGICAL  
APPROACH TO THE  
FORMATION OF  
THE MONITORING  
SYSTEM FOR THE  
COMPETITIVENESS  
OF INSTITUTIONS  
OF HIGHER  
EDUCATION**

Establishment and development of the educational sphere in Ukraine requires from educational institutions the formation of a market-oriented management strategy of institutions of higher education (IHEs) at a specific market of educational services aimed at creating and increasing their competitive advantage. According to the results of the research, the conclusion has been made about the fact that the level of the IHE competitiveness greatly depends on the level of strategic management and technology. The main goals of the strategic management in the context of ensuring competitiveness are to be the following: to expand the number of training programs and specialties in the field of pre-university and university education; to improve the quality of specialist training in accordance with the modern requirements; to increase scientific and academic potential; to implement new educational technology and teaching methods; to conduct scientific research and developments at a high level; to optimize the IHE structure; to improve material and technical resources of the educational institution according to the current standards.

In order to carry out these tasks and form a market-oriented strategy of the educational institution, it is necessary to develop and implement an integral monitoring system of the performance, business activity and, as a result, the IHE competitiveness at the market of educational services.

Socio-economic phenomena and processes have traditionally been the objects for monitoring: ecological state of the environment, people's standard of living, social and labour relations, socio-economic state of cities and towns, business activity of enterprises, financial and economic activity of business entities, etc.

The term 'monitoring' was introduced into the scientific use shortly before the United Nations Conference on the Human Environment that was held in Stockholm, in 1972. In scientific sources, monitoring is understood as: the process of detecting significant deviations in the course of the implementation by production systems [1]; the mechanism of constant monitoring of controlled indicators of financial activity of the enterprise, determining the size of deviations of actual results from the planned ones and determining the causes of such deviations [2]; a system of observations, assessing the quality of management of financial and economic activity of production systems (monitoring of financial and economic activity) over a certain period of time, as well as determining the future state of financial and economic activity based on effective business decision-making.

Constant monitoring makes it possible not only to assess the degree and quality of implementation of plans, but also to predict the results of activities and their relevance to the planned value; monitoring is needed to prepare reasonable reports [4, p. 13-14]. A special feature of monitoring, as noted in [4], is the repeatability, which is realized in the aggregate of several studies carried out according to a single plan, algorithm, toolkit; in sequence (at defined intervals) and in order to obtain results that characterize the dynamics of the object changes within the period of studies.

The works of such national and foreign scientists as N. Alekseenko, D. Aistrakhanov, I. Blank, J. Johnston, V. Galitsin, P. Yegorov, B. Litvak, B. Leong-Hong, R. Mann, E. Karpov, M. Pugachova, V. Stepashko, M. Titova and others were dedicated to the study of program and methodological monitoring issues. However, some problems remain controversial and underdeveloped, in particular with regard to the subject matter of competitiveness, including IHEs, which necessitates the solution to this problem both from a theoretical and a practical points

of view. The research has shown that among the tasks of monitoring the performance of an institution of higher education in the context of ensuring competitiveness are the following: the development of a system of target indicators and the choice of monitoring methodology; obtaining a quantitative assessment of the competitive potential level for substantiating programs and activities of scientific, technical, educational, instructional and socio-economic directions and developing a market-oriented strategy for the development of IHEs, aimed at increasing the competitive advantage.

Monitoring, as a process of scientific research (data control, analysis, synthesis and forecasting), has its own tools and methods that are used to achieve goals and justify effective management decisions. Existing foreign and domestic experience shows that monitoring means descriptive characteristics of key performance indicators of business activity in all spheres without any further generalization and calculation of the integral indicator. At the same time, during the monitoring process, it is desirable to obtain quantitative estimates of the indicators that are the most important in terms of assessing the level of effectiveness and efficiency achieved by the enterprise, since the results of monitoring are the basis for the development of the enterprise development strategy.

The concept of monitoring is considered by scholars in a broad and narrow senses: in a broad sense, monitoring means the collection of such actions as collection and systematization of data, their archiving, processing, analysis and forecast; in a narrow sense, “monitoring is a regular observation for keeping track of trends” [5, p. 7]; “a system of regular monitoring of processes and identifying the main trends that occur in the external and internal environment of the enterprise for timely operational assessment of emerging situations” [8, p. 67]. It should be noted that monitoring and observation are not identical concepts, as during the monitoring, on the basis of observation data, the following procedures are performed: assessment of the current state of objects; data analysis to determine the patterns of objects development; short-term forecasting of the state and trends of objects development; visualization of monitoring results and their presentation to users.

As a result of the synthesis of scientific works devoted to problems of monitoring [1, 2, 5-7], the following conclusions have been drawn regarding the advantages of its application in the activity management: the application of monitoring in the practice of management makes it possible to more reasonably approach the definition of goals and

objectives not only in relation to the object of monitoring, but also to the enterprise in general; the flexibility of the monitoring system enables its use in the management of various spheres of activity through the development and use of a system of performance indicators; the complexity of the monitoring system involves monitoring the state and trends of various monitoring objects (at the internal and external levels of performance) and ensuring the interaction of all structural units in order to manage the effectiveness and efficiency of the enterprise, eliminate deviations from the planned values of indicators and achieve the set goals.

An important conclusion made after the analysis of scientific literature was the definition of the role of monitoring in the process of managerial decision-making: based on the results of observation, monitoring provides the necessary information for making well-considered managerial decisions that requires the organization of the relevant service at the enterprise – the department that monitors the results of activities (quality of education, scientific achievements, financial, economic and other indicators that form competitive advantages and determine competitiveness of a higher educational institution) may be such a service at the IHE.

In preparing for the monitoring of the IHE competitiveness, it is expected to resolve such program and organizational-methodical tasks: the definition of the purpose, subject and principles of monitoring; formation of a system of target indicators of monitoring (target indicators are indicators that adequately characterize the investigated object – a process or phenomenon); justification of methods to be used at the stages of data collection, processing and visualization.

The synthesis of scientific works devoted to the problems of monitoring [5, 7] made it possible to define the following main functions: assessing, diagnostic, stimulating, corrective, and functions of providing feedback, forecasting and modeling as well.

In this study, the monitoring of IHE activities in the field of competitiveness will be understood as the process of ongoing observation, control, assessment, analysis and prediction of its effectiveness and efficiency to meet the needs of different groups of users.

The objective of monitoring in the field of managing the competitiveness of the IHE is to consider the receiving of information on the effectiveness of activities in the areas that determine its competitive advantages, on the basis of qualitative and quantitative

analysis and assessment of relevant indicators for the development and adoption of managerial decisions in the system of competitiveness management, forecasting the state of objects for monitoring and informing parties concerned.

Scholars point out the possibility of such situations in determining the target indicators, which constitute the subject area of monitoring [5, p. 16]:

1) a separate target indicator is set, which effectively characterizes the status of the subject area, as well as a certain set of additional indicators influencing it – independent (exogenous) variables or factors;

2) a group of target indicators is set, which effectively characterize the status of the subject area, as well as a group of independent factors;

3) a certain group of indicators-factors is set, among which the target ones are not defined, but which in aggregate sufficiently fully characterize the state of the subject area.

When forming a system of target indicators, it is necessary to take into account that one of the conditions, which should be consistent with the methodology of monitoring, is the ability to quantify all the studied indicators and factors.

The result of the analysis of scientific literature on the monitoring organization [1, 5-7] was the definition of the basic principles of its implementation in the field of competitiveness management. It is reasonable to distinguish three groups of such principles.

1. The principles determined by the peculiarities of the subject area of monitoring:

- the principle of the materiality of the information received, which will be provided to users (internal and external) to substantiate the conclusions, for decision-making and performance of certain actions;

- the principle of completeness of information and information support, which is to provide comprehensive information for assessing the achieved level of performance and effectiveness in all areas of the IHE activity according to which the competitiveness assessment is conducted;

- the principle of response is that the IHE develops policy and improves the management structure, plans and monitoring system, which provide openness for parties concerned (external – the Ministry of Education and Science of Ukraine, entrants, enterprises and organizations that are consumers of educational services, society; internal – management, personnel, teaching staff, and students) in terms of achieved competitiveness, response to inquiries and comments of

parties concerned, adequacy of information on the achieved level of performance in the relevant reporting.

## 2. Principles of the monitoring system formation:

- the principle of the correspondence of the monitoring system possibilities to objectives and tasks of the development of the IHE in the field of competitiveness management is that the monitoring system should provide users with a set of analytical tools for solving all tasks that arise in the process of work;

- the principle of decomposition of tasks, which involves the separation of the following components of the subsystems of the monitoring system: interaction with databases; visualization; analysis; modelling; short-term forecasting; computer graphics; documenting;

- the principle of the monitoring system openness, that is the ability of the system to self-evolve, improve, increase its functions, and adapt to new tasks;

- the principle of interactive interaction with users of information through a user-friendly interface (the work of the system should be transparent, understandable and clear);

- the program and algorithmic automation of monitoring stages, which provides users with final results without over-specification of intermediate stages of problem solving;

- the principle of universality of mathematical methods, which involves the possibility to use unified algorithms at the early stages of the monitoring system formation;

- the principle of scientificity, which involves the maximum use of scientific methods and approaches for the implementation of monitoring procedures in the field of competitiveness management;

- the principle of integrity is that the monitoring system is an integral part of the management system of the IHE, and it has logical functional relationships with its other elements (components);

## 3. Principles for displaying information in the monitoring system:

- the principle of conformity, which is to ensure the correspondence between the object of observation (performance indicators in the areas of competitive advantage formation) and the used monitoring methods;

- the principle of consistency, which means that the indicators to be monitored must agree with one another and be considered in their interrelation;

- the principle of integrity is that monitoring of the competitiveness involves monitoring all fields and areas of the IHE activity, a comprehensive study of cause-and-effect relationships in the system of

competitiveness management;

- the principle of dynamism is that the monitoring system should monitor the indicators selected for monitoring in the dynamics, taking into account the changes that are characteristic for each stage of implementation of its development strategy;

- the principle of effectiveness is that competitiveness monitoring should act as an active tool in managing the IHE development and strengthening its market positions both in the domestic and foreign markets;

- the principle of planning, which means balanced development and consistent implementation of procedures for collecting and systematizing data, their archiving, processing, analysis and forecasting;

- the principle of structuredness is to identify the main components of the monitoring object and to form a system of performance and efficiency indicators for each of the components in order to justify a set of programs in the areas of the competitive advantage formation;

- the principle of systematicity is to establish interrelationships and interdependences between all major structural components of the monitoring object taken for analysis;

- the principle of functionality, which involves the possibility of observing and thorough analysis of the monitoring object in general and its components in order to predict the competitive positions of the IHE and development of regulatory influences (management measures);

- the principle of controllability, which involves providing a constant direct and reverse link between the monitoring object and the management body for a rapid response to changes in the state of the monitoring object, business process modelling and the effectiveness of economic decisions, plans and programs;

- the principle of reality is that the effectiveness of implementing a market-oriented (competitive) strategy and related programs will be high if they are developed taking into account the actual state of the monitoring object (competitive potential of the IHE) and external factors, and the management system is capable of a wide range of response options;

- the principle of consistency is that the implementation of a market-oriented strategy for the IHE development and a balanced set of strategic programs, as a long-term process, is carried out at successive stages, each of which requires appropriate justification, setting deadlines for implementation, developing reference standards and implementing a system of motivation.



Based on the general methodology of statistical monitoring and considering the peculiarities of the subject area of the IHE competitiveness, the following urgent tasks have been identified in course of the development of a methodological approach to internal monitoring of a higher educational institution competitiveness:

- analysis of the subject area of monitoring;
- studying the structure of information flows and modelling the needs of information users;
- definition of database structure requirements;
- formation of a balanced system of indicators and criteria for assessing competitiveness;
- development and introduction of reporting on the results of activities in the areas of the competitive advantage formation into the practice of the enterprise (development of reporting forms);
- development of methodological support with procedures for collecting, coding, visualization, preliminary and multidimensional data analysis, as well as calculation of target indicators (individual, group, complex and integral);
- ensuring the efficiency of data transmission channels and developing software and information resources for monitoring their own competitiveness by higher education institutions;
- recommendations on the data interpretation and their use in a market-oriented (competitive) strategy formation for the IHE development.

Thus, it follows from the considered above that the process of the IHE competitiveness monitoring requires the development of an appropriate system integrated into the general management system, as well as the preparation of methodological support for the implementation of the relevant monitoring procedures. The general structure of the proposed system for the IHE competitiveness monitoring is shown in Figure 1.7.

The following symbols are used in Fig. 1: EPC, SC, OMC and EC – respectively educational and pedagogical component, scientific component, organizational-managerial and economic component of the competitiveness; «→» – channels of data transmission in the system of monitoring; outgoing information flows; incoming information flows.

Let us consider the elements of the monitoring system of the IHE competitiveness in more details. Labor and logistical resources are important components of the monitoring system of competitiveness, since the quality of the information received and, consequently, the

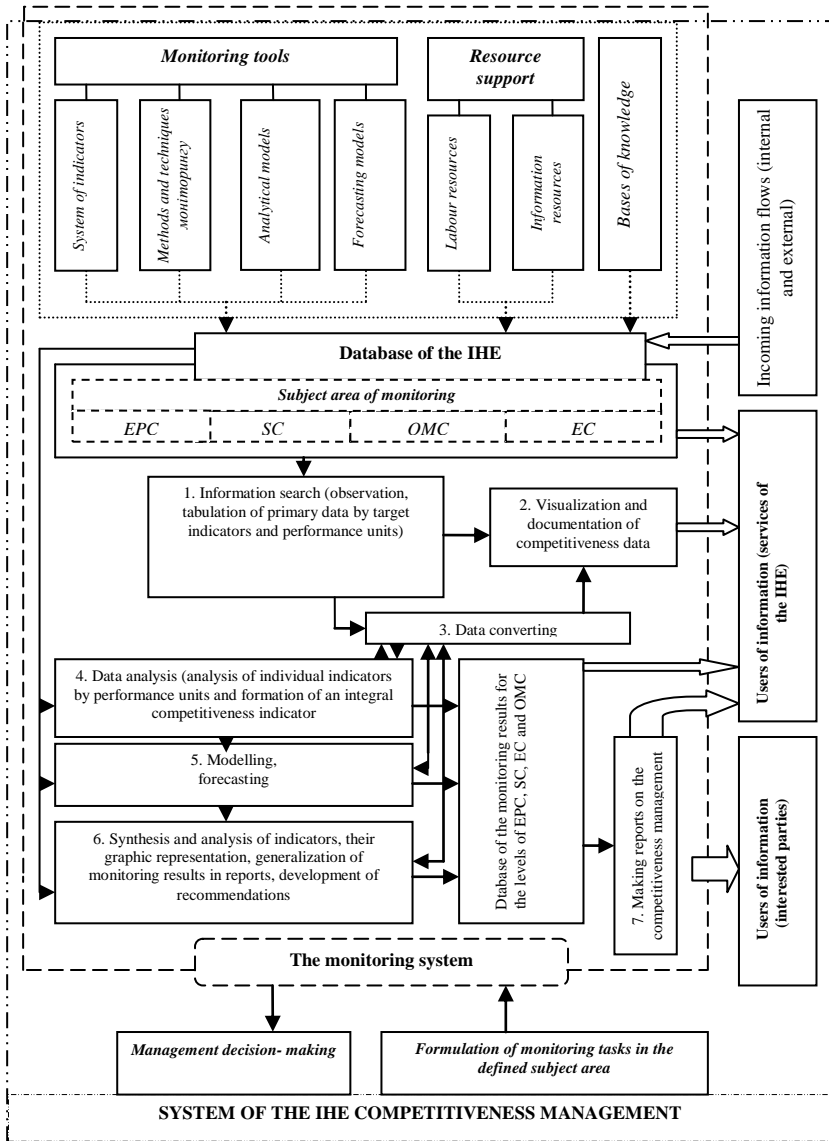

**Figure 1.7 General structure of the monitoring system of the IHE competitiveness**

*Source: adapted by the author according to the data [5, 7]*

effectiveness and validity of managerial decisions, conclusions and forecasts to a great extent depend on the level of facilities and personnel qualifications.

In order to assess the compliance of business qualities of management personnel and employees involved in the monitoring system, their competence and ability to perform their tasks promptly, the scientific literature suggests an indicator of personnel reliability [7, p. 39-40]. Generally agreeing with the appropriateness of using this indicator, it should be also noted that to assess the business qualities of the personnel, it is important to consider a set of characteristics of the employees who monitor the IHE competitiveness, in addition to their reliability.

Another important element of the monitoring system of the IHE competitiveness is the information support through which the processing of information coming from internal and external sources (incoming information flows) is carried out. The intensity of the monitoring system depends on the quality and level of information support; quality and multiplicity of calculations, completeness, reliability, efficiency and timeliness of analytical and reporting information; the validity of managerial decisions and the reliability of forecasts.

The processing of the information entering the monitoring system involves the use of appropriate monitoring methods, the accuracy and rationality of which depends on the effectiveness of the monitoring system and the quality of “outgoing” information flows.

The monitoring method is a set of methods and processes for research and analysis of information, which establishes interrelations between indicators, assesses the achieved level of performance in the spheres of educational, instructional, innovative, financial and economic activities. The main methods used in the monitoring system are methods of economic and mathematical statistics, econometric and economic-mathematical methods, methods of modelling and forecasting, analysis and synthesis, expert analysis, computer graphics. In addition, the monitoring system of the IHE competitiveness, like any statistical monitoring system, should support traditional processing procedures that functionally correspond to the main stages of the data lifecycle [5, p. 51]: data collection; processing (verification, averaging, generalization, reporting); data transfer to different groups of users; further processing; accumulation; storage; preparation of information samples to order; presentation of information in various forms and its publishing in order to inform the parties concerned (vocational

guidance, information in the media, provision of information for the rating of IHEs).

The statistical monitoring system, developed for various subject areas of socio-economic research [5], has been adapted by the author to meet the objectives of monitoring the IHE competitiveness. Seven basic functional modes have been identified for this system (see Figure 4).

*Information search* (Mode 1) includes the study of monitoring objects, the formation of primary data (individual indicators) and their preliminary analysis. The information obtained at this stage forms the primary database, which can be used at the next stages of analytical work.

The information obtained at the first stage, after proper *documentation and data visualization* (Mode 2), is transmitted to internal users – in the IHE divisions for the control and development of operational responses, as well as experts (in licensing, accreditation). It is expedient to keep the results of monitoring in databases systematized and processed at this stage.

*Data conversion* (Mode 3) involves the following actions: construction of new structures, models, transformation of input data by computational procedures (finding summary data, determining the maximum, minimum, average values, etc.). The results of these operations are entered in the database of monitoring results to be used at the next stages.

*Data analysis* (Mode 4) involves in-depth study of the data obtained at the previous stage and their assessment. In order to solve these problems in the monitoring system, it is recommended to create and maintain a database of statistical data processing tools (statistical monitoring tools). The results obtained at this stage must be entered into the database and be accessible to users through documenting (compilation of reporting) and data visualization (Mode 7).

*Modelling and Forecasting* (Mode 5) involves the use of more complex tools than at the previous stages; the result of the use of this tool is the laws, models and forecasts. At this stage, the monitoring system of the IHE competitiveness carries out the analysis of the existing trends, their modelling and drawing up a forecast of the competitiveness level, considering the results of the analysis of the IHE potential and the monitoring of the environment. Since the results of this stage cannot be directly observed, they must be included in the database of results and provided to users through the documentation and visualization system (Mode 7).

*Synthesis and analysis of indicators, their graphic representation, generalization of monitoring results in the report, development of recommendations* (Mode 6) involve the generation of complex (multi-dimensional) indicators and the creation of graphic images and dependences in order to study the relationship between the phenomena, processes and indicators. Users of information can observe received graphic images both directly on the terminal (internal users) and on the university's website (parties concerned). The results of this stage are entered in the database of monitoring results.

*The compilation of the monitoring results of the IHE competitiveness and the visualization of data* (Mode 7) is a mandatory subsystem of the competitiveness monitoring system; its purpose is to prepare and provide information on the performance level achieved by the higher educational institution in the educational, pedagogical, innovation, financial and economic spheres for different groups of users, prepare non-financial reports and publicize them. The main functions of this subsystem are the analysis of information from the database of monitoring results and the development of a market-oriented strategy of the IHE.

Taking into account the specifics of a particular subject area, the author has concluded that the system of the IHE competitiveness monitoring must have properties of the developing system, that is, have a base frame for filling with information that can be modified and improved. Agreeing with the list of features of the system of strategic monitoring of financial and economic activity, which are defined in the work [7, p. 34-36], it should be noted that the monitoring system in the field of the IHE competitiveness management is characterized by the following: purposefulness, integrity, completeness and transparency, flexibility, objectivity, dynamism, cyclicity, efficiency, adaptability, and promise for application.

It should be also noted that the level of consumer's satisfaction with the educational service depends on the quality of the educational product (training programs, scientific training, conditions of training and additional services provided by the specific IHE), and on the level of marketing – the effectiveness of advertising, compliance with the market needs, quality and completeness of information. This value will characterize the level of the IHE competitiveness by all the components.

## References

1. Demin S. V. (2010) *Rynochno-orientirovannaya strategiya upravleniya deyatel'nost'yu uchrezhdeniy vysshego professional'nogo obrazovaniya* [Market-oriented strategy of higher professional institutions activity management]. *Ekonomika obrazovaniya*, no. 3. (in Russian)
2. [On-line resource]. Available at: <http://microsoftua.wordpress.com/2011/05/26/summit/>
3. Loshenyuk I. R., Ivanchenko A. *Instrumenty formuvannia konkurentospromozhnosti ZNO* [Proceedings of the scientific conference]. [on-line resource]. Available at: <http://intkonf.org/ktn-loshenyuk-ir-ivanchenko-a-instrumenti-formuvannya-konkurentospromozhnosti-vnz/>
4. *Kachestvo i konkurentospособnost' obrazovatel'nyh uslug kak obschestvennoe blago* [On-line resource]. Available at: <http://www.mgu-consulting.ru/st/ecanom/uslugi.htm>
5. Lazarev V. A., Mokhnachev S. A. (2003) *Konkurentospособnost' vuza kak ob'ekt upravleniya: monografiya* [The competitiveness of a higher educational institution as an object of management: monograph]. Moscow: *Prirodnye vesti*. (in Russian)
6. Andreyeva O. *Otlichitel'nye cherty, opredelyayushchie konkurentospособnost' VUZov* [Distinctive features which specify the competitiveness of higher education institutions] [On-line resource]. Available at: <http://www.megaport-nn.ru/content/articles/19157/>
7. Ivanov Yu. (2011) *Konkurentospromozhnist zakladiv vyshchoi osvity spozhyvchoi kooperatsii na rynku osvityukh posluh Ukrainy* [The competitiveness of institutions of higher education of consumer cooperation in the market of educational services of Ukraine]. *Ukrainska kooperatsia*, no. 4. (in Ukrainian)
8. Bilyk H. H. (2007) *Monitorynh finansovoho stanu pidpriemstva yak instrument upravlinnia pidpriemstvom* [Monitoring of the financial state of the enterprise as a management tool]. *Professional magazine „Naukovi pratsi”*, the Black Sea State University named after Petro Mohyla: *Ekonomichni nauky*, issue 51, vol. 64, Mykolaiv, pp. 65-70. (in Ukrainian)
9. *Metodyka otsiniuvannia diialnosti vyshchych navchalnykh zakladiv III-IV rivniv akredytatsii*. (2009) Kyiv. (in Ukrainian)
10. Kendall M.G. (1995) *Rank Correlation Methods*. New York: Hafner Publ.Go.
11. Solovyev A. N., Kiryuhin S.M. (1974) *Ocenka kachestva i standartizatsiya tekstil'nykh materialov* [Quality assessment and standardization of textile materials]. Moscow: Light industry. (in Russian)

**Topleva Silviya**  
*PhD in Economics,*  
*Chief Assistant Professor*  
*University of Food Technologies*  
*(Plovdiv, Bulgaria)*

**THE COMPETITION  
STRUCTURE AND  
SOCIAL RESPONSIBILITY  
IN THE BULGARIAN  
ECONOMY**

The competition structure determines the effectiveness of the market system. The establishment of competition in the Bulgarian economy is marked by the collapse of the socialist planning system. In the modern Bulgarian economy dominates the neoliberal market rationality and efficiency, encoded in the freedom of competition and consumer choice and the non-intervention of the state in the market mechanism. The leadership positions of large firms often turn into monopolization of entire sectors.

In the years of transition to a market economy, Bulgarian expectations and realities are related to the right to entrepreneurial initiative, the restoration of private property, privatization, the liberalization of foreign trade and EU membership. The period of transformation and reform is dominated by inequality in access to resources and markets and in the distribution of the incomes. The monopoly, corruption and lack of transparency maintain the imbalances and frustration. The contradictions and externalities of the market highlight the need of society for institutionally guaranteed competition of the economy structure, social responsibility and equity.

The intensive development of economic processes, the globalization of world economy and the transition to a knowledge economy and a circular economy modernize the institutional structure by affirming the value of human capital, transparency and democratic choice in the market regulation.

The purpose of this article is to outline the contradiction between the neoliberal spirit coded in the model of the competitive market structure of the Bulgarian economy and the need for social responsibility and justice and to justify its overcoming through adequate institutional regulation of the market.

**Competition through neoliberalism and the “ghost” of social  
responsibility**

In the transition of the Bulgarian economy to market orientation, it stands out the transforming domination of consumer choice in the

market structure, the investment shortage, the changes in the industrial portfolio, in the internal trade, the gap in production relations in the conditions of scarce managerial impact and the need to achieve financial stability [8]. In this environment the neoliberalism based on individualism, liberty and ownership is emerging as a preferred alternative to regulation of these processes. In its essence, it relies on the individualistic principle, the free economic initiative, administrative deregulation, the limitation of social costs, privatization and free trade. An integral part of the neo-liberal economic organization is to ensure privacy of private property and the contractual relations at low transaction costs [10]. The transaction costs efficiency is achieved with a high degree of institutional transparency and low levels of corruption. These indicators are often problematic for the economies in transition.

The restoration of the right to private property is one of the necessary steps to establish competition in the market system. The achievement of private property determines the leading role of privatization in reforming the totalitarian social and economic order. The smooth and often opaque transformation of the property, in the absence of active civil regulators, exacerbates socio-economic inequalities and the ineffective implementation of the model. The social cost of reforms is not internalized by neoliberal market fundamentalism. The social responsibility and justice in the market order is perceived as a mirage [7].

The distinctive feature of the neoliberalism is the assumption of identity and community in the interests of companies and the society [4], whereby the “invisible hand” on the market achieves an optimal allocation of resources. Thus, the neoliberal rationality often causes redistribution of resources to the wealthier segments of society. The dissonance between public and private returns provoked J. Stiglitz to declare “the end of neoliberalism” [14].

The drama of the deepening inequalities is complemented by the growing monopoly in various sectors of the economy. According to J. Tyrole, the deserved market power derives from the innovation activity, investment and competitive race [16], on which an unfavorable spread appears in the Bulgarian economy. In the decades of change, monopolies are often tolerated and protected administratively, such as public regulation creates a sense of state protection of X-inefficiency. The undeserved market power covers both traditional sectors of energy and rail transport and public procurement where a lack of transparency, corruption and criterion system traditionally determine the winner. The apparent innovation of established monopolies crashes in the



inefficiency of investment and high prices. The outcome, driven by asymmetry of information, lack of transparency and corruption, is the consolidation and reproduction of the acquired status and the maximization of the rentier benefit. Stakeholders often distort market efficiency such as the restriction of competition resulting from private, profitable and rent interests that have political protection to expand their freedom at the expense of others [11:122].

A major indicator of the competitiveness of the national economy is the Global Competitiveness Index (GCI). The competitiveness is seen as a function of a mix of indicators related to institutions, sectoral policies and productivity (see Figure 1.8). The measurement scale for each of the sub-indices is 1 = extremely low to 7 = extremely high [5].

The competitiveness of the market environment in Bulgaria has positioned the country in the Efficiency-driven economies group. When measuring the competitiveness, priority is given to indicators related to the efficiency of the system. Despite some weaknesses, the market environment in the country maintains a good level of competitiveness (see Figure 1.9). The competitiveness of the Bulgarian economy as level is not significantly different from other countries in Central and Eastern Europe (see Figure 1.10). The major difference is that the competitiveness of Romania, Poland and Slovenia is determined by the sub-index Innovation and Business Sophistication. Thanks to the reforms, investments in human capital and efforts to digitize the public and economic environment, these countries manage to improve their competitive position. The transition in their market environment is of effectiveness to providing high added value for citizens and consumers. The impetus to achieve high added value for society strengthens the social responsibility of businesses and public authorities. The efforts of the Bulgarian economy are still focused on improving efficiency. The reforms to achieve added value have a fragmentary effect due to monopolism and lack of transparency.

Increasing topicality for the Bulgarian economy, dominated by the neoliberal spirit, acquire the J. K. Galbraith's words from the 1970s that leaders of large corporations whose power exceeds prices, cost and modeling of consumer behavior are the most influential and respected members of the community, and the trend is their interest to becoming public [4:140-141]. In terms of lack of transparency and corruption, this situation represents the celebration of group egoism [7] in the competitive environment and the erosion of social responsibility and justice.

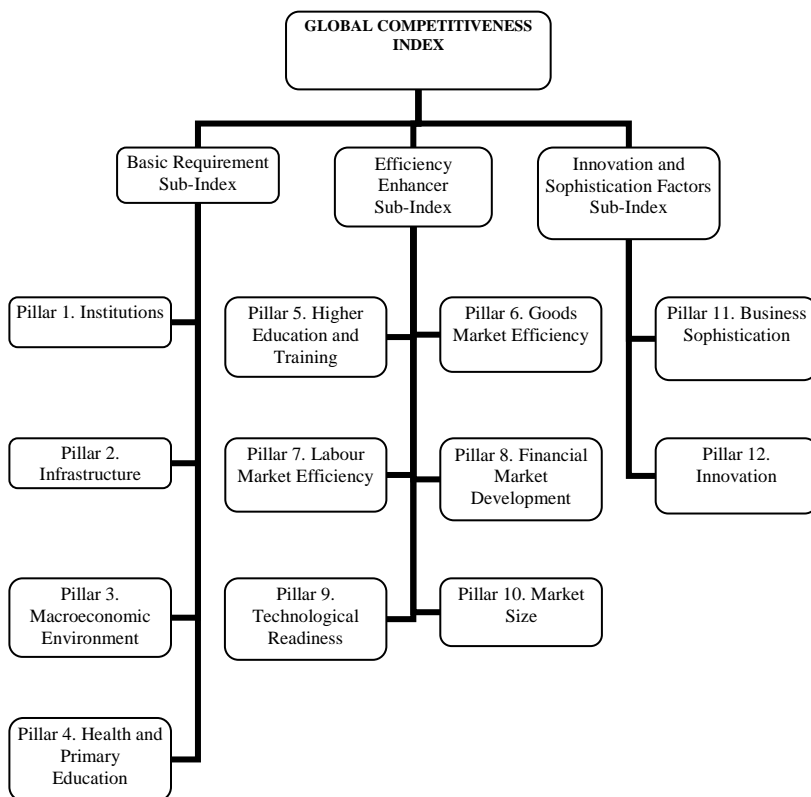

**Figure 1.8 The Global Competitiveness Index Framework**

*Source: CEIC Global Database*

In the light of this reality, fiscal policy confidently demonstrates neoliberal partialities, mixed with suspicious social measures. The low taxes and the increase of retirement age, as an expression of the neoliberal spirit, are combined with an administrative increase in the minimum wage. It inevitably increases the costs of small and medium-sized firms and consolidates the positions of large market participants.

The contradiction between neoliberal impetus and the need for social responsibility can be illustrated by the Index of Economic Freedom. For 2018, Bulgaria ranks 47th out of 159. The report also reaffirms that corruption, inefficiency and lack of transparency vitiate the market action. Business growth is hampered by frequent changes of the regulatory measures. [2]. The excessive regulation, which is often an expression of social responsibility, replaces choice, exchange and

cooperation and compromises neoliberal preferences.

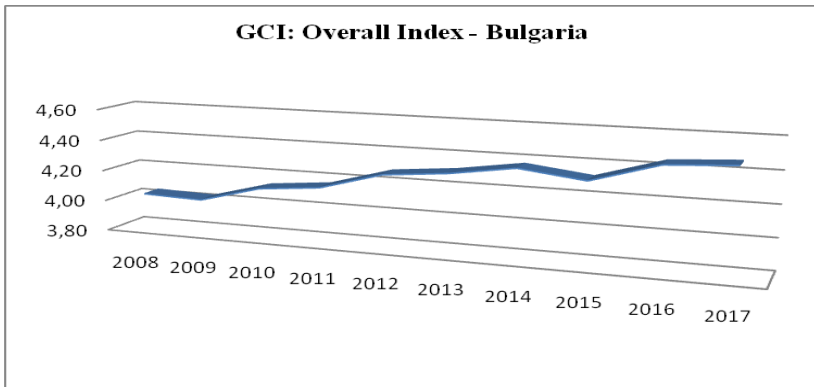

**Figure 1.9 Competitiveness of Bulgarian economy**

*Source: CEIC Global Database*

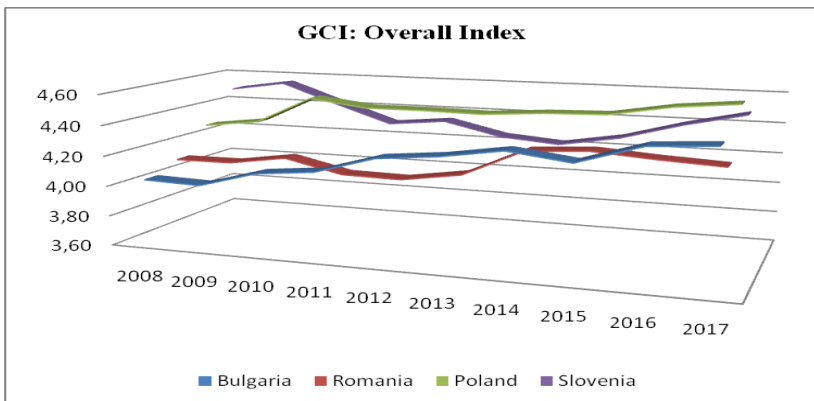

**Figure 1.10. Comparison of the competitiveness of the Bulgarian economy with other related countries**

*Source: CEIC Global Database*

It can be concluded that the preferred source for establishing a competitive market structure and well-being is neo-liberalism, the implementation of which is dominated by a lack of transparency and corrupt practices, and supports the growth of monopoly and corporatism. And a “ghost” of social responsibility in the neoliberal road degenerates into controversial measures with uncertain effects on market efficiency and desired prosperity.

## **Competition and Social Responsibility in the Circular Economy**

The transition to a knowledge economy and a circular bio-economy changes not only the economic and capital structure, but also the perception of neoliberalism and social responsibility. The priority for public and private social activity is the investment in human capital, whose qualitative characteristics are among the leading factors for corporate and national growth. The human capital is a source of innovations. The technological capability for innovations is becoming a determining factor for the competitive position of market participants. Thus, the welfare responsibility embodied in the development of human capital, supporting the progress of neoliberalism. At the same time, the process nature of the circular economy and the accumulation of human capital increase the requirements of transparency of the economic system and limit the negative effects of neoliberalism.

The situation of the contemporary world economy dominated by inflationary interruption sets new dimensions of the conflict between neoliberalism and social responsibility. The high price trap, declining real wages and the deepening diminishing returns on investment impose an adaptation and modernization of the institutional regulatory mechanisms and social programs. The firms transformation from investors to savers requires reforming market regulation and increasing the efficiency of public spending with a view to achieving social welfare. This is especially true for transition economies, which face the challenge of building a responsible competitive market order and taking the path to high added value.

### **Institutional organization of the responsible competitive market order**

The competitive efficiency increasing of the neoliberal order and limiting the negative effects depends on the structure and the principles of the institutional regulatory framework. The market regulation leads to a lower cost for consumers and expand their access to the product, but also to “fair” compensation for the firms [16:3].

The reproduction of market incentives in the competitive environment implies that the institutional organization embodies the interdependence of the interests of the public and private sectors, rational choice and democratic spirit. In the light of this idea, the institutional organization of the responsible competitive market order is based on the development of “economic facilities, political freedoms, social opportunities, transparency guarantees ...” [11:38]

The achievement of *economic facilities* depends on the existence of property rights on means of production, free industrial access, freedom of competition and freedom of trade [3:xviii]. Economic activity is a function of the access to resources and of conditions of change, such as relative prices and the functioning of markets.

The regulation of imperfect markets is an integral component of the neoliberal order adaptation to the need for social responsibility. In the context of information asymmetry on management efforts to costs optimization and business efficiency [16] and the risk of growing corruption, the 2014 Nobel Laureate, J. Tyrole, recommends that monopoly regulation be implemented through weaker incentives for cost recovery [15]. The traditional approach is cost recovery through maximum prices. The result is the high level of frustration among consumers. J. Tyrole's approach is seen as a way out of the regulatory trap – regulation to favor producers rather than consumers [13; 15]. The application of strong incentives, such as maximum prices, is appropriate for high-performance companies but requires enhanced monitoring by the regulator [9].

Institutional regulation of vertically competitive markets requires sector specific rationalization. The monopolist-holder of an infrastructure, technology or patent can only reproduce its market power if it imposes foreclosures in the chain below. The regulation is necessary when vertical agreements impose costs on third parties (for example, consumers) exceeding the benefits to the contracting parties [6].

Increasing community welfare through effective market regulation is based on the limitation of information asymmetry. The vocation of the responsible competitive market order is the integration of consumer welfare and corporate efficiency.

The *political freedoms* include the set of civil and political rights that ensure pluralistic democratic functioning through open argumentative public debate and rational social choice [12]. The *social opportunities* indicate the expansion of people's access to education and health services. In the neoliberal context, the goal is program funding for social initiatives related to human capital development. The *transparency guarantees* define the boundaries of socio-economic expectations of citizens and constitute a barrier to corruption. It increases the trust in the neoliberal order and the competitive structure. The efficiency of the market mechanism is ensured both by the institutional organization of the economy and the exchange relations, as well as by the shared value orientations and behavioral patterns.

It has to be concluded that the efficiency, choice and democratic-oriented regulatory institutions' practices help to integrate social responsibility and justice into neoliberal rationality by development of the responsible competitive market order of added value.

In conclusion, it can be summarized that the sources of contradiction between the neoliberal competitive structure and the social responsibility in the Bulgarian economy are the higher degree of lack of transparency, information asymmetry and corrupt practices. And, social measures that compensate market fundamentalism often have a suspicious effect on social welfare. In the context of knowledge economy and circular economy and rising inflation, only institutional regulation embodying the imperatives of efficiency, rational choice and democratic spirit ensures the compatibility of neoliberalism with social responsibility in the competitive structure of the economy. For the economies in transition, the result is the establishment of the responsible competitive market order of added value.

## References

1. *Cohesion Policy and Bulgaria*, <http://ec.europa.eu/>
2. *Economic Freedom of the World. 2018. Annual report. Fraser institute*
3. *Friedman, M. 2002. Economic Freedom behind the Scenes., in: Economic Freedom of the World: 2002 Annual Report, pp.xvii-xxi*
4. *Galbraith, J.K. 2001. The Essential Galbraith. Houghton Mifflin Company*
5. *Global Competitiveness Index on CEIC Global Database*
6. *Hart, O. & Tirole, J. 1990. Vertical Integration and Market Foreclosure. Booking papers: Microeconomics, pp. 205-286*
7. *Hayek, Fr. 1976. Law, legislation and liberty. Vol. II. The University of Chicago Press*
8. *Kornai, J. 1993. The macroeconomics of transitions. Budapest*
9. *Laffont, J.-J. & Tirole, J. 2000. Competition in Telecommunications. Cambridge*
10. *North, D. 1991. Institutions, Institutional Change and Economic Performance. Cambridge University Press*
11. *Sen, A. 1999. Development as Freedom. Alfred A. Knopf, New York*
12. *Sen, A. 2010. L'idée de justice. Flammarion, Paris*
13. *Stigler, G. 1971. The economic theory of regulation. The bell Journal of Economics and management Science, vol. 2, pp. 3-21*
14. *Stiglitz, J.E. 2008. The End of Neo-liberalism? Project Syndicate, Jul.*
15. *Tirole, J. 1986. Hierarchies and bureaucracies. Journal of Law, Economics and Organization, 2, pp. 181-214*
16. *Tirole, J. 2014. Market Failures and Public Policy. Nobel Prize Lecture*

## Chapter 2

# ORGANIZATIONAL-ECONOMIC MECHANISMS FORMATION OF COMPETITIVE ADVANTAGES THE ECONOMIC ENTITIES

### **Borowska Maria**

*Starszy wykładowca Wydziału Nauk  
Technicznych i Ekonomicznych  
Państwowej Wyższej Szkoły Zawodowej  
im. prof. Stanisława Tarnowskiego w  
Tarnobrzegu*

### **Zadworny Waldemar**

*Starszy wykładowca Instytutu Ekonomii  
i Zarządzania Państwowej Wyższej  
Szkoły Techniczno-Ekonomicznej im. ks.  
Bronisława Markiewicza w Jarosławiu  
(Tarnobrzeg, Jarosław, Polska)*

## MODELOWANIE PRZEPŁYWU STRUMIENI ŁADUNKÓW A PROBLEM KOLEJEK W SYSTEMACH LOGISTYCZNYCH

### 1. Wstęp

W projektowaniu procesów przepływów materiałów w systemach logistycznych poszukuje się najlepszych rozwiązań zapewniających funkcjonowanie tych systemów w sposób bezpieczny, niezawodny oraz racjonalny, tj. po możliwie najniższych kosztach. W tym kontekście, system logistyczny jest systemem obsługowym o określonej strukturze przestrzenno – czasowej, w którym obsługiwane są materiały traktowane jako zgłoszenia do systemu.

Jednym z warunków sprawnego działania tak postrzeganego systemu obsługowego jest dostosowanie wszystkich ogniw łańcucha logistycznego – zwłaszcza czasów obsługi (tzw. potencjału obsługowego) - do rytmu czasowego nadchodzenia zgłoszeń (strumieni materiałowych). W przeciwnym wypadku w systemie mogą powstawać spiętrzenia i kolejki.

Natomiast jeśli ogniwa łańcucha logistycznego zostaną dobrane z nadmiernym zapasem potencjału obsługowego, to wprawdzie nie

wystąpią kolejki, ale koszty systemu mogą być zbyt wysokie.

Analiza zagadnienia tworzenia kolejek nie jest zdaniem łatwym – zwłaszcza

w przypadkach, gdy zgłoszenia do systemu nadchodzą nieregularnie (w sposób losowy) oraz gdy czas obsługi tych zgłoszeń w poszczególnych ogniwach łańcucha logistycznego jest również zmienną losową.

Celem niniejszego artykułu jest analiza problemu tworzenia kolejek w systemach logistycznych w aspekcie procesów przepływu strumieni ładunków. Cel ten zrealizowano w oparciu o literaturę przedmiotu.

## 2. Przepływy strumieni ładunków w systemach logistycznych

W podsystemach magazynowych przepływy materiałowe mogą mieć różne struktury przestrzenno – czasowe, które są klasyfikowane najczęściej na podstawie<sup>1</sup>:

- geometrycznej formy strumieni ładunków,
- czasowej transformacji strumieni ładunków,

Geometryczna forma strumienia ładunków może mieć strukturę: liniową, pętlową, kołową, konwergentną, dywergentną lub heterogenną (rys. 2.1).

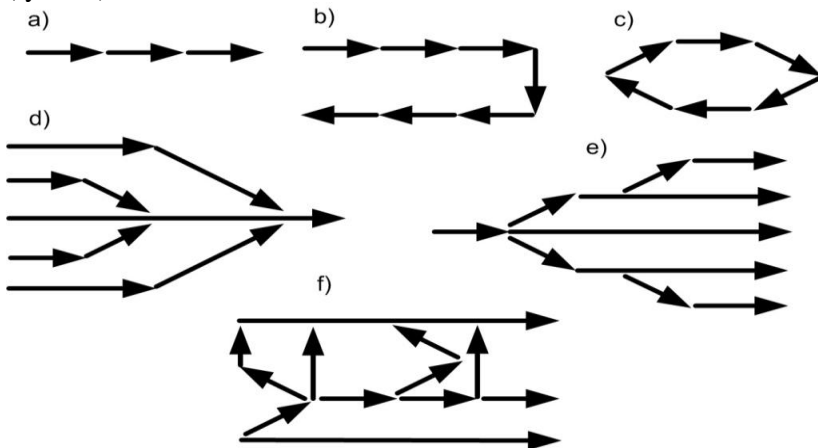

**Rysunek 2.1 Podstawowe formy geometryczne strumieni przepływów materiałowych w podsystemach magazynowych: a) liniowa, b) pętlowa, c) kołowa, d) konwergentna, e) dywergentna, f) heterogenna**

<sup>1</sup> Z. Korzeń, *Logistyczne systemy transportu...*, op. cit., s. 76.



Źródło: opracowanie własne na podstawie: Z Korzeń., *Logistyczne systemy transportu bliskiego i magazynowania. Projektowanie. Modelowanie. Zarządzanie*, t.2, Wyd. ILiM, Poznań 1999, s. 75-76.

Każda z tych struktur – w zależności od potrzeb i możliwości inwestycyjnych – może być rozbudowana w płaszczyźnie (struktury płaskie) lub w przestrzeni (struktury przestrzenne).

Transformacja czasowa strumieni ładunków, realizowana w systemach magazynowych, obejmuje procesy dzielenia, łączenia (konsolidacji), zmian częstotliwości taktowania przepływu ładunków oraz czasowych zmian przyjęć i wydań ładunków (składowanie/buforowanie tymczasowe)<sup>2</sup>. Podstawowe formy transformacji czasowej strumieni materiałowych przedstawiono na rys. 2.2.

W bardziej rozbudowanych systemach mogą występować sekwencje podstawowych form transformacji – np. operacje dzielenia ładunków mogą być realizowane równolegle ze zmianą częstotliwości taktowania przepływu (ładunki rozdzielone na mniejsze są tymczasowo składowane w miejscach buforowania).

Na ogół, nie wszystkie warianty transformacji czasowej strumieni materiałów występują jednocześnie, ale niektóre z nich są charakterystyczne dla danego rodzaju podsystemu magazynowego. Na przykład w magazynach przedsiębiorstw produkcyjnych dominują procesy dzielenia i taktowania częstotliwości przepływu strumieni materiałów (warianty c i d, rys. 2.2), realizowane w celu zapewnienia rytmicznego zaopatrzenia produkcji. Natomiast w magazynach przedsiębiorstw handlowych przeważają procesy dzielenia lub scalania ładunków stosownie do wymagań klientów.

Transformacje czasowe strumieni materiałowych są realizowane w technicznych podsystemach: rozdzielających i zbierających (skupiających), przy czym jest charakterystyczne, że każdy z tych podsystemów spełnia dodatkowo – w zależności od potrzeb – funkcje przewożenia i/lub buforowania ładunków.

Transport wewnętrzny stanowi swoisty „krwioobieg” przepływów materiałów w systemach logistycznych, przy czym – zwłaszcza w przypadku systemów magazynowych – strukturę funkcjonalną tego obiegu tworzą na ogół trzy podstawowe moduły<sup>3</sup>:

---

<sup>2</sup> M. Sokółski, *Technologie usług magazynowania, CL Consulting i Logistyka, Oficyna Wydawnicza NDiO, Wrocław 2013, s. 48.*

<sup>3</sup> *Ibidem*, s. 50.

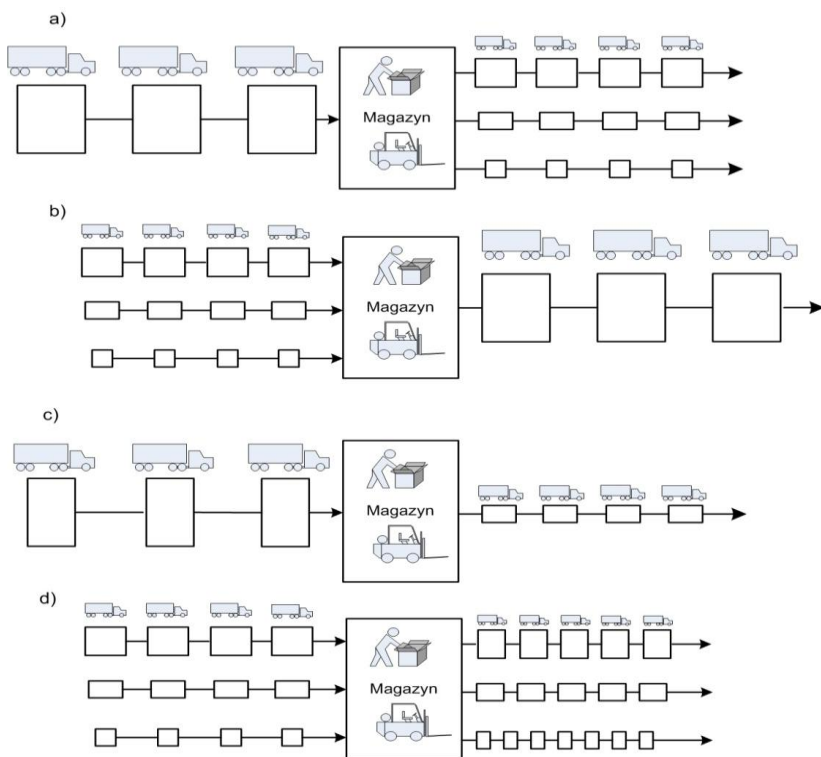

**Rysunek 2.2 Podstawowe formy transformacji czasowej strumieni materiałowych w podsystemach magazynowych:**  
**a) dzielenie ładunków, b) łączenie ładunków, c) zmiana częstotliwości taktowania przepływów, d) dzielenie i zmiany częstotliwości taktowania przepływów**

*Źródło: opracowanie własne na podstawie: M. Sokółski, Technologie usług..., op. cit., s.48-49.*

a) elementy połączeniowe, których zadaniem jest transportowanie i/lub buforowanie ładunków; elementy połączeniowe mogą być typu ciągłego (przenośniki) lub typu cyklicznego (dźwignice, wózki magazynowe, pojazdy),

b) elementy rozgałęziające, których zadaniem jest rozdzielanie strumienia głównego na dwa lub więcej strumieni cząstkowych; w zależności od wariantu konstrukcyjnego wyróżnia się elementy o działaniu ciągłym oraz elementy o działaniu cyklicznym,

c) elementy skupiające, których zadaniem jest łączenie strumieni

cząstkowych w jeden strumień głównym; elementy skupiające wykonują zatem odwrotne zadania w stosunku do elementów rozdzielających.

Z tych komponentów tworzone są bardziej złożone struktury podsystemów rozdzielających (rys. 2.3) oraz podsystemów skupiających (rys. 2.4) strumienie ładunków.

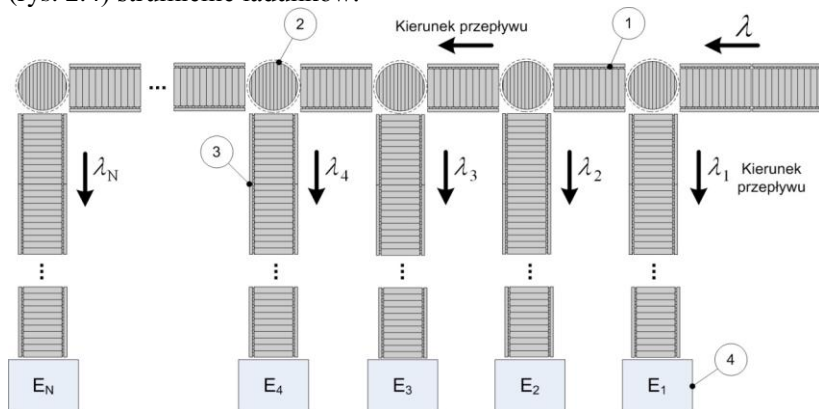

**Rysunek 2.3** Struktura podsystemu rozdzielającego główny strumień materiałowy: 1 – trasa strumienia głównego, 2 – element rozdzielający, 3 – trasa strumienia rozgałęzionego, 4 – punkt docelowy

*Źródło: opracowanie własne na podstawie: M. Sokólski, Technologie usług..., op. cit., s. 59.*

Podsystemy rozdzielające przepływy materiałowe (rys. 2.3) spełniają funkcje dostarczania ładunków do wielu punktów – np. do miejsc składowania, pakowania, kontroli, wydawania itp. i z tego względu mają one charakter podsystemów dostawczych.

W systemach transportowych o dużym natężeniu przepływu materiałów podsystemy rozdzielające strumienie ładunków budowane są na ogół przy wykorzystaniu środków transportu przepływowego – tj. przenośników taśmowych, łańcuchowych lub wałkowych.

Cechą charakterystyczną takich ciągów transportowych jest typowa struktura modułowa tworzona z elementów powtarzalnych, takich jak np. segmenty załadownicze, segmenty proste, segmenty łukowe, segmenty rozdzielające: kątowe, przesuwne lub obrotowe. Dzięki temu – w razie potrzeby – trasy ciągów transportowych mogą być stosunkowo łatwo rozbudowywane.

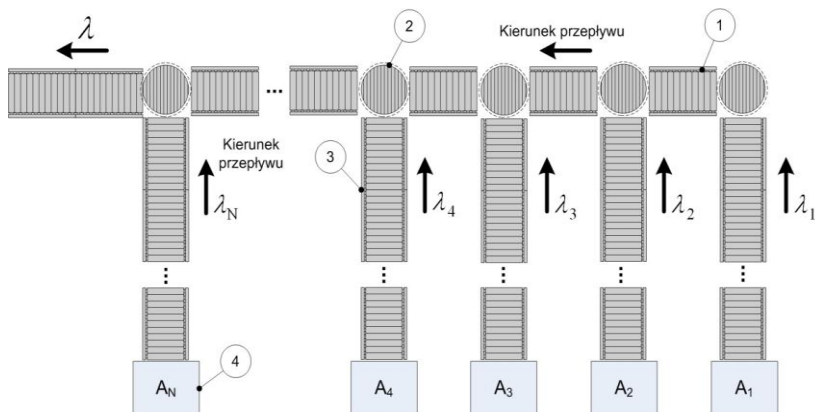

**Rys. 2.4** Struktura podsystem zbierającego strumienie materiałowe: 1 – trasa strumienia głównego, 2 - element skupiający, 3 – trasa strumienia dopływającego, 4 – punkt wyjściowy

Źródło: opracowanie własne na podstawie: M. Sokółski, *Technologie usług...*, op. cit., s. 64.

W podsystemie rozdzielającym spełniony jest warunek:  $\lambda = \lambda_1 + \lambda_2 + \lambda_3 + \dots + \lambda_N$ , gdzie  $N$  – liczb pojedynczych strumieni o natężeniu  $\lambda_i$  kierowanych do punktów docelowych  $E_i$

Podsystemy skupiające przepływy materiałowe (rys. 2.4) spełniają funkcje zbierania ładunków z wielu punktów (źródeł) i kierowania ich do strumienia głównego. Z tego względu mają one charakter podsystemów odbiorczych.

Analogicznie jak w podsystemach rozdzielających, w podsystemach skupiających strumienie ładunków spełniony jest warunek:  $\lambda_1 + \lambda_2 + \lambda_3 + \dots + \lambda_N = \lambda$ .

Jednym z podstawowych składników logistycznych systemów zaopatrzenia, produkcji oraz dystrybucji są podsystemy przepływu dóbr fizycznych, a wśród nich szczególnie znacznie mają podsystemy transportowo – magazynowe. W podsystemach tych występują szczególne relacje między przepływami materiałowymi i przepływami informacji – przy czym informacja wyprzedza przepływ materiałowy, sygnalizując jednocześnie co?, jak?, kiedy? i gdzie? powinno działać się z materiałem.

Wśród czynników charakteryzujących podsystemy przepływu materiałów pod względem technicznym szczególne znaczenie mają:

▪ Wydajność teoretyczna komponentów podsystemu transportowego  $Q$  (tzw. przepustowość), wynikająca z wartości parametrów technicznych poszczególnych środków technicznych tworzących strukturę podsystemu. Miernikiem przepustowości jest maksymalna liczba/masa ładunków w jednostce czasu, które mogą teoretycznie przepływać poprzez poszczególne elementy podsystemu. Przepustowość  $Q$  komponentów o działaniu ciągłym zależy od maksymalnej dopuszczalnej prędkości  $v$  przemieszczania ładunków oraz minimalnej dopuszczalnej odległości  $a$  pomiędzy ładunkami – zgodnie ze wzorem:  $Q = 3600 \frac{v}{a}$ . Przepustowość  $Q$  komponentów o działaniu

cyklicznym zależy natomiast od prędkości jazdy  $v$ , odległości transportowej  $L$  oraz liczby  $M$  zastosowanych środków technicznych –

zgodnie ze wzorem:  $Q = 3600 \frac{M}{t_0 + \frac{2L}{v}}$ . (gdzie:  $t_0$  – łączny czas

operacji załadunku/rozładunku, przyspieszania i hamowania środka transportu).

Wydajność rzeczywista podsystemu  $Q_{rz}$  charakteryzująca jego zdolność do przekazywania strumieni ładunków – bez zakłóceń – poprzez wszystkie komponenty tworzące strukturę podsystemu transportowego. Wydajność rzeczywista uwzględnia m.in. możliwość powstawania spiętrzeń i tworzenia się kolejek w podsystemie przepływu materiałów. Innymi słowy, wydajność rzeczywista wyraża maksymalne natężenie strumieni materiałów, przy którym czas spiętrzania ładunków oraz długość powstających kolejek nie przekraczają wartości dopuszczalnych.

### 3. Model centrum logistycznego z wykorzystaniem teorii kolejek

Model matematyczny funkcjonowania kolejek opiera się na teorii procesów stochastycznych. Istotą teorii obsługi masowej są następujące terminy<sup>4</sup>:

1. *Zgłoszenie* – w teorii kolejek zakłada się losowy charakter powstawania żądań obsługi tzn. odstęp czasu między sąsiednimi chwilami przybywania zgłoszeń do systemu jest nieujemną zmienną losową. Podobnie jest z innymi badanymi wielkościami.

---

<sup>4</sup> M. Jacyna, J. Żak, *Zastosowanie kolejek do analizy i oceny procesu transportowego w centrum logistycznym*, „Logistyka” nr 4/2012, s. 277.

2. *Wejściowy strumień zgłoszeń* – ciąg kolejnych odstępów czasu pomiędzy sąsiednimi chwilami przybycia zgłoszeń do systemu. Najczęściej jest *rekurencyjny* tzn. odstępy te są od siebie niezależne i mają jednakowy rozkład.
3. *Urządzenie obsługi* – osoba lub urządzenie, które wykonuje obsługę. Czas obsługi jest również nieujemną zmienną losową i podobnie jak przy strumieniu wejściowym najczęściej zakładamy, że obsługa jest *rekurencyjna* tzn. urządzenia obsługi pracują niezależnie od siebie, a czas obsługi każdego urządzenia ma taki sam rozkład.
4. *Kolejka* – kolejka w systemie obsługi powstaje, gdy nie ma możliwości w danej chwili czasu obsłużenia wszystkich zgłoszeń, ponieważ wszystkie urządzenia są w tej chwili zajęte.

Podstawowym warunkiem do stosowania metod analitycznych jest założenie, iż strumień zgłoszeń jest:

- strumieniem prostym (tzn. stacjonarnym) – prawdopodobieństwo pojawienia się zgłoszeń zależy tylko od długości odpowiednich przedziałów czasu, lecz nie zależy od ich położenia na osi czasu. Pojawienie się  $k$  zgłoszeń w przedziale  $(t, t+\tau)$  jest funkcją zmiennych  $k$  i  $\tau$ ;
- bez pamięci – prawdopodobieństwo pojawienia się  $k$  zgłoszeń w pewnym przedziale czasu nie zależy od tego ile zgłoszeń  $i$  w jaki sposób wystąpiło do tego momentu;
- pojedynczy – brak możliwości pojawienia się dwóch bądź większej liczby zgłoszeń w tym samym czasie.

Formułując model teorii kolejkowej należy określić:

- typ rozkładu prawdopodobieństwa zmiennych losowych;
- zależność lub niezależność zmiennych losowych czasu czekania na zgłoszenie i czasu obsługi;
- skończoną lub nieskończoną wartość liczby stanowisk obsługi, długości poczekalni;
- obowiązującą w systemie dyscyplinę obsługi.

Zmiennymi losowymi występującymi w modelu analizowanego typu są:

- a) czas upływający między wejściem do systemu kolejnych zgłoszeń;
- b) czas obsługi jednego zgłoszenia przez stanowisko obsługi;
- c) liczba stanowisk obsługi;
- d) liczba miejsc w poczekalni oczekujących na obsługę.

Prosty model kolejkowy został przedstawiony na rysunku 2.5, gdzie  $\lambda$ WE – jest intensywnością napływu zgłoszeń do systemu, natomiast  $\mu$  – jest intensywnością czasu obsługi.

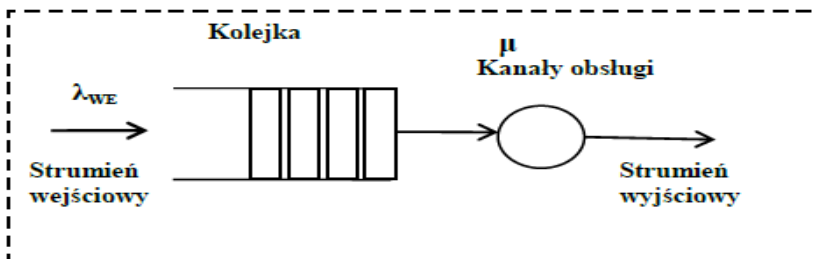

**Rysunek 2.5 Schemat prostego systemu kolejkowego**

Źródło: opracowanie własne na podstawie M. Jacyna, J. Żak, *Zastosowanie kolejek...*, op. cit., s. 278.

Opisując system kolejkowy można posłużyć się klasyfikacją systemów kolejkowych opracowaną przez A. M. Lee<sup>5</sup>. Kod opisujący system kolejkowy ma postać:

$$X / Y / m / d / l$$

gdzie:

$X$  – rodzaj rozkładu wejściowego strumienia zgłoszeń do systemu,

$Y$  – rodzaj rozkładu czasów obsługi zgłoszeń,

$m$  – liczba kanałów obsługi w systemie,

$d$  – dyscyplina kolejki,

$l$  – rozmiar systemu, czyli maksymalna liczba zgłoszeń mogących pomieścić się w systemie, tzn. w kanałach obsługi i w poczekalni.

Najczęściej występujące rozkłady wejściowego strumienia zgłoszeń oraz czasów obsługi zgłoszeń, oznaczono symbolami:

$M$  – rozkład wykładniczy czasów obsługi zgłoszeń albo odstępów czasu między sąsiednimi zgłoszeniami, tzn. poissonowski rozkład przybyć,

$E_k$  – rozkład Erlanga rzędu  $k$  czasów obsługi zgłoszeń albo odstępów czasu między sąsiednimi zgłoszeniami,

$D$  – strumień zdeterminowany lub regularny,

$G$  – strumień posiadający dowolny rozkład czasów obsługi,

$GI$  – strumień ogólnego typu, dowolny i niezależny,

$H_r$  – rozkład hyperwykładniczy  $r$  rzędu,

$C_k$  – rozkład Cox'a  $k$  rzędu,

$K_n$  – rozkład  $\chi^2$  odstępów między zgłoszeniami (z  $n$  stopniami swobody) lub rozkład  $\chi$  czasów obsługi.

W regulaminie obsługi kolejki (dyscypliny) – określającym

<sup>5</sup> M. Jacyna, J. Żak, *Zastosowanie kolejek...*, op. cit., s. 278.

kolejność wybierania zgłoszeń z kolejki znajdującej się w poczekalni wyróżniamy następujące zasady:

- *FIFO* – jako pierwszy obsługiwany jest klient najdłużej oczekujący w kolejce,
- *LIFO* – jako pierwszy obsługiwany jest klient, który przybył do kolejki ostatni,
- *RSS* – klienci wybierani są do obsługi z kolejki w sposób przypadkowy,
- *RR* – zgłoszenia obsługiwane są zgodnie z opisaną powyżej dyscypliną *FIFO*, ale obsługa jest przerywana na końcu przedziału czasu nazywanego kwantem  $T$ . W przypadku, gdy obsługa zgłoszenia nie zakończono, zgłoszenie zajmuje miejsce w poczekalni z prawdopodobieństwem  $p$  albo opuszcza system w sytuacji, gdy obsługa została zakończona z prawdopodobieństwem  $(1-p)$ ,
- *PS* – szczególny przypadek *RR*, w którym przedział czasu (kwant)  $T$  dąży do  $0$ , a prawdopodobieństwo  $p$  do  $1$ . Iloraz  $E(C) = T / (1-p)$  jest stały.  $C$  - czas trwania obsługi zgłoszenia. Regulamin kolejki oparty na tych zasadach *RR* i *PS* bywa stosowany w informatyce.

Jednym z częściej spotykanych systemów jest system kolejek  $M/M/n/FIFO/\infty$ , w którym zakładamy, że kanały obsługi, których jest  $m$ , posiadają identyczne intensywności obsługi  $\mu$ . W takim przypadku system może znajdować się w następujących stanach:

$$\underbrace{E_0, E_1, \dots, E_i, \dots, E_n}_{\text{Stany bez kolejki}}, \underbrace{E_{n+1}, E_{n+2}, \dots, E_j, \dots, E_\infty}_{\text{Stany z kolejką}}$$

gdzie:

$E_0$  – wszystkie kanały obsługi są wolne,

$E_1$  – jeden kanał obsługi jest zajęty, żaden klient nie czeka w poczekalni,

$E_i$  –  $k$  kanałów jest zajętych, żaden klient nie czeka w poczekalni,

$E_n$  – wszystkie kanały są zajęte, żaden klient nie czeka w poczekalni,

$E_{n+1}$  – wszystkie kanały są zajęte, jeden klient czeka w poczekalni,

$E_j$  – wszystkie kanały są zajęte,  $j-n$  klientów czeka w poczekalni,

$E_\infty$  – wszystkie kanały są zajęte, nieskończenie wielu klientów czeka w poczekalni.

Rozwiązaniem zadań opisanych przy pomocy teorii kolejek są parametry opisujące zachowanie się systemu tj.: długość kolejki i czas oczekiwania w kolejce.



#### 4. Problem kolejek w systemach logistycznych

Warunkiem koniecznym niezakłóconego przepływu ładunków przez element składowy podsystemu transportowego jest to, aby chwilowe natężenie strumienia materiałów (ładunków)  $\lambda_i$  nie było większe od wydajności teoretycznej (przepustowości)  $Q_i$  tego elementu, czyli – aby tzw. współczynnik wykorzystania potencjału transportowego  $\rho_i$  spełniał warunek:  $\rho_i = \frac{\lambda_i}{Q_i} \leq 1$

Postulat ten jest warunkiem wystarczającym dla sprawnego działania podsystemu transportowego jedynie w prostych przypadkach deterministycznych, tj. takich kiedy zgłoszenia (ładunki) nadchodzą w stałych odstępach czasowych oraz czas ich obsługi (przyjmowania do systemu) jest stały i krótszy niż czas zgłaszania się kolejnych ładunków.

W rzeczywistych systemach logistycznych przepływy materiałów odbywają się jednak na ogół w sposób losowy, tzn.:

- ładunki nadchodzą w nieregularnych odstępach czasowych,
- długość obsługi poszczególnych ładunków jest zróżnicowana – w zależności np. od rodzaju i wielkości ładunków.

W tych warunkach analiza działania podsystemu transportowego wymaga uwzględnienia losowych aspektów procesu przepływu materiałów – zwłaszcza:

- rozkładu prawdopodobieństwa nadchodzenia zgłoszeń (ładunków) do systemu,
- rozkładu prawdopodobieństwa czasów obsługi zgłoszeń (ładunków) w systemie.

W praktyce – w celu scharakteryzowania podsystemów przepływu materiałów, traktowanych jako systemy obsługowe, najczęściej stosuje się symbolikę wprowadzoną przez D.G. Kendalla<sup>6</sup>, zgodnie z którą oznaczenie systemu ma postać  $X/Y/n/N/f_i^j$ , gdzie:  $X$  – typ strumienia wejściowego,  $Y$  – typ rozkładu statystycznego czasu obsługi,  $n$  – liczba stanowisk obsługowych w systemie,  $N$  – maksymalna liczba miejsc oczekiwania (dopuszczalna długość kolejki),  $f_i^j$  – regulamin obsługi (indeks „i”) i regulamin kolejki (indeks „j”).

---

<sup>6</sup> J. Marcinkowski, *Rozkłady prawdopodobieństwa przydatne w rozwiązywaniu problemów transportu*, Oficyna Wydawnicza Politechniki Wrocławskiej, Wrocław 1997, s. 48.

System z teoretycznie nieograniczoną liczbą stanowisk oznacza się symbolem  $n=\infty$ . System z tzw. odmową (nie dopuszczający kolejek) oznacza się symbolem  $N=0$ . System z ograniczoną długością kolejki jest oznaczany przez  $N<\infty$ , natomiast system z nieograniczoną długością kolejki ma oznaczenie  $N=\infty$ . W odniesieniu do regulaminu obsługi ładunków, wskaźnik „i” oznacza:

- $i=0$  – obsługa niepriorytetowa,
- $i=1$  – względny priorytet bez przerywania bieżącej obsługi,
- $i=2$  – bezwzględny priorytet z przerywaniem obsługi zgłoszenia z niższym priorytetem i przyjęciem do obsługi zgłoszenia z wyższym priorytetem.

W odniesieniu do regulaminu kolejki, wskaźnik „j” oznacza sposób ustawienia zgłoszenia w kolejce jeśli liczba miejsc jest ograniczona – zgodnie z tym:

- $j=0$  – priorytet nie obowiązuje przy wejściu do systemu,
- $j=2$  – bezwzględny priorytet: zgłoszenie z wyższym priorytetem usuwa z kolejki jedno ze zgłoszeń z niższym priorytetem.

Znaczenie kolejnych symboli literowych objaśniono w tab. 2.1.

*Tabela 2.1*

**Oznaczenia systemów obsługowych wg klasyfikacji Kendalla**

<b>Symbol</b>	<b>X (charakter strumienia zgłoszeń)</b>	<b>Y (charakter czasu obsługi)</b>
<b>M</b>	• Rozkład Poissona strumienia zgłoszeń – rozkład wykładniczy odstępów między zgłoszeniami).	• Rozkład wykładniczy czasu obsługi.
<b>E</b>	• Rozkład Erlanga odstępów między zgłoszeniami.	• Rozkład Erlanga czasu obsługi.
<b>K</b>	• Rozkład $\chi^2$ odstępów między zgłoszeniami.	• Rozkład $\chi^2$ czasu obsługi.
<b>D</b>	• Regularne zgłoszenia deterministyczne	• Stały czas obsługi.
<b>G</b>	• Przypadek ogólny – brak założeń.	• Dowolny rozkład czasu obsługi.
<b>G<sub>j</sub></b>	• Rekurentny proces zgłoszeń.	

*Źródło: opracowanie własne na podstawie: J. Marcinkowski, Rozkłady prawdopodobieństwa..., op. cit., s. 49.*

Istotnymi parametrami charakteryzującymi działanie systemu obsługowego są:

- Natężenie strumienia zgłoszeń (klientów)  $\lambda$  wyrażające przeciętną liczbę zgłoszeń w jednostce czasu. W teorii systemów obsługowych wielkość  $\lambda$  jest nazywana średnim wskaźnikiem wejścia.
- Natężenie strumienia obsługi  $\mu$ , wyrażające przeciętną liczbę zgłoszeń obsługiwanych przez system w jednostce czasu. W teorii systemów obsługowych wielkość  $\mu$  jest nazywana średnim wskaźnikiem obsługi.

Na podstawie wzajemnej relacji między wskaźnikami  $\lambda$  oraz  $\mu$ , wyróżnia się następujące przypadki:

Stabilny system obsługowy, gdy  $\lambda < \mu$  – prawdopodobieństwo powstawania kolejek o określonej długości jest stałe w jednostce czasu.

Niestabilny system obsługowy, gdy  $\lambda \geq \mu$  – prawdopodobieństwo powstawania długich kolejek rośnie. Dotyczy to również przypadku, gdy  $\lambda = \mu$  wtedy bowiem nie jest możliwe „wchłonięcie” kolejek powstałych, gdy system był chwilowo nieczynny (np. wskutek awarii).

W probabilistycznym podejściu do zagadnienia kolejek przyjmuje się najczęściej następujące założenia podstawowe charakteryzujące system obsługi zgłoszeń (klientów, ładunków itp.):

- strumień zgłoszeń do systemu ma charakter rozkładu Poissona o parametrze  $\lambda$ ,
- intensywność obsługi zgłoszeń ma charakter rozkładu wykładniczego o parametrze  $\mu$ ,
- wartości parametrów  $\lambda$  oraz  $\mu$  są przyjmowane jako stałe, przy czym wielkość  $\lambda$  jest nazywana średnim wskaźnikiem (stopą) wejścia, natomiast wielkość  $\mu$  – średnim wskaźnikiem obsługi zgłoszeń (jest to odwrotność średniego czasu obsługi zgłoszeń).

Spiętrzenie ładunków i kolejki w systemie ze stałym czasem obsługi zgłoszeń  $t_0 = const$  mogą powstawać w przypadkach, gdy zgłoszenia (klienci lub ładunki) nadchodzą w sposób nierównomierny – tj. w różnych odstępach czasowych  $\Delta t$ : krótszych lub dłuższych niż czas obsługi  $t_0$  wynikający ze zdolności przyjmowania zgłoszeń do systemu.

Kolejki w systemie obsługowym mogą tworzyć się również, gdy średnia odstępów czasowych  $\Delta t_{sr}$  nadchodzenia zgłoszeń jest równa czasowi obsługi  $t_0$  – czyli, gdy jest spełniony warunek  $\Delta t_{sr} = t_0$ . W takich przypadkach nawet stosunkowo niewielka seria zgłoszeń nadchodzących w odstępach krótszych niż czas obsługi  $t_0$  może spowodować powstanie kolejki, której system nie będzie w stanie rozładować.

## 5. Przykłady rachunkowe obliczeń kolejek w wybranych strukturach systemów obsługowych

Pierwszym analizowanym przykładem jest przypadek systemu obsługi zgłoszeń w zakładzie produkcyjnym. Systemem obsługowym jest podsystem transportu wewnętrznego – z jednym stanowiskiem przyjmowania ładunków – między strefą produkcji i strefą wewnętrznego magazynu wyrobów gotowych. Zgłoszeniami do systemu są jednostki ładunkowe zawierające wyroby dostarczane w pojemnikach bezpośrednio ze strefy produkcji. Na wejściu do podsystemu transportowego – na stanowisku obsługowym - ładunki są sprawdzane pod względem ilościowym oraz asortymentowym – zgodnie z listą kompletacyjną – i kierowane do magazynu. W przykładzie przyjęto następujące założenia podstawowe: wyroby ze strefy produkcji (zgłoszenia do systemu) nadchodzą w sposób nieregularny, w różnych odstępach czasowych, system posiada jedno stanowisko przyjmowania ładunków (jeden kanał obsługi), zgłoszenia (ładunki) są obsługiwane według kolejności przybywania do stanowiska obsługowego – obowiązuje zatem zasada FIFO (pierwsze przyszło pierwsze wyszło); nie są uwzględniane żadne preferencje w stosunku do wybranych ładunków, czas obsługi jednostek ładunkowych, jest stały i wynosi alternatywnie (w zależności od rozpatrywanego wariantu):  $t_0=4 \text{ min}$ ,  $t_0=3 \text{ min}$  lub  $t_0=2 \text{ min}$ .

W analizie uwzględniono sekwencję 10 kolejnych zgłoszeń, nadchodzących w różnych losowych odstępach czasowych  $\Delta t$  – przy średniej wynoszącej  $\Delta t_{(sr)} = 2 \text{ min}$ . Podstawowe dane wyjściowe i wyniki obliczeń zaprezentowano w tab. 2.2 oraz na rys. 2.6.

Z analizowanego przykładu wynika m.in., że – w warunkach nierównomiernego nadchodzenia zgłoszeń (wyrobów ze strefy produkcji) – czas obsługi (przyjmowania ładunków do podsystemu transportu wewnętrznego) ma istotny wpływ na czas oczekiwania – przy czym zmniejszenie czasu obsługi zmniejsza czas oczekiwania zgłoszeń.

Dla stałego czasu obsługi  $t_0 = 4 \text{ min}$  każde kolejne zgłoszenie (począwszy od zgłoszenia nr 2) oczekuje w kolejce na obsługę, przy czym sumaryczny czas oczekiwania wszystkich zgłoszeń wynosi  $\Sigma t_{ocz} = 92,5 \text{ min}$ , co daje średnią  $t_{sr} = 9,2 \text{ min}$ . W tych warunkach system obsługowy zachowuje się niestabilnie, bowiem chwilowa intensywność nadchodzenia zgłoszeń  $\lambda [\text{min}^{-1}]$  jest większa niż potencjał obsługowy systemu  $\mu = 1/t_0 = 1/4 [\text{min}^{-1}]$  (tzw. stopa obsługi). W wyniku tego czasy oczekiwania kolejnych klientów zgłaszających się do systemu zwiększają się i kolejki rosną.

Tabela 2.2

**Dane do przykładu obliczeniowego nr 1 – systemu ze stałym czasem obsługi i nierównomiernym nadchodzeniem zgłoszeń (klientów)**

Nr zgłoszenia (ładunku)	1	2	3	4	5	6	7	8	9	10
Odstęp czasowy między zgłoszeniami, (min)	3	3	2	1	2,5	1	2	1	2	2,5
Czas skumulowany, (min)	3	6	8	9	11,5	12,5	14,5	15,5	17,5	20
<b>Wariant stałego czasu obsługi</b>										
Czas obsługi, (s)	4	4	4	4	4	4	4	4	4	4
Moment rozpoczęcia obsługi, min	3	7	11	15	19	23	27	31	35	39
Moment zakończenia obsługi, min	7	11	15	19	23	27	31	35	39	43
Czas oczekiwania na obsługę, min	0	1	3	6	7,5	10,5	12,5	15,5	17,5	19
Średni czas oczekiwania, (min)	9,25									
<b>Wariant zwiększenia potencjału usługowego</b>										
Czas obsługi, (min)	3	3	3	3	3	3	3	3	3	3
Moment rozpoczęcia obsługi, (min)	3	6	9	12	15	18	21	24	27	30
Moment zakończenia obsługi, (min)	6	9	12	15	18	21	24	27	30	33
Czas oczekiwania na obsługę, (min)	0	0	1	3	3,5	5,5	6,5	8,5	9,5	10
Średni czas oczekiwania, (min)	4,75									
<b>Wariant skrócenia czasu obsługi ładunków</b>										
Czas obsługi, (min)	2	2	2	2	2	2	2	2	2	2
Moment rozpoczęcia obsługi, (min)	3	6	8	10	12	14	16	18	20	22
Moment zakończenia obsługi, (min)	5	8	10	12	14	16	18	20	22	24
Czas oczekiwania na obsługę, (min)	0	0	0	1	0,5	1,5	1,5	2,5	2,5	2
Średni czas oczekiwania, (min)	1,15									

*Źródło opracowanie własne.*

W przypadku zwiększenia potencjału usługowego, tj. zmniejszenia czasu obsługi ładunków do wartości  $t_0 = 3 \text{ min}$ , system jest w dalszym ciągu niestabilny. Czasy oczekiwania kolejnych zgłoszeń zwiększają się, chociaż są ok. 2-krotnie mniejsze niż w wariacie poprzednim z czasem obsługi  $t_0 = 4 \text{ min}$ . Sumaryczny czas oczekiwania 10 zgłoszeń wynosi  $\Sigma t_{ocz} = 47,5 \text{ min}$ , co daje średnią  $t_{sr} = 4,7 \text{ min}$ .

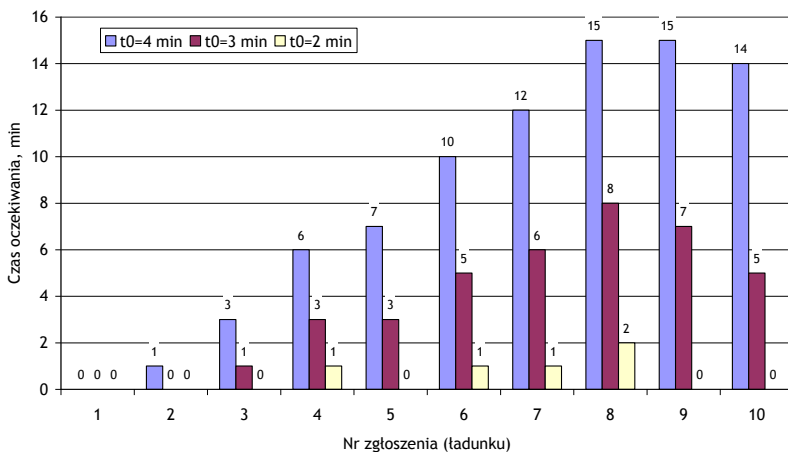

**Rysunek 2.6 Czas oczekiwania ładunków w jednostanowiskowym systemie obsługowym dla 3 wariantów czasów obsługi  $t_0$**

*Źródło opracowanie własne.*

Skrócenia czasu obsługi ładunków do wartości  $t_0 = 2 \text{ min}$  przyczynia się do istotnej poprawy efektywności działania systemu obsługowego. Mimo, że średnia intensywność natchodzenia zgłoszeń do systemu  $\lambda = 1/2 [\text{min}^{-1}]$  jest równa wartości potencjału obsługowego systemu  $\mu = 1/t_0 = 1/2 [\text{min}^{-1}]$ , to w systemie nadal tworzą się kolejki. Odnosi się to do zgłoszeń od 4 do 10, które oczekują na obsługę, ale sumaryczny czas oczekiwania jest znacznie mniejszy niż w poprzednich przypadkach i wynosi  $\Sigma t_{ocz} = 11,5 \text{ min}$ , co daje średnią  $t_{sr} = 1,1 \text{ min}$ .

Z przykładu tego wynika, że w celu zagwarantowania sprawnego przepływu ładunków w podsystemie transportu wewnętrznego możliwe są dwa rozwiązania: usprawnienie obsługi ładunków na wejściu do podsystemu (skrócenie czasu obsługi), zwiększenie liczby stanowisk obsługowych (stanowisk przyjmowania ładunków).

W przypadku zastosowania jednego stanowiska z czasem obsługi obniżonym do poziomu  $t_0 = 2 \text{ min}$ , średni czas oczekiwania ładunków na przyjęcie do systemu wynosi  $t_{sr} = 1,1 \text{ min}$ , co jest wartością akceptowalną.

Dla prostych, jednokanałowych systemów obsługowych – działających w warunkach losowych można przyjąć, że: zgłoszenia podlegają rozkładowi Poissona o stałym parametrze  $\lambda$ , czas obsługi zgłoszeń ma rozkład wykładniczy o stałym parametrze  $\mu$ ; z teorii obsługi masowej wynikają następujące zależności: funkcja gęstości

prawdopodobieństwa powstania kolejki  $n$  zgłoszeń oczekujących na

obsługę:  $f_N = \left(\frac{\lambda}{\mu}\right)^n \left(1 - \frac{\lambda}{\mu}\right)$ , dystrybuanta prawdopodobieństwa

powstania kolejki  $n$  zgłoszeń oczekujących na obsługę:

$F_N = P(N \leq n) = 1 - \left(\frac{\lambda}{\mu}\right)^{1+N}$ , wartość oczekiwana długości kolejki:

$H = \frac{\lambda^2}{\mu(\mu - \lambda)} = \frac{\rho^2}{1 - \rho}$ , funkcja gęstości prawdopodobieństwa czasu

oczekiwania w kolejce  $n$  zgłoszeń:  $f_T(t) = \lambda \left(1 - \frac{\lambda}{\mu}\right) e^{-(\mu - \lambda)t}$ ,

dystrybuanta prawdopodobieństwa czasu oczekiwania w kolejce  $n$

zgłoszeń:  $F_T(t) = P(T \leq t) = 1 - \frac{\lambda}{\mu} e^{-(\mu - \lambda)t}$ , wartość oczekiwana

czasu oczekiwania w kolejce:  $\bar{t} = \frac{\lambda}{\mu(\mu - \lambda)} = \frac{\rho}{1 - \rho}$ , gdzie:  $\rho = \lambda/\mu -$

wskaźnik wykorzystania systemu.

Drugim przykładem poddanym analizie jest przypadek jednokanałowego systemu obsługowego. Rozpatrujemy ruch pojazdów na remontowanym odcinku drogi, na którym prace są wykonywane etapami, na połowie szerokości jezdni - bez wyłączania drogi z ruchu. Wykonawca jest zainteresowany, aby remontowane odcinki były jak najdłuższe, jednak przepustowość ruchu jest tym mniejsza, im dłuższy jest zwężony odcinek drogi<sup>7</sup>.

W tym kontekście należy wyznaczyć maksymalną długość remontowanego odcinka dopuszczalną ze względu na wymaganą płynność ruchu, czas oczekiwania oraz długość kolejki pojazdów oczekujących przed remontowanym odcinkiem drogi.

Do obliczeń przyjęto następujące założenia: natężenie ruchu pojazdów dojeżdżających do remontowanego odcinka drogi ma rozkład Poissona z parametrem  $\lambda = 4,0$ ; przepustowość zwężonego odcinka drogi ma rozkład wykładniczy o parametrze  $\mu$ , którego średnia wartość

---

<sup>7</sup> Podobny przykład jest rozpatrywany w książce: R. Faure, J.P. Boss, A. Le Garff, *Badania operacyjne*, PWN, Warszawa 1982, s. 53.

zależy od długości zwężonego odcinka  $L$  oraz dopuszczalnej prędkości ruchu  $v_{dop}$ , zgodnie ze wzorem:  $\mu = v_{dop}/L$ .

Analizę ruchu przeprowadzono dla kilku wartości parametru przepustowości  $\mu$  zwężonego odcinka drogi (wskaźnika zdolności obsługowej) z przedziału  $\mu = 4,0 \div 5,0$ . Na tej podstawie wyznaczono: wartości oczekiwane oraz 95-procentowe kwantyle długości kolejek, wartości oczekiwane oraz 95-procentowe kwantyle czasu oczekiwania. Wyniki obliczeń przedstawiono na rys. 2.7 i 2.8.

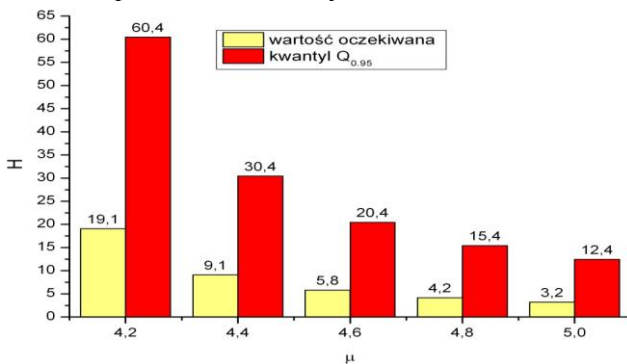

**Rysunek 2.7. Wartości oczekiwane oraz 95 - procentowe kwantyle długości kolejek pojazdów**

*Źródło: opracowanie własne.*

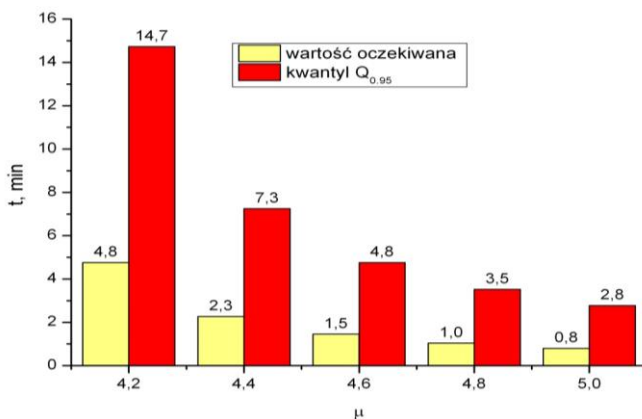

**Rysunek. 2.8. Wartości oczekiwane oraz 95 – procentowe kwantyle czasu oczekiwania pojazdów**

*Źródło: opracowanie własne.*



Jeśli założyć, że ze względu na niezbędną płynność ruchu średni czas oczekiwania pojazdów nie powinien być większy niż  $t \leq 2 \text{ min}$ , to wówczas wymagany wskaźnik przepustowości (zdolności obsługowej)  $\mu$  zwężonego odcinka drogi wyznacza się poprzez rozwiązanie równania (uwzględniając, że sens fizyczny ma tylko rozwiązanie dodatnie):

$$\bar{t} = \frac{4,0}{\mu(\mu - 4,0)} \leq 2,0 \rightarrow \mu_{(n-2)} \geq 4,45$$

Jeśli ponadto na zwężonym odcinku drogi wprowadzimy ograniczenie prędkości ruchu do wartości z przedziału  $v_{\max} = 15 \div 30 \text{ km/h}$ , to wówczas otrzymuje się następujące oszacowanie maksymalnej długości zwężonego odcinka drogi:

$$L_{\max} \cong \frac{v_{\max}}{\mu_{(n-2)}} = \frac{(15 \div 30) \cdot 10^3}{60 \cdot 4,45} \cong 56 \div 112 \text{ m}$$

Kolejny analizowany przykład to system obsługowy, w którym: strumień zgłoszeń jest opisany rozkładem Poissona, czas obsługi jest opisany rozkładem wykładniczym, występuje  $n$  jednakowych stanowisk obsługi. Do analizy wprowadza się następujące oznaczenia:

współczynnik wykorzystania systemu:  $\rho_n = \frac{\lambda}{\mu}$ , średni współczynnik

wykorzystania stanowiska:  $\rho = \frac{\rho_n}{n} = \frac{\lambda}{\mu \cdot n}$ , gdzie:  $\lambda$  – intensywność

strumienia zgłoszeń do systemu,  $\mu$  – intensywność obsługi (liczba zgłoszeń, którą stanowisko może obsłużyć w jednostce czasu),  $n$  – liczba stanowisk w systemie. Warunkiem stabilności systemu obsługowego jest, aby średni wskaźnik wykorzystania przepustowości

stanowiska był mniejszy od 1,  $\rho < 1$  – czyli:  $\rho = \frac{\rho_n}{n} = \frac{\lambda}{\mu \cdot n} < 1$

Prawdopodobieństwo  $P_0$ , że w całym systemie nie ma ani jednego zgłoszenia, czyli że wszystkie stanowiska są wolne, nazywa się współczynnikiem przestoju. W systemie tym prawdopodobieństwo to jest określone wzorem<sup>8</sup>:

$$P_0 = \frac{1}{\frac{n^{n-1} \rho^n}{(n-1)!(1-\rho)} + \sum_{i=0}^{n-1} \frac{n^i \rho^i}{i!}}$$

<sup>8</sup> J. Marcinkowski, *Rozkłady prawdopodobieństwa...*, op. cit., s. 66.

Dla systemu jednokanałowego, zawierającego  $n = 1$  stanowisko obsługowe, prawdopodobieństwo  $P_{01}$ , że w całym systemie nie ma ani jednego zgłoszenia, wyraża się wzorem:

$$P_{01} = \frac{1}{\frac{\rho_1}{0!(1-\rho_1)} + \sum_{i=0}^0 \frac{\rho_1^i}{0!}} = 1 - \rho_1 = 1 - \frac{\lambda}{\mu}$$

Na tej podstawie, prawdopodobieństwo, że w układzie jest dokładnie  $k$  zgłoszeń wyraża się w zależności od relacji między liczbą zgłoszeń  $k$

oraz liczbą stanowisk  $n$  – następującymi wzorami:  $P_k = \frac{\rho_n^k}{k!} \cdot P_0$  dla

$$0 \leq k \leq n \text{ oraz } P_k = \frac{\rho_n^k}{n!n^{k-n}} \cdot P_0 \text{ dla } n \leq k < \infty$$

Prawdopodobieństwo wystąpienia kolejki w systemie, tj. prawdopodobieństwo pojawienia się liczby zgłoszeń  $k$  przewyższających liczbę  $n$  stanowisk obsługowych w systemie (prawdopodobieństwo zdarzenia  $k > n$ ), jest równe:

$$P_{k>n} = P(k > n) = \frac{\rho_n^{n+1}}{n!(n-\rho_n)} \cdot P_0$$

Wartość oczekiwana kolejki  $H$  ładunków w systemie tym jest określona związkami<sup>9</sup>:  $H = \frac{\rho_n^{n+1}}{(n-\rho_n)^2(n-1)!} \cdot P_0$

Średnia liczba zgłoszeń  $U$  przebywających w tym systemie, tj. łączna liczba ładunków oczekujących oraz ładunków obsługiwanych, wynosi:

$$U = H + \rho_n$$

Średni czas oczekiwania ładunków w kolejce  $T_H$  oraz średni czas przebywania w systemie  $T_U$  wynoszą odpowiednio:

$$T_H = \frac{H}{\lambda} ; T_U = \frac{U}{\lambda} \text{ Wyniki obliczeń zaprezentowano w tab. 2.3.}$$

## Podsumowanie

Podsumowując powyższe rozważania związane z teorią tworzenia kolejek w wybranych strukturach systemów logistycznych, które dotyczą zagadnień kolejkowych:

---

<sup>9</sup> *Ibidem*, s. 70.

Tabela 2.3

## Wyniki analizy przykładu

Parametr	Wariant nr 1 $\lambda = 24 \text{ [h}^{-1}\text{]}$	Wariant nr 2 $\lambda = 28 \text{ [h}^{-1}\text{]}$
Minimalna wymagana liczba stanowisk	$n_{\min} \geq \frac{\lambda}{\mu} = \frac{24}{5} \rightarrow n_{\min} = 5$	$n_{\min} \geq \frac{\lambda}{\mu} = \frac{28}{5} \rightarrow n_{\min} = 6$
Współczynnik wykorzystania systemu	$\rho_n = \frac{\lambda}{\mu} = \frac{24}{5} = 4,80$	$\rho_n = \frac{\lambda}{\mu} = \frac{28}{5} = 5,60$
Współczynnik wykorzystania stanowiska	$\rho = \frac{\lambda}{n\mu} = \frac{24}{5 \cdot 5} = 0,96$	$\rho = \frac{\lambda}{n\mu} = \frac{28}{7 \cdot 5} = 0,93$
Współczynnik przestoju	$P_0 = \frac{1}{\frac{n^{n-1} \rho^n}{(n-1)!(1-\rho)} + \sum_{i=0}^{n-1} \frac{n^i \rho^i}{i!}} \cong 0,0017$	$P_0 = \frac{1}{\frac{n^{n-1} \rho^n}{(n-1)!(1-\rho)} + \sum_{i=0}^{n-1} \frac{n^i \rho^i}{i!}} \cong 0,0013$
Średnia długość kolejki	$H = \frac{\rho_n^{n+1}}{(n-\rho_n)^2(n-1)!} \cdot P_0 \cong 21,6$	$H = \frac{\rho_n^{n+1}}{(n-\rho_n)^2(n-1)!} \cdot P_0 \cong 11,5$
Średnia liczba zgłoszeń w systemie	$U = H + \rho_n \cong 26,4$	$U = H + \rho_n \cong 17,1$
Średni czas oczekiwania ładunków	$T_H = \frac{H}{\lambda} \cong 0,90 \text{ h} \cong 54,2 \text{ min}$	$T_H = \frac{H}{\lambda} \cong 0,41 \text{ h} \cong 24,7 \text{ min}$
Średni czas przebywania w systemie	$T_U = \frac{U}{\lambda} \cong 1,10 \text{ h} \cong 66,2 \text{ min}$	$T_U = \frac{U}{\lambda} \cong 0,61 \text{ h} \cong 36,7 \text{ min}$

Źródło: opracowanie własne na podstawie: J. Marcinkowski, Rozkłady prawdopodobieństwa..., op. cit., s. 70-72.

- w jednokanałowym systemie z losowo zmiennym strumieniem zgłoszeń (nie dającym się opisać znanym rozkładem statystycznym) o stałym czasie obsługi zamówień,
- w jednokanałowym systemie obsługowym, w którym strumień zgłoszeń ma rozkład Poissona, a czas obsługi – rozkład wykładniczy,
- w wielokanałowym systemie obsługowym, w którym strumień zgłoszeń ma rozkład Poissona, a czas obsługi – rozkład wykładniczy,

należy zauważyć, że nie wszystkie zagadnienia kolejkowe w realnych systemach obsługowych dają się opisać w sposób analityczny. Dotyczy

to w szczególności przypadków, gdy strumień zgłoszeń lub czas obsługi nie dają się opisać żadnym znanym rozkładem statystycznym. W związku z tym w celu zbudowania ogólnego modelu systemu kolejkowego niezbędne są informacje dotyczące przede wszystkim:

- rozkładu odstępów czasu między nadchodzeniem zgłoszeń (ładunków, klientów itp.) – w celu „dopasowania” adekwatnego rozkładu statystycznego,
- rozkładu czasów obsługi poszczególnych zgłoszeń (np. czasu na obsłużenie klienta, czasu na przyjęcie ładunku do systemu transportu wewnętrznego itp.) – w celu „dopasowania” adekwatnego rozkładu statystycznego,
- liczby stanowisk – w kontekście np. możliwości zwiększenia tej liczby,
- regulaminów kolejkowych – w kontekście np. ewentualnego wprowadzenia priorytetów obsługi określonych zgłoszeń.

Z przeprowadzonej analizy wynika, że na podstawie tych informacji można podjąć się zadania sformułowania modelu matematycznego systemu kolejkowego – w szczególności dokonać statystycznego opisu procesu nadchodzenia zgłoszeń oraz procesu obsługi tych zgłoszeń. Jednak w stosunkowo wielu przypadkach wielokanałowych systemów obsługowych o złożonej strukturze – w których np. czasy obsługi zgłoszeń na poszczególnych stanowiskach mają różne rozkłady statystyczne – nie istnieją ogólne modele analityczne. Takie przypadki analizowane są na ogół metodami symulacji komputerowej.

## Literatura

1. Faure R., Boss J.P., Le Garff A., *Badania operacyjne*, PWN, Warszawa 1982.
2. Jacyna M., Żak J., *Zastosowanie kolejek do analizy i oceny procesu transportowego w centrum logistycznym*, „Logistyka” nr 4/2012.
3. Korzeń Z., *Logistyczne systemy transportu bliskiego i magazynowania. Projektowanie. Modelowanie. Zarządzanie*, t.2, Wyd. ILiM, Poznań 1999.
4. Marcinkowski J., *Rozkłady prawdopodobieństwa przydatne w rozwiązywaniu problemów transportu*, Oficyna Wydawnicza Politechniki Wrocławskiej, Wrocław 1997.
5. Sokólski M., *Technologie usług magazynowania*, CL Consulting i Logistyka, Oficyna Wydawnicza NDiO, Wrocław 2013.
6. Бритченко И.Г. *Маркетинг менеджмент: новые решения / АА Шубин, РК Перепелция, ГИ Бритченко. - Донецк: ДонНУЕТ им. М. Туган-Барановского, 2007. - 326 с.*

**Kolbushkin Urii**

Professor

**Shevchenko Anna**

*PhD in Economics, Associate Professor*

*Department of Marketing*

*National Aviation University*

**Britchenko Igor**

*Doctor of Economics, Professor of the*

*Faculty of Technical and Economic*

*Sciences*

*State Higher Vocational School Memorial*

*of Prof. Stanislaw Tarnowski in Tarnobrzeg*

*(Kyiv, Ukraine; Tarnobrzeg Poland)*

**INFORMATION  
ENVIRONMENT  
OF  
INTERNATIONAL  
MARKETING**

The modern industry of information, information systems and communication networks, as well as information technology is of great importance for the development of international marketing and marketing tasks, since it allows marketers to conduct large-scale and deep marketing research, operate with a large number of data associated with the global marketing environment, markets, goods and firms of foreign countries, including through the connection to the databases of other organizations and through the unification of communication systems in the local, National, regional and international scale. It contributes to the effective collection, accumulation, processing, systematization and analysis of the multifaceted structure of marketing information, expands the possibility of using mathematical methods, complex, optimal econometric models for economic and market forecasting and modeling, creates conditions for increasing the efficiency and significant acceleration of the process of formation of marketing programs and management decisions, simulation tests in laboratory conditions, leads to the development of a new kind of marketing (e-marketing, etc.).

Informatization is a global process, due to the rapid development of scientific and technological progress, the transition to new generations of high technology technologies, systems of technology and materials and a new form of information exchange, which causes radical changes in the structure and nature of world economic and social development

[1]. This is the basis for defining a new stage in the development of society – an information society, in which, on a large scale, a huge amount of information is produced, accumulated, produced and consumed, and the area of information services is constantly evolving.

The information component provides not only orientation in processes and phenomena in the surrounding marketing environment, but also allows to optimize the construction of marketing programs and the adoption of managerial decisions and implement a strategy of active influence on the formation of market demand and sales promotion, to construct the market, as well as to carry out information, and not only sales, attacks on certain market segments. New information technology technologies have provided the basis for highly effective, scientifically sound, comprehensive marketing research, to prepare the basis for building quality marketing programs and the development of optimal plans for the development of production and sales and scientific and technical activities of the company.

The use of information technology, besides saving time, is a source of increasing the efficiency of the company and its management, since:

- allows for constant, timely and direct access to current information about products, consumers, market situation and internal state of affairs;
- provides effective coordination of internal activities through the system of transmission of audio signals (languages) and e-mail;
- organizes effective interaction with customers through the use of more informative and visual documents, as well as high-speed messaging systems;
- releases the necessary time for such high-performance activities as analysis, evaluation, interpretation, conclusions, recommendations.

Typically, such operations with information flows are only effective for large companies or specialized agencies and require significant financial and time costs, the availability of competent professionals, as well as a technologically advanced system of information support and, above all, advanced communications, communications, the latest comp computer technology and software.

Marketing Information System (MIS) – a set of people, hardware, equipment, software and methodological support, combined into a single whole, which allows collecting, analyzing and processing information for its further use in substantiating, accepting and evaluating marketing decisions. Therefore, the creation of a complete MIS is one of the important conditions for the effective implementation of international marketing. Since marketing solutions are only an integral part of all

managerial decisions taken by the company's management, the MIS is only a subsystem of the general information management system of the company. For the efficient functioning of the MIS it is necessary to constantly analyze the information available in it, to collect new data from different sources, to process them and to supplement existing data arrays on this basis. At the same time, such main sources of information are the reporting data on the company's activities, information on the state and change of the international marketing environment, the results of marketing research.

Companies that successfully carry out international activities use different types of information networks at the same time. In the process of organizing international marketing activities, all these networks become global and their geography extends to all countries of the world where the company operates.

The Internet, a worldwide information network, was originally developed in the United States for military purposes, and then began to be used for commercial purposes, resulting in the creation of a global virtual world of world-wide information and communications, uniting flows of information and data banks around the world [2]. The "World Wide Web" is the highest degree in the development of technology of international information networks and is now a leading position in the global information environment. The Internet is built on the basis of a hypertext representation of information, that is, in the form of a text containing links to other information blocks. This system allows you to display graphics, include multimedia (sound and video) inserts. The "World Wide Web" allow you to manipulate information located in millions of computers scattered around the world and integrated by this information network. It allows you to receive international marketing information, conduct electronic commerce, advertise and communicate with the public, develop new products, attracting a large number of Internet users.

Extranet (Extranet) is a vertical network that brings together counterpart companies (manufacturers and wholesalers, manufacturers and subcontractors, suppliers of raw materials, etc.) that are part of inter-firm associations with vertical manufacturing and marketing communications, and integrated networks that are intersectoral and are created jointly by counter-agencies from different sectors of the economy, and mainly provide for the exchange of information on the receipt and execution of orders, payment of invoices, communication m visitors online in real time. [6] Networks Extranet also provide a link

between the company and its customers. Together with the Internet, they are important for e-commerce.

Extranet allows partners to access a specific part of their internal network. The Extranet contains a variety of special information, not just an exploratory nature that is not open to widespread access. Therefore, to connect to it, you need a registration and a special password – a protocol. Extranet not only activates and enhances the business's business connections, but also allows new business partners and new clients to be acquired, giving them the opportunity to use a certain part of their information. This network is created on the basis of Internet protocols, which are carefully protected from external penetration. When you create an extranet, the company can use its intranet, as well as automate the entire chain of commodity movement: raw materials – finished products – marketing organizations – consumers, including its order, payment and delivery. Connection to the network is possible only if you register.

Extranet can be created on the basis of the information network of the firm (Intranet) or be carried out beyond its borders so that the individual organization creates and manages it. The latter option allows for more stable protection of the company's information from outside penetration and does not distract the company from its core business.

Intranet (Intranet) – the association of deleted local area networks within a single company or group of companies with the help of the remote access mechanism. Typically, these are horizontal networks within the group of companies, intended to collect and accumulate statistical information on production and sales for all companies – member of the group, as well as for the processing of information under the general scheme and the only criteria. They are strictly protected from penetration from the outside.

Intranets allow you to use Web capabilities to host and distribute information within a company or a single group of companies. Intranet does not have external connections and is protected from penetration by outsiders and organizations. The protection of internal networks is provided at the expense of so-called protocols, that is, sets of codes or signals through which computers establish links with each other and transmit information. On the Internet – it is TCP / IP, in local area networks – network protocols.

Intranet is cheaper than specialized local databases and networks. About 30% of US companies use Intranet internally in corporate governance and international marketing [7]. These networks are reliable



and easy to manage and operate. With the help of Intranet, the employees of its companies have the opportunity to share various information, enter into the authorized company databases, keep abreast of the main internal corporate events, connect to any component of the Intranet, and receive any information contained in this network.

This applies to product information, its sale and promotion, price policy. In addition, the network allows different departments to communicate quickly and efficiently with each other, making sure that this information is not available to external individuals and organizations. Such an information system allows the company's employees to quickly find out the main trends and data regarding the company's activities, obtain the necessary documents, react promptly and flexibly to the changes that take place, increase the degree of autonomy in decision-making and thus increase productivity in the company or in the group of united companies, including the replacement of paper analogues.

Marketing specialists conduct databases of goods, customers, competitors, markets, etc. They organize newsgroups and interactive chat (chats) on marketing topics related to the activities of company divisions throughout the globe. Intranet allows you to enhance the coordination of their actions when implementing international marketing programs and strategies. The equipment and service of the intranet network is cheaper than the Internet, and the exchange of data in them is faster than on the Internet. Typically, within the company's internal network, videoconferencing, teleconferencing, and discussion clubs can be conducted in writing, where the authors of the proposals or critical remarks may not be known. This is especially important in the study of the opinions of employees of subsidiaries and affiliated companies that can be located around the world. If earlier there was a significant difference in the principles of the construction and operation of Internet and Intranet networks, today there is a smoothing of differences, and the technology of the "World Wide Web" actively penetrates the systems of the company's intranet network: e-mail, newsgroups, file transfers, etc.

E-mail is easy to use and cheaper than other means of transmitting information. This type of communication allows you to effectively transfer information in real time, moreover in a variety of forms and in a form that allows the sender and recipient not to spend extra effort and time for reprint and computer set. If you pay for an Internet connection, use of e-mail does not require additional costs, which makes this form of transfer of information now the cheapest. Only a connection to the

Internet is paid and you do not have to pay for every sent and received message.

The advantages of e-mail can also be attributed to a rather massive coverage, the scale of which includes all users of the Internet. E-mail allows better, moreover, directly, to study and serve the customers of the company, to actively develop business relationships with its partners. In this case, the technique and time of the transfer of information to multiple addressees is almost as simple as transmitting information to one respondent. Also, information via e-mail is transmitted in a fairly convenient form, which is provided by a special program and does not require an additional set of messages. Time saving is first and foremost ensured that information can be transmitted in real time. E-mail allows you to send and receive messages of different kinds: not only typed text messages, but also files from databases, text files, photographs, tables, speech and music messages. In this case, the information is transmitted in electronic format, which allows the sender and the recipient not to spend time on its additional processing. At the same time, practically instantaneously you can make as many copies of information as you want, and if necessary add and send it to the necessary addresses, etc., which greatly simplifies the work with materials and documents in the company. Especially noteworthy is the ease of redirection and dissemination of information.

E-mail is currently the main form of communication between companies and between companies and consumers. In a number of countries, legislative acts have already been issued confirming the right to take digital signatures into commercial documents (contracts, agreements, etc.) that are sent by e-mail legally legitimate and they are equated to a written signature in real terms. It is also important that the use of e-mail does not require the presence of the addressee to receive and respond promptly, as is the case, for example, during telephone communication.

But there are certain disadvantages of using email:

- there are difficulties with regard to the reliability and reliability of the information obtained, for example, the address and / or the message itself can be fake. With such a problem are called for the fight against special encryption of texts and the inclusion of the end of each digital signature, the file being sent;

- the system of transmission of electronic communications can not ensure their confidentiality, and they can be deliberately or accidentally used for useful and unlawful purposes;

- excessive increase in the number of received information messages also creates serious difficulties in the company. Excess information, the so-called information noise, complicates the work of the relevant divisions of the company. In this case, it is recommended to install in the computers special programs-filters, passing only the information specified by special restrictions, sorting it according to the installed criteria, as well as blocking programs, which eliminate the information that the company does not want to receive;

- ease of use of e-mail reduces the attention of employees of the company, and correspondence sent by them may be misunderstood and lead to serious mistakes in working with partners;

- despite the benefits, e-mail can not and should not completely replace other forms of communication, especially personal contacts in business.

Usually, companies conducting international marketing research on the Internet have lists of sources of necessary information, as well as a list of mailing list materials to the company's clients, which is especially important for the distribution of advertisements and other messages. Relevant computer programs allow you to track which pages are visited more than others, as the Internet users often visit them. The marketer conducts statistics on reader demand and improves the forms of "self-serve" in electronic form. Important information about consumers is obtained by marketers-researchers through the flow of visitors to the company's server and e-mail.

Marketers-researchers for the collection of information on the Internet use sites of specialized companies that research markets, firms and consumers from different countries, sites of international and government agencies, sites of competitors and partner companies, electronic bureaus of statistical materials, international and national organizations, newspapers and magazine scraps (Fortune, The Economist, Financial Times, Tendances de la Conjoncture), sites of research institutes, universities, libraries, and more. In this case, search engines help, even if the address of the object being studied is unknown. It is important to find out their hypertext links.

Especially useful catalogs of Internet resources on information in the field of international marketing, the study of interactive materials of specialized agencies involved in marketing research and study of companies and well-known businessmen who produce special directories in paper and electronic form. These are primarily Dun & Breadstreet, Moody's, Compass, Who is Who, and others. For a fee,

they provide the opportunity to use their data banks to navigate the situation in the search and selection of partners in international business.

Market research on the Internet is carried out through the sites of the statistical departments of the relevant structures of the states, such as different ministries, chambers of commerce and industry, as well as international organizations, and before the United Nations (Statistical Yearbook, Monthly Bulletin of Statistics, Commodity Trade Statistics, etc.) international trade associations, the International Chamber of Commerce and Industry and regional organizations.

Consequently, the main task of developing an international information environment is the integration and compatibility of systems used by companies in their activities. The use of information technology will increase the effectiveness of marketing research in various (any) types of activities.

It should be noted that there are organizational and technical difficulties in paying for goods through the network, with the identification of the site visitor, his signature, legal status, that is, the task of ensuring the legal aspect of contracts, executed through the Internet, and their implementation. In particular, this concerns the taxation of online commercial transactions, which are still free of any fiscal charges.

It also raises the question of the need to increase the reliability and confidentiality of the company's networks, the need to provide their reliable protection against hacking. Companies are actively developing and improving the methods of encrypting information, but 100% protection can still be achieved. Special technical standards are being developed to guarantee the secured delivery of relevant information to companies.

## **References**

1. *International Markets: Teaching manual / ed. Yu.G. Kazak, S. Smichka, IL Litovchenko - K. : "Center for Educational Literature", 2014-294 p.*
2. *Pakhomov SB International Marketing: Experience of Foreign Firms: Study. allowance M., 2003.*
3. *Naumova O.E. Increasing the role of marketing information systems in providing effective management of enterprise marketing. Economic Newsletter Donbass № 2 (32), 2013. – p. 129-134.*
4. *Starostina A.O. Marketing researches of national and international markets [Text]: textbook / A.O. Starostina - K. : LLC "Lazarit-Poligraf", 2012. - 480 p.*

5. *It-tehnolog / Modern information technologies [Electronic resource]. - Access mode: <http://it-tehnolog.com/statti/suchasni-informatsiyni-tehnologiyi>*
6. *Information technology: a textbook / [Yu.Yu. Gromov, IV Didrich, O.G. Ivanova, MA Ivanovsky, V.G. One] - Tambov: Publishing house of Tambov. state tech Un-ta, 2015. - 260 s.*
7. *Boychuk I.V. Internet Marketing: Tutorial / IV Boichuk, O.M. Music - K.: Center for Educational Literature, 2010. - 512 p.*
8. *Melnikova O.A. Features of formation of marketing information system of the region. Economics and Law. No. 3 (45), 2016. - P. 11-16.*

**Kononenko Anna**

*PhD in Economics, Associate Professor, Department of Finance and Financial and Economic Security*

**Kugai Kseniia**

*Senior teacher, Department of Foreign Languages Kyiv National University of Technologies and Design (Kyiv, Ukraine)*

**COMPETITIVE  
MARKET TYPES  
DEVELOPMENT AND  
MARKET CONCEPT  
FOR COMPETITIVE  
POSITION  
FORMATION**

The theoretical framework of a competition began to develop as early as the precapitalist era. However, the first scientific provisions on competition and the sources of its development appeared only in the middle of the eighteenth century due to the works of the classical economic theory representatives. They considered competition as one of the main forces that contributes to the market price making at “natural” level.

The significant role in the development of these theories belongs to A. Smith, D. Ricardo. A great contribution to the development of the theory of competition was subsequently obtained through the works of A. Marshall, J. Keynes, J. Schumpeter, M. Porter and others.

The market concept recognizes market position and strategic industry-specific position of business entities as the basis of the competitive positions. Therefore, the choice of a strategy is formed

depending on the market type characteristics, as well as the resources available.

The following markets are distinguished by competitive pattern in the modern economic theory: the market of pure (perfect) competition, which provides equal rights and opportunities for sellers and buyers; the market of imperfect competition (market of oligopolistic, monopolistic competition and pure monopoly). Each of these market types has distinctive features. So it is very important for all market entities to take into account the type of a competition in certain markets and the behaviour of competitors during the competitive position formation.

Depending on the market situation, enterprises must necessarily select competitive advantage strategies, methods and means of their realization in the market segment in which they operate or intend to carry out activities. Thus, the existence of different types of market structures and types of competition in heterogeneous markets significantly influences the realization of the competitive advantages of each economic entity.

Pure or perfect competition is typical for the market, which operates a large number of sellers and buyers of the same product (service). The concept of a perfect competition was first formulated by the founder of the economic theory A. Smith in “An inquiry into the nature and causes of the wealth of nations” in his famous principle of “the invisible hand of the market”. He proclaimed that the model of a perfect (pure) competition completely excludes any conscious control over the market processes [1]. W. Jevons was also among the authors, who first used the concept of “a perfect market” [2].

Today agricultural markets, stock markets, international exchange market (Forex) can only relate to the markets of perfect competition (supported by most researchers). Such markets are introduced by somewhat homogeneous products (currency, shares, bonds, grain) and a large number of buyers.

There are some authors' viewpoints regarding the fact that the types of economic activity, related to the production of mass consumer goods (food products, light industry products, household appliances), can be referred to this group. We consider this to be incorrect, as a sign of pure competition is the launch of standardized products manufactured by different enterprises, but do not differ significantly in terms of quality, presale, aftersale service. Another sign of pure competition is slight differences between enterprises in the use of advertising products, brands and trademarks.

At present there is a completely opposite trend in the market, for example, products for the production of footwear, clothing, where differentiated goods are represented, as well as prevailing forms of non-price competition, which allows us to conclude about monopolistic competition, and not pure competition in this market.

Taking into account all the above, it is possible to draw the following conclusions regarding the nature of competitive positions in the market of perfect competition:

1. In such a market, it is most difficult to maintain the external competitive positions of business entities due to the presence of a significant number of sellers who sell goods (services) and a huge number of buyers who can buy these goods.

2. Products are largely interchangeable, not differentiated. This means that market participants do not have a significant market power and they can't make their demands, since prices are determined only by the supply-demand ratio.

3. There is a dominance of unified products, so the choice of competitive positions lies in the area of low cost formation; the value of competitive position by cost can be significant for some time, while they are hard to keep for a long time because of their ease of copying.

At the beginning of the 20th century the economic development was marked by the emergence of large monopolies and the growth of state policy in the economy regulation. This led to the emergence of the concept of "monopolistic competition", formulated in the works of Edward H. Chamberlin "The theory of monopolistic competition" [3], as well as J. Robinson "The economics of imperfect competition" [4]. E. Chamberlin expressed his opinion on the strength of the "coexistence" of monopoly and competition, pointing out two main ways of combining them:

- unique products market formation, that is possible in the presence of two or a small number of sellers;

- differentiated products (services) market organization with substantial control of sellers over products with peculiar qualities.

Regarding J. Robinson's viewpoint, she considered monopoly's functions useful to the society and saw them as reducing production costs, primarily due to the scale effect, technical progress stimulation with available investment potential, markets stabilization and the economy as a whole [5]. In addition to price competition, J. Robinson also offered other means of struggle: company image, product quality level, advertising, customer service specific nature, access to profitable

credit.

Subsequently, the criticism of the perfect competition concept, initiated by E. Chamberlin, was continued in the works of J. Schumpeter, a recognized author of effective competition theory. He proved that innovations were more effective framework for a new type of competition than price competition [6].

Monopolistic competition arises in the industry-specific market with many sellers, marketing a differentiated product. This allows them to control in some way the price of a product (service) until they are copied by competitors. In the market of monopolistic competition there is quite a large number of sellers who can satisfy the market demand for the same type of goods (which, instead, are not perfect goods – substitutes) of a small number of buyers. It means that the market share of enterprises operating in this market, as a rule, does not exceed 1-5% of the total market. It is more than business sales that operate in conditions of perfect competition, whose share is considerably less than 1%.

Integration into the market of monopolistic competition is not complicated by such barriers as in the market of pure monopoly or oligopoly, but it is not as easy as in the context of perfect competition.

The distinctive feature of monopolistic competition, especially under current conditions, is non-price competition. A producer has to compete and to achieve competitive positions not so much in price as by improving the consumer characteristics of products. At the same time, he can not only keep the price at a fixed level, but even increase it somewhat. It is possible only under certain conditions: consumers agree to pay a higher price, but due to tangible better consumer properties.

Therefore, products competitive positions associated with their novelty, quality, reliability, modern design, environmental compatibility, compliance with international standards, aftersale services, etc., prevail.

A large number of producers in the market of monopolistic competition do not allow them to coordinate cooperation for reducing the quantity of output to increase prices. In addition, each entity in such a market is not able to considerable affect market prices. That is why enterprises in most cases sell their products at almost the same prices, not allowing significant differences in prices compared to competitors.

The trademarks and business entities image play an important role in the context of non-price competition. The key role in creating a positive image of a company and promotion of products in the market belongs to advertising, which is the most important means of non-price



competition.

It is promising to use BTL advertising (below-the-line). These are non-standard marketing communication technologies to promote brand, products and services that provide a two-way dialogue between the seller and consumer directly at points of sale.

Leading foreign marketers believe that products successfully sold are 15% technologies, 85% – net marketing. It is for this reason that non-standard ideas for the promotion of goods are perfect means for competition in the market of monopolistic competition. Companies increasingly invest heavily in strengthening their brands, owing to the focus, first of all, on the values and emotions that connect a buyer with a product to a greater extent than focusing only on the qualitative characteristics of such product. The more differentiated mass-produced products are on the market, the more effective it is possible to individualize the product by means of emotional characteristics, promoting a special lifestyle rather than just advertise.

Examples of types of economic activity with the prevalence of monopolistic competition are: production of women's, men's, children's clothes and shoes; manufacture of fur, jewelry, furniture, soft drinks, books, retail trade, as well as various kinds of services (dry cleaning, laundry, hairdressing).

It is not so much the need to reduce prices as the main way of forming competitive positions is consequently distinctive for monopolistically competitive enterprises, as the improvement of consumer products characteristics, the use of aftersale service new forms, other means of non-price competition and, above all, the introduction of product differentiation principle. Products quality upgrading may frequently be artificial, but due to professional advertising activity, consumers believe in the unique products characteristics. It is the differentiation that promotes high price making by an enterprise. This provides high income for such enterprises on an equal cost level with competitors.

The competitive positions for modern enterprises that use methods of non-price competition are not always related to the technology of production. They often relate to the fields of marketing, service, research and development (R&D), management (quality management, brand management, re-engineering, etc.) and financial innovations – Initial Public Offering (IPO). This was noticed by M. Porter, who proved that the approach to individualization can take different forms: image, trademark, technology, particular services to customers [7].

The monopolistic competition therefore is similar to the conditions of a monopoly in the market entities having for a certain time the opportunity to control the price of their goods. On the other hand, it is in close meaning to perfect competition, because products are sold to many customers. In addition, there is a relatively free market entry and market exit [8].

Oligopolistic competition (Greek oligos – few, poleo – to sell) literally means domination of a small number of sellers and refers to an imperfect type of competition. Oligopolistic competition is characterized by the activity of several huge enterprises that compete with each other and control a significant part of production and sales. D. Robinson considered a real oligopoly more widespread phenomenon than the existence of perfect competition and absolute monopoly [5]. In other words, oligopoly exists, if the number of enterprises in the industry is so small that each of them should take into account the competitors reaction while pricing policy formation.

With an oligopoly, the products of enterprises can be both similar to competitors' products (i.e., to be standardized, for example, mobile communication, copper, zinc, steel) and differentiated (aircrafts, automobiles, household appliances, tobacco products). Enterprises use mainly non-price means of competition to achieve better results.

As noted above, the main feature of oligopoly is a small number of huge companies operating in the market (from 2 to 10). According to expert estimation, an oligopoly is considered to be the industries, where the four largest companies account for more than half of all goods manufactured.

There are high barriers for new enterprises to enter the market in oligopoly. These can be legal restrictions, as well as financial barriers: high seed capital, huge advertising costs and market promotion of a product. Other significant barriers relate to intangible assets holding (patents, licenses, technical secrets and the latest innovative technologies), raw materials and material sources control. That is why a big business prevails in oligopoly.

An oligopoly predominates in modern economy, first of all, in technologically sophisticated industries: metallurgy, chemistry, shipbuilding and automobile manufacturing, electronics, mobile communication, etc. As a rule, there are no light industry enterprises, including apparel industry in such markets.

A pure monopoly is a form of imperfect competition, characterized by a single seller of goods in the market that does not have parity

products – substitutes. The monopolist acts on the market alone, controls the price and volume of production, which in the long run allows him to have a monopolistically high profit.

A monopoly can be a large company as well that produces a unique product (or provides unique services) if there is no competition in the sales market. An industry in a pure monopoly consists of one company, that is, the concepts “industry” and “company” practically coincides. This is due to the fact that the demand function of a pure monopolist is combined with the demand function entirely in the industry, since the monopolist represents the whole industry.

There are very severe barriers in a pure monopoly for other enterprises (usually administrative) to enter the market, which are very difficult to overcome. The administrative barriers are also the licenses and patents, which confirm the exclusive right to operate in this market.

The public utilities – electric and gas companies, water supply companies, communication lines, transport companies can be the examples of natural monopolies. As for the enterprises involved in mass production (for example, food, leather, textile, clothing, leather goods and other materials), their main characteristics (small size of enterprises, small market share, low production and investment potential, lack of stable market authority, substitutes availability) do not give reason to claim the monopoly enterprises in the market of pure monopoly exist.

Regarding the competitive struggle methods and competitive positions formation, they practically do not exist unless necessary, because there is no competition in the market of pure monopoly.

Competitive positions depend not only on market models, but also on the characteristics of an overall economic status in the markets where the enterprises operate.

The market concept of competitive positions offered by the American professor of Harvard Business School M. Porter is classic (traditional). It was based on the premise that market entities success in competition is determined by the sector-specific issues, the type and extent of competition, and the activities of a company itself on the market. According to this concept, the source of competitive positions lies in the effective industry and market positions of a company, which are chosen according to its specific nature.

The market concept and the concept of a “competitive position” were directly worked out by Michael Porter in 1985, while formulating the main types of firm competitive strategies (cost leadership and differentiation, focusing on narrow market segments), as well as

between broad and narrow domain in the market, taking into account the resources of an enterprise [7].

According to M. Porter, the competitive positions of a market entity arise in the process of a competitive struggle against the five competitive forces that he has identified: with other sellers of similar products (services), enterprises – potential competitors, substitutes producers, resources suppliers, his products buyers. The content of M. Porter's model can be formulated using the three most important aspects of a competition: industry competitive forces, competitive strategies and competitive positions.

While creating his strategies, M. Porter relied on the market conditions stability over a long period of time. He, therefore, adhered to the principles of equilibrium and statics, while modern competition in the markets is much more complicated and steadily growing.

The strategies itself (cost control, differentiation, focusing) have remained unchanged. M. Porter considered the proposed typical strategies to be comprehensive, and asked therefore the management to choose only one of these. At the same time, it is known that a number of successful companies, including Japanese and American ones, used both a competitive strategy for controlling costs and differentiation, while achieving high results.

Taking into account the above, the essence of the market concept is that the attractiveness of an industry, the effective market position of a market entity, due to its specific nature, are the main factors of the influence on competitive positions and achievement of a market success [9].

The scientific literature analysis made it possible to conclude that traditional market concept of competitive positions does not largely correspond to the modern trends:

1. There are no adequate implementation tools in a highly competitive environment (rather than in relatively stable environment when the concept was created).

2. In modern conditions, leading enterprises use successfully both the strategy for controlling costs and differentiation, which M. Porter opposed.

3. This concept doesn't sufficiently consider the influence of a state that is the market entity and significantly influences the competitive positions of an enterprise.

4. It underestimates the role of partnership relations between different market entities. This has a negative impact on the sustainability

of enterprises competitive positions.

5. The traditional concept should be supplemented by the regulations for the modern of competitive positions innovative concept, which is associated with the need to create future markets, new products on the verge of different types of economic activity [10].

The importance of the market concept adherents works lies in the fact that competitive positions and competitive forces were identified within the limits of certain types of economic activity. This allowed solving the problem of an enterprise effectiveness taking into account the peculiarities of its internal and external environment under the dominance of external market factors.

## References

1. Smith A. (1993). *An Investigation of the Nature and Causes of the Wealth of Nations // Anthology of Economic Classics. Moscow: ME "ECONOV", p. 475.*
2. Jevons U.S. (1993). *On the general mathematical theory of political economy. A brief report on the general mathematical theory of political economy / The theory of consumer behavior and demand. Series of "Milestones of Economic Thought". In: V.M. Halperin, St. Petersburg: Economic School, pp. 67-77.*
3. Chamberlin E.H. (1962). *The Theory of Monopolistic Competition. 1st ed. Cambridge 1933; 8th ed. Cambridge (Mass.).*
4. Joan Violet Robinson. (1969). *The Economics of Imperfect Competition (1933). London: Macmillan. 2d ed.*
5. Robinson J. (1986). *Economic theory of imperfect competition / per. from English Moscow, p. 253.*
6. Schumpeter J. (1995). *Capitalism, Socialism and Democracy: Per. with him - Moscow: Economics, p. 540.*
7. Porter M. (2005). *Competitive Advantage: How to achieve a high result and ensure its sustainability [Text] / M. Porter; Per. from English - Moscow, Alpina Business Bus, p. 715.*
8. McKonel K.R., Brue S.L. (2000). *"Economics", Moscow, "Infra-M", 2000, p. 203.*
9. Sysoev E.A. (2011). *Competitive advantages of the enterprise: evolution and sources of formation / E.A. Sysoev // Issues of Economics and Law. Vol. 5, pp. 47-51.*
10. Tkachova S.S. (2012). *Modern concept of sustainable competitive advantages of the enterprise: integration and balancing of scientific approaches. In: Scientific Papers of the Taurida National University named after V.I. Vernadsky Series "Economics and Management". Vol. 25 (64), pp. 160-168.*

**Olshanskiy Oleksandr**

*PhD in Economics, Associate Professor,  
Department of International Business  
Management and Tourism*

**Kovyakh Igor**

*Assistant Professor, Leading Expert in  
Scientific Information, Office of  
International Programs  
Kharkiv State University of Food  
Technology and Trade  
(Kharkiv, Ukraine)*

**THE CONCEPT OF  
IMPROVING  
TRADE  
ENTERPRISES'  
BUSINESS  
PROCESS  
MANAGEMENT**

The work is devoted to the pressing issues of developing the concept of improving the management of trade enterprise business processes. The proposed concept for improving the management of business processes at trade enterprises is based on the hypothesis that effective management of business processes of the organization implies their continuous improvement and optimization. The optimization of business processes is an indispensable tool for ensuring the efficiency of trade enterprises' operations under the current conditions of globalization and European aspirations of Ukraine.

The integration and transformation processes taking place in the Ukrainian economy, high competition, the pressure of crisis factors, high unpredictability of changes in the external environment require Ukrainian enterprises to constantly seek new, more effective management methods. New management methods should be aimed at strengthening the competitive advantages of the enterprise in the market and its stable operation in the strategic perspective.

Thus, one of the most problem issues is the task of redirecting trade enterprises to a high-tech business process improvement and development model. The development of the classification and the concept of improving the trade enterprises' business process management allows finding ways to optimize their operations (economic efficiency) taking into account the specifics of prospective management.

The theoretical and methodological bases of the research are the scientific works and practical developments of foreign and domestic researchers devoted to the problems of strategic management: Igor H. Ansoff, P. F. Drucker, A. Marshall, Michael H. Mescon,

F. W. Taylor, Lido A. Iacocca. Questions of the use of the process approach in the practice of business organizations were investigated in the works by F. Zh. Huyar, V. Eliferov, J. M. Kelly, V. Repin, M. Robson, M. Hammer, J. Champi.

However, the analysis of the present theoretical research of the issue under consideration shows that the methodological and practical developments concerning the management of business enterprises based on the improvement of business processes have not yet been studied enough. However, the analysis of the present theoretical research of the issue under consideration shows that the methodological and practical developments concerning the management of business enterprises based on the improvement of business processes have not yet been studied enough. Despite the large number of writings on the issue the articles related to the classification and concept of improving the management of trade enterprises' business processes remain to be studied. It is a good idea to examine the trade business companies' business process and to classify them.

The purpose of the work is to develop practical recommendations for developing the classification and concept for improving trade enterprises' business processes management.

Studies have shown that the application of the process approach in the company management allows reducing costs and improving the quality of products and services, obtaining the necessary information about the current state of business. The management receives a unique opportunity to make timely and strategically correct decisions regarding the further existence of the enterprise. Business processes are the basis of process control [1].

The author believes that in trade enterprises business processes of analytical and trade-technological nature are prevalent, therefore the criteria for decomposition of business processes such as analysis / resources / product or service should be main.

To identify the business processes of a trading company it is considered appropriate to follow the classification logic of the American Productivity and Quality Center [2] which allows taking into account all the peculiar features of a trading company.

The following classification of trade enterprises' business processes is proposed in this paper (Figure 2.9):

*1. Trade enterprises' core business processes:*

1. Market and consumer needs analysis;
2. Development of assortment policy and assortment management;

**Trade enterprises' core business processes**

1. Market and consumer needs analysis
2. Development of assortment policy and assortment management
3. Purchasing management and logistics
4. Warehouse and goods storage management
5. Production operations management
6. Sales and customer service management
7. After sales and warranty service management

**Trade enterprises' auxiliary business processes**

1. Human resources management
2. Information resources management
3. Financial and spatial resources management
4. Material and technical resources management
5. Communications management
6. Improvements and changes management

**Trade enterprises' development business processes**

1. Introduction of innovative and communication management technologies
2. Implementation of resource-saving and science-intensive technologies
3. Modernization of shops: a trading hall, premises for the preparation of goods for sale, warehouses, trade and technological equipment, technological lines, administrative offices and recreational facilities for personnel
4. Implementation of modern sales and customer service methods

**Trade enterprises' supporting business processes**

1. Quality management system
2. Organizational structure of enterprise management
3. Managerial decision making system
4. Employee motivation and encouragement system

**Figure 2.9 Classification of trade enterprises' business processes**

3. Purchasing management and logistics;
4. Warehouse and goods storage management;
5. Production operations management;



6. Sales and customer service management;
7. After sales and warranty service management.

*II. Trade enterprises' auxiliary business processes:*

1. Human resources management;
2. Information resources management;
3. Financial and spatial resources management;
4. Material and technical resources management;
5. Communications management.
6. Improvements and changes management

*III. Managerial business processes:*

1. Quality management system;
2. Organizational structure of enterprise management;
3. Managerial decision making system;
4. Employee motivation and encouragement system.

*IV. Development business processes:*

1. Introduction of innovative and communication management technologies;
2. Implementation of resource-saving and science-intensive technologies;
3. Modernization of shops: a trading hall, premises for the preparation of goods for sale, warehouses, trade and technological equipment, technological lines, administrative offices and recreational facilities for personnel;
4. Implementation of modern sales and customer service methods.

It has been established that the management activity at trade enterprises on the basis of the process approach is the continuous performance of a complex of certain interrelated activities and general management functions. However, the execution of particular kinds of work and management functions is also considered as a process, that is, the overall process is a set of interconnected continuous actions that convert inputs of resources into corresponding outputs, i.e. results.

The experts in the field of process management distinguish the following main advantages of using the process approach [3]:

- a high motivational component. It is the process approach that allows taking into account such important aspects of business as targeting the end product, the interest of each particular performer in improving the quality of the final product and, consequently, the interest in the effective performance of their work;
- the reduction of the managers' burden, since the responsibility is shared between process owners;

- high flexibility and adaptability of the management system due to its capability of self-regulation and natural consumer focus;
- the high dynamism of the system and its internal processes due to the strong vertical integration of resource flows and the general interest in increasing the rate of exchange of resources;
- a significant reduction in the influence of the bureaucratic mechanism consequently saving time and financial resources;
- high transparency of the management system, as well as simplification of coordination, organization and control procedures;
- the possibility for the extensive integrated automation.

Under high uncertainty of the external environment trading companies have to optimally use their own resources and improve the quality of business processes to quickly adapt to various changes.

Thus, it is necessary to conduct a constant audit of all business processes of the trade enterprise and rank them as to the degree of influence on the economic activity of the trading company [4]. It is expedient to divide the methods of analysis of trading companies' business processes into two classes depending on the degree of change and the duration of use. These can be long-term and short-term methods [5].

The short-term ones are:

- the quick analysis method;
- the statistical management of the company's processes;
- idealization;
- structuring of quality functions.

The long-term methods are:

- redesigning business processes;
- reengineering;
- benchmarking;
- greenfield.

The optimization of business processes is a necessary tool for ensuring the efficiency of trade enterprises under the current conditions of globalization and European aspirations of Ukraine. All this should contribute to the improvement of the quality of products and services of trade enterprises in order to fully meet the consumers' demands.

Therefore, we consider it expedient to propose a concept for improving the management of trade enterprises' business processes which is based on the hypothesis that the effective business processes management of the organization envisages their continuous improvement and optimization.

Thus, it is very important to form a concept for improving the trade enterprises' business processes management (Figure 2.10).

The following process goals were formed while developing the concept for improving trade enterprises' business processes management:

1. Minimization of resources;
2. Reduction of working time spent;
3. Increase in labor productivity;
4. Improvement of product and service quality;
5. Optimization of the organizational structure of management, reduction of functions;
6. Decrease of the duration of the cycle of the trade and technological process.

The principles of improving the trade enterprises' business processes management have been developed and refined:

1. minimum number of participants in the process;
2. unified control over the business process, reduction in the number of approvals;
3. parallel execution of managerial functions;
4. typification of processes;
5. simplification of processes: decrease in the number of inputs, combining works;
6. increase in the autonomy of business processes by expanding decentralization with the simultaneous intensification of the centralization of information exchange;
7. eliminating gaps in the technological chain;
8. creating the maximum number of possible options for the process.

A considerable attention has been paid to trade enterprises' business processes management methods:

- continuous improvement – a detailed and systematic review of the existing process in order to find possible ways of improving or, if necessary, radically redesigning it including BPI, TQM methods;
- fast analysis solution technique (FAST) – focuses on a particular process during a one- or two-day meeting of the process improvement team to identify ways to improve this process within the following 90 days;
- business process re-engineering (BPR) – radical redesign of business processes to achieve improved key performance indicators such as cost, quality, efficiency;

## The concept for improving trade enterprises' business processes management

### GOALS:

- minimization of resources;
- reduction of working time spent, increase in labor productivity;
- improvement of product and service quality;
- optimization of the organizational structure of management, reduction of functions;
- decrease of the duration of the cycle of the trade and technological process

### PRINCIPLES:

- minimum number of participants in the process;
- unified control over the business process, reduction in the number of approvals;
- parallel execution of managerial functions;
- typification of processes;
- simplification of processes: decrease in the number of inputs, combining works;
- increase in the autonomy of business processes by expanding decentralization with the simultaneous intensification of the centralization of information exchange;
- eliminating gaps in the technological chain;
- creating the maximum number of possible options for the process

### METHODS:

- *continuous improvement* – a detailed and systematic review of the existing process in order to find possible ways of improving or, if necessary, radically redesigning it including BPI, TQM methods;
- *fast analysis solution technique (FAST)* – focuses on a particular process during a one- or two-day meeting of the process improvement team to identify ways to improve this process within the following 90 days;
- *business process re-engineering (BPR)* – radical redesign of business processes to achieve improved key performance indicators such as cost, quality, efficiency;
- *benchmarking* – a comparative analysis of trading enterprises' business processes to reference processes of enterprises that perform the same or similar processes, but function better, in order to improve the current activities;
- *greenfield* – analysis and decision making based on the presentation of a business process as having just been created, i.e. from scratch

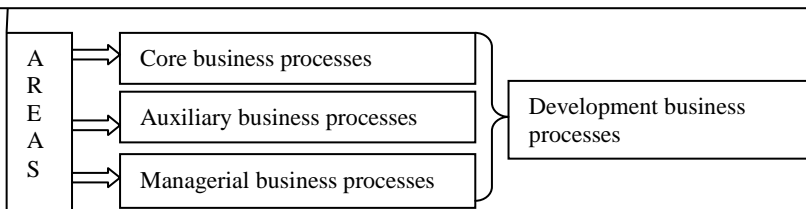

**Figure 2.10** The concept for improving trade enterprises' business processes management

– benchmarking – a comparative analysis of trading enterprises’ business processes to reference processes of enterprises that perform the same or similar processes, but function better, in order to improve the current activities;

– greenfield – analysis and decision making based on the presentation of a business process as having just been created, i.e. from scratch.

As a result, the four following basic areas or categories for the concept of improving the trading companies’ business processes management have been proposed:

- core business processes;
- support business processes;
- managerial business processes;
- development business processes.

The research has established the current existence of several innovative approaches to business process management: implementing quality management systems, business process benchmarking, continuous BPI (Business Process Improvement), business processes reengineering, joining the functional and process approaches. It is also an expedient idea to use continuous business process improvement (BPI) technique in trading companies which focuses on optimization of production organization, as well as management by continuous quality improvement of business processes by way of ensuring their full and exact performance, and automation of management functions.

The paper stresses the fact that the pressing need for the improvement of business process management is called for by changes in the external environment. Thus, it is important to take timely correctional and preventive measures to eliminate or reduce the effects of negative factors, as well as smooth and dampen the cyclic fluctuations in the external environment. So, company managers should first of all take into account the changes in the market environment, regularly compare the quality of their products with competitors’ products, actively implement scientific and technological progress not only in production but also in their management activities.

Managing business processes in a changing market environment requires process managers to promptly identify problem, unprofitable processes and implement their qualitative transformation by dividing large and complex processes into smaller ones or, conversely, by combining several small processes into a large one.

The process manager must quickly respond to the demands of time

and develop new adapted processes replacing if necessary the old ones that do not meet the needs of the end user and fail to achieve the desired performance.

Thus, improving the management of trade enterprises' business processes will provide an impressive number of strategic advantages promoting the rational use of production potential, increasing competitiveness and efficiency of production and sales, as well as improving the quality of management systems.

The analysis of trading companies' business process management has had the following outcomes:

1. The classification of trading companies' business process has been proposed. Four basic categories form the basis of this classification: core business processes, support business processes, development business processes, and auxiliary business processes. It has been proved that it is necessary to build a business process improvement mechanism which would ensure adapting the trade enterprises' management system to changes in the external environment under the conditions of uncertainty.

2. The concept of improving trade enterprises' business management based on the hypothesis that the effective business process management of an organization envisages their constant improvement and optimization has been developed. The optimization of business processes is an obligatory tool of trade enterprises' effective activities in the current situation of globalization and the European aspirations of Ukraine. All this ought to contribute to raising the product and service quality in trading companies with the purpose of satisfying consumer demands.

## References

1. *Olshanskiy, O. V. (2018). Evaluation the effectiveness of a company business processes. Visnyk of Sumy National University. Series «Economics and Management», No 6 (76), pp. 53–56.*
2. *<https://www.apqc.org> – official site of American Productivity and Quality Center.*
3. *Weske, M. (2012). Business Process Management: Concepts, Languages, Architectures. Ed. 2. Berlin: Springer, 404.*
4. *Olshanskiy O. (2018). Development of methods of improvement of business process management. Technology Audit and production reserves. No 5/4 (43). pp. 20–25.*
5. *Repin, V. V., Eliforov, V. G. (2006). Processes approach to management. Modelling of business process. Moscow: RIA «Standarty i kachestvo», 408.*

**Ing. Pohludka Michal**

*Ph.D., MBA*

**Ing. Stverkova Hana**

*Ph.D., MBA*

*Technical University of Ostrava  
(Ostrava, Czech Republic)*

**A NEW DISTRIBUTION  
LOGISTICS NETWORK IN  
A PRISM OF CUSTOMER  
SATISFACTION**

**Prelude**

Global companies issued in the financial markets report their results on a quarterly basis, with the company's core turnover, year-to-year growth and operational costs among the key performance parameters. In order for stock value to grow and the company create a unique and strong market position, it is necessary to focus on both the profitable and the cost side of the company.

The company's marketing and business strategy is based on its long-term vision. It depends on the market, the nature of the products and solutions offered, the human potential, the organizational structure of the company, and the amount of investment involved in these components. In most cases, the company has one main vision and strategy, which is then transformed into various forms of business and marketing strategies, depending on the nature of the market, geographical location and political, cultural and historical clusters. These strategies, even though they are created in the long run, change over the time.

On the other hand, the company's operative is very complex and costly to change over the time. The company's operative is, in essence, the cost side of the company and consists of several main areas - development and production, logistics and distribution, warehousing, finance and accounting, support (technical, service, legal and customer). They are interconnected even though global companies operate in a matrix structure in which each area has its own leadership, processes, competencies and responsibilities, and centralizes itself up to the level of senior management. Therefore, major changes in operations, such as changing the ERP system, changing logistics and distribution, or centralizing individual components of the company, require very demanding preparation, a great deal of investment and time. In this context, we are talking about strategic decisions of the company, as the

actual change or implementation takes time and is planned for the longest possible period of time.

For large corporations operating on global markets, logistics and distribution are part of an operational unit, and it must be taken into account in any analysis and setup. On the one hand, it is dependent on the production of the products as those are distributed from the place of production to all the countries of the world in which the company operates. On the other hand, it also depends on the end-user sites. This simple chain is, in its essence, a completely complex system in which its parts are closely linked, and if strategic decisions are made about changes in its individual parts, it is always considered as one whole.

The production of global company products takes place in different parts of the world. Site selection depends on several important parameters and mostly on their combination. There are companies that move their complete production to the countries where production is cheap due to inexpensive input materials and mainly due to cheap human strength. In these cases, however, the quality and image of the company decline. This is followed by marketing and business strategy, as well as the target group of customers. The second extreme is the production of more expensive input materials and locations in developed countries where human resource costs are high. The benefit for these companies is a high-quality product and, on the other hand, branding. Companies are currently trying to find a compromise between these two situations and find a location where they will produce their products for a long time at the required quality that is given by the company's strategy. A fairly common model of production in major global companies is the diversification of production in the different parts of the world, which consequently facilitates the distribution and logistics of products to the target user.

The distribution, warehousing and logistics of global companies from the manufacturing site to the target customers worldwide is one of the most costly areas of the entire operation. From the point of view of management, it is possible to separate logistics and distribution from warehouse management. Within logistics and distribution, companies generally have two different approaches. The first is the outsourcing of these services. This is due to the reduction of one-off costs for the procurement of all necessary equipment and a significant reduction in the level of management of the whole agenda. Even though this solution is more expensive, it has transparent and stable annual costs, and there is no need to employ additional human resources, train them and lead their



full agenda. The second approach is to create your own logistics and distribution network, which brings benefits in terms of flexibility, responsiveness to market events and simple controlling of the entire agenda. The choice of one, the other, or a mix of the model is in full competence of the top management of the company and is dependent on complex analyzes and forecasts not only of sales and long-term development in the market, but also of the whole geopolitical situation.

The aim of this chapter is to provide a methodical approach and a realistic example of introducing a new distribution logistics network in a prism of customer satisfaction, including the creation of a new distribution center within the global US company issued on the NASDAQ Stock Exchange. This process is time-consuming and investment-intensive, and yet companies are motivated to do this to fulfill long-term visions, such as long-term and stable profitable growth, transparency of all processes, and the ability to set up the system for as long as possible without the need for further strategic change. Only in this setting is it possible to have all the logistics and distribution network including warehouse management under control, thereby managing both the cost of this agenda and the marketing and business activities that have a significant overlap in this agenda.

### **Methodological basis**

A new setup of logistics, distribution and warehousing is an extremely costly process that requires a very thorough preparatory phase. It analyzes all models and options, whether to use external resources and outsourcing, or to cover this agenda with internal resources. This entire implementation process needs to be perceived as a part of the company's overall operation, and in most cases, it follows up on the changes already made.

Every step connected with the operation of the company is directed towards meeting the needs of customers. Several types of customer satisfaction are defined in the literature (more in Blecharz, 2015). Measuring customer satisfaction is seen as the most effective activity in fulfilling the principle of so-called feedback. This principle is one of the basic principles of any effective management system and recommends to create such an information channels that will constantly bring information to the organizations about the expected needs and expectations of customers and how these supply needs and expectations satisfy the supplying organization.

In recent years, it has turned out to monitor customer satisfaction

with indicators of customer experience. Customer Experience (CX) is understood as a comprehensive expression of the overall experience of a particular customer in relation to the business throughout the common relationship in the broadest sense (Goodman, 2018).

In general, the goal of each change is to get into a state that is more profitable and better than the original state. That's why companies set KPIs to track the fulfillment of internal goals. In order to monitor customer satisfaction, the companies introduce the Net Promoter Score, NPS, and its tracking should provide the company with an external view. The main advantages of NSS are the simplicity and clarity of the indicator, both for the customers, management and the stakeholders, and the brevity (one question) (Vysekalová, 2014).

Prior to the actual setup of a new logistics and distribution system, including warehousing, all processes, teams, KPIs for progress monitoring must be set. If new distribution centers are created, they must be fully operational, including a link to the company's ERP system, and logistics channels must be secured from production through warehouses to target customers. (Emmett, 2008). These indicators are absolutely crucial in managing the change and evaluating the success of the implementation itself.

Compared with the implementation of an ERP system, for example, where the change happens from day to day, implementation of the new logistics and distribution ase when new teams and processes are created first, then new distribution centers, and once warehouses are full of goods, processes ansystem is gradual and can be planned in waves. This is also the cd teams, new logistics and distribution channels are introduced.

The key to success in introducing a new system is the involvement of all components in the company. It is necessary to realize that the whole implementation is an internal process of the company and in the first stage it negatively affects the actions not only inside, but also outside - in the form of initial deteriorated deliveries, unavailability of products and possibly other unexpected events. Therefore, for the success itself, communication with customers is the key, even before the change, but also during the next phase and in the phase just after it. Here, the sales department and every other department of the company that has direct or indirect contact with customers plays its inherent role. The goal is to prepare customers for the time of implementation in the case of regular orders, or even the effort of customers to order goods for some time in advance if the nature of the product allows this.

## **Introducing a new logistics and distribution system**

The introduction of a new distribution logistics system must be linked to a single global ERP system (Pohludka et al., 2018b). Only in this case is it possible to talk about introducing a complex operating system that is transparent and flexible for potential growth or acquisition activities (Pohludka et al, 2018a).

Assuming that there is a unified ERP platform in the company, setting up logistics, distribution and warehouse management has several important phases. The first is to make decisions at the level of the company management about the change of the distribution logistic model, the budgeting and implementation time horizon. Preparatory phase is the period when a team of people responsible for the entire implementation and re-setting of logistics / distribution / warehouse management is set up. Follows the creation of a new setup plan, a new organizational structure, and new processes. Creating sub-teams for planning and executing partial steps. Creating new teams, in many cases centralizing them – logistics, customer service, distribution team, planning team. Define their competencies and responsibilities and KPI / NPS definitions to measure progress of implementation. Continuing communication with customers about new settings. Sharing the company's vision (before implementation, in the preparatory phase) about the introduction of new distribution centers and a new system of transportation of the goods to them. Implementation of logistics and distribution channels covering each country in which the company operates. Together with executing new settings, newly created teams, processes begin to work. And monitoring KPI, NPS. Monitoring the development after implementation. Elimination of negative effects, current response to the country developments and involvement of local teams in support activities. Communication with customers and affected people, respectively institutions.

This process has been used throughout Europe to implement a new logistics and distribution system, including the creation of a newly centralized Customer Care Organization, in one global US company issued on the NASDAQ. The reason for linking the implementation of a new logistics, distribution system with the new Customer Care organization is very close linking of processes and management with the goal of creating a new operating system with centralized, flexible and long-lasting professional customer communication. The implementation of such an extensive agenda itself took more than two years and required a great deal of investment and strategic decisions.

All of these steps have their time sequence, but in most cases they run concurrently. In the first phase, management requested all the data and suggestions for possible solutions, from which they selected the strategically most advantageous one and at the same time set the executive team. Team created an overall vision and a framework of the final form. The vision was to close all local contingent warehouses in individual countries and create two own distribution centers across Europe. Costs for Pond Storage represented more than 15% of the total costs in each country, including the distribution of goods directly to customers. New distribution centers cover each a half of Europe's territory independently, the cost of their operation decreased by 12-20% compared to the contingency stocks. They are loaded with all the goods from the production plants and, in cooperation with an external provider, each shipment is sent directly to the customers at the place of delivery. By fulfilling this vision, the company will achieve uniform processes for all European countries, reducing the number of warehouses to only two distribution centers that are fully substitutable. Thus, in the event of any emergency situation in one of them, only the latter can be used. This step also led to a significant reduction in staff, about 50%, as well as a reduction in labor costs. With the use of an external supplier for dispatching goods from distribution centers, the company has moved all of this agenda out of its operations. In the executive team managing the entire implementation, in most cases, there are representatives of all the functions of the company. They tend to be as complex as possible to complete the planning of the basic framework of the new system and to avoid negative effects that may be due to insufficient planning phases.

This point is the more crucial if the centralization of the new system is to happen. In fact, some teams will disappear, in most cases the local ones, and on the other, a new central team will be created, which is located in one place and governs the whole agenda for many countries of the world. There is a time lapse between these two phenomena in order to ensure continuity of company operations. The studied company experienced a complete change in organizational structure within one year, all the local teams within the logistics and distribution chain disappeared, and four governing European centers based on geographic distribution were created. Complete control is effective across geographic distance thanks to a unified ERP platform. The center in Budapest covered Central and Eastern Europe and the Balkan countries, London in Northern Europe, Paris in Western Europe, and Moscow in Russia and CIS. Thanks to this distribution, the region of Europe was

divided into four segments that were subject to the management and execution of all agendas to the mentioned centers. These teams have taken over from the local ones all the logistics-related agenda, including customer communication about deliveries. This includes receiving orders, picking up the goods, communicating with a planning team, communicating with customers on individual deliveries, issuing invoices, sending invoices to customers, and creating reports. The most important report is the back-order report of customers, which is formed on a weekly basis and shared with the sales and planning departments. Business Separate Benefit is an overview of affected customers who have not received the goods, as well as the financial amount of undelivered items. This report is particularly important at the end of the quarter, when global companies report their sales results. Therefore, every two weeks before the end of the quarter, this report is generated on a daily basis with the aim of minimizing undelivered goods.

The planning team responsible for warehousing and availability of the goods works in close cooperation with other teams, mainly logistics, sales and manufacturing teams. The aim of this planning team is to reduce stockpiles, thereby increasing the company's cash flow, minimizing lost goods, minimizing direct losses and maximizing the availability of all ordered products. With the introduction of only two distribution centers, the overall European stock inventory has fallen by more than 25% and a reduction in the disposal of lost goods by approximately 20%. A new system of sales forecasting by sales teams in each country was also created for the goods with short consumption times. Because of this, it was possible to create a system that can influence the quantity of goods produced and hence the warehouse stock. This system, which works primarily through a unified ERP platform across the company, is fast, flexible and, after its deployment, reduces the expired merchandise by another 10%. The planning team also works with the country's sales statistics and plans on the amount of inventory on their base. There is a set of safety stocks for all items and it is updated on a quarterly basis. This system of "safety stocks" reflects, in addition to sales statistics, the prediction of sales, seasonality, exceptional deals, etc., and therefore close cooperation with the sales team is needed.

The entire process of centralizing distribution logistics management and customer service was a challenging. The HR department played a significant role in the company, since at local levels people were being laid off and others were being hired in the countries where the

centralization took place. This has led to difficulties in terms of linguistic, cultural and time differences, so the companies generally have a motivation to recruit linguistic staff, which in combination with expertise greatly increases the cost of human resources. Even though it is a more expensive option in many cases, it is a preferred option for gaining cross-country process unification and easier management of the entire team. In all four newly established control centers, representatives of all countries managed to be able to communicate with end-users in their native language. This adapts the company's entire telephone system, communication channels, including the creation of competencies and the responsibility of individual people.

Once the central teams were established and each country was covered by all the necessary human resources and processes, the company come to the described centralized management of the entire logistics and distribution agenda, including the newly set communication with customers. Local teams were subsequently released and progress of each process began to be monitored by set KPIs:

- Entering the order into the system on the day of receipt of the order
- Ordering error rate less than 1%.
- Delivery of goods within one week of ordering goods within 5 business days in 99% of cases.
- Issuing an invoice on the day of delivery and more.

The whole process was accompanied by the technical and managerial problems that were being removed. That is why companies are taking two measures to minimize them. The first one is to test each process in the test facility and modify it based on its results. A second measure is to set up KPIs for each process to keep track of their trends over time and prioritize individual team activities. An integral part of this phase was direct communication with customers, both before and after the implementation of the new system. This step seems to be crucial with hindsight, and leads to the minimization of negative effects. Customer communication was primarily driven by a sales team that regularly contacts customers, and thanks to above-standard relationships, it was able to minimize negative effects on customers by professional communications. The reason for the change and the company's goals which lead to speed up delivery, availability of goods, replacement solutions in the event of a stock failure, and one central telephone number on which the centralized team will be able to respond operationally to all queries about the ordered goods – the stage of the order, when it will be delivered etc.

At the beginning of the project two European distribution centers were planned in Paris and Leipzig, but at the time of planning, a third center was added in Moscow. The reason was geopolitical global development and sanctions directed at Russia and its retaliatory steps. Was chosen external logistics system despite its financial operational difficulty. The reason was the elimination of a one-time “cash flow” investment, the creation of a new large department and, last but not least, the possibility of cooperating with one provider on a global basis, resulting in a strategic link. As a result, the three centers are a great asset for the company. This has ensured its substitutability in times of sudden outages of one of the centers, the division of the region of Europe into more segments and thus the reduction of logistics costs. The service centers for repairing the machines (products) of the company have also been established in the distribution centers. Even this centralization has proven to be of benefit as service technicians have access to the warehouse and thus all spare parts are immediately available, resulting in a reduction in the response time of the repair and thus in the image of the company.

After the implementation of a new logistics and distribution system, KPIs of various parameters are continuously monitored. Developments and trends have been and are being monitored and individual parameters are maintained in the required values after implementation.

Monthly KPIs were also monitored in relation to customer communication. To monitor the effect of the whole implementation on customer perception, NPSs have been introduced. The development was monitored on a monthly basis, drawing conclusions on how successful the entire implementation was in relation to customers and at what level the whole communication was handled.

## **Conclusion**

New product distribution trends focus on integrating improvements to all product lifecycle activities, particularly in terms of customer satisfaction and performance. One of the main tasks of current systems is to minimize the discrepancy between cost effectiveness and customer satisfaction. Finding a balance between customer satisfaction and supply chain efficiency is a critical issue in the overall operations of companies (see Ebrahimi, 2018). In this context, Customer Care appears to be a promising model, which is a beneficial solution for both companies and customers. This approach can take on a key role in global operations.

The complex operating system of the company is one of the possible

ways of effective organization management. The unified ERP platform is also an important aspect for the functioning of multinational corporations in terms of distribution logistics. From a case study conducted in a global company, it can be said that the introduction of Customer Care and its centralization has been a costly and lengthy process, but leads to customer sustainability and satisfaction and cost reduction.

By canceling the Pond stores, both storage and distribution costs were reduced by 10-20%, as well as the labor costs decreased by about 50%. Secondary effects include a 25% reduction in inventory and a 20% reduction in expulsion after expiry. Based on the results of key performance indicators and customer experience indicators, it is clear that by introducing a newly centralized customer relationship management, there is increasing satisfaction and slow performance of performance indicators and customer experience. These final results show the effectiveness of the change.

## References

1. Blecharz, P. (2015). *Kvalita a zákazník*. Praha: Ekopress. ISBN 978-80-87865-20-0.
2. Ebrahimi, S.B. (2018). *A bi-objective model for a multi-echelon supply chain design considering efficiency and customer satisfaction: a case study in plastic parts industry*. *The International Journal of Advanced Manufacturing Technology*, Vol. 95, Issue 9-12, pp. 3631.
3. Emmett, S. (2008). *Inventory Management: How to minimize costs and maximize value*. Brno: Computer Press. ISBN 978-80-251-1828-3.
4. Goodman, J. (2018). *Customer Experience 3.0: High-Profit Strategies in the Age of Techno Service*. New York: AMACOM. ISBN 978-08-144-3389-8.
5. Pohludka, M., Stverkova, H., Panna, A. (2018a). *Proper HR audit and due diligence process: key factors in a successful acquisition*. In: *8th International Multidisciplinary Scientific Symposium, 2018*, pp. 865.
6. Pohludka, M., Stverkova, H., Ślusarczyk, B. (2018b). *Implementation and Unification of the ERP System in a Global Company as a Strategic Decision for Sustainable Entrepreneurship*. *Sustainability*, Vol. 10, Issue 8, pp. 2916.
7. Vysekalova, (2014). *Emoce v marketingu*. Praha: Grada. ISBN 978-80-87865-20-0.



## Chapter 3

# ENSURING COMPETITIVENESS OF RESOURCE POTENTIAL THE ECONOMIC ENTITIES

**Kovalenko Viktoria**

*Dr. of Sc. (Economics), Professor*

**Sergeeva Elena**

*PhD (Economics)*

**Radova Natalia**

*PhD (Economics), Senior Lecturer*

*Department of Banking*

*Odessa National University of Economics*

*(Odessa, Ukraine)*

## DEPOSIT POLICY AND ITS IMPACT ON ENSURING OF COMPETITIVE ADVANTAGES OF BANK

Formation of deposit policy of banks is a leading place in ensuring their competitive advantages on the financial market. The latest banking crises have led to the fact that each bank within the regulatory framework should form an effective deposit policy with regard to interest rate policy, the structure of attraction resources, sources of replenishment equity in order to level out and cover the risks taken.

In the conditions of further development of market relations and intensification of competition between banking institutions for potential depositors, each bank should not formally, but reasonably approach to develop of the concept deposit policy, determining the optimal technology of deposit services, composition of the deposit portfolio, deadlines, interest rates and other conditions for attracting deposits [1, p. 66].

Deposit policy – a complex economic phenomenon; its essence must be considered in the broad, and in the narrow sense. In broad, the deposit policy of banks is characterized as a strategy and tactics of bank in its activities in relation to attraction of resources for return, as well as in the organization and management of the deposit process. Under deposit policy in the narrow sense understand the strategy and tactics of banks in part the organization of the deposit process in order to ensure its liquidity [2, p. 98; 3, p. 40; 4, p. 835].

The main features of the deposit policy of banks should include:

- closely related to the credit policy of bank, since it provides interconnection and interconnection between deposit and lending operations on terms and amounts;
- is aimed at satisfying the needs of bank in liquidity by actively attracting funds, in particular borrowed funds;
- combines the strategy and tactics of bank in attracting funds from depositors and other lenders and determining their most efficient combination;
- is based on the assortment of high-quality deposit services, various forms and methods of attraction funds, special attention is paid to term deposits, which help to maintain liquidity balance sheet of bank and are more predictable;
- ensures stability of deposit base and competitive advantages on the financial market.

When forming a deposit policy it is necessary to take into account the interests of all participants in these relationships. The interests of all the participants of the relations in the process of forming the deposit resources of banks partially contradict one another. At the same time, the global task facing the banking system and the state – is to reconcile all these interests and bring them into general system policy. And if banks and depositors have already successfully mastered the co-ordination of each other's interests in the process of forming a deposit policy of a separate bank, then to influence the state on their interests it is more difficult.

Deposit activity of banks correlates with the chosen concept of formation and implementation of deposit policy.

At the heart of formation deposit policy are both general and specific principles, namely:

- general principles: scientific substantiation, integrity system, complex approach, optimality and efficiency of element unity;
- specific principles: ensuring optimum level of costs; security operations of bank; reliability assurance.

Observance of these principles allows banks to formulate both strategic and tactical directions in the organization of deposit operations, thus ensuring the efficiency and optimization of its deposit policy.

It should be noted that the main part of banking resources is formed in the process realization of depositing operations of bank, from the effective and correct management of which depends the stability of

functioning a credit organization. Effective management of liabilities requires implementation a scientifically sound deposit policy. Deposit policy as a part of management system activity of bank includes directions and tasks for the purpose of development of deposit operations and increases their efficiency (Table 3.1).

*Table 3.1*

**Directions and tasks of deposit policy**

Directions	Characteristics of tasks
Deposit market analysis	research the needs of consumers, research deposit policies of competitors, assessing the impact of NBU policies on state the deposit market and trends in its development
Definition of target markets for minimization of deposit risk	raising the level of macroeconomic research of each market segment in order to gain competitive positions on certain market segments, as well as identification, control and risk monitoring
Minimizing costs in the process of attracting funds to deposits	permanent search of ways and means of reducing interest costs on the attracted resources, rationalization of banking business
Optimization management of deposit and loan portfolios of the bank	support of mutual communication and mutual agreement between deposit operations and operations on granting of loans by amounts and terms of deposits and credit investments
Supporting liquidity of the bank and increasing its stability	support of expensive and low-paying deposit resources at a level that ensures appropriate bank profitability and liquidity of balance sheet

*Source:* systematized by the authors on the materials [2-5]

Deposit policy represents a system that includes elements of the process management activity of bank, namely: strategy, tactics and control. Which managing any process, deposit operations management is subject to general banking requirements, that is, the combination of liquidity, profitability and risk.

The main criterion in develop of deposit policy is the correct formulation of the purpose and objectives for its implementation, namely:

Strategy of bank for developing the main directions of the deposit process: achievement of long-term goals of bank in terms of growth the client base and increase of competitiveness by providing customers of quality banking services in such a way and to the extent that they meet

the high professional standards and provide the corresponding profit of the bank;

Tactics of bank on the organization of formation a resource base: attracting as much cash as possible at the lowest price, provided that ensured liquidity of bank;

Control over the implementation of deposit policy: meeting customer needs by providing a quality level of service [4; 6].

Analyzing the resource base of bank it can be argued that its optimal structure is achieved by the ratio between its own funds and obligations of bank, which ensures the most effective proportion between the coefficient of financial profitability and the coefficient of financial stability of bank, that is, maximized its market value. The above gives grounds to distinguish the components of the integrated resource management mechanism of bank, using two main criteria: costs and profit. For the optimal influence of both the internal and external environment on bank, resources should be obtained with minimum costs and insuring maximum profits [4; 7].

When forming a deposit policy, the bank must take into account a number of factors that are able as possible to help expand share the client's market and attract as much deposit resources.

These factors include: taking into account the level of inflation and incomes of population in the country as a whole; influence of NBU and Government policy, state of social environment; improving the work of bank staff, which directly serve clients in the branch and carry out the current communication with them; introduction of new forms of cooperation with clients for their potential interest in the services of bank, creation of more convenient conditions for clients to execute a deposit agreement; a constant and systematic reduction of risk level associated with irrational decisions that may apply to a deposit agreement; application of different methods promotion the clients of bank (advertising, providing additional free services in addition to deposit agreement, location of branches in places close to customers, adapting the schedule of work to the needs of clients).

In case of crisis, deposit activity of banks should be directed to develop of a deposit strategy aimed at attracting new customers, namely: development strategy and diversification strategy; maintenance of existing clients (penetration strategy); introduction of new directions of development in products and services (innovative strategy).

Thus, it can be argued that the deposit activity of banks depends on the behavior of economic entities and households, as well as the

developed deposit policy, including their social responsibility.

It should be noted that income is the main factor that influence at the level of deposit investments. This issue was dealt with by prominent researchers. J. M. Keynes believed that the savings depend on the level of current income [8, p. 158]. I. Fischer also researched this issue, but concluded that basically savings depend on the income that consumers expect to receive throughout their lives [9, p. 464].

M. Friedman emphasized that the incomes of people often change, and these changes are random and temporary [19, p. 477]. The specified level of temporary income the household is sent to deposits. Based on the analysis of these factors, one can list a number of obstacles inherent in domestic economic realities that influence on efficiency of the process formation deposit resources of banks. They include:

- low level of real incomes in society, which remain after costs on current consumption. The volume of free cash resources that can be placed on bank accounts is less than potentially possible;
- high inflation that leads to rapid depreciation of savings and, consequently, have a negative influence on the desire to invest free cash resources on bank accounts, since the rate on them does not overlap the level of inflation, which means it is more profitable to buy durable goods or precious things than to store them in cash;
- high level of taxation incomes the citizens;
- large amounts of money outside the banking system due to the existence of shadow sector income, which makes it difficult to legalize them through the banking sector;
- insufficient trust to the banking system caused by the bankruptcy of banks and the unstable political and general economic situation;
- insufficient level of banking technologies for servicing the population in many banks and poor customer service;
- insufficient trust to national money, which prompts to keep deposits in bank accounts in foreign currency (more stable) [10, p. 202].

One from the factors influencing on the process of forming a deposit policy of banks is restoration of confidence to the banking system.

The banking system of any country is formed under the influence of many factors: historical, economic, cultural, political, legal and a number of others. At the same time, the exclusive role for the organization and functioning of both a particular banking institution and the banking sector in general is played by trust in them by economic

actors [11, p. 284].

The problem of trust to banking institutions became the subject of a study by a number of foreign and domestic researchers. In particular, W. Bedget, in his scientific paper, “The Money Market of England” [12] regards trust as a two-way equality: on the one hand, bankers need to trust borrowers, but on the other – depositors should fully trust the banks. Thus, the peculiarity of trust to the banking system is the unprecedented trust between the entities of financial relations. It means that bankers need to take all possible measures to maintain the rest and confidence of the population in banking institutions, because the panic of economic entities is one of the main causes of unpredictable loss of trust to the banking system.

N. Zigimel in the research “Necessary rules for merchants, bankers, commissioners, and in general for every person that involved any business” points out that any business is based on trust, so he advises bankers to always strive to gain trust those with whom they have to deal. This can be achieved of different ways, first of all, due to honesty and integrity [13, p. 22].

A well-known domestic banking market analyst A. Khilko [14] notes that “... trust – the basis of capital, primarily banking. First of all, trust on the part of a client of bank of ordinary citizen. Trust can not be measured or predicted as a planned indicator. Trust does not arise from vivid advertising, from promotions or large interest on deposits. Trust can not be artificially stimulated or caused by external irritants. Trust to the bank – a result of everyday laborious work, the result which is being developed of years, decades. This is what we need to understand and build around of this our banking system”.

It can be argued about influence on the formation of deposit resources banks their deposit policy, social responsibility and financial literacy of the population (if consider the factors of a market economy without political decisions) [15].

Among the principles of social responsibility, which are defined by banks, should be the following [16, p. 109]:

- The principle of openness and transparency. It provides insuring transparency of financial reporting, payment of taxes, official salary of the employee of bank, openness and transparency in relations with clients, partners, employees and authorities.

- The principle of respecting the interests and needs of future generations in order to ensure sustainable development. Banks are

involved in solving the economic, social, environmental problems that exist in our society.

– The principle of conducting a permanent dialogue with the interested parties. In order to comply with this principle, they are constantly working to identify the interests and needs of interested parties in a timely manner in order to improve banking services and social activities, as well as increase the level of trust to the bank.

In the area of social work of commercial banks, it is important to restore the trust to them of depositors. The low level of awareness of Ukrainian citizens about the functions and principles of the operation of financial institutions is causing a certain distrust of the bankers and the banking system as a whole among the various segments of society. So, when choosing savings instruments, listen to the advice employees of financial institutions only 7.4% of respondents.

The most trust of banking employees are used by citizens aged 20-29 (12.6% of respondents of this age are guided by their proposals). At least on the recommendations of bankers pay attention to the older generation. They first listen to their family members.

Thus, in addition to external economic factors influencing on changing sentiment of financial market participants, a significant place occupies of “sundress radio”. There are several directions to improve the situation: raising the level of financial literacy of the population and, in parallel, increasing the degree of transparency of banking activities [17, p. 20].

The trust to the banking system of Ukraine according to the Gallup Institute [18] is only 28% and is one of lowest in the world. The main problem is that ordinary citizens do not understand all the processes and transformations that take place inside the banking sector. This situation is also exacerbated by external factors – the fall of living standards, the presence of inflationary processes, the fluctuation of foreign exchange rates, the increase of level unemployment, the reduction of incomes population, etc. Today, one of the most important tasks for restoring the trust to the domestic banking system is raising the financial literacy of the population, ensuring openness of banking activities, expanding the range of banking services and ensuring their availability, the active use of marketing technologies and communications, and enhancing the image of banking institutions.

The proper clients servicing of bank allows them to increase level their loyalty and increase the trust, which is substantiated by the results of fundamental research [19, p. 219]: an increase the share of regular

buyers by 5% increases sales by 25%; the costs of attracting a new client for servicing the bank are larger by about 5-10 times than the amount available; reducing the outflow of customers by 5-10% provides the bank up to 75% of additional profit; an increase retention of customer by 5% contributes to an increase the profit of bank by 85%; satisfied customer will notify about successful purchase on average five of his acquaintances, dissatisfied – at least ten; customer relationship management system increases the quality of service to 40%; the cost of attracting each new client to a bank with rising market saturation is increasing, and the cost of maintaining customers remains low; stable customer base ensures stability activity of bank and contributes strengthens its competitiveness.

During the analyzed period there are three cycles of decline the economy of Ukraine: 1996-1998; 2008-2009; 2014-2015. As can be seen from the presented stage, in Ukrainian realities we always have to deal with small cycles (3-4 years). This is due to the fact that:

- *firstly*, an independent Ukrainian state has a rather short period of time, and therefore to trace long cycles of its development it is difficult;
- *secondly*, this is due to the regularities in our cyclicity and the influence on them of the characteristic features of the economy, such as: openness, dependence on raw exports and a small share in the world market;
- *thirdly*, the crisis in development is entirely in the area of reluctance of the authorities to carry out structural reforms and to change the nature of the economy from the raw materials of the world to the modern high-tech country [10, p. 202].

As of September 2018, the amount of cash that outside the banking system amounted to 348.284 billion UAH. It is this money that can be a guarantee development of domestic production and contribute to the general economic growth of Ukraine. Thus, we can assert that the deposit policy of banks is primarily connected with insuring a stable resource base on favorable for banks conditions and protecting the interests of depositors and creditors.

In order to improve this process we consider it expedient: introduction of differentiated norms to the capital of banks, that accepting time deposits from depositors; deposit guarantee fund should increase the differentiation of rates of fees for currency and hryvna deposits; initiation of adoption of legislative rules on revision of



provisions for early termination of deposit agreements; within the framework of projects for the dissemination of financial literacy, it is necessary to inform citizens about the benefits of deposits; alternative savings deposits (but not substitutes) should be an additional type of deposit that encourages long-term savings in hryvna; limit the cost of re-attracted foreign currency deposits at the level of 6% in dollars USA, 4% in EUR; to introduce restrictive measures on the return of foreign currency deposits only in case of early termination of deposit agreement; remove restrictions on the issuance of deposits in foreign currency after the expiration of deposit period; remove restrictions on the purchase of currency by individuals for the de-shadow of the currency market; to pay foreign currency deposits and interest on foreign currency deposits in the currency of deposit, providing for conducting in the national currency servicing operations.

## References

1. Zolatoreva O.V., Pivnjak Yu.V. & Gurbish O.V. (2015). *Modification of the deposit policy of commercial banks of Ukraine, Economy and the state, Vol. 2, pp. 65-69.*
2. Bartosh O. (2008). *Deposit policy of the bank and the main stages of its formation, Bulletin of the UBS NBU, Vol. 3, pp. 97-101.*
3. Kovalenko O.M. (2017). *Deposit policy of banks and its influence on the efficiency of attraction of deposit resources, Investments: practice and experience, Vol. 2, pp. 39-44.*
4. Kovalenko V.V.(2015). *Deposit activity of Ukrainian banks: realities and future development, Global and national problems of the economy, Issue 4, pp. 834-837.*
5. Olexenko M.V. (2011). *Deposit policy of banks at the present stage, Bulletin of the Berdyansk University of Management and Business, Vol. 4 (16), pp. 166-169.*
6. Bartosh O.M. (2014). *Deposit policy as a component of bank's management, Financial Space, Vol. 4(16), pp. 19-24.*
7. Ignatišin M.V. (2017)/ *Resource base of commercial banks and its role in the mechanism of development of banking business, Scientific Bulletin of the Mukachevo State University, Issue 1 (7), pp. 205-209.*
8. Keynes J.M. (1978). *The general theory of employment, interest and money, Moscow, Progress, 494 p.*
9. Mankov G. N.(2000). *Macroeconomics, Kyiv, Osnovy, 588 p.*
10. Kovalenko O.M. (2017). *Cycle of economic development of Ukraine and deposit resources in these conditions, Business-Inform, Vol. 1, pp. 199-204.*

11. *Stoyka V.S. (2017). Possibilities of restoring confidence in the banking system of Ukraine in modern conditions, Scientific Bulletin of Uzhgorod University, Vol. 1 (49), pp. 289-294.*
12. *Bagelot Walter. Lombard Street: A Description of the Money Market. Available at: <http://oll.libertyfund.org/simple.php?id=128>. (Accessed 23 November 2018).*
13. *Lukin D.,Mazilo T. (2004). Ethical Aspects of Business of Ukrainian Banks, Bulletin of the National Bank of Ukraine, Vol. 2, pp. 22 - 24.*
14. *Khilko A. Revive Ukraine through trust in banks Available at: <http://n-v.com.ua/vidroditi-ukra%D1%97nu-cherez-doviru-do-bankiv/>. (Accessed 25 November 2018).*
15. *Kovalenko V.V. (2015). Influence of deposit policy on formation of architectonics of banks development, Scientific Journal «Science Rise», Economic sciences, Vol. 3 (8), pp. 78 - 81.*
16. *Bashinsky T.V. (2014). Social responsibility of the banking sector of Ukraine, Scientific Papers of Kirovograd National Technical University. Economic sciences, Vol. 25, pp. 104 - 110.*
17. *Basadze K. M. (2015). Restoration of confidence in the banking system: myth or reality, Financial Space, Vol.. 1 (17), pp. 18 - 22.*
18. *How to restore confidence in banks? Available at: <http://kyiv1.org/news/yakvidnoviti-doviru-do-bankiv-043152/>.(Accessed 26 November 2018).*
19. *Torahian J.I., Antimonik K.V. (2013). New trends in banking marketing: domestic and foreign experience, Bulletin of the University of Banking of the NBU, Vol. 1, pp. 219 - 224.*

**Paliukas Vytautas**

*M.B.A, Lecturer, Head of Applied  
Research and Non-formal Education  
Department, Panevezys College*

**dr. Savaneviciene Asta**

*Professor Principal Investigator of  
Sustainable Management Research  
Group at the School of Economics  
and Business*

*Kaunas University of Technology  
(Panevezys, Kaunas, Lithuania)*

**ARTIFICIAL  
INTELLIGENCE  
BASED HUMAN  
RESOURCE  
DEVELOPMENT FOR  
ENSURING THE  
COMPETITIVENESS  
OF ECONOMIC  
ENTITIES**

## **1. Importance of Human Resources in economic entities competitiveness**

Successful business and competitiveness in the companies and institutions is moved forward by human resources development. It is employees who play most significant role creating efficient competitive team in the company and help company to stay competitive. The purpose of this article is to disclose the extent and nature of AI in human resource development for ensuring the competitiveness of economic entities.

### **1.1. Human resources as one of the most important economic entities competitiveness prerequisite**

Schuler, R.S., Dowling, P., at al. (1993) name human resources and human resource management as the main factor in effective competitiveness achievement. It has become obvious that investment into human resources is commonly recognized as development factor and one of the best investments. Even in the early historical business and economy development it was understood, that “the most valuable capital is the one invested in the human factor” (Marshall, A., 1890).

Furthermore, human resources are presented as Human Capital, which is explained as explained as an economic term for knowledge and skills that workers acquire through education, training and experience (Mankju, G. 2006). Podolny, J. M., and Baron, J. N. (1997). Discuss importance of the social capital as a factor that can affect the

competitive advantage and performance of a company. According to Bulatovic, I. and Djurasevic, S. at al. (2016) Productivity plays a key role in determining the living standard of each country. The standard of living of a country depends on its ability to produce goods and services, which is directly determined by the factors of production such as physical capital, natural resources, technological knowledge and human capital. Human capital is mentioned as a factor playing role in the competitiveness and productivity. Human capital resources include such things as the experience, judgement, and intelligence of the individual managers and workers in the firm.

## **1.2. Regional competitiveness and human resources**

As discussed previously the term “human resources” includes not only productivity aspects. Roman, M. (2003) discussing human resources competitiveness from the country perspective defines human resources as “the total population of a country, from the economical point of view, by the direct or indirect participation on the labor market, and from the spiritual point of view by knowledge accumulation”. The qualitative side of human resources often is analyzed from the point of knowledge accumulation which may be referred to education. From this point the human capital can be defined as knowledge, capacities, competences and attributes of the people who make easier the creation of the personal, social and economic welfare. (OECD, 2001).

According to the Ileanu, B.V. at al. (2009), the human capital, expressed by the human resources knowledge, aptitudes and competences manages the adapting capacity of the technologies and the creation of the new ones, by them being sustained the complex activities that generate added value. Knowledge and competences are directly related to education and modern technologies.

For the analysis and understanding of territorial competitiveness at the country and regional level, the European Commission has developed the Regional Competitiveness Index – RCI – which presents the strengths and weaknesses of EU regions. RCI was first published in 2010 as the result of a coordinated action between the Joint Research Centre and the Directorate-General for Regional Policy. The index development started in 2008 and builds on the methodology developed by the World Economic Forum for the Global Competitiveness Index. It covers a wide range of issues related to territorial competitiveness including innovation, quality of institutions, infrastructure (including digital networks) and measures of health and human capital. In the latest

issue by European Commission RCI 2016 regional competitiveness is defined as the ability of a region to offer an attractive and sustainable environment for firms and residents to live and work.

The RCI is composed of 11 pillars that describe the different aspects of competitiveness. They are classified into three groups: Basic, Efficiency and Innovation. The Basic group includes five pillars: (1) Institutions; (2) Macroeconomic Stability; (3) Infrastructure; (4) Health; and (5) Basic Education. These represent the key basic drivers of all types of economies. As a regional economy develops and advances in its competitiveness, factors related to a more skilled labor force and a more efficient labor market come into play as part of the Efficiency group. This includes three pillars: (6) Higher Education, Training and Lifelong Learning; (7) Labor Market Efficiency; and (8) Market Size.

At the most advanced stage of a regional economy's development, drivers of improvement are part of the Innovation group, which consists of three pillars: (9) Technological Readiness; (10) Business Sophistication; and (11) Innovation (RCI 2016). Innovation efficiency and innovation groups include aspects of competitiveness which are related to human resources.

A region with a good performance in the Innovation group is expected to have a good performance in the Basic and Efficiency groups as they are instrumental in increasing levels of competitiveness. In this sense, Basic and Efficiency aspects can be seen as necessary conditions for good levels in Innovation aspects. Conversely, regions with poor or insufficient levels in the Basic group cannot be expected to perform well in the other two groups. It is assumed that as regions move along the development path, their socio-economic conditions change and different determinants become more and more important for competitiveness. As a result, improving the competitiveness of more-developed regions will require other priorities than for a less-developed region.

Results of regional competitiveness assessment in EU show relation between human resource related factors and competitiveness increase.

## **2. Artificial intelligence as effective human resource learning for competitiveness development**

Interest in Virtual Reality (VR) and artificial intelligence (AI) based technologies and learning historically started by invention of virtual reality simulators. First of them "Sensorama Machine" was invented in 1957 and patented in 1962. It was a simulator for one to four people providing the illusion of reality using a 3-D motion picture with smell,

stereo sound, vibrations of the seat, and wind in the hair to create the illusion. The “Sensorama Machine” enabled feeling driving experience in virtual reality (Stein, C., 2016 and Howie, S., 2017). More developed adaptation of virtual reality is stimulated by „Oculus Rift” and „HTC/Valve „virtual reality glasses for Global market (Howie, S., 2017).

Development of virtual technologies and artificial intelligence applications indicate technological breakthrough which raises modern challenges for business and opens new research possibilities. In the psychological research and practice Virtual Reality is already used in Cognitive Behavioral Therapy helping clients to deal with various fears, phobia and other disorders (Rizzo, A., and Kim, G. J., 2005), but in the organizational psychology and human resource management VR makes only first steps in employer image formation, talent and employee development and instruction or simulating dangerous training via Virtual Reality (Hua-Ming, L. and Bao-Sheng, K., 2014; Grabowski, A. and Jankowski, J., 2015).

In business environment interest to Virtual Reality became more wide in 1990 when useful simulators were created (Pierce, Ch. A. and Aguinis, H., 1997, Howie, S., 2017). Pierce and Aguinis (1997) were among the first who paid attention to “highly immersive virtual reality (VR) technology to overcome limitations of written vignettes and other traditional methodologies” and can be effectively used to investigate various topics in organizational behavior and industrial/organizational psychology. Test compiled using VR lately are rapidly developing, because accumulated quantitative research data allows effectively use Artificial Intelligence, Machine Learning, Data Mining, Problem Solving supportive methods opening new possibilities in Human Resource Management (Cipresso, P. and Riva, G., 2015). Foreman, M. (2009) definition of virtual reality as “Virtual Reality was said to be “an answer waiting for a question”, but questions are being recognized, so that applications of VEs within the behavioral sciences are likely to multiply” stays actual.

## **2.1 Advantages of AI for Human resources learning and competitiveness development**

Artificial intelligence (AI) applications are utilized to simulate human intelligence for either solving a problem or making a decision. AI provides the advantages of permanency, reliability, and cost-effectiveness while also addressing uncertainty and speed in either

solving a problem or reaching a decision (Chowdhury, M. and Sadek, A. 2012). Three main advantages of AI based learning competitiveness development are worth mentioning. First, in the companies where knowledge sometimes is accumulated by individual workers and specialists Artificial intelligence applications present advantage of not losing accumulated data by changing or leaving person. Second, like many automations, AI supports cost minimization as it enables reduction on the need of personnel time. Third, adaptation of appropriate AI applications in the decision-making process reduces operational costs.

Chowdhury, M. and Sadek, A. (2012) outline, that AI methods are also capable of dealing with both qualitative as well as quantitative data, a feature that most strictly analytical methods lack.

Artificial Intelligence learning methods also have advantage of sufficient data assemble for forecasting and evaluation. Lino, A. and Rocha, A. et al. (2017) propose usage AI in virtual teaching and learning environments. Forecasting techniques are already widely used in automatic assessment in virtual teaching and learning environments, allowing educators to make decisions in both present and future planning.

Due to the element of uncertainty intrinsic to the forecasting methods, a number of studies have been carried out in order to find a more efficient model that allows for exploring and inferring the relation of a dependent variable with independent variables. Lino, A. and Rocha, A. et al. (2017) propose an alternative to solve the problem of automatic evaluation with the use of artificial neural networks that are adjusted, or trained, so that a certain input leads to a specific target output. AI based product configuration systems may be also used as commercial product-configuration tools which can solve complex configuration problems.

Artificial Intelligence based systems combined with new Virtual Reality tools and possibilities offer new challenges and initiatives in Human Resource Management enabling competitiveness development in economic entities.

## **2.2. Future learning technology trends for economic entities competitiveness development**

Development of Artificial Intelligence technologies is generating transformations in business and industries around the World. These transformations create challenges for the future human resources and business competitiveness development. Main future development trends

focus on basic technological areas which can be defined as Cyber Security; Internet of Things (based on AI systems); Big Data Management for Intelligent Systems; Machine learning and Cloud technologies (HOB, 2018).

Jordan M. I., Mitchell, T. M., (2015) address machine learning as future trend of how to build computers that improve automatically through experience. Authors' expression that this is "one of today's most rapidly growing technical fields, lying at the intersection of computer science and statistics, and at the core of artificial intelligence and data science" is relevant to the future AI development, data-intensive machine-learning methods can be found throughout science, technology and commerce, leading to more evidence-based decision-making across many walks of life, including health care, manufacturing, education, financial modeling, policing, and marketing.

Variety of forms and kinds of information produced around us by various technological environments stresses on importance of Big Data as competitiveness factor for the business companies. According to Kubina, M. and Varmus M. (2015), information plays crucial role for people and for companies as well. Their survival in the highly competitive environment depends upon possessing the right information in the right time. Companies must have information concerning their customers, products, environment and themselves. A real trend for future researchers – development of models of information system for work with big data, which will become base for successful information usage in reaching competitive advantage in the market.

Group of researchers on European AI intelligence (Craglia, M. at al., 2018), with respect to computing identified a window of opportunity for Europe to invest in the emerging new paradigm of computing distributed towards the edges of the network, in addition to centralized facilities. This future opportunity will support the future deployment of 5G and the Internet of Things. This group of authors also mention a future possibility opening access to data and developing interactivity with the users rather than just broadcasting data.

Developing Internet of Things is directly related with all upcoming cyber security threads. Paliath, V. and Shakarian, P. (2018) state, that „cyber adversaries employ a variety of malware and exploit to attack computer systems. Despite the prevalence of markets for malware and exploit kits, existing paradigms that model such cyber adversarial behavior do not account for sequential application or “chaining” of attacks, that take advantage of the complex and interdependent nature of



exploits and vulnerabilities.” Cyber security professionals are constantly challenged to develop new competitive security systems. As a result – the company or economic entity having modern IT security system and IT security specialists will have a competitive advantage over competitors in the market.

Artificial Intelligence learning for competitiveness development may also include the latest technological trends which at present are discussed as “Hot topics” in AI research. It is worth mentioning Large Scale Machine Learning, which is concerned about developing systems that improve their performance with experience, Deep Learning (DL), which is re-branding of neural networks- a class of models inspired by biological neurons in our brain. Deep Learning is considered as driving force for lots of applications in AI like object recognition, speech, language translation, playing computer games and controlling self - driving cars, reinforcement Learning (RL) which is the closed form of learning to the way a human being learns. It consists of an intelligent agent that interacts with its environment smartly to reap a numerical reward. The goal of the agent is to learn sequential actions so as to maximize the long-time reward. Like a human being who learns from his experience with the real world, keep exploring new things and updating his values and beliefs, the RL agents works on the similar principle to maximize his own rewards in the long run. (Abhishek P., 2018).

Big World Wide companies working with data, video games use AI learning to process large e amounts of data. Some forms of Artificial Intelligence are more useful for business entities than others. One of the most discussed AI learning trends related Natural Language Processing (NLP), which is usually defined as a tool or field of artificial intelligence learning systems, which enable computers to analyze and understand human language. Jackins, T. (2016) describes NLP “as the ability of a machine to analyze, understand, and generate human speech. The goal of NLP is to make interactions between computers and humans feel exactly like interactions between humans and humans.”

### **3. Conclusions**

Based on analysis in this paper we can summarize importance of AI based human resource learning to economic entities competitiveness by stating that:

Human resources play key role in economic entities competitiveness development along with whole country competitiveness;

Qualitative side of Human resources is related to knowledge accumulation and human capital including competences and attributes of social and economic welfare;

Regional and territorial competitiveness indirectly but clearly depends from Efficiency and Innovation, Training and lifelong learning and important technological innovations leading to technological readiness;

Most modern trends of technological readiness and innovations in Human Resource Management and learning are related to Artificial intelligence tools and systems development, research and development in Virtual Reality (VR) technologies for simulation in Human Resource training, AI possibilities in problem solving and decision making including operational costs minimization. Development of Artificial Intelligence technologies generates transformations in business and industries creating challenges for the future human resources and business competitiveness development.

AI and VR based learning methods including simulation techniques are safer in comparison to live person training in dangerous situations (traditional methods) and contribute to more effective Human Capital and economic entities competitiveness development.

## References

1. *Bulatovic, I. and Djurasevic, S. and Stranjančević, A. (2016). Human resources as a factor of competitiveness and quality in the hospitality industry. 143-149. 10.15308/Sitcon-2016-143-149.*
2. *Chowdhury, M. and Sadek, A. (2012). Advantages and Limitations of Artificial Intelligence.*
3. *Craglia, M., Annoni, A.; Benczúr, P., Bertoldi, P. and others, (2018). Artificial Intelligence: A European Perspective. 10.2760/11251.*
4. *Foreman, N. (2009). Virtual Reality in Psychology. Themes in science and technology education. Special Issue: 225-252.*
5. *Grabowski, A. and Jankowski, J. (2015). Virtual Reality-based pilot training for underground coal miners. Safety Science, 72: 310-314.*
6. *House of Bots, (2018). Major Technology Trends for Business Competitiveness. [online] Available at: <http://houseofbots.com/news-detail/2648-1-major-technology-trends-for-business-competitiveness> [Accessed 14 Dec. 2018].*
7. *Howie, S. (2017). Virtual Reality, The Now and Future of Gaming? Dissertation. University of the West of Scotland. P. 105.*
8. *Hua-Ming, L. & Bao-Sheng K. (2014). A Virtual Reality Safety Training System for Coal Mining Industry. Applied Mechanics and*

- Materials*. Vols. 687-691: pp 2371-2374.
9. Ileanu, B.V. and Dimian, G. and Mihai, D. (2009). REGIONAL COMPETITIVENESS DEVELOPMENT BASED ON HUMAN RESOURCES. *Annals of Faculty of Economics*. 2. 645-653.
  10. Jackins T. (2016). *Text2Speech blog*. [online] WHAT IS NATURAL LANGUAGE PROCESSING AND HOW DOES IT WORK?. Available at: <https://blog.neospeech.com/what-is-natural-language-processing/>. [Accessed 14 Dec. 2018].
  11. Jordan M. I., Mitchell, T. M., (2015). Machine learning: Trends, perspectives, and prospects. *Science*, 17 Jul 2015: Vol. 349, Issue 6245, pp. 255-260 DOI: 10.1126/science.aaa841
  12. Kubina, M. and Varmus, M. and Kubinova, I. (2015). Use of Big Data for Competitive Advantage of Company. *Procedia Economics and Finance*. 26. 561-565. 10.1016/S2212-5671(15)00955-7.
  13. Lino, A. and Rocha, A. and Sizo, A. (2017). Virtual teaching and learning environments: automatic evaluation with artificial neural networks. *Cluster Computing*. 10.1007/s10586-017-1122-y.
  14. Mankju, G. (2006). *Principi mikroekonomije*. Beograd: Publikum.
  15. Marshall, A. (1890). *Principles of Economics, Fifth edition*, Macmillan, London, 1907.
  16. OCDE. *Knowledge and Skills for Life: First Results from PISA (Executive Summary)*, (2000). OCDE, Paris.
  17. Paliath, V. and Shakarian, P. (2018). Defending Against Chained Cyber-Attacks by Adversarial Agents: An Artificial Intelligence Approach. 10.1007/978-3-319-92624-7\_8.
  18. Paola A., Lewis D. and Gargano N., (2016). *The EU Regional Competitiveness Index 2016*. ISBN 978-92-79-65839-6; ISSN 2529-3303 doi:10.2776/94425
  19. Parbhakar A. (2018). *Towards Data Science*. [online] Hot topics in AI research. Available at: <https://towardsdatascience.com/hot-topics-in-ai-research-4367bdd93564> . [Accessed 14 Dec. 2018]
  20. Pedroli, E., Serino, S., Cipresso, P., Pallavicini, F. and Riva, G., (2015), 'Assessment and rehabilitation of neglect using virtual reality: A systematic review' *Frontiers in Behavioral Neuroscience*, vol. 9, no. AUGUST. <https://doi.org/10.3389/fnbeh.2015.00226>
  21. Pierce, Ch. A. and Aguinis, H. (1997). Using virtual reality technology in organizational behavior research. *Journal of organizational behavior*, vol. 18: 407-410.
  22. Podolny, J. M., & Baron, J. N. (1997). Resources and relationships: social networks and mobility in the workplace. *American Sociological Review*, 62(5), 673-69
  23. Rizzo, A., and Kim, G. J. (2005). A SWOT analysis of the field of virtual

*reality rehabilitation and therapy. Presence: Teleoperators and Virtual Environments, 14, 119–146.*

24. Roman, M., *Human resources in Romania – evaluation and efficiency*, ASE Publishing, Bucharest, 2003.
25. Schuler, RS, Dowling, P., De Cieri, H., (1993). *An integrative framework of strategic international human resource management*, *Journal of Management*.
26. Stein, C. (2016) 'Virtual Reality Design: How Upcoming Head-Mounted Displays Change Design Paradigms of Virtual Reality Worlds'. *Mediatropes, 6, (1): 52-85.*

**Serdyuk Vasil**

*Doctor of science, Professor*

**Serdyuk Tetyana**

*PhD in Economics, Associate Professor*

**Franishyna Svitlana**

*Post Graduate Student*

*Construction, Urban Management and Architecture Department*

*Vinnitsa National Technical University (Vinnitsa, Ukraine)*

**MODERN  
MANAGEMENT  
TOOLS FOR  
INCREASE ENERGY  
EFFICIENCY LEVEL**

Providing competitive advantages in the activities of any organization should become a strategic priority and a key direction of development. It is necessary qualitatively appreciate all the potential of increasing the efficiency of production and economic processes. It's about managerial, organizational and technological potential, energy, ecological, resource and human reserves.

Energy efficiency – is one of the key aspects of the competitiveness, especially in conditions high energy intensity of production. According to some estimates, today, the Ukrainian industrial sector uses outdated technologies, production equipment and machinery at the same level as that exploitation in developed countries in the 90's of the last century. In parallel, some domestic enterprises use energy-intensive technologies that were used in Europe in the 1960's and today they are considered ineffective and “dying” [1].

It has been emphasized that in Global energy efficiency ranking in

2017 drawn up by the World Economic Forum, Ukraine takes the 73<sup>d</sup> place from 127 countries. In the same time, Ukraine has yielded all European countries and the level of energy efficiency is equivalent to such as Nicaragua and Ghana (Figure 3.1).

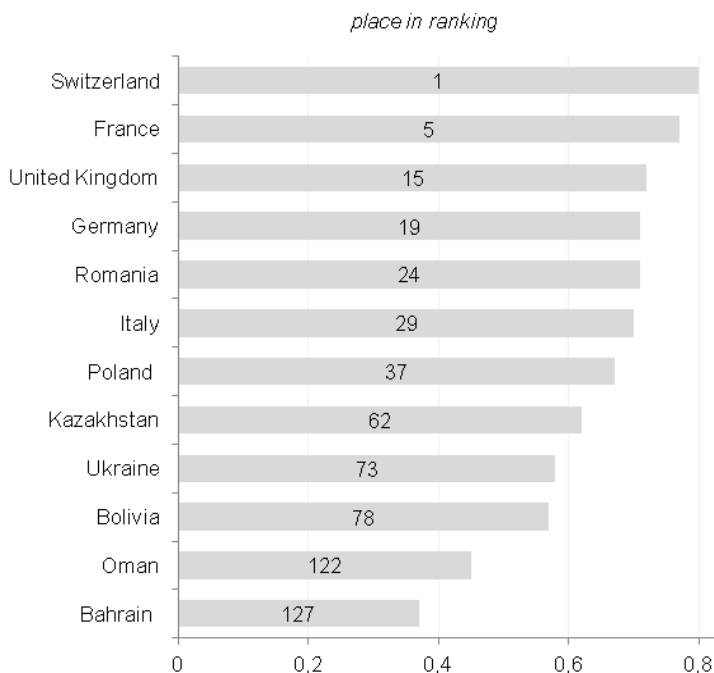

**Figure 3.1 Global Energy Architecture Performance Index 2017, for some countries (EAPI, score on a scale of 0 to 1)**

*Source: compiled by the authors [2,3]*

The Energy Architecture Performance Index (EAPI) is a composite index that focuses on tracking specific indicators to measure the energy system performance of 127 countries. At its core are 18 indicators defined across the three sides of the “energy triangle”, which are: economic growth and development, environmental sustainability, and energy access and security.

Ukraine takes the 119<sup>th</sup> place from 127 countries for the using of fuel and energy recourses per unit to the production. Also, our country takes the 122<sup>d</sup> place for the import dependence indicator (import value exceeds 12% of GDP). In 2017, in Ukraine natural gas consumption equals 32 billion cubic meters, of which 15 billion cubic meters (nearly

50%) was imported from different European countries [4].

Despite, for different international expert appreciates, Ukraine has every opportunity to realize its great potential and substantially increase its energy efficiency. The active state policy in sphere of energy saving is concentrated mainly on the processes of housing insulation and the thermo-modernization of existing buildings.

Today, in our country there are “warm loans”, targeted subsidies of the population for the accumulation of financial resources and reinvestment in the thermal modernization of residential building. However, with the mental national understanding of the global energy problems of the state level, low living standards, this practice of reinvestment of funds saved through payments in energy saving measures remains questionable [5].

If there is some energy efficiency motivation programs in housing sector of Ukraine, than for industry any motivation tools and mechanism are practically absent. Domestic business stays alone with the big problem of the increase their energy efficiency. Now domestic enterprises are looking for the way and opportunities, financial resources and organizational measures for realization their energy efficiency potential. The absurdity of such a state policy is intensified by the activity of motivational policy in developed countries, where state support was and remains quite substantial.

The problem of energy saving is still very important and actually in modern conditions of price ad tariff increase at Ukrainian enterprises. World experience shows that energy efficiency is primarily a process of investing in innovative development. That is, the process of increasing energy efficiency is impossible without a constant innovation and investment resource.

However, it is not necessary to promote the localization of only energy-saving activities, because it is in strong interaction and interconnection with innovation and investment processes of increasing energy efficiency. Conversely, the high potential for reducing energy intensity will contribute to the development of innovation infrastructure with further investment support. It is absolutely clear that energy efficient is a constant investment process, necessary to provide innovative shifts.

Despite a number of obvious advantages and great benefits of energy saving, it is difficult to say such activity is massive among Ukrainian producers.

It's an important to remember that, there is no implemented energy

management system in the Ukrainian enterprises (nearly 70% of 400 enterprises-respondents). About 13% of respondents believe that such an introduction is not appropriate. Nearly 21% of respondents do not have any information about energy management at all. Actually, about one third of the enterprises surveyed do not see any benefits from the implementation of energy management systems [5]. Radical modernization of industrial technologies on our domestic production, increase of product quality standards to European levels, growth of level competitiveness of Ukrainian products – are necessary requirements of modern management.

For an effective start-up of innovative changes, it is necessary to create a workable motivation system with clear innovative solutions that will function in a comfortable social climate. In practice, enterprise management can use international standards and concepts for the organization system management for the offered innovative solutions (Figure 3.2).

The processes of increasing energy efficiency and energy-saving activities are closely linked to the search, optimal selection and analysis of individual innovation projects. The world leaders such as the United States, Japan and Germany have raised this issue to a high standard and, at the national level, have developed universal methodologies for practical tools for managing projects and programs.

Ukrainian Project Management Association orientates managers with the IPMA certification system and Japanese standard P2M [9]. The P2M (Program and Project Management for Enterprise Innovation) is a conceptual Japan's methodology for project and program management in the use of innovative technologies for the enterprise. The main difference between this standard is the focus on improving the organization of management to innovative projects implementation.

Using PM methods and tools cannot ensure the success of a project, but it can improve its chances of success. Many methods and tools have been developed since and are now available and routinely used by projects managers.

However, the use of modern management concepts, as a rule, requires the presence of appropriate corporate culture and effective work, with high employee loyalty to the enterprise. Only in such situation is it possible to use workers creative potential for implementation innovative processes. Often, there is no need to use financing motivation for workers, when they feel their own significance for the company.

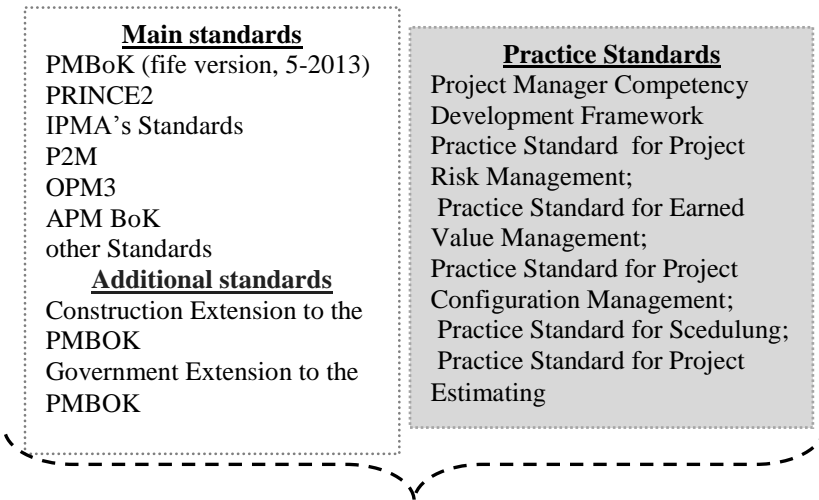

*ISO 10006:2003, ISO 9000:2005, ISO 9001:2008, ISO 9004:2000, ISO 10012:2003, ISO 19011:2002, ISO 21500, ISO/IEC 29110*

PMBoK – USA, Russian Federation  
PRINCE2- United Kingdom  
P2M - Japan  
IPMA’s Standards - European Union, Ukraine

**Figure 3.2 Project Management Standards and Guides**

*Source: compiled by the authors [6, 7, 8]*

People in organization are most valuable asset and the only source of competitive advantage for business today. Everything can be replicated – products, services, infrastructure – but not human recourses. Once, great business leader of General Motors Alfred Sloan said: “Take my assets-but leave me my people and in five years i’ll have it all back”.

Besides, when economic crises occurred in the 1980s and 1990s, many manufacturing companies such as Toyota, Honda, Canon and Sharp also survived, as they adapted to changing times by continuing to invest in human development, as inexhaustible sources of innovation changes.

Effective implementation of innovation-oriented human potential is possible when we create rational organization system. Organizational potential – is the aggregate reserve of management system efficiency



increase, rational organization structure and internal processes, with the aim to accumulate the innovation potential as a source of the enterprise growth, its market value and competitiveness.

The professional management of human resources – is a source of qualitative changes of innovation activity and comprehensive development of the company.

Human recourses are not only arithmetical set of knowledge, experience and practice of workers but also their ability to manifest themselves in the work. Therefore, successful organization and professional management of human resources are a main and significant reserve of innovation development of the company.

On Ukrainian domestic enterprises very often the innovation development slows down because of the lack of financing recourses and weak investment activity. The investment potential on our enterprises is quite limited and financial priority is given to urgent production needs.

Also, one of the most important problems is planning process of investment development directions. Often, the prioritization of implementation plans with calculating investment decisions in the company is simply absent.

The modern management practice shows that about 15% of the information at on each management level is lost during communications. Therefore none manager will never understand the problems of the grassroots level and, moreover, he should not propose their solutions [11].

If most resources in business are limited, in the same time, the human resource has an unlimited potential for innovation-oriented knowledge and ideas creation. Unfortunately, lot of Ukrainian top managers does not see any need to change something. So, large amount of our manufactures have low competitiveness with further bankruptcy, because refuse to apply effective approaches, methods and concepts of modern management.

The building materials industry of Ukraine consists of enterprises with old Soviet history and the same inadequately formed corporate culture. Enterprises of production building materials are objects of special attention because in manufacturing process significant amount of energy resources is used. Accordantly in such conditions cannot be applied modern tools, effective management standards and program and project management concepts. With the considering of Ukrainian managers mentality level such application will never happen...

First of all it is necessary to create correct innovative-oriented human

system, where every worker feels own importance in corporate time and understanding need innovation changes. Only in comfortable microclimate human resource can realize their creative potential. It's quite clear that new organization changes and innovation activity realisation are perceived negatively among workers because their afraid of uncertainty situation.

In the old Ukrainian high energy intensity manufactures there is no hope for massive using of effective management tools despite on great world experience. All this processes impossible without favourable microclimate. Thus, it's necessary to start powerful motivational mechanism with different financing stimulate and clear remuneration schemes for innovation activity.

The main development preconditions of innovative processes must become a clear and understandable methodology for every worker that describes steps for innovation realisation. These steps include suggesting an innovative ideas, their correspond to priority criteria, main rules of making decisions and possible premium of payment.

One of the most important components is a priority selection criterion for every innovation idea. It must help the managers make right choice among the potential decisions. Speaking about business and commercial company – the financing criteria (profitable indicators) has a great advantage. These indicators include a payback period, a net present value, a cash flow from investing, a profitable index etc [12].

In modern Ukrainian realities of higher prices and tariffs on energy resources energy efficiency indicators become equally important. As a result it directly affect on the reducing energy cost of technological process and production system. These energy efficiency criteria's can include indicators such as energy unit cost on per production, energy intensity on goods and services for some period, the share of energy in cost production and others.

The quality improvement indicators, development of marketing and logistic processes, more efficient organizational and managerial conditions and improvement of working conditions also have a great importance for enterprise activities.

Today it's quite clear that innovation is a very important vital process. Therefore, the main task for the enterprise top management is the most rational and effective organization management of innovation processes.

Radical modernization of industrial technologies on our domestic production, increases of product quality standards to European levels,

growth of level competitiveness of Ukrainian products – are necessary requirement of modern management. High level of energy inefficiency is mostly concentrated in the industrial sector.

In modern conditions Ukrainian business management should not ignore the newest management tools that proved their effectiveness and workability. The lack of activation is primarily due to the mental unwillingness and personal non-awareness of the need to use modern tools for managing the company.

If the managers and personal are not ready to change its business strategy and use modern well-known instruments and concepts of organization then their activity will not be successful.

Firstly, top-management must understand need of changes, especially in higher energy efficiency level. The culture of effective energy consumption is the key of the profitable and competitiveness. To improve energy efficiency and to reduce final energy consumption are very important for our enterprises and almost impossible without modernization of production, using of new energy efficient technologies, investments in energy efficiency projects.

## References

1. *Serdyuk T. (2017) Transformation of international economic relations: modern challenges, risks, opportunities and prospects: collective monograph /Serdyuk T., Franishina S. European integration processes in Ukraine in the sphere of energy efficiency // edited by M. Bezpartochnyi/ ISMA University. – Riga: «Landmark» SIA. – Vol. 3. – 197 p., 187-195.*
2. *Global Energy Architecture Performance Index Report (2017). The World Economic Forum. 91-93 route de la Capite CH-1223 Cologny/Geneva Switzerland [www.weforum.org](http://www.weforum.org)*
3. *Total energy consumption, Global Energy Statistical Yearbook, available at: <https://yearbook.enerdata.net/energyconsumptiondata>.*
4. *Kuzmin V. (2018) The higher energy efficiency. UNIAN. available at: <https://economics.unian.ua/energetics/10355241-doroga-neefektivnist-chomu-ukrajina-vtrachaye-energiyu.html>*
5. *Franishyna S. (2017) Activation of energy efficiency policy in conditions of European integration of Ukraine. Problems and tendencies development of the modern economy in the conditions of integration processes: theoretical and practical aspects: materials of the II International scientific and practical conference. Kherson. p. 62-65.*
6. *Serdyuk V. (2017) Features of conducting energy-saving activity at domestic enterprises. Materials of the International Scientific and Technical Conference "Energy Efficiency in the Spheres of Economics of*

- Ukraine", available at: <https://conferences.vntu.edu.ua/index.php/itb/egeu2017/paper/view/33495>
7. Baron C. *Analysis and Comparison of Project Management Standards and Guides* [Електронний ресурс]. /Rui XUE, Claude Baron, Philippe ESTEBAN // *Materials, Mechanical Engineering and Chemical Engineering*. Available at: <http://www.inase.org/library/2015/books/byrapaper/MMMCE/MMMCE01.pdf>
  8. *Library of PMI Global Standards*. [Електронний ресурс]. – Сайт Інституту управління проектами PMI, available at: <http://www.pmi.org/en/PMBOK-Guide-and-Standards/Standards-Library-of-PMI-Global-Standards>
  9. *Official site of the Ukrainian Project Management Association*, available at: <http://www.upma.kiev.ua>
  10. Scott D. Anthony (2011) *The Innovator's Guide to Growth. Putting Disruptive Innovation to Work*. Mark W. Johnson Joseph V. Sinfield Elizabeth J. Altman. Harvard business press Boston, Massachusetts, p. 346.
  11. Serdyuk T. (2016) *The place and role of innovative activity in the modern economic system* / T. V. Serdyuk, S. Yu. Franishina // *Modern technologies, materials and constructions in building: Scientific and technical journal*. Vinnitsa: VNTU. № 1(20). – 128 с.
  12. *Projects and project management in a modern company: study allowance* / G. L. Tsipes, A. S. Tovb. - M.: Olympus Business, 2009. – 463 с.

**Smerichevskiy Serhii**

*Doctor of Economic Sciences, Professor,  
Head of the Marketing Department  
National Aviation University*

**Byezgina Olena,**

*Post-graduate at the Department of  
Finance, Accounting and Audit  
Donetsk State University of Management  
(Kyiv, Mariupol, Ukraine)*

**COAL  
PRODUCER'S  
ENERGY  
EFFICIENT  
POTENTIAL  
ASSESSMENT**

In modern conditions, the limited availability of Ukraine's own fuel and energy resources, increasing the dependence on imported natural gas and, as a result, increasing energy prices are of particular importance for improving energy efficiency of industrial enterprises. In addition, in

the context of integration trends in the international arena, which results in lower customs barriers, the Ukrainian industry risks becoming unprotected to foreign competitors, which dictates the need to move to a qualitatively new level of energy use. Under current economic conditions, coal CHP stations represent the resource that can be counted on by Ukraine to ensure the stability of the Ukrainian power system. There are positive trends in the world in creating more efficient enterprises of coal mining and enrichment, modernization of existing mines and factories, closure of inefficient enterprises. At the same time, the coal industry in Ukraine is in a state of decline, and the experience of implementing energy-efficient measures is not widely used. In the next twenty-five years, three quarters of the new coal-producing plants will use high-performance low emission technologies (HELE), thereby reducing the share of low-performing industrial coal companies by 40%, according to the International Energy Association's report [16]. In modern conditions, the shortage of energy resources and the growth of their prices to coal mining enterprises is a task not only to provide other industries with fuel and energy resources but also their effective use in their own production activities and the introduction of innovative measures that increase the energy efficiency of production activities. In this regard, the development of a system of indicators for assessing the energy efficiency of coal mining enterprises, which will meet the needs and take into account the specific features of this industry, becomes particularly relevant.

The energy efficiency potential is an integral part of the enterprise's potential. Determining the energy efficiency potential is the first step towards effective energy use. The issue of determining the potential of the enterprise is devoted by the works of many authors, and they all agree that potential is a set of capabilities and capabilities of the company, aimed on achieving the strategic and tactical goals of enterprise development. Thus, the potential of energy efficiency is a set of available and possible energy resources and methods for their effective application, aimed at achieving the strategic and tactical goals of enterprise development.

In order to analyze the current state and potential prospects for increasing the energy efficiency of a coal-mining enterprise, the following types of it can be identified [2, 8, 9].

From the point of view of energy efficiency potential over a certain period of time:

- the existing energy efficiency potential (or current potential level),

which is determined by the energy efficiency measures currently available at the enterprise. At the same time, depending on the time interval for which the estimation of the level of the existing potential of the enterprise can be distinguished, its annual potential, which characterizes the company's ability to achieve the most efficient use of energy resources during the planned year, and the potential of energy efficiency for a certain period of the existence of an enterprise that describes this ability during the entire period;

- promising energy efficiency potential (prospective potential level), which is defined as existing energy efficiency measures currently in the enterprise, and those that the company may implement in the future for a certain period of time. According to the company's development strategy, this period can be medium-term (up to 5 years) or long-term (10 years or more), and in case of detailed planning of development of the enterprise, there will be several scenarios of development.

Such differentiation allows us to assess the degree of utilization of a company's potential by comparing its promising level with actual values. The main stage of the evaluation is determining the potential of the enterprise.

From the point of view of the company's current energy efficiency measures implemented:

- The realized energy efficiency potential is determined by the actual energy efficiency measures currently used in the enterprise, reflects already implemented changes in production processes that allow maintaining the current level of energy use.
- The untapped potential of energy efficiency is determined by the energy efficiency of the enterprise not used for various reasons. Under certain management decisions, energy efficiency measures can be implemented, which will increase the efficiency of the operation of the enterprise and its realized potential, or vice versa, due to lack of financial resources, lack of management awareness, excellent priorities in enterprise development and external factors, these opportunities remain unused.
- The benchmark aggregate achievable energy efficiency potential is determined by the aggregate capacity of the enterprise in increasing efficiency of energy use is the sum of realized and unrealized potential. As a benchmark, it is possible to use the actual experience gained from the most successful energy efficiency companies in the

industry. If to analyze the activity of the enterprise for a certain historical time period is isolated, in order to assess the quality of management decisions in the field of energy efficiency, the most successful year can be a references in terms of energy use of the enterprise. Measures implemented experimentally / irregularly during that year may be improved and introduced into the production process in order to increase its energy efficiency.

The energy efficiency potential is the share of specific actual annual energy consumption per tonne of extraction ( $E_{\text{fakt}}$ ) and specific consumption per tonne of production at standard operating conditions ( $E_{\text{norm}}$ ).

$$PE_{\text{pot}} = E_{\text{fakt}} / E_{\text{norm}} \quad (3.1)$$

Normative conditions of work for each concrete object are energy consumption in the implementation of a complex of energy saving measures, developed taking into account the technical feasibility and economic feasibility of application and organizational measures for energy saving. Possible methods for evaluating energy efficiency potential are:

- comparison of the actual indicator of energy consumption with the base value of the maximum efficiency benchmark, based on retrospective energy consumption of the rated enterprise;
- comparison of the actual indicator of energy consumption with the base value of the industry's maximum efficiency benchmark;
- comparison of the actual indicator of energy consumption with estimated energy consumption of the estimated enterprise provided implementation of concrete measures that will increase energy efficiency of production.

In order to calculate the energy efficiency potential, the first way as a benchmark is to determine the minimum energy consumption per tonne of ordinary coal for the last 5 years. Calculate the value of the potential of energy efficiency in retrospect ( $PE_{\text{retr}}$ ) as the share of specific annual energy consumption per tonne of ordinary coal of the current year ( $E_{\text{fakt}}$ ) and the minimum retrospective specific energy consumption per tonne of ordinary coal at comparable prices of the current year ( $E_{\text{retr}}$ ):

$$PE_{\text{retr}} = E_{\text{fakt}} / E_{\text{retr}} \quad (3.2)$$

In order to assess the energy efficiency potential of the industry, we will define a mine with a minimum energy consumption per tonne of

ordinary coal for the current year. We'll calculate the value of the energy efficiency potential of the industry ( $PE_{sect}$ ) as a share of the specific annual energy consumption per tonne of extraction of ordinary coal of each mine ( $E_{fakt}$ ) and the minimum energy consumption per tonne of ordinary coal ( $E_{sect}$ ) by the sector:

$$PE_{sect} = E_{fakt} / E_{sect} \quad (3.3)$$

In order to assess the potential of energy efficiency, provided that innovative measures are implemented that will increase the energy efficiency of production, we will determine scenarios for reducing the current energy consumption of each mine for a certain percentage. Calculate the value of the scenario potential of energy efficiency ( $PE_{scen}$ ) as a share of the specific annual energy consumption per tonne of extraction of ordinary coal of each mine ( $E_{fakt}$ ) and the scenario specific energy consumption per tonne of ordinary coal after the implementation of measures to improve energy efficiency ( $E_{scen}$ ):

$$PE_{scen} = E_{fakt} / E_{scen} \quad (3.4)$$

To calculate the hypothetical scenario, let's take a percentage reduction in the energy consumption of the mine from 10% to 50%. The following values of the calculated potential for the following mines will be relevant for all mines (Table 3.2):

*Table 3.2*

<b>Energy Efficiency Potential scenario</b>									
<b>% Reduced power consumption</b>	10%	15%	20%	25%	30%	35%	40%	45%	50%
<b>Potential value (PEscen)</b>	1,11	1,18	1,25	1,33	1,43	1,54	1,67	1,82	2,00

In calculating the scenario for implementing energy saving measures for each mine, it is necessary:

- take into account all the ways and principles of obtaining savings from the implementation of an energy saving measure;
- calculate the potential annual savings in physical and monetary terms;
- determine the composition of the required equipment, its approximate value, the cost of delivery, installation and other costs for bringing the equipment to working condition;



- consider all possibilities for reducing costs, for example, manufacturing and installation of equipment by the enterprise itself;
- identify potential side effects from implementing measures that affect real economic efficiency;
- assess the overall effect of the proposed measures, taking into account all of the above items.

There are three components of innovative measures necessary for implementation of the potential of energy efficiency: technological, structural and technical [1].

Technological component – increase of efficiency of production and, accordingly, reduction of energy intensity due to introduction of progressive energy-efficient technologies.

The structural component is the reduction of the share of energy-intensive equipment in the technological chain of the mine due to the introduction of equipment with low energy consumption.

The technical component is determined on the assumption that all outdated and inefficient equipment and technologies are replaced by the most effective ones used in the industry's flagships.

By the nature of the changes, there are three types of measures aimed at increasing energy efficiency:

- Organizational measures are fast payback initiatives that do not require significant investments and are reduced to the introduction of electricity accounting systems and the installation of meters on the main energy consumers' sites, improvement of the discipline of labor, and consequently the elimination of downtime of operating equipment due to staff, level of knowledge of workers in the issues of energy saving, stimulation and motivation of energy saving behavior of personnel, the creation of regulatory procedures in the field of procurement of equipment. The payback period of such initiatives does not exceed one year due to the low cost of their implementation. On average, quick payback initiatives allow up to 15% potential.
- Technological measures are generally more radical and involve separate technological processes and allow them to increase their energy efficiency. Such measures include the replacement of equipment on high-performance with similar or lower power consumption, change of the circuit of electric power supply, conditioning and type of heating of boiler-houses. Such measures allow to realize the potential of energy efficiency up to 50%. Since

the cost of technological measures is much higher than the organizational, an acceptable payback period for them is 1-3 years.

- Large investment measures can realize the remaining energy efficiency potential. High-cost, high-performance measures contribute to eliminating the main causes of low energy efficiency, in most cases guarantee substantial energy savings, but require higher initial costs. These are high-cost, highly effective measures, which involve replacing large stationary equipment, which affects the work of the entire mine (main air ventilation fans, lifting installations, etc.), making significant changes in the technological chain of the enterprise. Realization of such measures includes designing, manufacturing of specific equipment under the order, construction works and can last from 2 to 5 years. Therefore, the payback period of large investment measures is more than 5 years. Implementation of such measures is laid down in the strategic plans for the development of the mine, with the allocation of the corresponding budget over the years in accordance with the timetable for implementation.

In cases where simultaneously it is possible to apply different energy-saving technologies, it is advisable to divide them into the following two types:

- Alternative are technologies that cannot be applied together, and one must select one of the available list;
- Consecutive – technologies that do not have alternatives, and which can be used in conjunction with others.

The described ranking method can be used to identify the owner of priority enterprises for investing in energy efficiency, but not in the case of identifying industry leaders to stimulate energy efficiency at the state level. This is due to the fact that the efficiency of the coal-mining enterprise is influenced by various factors, not all of which the enterprise can manage [5, 10, 15]. The efficiency of coal mining activities depends on the structure of the mineral reserves and the strategy of their development, the level of used equipment and technology, the mining and geological conditions (rock strength, water availability, etc., slope and thickness of the reservoir, gas pollution, etc.), qualitative and quantitative composition of stocks, permanent change of the produced space, which is a working area, high degree of danger of accidents.

In addition, for the production activity of such enterprises

characterized by variability of mining and geological conditions, especially dangerous conditions for the personnel, rapid deterioration of the technological equipment, the impossibility of extracting equipment from flooded and prematurely excavated work, the need for periodic consolidation of the production space due to corrosion of materials mounting, the need for a preemptive holding of capital mining to prepare the refining front of future periods. The volume and speed of coal mining at mines are limited by the capacities of the mine, the depth of coal deposits, the method of coal production, etc. Therefore, when investing the same investment in energy efficiency, the effect of different enterprises will be incompatible, therefore, an assessment to promote measures in the field of energy efficiency should take into account the impact these factors in the form of correction coefficients.

Determine the key factors affecting the operation of the coal mining enterprise. Calculate the median and the mean square deviation for each factor. With the help of a group of experts in the field of geology, energy, production and technical development of coal mining enterprises, we reran the factors affecting the energy efficiency of the mine from 1 to 5, where 1 – low impact, 5 – high impact.

Calculate the adjusted values for the ranking as follows.

If the difference between the factor  $a_1$  on the mine  $x_1$  and its median is a positive value and greater than the root mean square deviation of factor  $a_1$ , then the adjusted value is equal to the particle value of the factor  $a_1 x_1$  and the median amount and the mean square deviation of this factor.

If the difference between the factor  $a_1$  on the mine  $x_1$  and its median is a negative value and the module is greater than the root mean square deviation of factor  $a_1$ , then the adjusted value is equal to the particle value of the factor  $a_1 x_1$  and the median difference and the mean square deviation of this factor.

If the difference between the factor  $a_1$  on the mine  $x_1$  and its median is zero, then the adjusted value is equal to the particle value of the factor  $a_1 x_1$  and the median, that is, the unit.

After that, we multiply the corrected values of the factors for the corresponding ball scores, sum up the mines and divide by the amount of ball scores.

Distribute the estimated mines into three categories in terms of complexity.

Category 1 – Uncomplicated conditions. The mine where the cumulative coefficient is less than the difference between the unit and

the mean square deviation calculated on the cumulative coefficient of this mine selection.

Category 2 – conditions of moderate complexity. We will refer the mine to this category if the cumulative coefficient is in the range of the unit plus minus the mean-square deviation.

Category 3 – difficult conditions. It's about the mine where the cumulative coefficient is greater than the unit amount and the mean square deviation.

The resulting cumulative values are corrective factors that should be used in comparing mines to stimulate energy efficiency at the state level. These coefficients take into account the complexity of production conditions and allow the indices of energy consumption of mines to be taken into a single evaluation vector.

For a more detailed analysis of the energy efficiency potential of coal-mining enterprises, we adapt the methodology of the International Energy Association, according to which macroeconomic indicators of energy efficiency can be schematically represented as a pyramid with a declining level of detail of the analyzed data and a growing level of aggregation of indicators (from the bottom up) [7].

Indicators of energy efficiency of an industrial enterprise can be expressed in units of energy (energy consumption of the enterprise as a whole or of some kind of final consumption), as well as by the ratio of energy consumption (in units of energy or in monetary units) to the data on enterprise activity (in physical units). They can also be expressed as a percentage as a share of electricity consumption for the production needs of the total energy consumption. For further application of energy efficiency indicators in the analysis of the impact of energy efficiency on the cash flow of the enterprise it is expedient to calculate them in monetary terms in comparable prices. Indicators of energy efficiency are calculated at the level of final consumption or at a more disaggregated level - the level of energy consumption of the unit of equipment.

Indicators of energy consumption can be developed at different levels of aggregation, depending on the purpose of the use and the amount of available information. The level of aggregation is very important, since it determines the degree of influence of structural differences on the observed results. Structural differences may include:

- Availability and quality of input resources. Energy requirements for some industrial processes depend on the quality of natural or other resources. Indicators should take into account the quality of the resource variation in the comparison of different enterprises.

- Definition of products. Product definition requires caution. For example, in the coal mining industry, the choice as a final product of ordinary or enriched coal can significantly affect the result of the analysis by excluding or incorporating the effects of enrichment processes.
- Variety of products. Manufactured goods are not monotonous. The indicator should be designed in such a way that the categorization product makes sense. So for coal mining enterprises, it is expedient to consider the product at a given quality of 5200 kcal for comparability of the results of the analysis.
- Definition of process technology. At industrial enterprises various technological processes with essentially different needs in energy are used. Indicators at this level should take into account different proportions technological processes in the total volume of production when compared. These problems can be solved by developing indicators at different levels of aggregation.

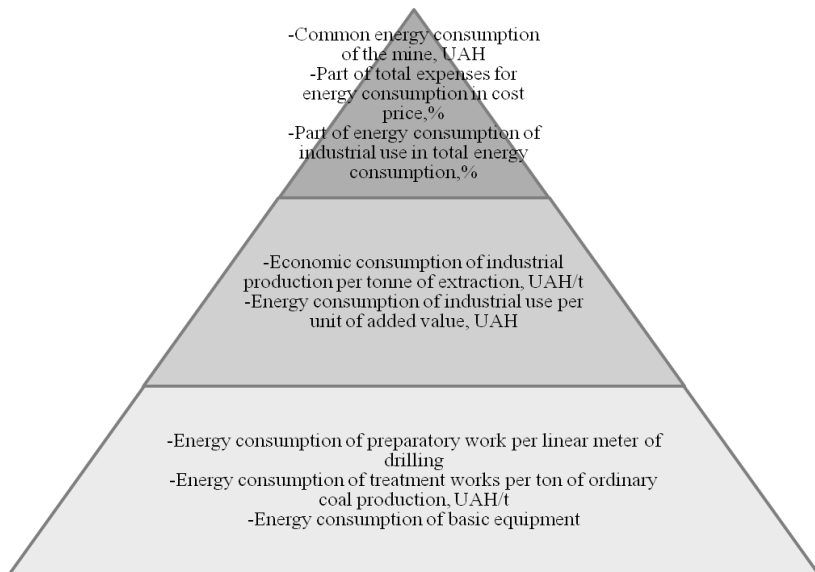

**Figure 3.3 The system of indicators of energy efficiency of coal mining enterprises**

The most aggregated level refers to the total energy consumption of coal mining enterprises in the monetary equivalent, as well as to the

share of energy consumption costs in cost and share of energy consumption of production in the overall structure of the energy consumption of the mine. These indicators give a generalized picture of the consumption of the enterprise and allow the first comparison of different mines, as well as a preliminary assessment of energy efficiency.

At the second level of the pyramid is the energy intensity of the mine as a whole, calculated as the ratio of energy consumption to value added. It is important to use value added at constant prices in order to avoid deviations caused by fluctuations in the money market. Since the overall energy consumption of an enterprise is not in a certain correlation with value added, in the calculation of the indicator include energy consumption for production needs. This indicator can give a first estimate of the total energy intensity of the sector and its trends. Due to the heterogeneity of the qualitative characteristics of ordinary coal extracted by different mines, and hence the impact of a ton of extraction on the cash flow of the company, the energy per unit of output in kind is calculated as the ratio of energy consumption to industrial needs to the volume of production.

At the third level of the pyramid there are indicators of energy efficiency of individual production processes. Proceeding from the specifics of coal mining enterprises, they can be divided into preparatory and sewage works. The result of the first process is the running meters of revealing and preparatory workings, the result of the second - directly extraction of coal. Accordingly, indicators of energy efficiency at the third level of the pyramid are the energy consumption of preparatory work per meter of penetration and energy consumption of treatment works per ton of coal. The processes of transportation of mountain mass and ventilation are, of course, also energy-intensive, but it is problematic to correlate their energy consumption with the final result, because in essence they are serving character and indirectly affect the total amount of coal mine production. Therefore, for the analysis of energy efficiency of certain units of equipment and the comparison of the impact of possible alternatives to their use on the cash flow, it is possible to calculate the energy consumption of the main equipment (clearing and traction combines, ventilators of the main airing, etc.) in the monetary equivalent in comparable conditions.

Thus, the considered system of indicators can be used to analyze the energy efficiency of coal mining enterprises at different levels from specific units of equipment and production processes to the enterprise as

a whole.

As the result, the following conclusions can be drawn from the research:

- Scientific views on the determination of the energy efficiency potential of the enterprise are systematized and summarized.
- Adapted to coal mining enterprises a methodology for calculating energy efficiency indicators based on the hierarchical methodology of the International Energy Association, where energy efficiency indicators can be schematically presented in the form of a pyramid with a declining level of detail of the analyzed data and a growing level of aggregation of indicators. The proposed indicators are determined on the basis of the following criteria: availability and quality of input resources, product definition, product diversity, process technology definition.
- The methodology for evaluating the energy efficiency potential for coal mining companies is proposed for further ranking in order to determine the priorities of investing in energy efficiency based on three parameters: retrospective, sectoral and expected.

A methodology for calculating correction coefficients for a fair comparison of coal mining enterprises to promote energy efficiency at the state level is developed. These coefficients take into account the level of complexity of the conditions of conducting the main industrial activity of the enterprise on the basis of expert evaluation of mining and geological and production-operational criteria and allow to bring energy consumption indexes of mines to a single evaluation vector.

## References

1. *Energety'chna strategiya Ukrayiny' do 2030 roku [The Energy Strategy of Ukraine for the period up to 2030].* (n.d.). zakon.rada.gov.ua. Retrieved from: <http://zakon.rada.gov.ua/laws/show/n0002120-13> [in Ukrainian].
2. Krasnokutskaya, N.S. (2005) *Potentsial predpriyatiya: formirovaniye i otsenka [The potential of the enterprise: the formation and evaluation].* Kyiv: Krom [in Russian].
3. Kuz'min, O. E., & Mel'nik, O.G. (2011) *Diagnostika potentsiala predpriyatiya [Diagnostics of enterprise potential]. Marketing i menedzhment innovatsiy – Marketing and innovation management, 1, 155-166 [in Russian].*
4. Kuntsevich, V.O. (2004) *Ponyatiye finansovogo potentsiala razvitiya predpriyatiya i ego otsenki [The concept of financial potential of*

- enterprise development and its evaluation*]. *Aktual'nyye problemy ekonomiki – Actual problems of the economy*, 7 (37), 123-130 [in Russian].
5. Kushekov, K.K. (2012) *Problema vskrytiya i razrabotki malomoshchnykh plastov, ostavlennykh vyshe deystvuyushchikh gorizontov shakht Karagandinskogo basseyna* [The problem of opening and development of thin layers, left above the existing horizons of the mines of the Karaganda basin]. *Ugol' – Coal*, 6, 83-84 [in Russian].
  6. Lyukshinov, A.N. (2000) *Strategicheskiy menedzhment* [Strategic management]. Moscow: Yuniti [in Russian].
  7. *Pokazateli energoeffektivnosti: osnovy statistiki* [Energy efficiency indicators: the basics of statistics]. (n.d.). *iea.org* Retrieved from: <https://www.iea.org/media/training/eeukraine2015/EEIrussianversion.PDF> [in Russian].
  8. Popov, E.V. (2002) *Rynochnyy potentsial predpriyatiya* [Market potential of the enterprise]. Moscow: *Ekonomika* [in Russian].
  9. Ryepina, I.M. (1998) *Pidpry'yemny'cz'ky'j potentsial: metodologiya ocinky` ta upravlinnya* [Entrepreneurial potential: assessment and management methodology]. *Visny`k Ukrayins`koyi Akademiyi derzhavnogo upravlinnya pry` Prezy`dentovi Ukrayiny` - Bulletin of the National Academy of Public Administration under the President of Ukraine*, 2, 262-271 [in Ukrainian].
  10. Starikov, A.P. & Izygzon N.B. (2009) *Metodicheskoye obespecheniye adaptatsii ugledobyvayushchey kompanii k innovatsionnoy modeli tekhnologicheskogo razvitiya* [Methodical provision of adaptation of a coal mining company to an innovative model of technological development]. *Ugol` - Coal*, 9, 24–26 [in Russian].
  11. Dolzhanskiy, I.S. (2006) *Upravleniye potentsialom predpriyatiya* [Enterprise Capacity Management]. Kyiv: *Tsentr uchebnoy literatury* [in Russian].
  12. Fedonin, O.S., Repina, I.M., & Oleksyuk O.I. (2004) *Potentsial pidpryyemstva: formuvannya ta otsinka* [Potential of the enterprise: formation and estimation]. Kyiv: *KNEU* [in Ukrainian].
  13. Khramtsova, T.G., & Khramtsova, O.O. (2013) *Statisticheskii podkhod k sravnitel'noy otsenke deyatel'nosti regional'nykh kooperativnykh organizatsiy* [Statistical approach to the comparative assessment of regional cooperative organizations]. *Vestnik NGUEU - Bulletin of the NSUEM*, 2, 126-135 [in Russian].
  14. Obeng, E. (2001) *New Rules for the New World: Cautionary Tales for the New World Manager*. Oxford: *Capstone*
  15. Shvichenko, A.V. (2011) *Napraveniyya sovershenstvovaniya tekhniki dlya buroshnekovoy vyyemki uglya v podzemnykh usloviyakh* [Directions of



- improvement of technology for auger coal excavation in underground conditions*]. *Ugol' – Coal*, 5, 82 [in Russian].
16. *The National Renewable Energy Laboratory (NREL)*. (n.d.). [nrel.gov](http://www.nrel.gov/publications). Retrieved from: [www.nrel.gov/publications](http://www.nrel.gov/publications)
  17. Winch, G. M. (2002) *Managing the Construction Project*. Oxford: Blackwell
  18. *World Energy Outlook 2017*. (n.d.). [iea.org](http://www.iea.org) Retrieved from: <https://www.iea.org/publications/freepublications/>
  19. *World resource institute. Energy*. (n.d.). [wri.org](http://www.wri.org) Retrieved from: <https://www.wri.org/our-work/topics/energy>

**Trifonova Olena**

*Doctor in Economics, Associate Professor  
National Technical University “Dnipro  
Polytechnic”*

**Trushkina Natalia**

*Ph.D. in Economics  
Institute of Industrial Economics,  
National Academy of Sciences of Ukraine  
(Dnipro, Kyiv, Ukraine)*

**APPLICATION OF  
INFORMATION  
TECHNOLOGIES  
IN LOGISTIC  
ACTIVITIES OF  
ENTERPRISES**

In today's conditions of dynamic development the digital economy is actualized the problem use of information technologies as an instrument of management logistics activities of enterprises. At present time the enterprises have to move on to qualitatively new technologies that can provide a level of service that meets the high demand and needs of consumers while at the same time maximizing possible costs. Therefore, the key task of enterprises is to create an effective logistics information system capable of flexibly responding to changing market conditions.

According to the Goals of sustainable development for 2016-2030 the priority measures to create sustainable infrastructure, promotion of neo-industrialization and innovation were recognized by strengthening the integration of industrial enterprises into logistics chains and markets, reducing losses of food products in the process of promotion and storage, moving to more rational models of production and consumption [1].

This is confirmed by the results of analysis the statistical data. According to the State Statistics Service of Ukraine, the number of enterprises that using automated data exchange for sending or receiving goods-consignment notes increased for 2011-2015 by 119.7%; receipt of orders from clients – by 70.4%; sending or receiving information about products – by 57,6%. At the same time the share of enterprises where is carried out automated data exchange, in their total number increased by 14.4% (from 24.4 to 38.5%); 11.3% (from 49.5 to 60.8%) and 7.8% (from 57.2 to 65%) respectively [2, p. 12].

For 2011-2015 the number of enterprises where is carried out regular electronic information exchange, by the level of technical-material ensuring, production plan or customer demand forecast increased by 35.6%; the development delivery of final product to consumers – by 40.6%. The share of these enterprises in the total number of enterprises, which using automated data exchange in 2015 was 14.3% and 16.7% respectively [2, p. 13].

Based on the survey of the level awareness benefits of using information-communication technologies in the organization of sales market it was found that 10.7% of respondents noted significant improvements (in 2011 – 7.7%) [2, p. 16].

Analysis shows that the number of enterprises that used the Internet to receive information about goods and services in 2016 amounted to 33298, or 85.8% of the total number of enterprises having access to the Internet. The number of enterprises in which the website provided capability customer service was 7188 (46.1%), and to form orders for goods and services online was 4255, or 27.3% of the total number of enterprises having a website that functions in the Internet.

Social media used to collaborate with business partners and other organizations 6789 enterprises (20% of the total number of enterprises which using social media); to receive feedback from customers or provide answers to their questions – 6089 enterprises (18%), and attracted of customers to the development or innovation of goods and services – 3963 enterprises (11.7% of the total number of enterprises). In 2016 the number of enterprises that purchased programs for customer relationship management was 967 or 26.6% of the total numbers of enterprises that purchasing cloud computing services [3, p. 11, 12, 14, 15].

Electronic commerce through computer networks was carried out, as a rule, enterprises of processing industry, wholesale and retail trade, in the area information and telecommunications, transport, warehousing,

postal and courier activities, and building. As shows analysis statistical data, the number of enterprises that received orders through computer networks for the sale of goods or services, was in 2016 – 2503, and those who made purchases through computer networks – 7147 [3, p. 20].

In 2017 the number of enterprises that had access to the Internet was 39582, or 98.2% of the total number of enterprises that using computers [4, p. 200]. At the same time the priority direction of using the Internet is the sending or receiving a message by e-mail (98.4% of the total number of enterprises that having Internet access); further information is obtained about goods and services (87.6%), use of instant messaging and an electronic bulletin board (47.3%) and phone calls via Internet/VoIP communication or video conferencing (30.4%). A similar situation is observed at the enterprises in the main types of economic activity (Table 3.3).

*Table 3.3*

**Directions of use the Internet in 2017**

Directions	Main types of economic activity				
	Manufacturing industry	Building	Wholesale and retail trade	Transport, warehousing, postal and courier activities	Information and telecommunications
<i>Sending or receiving a message by e-mail</i>					
<i>Number of enterprises</i>	9792	3977	9732	3156	1770
<i>Share *,%</i>	98,7	98,4	98,5	98,2	99,2
<i>Obtaining information about goods and services</i>					
<i>Number of enterprises</i>	9012	3589	8943	2676	1606
<i>Share *,%</i>	90,9	88,8	90,6	83,2	90,0
<i>Use of instant messaging and an electronic bulletin board</i>					
<i>Number of enterprises</i>	4927	1761	4926	1415	1067
<i>Share *,%</i>	49,7	43,6	49,9	44,0	59,8
<i>Phone calls via Internet/VoIP communication or video conferencing</i>					
<i>Number of enterprises</i>	3215	824	3400	937	939
<i>Share *,%</i>	32,4	20,4	34,4	29,1	52,6

*Note: \* in % to the total number of enterprises that using the Internet.*

*Source: compiled according to the data: [4, p. 201].*

The number of enterprises which using social networks in 2017 was 10558, websites with multimedia content – 5312, means of knowledge sharing – 5069, blogs or micro-blogs – 2910. By type of social media most enterprises in the areas of processing industry, wholesaling and retailing trade, information and telecommunications are used generally by social networks and websites with multimedia content. And the

largest number of enterprises in the areas of building and transport, warehousing, postal and courier activities use social networks and means of knowledge sharing (Table 3.4).

*Table 3.4*

**The number of enterprises that used social media in 2017**

Types of economic activity	Types of social media			
	social networks	blogs or micro-blogs	websites with multimedia content	means of knowledge sharing
Manufacturing industry	2350	676	1289	1113
Wholesale and retail trade	2814	799	1495	1320
Information and telecommunications	869	316	527	353
Building	895	217	384	532
Transport, warehousing, postal and courier activities	662	156	275	362

*Source: compiled according to the data: [4, p. 203].*

The analysis shows that the share of enterprises which using social networks increased from 2015-2017 by 9.2%, or from 17.5 to 26.7% of the total number of enterprises that having access to the Internet; websites with multimedia content – by 2.3%, or from 11.1 to 13.4%; blogs or micro-blogs – by 2.2%, or from 5.2 to 7.4%. The share of enterprises that using means of knowledge sharing, conversely, decreased by 6.3%, or from 19.1% to 12.8% of the total number of enterprises that having access to the Internet. The same situation is observed on enterprises by main types of economic activity (Table 3.5).

Therefore, in order to efficiently operating enterprises in an unstable institutional environment it is advisable to create conditions that would enable enterprises to obtain maximize the benefits from organizing logistics activities taking into account the specifics of the development of the global economy, maintaining an optimal level of costs, and increasing the quality service of customer.

All this requires the introduction a complex of various logistics information technologies, which can include: *MRP* (Material Requirements Planning), *ERP* (Enterprise Resource Planning System), *OPT* (Optimized Production Technology), *SCM* (Supply Chain Management), *CRM* (Customer Relationship Management), *QR* (concept “Quickly Reaction”), *ECR* (system organization of economic

Table 3.5

### Share of enterprises that using social media, %

Types of social media / years	Main types of economic activity				
	Manufacturing industry	Building	Wholesale and retail trade	Transport, warehousing, postal and courier activities	Information and telecommunications
Social networks					
2015	14,7	12,6	17,7	12,5	37,8
2016	21,8	21,0	26,1	19,8	45,4
2017	23,7	22,1	28,5	20,6	48,7
Blogs or micro-blogs					
2015	4,4	3,7	5,1	3,6	14,8
2016	5,8	5,7	7,4	5,2	16,5
2017	6,8	5,4	8,1	4,9	17,7
Websites with multimedia content					
2015	10,6	9,4	10,4	7,9	26,2
2016	12,0	9,4	13,5	8,4	28,0
2017	13,0	9,5	15,1	8,6	29,5
Means of knowledge sharing					
2015	17,8	19,4	17,5	17,8	32,6
2016	10,8	12,9	12,7	11,2	19,7
2017	11,2	13,2	13,4	11,3	19,8

Source: compiled according to the data: [4, p. 203; 5, p. 434].

relations the producers products and trade enterprises), *LP* (concept “Lean Production”), *DDT* (concept “Demand Reaction”), *DRP* (planning system of products and resources in distribution), *E-SKLAB* (automated management system of warehouse), *CALS-technologies* (concept Integrated Logistic Support) (Table 3.6).

A complex of modern information and digital technologies that used in organizing logistics activities at enterprises is systematized according to the process approach (Table 3.7).

Table 3.6

### The essence and content of modern information and digital technologies

Technology	The essence and content of technology
1	2
<i>MRP</i>	Allows optimal regulate delivery of components to the production process, controlling stocks in warehouse and production technology. The main task is to provide a guarantee the availability of required number of relevant materials and components at any time within the planning period along with possible reduction of permanent stocks. <i>MRPI</i> – material requirement planning. <i>MRPII</i> – planning and monitoring all resources of production enterprise on the basis of a closed-loop system and generation of financial indicators. An important feature of this technology is the possibility of modeling a production system.

Table 3.6 (continued)

1	2
<i>ERP</i>	Expands the range of supply chain management beyond the enterprise, allows you to control and regulation of communications between the supply chain members. Oriented on processes and internal integration (logistic and financial). <i>ERP II</i> oriented on processes and external integration (business processes, supply chains), on cooperation and solving common problems with business partners. Oriented on electronic markets and based on services of the Internet.
<i>OPT</i>	The basic principle is to identify “bottlenecks” on production or critical resources (stocks of raw materials, materials, equipments). Solved the tasks of operational and short-term management of production, including the formation of a production schedule on one day, week, etc.
<i>SCM</i>	It is the integration of key business processes from begins the end-user and covering all suppliers of goods, services and products that add value for consumers and other stakeholders. This is a technology that ensuring corporate strategy of enterprise with optimal cost of resources. It allows you to solve the tasks of integrated management of functional areas and coordinate the logistics process of enterprise with business partners depending from the electronic platform (B2B or B2C).
<i>CRM</i>	It is a set of information technologies that implement a client-oriented approach to management of enterprise. The essence of this system consist in personalization of relations with clients, achievement a favorable attitude of clients to the enterprise and products, understanding the process of sale as a permanent process with involvement of each employee the enterprise.
<i>QR</i>	Quickly customer service that used to management the movement of goods with a short life cycle. It is system of service delivery end-customer based on the electronic data exchange between retailers and wholesalers and manufacturing areas.
<i>LP</i>	Realized idea of combining low cost with large volumes of mass production and product diversity and the flexibility of small-scale production. The main idea is to identify operations that consume resources, but do not create added value and their complete elimination.
<i>ECR</i>	This system is based by the principle of JIT and is based on the exact synchronization of production and sales, which involves a specific approach to control the state of stocks and reorganization of the functions of distribution centers. Used the principle of continuous replenishment of stocks, according to which extended of powers the suppliers in order to provide the necessary amount of supply and delivery terms.
<i>DDT</i>	It allows to maximize the response time reaction of enterprise to change demand through the rapid replenishment of stocks at those points of the market where predicted the growth of such demand, improves the coordination and relationship of producers, intermediaries and retailers as links to the integrated logistics chain.

Table 3.6 (the end)

1	2
DRP	<p>DRP I (management system and product distribution planning) allows not only to take into account conjuncture, but also to actively influence on it. This system ensures stable ties supply, production and sales. The ultimate function of DRP I system – planning transport traffics. In the system processed requests for transport services, drawn up and adjusted in real time the schedules traffics. Due to the DRP II technology (distribution resource planning) is solved the tasks of medium to long-term forecasting of consumer demand, indicators system of work of warehouses and other parameters.</p>
E-SKLAD	<p>The only suite that contains software, barcode printers, radio terminals or data collection terminals. The main purpose of the system is automation of operational management of all warehouse processes. It allows business partners to control individual transactions in their own warehouses via the Internet. In the system implemented such a set of warehouse functions: acceptance, placement, replenishment of stocks, selection and shipment of goods, inventory.</p>
CALS-technologies	<p>Integrated system strategy for increasing the efficiency, productivity and profitability of processes production-economic activity the enterprise, which directly influence on the competitiveness of its products. The task of this technology is to increase the efficiency of all participants the process creation, production and use of the product by expediting the process research and development of the product; providing the product of new properties; cost reduction; increase the level of service in the processes of production the product, its operation and technical maintenance.</p>

Source: compiled according to the data: [6, p. 220-225; 7, p. 92-94; 8; 9, p. 275-277; 10, p. 66; 11, p. 139, 143].

Consider the benefits of introduce an information system CRM [6, p. 220; 8; 11, p. 139], which implements a client-oriented approach to customer service. The essence of this system is the rational management of customer relationships. That is, it is an information technology that provides functionality opportunities for automating a complete customer relationship cycle and provides the necessary tools for management spheres of marketing, sales, service.

CRM-system provides automation works from sales: providing all information about customers, working time planning and making negotiation, control of operations and projects. CRM is a tool for control and evaluating the effectiveness work of specialists in sales. Standard reporting of company, as a rule, allows you to evaluate only the final result in the form of financial revenues. There are cases when the company is operating, the flow of customer referrals and the financial

result is not very high – then there may be problems in the previous stages.

Table 3.7

**Systematization of information technologies that used at enterprises**

Process	Contents of information technologies
Projection	<i>CAD</i> – supported by computer projection of products <i>CAM</i> – supported by computer manufacturing
Planning	<i>CAP</i> – supported by computer planning <i>CAE</i> – computer support of calculations and simulations (imitation) <i>CRP</i> – planning of necessary capacities <i>FRP</i> – planning of financial resources
Organization of supply	<i>MRP</i> – planning of material needs <i>MRPII</i> – resource planning <i>ERP</i> – integrated planning of enterprise facilities
Production management	<i>CIM</i> – computer integrated manufacturing <i>OPT</i> – optimization of production technology <i>PPC</i> – planning and production management <i>PC</i> – production control <i>LP</i> – «lean production»
Management of warehousing	<i>WMS</i> – warehouse management system <i>E-SKLAB</i> – automated warehouse management system
Management the process of customer service	<i>CRM</i> – customer relationship management system <i>QR</i> – consumer service system <i>ECR</i> – effective consumer feedback system
Distribution management	<i>DRP I</i> – management system and product distribution planning <i>DRP II</i> – resource planning in distribution
Quality management	<i>AQ</i> – analysis quality <i>CAQ</i> – supported by computer quality control <i>SQC</i> – statistical quality control <i>TQC</i> – total quality control <i>TQM</i> – total quality management
Controlling	<i>C</i> – controlling <i>CONWIP</i> – system of constant control in the process of work

Source: compiled according to the data: [6, p. 220-225; 7, p. 92-94; 8; 9, p. 275-277; 10, p. 66; 11, p. 139, 143].

Unlike accounting systems, CRM fixes all stages of working with a client, starting from the first call or the first meeting. Then this work can be analyzed and made corrective, as well as assess how effective were the cost of work personnel for organization of marketing activities.

The tasks of implementation CRM-system at the enterprise include: structuring data about consumer; simplification process of decision-making regarding commodity, customer and marketing policy; optimization work of employees by creating a unified information base.

CRM-system allows you to organize a single database and provide up-to-date information about the benefits of customers, their financial



capabilities. Thus, the specialist has the opportunity to quickly find the optimal offer for each consumer.

Using CRM-technologies in the activity of enterprise will allow keeping existing customers with minimal effort, increasing the market share by attracting new customers, reducing level costs as a result of increased productivity.

Adapted to the needs of enterprise the CRM-solution provides: optimization of internal processes service customers; providing consumers more operational and transparent information about the progress of execution of his order; the only information database of existing consumers; integration CRM-system with other information systems; increase the efficiency of attracting new orders; increasing the level of validity of making managerial decisions about the organization of sales activities; improving efficiency work of employees.

Up to 30-40% of the work time employees of most enterprises spend on re-entering data, working with formulas and settings, compiling reports. Modern CRM-systems allow you to refuse to prepare periodic reports.

In conditions of high competition the costs of promoting the product have a fairly large share in its price and in the cost of enterprise. To evaluate and optimize the costs on marketing and promotion helps CRM-system, that is, its analytical part. It allows you to compare the costs on promoting the product with increased profits of enterprise.

This technology provides tools for conquering and retaining exist customers; allows to greatly reduce the cost on organizing logistics activity through the automation of current processes and coordination of work in general; offers a service that maximally satisfies the needs of consumers and, as a consequence, increases their loyalty; it allows to increase the level of profitability from sales of products.

The main advantages of implementing CRM-system in the activity of enterprise are as follows:

- increasing of volumes sales products. The average indicator is 10% the growth of sales per year by one employee during the first three years after introduction of system. This is due to the efficiency of management system logistics activity;

- increasing of percentage the contracted contracts on orders. The average is 5% per year during the first three years after introduction of system. This is due to the fact that using the system can select unwanted operations at the early stages of sales;

- increasing of level profitability. The average rate is 1-3% for one

contract during the first three years after introduction of system. The increase of profits is related with a better understanding of the needs customer, a higher level of satisfaction consumer;

increasing the level satisfaction consumer. The average rate is 3% per year during the first three years after introduction of system. Consumers believe that the enterprise is oriented on solving their specific problems, and are satisfied with considerable attention to their needs;

reducing of administrative costs on marketing and sales. The average decrease rate is by 10% per year during the first three years after introduction of system. Reducing costs is done by automating the current processes of logistics activity. CRM-system allows you to accurately identify target customer segments and understand their needs;

reducing receivables. The capital turnover of enterprise more often due reduced through untimely repayment indebtedness of consumer, and it is often this fault of employees, forgetting to set up an invoice in due time or remind of the due date of payment, which came. Implementation CRM-system, which includes a subsystem of accounting for mutual settlements with customers, can significantly reduce the number of such cases.

The use of CRM information system will increase the level of customer service by obtaining:

the economic effect due to an increasing average profitability from organization of logistics activities by 15-20%; increasing of indicator the consumer retention by 5%; time reduction on performing current operations by 25-30%; increasing the accuracy of forecasting volumes of shipment products up to 99%; reduction of costs on sales, marketing and customer support by 10-15%;

social effect as a result of service quality growth; optimizing the work of employees the enterprise; increasing the speed of customer orders processing and level information security; reduction of time losses on organization exchange of information between the enterprise and economic contractors; formation of client-oriented approach to management of relations with different groups of consumers the enterprise.

On the basis of generalization foreign and domestic experience in the use of information and digital technologies are determined the directions of improvement management of logistics activities the enterprises, which are systematized in 3 groups (Table 3.8).

Based on the foregoing, one can come to this conclusion.

Table 3.8

**Directions of improvement management of logistics activity the enterprises with the help of information technologies**

Direction	Content direction
Improvement of customer service processes	implementation the system of electronic commerce (B2B – “business-to-business”) – program complexes for carrying out commercial activities between enterprises in the Internet (for example, creating a corporate site of enterprises, information site); under this system is carried out about 80% of e-commerce; application of e-commerce system (B2C – “business-to-consumer”) – program complex for carrying out electronic trade; implementation concept CRM (Customer Relationship Management) – information technology that provides functionality opportunities for automating the full cycle of customer relationships and ensuring the necessary tools for managing of areas marketing, sales, service
Increasing the efficiency of organization sales activities	introduction of modern information technologies in order to improve organization of distribution – DRP, DRPII; develop of a methodic for selecting effective sale channels on the basis of special software for calculations by using the method of analysis hierarchies (method of T. Saati), expert and analytical-evaluation methods
Improvement the organization of transport operations	optimization of transport traffics in the implementation of cargo management systems: Gonrand (collection of information on the availability of consignments), Videotrans (information service of transport enterprises), CTC (information about the availability of consignments, type of vehicles, rational traffic routes), GIS, GPS (location of vehicles ); develop of a proposal for optimization of loading of vehicles; implementation of software and use of Internet-technologies for automation of transport processes; application of automated processing of documents for registration the process transportation of consignments

*Source: author’s development.*

Implementation of information support systems for organizing logistics activities at enterprises will contribute to: reduction of level productive inventories up to 60%; reduction time of production the products due to the harmonization of process chains up to 50%; increasing of profit by 30% based on optimization the process of create value added and reduction of transaction costs; increasing of product quality by 30%; increasing turnover and market share by 55% through improving the reactivity ability of system and changing relations with consumers; reduce the level of administrative costs for sales and marketing; increasing the quality of document circulation; reduction of costs for sales, marketing and customer support by 10-15%; increase the accuracy of forecasting sales up to 80%; reduction of time for performing current operations by 25-30%; increasing of profitability sales by 15-20%.

## References

1. *The goals of sustainable development for 2016-2030.* – Available at: <http://www.un.org.ua/ua/tsili-rozvytku-tysiacholititia/tsili-staloho-rozvytku>.
2. *Use of information-communication technologies at the enterprises in Ukraine in 2015: stat. collection (2016),* Kyiv, State Statistics Service of Ukraine, 24 p.
3. *Use of information-communication technologies at the enterprises in Ukraine in 2016: stat. collection (2017),* Kyiv, State Statistics Service of Ukraine, 30 p.
4. *Ukraine in figures in 2017: state. collection (2018),* Kyiv, State Statistics Service of Ukraine, 241 p.
5. *Statistical yearbook of Ukraine for 2017 (2018),* Kyiv, State Statistics Service of Ukraine, 541 p.
6. Ponomarenko, V.S., Tankov, K.M., Lepeiko, T.I. (2010). *Logistics Management, Kharkiv, HP "INZHEK", 440 p.*
7. Kisliy, V.M., Bilovodska, O.A., Olefirenko, O.M., Smolyanik, O.M. (2010). *Logistics: theory and practice, Kyiv, Center for Educational Literature, 360 p.*
8. Kondratyuk, D.M. (2011). *The essence of concepts logistics and prospects of their application in agricultural activities.* – Available at: [http://www.nbuv.gov.ua/old\\_jrn/Chem\\_Biol/Vzhnau/2011\\_1/179.pdf](http://www.nbuv.gov.ua/old_jrn/Chem_Biol/Vzhnau/2011_1/179.pdf).
9. Posilkina, O.V., Sagaidak-Nikityuk, R.V., Zhagory G.V. (2011). *Logistic management of pharmaceutical production: monograph, Kharkiv, National Pharmaceutical University, 772 p.*
10. Pakula, N.M., Sagaidak-Nikityuk, R.V. (2012). *Overview of the market modern program products aimed at solving logistic tasks, Logistics: problems and solutions, No. 6 (43), pp. 60-70.*
11. Krikavskiy, Ye.V., Pokhilchenko, O.A. (2014). *Economics of Logistics, Lviv: Publisher of National University "Lviv Polytechnic", 640 p.*

## Chapter 4

# PRACTICAL ASPECTS MANAGEMENT OF COMPETITIVENESS THE ECONOMIC ENTITIES IN VARIOUS SECTORS OF THE ECONOMY

### **Ilichenko Victoria**

*PhD in Economics, Associate  
Professor, Chair of  
Management*

### **Bondarenko Vladislava**

*Chair of Tourism  
National Transport University  
(Kyiv, Ukraine)*

## COMPETITIVENESS MANAGEMENT OF A COMPANY OPERATING AT THE TRAVEL SERVICES MARKET

As the competition at the market of international travel services increases, travel companies face the problem seeing their competitive positions weakening. Due to this fact more and more measures have been taken in order to strengthen the competitive capacity of companies operating in a touristic sector. The successful approach to building international partnerships directly influences the development of companies operating in the touristic sector of Ukraine and partner countries. The experience of many travel enterprises proves that the efficiency of international partnership depends on successfully built relationships between companies. In its turn, it enables companies to get quite a few advantages that subsequently allow widening the range of services, increasing the income, reducing costs, acquiring experience and knowledge, gaining competitive advantages or even extending the life cycle of business thus enabling its stable functioning amidst unstable global environment.

The aim of building international partnerships is risk sharing, strengthening market power, entering new markets, acquiring new technologies, knowledge and experience. Researches by many scientists show that, over the long term, the companies oriented towards gaining knowledge earn higher incomes if compared with other companies and partnerships work well for acquiring know-hows and learning from other enterprises [1, 2, 3].

The authors believe that international partnerships of a travel company shall mean a system of agreements between enterprises operating in a touristic sector aimed at both achieving their strategic goals through common exploitation of resources and enjoying the synergy.

Any company strives to find a long-term and stable partner that will generate the highest profit within the shortest period of time at the lowest cost and consuming as little human resources as possible. The process of making a good choice is quite complicated and is divided into several stages (Table 4.1) [4, 5].

*Table 4.1*

**The stages and the content of the process of selecting the best possible foreign partner**

The stage name	The content of the stage
1	2
Stage 1. Creating a portrait of the best possible partner	Criteria and properties attributable to an ideal partner are outlined in detail.
Stage 2. Making a preliminary list of potential partners based on the criteria	First, out of the general description those primary criteria that can be easily identified based on the brief information about a potential partner (position on the market, rating, reputation of a company, its location, media hits, recommendations of partners) are selected and used as the basis for the initial sorting-out.  Then, the companies selected undergo an in depth study and those more attractive based on additional criteria (economical and organizational potential, business characteristics, availability of competitors and home partners) are sorted out. It is established who is responsible for contacting business partners in the foreign travel companies selected (the name of a person, his e-mail address and phone number).
Stage 3. Identification of viable partners	Viable foreign partners (alternative partners) meeting the requirements of partner selection and interested in cooperation ( <i>initial selection of partners</i> ) constitute a list.
Stage 4. Preparation of a partnership offer	Own organizational and economical potential and potential strategic needs are estimated enabling determination of available and required resources for a company's operation and achievement of strategic goals.  A brief but informative description of the scope of the offer (feasibility report on the necessity of partnerships) is prepared.
Stage 5. Assessing the readiness of potential foreign partners for cooperation	A trip to the country of partners and meetings with them are organized. As a matter of fact, it is a process of selling cooperation with the company to a potential foreign partner. Thus partnership offers must be prepared with the consideration of all peculiarities of a partner and local travel market.

Table 4.1 (the end)

1	2
Stage 6. Making a foreign partner portfolio	<p>A draft of foreign partner portfolio is made (<i>second selection</i>) based on the <i>optimality index</i>. It will be beneficial to make a profile of every interested partner for further comparison of certain criteria (their location, coverage, size, range of touristic services, contacts, peculiarities and etc.).</p>
Stage 7. Selecting a foreign business partner	<p><i>The final selection</i> of the partner is done based on verification of his reputation on the travel services market. It happens quite often that short-term planning and cooperation tend to make a quick benefit more important than investments in future dividends resulting from a safe long-term cooperation. In order to verify the reputation of a foreign partner, the following is recommended: inquiring about the contact information on partners and agents of the company (preferably containing details such as names and phone numbers);</p> <ul style="list-style-type: none"> <li>• analyzing the list of company's customers and selecting some of those that were not mentioned by the travel company itself;</li> <li>• analyzing the information on the local internet for scandals or good references related to the company;</li> <li>• verifying dockets for disputes and law suits. If in place, find the contacts of parties involved in the legal proceedings;</li> <li>• having collected all those data, call all the contacts selected and ask questions about their cooperation with the selected partner. All the information collected will make it clear if the partner selected is reliable.</li> </ul>
Stage 8. Formalizing relationships	<p>The conditions of partnership are agreed, the way, the character and the type of cooperation are settled, and contractual obligations are formalized. Performance parameters are established for estimating fulfillment of project documents and optimality of partnership conditions.</p>
Stage 9. Implementation of the strategic partnership	<p>The scope and structure of consolidated resources, criteria for establishing the system for managing joint activities, conditions and target parameters of the development strategy and follow-up mechanisms are established.</p>
Stage 10. Assessment and follow-up of the performance of the strategic partnership	<p>Assessment and follow-up of the performance of the strategic partnership are carried out as follows:</p> <ul style="list-style-type: none"> <li>• due diligence of fulfilling existing contractual obligations that enables analysis of reasons and consequences of breaking the contract;</li> <li>• overall assessment of the efficiency of the parties' consolidated economic potential in the context of partnership implementation;</li> <li>• performance analysis of the partnership (conclusion on reasonability of pursuing the partnership, penalty provisions and motivation for relationships).</li> </ul>

In order to assess the portfolio of foreign partners (stage 6 in Table 4.1), the authors offer to use the parameter for choosing the best possible partner that will enable to know partners in more detail based on the criteria groups and to select the best for drawing up a partnership agreement.

The parameter for choosing the best possible foreign partner is a system of overall criteria for quantitative assessment of financial and economic potential of a foreign partner where each and every criterion is composed of individual parameters for assessing components of a partner's potential.

The criteria for a quantitative assessment of a foreign partner's potential and their components were defined using an expert survey that was carried out based on Delphi approach. In order to conduct a successful expertise and get science-based results, a staged process for a survey was prepared as shown in Figure 4.1.

While forming a group of experts, two important issues had to be solved, i.e. defining the number of experts and assessing their competence.

The number of experts notably influences the accuracy of the assessment. That is why when choosing the number of experts the compromise is made among the accuracy, labour intensity, duration and the cost of conducting the survey.

In order to determine the necessary number of experts, a methodology based on the statistical approach was applied [6]:

$$N = \frac{t_{\alpha}^2}{\Delta_1^2}, \quad (4.1)$$

where N – stands for the required number of experts in a group;

$t_{\alpha}$  is a Student's coefficient for the aimed confidence figure of the result obtained;

$\Delta_1$  – stands for the critical allowed error expressed as a part of a root-square-mean deviation:

$$\Delta_1 = \frac{\Delta}{\delta}, \quad (4.2)$$

where  $\Delta$  is an absolute error;

$\delta$  – stands for a root-square-mean deviation of an expert assessment.

Upon comparing  $\Delta_1 = 0.55$  with a confidence figure  $\alpha = 0.95$  i  $t_{\alpha} = 2.13$ , the necessary amount of experts is obtained, i.e. 15 [7].



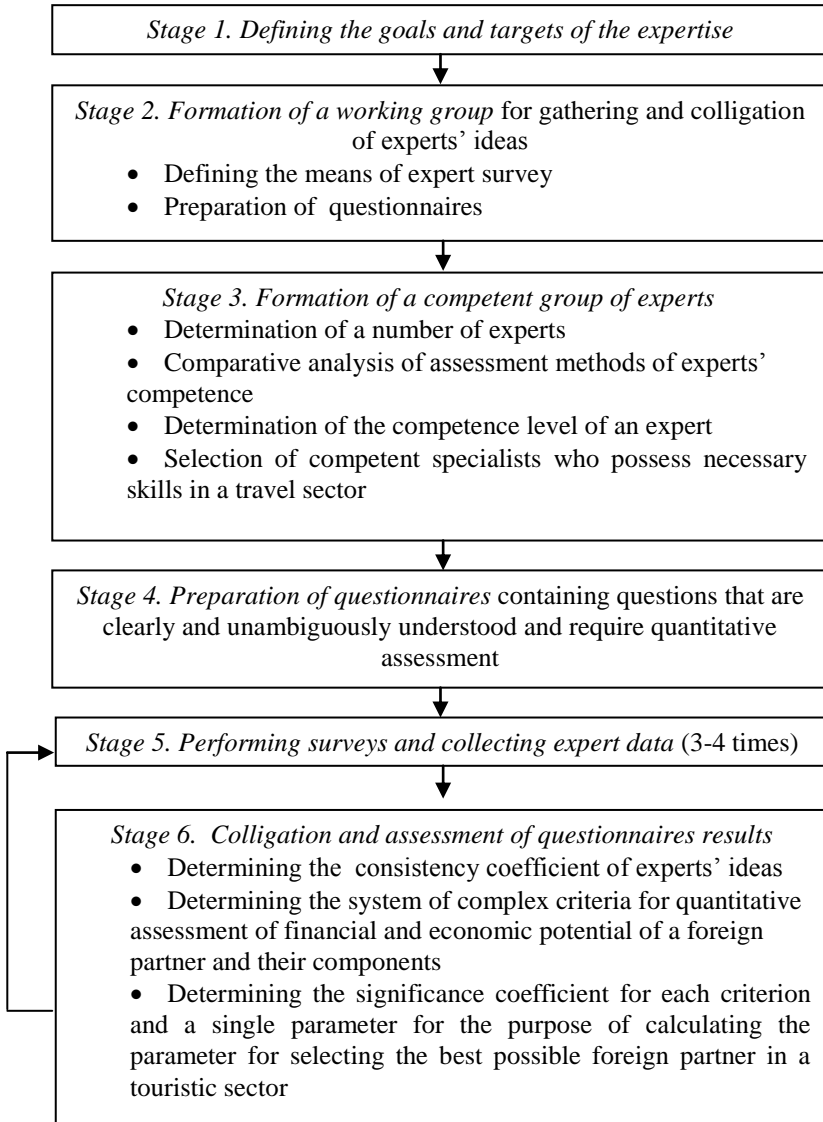

**Figure 4.1 A generic algorithm of an expert survey for assessing the potential of a foreign partner in a touristic sector**

The next step to successfully solve the declared problem was determining a competence level of experts.

A detailed analytical research of advantages, disadvantages and application degree of methods described in works [7, 8] showed that any of the existing methods cannot assess an expert competence to solve the task set.

Taking into account the specific character of the survey, the authors offer to assess the competence level of experts based on the following parameters that reveal the qualification of experts in the best possible way:

- Length of work in the touristic sector;
- Complete basic higher education;
- Postgraduate education (advanced vocational internship work, professional development);
- Acquiring of certain expert professions;
- Self-education;
- Position in a service hierarchy;
- Awareness of a correspondent subject field;
- Real-life experience available;
- Personality.

Every parameter specified can have a quantitative assessment using one of the partial evaluations (heuristic, statistical or documentary). The complete characteristics of an expert can only be given using different methods through calculation of a combined figure [8].

In order to obtain trustful data on the competence level of experts, the combination of heuristic and statistical methods was applied. The competence level was assessed with a quantitative parameter, i.e. competence coefficient ( $K$ ) that was determined based on the assessment of the qualification level of an expert, i.e.  $K_q$ , while determining the components of selecting the best possible foreign partner (coefficient  $K_q \in [0, 1]$ ), and an expert's self-assessment of the level of his argumentation, i.e. argumentation coefficient of an expert  $K_a$  (coefficient  $K_a \in [0, 1]$ ) [8]:

$$K = a_q \cdot K_q + (1 - a_q) \cdot K_a, \quad (4.3)$$

where  $a_q$  – stands for the coefficient that counts for the significance of an expert's qualification ( $a_q \in [0.1, 1]$ ).

Considering the specific character of assessing the potential of a

foreign partner in a touristic sector where the qualification of an expert must be considered to a large extent, it is reasonable to take  $a_q$  equal to 0.8.

It is reasonable to determine the expert's qualification  $K_q$  through a documentary method applying the following formula:

$$K_q = \frac{\sum_{i=1}^m b_i}{b_{max}}, \quad (4.4)$$

where  $b_i$  – stands for the expert's numerical score;

$m$  – stands for the numerical number of the assessment parameter ( $i = 1, m$ ).

$b_{max}$  – stands for the maximum value of the numerical score of an expert ( $b_{max} = 20$ ).

The figures for parameters  $b_i$  and  $b_{max}$  were determined based on the data given in Table 4.2.

Results of determining qualification level of the 15 experts selected are shown in Table 4.3.

The data in the table show that the group of experts got 252 scores. The average value of the qualification index for 15 people compiled 0.84 which is quite a high value (based on the reference scale describe in Table 4.2).

The argumentation coefficient of an expert, i.e.  $K_a$  was determined in the following way based on the self-assessment of an expert. An expert was given a questionnaire to fill in the information given in Table 4.4 (without numbers) where it is mentioned which source of information he used with a corresponding grading: H (high), A (average), L (low) [9].

The coefficient  $K_a$  was calculated by summing up the numbers with expert's notes in the table based on the formula:

$$K_a = \sum_{j=1}^n d_j, \quad (4.5)$$

where  $d_j$  – stands for a numeric mark of an expert;

$j$  – stands for a sequence number of the source of argumentation ( $j = 1, n$ ).

The research conducted gave the possibility to obtain a final formula for calculating the competence coefficient of an expert:

$$K = 0.8 \cdot \left( \frac{\sum_{i=1}^m b_i}{b_{max}} \right) + 0.2 \cdot \sum_{j=1}^n d_j. \quad (4.6)$$

Table 4.2

**Rating scale for the qualification level of an expert**

Assessment criteria	Numeric score	Maximum score
1. <i>Length of work in the touristic sector</i>		4
• less than 5 years	1	
• upto 10 years	2	
• more than 10 years	4	
2. <i>Higher education</i>		3
• bachelor degree	1	
• specialist degree	2	
• magister degree	3	
3. <i>Postgraduate education</i>		4
• practice	1	
• internship	1	
• training	1	
• retraining	1	
4. <i>Acquiring of certain expert professions</i>	2	2
5. <i>Self-education</i>	1	1
6. <i>Position in a service hierarchy</i>		3
• manager	1	
• middle manager	2	
• senior manager	3	
7. <i>Awareness of a correspondent subject field</i>	2	2
8. <i>Expert experience</i>	1	1
Total	-	20

Generalization and statistic assessment of the survey were performed at the final stage of an experts' assessment. Finally, the expert group offered the system of complex criteria for a quantitative assessment of a foreign partner's potential. Significance coefficients of each criterion and single parameters for calculating the parameter of selecting the best possible foreign partner in a touristic sector were determined, as well as the formula (4.7).

$$PS_{fp} = 0.24 \cdot K_s + 0.2 \cdot K_{ea} + 0.22 \cdot K_p + 0.1 \cdot K_{pp} + 0.24 \cdot K_{cc}, \quad (4.7)$$

where  $PS_{fp}$  is the parameter for selecting the best possible foreign partner;

Table 4.3

### Qualification level of the experts selected

Reference number of an expert	Length of work in the touristic sector	Education level	Post-graduate education	Professional education	Self-education	Position in a service hierarchy	Awareness of a correspondent field	Expert experience	Total	Ratio
1	4	2	3	2	1	2	2	0	15	0.75
2	2	1	4	2	1	3	2	1	16	0.80
3	4	3	3	2	1	3	2	1	19	0.95
4	4	3	4	2	0	3	2	0	18	0.90
5	4	3	4	2	0	2	2	0	17	0.85
6	4	3	3	0	1	2	2	0	15	0.75
7	4	2	4	2	1	2	2	0	17	0.85
8	4	3	2	0	1	3	2	1	16	0.80
9	2	3	3	2	1	3	2	1	18	0.90
10	2	2	3	2	1	3	2	1	16	0.80
11	2	2	4	2	1	3	2	1	17	0.85
12	2	3	3	2	1	2	2	1	16	0.80
13	4	2	2	2	1	2	2	1	16	0.80
14	4	3	3	2	0	3	2	0	17	0.85
15	4	3	4	2	1	2	2	1	19	0.95

$K_s$  is a solvability criterion;

$K_{ea}$  is an economic activity criterion;

$K_p$  is a profitability criterion;

$K_{pp}$  is a personnel policy criterion;

$K_{cc}$  is competitiveness criterion of travel services.

Respectively, all the criteria mentioned can be calculated as follows:

$$K_s = 0.27 \cdot k_{al} + 0.21 \cdot NWC + 0.29 \cdot k_{dl} + 0.23 \cdot k_{fs}, \quad (4.8)$$

where  $k_{al}$  is an absolute liquidity coefficient;

$NWC$  is a net working capital;

$k_{dl}$  is a day-to-day liquidity coefficient;

$k_{fs}$  is a financial strength coefficient.

$$K_{ea} = 0.30 \cdot k_{na} + 0.22 \cdot k_{rm} + 0.20 \cdot RA + 0.28 \cdot k_{wcn}, \quad (4.9)$$

Table 4.4

**Assessment scale of the information source for the argumentation of an expert**

No.	The source of argumentation	Influence of the source on your opinion (a <sub>n</sub> )		
		H (high)	A (average)	L (low)
1.	Materials of the specialized publications of information companies	0.3 (V*)	0.2	0.1
2.	Information materials from unofficial resources	0.3	0.2	0.1
3.	Personal awareness of the activity of a partner company	0.5	0.3	0.1
4.	Personal expert experience	0.05	0.03	0.01
5.	Expert intuition	0.05	0.03	0.01

\* Note: V is an expert's

where  $k_{na}$  is an assets negotiability coefficient;  
 $k_m$  is a receivables negotiability coefficient;  
 $RA$  is a returns-on-assets coefficient;  
 $K_{wcn}$  is a working-capital negotiability coefficient.

$$K_p = 0.253 \cdot R_a + 0.226 \cdot R_e + 0.306 \cdot R_{ca} + 0.213 \cdot R_{ac}, \quad (4.10)$$

where  $R_a$  is assets profitability coefficient;  
 $R_e$  is an equity profitability coefficient;  
 $R_{ca}$  is a core activity profitability coefficient;  
 $R_{ac}$  is an activity profitability coefficient.

$$K_{pp} = 0.25 \cdot P_{1e} + 0.25 \cdot LP + 0.28 \cdot k_q + 0.22 \cdot k_{pt}, \quad (4.11)$$

where  $P_{1e}$  is a part of profit for one employee;  
 $LP$  is a labour productivity;  
 $k_q$  is an average level of personnel qualification;  
 $k_{pt}$  is a personnel turnover coefficient.

$$K_{cc} = 0.25 \cdot SB + 0.25 \cdot AE + 0.25 \cdot NA + 0.25 \cdot NRO, \quad (4.12)$$

where  $SB$  is the size of a customer base;  
 $AE$  is a market activity experience;  
 $NA$  is a number of agreements concluded with partners;  
 $NRO$  is the availability of national representative offices.

Below there are results of a trial check-out of the methodology for calculating the parameter of selecting the best possible foreign partner for three receptive travel companies working on the travel market of Turkey. Criteria-wise calculation results of single parameters for selecting the best possible foreign partner out of three Turkish travel companies for a Ukrainian travel company are shown in Table 4.5.

Table 4.5

**Calculation results of single parameters for selecting the best possible partner**

No.	Parameter	Turkish travel company		
		«A»	«B»	«C»
Solvability criterion ( $K_s$ )				
1.	Absolute liquidity coefficient ( $k_{al}$ )	0.7	0.05	0.5
2.	Day-to-day liquidity coefficient ( $k_{dl}$ )	0.1	0.7	1.1
3.	Net working capital (NWC)	451.6	2254	4915.7
4.	Financial strength coefficient ( $k_{fs}$ )	2.9	1.22	0.1
Economic activity criterion ( $K_{ea}$ )				
1.	Receivables negotiability coefficient ( $k_{an}$ )	34	17.3	6
2.	Working-capital negotiability coefficient ( $k_m$ )	10.3	12.8	21
3.	Assets negotiability coefficient ( $k_{wcn}$ )	0.3	0.25	0.4
4.	Returns-on-assets coefficient ( $RA$ )	4.4	4.5	534
Profitability criterion ( $K_p$ )				
1.	Core activity profitability coefficient ( $R_{ca}$ )	0.2	0.3	0.5
2.	Assets profitability coefficient ( $R_a$ )	0.6	0.8	0.9
3.	Equity profitability coefficient ( $R_e$ )	0.7	1.4	42
4.	Activity profitability coefficient ( $R_{ac}$ )	0.3	0.3	0.7
Personnel policy criterion ( $K_{pp}$ )				
1.	Part of profit for one employee ( $P_{le}$ ), thou UAH	187.8	347.6	1035
2.	Average level of personnel qualification ( $k_q$ )	1.7	1.7	1.3
3.	Labour productivity ( $PL$ ), thou UAH	996	1713	3002
4.	Personnel turnover coefficient ( $k_{pt}$ )	0.1	0.2	0.02
Service competitiveness criteria ( $K_{cc}$ )				
1.	The size of a customer base ( $SB$ ), units.	30493	20309	60632
2.	Number of agreements concluded with partners ( $NA$ )	3159	1797	4512
3.	Market activity experience (AE), years	24	18	15
4.	Availability of national representative offices (NRO), units	3	2	5

Based on the data shown in Table 4.5 and using formulae (4.8) – (4.12) here is the calculation of complex criteria for selecting the best possible partner for three Turkish travel companies. The results of the calculation are shown in Table 4.6.

*Table 4.6*

**Calculation results of complex criteria for selecting the best possible partner**

No.	Complex criterion	Ratio	Turkish travel company		
			“A”	“B”	“C”
1.	Solvability criterion	0.24	95.72	473.83	1032.77
2.	Economic activity criterion	0.2	12.14	8.36	114.12
3.	Profitability criteria	0.22	0.43	0.67	10.02
4.	Personnel policy criterion	0.1	296.45	515.67	1009.65
5.	Service competitiveness criterion	0.24	77028.75	5531.5	61765.25

Considering the data shown in Table 4.6, here is the calculation of the final parameter for selecting the best possible partner based on the formula (4.7). The calculation results are given in Table 4.7.

*Table 4.7*

**The final parameter for selecting the best possible partner for Turkish travel companies**

Turkish travel company	Calculation results
“A”	18542
“B”	1494.65
“C”	15192.46

The data in Table 4.7 show that the highest value of the parameter is for travel company “A”, i.e. 18542. That is why it is reasonable for the Ukrainian travel company to choose this company as a partner.

Determination of complex criteria for a quantitative assessment of an economic potential of a foreign partner in a touristic sector depends on many factors: a preferred methodology for conducting an expert survey, the qualitative and quantitative composition of the expert group, the correct processing of results, a carefully worded questionnaire. In order to improve the process of forming a competent group of experts, a systematic approach is offered that allows conducting a complex assessment of experts’ competence with due regard to their qualification and argumentation level of experts.



Partnership relationships are defined as a priority vector of development of integration process in tourism enabling the companies in that sector getting additional competitive advantage. In order to enhance international partnership of travel companies, stages for finding and selecting the best possible business partner are offered. The system of criteria and single parameters resulted from the research will enable performing a complex assessment of financial and economic potential of foreign partners portfolio.

The results of the work have a tangible embodiment. The outcomes of the researches conducted have been applied in the activities of travel companies in Ukraine for improving competitiveness of a travel company, its stability and reliability when compared to other travel companies which is important both for investors and customers, as well as for the entire touristic sector.

## References

1. Oster, Sh. (1999). *Modern competitive analysis*, Oxford University Press, New York.
2. Walker, G. (2002). *Introduction to Hospitality: a guide for higher and specialized secondary schools*, UNITI-DANA, Moscow.
3. Kwartalnov, V.A. (2010). *Strategic Management in Tourism. A Contemporary Method of Management*, Financy i Statistika, Moscow.
4. Bosovska, M.V. (2014). "Methodology of Formation and Development of Strategic Partnership in Tourism", *Naukovyi Visnyk ChDIEU*, Issue 4 (24), pp. 115-122, available at: <http://ir.stu.cn.ua/bitstream/handle/123456789/8184/115-122.pdf>.
5. Sukhar, M. (2015). *Searching for a Partner in EU. Some Practical Advice*, *Yevropeyska Pravda*, available at: <http://www.eurointegration.com.ua/experts/2015/03/17/7031895/>
6. Eitingon, V.N. (2004). *Methods of Arranging Expert Evaluations and Processing Expert Assessments in Management*, VGU, Voronezh.
7. Bubela, T., Mykyichuk, M., Gunkalo, A., Boyko, O., Basalkevych, O. (2016). *Exploration of Uncertainty in Results of Expert Measurements in the System of Quality Management*, *East-European Advanced Technology Journal*, Issue 3/3 (81), available at: <http://journals.uran.ua/eejet/article/viewFile/71607/70796>.
8. Korchenko, O.G., Gornitska, D.A., Ivanchenko, Y.V. (2011). *Methods of Assessing the Quality of an Expert in the Information Security Field*, available at: [http://avia.nau.edu.ua/dos/2011/2/avia2011\\_2\\_3.pdf](http://avia.nau.edu.ua/dos/2011/2/avia2011_2_3.pdf).
9. Raykhman, E.P. (1974). *Expert Methods for Assessing Goods Quality*, *Ekonomika*, Moscow.

**Laptiev Sergiy**

*Candidate of Economic Sciences, Professor,  
Rector KROK University*

**Sidak Volodymyr**

*Doctor of Historical Sciences,  
Candidate of Judicial Sciences, Professor,  
Corresponding Member of the Pedagogical  
Academy of Sciences of Ukraine, Professor of  
the Department of Financial and Economic  
Security Management  
KROK University*

**Mihus Irina**

*Doctor of Economics, Professor, Vice-Rector  
for Scientific Activities, Professor of the  
Department of Financial and Economic  
Security Management  
KROK University*

**Koval Yana**

*Assistant Professor of the Department of  
Financial and Economic Security  
Management  
(Kyiv, Ukraine)*

**THREATS TO  
ECONOMIC  
SECURITY OF  
UKRAINIAN  
EMITENTS  
AFTER  
PLACEMENT  
OF SHARES ON  
FOREIGN  
MARKETS**

Ukrainian legislation provides for a certain list of restrictions that impede the placement of shares of Ukrainian issuers outside the territory of Ukraine and negatively affect the state of their economic security. The main of these restrictions are: shares of Ukrainian issuers can be nominated only in the national currency, the nominal value of shares must be indicated in the certificate of shares; the pre-emptive right of existing shareholders of a joint-stock company to purchase shares of additional issue (in the case of closed (private) placement); the circulation of securities of Ukrainian issuers outside Ukraine requires the approval of the State Commission for Securities and Stock Market (SCfSaSM).

At the same time, in the course of granting the corresponding permission, the SCfSaSM determines, at its own discretion, how and at what exchanges or trade information systems outside Ukraine, the shares

of a Ukrainian issuer may be placed [1].

The absolute non-compliance of the aforementioned provisions of Ukrainian legislation with the requirements of foreign stock exchanges, as well as the active interference of the SCfSaSM in the process of issuing a decision on the placement of shares and the lack of a clear procedure for obtaining a permit for the circulation of shares abroad, leads to the actual impossibility of placing shares of Ukrainian issuers on foreign stock exchanges (within the existing legislative framework).

In connection with the mentioned problems and difficulties in Ukraine, by this time, there has been no direct access of Ukrainian issuers to Initial Public Offerings (IPOs) in foreign jurisdictions. Access to stock markets of European jurisdictions by Ukrainian issuers can be achieved by issuing global depositary receipts (GDRs) or US depositary receipts (USDRs) [2].

Currently, depositary receipts issued by companies around the world can be classified as follows (Table 4.8).

*Table 4.8*

**Classification of depositary receipts**

Classification mark	Type of depositary receipt
by the place of issue and circulation	global; american; european; local
by the participation of the issuer in their issue	unsponsored depositary receipts; sponsored depositary receipts
by the market of securities circulation	depositary receipts of the primary market; depositary receipts of the secondary market
by the level of the depositary program	level I depositary receipts; level II depositary receipts; level III depositary receipts; depositary receipts of private placement

*Source: written by the authors*

It should be noted that the most well-known is the issuance of depositary receipts (ADR and GDR) in developed markets. Less known is the experience of issuing and dealing with depositary receipts in emerging markets. In the literature, such depositary receipts were called *local depositary receipts*. So, if the ADR and GDR allow issuers from developing countries to go to developed US and European stock markets, local depositary receipts expand the ability of investors from developing countries to allow them to invest in securities of foreign issuers. At the same time, in emerging markets there is a competition for the capital of domestic investors, which stimulates the improvement of the quality of corporate governance and the improvement of information transparency of issuing companies [3].

Apart from this, investors are the GDR owners, and in fact, they are

the beneficiary owners of the shares of a Ukrainian issuer, whose interests are represented by the depository bank, and, from the perspective of Ukrainian legislation, they do not become formal owners of such actions (due to the lack of the concept of beneficiary property in Ukrainian legislation). When establishing the peculiarities of entering the IRO through the release of the GDR, the authors want to draw attention to those factors that indirectly affect the state of the economic security of issuers:

- acquisition of shares of a Ukrainian issuer by a foreign depository requires the involvement of a Ukrainian bank acting as a securities trader and custodian of shares owned by a foreign depository (in order to comply with the requirements of Ukrainian legislation regarding the treatment and accounting of securities) in favor of a Ukrainian bank;

- analysis of issues of antimonopoly legislation that arises when shares and GDRs are bought (the need to obtain a permit from the Antimonopoly Committee of Ukraine in the case of acquiring indirect control over a Ukrainian issuer in the amount of 50% or more votes in the management bodies);

- structuring *the voting process at the meetings* of the issuer's shareholders on behalf of the beneficiary owners;

- need for proper structuring with the attraction of funds from investors for the full payment of shares until the moment of final registration of the issue of shares (that is, registration of the report on the placement of shares at the SCfSaSM).

The following fig. 1 for the issuance of American Depository Receipts (ADRs) is rather general, for example, it does not involve listing on the stock exchange. Let us recollect, that the principal scheme is that the initiator of the issue finds a custodian bank (custodian), which can immobilize the securities and at the same time has contractual relations with one of the four depository banks in the USA [3].

This Figure 4.2 omits the relationship between the custodian and the depository through the Central Depository (if it is functioning), but SEC as a participant in the registration process is separately considered. The first thing the initiator of the release does is to choose legal and financial advisers (1). If the issuer registers ADRs of the first, second, or third level, he simply requires a legal adviser to ensure the filling of registration documents in the SEC. The costs for legal consultant range from \$ 30,000 to \$ 50,000. Subsequently, the preparation of documents to the Securities and Exchange Commission (SEC) begins according to the level (appearance) of registered receipts (2).

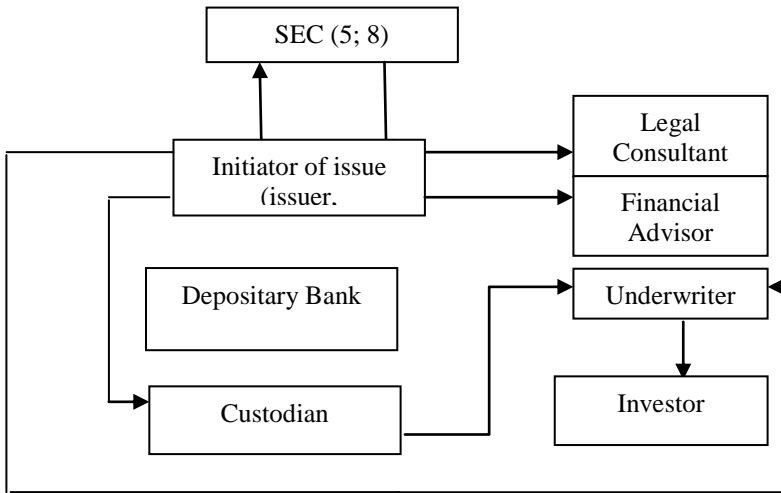

**Figure 4.2 A generalized release scheme of American Depository**  
*Source: receipts [4]*

It is important to note that if the issuer registers receipts under rule 144a or by the rule “Regulation S”, then in the second stage he is exempted from submitting regular reports. Such exemption from reporting to the Commission is known as Rule 12g3-2 (b). In this case, the application sent to the SEC must contain the following information: the issuer’s obligation to the SEC to distribute the reporting or information about its company among investors; the obligation to transfer all essential information to investors that was mandatory for publication in the issuer's country; all information that was provided for listing on the stock exchange or other bidder.

When the Commission decides to satisfy the application of the issuer, the applicant for the DR issue additionally submits the company’s charter, annual reports, quarterly and current financial statements, information materials or prospectuses for shareholders. The collection and delivery of such documents to the Commission (3) must be carried out promptly. A more specific list of documents submitted to the US regulator, is already dependent on the type of receipts issued. It is true that if you plan to issue receipts for an organized market in the United States, then the cost of preparing such a company’s annual report may exceed several million US dollars.

The next stage involves conducting negotiations (4) with the depository bank for the purpose of signing a service contract. An

important point of such an agreement is the amount of commission for their issue. Among depository banks, the size of the commission is significantly different; for example, BNYM bills an average of \$0.05 for each receipt, but this landmark is also changing. A deputy commission fee reduction is possible provided there is a reason to believe that the registered depository program will have high trading activity.

During the negotiations with the depository or custodian, the final registration in the SEC (5) takes place. The Commission may reject the application for registration as a result of non-compliance with the documentation, or if it considers that the applicant company for registration of DR represents a threat to investors in the United States. The SEC seldom dismisses the request for registration. Most administrative cases against foreign issuers, issued by ADR, are formed after the receipt of receipts under the influence of complaints from investors.

After registration, the contract is signed directly with the depository bank (6), which, together with the F-6 form, is filed in the SEC (7). After the Commission considers the contract and registration form F-6 (8), the final stage of negotiations begins with the underwriting bank, or the placement agent and the final determination of the size of the commission for underwriting services (9). Only after signing the contract with the underwriter, SEC issues the final permit for the DR issue (10). Immediately thereafter, the transfer should be initiated by the issuer of the block of shares in the custodian bank (11). The Custodian Bank immobilizes the block of shares (12) and notifies the depository bank thereof, after which the depository bank issues receipts and transfers them to the investor (13).

It has to be noted that the scheme with the participation of legal and financial advisers can be expanded through the involvement of consultants in the United States. These may be law or advocate firms that will directly engage in a relationship with the SEC. However, each additional link in the system of DR production means another 30-50 thousand dollars of additional costs. The question of the need to attract financial and legal advisers is debatable, and the answer to it depends on the complexity of the depository program chosen by the issuer. It should be understood that, in a generalized scheme, the issuance of depository programs (Figure 4.2), the role of a custodian, underwriter, financial and legal consultant can be performed both by one legal entity, and the companies belonging to the same holding.

The final cost, terms and efforts of the company to issue depositary receipts will depend on the types of DRs the company will select. Taking into account the role and place of depositary receipts in attracting capital to the foreign stock market, the author systematized the main advantages and disadvantages of these financial instruments that directly or indirectly influence the issuer's decision to issue depositary receipts and may endanger its economic security (Table 4.9).

*Table 4.9*

**Advantages and disadvantages of depositary receipts from the standpoint of the issuers' economic security**

	Advantages	Disadvantages
for companies	expansion of potential investors group at the expense of better infrastructure and transparency of stock markets of other countries; forming a positive image and increasing trust in the issuing company.	the need to constantly monitor compliance with the requirements of foreign stock sites for the inclusion of securities to the listings.
for investors	obtaining alternative options for investing in the shares of foreign companies. Investments in depositary receipts do not require the physical transfer of investor's capital abroad or currency exchange transactions; diversification of investment portfolio and reduction of financial risks. Investments in depositary receipts make it possible for an investor to benefit from the correlation of yield, and accordingly, from risks from activities in stock markets of different countries	untimely information on dividend payment by the issuing company (dividend payment information is published only in the country of the issuing company); the need for foreign exchange operations in obtaining dividends (dividends are paid in the currency of the issuing country)
for the country	improving the image of the state at the world level	possibility of regulating the securities market and managing the risks and liquidity of this market; income receivable in the form of taxes when dealing with securities only in the local market; the local market becomes dependent on markets where depositary receipts are being rolled out, although this is an inevitable consequence of the integration of the economy

*Source: written by the authors*

Consequently, depositary receipts facilitate the possession and trading of issuers' securities, but they can both positively and negatively affect the state of its economic security.

The above-mentioned scheme of access to IPO is acceptable for foreign stock exchanges, taking into account the fact that this transaction is caused by a number of regulatory restrictions of Ukrainian legislation, which can legally be bypassed through the creation of a foreign holding. When structuring an IPO transaction through the creation of a foreign holding company, the main threats to be taken into account are: reputation of jurisdiction; adequate level of the shareholders and investors' rights and interests protection, provided by the legislation of foreign jurisdiction; possibility of effective tax planning (including the existence of a bilateral convention on the prevention of double taxation between Ukraine and the jurisdiction of the holding).

In cases where the volume of issuance of securities is insignificant, most issuers prefer not to issue the GDRs, which are quite burdensome from the point of view of the administrative process and substantial time resources necessary for the implementation of the GDR structure, and the use of an alternative IPO option, which involves the creation of a holding company (de jure issuer of shares) controlling the Ukrainian share issuer de facto (Figure 4.3).

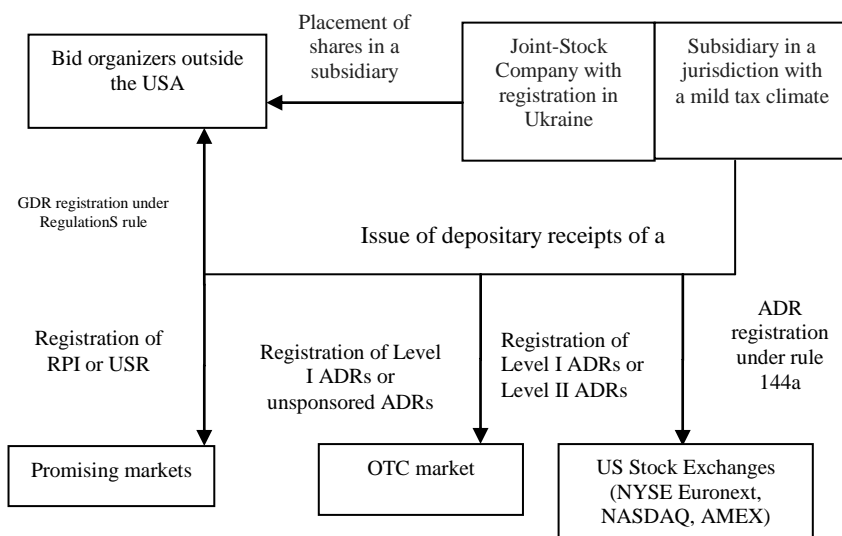

**Figure 4.3 Scheme of share issue through the creation of a holding company and issuance of its depositary receipts**

*Source: written by the author [5]*



The main function that a holding company must accomplish when structuring a transaction to enter an IPO is the transfer of funds received from the implementation of IPOs into the holding group, the receipt and payment of dividends with a minimum tax burden.

Taking into account the above criteria, there are jurisdictions with the least impact on the state of the economic safety of the joint-stock company while establishing its holding company, which will be used to promote the Ukrainian issuer for the IPO, namely Cyprus, the Netherlands, Switzerland, Austria, Great Britain and other.

When implementing this structure, it is also necessary to pay attention to the following criteria, which the holding company must meet for the successful conduct of the IPO, and the absence or imperfection of which will significantly affect the state of the issuer's economic security: transparent ownership structure; effective corporate governance system; possibility to prepare consolidated financial statements; presence of officials with a positive business reputation, accountants, auditors, and lawyers in the holding company.

As alternative means of obtaining income by the holding company from the Ukrainian de facto issuer of shares can be used: interest payable on the loan (in case of application, it is necessary to take into account the need to register a loan agreement with the National Bank of Ukraine as well as restrictions established by the NBU in relation to the maximum interest rates on loans from non-residents); rent payments; royalty payments under license agreements. The application of each of these profit making instruments by the holding company or their combination requires effective tax planning in order to minimize the tax burden.

Consequently, alternative options for the placement of companies through subsidiary offshore companies can only be considered as temporary schemes, or as schemes for jurisdictions with problematic tax regulations. If a company wants to attract large portfolio investors, then its placing through an offshore company is problematic, but technically feasible. It is also true that placement conducted through an offshore company is cheaper compared to others.

Access to the US stock markets is most commonly done in a standard, long and costly way, involving the release of US depository receipts (ADRs), which are an “American option” of the GDR. In this case, the nominee owner of ADR must act as an American depository. However, the above-discussed methods favored by the companies with significant capital are often unavailable to medium and small-sized

companies because of their high cost and the length of the process. In this regard, an effective and less expensive alternative to enter the US public markets for small and medium-sized companies can be a reverse merger, which involves the merger of a private operating company with a shell company whose shares are publicly traded and exchange trading.

As a rule, a shell company (incorporated in the US) is usually chosen to implement a takeover program; this company once appeared in the stock exchange, but ceased its activities under various circumstances, sold its assets to cover obligations and stopped its commercial activity.

Being not burdened with debts or litigation, Shell company, however, does not lose its place on the electronic exchange of OTC Bulletin Board and may even be in a 'sleeping' state for several months on the NASDAQ. Its shares are still registered, have official quotations, and may be the object of sale. Acquiring a similar shell company enables a foreign legal entity to make a quick and inexpensive access to the US stock market.

Advantages of re-absorption in comparison with IPO are: lower level of capital expenditures; temporary advantages in attracting capital (reverse take-over can be done within 3 months from the time of the audit, while it takes IPO 9-12 months); minimizing the dependence on fluctuations in the IPO market; possibility to implement placements without the involvement of the underwriter.

The final choice of the issuer must take into account: the desired parameters of the planned placement; bottlenecks in the taxation system within the jurisdiction of the issuer; peculiarities of the issuer's foreign economic activity; the need to organize a series of several markets (placements) of their own shares. Simultaneously with the choice of options and forms of public placement, the issuer has to solve the task of choosing a stock exchange. This choice should take into account the current state of the stock market.

Therefore, when choosing the place and form of placement of securities on foreign stock sites, each joint stock company must pay special attention to the threats to its economic security in the process of preparing for release (issue), directly during the issue and after the public placement.

## **References:**

1. *Dukhnenko VB, Shapran VS, Kornelyuk RV IPO from "A" to "I": a directory. View of Kiev Ltd. "Akadempress", 2007. 120 p.*
2. *Shulga I.P. Economic security of the issue activity of joint stock*

- companies: a monograph. Cherkasy, 2010. 425 p.*
3. *Korneev V.V. Credit and investment flows of capital in the financial markets: a monograph. Kyiv, 2003. P. 205-218.*
  4. *Shelodko V.M. Financial Market: Teach. manual. Kyiv: Knowledge-Press, 2002. P. 76-78.*
  5. *Salikhova O. Depositary receipts as an instrument of international investment. Securities of Ukraine: science-practice. magazine. 1999. №45 (82). P. 14-15.*

**Širá Elena**

*PhD. in Management, Lecturer,  
Faculty of Management  
University of Prešov*

**Radvanská Katarína**

*M.A. in Language Studies, Lecturer  
College of International Business  
ISM Slovakia in Prešov  
(Prešov, Slovakia)*

## **COMPETITIVENESS OF TOURISM ON THE EXAMPLE OF THE SLOVAK REPUBLIC**

### **Competitiveness of Tourism**

Tourism is one of the most important and most rapidly growing economy sectors, which faces the challenges and possibilities of globalization. Tourism development has great importance and plays a significant role in the development of national economies. (Karahuta et al., 2017) According to statistics of the UNWTO, this is a sector with significant economic benefits. (Hvizdová, 2017) Tourism is to be considered a greatly important part of urban development, as it combines a competitive supply of tourism services, which corresponds to the expectations of tourists, and a positive impact on the development of regions and cities. Cultural potential of regions or particular localities is an important factor of their economic development and competitiveness. (Tej - Matusikova, 2014)

The creation of attractive destinations requires more than natural resources that left us breathless and favourable conditions for rest in nature. Despite these potentials which one tourist destination may have, the supply of different types of services to the guests that are followed by access to a storage environment that is at the core of sustainable

tourism. (Angelkova et al., 2012)

Tourism is a cross-cutting activity across several sectors of the economy. It requires inputs of economic, social, cultural and environmental nature. Tourism is not a manufacturing sector, it is not possible to use a normal production function, nor does it have output that would be physically measurable. It also has no common structure that would be typical on many countries, since the attractiveness of tourism varies greatly from country to country. Even the basic elements of tourism, such as accommodation or transport, are highly differentiated (Lickorish - Jenkins, 1997).

The competitiveness of tourism begins with the statement that experience, the images that the tourist acquires in the tourist destination is fundamental product in tourism. According to this, the competitiveness in tourism is towards tourist destinations. There is competitiveness between the products in enterprises in the area of tourism (organizers of travels, hotel, transport and other tourist services), but this kind of competitiveness arises from the choice and depends on the choice that is made by the tourist regarding alternative tourist destinations. (Angelkova et al., 2012)

We understand tourism as a sector of social activity which formation dates back to the 19th and 20th centuries and is linked to the development of the industrial revolution as a consequence of technical, social and economic developments. In order to develop tourism, it was essential that certain conditions were met, namely:

- the possibility of free movement of people,
- the existence of a primary supply of tourism, which forms the basis of the tourism product as a subject of consumption,
- higher degree of technical, social and economic development, resulting in shortened working hours and a prolonged pool of free time,
- higher degree of satisfaction of basic living needs, with the possibility of satisfying even less urgent needs, where tourism and recreation are included. (Linderová, 2013)

If tourism is to have a greater weight in the economy of the country in the future, then in all sectoral policies it is necessary to support at its interests and goals. Although the private sector has a crucial role to play in development tourism, the role of the public sector is to formulate a strategy for its development and to define its instruments for securing it. Therefore, the basis of the state's tourism policy is important.

There are many definitions of competitiveness in tourism (Hvizdova, 2018), (Widawski, 2017), (Webster - Ivanov, 2014). But the most comprehensive is made by Dupeyras - MacCallum (2013). They said, that: “Tourism competitiveness for a destination is about the ability of the place to optimise its attractiveness for residents and non-residents, to deliver quality, innovative, and attractive (e.g. providing good value for money) tourism services to consumers and to gain market shares on the domestic and global market places, while ensuring that the available resources supporting tourism are used efficiently and in a sustainable way.”

Competitiveness and attractiveness view destinations from two different perspectives, one from the tourist perspective (attractiveness) (Šambronská et al., 2016), and the other from the destination perspective (competitiveness). (Vengesayi, 2013)

### **Travel & Tourism Competitiveness Index**

There are many institutions that evaluate the competitiveness. We have chosen the World Economic Forum. This institution published bi-annually the Travel & Tourism Competitiveness Index (TTCI) since 2007. First Travel & Tourism Competitiveness Index measures in 2007 “the set of factors and policies that enable the sustainable development of the Travel & Tourism sector, which, in turn, contributes to the development and competitiveness of a country”. The index has been developed in the context of the World Economic Forum’s Industry Programme for Aviation, Travel and Tourism, and in close collaboration with our other partners.

The Report, which analyses the performance of 136 economies through the Travel & Tourism Competitiveness Index, provides unique insight into the strengths and areas for development of each country to enhance its industry competitiveness. It allows for cross-country comparison, for benchmarking countries’ policy progress and for making investment decisions related to business and industry development. (Annual Report TTCR 2017)

This index is created from the set of 11 indicators. These indicators are dedicated to the travel and tourism areas, that are important for tourism development, as seen in Figure 4.4. The indicators are grouped into 4 areas:

- Enabling environment,
- T&T policy and enabling conditions,

- Infrastructure,
- Natural and cultural resources. (Annual Report TTCR 2017)

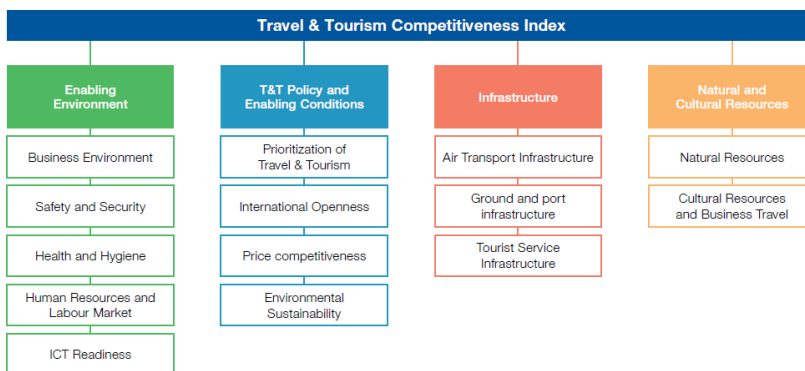

**Figure 4.4 Travel & Tourism Competitiveness Index**

*Source: Annual Report TTCR 2017*

### Tourism in the Slovak Republic

Tourism is an important part of each country. When we analysed the share of tourism on GDP in the Slovak Republic, we could see the low values of this indicator. Through the years 2011 - 2017, the development was rising up. The highest value was about 2.4 % in 2017.

*Table 4.10*

#### Travel and Tourism on GDP in %

	T&T 2011	T&T 2013	T&T 2015	T&T 2017
Slovak Republic	1,5	2,3	2,3	2,4

*Source: Own processing*

When we examine the performance of tourism competitiveness evaluated by TTCI, we can see worsening position of the country. The score fell down in 2015 and in 2017 it was still not on the value as before. The best position in TTCI was reached in the year 2009. From this year, its position fell down.

*Table 4.11*

#### Development of TTCI in the Slovak Republic

	TTCI 2009	TTCI 2011	TTCI 2013	TTCI 2015	TTCI 2017
Score	4,3	4,4	4,3	3,84	3,9
Rank	46	54	54	61	59

*Source: Own processing*

In Slovakia, some types of tourism are more developed than others. The main types of tourism are determined by the cultural, historical and natural potential of the country. They are:

- **Summer tourism.** Mainly a stay near water sources (e.g. thermal swimming pools, aqua parks, lakes), relaxation and hiking in mountain resorts.
- **Winter tourism.** This category includes a wide range of ski resorts as well as the right natural conditions for winter hiking and winter sports.
- **Spa and Health Tourism.** Natural spas play an important role in disease prevention. Many Slovak spa resorts include wellness services, weekend stays, some even under medical supervision. At the same time, a relatively wide network of thermal swimming pools and aqua parks was created in Slovakia.
- **Cultural and urban tourism.** In this respect, Slovakia has a relatively large offer of historical monuments, museums, folk architecture museums.
- **Rural tourism and agro tourism.** Rural tourism is mainly linked to simpler forms of accommodation (private accommodation, guesthouses, etc.) in countryside with the opportunity to explore rural life. Part of rural tourism is agro tourism associated with staying in the courtyard. In the world, it is a fairly widespread type of tourism, but in terms of Slovakia it is a relatively new but highly perspective kind of tourism.

To increase the competitiveness of tourism in the Slovak Republic, the Slovak Government set the aims for the period 2016-2020. We have chosen these areas of interest:

- Brand of the country,
- Infrastructure,
- Presentation of the country abroad,
- Unified information portal.

### **Brand of the country**

It took a lot of effort and long time to create a modern brand of Slovakia in 2016. The government has developed the communication policies of “brand Slovakia” and transformed them into concrete positive steps that enable them to be translated into an attractive and creative cultural, economic, and tourist forms. The government implements the unified presentation of the Slovak Republic abroad and

the ambitious promotion of this brand of the country as an expression of a modern, self-confident country. It will continue to support creative and broad-spectrum cultural and public diplomacy activities.

The key slogan is “Good Idea Slovakia”. This brand is currently presented at all official portals dedicated to tourism.



**Figure 4.5 Brand of the country**

*Source: Ministry of Transport and Construction*

### **Infrastructure**

The Government’s intention in tourism will be to increase its competitiveness. The development of tourism in selected touristically attractive localities also includes national and regional transport. The government took some measures to better coordinate rail and bus transport. (Government Programme Statement 2016-2020)

Also, in recent years, intensive construction of highways has been taking place, which would go smoothly throughout the country and follow the road network in the neighbouring countries. Completion of the highway network accelerates the transfer of passengers between airports and destinations within the country.

### **Presentation of the country abroad**

During the last presidency of the Slovak Republic in the European Union (1 July-31 December 2016), Slovakia had the opportunity to present itself abroad. The landscape was presented as a touristically interesting and safe destination that can attract. On this occasion a country logo was created, which is shown in Figure 4.6.

The logo presented the country outside. It was created in colours typical for Slovakia, using the symbols of folk culture.





**Figure 4.6 Brand of the country**

*Source: European Commission*

### **Unified information system**

The “Slovakia.travel portal” was created on the basis of a project called National Uniform Tourism Information System of the Slovak Republic. It is the official, central information and tourism information system of the SR, which is to promote Slovakia as a tourist destination. The main mission and priority of this portal is the provision of information and incentives for tourists.

Visitors can find information in 7 languages. The portal offers information on accommodation, catering, attractions and events in individual regions of Slovakia. It offers visitors an overview of UNESCO historical sites in Slovakia, an overview of national parks, the possibility of visiting caves and castles. Via this portal, a visitor can plan their stay in Slovakia at one place, taking into account their preferences, whether active holiday or relaxation. An advantage is the aggregated arrangement of all the necessary information in one place. It is also offered to download the application of this on-line mobile wizard. Here is a preview of the page mentioned above.

One of the tasks of the government for the future will be not only to increase the number of tourists but also extend the time they spend in Slovakia. Several resources are available to meet this goal. The most effective way to attract tourists to the country is the active presentation of Slovakia, the creation of a stable brand and, in particular, accessible and comprehensible information. Given the potential of tourism, it is possible to counterbalance regional economic and social disparities, thereby continuously improving the competitiveness of the country in the field of tourism. It is necessary to strengthen the development of those products of tourism that have a high added value and bring higher cost efficiency. In particular, there are leisure activities such as rural tourism, winter and adventure tourism.

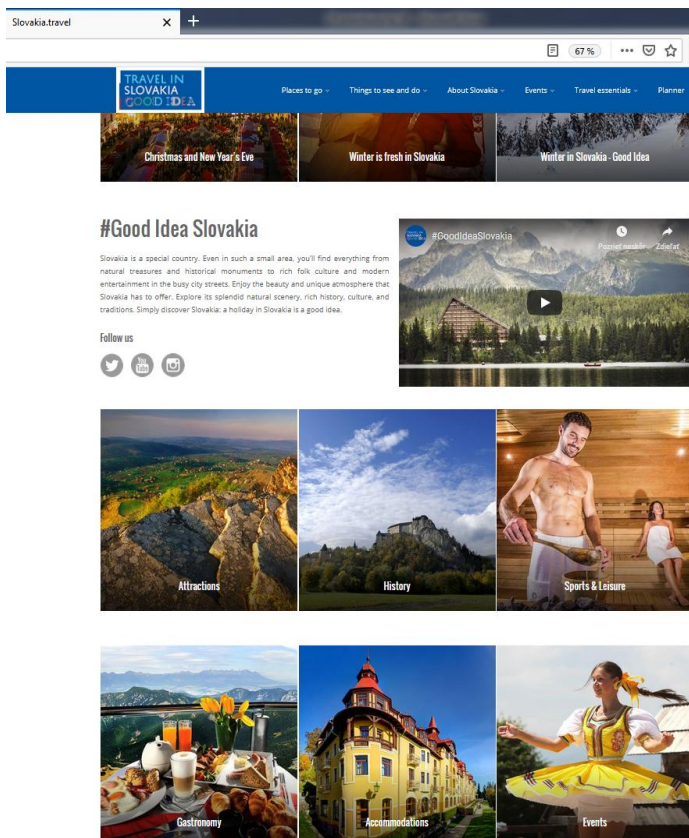

**Figure 4.7 Official web site**

Source: [www.slovakia.travel](http://www.slovakia.travel)

## References

1. Angelkova, T., Koteski, C., Jakovlev, Z., & Mitrevska, E. (2012). *Sustainability and competitiveness of tourism. Procedia-Social and Behavioral Sciences*, 44, pp. 221-227.
2. *Annual Report TTCR 2017*. (2017). *Word Economic Forum*, [ONLINE] Available at: <https://www.weforum.org/reports/the-travel-tourism-competitiveness-report-2017> [accessed: 2018-11-26]
3. *Brand "Slovakia"* [ONLINE] Available at: <https://www.mindop.sk/ministry-5191/tourism/slovakia-travel> [accessed: 2018-11-20]
4. Dupeyras, A., & MacCallum, N. (2013). *Indicators for measuring*

- competitiveness in tourism: A Guidance Document*”, *OECD Tourism Papers*, 2013/02, OECD Publishing.  
<http://dx.doi.org/10.1787/5k47t9q2t923-en>
5. *Government Programme Statement 2016-2020 [ONLINE] Available at: <https://www.vlada.gov.sk/programove-vyhlasenie-vlady-sr-na-roky-2016-2020/> [accessed: 2018-12-3]*
  6. *Hvizdová, E. (2017) New Challenges for Sustainable Tourism. Current trends and challenges in economics and management, Ružomberok : VERBUM, pp. 106-112. ISBN 978-80-561-0440-8*
  7. *Hvizdova, E. (2018). Religious tourism and its socio-economic dimensions. European Journal of Science and Theology, 14(2), pp. 89-98.*
  8. *Karahuta, M., Gallo, P., Matušíková, D., Šenková, A., & Šambronská, K. (2017). Forecast of using neural networks in the tourism sector. In CBU International Conference Proceedings. (Vol. 5, p. 218). Central Bohemia University.*
  9. *Lickorish, L. J. & Jenkins, C. L., (1997). An Introduction to Tourism. Oxford: Butterworth-Heinemann. ISBN 0-7506-1956-2.*
  10. *Linderová, I., (2013). Cestovní ruch. Základy a právní úprava. Jihlava: Vysoká škola polytechnická, pp. 265. ISBN 978-80-87035-82-5.*
  11. *Šambronská, K., Matušíková, D., Šenková, A., & Mitříková, J. (2016). Comparison of tourism performance in chosen European countries with the accent to Slovak Republic in the period before and after accession to European Union membership at the beginning of 21st century. Ecoforum Journal, 5(1).*
  12. *Tej, J., & Matusikova, D. (2014). Tourism product creation as a basis of economic prosperity of a destination. Економічний часопис-XXI, (5-6), pp. 45-48.*
  13. *Vengesayi, S. (2013). A conceptual model of tourism destination competitiveness and attractiveness. In ANZMAC 2003 Conference Proceedings Adelaide 1-3 December 2003, pp. 637-647.*
  14. *Webster, C., & Ivanov, S. (2014). Transforming competitiveness into economic benefits: Does tourism stimulate economic growth in more competitive destinations?. Tourism Management, 40, pp. 137-140.*
  15. *Widawski, K. (2017). Spa and Wellness Tourism in Poland-A New Geographical Analysis. Czech Journal of Tourism, 6(1), pp. 69-92.*

**Yatsiv Ihor**

*Doctor in Economics, Associate  
Professor, Vice-rector*

**Yatsiv Svitlana**

*PhD in Economics, Associate  
Professor, Associate Professor of  
the Department of Economics  
Lviv National Agrarian University  
(Lviv, Ukraine)*

**SOCIAL FUNCTIONAL  
STRATEGY TO SECURE  
COMPETITIVE  
CAPACITY OF  
AGRICULTURAL  
ENTERPRISES**

Relations of competition make a fundamental element of principal economic models, used worldwide. They make a sufficient impact on businessmen's behavior, force improvement of products quality and production technologies, organization of a reliable resource support and development of a system of products sale. Actions of the subjects of competitive relations, which demonstrate a system target character, are manifested by a competitive strategy.

The notion of "competitive strategy" comes from a more general definition, i.e. a strategy of an enterprise. The last one is traditionally interpreted as a system of actions, which is focused on achievement of the set goals of an enterprise by means of coordination and distribution of resources (Kovtun, 2009, p. 112; O'Shaughnessy, 2001, p. 57; Soroka and Kryvtsova, 2014, p. 317). A competitive strategy considers development of an enterprise in the context of competitive relations. Making argumentation of the strategy, one emphasizes that the enterprise performs its activity in a competitive environment, sets a task to get some competitive advantages. To reach the set goals the enterprise should consider realities of a competitive fight. It specifies nature of the problem, which the enterprise's administration faces, and names an approach to its solution. Thus, if strategic goals of an enterprise expect development of competitive advantages, the enterprise's strategy is identified as its competitive strategy.

Competitive strategies of an enterprise deal with different levels of planning and management: corporative, functional, commercial. Considering the above said, theory and practice of strategic management can distinguish corporative (basic), functional and commercial strategies. Corporative strategies determine a general direction of competitive development of an enterprise. The most often used

approaches to define their essence are determined by M. Porter as three basic strategies of competition, i.e. the least expenditures, differentiation, concentration (Porter, 1997, p. 51). Functional strategies to secure competitive capacity of an enterprise specify and give details for implementation of a basic strategy, commercial ones – describe ways to increase competitive capacity of some kinds of products.

Implementation of functional strategists is focused on support of efficient activity of functional subsystems of an enterprise, within which some its departments and services perform. Efficient performance of those subsystems is a feature of competitive capacity and a source for competitive advantages of the enterprise. Among the typical functional strategies, which are proposed for use by enterprises, including agricultural ones, the most often used are productive, marketing, financial, staff management strategy. The list can be expanded with a social strategy.

A social strategy is a system of decisions, actions, which is focused on achievement of social goals of an enterprise. The goals deal with satisfaction of social needs, which appear in internal and external environment of the enterprise. Internal social needs of an enterprise deal with satisfaction of the interests of its staff. Social needs in external environment concern creation of conditions for life and activity of people, who make or can make some impact (direct or indirect) on the enterprise activity.

As it concerns a functional strategy, social goals of an enterprise should be agreed with the goal, defined by a basic competitive strategy. The basic strategy expects acquiring of the features of strong competitive capacity, which is interpreted as a capability of an enterprise to run profitable activity for a long period. The necessity to distinguish a social strategy is forced by the actuality of formation of social responsibility of business subjects. Its introduction should take an important position in the hierarchy of competitive advantages of those subjects.

Implementation of a social strategy at the level of internal environment is connected with formation of employer's responsibility. An enterprise supplies an appropriate level of salary for its employees, performs a complex of measures, focused on improvement of their work conditions. It enables success in competition with other enterprises concerning attraction of qualified, initiative employees to work. Such competition is particular both for separate enterprises and for the branches of economy.

In many countries of the world, the level of salaries in agriculture is lower than the average one in the economy (Table 4.12). Such situation is forced by unequal requirements to the level of education for employees, difference in labor productivity in some branches of economy, which, in its turn, depends on technical supply of production processes.

*Table 4.12*

**Level of salaries in agriculture as compared to the average salary in the country's economy, %\***

Country	2013	2014	2015	2016	2017
Byelorussia	74,9	74,5	72,2	68,2	68,5
Czech Republic****	81,0	83,1	81,6	81,7	...
Hungary****	76,0	77,3	77,3	77,9	77,6
Poland**	85,4	84,9	84,8	85,1	...
Russia***	52,8	54,5	57,9	59,3	65,5
USA****	57,8	55,0	57,5	62,4	62,6
Ukraine	69,5	71,1	74,9	75,6	81,1

\* Completed, basing on the data of statistical services of the corresponding countries

\*\* Agriculture and hunting

\*\*\* Agriculture, hunting and forest industry

\*\*\*\* Agriculture, forest and fish industry

A low level of salary has become a reason for employees transfer to other branches of economy, along with lack of motivation to work efficiently of those, who stay in agriculture. That problem is of urgent importance for agrarian sector of Ukraine, where many employers complain on lack of experienced, well-organized workers. Thus, sufficient reducing of the gap between the level of salaries in agriculture and the average salary in the economy, which is observed in the recent years, is a regular and expected process, considering high investment attractiveness of Ukraine' agriculture.

Modernization of the system of financial stimulation for workers at agricultural enterprises should not be limited just by increase of the salary level. It is also important to secure optimization of the structure of labor payment through bonuses, commissions, rewards. Agrarian enterprises can practice a widely used individual approach, which concerns value of each employee, i.e. his/her qualification, experience, business competences, creativity, etc. Employees should be also provided with appropriate conditions for their professional growth, particular training.

At agricultural enterprises, formation of social protection for

employees should not be limited by improvement of the system of labor payment. Administration of enterprises should propose additional benefits for their employees in the form of wage supplements. Such supplements can include organization of food maintenance, traffic support, healthcare, medical insurance, supply of some kinds of commodities (agricultural and food products, fuel, building materials, etc.) on preferable terms, payment for training, additional compensations for vulnerable categories of employees and others.

Wage supplements should not include norms and guaranties, expected by laws in force. Those conditions, which should be obligatory supplied by an employer, can not be taken as a competitive advantage of the enterprise. However, the practice confirms that legal requirements concerning employees' social protection are often deliberately violated by employers. Thus, it is proposed to include all legally approved obligations and rules into the notion of "social responsibility of business" (International Organization for Standardization, 2010). However, the regularity should not be considered as an element of social strategy of an enterprise. On the other hand, violation of some standards and rules, approved by the state, invalidates the very idea of implementation of such strategy for security of competitive capacity of the enterprise.

Developing wage supplements, one should not closely relate amount of expenditures with the work contribution by an employee. Of course, appropriate expenditures can be differentiated to some extent. However, an employer has to demonstrate his/her will to concern needs of all categories of employees.

Solution of social problems, which appear in the internal environment of an enterprise, should support a wider attraction of employees to the process. Performance of employees associations is a powerful tool to advocate the interests of employees. The practice proves that, in agriculture, employees organizations are less active than in industry, building or transportation. It is caused by a high labor turnover at agricultural enterprises, by attraction of a great number of seasonal workers to production processes. Administration of medium-size and large enterprises should cooperate with employees organizations as the main instrument for implementation of a social strategy at an enterprise level. A principle of fair wage should be kept along with the principle of equal rights for an employer and employee, which expects creation of transparent prospective relations between them.

Development of an efficient system of social protection for employees and creation of conditions for their carrier move are competitive advantages, which can secure lower production costs for the enterprise and high quality of produced goods. Lower costs can be secured by high labor productivity of motivated employees. High quality of products is supplied by appropriate level of their productive discipline.

Implementation of a social strategy expects not only solution of internal problems, but also active interaction of agricultural enterprises with external environment. Among the subjects of that environment, one can distinguish: 1) owners of land parcels, which are leased by agricultural enterprises, residents of rural settlements and local authorities on the territory of the enterprise operating; 2) consumers of the products of an agricultural enterprise and products of their processing.

Groups of those subjects can be largely duplicated, i.e. many of them simultaneously belong to different categories of stakeholders of agrarian producers. The mentioned distribution of the subjects of external environment depicts different social requests, which are to be satisfied by a social strategy of agricultural enterprises.

Agrarian enterprises are distinguished among the subjects of other branches of economy by employment of a particular resource, i.e. agricultural lands. Amount of the resource is limited, and its users must maintain and improve the lands fertility. In Ukraine, agricultural enterprises use above 90% of lands on the base of lease of land shares, which are mainly owned by rural residents. There is a specific market of land parcels lease, most segments of which experience a severe competition. Such competition results in a fast growth of payment for land lease. However, only money payments are not enough for success in competition with other land-users. Agricultural enterprises should develop positive relations with rural communities, bodies of local government. Their favor is one of the main tasks of a social strategy of agrarian producers.

To secure the right of land parcels lease, agrarian enterprises spend some costs for charity projects in villages with concentrated residence of land parcels owners. Those projects expect support for the objects of social infrastructure (establishments of education, culture, healthcare), financial aid for vulnerable categories of population, support for public organizations performance at the local level, etc.

In Ukraine, reasonability and efficiency of such projects is connected



with serious problems in social-economic development of many rural territories. Complicated conditions of rural population living, caused by a low level of social infrastructure development and lack of work places, are the reason for such demographic losses. There is a public idea that agricultural enterprises, getting access to land resources, should participate in solution of the relating problems. That reason forces many agrarian producers develop and perform the measures, which are essential in a social strategy.

The necessity to protect land resources for the future generations is revealed in social aspects of their use. Careful employment of agricultural lands and environment, as well as ecological responsibility, are some of the constituents of social responsibility of an enterprise. Strict keeping to appropriate requirements should become one of the key elements of the philosophy of agrarian business performance. Thus, there is an actual question: how good is that principle kept in the present performance of agricultural enterprises?

A negative impact on environment is one of the strongest consequences of agrarian business performance. To minimize the impact, the state should legally approve the standards, which regulate each parameter of the corresponding activity. Particularly, in Ukraine there are officially approved standards concerning an optimal correlation of crops in crop rotations (Cabinet of the Ministers of Ukraine, 2010). However, in practice, the standards are very often violated by agricultural enterprises. Administrative penalties in the form of fines for violation of the corresponding norms are small, comparing to the benefits, which agrarian producers can get in case of maximization of production output of some kinds of products. It is not a rare case and it is a direct violation of ecological requirements concerning use of agro-chemical substances, disposal of wastes of animal breeding production, etc.

Prospects of introduction of the obligations concerning minimization of negative impact on environment and protection of land fertility into a social functional strategy concerning security of competitive capacity of agricultural enterprises depend on which competitive advantages will be supplied for the farming subjects. One should consider that agricultural enterprises are first business structures, which are focused on getting a maximum profit. Implementation of a social strategy by them aims to develop a positive image of the enterprise as a user of resources and producer of products. That image should contribute to strengthening of market positions of the enterprise.

As it is mentioned above, security of a high level of social protection for employees creates competitive advantages at the labor market. Participation in implementation of social projects in rural settlements is an important instrument in competition for the right of agricultural lands use. There is also a competition from the side of other enterprises, which are interested in qualified employees and land resources. In contrast, a need to spend costs for measures concerning minimization of negative impact on environment for many representatives of agrarian business is not among the primary tasks. Thus, agreements of land parcel lease by agricultural enterprises of Ukraine should include the point about inadmissibility of deterioration of land quality characteristics. However, there are no defined tools of control for violation of the norms.

An ecological component in a social strategy of security of competitive capacity is important for those agricultural enterprises, which have the image of producers of organic products or those, which are focused on a small group of consumers with specific requests. However, number of such enterprises is not large. In Ukraine, their position is hardly observed.

Formation of the essence of a social strategy and forces for its implementation depend on different characteristics of enterprises, including their size. Agrarian sector of Ukraine demonstrates a high degree of production concentration. In 2017, there were 166 agricultural enterprises, which employed 10 thousand ha of land area each. The share of employed lands constituted 18,3 % of the total area of all agricultural enterprises (State Statistics Service of Ukraine, 2018, p. 301). Ukrainian model of agrarian production principally differs from the model, which is developed in the countries of the Central and Eastern Europe, where smaller enterprises dominate. For instance, in 2016 in Poland there were 270 agricultural enterprises, which employed 1000 ha of lands and more. It constituted 4,4% of the area of all agricultural lands (Statistics Poland, 2017, p. 155). In Ukraine, number of such enterprises was 18 times larger.

Large agricultural enterprises employ workers and plan long lease of land area. For them, implementation of a social strategy is an important instrument of formation of competitive advantages in competition for resources. The research, made by the article authors, demonstrates that in Ukraine level of expenditures by large land users, within the process of social responsibility development, is sufficiently higher than by small agricultural enterprises. Higher standards of social responsibility are manifested by agricultural enterprises, established with foreign capital

(Yatsiv and Kolodiichuk, 2017, p. 52). The last aspect forces Ukrainian agrarian producers to move in direction to appropriate standards.

Large agricultural enterprises mainly produce raw materials, which are sold to wholesalers for their following processing. They are obliged to keep to the standards of products quality. However, they are often not ready to spend costs for reduction of their negative impact on the environment, in case results of their activity meet the national ecological norms.

Social strategies of small agricultural enterprises are first focused on satisfaction of the requests, which occur in external environment. Family farms employ few workers. The level of farmers' personal income is not considered by them as a competitive advantage. Besides, among the lands, used by small enterprises, the share of leased lands is also smaller than by large land users.

A principle of solidarity of employer's and employee's income is actual for those small agricultural enterprises, which hire people. At such enterprises, contribution of each worker into the ultimate result of farming is of particular importance. Consequently, potential expenditures, connected with the fall of employees' motivation, increase.

For small agricultural enterprises, a basic strategy of focusing is a prospective one. The strategy expects concentration of attention and attempts at a definite segment of market, nomenclature of commodities. Thus, farmers can avoid a direct competition with large producers. Strategy of differentiation is also focused on avoidance of such competition. The strategy expects supply of commodities, which have no analogues at the corresponding geographical segment of market. Obtaining of competitive advantages due to the strategy of focusing or differentiation requires active cooperation of producers and consumers. Such cooperation is developed within implementation of a marketing functional strategy. A social strategy can serve as a supplement. Implementing the strategy, a small agricultural enterprise is positioned as a producer of high quality products, which are supplied at a reasonable price, and has feedback with consumers.

Thus, elements of a social functional strategy for strengthening of competitive capacity can be used in activity of different-size agricultural enterprises. Supplementing other functional strategies, they are able to intensify a synergetic effect of their application. A social strategy can include a wide range of measures, focused on satisfaction of social needs in internal and external environment of an enterprise.

## References

1. *Cabinet of the Ministers of Ukraine (2010). The Decree of the Cabinet of the Ministers of Ukraine “About approval of the norms of the optimal ratio of crops in crop rotation in various natural and agricultural regions” [online] Available at: <http://zakon.rada.gov.ua/laws/show/164-2010-%D0%BF> (in Ukrainian) [Application Date: Desember 1, 2018].*
2. *International Organization for Standardization (ISO) (2010). ISO – guidance on social responsibility. [online] Available at: <https://www.iso.org/obp/ui/#iso:std:iso:26000:ed-1:v1:en>. [Application Date: Desember 1, 2018].*
3. *Kovtun, O. I. (2009). Competitiveness of the enterprise: strategic context. Lviv: Vydavnytstvo Lvivskoi komertsii noi akademii. 276 p. (in Ukrainian).*
4. *O’Shaughnessy, J. (2001). Competitive Marketing: A Strategic Approach. Saint Petersburg: Piter, 864 p. (in Russian).*
5. *Porter, M. E. (1997). Competitive Strategy. Kyiv: Osnovy. 390 p. (in Ukrainian).*
6. *Soroka, O. V. and Kryvtsova, M. S. (2014). Social strategy in the system of modern enterprise management. Social and Labour Relations: theory and practice, Issue 1, p. 315-319.*
7. *State Statistics Service of Ukraine (2018). Statistical Yearbook of Ukraine for 2017. Kyiv. 540 p.*
8. *Statistics Poland (2017). Characteristics of agricultural holdings for 2016. Warsaw: The Central Statistical Office [online] Available at: <http://stat.gov.pl> (in Polish) [Application Date: Desember 1, 2018].*
9. *Yatsiv, I. and Kolodiichuk, V. (2017). Formation of social responsibility of large agricultural land users in Ukraine. Economic Annals-XXI, Issue 168(11-12), p. 48-52.*

## Chapter 5

# DEVELOPMENT OF STRATEGIES TO ENSURE EFFECTIVE MANAGEMENT OF COMPETITIVENESS THE ECONOMIC ENTITIES

### **Borowska Maria**

*Starszy wykładowca Wydziału  
Nauk Technicznych i  
Ekonomicznych Państwowej  
Wyższej Szkoły Zawodowej im.  
prof. Stanisława Tarnowskiego w  
Tarnobrzegu*

### **Zadworny Waldemar**

*Starszy wykładowca Instytutu  
Ekonomii i Zarządzania  
Państwowej Wyższej Szkoły  
Techniczno-Ekonomicznej im. ks.  
Bronisława Markiewicza w  
Jarosławiu  
(Tarnobrzeg, Jarosław, Polska)*

## STRATEGICZNE UWARUNKOWANIA ZARZĄDZANIA ZAPASAMI W PRZEDSIĘBIORSTWACH PRODUKCYJNYCH I HANDLOWYCH

### 1. Wstęp

Bieżąca analiza i ocena efektywności gospodarki zapasami jest jednym z ważniejszych elementów zarządzania przedsiębiorstwem. Utrzymanie zapasów powyżej ilości niezbędnej do niezakłóconego przebiegu działalności powoduje zamrażanie środków, zwiększając tym samym koszty funkcjonowania przedsiębiorstwa. Z kolei zbyt niski poziom zapasów może powodować przestoje i zakłócenia pracy urządzeń technologicznych. Ważne jest więc utrzymanie wielkości zapasów magazynowych na optymalnym poziomie. Dokonywanie analizy wartości posiadanych zapasów i ich wykorzystania w odniesieniu do przyjętego budżetu prowadzi się najczęściej przy pomocy klasycznych metod. Przy czym każde przedsiębiorstwo produkcyjne na podstawie własnych

doświadczeń, analizy kosztów, prognoz sprzedaży oraz możliwości produkcyjnych przy uwzględnieniu czynników zewnętrznych opracowuje własny schemat zarządzania zapasami. Jest on dopasowany do indywidualnych potrzeb danego podmiotu oraz jego profilu działalności, a także przyjętej filozofii zarządzania. Sposób wykorzystania wybranych metod czy też technik zarządzania procesami logistycznymi w dużej mierze zależy od wewnętrznych uwarunkowań każdego przedsiębiorstwa.

Mając na uwadze powyższe, celem artykułu jest próba wskazania strategii, które pozwolą zoptymalizować proces zarządzania zapasami w przedsiębiorstwach produkcyjnych i handlowych, tak aby możliwe stało się osiągnięcie przewagi konkurencyjnej, zwiększenie dotychczasowego poziomu sprzedaży i poprawienie wyników finansowych. Podstawą charakterystyki badanego problemu jest analiza literatury przedmiotu.

## 2. Funkcja zapasów towarowych

Zapas to odpowiednia ilość zasobów towarowych zgromadzonych w celu odsprzedaży w celu zapewnienia przedsiębiorstwu normalnego funkcjonowania<sup>10</sup>.

Jednym z powodów gromadzenia zapasów jest oddziaływanie czynnika losowego na kształtowanie się popytu, jak również na procesy logistyczne. Utrzymywanie zapasów towarów jest więc wynikiem braku synchronizacji dostaw i sprzedaży, co przeciwdziała ich gromadzeniu. Zapas w takiej sytuacji gra rolę swoistego amortyzatora między popytem a sprzedażą. Każde przedsiębiorstwo handlowe jest zatem zmuszone do zabezpieczania się przed skutkami zakłóceń losowych poprzez tworzenie zapasów. Zapasy mają za zadanie zmniejszyć koszty utraconej sprzedaży. Innymi przyczynami powodującymi potrzebę tworzenia zapasów są: niepewność co do terminowości dostaw, uzyskanie oszczędności na transporcie, możliwość wynegocjowania niższej ceny zakupu, sezonowość podaży dóbr, zabezpieczenie przed zmianami cen oraz przed nagłymi, nieprzewidywanymi zdarzeniami<sup>11</sup>.

Ze względu na funkcję, jaką pełnią zapasy, można je podzielić na:

- bieżące (cykliczne),
- w produkcji,
- bezpieczeństwa (buforowe),

---

<sup>10</sup> M. Sławińska, *Zarządzanie przedsiębiorstwem handlowym*, PWE, Warszawa 2002, s. 103.

<sup>11</sup> D. Kempny, *Zapasy w systemie logistycznym firmy*, „Gospodarka Materialowa i Logistyka” 1996, nr 6, s. 125.

- sezonowe,
- promocyjne,
- spekulacyjne,
- martwe.

*Zapasy bieżące* to część zapasów towarowych, która jest zużywana w toku normalnej sprzedaży; jest to zapas, który ma na celu zaspokoić zdeterminowany (z góry określony) popyt przy znanym czasie dostawy; ustala się go jako wielkość odpowiadającą przeciętnemu (prognozowanemu) popytowi na określony towar między dwoma kolejnymi dostawami.

*Zapasy w produkcji* są utrzymywane ze względu na czas niezbędny do wytworzenia produktów, oraz tzw. produktów w drodze. Ta kategoria zapasów jest określana czasem jako „produkcją w toku”, produktami przetwarzanymi lub półproduktami, jest ważna dla zaopatrzenia sfery wytwarzania. W stosunku do tej kategorii stosowane jest również określenie „zapasy w drodze”, które odnosi się do zapasów transportowanych przez przewoźnika do nabywcy, przy czym tytuł własności tych zapasów może posiadać dostawca lub odbiorca.

*Zapasy bezpieczeństwa* mają za zadanie kompensować wszelką niepewność związaną z popytem lub czasem dostawy. Z tego względu każde przedsiębiorstwo utrzymuje trochę większą ilość towarów, niż wynika ona z zapotrzebowania. Dzięki tym zapasom przedsiębiorstwa handlowe mogą zaspokoić popyt nawet wtedy, gdy jest on wyższy, niż planowano, lub gdy zamówiony towar zostanie dostarczony z opóźnieniem. Przy określaniu wielkości tego zapasu należy uwzględnić oczekiwany błąd obliczonej prognozy popytu na dany towar. Im niższy jest błąd prognozy popytu, tym niższy jest potrzebny zapas bezpieczeństwa. Ważna jest więc przy określaniu wielkości zapasu bezpieczeństwa metoda prognozowania, dzięki której możliwe jest jak najdokładniejsze określenie przyszłego popytu.

*Zapasy sezonowe* zabezpieczają przed okresowymi wahaniami konsumpcyjnymi. Gromadzone są zazwyczaj przed sezonem, w którym będą one potrzebne, na przykład zabawki, ozdoby świąteczne, odzież albo żywność.

*Zapasy promocyjne* gromadzone są wówczas, gdy przedsiębiorstwo planuje promocję marketingową lub ofertę cenową. Zapasy spekulacyjne mogą wystąpić w przypadku, gdy przedsiębiorstwo chce się zabezpieczyć na przykład przed planowanymi w kraju podwyżkami cen na dany towar czy nagłymi zmianami taryf.

*Zapasy martwe* nie przedstawiają żadnej wartości z punktu widzenia

normalnych celów gospodarczych. Mogą należeć do tej grupy zapasów towary przestarzałe, które wynikły z niedopasowania podaży do popytu, zmiany mody i stanowią obecnie zbędny towar w punkcie sprzedaży. Mogą być one likwidowane poprzez organizowanie wyprzedaży.

Z uwagi na kategorie ewidencyjne (ilość, wartość), a nie fizyczne, zapasy można podzielić na dwie części<sup>12</sup>:

- a) rotującą, obejmującą zapas związany z bieżącymi potrzebami (prognozowaną sprzedażą);
- b) nierotującą, obejmującą zapas bezpieczeństwa, ale również często zapas nadmierny, generujący koszty związane z jego utrzymaniem, który nie tworzy żadnej wartości w procesie sprzedaży.

Podstawowym zadaniem zapasów jest dostarczenie właściwego towaru klientom w odpowiednim czasie, czyli zgodnie z ich zapotrzebowaniem. Dlatego, zarządzając zapasami, należy zwrócić uwagę na elementy, które ułatwią ocenę efektywności stosowanej polityki zapasów w przedsiębiorstwie handlowym. Należą do nich<sup>13</sup>:

- realizowany poziom obsługi klientów, z którego wynikać będzie zadowolenie klientów. Wyrazem zadowolenia klientów może być na przykład ich lojalność;
- częstotliwość występowania dostaw opóźnionych lub przyspieszonych, co powoduje że towar nie znajduje się w odpowiednim czasie i miejscu zgodnie z potrzebami klienta. W takich przypadkach należy rozważyć możliwość zmiany dostawców lub usługodawców transportowych;
- obrotowość zapasów, zbyt wysoka może świadczyć o niedostępności towarów dla klientów w wyniku braku pewnych pozycji w zapasie;
- stosunek zapasów do sprzedaży, który mówi, czy wartość zapasu wzrasta, czy spada w miarę wzrostu sprzedaży. Jeżeli zapasy rosną w takim samym tempie lub wyższym do wzrostu sprzedaży, to jest to sygnał negatywny dla przedsiębiorstwa handlowego, które powinno zastanowić się nad prowadzoną polityką zapasów. Wzrost popytu na dane towary powoduje często wzrost gromadzonych przez przedsiębiorstwo zapasów. Nie zawsze jest to rozwiązanie słuszne, ponieważ należałoby zastanowić się nad możliwością częstszych i terminowych dostaw towarów cieszących się popytem poprzez

---

<sup>12</sup> S. Krzyżaniak, *Krótką powtórka z klasycznej teorii zapasów*, „Logistyka” 2003, nr 1, s. 7.

<sup>13</sup> J.J. Coyle, E.J. Bardi, C.J. Langley Jr., *Zarządzanie logistyczne*, PWE, Warszawa 2002, s. 235-237.



usprawnienie systemu zamawiania dostawy.

### 3. Istota zarządzania zapasami w przedsiębiorstwach

Zapasy są bardzo ważnym czynnikiem wykorzystywanym w prowadzeniu działalności w przedsiębiorstwach handlowych i produkcyjnych. W firmach usługowych pozycje „zapasy” praktycznie nie występują. Aby zapewnić ciągłość produkcji, sprzedaży, konieczne jest posiadanie zapasów. Problemem zarządzania zapasami jest ukształtowanie takiego ich poziomu, który zapewni ciągłość produkcji i sprzedaży przy minimalnych kosztach<sup>14</sup>. Błędy w ustalaniu tego poziomu prowadzą do utraty możliwości sprzedaży albo do podniesienia niezasadnionych kosztów utrzymania zapasów. Zarządzanie nimi jest niezmiernie ważne i zarazem bardzo skomplikowane dla kadr zarządzających jednostką. Jeżeli w przedsiębiorstwie są wysokie stany zapasów, wtedy ponosi ona wysokie koszty związane z ich utrzymaniem. Takie koszty są niepotrzebne i wpływają negatywnie na wyniki finansowe. W literaturze nazywane są kosztami utraconych możliwości. W sytuacji, gdy poziom zapasów jest bardzo wysoki, to firmy też ponoszą niepotrzebne koszty utrzymania nadmiaru zapasów. Jeżeli zawyżony poziom zapasów spowodowany jest chęcią uzyskania korzystnych cen, czyli jest związany z wielką skalą zamówień, jest to korzystne dla firmy. Znajduje to pozytywne przełożenie na koszty działalności przedsiębiorstwa. Odpadają bowiem pojedyncze zamówienia i ich logistyka, co powoduje obniżenie kosztów i co najważniejsze cena zakupionych towarów jest niska.

Wysokie stany zapasów mają korzystne i niekorzystne przełożenie na funkcjonowanie przedsiębiorstwa. Zarządzający muszą zbilansować je i podjąć odpowiednie decyzje, czy kierunek obranej polityki zarządzania zapasami jest słuszny. Jeżeli jednak koszty związane z utrzymaniem wysokich stanów zapasów są niższe od kosztów, które należałoby ponieść, np. logistyki zamówień w celu uzupełnienia magazynu do stanu obecnego, to warto tę strategię realizować. Kolejny pozytywny czynnik przemawiający za utrzymywaniem wysokiego poziomu zapasów to ich pozytywny wpływ na ograniczenie ryzyka utraty płynności. Bezpieczeństwo funkcjonowania i wysoka gotowość dostaw w danej jednostce jest ważnym determinantem w grze konkurencyjnej na rynku.

---

<sup>14</sup> J. Czekaj, Z. Dresler, *Zarządzanie finansami przedsiębiorstw. Podstawy teorii*, Wydawnictwo Naukowe PWN, Warszawa 2005, s. 58.

W sytuacji, gdy wystąpią niedobory zapasów, to pojawiają się koszty w związku z zatrzymaniem sprzedaży, z utratą kontrahentów, tzw. koszty utraconych możliwości. Rozwiązaniem tych problemów jest optymalizacja zarządzania zapasami. Jednak, aby do tego doszło, należy przeprowadzić analizę poniesionych kosztów związanych z utrzymaniem zapasów.

Zarządzanie zapasami w przedsiębiorstwie jest kwestią bardzo istotną. Podczas tego procesu przedsiębiorstwa skupiają się na czterech podstawowych kwestiach:

- Kiedy należy złożyć zamówienie?
- Ile należy zamówić?
- Czy istnieje możliwość obniżenia kosztów związanych zarządzaniem zapasami?
- Którym składnikom trzeba poświęcić szczególną uwagę?

Odpowiedzi na te pytania wyznaczają kierunek zarządzania zapasami.

#### **4. Strategie i metody zarządzania zapasami w przedsiębiorstwach**

Współczesne przedsiębiorstwa mogą stawiać sobie różne cele, do których osiągnięcia ma się przyczyniać stosowanie odpowiedniej strategii zarządzania zapasami. Realizowanie danej strategii oznacza, że przedsiębiorstwo podejmuje przemyślane działania. Wyróżnia się trzy podstawowe strategie zarządzania zapasami<sup>15</sup>:

- defensywną,
- ofensywną,
- umiarkowaną.

Strategia defensywna, inaczej konserwatywna, jest uznawana za bezpieczną. Jej główne założenie to zachowanie bezpieczeństwa. Firmy, które stosują ten typ zarządzania, posiadają wysokie stany zapasów, czyli zapas bezpieczeństwa jest w nich wysoki. Wysoki poziom zapasów to również wysokie koszty zarządzania nimi. Przedsiębiorstwo będzie ponosić bardzo wysokie koszty utrzymania zapasów, tj. magazynowania, wynagrodzenia pracowników magazynu. Przy tym sposobie zarządzania zapasami na pewno pojawią się koszty starzenia zapasów, złogi magazynowe. Teoretycznie przedsiębiorstwom nie grozi sytuacja, kiedy brakuje towarów i sprzedaż zostanie zatrzymana. Jest to ważne dla przedsiębiorstwa z punktu widzenia sprzedaży. Istnieje niewielkie

---

<sup>15</sup> N. Kumar, *Strategie walki z rywalami, których orężem są niskie koszty*, Harvard Business Review Polska, 2007.

prawdopodobieństwo, że firma może stracić kontrahentów z powodu braku zapasów. Zatem ten sposób zarządzania zapasami nie będzie w żaden sposób ograniczał przychodów ze sprzedaży. Ten typ zarządzania zapasami powinien prowadzić do wysokiej płynności finansowej.

Strategia ofensywna inaczej agresywna polega na minimalizacji poziomu zapasów. Firmy starają się optymalizować poziom zapasów do takiego, który będzie ograniczał poziom zapasów do minimum. Jednostki, które wybrały strategię agresywną w zarządzaniu zapasami ponoszą niskie koszty tworzenia i utrzymania zapasów. Działają według metody Just in time (dokładnie na czas). Koszty utrzymania zapasów są niskie. Przedsiębiorstwo posiada niewielkie stany zapasów, może ograniczyć zatrudnienie, koszty angażowania kapitału też są niewielkie. Ten sposób zarządzania zapobiega występowaniu złogów magazynowych i eliminuje proces starzenia się zapasów. Agresywne zarządzanie zapasami może doprowadzić do sytuacji wystąpienia braków magazynowych. Pojawiają się wtedy koszty wyczerpania zapasów, koszty utraconych korzyści. Jeżeli taka sytuacja się powtarza, może dojść do tego, co najgorsze dla przedsiębiorstwa, do utraty nowych i stałych kontrahentów. Jest to najwyższy koszt, jaki jednostka ponosi, jeżeli będzie chciała odzyskać klienta, będzie musiała ponieść dodatkowo ogromne koszty. Utrata kontrahentów to spadek przychodów. Ten typ zarządzania jest ryzykowny, gdyż firmy posiadają niskie stany zapasów, które muszą zapewnić im ciągłość produkcji i sprzedaży.

Z kolei strategia umiarkowana jest strategią pośrednią pomiędzy strategiami agresywną i konserwatywną. Ten typ zarządzania zapasami minimalizuje słabe strony wcześniej opisanych strategii oraz wykorzystuje to, co najlepsze w strategiach agresywnych i konserwatywnych tj. maksymalizować ich zalety.

Jako dodatkową strategię zarządzania zapasami można przedstawić strategię zarządzania zapasami w grupie marketingowo-zakupowej. Strategię tę można określić jako konserwatywno-umiarkowaną. Firmy, tworzące grupą zakupową, tworzą odrębną jednostkę centralną, której głównym zadaniem jest realizacja celów wytyczonych przez przedsiębiorstwa działające w danym systemie. Strategie zarządzania zapasami w firmach funkcjonujących w grupach zakupowych w pewnym stopniu oparta jest na wytycznych otrzymywanych od jednostki centralnej, która zarządza grupą zakupową. Firmy starają się utrzymywać zapasy na wysokim, ale optymalnym poziomie. Zamawiają więcej niż potrzeba, ale do wysokości, która gwarantuje im uzyskanie wysokiego rabatu, na tym ta optymalizacja polega. Minimalne limity gwarantujące

atrakcyjne ceny ustala jednostka centralna. Firmy, stosując tego typu metodę, bardzo często korzystają z metody opartej na zasadach ekonomicznej wielkości – EOQ (Economic Order Quantity). Jest to model pozwalający ustalić optymalny poziom zamówienia dla firmy. Jego wadą jest to, że przechowuje się więcej zapasów niż potrzeba na dany dzień, z wyjątkiem ostatniego dnia cyklu. Szczegóły przedstawia Tabela 5.1.

*Tabela 5.1*

**Ocena wpływu strategii zarządzania zapasami na koszty i przychody**

<b>Strategia/koszty i przychody</b>	<b>Koszty tworzenia</b>	<b>Koszty utrzymania</b>	<b>Koszty wyczerpania</b>	<b>Przychody</b>
<b>konserwatywna</b>	wysoki poziom	wysoki poziom	niski poziom lub brak	brak wpływu
<b>agresywna</b>	niski poziom	niski poziom	wysoki poziom	zmniejsza
<b>umiarkowana</b>	średni poziom	średni poziom	średni poziom	brak wpływu/ zmniejsza
<b>w grupach marketingowo-zakupowych</b>	niski poziom	średni poziom	niski poziom lub brak	zwiększa

*Źródło: opracowanie własne.*

Strategia stosowana w grupach marketingowo-zakupowych to przede wszystkim zastosowanie podziału asortymentu choćby według klasyfikacji ABC. Jest ona oparta na prawie Pareta, które mówi, że ok. 20% badanych elementów wpływa w 80% na wyniki tego zagadnienia. Jej istotą jest przyporządkowanie zapasów do trzech grup (A, B i C) mających sprecyzowane udziały – zazwyczaj 80/15/5% – wedle przyjętego kryterium. Kryteria takie mogą być różne, jednakże w stosunku do zarządzania zapasami za kryterium analizy ABC uznaje się zazwyczaj wartość sprzedaży (obrotu). Szczegóły przedstawia Tabela 5.2<sup>16</sup>.

W analizie ABC istotne jest, aby – przy priorytetowym traktowaniu asortymentów zaklasyfikowanych do grupy A – „nie tracić z pola widzenia” asortymentów grup B i C (rys. 5.1). W przeciwnym przypadku może bowiem dojść do niepożądanych sytuacji, kiedy „zlekceważone” asortymenty B i C będą trudno dostępne w wymaganych ilościach. Innymi słowy: wszystkie grupy A, B i C są na swój sposób ważne i w odniesieniu do nich należy stosować odpowiednią strategię ich pozyskiwania i utrzymywania w formie zapasów.

<sup>16</sup> S. Abt, *Zarządzanie logistyczne w przedsiębiorstwie*, PWE, Warszawa 1998, s. 58.

Tabela 5.2

**Relacje procentowe: wartości – liczebności według klasyfikacji ABC**

Grupa według klasyfikacji ABC	Procentowy udział łącznej wartości obrotu danej grupy w obrocie całkowitym	Procentowy udział liczebności danej grupy w odniesieniu do liczebności wszystkich rozpatrywanych pozycji
A	80%	20%
B	15%	50%
C	5%	30%

*Źródło: opracowanie własne.*

Strategia zarządzania zapasami według metody ABC polega na tym, że asortymenty grupy A są dostępne natychmiast lub w ekspresowym tempie, natomiast asortymenty grup B i C są dostępne wtedy, kiedy pojawia się zapotrzebowanie. W metodzie ABC zaleca się utrzymywanie ostrej dyscypliny zamawiania w odniesieniu do grupy towarów A. Dla pozostałych grup towarowych – zwłaszcza dla grupy C – można stosować mniej rygorystyczne zasady zarządzania zapasami.

Metoda ABC może być wykorzystana jako narzędzie klasyfikacji zapasów na odpowiednie grupy. Służy do tworzenia klasyfikacji danych grup zapasów i pozwala nimi odpowiednio zarządzać. Zastosowanie analizy ABC poprawia efektywność zarządzania magazynem<sup>17</sup>.

Asortyment A jest najważniejszy (strategiczny) dla jednostki, kupowany jest w ramach zakupów grupowych w celu uzyskania efektu skali. Dla grupy A przedsiębiorstwa stosują strategie konserwatywne zarządzania zapasami. Zakupy są często większe od optymalnej wielkości zamówienia. Przedsiębiorstwo ponosi wysokie koszty utrzymania, ale niska cena niweluje poniesione koszty. Zamawianiem, organizacją zakupów i dostaw zajmuje się jednostka centralna. Koszty tworzenia zapasów w przedsiębiorstwach działających w grupach zakupowych są więc minimalne, ponieważ za organizację dostawy odpowiada jednostka centralna<sup>18</sup>. Dla asortymentu B i C firmy stosują dowolne metody i strategie.

<sup>17</sup> G. Richards, *Warehouse Managament, Kogan Paged Limited, Hongkong 2011.*

<sup>18</sup> G.. Zimon *Metody zarządzania zapasami a koszty w przedsiębiorstwie działającym w ramach grupy zakupowej*, [w:] J. Chluska, S. Kowalska (red.), *Zarządzanie kosztami przedsiębiorstwa w warunkach ryzyka. Aspekty praktyczne*, WWZPCz, Częstochowa 2014.

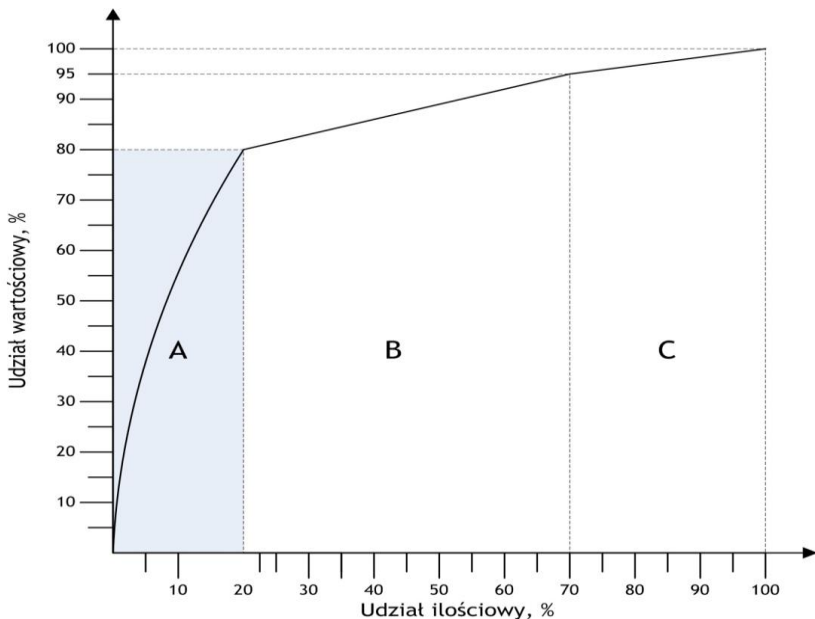

**Rysunek 5.1 Wizualizacja wyników analizy ABC z pomocą krzywej Lorenca**

*Źródło: opracowanie własne na podstawie: J.J. Coyle, E.J. Bardi, C.J. Langley. Jr., Zarządzanie logistyczne, PWE, Warszawa 2010., S. Abt, Systemy logistyczne w gospodarowaniu. Teoria i praktyka logistyki, Wyd. Akademii Ekonomicznej w Poznaniu, Poznań 1996.*

Przedsiębiorstwa działające w grupach zakupowych dla strategicznych towarów uzyskują niskie ceny. Zamawiają ich duże ilości, więc ponoszą wysokie koszty ich utrzymania. Posiadają zapasy bezpieczeństwa, nie grozi im ryzyko utraty kontrahentów. W grupach zakupowych w razie potrzeby sieć dostaw i wzajemna współpraca pozwala eliminować braki w magazynach po najniższych kosztach. Towary są przesyłane z jednej firmy do drugiej. Dodatkowo można też korzystać z „magazynu centralnego” jednostki centralnej<sup>19</sup>.

Efekt skali poprzez organizację wspólnych zakupów pozwala uzyskać niską cenę. Atrakcyjna cena to broń w walce o odbiorców. Ten

<sup>19</sup> G. Zimon, Strategie zarządzania kapitałem obrotowym a płynność finansowa przedsiębiorstw. Prace Naukowe Uniwersytetu Ekonomicznego we Wrocławiu nr 344, Wydawnictwo Uniwersytetu Ekonomicznego we Wrocławiu, Wrocław 2014.

sposób zarządzania zapasami może prowadzić do pozyskiwania nowych odbiorców, utrzymuje dotychczasowych, więc przychody ze sprzedaży mogą wzrastać.

Bardzo dobrym rozwiązaniem dla jednostek funkcjonujących w grupach marketingowo-zakupowych i firm stosujących metody konserwatywne i umiarkowane byłoby zastosowanie dodatkowej metody klasyfikacji zapasów XYZ.

Analiza XYZ jest odmianą analizy ABC, budowana jest na podstawie zużycia asortymentu<sup>20</sup>. Zapasy zużywane są z różną intensywnością. Grupa X zawiera produkty, które charakteryzują się znaczną regularnością zużycia. Przedsiębiorstwo jest w stanie przewidzieć z dużym prawdopodobieństwem ich zużycie (popyt na te towary) w danym okresie. Grupa Y to zapasy, na które w mniejszym stopniu można przewidzieć zużycie, popyt. Charakteryzują się one sezonowością, określonym trendem. Grupa Z to zapasy o nieregularnym zużyciu. Bardzo trudno jest przewidzieć zapotrzebowanie na tego typu asortyment.

Połączenie analizy XYZ oraz ABC jest analizą składającą się z dwóch kryteriów. Pozwala ona na podział całego asortymentu znajdującego się w przedsiębiorstwie na 9 grup, względem których można podejmować odpowiednie działania związane z utrzymaniem oraz zarządzaniem zapasami. Szczegóły przedstawia Tabela 5.3.

Metoda określana mianem Just in time (JiT) stanowi rozwinięcie metody Kanban<sup>21</sup> (opracowanej w firmie Toyota Motor Company) i jednym z jej głównych celów jest ograniczenie wielkości zapasów do niezbędnego minimum. Założenia tej metody obejmują krótkie cykle realizacji zamówień, małych, ale częste dostawy realizowanych dokładnie na czas, wysoka jakość towarów.

Idea Just in time bywa porównywana do systemu „dwóch pojemników”, w którym pojemnik nr 1 jest wykorzystywany dla dostawy materiałów w celu pokrycia bieżącego zapotrzebowania. Kiedy pojemnik nr 1 zostanie opróżniony, wysyłany jest sygnał o konieczności uzupełnienia towaru (np. części do montażu) – i pojemnik nr 1 jest kierowany do dostawcy w celu pobrania kolejnej partii towaru. W tym samym czasie towar jest dostarczany do systemu (np. produkcji) z pojemnika nr 2.

---

<sup>20</sup> Cz. Skowronek, Z. Sarjusz-Wolski, *Logistyka w przedsiębiorstwie*, PWE, Warszawa 2008, s. 151.

<sup>21</sup> Cz. Skowronek, Z. Sarjusz-Wolski, *Logistyka...*, op. cit., s. 155.

Tabela 5.3

**Podział metod zarządzania zapasami z wykorzystaniem klasyfikacji ABC i XYZ**

<b>Strategia ABC/XYZ</b>	<b>A</b>	<b>B</b>	<b>C</b>
X	Metody Just in time	Metody Just in time	EOQ ( <i>Economic order quantity</i> )
Y	Metody konserwatywne	EOQ ( <i>Economic order quantity</i> )	Metody typu <i>Two basket, red line</i>
Z	Metody konserwatywne	EOQ ( <i>Economic order quantity</i> )	Metody typu <i>Two basket, red line</i>

*Źródło: opracowanie własne.*

Filozofia Just in time jest stosowana na przykład przez elektrownie lub wodociągi, które dostarczają swoje „produkty” właśnie dokładnie „na czas”, nie tworząc zapasów. Wadą tej metody jest jej wrażliwość na zakłócenia, które mogą wystąpić się w systemie zaopatrzenia – na przykład z powodu kłęsk żywiołowych, strajków u dostawców lub przewoźników, wprowadzenia embarga na dostawy itp.

W aspekcie sprawnego przepływu strumieni materiałów w systemach logistycznych byłoby najkorzystniej – w miarę możliwości – kierować się zasadą JiT, ograniczającą wielkość zapasów magazynowych. Jednak praktyka wykazuje, że strategia ograniczania zapasów może nierzadko prowadzić do tzw. kosztów utraconych korzyści. Zbyt niski poziom zapasów – w przypadku losowych zakłóceń w dostawach – może powodować utratę ciągłości procesów produkcyjnych lub sprzedaży towarów. Oznacza to dodatkowe koszty związane z przestojami produkcyjnymi lub utratę klientów, których odzyskanie może być trudne.

Z kolei metoda ekonomicznej wielkości zamówienia<sup>22</sup> (*Economic Order Quantity – EOQ*) polega na poszukiwaniu kompromisu między kosztami utrzymywania zapasów i kosztami składania zamówień. Podstawowe założenia prostego modelu EOQ uzupełniania zapasów są następujące:

- ciągła, stała i znana wielkość popytu,
- stały i znany cykl uzupełnienia zapasów (czas dostawy),
- pełne zaspokojenie popytu,
- stałe koszty zakupu i transportu, niezależne od wielkości zamówienia i czasu,

<sup>22</sup> Coyle J.J., Bardi E.J., Langley C.J. Jr., *Zarządzanie logistyczne*, PWE, Warszawa 2010, s. 69.



- brak zapasów w drodze,
  - zapas jest jednorodny (jeden asortyment),
  - nieskończony horyzont planistyczny,
  - nieograniczona wielkość dostępnych środków finansowych (kapitału).
- Ekonomiczną wielkość zamówienia wyznacza punkt, w którym łączne koszty składania zamówień i utrzymania zapasów są najniższe. Wartość liczbową ekonomicznie uzasadnionej wielkości zamówienia oblicza się ze wzoru<sup>23</sup>:

$$Q = \sqrt{\frac{2RA}{VW}}$$

gdzie:

R – popyt roczny na dany asortyment,

A – koszt zamawiania jednostki asortymentu towarowego,

V – wartość jednostki zapasu,

W – procentowy udział kosztów zapasów danego asortymentu w ogólnych kosztach zapasów.

Ekonomiczna wielkość zamówienia, obliczona na podstawie powyższego wzoru, może wymagać skorygowania z powodów np. zmian kosztów transportu lub upustów cenowych. Na ogół jednostkowe ceny transportu zależą od masy lub wielkości (gabarytów) przewożonego ładunku. Przy transporcie małych ładunków cena przewozu jednostki masy (np. 1 tony) jest na ogół wyższa, niż w przypadku dużych ładunków. Ponadto, przy większych zamówieniach dostawcy stosują zwykle większe upusty cenowe. Wpływa to na zmianę założeń wyjściowych prostego modelu EOQ i powinno być uwzględniane przy obliczaniu ekonomicznej wielkości zamówienia.

Podział asortymentu na 9 grup jest jednym ze sposobów na redukcję kosztów zarządzania zapasami w przypadku, gdy przedsiębiorstwa stosują strategię konserwatywną, działają w grupach zakupowych lub gdy stosują metody umiarkowane oparte w dużym stopniu na defensywnym zarządzaniu zapasami.

## 5. Podsumowanie

Zapasy są niewątpliwie pojęciem ściśle związanym z kosztami ponoszonymi przez przedsiębiorstwa. Nie jest jednak możliwe ich całkowite wyeliminowanie w każdej firmie czy branży. Optymalizacja

---

<sup>23</sup> *Ibidem*, s. 70.

procesu zarządzania nimi jest jednak konieczna.

Wybór odpowiedniej strategii zarządzania zapasami ma duży wpływ na proces zarządzania kosztami. Pewne strategie mają na celu zabezpieczać przedsiębiorstwo przed ryzykiem utraty płynności finansowej. Inne mają prowadzić do obniżenia kosztów. Wybór strategii zarządzania zapasami będzie można też powiązać z przychodami, jakie firmy uzyskują. Pewne strategie mogą zabezpieczać przedsiębiorstwo przed ryzykiem związanym z utratą stałych kontrahentów, niektóre z kolei są bardzo ryzykowne i mogą doprowadzić do ich utraty.

Przeprowadzona analiza wskazuje, że najlepszą metodą zarządzania zapasami jest działanie w grupach zakupowych. Przedsiębiorstwa, które działają w grupach zakupowych, mogą uzyskiwać wysoki wynik finansowy, ponieważ koszty zarządzania zapasami są na niskim poziomie i ten sposób zarządzania może zwiększać przychody. Strategia konserwatywna jest kosztowna, ale nie ma ona negatywnego wpływu na przychody ze sprzedaży. Wynik finansowy zależy od kosztów zarządzania zapasami, które w tej strategii są wysokie. Strategie umiarkowane trudno określić. Ogólnie powinny charakteryzować się niskim poziomem kosztów. Jednak od zarządzających zależy, w którym kierunku tego typu strategii zarządzania zapasami będą prowadzić: czy w kierunku agresywnym, czy konserwatywnym. Jeżeli wybiorą kierunek agresywny, może to negatywnie wpływać na poziom przychodów ze sprzedaży, jeżeli konserwatywny, to poziom sprzedaży się nie zmieni. Strategię agresywną należy określić jako ryzykowną. Koszty niskie, ale ostatnia grupa kosztów wyczerpania bardzo wysoka. Ta kategoria kosztów jest ściśle związana z przychodami. Jeżeli się pojawia, to przychody ze sprzedaży będą spadać. Przedsiębiorstwa, które stawiają sobie za główny cel obniżyć koszty zarządzania zapasami poprzez ciągłe obniżanie poziomu zapasów i działanie na zasadzie JiT, mogą być konkurencyjne.

Reasumując, stwierdzić należy, że zastosowanie metod wspomagających kontroli zarządzania zapasami, które pozwolą dokonać klasyfikacji zapasów na różne grupy, następnie zastosowanie metod prowadzących do optymalizacji poziomu dla każdej z grup jest najlepszym rozwiązaniem stosowanym w procesie zarządzania zapasami. W krótkim okresie jest to kosztowne, jednak z biegiem czasu pozwala przedsiębiorstwom zyskać przewagę nad konkurencją, zwiększać sprzedaż i poprawiać wyniki finansowe.

## **Literatura:**

1. *Abt S., Zarządzanie logistyczne w przedsiębiorstwie, PWE, Warszawa 1998.*
2. *Abt S., Systemy logistyczne w gospodarowaniu. Teoria i praktyka logistyki, Wyd. Akademii Ekonomicznej w Poznaniu, Poznań 1996.*
3. *Czekaj J., Dresler Z., Zarządzanie finansami przedsiębiorstw. Podstawy teorii, Wydawnictwo Naukowe PWN, Warszawa 2005.*
4. *Coyle J.J., Bardi E.J., Langley C.J. Jr., Zarządzanie logistyczne, PWE, Warszawa 2002.*
5. *Coyle J.J., Bardi E.J., Langley C.J. Jr., Zarządzanie logistyczne, PWE, Warszawa 2010.*
6. *Chłodnicka H., Zimon (red.) G., Predykcja upadłości w obecnych warunkach gospodarowania, Steiner, Rzeszów 2014.*
7. *Christopher M., Logistic & Supply Chain Management, Fourth Edition, FT Prentice Hall. 2011.*
8. *Kempny D., Zapasy w systemie logistycznym firmy, „Gospodarka Materiałowa i Logistyka” 1996, nr 6.*
9. *Krzyżaniak S., Krótka powtórka z klasycznej teorii zapasów, „Logistyka” 2003, nr 1.*
10. *Kumar N., Strategie walki z rywalami, których orężem są niskie koszty, Harvard Business Review Polska, 2007.*
11. *Richards G., Warehouse Managamnet, Kogan Paged Limited, Hongkong 2011.*
12. *Skowronek Cz., Sarjusz-Wolski Z., Logistyka w przedsiębiorstwie, PWE, Warszawa 2008.*
13. *Sławińska M., Zarządzanie przedsiębiorstwem handlowym, PWE, Warszawa 2002.*
14. *Zimon G., Metody zarządzania zapasami a koszty w przedsiębiorstwie działającym w ramach grupy zakupowej, [w:] J. Chluska, S. Kowalska (red.), Zarządzanie kosztami przedsiębiorstwa w warunkach ryzyka. Aspekty praktyczne, WWZPCz, Częstochowa 2014.*
15. *Zimon G., Strategie zarządzania kapitałem obrotowym a płynność finansowa przedsiębiorstw. Prace Naukowe Uniwersytetu Ekonomicznego we Wrocławiu nr 344, Wydawnictwo Uniwersytetu Ekonomicznego we Wrocławiu, Wrocław 2014.*
16. *Бритченко І.Г. Стратегічне управління конкурентоспроможністю: епістолологічні підходи та практична проблематика / Мікловда В.П., Бритченко І.Г., Кубиній Н.Ю., Колодинський С.Б., Ціцак Л.М. – Полтава : ПУЕТ, 2013. – 307 с.*

**Dudko Pavlo**

*PhD in Economics, Associate  
Professor, Department of  
Entrepreneurship and  
Business  
Kyiv National University of  
Technologies and Design  
(Kyiv, Ukraine)*

**THE WAYS OF  
IMPLEMENTATION OF  
STRATEGIC MODEL OF  
HIGHER EDUCATIONAL  
INSTITUTION  
MANAGEMENT ON THE  
BASIS OF COMPETITIVE  
ADVANTAGES**

**Introduction.** Higher education institution is a special institution, the main statutory task of which is the organization of professional training (basic training, retraining, advanced training, etc.) of high qualification specialists. Higher educational institution carries out educational activities, namely providing educational services to consumers through various sources of financing [1].

A modern higher education institution is a complex production system that produces specific goods (goods and services, mainly educational) and unites people of different specialties and qualifications. Higher educational institution, figuratively speaking, is a “highly diversified production”, which provides education, retraining, advanced training, managerial counseling, scientific services, publishes textbooks, scientific publications, methodical materials, prepares scientific personnel of the highest qualification, conducts scientific and expert research, often organizes nutrition and residence of students, as well as produces “adjacent benefits” (renting space, holding mass events, etc.).

The main tasks of a higher educational institution are [2]:

- 1) the provision of level of educational activities, which ensure the receipt of higher education qualifications by their respective specialties;
- 2) carrying out the scientific activities through conducting scientific research and providing the creative activity of participants in the educational process for universities, academies and institutes, training of scientific personnel of higher qualification and using the obtained results in the educational process;
- 3) the participation in ensuring the social and economic development of the state through the formation of human capital;
- 4) the formation of personality through patriotic, legal, environmental education, the approval of participants in the educational

process of moral values, social activity, civic attitude and responsibility, a healthy lifestyle, the ability to think freely and to self-organize in modern conditions;

5) the provision of organic combination in educational process of educational, scientific and innovative activity;

6) the creation of necessary conditions for the implementation of their abilities and talents by participants in the educational process;

7) the preservation and enhancing of moral, cultural, scientific values and achievements of society;

8) the dissemination of knowledge among the population, raising the educational and cultural level of citizens;

9) the establishment of international relations and conducting international activities in the field of education, science, sports, art and culture;

10) the studying of demand for individual specialties in the labor market.

As a result of educational activities ,carried out by an educational institution, educational products are produced. In the scientific literature, the mention of “educational product” is different among scholars and economists, since they are multidimensional and multivectoral. As the study of phenomenon of educational services testifies to date that the conceptual apparatus of this sphere of economy has not yet been formed [3].

L. Pan considering the higher educational institution as an open, complex and dynamic system, conducted a comprehensive theoretical and methodological research and concluded that the model of strategic management of a higher educational institution in the present conditions should have the following properties [4]:

1) integration (professional level of the teaching staff, its motivation, organizational culture, level of development of the latest educational technologies, understanding of the mission and strategy of the institution, etc.);

2) differentiation (different structural units of a higher educational establishment must perform only their inherent functions);

3) centralization (the domination of one part of the system – social, economic, scientific and innovative or other);

4) informativeness and necessity to take into account the reverse link (the input stream of information either perceived and used or not perceived);

5) dynamism and adaptability (higher education institution as an

open system must be continuously developed);

6) availability of marginal possibilities (according to available resources)

7) uniqueness (education, teaching methods, proposed training directions, levels of education, etc.);

8) ability to change structure, mobility;

9) purposefulness.

Among the modern models of strategic management of a higher educational institution we can distinguish the following:

- the model of the balance of the organization's life cycle;
- the model of the balance of the product life cycle (services);
- models of management modernization on the basis of market research;

- the model of monopolization of the production of a particular service;

- the model of analysis of selected cases;

- the consumer-shopping and sales outlet audit model;

- model of "imposition of needs".

On the basis of these models and methodological approaches the strategy of development of the higher educational institution, which forms the basis of its strategic management, is projected.

Competitive position of a higher educational institution can be considered as a system (complex) characteristic of such an institution, which allows identifying and assessing its relative advantages over other competitive institutions in accordance with objective criteria, including the availability and effectiveness of the use of certain strategic resources. At the same time, in modern conditions, the competitive position of a higher educational institution is largely determined by the effectiveness of its strategic management system, which should provide a flexible and adequate response to changes in the environment, as the experts rightly point out [5]. This is partly explained by the fact that the consumer, at the time of signing the contract, proceeds from today's conditions, but the higher educational institution must ensure compliance with the contract for the next long period.

The key characteristic that affects the competitive position of a higher education institution is the quality of educational services that this institution produces (commercializes). The quality of educational services is defined as a set of consumer characteristics of educational services, which provide the opportunity to meet a set of needs for the comprehensive development of personality [6; 3]. At the same time,

state standards, social expectations, employers' requests are affected by perceptions of the quality of educational services.

An important role in the strategic management of universities plays its competitive advantage.

Competitive advantage is the property, ability, characteristic of a market agent (an economic organization) that makes it possible to produce goods (goods, services) of higher competitiveness (higher quality and / or lower price) compared to the goods produced by competitors [7].

The source of competitive advantages of a higher educational institution is the concrete measures being implemented (implemented) at the institution and lead to an improvement of its positioning in the market of educational services and increase of its positive perception by consumers (customers) of educational services.

Competitive advantages of a higher educational institution in the educational services market are formed as a result of purposeful work within the framework of the implementation of the approved strategy for its development, which serves as the main element of effective strategic management. There exist as fundamental (predefined) so variable (those that can be developed) advantages. The fundamental advantages include the location of the institution, its history and prestige, etc.). The management of a higher education institution should clearly understand the factors that lead to changes in the current competitive position of the institution. The main factors include: increasing the number of educational institutions in the field of vocational education; integration processes (cooperation of leading higher educational establishments with scientific institutions, large enterprises, foreign institutions, etc.); changing the dynamics and structure of demand for educational services, including the growth of demand for higher quality educational services; increase in price competition; reduction of effective demand, first of all due to the fall in purchasing power of the population; increase in the relative share of transaction costs; unfriendly manifestations of competition for the best cadres; discrimination by the state (application of different approaches to state support). The indicated factors in the process of strategic management should undergo a proper analysis.

A key element of the strategic management model of a higher education institution is its autonomy. The autonomy of a higher educational establishment is considered as a tool for its autonomy, responsibility and high quality of activity at the same time. The academic, economic, organizational autonomy of a higher educational

establishment are allocated. The autonomy of a higher educational institution is an instrument that supports the solution of the problems facing the institution as a producer of educational and related services.

Another element of strategic management of a higher education institution is the quality management of education or the quality of educational services. In world practice, different approaches to the assessment of the quality of work of a higher educational institution are used. The most widespread are reputational, productive and general approaches. In the United States, the United Kingdom, Germany, Austria, Australia and some other countries have been adopted the standards of quality of education which determine the relevant imperative and optional characteristics of the learning process, as well as its results.

Today, successful institutions of higher education, when implementing the concept of strategic development, introduce information and communication technologies to management mechanisms. The potential of supporting the strategic development of a higher educational institution through the use of information and communication technologies is significant, due to the need of studying and mastering more informative (more complex) information.

The main financial instruments of higher education institutions are distinguished: budget financing (covering capital and current expenditures, program-targeted method, using state liabilities); educational loans; state, corporate and private savings on education; grants; payment of educational services by the customer; corporate finance. A key condition for maintaining high competitiveness of the system of higher education is its availability with an adequate amount of financial resources, which is primarily supported by budget funds.

We will present the main competitive advantages that can be used by higher education institutions as a source of strengthening the market position in the market of educational services. All competitive advantages, according to the methodological recommendations, will be divided into several groups: the advantages of product quality (services); price advantages; service and warranty benefits; convenience and availability of consumption; reputational (brand).

*Competitive advantages, which affect the quality of educational product (educational services):*

- adequate level of personnel, financial, methodological, material-technical and scientific support of the educational process (observance of all standards);



- high level of teaching staff, presence of successful scholars and experienced practitioners, creative, initiative people, as well as specialists engaged in real (and not viable) innovation work;
- high efficiency of scientific activity, introduction of mechanisms for the implementation of scientific activity in the educational process;
- creation and support of the atmosphere of creativity in the teaching and student groups, healthy competition, "team spirit", positive perception of innovative changes;
- strict observance of the requirements of the legislation on education by all participants in the educational process;
- application of modern information and communication technologies of knowledge transfer in the educational process, as well as the use of advanced teaching methods;
- creation of technologies for monitoring the student's progress on the part of external users (potential employer, parents);
- support of cooperation with social partners and potential employers, including issues related to the development of the content of education, the mastering of the latest knowledge and the subsequent employment of graduates.

*Among the possible price competitive advantages of an educational product (educational service) we can distinguish the following:*

- lower than the prices of similar educational services;
- application of flexible mechanisms for educational services payment, including the use of installments and deferrals;
- grants (including partial waiving) for the most successful students who demonstrate outstanding results in learning and community activities;
- participation in promising programs of educational lending (use of educational credits);
- use of discounts for payment of educational services in their complex order.

*Brand and its relevance.*

The practice of higher education institutions shows that the main sources of economic power today are the right positioning and strong brand.

Brand is a reputation of the university. And branding is a long-term trust in the university, its educational and scientific services [8].

That is the presence of a higher educational institution in the leading rankings of the universities; successful and timely passing of the

monitoring and licensing (licensing, accreditation, attestation) procedures by the higher educational institution; high level of employment of graduates, first of all for the profession; positive feedback from employers on the qualifications of graduates; support of higher educational institutions of public, public, artistic, creative initiatives with a callous (creative) content; presence of positive materials about the activity of a higher educational institution in mass media.

*Scientific recognition.*

Scientific activity and scientific recognition – in higher educational institutions, by the conditions of the transition of Ukraine to the new stage of formation of an innovative society, the construction of an economy based on the generation, distribution and use of knowledge lies in the strategic task – to form local elements of innovation in the form of development of new products and technologies, creation of new business incubators, technological parks, etc., to increase their efficiency, to integrate the innovative component in all kinds of activities educational, scientific, experimental, periodically productive.

*Diversification of the portfolio of educational services.*

Diversity and versatile development of educational services. In this case, the growth of the complexity of the internal infrastructure of the educational services system is expected due to: the emergence of new types and types of educational services; penetration of some forms of educational services into others; association of different types, types and forms of educational services previously unrelated; the expansion of the fields of activity and the diversity of educational services.

On the basis of these generalizations, we will form a model of market-oriented strategic development of higher educational institutions based on the management of competitive advantages (Figure 5.2).

Conditional design of a model of market-oriented strategic development of higher educational institutions on the basis of management of competitive advantages:

- HEI – higher education institution;
- EA – educational activity;
- SIA – scientific and innovation activity;
- FEA – financial and economic activity;
- MCA – marketing and communication activity.

The applied development of strategic guidelines for the development of a higher educational institution based on the use of competitive advantages will be performed on the basis of Kyiv National University

of Technology and Design. The choice of a given higher education institution as an object of development is due to a number of reasons:

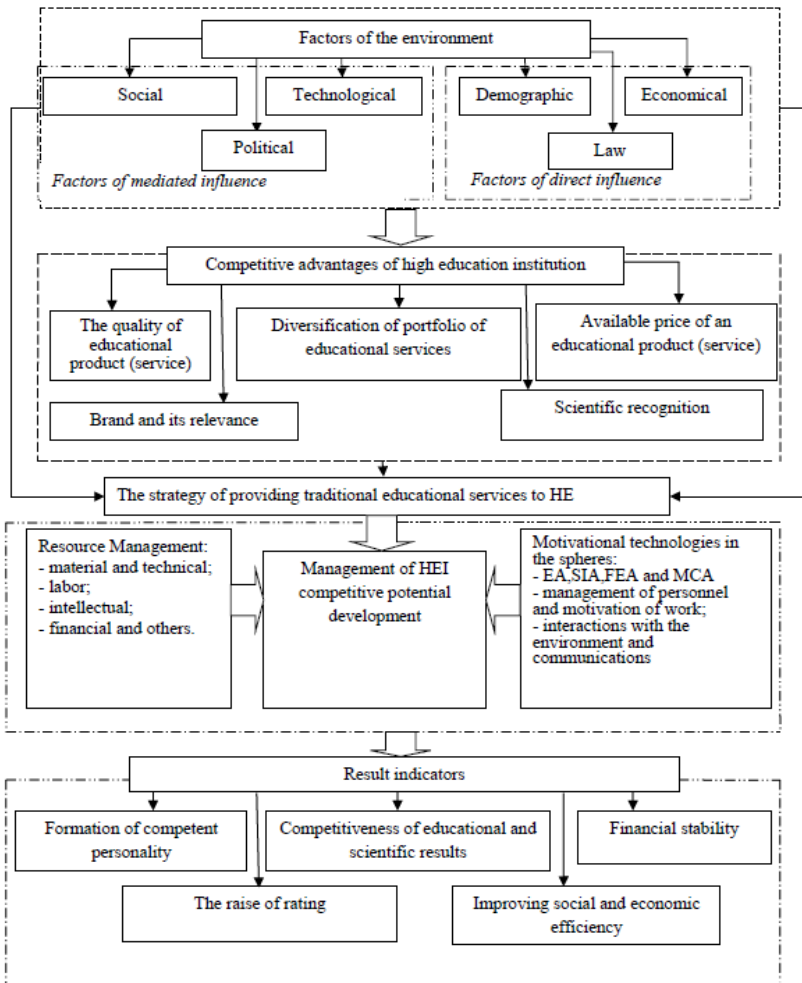

**Figure 5.2 Model of market-oriented strategic development of higher educational institutions on the basis of management of competitive advantages**

*Sorce: developed by the author.*

- the university trains designers, technologists, economists, chemists, computer technicians, managers, ie, carries out training in different areas, and therefore, its educational activity is highly diversified;

- produces and provides various educational and related services (educational services, including preparation of junior specialists in bachelor's, specialist, magistracy, postgraduate study, doctoral studies, additional educational services (pre-university training, additional vocational education programs), professional development, accommodation in a hostel, scientific services (implementation of scientific works); laboratory research; printing services; publication of scientific journals; organization and implementation of defense of dissertation papers, etc.);

- operates in the sector of so-called professional higher education, that is, it prepares specialists for a particular industry, and therefore should take into account the state and trends of the development of this sector and the demands of employers;

- the university is functioning in a highly competitive environment (a group of “Polytechnic and Technological Higher Educational Institutions”);

- a significant role in maintaining the quality of education (educational services) is provided by qualified lecturers, educational equipment, consumables;

- receives funding from budget and extrabudgetary funds.

Thus, the Kyiv National University of Technology and Design faces various ambitious external challenges associated with changes in public policy and state regulation in the field of higher education, with the actions of competitors, and with the influence of objective market forces. The management of the Kyiv National University of Technology and Design, in developing and implementing the strategic development program, must timely identify and assess the challenges of the environment and, taking into account the strategic goals of development and internal capacity, develop measures to minimize these challenges and further strengthen the market position of the institution (positions in the educational market services).

Kyiv National University of Technology and Design holds strong competitive positions in the market of educational services, which is confirmed by the presence of the institution in recognized national ratings at rather high places.

Based on the analysis of available sources, we can determine the key competitive advantages of the Kyiv National University of Technology

and Design a market participant in educational services:

1) in the field of maintenance and maintenance of the quality of an educational product (educational service):

- passing of the accreditation examination by the university, which confirmed the IV (highest) accreditation level; the results of the accreditation examination confirmed the proper level of personnel, financial, methodological, material-technical and scientific support of the educational process (observance of all standards); the next accreditation examination should take place in 2023;

- high (the highest in the state, according to the results of surveys of employers) level of training of specialists in certain areas of training (pharmaceutical and individual technological specialties);

- presence of successful (effective) scientific schools at the university, including in the field of technical physics, physical chemistry, light industry technologies, industrial design, graphic and spatial design);

- intensification of the use of modern information and communication technologies in the educational process of training and monitoring of the quality of education (in particular, the introduction of the modular environment, the establishment of the software complex “electronic journal”, the use of technologies for testing the quality of final works “antiplagiat”, etc.);

- the presence of positive experience of cooperation with social partners by potential employers (including through joint cultural and artistic activities, organization of training internships, pre-diploma practice of students, etc.);

2) in the area of use of price competitive advantages:

- freezing (refusal to raise) or even lower prices for educational services;

- the possibility of applying flexible mechanisms for the payment of educational services (including the use of installments and deferred payment for educational services in the case of a valid reason);

3) diversification of educational services, which is associated with the introduction of new areas of study, new programs, disciplines. Student recruitment procedures, methods and learning methods are changing. The system of education management, the structure of educational institutions and the order of their financing are reorganized.

4) scientific recognition: confirmation of the importance and usefulness of the results of scientific researches of higher education institutions in the field of education and science. Scientific recognition

proves the existence of competitive advantages and serves as a factor in ensuring the quality of education. Confirmation of scientific recognition are diplomas, grants, participation in joint scientific projects, which provide a beneficial effect, aim to meet the needs of consumers and improve the quality of life of society.

Conducting in Kyiv National University of Technology and Design scientific conferences: International scientific and practical conference “Efficiency of organizational and economic mechanism of innovative development of higher education”; All-Ukrainian Conference of Young Scientists and Students “Problems of Research and Social Responsibility of Students and Young Scientists”; International scientific conference “Prospective polymer materials and technologies”; III International Scientific and Practical Conference “Clean Water: Fundamental, Applied and Industrial Aspects”;

Participation in international scientific projects: Support for cooperation between research centers and industrial enterprises for the rapid acceleration of the use on the world market of innovative textiles and textile products; lithium-air batteries with decomposition of absorbed oxygen and oxidation-reducing processes;

The awarding of state awards to scientists of Kyiv National University of Technology and Design;

- demand for scientific materials (publications in international specialized publications);

- availability of professional editions at the university: Journal “Bulletin of the Kyiv National University of Technologies and Design” (Bulletin of the Kyiv National University of Technologies and Design); Scientific and Production Magazine “Light Industry”; Electronic scientific journal “Technologies and design”.

- participation of Kyiv National University of Technology and Design scientists in innovative projects;

5) in the field of maintaining the positive reputation of an educational product (educational service):

- the presence of a higher educational establishment in the leading national higher education institutions rankings;

- successful and timely passing of the monitoring and licensing (licensing, accreditation, attestation) procedures by the higher educational institution;

- positive feedback from employers on the qualifications of graduates;

- the support of the higher educational institution for social, public,

artistic, creative initiatives with a creative content (the international art competition “Pechersk Chestnuts”, regular creative meetings with artists and designers, urban creative reviews-contests, the functioning of the Student’s House of Fashion, etc.);

- the availability of positive materials on the activities of the higher educational institution in the media (newspaper “Osvita Ukraina”, the functioning of the university video channel, popular science publications, etc.).

We believe that the model of development of the Kyiv National University of Technology and Design in comparison with other higher educational institutions (educational services market players) has certain competitive disadvantages that reduce its market position, namely:

- the presence of the practice of organizing and holding classes with the use of ineffective (outdated) methods (reading material on lectures, “mechanical” surveys at a seminar session) that do not create motivation for the acquisition of knowledge;

- insufficient pace of improvement of the qualification of the scientific and pedagogical staff in certain areas of training (in particular, the lack of sufficient number of doctors in separate departments), aging (raising the middle age) of lecturers;

- the absence of special pedagogical training of many lecturers, insufficient level of possession of modern educational equipment, unwillingness (including lack of motivation) to introduce the latest innovative technologies into the educational process;

- insufficient scientific effectiveness of individual scientific and pedagogical workers (lack of results containing scientific novelty or of practical value), the targeting of a significant number of employees to fulfill formal requirements;

- the absence in the curriculum of specialists in technological, pharmaceutical and engineering specialties disciplines aimed at using economic skills, organizing their own business, implementing entrepreneurial initiatives, insufficient level of mastering by the majority of foreign language students, and the lack of possibility for successful students to learn a second foreign language;

- the presence of formalism and inadequate demands on the part of lecturers when students pass all types of practice, which reduces the practical readiness of graduates for independent work in their specialty;

- lack of practice of secondment of the most successful scientific and pedagogical workers to international conferences, including abroad, support of their participation in scientific and practical events;

- insufficient system of employment support for graduates, implementation of programs of “narrow” professional orientation, regular dialogue with graduates;

- the existence of cases of violation of the legislation on education, the absence of an effective (result-oriented) system of protection of rights and legitimate interests of participants in the educational process;

- lack of practice in implementing programs aimed at forming a “team spirit” in the teaching staff and students, positive perceptions of innovation changes, lack of feedback channels between management and teams;

- insufficient level of dialogue with social partners, including employers, in matters of educational content, formation of innovative educational programs, organization of industrial practices and sightseeing excursions;

- weak use of modern educational equipment in the educational process, including interactive whiteboards, automated workplaces, information kiosks, etc.;

- low relevance of available information and bibliographic sources, decrease of the number of scientific (including foreign) publications, coming to library funds;

- lack of practice of providing the most successful students with elevated “rector’s” scholarships, fragmentation of the practice of paying at the expense of the higher educational institution participation of the most successful students in the subject Olympiads.

Due to all, that have been mentioned above, we suppose that it is advisable to use a competitive development strategy that is, aimed at multiplying existing and developing new strategic advantages. The protective strategy is inappropriate in view of the difficult competitive situation in the market of educational services, an offensive strategy is impossible due to the shortage of financial resources.

The priority directions of strategy implementation, which are determined by analyzing the nature of the existing competitive advantages, can be as follows:

- further development of the new generation training mechanism;
- scientific substantiation of the development of the industry of high fashion and light industry technologies;

- support and full support of university schools development;

- development and implementation of educational technologies in the field of training specialists for the fashion industry and light industry;

- support of effective cooperation with social partners and leading



employers;

- implementation of artistic and cultural events that promote the formation of a modern specialist;
- support for the academic mobility of lecturers and students;
- implementation of the concept of “life-long education”;
- support of an effective model of education and socialization of student youth.

In the process of strategic management, it is advisable to determine the criteria (or indicators) for assessing the resultativity and effectiveness of strategic programs (strategies) implementation. These criteria (or indicators) serve as benchmarks to be achieved through the introduction of strategic programs (strategies).

**Conclusions.** Taking into account the generalizations made, we believe that the key criteria for assessing the effectiveness of the strategy implementation can be:

- strengthening of the market position at the university (in particular, due to the improvement of the places in the ratings of the universities);
- increase of university revenues from the provision of modern educational and related services;
- steady growth of the scientific, innovative and patent activity of the university's academic schools, transformation of science into a real factor of the university's development,
- positive passing of licensing and accreditation procedures,
- an increase in the share of scientific and pedagogical workers with scientific degrees, rejuvenation of teaching staff,
- the growth of the competition at the entrance to the university,
- increase in the employment rate of graduates.

The main expected result of the implementation of the strategy is the growth of the competitiveness of the Kyiv National University of Technology and Design through the implementation of a competitive development strategy for the development of the University, based on the use of its competitive advantages.

## References

1. *Kremen V. H. Osvita i nauka v Ukraini – innovatsiini aspekty: Stratehiia. Realizatsiia. Rezultaty [naukove vydannia] / V.H.Kremen – K.: Hramota, 2005. – 448 p.*
2. *Zakon Ukrainy “Pro vyshchu osvitu” [Elektronnyi resurs]. – Rezhym dostupu <http://zakon.rada.gov.ua>.*
3. *Hryshchenko I. M. Profesiina osvita v systemi ekonomichnykh*

- doslidzhen [monohrafiia] / I. M. Hryshchenko. – K.: Hramota, 2014. – 384 p.*
4. *Pan L.V. Rol doslidzhennia seredovyshcha funktsionuvannia vyshchoho navchalnoho zakladu u systemi upravlinnia / L.V.Pan. – [elektronnyi resurs]. – Dostupnyi z: [http://www.ekmair.ukma.kiev.ua/bitstream/123456789/381/1/Pan\\_Rol\\_doslidzhennia.pdf](http://www.ekmair.ukma.kiev.ua/bitstream/123456789/381/1/Pan_Rol_doslidzhennia.pdf).*
  5. *Lazarev V. A. Konkurentosposobnost vuza kak obekt upravleniia [monohrafiia] / V. A. Lazarev, S. A. Mokhnachev. – M.: Pryhorodnye vesty, 2003. – 422 p.*
  6. *Borysova Yu. V. Analiz konkurentosposobnosti vuza / Yu. V. Borysova, N. V. Tykhomyrova / Standarty y kachestvo. – 2001. – № 32. – p. 58-61.*
  7. *Konkurentsiia i konkurentna polityka: katehorii ta poniattia / V. D. Lahutin ta in.; za red. d-ra ekon. nauk, prof. V. D. Lahutina. – K. : Kyiv. nats. torh.-ekon. un-t, 2009. – 319 p.*
  8. *8. Formation and development of brand equity of higher education institution / V. Shcherbak, S. Marchenko / Aktualni problemy ekonomiky. – 2016. – № 6. – p. 213–222*

**Maliuk Liudmyla**

*PhD. in Technical Sciences, Professor*

**Varypaiev Oleksii**

*PhD in Philosophy, Professor*

**Varypaieva Liudmyla**

*Associate Professor*

*The Kharkiv State University for Food*

*Technologies and Trade*

*(Kharkiv, Ukraine)*

**SERVICEOLOGY IN  
THE HOSPITALITY  
INDUSTRY**

The purpose of the research is to analyze the processes of formation and functioning of the “service society”, the analysis of the transformation processes occurring in it, the research of human needs that arise and are modified in a such society, and the development of a comprehensive service strategy that aims at the formation of quality services to meet the needs of the consumer.

The research methodology consisted in a combination of historical-sociological and comparative methods, and a method of theoretical,

economic-statistical and logical analysis is also used.

The scientific novelty of the article lies in an attempt to develop a typology and classification of human needs that would allow, in the intercommunication with the relevant services, to develop a scientifically grounded service and service strategy, in particular in such areas as hotel and restaurant business, to create and develop common service strategy criteria in hospitality industry, which include a perception of consumer values and norms governing consumption, a cross-correlation of the consumer needs and services aimed at its satisfaction, to improve service quality and motivation of the personnel in the field of service activities.

Problems of the formation of the so-called “service society” are associated with the radical transformation of both the economic and spiritual sphere of human existence from the priorities of production and the producer to meet the needs and development of the intangible service sector, the development of which forms a new culture of behavior and the type of being.

Understanding the properties of the formation and functioning of a “service society” is important for economic and social development, since the reorientation to the interests and demands of the consumer is generally recognized in recent economic, sociological and philosophical studies.

Changes in understanding of the service sector importance have led to the fact that in theoretical developments, and in mass consciousness perception of service spreads as a positive social technology relying on human possessing properties. The essence of social space created by service activities performs the search for effective ways of implementing and satisfaction of aspirations and needs of each person.

Researchers have recently defined the current state of economic and cultural development as “service society”, the problems of research in this area are becoming the priority in the United States, Western Europe, Japan, where in 2013 and 2014, an International Congress on serviceology took place, and a scientific journal was published. Serviceology stands out as a dynamically developing branch of human knowledge, which has been actively developing during the last decade. It is a theoretical background for service activities, marketing, management, hospitality and tourism.

According to the law of raising the needs in the modern world, so high demands on the quality of life generate that the entire service sector permeates all hierarchy of needs.

The service sector focuses not on the material side of life and everyday household, but on social and spiritual needs. Understanding of service and service activity as important cultural characteristics of social existence is developing in scientific researches of serviceology as a science about the essence, principles and methods of servicing that accounts an individual as an integral moral personhood [7].

Serviceology is a theoretic background for service activity, marketing, and management in hospitality industry. The research of the complex of human needs is the main factor for the science because the services sphere activity is directed towards the satisfaction of human needs.

“Service” is understood as the basic category of service sector, it is the basis of the service reality that surrounds the modern person, is the most profitable industry in the world. One of the most important categories of service is quality, so much attention is paid to the issue of the impact on the quality of service, the development of transparent customer service criteria, customer satisfaction or dissatisfaction.

From our point of view, based on the works of the authors, set forth in a number of publications [6-9], in order to develop scientific services as a complex field of scientific knowledge about human needs, principles and methods of their satisfaction, it is not necessary to mechanically transfer from psychology, economics or marketing the idea of a psychological, individualized type of customer service, and develop a typology and classification of human needs that would allow interactions with the relevant services to develop a scientifically based strategy of service and service activities spine, particularly in areas such as hotel and restaurant business in the hospitality industry.

Creating normal, comfortable living conditions, forming and raising the level and quality of life, meeting the needs of the population is one of the most important tasks of the service sector. The concept of “sphere of service” should be interpreted expanded, since it includes a significant number of industries, spheres of activity and objects [7; 17].

Service as the process of its delivery is a reflection of social reality, in which the social world is considered as the result of its various practices, politics, economics, material and spiritual practices, methods of production and reproduction of social reality.

Since service in researches of the last decade has been allocated and is distinguished as an independent sphere of social existence, it is possible to characterize modern society as a “service society”, which has specific features of development and derives from the concept of the

“consumer society”, which characterizes the western one from the 70s of the XX century, a civilizational model of a developed capitalist society [2; 3; 9; 17].

Among the positive moments of the development of “service civilization”, researchers determine that in the service sector, not only exist the satisfaction of vital needs, but also the creation of a state of comfort [1; 3; 7].

The importance of identifying a complex of physiological, social and spiritual needs of a person, studying the processes of actualization of needs, principles of satisfaction of needs, mechanisms of reinforcement and the emergence of new needs are important in terms of compliance of the range of services offered by the service company.

The questions of organization of complex service, development of the general strategy of service were the subject of research of many ukrainian and foreign scientists [13-15].

As the ukrainian and foreign experience shows, the most promising area in this area is the organization of a complex of various services of the accompanying, auxiliary and independent character of the enterprise. Though the assortment of services offered and other service parameters are reduced by the ukrainian enterprises of the hotel and restaurant business sector in comparison with economically developed countries, this sphere of activity is rapidly developing and has great prospects in Ukraine [2; 5].

From the point of view of such priorities, the combination of the network of enterprises of the hotel and restaurant business is important, which will allow the city, region and the country as a whole to offer the customer a high-quality service.

Fulfilling of the diverse needs of the population and creating, thus, comfortable living conditions, raising the level and quality of life is one of the characteristic features and the most important tasks of the functioning of “service civilization”.

It is universally accepted that an individual feels the need when he feels physiologically or psychologically lacking something [12]. The meaningful theories in sociology, economics and psychology are attempts to classify these general human needs for certain categories, although due to different methodological differences and interdisciplinary disagreement, there is still no unified, accepted by all classification of certain needs [8].

From our point of view, it is possible to allocate the classification of needs for primary and secondary ones as logical according to the

principles of the distribution of concepts. Primary needs for such a division are physiological by nature, need to be satisfied throughout human life, are welcome and, as a rule, congenital. Examples include the need for food, water, need to breathe, the need for sleep and rest, and sexual needs.

Secondary needs arise with the process of socialization, their satisfaction is directly related to the mechanisms of social communication, their satisfaction has no limit. These are the needs, such as the need for success, respect, affection, power, the need for affiliation, the need for self-actualization, and so on.

Primary needs are laid down genetically, and secondary is usually understood with the acquisition of social and personal experience. Since different people have different experiences, the secondary needs of people differ to a greater degree than primary.

In general, in the practice of management and marketing, are considered mainly the theory of A. Maslow, D. McClelland and F. Herzberg.

It is known, Maslow's theory is based on the levels or stages of needs, and when the strongest and most important needs are met, they arise and demand the satisfaction of the needs of the hierarchy behind them. When these needs are satisfied, there is a transition to the next step of the ladder of factors that determine human behavior [10].

A higher level is the need for self-actualization, and since with the development of man as a person its potential capabilities are expanding, the need for self-expression can never be fully satisfied. Therefore, the process of motivating behavior through needs is endless.

The main disadvantage of A. Maslow's theory of needs is that some researchers consider that it failed to take into account the individual differences of people, suggest a hierarchical structure of individual needs-benefits that a person forms based on his past experience.

Opposes the Maslow's theory of an individualized approach, which is typical of the American paradigm of micro-sociology and social psychology, with roots in the psychology of behaviorism [16].

Another well-known theory of needs is David McClelland's theory. He believed that people have three basic needs: power, success and involvement. The need for power is expressed as a desire to influence other people. F. Herzberg's theory of motivation attempts to adapt A. Maslow's theory of needs to motivate an employee at an enterprise and to highlight general principles of management.

F. Herzberg's hygienic factors correspond with physiological needs,

needs for safety and confidence in the future, and its motivation can be compared to the needs of Maslow's higher levels. The difference is that F. Herzberg believes that an employee begins to pay attention to hygiene factors only when he considers their implementation as inadequate or unfair [11; 16].

It seems important to us, especially in developing service and service strategies, to rely on the experience of native researchers, to use the achievements of an "activity school" in native psychology, to rely on the developed classification of needs in the works of S.B. Kaverin, P.M. Ershov and P.V. Simonov.

The "information and emotional" concept of the needs of Simonov-Ershov has a great heuristic potential, allows us to highlight the emotional characteristics of the service, to understand the mechanisms of formation of purposeful behavior of the individual.

According to P.V. Simonov, the more favorable is the external conditions for the satisfaction of needs, the more emotionally reacts the brain, arise positive emotions, which a person tries to maximize increase, continue, consolidate.

On the other hand, with the difficulty of reaching the state of satisfaction of needs, negative emotions are produced, they try to be extinguished and minimized, even in many cases, prevented [12].

Understanding needs as the root causes and driving forces of human behavior, P.V. Simonov and P.M. Ershov proposes the division of needs for the vital, social and ideal, which are basic (primary, independent of origin), and auxiliary (ethnic, ideological, will, and others).

Vital needs must ensure the species and individual existence of a person, accordingly, they include the need for food, water, sleep, temperature comfort, and others. The difference in the psychophysiological theory of needs in the analysis of primary needs is that the vital needs of the physical needs are quasipreces, that is, the modified needs of the person in the objects of vital necessity, created as a result of many-thousand-year activity of mankind, and among the fundamental vital needs is a biologically motivated stimulus in saving effort [12].

Social needs include the need for belonging to a social group, a certain hierarchical belonging, affection, attention, respect and love. It seems to be correct that the theory of the needs two division which proposed by the authors: 1) the needs "for oneself", which the subject identifies with the rights that belong to him, and 2) the needs "for others" which are perceived as responsibilities.

Thus, knowledge of the theory of needs, the study of their connection

with the system of service is urgently needed both for the head and employees of the service company in the hospitality industry in solving a number of tasks aimed at achieving the goals of the organization.

The development of recommendations and practical proposals for the scientifically substantiated formation of a complex of services is one of the most important areas of theoretical and practical research in the field of hotel and restaurant business, aimed at finding interrelation of the processes of satisfying the needs of the consumer with the optimal amount and quality of the offered services.

The next important step after determining the classification of needs in the serviceology is the process of development of the service. Service development is an important step in creating value and customer satisfaction.

It is considered an effective strategy if the service satisfies the needs of consumers or solves their problems. The purpose of service development is to determine the most correct implementation of the service.

The specificity of the service is, above all, that the service can be provided at any time and anywhere. A person who provides an individual service should be oriented by the needs and wishes of the client. The variability in the quality of service delivery results worsens the performance of service and guarantees its quality [4; 7].

The next value of the service is its human-dimensionality. Most of the services are mostly performed by people, so the buyer and the person who sells the service are forced to interact.

In the restaurant business, the main problem for restaurant managers is the matching of the demand for the service with the scope of activity of their firms. The unshakable quality of the work done by the people who provide the service, as well as the differences in the perception of consumers, create significant problems for managers working in the restaurant business.

From our point of view, service organizations exist in order to provide services to the consumer. It is their mission, strategy and politics. Today, successful companies and service firms understand that consumers are their the most valuable asset [7].

For an efficient and optimal operation, a company operating in the service area must have a developed and implemented service strategy. Under the strategy of economic research understanding the search for a plan of action for a plan to develop a competitive position in the market [13-14].



Western researchers define a service strategy as “the precise knowledge of which clients you want to serve, and an understanding of what kind of service will open their wallets for you” [4]. To do this, you need to analyze and thoroughly examine the needs and requests of your customers, and make it possible to transfer them to potential customers. Potential customers can be considered the massive of all people whose needs can be satisfied by the proposed product or service. The function of the service is to preserve existing customers, attract new ones and create the need for all customers to continue their cooperation. Quality service is an effective tool of sales, it provides a steady competitive advantage [2].

Consequently, we can conclude that in a situation where the most companies offer the same product at similar prices, the service becomes the main competitive advantage that helps companies to stand out and take the leading position in the market. Service strategies are of particular importance to the hospitality industry, since studying the problems of the integrated satisfaction of the physical and spiritual needs of people from Ukraine weren't given sufficient attention in the past.

Recently, in the works of foreign and native researchers, the understanding of the category of “hospitality” as one of the important and fundamental dimensions of human civilization has spread [5; 7; 14]. The task of creating a positive image in the field of hospitality should be addressed through the full use of hospitality resources, which can be considered as an integrated service that has certain consumer properties and requires the creation of a positive image of the company.

The technology of hospitality is realized through taking into account the whole complex of physiological, social and spiritual needs of a person, is improved, using socio-psychological elements and laws of a market economy. After analyzing a number of studies, we consider it expedient to determine the following main goals of the restaurant service: to enhance the health of customers in unity with the culture of food; maintaining a stable social mood; formation of effective ways of life; improvement of incentives for knowledge of types of food in accordance with costs and outcomes.

Thus, an idealized model of restaurant service e foresees adequate satisfaction of a wide range of rationally-assembled services offered, where the service should be considered as a marketing asset of the hospitality industry, which should be distinguished by an enterprise in the field of hotel and restaurant business.

From our point of view, the strategy of service in the hospitality industry should be based on the conclusion that the modern consumer is looking for goods and services adapted to his needs, requires full information and seeks to fulfill their desires.

Thus, linking the needs of people with the services provided in the field of service for their satisfaction can be defined as a general strategy of service of the enterprise, as well as an integrated strategy for the development of hospitality and hotel and restaurant business.

In our opinion, for the development of this sectoral strategy, we should use both theoretical generalizations that are available in philosophy, psychology and economics, as well as applied researches using the methodology of specific sociological research that can confirm or refute the effectiveness of a general strategy for the development of hospitality industry.

A comprehensive study of the theory of needs and its mutual correlation with the system of services offered, from our point of view, will allow to build both a comprehensive service strategy in general and a service strategy for use in the hospitality industry, in the hotel and restaurant business.

This service strategy should take into account both general issues of personnel motivation, understanding of the functioning of the service (its intangibility, provision for a short period of time), and the specifics of the forms and means of satisfying the needs of customers in the restaurant business (dishes, waiters, etc.).

## References

1. Avanesova, G.A. (2006) *Service activity: a textbook for university students*. Moscow: Aspect Press. 320 p.
2. Bailik, S.I. (2008) *Hotel industry. Organization, management, service*. Kiev: Dakor. 288 p.
3. Balashova, E.A. (2006) *Hotel business. How to achieve perfect service*. Moscow: Verzhina. 200 p.
4. Blackwell, D. (2002) *Consumer Behavior*. St. Petersburg: Peter. 354 p.
5. Lukyanova, L.G. (2008) *Education in tourism*. Kiev, High School. 719 p
6. Malyuk, L.P. et al. (2009) *Serviceology and service activity: a textbook*. Kharkiv, KSUFT. 211 p.
7. Malyuk, L.P., Varypaiev, O.M. (2011) *Serviceology: a textbook*. Kharkiv, KSUFT. 258 p.
8. Malyuk, L.P., Varypaiev, O.M. (2016) *Serviceology in the system of the scientific knowledge. Economy. Management. Innovations, vol. 2, pp. 115-121*.

9. Malyuk L., Varipaev O., Varipaeva L. (2017) *Specifics of the classification of the needs of the servisology. Scientific letters of the academic society of Michal Baludansky (Košice, Slovakia), vol. 5, No. 4, pp. 52-55.*
10. Maslow A. (2003) *Motivation and personality. St. Petersburg: Peter. 465 p.*
11. Obukhovskiy, K. (2003) *Galaxy of needs. Psychology of human drives. St. Petersburg. 296 p.*
12. Simonov, P.V. (2004) *Selected works: In 2 volumes, Volume 1: Brain: emotions, needs, behavior. Moscow: Science. 437 p.*
13. Slinkov, V.N. (2008) *First-class service. Strategy, tactics, evaluation. Practical recommendations. Kiev: CST 272 p.*
14. Walker, J.R. (2002) *Introduction to Hospitality. Moscow:*
15. *UNITY-DANA 607 p.*
16. Haksever, K. (2002) *Management and organization in the service sector. St. Petersburg: Peter. 752 p.*
17. Hjjell L., Ziegler D. (2000) *Theories of personality. St. Petersburg: Peter. 608 p.*
18. Shmigun, I. (2009) *Philosophy of consumption. Kharkiv: Humanitarian Center. 304 p.*

**Skachkova Irina**

*PhD (Engineering), Associate  
Professor, Chair of Management*

**Skachkov Oleksandr**

*PhD (Engineering), Chair of  
Economics and Marketing  
National Aerospace University  
(Kharkiv, Ukraine)*

**APPLYING PROJECT  
MANAGEMENT TOOLS  
IN THE  
IMPLEMENTATION OF  
LEAN PRODUCTION  
TECHNIQUES**

The development of any enterprise takes place against the background of the continuous complication of all its main elements: organizational structure, management style, focus of leadership, markets, systems of motivation, work organization, and more.

Consequently, new development strategies are created and subsequently reformed, and, as a result, the enterprise management model is constantly updated. In these conditions, it is very important to introduce new methods that improve the enterprise efficiency. One of

these is lean production (lean manufacturing), an approach to managing an organization aimed at improving the quality of work by reducing costs. This approach applies to all aspects of activity, from design to product sales.

The concept of lean production was introduced in the works of Jeffrey Liker, Daniel Johnson, Michael Wader, James Womack, Michael L. George, Masaaki Imai, Oleksiy Nesyolovskiy, O.S. Vikhanskiy, K.A. Horgyeva and other scientists.

During recent years such scientists as L.M. Sakun, I.A. Nevmyvaka, V.O. Zubenko, I.V. Kolos, I.L. Hrabchuk, M.A. Donnik started paying attention to the peculiarities of implementing the methodology of lean production at the enterprises and in establishments of various management spheres.

At the same time, many aspects of implementing the methodology of lean production at enterprises and establishments have not been developed profoundly enough, including such aspects as theoretical, methodological, and especially applied ones, and this determines the actuality of the problem studied.

The purpose of this work is to develop recommendations for the introduction, with the help of project management tools, of the lean production method, namely the 5S approach, into the operation of a manufacturing enterprise.

The principles of lean production (the Lean System) were developed by Japanese companies in the late 1980s and early 1990s with the aim to reduce the actions that do not add value to the product throughout its lifecycle.

The purposes of lean production are: reduction of labour costs, reduction of the time required for development of new goods and services, reduction of the time required for production of goods and services, reduction of production and warehouse premises, guarantee of delivering products to the customer, the best quality with minimal cost. In general, production mainly involves a sequence of actions which transform source material into a finished product. Some of these actions add value to the product while others do not. Those that do not add value are losses, which should be eliminated

All the losses (or waste) are divided into two types.

The first type of losses includes all the losses that cannot be eliminated. From the customer point of view, this process does not add to the value of the product, but the company's efficiency cannot be supported without it. It cannot be eliminated, it can only be optimized.

While the second type of losses can be eliminated.

In the lean production method, the following seven types of losses are identified: overproduction; needless transport; extra inventory; needless operations and extra moving at the working place; waiting; over processing; defects. [2].

Overproduction is the result of the managers' way of thinking, who set the priority to the fullest load of the equipment and personnel. All this results in the following: untimely loss of raw and other materials; non-optimized workforce usage; necessity to purchase extra equipment; expanding the premises used; increased taxes percentage (for example, property tax); excessive stock increase; increase of transport and administrative expenses.

Extra inventory includes raw and other materials, ready and unfinished products, spare parts and materials for repairing equipment and premises which are stored in the inventory and do not add value to the product from the customer point of view.

Defects are obvious wastes which cost material and human resources.

Over processing uncovers when analysis of production streams reveals operations which can be excluded while keeping the product's quality at the same level.

Extra transportation includes all internal moving and transportation which do not add value to the product.

Waiting can happen while expecting for the products to arrive from the previous stage of the manufacturing process. In most cases waiting results from productivity imbalance between the manufacturing areas, workplaces and workshops. Also, waiting can be a result of broken equipment.

Needless operations and extra moving at the workplaces do not add value to the product as well.

The main tools and approaches to lean production are as follows: Just in Time; Kaizen; 5S; Andon; Kanban; SMED (Single Minute Exchange of Die); Work Standardization; Poka - Yoke.

Just in Time is a method of manufacturing organization that works as follows: during the manufacturing process, the details required for assembly appear on the production line just in time required, strictly limited to the required amount. As a result, a company which consequently implements such a principle, will eliminate waiting, minimize extra inventory, or can even eliminate it at all.

Kaizen – is a system of continuously improving quality,

technologies, processes, corporate culture, work productivity, reliability, leadership and other aspects of a company's activity. Kaizen focuses on the personnel 'quality', as the personnel affects the quality of the goods and services that are produced. This system attracts each employee to the improvement process, starting with the highest ranking manager and ending with a regular employee. Each employee of the organization suggests small improvements on a regular basis. The suggestions are made not just during a month or a year, but all the time. These are mostly not global changes, but minor improvements. The main idea of the Kaizen system is that a large amount of small and minor changes results in major quality improvement.

Andon is a method of information management which provides information about the current status of the production process, as well as creates visual and sound warning if a defect appears, if necessary. Such information methods can include light bulbs, light board, information panels, monitors.

SMED (Single Minute Exchange of Die) – is one of the many methods of lean production, and it is a way to reduce the expenses and wastes on equipment adjustments and retooling. It is a set of theoretical and practical methods which allow reducing the time required for adjustment and retooling to 10 minutes. First this system was created to optimize the operations of stamps replacement and adjustment of the corresponding equipment, however the rules of fast adjustment can be applied to all process types.

Poka – Yoke (principle of Zero defects) is a method allowing to perform the work only in the only possible way, and as a result, defects simply cannot appear. Zero defects principle implies that either no mistakes are made, or there's only one mistake. Still, errors caused by forgetfulness, accidental rearrangement, confusion, incorrect reading, wrong interpretation are possible and inevitable. However, they should be regarded by the employees as a normal phenomenon. They must be revealed and not hidden. Also, it is important to look for the reason of a defect, but not for people who caused it.

One of the least costly approaches is the 5s, which consists of five actions: sorting, rational arrangement, cleaning, standardization, and improvement [1].

The 5S system is part of the lean manufacturing concept, which allows the company to achieve a competitive advantage by optimizing all production processes, from product development to relations with suppliers and customers.

5S deals with the workplace organization, interaction of worksites, and the employees' behavior in the process of work:

- to reduce the number of work-related accidents;
- to raise the quality of products, while reducing the number of defects;
- to create a comfortable, motivating psychological environment;
- to unify and standardize workplaces;
- to increase productivity by reducing the time of item search within the working space.

*Table 5.4*

**5S system**

<b>Step number</b>	<b>English name</b>	<b>Japanese name</b>
1 step	Sort	Seiri (整理)
2 step	Set in order	Seiton (整頓)
3 step	Shine/Sweeping	Seiso (整頓)
4 step	Standardize	Seiketsu (清潔)
5 step	Sustain	Shitsuke (躰)

Each S in the heading means a key principle that is important for high-quality, effective, and, importantly, safe work. The Japanese experts described step by step how to turn these principles from a slogan into a guide to action. There are specific detailed instructions regarding the implementation of each principle.

«Seiri» – Sorting. The purpose of the first step is to free the working space from unnecessary items (tools, materials, documents, etc.).

All materials, equipment and tools are sorted into

- always needed (materials used at work at this time);
- sometimes needed (materials that can be used, but not at this moment);
- never needed (defective or inapplicable tools, packaging, foreign objects, etc.).

In the process of sorting, unnecessary items are marked with a red tag and then removed from the work area.

«Seiton» – Setting in Order. The purpose of the second step is to eliminate any chaos in the storage and use of tools, materials, documents, and equipment.

For all necessary items storage places should be allocated and well-marked.

The location of the items should meet the requirements of safety, quality, and efficiency of work;

There are four rules according to which all items should be kept where they are: easy to see; easy to take; easy to use; easy to return to their place.

«Seiso» – Principle of Cleanliness. The purpose of the third step is to eliminate the contamination of the working environment, which is a potential source of problems or conceals already existing ones.

The work area should be maintained in perfect order. The following procedure is proposed:

- to break the working environment into areas, to create cleaning schemes and maps with the designation of workplaces, locations of equipment, etc.;
- to assign a team to each cleaning area;
- to determine the time of cleaning (e.g. morning cleaning: 5-10 minutes before the start of the day; midday cleaning: 5-10 minutes after lunch break; cleaning after work: 15-20 minutes after the workday).

The company provides employees with necessary cleaning supplies (cloths, brushes, detergents, etc.). Cleanliness in the workplace makes it possible to find things where they should be and in working order.

«Seiketsu» – Standardization. The purpose of the fourth step is to develop standards of control and support of the working environment

This principle ensures the formal, written overview of the rules regarding the maintenance of the workplace, work practices, other procedures and schedules with step-by-step instructions aimed at maintaining order. It is also necessary to develop audit checklists and remuneration schemes. Pictures of workplaces organized according to the 5S rules are recommended in order to standardize documentation, the equipment servicing routine, and safety precautions.

«Shitsuke» – Improvement. The purpose of the fifth step is to continuously enhance the effectiveness of methods for maintaining the working environment, to form the sustained workplace orderliness in accordance with existing procedures, as well as improve the system itself.

The 5S system authors singled out the following points: visual inspection of workbenches, tools and machines in order to facilitate their maintenance; use of BEFORE / AFTER photos to compare the previous state with the end result; regular audits to assess the effectiveness of implementing the 5S system.

The rules and norms of behavior work only when they have become a habit and are adhered to by everybody. The use of the 5S principles in



everyday activities implies the formation of a new production culture, therefore, at the fifth stage, the main responsibility lies on managers. Typically, the 5S system introduction in a production process takes about six months. In Japan, companies tend to use the method of gradual but continuous improvements in which they do something, appreciate the results, analyze again, and make necessary corrections. Among the required procedures are regular audit, discussion of the results achieved, development of operational standards. Then examples should be photographed, and, with the help of posters, booklets and pocket guides, should be used to make the employees aware of the system implementation. For this purpose, a process model for the implementation of the lean production methodology, namely the 5S approach, at a manufacturing enterprise was constructed, on the basis of the AllFusion Process Modeller software product (Figure 5.3).

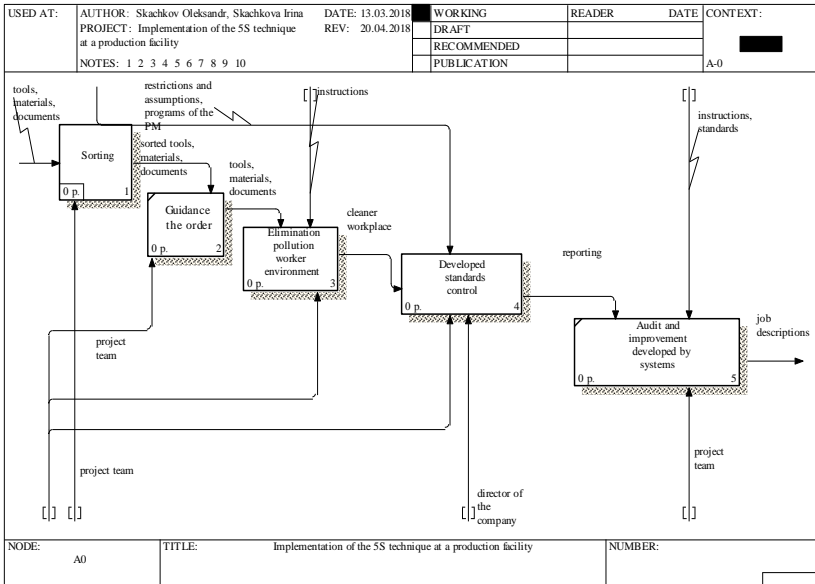
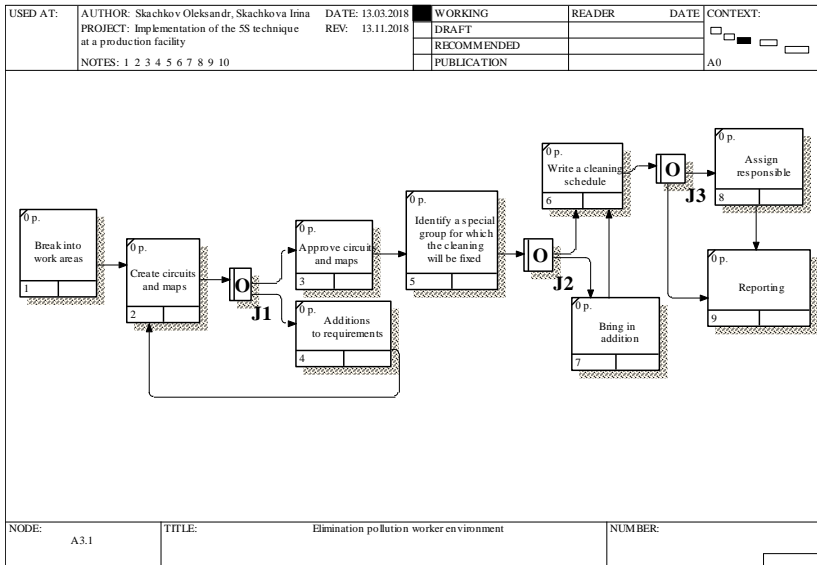

**Figure 5.3 Diagram of the decomposition of the process of implementing the 5S approach at a manufacturing enterprise**

The implementation of lean production methodology, namely the 5S approach, at a manufacturing enterprise, consists of the following processes: sorting, ordering, eliminating the contamination of the

working environment, developing standards of control and support at the workplace, auditing and improving the developed system.

In this study a “Removing the contamination of the working environment” process model and a step-by-step set of instructions were developed. The diagram of “Elimination of contamination in the working environment” scenarios (Figure 5.4) includes the following processes: breaking working space into areas, creating schemes and maps, approving the schemes and maps, making additions to the requirements, identifying cleaning teams for every area, writing a cleaning schedule, making addenda, appointing people in charge, and reporting.



**Figure 5.4 Diagram of “Elimination of contamination in the working environment” scenarios**

In this study we used the MS Project to elaborate a plan for introducing the lean production methodology in the form of the 5S approach into the activity of a production enterprise. The MS Project makes it possible to successfully manage and complete a project in a timely manner, providing flexible planning and monitoring capabilities for project execution within the budget, as well as operational allocation of resources, and convenient reporting [4].

A fragment of the Gantt chart project implementing the 5S approach at a manufacturing enterprise is shown in Figure 5.5.

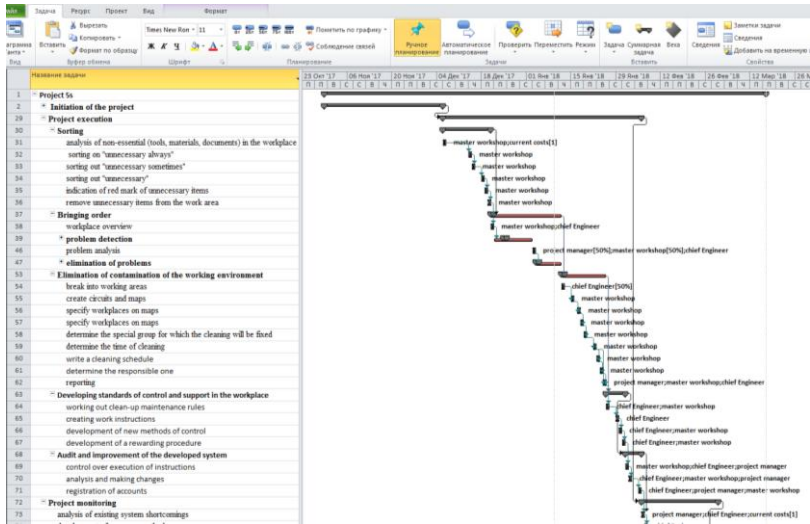

**Figure 5.5** A fragment of the Gantt chart

The project of the 5S approach implementation at an enterprise will take 100 working days and cover 100 procedures. The main stages of the project are initiation, implementation, monitoring and completion of the project.

In the Table 5.5 you can see labour costs of the project on implementing lean production methodology, namely the 5S approach, into the activity of a manufacturing enterprise.

*Table 5.5*

**Labour costs**

The main tasks of the project	Labour costs
1. Initiation of the project	244 hours
2. Implementation of the project	376 hours
2.1. Sorting	48 hours
2.2. Bringing order	116 hours
2.3. Elimination of contamination in the working environment	84 hours
2.4. Developing standards of control and support in the workplace	56 hours
2.5. Audit and improvement of the developed system	72 hours
3. Project monitoring	160 hours
4. Completion of the project	136 hours

The implementation of the 5S approach is not expensive. The project team may include the CEO, chief engineer, workshop head, and a specially appointed project manager.

Strategies constituting the 5S system are logical and standardized. Thus, they may be applied at any workplace, starting with a cleaner and ending with the CEO. Their use does not require an introduction of new technologies or management theories, and so does not involve significant expenditures.

At the same time the order and cleanliness of a workplace are crucial for raising the productivity and quality of labor at any enterprise, because only in a regular and orderly working environment is it possible to produce defect-free goods and services that meet consumer requirements.

## References

1. Masaaki, Imai *Gemba Kaizen: A Commonsense, Low-Cost Approach to Management*, McGraw-Hill, New York, 354 p., 1997.
2. Womack, J. P., Jones, D. T., Roos, D. *The Machine that changed the World: The Story of Lean Production*, Harper Collins, New York, 323 p., 1990.
3. Dubejkovskij, V.I. *Effective modeling with AllFusion Process Modeler [Jeffektivnoe modelirovanie s AllFusion Process Modeler]*, Dialog-Mifi, Moscow, 384 p., 2007.
4. Gul'tjaev, A.K. *MS Project 2007 Project Management [MS Project 2007 Upravlenie proektami]*, Korona-Vek, Saint Petersburg, 480 p., 2012.
5. Perevoshhikov, Ju.S. *Project management in engineering [Upravlenie proektami v mashinostroenii]*, INFRA-M, Moscow, 233 p., 2014.
6. Grekul, V.I. Korovkina, N.L. Denishhenko, G.N. *Management of the implementation of information systems [Upravlenie vnedreniem informacionnyh sistem]*, Aspekt Press, Moscow, 2010.
7. *A Guide to the Project Management Body of Knowledge (PMBOK® Guide) – Fifth Edition.* – Project Management Institute, 2013. – 589 p.
8. V. Repin, V. Yeliferov. *Process method in management. Business process modeling.* MIF, Moscow: 2012. - 544 p.

**Vasilienė-Vasiliauskienė Virgilija**  
*PhD in Management Sciences,*  
*Associate Professor*  
*Vilnius Gediminas Technical University*

**Vasilis Vasiliauskas Aidas**  
*PhD in Technological Sciences,*  
*Associate Professor*  
*General Jonas Žemaitis Military*  
*Academy of Lithuania*

**Meidutė-Kavaliauskienė Ieva**  
*PhD in Technological Sciences,*  
*Associate Professor*  
*General Jonas Žemaitis Military*  
*Academy of Lithuania*  
*(Vilnius, Lithuania)*

**PREREQUISITES  
FOR  
IMPLEMENTING  
SUSTAINABLE  
DEVELOPMENT  
AND ITS LINKS TO  
GREEN LOGISTICS**

The advancements in modern society is hardly possible without a sustainable development, which is currently under the process of highlighting major problems pertaining to ecological, economic and social challenges and its compatibility matters will be even more sharpened in the future. Therefore, it is necessary to seek for methods and measures to solve these problems. One of the possible measures is the application of green logistics principles, as Kutkaitis and Župerkienė (2011) and Rita *et al.* (2018) put it, *green logistics* is one of the components of sustainable development. According to Pazirandeh and Jafari (2013), usually sustainable development is described on the grounds of the definition proposed by the Brundtland Commission 1987: „Sustainable development is development that meets the needs of the present without compromising the ability of future generations to meet their own needs”. Atkočiūnienė and Radiunaitė (2011) describe sustainable development as "one of the most popular and ambitious ideologies of social development. Čiegis and Norkutė (2012) claim that *sustainable development* is not a static paradigm, on the contrary – it is rather dynamic and dependant on socio-cultural contexts and advancements in economic and social societies. McKinnon and Kreie (2010), Šimanskienė and Petrulis (2014) agree on that stating that sustainable development is a developmental philosophy based on systematic reasoning and the essence of it are fundamental laws of

nature not to be violated by a human in order to ensure the sustainability of the system, as well as human continuity on this planet whilst safeguarding our social justice and economic prosperity. Atkočiūnienė and Radiunaitė (2011) are inclined to believe that sustainable development is more than environmental protection – its foundation lies in the harmony of humans, planet and profits. Considering this, it is possible to claim that sustainable development is an economic and social progress that manifests itself as economic development, the potential of resources (ecosystems), the process of change driven by the current and future needs, and the pursuit of socio-economic development (Lyon and Maxwell, 2008; McKinnon and Kreie, 2010; Rodrigue *et al.*, 2014).

Thus, the prerequisites for the emergence of *green logistics* are associated with the idea of sustainable development implementation in all areas of human activity. As *green logistics* is closely related to business and organizations, it is expedient to analyse the sustainable development at the level of business organizations. (Nowakowska-Grunt, 2008; Hans, 2011; Vasilis Vasiliauskas *et al.*, 2013). In their analysis on organizational sustainability, researchers (Lyon and Maxwell, 2008; Bagdonienė *et al.*, 2009; Rodrigue *et al.*, 2014) usually associate it with implementing the principles of sustainable development in an organization. According to Hans (2011) and Rodrigue *et al.* (2014), a sustainable organization is not merely a sustainable development based on highlighting economic, social and environmental aspects, but rather it is a social responsibility, an object of accountability expressed by organizations and interested parties. To obtain a sustainable organization, one must take into account social attitudes, company's philosophy, objectives, and ethical arguments that are based on public activity reports.

In this regard, it can be argued that an organization seeking to be recognized as implementing the principles of green logistics should understand the sustainability as an application of strategies and actions that meet the needs of the organization and interested parties, while safeguarding and contributing to a greater conservation of natural resources.

Lyon and Maxwell (2008), Čiegis and Norkutė (2012), Kutkaitis and Župerkienė (2011), Martinsen and Björklund (2012), Pazirandeh and Jafari (2013), Vasilis Vasiliauskas *et al.* (2013), Cosimato and Troisi (2015), note that green logistics, as a part of micro-level in social processes is constantly affected by societal development, economic and social progress, environmental initiatives. According to authors, (Lee

and Klassen, 2008; Sbihi and Eglese, 2010; Rodrigue *et al.*, 2014) the relevance of these theories and the assumptions for its emergence are based on societal development as it is aimed at maintaining coherence between the elements that ensure the welfare of society, including the use of knowledge to create logistics processes.

Hans (2011), Kutkaitis and Župerkienė (2011), Pazirandeh and Jafari (2013) claim that sustainable development is not entirely new as a concept. It can be linked to logistics concept, and logistic action can be linked to sustainable development as a process. Rogers and Tibben-Lembke (2001), Srivastava (2007), Carter and Rogers (2008), Bjorklund and Forslund (2013) argue that concepts of *sustainable development* and *green logistics* should be explained with regard to logistics context, and the ways in which different solutions at different hierarchy levels of logistic system may impact the sustainability of systems. (McKinnon *et al.*, 2010).

Lee and Klassen (2008), Kutkaitis and Župerkienė (2011), Rodrigue *et al.* (2014), Pazirandeh and Jafari (2013) note that sustainable development in logistics organization is linked to a sustainable development as a process involving organization's attempts to establish an energy efficient and less harmful logistics system that ensures the saving of resources, improves waste disposal and increases labour productivity, as well as reduces the negative impact of the activities on the environment and increases the competitiveness. Moreover, companies may improve operation efficiency and long-term benefits, as well as enhance market share and profitability by applying the principles of green logistics in their logistics system. (Sbihi and Eglese, 2010; Vasilis Vasiliauskas *et al.*, 2013).

In recent years, there has been a strong interest in green logistics, although the unified concept of green logistics has not yet been established:

- *Green Supply Chain Management* can be defined as an organization's activity taking into account environmental issues and integrating it into supply chain management in order to change the environmental performance of suppliers and customers (Lee and Klassen, 2008).
- *Green logistics* activities include measuring the environmental impact of different distribution strategies, reducing the energy usage in logistics activities, reducing waste and managing its treatment (Sbihi and Eglese, 2010).

- *Green Logistics* is an integrated solution that covers all activities related to transporting of goods. An equal attention is paid to managing overall process starting with the search for manufacturing equipment, production and distribution and finally ensuring the processing and disposal of obsolete equipment (Rimašauskaitė, 2010).
- The term "*green logistics*" refers to organization's actions to create an energy-efficient and less damaging to the environment „sustainable logistics (Kutkaitis and Župerkienė, 2011).
- *Green logistics* is defined as supply chain management practices and strategies that reduce the environmental and energy footprint of freight distribution, which focuses on material handling, waste management, packaging and transport (Rodrigue *et al.*, 2014).
- *Green Logistics* – are logistics activities that focus not only on environmental protection, but also on economically viable activities (Pazirandeh and Jafari, 2013).

As can be seen from the abovementioned definitions, the term “green logistics” is understood as a logistics system, an activity, a component, and organizational actions aimed at efficient and environmentally-friendly interactions of distribution, energy-saving consumption, and raw materials’ production considering human needs and interests in order to satisfy social expectations pertaining to environment protection. The main features of the green logistics concept are associated with logistics processes, efficient management of the system activities - which assurance is limited and based on ecological and social requirements (Vasilis Vasiliauskas *et al.*, 2013).

According to Kutkaitis and Župerkienė (2011), the main objectives of green logistics are related to saving of resources, waste collection and improvement of this action, increase of operational efficiency and competitiveness, reduction and optimization of negative impact on the environment imposed by organization, and ensuring an ergonomic working space.

Čepinskas and Masteika (2011), Martisen and Björklund (2012), Björklund and Forslund (2014) have distinguished major activities of green logistics covering such areas as distribution (combined transport, alternative modes of transport, reverse logistics), efficient use of energy (reducing energy consumption and pollution levels, integrating the aspects of reducing CO<sub>2</sub> levels into companies policies, measuring the



environmental impact of logistics activities), manufacturing (use of clean technologies, reducing production waste, processing and management) and the extraction of raw materials (sustainable purchase, use of less polluting materials, waste recycling, reuse of products). In this context, green logistics can only be seen as a combination of its diverse activities. For instance, distribution, which covers such aspects as combined transport, reverse logistics and alternative modes of transport do not ensure implementation of the principles of green logistics. To achieve this, transport and logistics activities should be directed to optimizing the consumption of energy – only in this case it is possible to claim that implementation of green logistics is successful.

The analysis on the concepts of green logistics and sustainable development have shown that these concepts connect two environments or dimensions. Different authors present different numbers of elements belonging to these environments. According to Navickas and Navickienė (2009), the concept of *sustainable development* is comprised of 3 dimensions: environment protection, economic and social development and the greatest attention should be given to environment protection which forms the basis for social environment and economic existence. Šimanskienė and Petrulis (2014) adds to this concept of sustainable development by claiming that these dimensions should be analysed in a long-term perspective. Meanwhile Šimanskienė and Paužuolienė (2011), distinguish three major levels of sustainable development: economic, environmental and social. *Economic level* contributes to preserving financial stability, ability to invest, innovative activities, productivity of the economic activity, quality assurance of services. *Environmental level* includes the reduction of air pollution, the use of fossil fuels and other renewable resources. This level is characterized by environment-protection potential whilst applying cleaner, and more sustainable technologies. *Social level* covers corporate social responsibility, employee competencies, regulated occupational safety, work and rest regimes, as well as the provision of good and ergonomic working conditions for employees, reduction of road accidents. Social level determines the motivation and interest expressed by company's employees in the well-being of organization, society and the state.

Monnet (2008) claims that ethical segment is particularly important in the area of *sustainable development* and *green logistics* since it can be described as a right to a fair share of planet treasures for every human-being. These rights are comprised of the following components:

- biophysical environment;
- economic component;
- social component;
- institutional component.

It is worth noting that the ethical segment contains a content that is declared in economic and social concepts, and adds new components to it, such as biophysical environment and the institutional component. Therefore, this component is to be understood as semantically broader than economic and social components. Thus, the essence of green logistics can be expressed via four major components:

- economic and social progress, which manifests itself through economic development;
- resource (ecosystems) potential;
- process of change arising from present and future demands;
- pursuit of social and economic development.

Additionally, it is necessary to draw the attention to the fact that a pursuit to implement the concept of *green logistics* is determined by the national and EU legislation, documents, agreements, contracts and other. Guidelines, strategies and programs under implementation are presented in the documents. The state and the economic environment create prerequisites and factors that have certain effects on organizations and promote (otherwise limit) the implementation of green logistics (Diabat and Govindan, 2011):

- *political (legal) and economic factors*: state support, flexible and transparent provision of subsidies and grants for business, foreign investments, political system and its stability, activities of non-governmental organizations and international economic unions, implementation of legal acts constituting certain effects on the environment and human health.
- *social – cultural factors*: living conditions, level of education, health care, public organizations, media. Implementation of the concept of green logistics is related to the interests of the state and society (implementation of economic, social, environmental obligations and requirements at international and national levels).
- *scientific–technological factors*: modern, innovation-based transport infrastructure, state promotion and support to use high technologies and innovations, creating conditions for successful launching of new products, materials, services, technologies

and technical equipment.

- *Nature-ecological factors*: shortage of raw materials, energy costs rising, government regulation on the use of natural resources, increasing environmental pollution.

Implementation process of green logistics principles is affected not only by external, but also internal environment in logistics companies. There are distinguished groups of internal environment factors (Hu and Hsu, 2010; Lin and Ho, 2010):

- *Human factors* – corporate social responsibility, competencies and abilities, innovative activities and creativity, motivation system.
- *Institutional factors* – policy and corporate culture promoting employee innovative activities and communication determines more efficient operations, as well as decision-making process in regards to new activities and pursuit for competitiveness. In addition, a close partnership between scientific community and business is really important. Information and knowledge obtained from scientific community provides opportunities for businesses to implement and integrate the principles of green logistics into their own operations.
- *Technological factors* include the use of information technology (systems), modernized transport fleet, innovative solutions for transporting goods. These factors lead to a smoother and faster implementation of green logistics principles.
- *Economic factors*. The implementation of green logistics principles requires financial resources.

Financial resources are required for acquiring innovative technologies and improving employee competencies. Targeted investment of financial resources determines the success of the implementation process. Thus, to pursue the successful application and implementation of sustainable development principles, a balance between all factors should be established. This balance should cover both – separate factors, as well as specific ones, like application of the concept of green logistics to attain the substantial economic, social and ecological activity results.

## References

1. Atkočiūnienė, Z. O.; Radiunaitė, R. 2011. Žinių vadybos įtaka darnaus vystymosi reikšmėms įgyvendinti organizacijoje. *Informacijos mokslai [Knowledge Management Influence on Implementing Sustainable Development Means in Organizations, Information Sciences]* 58: pp. 56–73.
2. Bagdonienė, D.; Galbuogienė, A.; Paulavičienė, E. 2009. Darnios organizacijos koncepcijos formavimas visuotinės kokybės vadybos pagrindu [Formation of the Conception of Sustainable organization on the Basis of Total Quality Management], *Ekonomika ir vadyba [Economic and Management]* 14: pp. 1044–1052.
3. Björklund, M.; Forslund, H. 2013. The purpose and focus of environmental performance measurement systems in logistics, *International Journal of Productivity and Performance Management* 62(3): pp. 230-249.
4. Carter, C. R.; Rogers, D. S. 2008. A framework of sustainable supply chain management: moving toward new theory, *International Journal of Physical Distribution & Logistics Management* 38(5): pp. 360-387.
5. Čepinskis, J.; Masteika, I. 2011. Impacts of globalization on Green Logistics Centre's in Lithuania, *Aplinkos tyrimai, inžinerija ir vadyba [Environment Research, Engineering and Management]* 1(55): pp. 34–42.
6. Čiegis, R.; Norkutė, R. 2012. Lietuvos bankų socialinė atsakomybė darnaus vystymosi kontekste. Organizacijų vadyba: sisteminiai tyrimai [Social responsibility of Lithuanian banks in the context of sustainable development, *Management of Organizations: Systematic Research*] 63: pp. 19–33.
7. Cosimato, S. Troisi, O. 2015. Green supply chain management, *The Total Quality Management Journal* 27(2): pp. 256-276.
8. Diabat, A.; Govindan, K. 2011. An analysis of the drivers affecting the implementation of green supply chain management. *Resources, Conservation and Recycling* 55(6): pp. 659-667.
9. Hans, I. W. 2011. Green Supply Chains – a new priority for supply chain managers CSIR Built Environment.
10. Hu, A. H.; Hsu, C. W. 2010. Critical factors for implementing green supply chain management practice: an empirical study of electrical and electronics industries in Taiwan, *Management Research Review* 33(6): pp. 586-608.
11. Kutkaitis, A.; Župerkienė, E. 2011. Darnaus vystymosi koncepcijos raiška uosto logistinėse organizacijose [Expression of the Sustainable Development Concept in Seaport Logistics Organizations], *Management Theory and Studies for Rural Business and Infrastructure*

- Development* 2(26): pp. 130–136.
12. Lee, S. Y.; Klassen, R. D. 2008. *Drivers and Enablers That Foster Environmental Management Capabilities in Small- and Medium Sized Suppliers in Supply Chains*, *Production and Operations Management Society* 17(H6): pp. 573-586.
  13. Lin, C. Y.; Ho, Y. H. 2010. *Determinants of Green Practice Adoption for Logistics Companies in China*, *Journal of Business Ethics* 98: pp. 67-83.
  14. Lyon, T. P.; Maxwell, J. W. 2008. *Corporate Social Responsibility and the Environment: A theoretical perspective*, *Review of Environmental Economics and Policy* 2(2): pp. 240 - 260.
  15. Martinsen, U.; Bjorklund, M. 2012. *Matches and gaps in the green logistics market*, *International Journal of Physical Distribution and Logistics Management* 42(6): 562–583.
  16. McKinnon, A.; Browne M.; Whiteing, A. 2010. *Green Logistics: Improving the environmental sustainability of logistics*, (3rd ed.), Published by Kogan Page, London.
  17. McKinnon, A.; Kreie, A. 2010. *Adaptive Logistics: Preparing Logistical Systems for Climate Change* [online]. Available from Internet: <http://www.greenlogistics.org/>
  18. Monnet, M. 2008. *The intermediary conditions of logistics service providers in the context of sustainable development*, *Supply Chain Forum* 9(2): pp. 78–87.
  19. Navickas, K., Navickienė, R. 2009. *Darnios organizacijos modelio kūrimas, Ekonomika ir vadyba: aktualijos ir perspektyvos* [Developing the Model of a Sustainable Organisation, Economics and Management: Current Issues and Perspectives] 2 (15): pp. 192–201.
  - Nowakowska-Grunt, J. 2008. *Impact of Lean Management on Logistics infrastructure in enterprises*, *Advanced Logistic systems* 2(1): pp. 71-74.
  20. Pazirandeh, A.; Jafari, H. 2013. *Making sense of green logistics*, *International Journal of Productivity and Performance Management* 62(8): pp. 889 – 904.
  21. Rimašauskaitė, V. 2010. *Žaliojo koncepcinio modelio pritaikymas IT įmonėje* [Green IT strategy model for business, Master thesis] Kaunas: VDU.
  22. Rita D., I. G.; Ferreira, F. A. F.; Meidutė-Kavaliauskienė, I.; Govindan, K.; Ferreira, J. J. M. 2018. *Proposal of a green index for small and medium-sized enterprises: A multiple criteria group decision-making approach*, *Journal of Cleaner Production* 196: pp. 985-996.

23. Rodrigue, J. P.; Slack, B.; Comtois, C. 2014. *Green logistics*.
24. Rogers, S.; Tibben-Lembke, R. 2001. *An examination of reverse logistics practices*, *Journal of business logistics* 22(2): pp. 129-146.
25. Sbihi, A.; Eglese, R. W. 2010. *Combinatorial optimization and green logistics*, *Annals of Operations Research* 175: pp. 159–175.
26. Šimanskienė, L.; Paužuolienė, J. 2011. *Darnaus vystymo koncepcijos suvokimas organizacijoje [Perception of sustainable development concept in organizations]*, *Management theory and studies for rural business and infrastructure development* 2(26): pp. 241 – 247.
27. Šimanskienė, L.; Petrulis, A. 2014. *Darnumas ir jo teikiama nauda organizacijoms [Sustainability and its benefits to organizations]*, *Regional Formation and Development Studies* 1(11): pp. 221 – 229.
28. Srivastava, S. 2007. *Green supply-chain management: a state-of-the-art literature review*, *International Journal of Management Reviews* 9(1): pp. 53–80.
29. Vasilis Vasiliauskas, A.; Zinkevičiūtė, V.; Šimonytė, E. 2013. *Implementation of the concept of green logistics referring to it applications for road freight transport enterprises*, *Business: Theory and Practice* 14(1): pp. 43–50.

## CONCLUSION

The practice of modern business development proves that without an effective competitiveness management system it is impossible to ensure the success of economic entities in their struggle for survival, achieve leading market positions and ensure long-term effective functioning in a dynamic competitive environment. The issue of management the competitiveness of economic entities is not fundamentally new for science, since competition has always been and is an immanent component of the economic life of all countries of the market economic system without exception.

The results of the author's research in a collective monograph are devoted to solving the problems of improving the management of competitiveness the economic entities, the theoretical and methodological foundations of the organizational-economic mechanism of management competitiveness through modern directions of development the economic entities and formation of competitive advantages.

The modern market environment imposes a whole range of specific requirements for the management system of economic entities, on which the first and foremost depends efficiency of doing business. One of the main requirements is the successful interaction of an element the economic system in the context of vigorous actions on the part of both the internal and external competitive environment.

Globalization of the world economic space and the intensification of competition formed new economic conditions for the development of economic entities.

The problem of ensuring competitiveness is the main condition for increasing and maintaining the position of economic entities in the domestic and foreign markets. To ensure success in competitive struggle are necessary constant monitoring of markets, positions of economic entities and competitors, needs of regular customers, research of strengths and weaknesses of own economic activity, flexibility and quick response to market changes.

The presented research results in a collective monograph reflect the theoretical and practical aspects of introduction the mechanisms for management of competitiveness the economic entities.

It has been established that the increase of efficiency activity the economic entities in the modern tough market environment is based on the improvement of competitiveness management process.

It was determined that in the conditions of financial crisis the world economy is characterized by a slowdown in GDP growth rates under the influence of such factors as falling demand for products, rising unemployment, lack of financial resources and others. Globalization, internationalization, the rapid development of information and innovative technologies encourage the economic entities to ensure the benefits of their own products on several competitive foundations. Many economic entities achieve strategic goals by changing the structure of production, introducing innovations, increasing productivity on a high-tech and competitive basis.

Economic entities not able to withstand the pace and rhythm of modern production processes leave the market, and the process of economic recovery in the country directly depends on the extent to which they are working to improve technology, conduct benchmarking research and develop competitive strategies. In the conditions of formation a transnational market and toughening of competition it is important for economic entities to both maintain existing and form new competitive advantages based on innovations and innovations. Under new conditions competitors have become more agile, sophisticated, and aggressive than before.

In the new conditions, when consumers on the market have become the dominant force, and competition is not only intensifying, but also becoming diverse, economic entities are forced to reduce prices for goods as much as possible, to ensure high quality of goods and high level of customer service. Now consumers dictate what to produce, how to produce and at what prices to sell the product and what kind of service must be provided in order to meet their requirements. In the new conditions are changing rapidly the characteristics of consumer requirements, so for a number of objective and subjective factors the activities of many economic entities are uncompetitive.

Against the background of traditionally established methods of management the competitiveness of economic entities modern approaches are changing both with the development of the enterprises themselves and the external conditions of their operation. Today, the enterprise has become significantly more complicated in terms of structure the functions, in the style of relations between employees at different levels of management, there is a tendency towards an increase in the number of managers, and the requirements for staff competence have increased. The active behavior of the enterprise in a competitive environment breaks the traditional methods and management style.



Large associations appear and at the same time small firms successfully function.

A new stage in development of the national economy is focused on the fundamental restructuring of sectoral production structures related to its integration into the world economic system. In this regard, government policy today is aimed at creating an appropriate institutional environment that stimulates the development of modernization processes on industrial enterprises and contributes to the creation of rational industry-specific competitive entities.

It is obvious that in the conditions of globalization the economy an effective model of management competitiveness must meet international standards for technical, technological and organizational and managerial indicators, product quality. The main conceptual aspect contributing to the implementation of this process is to develop a methodology and identify effective management tools for the key components of the vital activity of economic entities.

Generalized studies in a collective monograph indicate that management competitiveness of economic entities should be considered as a systematic direction for improving activities aimed at creating and ensuring the achievement of competitive advantages through rational formation, effective use, increase and development of resource potential, introduction of modern innovations, marketing systems and logistics. That is, when management the competitiveness of economic entities a systematic process of making management decisions and turning the resource potential into competitive advantages, which lead to strengthening the position on the market, increasing the number of consumers and their loyalty, ensures sustainable development and profitability in the future.

# **Conceptual aspects management of competitiveness the economic entities**

Collective monograph edited by  
M. Bezpartochnyi, I. Britchenko

## **Koncepcyjne aspekty zarządzania konkurencyjnością podmiotów gospodarczych**

Monografia zbiorowa pod redakcją naukową  
M. Bezpartochnogo, I. Britchenko

---

**Wyższa Szkoła Społeczno Gospodarcza w  
Przeworsku**  
Gimnazjalna 35, 37-200 Przeworsk, Polska  
tel.: +48 721 207 300, +48 16 733 41 36  
e-mail: wssg@vp.pl

Przyjęto do druku: 10.01.2019  
Nakład: 95 egzemplarzy  
Objętość: 15,28 arkuszy druku