

NATURAL PERSPECTIVE

Introduction

The first studies on perspective were made in Europe surely by Bruneleschi, and Alberti was the first to write them. Before them, the Arabic author Alhazen had already written “Perspective”, showing that light arrives at the eye in conical rays. Classical perspective theory was rapidly used by artists from the 15th century to nowadays. But the strict geometry and straight lines of cavalier perspective has always been in contradiction with the intuition of many painters who curved the building edges and the horizon according to what they viewed.

In this paper, we intend to demonstrate that the intuition of these artists was based on a more accurate perspective theory than the classical one. That, if it is true that classical perspective gives a quite good representation of vision for small angles, the errors increase when the vision angle widens.

First paradox of classical perspective

Figure 1 shows the projection of two objects A and B, of the same size and on the same plane, over a flat and a spherical screen. The projection over a flat surface is made according to the cavalier perspective or the result of a photography made with an orthoscopic optic or a pin hole camera.

The projection over a spherical surface is similar to the one on the retina. In fact, in the case of cavalier perspective, the projection plane would be placed between the centre of vision O and the object, but apart from the image inversion, the proportions remain the same.

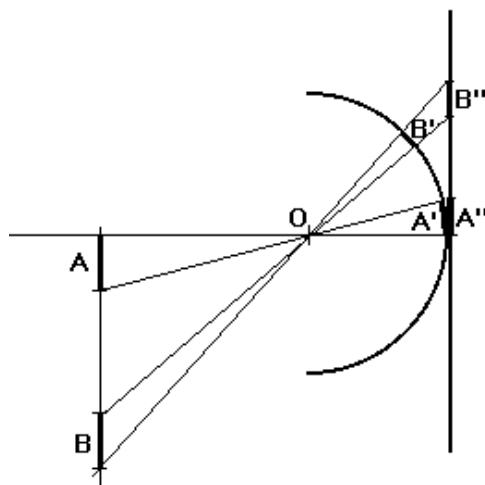

Fig. 1

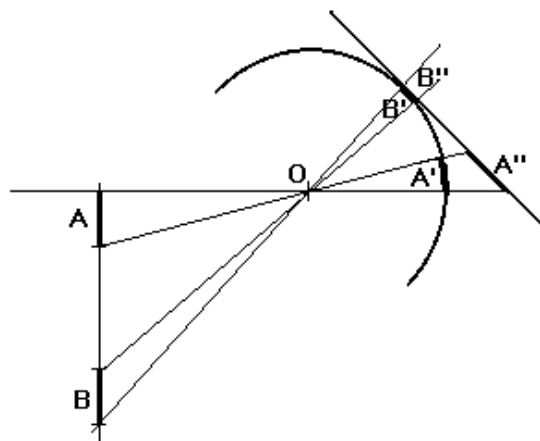

Fig. 2

According to elemental geometry, the plane projection, according to cavalier perspective, keeps the size proportion, so $A'' = B''$. But over the spherical plane, the more distant object B gives a smaller image B' than the nearest object A. The exact ratio between the images and the objects will be seen later.

What happens if the screen rotates around the optical centre O, as fig. 2 shows?

In the case of the plane projection the images change absolutely: now A'' is bigger than B''. In the spherical projection, images keep their size.

If our vision was made according to the cavalier perspective, objects would change size just by rotating our head. Fortunately, we do not have orthoscopic crystalline lenses, or a normal crystalline lens with a flat retina: we would always be seasick!

The size of an image according to the distance.

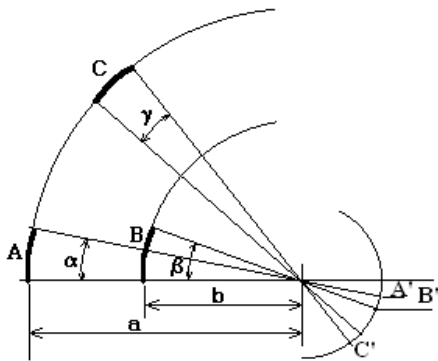

Fig. 3

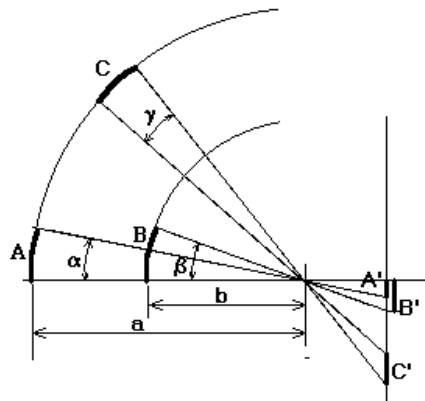

Fig. 4

Fig. 3 shows two objects A and B of the same size, placed at the distances a and b from the optical centre, in the case of a spherical projection. The images A', B' are proportional to the vision angles. As $A = B$ and the arcs are proportional to the radius it is deduced that $A'/B' = b/a$. This is the classical law of image size being at the inverse proportion of the distances.

An object C of the same size as A and at the same distance gives the same image $C' = A'$.

Fig. 4 shows the same objects but in the case of cavalier perspective. If the angles are small, $\tan \alpha \approx \sin \alpha \approx \alpha$ and the previous law is approximately kept. But if the object moves away from the perpendicular to the plane, keeping the same distance, the image increases ($C' > A'$). If our eye behaved according to classical perspective, objects would change size by rotating the head, as in the experiment with a camera equipped with an orthoscopic lens mentioned before.

Note: A simple not corrected camera lens with a diaphragm in the front behaves approximately like the human eye ("barrel" distortion, perhaps better called "natural" distortion). A pin hole camera behaves like one with an orthoscopic lens (fig. 1, projections A', B').

The long wall paradox.

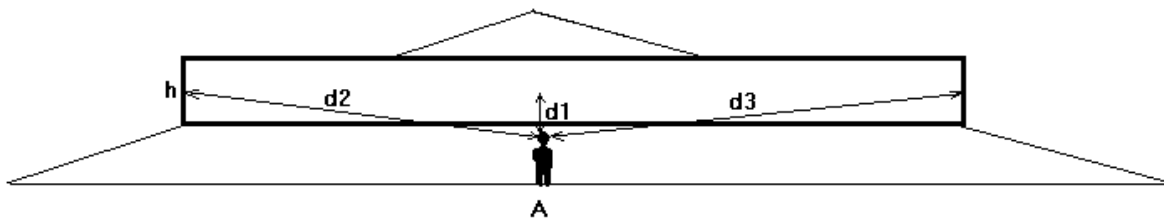

Fig. 5

Take the case of an observer in "A" facing a very long vertical wall (fig. 5). The distance to the ends d2, d3, are longer than the distance d1 from A to the wall. According to the law of the size being inversely proportional to the distance, the observer would see the height "h" of the wall much smaller than the height of the centre of the wall: $h'/h = d1/d2$.

According to classical perspective we would represent the wall as in fig. 6a and if the observer moves his head towards the left or the right, as in fig. 6b and 6c.



Fig. 6

Of course, we know from experience that objects do not change dimension by rotating our eyes or our head. So, what does cavalier perspective represent? Is it a fake, are all people who have been using it for centuries wrong? No. In fact it is a real representation of what we see if we look at an image from the same angle as the object was projected (fig. 7).

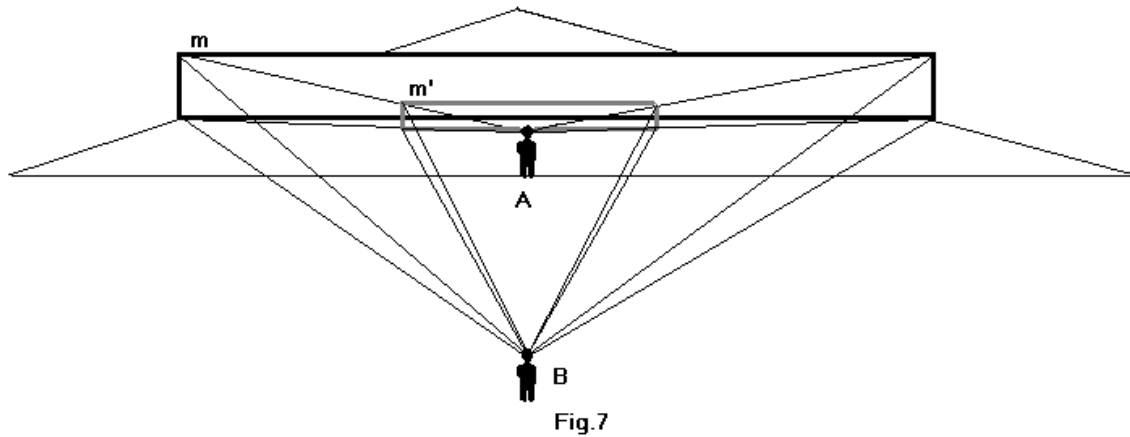

The observer in “A” sees the wall “m” of the previous example from the same angle as the drawing of the wall m’. So the ends of the wall will be seen smaller than the centre of the wall and with the same reduction. But the observer in “B” will see the ends of the drawn wall with much less height reduction, because his viewing angle to the drawing m’ is much smaller than his viewing angle to the real wall “m”.

The column paradox

Leonardo da Vinci was the first to remark a still worse paradox of the cavalier perspective, an example were the object which is farther from the observer should be represented bigger than the one near the observer.

In the figure 8, A and B are columns which are projected to the plane in A' and B'. B' which is the projection of the farthest column, is bigger than A'.

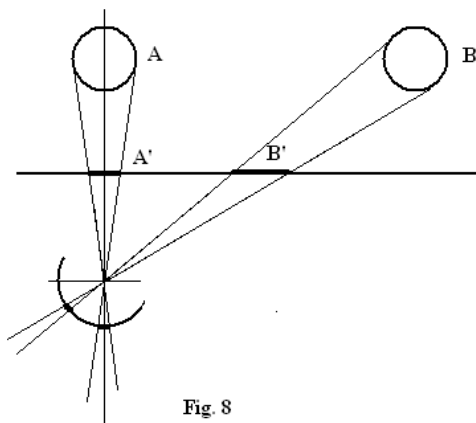

So cavalier perspective does not intend to represent what we see in a particular viewing position. Nor can it give us any hint of the distance from which the object was seen. It is a convenient but somewhat abstract representation of reality. It is what we see if the distance to the object tends to infinite (viewing angle tending to 0). So the representation it gives, not depending on the viewer distance, is most appropriate for architects, engineers, etc.

But what do we do if what is intended is to represent what we see at a normal distance and under a wide viewing angle? This is a real problem for painters and photographers.

Natural perspective.

So our aim is to find how to represent what we see over a plane following the mathematical rules of vision: size inversely proportional to the distance and invariance of size with viewing angle, inexorable rules that, as we have seen, classic perspective does not follow.

In cavalier perspective, the viewing angle of the drawing has to be the same as the viewing angle of reality if we want to see the same. In natural perspective, the viewing angle of the drawing tends to 0.

Of course, in many cases the viewing angle is small and the difference between cavalier perspective and real vision is also small. Our eyes cover about 170° of which about 60° (±30°) correspond to binocular vision. But only a small angle of about 1° is covered by the fovea where the vision is clear. The rest is blurred.

But our eyes move constantly and the image is reconstructed by the brain. It corrects and integrates the multiple images we see. That is the reason we do not see the blind spot of the retina.

To start with, we come back to the long wall of fig. 5 and we will try to draw it as we see it, or better said, following the mathematical rules of vision. We do not want the drawing to be very large, just the size to be seen under a reasonable angle (where practically there is no natural perspective distortion), as the width of this sheet. The ends must be seen smaller than the centre as they are further away. The centre zone has to be quite flat, without any disrupting point as in w' in fig. 9, as this would be contrary to our daily experience. So it can be deduced that the long wall should be represented approximately as w''.

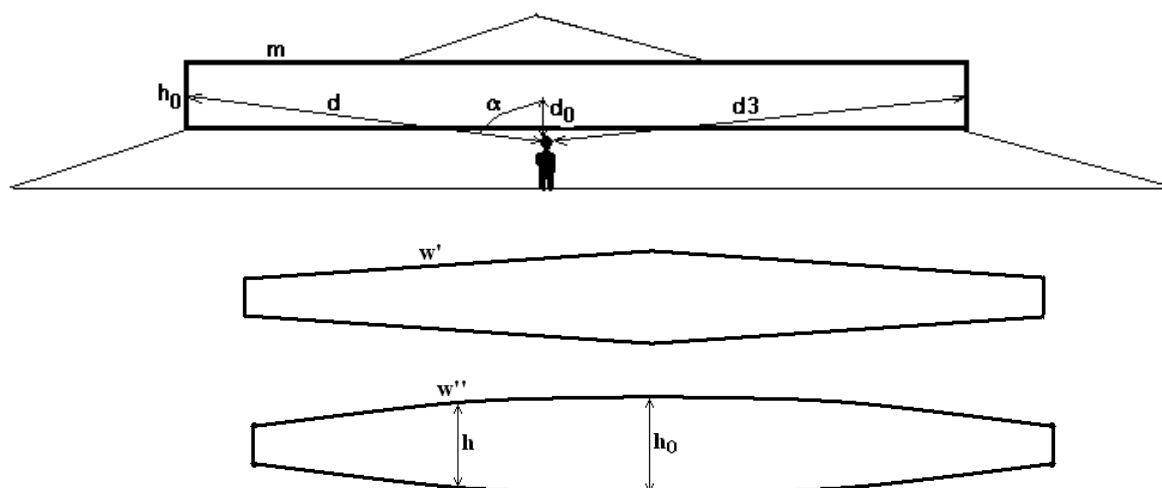

Fig. 9

If we try to calculate rigorously the law according to which these curves are elaborated, the solution is straightforward:

Just applying the law of size inversely proportional to distance:

$$\frac{h}{h_0} = \frac{d_0}{d} = \cos \alpha$$

So the function we look for is:

$$h = h_0 \cdot \cos \alpha \quad (1)$$

It is interesting to look at the result of (1) for several angles:

α	h/h_0
10°	0,985
20°	0,94

30°	0,866
45°	0,707

Unlike cavalier perspective this representation carries the information of the angle of vision, and if we know the size of the object, we can deduce the viewing distance. Fig. 10 shows the representation of the previous wall under 120° (±60°) and 60° (±30°) vision angles. Note that even for a quite wide angle as (±30°) the curvature is still small.

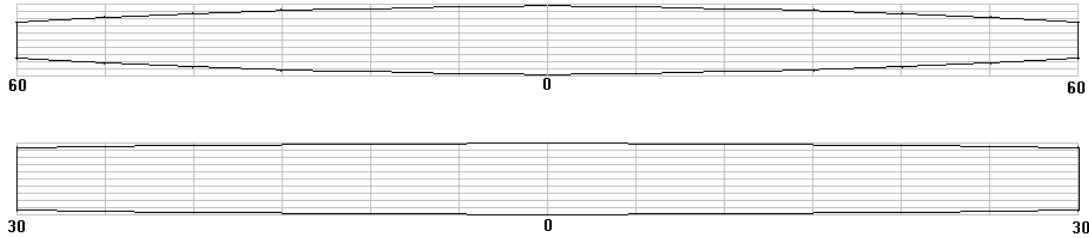

Fig. 10

Of course, the law is the same for the vertical or any other direction.

Fig 11 shows the case of a reference plane inclined with respect to the observer. It is clear that just by prolonging the plane and drawing the perpendicular to it from the observer, we may apply the rules deduced from fig. 9, where the characters “h” refer to the vertical heights (not drawn):

$$h_1 = h_0 \cdot \cos\theta_1, \quad h_2 = h_0 \cdot \cos\theta_2$$

$$\frac{h_2}{h_1} = \frac{\cos\theta_2}{\cos\theta_1} \quad (2) \text{ when } \theta_1=0 \text{ it is reduced to equation (1).}$$

We shall skip the demonstration that the reduction coefficient given the plane angle β and the vision angle α is:

$$\frac{h_2}{h_1} = \cos\alpha - \frac{\sin\alpha}{\tan\beta}$$

which if $\beta = 90^\circ$ becomes (1).

The result is quite similar to the cavalier perspective, except that edges are slightly curved (see comparison in fig. 12).

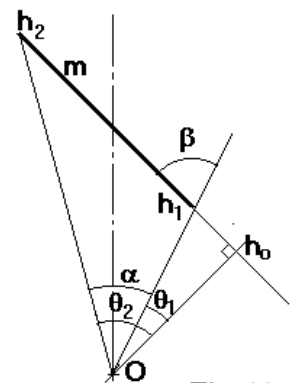

Fig. 11

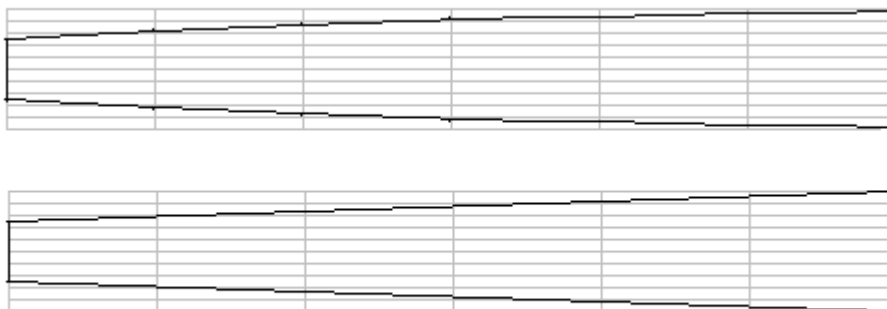

Fig. 12

Experimenting with natural perspective.

Place yourself in front of a long wall, a long shelf, window, corridor, etc., or a vertical building. Use a pencil or a rule in vertical position, with your arm fully extended and measure vertical distances (horizontal ones if you look at a vertical object), in the way painters use to do. You can check the rules of natural perspective comparing dimensions in the centre, ends and intermediate points (Fig. 13).

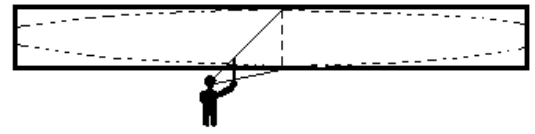

Fig. 13

Curvature of an isolated straight line

Applying equation (1) to a straight line, it results that the ratio h/h_0 is constant and independent of the distance to the centre of vision. But the absolute value $h_0 - h$, or the curvature, increases with the distance from the centre (fig 14)

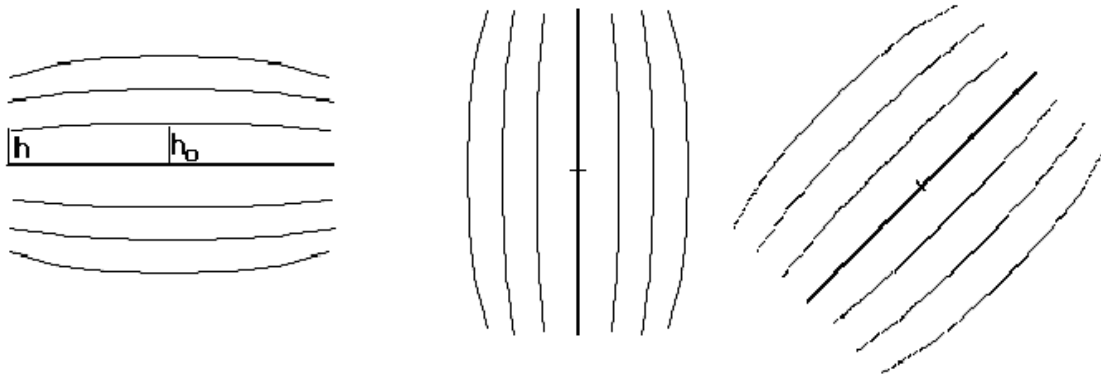

Fig. 14

Relativity (or invariance) and natural perspective.

The simple mathematical rules of natural perspective were found in an attempt to explain why dimensions do not change when the angle of vision changes. The theory of relativity first called by Einstein the “invariance” theory, was elaborated to explain why dimensions of objects do not change in spite of their relative velocity from the observer. For the low speeds of everyday life, the equations tend to the classical Newtonian ones. For normal viewing angles, the natural perspective equations give results similar to the classical perspective.

If the observer in fig. 13 takes a straight ruler and puts it horizontally to check the curvature of the lines, the edge of the ruler will also be seen curved (because viewed under the same angle) and it will match the line ... something like mental experiments in the curved space.

This is shown here as a curiosity, not to be taken too seriously, of course.

Perspective and illumination

In classical perspective, objects parallel to the projection plane do not change dimension, regardless of their distance. Using classical perspective, the square A the reticule of fig. 15 has the same dimensions as the square B which is far away (fig. 15, right side).

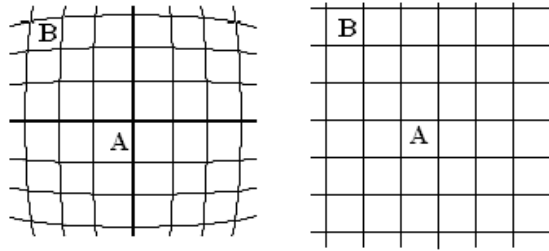

Fig. 15

But less light reaches the eye or the camera from the distant square B than from square A. The intensity of light received from A is related to the one from B by

$$\frac{E_A}{E_B} = \frac{d_A^2}{d_B^2} \cos \alpha$$

so a projection over a plane in classical perspective gives a centre of the screen brighter than the borders, and this effect is easily observed using a pin hole camera.

In natural perspective, the surface of B is already corrected by the factor

$$\frac{S'_A}{S'_B} = \frac{d_A^2}{d_B^2} \cos \alpha \quad (\text{where } S' \text{ means the represented areas})$$

and as surface decreases in the same proportion as illumination, the surface brightness is the same and it is kept in all the plane.

Natural perspective in arts

The edges of the Parthenon are not straight lines, but have subtle curves (see fig. 16). Columns are thinner at the top. It has been said that this was done to correct supposed visual aberrations. But we can give a more plausible explanation. Greek architects knew intuitively the rules of natural perspective and the horizontal curves make the Parthenon look wider than it is, curved columns look taller than they are.

Many painters had followed intuitively the rules of natural perspective and painted buildings, streets and so on with the edges slightly curved in the right sense. Paintings following strictly the classical perspective, as those of Canaletto, give an impression of artificiality. An interesting example is the painting of fig. 17, where Canaletto has drawn the perspective lines with a ruler, according to cavalier perspective and probably against his intuition. But the old columns, according to Greek practice and natural perspective intuition, have the top thinner than the bottom: a striking example of 1000 years of obscurantism and loss of most of Greek knowledge.

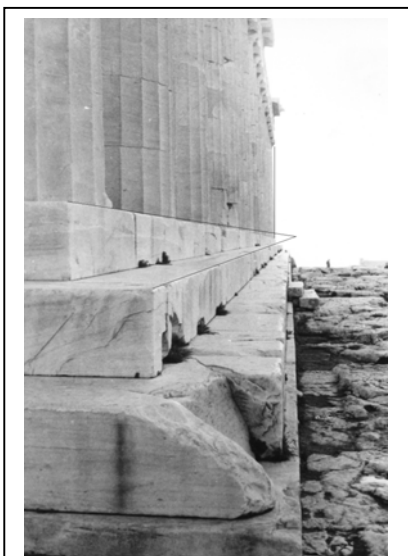

Fig. 16. The Parthenon.
Photography by the author.

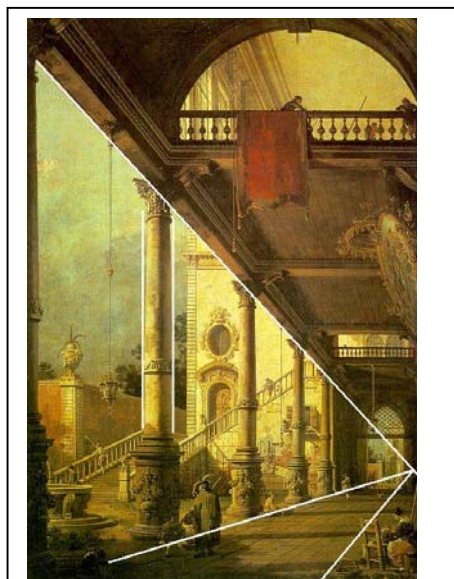

Fig. 17. Canaletto

Painters who have followed their instincts more than learned rules, curved lines in the “correct” direction. The same painters may have used straight lines when the viewing angle was small, all according to natural perspective. It is not easy to find examples: objects with straight lines and viewed form a very wide angle are rare in paintings. Furthermore artists learned cavalier perspective at school and tried to represent reality accordingly. But impressionists tried to follow their instincts. They avoided straight lines and curvature is normally in the “correct” sense, as fig. 18 shows.



Fig. 18. Pissarro, Bvd. Montmartre

Summary:

Cavalier perspective gives a representation that is viewed as the real object only if it is viewed from the same angle as it was drawn.

Natural perspective gives an image that it is viewed as the real object if the angle is small enough as distortion being not appreciable.